



**GAS COMPONENTS**



**ELECTRIC COMPONENTS**



**WATER TECHNOLOGY**



**MECHANICAL COMPONENTS**



**TOOLS**

Spare parts suitable for

**LA-SCALA**

Find the complete and up-to-date range of products in our GEV Webshop



# Manufacturer catalogue

The most important spare parts and accessories arranged clearly for every manufacturer

- ✓ Complete product range and all appliance data always up to date in the GEV Webshop
- ✓ Alphabetical Index at the end of the catalogue

## GEV Webshop

[www.gev-online.co.uk](http://www.gev-online.co.uk)

[www.gev-online.com](http://www.gev-online.com)





- 🔍 Add to Favourites
- 🔍 Sign In with email address and usual password
- 🔍 Easy-order – place several items in your basket at the same time
- 🔍 Quick Item search – no login needed





## heating elements

### heating elements for coffee machine

			
1			
<b>GEV No.</b>	417241	<b>Ref. No.</b>	C-0353
<b>description</b>	heating element 2200W 230V heating circuits 3 mounting ø 40mm hole distance 58mm L 140mm W 32mm H 60mm L1 45mm L2 60mm L3 40mm H1 34mm H2 26mm hole ø 10mm tube ø 8mm thermostat sleeves ø 4.5mm length thermostat sleeves 126mm thermostat sleeve eccentric, non clinging number of thermostat sleeves 1 connection M3 immersion heater 3 hole flange		

			
1			
<b>GEV No.</b>	417360	<b>Ref. No.</b>	C-0527
<b>description</b>	heating element 2500W 230V heating circuits 3 mounting ø 40mm hole distance 58mm L 180mm W 32mm H 60mm L1 45mm L2 60mm L3 75mm H1 34mm H2 26mm hole ø 10mm tube ø 8mm thermostat sleeves ø 4.5mm length thermostat sleeves 130mm thermostat sleeve eccentric, non clinging number of thermostat sleeves 1 connection M3 immersion heater 3 hole flange		

			
1			
<b>GEV No.</b>	417242	<b>Ref. No.</b>	C-0356
<b>description</b>	heating element 3500W 230V heating circuits 3 mounting ø 39mm hole distance 58mm L 340mm W 35mm H 58mm L1 46mm L2 64mm L3 230mm H1 33mm H2 25mm windings 3 hole ø 10mm tube ø 8mm thermostat sleeves ø 5mm length thermostat sleeves 144mm thermostat sleeve eccentric, non clinging number of thermostat sleeves 1 connection M3 immersion heater 3 hole flange		

			
1			
<b>GEV No.</b>	417243	<b>Ref. No.</b>	C-0358
<b>description</b>	heating element 4500W 230V heating circuits 3 mounting ø 39mm hole distance 58mm L 550mm W 34mm H 60mm L1 50mm L2 50mm L3 450mm H1 35mm H2 25mm windings 3 hole ø 10mm tube ø 8mm thermostat sleeves ø 5mm length thermostat sleeves 142mm thermostat sleeve eccentric, non clinging number of thermostat sleeves 1 connection M3 immersion heater 2 hole flange		

## accessories

### flange gaskets

			
1			
<b>GEV No.</b>	528740	<b>Ref. No.</b>	C-0361
<b>description</b>	gasket ID ø 44mm PTFE thickness 3.5mm hole ø 9.5mm hole distance 58mm suitable for ITALCREM, VISACREM for heating element coffee machine parts		

## thermostats

### control and safety thermostats

EGO			
safety thermostats			
55.32_ series			
			
1			
<b>GEV No.</b>	375502	<b>Ref. No.</b>	C-0457
<b>description</b>	safety thermostat switch-off temp. 177°C 3-pole 20A probe ø 4mm probe L 130mm capillary pipe 1500mm capillary pipe isolated 420mm gland nut starting temperature 159°C probe		

## switches and momentary switches

### rocker/momentary rocker switches

30x22mm			
			
1			
<b>GEV No.</b>	347813	<b>Ref. No.</b>	C-0474
<b>description</b>	rocker switch mounting measurements 30x22mm orange 2CO 250V 16A illuminated connection male faston 6.3mm ambient temperature max. 125/55°C protection IP40		

			
1			
<b>GEV No.</b>	301188	<b>Ref. No.</b>	C-0479
<b>description</b>	rocker switch mounting measurements 30x22mm black 2NO/2NO 250V 16A I O II connection male faston 6.3mm ambient temperature max. 125/55°C protection IP40		
<b>accessories for</b>	301188		
	<b>GEV No.</b>	301036	<b>Ref. No.</b>
			—
<b>description</b>	protective cover internal size 30x22mm for rocker switch mounting measurementsmm		

			
1			
<b>GEV No.</b>	346110	<b>Ref. No.</b>	C-0418
<b>description</b>	rocker switch mounting measurements 30x22mm red 2NO 250V 16A illuminated coffee connection male faston 6.3mm ambient temperature max. 125/55°C protection IP40		



## accessories

## blank elements



1

<b>GEV No.</b>	347281	<b>Ref. No.</b>	C-0470
----------------	--------	-----------------	--------

<b>description</b>	blank external size 30x30mm black		
--------------------	-----------------------------------	--	--

## microswitches

## pin-plunger actuated

M12



1

<b>GEV No.</b>	345350	<b>Ref. No.</b>	C-0465
----------------	--------	-----------------	--------

<b>description</b>	microswitch with plunger mounting distance 22mm thread M12x0.75 thread L 16mm 250V 16A 1CO connection male faston 6.3mm stroke 4mm ambient temperature max. 125°C type EF83161.3 actuating force: 66g		
--------------------	---	--	--

<b>accessories for</b>	345350		
------------------------	--------	--	--



<b>GEV No.</b>	345351	<b>Ref. No.</b>	—
<b>description</b>	nut thread M12x0.75 H 1.6mm WS 14 chrome-plated brass Qty 1 pcs		

## system switches (ROLD)



1

<b>GEV No.</b>	345536	<b>Ref. No.</b>	C-0486
----------------	--------	-----------------	--------

<b>description</b>	element holder mounting ø 16mm flat black		
--------------------	---	--	--



1

<b>GEV No.</b>	345538	<b>Ref. No.</b>	C-0481
----------------	--------	-----------------	--------

<b>description</b>	push button ø 11.9mm black		
--------------------	----------------------------	--	--



1

<b>GEV No.</b>	345720	<b>Ref. No.</b>	C-0485
----------------	--------	-----------------	--------

<b>description</b>	switch 2NO 250V 16A connection male faston 6.3mm		
--------------------	--	--	--

## key lock switches



1

<b>GEV No.</b>	400297	<b>Ref. No.</b>	C-0135
----------------	--------	-----------------	--------

<b>description</b>	key lock switch 1 group thread M12x1 1NO mounting ø 12mm cable length 300mm		
--------------------	---	--	--

## rotary switches

## BREMAS

## A3200 series



1

<b>GEV No.</b>	345114	<b>Ref. No.</b>	C-0121
----------------	--------	-----------------	--------

<b>description</b>	rotary switch 3 1-0-2 sets of contacts 5 type CS0325832 600V 32A shaft ø 5x5mm shaft L 23mm shaft square connection screw		
--------------------	---	--	--

## A4000 series



1

<b>GEV No.</b>	347712	<b>Ref. No.</b>	— C-0154
----------------	--------	-----------------	-------------

<b>description</b>	rotary switch 3 1-0-2 sets of contacts 5 690V 40A shaft ø 5x5mm shaft L 21mm shaft square with knob connection screw		
--------------------	--	--	--

## accessories



1

<b>GEV No.</b>	527259	<b>Ref. No.</b>	C-0130
----------------	--------	-----------------	--------

<b>description</b>	knob push-in ø 34/60mm shaft ø 5x5mm black H 21.4mm L 49mm		
--------------------	--	--	--

## lamps

## indicator lights

## indicator lights 2-piece (lens and indicator lamp)

## indicator light lenses

ø10mm (type SRZ-3)



1

<b>GEV No.</b>	359123	<b>Ref. No.</b>	C-0254
----------------	--------	-----------------	--------

<b>description</b>	indicator light housings mounting measurements ø10mm green round Qty 1 pcs		
--------------------	--	--	--

<b>accessories for</b>	359123		
------------------------	--------	--	--

<b>GEV No.</b>	359132	<b>Ref. No.</b>	C-0262
----------------	--------	-----------------	--------

<b>description</b>	indicator lamp green 250V connection male faston 6.3mm protection IP54 ambient temperature max. 85°C		
--------------------	--	--	--



			
1			
<b>GEV No.</b>	359125	<b>Ref. No.</b>	C-0253
<b>description</b>	indicator light housings mounting measurements ø10mm red round Qty 1 pcs		

indicator lamps for socket type SRZ / SDK / SDY / SFK			
			
1			
<b>GEV No.</b>	359130	<b>Ref. No.</b>	C-0263
<b>description</b>	indicator lamp 230V clear connection male faston 6.3mm ø 8mm		

			
1			
<b>GEV No.</b>	359132	<b>Ref. No.</b>	C-0262
<b>description</b>	indicator lamp green 250V connection male faston 6.3mm protection IP54 ambient temperature max. 85°C		

## relays

### level relays

GICAR			
			
1			
<b>GEV No.</b>	402103	<b>Ref. No.</b>	C-0069
<b>description</b>	level controller 230/240V voltage AC 50/60Hz connection F6.3 type NRL30/1E-2C/F		

## electronics

### PCBs

			
1			
<b>GEV No.</b>	402422	<b>Ref. No.</b>	C-0133
<b>description</b>	display L 117mm W 42mm		

## central units

			
1			
<b>GEV No.</b>	402501	<b>Ref. No.</b>	C-0147
<b>description</b>	central unit 240V 50/60Hz type DOS RL2 3GR+3THE+RL/ON-OFF/C voltage AC		

			
1			
<b>GEV No.</b>	402500	<b>Ref. No.</b>	C-0148
<b>description</b>	central unit 240V 50/60Hz type DOS RL2 3GR+RL+THE/C voltage AC		

## dosing electronics

GICAR			
			
1			
<b>GEV No.</b>	401066	<b>Ref. No.</b>	C-0015/24N
<b>description</b>	level relay 230V voltage AC 50/60Hz connection F6.3 type Dosatura Manuale DELUXE F		



# keypads

## front foils

1 

<b>GEV No.</b>	526422	<b>Ref. No.</b>	C-0141
<b>description</b>	keypad foil black/silver L 75mm W 70mm buttons 2		

1 

<b>GEV No.</b>	526423	<b>Ref. No.</b>	C-0140
<b>description</b>	keypad foil black/silver L 75mm W 70mm buttons 8		

## keypad units

1 

<b>GEV No.</b>	402722	<b>Ref. No.</b>	C-0603
<b>description</b>	keypad unit coffee machine BUTTERFLY/MARINA buttons 5 black/white/silver type 1d5e GRCZ NKP S10 „Tank Probe“ 230V		

1 

<b>GEV No.</b>	402502	<b>Ref. No.</b>	C-0462
<b>description</b>	keypad unit coffee machine CARMEN buttons 2 black/silver L 88mm W 83mm		

1 

<b>GEV No.</b>	402503	<b>Ref. No.</b>	C-0461
<b>description</b>	keypad unit coffee machine CARMEN buttons 8 black/silver L 88mm W 83mm		



<b>GEV No.</b>	531188	<b>Ref. No.</b>	C-0586 C-0602
<b>description</b>	keypad unit coffee machine parts buttons 5 black type 9.9.07.03G L 116mm W 44mm		

# solenoid valves

## solenoid valves (water)



- metal
- ODE
- solenoid valves steam (water)
- 21A series

1 

<b>GEV No.</b>	370703	<b>Ref. No.</b>	C-0207
<b>description</b>	solenoid valve brass 2-ways 230VAC inlet 1/4" IT outlet 1/4" IT connection 1/4" L 40mm DN 2.5mm t.max. 140°C -10 up to 140°C ODE type series 21A coil type BDA membranes FKM (water/steam) p max 14bar p min 0bar 50/60Hz		

## 21A1 series

1 

<b>GEV No.</b>	370093	<b>Ref. No.</b>	C-0403	
<b>description</b>	solenoid valve 2/2-ways 230VAC body 25-F39 DN 2.5mm slide-on receptacle DIN -10 up to 140°C ODE type series 21A1 coil type BDA membranes FKM p max 14bar 50/60Hz silicone flange 32x32mm			
<b>spare parts for</b>	370093			
	<b>GEV No.</b>	371150	<b>Ref. No.</b>	—
<b>accessories for</b>	370093			
	<b>GEV No.</b>	371090	<b>Ref. No.</b>	—
	power socket plug type DIN 43650A screw			



21J series



1

<b>GEV No.</b>	370232	<b>Ref. No.</b>	C-0302
<b>description</b>	solenoid valve brass 2-ways 230VAC connection 1/8" L 30mm DN 2.3mm -10 up to 140°C membranes FKM p max 18bar		

pressure switches

for coffee machines

ø 38mm



1

<b>GEV No.</b>	541158	<b>Ref. No.</b>	C-0522
<b>description</b>	pressure control ø 38mm pressure range 1-2.5bar pressure connection vertical 16A 250V coffee machine parts connection 1/4" pressure connection 1/4"		

electrodes



1

<b>GEV No.</b>	400790	<b>Ref. No.</b>	C-0351
<b>description</b>	level electrode 1/4" total length 125mm probe L 98mm insulated probe length 26mm connection male faston 6.3mm stainless steel ø 3mm rubber		

flow meters and flow sensors

flow meters

GICAR



1

<b>GEV No.</b>	530368	<b>Ref. No.</b>	C-0215B
<b>description</b>	flow meter thread 1/4" IT nickel-plated brass approval NSF		

pumps

booster pumps II

pump heads

FLUID-O-TECH



1

<b>GEV No.</b>	500064	<b>Ref. No.</b>	C-0521
<b>description</b>	pump head PO204 FLUID-O-TECH L 82mm 200l/h connection 3/8" GAS with bypass brass clip connection for coffee machine shaft ø 4.8x11mm		
<b>accessories for</b>	500064		
	<b>GEV No.</b>	520126	<b>Ref. No.</b> —
	clamp for pump/motor		

electric accessories

cables

ribbon cables

group 3



1

<b>GEV No.</b>	402429	<b>Ref. No.</b>	C-0134
<b>description</b>	ribbon cable 4-pole L 1000mm plug type 1-row plug: number of poles 4/6 Qty 1m		

equipment-specific units

for espresso machines

filter holders

filter holders standard

filter holders (complete)



1

<b>GEV No.</b>	526453	<b>Ref. No.</b>	C-0532N
<b>description</b>	filter holder double complete ID ø 61.7mm outlet distance 47.6mm mounting ø 82.6		

## filter holders short



1

<b>GEV No.</b>	529058	<b>Ref. No.</b>	N/A
<b>description</b>	filter holder mounting $\varnothing$ 83mm outlet 3/8" ID $\varnothing$ 61.5mm handle M12x1.75 wedge height 10mm wedge position horizontal number of wedges 2 lever inclined chrome-plated, polished		

## filters

## for 1 cup



1

<b>GEV No.</b>	526479	<b>Ref. No.</b>	C-0499
<b>description</b>	coffee filter $\varnothing$ 69.5mm mounting $\varnothing$ 60mm H 24mm cups 1 amount of coffee 7g perforation $\varnothing$ 0.3mm		



1

<b>GEV No.</b>	526261	<b>Ref. No.</b>	C-0498
<b>description</b>	coffee filter $\varnothing$ 70mm mounting $\varnothing$ 60.5mm H 20.5mm cups 1 amount of coffee 6.5g		

## for 2 cups



1

<b>GEV No.</b>	529014	<b>Ref. No.</b>	C-0500
<b>description</b>	coffee filter $\varnothing$ 70mm mounting $\varnothing$ 60mm H 21mm cups 2 amount of coffee 12g perforation $\varnothing$ 0.3mm round		



1

<b>GEV No.</b>	529197	<b>Ref. No.</b>	C-0501
<b>description</b>	coffee filter $\varnothing$ 70mm mounting $\varnothing$ 60mm H 24.5mm cups 2 amount of coffee 14g		

## blind filters



1

<b>GEV No.</b>	529023	<b>Ref. No.</b>	C-0495
<b>description</b>	blind filter $\varnothing$ 70mm mounting $\varnothing$ 60mm H 18mm		

## brewing units

## shower screens

## with upstand



1

<b>GEV No.</b>	529080	<b>Ref. No.</b>	C-0322
<b>description</b>	shower screen $\varnothing$ 58mm H 20mm		

## filter holder gaskets

## flat

## standard



1

<b>GEV No.</b>	526445	<b>Ref. No.</b>	C-0321
<b>description</b>	filter holder gasket D1 $\varnothing$ 73mm D2 $\varnothing$ 57mm H 8mm Qty 1 pcs		

## components

## drain units

## drain valves



1

<b>GEV No.</b>	526438	<b>Ref. No.</b>	C-0308
<b>description</b>	drain fitting $\varnothing$ 24.5mm L 54mm brass D1 $\varnothing$ 7.5mm D2 $\varnothing$ 20mm		



nozzles			
with thread			
			
1			
<b>GEV No.</b>	526441	<b>Ref. No.</b>	C-0314
<b>description</b>	nozzle bore $\varnothing$ 0.5mm thread M6x0.75 L 9mm		

springs			
			
1			
<b>GEV No.</b>	526442	<b>Ref. No.</b>	C-0311
<b>description</b>	compression spring $\varnothing$ 10.8mm L 57.2mm wire gauge $\varnothing$ 1mm		



gaskets			
			
1			
<b>GEV No.</b>	526429	<b>Ref. No.</b>	C-0301
<b>description</b>	gasket L 76mm fibre H 2mm W 70mm		

water dispersions			
water dispersions			
group 2			
			
1			
<b>GEV No.</b>	529081	<b>Ref. No.</b>	C-0318
<b>description</b>	water distributor $\varnothing$ 30mm hole $\varnothing$ 1.5mm H 15mm ET M10x1 grooves 6 2.5mm brass		

expansion valves			
with hose connection			
			
1			
<b>GEV No.</b>	526452	<b>Ref. No.</b>	C-0379
<b>description</b>	expansion valve T1: 1/4" ET hose $\varnothing$ 9.5mm BL 42mm		

drain pans			
drain pans			
			
1			
<b>GEV No.</b>	526440	<b>Ref. No.</b>	C-0011
<b>description</b>	drain pan L 102mm W 70mm H 48mm hose $\varnothing$ 8mm		

boilers			
heat exchangers			
injector tubes			
			
1			
<b>GEV No.</b>	527952	<b>Ref. No.</b>	R4
<b>description</b>	injector pipe tube $\varnothing$ 8mm pipe length 140mm T1: 1/4" T2: 1/4"		

steam/water taps			
steam/water taps			
steam/water taps			
			
1			
<b>GEV No.</b>	526074	<b>Ref. No.</b>	C-0271
<b>description</b>	steam/water tap inlet 1/4" outlet 3/8" brass		
<b>accessories for</b>	526074		
	<b>GEV No.</b>	111318	<b>Ref. No.</b> C-0280
	<b>GEV No.</b>	361184	<b>Ref. No.</b> —
			nut thread 1/2" H 6mm nickel-plated brass WS 24 Qty 1 pcs

## components

## gaskets



1

<b>GEV No.</b>	527961	<b>Ref. No.</b>	C-0430
<b>description</b>	flat gasket copper ED $\varnothing$ 21mm ID $\varnothing$ 17.2mm thickness 1.5mm		

## springs



1

<b>GEV No.</b>	526443	<b>Ref. No.</b>	C-0273
<b>description</b>	compression spring $\varnothing$ 12mm L 15.5mm wire gauge $\varnothing$ 1.5mm		

## washers



1

<b>GEV No.</b>	526436	<b>Ref. No.</b>	C-0270
<b>description</b>	plain washer D1 $\varnothing$ 14mm D2 $\varnothing$ 7.1mm thickness 0.5mm brass		

## steam/water pipes

## steam pipes



1

<b>GEV No.</b>	526432	<b>Ref. No.</b>	C-0278
<b>description</b>	steam pipe thread 1/2" H 160mm $\varnothing$ 14.5mm tube $\varnothing$ 10mm		

## nozzles for water pipes

## tap aerators



1

<b>GEV No.</b>	526424	<b>Ref. No.</b>	C-0467
<b>description</b>	tap aerator D1 $\varnothing$ 23.5mm H 30mm thread M10x1		

## water pipes



1

<b>GEV No.</b>	526426	<b>Ref. No.</b>	C-0026
<b>description</b>	water pipe thread 1/2" $\varnothing$ 23.5mm L 45mm WS 7.5		



1

<b>GEV No.</b>	526425	<b>Ref. No.</b>	C-0459
<b>description</b>	water pipe thread 1/4" $\varnothing$ 23.5mm L 78mm tube $\varnothing$ 10mm		

## accessories

## bushes



1

<b>GEV No.</b>	526437	<b>Ref. No.</b>	C-0274
<b>description</b>	bush D1 $\varnothing$ 14.3mm D2 $\varnothing$ 11.5mm H 6mm PTFE steam ID $\varnothing$ 7.1mm		

## fine filters

## fine filters



1

<b>GEV No.</b>	529979	<b>Ref. No.</b>	C-0315
<b>description</b>	fine filter $\varnothing$ 8.8mm H 22mm		

## intake valves

## intake valves



1

<b>GEV No.</b>	526451	<b>Ref. No.</b>	C-0414N
<b>description</b>	intake valve brass		

## accessories

## bushes



1

<b>GEV No.</b>	526501	<b>Ref. No.</b>	C-0432
<b>description</b>	bush for lever D1 $\varnothing$ 12mm D2 $\varnothing$ 14.6mm int. $\varnothing$ 1.7mm H 6.7mm brass		

## gaskets



1

<b>GEV No.</b>	526439	<b>Ref. No.</b>	C-0424
<b>description</b>	gasket ED $\varnothing$ 13mm ID $\varnothing$ 4mm H 4mm for filling valve		



springs			
			
1			
<b>GEV No.</b>	526444	<b>Ref. No.</b>	C-0421
<b>description</b>	compression spring ø 12.5mm L 30.5mm wire gauge ø 1.7mm		

level glasses			
level glasses			
pressure rings			
			
1			
<b>GEV No.</b>	526434	<b>Ref. No.</b>	C-0258
<b>description</b>	press ring D1 ø 14.7mm D2 ø 11.6mm thickness 3.7mm conical		

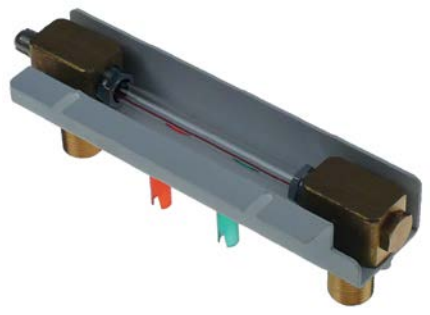
level glasses (complete)			
			
1			
<b>GEV No.</b>	526428	<b>Ref. No.</b>	C-0261
<b>description</b>	level glass with socket element		

level glass pipes			
			
1			
<b>GEV No.</b>	526427	<b>Ref. No.</b>	C-0260
<b>description</b>	water level tube ø 11mm H 155mm ID ø 8mm marking red		

## knobs

steam/water taps			
			
1			
<b>GEV No.</b>	111318	<b>Ref. No.</b>	C-0280
<b>description</b>	knob ø 50mm thread Tr18x2 black		

knob dial plates			
			
1			
<b>GEV No.</b>	111320	<b>Ref. No.</b>	C-0283
<b>description</b>	knob dial plate steam ø 28mm black		

			
1			
<b>GEV No.</b>	111319	<b>Ref. No.</b>	C-0295
<b>description</b>	knob dial plate water ø 28mm black		

accessories			
			
1			
<b>GEV No.</b>	111273	<b>Ref. No.</b>	C-0282
<b>description</b>	cotter pin ø 1.3mm L 25mm		

## miscellaneous

			
1			
<b>GEV No.</b>	527259	<b>Ref. No.</b>	C-0130
<b>description</b>	knob push-in ø 34/60mm shaft ø 5x5mm black H 21.4mm L 49mm		

## gaskets

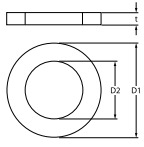
O-rings			
EPDM			
 			
1			
<b>GEV No.</b>	504574	<b>Ref. No.</b>	C-0427
<b>description</b>	O-ring EPDM thickness 1.78mm ID ø 9.25mm Qty 1 pcs		

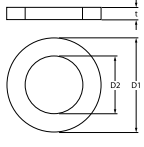
Viton			
 			
1			
<b>GEV No.</b>	528833	<b>Ref. No.</b>	C-0289
<b>description</b>	O-ring Viton thickness 1.78mm ID ø 11.11mm Qty 1 pcs		

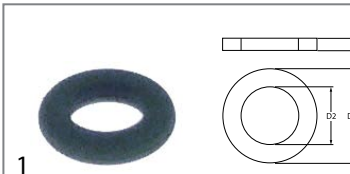

1

<b>GEV No.</b>	532571	<b>Ref. No.</b>	C-0425
<b>description</b>	O-ring Viton thickness 1.78mm ID ø 3.85mm Qty 1 pcs		

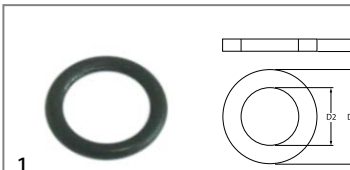

1

<b>GEV No.</b>	528291	<b>Ref. No.</b>	C-0257
<b>description</b>	O-ring Viton thickness 2.62mm ID ø 11.91mm Qty 1 pcs		



1

<b>GEV No.</b>	532504	<b>Ref. No.</b>	C-0309
<b>description</b>	O-ring Viton thickness 2.62mm ID ø 20.24mm Qty 1 pcs		

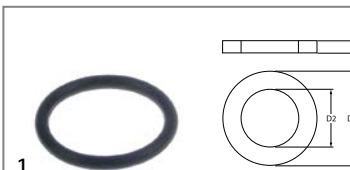

1

<b>GEV No.</b>	532560	<b>Ref. No.</b>	C-0324
<b>description</b>	O-ring Viton thickness 2.62mm ID ø 20.63mm Qty 1 pcs		

sealing washers

fibre gaskets



1

<b>GEV No.</b>	528210	<b>Ref. No.</b>	C-0272
<b>description</b>	flat gasket FIBER ED ø 21mm ID ø 16.5mm thickness 2mm Qty 1 pcs		

copper gaskets

DIN-7603-A



1

<b>GEV No.</b>	527961	<b>Ref. No.</b>	C-0430
<b>description</b>	flat gasket copper ED ø 21mm ID ø 17.2mm thickness 1.5mm		



1

<b>GEV No.</b>	527994	<b>Ref. No.</b>	C-0419
<b>description</b>	flat gasket copper ED ø 25mm ID ø 19.3mm thickness 1.5mm		

DIN-7603-C



1

<b>GEV No.</b>	526433	<b>Ref. No.</b>	C-0256
<b>description</b>	gasket copper ED ø 18mm ID ø 14mm thickness 2mm		



1

<b>GEV No.</b>	526431	<b>Ref. No.</b>	C-0376
<b>description</b>	gasket copper ED ø 26mm ID ø 21.5mm thickness 2.2mm for thread 1/2" Qty 1 pcs		

PTFE gaskets



1

<b>GEV No.</b>	526679	<b>Ref. No.</b>	C-0426
<b>description</b>	flat gasket PTFE ED ø 18mm ID ø 13mm thickness 2mm Qty 1 pcs		



1

<b>GEV No.</b>	526014	<b>Ref. No.</b>	C-0310
<b>description</b>	flat gasket PTFE ED ø 35mm ID ø 30mm thickness 2mm Qty 1 pcs		



1

<b>GEV No.</b>	526435	<b>Ref. No.</b>	C-0316
<b>description</b>	gasket PTFE ED ø 22mm ID ø 17mm thickness 2mm Qty 1 pcs		

springs

compression springs



1

<b>GEV No.</b>	526444	<b>Ref. No.</b>	C-0421
<b>description</b>	compression spring ø 12.5mm L 30.5mm wire gauge ø 1.7mm		



1

<b>GEV No.</b>	526443	<b>Ref. No.</b>	C-0273
<b>description</b>	compression spring ø 12mm L 15.5mm wire gauge ø 1.5mm		



1

<b>GEV No.</b>	527992	<b>Ref. No.</b>	C-0429
<b>description</b>	compression spring ø 8mm L 32mm wire gauge ø 0.5mm		

## manometers



1

<b>GEV No.</b>	541721	<b>Ref. No.</b>	C-0150
<b>description</b>	manometer double scale ø 63mm pressure range 0-2.5 / 0-16bar connection on the backside thread 1/8"		

## valves and tank inlets

### ball valves

#### universal

#### mini ball valves



1

<b>GEV No.</b>	520722	<b>Ref. No.</b>	C-0401
<b>description</b>	ball valve connection 1/4" IT - 1/4" ET DN8 total length 39mm chrome-plated brass		

## fastening material

### screws

#### hexagonal screws



1

<b>GEV No.</b>	560081	<b>Ref. No.</b>	C-0021M
<b>description</b>	hexagonal screw thread M4 thread L 10mm SS WS 7 Qty 20 pcs DIN 933 / ISO 4017		

### fasteners

#### cotter pins



1

<b>GEV No.</b>	111273	<b>Ref. No.</b>	C-0282
<b>description</b>	cotter pin ø 1.3mm L 25mm		



<b>B</b>			
ball valves	13		
booster pumps II	7		
<b>C</b>			
cables	7		
cotter pins	13		
<b>E</b>			
electric accessories	7		
electrodes	7		
<b>F</b>			
fasteners	13		
fastening material	13		
flow meters	7		
<b>H</b>			
heating elements	3		
heating elements for coffee machine	3		
hexagonal screws	13		
<b>I</b>			
indicator lights	4		
<b>K</b>			
key lock switches	4		
<b>L</b>			
lamps	4		
<b>M</b>			
microswitches	4		
<b>O</b>			
O-rings	11		
<b>P</b>			
pressure switches	7		
pumps	7		
<b>R</b>			
relays	5		
ribbon cables	7		
rocker/momentary rocker switches	3		
rotary switches	4		
<b>S</b>			
safety thermostats	3		
screws	13		
sealing washers	12		
solenoid valves	6		
		switches and momentary switches	3
		system switches (ROLD)	4
		<b>T</b>	
		thermostats	3
		<b>V</b>	
		valves and tank inlets	13