



GAS COMPONENTS



ELECTRIC COMPONENTS



WATER TECHNOLOGY



MECHANICAL COMPONENTS



TOOLS

Spare parts suitable for

KROMO

Find the complete and up-to-date range of products in our GEV Webshop



Manufacturer catalogue

The most important spare parts and accessories arranged clearly for every manufacturer

- ✓ Complete product range and all appliance data always up to date in the GEV Webshop
- ✓ Alphabetical Index at the end of the catalogue

GEV Webshop

www.gev-online.co.uk

www.gev-online.com



- 🔍 Add to Favourites
- 🔍 Sign In with email address and usual password
- 🔍 Easy-order – place several items in your basket at the same time
- 🔍 Quick Item search – no login needed





heating elements

heating elements for crepes makers

 <p>1</p>			
GEV No.	416636	Ref. No.	006006 DW6006
description	heating element 2000W 230V L 280mm Wmm H 34mm tube ø 9mm connection M4 dry heating element heating circuits 1 ED ø 305mm crepes maker		
For models:	X1-TK20, X2-TK21		

heating elements for contact grills

 <p>1</p>			
GEV No.	416176	Ref. No.	009561 DW9561
description	heating element 1000W 230V L 180mm W 180mm H 18mm W1 45mm W2 90mm tube ø 6.3mm windings 5 connection M4 dry heating element		
For models:	K1L, K1R		

 <p>1</p>			
GEV No.	416198	Ref. No.	009717 DW9717
description	heating element 1000W 230V L 180mm W 180mm H 20mm W1 45mm W2 90mm tube ø 6.3mm windings 3 connection M4 dry heating element		
For models:	K2L, K2M, K2R		

 <p>1</p>			
GEV No.	416177	Ref. No.	009562 DW9562
description	heating element 1200W 230V L 180mm W 220mm H 20mm W1 55mm W2 110mm connection length 23mm tube ø 6.3mm windings 4 connection M5 dry heating element		
For models:	K1L, K1R		

 <p>1</p>			
GEV No.	416197	Ref. No.	009716 DW9716
description	heating element 800W 230V L 180mm W 180mm H 20mm W1 45mm W2 85mm tube ø 6.3mm windings 3 connection M4 dry heating element		
For models:	K2L, K2M, K2R		



 <p>1</p>			
GEV No.	416038	Ref. No.	00906/A DW906/A
description	heating element 800W 230V mounting pos. upper		

 <p>1</p>			
GEV No.	416039	Ref. No.	00909/A DW909/A
description	heating element 900W 230V mounting pos. lower		



heating elements for salamanders/toast-



GEV No.	416647	Ref. No.	009153 DW9153
description	heating element 2000W 230V L 225mm W 208mm 2 hole fixing thread 1/4" mounting distance 198mm connection M4 dry heating element tube ø 8.5mm heating circuits 1 H 8.5mm		
For models:	BK21, S2		
spare parts for	416647		
	GEV No.	510417	Ref. No. —
	flat gasket fibre ED ø 20mm ID ø 14mm thickness 2mm Qty 1 pcs		
accessories for	416647		
	GEV No.	361182	Ref. No. —
	nut thread 1/4" H 5mm nickel-plated brass WS 17 Qty 1 pcs		
	GEV No.	520228	Ref. No. —
	tooth lock washer ID ø 15.3mm ED ø 24mm steel Qty 1 pcs for thread M14		
	GEV No.	550262	Ref. No. —
	flat gasket copper ED ø 20mm ID ø 14mm thickness 2mm		

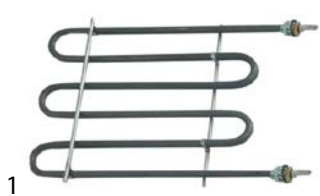

GEV No.	416646	Ref. No.	009113 DW9113
description	heating element 2000W 230V L 290mm W 216mm 2 hole fixing thread M12x1 mounting distance 195mm connection male faston 6.3mm dry heating element tube ø 8.5mm heating circuits 1 connection length 35mm H 8.5mm		
For models:	S1		

quartz heating elements

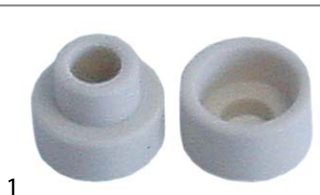

GEV No.	693055	Ref. No.	008026 DW8026
description	insulator complete ø 13mm bore ø 5mm		
For models:	F12, F120-TK120P, F6, F60-TK60P		



GEV No.	416174	Ref. No.	008075 DW8075
description	quartz heating element 450W 75V L 390mm ø 11mm connection eye		
For models:	F12, F6		



GEV No.	417534	Ref. No.	008156 DW8156
description	quartz heating element 500W 115V L 365mm ø 10mm		
For models:	F120-TK120P, F60-TK60P		

coil heating elements





GEV No.	419039	Ref. No.	002000359 DW2000359
description	heating element 2000/2180W 230/240V L 395mm W 93mm thread 3/8" connection M6 connection length 45mm dishwasher dry heating element heating circuits 1 2 hole fixing		
For models:	F, FP, K11, K11A, K12, K12-90, K12T, K1600, K1600-ALTA-VELOCITA, K1700, K1800, K2100, K2200, K24, K2500, K2700, K3000, K3000+K10, K3100, K3100+K10, K3300, K3800, K3800+K10, K4000, K4400, K4400+K10, K5400, K5400+K10, KP2300, KP2300+KP23, KP3000, KP4000		

immersion heating elements

3 hole flange ø38.5mm



GEV No.	415261	Ref. No.	0018206 DW18206
description	heating element 2400W 230V mounting ø 38.5mm heating circuits 1 L 242mm W 31mm H 22mm number of thermostat sleeves 1 thermostat sleeves ø 7.5mm length thermostat sleeves 180mm thermostat sleeve eccentric, non clinging tube ø 6.3mm hole distance 57mm hole ø 10mm cable length 130mm 3 hole flange connection male faston 6.3mm immersion heater		
For models:	AQUA-35-RL09, AQUA-37, AQUA-37-RL09, AQUA-40, AQUA-40-RL09, DUPLA-35, K35, K37, K40, LUX-40, LUX-40-ELETRONICA, LUX-41-ELETRONICA		
spare parts for	415261		
	GEV No.	521120	Ref. No. —
	O-ring EPDM thickness 5.34mm ID ø 37.47mm Qty 1 pcs		
accessories for	415261		
	GEV No.	532577	Ref. No. —
	O-ring EPDM thickness 5.34mm ID ø 40.65mm Qty 1 pcs		

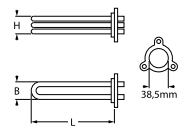

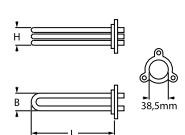

1

GEV No.	416277	Ref. No.	0018206/D DW18206/D
description	heating element 2800W 230V mounting ø 38.5mm heating circuits 1 L 302mm W 37mm H 28mm number of thermostat sleeves 1 thermostat sleeves ø 7mm length thermostat sleeves 199mm thermostat sleeve not clinging tube ø 6.4mm hole distance 57mm hole ø 10mm cable length 114mm 3 hole flange connection 26 immersion heater		
For models:	AQUA-37, AQUA-37-RL09, AQUA-40, AQUA-40-RL09, DUPLA-35, DUPLA-37, DUPLA-40, K40, K40-LUX, K41-LUX, LUX-40, LUX-40-ELETTRONICA, LUX-41-ELETTRONICA		
accessories for	416277		
	GEV No.	532577	Ref. No. —
O-ring EPDM thickness 5.34mm ID ø 40.65mm Qty 1 pcs			



1

GEV No.	416398	Ref. No.	0018215 DW18215
description	heating element 4000W 230V mounting ø 38.5mm heating circuits 3 L 287mm W 26mm H 34mm number of thermostat sleeves 1 thermostat sleeves ø 7mm length thermostat sleeves 255mm thermostat sleeve centred, adjacent tube ø 6.3mm hole distance 57mm hole ø 10mm 3 hole flange connection male faston 6.3mm immersion heater		
For models:	AQUA-37, AQUA-40, DUPLA-40, K40-LUX, K41-LUX, LUX-40, LUX-40-ELETTRONICA, LUX-41-ELETTRONICA		
accessories for	416398		
	GEV No.	521120	Ref. No. —
O-ring EPDM thickness 5.34mm ID ø 37.47mm Qty 1 pcs			

3 hole flange ø47.5mm

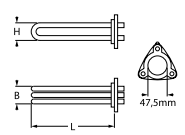
1

GEV No.	420359	Ref. No.	00590121 DW590121
description	heating element 6000W 230V mounting ø 47.5mm heating circuits 3 L 275mm W 32mm H 40mm number of thermostat sleeves 1 thermostat sleeves ø 7.5mm length thermostat sleeves 150mm thermostat sleeve eccentric, non clinging tube ø 8.5mm hole distance 62mm hole ø 10mm connection male faston 6.3mm 3 hole flange immersion heater		
accessories for	420359		
	GEV No.	510408	Ref. No. 0013005 13005 DW13005
O-ring EPDM thickness 5.34mm ID ø 47mm Qty 1 pcs			
	GEV No.	510562	Ref. No. —
O-ring silicone thickness 5.34mm ID ø 47mm Qty 1 pcs			

3 hole flange ø57.5mm

1

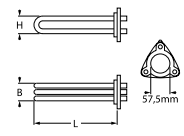
GEV No.	419191	Ref. No.	0010300011 DW10300011
description	heating element 3000-3270W 230-240V mounting ø 57.5mm heating circuits 3 L 195mm W 35mm H 40mm with O-ring		
For models:	K4400		

with compression flange 62 x 26mm

1

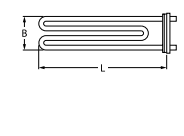
GEV No.	415267	Ref. No.	0017201 DW17201
description	heating element 1800W 230V heating circuits 1 compression flange flange 62x26mm L 190mm W 41mm Hmm connection male faston 6.3mm tube ø 6.3mm immersion heater		
accessories for	415267		
	GEV No.	510387	Ref. No. —
gasket L 46mm W 22mm ømm EPDM for heating element for flange 50x26mm			

1

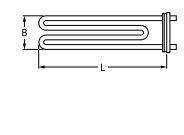
GEV No.	415266	Ref. No.	0010714 DW10714
description	heating element 2000W 230V heating circuits 1 compression flange flange 62x26mm L 300mm W 41mm Hmm connection male faston 6.3mm tube ø 6.3mm immersion heater		
For models:	AQUA-35, K36		

1

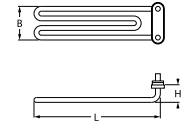
GEV No.	415268	Ref. No.	0016035/A DW16035/A
description	heating element 1850-2020W 230-240V heating circuits 1 expansion flange flange 62x26mm L 245mm W 40mm H 25mm tube ø 6.5mm connection male faston 6.3mm immersion heater		
For models:	AQUA-37, AQUA-37-RL09, AQUA-40, AQUA-40-RL09, AQUA-50, DUPLA-35, DUPLA-37, DUPLA-40, DUPLA-45, DUPLA-50, K35, K37, K40		

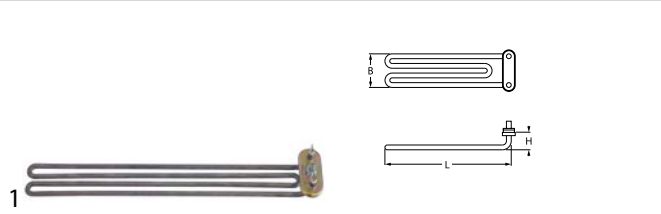

GEV No.	415270	Ref. No.	00150047 DW150047
description	heating element 2700W 230V heating circuits 1 compression flange flange 62x26mm L 335mm W 43mm H 25mm tube ø 6.3mm connection male faston 6.3mm immersion heater		
For models:	AQUA-50, AQUA-80, DUPLA-45, DUPLA-50, HOOD-110, HOOD-110-E, HOOD800SP-3D-GOGGLES-IMAX, K45, K50, K60, K80, K90, KP70-EL, KP85-EL, LUX-60, LUX-60-ELETTRONICA, LUX-61-ELETTRONICA, LUX-70-EL, LUX-85, LUX-85-ELETTRONICA		

with expansion flange 40 x 14mm



GEV No.	416276	Ref. No.	00540401 DW540401
description	heating element 1100W 230V flange 40x14mm L 203mm W 40mm H 27mm heating circuits 1 connection male faston 6.3mm immersion heater		
For models:	K40-LUX, LUX-40, LUX-40-ELETTRONICA		

with round flange ø47.5mm



GEV No.	415260	Ref. No.	0016036/A DW16036/A	
description	heating element 2180/2370W 230/240V heating circuits 1 mounting ø 47.5mm L 185mm W 40mm H 36mm round flange cable length 130mm immersion heater tube ø 6.3mm thermostat sleeves ø 7mm number of thermostat sleeves 1 length thermostat sleeves 165mm			
For models:	DUPLA-50, K45			
accessories for	415260			
	GEV No.	510408	Ref. No.	0013005 13005 DW13005
	O-ring EPDM thickness 5.34mm ID ø 47mm Qty 1 pcs			
	GEV No.	520235	Ref. No.	0030001024 30001024 DW30001024
	3 hole flange hole distance 70.5mm perforation ø 6.5mm ID ø 53.5mm			
	GEV No.	520236	Ref. No.	—
	flange for heating element ID ø 50mm ED ø 90mm hole ø 6.5mm 3 holes			
	GEV No.	521012	Ref. No.	—
	gasket graphite ED ø 15mm ID ø 5mm thickness 1.2mm Qty 1 pcs			
	GEV No.	550002	Ref. No.	0016045 16045 DW16045
	tension strap H 10mm L 21mm W 10mm hole ø 6.5mm for heating element			

accessories for	415260			
	GEV No.	550362	Ref. No.	—
	blind flange ø 64mm mounting ø 47.5mm			





GEV No.	415269	Ref. No.	0015047 0015047/A DW15047 DW15047/A
description	heating element 2700W 230V heating circuits 3 mounting ø 47.5mm L 257mm W 28mm H 45mm round flange connection male faston 6.3mm immersion heater tube ø 6.3mm H1 11mm H2 34mm connection length 28mm		
For models:	HOOD-130, HOOD-130-ELETTRONICA, K100, K70, KP130-ELETTRONICA, KP149, KP150, KP151, KP151-E		

accessories for	415269		
------------------------	--------	--	--

	GEV No.	510408	Ref. No.	0013005 13005 DW13005
	O-ring EPDM thickness 5.34mm ID ø 47mm Qty 1 pcs			

	GEV No.	510562	Ref. No.	—
	O-ring silicone thickness 5.34mm ID ø 47mm Qty 1 pcs			

	GEV No.	520235	Ref. No.	0030001024 30001024 DW30001024
	3 hole flange hole distance 70.5mm perforation ø 6.5mm ID ø 53.5mm			

	GEV No.	520236	Ref. No.	—
	flange for heating element ID ø 50mm ED ø 90mm hole ø 6.5mm 3 holes			







	GEV No.	550002	Ref. No.	0016045 16045 DW16045
	tension strap H 10mm L 21mm W 10mm hole ø 6.5mm for heating element			





	GEV No.	550362	Ref. No.	—
	blind flange ø 64mm mounting ø 47.5mm			





GEV No.	420056	Ref. No.	0015089/D DW15089/D	
description	heating element 2800W 230V heating circuits 1 L 380mm W 34mm H 33mm tube ø 6mm thermostat sleeves ø 8.5mm number of thermostat sleeves 1 length thermostat sleeves 230mm			
For models:	AQUA-50, AQUA-80, DUPLA-45			
accessories for	420056			
	GEV No.	510408	Ref. No.	0013005 13005 DW13005
	O-ring EPDM thickness 5.34mm ID ø 47mm Qty 1 pcs			









			
GEV No.	415262	Ref. No.	0015046 DW15046
description	heating element 3000W 230V heating circuits 3 mounting \varnothing 47.5mm L 260mm W 40mm H 36mm round flange connection male faston 6.3mm immersion heater tube \varnothing 6.3mm thermostat sleeves \varnothing 7mm number of thermostat sleeves 1 length thermostat sleeves 250mm thermostat sleeve upper centre not clinging		
For models:	AQUA-50, AQUA-80, DUPLA-45, DUPLA-50, K50, K60, K70, LUX-60, LUX-60-ELETTRONICA, LUX-61-ELETTRONICA		
accessories for	415262		
	GEV No.	510408	Ref. No.
			0013005 13005 DW13005
	O-ring EPDM thickness 5.34mm ID \varnothing 47mm Qty 1 pcs		
	GEV No.	510562	Ref. No.
			—
	O-ring silicone thickness 5.34mm ID \varnothing 47mm Qty 1 pcs		
	GEV No.	520235	Ref. No.
			0030001024 30001024 DW30001024
	3 hole flange hole distance 70.5mm perforation \varnothing 6.5mm ID \varnothing 53.5mm		
	GEV No.	520236	Ref. No.
			—
	flange for heating element ID \varnothing 50mm ED \varnothing 90mm hole \varnothing 6.5mm 3 holes		
	GEV No.	550002	Ref. No.
			0016045 16045 DW16045
	tension strap H 10mm L 21mm W 10mm hole \varnothing 6.5mm for heating element		
	GEV No.	550362	Ref. No.
			—
	blind flange \varnothing 64mm mounting \varnothing 47.5mm		

			
GEV No.	415263	Ref. No.	0015089 DW15089
description	heating element 4500W 230V heating circuits 3 mounting \varnothing 47.5mm L 375mm W 38mm H 46mm round flange connection male faston 6.3mm immersion heater tube \varnothing 6.3mm thermostat sleeves \varnothing 7mm number of thermostat sleeves 1 length thermostat sleeves 240mm thermostat sleeve not clinging		
For models:	AQUA-50, AQUA-80, DUPLA-45, DUPLA-50, K120, K50, K60, K70, K80, KP70-EL, KP85-EL, LUX-60, LUX-60-ELETTRONICA, LUX-70-EL, LUX-85-ELETTRONICA		
accessories for	415263		
	GEV No.	510408	Ref. No.
			0013005 13005 DW13005
	O-ring EPDM thickness 5.34mm ID \varnothing 47mm Qty 1 pcs		
	GEV No.	520235	Ref. No.
			0030001024 30001024 DW30001024
	3 hole flange hole distance 70.5mm perforation \varnothing 6.5mm ID \varnothing 53.5mm		
	GEV No.	520236	Ref. No.
			—
	flange for heating element ID \varnothing 50mm ED \varnothing 90mm hole \varnothing 6.5mm 3 holes		
	GEV No.	521012	Ref. No.
			—
	gasket graphite ED \varnothing 15mm ID \varnothing 5mm thickness 1.2mm Qty 1 pcs		

accessories for	415263		
	GEV No.	550002	Ref. No.
			0016045 16045 DW16045
	tension strap H 10mm L 21mm W 10mm hole \varnothing 6.5mm for heating element		
	GEV No.	550362	Ref. No.
			—
	blind flange \varnothing 64mm mounting \varnothing 47.5mm		

			
GEV No.	419040	Ref. No.	0015089/E DW15089/E
description	heating element 6000/6530W 230/240V heating circuits 3 mounting \varnothing 47.5mm L 375mm W 38mm H 39mm round flange connection male faston 6.3mm immersion heater tube \varnothing 6.3mm thermostat sleeves \varnothing 7mm number of thermostat sleeves 1 length thermostat sleeves 240mm thermostat sleeve eccentric, non clinging		
For models:	AQUA-50, AQUA-80, DUPLA-50, K50, KP70-EL, KP85-EL, LUX-60, LUX-60-ELETTRONICA, LUX-61-ELETTRONICA, LUX-70-EL, LUX-85-ELETTRONICA		

			
GEV No.	416278	Ref. No.	0015089/A DW15089/A
description	heating element 6000W 230V heating circuits 3 mounting \varnothing 47.5mm L 435mm W 38mm H 38mm round flange connection male faston 6.3mm immersion heater tube \varnothing 6.3mm thermostat sleeves \varnothing 7mm number of thermostat sleeves 1 length thermostat sleeves 236mm thermostat sleeve eccentric, non clinging		
accessories for	416278		
	GEV No.	510408	Ref. No.
			0013005 13005 DW13005
	O-ring EPDM thickness 5.34mm ID \varnothing 47mm Qty 1 pcs		
	GEV No.	510562	Ref. No.
			—
	O-ring silicone thickness 5.34mm ID \varnothing 47mm Qty 1 pcs		
	GEV No.	520235	Ref. No.
			0030001024 30001024 DW30001024
	3 hole flange hole distance 70.5mm perforation \varnothing 6.5mm ID \varnothing 53.5mm		
	GEV No.	520236	Ref. No.
			—
	flange for heating element ID \varnothing 50mm ED \varnothing 90mm hole \varnothing 6.5mm 3 holes		
	GEV No.	550002	Ref. No.
			0016045 16045 DW16045
	tension strap H 10mm L 21mm W 10mm hole \varnothing 6.5mm for heating element		
	GEV No.	550362	Ref. No.
			—
	blind flange \varnothing 64mm mounting \varnothing 47.5mm		



with round flange ø57.5mm



GEV No.	416279	Ref. No.	0030001011/A DW30001011/A
----------------	--------	-----------------	------------------------------

description heating element 12000W 230V heating circuits 3 mounting ø 57.5mm L 470mm W 48mm H 34mm round flange connection M5 immersion heater tube ø 8.5mm connection length 30mm thermostat sleeves ø 7mm number of thermostat sleeves 1 length thermostat sleeves 295mm thermostat sleeve eccentric, non clinging

For models: BB-2500, F, FP, HOOD-110, HOOD-110-E, HOOD-130, HOOD-800SP-3D-GOGGLES-IMAX, K1600, K1600-ALTA-VELOCITA, K1700, K1800, K2100, K2200, K2500, K26, K26A, K2700, K3000, K3000+K10, K3100, K3100+K10, K3300, K3800, K3800+K10, K4000, K4400, K4400+K10, K5400, K5400+K10, KP149, KP200-ELETTRONICA, KP2300, KP2300+KP23, KP2800, KP3000, KP300-ELETTRONICA, KP4000, KT-1500

accessories for 416279

	GEV No.	550002	Ref. No.	0016045 16045 DW16045
tension strap H 10mm L 21mm W 10mm hole ø 6.5mm for heating element				



GEV No.	420055	Ref. No.	0030001011/B DW30001011/B
----------------	--------	-----------------	------------------------------

description heating element 14000W 230V heating circuits 3 L 480mm W 36mm H 44mm connection M5 tube ø 8.5mm thermostat sleeves ø 7.7mm number of thermostat sleeves 1 length thermostat sleeves 280mm

For models: BB-2500, F, FP, K1600, K1600-ALTA-VELOCITA, K1700, K1800, K2100, K2200, K2500, K26, K2700, K3000, K3000+K10, K3100, K3100+K10, K3300, K3800, K3800+K10, K4000, K4400, K4400+K10, K5400, K5400+K10, KP2300, KP2300+KP23, KP2800, KP3000, KP4000, KT-1500



GEV No.	415264	Ref. No.	001008842 0030001010 DW1008842 DW30001010
----------------	--------	-----------------	--

description heating element 6000W 230V heating circuits 3 mounting ø 57.5mm L 480mm W 33mm H 42mm round flange connection M5 immersion heater tube ø 8.5mm connection length 19mm thermostat sleeves ø 7.5mm number of thermostat sleeves 1 length thermostat sleeves 268mm thermostat sleeve not clinging

For models: BB-2500, F, FP, HOOD-110, HOOD-110-E, HOOD-130, HOOD-800SP-3D-GOGGLES-IMAX, K100, K2500, K3000, K3000+K10, K3100, K3100+K10, K3300, K3800, K3800+K10, K4000, K4400, K4400+K10, K5400, K5400+K10, K90, KP149, KP150, KP151, KP151-E, KP200, KP200-ELETTRONICA, KP202-E, KP2300, KP2300+KP23, KP2800, KP300, KP3000, KP300-ELETTRONICA, KP302-E, KP4000, KP85-EL, KT-1500, LUX-85, LUX-85-ELETTRONICA

spare parts for 415264

	GEV No.	510409	Ref. No.	0013015 0013020 13015 13020 DW13015 DW13020
O-ring EPDM thickness 5.34mm ID ø 56.52mm Qty 1 pcs				

accessories for 415264

	GEV No.	550002	Ref. No.	0016045 16045 DW16045
tension strap H 10mm L 21mm W 10mm hole ø 6.5mm for heating element				



GEV No.	415265	Ref. No.	0016303 0030001011 DW16303 DW30001011
----------------	--------	-----------------	--

description heating element 9000W 230V heating circuits 3 mounting ø 57.5mm L 470mm W 35mm H 41mm round flange connection M5 immersion heater tube ø 8.5mm connection length upper centre not clinging-mm thermostat sleeves ø 7.5mm number of thermostat sleeves 1 length thermostat sleeves 295mm

For models: BB-2500, F, FP, GR300, GR800, HOOD-110, HOOD-110-E, HOOD-130, HOOD-130-ELETTRONICA, HOOD800SP-3D-GOGGLES-IMAX, K100, K120, K1600, K1600-ALTA-VELOCITA, K1700, K1800, K2100, K2200, K2500, K2700, K3000, K3000+K10, K3100, K3100+K10, K3300, K3800, K3800+K10, K4000, K4400, K4400+K10, K5400, K5400+K10, KP130-ELETTRONICA, KP149, KP150, KP151, KP151-E, KP200, KP200-ELETTRONICA, KP202-E, KP2300, KP2300+KP23, KP2800, KP300, KP3000, KP300-ELETTRONICA, KP302-E, KP400, KP4000, KP400-ELETTRONICA...(Other models you can see in the webshop)

spare parts for 415265

	GEV No.	510409	Ref. No.	0013015 0013020 13015 13020 DW13015 DW13020
O-ring EPDM thickness 5.34mm ID ø 56.52mm Qty 1 pcs				

accessories for 415265

	GEV No.	550002	Ref. No.	0016045 16045 DW16045
tension strap H 10mm L 21mm W 10mm hole ø 6.5mm for heating element				



GEV No.	415271	Ref. No.	0010300022 DW10300022
----------------	--------	-----------------	--------------------------

description heating element 4500W 230V heating circuits 3 thread 1/4" L 88mm W 285mm H 60mm L1 100mm L2 185mm W1 33mm W2 272mm H1 35mm H2 25mm tube ø 6.3mm connection male faston 6.3mm connection length 36mm flange with thread immersion heater

accessories for 415271

	GEV No.	510405	Ref. No.	0010200056 10200056 DW10200056
flat gasket fibre ED ø 56mm ID ø 42mm thickness 2mm for thread 1/4" Qty 1 pcs				

	GEV No.	520232	Ref. No.	0010200080 10200080 DW10200080
nut thread 1/4" H 5mm nickel-plated brass WS 47 Qty 1 pcs				

	GEV No.	528021	Ref. No.	—
flat gasket PTFE ED ø 53mm ID ø 42.5mm thickness 3mm Qty 1 pcs equiv. no. 12001/02286 suitable for Astoria/Aurora/Brasilia/Wega				



radiation heaters

1-circuit



1

GEV No.	490116	Ref. No.	Y12208
description	radiation heater ø 165mm 1200W 230V heating circuits 1 H 33mm 7-position control with temperature signalization with ribbon heater connections 2+2 connection type male faston 6.3mm CERAMASPEED		

energy regulators

EGO

1-circuit



1

GEV No.	380015	Ref. No.	009107 DW9107
description	energy regulator 230V 13A single-circuit turn direction right shaft ø 6x4.6mm shaft L 23mm mounting thread M4 power release 6-100% no. 50.57021.010		
For models:	BK21, S1, S2		

thermostats

bi-metal thermostats

safety bi-metal thermostats



1

GEV No.	390480	Ref. No.	0015550 DW15550
description	bi-metal safety thermostat hole distance 23.8mm switch-off temp. 105°C 1NC 1-pole 16A connection F6.3 2 hole fixing		
For models:	AQUA-37, AQUA-37-RL09, AQUA-40, AQUA-40-RL09, AQUA-50, AQUA-80, DUPLA-35, DUPLA-37, DUPLA-40, DUPLA-45, DUPLA-50, K35, K36, K37, K40, K40-LUX, K41-LUX, K45, K50, K60, K70, K80, KP70-EL, LUX-40, LUX-40-ELETTRONICA, LUX-41-ELETTRONICA, LUX-60, LUX-60-ELETTRONICA, LUX-61-ELETTRONICA, LUX-70-EL		



1

GEV No.	390187	Ref. No.	006011 DW6011
description	bi-metal safety thermostat hole distance 40mm switch-off temp. 180°C 2NC 2-pole 16A connection F6.3 2 hole fixing		
For models:	K1L, K1R, K2L, K2M, K2R, X1-TK20, X2-TK21		

bi-metal thermostats



1

GEV No.	390231	Ref. No.	0015551 DW15551
description	bi-metal thermostat hole distance 40mm switch-off temp. 55°C 1CO 1-pole 16A connection F6.3 2 hole fixing		
For models:	K40-LUX, K41-LUX, LUX-40, LUX-40-ELETTRONICA, LUX-41-ELETTRONICA		

control and safety thermostats

EGO

control thermostats

55.10/19_ series



1

GEV No.	375002	Ref. No.	009010 DW9010
description	thermostat t.max. 320°C temperature range 55-320°C 1-pole 1NO 16A probe ø 3.1mm probe L 226mm capillary pipe 870mm capillary pipe isolated 850mm gland nut shaft L 23mm shaft position upper rotation 270°		
For models:	F, FP, K1L, K1R, K2L, K2M, K2R, X1-TK20, X2-TK21		

safety thermostats

55.32_ series



GEV No.	390907	Ref. No.	0015553 DW15553
description	safety thermostat switch-off temp. 110°C 3-pole 3NC 20A probe ø 6mm probe L 95mm capillary pipe 1500mm capillary pipe isolated 1400mm gland nut probe		
For models:	AQUA-50, DUPLA-50		

IMIT / TEMPOMATIC / ARTERMO

control thermostats



GEV No.	390421	Ref. No.	0015621 DW15621
description	thermostat t.max. 85°C temperature range 0-90°C 1-pole 1CO 16A probe ø 6.5mm probe L 95mm capillary pipe 1500mm capillary pipe isolated 1450mm gland nut shaft ømm shaft Lmm shaft position rotation 270° probe material copper		
For models:	K13		

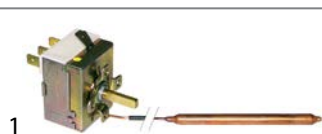

GEV No.	390192	Ref. No.	0010707/2 DW10707/2
description	thermostat t.max. 90°C temperature range 0-90°C 1-pole 1CO 16A probe ø 6.5mm probe L 95mm capillary pipe 2000mm capillary pipe isolated 2000mm gland nut shaft ø 6x4.6mm shaft L 19mm shaft position upper° rotation 270° probe material copper		
For models:	BM100, BM200, BM300, K11, K11A, K12, K12-90, K1600, K1600-ALTA-VELOCITA, K1800, K2100, K2200, K24, K2500, K3000, K3000+K10, K3100, K3100+K10, K3300, K3800, K3800+K10, K4000, K4400, K4400+K10, K5400, K5400+K10, KP2300, KP2300+KP23, KP3000, KP4000		



GEV No.	390460	Ref. No.	0010707/1 DW10707/1
description	thermostat t.max. 90°C temperature range 30-90°C 1-pole 1CO 16A probe ø 6.5mm probe L 95mm capillary pipe 2000mm capillary pipe isolated 1950mm gland nut shaft ømm shaft Lmm shaft position rotation 270° probe material copper		
For models:	AQUA-35, AQUA-35-RL09, AQUA-37, AQUA-37-RL09, AQUA-40, AQUA-40-RL09, AQUA-50, AQUA-80, BB-2500, DUPLA-35, DUPLA-37, DUPLA-40, DUPLA-45, DUPLA-50, F, FP, HOOD-110, HOOD-130, HOOD800SP-3D-GOGGLES-IMAX, K100, K120, K1600, K1600-ALTA-VELOCITA, K1800, K2100, K2200, K2500, K26, K26A, K3000, K3000+K10, K3100, K3100+K10, K3300, K35, K36, K37, K3800, K3800+K10, K40, K4000, K40-LUX, K41-LUX, K4400, K4400+K10, K45, K50, K5400, K5400+K10, K60...(Other models you can see in the webshop)		

CAMPINI

control thermostats

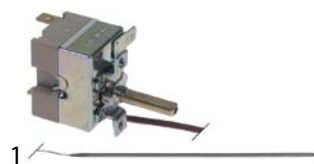

GEV No.	375934	Ref. No.	0010707/3 DW10707/3
description	thermostat t.max. 280°C temperature range 50-280°C 1-pole 1NO 16A probe ø 3mm probe L 185mm capillary pipe 960mm capillary pipe isolated 700mm gland nut shaft ø 6x4.6mm shaft L 23mm shaft position upper rotation 270° probe material SS 250V		
For models:	K1600, K1600-ALTA-VELOCITA, K1700, K1800, K2100, K2200, K24, K2500, K2700, K3000, K3000+K10, K3100, K3100+K10, K3300, K3800, K3800+K10, K4000, K4400, K4400+K10, K5400, K5400+K10, KP2300, KP2300+KP23, KP3000, KP4000		

various

safety thermostats

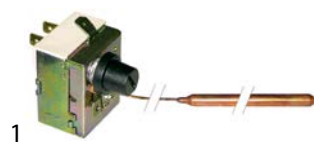

GEV No.	390194	Ref. No.	002000430 DW2000430
description	safety thermostat switch-off temp. 90-110°C 1-pole 16A probe ø 6.5mm probe L 87mm capillary pipe 1500mm capillary pipe isolated 1497mm connection male faston 6.3mm adjustable		
For models:	5M, 6+6M, 6+6T, 6M, 6T, 8+8T, 8T, BB-2500, F, FP, GR300, GR800, HOOD-110, HOOD-110-E, HOOD-130, HOOD-130-ELETRONICA, HOOD800SP-3D-GOGGLES-IMAX, K100, K120, K12T, K1600, K1600-ALTA-VELOCITA, K1700, K1800, K2100, K2200, K2500, K26, K26A, K2700, K3000, K3000+K10, K3100, K3100+K10, K3300, K3800, K3800+K10, K4000, K4400, K4400+K10, K5400, K5400+K10, K90, KP130-ELETRONICA, KP149, KP150, KP151, KP151-E, KP200, KP200-ELETRONICA...(Other models you can see in the webshop)		



accessories

plunger sockets



1			
GEV No.	517293	Ref. No.	0010200270 DW10200270
description	thermowell double		
For models:	K100, KP150, KP151, KP200, KP300, KP400		



1			
GEV No.	517292	Ref. No.	0012510 DW12510
description	thermowell thread M10x1 ID ø 7.7mm L 108mm SS single ø 10mm		
For models:	BM100, BM200, BM300, K70		

switches and momentary switches

rocker/momentary rocker switches

30x22mm

blank



1			
GEV No.	345983	Ref. No.	0015049 DW15049
description	momentary rocker switch mounting measurements 30x22mm green 2NO 250V 16A illuminated 0-I connection male faston 6.3mm ambient temperature max. 85°C protection IP65 with cover cap		
For models:	K120		
accessories for	345983		

	GEV No.	301036	Ref. No.	—
		protective cover internal size 30x22mm for rocker switch mounting measurementsmm		



1			
GEV No.	345982	Ref. No.	0015050 DW15050
description	rocker switch mounting measurements 30x22mm green 2CO 250V 16A illuminated connection male faston 6.3mm ambient temperature max. 125/55°C protection IP65 with cover cap		
accessories for	345982		

	GEV No.	301036	Ref. No.	—
		protective cover internal size 30x22mm for rocker switch mounting measurementsmm		

labelled



1			
GEV No.	345981	Ref. No.	0015048 DW15048
description	rocker switch mounting measurements 30x22mm green 2NO 250V 16A illuminated 0-I connection male faston 6.3mm ambient temperature max. 125/55°C protection IP65 with cover cap		
For models:	5M, 6+6M, 6+6T, 6M, 6T, 8+8T, 8T, BM100, BM200, BM300		
accessories for	345981		

	GEV No.	301036	Ref. No.	—
		protective cover internal size 30x22mm for rocker switch mounting measurementsmm		

push/momentary push switches

28.5x28.5mm



1			
GEV No.	345973	Ref. No.	0015860 DW15860
description	momentary push switch mounting measurements 28.5x28.5mm blue 1NO 250V 16A connection male faston 6.3mm ambient temperature max. 150°C protection IP40		



1			
GEV No.	345974	Ref. No.	0015859 DW15859
description	momentary push switch mounting measurements 28.5x28.5mm yellow 1NO 250V 16A connection male faston 6.3mm ambient temperature max. 85°C protection IP40		



1			
GEV No.	345979	Ref. No.	0015863 DW15863
description	push switch mounting measurements 28.5x28.5mm blue 2CO 250V 16A connection male faston 6.3mm ambient temperature max. 150°C protection IP40		



1			
GEV No.	345977	Ref. No.	0015861/A DW15861/A
description	momentary push switch mounting measurements 28.5x28.5mm green/red 2NO 250V 16A outflow connection male faston 6.3mm ambient temperature max. 150°C protection IP40		





GEV No.	345976	Ref. No.	0015865 DW15865
description	push switch mounting measurements 28.5x28.5mm green/red 2CO 250V 16A main switch connection male faston 6.3mm ambient temperature max. 150°C protection IP40 with indicator green/red		



GEV No.	345975	Ref. No.	0015849 0015861 DW15849 DW15861
description	push switch mounting measurements 28.5x28.5mm green/red 2NO 250V 16A main switch connection male faston 6.3mm ambient temperature max. 150°C protection IP40 with indicator green/red		
For models:	BB-2500, BK10, BK11, BK4, BK5, F, F12, F120-TK120P, F6, F60-TK60P, FP, GM-2-BK11, GM-BK10, GM-BK11, K1600, K1600-ALTA-VELOCITA, K1700, K1800, K2100, K2200, K2500, K26, K26A, K2700, K3000, K3000+K10, K3100, K3100+K10, K3300, K3800, K3800+K10, K4000, K4400, K4400+K10, K5400, K5400+K10, KP2300, KP2300+KP23, KP2800, KP3000, KP4000, KT-1500, M1-BK1, M2-BK2, MP-BKP, S40-BK4, S55-BK5, SG2-BK91		

28.5x52.6mm



GEV No.	345875	Ref. No.	0015899/C DW15899/C
description	switch combination momentary mounting measurements 28.5x52.6mm green 1NO/indicator light 250V 16A drain/temperature connection male faston 6.3mm ambient temperature max. 85°C protection IP40		



GEV No.	345874	Ref. No.	0015899/B DW15899/B
description	switch combination momentary mounting measurements 28.5x52.6mm green 1NO/indicator light 250V 16A temperature/regeneration connection male faston 6.3mm ambient temperature max. 85°C protection IP40		



GEV No.	345876	Ref. No.	0015899 DW15899
description	switch combination momentary mounting measurements 28.5x52.6mm green 1NO/indicator light 250V 16A temperature/regeneration connection male faston 6.3mm ambient temperature max. 85°C protection IP40		

28.5x77.5mm



GEV No.	347856	Ref. No.	0027315 DW27315
description	double momentary switch mounting measurements 28.5x77.5mm green/blue 2NO/indicator light/2NO 250V 16A drain pump/rinsing/temperature connection male faston 6.3mm ambient temperature max. 85°C momentary protection IP40		

spare parts for 347856

	GEV No.	345601	Ref. No.	0015827 15827 DW15827
	indicator lamp holder V ø 11mm			
	GEV No.	345603	Ref. No.	0015843 15843 DW15843
	element holder triple mounting measurements 28.5x77.5mm black for push buttons 23x23mm			
	GEV No.	345720	Ref. No.	0015812 15812 DW15812
	switch 2NO 250V 16A connection male faston 6.3mm			
	GEV No.	346249	Ref. No.	0015876 15876 DW15876
	indicator light lens size 23x23mm green temperature			
	GEV No.	359350	Ref. No.	—
	indicator light 230V blue connection male faston 6.3mm ø 11mm			





GEV No.	345867	Ref. No.	0015891 DW15891
description	switch combination latching mounting measurements 28.5x77.5mm green 2CO/indicator light/1NO 250V 16A START/indicator light/on-off connection male faston 6.3mm ambient temperature max. 85°C protection IP40		





 <p>1</p>			
GEV No.	345866	Ref. No.	0015888 DW15888
description	switch combination latching mounting measurements 28.5x77.5mm green 2NO/1NO/indicator light 250V 16A START/indicator light/on-off connection male faston 6.3mm ambient temperature max. 85°C protection IP40		
For models:	K40-LUX, K60, K70		

 <p>1</p>			
GEV No.	345868	Ref. No.	0015893 DW15893
description	switch combination momentary mounting measurements 28.5x77.5mm green 2NO/indicator light 250V 16A drain/temperature connection male faston 6.3mm ambient temperature max. 85°C protection IP40		
For models:	K40-LUX		

 <p>1</p>			
GEV No.	345871	Ref. No.	0015796 DW15796
description	switch combination momentary mounting measurements 28.5x77.5mm green 1CO/indicator light 250V 16A rinsing/temperature connection male faston 6.3mm ambient temperature max. 150°C protection IP40		

 <p>1</p>			
GEV No.	347731	Ref. No.	0075090 DW75090
description	switch combination mounting measurements 28.5x77.5mm green/yellow 2NO/2CO/indicator light 250V 16A connection male faston 6.3mm ambient temperature max. 150°C		
For models:	K120		

 <p>1</p>			
GEV No.	345869	Ref. No.	0015894 DW15894
description	switch combination momentary mounting measurements 28.5x77.5mm green 1NO/indicator light/indicator light 250V 16A temperature/regeneration connection male faston 6.3mm ambient temperature max. 85°C protection IP40		

<h3>accessories</h3>			
<h4>frame</h4>			
 <p>1</p>			
GEV No.	347946	Ref. No.	00590092 DW590092
description	frame for position switch SS mounting distance 32.5mm mounting ø 46mm hole ø 10.5mm H 31mm		

 <p>1</p>			
GEV No.	345870	Ref. No.	0015892 DW15892
description	switch combination momentary mounting measurements 28.5x77.5mm green 2NO/1NO/indicator light 250V 16A drain/temperature/regeneration connection male faston 6.3mm ambient temperature max. 85°C protection IP40		

<h3>microswitches</h3>			
<h4>lever actuated</h4>			
 <p>1</p>			
GEV No.	345257	Ref. No.	0010704 DW10704
description	microswitch with lever 250V 16A 1CO connection male faston 6.3mm L 29mm L1 33mm ambient temperature max. 120°C mounting distance 22mm actuating force: 130g lever length 31.5mm		
For models:	BK10, BK11, BK12, BK13, BK5, F1-KF1, F2-KF2, GM2-2, GM-2-BK11, GM3, GM3-BK12, GM4, GM4-BK13, GM-BK10, GM-BK11, K36, K40-LUX, K41-LUX, K60, K70, K90, KF1S, KF2S, KP70-EL, KP85-EL, KT-1500, LUX-40, LUX-40-ELETTRONICA, LUX-41-ELETTRONICA, LUX-60, LUX-60-ELETTRONICA, LUX-61-ELETTRONICA, LUX-70-EL, LUX-85, LUX-85-ELETTRONICA, S55-BK5		

 <p>1</p>			
GEV No.	345872	Ref. No.	0015893/A DW15893/A
description	switch combination momentary mounting measurements 28.5x77.5mm green 2NO/1NO/indicator light 250V 16A drain/temperature/regeneration connection male faston 6.3mm ambient temperature max. 85°C protection IP40		

pin-plunger actuated

M10



GEV No.	347945 ¹	Ref. No.	00590021 DW590021
description	microswitch with plunger thread M10x0.75 thread L 13mm 250V 5A 1CO connection male faston 6.3mm stroke 6mm mounting distance 25mm L 49mm L1 13mm ambient temperature max. 85°C IP65 type MKH12D09 actuating force: 340g		

¹protection class IP65

roller actuated

roller 90°



GEV No.	347096	Ref. No.	0070305 DW70305
description	microswitch with roller plunger 250V 20A 1CO connection screw L1 49mm ambient temperature max. 125°C thread L 14.5mm thread M12x1 mounting distance 25mm actuating force: 370g type Z15G1318		
For models:	HOOD-110, HOOD-110-E, HOOD-130, HOOD-130-ELETTRONICA, HOOD800SP-3D-GOGGLES-IMAX, K100, K29, KP130-ELETTRONICA		

position switches

PIZZATO

FR series



GEV No.	345181	Ref. No.	0010600138 DW10600138
description	position switch plastic 1NC/1NO 400V 3A L 92mm W 31mm H 31mm protection IP67 actuating force: 450g screw connection PG13.5 mounting distance 22mm screw		

system switches (ROLD)



GEV No.	346229	Ref. No.	0015880 DW15880
description	blank size 23x23mm grey		
For models:	K120, K35, K36, K37, K40, K41-LUX, K45, K50, K70, K80, KP151-E		



GEV No.	345721	Ref. No.	0015844 DW15844
description	blank cap holder		
For models:	AQUA-35, AQUA-35-RL09, AQUA-37, AQUA-37-RL09, AQUA-40, AQUA-40-RL09, AQUA-50, AQUA-80, DUPLA-35, DUPLA-37, DUPLA-40, DUPLA-45, DUPLA-50, HOOD-110, HOOD-130, HOOD800SP-3D-GOGGLES-IMAX, K70, KP149, KP151, KP151-E, LUX-40, LUX-60, LUX-85		



GEV No.	347592	Ref. No.	0015815 DW15815
description	element holder single mounting measurements 28.5x28.5mm grey for push buttons 23x23mm		
For models:	BB-2500, F, FP, K1600, K1600-ALTA-VELOCITA, K1700, K1800, K2100, K2200, K2500, K2700, K3000, K3000+K10, K3100, K3100+K10, K3300, K3800, K3800+K10, K4000, K4400, K4400+K10, K5400, K5400+K10, KP151-E, KP2300, KP2300+KP23, KP2800, KP3000, KP4000, KP1500		



GEV No.	345603	Ref. No.	0015843 DW15843
description	element holder triple mounting measurements 28.5x77.5mm black for push buttons 23x23mm		
For models:	K70		





GEV No.	347620	Ref. No.	0015836 DW15836
description	element holder triple mounting measurements 28.5x77.5mm grey for push buttons 23x23mm		
For models:	K100, K36, K41-LUX, K70, KP150		



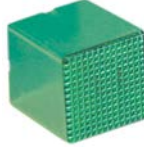

 <p>1</p>			
GEV No.	345601	Ref. No.	0015827 DW15827
description	indicator lamp holder V ø 11mm		
For models:	K100, K36, K41-LUX, K70, KP151-E		

 <p>1</p>			
GEV No.	346245	Ref. No.	0015825 DW15825
description	indicator light lens size 23x23mm green		
For models:	K100, K36, K45, K50, K70, K80, KP151-E		

 <p>1</p>			
GEV No.	346249	Ref. No.	0015876 DW15876
description	indicator light lens size 23x23mm green temperature		
For models:	K41-LUX, K70		

 <p>1</p>			
GEV No.	346250	Ref. No.	0015875 DW15875
description	indicator light lens size 23x23mm green washing cycle		
For models:	K41-LUX, K70		

 <p>1</p>			
GEV No.	347193	Ref. No.	0015813 DW15813
description	momentary switch unit 1NO 250V 16A connection male faston 6.3mm		
For models:	AQUA-35, AQUA-35-RL09, AQUA-37, AQUA-37-RL09, AQUA-40, AQUA-40-RL09, AQUA-50, AQUA-80, DUPLA-35, DUPLA-37, DUPLA-40, DUPLA-45, DUPLA-50, HOOD-110, HOOD-130, HOOD800SP-3D-GOGGLES-IMAX, K100, K35, K36, K37, K40, K41-LUX, K45, K50, K70, K80, KP149, KP150, KP151, KP151-E, LUX-40, LUX-60, LUX-85		

 <p>1</p>			
GEV No.	345606	Ref. No.	0015811/A DW15811/A
description	momentary switch unit 2CO 250V 16A connection male faston 6.3mm		
For models:	AQUA-35, AQUA-35-RL09, AQUA-37, AQUA-37-RL09, AQUA-40, AQUA-40-RL09, AQUA-50, AQUA-80, DUPLA-35, DUPLA-37, DUPLA-40, DUPLA-45, DUPLA-50, HOOD-110, HOOD-130, HOOD800SP-3D-GOGGLES-IMAX, K45, K50, K70, K80, KP149, KP151, KP151-E, LUX-40, LUX-60, LUX-85		

 <p>1</p>			
GEV No.	345980	Ref. No.	0015800 DW15800
description	momentary switch unit 2NO 250V 16A connection male faston 6.3mm		
For models:	AQUA-35, AQUA-35-RL09, AQUA-37, AQUA-37-RL09, AQUA-40, AQUA-40-RL09, AQUA-50, AQUA-80, DUPLA-35, DUPLA-37, DUPLA-40, DUPLA-45, DUPLA-50, HOOD-110, HOOD-130, HOOD800SP-3D-GOGGLES-IMAX, K100, K40, K50, K70, K80, KP149, KP151, KP151-E, LUX-40, LUX-60, LUX-85		

 <p>1</p>			
GEV No.	345539	Ref. No.	0084001 DW84001
description	push button size 17x13mm grey		

 <p>1</p>			
GEV No.	347895	Ref. No.	0015817 DW15817
description	push button size 23x23mm blue		
For models:	K70, KP150, KP151-E		

 <p>1</p>			
GEV No.	347892	Ref. No.	0015990 DW15990
description	push button size 23x23mm blue drain pump		
For models:	K70, KP151-E		



1

GEV No.	347893	Ref. No.	0015988 DW15988
description	push button size 23x23mm blue ON-OFF with lens		
For models:	K70, KP151-E		



1

GEV No.	347701	Ref. No.	0015877 DW15877
description	push button size 23x23mm blue programme		
For models:	K70, KP151-E		



1

GEV No.	347891	Ref. No.	0015993 DW15993
description	push button size 23x23mm blue regeneration		
For models:	K70		



1

GEV No.	347894	Ref. No.	0015986 DW15986
description	push button size 23x23mm blue START		
For models:	K70, KP151-E		



1

GEV No.	347896	Ref. No.	0015872 DW15872
description	push button size 23x23mm green cold rinsing		
For models:	K35, K36, K37, K40		



1

GEV No.	347590	Ref. No.	0015854 DW15854
description	push button size 23x23mm green drain pump		
For models:	K100, K35, K37, K40, K45, K50, K70, K80, KP150, KP151-E		



1

GEV No.	346221	Ref. No.	0015857 0015874 DW15857 DW15874
description	push button size 23x23mm green ON-OFF with lens		
For models:	BB-2500, F, FP, K100, K120, K1600, K1600-ALTA-VELOCITA, K1700, K1800, K2100, K2200, K2500, K2700, K3000, K3000+K10, K3100, K3100+K10, K3300, K35, K36, K37, K3800, K3800+K10, K40, K4000, K41-LUX, K4400, K4400+K10, K45, K50, K5400, K5400+K10, K70, K80, KP150, KP151-E, KP2300, KP2300+KP23, KP2800, KP3000, KP4000, KT-1500		



1

GEV No.	346224	Ref. No.	0015871 DW15871
description	push button size 23x23mm green regeneration		
For models:	K100, K36, K70		





1

GEV No.	346222	Ref. No.	0015873 DW15873
description	push button size 23x23mm green START		
For models:	K36, K41-LUX, K70, KP150, KP151-E		





			
1			
GEV No.	346214	Ref. No.	0015819 DW15819
description	push button size 23x23mm yellow		
For models:	K100, K70, KP150, KP151-E		

			
1			
GEV No.	347889	Ref. No.	0015991 DW15991
description	push button size 23x23mm yellow drain pump		
For models:	K70, KP151-E		

			
1			
GEV No.	347484	Ref. No.	0015818 0015855 0015989 DW15818 DW15855 DW15989
description	push button size 23x23mm yellow ON-OFF with lens		
For models:	K100, K35, K37, K40, K50, K70, K80, KP150, KP151-E		

			
1			
GEV No.	347890	Ref. No.	0015858 DW15858
description	push button size 23x23mm yellow regeneration		
For models:	K40, K45, K50, K70, K80		

			
1			
GEV No.	347888	Ref. No.	0015987 DW15987
description	push button size 23x23mm yellow START		
For models:	K70, KP151-E		

			
1			
GEV No.	346251	Ref. No.	0015824 0015824/A DW15824 DW15824/A
description	rotary disc orange/green disc ø 20.6mm		
For models:	BB-2500, F, FP, K100, K120, K1600, K1600-ALTA-VELOCITA, K1700, K1800, K2100, K2200, K2500, K2700, K3000, K3000+K10, K3100, K3100+K10, K3300, K35, K36, K37, K3800, K3800+K10, K40, K4000, K41-LUX, K4400, K4400+K10, K45, K50, K5400, K5400+K10, K70, K80, KP150, KP151-E, KP2300, KP2300+KP23, KP2800, KP3000, KP4000, KT-1500		

			
1			
GEV No.	345605	Ref. No.	0015811 DW15811
description	switch 2CO 250V 16A connection male faston 6.3mm		
For models:	AQUA-35, AQUA-35-RL09, AQUA-37, AQUA-37-RL09, AQUA-40, AQUA-40-RL09, AQUA-50, AQUA-80, DUPLA-35, DUPLA-37, DUPLA-40, DUPLA-45, DUPLA-50, HOOD-110, HOOD-130, HOOD800SP-3D-GOGGLES-IMAX, K100, K35, K37, K40, K41-LUX, K70, KP149, KP150, KP151, KP151-E, LUX-40, LUX-60, LUX-85		

			
1			
GEV No.	345720	Ref. No.	0015812 DW15812
description	switch 2NO 250V 16A connection male faston 6.3mm		
For models:	AQUA-35, AQUA-35-RL09, AQUA-37, AQUA-37-RL09, AQUA-40, AQUA-40-RL09, AQUA-50, AQUA-80, BB-2500, DUPLA-35, DUPLA-37, DUPLA-40, DUPLA-45, DUPLA-50, F, FP, HOOD-110, HOOD-130, HOOD800SP-3D-GOGGLES-IMAX, K100, K120, K1600, K1600-ALTA-VELOCITA, K1700, K1800, K2100, K2200, K2500, K2700, K3000, K3000+K10, K3100, K3100+K10, K3300, K35, K36, K37, K3800, K3800+K10, K40, K4000, K4400, K4400+K10, K45, K50, K5400, K5400+K10, K70, K80, KP149...(Other models you can see in the webshop)		

cam switches

on/off

			
1			
GEV No.	300176	Ref. No.	009564 DW9564
description	cam switch 2 operating positions 4NO sequence 0-1 16A shaft ø 6x4.6mm shaft L 23mm connection screw		
For models:	K1L, K1R, K2L, K2M, K2R, X1-TK20, X2-TK21		



rotary switches

BREMAS

A1200 series



1

GEV No.	345912	Ref. No.	0010300206 DW10300206
description	rotary switch		



1

GEV No.	345019	Ref. No.	0030009001 DW30009001
description	rotary switch sets of contacts 2 2 0-1 type CA0120002 380V 12A shaft ø 5x5mm shaft L 23mm shaft square connection screw		
For models:	KP300, KP400		



1

GEV No.	345913	Ref. No.	0010300207 0010300208 DW10300207 DW10300208
description	rotary switch sets of contacts 4 4 1-2-3-4 type CS012M014 400V 12A shaft ø 5x5mm shaft L 23mm shaft square with knob connection screw		
For models:	HOOD-110, HOOD-130, K120		



1

GEV No.	347857	Ref. No.	003002031 DW3002031
description	rotary switch sets of contacts 6 4 0-1-2-3 type CA0127042 600V 12A shaft ø 5x5mm shaft L 25mm shaft square with knob connection screw		
For models:	BB-2500, K1600, K1600-ALTA-VELOCITA, K1800, K2100, K2200, KP2300, KP2300+KP23, KP2800		

A1600 series



1

GEV No.	345910 ¹	Ref. No.	0080411 DW80411
description	rotary switch 5 0-1-2-3-4 sets of contacts 4 type CS0168485 400V 16A shaft ø 5x5mm shaft L 23mm shaft square connection screw		

¹incl. knob and dial plate

producer-specific rotary switches

DIHR / KROMO



1

GEV No.	345911	Ref. No.	0089349 DW89349
description	element holder blue-grey format round 0-3		
For models:	HOOD-110, HOOD-130		



1

GEV No.	697909	Ref. No.	0089322 DW89322
description	fastening angle for rotary switch plastic L 76mm W 31mm		
For models:	HOOD-110, HOOD-130		



1

GEV No.	697910	Ref. No.	0089323 DW89323
description	fixing plate for rotary switch L 80mm W 60mm thickness 1mm		
For models:	HOOD-110, HOOD-130		



1

GEV No.	110731	Ref. No.	0089321 DW89321
description	knob switch zero mark ø 29mm black shaft special		
For models:	HOOD-110, HOOD-130		



1

GEV No.	345896	Ref. No.	0089332 DW89332
description	O-ring EPDM thickness 1.5mm ID ø 37mm Qty 1 pcs		
For models:	HOOD-110, HOOD-130		



electric components



1

GEV No.	345913	Ref. No.	0010300207 0010300208 DW10300207 DW10300208
description	rotary switch sets of contacts 4 4 1-2-3-4 type CS012M014 400V 12A shaft \varnothing 5x5mm shaft L 23mm shaft square with knob connection screw		
For models:	HOOD-110, HOOD-130, K120		

magnetic switches

40x13mm

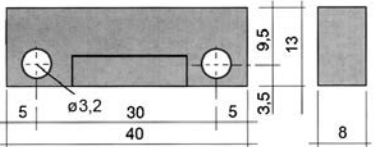
1

GEV No.	345990	Ref. No.	0010778 DW10778
description	magnetic switch L 40mm W 13mm 1NO 250V 0.04A P max. 10W connection male faston 6.3mm cable length 2000mm		
For models:	AQUA-50, AQUA-80, DUPLA-45, DUPLA-50, K1700, K2700, K45, K50, K80		

65x20mm

1

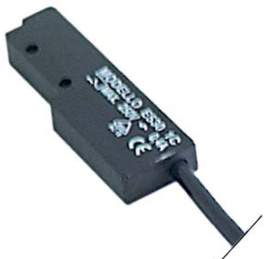
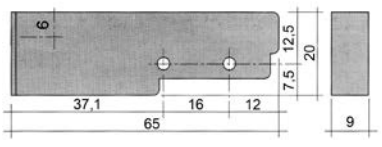
GEV No.	345116	Ref. No.	003003112 DW3003112
description	magnetic switch L 65mm W 20mm 1NO 250V 0.4A P max. 100W connection cable cable length 3000mm		
For models:	BB-2500, F, FP, GR300, GR800, K12T, K1600, K1600-ALTA-VELOCITA, K1700, K1800, K2100, K22, K2200, K23, K24, K2500, K2700, K3000, K3000+K10, K3100, K3100+K10, K3300, K3800, K3800+K10, K4000, K4400, K4400+K10, K5400, K5400+K10, KP202-E, KP2300, KP2300+KP23, KP2800, KP3000, KP302-E, KP4000, KP402-E, KT-1500		
accessories for	345116		
	GEV No.	345399	Ref. No.
			00391046 391046 DW391046
	magnet \varnothing 3.3mm L 40mm H 8mm W 13mm hole distance 30mm M3		

\varnothing 9mm



1

GEV No.	345991	Ref. No.	002000309 DW2000309
description	magnetic switch 250V 0.04A P max. 10W probe L 30mm 1NO connection cable cable length 2000mm		
For models:	BK12, BK13, F1-KF1, F2-KF2, KP149, KP150, KP151, KP151-E, KP200, KP200-ELETTRONICA, KP300, KP300-ELETTRONICA, KP400, KP400-ELETTRONICA		

accessories

magnets



1

GEV No.	347702	Ref. No.	003003113 DW3003113
description	magnet H 10mm ED \varnothing 12mm		
For models:	F, FP, K1600, K1600-ALTA-VELOCITA, K1800, K2100, K2200, K2500, K3000, K3000+K10, K3100, K3100+K10, K3300, K3800, K3800+K10, K4000, K4400, K4400+K10, K5400, K5400+K10, KP2300, KP2300+KP23, KP2800, KP3000, KP4000, KT-1500		

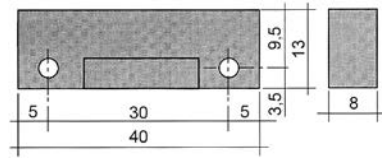
1

GEV No.	345399	Ref. No.	00391046 DW391046
description	magnet \varnothing 3.3mm L 40mm H 8mm W 13mm hole distance 30mm M3		
For models:	K1700, K2700		



GEV No.	345336	Ref. No.	0080232 DW80232
description	magnet \varnothing 4.8mm L 63mm H 11mm W 18.8mm hole distance 51mm M4		
For models:	GR300, GR800, K1600, K1600-ALTA-VELOCITA, K1800, K2100, K2200, K23, K2500, K3000, K3000+K10, K3100, K3100+K10, K3300, K3800, K3800+K10, K4000, K4400, K4400+K10, K5400, K5400+K10, KP149, KP150, KP151, KP151-E, KP200, KP200-ELETRONICA, KP202-E, KP300, KP300-ELETRONICA, KP302-E, KP400, KP400-ELETRONICA, KP402-E		

magnetic holders			
GEV No.	524076	Ref. No.	003003058 003003058+003004184 3003058+3004184 DW3003058 DW3003058+DW3004184
description	magnet holder internal size 13mm H 60mm for dishwasher		
For models:	K1600, K1600-ALTA-VELOCITA, K1800, K2100, K2200, K2500, K3000, K3000+K10, K3100, K3100+K10, K3300, K3800, K3800+K10, K4000, K4400, K4400+K10, K5400, K5400+K10, KP2300, KP2300+KP23, KP2800, KP3000, KP4000, KT-1500		
accessories for	524076		
	GEV No.	524655	Ref. No.
			003004184 3004184 DW3004184
screw cap for magnet holder thread M16x1.25 SS WS 19			

GEV No.	524655	Ref. No.	003004184 DW3004184
description	screw cap for magnet holder thread M16x1.25 SS WS 19		

control equipment

ERSCE

push buttons

GEV No.	346654	Ref. No.	002000284 DW2000284
description	push button mounting measurements \varnothing 22mm green illuminated		
For models:	F, FP, K2500, K3000, K3000+K10, K3100, K3100+K10, K3300, K3800, K3800+K10, K4000, K4400, K4400+K10, K5400, K5400+K10, KP3000, KP4000, KT-1500		

GEV No.	346659	Ref. No.	003002052 DW3002052
description	contact block ERSCE C02 2NC max 400V 10(4)A red/red		
For models:	BB-2500, F, FP, K11, K11A, K12, K12-90, K14, K14A, K1600, K1600-ALTA-VELOCITA, K1800, K2100, K2200, K24, K2500, K3000, K3000+K10, K3100, K3100+K10, K3300, K3800, K3800+K10, K4000, K4400, K4400+K10, K5400, K5400+K10, KP2300, KP2300+KP23, KP2800, KP3000, KP4000, KT-1500		

GEV No.	346658	Ref. No.	003002051 DW3002051
description	contact block ERSCE C02 2NO max 400V 10(4)A green/green		
For models:	BB-2500, F, FP, K2500, K3000, K3000+K10, K3100, K3100+K10, K3300, K3800, K3800+K10, K4000, K4400, K4400+K10, K5400, K5400+K10, KP3000, KP4000, KT-1500		

TELEMECANIQUE (EFA)

XB4 series

GEV No.	347497	Ref. No.	003002056 DW3002056
description	contact block 2NC colour coding red		
For models:	BB-2500, F, FP, K1600, K1600-ALTA-VELOCITA, K1700, K1800, K2100, K2200, K2500, K2700, K3000, K3000+K10, K3100, K3100+K10, K3300, K3800, K3800+K10, K4000, K4400, K4400+K10, K5400, K5400+K10, K90, KP2300, KP2300+KP23, KP2800, KP3000, KP4000, KT-1500		





 <p>1</p>			
GEV No.	347496	Ref. No.	003002054 DW3002054
description	contact block 2NO colour coding green		
For models:	BB-2500, F, FP, K1600, K1600-ALTA-VELOCITA, K1700, K1800, K2100, K2200, K2500, K2700, K3000, K3000+K10, K3100, K3100+K10, K3300, K3800, K3800+K10, K4000, K4400, K4400+K10, K5400, K5400+K10, K90, KP200, KP2300, KP2300+KP23, KP2800, KP300, KP3000, KP400, KP4000, KT-1500		

 <p>1</p>			
GEV No.	347728	Ref. No.	002000230 DW2000230
description	signal element mounting measurements ø22mm yellow metal		
For models:	K2500, K3000, K3000+K10, K3100, K3100+K10, K3300, K3800, K3800+K10, K4000, K4400, K4400+K10, K5400, K5400+K10, KP3000, KP4000		

<p>signal element</p>  <p>1</p>			
GEV No.	347700	Ref. No.	002000232 DW2000232
description	signal element mounting measurements ø22mm green metal		
For models:	K2500, K3000, K3000+K10, K3100, K3100+K10, K3300, K3800, K3800+K10, K4000, K4400, K4400+K10, K5400, K5400+K10, KP3000, KP4000		

<p>momentary mushroom switches</p>  <p>1</p>			
GEV No.	347485	Ref. No.	003002050 DW3002050
description	emergency switch mounting measurements ø22mm red		
For models:	BB-2500, F, FP, K1600, K1600-ALTA-VELOCITA, K1700, K1800, K2100, K2200, K2500, K2700, K3000, K3000+K10, K3100, K3100+K10, K3300, K3800, K3800+K10, K4000, K4400, K4400+K10, K5400, K5400+K10, KP2300, KP2300+KP23, KP2800, KP3000, KP4000, KT-1500		

 <p>1</p>			
GEV No.	347730	Ref. No.	002000234 DW2000234
description	signal element mounting measurements ø22mm metal		
For models:	F, FP, K2500, K3000, K3000+K10, K3100, K3100+K10, K3300, K3800, K3800+K10, K4000, K4400, K4400+K10, K5400, K5400+K10, KP3000, KP4000		

<p>rotary switches</p>  <p>1</p>			
GEV No.	347729	Ref. No.	002000311 DW2000311
description	rotary selector mounting measurements ø22mm black		
For models:	K2500, K3000, K3000+K10, K3100, K3100+K10, K3300, K3800, K3800+K10, K4000, K4400, K4400+K10, K5400, K5400+K10, K90, KP3000, KP4000, KT-1500		

 <p>1</p>			
GEV No.	347727	Ref. No.	002000231 DW2000231
description	signal element mounting measurements ø22mm red metal		
For models:	K2500, K3000, K3000+K10, K3100, K3100+K10, K3300, K3800, K3800+K10, K4000, K4400, K4400+K10, K5400, K5400+K10, KP3000, KP4000		

<p>miscellaneous</p>  <p>1</p>			
GEV No.	347698	Ref. No.	003002055 DW3002055
description	push button mounting measurements ø22mm black metal		
For models:	BB-2500, F, FP, K1600, K1600-ALTA-VELOCITA, K1800, K2100, K2200, K2500, K3000, K3000+K10, K3100, K3100+K10, K3300, K3800, K3800+K10, K4000, K4400, K4400+K10, K5400, K5400+K10, KP2300, KP2300+KP23, KP2800, KP3000, KP4000, KT-1500		



1

GEV No.	347699	Ref. No.	002000310 DW2000310
description	rotary selector mounting measurements ø22mm black metal		
For models:	BB-2500, K2500, K3000, K3000+K10, K3100, K3100+K10, K3300, K3800, K3800+K10, K4000, K4400, K4400+K10, K5400, K5400+K10, KP3000, KP4000		

lamps



1

GEV No.	359807	Ref. No.	003002068 DW3002068
description	light bulb socket Ba9s 24V 2W ø 10mm L 28mm clear		
For models:	F, FP, K2500, K3000, K3000+K10, K3100, K3100+K10, K3300, K3800, K3800+K10, K4000, K4400, K5400, KP3000, KP4000		

lamps

indicator lights

indicator lights 2-piece (lens and indicator lamp)

indicator lamps for socket type SRZ / SDK / SDY / SFK



1

GEV No.	359132	Ref. No.	0015826 DW15826
description	indicator lamp green 250V connection male faston 6.3mm protection IP54 ambient temperature max. 85°C		
For models:	AQUA-35, AQUA-35-RL09, AQUA-37, AQUA-37-RL09, AQUA-40, AQUA-40-RL09, AQUA-50, AQUA-80, DUPLA-35, DUPLA-37, DUPLA-40, DUPLA-45, DUPLA-50, HOOD-110, HOOD-130, HOOD800SP-3D-GOGGLES-IMAX, K100, K36, K41-LUX, K45, K50, K70, K80, KP149, KP151, KP151-E, KP300, KP400, LUX-40, LUX-60, LUX-85		

indicator lights 3-piece (housing, lens and bulb)

lamps

light bulbs



1

GEV No.	359807	Ref. No.	003002068 DW3002068
description	light bulb socket Ba9s 24V 2W ø 10mm L 28mm clear		
For models:	F, FP, K2500, K3000, K3000+K10, K3100, K3100+K10, K3300, K3800, K3800+K10, K4000, K4400, K5400, KP3000, KP4000		

indicator lights (complete)

ø 6mm



1

GEV No.	359004	Ref. No.	0010711 DW10711
description	indicator light ø 6mm 230V green cable length 400mm temp.-resist. 106°C		
For models:	AQUA-35, AQUA-35-RL09, AQUA-37, AQUA-37-RL09, BM100, BM200, BM300, DUPLA-35, DUPLA-37, K36, KP150		

ø10mm

with screw socket



1

GEV No.	360148	Ref. No.	003002066 DW3002066
description	indicator light ø 10mm 24V green cable length 200mm socket screw base		
For models:	BB-2500, K1600, K1600-ALTA-VELOCITA, K1800, K2100, K2200, KP2300, KP2300+KP23, KP2800, KT-1500		

with plug-in socket



1

GEV No.	360111	Ref. No.	003002065 DW3002065
description	indicator light ø 10mm 24V red cable length 200mm socket screw base		
For models:	BB-2500, K1600, K1600-ALTA-VELOCITA, K1800, K2100, K2200, KP2300, KP2300+KP23, KP2800, KT-1500		

with plug-in socket



1

GEV No.	360502	Ref. No.	003002067 DW3002067
description	indicator light ø 10mm 24V yellow cable length 200mm socket screw base		
For models:	BB-2500, K1600, K1600-ALTA-VELOCITA, K1800, K2100, K2200, KP2300, KP2300+KP23, KP2800		

with plug-in socket





1

GEV No.	359139	Ref. No.	0010711/B DW10711/B
description	indicator light ø 10mm green 230V connection male faston 6.3mm Qty 1 pcs		
For models:	5M, 6+6M, 6+6T, 6M, 6T, 8+8T, 8T, K100, K120, K1L, K1R, K2L, K2M, K2R, K35, K37, K40, K45, K50, K60, K70, K80, K90, KP150, KP151-E, X1-TK20, X2-TK21		





ø12mm			
with screw socket			
			
1			
GEV No.	359027	Ref. No.	009108 DW9108
description	indicator light ø 12mm 250V green connection male faston 6.3mm		
For models:	BK21, S1, S2		

28.5x28.5mm			
lamps (complete)			
			
1			
GEV No.	345978	Ref. No.	0015862 DW15862
description	indicator light mounting measurements 28.5x28.5mm 230V green		
For models:	K120		

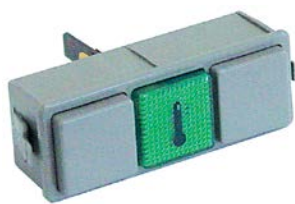
28.5x52.6mm			
			
1			
GEV No.	345877	Ref. No.	0015899/A DW15899/A
description	indicator light mounting measurements 28.5x52.6mm 230V green connection male faston 6.3mm protection IP40 ambient temperature max. 85°C		

28.5x77.5mm			
			
1			
GEV No.	345873	Ref. No.	0015889 DW15889
description	indicator light mounting measurements 28.5x77.5mm 230V green connection male faston 6.3mm protection IP40 ambient temperature max. 85°C		
For models:	K70		

30x22mm			
			
1			
GEV No.	345985	Ref. No.	0015051 DW15051
description	indicator light mounting measurements 30x22mm 230V green		
accessories for	345985		
	GEV No.	301036	Ref. No.
			—
	protective cover internal size 30x22mm for rocker switch mounting measurementsmm		

LED

indicator lamps

mounting diameter 25mm

			
1			
GEV No.	360584	Ref. No.	00590066 DW590066
description	indicator light LED mounting ø 25mm 3VDC blue connection cable 1000mm 1W 350mA mounting thread M25x1.25		

			
1			
GEV No.	360585	Ref. No.	00590067 DW590067
description	indicator light LED mounting ø 25mm 3VDC green connection cable 1000mm 1W 350mA mounting thread M25x1.25		

			
1			
GEV No.	360583	Ref. No.	00590065 DW590065
description	indicator light LED mounting ø 25mm 3VDC red connection cable 1000mm 1W 350mA mounting thread M25x1.25		

accessories			
			
1			
GEV No.	357178	Ref. No.	00590068 DW590068
description	power supply for LEDs 3W primary 100-240V secondary 0.35A 50/60Hz KPB-3F351 Qty 1 pcs		

screw-on/push-on fit

light bulbs

for indicator lights



GEV No.	359807	Ref. No.	003002068 DW3002068
description	light bulb socket Ba9s 24V 2W ø 10mm L 28mm clear		
For models:	F, FP, K2500, K3000, K3000+K10, K3100, K3100+K10, K3300, K3800, K3800+K10, K4000, K4400, K5400, KP3000, KP4000		

1

GEV No.	360411	Ref. No.	0010708 DW10708
description	timer CDC 11803 engines 1 chambers 3 operation time 120s 230V shaft ømm shaft Lmm motor type M48R ATS		
spare parts for	360411		
	GEV No.	360118	Ref. No. —
	motor CDC pinion ø 4.9mm teeth 10 230V voltage AC 50/60Hz turn direction right motor ø 47mm H 19.3mm motor type M48R ATS for timer cable length 260mm 1.9/2.5W		

timers

programme timers



1

GEV No.	360291	Ref. No.	0010708/E DW10708/E
description	timer CDC 11803 engines 1 chambers 3 operation time 120s 115V shaft ømm shaft Lmm manuf. no. 11803F1 / 10708E motor type M48R ATS /60Hz connection F4.8 supply at 60Hz 115V		
For models:	AQUA-35-RL09, AQUA-37-RL09, AQUA-40-RL09, AQUA-50, DUPLA-35, DUPLA-40		
spare parts for	360291		
	GEV No.	360118	Ref. No. —
	motor CDC pinion ø 4.9mm teeth 10 230V voltage AC 50/60Hz turn direction right motor ø 47mm H 19.3mm motor type M48R ATS for timer cable length 260mm 1.9/2.5W		

1

GEV No.	360273	Ref. No.	0016064/A DW16064/A
description	timer CDC 11803 engines 1 chambers 3 operation time 18min 230V shaft ømm shaft Lmm manuf. no. 11803F1 / 16064/A motor type M48R ATS		
For models:	AQUA-35, AQUA-37, AQUA-40, AQUA-50, DUPLA-35, DUPLA-40, K100, K36, K40, K60, K70, K90, LUX-40, LUX-60		
spare parts for	360273		
	GEV No.	360118	Ref. No. —
	motor CDC pinion ø 4.9mm teeth 10 230V voltage AC 50/60Hz turn direction right motor ø 47mm H 19.3mm motor type M48R ATS for timer cable length 260mm 1.9/2.5W		



1

GEV No.	360467	Ref. No.	0010708/L old DW10708/L old
description	timer CDC 11803 engines 1 chambers 3 operation time 120s 230V shaft ømm shaft Lmm manuf. no. 11803F1 / 10708L motor type M48R ATS		

1

GEV No.	360569	Ref. No.	0010708/B DW10708/B
description	timer CDC 11804F engines 1 chambers 3 operation time 120s 230V 60Hz shaft ømm shaft Lmm manuf. no. 11804F1ADY000.0010 motor type M48R ATS voltage AC		
For models:	AQUA-35, AQUA-50, DUPLA-35, DUPLA-37, DUPLA-40, K37, K45, K50, K70, K80, LUX-40		

1

GEV No.	360290	Ref. No.	0010708/T DW10708/T
description	timer CDC 11804F engines 1 chambers 4 operation time 120s 230V shaft ømm shaft Lmm manif. no. 11804F1 / 10708T motor type M48R ATS connection F4.8		
For models:	AQUA-35, AQUA-35-RL09, AQUA-37-RL09, AQUA-40-RL09, AQUA-50, DUPLA-35, DUPLA-37, DUPLA-40, HOOD-110, K35, K40, K40-LUX, K45, K50, K70, K80, LUX-40		
spare parts for	360290		
	GEV No.	360118	Ref. No. —
	motor CDC pinion ø 4.9mm teeth 10 230V voltage AC 50/60Hz turn direction right motor ø 47mm H 19.3mm motor type M48R ATS for timer cable length 260mm 1.9/2.5W		



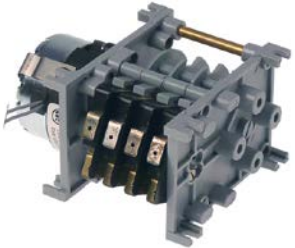

1

GEV No.	360427	Ref. No.	0010708/N DW10708/N
description	timer CDC 11804F engines 1 chambers 4 operation time 90s 230V shaft ømm shaft Lmm motor type M48R ATS		
For models:	DUPLA-35, DUPLA-40, HOOD-110, HOOD800SP-3D-GOGGLES-IMAX, K70, LUX-40		



1

GEV No.	360389	Ref. No.	0010300122 DW10300122
description	timer CDC 4904F engines 1 chambers 4 operation time 5min 230V shaft ømm shaft Lmm manif. no. 4904F3 / 10300122 motor type M48L ATS		
For models:	HOOD-130		
spare parts for	360389		
	GEV No.	360083	Ref. No. —
	motor CDC pinion ø 4.9mm teeth 10 230V turn direction left motor ø 47mm H 19.3mm motor type M48L ATS for timer		





1

GEV No.	360464	Ref. No.	0010300118 DW10300118
description	timer CDC 4904F engines 1 chambers 4 operation time 6min 230V 60Hz shaft ømm shaft Lmm voltage AC		
For models:	HOOD-110, HOOD800SP-3D-GOGGLES-IMAX, K100		



1

GEV No.	360297	Ref. No.	0010300121 DW10300121
description	timer CDC 4904F engines 1 chambers 4 operation time 6min 230V manif. no. 4904F3 / 10300121 motor type M48L ATS run-time 60/120/180s		
For models:	HOOD-110, HOOD800SP-3D-GOGGLES-IMAX, K100		
spare parts for	360297		
	GEV No.	360083	Ref. No. —
	motor CDC pinion ø 4.9mm teeth 10 230V turn direction left motor ø 47mm H 19.3mm motor type M48L ATS for timer		





1

GEV No.	360257	Ref. No.	0010300117 DW10300117
description	timer CDC 4904F engines 1 chambers 4 operation time 6min 230V shaft ømm shaft Lmm manif. no. 4904F3 / 360257 motor type M48L ATS		
For models:	K100, K120		
spare parts for	360257		
	GEV No.	360083	Ref. No. —
	motor CDC pinion ø 4.9mm teeth 10 230V turn direction left motor ø 47mm H 19.3mm motor type M48L ATS for timer		





1

GEV No.	360296	Ref. No.	0010300123 DW10300123
description	timer CDC 7804DV engines 2 chambers 4 operation time 6s / 3min 230V shaft ømm shaft Lmm manuf. no. 7804DV / 10300123 motor type M37RN/M37LN		
For models:	KP85-EL, LUX-60, LUX-85, LUX-85-ELETTRONICA		
spare parts for	360296		
	GEV No.	360119	Ref. No. —
	motor CDC pinion ø 5.4mm teeth 12 230V turn direction right motor ø 37mm motor type M37RN for timer		
	GEV No.	360131	Ref. No. —
	motor CDC pinion ø 5.4mm teeth 12 230V turn direction left motor ø 37mm motor type M37LN for timer		



1

GEV No.	360293	Ref. No.	0030001027 DW30001027
description	timer CDC 7804DV engines 2 chambers 4 operation time 6s / 3min 230V shaft ømm shaft Lmm manuf. no. 7804DV / 30001027 motor type M37RN/M37LN		
For models:	DUPLA-50, K60, LUX-60		
spare parts for	360293		
	GEV No.	360119	Ref. No. —
	motor CDC pinion ø 5.4mm teeth 12 230V turn direction right motor ø 37mm motor type M37RN for timer		
	GEV No.	360131	Ref. No. —
	motor CDC pinion ø 5.4mm teeth 12 230V turn direction left motor ø 37mm motor type M37LN for timer		



1



GEV No.	360295	Ref. No.	0022011 DW22011
description	timer CDC 7805DV engines 2 chambers 5 operation time 6s / 4min 230V shaft ømm shaft Lmm manuf. no. 7805DV / 22011 motor type M37RN/M37LN		
For models:	K90, KP149, KP150, KP151, KP151-E, KP85-EL, LUX-85, LUX-85-ELETTRONICA		
spare parts for	360295		
	GEV No.	360119	Ref. No. —
	motor CDC pinion ø 5.4mm teeth 12 230V turn direction right motor ø 37mm motor type M37RN for timer		

spare parts for 360295

	GEV No.	360131	Ref. No.	—
	motor CDC pinion ø 5.4mm teeth 12 230V turn direction left motor ø 37mm motor type M37LN for timer			





1

GEV No.	360294	Ref. No.	0030001031 DW30001031	
description	timer CDC 7806DV engines 2 chambers 6 operation time 6s / 3min 230V shaft ømm shaft Lmm manuf. no. 7806DV / 30001031 motor type M37RN/M37LN			
For models:	DUPLA-50, K60, KP85-EL, LUX-60, LUX-85, LUX-85-ELETTRONICA			
spare parts for	360294			
	GEV No.	360119	Ref. No.	—
	motor CDC pinion ø 5.4mm teeth 12 230V turn direction right motor ø 37mm motor type M37RN for timer			
	GEV No.	360131	Ref. No.	—
	motor CDC pinion ø 5.4mm teeth 12 230V turn direction left motor ø 37mm motor type M37LN for timer			



1

GEV No.	360346	Ref. No.	0030001032 DW30001032	
description	timer CDC 7806DV engines 2 chambers 6 operation time 6s / 3min 230V shaft ømm shaft Lmm manuf. no. 7806DV / 30001032 motor type M37RN/M37LN			
For models:	LUX-60			
spare parts for	360346			
	GEV No.	360119	Ref. No.	—
	motor CDC pinion ø 5.4mm teeth 12 230V turn direction right motor ø 37mm motor type M37RN for timer			
	GEV No.	360131	Ref. No.	—
	motor CDC pinion ø 5.4mm teeth 12 230V turn direction left motor ø 37mm motor type M37LN for timer			

1

GEV No.	360289	Ref. No.	0010708/L DW10708/L
description	timer CROUZET engines 1 chambers 2 operation time 120s 230V shaft ømm shaft Lmm manif. no. 627/5309 motor type 600		
For models:	AQUA-35, AQUA-37, AQUA-40, AQUA-50, AQUA-80, DUPLA-35, DUPLA-37, DUPLA-40, DUPLA-50, K35, K36, K37, K40, K40-LUX, K45, K50, K80, LUX-40		

mechanical timers



1

GEV No.	350032	Ref. No.	008030 DW8030
description	timer M2 2-pole operation time 15min impulse mechanical 2NO at 250V 16A permanent position no shaft ø 6x4.6mm shaft 6x4.6mm shaft L 18mm mounting distance 28mm connection rear		
For models:	F12, F6		
accessories for	350032		
	GEV No.	110366	Ref. No. —
	knob switch zero mark t.max.°C ø 44mm shaft ø 6x4.6mm shaft flat upper black		
	GEV No.	110371	Ref. No. —
	dial plate graduation 15min permanent position no rotation 30-330° ø 60mm timers knob ø 45mm		

contactors

GENERAL ELECTRIC (AEG)

power contactors



1

GEV No.	380239	Ref. No.	0010300391 0015086/B DW10300391 DW15086/B
description	power contactor resistive load 20A 230VAC (AC3/400V) 8.4A/4kW main contacts 3NO auxiliary contacts 1NC connection screw connection type LS05 01A type AEG LS05 01A type GE MC1A 301A		
For models:	AQUA-50, GR300, GR800, HOOD-110, HOOD-110-E, HOOD-130, HOOD-130-ELETRONICA, HOOD800SP-3D-GOGGLES-IMAX, K100, K120, K45, K50, K60, K70, K80, K90, KP130-ELETRONICA, KP151, KP151-E, KP70-EL, KP85-EL, LUX-40-ELETRONICA, LUX-41-ELETRONICA, LUX-60, LUX-60-ELETRONICA, LUX-61-ELETRONICA, LUX-70-EL, LUX-85, LUX-85-ELETRONICA		



1

GEV No.	380238	Ref. No.	0010300392 DW10300392
description	power contactor resistive load 20A 230VAC (AC3/400V) 8.4A/4kW main contacts 3NO auxiliary contacts 1NO connection screw connection type LS0510A type AEG LS0510A type GE MC1A 310A		
For models:	HOOD-110, HOOD-110-E, HOOD-130, HOOD-130-ELETRONICA, HOOD800SP-3D-GOGGLES-IMAX, K100, KP130-ELETRONICA		



1

GEV No.	380839	Ref. No.	002000370 DW2000370
description	power contactor resistive load 20A 24VAC (AC3/400V) 9A/4kW main contacts 3NO auxiliary contacts 1NO connection screw connection type LS0510A type AEG LS0510A type GE MC1A 310A		
For models:	BB-2500, F, FP, K11, K11A, K12, K12-90, K14, K14A, K1600, K1600-ALTA-VELOCITA, K1700, K1800, K2100, K22, K2200, K23, K24, K2500, K2700, K29, K3000, K3000+K10, K3100, K3100+K10, K3300, K3800, K3800+K10, K4000, K4400, K4400+K10, K5400, K5400+K10, KP2300, KP2300+KP23, KP2800, KP3000, KP4000, KT-1500		



1

GEV No.	380244	Ref. No.	0010300050 DW10300050
description	power contactor resistive load 25A 230VAC (AC3/400V) 9A/4kW main contacts 3NO auxiliary contacts 1NO connection screw connection type AEG LS4K 10A type GE CL00A 310		
For models:	GR300, GR800, HOOD-110, HOOD-110-E, HOOD-130, HOOD-130-ELETRONICA, HOOD800SP-3D-GOGGLES-IMAX, K100, K120, K90, KP130-ELETRONICA, KP149, KP150, KP151, KP151-E, KP200, KP200-ELETRONICA, KP202-E, KP300, KP300-ELETRONICA, KP302-E, KP400, KP400-ELETRONICA, KP402-E, KP85-EL, LUX-85, LUX-85-ELETRONICA		



1

GEV No.	381154	Ref. No.	0010300054 DW10300054
description	power contactor resistive load 32A 230VAC (AC3/400V) 17A/7.5kW main contacts 3NO auxiliary contacts 1NO connection screw connection type AEG type GE CL02A310R6		
For models:	HOOD-110, HOOD-110-E, HOOD-130, HOOD-130-ELETRONICA, HOOD800SP-3D-GOGGLES-IMAX, KP130-ELETRONICA, KP200-ELETRONICA, KP300, KP400, KP400-ELETRONICA		



1

GEV No.	381136	Ref. No.	002000380 DW2000380
description	power contactor resistive load 25A 24VAC (AC3/400V) 12A/5.5kW main contacts 3NO auxiliary contacts 1NO connection screw connection type AEG type GE CL01A310T1		
For models:	BB-2500, F, FP, K11, K11A, K1600, K1600-ALTA-VELOCITA, K1700, K1800, K2100, K2200, K2500, K2700, K3000, K3000+K10, K3100, K3100+K10, K3300, K3800, K3800+K10, K4000, K4400, K4400+K10, K5400, K5400+K10, KP2300, KP2300+KP23, KP2800, KP3000, KP4000, KT-1500		



1

GEV No.	380671	Ref. No.	002000385 DW2000385
description	power contactor resistive load 45A 24VAC (AC3/400V) 25A/11kW main contacts 3NO auxiliary contacts connection screw connection type AEG LS11K 00A type GE CL25A300T1		
For models:	BB-2500, F, FP, K11, K11A, K12, K12-90, K1600, K1600-ALTA-VELOCITA, K1700, K1800, K2100, K2200, K24, K2500, K2700, K3000, K3000+K10, K3100, K3100+K10, K3300, K3800, K3800+K10, K4000, K4400, K4400+K10, K5400, K5400+K10, KP2300, KP2300+KP23, KP2800, KP3000, KP4000, KT-1500		



1

GEV No.	380262	Ref. No.	0010300052 DW10300052
description	power contactor resistive load 32A 230VAC (AC3/400V) 17A/7.5kW main contacts 3NO auxiliary contacts 1NC connection screw connection type AEG LS7K01A type GE CL02A 301 H 85mm		
For models:	HOOD-110, HOOD-110-E, HOOD-130, HOOD-130-ELETRONICA, HOOD800SP-3D-GOGGLES-IMAX, KP130-ELETRONICA, KP200-ELETRONICA, KP70-EL, KP85-EL, LUX-60-ELETRONICA, LUX-70-EL, LUX-85, LUX-85-ELETRONICA		

motor protection circuit breakers



1

GEV No.	380940	Ref. No.	002000394 DW2000394
description	motor protection circuit breaker type GPS1BSAH setting range 2.5-4A DIN rail contacts screw clamp		
For models:	BB-2500, F, FP, K11, K11A, K12, K12-90, K1600, K1600-ALTA-VELOCITA, K1700, K1800, K2100, K2200, K24, K2500, K2700, K3000, K3000+K10, K3100, K3100+K10, K3300, K3800, K3800+K10, K4000, K4400, K4400+K10, K5400, K5400+K10, KP2300, KP2300+KP23, KP2800, KP3000, KP4000, KT-1500		





1

GEV No.	380939	Ref. No.	002000400 DW2000400
description	motor protection circuit breaker type GPs1B5AJ setting range 4-6.3A DIN rail connection screw		
For models:	BB-2500, F, FP, K12, K12-90, K1600, K1600-ALTA-VELOCITA, K1700, K1800, K2100, K2200, K24, K2500, K2700, K3000, K3000+K10, K3100, K3100+K10, K3300, K3800, K3800+K10, K4000, K4400, K4400+K10, K5400, K5400+K10, KP200, KP2300, KP2300+KP23, KP2800, KP3000, KP4000, KP-1500		

ISKRA (FANAL)

power contactors



1

GEV No.	380213	Ref. No.	0015086 DW15086
description	power contactor resistive load 20A 230VAC (AC3/400V) 8.5A/5.5kW main contacts 3NO auxiliary contacts 1NO connection screw connection type Fanal DSL7 10 type ISKRA K07M 10		
For models:	5M, 6+6M, 6+6T, 6M, 6T, 8+8T, 8T, AQUA-50, AQUA-80, DUPLA-45, DUPLA-50, GR300, GR800, HOOD-110, HOOD-110-E, HOOD-130, HOOD-130-ELETRONICA, HOOD800SP-3D-GOGGLES-IMAX, K100, K120, K40-LUX, K41-LUX, K45, K50, K60, K70, K80, K90, KP130-ELETRONICA, KP149, KP150, KP151, KP151-E, KP200, KP200-ELETRONICA, KP202-E, KP300, KP300-ELETRONICA, KP302-E, KP400, KP400-ELETRONICA, KP402-E, KP70-EL, KP85-EL, LUX-40, LUX-40-ELETRONICA, LUX-41-ELETRONICA, LUX-60, LUX-60-ELETRONICA, LUX-61-ELETRONICA...(Other models you can see in the webshop)		

ABL SURSUM

motor protection circuit breakers



1

GEV No.	380300	Ref. No.	002000390 DW2000390
description	motor protection circuit breaker type Mbs25-016 setting range 1-1.6A (AC3/400V) 0.55kW		
For models:	BB-2500, F, FP, K14, K14A, K1600, K1600-ALTA-VELOCITA, K1800, K2100, K22, K2200, K23, K24, K2500, K29, K3000, K3000+K10, K3100, K3100+K10, K3300, K3800, K3800+K10, K4000, K4400, K4400+K10, K5400, K5400+K10, KP200-ELETRONICA, KP2300, KP2300+KP23, KP2800, KP3000, KP4000, KP-1500		
accessories for	380300		
	GEV No.	380305	Ref. No. —
	auxiliary contact contacts 1NO/1NC HMS11		

relays

power relays

with DIN rail mounting

upper



1

GEV No.	380180	Ref. No.	00560301 DW560301
description	power relays FINDER 230VAC 16A 3CO connection male faston 6.3mm DIN rail manuf. no. 62.83.8.230.4007		
For models:	AQUA-80, DUPLA-45, DUPLA-50, HOOD-110, HOOD-130, HOOD-130-ELETRONICA, HOOD800SP-3D-GOGGLES-IMAX, K120, KP130-ELETRONICA		

with bracket mounting



GEV No.	380139	Ref. No.	0015620 DW15620
description	power relays FINDER 230VAC 16A 2CO connection F6.3 bracket mounting dimensions 68x38.2x35.8mm manuf. no. 62.82.8.230.0000		
For models:	AQUA-35, AQUA-35-RL09, AQUA-37, AQUA-37-RL09, AQUA-40, AQUA-40-RL09, AQUA-50, AQUA-80, BK12, BK13, DUPLA-35, DUPLA-37, DUPLA-40, DUPLA-50, F1-KF1, F2-KF2, HOOD-110, HOOD800SP-3D-GOGGLES-IMAX, K100, K45, K50, K70, K80, K90, KP150, KP151, KP151-E, KP85-EL, LUX-40, LUX-60, LUX-85, LUX-85-ELETTRONICA		



GEV No.	380403	Ref. No.	0016047 DW16047
description	power relays FINDER 230VAC 16A 3CO connection F6.3 bracket mounting manuf. no. 62.83.8.230.0500		
For models:	AQUA-35, AQUA-35-RL09, AQUA-37, AQUA-37-RL09, AQUA-40, AQUA-40-RL09, AQUA-50, DUPLA-35, DUPLA-40, K45, K50, K80, LUX-60		

plug-in/print relays

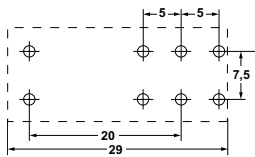

GEV No.	381151	Ref. No.	003006078 DW3006078
description	print relay 24VAC 2CO 2-pole at 250V 8A connection pins raster size 5mm FINDER manuf. no. 40.52.8.024.0000 95.65/95.75		
For models:	BB-2500, F, FP, K1600, K1600-ALTA-VELOCITA, K1700, K1800, K2100, K2200, K2500, K2700, K3000, K3000+K10, K3100, K3100+K10, K3300, K3800, K3800+K10, K4000, K4400, K4400+K10, K5400, K5400+K10, KP2300, KP2300+KP23, KP2800, KP3000, KP4000, KT-1500		



GEV No.	380941	Ref. No.	003006178 DW3006178
description	print relay 250VAC 2CO at 250V 8A connection pins raster size 5mm		

relay sockets

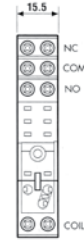
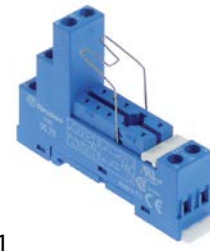

GEV No.	381181	Ref. No.	003006079 DW3006079	
description	relay socket 2-pole 40.51/40.52/40.61 connection screw clamp dimensions 15.8x78.6mm 250V voltage AC 10A FINDER manuf. no. 95.75			
For models:	BB-2500, F, FP, K1600, K1600-ALTA-VELOCITA, K1700, K1800, K2100, K2200, K2500, K2700, K3000, K3000+K10, K3100, K3100+K10, K3300, K3800, K3800+K10, K4000, K4400, K4400+K10, K5400, K5400+K10, KP2300, KP2300+KP23, KP2800, KP3000, KP4000, KT-1500			
accessories for	381181			
	GEV No.	381455	Ref. No.	—
	support bracket			

time relays

time relays



GEV No.	380878	Ref. No.	003006225 003006226 DW3006225 DW3006226
description	time relay FINDER 80.11.0.240 time range 0.1s-20h 12-240V AC/DC 16A mounting measurements DIN railmm 1CO connection grip connection		
For models:	BB-2500, F, FP, K11, K11A, K12, K12-90, K14, K14A, K1600, K1600-ALTA-VELOCITA, K1800, K2100, K2200, K24, K2500, K29, K3000, K3000+K10, K3100, K3100+K10, K3300, K3800, K3800+K10, K4000, K4400, K4400+K10, K5400, K5400+K10, KP2300, KP2300+KP23, KP2800, KT-1500		



electronic controllers

DIXELL

refrigeration controllers

built-in version



1

GEV No.	378249	Ref. No.	003006120 DW3006120
description	electronic controller DIXELL XR20C-1P3C0 mounting measurements 71x29mm 24V voltage AC/DC NTC/PTC relay outputs 1 CO-8A(3) NTC/PTC DI protection IP54 -50 up to +150°C display 3½ digits		
For models:	K2500, K3000, K3000+K10, K3100, K3100+K10, K3300, K3800, K3800+K10, K4000, K4400, K4400+K10, K5400, K5400+K10, KP3000, KP4000		

electronic thermometers

built-in version

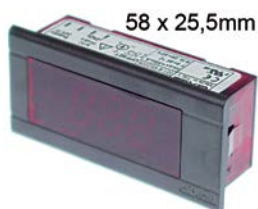

1

GEV No.	378046	Ref. No.	002000402 DW2000402
description	thermometer DIXELL XT11S mounting measurements 58x25.5mm 24V voltage AC/DC NTC 0 up to +60°C display 2½ digit 1 Templn1 NTC Digiln1 defr. funct. front measurements 31x64mm		
For models:	BB-2500, K1600, K1600-ALTA-VELOCITA, K1800, K2100, K2200, KP2300, KP2300+KP23, KP2800		

probes

universal probes

temperature probes



1

GEV No.	379161	Ref. No.	002000401 DW2000401
description	temperature probe NTC 10kOhm cable thermoplastic probe -40 up to +110°C cable -40 up to +110°C probe ø6x14mm cable length 3m without screw connection 2-wire		
For models:	BB-2500, K1600, K1600-ALTA-VELOCITA, K1800, K2100, K2200, KP2300, KP2300+KP23, KP2800		



1

GEV No.	379199	Ref. No.	003006121 DW3006121
description	temperature probe PTC 1kOhm cable PVC probe -50 up to +150°C cable -10 up to 100°C probe ø6x30mm cable length 5m without screw connection 2-wire		
For models:	K2500, K3000, K3000+K10, K3100, K3100+K10, K3300, K3800, K3800+K10, K4000, K4400, K4400+K10, K5400, K5400+K10, KP3000, KP4000		

producer-specific probes

probes



1

GEV No.	378347	Ref. No.	00590104 DW590104
description	temperature probe 2x NTC 10K cable silicone probe -40 up to +110°C cable -50 up to +180°C connection coded plug thread M10x1 probe ø6x15/32mm cable length 3m		



1

GEV No.	378248	Ref. No.	0050562 DW50562
description	temperature probe NTC 10kOhm cable PVC probe -40 up to +110°C cable -10 up to 100°C connection coded plug thread probe ø6x14mm cable length 2m		
For models:	GR300, GR800, HOOD-110-E, HOOD-130, HOOD-130-ELETTRONICA, K100, K120, K45, K50, K80, KP130-ELETTRONICA, KP151-E, KP200-ELETTRONICA, KP202-E, KP300-ELETTRONICA, KP302-E, KP400-ELETTRONICA, KP402-E, KP70-EL, KP85-EL, LUX-40-ELETTRONICA, LUX-41-ELETTRONICA, LUX-60, LUX-60-ELETTRONICA, LUX-61-ELETTRONICA, LUX-70-EL, LUX-85-ELETTRONICA		



1

GEV No.	378312	Ref. No.	00392047/A DW392047/A
description	temperature probe NTC 10kOhm cable PVC probe -40 up to +110°C cable -10 up to 100°C connection coded plug thread probe ø6x14mm cable length 3.5m		



1

GEV No.	378314	Ref. No.	003006165 DW3006165
description	temperature probe NTC 10kOhm cable silicone probe -40 up to +110°C cable -50 up to +180°C connection coded plug thread probe ø5x30mm cable length 0.35m		
For models:	F, FP, K1700, K2500, K2700, K3000, K3000+K10, K3100, K3100+K10, K3300, K3800, K3800+K10, K4000, K4400, K4400+K10, K5400, K5400+K10, KP3000, KP4000, KT-1500		





1

GEV No.	378313	Ref. No.	00392047 DW392047
description	temperature probe NTC 10kOhm cable silicone probe -40 up to +110°C cable -50 up to +180°C connection coded plug thread probe ø6x14mm cable length 3m		

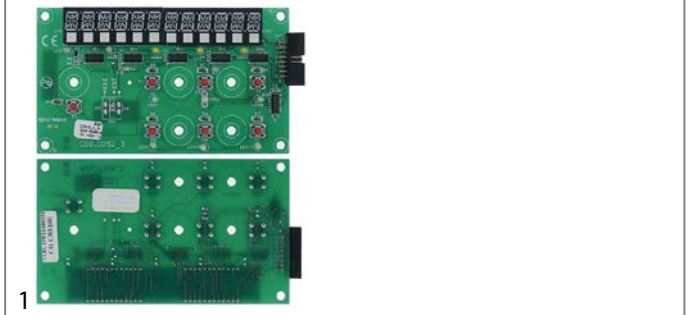

			
GEV No.	378268	Ref. No.	0050563 DW50563
description	temperature probe NTC cable silicone probe -40 up to +110°C cable -50 up to +180°C connection coded plug thread probe ø6x15mm cable length 1.1m		
For models:	KP200, KP200-ELETTRONICA, KP300, KP300-ELETTRONICA, KP400, KP400-ELETTRONICA		

			
GEV No.	403731	Ref. No.	0011600931 DW11600931
description	control PCB L 135mm W 80mm		
accessories for	403731		

	GEV No.	400706	Ref. No.	0050651 50651 DW50651
ribbon cable 16-pole L 1100mm plug type FC-16P raster size 2.54mm				

electronics

PCBs

			
GEV No.	403893	Ref. No.	0050553/F DW50553/F
description	control		

			
Image not available			

			
GEV No.	403222	Ref. No.	0050570/H DW50570/H
description	control PCB dishwasher AX 161/ AX 290 L 160mm W 115mm cable length 970mm with housing Qty 1 pcs		
For models:	K1700, K2700		

GEV No.	403891	Ref. No.	0050552 DW50552
description	keypad PCB		

			
GEV No.	403724	Ref. No.	50602 DW50602
description	control PCB dishwasher L 175mm W 30mm		

			
GEV No.	403231	Ref. No.	0050570/D DW50570/D
description	keypad PCB dishwasher 80E/81E L 155mm W 100mm with display H 25mm buttons 6		
For models:	KP202-E, KP302-E, KP402-E		

			
GEV No.	403288	Ref. No.	00590107 DW590107
description	control PCB dishwasher TWIN STAR L 157mm W 112mm with display buttons 6		

			
GEV No.	403221	Ref. No.	003006164 DW3006164
description	main PCB dishwasher AX 250/300/310/320/330 L 168mm W 148mm for display PCB Qty 1 pcs		
For models:	F, FP, K2500, K3000, K3000+K10, K3100, K3100+K10, K3300, K3800, K3800+K10, K4000, K4400, K4400+K10, K5400, K5400+K10, KP3000, KP4000, KT-1500		

1

GEV No.	403770	Ref. No.	0091120 DW91120
description	main PCB dishwasher L 190mm W 103mm		



1

GEV No.	403286	Ref. No.	00590105 DW590105
description	PCB dishwasher 116EK L 250mm W 118mm Qty 1 pcs		



1

GEV No.	403230	Ref. No.	0050603 DW50603
description	PCB dishwasher 125EU L 190mm W 110mm with housing H 70mm		



1

GEV No.	402687	Ref. No.	0050584 DW50584
description	PCB dishwasher DS40/DS50 for flow meter		
For models:	KP70-EL, KP85-EL, LUX-40-ELETTRONICA, LUX-41-ELETTRONICA, LUX-60-ELETTRONICA, LUX-61-ELETTRONICA, LUX-70-EL, LUX-85-ELETTRONICA		



1

GEV No.	402677	Ref. No.	0050580 DW50580
description	PCB dishwasher DS40/DS50 L 161mm W 90mm		
For models:	KP70-EL, KP85-EL, LUX-40-ELETTRONICA, LUX-41-ELETTRONICA, LUX-60-ELETTRONICA, LUX-61-ELETTRONICA, LUX-70-EL, LUX-85-ELETTRONICA		



1

GEV No.	403285	Ref. No.	0050553/E DW50553/E
description	PCB dishwasher D550 L 117mm W 96mm with housing H 43mm Qty 1 pcs		



1

GEV No.	403284	Ref. No.	0050604 DW50604
description	PCB dishwasher Elektron500 L 190mm W 110mm with housing programmable H 70mm Qty 1 pcs		



1

GEV No.	402676	Ref. No.	0050559 DW50559
description	PCB dishwasher HT11/12 L 102mm W 62mm timer		
For models:	GR300, HOOD-110-E, HOOD-130, HOOD-130-ELETTRONICA, K120, K45, K50, K80, KP130-ELETTRONICA, KP151-E, KP200-ELETTRONICA, KP202-E, KP300-ELETTRONICA, KP302-E, KP402-E, KP85-EL, LUX-60, LUX-60-ELETTRONICA, LUX-85-ELETTRONICA		



1

GEV No.	402682	Ref. No.	0050557 DW50557
description	PCB dishwasher HT600/HT11/HT12 L 160mm W 102mm timer run-time 60/100/180s		
For models:	HOOD-130, HOOD-130-ELETTRONICA, K100, K120, K45, K50, K80, KP130-ELETTRONICA		



1

GEV No.	402675	Ref. No.	0050581 DW50581
description	PCB dishwasher KD60 L 185mm W 30mm buttons 4		
For models:	KP70-EL, KP85-EL, LUX-40-ELETTRONICA, LUX-41-ELETTRONICA, LUX-60-ELETTRONICA, LUX-61-ELETTRONICA, LUX-70-EL, LUX-85-ELETTRONICA		
accessories for	402675		

	GEV No.	400066	Ref. No.	005058 0050589 5058 50589 DW5058 DW50589
--	----------------	--------	-----------------	---

ribbon cable 10-pole L 1000mm plug type FC-10P raster size 2.54mm



1

GEV No.	403283	Ref. No.	00540201 DW540201
description	PCB dishwasher Optima 400 L 190mm W 110mm with housing H 70mm Qty 1 pcs		



1

GEV No.	403282	Ref. No.	00561060 DW561060
description	PCB dishwasher Optima L 190mm W 110mm with housing H 70mm Qty 1 pcs		



1

GEV No.	403287	Ref. No.	00590106 DW590106
description	PCB dishwasher TWIN STAR L 215mm W 140mm Qty 1 pcs		



1

GEV No.	403558	Ref. No.	0050650 DW50650
description	PCB for dishwasher GR800/900/1000, LP2S, LP3S, LP4S8		
For models:	GR800		

central units



1

GEV No.	402683	Ref. No.	0050556 DW50556
description	control box timer operation time 3/6/9min		
For models:	KP200, KP200-ELETTRONICA, KP300, KP300-ELETTRONICA, KP400, KP400-ELETTRONICA		





1

GEV No.	402681	Ref. No.	0050553/A DW50553/A
description	control box timer run-time 50/120/180s		
For models:	HOOD-110, HOOD800SP-3D-GOGGLES-IMAX		



			
1			
GEV No.	402684	Ref. No.	0050569 DW50569
description	control box without EPROM		
For models:	GR300, HOOD-110-E, HOOD-130, HOOD-130-ELETTRONICA, KP130-ELETTRONICA, KP151-E, KP200-ELETTRONICA, KP202-E, KP300-ELETTRONICA, KP302-E, KP400-ELETTRONICA, KP402-E, KP85-EL, LUX-60, LUX-60-ELETTRONICA, LUX-85-ELETTRONICA		

			
1			
GEV No.	402685	Ref. No.	0050571 0050575 0050578 DW50571 DW50575 DW50578
description	keypad foil dishwasher H63/373E/144E L 134mm W 79mm buttons 6		
For models:	HOOD-110-E, HOOD-130-ELETTRONICA, KP130-ELETTRONICA, KP151-E, KP200-ELETTRONICA, KP202-E, KP300-ELETTRONICA, KP302-E, KP400-ELETTRONICA, KP402-E		

			
1			
GEV No.	379026	Ref. No.	0050553 DW50553
description	electronic timer for dishwasher		
For models:	AQUA-35, AQUA-35-RL09, AQUA-37, AQUA-37-RL09, AQUA-40, AQUA-40-RL09, AQUA-50, AQUA-80, DUPLA-35, DUPLA-37, DUPLA-40, DUPLA-45, DUPLA-50, HOOD-110, K70, LUX-60		

			
1			
GEV No.	403289	Ref. No.	0096704 DW96704
description	keypad foil dishwasher LP25/LP35/LP48/GR800/TwinStar blue L 200mm W 135mm buttons 6		
For models:	GR800		

keypads

front foils

			
1			
GEV No.	403256	Ref. No.	00560039 00560042 DW560039 DW560042
description	keypad foil dishwasher 20/29/83ELK 2055 blue L 557mm W 36mm buttons 4		

membrane keypads

			
1			
GEV No.	403732	Ref. No.	0011600933 DW11600933
description	keypad foil buttons 5 L 155mm W 95mm		

			
1			
GEV No.	402914	Ref. No.	00550256 00550262 DW550256 DW550262
description	keypad foil dishwasher G100/K90 blue L 190mm W 190mm		
For models:	K90		

keypad units

			
1			
GEV No.	402679	Ref. No.	0050570/C DW50570/C
description	keypad unit dishwasher 17U/70U buttons 6 L 158mm W 103mm		
For models:	KP151-E		



GEV No.	402913	Ref. No.	0050570/A DW50570/A
description	keypad unit dishwasher 37E/80E/81E/18ER/19E buttons 6 suitable for Dihr L 145mm W 90mm with cable		
For models:	KP200-ELETTRONICA, KP202-E, KP300-ELETTRONICA, KP400-ELETTRONICA		

GEV No.	402678	Ref. No.	0050570 DW50570
description	keypad unit dishwasher H63/373E/144E buttons 6 L 158mm W 103mm		
For models:	HOOD-110-E, HOOD-130-ELETTRONICA, KP130-ELETTRONICA, KP200-ELETTRONICA, KP300-ELETTRONICA, KP400-ELETTRONICA		
accessories for	402678		
			0050571 0050575 0050578 50571 50575 50578 DW50571 DW50575 DW50578
	GEV No.	402685	Ref. No.
			keypad foil dishwasher H63/373E/144E L 134mm W 79mm buttons 6

solenoid valves

solenoid valves (water)

ELBI

straight

GEV No.	373025	Ref. No.	0015099 DW15099
description	solenoid valve triple straight 230VAC inlet 3/4" outlet 11.5mm DN10 ELBI		
For models:	K36, K40, K40-LUX, LUX-40, LUX-40-ELETTRONICA		
spare parts for	373025		
	GEV No.	370467	Ref. No.
			—
			solenoid valve filter suitable for ELBI

<p>RPE</p>			
GEV No.	374017	Ref. No.	0010703 DW10703
description	solenoid valve single straight 230VAC inlet 3/4" outlet 10mm input 6l/min DN10 RPE polyamide flow regulating valve inlet white membranes NBR pressure range 0.2-10bar		
For models:	AQUA-35, AQUA-35-RL09, AQUA-37, AQUA-37-RL09, AQUA-40, AQUA-40-RL09, AQUA-50, AQUA-80, DUPLA-35, DUPLA-37, DUPLA-40, DUPLA-45, DUPLA-50, GR300, GR800, K40, K41-LUX, K45, K50, K60, K70, K80, KP202-E, KP302-E, KP402-E, KP70-EL, LUX-40, LUX-40-ELETTRONICA, LUX-41-ELETTRONICA, LUX-60, LUX-60-ELETTRONICA, LUX-61-ELETTRONICA, LUX-70-EL		

GEV No.	374016	Ref. No.	0030001000 DW30001000
description	solenoid valve single angled 230VAC inlet 3/4" outlet 13mm DN10 duty cycle 100% RPE polyamide		
For models:	HOOD-110, HOOD-110-E, HOOD-130, HOOD-130-ELETTRONICA, HOOD800SP-3D-GOGGLES-IMAX, K100, K120, K90, KP130-ELETTRONICA, KP149, KP150, KP151, KP151-E, KP85-EL, LUX-85, LUX-85-ELETTRONICA		

GEV No.	374060	Ref. No.	002000093 DW2000093
description	solenoid valve single angled 24V inlet 3/4" outlet 13mm DN10 duty cycle 100% RPE polyamide		
For models:	K14A, K1600, K1600-ALTA-VELOCITA, K1700, K2700, KT-1500		

solenoid valves with reducers



2-fold







GEV No.	374010	Ref. No.	002000094 DW2000094
description	solenoid valve double angled 24VAC inlet 3/4" outlet 14.5mm input 10-12l/min t.max. 60°C RPE plastic flow regulating valve inlet white		
For models:	K1700, K2700		



			
1			
GEV No.	370742	Ref. No.	0015214 DW15214
description	solenoid valve double straight 230VAC inlet 3/4" outlet 11.5mm input 10-12l/min t.max. 60°C RPE plastic flow regulating valve inlet white 1NO/1NC		

3-fold			
			
1			
GEV No.	371153	Ref. No.	002000095 DW2000095
description	solenoid valve triple angled 24V inlet 3/4" outlet 14mm input 10-12l/min t.max. 60°C RPE plastic flow regulating valve inlet white		
For models:	K1700, K2700		

TP			
			
			
1			
GEV No.	370021	Ref. No.	0015098 DW15098
description	solenoid valve double straight 230VAC inlet 3/4" outlet 11.5mm DN10 TP flow regulating valve inlet white		
For models:	AQUA-35, AQUA-35-RL09, AQUA-37, AQUA-37-RL09, AQUA-40, AQUA-40-RL09, AQUA-50, AQUA-80, DUPLA-35, DUPLA-37, DUPLA-40, DUPLA-45, DUPLA-50, HOOD-110, HOOD-110-E, HOOD-130, HOOD-130-ELETRONICA, HOOD800SP-3D-GOGGLES-IMAX, K100, K35, K36, K37, K40, K40-LUX, K45, K60, K70, KP130-ELETRONICA, KP70-EL, KP85-EL, LUX-40, LUX-40-ELETRONICA, LUX-60, LUX-60-ELETRONICA, LUX-70-EL, LUX-85, LUX-85-ELETRONICA		

spare parts for	370021		
	GEV No.	371013	Ref. No. —
solenoid coil TP 230VAC 50/60Hz			
accessories for	370021		
	GEV No.	371220	Ref. No. —
reducer TP flow rate 3l/min red tolerance ±15%			
	GEV No.	371221	Ref. No. —
reducer TP flow rate 5.5l/min yellow tolerance ±15%			
	GEV No.	371222	Ref. No. —
reducer TP flow rate 6l/min grey tolerance ±15%			
	GEV No.	371223	Ref. No. —
reducer TP flow rate 10l/min white tolerance ±15%			
	GEV No.	371224	Ref. No. —
reducer TP flow rate 12l/min bronze tolerance ±15%			

accessories for	370021		
	GEV No.	371225	Ref. No. —
reducer TP flow rate 16l/min light brown tolerance ±15%			
	GEV No.	371226	Ref. No. —
reducer TP flow rate 20l/min red tolerance ±15%			
	GEV No.	371230	Ref. No. —
reducer TP flow rate 0.25l/min red tolerance ±25%			
	GEV No.	371231	Ref. No. —
reducer TP flow rate 0.35l/min violet tolerance ±25%			
	GEV No.	371232	Ref. No. —
reducer TP flow rate 0.5l/min orange tolerance ±25%			
	GEV No.	371233	Ref. No. —
reducer TP flow rate 0.8l/min white tolerance ±25%			
	GEV No.	371234	Ref. No. —
reducer TP flow rate 1l/min light blue tolerance ±25%			
	GEV No.	371235	Ref. No. —
reducer TP flow rate 1.2l/min brown tolerance ±25%			
	GEV No.	371236	Ref. No. —
reducer TP flow rate 1.5l/min light brown tolerance ±25%			
	GEV No.	371237	Ref. No. —
reducer TP flow rate 2.5l/min yellow tolerance ±25%			
	GEV No.	371238	Ref. No. 0015115 15115 DW15115
reducer TP flow rate 3.4l/min dark green tolerance ±25%			
	GEV No.	371239	Ref. No. —
reducer TP flow rate 5l/min black tolerance ±25%			
	GEV No.	371240	Ref. No. —
reducer TP flow rate 8l/min blue tolerance ±20%			



			
			
1			
GEV No.	370022	Ref. No.	003000101 DW3000101
description	solenoid valve double straight 230VAC inlet 3/4" outlet 14mm DN10 TP		
For models:	K1600, K1800, K2100		
spare parts for	370022		
	GEV No.	371013	Ref. No. —
solenoid coil TP 230VAC 50/60Hz			

Table continues overleaf

accessories for		370022	
	GEV No.	371220	Ref. No. —
reducer TP flow rate 3l/min red tolerance ±15%			
	GEV No.	371221	Ref. No. —
reducer TP flow rate 5.5l/min yellow tolerance ±15%			
	GEV No.	371222	Ref. No. —
reducer TP flow rate 6l/min grey tolerance ±15%			
	GEV No.	371223	Ref. No. —
reducer TP flow rate 10l/min white tolerance ±15%			
	GEV No.	371224	Ref. No. —
reducer TP flow rate 12l/min bronze tolerance ±15%			
	GEV No.	371225	Ref. No. —
reducer TP flow rate 16l/min light brown tolerance ±15%			
	GEV No.	371226	Ref. No. —
reducer TP flow rate 20l/min red tolerance ±15%			
	GEV No.	371230	Ref. No. —
reducer TP flow rate 0.25l/min red tolerance ±25%			
	GEV No.	371231	Ref. No. —
reducer TP flow rate 0.35l/min violet tolerance ±25%			
	GEV No.	371232	Ref. No. —
reducer TP flow rate 0.5l/min orange tolerance ±25%			
	GEV No.	371233	Ref. No. —
reducer TP flow rate 0.8l/min white tolerance ±25%			
	GEV No.	371234	Ref. No. —
reducer TP flow rate 1l/min light blue tolerance ±25%			
	GEV No.	371235	Ref. No. —
reducer TP flow rate 1.2l/min brown tolerance ±25%			
	GEV No.	371236	Ref. No. —
reducer TP flow rate 1.5l/min light brown tolerance ±25%			
	GEV No.	371237	Ref. No. —
reducer TP flow rate 2.5l/min yellow tolerance ±25%			
	GEV No.	371238	Ref. No. 0015115 15115 DW15115
reducer TP flow rate 3.4l/min dark green tolerance ±25%			
	GEV No.	371239	Ref. No. —
reducer TP flow rate 5l/min black tolerance ±25%			
	GEV No.	371240	Ref. No. —
reducer TP flow rate 8l/min blue tolerance ±20%			





















 <small>componenti per elettromeccanica</small>			
 1			
GEV No.	370018	Ref. No.	003000100 DW3000100
description	solenoid valve single straight 230VAC inlet 3/4" outlet 14mm DN10 TP		
spare parts for	370018		
	GEV No.	371013	Ref. No. —
solenoid coil TP 230VAC 50/60Hz			
accessories for	370018		
	GEV No.	371220	Ref. No. —
reducer TP flow rate 3l/min red tolerance ±15%			
	GEV No.	371221	Ref. No. —
reducer TP flow rate 5.5l/min yellow tolerance ±15%			
	GEV No.	371222	Ref. No. —
reducer TP flow rate 6l/min grey tolerance ±15%			
	GEV No.	371223	Ref. No. —
reducer TP flow rate 10l/min white tolerance ±15%			
	GEV No.	371224	Ref. No. —
reducer TP flow rate 12l/min bronze tolerance ±15%			
	GEV No.	371225	Ref. No. —
reducer TP flow rate 16l/min light brown tolerance ±15%			
	GEV No.	371226	Ref. No. —
reducer TP flow rate 20l/min red tolerance ±15%			
	GEV No.	371230	Ref. No. —
reducer TP flow rate 0.25l/min red tolerance ±25%			
	GEV No.	371231	Ref. No. —
reducer TP flow rate 0.35l/min violet tolerance ±25%			
	GEV No.	371232	Ref. No. —
reducer TP flow rate 0.5l/min orange tolerance ±25%			
	GEV No.	371233	Ref. No. —
reducer TP flow rate 0.8l/min white tolerance ±25%			
	GEV No.	371234	Ref. No. —
reducer TP flow rate 1l/min light blue tolerance ±25%			
	GEV No.	371235	Ref. No. —
reducer TP flow rate 1.2l/min brown tolerance ±25%			
	GEV No.	371236	Ref. No. —
reducer TP flow rate 1.5l/min light brown tolerance ±25%			

Table continues overleaf



accessories for		370018		
GEV No.	371237	Ref. No.	—	
	reducer TP flow rate 2.5l/min yellow tolerance ±25%			
GEV No.	371238	Ref. No.	0015115 15115 DW15115	
	reducer TP flow rate 3.4l/min dark green tolerance ±25%			
GEV No.	371239	Ref. No.	—	
	reducer TP flow rate 5l/min black tolerance ±25%			
GEV No.	371240	Ref. No.	—	
	reducer TP flow rate 8l/min blue tolerance ±20%			

spare parts and accessories

reducers

outlet side

	1			
GEV No.	371238	Ref. No.	0015115 DW15115	
description	reducer TP flow rate 3.4l/min dark green tolerance ±25%			
For models:	AQUA-35, AQUA-35-RL09, AQUA-37, AQUA-37-RL09, AQUA-40, AQUA-40-RL09, AQUA-50, AQUA-80, DUPLA-35, DUPLA-37, DUPLA-40, DUPLA-45, DUPLA-50, HOOD-110, HOOD-110-E, HOOD800SP-3D-GOGGLES-IMAX, KP130-ELETTRONICA, KP70-EL, KP85-EL, LUX-40, LUX-40-ELETTRONICA, LUX-60, LUX-60-ELETTRONICA, LUX-70-EL, LUX-85, LUX-85-ELETTRONICA			

various

	1			
GEV No.	370636	Ref. No.	0015213 DW15213	
description	solenoid valve single CO 230VAC outlet 10.5mm MILANO 00168401 plastic 3-ways inlet 10.5mm 50/60Hz male faston 6.3mm			
For models:	AQUA-35-RL09, AQUA-37-RL09, AQUA-40-RL09			
accessories for	370636			
GEV No.	371142	Ref. No.	—	
	reducer for solenoid valve ø 8.2mm			

metal

BÜRKERT

solenoid valves (various)



GEV No.	370464	Ref. No.	003002030 DW3002030	
description	solenoid valve 2-ways 24VAC connection 1/2" DN 13mm t.max. -10 up to +90°C membranes NBR p max 10bar brass water			
For models:	BB-2500, F, FP, K14, K1600, K1600-ALTA-VELOCITA, K1800, K2100, K2200, K2500, K26, K26A, K3000, K3000+K10, K3100, K3100+K10, K3300, K3800, K3800+K10, K4000, K4400, K4400+K10, K5400, K5400+K10, KP2300, KP2300+KP23, KP2800, KP3000, KP4000, KT-1500, Optional-Steam			

pressure switches

for warewashing

ø 58mm with male faston 6.3mm

with connection horizontal



GEV No.	541136	Ref. No.	0080225 DW80225	
description	pressure control pressure range 100/18mbar connection 6mm ø 58mm pressure connection horizontal warewashing			
For models:	KP200, KP200-ELETTRONICA, KP70-EL, LUX-60-ELETTRONICA, LUX-61-ELETTRONICA, LUX-70-EL			



GEV No.	541975	Ref. No.	0090023 DW90023	
description	pressure control pressure range 190/60mbar connection 6mm ø 58mm pressure connection horizontal warewashing pressure connection ø 5.5mm			



GEV No.	541619	Ref. No.	0088110 DW88110
description	pressure control pressure range 250/40mbar connection 6mm ø 58mm pressure connection ø 6mm		
For models:	BB-2500, F, FP, GR300, GR800, HOOD-130, HOOD-130-ELETTRONICA, K120, K1600, K1600-ALTA-VELOCITA, K1700, K1800, K2100, K2200, K2500, K2700, K3000, K3000+K10, K3100, K3100+K10, K3300, K3800, K3800+K10, K4000, K4400, K4400+K10, K5400, K5400+K10, KP130-ELETTRONICA, KP202-E, KP2300, KP2300+KP23, KP2800, KP300, KP3000, KP300-ELETTRONICA, KP302-E, KP400, KP4000, KP400-ELETTRONICA, KP402-E, KT-1500		



GEV No.	541312	Ref. No.	0075950 DW75950
description	pressure control pressure range 86/59mbar connection 6mm ø 58mm pressure connection horizontal warewashing pressure connection ø 6mm		
For models:	HOOD-110, HOOD-110-E, KP149, KP151, KP151-E, LUX-41-ELETTRONICA, LUX-60-ELETTRONICA		

pressure transmitters



GEV No.	541314	Ref. No.	0010706/A DW10706/A
description	pressure control pressure range 46/26mbar connection 6mm ø 58mm pressure connection horizontal warewashing pressure connection ø 6mm		
For models:	AQUA-35, AQUA-35-RL09, AQUA-37, AQUA-37-RL09, AQUA-40, AQUA-40-RL09, AQUA-50, AQUA-80, DUPLA-35, DUPLA-37, DUPLA-40, DUPLA-45, DUPLA-50, F, FP, GR300, GR800, HOOD-110, HOOD-110-E, HOOD-130, HOOD-130-ELETTRONICA, HOOD800SP-3D-GOGLES-IMAX, K120, K2500, K35, K36, K37, K3800, K3800+K10, K40, K4000, K40-LUX, K41-LUX, K4400, K4400+K10, K45, K50, K5400, K5400+K10, K60, K70, K80, K90, KP130-ELETTRONICA, KP151, KP151-E, KP202-E, KP302-E, KP402-E, KP70-EL...(Other models you can see in the webshop)		



GEV No.	541149	Ref. No.	00540205 DW540205
description	pressure transmitter pressure range 0-30mbar output voltage 0.5-3.5VDC input voltage 5VDC max 200mbar		

miscellaneous



GEV No.	541133	Ref. No.	00540450 DW540450
description	pressure control pressure range 60/25mbar connection male faston 6.3mm ø 58mm pressure connection horizontal warewashing pressure connection ø 6mm		
For models:	LUX-40-ELETTRONICA		



GEV No.	541976	Ref. No.	00590100 DW590100
description	pressure control pressure range -10/-20mbar connection M8x1.25 ø 38mm		



GEV No.	541311	Ref. No.	0010300026 DW10300026
description	pressure control pressure range 76/38mbar connection 6mm ø 58mm pressure connection horizontal warewashing pressure connection ø 6mm		
For models:	K100, K90, KP150, KP151, KP200, KP85-EL, LUX-61-ELETTRONICA, LUX-85, LUX-85-ELETTRONICA		



GEV No.	541977	Ref. No.	003060195 DW3060195
description	pressure control pressure range 200-3000mbar connection 1/4" ø 38mm 250V 1CO 16A MA-TER pressure connection 1/4"		



flow meters and flow sensors

flow meters

miscellaneous



1

GEV No.	402680	Ref. No.	0050583 DW50583
description	flow meter pressure range 0.2-10bar connection 10mm L 69mm		
For models:	KP70-EL, KP85-EL, LUX-40-ELETTRONICA, LUX-41-ELETTRONICA, LUX-60-ELETTRONICA, LUX-61-ELETTRONICA, LUX-70-EL, LUX-85-ELETTRONICA		

fans

axial fans

import



1

GEV No.	601601 ¹	Ref. No.	003000118 DW3000118
description	axial fan L 119mm W 119mm H 38mm 230VAC 50/60Hz 22W bearing slide bearing manuf. no. DP200A2123XST.GN SUNON input current 0.14A		
For models:	BB-2500, F, FP, K1600, K1600-ALTA-VELOCITA, K1700, K1800, K2100, K2200, K2500, K2700, K3000, K3000+K10, K3100, K3100+K10, K3300, K3800, K3800+K10, K4000, K4400, K4400+K10, K5400, K5400+K10, KP2300, KP2300+KP23, KP2800, KT-1500		

¹with slide bearings

hot air fans

miscellaneous



1

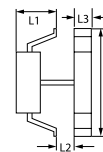

GEV No.	602149	Ref. No.	003000300 DW3000300
description	fan motor 230/400V 0.55W type N552		
For models:	K11, K11A, K13, K1600, K1600-ALTA-VELOCITA, K1700, K1800, K2100, K2200, K2500, K2700, K3000, K3000+K10, K3100, K3100+K10, K3300, K3800, K3800+K10, K4000, K4400, K4400+K10, K5400, K5400+K10		

motors

gear motors

for dishwashers



1

GEV No.	501405	Ref. No.	003000120 DW3000120
description	motor without gearbox 180/220W 230/400-280/480V 50/60Hz 3 phase 1.2/0.7-1.15/0.67A shaft ø 11mm shaft length 26mm flange ø 89mm 1340/1608rpm type MS63B-4 ø 119mm H 163mm L 215mm E.M.C. for drying 0.18/0.22kW		
For models:	F, FP, K14, K15, K1800, K2100, K2200, K2500, K26, K3000, K3000+K10, K3100, K3100+K10, K3300, K3800, K3800+K10, K4000, K4400, K4400+K10, K5400, K5400+K10, KP2300, KP2300+KP23, KP2800, KP3000, KP4000, KT-1500		



motors

for dishwashers



1

GEV No.	501477	Ref. No.	003000110 DW3000110
description	motor 260W 400V 50Hz 0.8A shaft ϕ 14mm shaft length 40mm flange ϕ 156mm 900rpm ϕ 140mm H 215mm OLYMPIA 0.26kW		
For models:	K1600-ALTA-VELOCITA, K1700, K2100, K22, K2200, K23, K24, K2500, K2700, K3000, K3000+K10, K3100, K3100+K10, K3300, K3800, K3800+K10, K4000, K4400, K4400+K10, K5400, K5400+K10, KP2300, KP2300+KP23, KP2800, KP3000, KP4000		



2

GEV No.	501405	Ref. No.	003000120 DW3000120
description	motor without gearbox 180/220W 230/400-280/480V 50/60Hz 3 phase 1.2/0.7-1.15/0.67A shaft ϕ 11mm shaft length 26mm flange ϕ 89mm 1340/1608rpm type MS63B-4 ϕ 119mm H 163mm L 215mm E.M.C. for drying 0.18/0.22kW		
For models:	F, FP, K14, K15, K1800, K2100, K2200, K2500, K26, K3000, K3000+K10, K3100, K3100+K10, K3300, K3800, K3800+K10, K4000, K4400, K4400+K10, K5400, K5400+K10, KP2300, KP2300+KP23, KP2800, KP3000, KP4000, KT-1500		

pumps



wash and rinse pumps

ALBA (C&A)

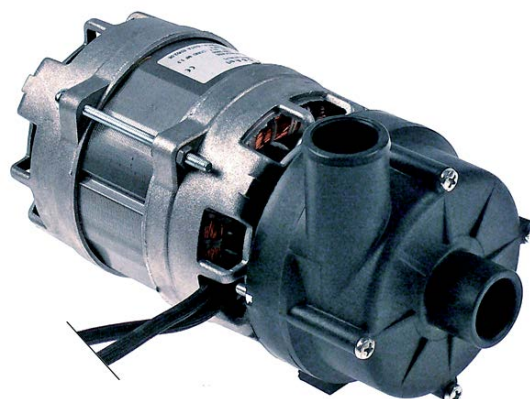
pumps







1



GEV No.	500298	Ref. No.	N/A
description	pump inlet ϕ 28mm outlet ϕ 28mm type C.902SX 230V 50Hz 1 phase 0.074kW 0.1HP L 200mm rotation direction right capacitor 6.3 μ F ALBA PUMPS (C&A)		
spare parts for	500298		
	GEV No.	365012	Ref. No. —
	operating capacitor capacity 6.3 μ F 450V tolerance 5% 50Hz ambient temperature max. -25 to +85°C ϕ 30mm L 61mm M8 plastic connection male faston 6.3mm protection		
	GEV No.	510693	Ref. No. 0010200055 0015080 0015080/E 10200055 15080 15080/E DW10200055 DW15080 DW15080/E
	mechanical shaft seal for shaft ϕ 12mm slide ring ext. ϕ 24mm slide ring H 15.5mm slide ring int. ϕ 11mm counter ring mounting ϕ 24mm height counter ring 8mm counter ring int. ϕ 13.5mm		
	GEV No.	532490	Ref. No. —
	O-ring EPDM thickness 2.62mm ID ϕ 72.69mm Qty 1 pcs		



1



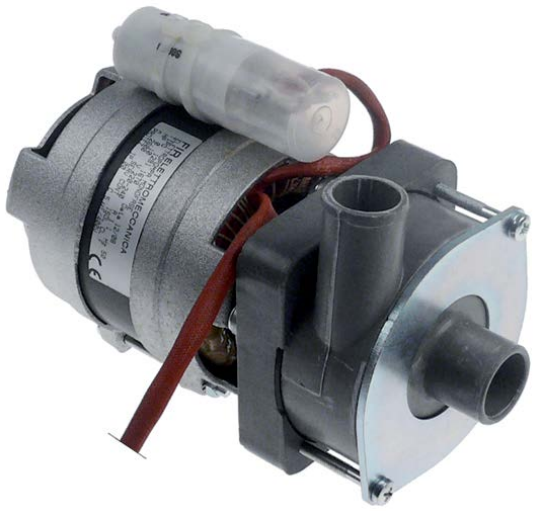

GEV No.	499016	Ref. No.	N/A	
description	pump inlet ø 62mm outlet ø 52mm type CM12040 230/400V 50Hz 3 phase 1.47kW 2HP L 342mm rotation direction left ALBA PUMPS (C&A)			
spare parts for	499016			
	GEV No.	508395	Ref. No.	—
	pump cover ALBA PUMPS (C&A) inlet ø 62mm outlet ø 52mm turn direction left ø 180mm ID ø 150mm inner height 38mm			
	GEV No.	510693	Ref. No.	0010200055 0015080 0015080/E 10200055 15080 15080/E DW10200055 DW15080 DW15080/E
	mechanical shaft seal for shaft ø 12mm slide ring ext. ø 24mm slide ring H 15.5mm slide ring int. ø 11mm counter ring mounting ø 24mm height counter ring 8mm counter ring int. ø 13.5mm			
	GEV No.	521039	Ref. No.	—
	fanwheel cover ID ø 156mm ED ø 161mm H 76mm for wash pump			
	GEV No.	521532	Ref. No.	—
	pump cover bottom part			

	1		
GEV No.	500532	Ref. No.	0010300057/A DW10300057/A
description	pump		
For models:	K120, KP149		





	1			
GEV No.	499004	Ref. No.	0010501/C old DW10501/C old	
description	pump inlet ø 28mm outlet ø 26mm type 1291.1670 230V 50Hz 1 phase 0.07kW 0.1HP L 195mm rotation direction right capacitor 5µF FIR			
spare parts for	499004			
	GEV No.	365017	Ref. No.	0010702 10702 DW10702
	operating capacitor capacity 5µF 450V tolerance 5% 50/60Hz ambient temperature max. -25 to +85°C ø 28mm L 54mm M8 plastic connection male faston 6.3mm 16.10.08 protection			

FIR			
pumps			
	1		
GEV No.	500531	Ref. No.	0010300057 DW10300057
description	pump		



GEV No.	501446	Ref. No.	0010508 Dw10508
description	pump inlet ø 28mm outlet ø 26mm type 4213E2250 220-240V 50Hz 1 phase 0.19kW 0.26HP L 190mm rotation direction left capacitor 5µF FIR		
For models:	HOOD-130, HOOD-130-ELETTRONICA, LUX-60, LUX-60-ELETTRONICA		
spare parts for	501446		
	GEV No.	365017	Ref. No. 0010702 10702 DW10702
	operating capacitor capacity 5µF 450V tolerance 5% 50/60Hz ambient temperature max. -25 to +85°C ø 28mm L 54mm M8 plastic connection male faston 6.3mm 16.10.08 protection		
	GEV No.	510384	Ref. No. —
	pump cover inlet ø 28mm outlet ø 26mm ø 100mm ID ø 76mm		
	GEV No.	510695	Ref. No. 0010505 10505 DW10505
	mechanical shaft seal height counter ring 5.5mm ID ø 11mm		
	GEV No.	521203	Ref. No. —
	impellor ø 72mm H 18mm thread M7 shaft ø 11mm shaft length 32mm blades 3		
	GEV No.	521703	Ref. No. 0010506 003786579 10506 3786579 DW10506 DW3786579
	pump cover gasket EPDM thickness 2.5mm ID ø 75mm Qty 1 pcs		







GEV No.	500527	Ref. No.	0015908/A DW15908/A
description	pump inlet ø 60mm outlet ø 50/30mm type 2233.B140 230V 50Hz 1 phase 0.55kW 0.75HP L 210mm rotation direction right capacitor 12.5µF FIR inlet ø 60mm		
For models:	K60, LUX-60, LUX-60-ELETTRONICA		
spare parts for	500527		
	GEV No.	365014	Ref. No. —
	operating capacitor capacity 12.5µF 450V tolerance 5%Hz ambient temperature max. -25 to +85°C ø 35mm L 70mm M8 plastic connecti- on male faston 6.3mm 45S.C3DS.12.5 protection		
	GEV No.	510552	Ref. No. 0015079/D 15079/D DW15079/D
	pump cover gasket pump type 1292-2/3942/3981/3911/3983		
	GEV No.	510608	Ref. No. 0015019/B 0015079/B 15019/B 15079/B DW15019/B DW15079/B
	impellor ø 93mm H 32mm shaft intake ø 9/8mm blades 6 inner high 11mm		
	GEV No.	510692	Ref. No. —
	mechanical shaft seal for shaft ø 11mm slide ring ext. ø 24mm slide ring H 13mm counter ring mounting ø 26mm height counter ring 8mm counter ring int. ø 14mm		
	GEV No.	521511	Ref. No. 0015031/E 0015031/ E+0012524 15031/E 15031/E+12524 DW15031/E DW15031/ E+DW12524
	pump cover inlet ø 60mm outlet ø 50/30mm supporting pressure M12x1.75 supporting pressure open pump type 2233 turn direction right ø 160mm ID ø 120mm inner high 23mm		







1			
GEV No.	500528	Ref. No.	0015908/D DW15908/D
description	pump inlet ø 60mm outlet ø 50mm type 4233.1500 230V 50Hz 1 phase 0.74kW 1HP L 220mm rotation direction right capacitor 16µF FIR		
For models:	K70, LUX-60, LUX-60-ELETTRONICA		
spare parts for	500528		
	GEV No.	365021	Ref. No. —
	operating capacitor capacity 16µF 425V tolerance 5% 50/60Hz ambient temperature max. -25 to +85°C ø 35mm L 73mm single M8 plastic connection male faston 6.3mm 416.10.99 protection		
	GEV No.	510552	Ref. No. 0015079/D 15079/D DW15079/D
	pump cover gasket pump type 1292-2/3942/3981/3911/3983		
	GEV No.	510693	Ref. No. 0010200055 0015080 0015080/E 10200055 15080 15080/E DW10200055 DW15080 DW15080/E
	mechanical shaft seal for shaft ø 12mm slide ring ext. ø 24mm slide ring H 15.5mm slide ring int. ø 11mm counter ring mounting ø 24mm height counter ring 8mm counter ring int. ø 13.5mm		
	GEV No.	517319	Ref. No. 0012524 12524 DW12524
	hose connector T1: M12x1.75 hose ø 11mm brass		
	GEV No.	521177	Ref. No. 0015912 15912 DW15912
	impellor ø 93mm H 23mm thread M10L suitable for FIR		
	GEV No.	521511	Ref. No. 0015031/E 0015031/ E+0012524 15031/E 15031/E+12524 DW15031/E DW15031/ E+DW12524
	pump cover inlet ø 60mm outlet ø 50/30mm supporting pressure M12x1.75 supporting pressure open pump type 2233 turn direction right ø 160mm ID ø 120mm inner height 23mm		



1			
GEV No.	499139	Ref. No.	0080912 DW80912
description	pump inlet ø 62mm outlet ø 62mm type 2275.2722 230/400V 50Hz 3 phase 2.6kW L 400mm rotation direction right FIR		
For models:	KP400, KP400-ELETTRONICA, KP402-E, Optional-Steam, Pumps		
spare parts for	499139		
	GEV No.	510687	Ref. No. 0080912/B 80912/B DW80912/B
	mechanical shaft seal for shaft ø 18mm height counter ring 8mm ID ø 17mm ED ø 39mm H 15mm mounting ø 42mm int. ø 121mm		
	GEV No.	521026	Ref. No. 0080912/D 80912/D DW80912/D
	pump cover gasket ID ø 182.5mm thickness 5x4.5mm		
	GEV No.	521028	Ref. No. 0080912/C 80912/C DW80912/C
	pump cover FIR inlet ø 62mm outlet ø 62mm turn direction right ø 215mm ID ø 175mm inner height 40mm		
	GEV No.	521277	Ref. No. 0080912/A 80912/A DW80912/A
	impellor ø 135mm H 39mm pump type Fir 2275 - 3.6HP thread M14L		
	GEV No.	524676	Ref. No. —
	fan wheel ø 160mm shaft intake ø 24mm plastic blades 12 W 30mm		





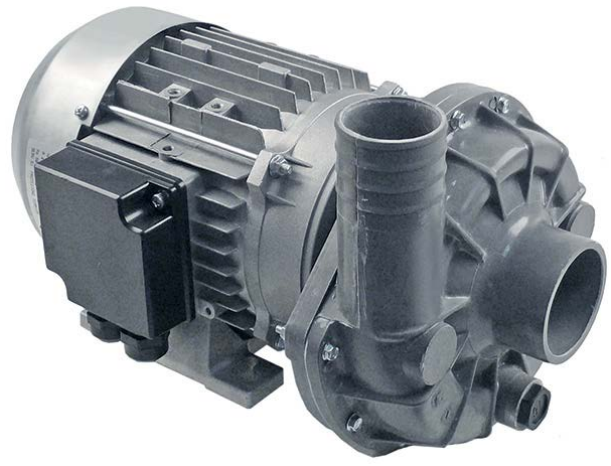

1

GEV No.	500155	Ref. No.	0010300058 DW10300058
description	pump inlet ø 63mm outlet ø 47mm type 1225 230V 50Hz 1 phase 1.1kW 1.5HP L 335mm rotation direction right capacitor 31.5µF FIR		
spare parts for	500155		
	GEV No.	365016	Ref. No. —
	operating capacitor capacity 31.5µF 400V tolerance 5%Hz ambient temperature max. -25 to +85°C ø 45mm L 95mm M8 plastic connection male faston 6.3mm protection		
	GEV No.	510602	Ref. No. —
	impellor ø 110mm H 34mm rotation direction right thread M8L shaft ø 28mm seat ø 12.2mm blades 6		
	GEV No.	510693	Ref. No. 0010200055 0015080 0015080/E 10200055 15080 15080/E DW10200055 DW15080 DW15080/E
	mechanical shaft seal for shaft ø 12mm slide ring ext. ø 24mm slide ring H 15.5mm slide ring int. ø 11mm counter ring mounting ø 24mm height counter ring 8mm counter ring int. ø 13.5mm		
	GEV No.	521513	Ref. No. 0010200222 10200222 DW10200222
	pump cover FIR inlet ø 63mm outlet ø 47mm turn direction right ID ø 150mm inner height 32mm		
	GEV No.	524416	Ref. No. 0010200290 10200290 DW10200290
	pump cover gasket thickness 4x4mm Qty 1 pcs		







1

GEV No.	500023	Ref. No.	0010300057 DW10300057
description	pump inlet ø 63mm outlet ø 47mm type 1225.2725 230/400V 50Hz 3 phase 1.1kW 1.5HP L 335mm rotation direction right FIR		
spare parts for	500023		
	GEV No.	510602	Ref. No. —
	impellor ø 110mm H 34mm rotation direction right thread M8L shaft ø 28mm seat ø 12.2mm blades 6		
	GEV No.	510693	Ref. No. 0010200055 0015080 0015080/E 10200055 15080 15080/E DW10200055 DW15080 DW15080/E
	mechanical shaft seal for shaft ø 12mm slide ring ext. ø 24mm slide ring H 15.5mm slide ring int. ø 11mm counter ring mounting ø 24mm height counter ring 8mm counter ring int. ø 13.5mm		
	GEV No.	521513	Ref. No. 0010200222 10200222 DW10200222
	pump cover FIR inlet ø 63mm outlet ø 47mm turn direction right ID ø 150mm inner height 32mm		
	GEV No.	524416	Ref. No. 0010200290 10200290 DW10200290
	pump cover gasket thickness 4x4mm Qty 1 pcs		



1

GEV No.	499297	Ref. No.	0088106 DW88106
description	pump inlet ø 63mm outlet ø 53mm type 1205.2820 230/400V 50Hz 3 phase 2.7HP L 330mm rotation direction left FIR		
For models:	F, FP, K2100, K2200, K2500, K3000, K3000+K10, K3100, K3100+K10, K3300, K3800, K3800+K10, K4000, K4400, K4400+K10, K5400, K5400+K10, KP151, KP151-E, KP2300, KP2300+KP23, KP300, KP3000, KP300-ELETTRONICA, KP302-E, KP4000, Optional-Steam, Pumps		
spare parts for	499297		
	GEV No.	510357	Ref. No. 0088222 88222 DW88222
	impellor ø 124mm H 34/16mm thread M8R blades 6		
	GEV No.	510523	Ref. No. —
	fan wheel ø 142mm shaft intake ø 15mm blades 12		
	GEV No.	510531	Ref. No. —
	pump cover FIR inlet ø 63mm outlet ø 53mm auxiliary pressure connection M16x1.5mm supporting pressure open turn direction left ø 185mm ID ø 150mm inner hight 37mm		
	GEV No.	510693	Ref. No. 0010200055 0015080 0015080/E 10200055 15080 15080/E DW10200055 DW15080 DW15080/E
	mechanical shaft seal for shaft ø 12mm slide ringext. ø 24mm slide ring H 15.5mm slide ring int. ø 11mm counter ring mounting ø 24mm height counter ring 8mm counter ring int. ø 13.5mm		

LOWARA

pumps



1

GEV No.	499255	Ref. No.	0015100/L DW15100/L
description	pump inlet ø 1 1/4" IT outlet ø 1" IT type CEAM/70/3/A 220-240V 50Hz 1 phase 0.6kW L 310mm rotation direction left capacitor 14µF LOWARA		
For models:	KP400, KP400-ELETTRONICA		

OLYMPIA

pumps



1











GEV No.	500521	Ref. No.	00135501 DW135501
description	pump inlet ø 1" IT outlet ø 26mm type T33 230V 50Hz 1 phase 0.25kW 0.34HP L 225mm rotation direction right capacitor 5µF auxiliary pressure connection 11mm supporting pressure closed OLYMPIA		
For models:	AQUA-40, K40, Pumps		
spare parts for	500521		
	GEV No.	365017	Ref. No. 0010702 10702 DW10702
	operating capacitor capacity 5µF 450V tolerance 5% 50/60Hz ambient temperature max. -25 to +85°C ø 28mm L 54mm M8 plastic connection male faston 6.3mm 16.10.08 protection		
	GEV No.	510693	Ref. No. 0010200055 0015080 0015080/E 10200055 15080 15080/E DW10200055 DW15080 DW15080/E
	mechanical shaft seal for shaft ø 12mm slide ringext. ø 24mm slide ring H 15.5mm slide ring int. ø 11mm counter ring mounting ø 24mm height counter ring 8mm counter ring int. ø 13.5mm		

Table continues overleaf





spare parts for		500521	
	GEV No.	521256	Ref. No.
			00133505 00135505 133505 135505 DW133505 DW135505
impellor ø 74mm H 14mm thread M10L shaft ø 12mm shaft length 7.5mm blades 8			
	GEV No.	521554	Ref. No.
			00135503 135503 DW135503
pump cover OLYMPIA inlet 1" ø 90mm ID ø 66mm inner high 5mm			
	GEV No.	521724	Ref. No.
			00135506 0025029 135506 25029 DW135506 DW25029
O-ring EPDM thickness 1.78mm ID ø 72.75mm Qty 1 pcs			
	GEV No.	528800	Ref. No.
			00135502 135502 DW135502
O-ring EPDM thickness 2.62mm ID ø 75.87mm Qty 1 pcs			



spare parts for		499257	
	GEV No.	365013	Ref. No.
			—
operating capacitor capacity 8µF 400V tolerance 5%Hz ambient temperature max. -25 to +85°C ø 31.5mm L 55mm M8 plastic connection male faston 6.3mm protection			
	GEV No.	509007	Ref. No.
			—
impellor ø 85mm H 20mm rotation direction left thread M10R shaft ø 12mm shaft length 7.5mm blades 12			
	GEV No.	510693	Ref. No.
			001020055 0015080 0015080/E 10200055 15080 15080/E DW10200055 DW15080 DW15080/E
mechanical shaft seal for shaft ø 12mm slide ring ext. ø 24mm slide ring H 15.5mm slide ring int. ø 11mm counter ring mounting ø 24mm height counter ring 8mm counter ring int. ø 13.5mm			
	GEV No.	521167	Ref. No.
			—
pump cover OLYMPIA inlet ø 1"mm outlet ø 30/30mm ID ø 94mm			





spare parts for		499257	
	GEV No.	521723	Ref. No.
			0018245 18245 DW18245
pump cover gasket EPDM thickness 2mm ID ø 90mm Qty 1 pcs			

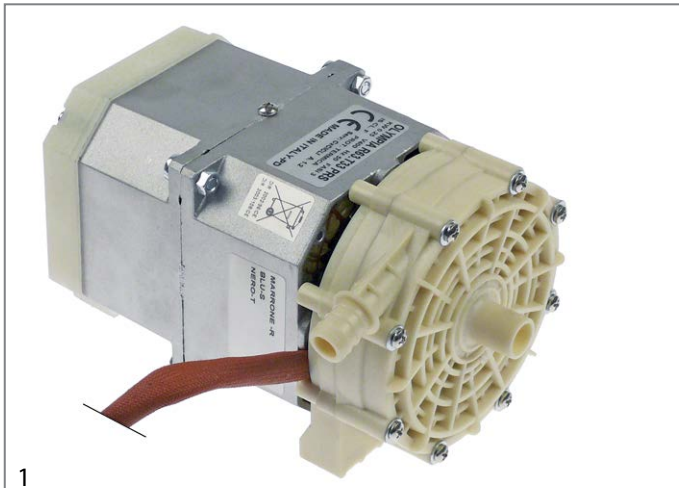

spare parts for		499131	
	GEV No.	365017	Ref. No.
			0010702 10702 DW10702
operating capacitor capacity 5µF 450V tolerance 5% 50/60Hz ambient temperature max. -25 to +85°C ø 28mm L 54mm M8 plastic connection male faston 6.3mm 16.10.08 protection			
	GEV No.	510693	Ref. No.
			001020055 0015080 0015080/E 10200055 15080 15080/E DW10200055 DW15080 DW15080/E
mechanical shaft seal for shaft ø 12mm slide ring ext. ø 24mm slide ring H 15.5mm slide ring int. ø 11mm counter ring mounting ø 24mm height counter ring 8mm counter ring int. ø 13.5mm			
	GEV No.	521168	Ref. No.
			—
pump cover OLYMPIA inlet ø 1"mm outlet ø 30mm pump type T.19DX			
	GEV No.	521169	Ref. No.
			—
impellor ø 64mm H 15mm pump type T.19DX thread M7R shaft ø 12mm shaft length 30mm			
	GEV No.	521723	Ref. No.
			0018245 18245 DW18245
pump cover gasket EPDM thickness 2mm ID ø 90mm Qty 1 pcs			





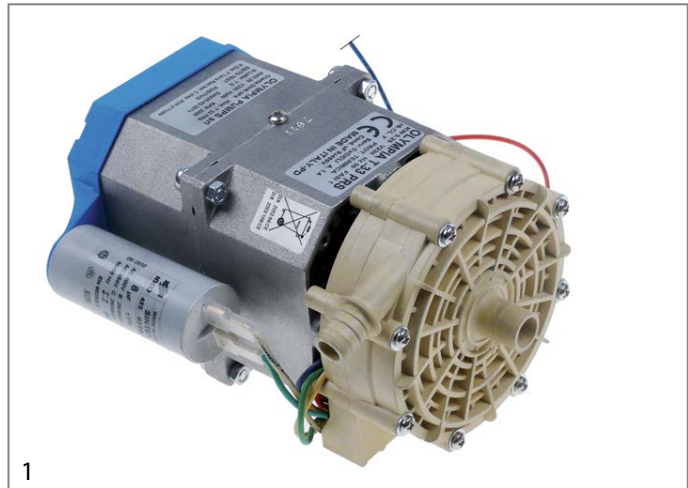

1





GEV No.	499258	Ref. No.	0015100/QO DW15100/QO
description	pump inlet ø 15mm outlet ø 13mm type R63.T33 PRS 400V 50Hz 3 phase 0.25kW L 185mm rotation direction left OLYMPIA		
spare parts for	499258		
	GEV No.	510693	Ref. No. 0010200055 0015080 0015080/E 10200055 15080 15080/E DW10200055 DW15080 DW15080/E
	mechanical shaft seal for shaft ø 12mm slide ring ext. ø 24mm slide ring H 15.5mm slide ring int. ø 11mm counter ring mounting ø 24mm height counter ring 8mm counter ring int. ø 13.5mm		
	GEV No.	521165	Ref. No. —
	pump cover OLYMPIA inlet ø 15mm outlet ø 13mm pump type R63.T33 PRS		
	GEV No.	521166	Ref. No. 0015100/U 15100/U DW15100/U
	impellor ø 90mm H 9mm pump type R63.T33 PRS thread M10R shaft ø 12mm shaft length 8mm		
	GEV No.	525022	Ref. No. —
	O-ring EPDM thickness 1.78mm ID ø 75.92mm Qty 1 pcs		







1

GEV No.	499095	Ref. No.	0015100/DO DW15100/DO
description	pump inlet ø 15mm outlet ø 14mm type T.33PRS 230V 50Hz 1 phase 0.25kW L 185mm rotation direction right capacitor 8µF OLYMPIA		
For models:	GR300, GR800, HOOD-110, HOOD-130, HOOD-130-ELETTRONICA, KP130-ELETTRONICA, KP151, KP151-E, KP202-E, KP302-E, KP402-E, KP85-EL, LUX-60, LUX-60-ELETTRONICA, LUX-85, LUX-85-ELETTRO-NICA		
spare parts for	499095		
	GEV No.	365013	Ref. No. —
	operating capacitor capacity 8µF 400V tolerance 5%Hz ambient temperature max. -25 to +85°C ø 31.5mm L 55mm M8 plastic connection male faston 6.3mm protection		
	GEV No.	510693	Ref. No. 0010200055 0015080 0015080/E 10200055 15080 15080/E DW10200055 DW15080 DW15080/E
	mechanical shaft seal for shaft ø 12mm slide ring ext. ø 24mm slide ring H 15.5mm slide ring int. ø 11mm counter ring mounting ø 24mm height counter ring 8mm counter ring int. ø 13.5mm		
	GEV No.	521165	Ref. No. —
	pump cover OLYMPIA inlet ø 15mm outlet ø 13mm pump type R63.T33 PRS		
	GEV No.	521166	Ref. No. 0015100/U 15100/U DW15100/U
	impellor ø 90mm H 9mm pump type R63.T33 PRS thread M10R shaft ø 12mm shaft length 8mm		







1			
GEV No.	499318	Ref. No.	0010501/A DW10501/A
description	pump inlet ø 28mm outlet ø 28mm type L63.T19 230V 50Hz 1 phase 0.19kW L 185mm rotation direction right capacitor 5µF OLYMPIA inlet ø 28mm outlet ø 28mm		
For models:	AQUA-35, AQUA-37, HOOD-110, HOOD-110-E, HOOD-130, HOOD-130-ELETRONICA, K120, K35, K36, K37, K90, KP130-ELETRONICA, KP149, KP151, KP151-E, KP200-ELETRONICA, KP202-E, KP300-ELETRONICA, KP302-E, KP85-EL, LUX-85, LUX-85-ELETRONICA, Pumps		
spare parts for	499318		
	GEV No.	365017	Ref. No. 0010702 10702 DW10702
	operating capacitor capacity 5µF 450V tolerance 5% 50/60Hz ambient temperature max. -25 to +85°C ø 28mm L 54mm M8 plastic connection male faston 6.3mm 16.10.08 protection		
	GEV No.	510693	Ref. No. 0010200055 0015080 0015080/E 10200055 15080 15080/E DW10200055 DW15080 DW15080/E
	mechanical shaft seal for shaft ø 12mm slide ring ext. ø 24mm slide ring H 15.5mm slide ring int. ø 11mm counter ring mounting ø 24mm height counter ring 8mm counter ring int. ø 13.5mm		
	GEV No.	521163	Ref. No.
	pump cover OLYMPIA inlet ø 28mm outlet ø 26mm pump type L63.T19		
	GEV No.	521164	Ref. No.
	impeller ø 64mm H 15mm pump type L63.T19 thread M7L shaft ø 12mm shaft length 30mm		
	GEV No.	521724	Ref. No. 00135506 0025029 135506 25029 DW135506 DW25029
	O-ring EPDM thickness 1.78mm ID ø 72.75mm Qty 1 pcs		



1			
GEV No.	499229	Ref. No.	0025021 DW25021
description	pump inlet ø 28mm outlet ø 30mm type L63.T19 230V 50Hz 1 phase 0.19kW L 215mm rotation direction right capacitor 5µF OLYMPIA		
For models:	AQUA-35-RL09, AQUA-37-RL09		
spare parts for	499229		
	GEV No.	365017	Ref. No. 0010702 10702 DW10702
	operating capacitor capacity 5µF 450V tolerance 5% 50/60Hz ambient temperature max. -25 to +85°C ø 28mm L 54mm M8 plastic connection male faston 6.3mm 16.10.08 protection		
	GEV No.	510693	Ref. No. 0010200055 0015080 0015080/E 10200055 15080 15080/E DW10200055 DW15080 DW15080/E
	mechanical shaft seal for shaft ø 12mm slide ring ext. ø 24mm slide ring H 15.5mm slide ring int. ø 11mm counter ring mounting ø 24mm height counter ring 8mm counter ring int. ø 13.5mm		
	GEV No.	521164	Ref. No.
	impeller ø 64mm H 15mm pump type L63.T19 thread M7L shaft ø 12mm shaft length 30mm		
	GEV No.	521170	Ref. No. 0025001 25001 DW25001
	pump cover OLYMPIA outlet ø 30mm auxiliary pressure connection 11mm pump type L63.T19		
	GEV No.	521724	Ref. No. 00135506 0025029 135506 25029 DW135506 DW25029
	O-ring EPDM thickness 1.78mm ID ø 72.75mm Qty 1 pcs		





1

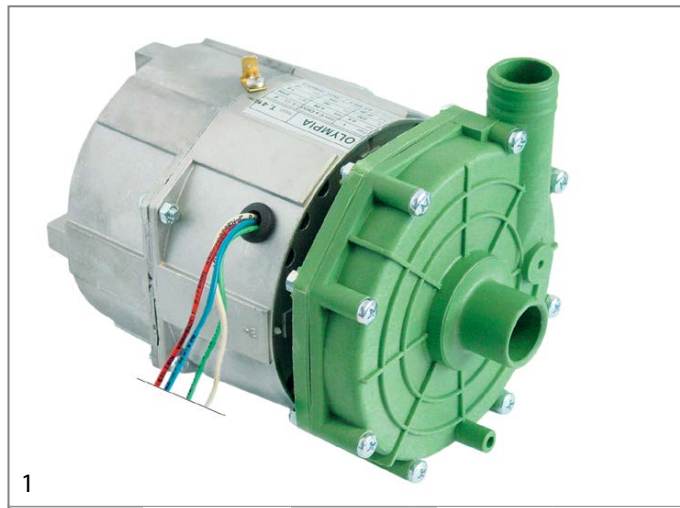



GEV No.	499256	Ref. No.	0025024 DW25024
description	pump inlet ø 28mm outlet ø 30mm type L63.T40 230V 50Hz 1 phase 0.4kW L 235mm rotation direction right capacitor 5µF OLYMPIA		
For models:	AQUA-37-RL09, AQUA-40-RL09		
spare parts for	499256		
	GEV No.	365017	Ref. No. 0010702 10702 DW10702
	operating capacitor capacity 5µF 450V tolerance 5% 50/60Hz ambient temperature max. -25 to +85°C ø 28mm L 54mm M8 plastic connection male faston 6.3mm 16.10.08 protection		
	GEV No.	510693	Ref. No. 0010200055 0015080 0015080/E 10200055 15080 15080/E DW10200055 DW15080 DW15080/E
	mechanical shaft seal for shaft ø 12mm slide ring ext. ø 24mm slide ring H 15.5mm slide ring int. ø 11mm counter ring mounting ø 24mm height counter ring 8mm counter ring int. ø 13.5mm		
	GEV No.	521170	Ref. No. 0025001 25001 DW25001
	pump cover OLYMPIA outlet ø 30mm auxiliary pressure connection 11mm pump type L63.T19		
	GEV No.	521171	Ref. No. 0025024/A 25024/A DW25024/A
	impellor ø 74mm H 16mm pump type L63.T40 thread M10L		
	GEV No.	521724	Ref. No. 00135506 0025029 135506 25029 DW135506 DW25029
	O-ring EPDM thickness 1.78mm ID ø 72.75mm Qty 1 pcs		







1

GEV No.	500522	Ref. No.	0016042 DW16042
description	pump inlet ø 29mm outlet ø 27mm type T41 230V 50Hz 1 phase 0.29kW 0.4HP L 200mm rotation direction left capacitor 8µF OLYMPIA		
spare parts for	500522		
	GEV No.	365013	Ref. No. —
	operating capacitor capacity 8µF 400V tolerance 5%Hz ambient temperature max. -25 to +85°C ø 31.5mm L 55mm M8 plastic connection male faston 6.3mm protection		
	GEV No.	510693	Ref. No. 0010200055 0015080 0015080/E 10200055 15080 15080/E DW10200055 DW15080 DW15080/E
	mechanical shaft seal for shaft ø 12mm slide ring ext. ø 24mm slide ring H 15.5mm slide ring int. ø 11mm counter ring mounting ø 24mm height counter ring 8mm counter ring int. ø 13.5mm		
	GEV No.	521259	Ref. No. 007135 7135 DW7135
	impellor ø 94mm H 11mm rotation direction left thread M10R blades 6		
	GEV No.	521555	Ref. No. 007133 7133 DW7133
	pump cover OLYMPIA inlet ø 29mm outlet ø 28mm ø 132mm ID ø 123mm inner height 18mm		
	GEV No.	521726	Ref. No. —
	pump cover gasket EPDM thickness 2mm ID ø 120mm Qty 1 pcs		







GEV No.	499296	Ref. No.	00590046 DW590046
description	pump inlet \varnothing 30mm outlet \varnothing 30mm type L71.T730_30 230V 50Hz 1 phase 0.52kW L 230mm rotation direction right capacitor 12.5 μ F OLYMPIA		
spare parts for	499296		
	GEV No.	365014	Ref. No. —
	operating capacitor capacity 12.5 μ F 450V tolerance 5%Hz ambient temperature max. -25 to +85°C \varnothing 35mm L 70mm M8 plastic connection male faston 6.3mm 45S.C3DS.12.5 protection		
	GEV No.	510554	Ref. No. 007130 7130 DW7130
	O-ring EPDM thickness 2mm ID \varnothing 120mm Qty 1 pcs		
	GEV No.	510693	Ref. No. 0010200055 0015080 0015080/E 10200055 15080 15080/E DW10200055 DW15080 DW15080/E
	mechanical shaft seal for shaft \varnothing 12mm slide ring ext. \varnothing 24mm slide ring H 15.5mm slide ring int. \varnothing 11mm counter ring mounting \varnothing 24mm height counter ring 8mm counter ring int. \varnothing 13.5mm		
	GEV No.	521159	Ref. No. —
	pump cover OLYMPIA inlet 30 inlet \varnothing 30mm auxiliary pressure connection 10mm pump type L71.T730_30		
	GEV No.	521160	Ref. No. —
	impellor \varnothing 97mm H 22mm thread M10L		

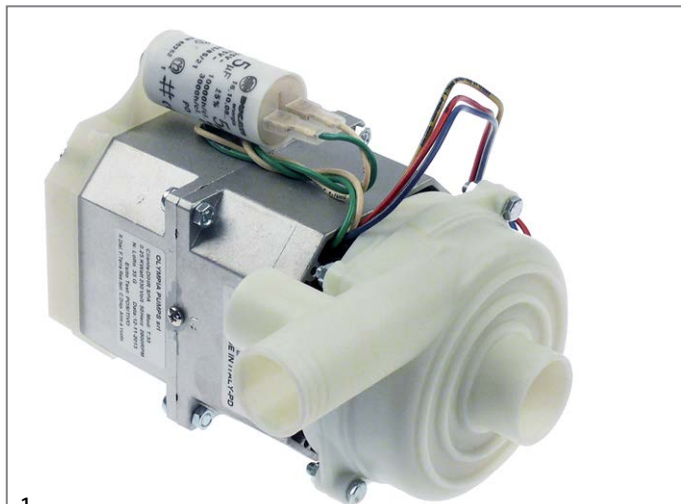

GEV No.	499295	Ref. No.	00590108 DW590108
description	pump inlet \varnothing 30mm outlet \varnothing 30mm type L71.T730_30 230V 50Hz 1 phase 0.52kW L 230mm rotation direction right capacitor 12.5 μ F OLYMPIA inlet \varnothing 30mm outlet \varnothing 30mm		
spare parts for	499295		
	GEV No.	365014	Ref. No. —
	operating capacitor capacity 12.5 μ F 450V tolerance 5%Hz ambient temperature max. -25 to +85°C \varnothing 35mm L 70mm M8 plastic connection male faston 6.3mm 45S.C3DS.12.5 protection		
	GEV No.	510554	Ref. No. 007130 7130 DW7130
	O-ring EPDM thickness 2mm ID \varnothing 120mm Qty 1 pcs		
	GEV No.	510693	Ref. No. 0010200055 0015080 0015080/E 10200055 15080 15080/E DW10200055 DW15080 DW15080/E
	mechanical shaft seal for shaft \varnothing 12mm slide ring ext. \varnothing 24mm slide ring H 15.5mm slide ring int. \varnothing 11mm counter ring mounting \varnothing 24mm height counter ring 8mm counter ring int. \varnothing 13.5mm		
	GEV No.	521159	Ref. No. —
	pump cover OLYMPIA inlet 30 inlet \varnothing 30mm auxiliary pressure connection 10mm pump type L71.T730_30		
	GEV No.	521160	Ref. No. —
	impellor \varnothing 97mm H 22mm thread M10L		







1

GEV No.	500520	Ref. No.	0018242 0018242B DW18242 DW18242B
description	pump inlet ø 33mm outlet ø 30/28mm type T33 230V 50Hz 1 phase 0.25kW 0.34HP L 190mm rotation direction left capacitor 5µF OLYMPIA		
For models:	AQUA-37, AQUA-40, K37, K40, K41-LUX, LUX-40, LUX-40-ELETTRONICA, LUX-41-ELETTRONICA, Pumps		
spare parts for	500520		
	GEV No.	365017	Ref. No. 0010702 10702 DW10702
	operating capacitor capacity 5µF 450V tolerance 5% 50/60Hz ambient temperature max. -25 to +85°C ø 28mm L 54mm M8 plastic connection male faston 6.3mm 16.10.08 protection		
	GEV No.	510693	Ref. No. 0010200055 0015080 0015080/E 10200055 15080 15080/E DW10200055 DW15080 DW15080/E
	mechanical shaft seal for shaft ø 12mm slide ring ext. ø 24mm slide ring H 15.5mm slide ring int. ø 11mm counter ring mounting ø 24mm height counter ring 8mm counter ring int. ø 13.5mm		
	GEV No.	521151	Ref. No.
	impellor ø 71mm H 19mm pump type OLYMPIA thread M10R shaft ø 12mm shaft length 8mm		
	GEV No.	521551	Ref. No. 0018247 18247 DW18247
	pump cover OLYMPIA inlet ø 33mm outlet ø 30mm outlet 2 ø 28 turn direction left ø 103mm ID ø 93mm inner height 30mm		
	GEV No.	521723	Ref. No. 0018245 18245 DW18245
	pump cover gasket EPDM thickness 2mm ID ø 90mm Qty 1 pcs		







1

GEV No.	500958	Ref. No.	0018300 DW18300
description	pump inlet ø 33mm outlet ø 30/28mm type T45 230V 50Hz 1 phase 0.33kW 0.45HP L 215mm rotation direction left capacitor 8µF OLYMPIA		
For models:	AQUA-40, K37, K40, LUX-40, LUX-40-ELETTRONICA		
spare parts for	500958		
	GEV No.	365013	Ref. No. —
	operating capacitor capacity 8µF 400V tolerance 5%Hz ambient temperature max. -25 to +85°C ø 31.5mm L 55mm M8 plastic connection male faston 6.3mm protection		
	GEV No.	510693	Ref. No. 0010200055 0015080 0015080/E 10200055 15080 15080/E DW10200055 DW15080 DW15080/E
	mechanical shaft seal for shaft ø 12mm slide ring ext. ø 24mm slide ring H 15.5mm slide ring int. ø 11mm counter ring mounting ø 24mm height counter ring 8mm counter ring int. ø 13.5mm		
	GEV No.	521257	Ref. No. 0018246 18246 DW18246
	impellor ø 80mm H 12mm rotation direction left thread M10R shaft ø 12mm shaft length 7.5mm blades 6		
	GEV No.	521551	Ref. No. 0018247 18247 DW18247
	pump cover OLYMPIA inlet ø 33mm outlet ø 30mm outlet 2 ø 28 turn direction left ø 103mm ID ø 93mm inner height 30mm		
	GEV No.	521723	Ref. No. 0018245 18245 DW18245
	pump cover gasket EPDM thickness 2mm ID ø 90mm Qty 1 pcs		





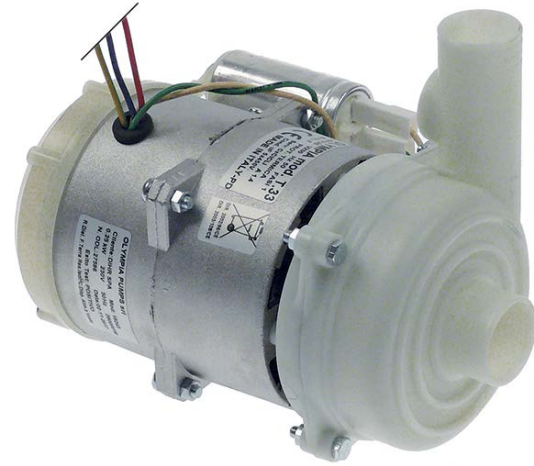

1





GEV No.	499320	Ref. No.	0010501/C DW10501/C
description	pump inlet ø 33mm outlet ø 30mm type L63.T20SX 230V 50Hz 1 phase 0.2kW L 200mm rotation direction right capacitor 5µF auxiliary pressure connection 10mm supporting pressure closed OLYMPIA		
For models:	BB-2500, F, FP, K2100, K2200, K2500, K26, K26A, K3000, K3000+K10, K3100, K3100+K10, K3300, K3800, K3800+K10, K4000, K4400, K4400+K10, K5400, K5400+K10		
spare parts for	499320		
	GEV No.	365017	Ref. No. 0010702 10702 DW10702
	operating capacitor capacity 5µF 450V tolerance 5% 50/60Hz ambient temperature max. -25 to +85°C ø 28mm L 54mm M8 plastic connection male faston 6.3mm 16.10.08 protection		
	GEV No.	510693	Ref. No. 001020055 0015080 0015080/E 10200055 15080 15080/E DW10200055 DW15080 DW15080/E
	mechanical shaft seal for shaft ø 12mm slide ring ext. ø 24mm slide ring H 15.5mm slide ring int. ø 11mm counter ring mounting ø 24mm height counter ring 8mm counter ring int. ø 13.5mm		
	GEV No.	521173	Ref. No.
	pump cover OLYMPIA inlet ø 33mm outlet ø 30mm auxiliary pressure connection 10mm pump type L63.T20SX		
	GEV No.	521174	Ref. No.
	impellor ø 60mm H 16mm pump type L63.T20SX shaft ø 12mm shaft length 8mm		
	GEV No.	521723	Ref. No. 0018245 18245 DW18245
	pump cover gasket EPDM thickness 2mm ID ø 90mm Qty 1 pcs		







1

GEV No.	500519	Ref. No.	0018243 DW18243
description	pump inlet ø 33mm outlet ø 30mm type T33 230V 50Hz 1 phase 0.25kW 0.34HP L 195mm rotation direction left capacitor 5µF OLYMPIA		
For models:	K40-LUX, LUX-40, LUX-40-ELETTRONICA, Pumps		
spare parts for	500519		
	GEV No.	365017	Ref. No. 0010702 10702 DW10702
	operating capacitor capacity 5µF 450V tolerance 5% 50/60Hz ambient temperature max. -25 to +85°C ø 28mm L 54mm M8 plastic connection male faston 6.3mm 16.10.08 protection		
	GEV No.	510693	Ref. No. 001020055 0015080 0015080/E 10200055 15080 15080/E DW10200055 DW15080 DW15080/E
	mechanical shaft seal for shaft ø 12mm slide ring ext. ø 24mm slide ring H 15.5mm slide ring int. ø 11mm counter ring mounting ø 24mm height counter ring 8mm counter ring int. ø 13.5mm		
	GEV No.	521257	Ref. No. 0018246 18246 DW18246
	impellor ø 80mm H 12mm rotation direction left thread M10R shaft ø 12mm shaft length 7.5mm blades 6		
	GEV No.	521553	Ref. No. 0018248 18248 DW18248
	pump cover OLYMPIA inlet ø 33mm outlet ø 30mm turn direction left ø 103mm ID ø 93mm inner high 25mm		
	GEV No.	521723	Ref. No. 0018245 18245 DW18245
	pump cover gasket EPDM thickness 2mm ID ø 90mm Qty 1 pcs		







1			
GEV No.	500523	Ref. No.	0016176 DW16176
description	pump inlet ø 50mm outlet ø 30mm type T5 230V 50Hz 1 phase 0.35kW 0.48HP L 205mm rotation direction right capacitor 10µF auxiliary pressure connection 10mm supporting pressure open OLYMPIA		
For models:	K45, Pumps		
spare parts for	500523		
	GEV No.	365015	Ref. No. 0018043 18043 DW18043
	operating capacitor capacity 10µF 400V tolerance 5%Hz ambient temperature max. -25 to +85°C ø 35.5mm L 59mm M8 plastic connection male faston 6.3mm protection		
	GEV No.	510554	Ref. No. 007130 7130 DW7130
	O-ring EPDM thickness 2mm ID ø 120mm Qty 1 pcs		
	GEV No.	510693	Ref. No. 0010200055 0015080 0015080/E 10200055 15080 15080/E DW10200055 DW15080 DW15080/E
	mechanical shaft seal for shaft ø 12mm slide ringext. ø 24mm slide ring H 15.5mm slide ring int. ø 11mm counter ring mounting ø 24mm height counter ring 8mm counter ring int. ø 13.5mm		
	GEV No.	521260	Ref. No. 0015079 15079 DW15079
	impellor ø 90mm H 12mm M10L type B		
	GEV No.	521556	Ref. No. 0016182 16182 DW16182
	pump cover OLYMPIA inlet ø 50mm outlet ø 30mm outlet 2 ø 30 auxiliary pressure connection 10mm supporting pressure open turn direction right ø 130mm ID ø 124mm inner height 20mm		



1			
GEV No.	500524	Ref. No.	0026176 DW26176
description	pump inlet ø 50mm outlet ø 30mm type T6 230V 50Hz 1 phase 0.48kW 0.65HP L 215mm rotation direction right capacitor 10µF OLYMPIA		
spare parts for	500524		
	GEV No.	365015	Ref. No. 0018043 18043 DW18043
	operating capacitor capacity 10µF 400V tolerance 5%Hz ambient temperature max. -25 to +85°C ø 35.5mm L 59mm M8 plastic connection male faston 6.3mm protection		
	GEV No.	510554	Ref. No. 007130 7130 DW7130
	O-ring EPDM thickness 2mm ID ø 120mm Qty 1 pcs		
	GEV No.	510693	Ref. No. 0010200055 0015080 0015080/E 10200055 15080 15080/E DW10200055 DW15080 DW15080/E
	mechanical shaft seal for shaft ø 12mm slide ringext. ø 24mm slide ring H 15.5mm slide ring int. ø 11mm counter ring mounting ø 24mm height counter ring 8mm counter ring int. ø 13.5mm		
	GEV No.	521262	Ref. No. 0022009/A 22009/A DW22009/A
	impellor ø 102mm H 19mm rotation direction right thread M10L blades 6		
	GEV No.	521556	Ref. No. 0016182 16182 DW16182
	pump cover OLYMPIA inlet ø 50mm outlet ø 30mm outlet 2 ø 30 auxiliary pressure connection 10mm supporting pressure open turn direction right ø 130mm ID ø 124mm inner height 20mm		







1

GEV No.	500525	Ref. No.	00150906 00150908 00150914 DW150906 DW150908 DW150914
description	pump inlet \varnothing 50mm outlet \varnothing 30mm type T7 230V 50Hz 1 phase 0.52kW 0.71HP L 230mm rotation direction right capacitor 12.5 μ F OLYMPIA		
For models:	AQUA-50, DUPLA-45, DUPLA-50, K50, KP70-EL, LUX-60, LUX-60-ELETT- RONICA, LUX-61-ELETRONICA, LUX-70-EL, Pumps		
spare parts for	500525		
	GEV No.	365014	Ref. No. —
	operating capacitor capacity 12.5 μ F 450V tolerance 5%Hz ambient temperature max. -25 to +85°C \varnothing 35mm L 70mm M8 plastic connecti- on male faston 6.3mm 45S.C3DS.12.5 protection		
	GEV No.	510554	Ref. No. 007130 7130 DW7130
	O-ring EPDM thickness 2mm ID \varnothing 120mm Qty 1 pcs		
	GEV No.	510693	Ref. No. 0010200055 0015080 0015080/E 10200055 15080 15080/E DW10200055 DW15080 DW15080/E
	mechanical shaft seal for shaft \varnothing 12mm slide ring ext. \varnothing 24mm slide ring H 15.5mm slide ring int. \varnothing 11mm counter ring mounting \varnothing 24mm height counter ring 8mm counter ring int. \varnothing 13.5mm		
	GEV No.	517368	Ref. No. 0015079/F 15079/F DW15079/F
	impellor \varnothing 102mm H 21mm rotation direction right thread M10L suitable for Dühr blades 8		
	GEV No.	521556	Ref. No. 0016182 16182 DW16182
	pump cover OLYMPIA inlet \varnothing 50mm outlet \varnothing 30mm outlet 2 \varnothing 30 auxiliary pressure connection 10mm supporting pressure open turn direction right \varnothing 130mm ID \varnothing 124mm inner height 20mm		







1

GEV No.	499260	Ref. No.	0022041 DW22041
description	pump inlet \varnothing 60mm outlet \varnothing 48mm type A.4.5/2.6 220-240/380- 415V 50Hz 3 phase 1.12kW 1.5HP L 310mm rotation direction right OLYMPIA		
For models:	HOOD-110, HOOD-110-E		
spare parts for	499260		
	GEV No.	510693	Ref. No. 0010200055 0015080 0015080/E 10200055 15080 15080/E DW10200055 DW15080 DW15080/E
	mechanical shaft seal for shaft \varnothing 12mm slide ring ext. \varnothing 24mm slide ring H 15.5mm slide ring int. \varnothing 11mm counter ring mounting \varnothing 24mm height counter ring 8mm counter ring int. \varnothing 13.5mm		
	GEV No.	521175	Ref. No. —
	pump cover OLYMPIA inlet \varnothing 60mm outlet \varnothing 48mm outlet 2 \varnothing 31 auxiliary pressure connection 10mm		
	GEV No.	521262	Ref. No. 0022009/A 22009/A DW22009/A
	impellor \varnothing 102mm H 19mm rotation direction right thread M10L blades 6		
	GEV No.	521727	Ref. No. 0015080/A 15080/A DW15080/A
	pump cover gasket EPDM thickness 1.78mm ID \varnothing 145mm Qty 1 pcs		



1

GEV No.	500529	Ref. No.	0015913 DW15913
description	pump inlet ø 60mm outlet ø 48mm type T12 230V 50Hz 1 phase 0.88kW 1.2HP L 270mm rotation direction right capacitor 16µF auxiliary pressure connection 10mm supporting pressure open OLYMPIA		
For models:	AQUA-80, HOOD-110, HOOD-110-E, HOOD800SP-3D-GOGGLES-IMAX, K80, Pumps		
spare parts for	500529		
	GEV No.	365021	Ref. No. —
	operating capacitor capacity 16µF 425V tolerance 5% 50/60Hz ambient temperature max. -25 to +85°C ø 35mm L 73mm single M8 plastic connection male faston 6.3mm 416.10.99 protection		
	GEV No.	510693	Ref. No.
			0010200055 0015080 0015080/E 10200055 15080 15080/E DW10200055 DW15080 DW15080/E
	mechanical shaft seal for shaft ø 12mm slide ring ext. ø 24mm slide ring H 15.5mm slide ring int. ø 11mm counter ring mounting ø 24mm height counter ring 8mm counter ring int. ø 13.5mm		
	GEV No.	521010	Ref. No.
			0015079/I 15079/I DW15079/I
	impellor ø 98mm H 12mm M10L blades 8		
	GEV No.	521559	Ref. No.
			0015078 15078 DW15078
	pump cover OLYMPIA inlet ø 60mm outlet ø 48mm outlet 2 ø 31 auxiliary pressure connection 10mm supporting pressure open turn direction right ø 170mm ID ø 150mm inner height 22mm		
	GEV No.	521727	Ref. No.
			0015080/A 15080/A DW15080/A
	pump cover gasket EPDM thickness 1.78mm ID ø 145mm Qty 1 pcs		







1

GEV No.	500530	Ref. No.	0022009 DW22009
description	pump inlet ø 60mm outlet ø 48mm type T15 230V 50Hz 1 phase 1.1kW 1.5HP L 305mm rotation direction right OLYMPIA		
For models:	HOOD-110, HOOD-110-E, K100, K90, KP85-EL, LUX-85, LUX-85-ELETT-RONICA, Pumps		
spare parts for	500530		
	GEV No.	365021	Ref. No. —
	operating capacitor capacity 16µF 425V tolerance 5% 50/60Hz ambient temperature max. -25 to +85°C ø 35mm L 73mm single M8 plastic connection male faston 6.3mm 416.10.99 protection		
	GEV No.	510693	Ref. No.
			0010200055 0015080 0015080/E 10200055 15080 15080/E DW10200055 DW15080 DW15080/E
	mechanical shaft seal for shaft ø 12mm slide ring ext. ø 24mm slide ring H 15.5mm slide ring int. ø 11mm counter ring mounting ø 24mm height counter ring 8mm counter ring int. ø 13.5mm		
	GEV No.	521039	Ref. No. —
	fanwheel cover ID ø 156mm ED ø 161mm H 76mm for wash pump		
	GEV No.	521262	Ref. No.
			0022009/A 22009/A DW22009/A
	impellor ø 102mm H 19mm rotation direction right thread M10L blades 6		
	GEV No.	521559	Ref. No.
			0015078 15078 DW15078
	pump cover OLYMPIA inlet ø 60mm outlet ø 48mm outlet 2 ø 31 auxiliary pressure connection 10mm supporting pressure open turn direction right ø 170mm ID ø 150mm inner height 22mm		
	GEV No.	521727	Ref. No.
			0015080/A 15080/A DW15080/A
	pump cover gasket EPDM thickness 1.78mm ID ø 145mm Qty 1 pcs		







1

GEV No.	500526	Ref. No.	0015908 DW15908
description	pump inlet \varnothing 60mm outlet \varnothing 48mm type T75 230V 50Hz 1 phase 0.55kW 0.75HP L 250mm rotation direction right capacitor 12.5 μ F auxiliary pressure connection 10mm supporting pressure open OLYMPIA		
spare parts for	500526		
	GEV No.	365014	Ref. No. —
	operating capacitor capacity 12.5 μ F 450V tolerance 5%Hz ambient temperature max. -25 to +85°C \varnothing 35mm L 70mm M8 plastic connection male faston 6.3mm 45S.C3DS.12.5 protection		
	GEV No.	510693	Ref. No. 0010200055 0015080 0015080/E 10200055 15080 15080/E DW10200055 DW15080 DW15080/E
	mechanical shaft seal for shaft \varnothing 12mm slide ring ext. \varnothing 24mm slide ring H 15.5mm slide ring int. \varnothing 11mm counter ring mounting \varnothing 24mm height counter ring 8mm counter ring int. \varnothing 13.5mm		
	GEV No.	521260	Ref. No. 0015079 15079 DW15079
	impellor \varnothing 90mm H 12mm M10L type B		
	GEV No.	521559	Ref. No. 0015078 15078 DW15078
	pump cover OLYMPIA inlet \varnothing 60mm outlet \varnothing 48mm outlet 2 \varnothing 31 auxiliary pressure connection 10mm supporting pressure open turn direction right \varnothing 170mm ID \varnothing 150mm inner height 22mm		
	GEV No.	521727	Ref. No. 0015080/A 15080/A DW15080/A
	pump cover gasket EPDM thickness 1.78mm ID \varnothing 145mm Qty 1 pcs		









1

GEV No.	499259	Ref. No.	003000082 DW3000082
description	pump inlet \varnothing 62mm outlet \varnothing 52mm type MEC.T120DX 220-240/380-415V 50Hz 3 phase 0.89kW 1.2HP L 310mm rotation direction left OLYMPIA		
For models:	F, FP, K3000, K3000+K10, K3100, K3100+K10, K3300, K3800, K3800+K10, K4000, K4400, K4400+K10, K5400, K5400+K10, KT-1500, Pumps		
spare parts for	499259		
	GEV No.	510693	Ref. No. 0010200055 0015080 0015080/E 10200055 15080 15080/E DW10200055 DW15080 DW15080/E
	mechanical shaft seal for shaft \varnothing 12mm slide ring ext. \varnothing 24mm slide ring H 15.5mm slide ring int. \varnothing 11mm counter ring mounting \varnothing 24mm height counter ring 8mm counter ring int. \varnothing 13.5mm		
	GEV No.	521152	Ref. No. —
	pump cover OLYMPIA inlet 62 \varnothing 190mm		
	GEV No.	521153	Ref. No. —
	pump casing OLYMPIA outlet \varnothing 52mm		
	GEV No.	521154	Ref. No. —
	O-ring ID \varnothing 152.7mm thickness 2.62mm EPDM Qty 1 pcs		
	GEV No.	521172	Ref. No. —
	impellor \varnothing 107mm H 28mm pump type MEC.T120DX thread M8R		



1

GEV No.	499226	Ref. No.	0022037 DW22037
description	pump inlet \varnothing 62mm outlet \varnothing 52mm type MEC80.T200SX 230/400V 50Hz 3 phase 1.5kW 2HP L 340mm rotation direction right OLYMPIA		
For models:	F, FP, HOOD-130, HOOD-130-ELETTRONICA, K1600, K1600-ALTA-VELOCITA, K1800, K2100, K2200, K2700, K3000, K3000+K10, K3100, K3100+K10, K3300, K3800, K3800+K10, K4000, K4400, K4400+K10, K50, K5400, K5400+K10, K90, KP149, KP150, KP151, KP151-E, KP200, KP200-ELETTRONICA, KP2300, KP2300+KP23, KP2800, KP300, KP3000, KP300-ELETTRONICA, KP4000, KP85-EL, KT-1500, LUX-85, LUX-85-ELETTRONICA		
spare parts for	499226		
	GEV No.	510693	Ref. No. 0010200055 0015080 0015080/E 10200055 15080 15080/E DW10200055 DW15080 DW15080/E
	mechanical shaft seal for shaft \varnothing 12mm slide ring ext. \varnothing 24mm slide ring H 15.5mm slide ring int. \varnothing 11mm counter ring mounting \varnothing 24mm height counter ring 8mm counter ring int. \varnothing 13.5mm		
	GEV No.	521152	Ref. No. —
	pump cover OLYMPIA inlet 62 \varnothing 190mm		
	GEV No.	521153	Ref. No. —
	pump casing OLYMPIA outlet \varnothing 52mm		
	GEV No.	521154	Ref. No. —
	O-ring ID \varnothing 152.7mm thickness 2.62mm EPDM Qty 1 pcs		
	GEV No.	521155	Ref. No. —
	impellor \varnothing 107mm H 34mm pump type OLYMPIA thread M8L blades 6		
accessories for	499226		
	GEV No.	542157	Ref. No. —
	bracket for wash pump L 267mm W 132mm H 43mm		

booster pumps I



1

GEV No.	500060	Ref. No.	0015100 DW15100
description	pump inlet \varnothing 1" outlet \varnothing 1" type PQM60 230V 50Hz 1 phase 0.37kW PEDRELLLO		
For models:	BB-2500, F, FP, HOOD-110, HOOD-130, HOOD-130-ELETTRONICA, K100, K120, K1600, K1600-ALTA-VELOCITA, K1800, K2100, K2200, K2500, K3000, K3000+K10, K3100, K3100+K10, K3300, K3800, K3800+K10, K4000, K4400, K4400+K10, K50, K5400, K5400+K10, K90, KP149, KP150, KP151, KP151-E, KP200, KP200-ELETTRONICA, KP2300, KP2300+KP23, KP2800, KP300, KP3000, KP300-ELETTRONICA, KP4000, KP85-EL, KT-1500, LUX-85, LUX-85-ELETTRONICA		
accessories for	500060		
	GEV No.	365015	Ref. No. 0018043 18043 DW18043
	operating capacitor capacity 10 μ F 400V tolerance 5%Hz ambient temperature max. -25 to +85°C \varnothing 35.5mm L 59mm M8 plastic connection male faston 6.3mm protection		



1

GEV No.	499294	Ref. No.	0015100/D DW15100/D DW15100/D+2xDW10221311
description	pump inlet \varnothing 3/8" outlet \varnothing 3/8" type B299.2351 230V 50Hz 1 phase 0.15kW 2800rpm L 170mm capacitor 6.3 μ F FIR		
For models:	Accessories, AQUA-40, AQUA-40-RL09, AQUA-50, AQUA-80, DUPLA-35, DUPLA-37, DUPLA-40, DUPLA-45, DUPLA-50, GR300, HOOD-110, HOOD-110-E, HOOD-130, HOOD-130-ELETTRONICA, K120, K40, K40-LUX, K50, K60, K70, KP130-ELETTRONICA, KP149, KP151, KP151-E, KP202-E, KP302-E, KP402-E, KP70-EL, KP85-EL, LUX-40, LUX-40-ELETTRONICA, LUX-41-ELETTRONICA, LUX-60, LUX-60-ELETTRONICA, LUX-61-ELETTRONICA, LUX-70-EL, LUX-85, LUX-85-ELETTRONICA		
accessories for	499294		
	GEV No.	365017	Ref. No. 0010702 10702 DW10702
	operating capacitor capacity 5 μ F 450V tolerance 5% 50/60Hz ambient temperature max. -25 to +85°C \varnothing 28mm L 54mm M8 plastic connection male faston 6.3mm 16.10.08 protection		

drain pumps

ASKOLL



GEV No.	500515	Ref. No.	0015101/A 0015101/A+0015101/F 15101/A+15101/F DW15101/A DW15101/A+DW15101/F
description	drain pump inlet ø 30mm outlet ø 22mm 230V 25W 50Hz ASKOLL type M253 with thermal fuse		
For models:	Accessories, K40-LUX, K60, LUX-40, LUX-40-ELETTRONICA		

PLASET



GEV No.	499298	Ref. No.	0015101 DW15101
description	drain pump inlet ø 30mm outlet ø 22mm 220-240V 22W 50Hz PLASET type 59491		
For models:	Accessories, AQUA-35, AQUA-35-RL09, AQUA-37, AQUA-37-RL09, AQUA-40, AQUA-40-RL09, AQUA-50, AQUA-80, DUPLA-35, DUPLA-37, DUPLA-40, DUPLA-45, DUPLA-50, K37, K40, K40-LUX, K41-LUX, K45, K50, K70, K80, KP70-EL, LUX-40, LUX-40-ELETTRONICA, LUX-41-ELETTRONICA, LUX-60, LUX-60-ELETTRONICA, LUX-61-ELETTRONICA, LUX-70-EL		



GEV No.	499223	Ref. No.	00999900081 DW999900081
description	drain pump service kit inlet ø 30mm outlet ø 22mm 220-240V 22W 50Hz PLASET type 59491		

booster pumps II

accessories



GEV No.	365015	Ref. No.	0018043 DW18043
description	operating capacitor capacity 10µF 400V tolerance 5%Hz ambient temperature max. -25 to +85°C ø 35.5mm L 59mm M8 plastic connection male faston 6.3mm protection		
For models:	BK10, BK11, BK12, BK13, GM2-2, GM-2-BK11, GM3, GM4, GM-BK11, K40-LUX, K41-LUX, LUX-40, LUX-40-ELETTRONICA, LUX-41-ELETTRONICA		



GEV No.	365017	Ref. No.	0010702 DW10702
description	operating capacitor capacity 5µF 450V tolerance 5% 50/60Hz ambient temperature max. -25 to +85°C ø 28mm L 54mm M8 plastic connection male faston 6.3mm 16.10.08 protection		
For models:	AQUA-35, AQUA-35-RL09, AQUA-37, AQUA-37-RL09, AQUA-40, AQUA-40-RL09, AQUA-50, AQUA-80, BK4, BK5, DUPLA-35, DUPLA-37, DUPLA-40, DUPLA-45, DUPLA-50, F, FP, GR300, GR800, HOOD-110, HOOD-110-E, HOOD-130, HOOD-130-ELETTRONICA, K120, K2500, K26, K26A, K35, K36, K37, K3800, K3800+K10, K40, K4000, K4400, K4400+K10, K5400, K5400+K10, K70, K90, KP130-ELETTRONICA, KP149, KP151, KP151-E, KP200-ELETTRONICA, KP202-E, KP300-ELETTRONICA, KP302-E, KP402-E, KP70-EL...(Other models you can see in the webshop)		

condensators & interference suppression filters

operating capacitors

plastic



GEV No.	365015	Ref. No.	0018043 DW18043
description	operating capacitor capacity 10µF 400V tolerance 5%Hz ambient temperature max. -25 to +85°C ø 35.5mm L 59mm M8 plastic connection male faston 6.3mm protection		
For models:	BK10, BK11, BK12, BK13, GM2-2, GM-2-BK11, GM3, GM4, GM-BK11, K40-LUX, K41-LUX, LUX-40, LUX-40-ELETTRONICA, LUX-41-ELETTRONICA		





 <p>1</p>			
GEV No.	365017	Ref. No.	0010702 DW10702
description	operating capacitor capacity 5µF 450V tolerance 5% 50/60Hz ambient temperature max. -25 to +85°C ø 28mm L 54mm M8 plastic connection male faston 6.3mm 16.10.08 protection		
For models:	AQUA-35, AQUA-35-RL09, AQUA-37, AQUA-37-RL09, AQUA-40, AQUA-40-RL09, AQUA-50, AQUA-80, BK4, BK5, DUPLA-35, DUPLA-37, DUPLA-40, DUPLA-45, DUPLA-50, F, FP, GR300, GR800, HOOD-110, HOOD-110-E, HOOD-130, HOOD-130-ELETRONICA, K120, K2500, K26, K26A, K35, K36, K37, K3800, K3800+K10, K40, K4000, K4400, K4400+K10, K5400, K5400+K10, K70, K90, KP130-ELETRONICA, KP149, KP151, KP151-E, KP200-ELETRONICA, KP202-E, KP300-ELETRONICA, KP302-E, KP402-E, KP70-EL...(Other models you can see in the webshop)		

<p>metal</p>  <p>1</p>			
GEV No.	365140	Ref. No.	0015081 DW15081
description	operating capacitor capacity 12.5µF 450V tolerance 5% 60Hz ambient temperature max. -25 up to +70°C ø 40mm L 83mm M8 aluminum connection male faston 6.3mm C.87.8BF2 MKP protection		
For models:	AQUA-50, AQUA-80, DUPLA-45, DUPLA-50, K50, K60, K70, KP70-EL, LUX-60, LUX-60-ELETRONICA, LUX-61-ELETRONICA, LUX-70-EL, Pumps		

fuses

<p>fine fuses</p>  <p>1</p>			
GEV No.	358610	Ref. No.	0015160 DW15160
description	fine fuse size ø5x20mm 10A fast-acting rated 250V Qty 10 pcs		
For models:	BB-2500, F, FP, K1600, K1600-ALTA-VELOCITA, K1800, K2100, K2200, K2500, K3000, K3000+K10, K3100, K3100+K10, K3300, K3800, K3800+K10, K4000, K4400, K4400+K10, K5400, K5400+K10, KP202-E, KP2300, KP2300+KP23, KP2800, KP3000, KP302-E, KP4000, KP402-E, KT-1500		

 <p>1</p>			
GEV No.	358671	Ref. No.	0015163 DW15163
description	fine fuse size ø5x20mm 1A fast-acting rated 250V Qty 10 pcs		
For models:	AQUA-50, BB-2500, F, FP, HOOD-130, K1600, K1600-ALTA-VELOCITA, K1700, K1800, K2100, K2200, K2500, K2700, K3000, K3000+K10, K3100, K3100+K10, K3300, K3800, K3800+K10, K4000, K4400, K4400+K10, K5400, K5400+K10, KP2300, KP2300+KP23, KP2800, KP3000, KP4000, KP70-EL, KT-1500, LUX-60, LUX-60-ELETRONICA, LUX-70-EL		

 <p>1</p>			
GEV No.	358607	Ref. No.	0015212 DW15212
description	fine fuse size ø5x20mm 6.3A slow-acting rated 250V Qty 10 pcs		

 <p>1</p>			
GEV No.	358027	Ref. No.	003006095 DW3006095
description	fine fuse size ø10x38mm 16A rated 500V type Gg fast-acting Qty 1 pcs		
For models:	K2500, K3800, K4400, K5400		

electric accessories

<p>cables</p>			
<p>ribbon cables</p>			
<p>group 1</p>			
 <p>1</p>			
GEV No.	400066	Ref. No.	005058 0050589 DW5058 DW50589
description	ribbon cable 10-pole L 1000mm plug type FC-10P raster size 2.54mm		
For models:	KP85-EL, LUX-40-ELETRONICA, LUX-41-ELETRONICA, LUX-60-ELETRONICA, LUX-61-ELETRONICA, LUX-85-ELETRONICA		

 <p>1</p>			
GEV No.	400706	Ref. No.	0050651 DW50651
description	ribbon cable 16-pole L 1100mm plug type FC-16P raster size 2.54mm		



terminals

connection terminals with screw/faston connections



1

GEV No.	550411	Ref. No.	00500551 DW500551
description	power terminal block 6-pole max. 40A max 450V connection ø6mm ² / F6.3 temp.-resist. 150°C cross section 6mm ²		
For models:	AQUA-35-RL09, AQUA-37-RL09, AQUA-40-RL09, AQUA-50, AQUA-80, DUPLA-45, DUPLA-50, HOOD-110, HOOD-110-E, HOOD-800SP-3D-GOGGLES-IMAX, K100, K1L, K1R, K40-LUX, K41-LUX, K45, K50, K60, K80, K90, KP70-EL, KP85-EL, LUX-40, LUX-40-ELETTRONICA, LUX-41-ELETTRONICA, LUX-60, LUX-60-ELETTRONICA, LUX-61-ELETTRONICA, LUX-70-EL, LUX-85, LUX-85-ELETTRONICA		

connection terminals with screw connection



1

GEV No.	550470	Ref. No.	00500550 DW500550
description	power terminal block 3-pole max. 40A max 400V connection M6/M6 temp.-resist. 150°C cross section 6mm ²		
For models:	AQUA-50, DUPLA-45, DUPLA-50, K100, K36, K40-LUX, K41-LUX, K90, KP85-EL, LUX-40, LUX-40-ELETTRONICA, LUX-85, LUX-85-ELETTRONICA, X1-TK20, X2-TK21		

auxiliary gas parts

consumables

thread sealants



1

GEV No.	890135	Ref. No.	Loctite 511
description	thread sealing LOCTITE 511 tube 50ml approval DVGW		
description	LOCTITE® 511™ - tube 50ml It is designed for the locking and sealing of metal threaded pipes and fittings. The product cures rapidly when confined in the absence of air between close fitting metal surfaces.		



1

GEV No.	890128	Ref. No.	Loctite 542
description	thread sealing LOCTITE 542 medium-strength bottle 50ml approval DVGW		
description	LOCTITE® 542™ - bottle 50ml It is designed for the locking and sealing of metal pipes and fittings as well as other cylindrical metal assemblies. The product cures when confined in the absence of air between close-fitting metal surfaces and prevents loosening and leakage due to shock and vibration. The thixotropic nature of LOCTITE 542 reduces the migration of liquid product after application to the part.		



1

GEV No.	890097	Ref. No.	Loctite 577
description	thread sealing LOCTITE 577 medium-strength bottle 50ml pipe thread sealing t.max. 150°C approval BAM and DVGW		
description	LOCTITE® 577™ - bottle 50ml It is designed for the locking and sealing of metal pipes and fittings as well as other cylindrical metal assemblies. The product provides an instant, low-pressure seal for metal pipes and fittings. It will not creep, shrink or block systems by shredding. Suitable for fast application at low temperatures. It has excellent chemical and thermal resistance and offers less migration of liquid product after application to the part.		

equipment-specific units

for bar blender

blenders

jar components

jars

complete



1

GEV No.	696347	Ref. No.	0060176 0060191 DW60176 DW60191
description	blender jar plastic 1500ml with blade		
For models:	BK12, BK13, F1-KF1, F1-KF1INOX, F2-KF2, GM2-2, GM3, GM3-BK12, GM4, GM4-BK13, KF1, KF1S, KF2, KF2S		



1

GEV No.	696437	Ref. No.	0060178 DW60178
description	blender jar plastic 1500ml with mixer disc		
For models:	BK12, BK13, F1-KF1, F1-KF1INOX, F2-KF2, GM2-2, GM3, GM3-BK12, GM4, GM4-BK13, KF1, KF1S, KF2, KF2S		

gaskets



1

GEV No.	651007	Ref. No.	0060183 DW60183
description	gasket ED ø 75mm ID ø 55mm thickness 3mm Qty 1 pcs		
For models:	BK12, BK13, F1-KF1, F1-KF1INOX, F2-KF2, GM2-2, GM3, GM3-BK12, GM4, GM4-BK13, KF1, KF1S, KF2, KF2S		

actuators

group 1



1

GEV No.	698401	Ref. No.	0060107 DW60107
description	mixer coupling for motor ø 30mm H 16mm IT M6 teeth 4 plastic		
For models:	BK12, BK13, F1-KF1, F1-KF1INOX, F2-KF2, GM2-2, GM3, GM3-BK12, GM4, GM4-BK13, KF1, KF1S, KF2, KF2S		

group 3



1

GEV No.	698377	Ref. No.	0060106 DW60106
description	mixer coupling for jar ø 53mm H 30mm ID ø 30mm plastic		
For models:	BK12, BK13, GM2-2, KF1, KF2		

for citrus juicers

juicer insert



1

GEV No.	650179	Ref. No.	0060559 DW60559
description	juicer insert ø 74mm H 58mm plastic		
For models:	S40-BK4		

miscellaneous



GEV No.	650178	Ref. No.	0061051 DW61051
----------------	--------	-----------------	--------------------

description ball for citrus juicers ø 5mm

For models: GM-2-BK11, GM3-BK12, GM4-BK13

accessories for 650178



GEV No.	650176	Ref. No.	0060153 60153 DW60153
----------------	--------	-----------------	-----------------------------

shaft for citrus juicers ø 6mm L 16mm



GEV No.	650177	Ref. No.	0061052 61052 DW61052
----------------	--------	-----------------	-----------------------------

spring for citrus juicers ø 6mm L 25mm



GEV No.	650176	Ref. No.	0060153 DW60153
----------------	--------	-----------------	--------------------

description shaft for citrus juicers ø 6mm L 16mm

For models: BK10, BK11, BK12, BK13, GM-2-BK11, GM3, GM4, GM-BK11

accessories for 650176



GEV No.	650177	Ref. No.	0061052 61052 DW61052
----------------	--------	-----------------	-----------------------------

spring for citrus juicers ø 6mm L 25mm



GEV No.	650178	Ref. No.	0061051 61051 DW61051
----------------	--------	-----------------	-----------------------------

ball for citrus juicers ø 5mm



GEV No.	650177	Ref. No.	0061052 DW61052
----------------	--------	-----------------	--------------------

description spring for citrus juicers ø 6mm L 25mm

For models: GM-2-BK11, GM3-BK12, GM4-BK13

accessories for 650177



GEV No.	650176	Ref. No.	0060153 60153 DW60153
----------------	--------	-----------------	-----------------------------

shaft for citrus juicers ø 6mm L 16mm



GEV No.	650178	Ref. No.	0061051 61051 DW61051
----------------	--------	-----------------	-----------------------------

ball for citrus juicers ø 5mm

for espresso machines

brewing units

filter holder gaskets

O-rings



GEV No.	510409	Ref. No.	0013015 0013020 DW13015 DW13020
----------------	--------	-----------------	--

description O-ring EPDM thickness 5.34mm ID ø 56.52mm Qty 1 pcs

For models: AQUA-50, AQUA-80, BB-2500, DUPLA-45, DUPLA-50, F, FP, GR300, GR800, HOOD-110, HOOD-110-E, HOOD-130, HOOD-130-ELETTRONICA, HOOD800SP-3D-GOGGLES-IMAX, K100, K120, K1600, K1600-ALTA-VELOCITA, K1700, K1800, K2100, K2200, K2500, K26, K26A, K2700, K3000, K3000+K10, K3100, K3100+K10, K3300, K3800, K3800+K10, K4000, K4400, K4400+K10, K5400, K5400+K10, K60, K90, KP130-ELETTRONICA, KP149, KP150, KP151, KP151-E, KP200, KP200-ELETTRONICA, KP202-E, KP2300, KP2300+KP23...(Other models you can see in the webshop)

water dispersions

accessories



GEV No.	529494	Ref. No.	0096115 DW96115
----------------	--------	-----------------	--------------------

description gasket water dispersion

For models: GR300, GR800

steam/water taps

steam/water pipes

accessories

gaskets



GEV No.	510893	Ref. No.	0013003 DW13003
----------------	--------	-----------------	--------------------

description O-ring EPDM thickness 2.62mm ID ø 9.92mm Qty 1 pcs

For models: AQUA-35, AQUA-35-RL09, AQUA-37, AQUA-37-RL09, AQUA-40, AQUA-40-RL09, DUPLA-35, DUPLA-37, DUPLA-40, HOOD-110, HOOD-110-E, HOOD-130, HOOD-130-ELETTRONICA, HOOD800SP-3D-GOGGLES-IMAX, K100, K120, K35, K37, K40, K45, K50, K70, K80, K90, KP130-ELETTRONICA, KP149, KP150, KP151, KP151-E

for coffee grinders

grinding burrs

screws



GEV No.	560365	Ref. No.	0011121 DW11121
description	flat-headed bolt thread M4 thread L 8mm SS DIN 7985/ISO 7045 Qty 1 pcs intake Phillips head ø 8mm head thickness 3mm		
For models:	AQUA-35, AQUA-35-RL09, AQUA-37, AQUA-37-RL09, AQUA-40, AQUA-40-RL09, AQUA-50, AQUA-80, DUPLA-35, DUPLA-37, DUPLA-40, DUPLA-45, DUPLA-50, HOOD-110, HOOD-110-E, HOOD-130, HOOD-130-ELETRONICA, K70, KP130-ELETRONICA		

for dishwashers

containers

container lids



GEV No.	517424	Ref. No.	00540044 DW540044
description	lid for dosing container L 61mm W 50mm H 5mm mounting pos. front		
For models:	K40-LUX, K41-LUX, LUX-40, LUX-40-ELETRONICA, LUX-41-ELETRONICA		



GEV No.	517423	Ref. No.	00540049 DW540049
description	lid for dosing container L 84.5mm W 44mm H 10mm mounting pos. rear		
For models:	K40-LUX, K41-LUX, LUX-40, LUX-40-ELETRONICA, LUX-41-ELETRONICA		

dosing containers



GEV No.	517380	Ref. No.	00540050 DW540050
description	cleaner container L 94mm W 80mm H 130mm suitable for Dihr		
For models:	K40-LUX, K41-LUX, LUX-40, LUX-40-ELETRONICA, LUX-41-ELETRONICA		

salt tanks



GEV No.	517398	Ref. No.	0016067/B DW16067/B
description	flat gasket rubber ED ø 82mm ID ø 66mm thickness 4mm for salt tank Qty 1 pcs		
For models:	AQUA-35, AQUA-35-RL09, AQUA-37, AQUA-37-RL09, AQUA-40, AQUA-40-RL09, AQUA-50, AQUA-80, DUPLA-35, DUPLA-37, DUPLA-40, DUPLA-45, DUPLA-50, HOOD-110, HOOD-110-E, HOOD-130, HOOD-130-ELETRONICA, K100, K36, K37, K40, K40-LUX, K45, K50, K60, K70, K90, KP130-ELETRONICA, KP70-EL, KP85-EL, LUX-40, LUX-40-ELETRONICA, LUX-60, LUX-60-ELETRONICA, LUX-70-EL, LUX-85-ELETRONICA		



GEV No.	517396	Ref. No.	0016067/D DW16067/D
description	lid ø 69mm H 19mm for salt tank ID ø 50.5mm		
For models:	AQUA-35, AQUA-35-RL09, AQUA-37, AQUA-37-RL09, AQUA-40, AQUA-40-RL09, AQUA-50, AQUA-80, DUPLA-35, DUPLA-37, DUPLA-40, DUPLA-45, DUPLA-50, HOOD-110, HOOD-110-E, HOOD-130, HOOD-130-ELETRONICA, K100, K36, K37, K40, K40-LUX, K45, K50, K60, K70, K90, KP130-ELETRONICA, KP70-EL, KP85-EL, LUX-40, LUX-40-ELETRONICA, LUX-60, LUX-60-ELETRONICA, LUX-70-EL, LUX-85-ELETRONICA		







1

GEV No.	517397	Ref. No.	0016067/C DW16067/C
description	nut ø 93mm H 13mm for salt tank ID ø 64mm		
For models:	AQUA-35, AQUA-35-RL09, AQUA-37, AQUA-37-RL09, AQUA-40, AQUA-40-RL09, AQUA-50, AQUA-80, DUPLA-35, DUPLA-37, DUPLA-40, DUPLA-45, DUPLA-50, HOOD-110, HOOD-110-E, HOOD-130, HOOD-130-ELETTRONICA, K100, K36, K37, K40, K40-LUX, K45, K50, K60, K70, K90, KP130-ELETTRONICA, KP70-EL, KP85-EL, LUX-40, LUX-40-ELETTRONICA, LUX-60, LUX-60-ELETTRONICA, LUX-70-EL, LUX-85-ELETTRONICA		



1

GEV No.	510929	Ref. No.	0016067 DW16067	
description	salt tank ø 120mm H 117mm hose ø 10mm mounting ø 70mm overall height 157mm			
For models:	K100, K36, K60, K90			
spare parts for	510929			
	GEV No.	506015	Ref. No.	0016067/A 16067/A DW16067/A
	O-ring EPDM thickness 3.53mm ID ø 39.69mm Qty 1 pcs			
	GEV No.	510018	Ref. No.	—
	nut ø 92mm H 10.5mm for salt tank ID ø 64mm			
	GEV No.	524177	Ref. No.	—
	lid ø 69mm H 20mm for salt tank ID ø 50mm			
accessories for	510929			
	GEV No.	510071	Ref. No.	—
	flat gasket rubber ED ø 81mm ID ø 68mm thickness 3mm for salt tank Qty 1 pcs			
	GEV No.	510654	Ref. No.	—
	gasket H 6mm D1 ø 82mm D2 ø 68mm			
	GEV No.	510883	Ref. No.	—
	gasket rubber ED ø 86mm ID ø 66mm thickness 2mm for salt tank Qty 1 pcs			







1

GEV No.	517686	Ref. No.	0016072 DW16072
description	salt tank ø 90mm H 125mm with magnetic switch plastic		



1

GEV No.	517347	Ref. No.	0016065 0016065+0016067/B+0016067C+0016067/D 16065+16067/A+16067/B+16067C+16067/D 16065+16067/B+16067C+16067/D DW16065 DW16065+DW16067/B+DW16067C+DW16067/D	
description	salt tank ø 90mm H 88mm complete			
For models:	AQUA-35, AQUA-35-RL09, AQUA-37, AQUA-37-RL09, AQUA-40, AQUA-40-RL09, AQUA-50, AQUA-80, DUPLA-35, DUPLA-37, DUPLA-40, DUPLA-45, DUPLA-50, HOOD-110, HOOD-110-E, HOOD-130, HOOD-130-ELETTRONICA, K100, K37, K40, K40-LUX, K45, K50, K60, K70, K90, KP130-ELETTRONICA, KP70-EL, KP85-EL, LUX-40, LUX-40-ELETTRONICA, LUX-60, LUX-60-ELETTRONICA, LUX-70-EL, LUX-85-ELETTRONICA			
spare parts for	517347			
	GEV No.	506015	Ref. No.	0016067/A 16067/A DW16067/A
	O-ring EPDM thickness 3.53mm ID ø 39.69mm Qty 1 pcs			
	GEV No.	517396	Ref. No.	0016067/D 16067/D DW16067/D
	lid ø 69mm H 19mm for salt tank ID ø 50.5mm			
	GEV No.	517397	Ref. No.	0016067/C 16067/C DW16067/C
	nut ø 93mm H 13mm for salt tank ID ø 64mm			
	GEV No.	517398	Ref. No.	0016067/B 16067/B DW16067/B
	flat gasket rubber ED ø 82mm ID ø 66mm thickness 4mm for salt tank Qty 1 pcs			



boilers

boilers for dishwashers

			
1			
GEV No.	517296	Ref. No.	00540006 00540006 + 00540040 540006 + 540040 DW540006 DW540006 + DW540040
description	boiler		
For models:	K40-LUX, LUX-40, LUX-40-ELETTRONICA, LUX-41-ELETTRONICA		

			
1			
GEV No.	517297	Ref. No.	0016904 DW16904
description	boiler		

			
1			
GEV No.	517402	Ref. No.	003007013 DW3007013
description	boiler		
For models:	BB-2500, F, FP, K1600, K1600-ALTA-VELOCITA, K1800, K2100, K2200, K2500, K26, K26A, K3000, K3000+K10, K3100, K3100+K10, K3300, K3800, K3800+K10, K4000, K4400, K4400+K10, K5400, K5400+K10, KP2300, KP2300+KP23, KP2800, KP3000, KP4000, KT-1500		

			
1			
GEV No.	517294	Ref. No.	00135905 00135905+0015066+0015205 135905+15066+15205 DW135905 DW135905+DW15066+DW15205
description	boiler ø 113mm L 320mm		
For models:	AQUA-37, AQUA-37-RL09, DUPLA-35, DUPLA-37, K35, K37		



			
1			
GEV No.	517295	Ref. No.	00140905 DW140905
description	boiler ø 113mm L 370mm		
For models:	AQUA-37, AQUA-40, AQUA-40-RL09, DUPLA-40, K40		

			
1			
GEV No.	517298	Ref. No.	0017905 DW17905
description	boiler ø 138mm L 210mm		

			
1			
GEV No.	517299	Ref. No.	0026905 DW26905
description	boiler ø 140mm L 335mm		

			
1			
GEV No.	517300	Ref. No.	00150905 00150905+0015066+0015205 150905+15066+15205 DW150905 DW150905+DW15066+DW15205
description	boiler ø 140mm L 390mm		
For models:	AQUA-50, AQUA-80, DUPLA-45, DUPLA-50, K45, K50, K60, K70, K80, KP70-EL, LUX-60, LUX-60-ELETTRONICA, LUX-61-ELETTRONICA, LUX-70-EL		

			
1			
GEV No.	517301	Ref. No.	0015905 0015924 0015924+0015066 0015924+0015066+0015205 15924+15066 15924+15066+15205 DW15905 DW15924 DW15924+DW15066 DW15924+DW15066+DW15205
description	boiler ø 140mm L 390mm		



			
1			
GEV No.	517394	Ref. No.	003007012 003007012+0030002030+0075205 3007012+30002030+75205 DW3007012 DW3007012+DW30002030+DW75205
description	boiler ø 160mm L 530mm with insulation		
For models:	BB-2500, F, FP, K1600, K1600-ALTA-VELOCITA, K1800, K2100, K2200, K2500, K26, K26A, K3000, K3000+K10, K3100, K3100+K10, K3300, K3800, K3800+K10, K4000, K4400, K4400+K10, K5400, K5400+K10, KP2300, KP2300+KP23, KP2800, KP3000, KP4000, KT-1500		
spare parts for	517394		
	GEV No.	517336	Ref. No. 0030002030 30002030 DW30002030
insulating mat boiler L 500mm W 155mm			

accessories			
			
1			
GEV No.	517125	Ref. No.	0012506 DW12506
description	hose connector		
For models:	Accessories, AQUA-35, AQUA-37, AQUA-40, AQUA-50, AQUA-80, DUPLA-45, GR300, GR800, HOOD-110, HOOD-110-E, HOOD-130, HOOD-130-ELETTRONICA, K100, K50, K70, K80, KP149, KP150, KP151, KP151-E, KP202-E, KP302-E, KP402-E, KP70-EL, KP85-EL, LUX-40, LUX-40-ELETTRONICA, LUX-41-ELETTRONICA, LUX-61-ELETTRONICA, LUX-70-EL, LUX-85-ELETTRONICA		

			
1			
GEV No.	517336	Ref. No.	0030002030 DW30002030
description	insulating mat boiler L 500mm W 155mm		
For models:	BB-2500, F, FP, HOOD-110, HOOD-110-E, HOOD-130, HOOD-130-ELETTRONICA, HOOD800SP-3D-GOGGLES-IMAX, K1600, K1600-ALTA-VELOCITA, K1800, K2100, K2200, K2500, K3000, K3000+K10, K3100, K3100+K10, K3300, K3800, K3800+K10, K4000, K4400, K4400+K10, K5400, K5400+K10, KP130-ELETTRONICA, KP149, KP151, KP151-E, KP200-ELETTRONICA, KP2300, KP2300+KP23, KP2800, KP3000, KP300-ELETTRONICA, KP4000, KP400-ELETTRONICA, KP85-EL, KT-1500, LUX-85, LUX-85-ELETTRONICA		

			
1			
GEV No.	517337	Ref. No.	0075205 DW75205
description	insulating mat boiler ø 160mm		
For models:	BB-2500, F, FP, HOOD-110, HOOD-110-E, HOOD-130, HOOD-130-ELETTRONICA, HOOD800SP-3D-GOGGLES-IMAX, K1600, K1600-ALTA-VELOCITA, K1800, K2100, K2200, K2500, K3000, K3000+K10, K3100, K3100+K10, K3300, K3800, K3800+K10, K4000, K4400, K4400+K10, K5400, K5400+K10, KP130-ELETTRONICA, KP149, KP151, KP151-E, KP200-ELETTRONICA, KP2300, KP2300+KP23, KP2800, KP3000, KP300-ELETTRONICA, KP4000, KP400-ELETTRONICA, KP85-EL, KT-1500, LUX-85, LUX-85-ELETTRONICA		

			
1			
GEV No.	699262	Ref. No.	0015066 DW15066
description	insulation for boiler L 455mm W 395mm thickness 2mm		
For models:	AQUA-50, AQUA-80, DUPLA-45, DUPLA-50, K70, KP70-EL, LUX-60, LUX-60-ELETTRONICA, LUX-61-ELETTRONICA, LUX-70-EL		

			
1			
GEV No.	517302	Ref. No.	0022002 0022002+0030002030+0075205 22002+30002030+75205 DW22002 DW22002+DW30002030+DW75205
description	boiler with insulation ø 160mm L 500mm		
For models:	HOOD-110, HOOD-110-E, HOOD-130, HOOD-130-ELETTRONICA, HOOD800SP-3D-GOGGLES-IMAX, K100, K120, K90, KP130-ELETTRONICA, KP149, KP150, KP151, KP151-E, KP85-EL, LUX-85, LUX-85-ELETTRONICA		
accessories for	517302		
	GEV No.	517337	Ref. No. 0075205 75205 DW75205
insulating mat boiler ø 160mm			

			
1			
GEV No.	517303	Ref. No.	0010600904 10600904+2x 30002030+91115 10600904+30002030+75205 DW10600904
description	boiler with insulation ø 160mm L 530mm flange 4 hole flange inlet ø 12		

softener cartridges

softening columns



1

GEV No.	530084	Ref. No.	0016066 DW16066
description	softener 4-fold L 380mm W 180mm		
For models:	AQUA-35-RL09, AQUA-37, AQUA-37-RL09, AQUA-40, AQUA-40-RL09, AQUA-50, AQUA-80, DUPLA-35, DUPLA-37, DUPLA-40, DUPLA-45, DUPLA-50, HOOD-110, HOOD-110-E, HOOD-130, HOOD-130-ELETTRONICA, K100, K36, K37, K40, K40-LUX, K50, K60, K70, K90, KP130-ELETTRONICA, KP70-EL, KP85-EL, LUX-40, LUX-40-ELETTRONICA, LUX-60, LUX-60-ELETTRONICA, LUX-70-EL, LUX-85-ELETTRONICA		

housing and bezels

fascias



1

GEV No.	517422	Ref. No.	0089306 DW89306
description	bezel for thermometer L 90mm H 53.5mm		
For models:	HOOD-110, HOOD-130, HOOD800SP-3D-GOGGLES-IMAX, KP149, KP151		



1

GEV No.	996014	Ref. No.	75311 DW75311
description	cover for boiler H 40mm ø 125mm		
For models:	BB-2500, F, FP, HOOD-110, HOOD-110-E, HOOD-130, HOOD-130-ELETTRONICA, HOOD800SP-3D-GOGGLES-IMAX, K1600, K1600-ALTA-VELOCITA, K1700, K1800, K2100, K2200, K2500, K2700, K3000, K3000+K10, K3100, K3100+K10, K3300, K3800, K3800+K10, K4000, K4400, K4400+K10, K5400, K5400+K10, KP130-ELETTRONICA, KP200-ELETTRONICA, KP2300, KP2300+KP23, KP2800, KP3000, KP300-ELETTRONICA, KP4000, KP400-ELETTRONICA, KP85-EL, KT-1500, LUX-85, LUX-85-ELETTRONICA		



1

GEV No.	517399	Ref. No.	00135600 00135606/A DW135600 DW135606/A
description	switch panel L 185mm W 85mm H 45mm		
For models:	K35, K37, K40, K45, K50, K80		

miscellaneous



1

GEV No.	517400	Ref. No.	00560007 DW560007
description	bearing for door rubber ID ø 12mm mounting pos. left		
For models:	K60, KP70-EL, LUX-60, LUX-60-ELETTRONICA, LUX-61-ELETTRONICA, LUX-70-EL		





1

GEV No.	524803	Ref. No.	0011600018 DW11600018
description	bracket for dishwasher rack SS L 25mm ED ø 10mm thread M6		
For models:	HOOD-110, HOOD-110-E, HOOD-130, HOOD-130-ELETTRONICA, HOOD800SP-3D-GOGGLES-IMAX, K120, KP130-ELETTRONICA		



1

GEV No.	698297	Ref. No.	0076081 DW76081
description	duct ID ø 35mm ED ø 51mm thickness 14mm		
For models:	HOOD-110, HOOD-110-E, HOOD-130, HOOD-130-ELETTRONICA, KP130-ELETTRONICA		

			
1			
GEV No.	524076	Ref. No.	003003058 003003058+003004184 3003058+3004184 DW3003058 DW3003058+DW3004184
description	magnet holder internal size 13mm H 60mm for dishwasher		
For models:	K1600, K1600-ALTA-VELOCITA, K1800, K2100, K2200, K2500, K3000, K3000+K10, K3100, K3100+K10, K3300, K3800, K3800+K10, K4000, K4400, K4400+K10, K5400, K5400+K10, KP2300, KP2300+KP23, KP2800, KP3000, KP4000, KT-1500		
accessories for	524076		
			
GEV No.	524655	Ref. No.	003004184 3004184 DW3004184
screw cap for magnet holder thread M16x1.25 SS WS 19			

hood mechanics for dishwashers

bushes

			
1			
GEV No.	512423	Ref. No.	0011600055 DW11600055
description	bush for hood handle		
For models:	HOOD-110, HOOD-110-E, HOOD-130, HOOD-130-ELETTRONICA, HOOD800SP-3D-GOGGLES-IMAX, KP130-ELETTRONICA		

			
1			
GEV No.	517284	Ref. No.	0010800130 DW10800130
description	bush hood mechanics		
For models:	K100		

			
1			
GEV No.	517279	Ref. No.	0075204 DW75204
description	bush hood mechanics PTFE		
For models:	K100		

			
1			
GEV No.	517282	Ref. No.	0010800231 DW10800231
description	cylinder liner hood mechanics		
For models:	K100		

			
1			
GEV No.	694679	Ref. No.	0011600014 DW11600014
description	roller ID ø 10.5mm L 33mm for hood mechanics D1 ø 22mm D2 ø 19.8mm		
For models:	HOOD-110, HOOD-110-E, HOOD-130, HOOD-130-ELETTRONICA, K120, KP130-ELETTRONICA		

spring holders

			
1			
GEV No.	517285	Ref. No.	0070306 DW70306
description	spring holder		
For models:	HOOD-110, HOOD-110-E, HOOD800SP-3D-GOGGLES-IMAX, K100		

guide bars

			
1			
GEV No.	517358	Ref. No.	0075304 DW75304
description	guide bar L 600mm for hood mechanics		
For models:	K100, K1700, K2700		

			
1			
GEV No.	517378	Ref. No.	0011600029 DW11600029
description	guide bar L 650mm mounting pos. left for hood mechanics thickness 25mm		
For models:	HOOD-110, HOOD-110-E, HOOD-130, HOOD-130-ELETTRONICA, K120, KP130-ELETTRONICA		





 <p>1</p>			
GEV No.	513019	Ref. No.	0011600028 003189041 DW11600028 DW3189041
description	guide bar L 695mm mounting pos. right thickness 25mm		
For models:	HOOD-110, HOOD-110-E, HOOD-130, HOOD-130-ELETTRONICA, K120, KP130-ELETTRONICA		

 <p>2</p>			
GEV No.	524800	Ref. No.	0076080 DW76080
description	guide bar L 700mm for hood W 26mm H 21mm		
For models:	HOOD-110, HOOD-110-E, HOOD800SP-3D-GOGGLES-IMAX		

<p>rollers</p>  <p>1</p>			
GEV No.	524805	Ref. No.	0089919 DW89919
description	roller ø 23mm H 9.6mm for hood mechanics plastic white hole ø 8mm		
For models:	HOOD-110, HOOD-110-E, HOOD-130, HOOD-130-ELETTRONICA, HOOD800SP-3D-GOGGLES-IMAX, K120, KP130-ELETTRONICA, KP302-E, KP402-E		

<p>miscellaneous</p>  <p>1</p>			
GEV No.	517280	Ref. No.	0075203 DW75203
description	bush with thread hood mechanics brass		
For models:	K100		

 <p>1</p>			
GEV No.	517281	Ref. No.	0075202 DW75202
description	nut hood mechanics		
For models:	K100		

 <p>1</p>			
GEV No.	517283	Ref. No.	0010800244 DW10800244
description	roller for hood handle		

<p>basket guides</p> <p>guide bars</p>  <p>1</p>			
GEV No.	517813	Ref. No.	0010600923 DW10600923
description	basket guide mounting pos. left/right L 450mm W 3.5mm H 37.5mm		
For models:	HOOD-110, HOOD-110-E, HOOD-130, HOOD-130-ELETTRONICA, HOOD800SP-3D-GOGGLES-IMAX, K100, K120, KP130-ELETTRONICA		

 <p>1</p>			
GEV No.	692615	Ref. No.	392029
description	guide L 293mm W 25mm H 92mm		
For models:	K1700, K2700		









<p>air traps</p> <p>air traps</p>  <p>1</p>			
GEV No.	517168	Ref. No.	0010911/D 00135911/D DW10911/D DW135911/D
description	air trap H 56mm		
For models:	AQUA-37, DUPLA-35, DUPLA-37, DUPLA-40, K35, K37, K40, K70, KP70-EL, LUX-70-EL		
accessories for	517168		
	GEV No.	517173	Ref. No.
			0013301 13301 DW13301
	flat gasket FIBER ED ø 14mm ID ø 8mm thickness 1.5mm Qty 1 pcs		



Table continues overleaf

accessories for 517168					
	<table border="1"> <tr> <th>GEV No.</th> <th>517174</th> <th>Ref. No.</th> <th>0011702 11702 DW11702</th> </tr> </table>	GEV No.	517174	Ref. No.	0011702 11702 DW11702
GEV No.	517174	Ref. No.	0011702 11702 DW11702		
nut thread M8 H 6.5mm WS 13 SS DIN/ISO DIN 934 / ISO 4032/8673 Qty 1 pcs					

			
1			
GEV No.	517308	Ref. No.	0010911/C 00135911/C DW10911/C DW135911/C
description	air trap H 65mm		
For models:	AQUA-35, AQUA-35-RL09, AQUA-37-RL09, AQUA-40-RL09, K40, K90, KP149, KP151, KP151-E, KP85-EL, LUX-85, LUX-85-ELETTRONICA		

							
1							
GEV No.	517170	Ref. No.	00135911/B DW135911/B				
description	air trap H 75mm						
For models:	AQUA-40, AQUA-50, AQUA-80, DUPLA-45, DUPLA-50, HOOD-110, HOOD-110-E, HOOD800SP-3D-GOGGLES-IMAX, K120, K40-LUX, KP130-ELETTRONICA, LUX-40, LUX-40-ELETTRONICA, LUX-41-ELETTRONICA, LUX-60, LUX-60-ELETTRONICA						
accessories for	517170						
	<table border="1"> <tr> <th>GEV No.</th> <th>517173</th> <th>Ref. No.</th> <th>0013301 13301 DW13301</th> </tr> </table>	GEV No.	517173	Ref. No.	0013301 13301 DW13301	flat gasket FIBER ED ø 14mm ID ø 8mm thickness 1.5mm Qty 1 pcs	
GEV No.	517173	Ref. No.	0013301 13301 DW13301				
	<table border="1"> <tr> <th>GEV No.</th> <th>517174</th> <th>Ref. No.</th> <th>0011702 11702 DW11702</th> </tr> </table>	GEV No.	517174	Ref. No.	0011702 11702 DW11702	nut thread M8 H 6.5mm WS 13 SS DIN/ISO DIN 934 / ISO 4032/8673 Qty 1 pcs	
GEV No.	517174	Ref. No.	0011702 11702 DW11702				



							
1							
GEV No.	517172	Ref. No.	0080106 DW80106				
description	air trap L 90mm ø 45mm stainless steel						
For models:	BB-2500, F, FP, K1600, K1600-ALTA-VELOCITA, K1800, K2100, K2200, K2500, K3000, K3000+K10, K3100, K3100+K10, K3300, K3800, K3800+K10, K4000, K4400, K4400+K10, K5400, K5400+K10, KP2300, KP2300+KP23, KP2800, KP300, KP3000, KP300-ELETTRONICA, KP400, KP4000, KP400-ELETTRONICA, KT-1500						
accessories for	517172						
	<table border="1"> <tr> <th>GEV No.</th> <th>517173</th> <th>Ref. No.</th> <th>0013301 13301 DW13301</th> </tr> </table>	GEV No.	517173	Ref. No.	0013301 13301 DW13301	flat gasket FIBER ED ø 14mm ID ø 8mm thickness 1.5mm Qty 1 pcs	
GEV No.	517173	Ref. No.	0013301 13301 DW13301				
	<table border="1"> <tr> <th>GEV No.</th> <th>517174</th> <th>Ref. No.</th> <th>0011702 11702 DW11702</th> </tr> </table>	GEV No.	517174	Ref. No.	0011702 11702 DW11702	nut thread M8 H 6.5mm WS 13 SS DIN/ISO DIN 934 / ISO 4032/8673 Qty 1 pcs	
GEV No.	517174	Ref. No.	0011702 11702 DW11702				

							
1							
GEV No.	517171	Ref. No.	0010402 0010911 00135911 DW10402 DW10911 DW135911				
description	air trap L 90mm W 55mm H 31mm						
For models:	GR300, GR800, HOOD-130, HOOD-130-ELETTRONICA, K100, K1700, K2700, K36, K45, K50, K60, K80, KP130-ELETTRONICA, KP150, KP200, KP200-ELETTRONICA, KP202-E, KP302-E, KP402-E						
accessories for	517171						
	<table border="1"> <tr> <th>GEV No.</th> <th>517173</th> <th>Ref. No.</th> <th>0013301 13301 DW13301</th> </tr> </table>	GEV No.	517173	Ref. No.	0013301 13301 DW13301	flat gasket FIBER ED ø 14mm ID ø 8mm thickness 1.5mm Qty 1 pcs	
GEV No.	517173	Ref. No.	0013301 13301 DW13301				
	<table border="1"> <tr> <th>GEV No.</th> <th>517174</th> <th>Ref. No.</th> <th>0011702 11702 DW11702</th> </tr> </table>	GEV No.	517174	Ref. No.	0011702 11702 DW11702	nut thread M8 H 6.5mm WS 13 SS DIN/ISO DIN 934 / ISO 4032/8673 Qty 1 pcs	
GEV No.	517174	Ref. No.	0011702 11702 DW11702				



			
1			
GEV No.	524797	Ref. No.	00135911/E DW135911/E
description	air trap W 54mm H 45mm thread M8 hose ø 5mm plastic		
For models:	LUX-61-ELETTRONICA		

mechanics for flight type dishwashers			
			
1			
GEV No.	517818	Ref. No.	003060014 DW3060014
description	distance washers for tape L 46mm ø 15mm ID ø 9mm		
For models:	F, FP		





 <p>1</p>											
GEV No.	524455	Ref. No.	003003020 003003021 003003116 DW3003020 DW3003021 DW3003116								
description	drive shaft for transport system L 225mm ø 120mm suitable for Dihr										
For models:	K1600, K1600-ALTA-VELOCITA, K1700, K1800, K2100, K2200, K2500, K2700, K3000, K3000+K10, K3100, K3100+K10, K3300, K3800, K3800+K10, K4000, K4400, K4400+K10, K5400, K5400+K10, KP2300, KP2300+KP23, KP2800, KP3000, KP4000										
accessories for	524455										
 <table border="1"> <tr> <td>GEV No.</td> <td>524456</td> <td>Ref. No.</td> <td>003003012 3003012 DW3003012</td> </tr> <tr> <td colspan="4">roller for drive shaft L 27.3mm ø 30mm hole ø 12.5mm suitable for Dihr</td> </tr> </table>				GEV No.	524456	Ref. No.	003003012 3003012 DW3003012	roller for drive shaft L 27.3mm ø 30mm hole ø 12.5mm suitable for Dihr			
GEV No.	524456	Ref. No.	003003012 3003012 DW3003012								
roller for drive shaft L 27.3mm ø 30mm hole ø 12.5mm suitable for Dihr											

 <p>1</p>			
GEV No.	517317	Ref. No.	003060001 DW3060001
description	roller		
For models:	F, FP		

 <p>1</p>											
GEV No.	524456	Ref. No.	003003012 DW3003012								
description	roller for drive shaft L 27.3mm ø 30mm hole ø 12.5mm suitable for Dihr										
For models:	K1600, K1600-ALTA-VELOCITA, K1700, K1800, K2100, K2200, K2500, K2700, K3000, K3000+K10, K3100, K3100+K10, K3300, K3800, K3800+K10, K4000, K4400, K4400+K10, K5400, K5400+K10, KP2300, KP2300+KP23, KP2800, KP3000, KP4000										
accessories for	524456										
 <table border="1"> <tr> <td>GEV No.</td> <td>524455</td> <td>Ref. No.</td> <td>003003020 003003021 003003116 3003020 3003021 3003116 DW3003020 DW3003021 DW3003116</td> </tr> <tr> <td colspan="4">drive shaft for transport system L 225mm ø 120mm suitable for Dihr</td> </tr> </table>				GEV No.	524455	Ref. No.	003003020 003003021 003003116 3003020 3003021 3003116 DW3003020 DW3003021 DW3003116	drive shaft for transport system L 225mm ø 120mm suitable for Dihr			
GEV No.	524455	Ref. No.	003003020 003003021 003003116 3003020 3003021 3003116 DW3003020 DW3003021 DW3003116								
drive shaft for transport system L 225mm ø 120mm suitable for Dihr											

 <p>1</p>			
GEV No.	699563	Ref. No.	003060134 DW3060134
description	gear wheel for impulse ø 150mm ID ø 35.5mm suitable for Dihr		
For models:	BB-2500, F, FP		

 <p>1</p>			
GEV No.	699261	Ref. No.	003060022 DW3060022
description	gear wheel plastic W 37.5mm ID ø 25mm ED ø 150mm		
For models:	BB-2500, F, FP		

 <p>1</p>			
GEV No.	698412	Ref. No.	003000261 DW3000261
description	gear wheel teeth 8 shaft intake ø 20mm ø 133mm tooth width 11mm plastic W 40mm for transport system suitable for dishwasher		
For models:	K1600, K1600-ALTA-VELOCITA, K1800, K2100, K22, K2200, K23, K24, K2500, K3000, K3000+K10, K3100, K3100+K10, K3300, K3800, K3800+K10, K4000, K4400, K4400+K10, K5400, K5400+K10		

 <p>1</p>			
GEV No.	517371	Ref. No.	003003026 DW3003026
description	roller L 22mm ø 24.5mm hole ø 8mm suitable for Dihr		
For models:	K1600, K1600-ALTA-VELOCITA, K1700, K1800, K2100, K2200, K2500, K2700, K3000, K3000+K10, K3100, K3100+K10, K3300, K3800, K3800+K10, K4000, K4400, K4400+K10, K5400, K5400+K10		

 <p>1</p>			
GEV No.	517356	Ref. No.	003003048 DW3003048
description	spacer for spindle ø 32mm		
For models:	K1600, K1600-ALTA-VELOCITA, K1800, K2100, K22, K2200, K23, K24, K2500, K3000, K3000+K10, K3100, K3100+K10, K3300, K3800, K3800+K10, K4000, K4400, K4400+K10, K5400, K5400+K10, KT-1500		

 <p>1</p>			
GEV No.	524971	Ref. No.	003060035 DW3060035
description	tappet for dishwasher L 75mm W 36mm H 90mm hole ø 9mm suitable for Dihr		
For models:	F, FP		

backflow preventers

backflow preventers



GEV No.	516101	Ref. No.	00999900006 DW999900006
description	backflow preventer dishwasher hose ø 12mm		
For models:	AQUA-35, AQUA-37, AQUA-40, AQUA-50, AQUA-80, BB-2500, DUPLA-35, DUPLA-37, DUPLA-40, DUPLA-45, DUPLA-50, F, FP, HOOD-110, HOOD-130, HOOD-130-ELETTRONICA, K1600, K1600-ALTA-VELOCITA, K1800, K2100, K2200, K2500, K3000, K3000+K10, K3100, K3100+K10, K3300, K3800, K3800+K10, K4000, K4400, K4400+K10, K5400, K5400+K10, K70, KP130-ELETTRONICA, KP149, KP151, KP151-E, KP200-ELETTRONICA, KP2300, KP2300+KP23, KP2800, KP3000, KP300-ELETTRONICA, KP4000, KP400-ELETTRONICA, KP70-EL, KP85-EL, KT-1500...(Other models you can see in the webshop)		
spare parts for	516101		
	GEV No.	506367	Ref. No. —
	flat gasket rubber ED ø 40mm ID ø 28mm thickness 1.8mm Qty 1 pcs		

accessories



GEV No.	996010	Ref. No.	15284 DW15284
description	ball ø 16mm		



GEV No.	996012	Ref. No.	15280 DW15280
description	body for back flow restrictor L 71mm W 56mm H 32mm hose ø 12mm		
For models:	BB-2500, F, FP, HOOD800SP-3D-GOGGLES-IMAX, K1700, K1800, K2100, K2200, K2500, K2700, K3000, K3000+K10, K3100, K3100+K10, K3300, K3800, K3800+K10, K4000, K4400, K4400+K10, K5400, K5400+K10, KP2300, KP2300+KP23, KP2800, KP3000, KP4000, KT-1500		



GEV No.	996013	Ref. No.	15282 DW15282
description	lid for back flow restrictor ø 40mm H 14.5mm plastic		
For models:	AQUA-35-RL09, AQUA-37-RL09, AQUA-40-RL09, BB-2500, F, FP, HOOD800SP-3D-GOGGLES-IMAX, K1700, K1800, K2100, K2200, K2500, K2700, K3000, K3000+K10, K3100, K3100+K10, K3300, K3800, K3800+K10, K4000, K4400, K4400+K10, K5400, K5400+K10, KP2300, KP2300+KP23, KP2800, KP3000, KP4000, KT-1500		



GEV No.	996011	Ref. No.	15281 DW15281
description	nut with hole L 32mm W 32mm H 25mm thread M26x1.5 WS 32 plastic		
For models:	AQUA-35-RL09, AQUA-37-RL09, AQUA-40-RL09, BB-2500, F, FP, HOOD800SP-3D-GOGGLES-IMAX, K1700, K1800, K2100, K2200, K2500, K2700, K3000, K3000+K10, K3100, K3100+K10, K3300, K3800, K3800+K10, K4000, K4400, K4400+K10, K5400, K5400+K10, KP2300, KP2300+KP23, KP2800, KP3000, KP4000, KT-1500		

miscellaneous



GEV No.	506160	Ref. No.	0011185 0011611 DW11185 DW11611
description	plain washer ID ø 8.6mm ED ø 16mm thickness 1.5mm SS Qty 1 pcs		
For models:	BB-2500, F, FP, HOOD800SP-3D-GOGGLES-IMAX, K100, K1600, K1600-ALTA-VELOCITA, K1700, K1800, K2100, K2200, K2500, K2700, K3000, K3000+K10, K3100, K3100+K10, K3300, K3800, K3800+K10, K4000, K4400, K4400+K10, K5400, K5400+K10, K70, KP149, KP150, KP151, KP151-E		



GEV No.	517819	Ref. No.	003009387 DW3009387
description	spacer ring for intake tap D1 ø 30mm ID ø 17mm		
For models:	BB-2500, F, FP, K1600, K1600-ALTA-VELOCITA, K1700, K1800, K2100, K2200, K2500, K2700, K3000, K3000+K10, K3100, K3100+K10, K3300, K3800, K3800+K10, K4000, K4400, K4400+K10, K5400, K5400+K10, KP2300, KP2300+KP23, KP2800, KP3000, KP4000, KT-1500		

door mechanics

bolts





GEV No.	517290	Ref. No.	0075201 DW75201
description	door bolt SS		
For models:	K100		





springs			
tension springs			
			
GEV No.	517421	Ref. No.	00570200 DW570200
description	tension spring ø 12mm total length 240mm wire gauge ø 1.8mm for door Qty 1 pcs		
For models:	KP70-EL, LUX-60, LUX-60-ELETTRONICA, LUX-61-ELETTRONICA, LUX-70-EL		

linkage			
			
GEV No.	512425	Ref. No.	00250041 DW250041
description	door pin L 190mm mounting pos. left/right		
For models:	AQUA-35, AQUA-35-RL09, AQUA-37, AQUA-37-RL09, AQUA-40, AQUA-40-RL09, DUPLA-35, DUPLA-37, DUPLA-40		

			
GEV No.	517388	Ref. No.	00150221 DW150221
description	door pin L 193mm mounting pos. left/right		
For models:	AQUA-50, AQUA-80, DUPLA-45, DUPLA-50, K40, K45, K50, K80		

			
GEV No.	524951	Ref. No.	0015009 DW15009
description	door pin L 580mm ø 8mm		
For models:	K70		



			
GEV No.	517263	Ref. No.	00135221/A DW135221/A
description	door pin mounting pos. left tie bar		
For models:	K35, K37		



			
GEV No.	517262	Ref. No.	00135221 DW135221
description	door pin mounting pos. right tie bar		
For models:	K35, K37		

			
GEV No.	517274	Ref. No.	00150221/A DW150221/A
description	door pin tie bar		
For models:	K90, KP85-EL, LUX-85, LUX-85-ELETTRONICA		

sliding plates			
			
GEV No.	517264	Ref. No.	00150401 DW150401
description	sliding plate sliding plate		
For models:	AQUA-35, AQUA-35-RL09, AQUA-37, AQUA-37-RL09, AQUA-40, AQUA-40-RL09, AQUA-50, AQUA-80, DUPLA-35, DUPLA-37, DUPLA-40, DUPLA-45, DUPLA-50, K35, K37, K40, K45, K50, K80, K90, KP85-EL, LUX-85, LUX-85-ELETTRONICA		

hinges			
			
GEV No.	517268	Ref. No.	0011835/A DW11835/A
description	bush ID ø 8mm H 9mm bush thread M11x1 WS 13		
For models:	AQUA-50, AQUA-80		

			
1			
GEV No.	517267	Ref. No.	00150211 DW150211
description	door hinge hinge mounting pos. left		
For models:	AQUA-50, AQUA-80, K40, K45, K50, K80		
accessories for	517267		
	GEV No.	517266	Ref. No. 00150200 00150210 150200 150210 DW150200 DW150210
door hinge hinge mounting pos. right			
	GEV No.	517268	Ref. No. 0011835/A 11835/A DW11835/A
bush ID ø8mm H9mm bush thread M11x1 WS 13			

			
1			
GEV No.	517266	Ref. No.	00150200 00150210 DW150200 DW150210
description	door hinge hinge mounting pos. right		
For models:	AQUA-50, AQUA-80, K40, K45, K50, K80		
accessories for	517266		
	GEV No.	517267	Ref. No. 00150211 150211 DW150211
door hinge hinge mounting pos. left			
	GEV No.	517268	Ref. No. 0011835/A 11835/A DW11835/A
bush ID ø8mm H9mm bush thread M11x1 WS 13			

			
1			
GEV No.	517271	Ref. No.	00550909 DW550909
description	spring holder spring holder mounting pos. left		
For models:	K90, KP85-EL, LUX-85, LUX-85-ELETTRONICA		

			
1			
GEV No.	517270	Ref. No.	00550908 DW550908
description	spring holder spring holder mounting pos. right		
For models:	K90, KP85-EL, LUX-85, LUX-85-ELETTRONICA		

door guides

			
1			
GEV No.	508421	Ref. No.	0011600030 11600036 DW11600030
description	opposite support conversion kit		

door bumpers

			
1			
GEV No.	517265	Ref. No.	00135222 DW135222
description	door bumper end stop		
For models:	AQUA-50, AQUA-80, DUPLA-45, DUPLA-50, K35, K37, K40, K45, K50, K80, K90, KP85-EL, LUX-85, LUX-85-ELETTRONICA		

			
1			
GEV No.	512426	Ref. No.	00250042 DW250042
description	door bumper L 16mm W 12mm		
For models:	AQUA-35, AQUA-35-RL09, AQUA-37, AQUA-37-RL09, AQUA-40, AQUA-40-RL09, DUPLA-35, DUPLA-37, DUPLA-40		

			
1			
GEV No.	694629	Ref. No.	00590014 DW590014
description	door bumper silicone ø 11.5mm L 18mm		

door shafts



1			
GEV No.	517814	Ref. No.	0016046 DW16046
description	door guides ø 8mm L 490mm		



1			
GEV No.	517372	Ref. No.	0018136 DW18136
description	door shaft ø 8mm L 432mm for dishwasher		
For models:	K36		

locks



1			
GEV No.	517278	Ref. No.	00150402/D DW150402/D
description	counterpart door catch		
For models:	AQUA-35, AQUA-35-RL09, AQUA-37, AQUA-37-RL09, AQUA-40, AQUA-40-RL09, DUPLA-35, DUPLA-37, DUPLA-40, K35, K37		



1			
GEV No.	517275	Ref. No.	0010775 DW10775
description	door catch catch		
For models:	AQUA-50, AQUA-80, DUPLA-45, DUPLA-50, K45, K50, K80, KP149		



1			
GEV No.	517276	Ref. No.	00150402 DW150402
description	door catch catch		
For models:	AQUA-35, AQUA-35-RL09, AQUA-37, AQUA-37-RL09, AQUA-40, AQUA-40-RL09, DUPLA-35, DUPLA-37, DUPLA-40, K35, K37, K40		
accessories for	517276		



GEV No.	517277	Ref. No.	00150403 150403 DW150403
description	gasket for catch		

accessories for 517276



GEV No.	517278	Ref. No.	00150402/D 150402/D DW150402/D
description	counterpart door catch		

miscellaneous



1			
GEV No.	524955	Ref. No.	00560006 DW560006
description	bearing for door ID ø 12mm H 22mm L 32mm W 9mm mounting pos. right		
For models:	K60, KP70-EL, LUX-60, LUX-60-ELETTRONICA, LUX-61-ELETTRONICA, LUX-70-EL		



1			
GEV No.	507552	Ref. No.	003009269 DW3009269
description	stop for door SS H 60mm L 72mm W 38mm		
For models:	BB-2500, F, FP, K1600, K1600-ALTA-VELOCITA, K1700, K1800, K2100, K2200, K2500, K2700, K3000, K3000+K10, K3100, K3100+K10, K3300, K3800, K3800+K10, K4000, K4400, K4400+K10, K5400, K5400+K10, KP2300, KP2300+KP23, KP2800, KP3000, KP4000, KT-1500		

screw connections



1			
GEV No.	517304	Ref. No.	0010200276 DW10200276
description	nut thread 1/2" for thermowell		
For models:	K100, KP150, KP151		



1			
GEV No.	517007	Ref. No.	0015042 DW15042
description	screw connection		
For models:	HOOD-130, HOOD-130-ELETTRONICA, K100, K120, K70, K90, KP130-ELETTRONICA, KP149, KP150, KP151, KP151-E		

curtains

curtains

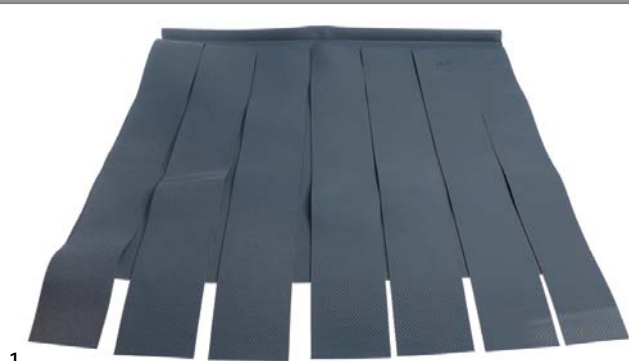

GEV No.	533006	Ref. No.	003004050 DW3004050
description	curtain W 545mm H 590mm LANG thickness 1.6mm		
For models:	BB-2500, K1600, K1600-ALTA-VELOCITA, K1800, K2100, K2200, K2500, K3000, K3000+K10, K3100, K3100+K10, K3300, K3800, K3800+K10, K4000, K4400, K4400+K10, K5400, K5400+K10, KP2300, KP2300+KP23, KP3000, KP4000, KT-1500		



GEV No.	524801	Ref. No.	003004051 DW3004051
description	curtain W 620mm H 500mm plastic thickness 1.4mm for dishwasher		
For models:	BB-2500, K1600, K1600-ALTA-VELOCITA, K1700, K1800, K2100, K2200, K2500, K2700, K3000, K3000+K10, K3100, K3100+K10, K3300, K3800, K3800+K10, K4000, K4400, K4400+K10, K5400, K5400+K10, KP2300, KP2300+KP23, KP2800, KP3000, KP4000, KT-1500		

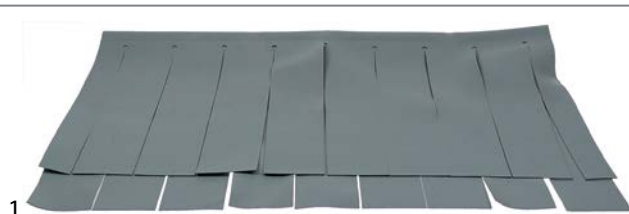

GEV No.	533020	Ref. No.	003060023 DW3060023
description	curtain W 725mm mounting pos. 500 thickness 1.5mm		
For models:	F, FP		

curtain rods



GEV No.	533017	Ref. No.	003004052 DW3004052
description	curtain rod L 635mm ø 8mm		
For models:	BB-2500, K1600, K1600-ALTA-VELOCITA, K1700, K1800, K2100, K2200, K2500, K2700, K3000, K3000+K10, K3100, K3100+K10, K3300, K3800, K3800+K10, K4000, K4400, K4400+K10, K5400, K5400+K10, KP2300, KP2300+KP23, KP2800, KP3000, KP4000, KT-1500		

washing and rinsing systems



GEV No.	517086	Ref. No.	0088126 DW88126
description	bush for wash arm		
For models:	KP300, KP400		





GEV No.	517682	Ref. No.	0010200121 DW10200121
description	bush for wash arm mounting pos. upper H 52mm thread 1¼" D1 ø 54mm D2 ø 41mm Qty 1 pcs		





GEV No.	517341	Ref. No.	0075320 DW75320
description	bush ID ø 16mm ED ø 48mm		
For models:	F, FP, HOOD-110, HOOD-110-E, HOOD-130, HOOD-130-ELETTRONICA, K100, K120, KP130-ELETTRONICA, KP149, KP150, KP151, KP151-E		





			
1			
GEV No.	517310	Ref. No.	0010260 DW10260
description	connector holder		
For models:	AQUA-50, AQUA-80, DUPLA-45, DUPLA-50, HOOD-110, HOOD-110-E, HOOD800SP-3D-GOGGLES-IMAX, K100, K35, K37, K40, K45, K50, K60, K70, K80, KP150, KP151, LUX-60, LUX-60-ELETTRONICA, LUX-61-ELETTRONICA		

			
1			
GEV No.	517103	Ref. No.	0010204 DW10204
description	cover		

			
1			
GEV No.	517094	Ref. No.	0019250 DW19250
description	cover for rinse arm shaft H 108mm D1 ø 28mm		
For models:	AQUA-35, DUPLA-35, DUPLA-37, K45		

			
1			
GEV No.	517098	Ref. No.	00135250 DW135250
description	cover for rinse arm shaft mounting pos. lower		
For models:	AQUA-37, DUPLA-35, DUPLA-37, K35, K37		

			
1			
GEV No.	504370	Ref. No.	0016250 DW16250
description	cover for rinse arm shaft mounting pos. lower H 102mm D1 ø 27.5mm D2 ø 30mm L1 32mm L2 59mm ID ø 25mm		
For models:	AQUA-40, DUPLA-40, K40		

			
1			
GEV No.	517100	Ref. No.	0018250 DW18250
description	cover wash arm support mounting pos. lower		

			
1			
GEV No.	517129	Ref. No.	00550225 DW550225
description	cover wash arm support mounting pos. lower		
For models:	AQUA-50, AQUA-80, DUPLA-45, DUPLA-50, KP85-EL, LUX-60, LUX-60-ELETTRONICA, LUX-85, LUX-85-ELETTRONICA		

			
1			
GEV No.	517130	Ref. No.	00560004 00560024 DW560004 DW560024
description	cover wash arm support mounting pos. lower		
For models:	K60, KP70-EL, LUX-70-EL		

			
1			
GEV No.	517374	Ref. No.	0013304 DW13304
description	duct D1 ø 20mm D2 ø 14mm L 17mm int. ø 110mm		
For models:	HOOD-110, HOOD-110-E, HOOD-130, HOOD-130-ELETTRONICA, HOOD800SP-3D-GOGGLES-IMAX, K100, K120, K1700, K2100, K2200, K2500, K2700, K3000, K3000+K10, K3100, K3100+K10, K3300, K35, K36, K37, K3800, K3800+K10, K40, K4000, K4400, K4400+K10, K45, K50, K5400, K5400+K10, K70, K80, K90, KP130-ELETTRONICA, KP149, KP150, KP151, KP151-E		

			
1			
GEV No.	517112	Ref. No.	0015039/A DW15039/A
description	extension for wash arm support		
For models:	K70, K80		

			
GEV No.	517114	Ref. No.	0015039 DW15039
description	extension for wash arm support		
For models:	K100, K50, K80		

			
GEV No.	517120	Ref. No.	0022031 0022050 DW22031 DW22050
description	extension for wash arm support		
For models:	K100, KP149, KP150, KP151, KP151-E		

			
GEV No.	517095	Ref. No.	0016038 DW16038
description	flange ø 60mm		
For models:	AQUA-35, AQUA-37, AQUA-40, DUPLA-35, DUPLA-37, DUPLA-40, K35, K37, K40, K45		

			
GEV No.	517148	Ref. No.	00540032 DW540032
description	flat gasket rubber ED ø 57mm ID ø 43mm thickness 2mm Qty 1 pcs		
For models:	DUPLA-40, K40-LUX, K41-LUX, LUX-40, LUX-40-ELETTRONICA, LUX-41-ELETTRONICA, LUX-61-ELETTRONICA		

			
GEV No.	511944	Ref. No.	0013306/A DW13306/A
description	gasket for wash pipe ø 41mm thickness 10mm ID ø 27mm		
For models:	AQUA-37, AQUA-40, K37, K40, K45, K50, K80		

			
GEV No.	517138	Ref. No.	0010225 DW10225
description	guide for rinse arm shaft		
For models:	LUX-40, LUX-40-ELETTRONICA, LUX-61-ELETTRONICA		

			
GEV No.	517164	Ref. No.	0015152 DW15152
description	manifold connection 3-way		
For models:	K45		

			
GEV No.	517165	Ref. No.	0015165 DW15165
description	manifold connection 3-way		
For models:	K50, K60, K80, KP200, KP300, KP400		

			
GEV No.	517163	Ref. No.	0015151 DW15151
description	manifold connection 4-way		
For models:	AQUA-35, AQUA-37, AQUA-40, K35, K37, K40, K40-LUX, LUX-40, LUX-40-ELETTRONICA		

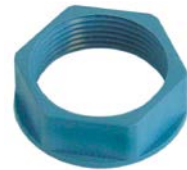
			
GEV No.	517134	Ref. No.	00540010 00540069 DW540010 DW540069
description	nut		
For models:	DUPLA-40, K40-LUX, K41-LUX, LUX-40, LUX-40-ELETTRONICA, LUX-41-ELETTRONICA, LUX-61-ELETTRONICA		

			
GEV No.	517070	Ref. No.	0075317 DW75317
description	nut for wash arm		
For models:	F, FP, HOOD-110, HOOD-110-E, HOOD-130, HOOD-130-ELETTRONICA, K100, K120, K90, KP130-ELETTRONICA, KP149, KP150, KP151, KP151-E, KP202-E, KP300-ELETTRONICA, KP302-E, KP400-ELETTRONICA, KP402-E, KP85-EL, LUX-85, LUX-85-ELETTRONICA		



 <p>1</p>			
GEV No.	517085	Ref. No.	0080222 DW80222
description	nut for wash arm		
For models:	KP200, KP200-ELETTRONICA		



 <p>1</p>			
GEV No.	524959	Ref. No.	00500702 DW500702
description	nut for wash arm mounting pos. upper/lower ø 35mm H 34mm PTFE		
For models:	AQUA-50, AQUA-80, DUPLA-50, KP70-EL, LUX-60, LUX-60-ELETTRONICA, LUX-61-ELETTRONICA, LUX-70-EL		

 <p>1</p>			
GEV No.	517154	Ref. No.	00500610 00500623 DW500610 DW500623
description	nut mounting pos. upper for wash arm support		
For models:	AQUA-50, AQUA-80, DUPLA-45, DUPLA-50, K60, KP70-EL, KP85-EL, LUX-60, LUX-60-ELETTRONICA, LUX-70-EL, LUX-85, LUX-85-ELETTRONICA		

 <p>1</p>			
GEV No.	524853	Ref. No.	0012518 DW12518
description	reducer for wash arm support ø 30mm ID ø 14mm ED ø 24.5mm H 9mm		
For models:	AQUA-37, K41-LUX		

 <p>1</p>			
GEV No.	524973	Ref. No.	0010600503 0016528 DW10600503 DW16528
description	rinse arm boss mounting pos. upper/lower ø 30mm H 25mm		
For models:	KP200, KP300, KP400		

 <p>1</p>			
GEV No.	517155	Ref. No.	0075319 DW75319
description	rinse arm support for stationary arms mounting pos. upper		
For models:	HOOD-110, HOOD-110-E, HOOD-130, HOOD-130-ELETTRONICA, HOOD800SP-3D-GOGGLES-IMAX, K100, K120, KP130-ELETTRONICA, KP149, KP150, KP151, KP151-E		

 <p>1</p>			
GEV No.	517143	Ref. No.	0010909 0010909/A DW10909 DW10909/A
description	rinse arm support mounting pos. upper		
For models:	K35, K37, K40, K45		
accessories for	517143		
			
GEV No.	517066	Ref. No.	0011101/A 11101/A DW11101/A
Thumb screw thread M8 thread L 8mm ø 30mm H 3mm SS mounting pos. upper			

 <p>1</p>			
GEV No.	517161	Ref. No.	0010600202 DW10600202
description	rinse arm support mounting pos. upper		
For models:	KP200, KP200-ELETTRONICA, KP300, KP300-ELETTRONICA, KP400, KP400-ELETTRONICA		

 <p>1</p>			
GEV No.	524952	Ref. No.	003003129 DW3003129
description	rinse arm support mounting pos. upper/lower thread 3/8" hose ø 11.5mm		
For models:	F, FP, K1700, K2500, K2700, K3000, K3000+K10, K3100, K3100+K10, K3300, K3800, K3800+K10, K4000, K4400, K4400+K10, K5400, K5400+K10		

1			
GEV No.	517111	Ref. No.	0015303 DW15303
description	rinse pipe		
For models:	K70		

1			
GEV No.	517113	Ref. No.	0015304 DW15304
description	rinse pipe		
For models:	K100, K50, K80		

1			
GEV No.	517116	Ref. No.	0075315 DW75315
description	rinse pipe		
For models:	DUPLA-50, K100, KP149, KP150, KP151, KP151-E, KP85-EL, LUX-85, LUX-85-ELETTRONICA		

1			
GEV No.	517119	Ref. No.	0022026 DW22026
description	rinse pipe		
For models:	K100, KP149, KP150, KP151, KP151-E		

1			
GEV No.	517126	Ref. No.	00550208 00550226 DW550208 DW550226
description	rinse pipe		
For models:	AQUA-50, AQUA-80, DUPLA-45, DUPLA-50, LUX-60, LUX-60-ELETTRONICA		

1			
GEV No.	517128	Ref. No.	00550219 DW550219
description	rinse pipe		
For models:	DUPLA-50, K90, KP85-EL, LUX-85, LUX-85-ELETTRONICA		

1			
GEV No.	517132	Ref. No.	00560005 DW560005
description	rinse pipe		
For models:	K60		

1			
GEV No.	517153	Ref. No.	001060023 DW1060023
description	rinse pipe		

1			
GEV No.	517157	Ref. No.	0075322 DW75322
description	rinse pipe		
For models:	HOOD-110, HOOD-110-E, HOOD-130, HOOD-130-ELETTRONICA, K100, K120, KP130-ELETTRONICA, KP149, KP150, KP151, KP151-E		

1			
GEV No.	517144	Ref. No.	00350402 DW350402
description	rinse pipe angled mounting pos. upper		
For models:	AQUA-35, AQUA-35-RL09, AQUA-37, AQUA-37-RL09, AQUA-40, AQUA-40-RL09, DUPLA-35, DUPLA-37		

1			
GEV No.	511638	Ref. No.	003003951 DW3003951
description	rinse pipe L 600mm		
For models:	K3000, K3000+K10, K3100, K3100+K10, K3300		

1			
GEV No.	517140	Ref. No.	0011600021 004374 DW11600021 DW4374
description	rinse pipe mounting pos. lower		
For models:	HOOD-130, HOOD-130-ELETTRONICA, K120, KP130-ELETTRONICA		

1			
GEV No.	517149	Ref. No.	00540016 00540070 DW540016 DW540070
description	screw connection ø 10mm with hole		
For models:	K40-LUX, LUX-40, LUX-40-ELETTRONICA		

1			
GEV No.	517115	Ref. No.	0075321 DW75321
description	spacer piece		
For models:	HOOD-110, HOOD-110-E, K100, KP149, KP150, KP151, KP151-E		





 <p>1</p>			
GEV No.	517127	Ref. No.	00550220 DW550220
description	spacer piece		
For models:	AQUA-50, AQUA-80, DUPLA-50, K90, KP70-EL, KP85-EL, LUX-60, LUX-60-ELETTRONICA, LUX-70-EL, LUX-85, LUX-85-ELETTRONICA		



 <p>1</p>			
GEV No.	517071	Ref. No.	0075316 DW75316
description	wash arm bearing		
For models:	K90, KP202-E, KP302-E, KP402-E, KP85-EL, LUX-85, LUX-85-ELETTRONICA		

 <p>1</p>			
GEV No.	517139	Ref. No.	0010600011/A 0011600033 DW10600011/A DW11600033
description	throttle disc		
For models:	HOOD-130, HOOD-130-ELETTRONICA, K120, KP130-ELETTRONICA, KP200, KP200-ELETTRONICA, KP300-ELETTRONICA, KP400, KP400-ELETTRONICA		

 <p>1</p>			
GEV No.	517084	Ref. No.	0080221 DW80221
description	wash arm bearing		
For models:	KP200, KP200-ELETTRONICA		

 <p>1</p>			
GEV No.	517158	Ref. No.	0010377 DW10377
description	Thumb screw ø 8mm		
For models:	AQUA-35, AQUA-35-RL09, AQUA-37, AQUA-37-RL09, AQUA-40, AQUA-40-RL09, DUPLA-35, DUPLA-37, DUPLA-40, K35, K37, K40, LUX-40, LUX-40-ELETTRONICA		

 <p>1</p>			
GEV No.	524798	Ref. No.	00540077 DW540077
description	wash arm bearing mounting pos. lower 3 holes hole ø 3mm seat ø 20mm ø 46mm H 35mm		
For models:	K41-LUX, LUX-40, LUX-40-ELETTRONICA, LUX-41-ELETTRONICA		

 <p>1</p>			
GEV No.	524804	Ref. No.	0010652 DW10652
description	Thumb screw thread M5 thread L 7mm ø 30mm H 5mm SS Qty 1 pcs		
For models:	AQUA-50, AQUA-80, DUPLA-50, HOOD-110, HOOD-110-E, HOOD-130, HOOD-130-ELETTRONICA, KP130-ELETTRONICA, KP149, KP151, KP151-E, KP200-ELETTRONICA, KP202-E, KP300-ELETTRONICA, KP302-E, KP400-ELETTRONICA, KP402-E, KP70-EL, KP85-EL, LUX-40, LUX-40-ELETTRONICA, LUX-41-ELETTRONICA, LUX-60, LUX-60-ELETTRONICA, LUX-61-ELETTRONICA, LUX-70-EL, LUX-85, LUX-85-ELETTRONICA		
accessories for	524804		
			
GEV No.	505277	Ref. No.	0010651 10651 DW10651
rinse arm shaft warewashing ø 14mm H 38mm thread 1/4"			

 <p>1</p>			
GEV No.	524799	Ref. No.	00540078 DW540078
description	wash arm bearing mounting pos. upper/lower 3 holes hole ø 3mm seat ø 20mm ø 46mm H 32mm		
For models:	LUX-40, LUX-40-ELETTRONICA, LUX-41-ELETTRONICA		

 <p>1</p>			
GEV No.	517369	Ref. No.	00500701 DW500701
description	wash arm bearing ø 16.5mm H 18.5mm		
For models:	AQUA-50, AQUA-80, DUPLA-50, KP70-EL, LUX-60, LUX-60-ELETTRONICA, LUX-61-ELETTRONICA, LUX-70-EL		



1

GEV No.	517471	Ref. No.	003060204 DW3060204
description	wash distributor mounting pos. lower ø 32mm L 177mm SS		
For models:	F, FP		



1

GEV No.	517469	Ref. No.	003060151 DW3060151
description	wash distributor mounting pos. lower ø 32mm L 355mm SS		
For models:	F, FP		



1

GEV No.	517382	Ref. No.	0011600103 DW11600103
description	wash pipe L 635mm stainless steel suitable for Dühr		
For models:	HOOD-110, HOOD-110-E, HOOD-130, HOOD-130-ELETTRONICA, HOOD800SP-3D-GOGGLES-IMAX, KP130-ELETTRONICA		

gear wheels



1

GEV No.	699261	Ref. No.	003060022 DW3060022
description	gear wheel plastic W 37.5mm ID ø 25mm ED ø 150mm		
For models:	BB-2500, F, FP		

for toasters

pliers

pliers



1

GEV No.	690010	Ref. No.	008008 DW8008
description	plier for toaster H 180mm total length 100mm		
For models:	F12, F120-TK120P, F6, F60-TK60P		

handles and hand wheels

handle rails

end caps



1

GEV No.	694609	Ref. No.	00135241 DW135241
description	end cap for handle rail mounting pos. left/right		
For models:	K35, K36, K37, K40, K45, K50, K80		

recessed handles



1

GEV No.	694613	Ref. No.	00135240 DW135240
description	handle rail L 255mm W 30mm H 55mm plastic for dishwasher		
For models:	K35, K37, K40, K45, K50, K80		





locks







espagnolette locks







producer-specific

KROMO

	1		
GEV No.	694630	Ref. No.	00590020 DW590020
description	bush H 9mm for espagnolette lock ID ø 10mm ED ø 14mm		

	1			
GEV No.	560540	Ref. No.	00590113 DW590113	
description	countersunk screw ø 5mm L 120mm SS Qty 1 pcs intake Phillips for door handle			
accessories for	560540			
	GEV No.	694624	Ref. No.	00590017 590017 DW590017
	door handle L 185mm handle ø 28mm screw mounting dark grey plastic hole ø 6mm			

	1			
GEV No.	694625	Ref. No.	00590018 DW590018	
description	coupling for door handle ø 20mm L 28mm hole ø 11mm			
accessories for	694625			
	GEV No.	560540	Ref. No.	00590113 590113 DW590113
	countersunk screw ø 5mm L 120mm SS Qty 1 pcs intake Phillips for door handle			
	GEV No.	694611	Ref. No.	00590016 590016 DW590016
	tap head for door handle ø 60mm grey L 105mm W 60mm H 65mm			
	GEV No.	694624	Ref. No.	00590017 590017 DW590017
	door handle L 185mm handle ø 28mm screw mounting dark grey plastic hole ø 6mm			
	GEV No.	694626	Ref. No.	00590006 590006 DW590006
	cross bar H 17mm L 107mm W 50mm for espagnolette lock mounting distance 40mm D1 ø 11mm D2 ø 12mm			
	GEV No.	694630	Ref. No.	00590020 590020 DW590020
	bush H 9mm for espagnolette lock ID ø 10mm ED ø 14mm			

	1			
GEV No.	694626	Ref. No.	00590006 DW590006	
description	cross bar H 17mm L 107mm W 50mm for espagnolette lock mounting distance 40mm D1 ø 11mm D2 ø 12mm			
accessories for	694626			
	GEV No.	560540	Ref. No.	00590113 590113 DW590113
	countersunk screw ø 5mm L 120mm SS Qty 1 pcs intake Phillips for door handle			
	GEV No.	694611	Ref. No.	00590016 590016 DW590016
	tap head for door handle ø 60mm grey L 105mm W 60mm H 65mm			
	GEV No.	694624	Ref. No.	00590017 590017 DW590017
	door handle L 185mm handle ø 28mm screw mounting dark grey plastic hole ø 6mm			
	GEV No.	694625	Ref. No.	00590018 590018 DW590018
	coupling for door handle ø 20mm L 28mm hole ø 11mm			
	GEV No.	694627	Ref. No.	00590019 590019 DW590019
	thread bolt L 13.5mm for espagnolette lock D1 ø 11mm D2 ø 10mm thread M6			
	GEV No.	694630	Ref. No.	00590020 590020 DW590020
	bush H 9mm for espagnolette lock ID ø 10mm ED ø 14mm			











	1			
GEV No.	694624	Ref. No.	00590017 DW590017	
description	door handle L 185mm handle ø 28mm screw mounting dark grey plastic hole ø 6mm			
spare parts for	694624			
	GEV No.	560540	Ref. No.	00590113 590113 DW590113
	countersunk screw ø 5mm L 120mm SS Qty 1 pcs intake Phillips for door handle			
accessories for	694624			
	GEV No.	560540	Ref. No.	00590113 590113 DW590113
	countersunk screw ø 5mm L 120mm SS Qty 1 pcs intake Phillips for door handle			
	GEV No.	694611	Ref. No.	00590016 590016 DW590016
	tap head for door handle ø 60mm grey L 105mm W 60mm H 65mm			





Table continues overleaf

accessories for 694624			
	GEV No. 694625	Ref. No.	00590018 590018 DW590018
coupling for door handle ø 20mm L 28mm hole ø 11mm			
	GEV No. 694626	Ref. No.	00590006 590006 DW590006
cross bar H 17mm L 107mm W 50mm for espagnolette lock mounting distance 40mm D1 ø 11mm D2 ø 12mm			
	GEV No. 694630	Ref. No.	00590020 590020 DW590020
bush H 9mm for espagnolette lock ID ø 10mm ED ø 14mm			

			
1	GEV No. 560542	Ref. No.	0011505 DW11505
description grub screw thread M6 L 16mm in stainless steel DIN 916/ISO 4029 intake internal hexagon WS 3 Qty 1 pcs			
For models: KT-1500			

			
1	GEV No. 560541	Ref. No.	00590099 DW590099
description raised countersunk head screw thread M6 thread L 13mm SS DIN 966/ISO 7047 Qty 1 pcs intake slotted head ø 11mm head thickness 5mm			

			
1	GEV No. 560289	Ref. No.	0011168 DW11168
description side bolts thread M6 L 12mm SS Qty 1 pcs intake Phillips head ø 12.6mm			
For models: DUPLA-45, DUPLA-50, K120, K40-LUX, K41-LUX, K60			

			
1	GEV No. 694611	Ref. No.	00590016 DW590016
description tap head for door handle ø 60mm grey L 105mm W 60mm H 65mm			
accessories for 694611			
	GEV No. 560540	Ref. No.	00590113 590113 DW590113
countersunk screw ø 5mm L 120mm SS Qty 1 pcs intake Phillips for door handle			
	GEV No. 694624	Ref. No.	00590017 590017 DW590017
door handle L 185mm handle ø 28mm screw mounting dark grey plastic hole ø 6mm			
	GEV No. 694625	Ref. No.	00590018 590018 DW590018
coupling for door handle ø 20mm L 28mm hole ø 11mm			

accessories for 694611			
	GEV No. 694626	Ref. No.	00590006 590006 DW590006
cross bar H 17mm L 107mm W 50mm for espagnolette lock mounting distance 40mm D1 ø 11mm D2 ø 12mm			

			
1	GEV No. 694627	Ref. No.	00590019 DW590019
description thread bolt L 13.5mm for espagnolette lock D1 ø 11mm D2 ø 10mm thread M6			

hinges

door bearing



			
1	GEV No. 519397	Ref. No.	00540036 00540636 DW540036 DW540636
description bush mounting pos. left for hinge			
For models: K40-LUX, K41-LUX, LUX-40, LUX-40-ELETTRONICA, LUX-41-ELETTRO-NICA			



			
1	GEV No. 519396	Ref. No.	00540035 DW540035
description bush mounting pos. right for hinge			
For models: K40-LUX, K41-LUX, LUX-40, LUX-40-ELETTRONICA, LUX-41-ELETTRO-NICA			

			
1	GEV No. 694628	Ref. No.	00590093 DW590093
description hinge L 50mm W 15mm H 20mm bolt 14mm bolt ø 10mm with bolt for dishwasher			



miscellaneous

 <p>1</p>			
GEV No.	519399	Ref. No.	00540629 DW540629
description	door hinge mounting pos. left		
For models:	K40-LUX, K41-LUX, LUX-40, LUX-40-ELETTRONICA, LUX-41-ELETTRONICA		
accessories for	519399		
	GEV No.	519397	Ref. No. 00540036 00540636 540036 540636 DW540036 DW540636
bush mounting pos. left for hinge			

 <p>1</p>			
GEV No.	519398	Ref. No.	00540624 DW540624
description	door hinge mounting pos. right		
For models:	K40-LUX, K41-LUX, LUX-40, LUX-40-ELETTRONICA, LUX-41-ELETTRONICA		
accessories for	519398		
	GEV No.	519396	Ref. No. 00540035 540035 DW540035
bush mounting pos. right for hinge			

equipment feet and end caps

screw-in feet

 <p>1</p>			
GEV No.	701292	Ref. No.	0010786 DW10786
description	equipment foot thread M10 thread L 23mm ø 38mm H 12.5mm WS 17 Qty 1 pcs		
For models:	K35, K36, K37, K40, K45, K50, K70, KP70-EL, LUX-60, LUX-60-ELETTRONICA, LUX-61-ELETTRONICA, LUX-70-EL		

 <p>1</p>			
GEV No.	701293	Ref. No.	0015057 DW15057
description	equipment foot thread M10 thread L 51mm ø 50mm H 14mm WS 17 Qty 1 pcs		
For models:	K50, K60, K80		

 <p>1</p>			
GEV No.	695601	Ref. No.	0010850 DW10850
description	equipment foot thread M17 thread L 23mm ø 24mm H 11mm plastic WS 24 Qty 1 pcs		
For models:	AQUA-35, AQUA-35-RL09, AQUA-37, AQUA-37-RL09, AQUA-40, AQUA-40-RL09, AQUA-50, DUPLA-35, DUPLA-37, DUPLA-40, K40-LUX, K41-LUX, LUX-40, LUX-40-ELETTRONICA, LUX-41-ELETTRONICA		

 <p>1</p>			
GEV No.	696536	Ref. No.	0010851 DW10851
description	equipment foot thread M17 thread L 30mm ø 17mm H 20mm plastic WS 24 Qty 1 pcs		
For models:	AQUA-50, DUPLA-45, DUPLA-50		

baskets

warewashing baskets

steel wire baskets round

mix baskets

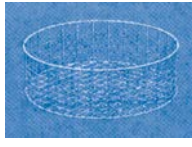
 <p>1</p>			
GEV No.	970317	Ref. No.	00C21 DWC21
description	mix basket ED ø 350mm H 110mm		
For models:	Baskets		

 <p>1</p>			
GEV No.	970580	Ref. No.	00C07 DWC07
description	mix basket ED ø 370mm H 120mm		
For models:	Baskets		

 <p>1</p>			
GEV No.	970318	Ref. No.	00C16 DWC16
description	mix basket ED ø 400mm H 145mm		
For models:	Baskets		

steel wire baskets square

glass basket



GEV No.	971008	Ref. No.	00C39 00C78 DWC39 DWC78
description	glass basket L 370mm W 370mm H 170mm number of rows 3 inclined bottom		
For models:	Baskets		



GEV No.	971024	Ref. No.	00C25 DWC25	
description	glass basket L 400mm W 400mm H 170mm number of rows 3 rows spacing 120mm			
For models:	Baskets			
spare parts for	971024			
	GEV No.	970001	Ref. No.	0010768 10768 DW10768
sliding corner wire gauge ø 5mm L 120mm W 120mm H 12mm L-shape				

mix baskets



GEV No.	971001 ¹	Ref. No.	0010730 DW10730
description	mix basket L 350mm W 350mm H 120mm mesh type wide-meshed		
For models:	Baskets		

¹wide-meshed



GEV No.	971007 ¹	Ref. No.	00C10 DWC10
description	mix basket L 370mm W 370mm H 135mm mesh type wide-meshed		
For models:	Baskets		

¹wide-meshed



GEV No.	971023 ¹	Ref. No.	00C04 00C121 DWC04 DWC121
description	mix basket L 400mm W 400mm H 130mm mesh type close-meshed		
For models:	Baskets		

¹fine-meshed



GEV No.	971128 ¹	Ref. No.	00C75 DWC75
description	mix basket L 450mm W 450mm H 140mm mesh type wide-meshed		
For models:	Baskets		

¹wide-meshed



GEV No.	970074 ¹	Ref. No.	00C044 00C09 DWC044 DWC09
description	mix basket L 500mm W 500mm H 130mm mesh type close-meshed		
For models:	Baskets		

¹fine-meshed

plate baskets



GEV No.	971009	Ref. No.	00C03 DWC03
description	plate basket L 370mm W 370mm H 100mm plates 10 plate ø 250mm		
For models:	Baskets		



GEV No.	971126	Ref. No.	00C31 DWC31
description	plate basket L 400mm W 400mm H 120mm plates 12 plate ø 270mm		
For models:	Baskets		



			
GEV No.	971032	Ref. No.	00C76 DWC76
description	plate basket L 450mm W 450mm H 95mm plates 14 plate ø 230mm		
For models:	Baskets		

accessories

cutlery inserts

			
GEV No.	976011	Ref. No.	0015060 DW15060
description	cutlery insert Lmm Wmm ø 110mm H 130mm		
For models:	Accessories		

sliding corners

			
GEV No.	970001	Ref. No.	0010768 DW10768
description	sliding corner wire gauge ø 5mm L 120mm W 120mm H 12mm L-shape		

basket holders

			
GEV No.	971000	Ref. No.	00C36 DWC36
description	basket support L 350mm W 350mm for basket ø350mm		
For models:	Baskets		

plate inserts

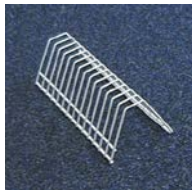
			
GEV No.	971155	Ref. No.	0010728 DW10728
description	plate insert L 297mm W 100mm H 84mm plates 14		
For models:	Accessories		

gaskets

O-rings

EPDM

			
GEV No.	510302	Ref. No.	0013009 0013017 DW13009 DW13017
description	O-ring EPDM ID ø 12.42mm thickness 1.78mm Qty 1 pcs		
For models:	AQUA-35, AQUA-35-RL09, AQUA-37, AQUA-37-RL09, AQUA-40, AQUA-40-RL09, AQUA-50, AQUA-80, DUPLA-35, DUPLA-37, DUPLA-40, DUPLA-45, F, FP, HOOD-110, HOOD-110-E, HOOD800SP-3D-GOGGLES-IMAX, K2100, K2200, K2500, K3000, K3000+K10, K3100, K3100+K10, K3300, K35, K37, K3800, K3800+K10, K40, K4000, K40-LUX, K4400, K4400+K10, K45, K5400, K5400+K10, K80, KP200-ELETTRONICA, KP300, KP300-ELETTRONICA, KP400-ELETTRONICA, LUX-40, LUX-40-ELETTRONICA		

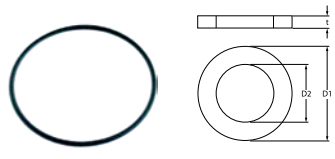
			
GEV No.	345896	Ref. No.	0089332 DW89332
description	O-ring EPDM thickness 1.5mm ID ø 37mm Qty 1 pcs		
For models:	HOOD-110, HOOD-130		

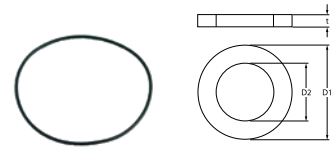
			
GEV No.	345908	Ref. No.	0089331 DW89331
description	O-ring EPDM thickness 1.5mm ID ø 58.5mm Qty 1 pcs		
For models:	HOOD-110, HOOD-130, HOOD800SP-3D-GOGGLES-IMAX, KP149, KP151		

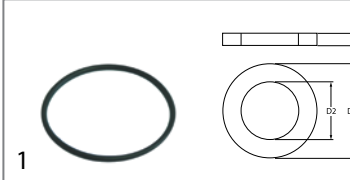
			
GEV No.	510824	Ref. No.	0013025 DW13025
description	O-ring EPDM thickness 1.78mm ID ø 20.35mm Qty 1 pcs		
For models:	AQUA-50, AQUA-80, BB-2500, F, FP, GR300, GR800, HOOD-110, HOOD-110-E, HOOD800SP-3D-GOGGLES-IMAX, K1600, K1600-ALTA-VELOCITA, K1700, K1800, K2100, K2200, K2500, K26, K26A, K2700, K3000, K3000+K10, K3100, K3100+K10, K3300, K3800, K3800+K10, K4000, K4400, K4400+K10, K5400, K5400+K10, KP2300, KP2300+KP23, KP2800, KP3000, KP302-E, KP4000, KP402-E, KT-1500		

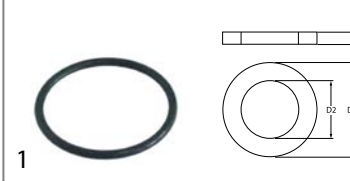
			
GEV No.	517045	Ref. No.	0013018 DW13018
description	O-ring EPDM thickness 1.78mm ID ø 21.95mm Qty 1 pcs		
For models:	AQUA-50, AQUA-80, DUPLA-50, K100, K50, K60, K70, K80, KP150, LUX-60, LUX-60-ELETTRONICA		

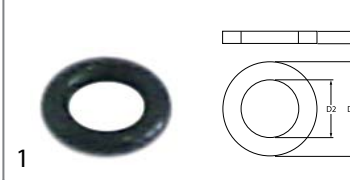
			
GEV No.	517035	Ref. No.	0013016 DW13016
description	O-ring EPDM thickness 1.78mm ID ø 4.48mm Qty 1 pcs		
For models:	AQUA-50, AQUA-80, DUPLA-50, K100, K35, K37, K40, K45, K50, K60, K70, K80, KP150, LUX-60, LUX-60-ELETTRONICA, LUX-61-ELETTRONICA		

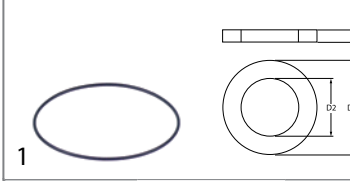
			
GEV No.	521724	Ref. No.	00135506 0025029 DW135506 DW25029
description	O-ring EPDM thickness 1.78mm ID ø 72.75mm Qty 1 pcs		
For models:	AQUA-35-RL09, AQUA-37-RL09, AQUA-40, AQUA-40-RL09, Pumps		

			
GEV No.	532680	Ref. No.	15285 DW15285
description	O-ring EPDM thickness 2.5mm ID ø 12mm Qty 1 pcs		
For models:	AQUA-35-RL09, AQUA-37-RL09, AQUA-40-RL09, BB-2500, F, FP, HOOD800SP-3D-GOGGLES-IMAX, K1700, K1800, K2100, K2200, K2500, K2700, K3000, K3000+K10, K3100, K3100+K10, K3300, K3800, K3800+K10, K4000, K4400, K4400+K10, K5400, K5400+K10, KP2300, KP2300+KP23, KP2800, KP3000, KP4000, KT-1500		

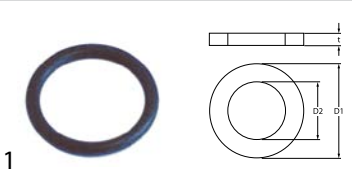
			
GEV No.	507309	Ref. No.	0013007 DW13007
description	O-ring EPDM thickness 2.62mm ID ø 17.13mm Qty 1 pcs		

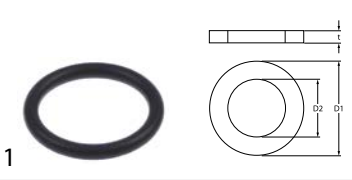
			
GEV No.	516026	Ref. No.	003003130 DW3003130
description	O-ring EPDM thickness 2.62mm ID ø 17.86mm Qty 1 pcs		
For models:	F, FP, K1700, K2500, K2700, K3000, K3000+K10, K3100, K3100+K10, K3300, K3800, K3800+K10, K4000, K4400, K4400+K10, K5400, K5400+K10		

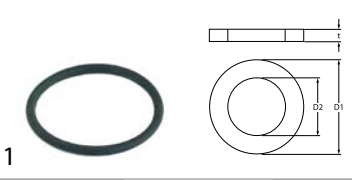
			
GEV No.	532062	Ref. No.	0013027 DW13027
description	O-ring EPDM thickness 2.62mm ID ø 29.82mm Qty 10 pcs		
For models:	K3800+K10		

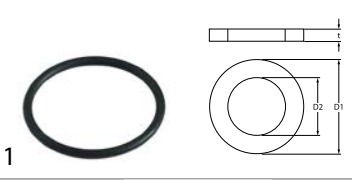
			
GEV No.	517104	Ref. No.	0013000 DW13000
description	O-ring EPDM thickness 2.62mm ID ø 31.42mm Qty 1 pcs		
For models:	AQUA-35, AQUA-37, AQUA-40, DUPLA-35, DUPLA-37, DUPLA-40, F, FP, K100, K35, K37, K40, K41-LUX, K45, K50, KP2300, KP2300+KP23, KP2800, KP3000, KP4000		

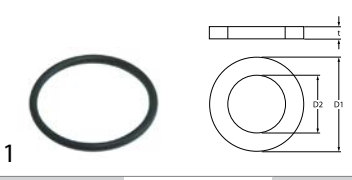
			
GEV No.	517004	Ref. No.	0013004 DW13004
description	O-ring EPDM thickness 2.62mm ID ø 34.6mm Qty 1 pcs		
For models:	HOOD-130, HOOD-130-ELETTRONICA, K100, K70, K90, KP130-ELETTRONICA, KP149, KP150, KP151, KP151-E		

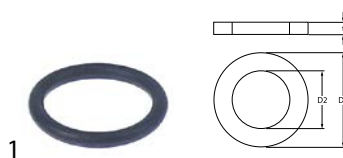

			
GEV No.	505192	Ref. No.	0013006 0013022 DW13006 DW13022
description	O-ring EPDM thickness 2.62mm ID ø 39.34mm Qty 1 pcs		
For models:	K100, K50, K70, K80, KP150, KP151		

			
GEV No.	517087	Ref. No.	0013023 DW13023
description	O-ring EPDM thickness 3.53mm ID ø 23.4mm Qty 1 pcs		
For models:	GR300, GR800, K1600, K1600-ALTA-VELOCITA, K1700, K1800, K2100, K2200, K2500, K2700, K3000, K3000+K10, K3100, K3100+K10, K3300, K3800, K3800+K10, K4000, K4400, K4400+K10, K5400, K5400+K10, KP200-ELETTRONICA, KP202-E, KP2300, KP2300+KP23, KP2800, KP3000, KP300-ELETTRONICA, KP302-E, KP400, KP4000, KP400-ELETTRONICA, KP402-E		

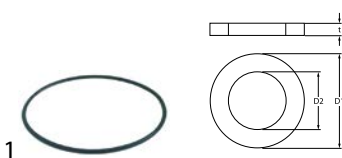
			
GEV No.	528800	Ref. No.	00135502 DW135502
description	O-ring EPDM thickness 2.62mm ID ø 75.87mm Qty 1 pcs		
For models:	AQUA-40, Pumps		

			
GEV No.	510895	Ref. No.	0013019 DW13019
description	O-ring EPDM thickness 3.53mm ID ø 34.52mm Qty 1 pcs		
For models:	AQUA-40, DUPLA-35, DUPLA-37, DUPLA-40, K1600, K1600-ALTA-VELOCITA, K40		

			
GEV No.	510893	Ref. No.	0013003 DW13003
description	O-ring EPDM thickness 2.62mm ID ø 9.92mm Qty 1 pcs		
For models:	AQUA-35, AQUA-35-RL09, AQUA-37, AQUA-37-RL09, AQUA-40, AQUA-40-RL09, DUPLA-35, DUPLA-37, DUPLA-40, HOOD-110, HOOD-110-E, HOOD-130, HOOD-130-ELETTRONICA, HOOD800SP-3D-GOGGLES-IMAX, K100, K120, K35, K37, K40, K45, K50, K70, K80, K90, KP130-ELETTRONICA, KP149, KP150, KP151, KP151-E		

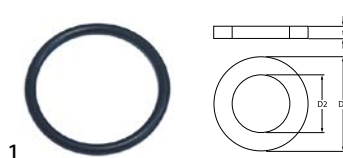
			
GEV No.	510899	Ref. No.	0013022 DW13022
description	O-ring EPDM thickness 3.53mm ID ø 37.69mm Qty 1 pcs		
For models:	KP149, KP151, KP151-E		

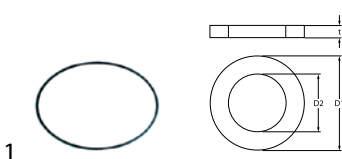
			
GEV No.	510554	Ref. No.	007130 DW7130
description	O-ring EPDM thickness 2mm ID ø 120mm Qty 1 pcs		
For models:	AQUA-50, DUPLA-45, DUPLA-50, KP70-EL, LUX-60, LUX-60-ELETTRONICA, LUX-61-ELETTRONICA, LUX-70-EL, Pumps		

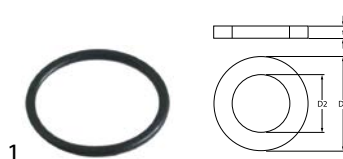
			
GEV No.	506015	Ref. No.	0016067/A DW16067/A
description	O-ring EPDM thickness 3.53mm ID ø 39.69mm Qty 1 pcs		
For models:	AQUA-35, AQUA-35-RL09, AQUA-37, AQUA-37-RL09, AQUA-40, AQUA-40-RL09, AQUA-50, AQUA-80, DUPLA-35, DUPLA-37, DUPLA-40, DUPLA-45, DUPLA-50, HOOD-110, HOOD-110-E, HOOD-130, HOOD-130-ELETTRONICA, K100, K36, K37, K40, K40-LUX, K45, K50, K60, K70, K90, KP130-ELETTRONICA, KP70-EL, KP85-EL, LUX-40, LUX-40-ELETTRONICA, LUX-60, LUX-60-ELETTRONICA, LUX-70-EL, LUX-85-ELETTRONICA		

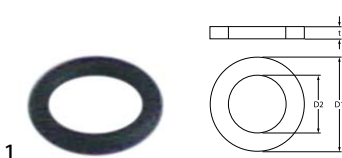
			
GEV No.	517056	Ref. No.	0013002 DW13002
description	O-ring EPDM thickness 2mm ID ø 6.5mm Qty 1 pcs		
For models:	AQUA-35, AQUA-35-RL09, AQUA-37, AQUA-37-RL09, AQUA-40, AQUA-40-RL09, AQUA-50, AQUA-80, DUPLA-35, DUPLA-37, DUPLA-40, DUPLA-45, DUPLA-50, HOOD-110, HOOD-110-E, HOOD-130, HOOD-130-ELETTRONICA, HOOD800SP-3D-GOGGLES-IMAX, K35, K37, K40, K40-LUX, KP130-ELETTRONICA, KP300, KP400, KP70-EL, KP85-EL, LUX-40, LUX-40-ELETTRONICA, LUX-60, LUX-60-ELETTRONICA, LUX-70-EL, LUX-85, LUX-85-ELETTRONICA		

GEV No.	508061	Ref. No.	0013008 DW13008
description	O-ring EPDM thickness 3.53mm ID \varnothing 42.86mm Qty 1 pcs		
For models:	BB-2500, F, FP, HOOD-130, HOOD-130-ELETTRONICA, K100, K120, K70, K90, KP130-ELETTRONICA, KP149, KP150, KP151, KP151-E		

GEV No.	510408	Ref. No.	0013005 DW13005
description	O-ring EPDM thickness 5.34mm ID \varnothing 47mm Qty 1 pcs		
For models:	AQUA-50, AQUA-80, DUPLA-45, DUPLA-50, K100, K35, K37, K40, K45, K50, K60, K70, K80, KP149, KP150, KP151, KP70-EL, LUX-60, LUX-60-ELETTRONICA, LUX-61-ELETTRONICA, LUX-70-EL		

GEV No.	510409	Ref. No.	0013015 0013020 DW13015 DW13020
description	O-ring EPDM thickness 5.34mm ID \varnothing 56.52mm Qty 1 pcs		
For models:	AQUA-50, AQUA-80, BB-2500, DUPLA-45, DUPLA-50, F, FP, GR300, GR800, HOOD-110, HOOD-110-E, HOOD-130, HOOD-130-ELETTRONICA, HOOD800SP-3D-GOGGLES-IMAX, K100, K120, K1600, K1600-ALTA-VELOCITA, K1700, K1800, K2100, K2200, K2500, K26, K26A, K2700, K3000, K3000+K10, K3100, K3100+K10, K3300, K3800, K3800+K10, K4000, K4400, K4400+K10, K5400, K5400+K10, K60, K90, KP130-ELETTRONICA, KP149, KP150, KP151, KP151-E, KP200, KP200-ELETTRONICA, KP202-E, KP2300, KP2300+KP23...(Other models you can see in the webshop)		

GEV No.	532653	Ref. No.	0080302 DW80302
description	O-ring EPDM thickness 5mm ID \varnothing 20mm Qty 1 pcs		
For models:	K1600, K1600-ALTA-VELOCITA		

<h3>Viton</h3>			
GEV No.	528525	Ref. No.	0060377 0060532 DW60377 DW60532
description	O-ring Viton thickness 3.53mm ID \varnothing 18.64mm Qty 1 pcs		
For models:	BK4, S40-BK4, S55-BK5		

<h3>NBR</h3>			
GEV No.	511941	Ref. No.	0013013 DW13013
description	O-ring NBR thickness 3.53mm ID \varnothing 29.75mm Qty 1 pcs		

GEV No.	532654	Ref. No.	0013028 DW13028
description	O-ring NBR thickness 3.6mm ID \varnothing 30.8mm Qty 1 pcs		
For models:	BB-2500, F, FP, K1600, K1600-ALTA-VELOCITA, K1800, K2100, K2200, K2500, K3000, K3000+K10, K3100, K3100+K10, K3300, K3800, K3800+K10, K4000, K4400, K4400+K10, K5400, K5400+K10, KP2300, KP2300+KP23, KP2800, KP3000, KP4000, KT-1500		

sealing washers

<h3>fibre gaskets</h3>			
GEV No.	517789	Ref. No.	0013303 DW13303
description	flat gasket ED \varnothing 10mm ID \varnothing 5mm thickness 1.2mm suitable for Dihr Qty 1 pcs		





			
1			
GEV No.	517173	Ref. No.	0013301 DW13301
description	flat gasket FIBER ED ø 14mm ID ø 8mm thickness 1.5mm Qty 1 pcs		
For models:	AQUA-35, AQUA-35-RL09, AQUA-37, AQUA-37-RL09, AQUA-40, AQUA-40-RL09, AQUA-50, AQUA-80, BB-2500, DUPLA-35, DUPLA-37, DUPLA-40, DUPLA-45, DUPLA-50, F, FP, GR300, GR800, HOOD-110, HOOD-110-E, HOOD-130, HOOD-130-ELETTRONICA, HOOD-800SP-3D-GOGGLES-IMAX, K100, K120, K1600, K1600-ALTA-VELOCITA, K1700, K1800, K2100, K2200, K2500, K2700, K3000, K3000+K10, K3100, K3100+K10, K3300, K36, K3800, K3800+K10, K4000, K40-LUX, K4400, K4400+K10, K5400, K5400+K10, K60, K70, K90...(Other models you can see in the webshop)		

			
2			
GEV No.	508017	Ref. No.	0010200171 DW10200171
description	flat gasket FIBER ED ø 24mm ID ø 17mm thickness 2mm Qty 1 pcs		
For models:	BB-2500, F, FP, K11, K11A, K12, K12-90, K14, K1600, K1600-ALTA-VELOCITA, K1700, K1800, K2100, K2200, K24, K2500, K26, K26A, K2700, K3000, K3000+K10, K3100, K3100+K10, K3300, K3800, K3800+K10, K4000, K4400, K4400+K10, K5400, K5400+K10, KP151, KP151-E, KP200-ELETTRONICA, KP2300, KP2300+KP23, KP2800, KP300, KP3000, KP300-ELETTRONICA, KP400, KP4000, KP400-ELETTRONICA, KT-1500, Optional-Steam		

			
1			
GEV No.	521122	Ref. No.	0010200212 DW10200212
description	flat gasket fibre ED ø 31mm ID ø 21.5mm thickness 2mm for thread 1/2" Qty 1 pcs		
For models:	K100, KP150, KP151, KP200, KP300, KP400		

			
1			
GEV No.	506072	Ref. No.	0013326 DW13326
description	flat gasket fibre ED ø 38mm ID ø 27mm thickness 2mm outflow for thread 1 1/4" Qty 1 pcs		
For models:	BB-2500, F, FP, K14, K1600, K1600-ALTA-VELOCITA, K1700, K1800, K2100, K2200, K2500, K26, K26A, K2700, K3000, K3000+K10, K3100, K3100+K10, K3300, K3800, K3800+K10, K4000, K4400, K4400+K10, K5400, K5400+K10, KP2300, KP2300+KP23, KP2800, KP3000, KP302-E, KP4000, KP402-E, KT-1500, Optional-Steam		

			
1			
GEV No.	510405	Ref. No.	0010200056 DW10200056
description	flat gasket fibre ED ø 56mm ID ø 42mm thickness 2mm for thread 1 1/4" Qty 1 pcs		

			
1			
GEV No.	511943	Ref. No.	0013313 DW13313
description	flat gasket rubber ED ø 24mm ID ø 8mm thickness 2mm Qty 1 pcs		
For models:	K100, K50, K70, K80, KP149, KP150, KP151, KP151-E		

			
1			
GEV No.	508423	Ref. No.	0015283 DW15283
description	flat gasket rubber ED ø 40mm ID ø 25.5mm thickness 1.7mm Qty 1 pcs		
For models:	AQUA-35-RL09, AQUA-37-RL09, AQUA-40-RL09, BB-2500, F, FP, HOOD800SP-3D-GOGGLES-IMAX, K1700, K1800, K2100, K2200, K2500, K2700, K3000, K3000+K10, K3100, K3100+K10, K3300, K3800, K3800+K10, K4000, K4400, K4400+K10, K5400, K5400+K10, KP2300, KP2300+KP23, KP2800, KP3000, KP4000, KT-1500		

			
1			
GEV No.	519341	Ref. No.	0080305 DW80305
description	flat gasket rubber ED ø 40mm ID ø 5.5mm thickness 2mm Qty 1 pcs		
For models:	BB-2500, F, FP, K1600, K1600-ALTA-VELOCITA, K1700, K1800, K2100, K2200, K2500, K2700, K3000, K3000+K10, K3100, K3100+K10, K3300, K3800, K3800+K10, K4000, K4400, K4400+K10, K5400, K5400+K10, KP200, KP2300, KP2300+KP23, KP2800, KP300, KP3000, KP4000, KT-1500		

			
1			
GEV No.	517181	Ref. No.	0013305 DW13305
description	flat gasket rubber ED ø 44mm ID ø 32mm thickness 3mm Qty 1 pcs		
For models:	AQUA-35, AQUA-37, AQUA-40, DUPLA-35, DUPLA-37, DUPLA-40, F, FP, GR300, GR800, HOOD-130, HOOD-130-ELETTRONICA, K120, K2500, K35, K36, K37, K3800, K3800+K10, K40, K4000, K4400, K4400+K10, K5400, K5400+K10, K70, KP202-E, KP302-E, KP402-E		

			
1			
GEV No.	517135	Ref. No.	00540034 DW540034
description	flat gasket rubber ED ø 56mm ID ø 44mm thickness 4.5mm Qty 1 pcs equiv. no. 540034 suitable for Dühr		
For models:	K40-LUX, K41-LUX, LUX-40, LUX-40-ELETTRONICA, LUX-41-ELETTRONICA, LUX-61-ELETTRONICA		

			
1			
GEV No.	517148	Ref. No.	00540032 DW540032
description	flat gasket rubber ED ø 57mm ID ø 43mm thickness 2mm Qty 1 pcs		
For models:	DUPLA-40, K40-LUX, K41-LUX, LUX-40, LUX-40-ELETRONICA, LUX-41-ELETRONICA, LUX-61-ELETRONICA		

			
1			
GEV No.	511940	Ref. No.	0025009 DW25009
description	flat gasket rubber ED ø 67mm ID ø 51mm thickness 3mm Qty 1 pcs		
For models:	AQUA-35-RL09, AQUA-37-RL09, AQUA-40-RL09		

			
1			
GEV No.	517205	Ref. No.	0010200173 0010200173/A 0010600013 DW10200173 DW10200173/A DW10600013
description	flat gasket rubber ED ø 75mm ID ø 58mm thickness 3mm Qty 1 pcs		
For models:	BB-2500, F, FP, K100, K1600, K1600-ALTA-VELOCITA, K1700, K1800, K2100, K2200, K23, K25, K2500, K2700, K29, K3000, K3000+K10, K3100, K3100+K10, K3300, K3800, K3800+K10, K4000, K4400, K4400+K10, K5400, K5400+K10, KP149, KP150, KP151, KP151-E, KP200, KP2300, KP2300+KP23, KP2800, KP300, KP3000, KP300-ELETRONICA, KP400, KP4000, KP400-ELETRONICA, KT-1500		

			
1			
GEV No.	517398	Ref. No.	0016067/B DW16067/B
description	flat gasket rubber ED ø 82mm ID ø 66mm thickness 4mm for salt tank Qty 1 pcs		
For models:	AQUA-35, AQUA-35-RL09, AQUA-37, AQUA-37-RL09, AQUA-40, AQUA-40-RL09, AQUA-50, AQUA-80, DUPLA-35, DUPLA-37, DUPLA-40, DUPLA-45, DUPLA-50, HOOD-110, HOOD-110-E, HOOD-130, HOOD-130-ELETRONICA, K100, K36, K37, K40, K40-LUX, K45, K50, K60, K70, K90, KP130-ELETRONICA, KP70-EL, KP85-EL, LUX-40, LUX-40-ELETRONICA, LUX-60, LUX-60-ELETRONICA, LUX-70-EL, LUX-85-ELETRONICA		

			
1			
GEV No.	517194	Ref. No.	0080208 DW80208
description	flat gasket rubber ED ø 95mm ID ø 75mm thickness 3mm Qty 1 pcs		
For models:	AQUA-50, AQUA-80, BB-2500, DUPLA-45, DUPLA-50, HOOD-110, HOOD-110-E, HOOD-130, HOOD-130-ELETRONICA, HOOD-800SP-3D-GOGGLES-IMAX, K1700, K2100, K2200, K2700, K3000, K3000+K10, K3100, K3100+K10, K3300, K40-LUX, K41-LUX, K45, K50, K5400, K5400+K10, K60, K80, K90, KP130-ELETRONICA, KP200-ELETRONICA, KP202-E, KP302-E, KP402-E, KP70-EL, KP85-EL, LUX-40, LUX-40-ELETRONICA, LUX-41-ELETRONICA, LUX-60, LUX-60-ELETRONICA, LUX-61-ELETRONICA, LUX-70-EL, LUX-85, LUX-85-ELETRONICA		

PTFE gaskets			
			
1			
GEV No.	517101	Ref. No.	0013302 DW13302
description	gasket PTFE ED ø 16mm ID ø 10mm thickness 2.5mm Qty 1 pcs		

silicone gaskets			
			
1			
GEV No.	651007	Ref. No.	0060183 DW60183
description	gasket ED ø 75mm ID ø 55mm thickness 3mm Qty 1 pcs		
For models:	BK12, BK13, F1-KF1, F1-KF1INOX, F2-KF2, GM2-2, GM3, GM3-BK12, GM4, GM4-BK13, KF1, KF1S, KF2, KF2S		

shaft gaskets			
shaft gaskets			
			
1			
GEV No.	512424	Ref. No.	0013024 DW13024
description	shaft seal ID ø 30mm ED ø 42mm thickness 7mm		
For models:	GR300, GR800, K1600, K1600-ALTA-VELOCITA, K1700, K1800, K2100, K2200, K2500, K2700, K3000, K3000+K10, K3100, K3100+K10, K3300, K3800, K3800+K10, K4000, K4400, K4400+K10, K5400, K5400+K10, KP2300, KP2300+KP23, KP2800, KP3000, KP4000		

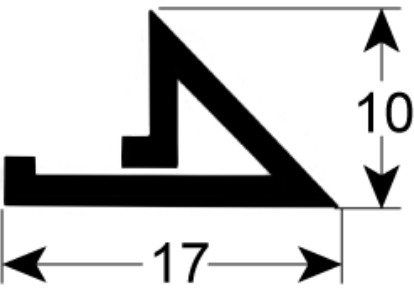
special gaskets			
door seals for dishwashers			
			
1			
GEV No.	517385	Ref. No.	00135205 DW135205
description	door seal		
For models:	AQUA-40-RL09, AQUA-50, AQUA-80, DUPLA-40, DUPLA-45, DUPLA-50		



1

GEV No.	517383	Ref. No.	00560013 DW560013
description	door seal L 1012mm W 10.5mm H 4mm Qty 1		
For models:	LUX-60, LUX-60-ELETTRONICA, LUX-61-ELETTRONICA		

1

GEV No.	517384	Ref. No.	00560021 DW560021
description	door seal L 1050mm W 22mm H 9.5mm Qty 1		
For models:	K40-LUX, K41-LUX, K60, KP70-EL, LUX-40, LUX-40-ELETTRONICA, LUX-41-ELETTRONICA, LUX-60, LUX-60-ELETTRONICA, LUX-61-ELETTRONICA, LUX-70-EL		

1

GEV No.	518616	Ref. No.	00590034 DW590034
description	door seal L 1445mm W 495mm for dishwasher suitable for Dhr		

sealing discs

1

GEV No.	511945	Ref. No.	0013316/A DW13316/A
description	gasket ø 38mm thickness 10mm rubber Qty 1 pcs ID ø 24mm		
For models:	AQUA-37, AQUA-40, AQUA-50, AQUA-80, DUPLA-35, DUPLA-37, DUPLA-40, DUPLA-50, HOOD-110, HOOD-110-E, HOOD-130, HOOD-130-ELETTRONICA, K100, K35, K37, K40, K40-LUX, K41-LUX, K45, K50, K60, K70, KP130-ELETTRONICA, KP149, KP151, KP151-E, KP70-EL, KP85-EL, LUX-40, LUX-40-ELETTRONICA, LUX-41-ELETTRONICA, LUX-60, LUX-60-ELETTRONICA, LUX-61-ELETTRONICA, LUX-70-EL, LUX-85, LUX-85-ELETTRONICA		

miscellaneous

1

GEV No.	517219	Ref. No.	0013306 DW13306
description	boot for suction connection		

1

GEV No.	517220	Ref. No.	0013350 DW13350
description	boot for suction connection		

1

GEV No.	517277	Ref. No.	00150403 DW150403
description	gasket for catch		
For models:	AQUA-35, AQUA-35-RL09, AQUA-37, AQUA-37-RL09, AQUA-40, AQUA-40-RL09, DUPLA-35, DUPLA-37, DUPLA-40		

1

GEV No.	511944	Ref. No.	0013306/A DW13306/A
description	gasket for wash pipe ø 41mm thickness 10mm ID ø 27mm		
For models:	AQUA-37, AQUA-40, K37, K40, K45, K50, K80		

			
1			
GEV No.	511945	Ref. No.	0013316/A DW13316/A
description	gasket ø 38mm thickness 10mm rubber Qty 1 pcs ID ø 24mm		
For models:	AQUA-37, AQUA-40, AQUA-50, AQUA-80, DUPLA-35, DUPLA-37, DUPLA-40, DUPLA-50, HOOD-110, HOOD-110-E, HOOD-130, HOOD-130-ELETTRONICA, K100, K35, K37, K40, K40-LUX, K41-LUX, K45, K50, K60, K70, KP130-ELETTRONICA, KP149, KP151, KP151-E, KP70-EL, KP85-EL, LUX-40, LUX-40-ELETTRONICA, LUX-41-ELETTRONICA, LUX-60, LUX-60-ELETTRONICA, LUX-61-ELETTRONICA, LUX-70-EL, LUX-85, LUX-85-ELETTRONICA		

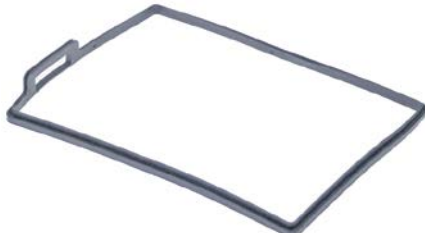

			
1			
GEV No.	524954	Ref. No.	0011600931/B DW11600931/B
description	gasket suitable for Dihr for PCB L 145mm W 90mm		

			
1			
GEV No.	524953	Ref. No.	0050650/B DW50650/B
description	gasket suitable for Dihr for PCB L 170mm W 124mm		

springs

torsion springs

			
1			
GEV No.	693934	Ref. No.	009563 DW9563
description	torsion spring		
For models:	K1L, K1R, K2L, K2M, K2R		

			
1			
GEV No.	690080	Ref. No.	009019 DW9019
description	torsion spring ø 19.4mm L2 37mm wire gauge ø 3.4mm mounting pos. right L1 42mm L3 37mm Qty 1 pcs		
accessories for	690080		
	GEV No.	690081	Ref. No. —
	torsion spring ø 19.4mm L2 36mm wire gauge ø 3.3mm mounting pos. left L1 42mm L3 36mm Qty 1 pcs		

compression springs

			
1			
GEV No.	650177	Ref. No.	0061052 DW61052
description	spring for citrus juicers ø 6mm L 25mm		
For models:	GM-2-BK11, GM3-BK12, GM4-BK13		
accessories for	650177		
	GEV No.	650176	Ref. No. 0060153 60153 DW60153
	shaft for citrus juicers ø 6mm L 16mm		
	GEV No.	650178	Ref. No. 0061051 61051 DW61051
	ball for citrus juicers ø 5mm		

spring compressors

			
1			
GEV No.	517160	Ref. No.	0010800210 0010800210 + 2x0011711 10800210 + 2x11711 DW10800210 DW10800210 + 2xDW11711
description	spring compressor thread M10		
For models:	HOOD-110, HOOD-110-E, HOOD-130, HOOD-130-ELETTRONICA, HOOD800SP-3D-GOGGLES-IMAX, K100, K120, KP130-ELETTRONICA		



roller springs

roller springs



1

GEV No.	517419	Ref. No.	003009906 DW3009906
description	roller spring complete incl. holder type BBSR 22		
For models:	F, FP, K2500, K3000, K3000+K10, K3100, K3100+K10, K3300, K3800, K3800+K10, K4000, K4400, K4400+K10, K5400, K5400+K10, KP2300, KP3000, KP4000, KT-1500		



1

GEV No.	517367	Ref. No.	003004013 003004013+003009555 3004013+3009555 DW3004013 DW3004013+DW3009555
description	roller spring L 70mm W 50mm ID ømm lug length 50mm		
For models:	F, FP, K2500, K3000, K3000+K10, K3100, K3100+K10, K3300, K3800, K3800+K10, K4000, K4400, K4400+K10, K5400, K5400+K10, KP2300, KP3000, KP4000		



1

GEV No.	517321	Ref. No.	003004011 003004011 + 003009555 003004015 003009905 3004011 + 3009555 DW3004011 DW3004011 + DW3009555 DW3004015 DW3009905
description	roller spring type BBSR 23 W 51mm ID ø 45mm lug length 50mm		
For models:	F, FP, K1800, K2100, K2200, K2500, K2700, K3000, K3000+K10, K3100, K3100+K10, K3300, K3800, K3800+K10, K4000, K4400, K4400+K10, K5400, K5400+K10, KP2300, KP2300+KP23, KP2800, KP3000, KP4000, KT-1500		



1

GEV No.	517315	Ref. No.	003004010 + 003009555 3004010 + 3009555 DW3004010 + DW3009555
description	roller spring W 50mm ID ømm lug length 49mm		
For models:	BB-2500, F, FP, K1600, K1600-ALTA-VELOCITA, K1700, KT-1500		
accessories for	517315		
	GEV No.	517314	Ref. No.
			003004012 3004012 DW3004012
	spring holder for roller spring ø 29mm Lmm Wmm H 9mm		

accessories

holders



1

GEV No.	517314	Ref. No.	003004012 DW3004012
description	spring holder for roller spring ø 29mm Lmm Wmm H 9mm		
For models:	BB-2500, F, FP, K1600, K1600-ALTA-VELOCITA, K1700, K1800, K2100, K2200, K2500, K2700, K3000, K3000+K10, K3100, K3100+K10, K3300, K3800, K3800+K10, K4000, K4400, K4400+K10, K5400, K5400+K10, KP2300, KP2300+KP23, KP2800, KP3000, KP4000, KT-1500		

tension springs



1

GEV No.	517273	Ref. No.	00550206/A DW550206/A
description	tension spring ø 10mm total length 225mm wire gauge ø 1.5mm mounting pos. upper		
For models:	F, FP, K90, KP85-EL, LUX-85, LUX-85-ELETTRONICA		



1

GEV No.	517421	Ref. No.	00570200 DW570200
description	tension spring ø 12mm total length 240mm wire gauge ø 1.8mm for door Qty 1 pcs		
For models:	KP70-EL, LUX-60, LUX-60-ELETTRONICA, LUX-61-ELETTRONICA, LUX-70-EL		





1

GEV No.	501296	Ref. No.	00560003 DW560003
description	tension spring ø 12mm total length 275mm wire gauge ø 1.6mm		
For models:	BB-2500, F, FP, K40-LUX, K41-LUX, K60, KT-1500, LUX-40, LUX-40-ELETTRONICA, LUX-41-ELETTRONICA, LUX-60, LUX-60-ELETTRONICA, LUX-61-ELETTRONICA		

			
GEV No.	517259	Ref. No.	0010700 DW10700
description	tension spring \varnothing 15.3mm total length 130mm wire gauge \varnothing 2mm for door		
For models:	HOOD-110, HOOD-110-E, HOOD-130, HOOD-130-ELETTRONICA, HOOD800SP-3D-GOGGLES-IMAX, K120, K36, KP130-ELETTRONICA		

			
GEV No.	517272	Ref. No.	00550206 00550212 DW550206 DW550212
description	tension spring \varnothing 15mm total length 540mm wire gauge \varnothing 2mm mounting pos. lower		
For models:	K90, KP85-EL, LUX-85, LUX-85-ELETTRONICA		

			
GEV No.	517260	Ref. No.	0010700/B DW10700/B
description	tension spring \varnothing 17.3mm total length 140mm wire gauge \varnothing 2.2mm for door		

			
GEV No.	517261	Ref. No.	0010700/A DW10700/A
description	tension spring \varnothing 20mm total length 140mm wire gauge \varnothing 2.5mm for door		
For models:	K70		

			
GEV No.	517286	Ref. No.	0075303 DW75303
description	tension spring \varnothing 35mm total length 865mm wire gauge \varnothing 5mm		
For models:	HOOD-110, HOOD-110-E, HOOD800SP-3D-GOGGLES-IMAX, K100		

			
GEV No.	517287	Ref. No.	0070302 DW70302
description	tension spring \varnothing 38.8mm total length 663mm wire gauge \varnothing 4.2mm		
For models:	HOOD-110, HOOD-110-E, HOOD-130, HOOD-130-ELETTRONICA, K100, K120, KP130-ELETTRONICA		

			
GEV No.	517048	Ref. No.	0010800033 0010800034 DW10800033 DW10800034
description	tension spring \varnothing 39.7mm total length 305mm wire gauge \varnothing 5mm mounting pos. lateral		

kitchen accessories

waste chute rings

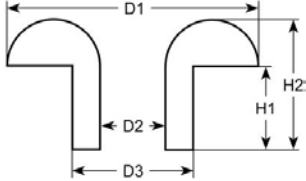
			
			
GEV No.	530600	Ref. No.	0010500025 DW10500025
description	waste chute ring D1 \varnothing 237mm D2 \varnothing 180mm D3 \varnothing 205mm H1 30mm H2 55mm		

manometers

			
GEV No.	541876	Ref. No.	002000244 DW2000244
description	manometer \varnothing 49mm pressure range 0-4bar connection lower marking adjustable thread 1/4"		
For models:	BB-2500, F, FP, K1600, K1600-ALTA-VELOCITA, K1700, K1800, K2100, K2200, K2500, K26, K26A, K2700, K3000, K3000+K10, K3100, K3100+K10, K3300, K3800, K3800+K10, K4000, K4400, K4400+K10, K5400, K5400+K10, KP2300, KP2300+KP23, KP2800, KP3000, KP4000, KT-1500, Optional-Steam		

dosing pumps

peristaltic dosing pumps













GERMAC			
built-in version			
without control			
			
GEV No.	361020	Ref. No.	0015108/C DW15108/C
description	dosing pump GERMAC without control 0.8l/h 230VAC detergent hose \varnothing 4x6mm hose thermoplastic type G80 built-in version dimensions 55x70x88mm		
For models:	Accessories, K37, K40		
spare parts for	361020		
	GEV No.	361263	Ref. No. —
roller assembly GERMAC suitable for G80/82/150/152/200/202/250/252/600			

Table continues overleaf



spare parts for 361020				
	GEV No.	361554	Ref. No.	—
pump hose GERMAC detergent hose type thermoplastic hose ø 5x8mm for model G200/G250/G252				
accessories for 361020				
	GEV No.	520090	Ref. No.	—
PVC hose ID ø 4mm ED ø 6mm L 2m thickness 1mm t.max. 60°C transparent				
	GEV No.	520091	Ref. No.	—
nylon hose ID ø 4mm ED ø 6mm L 2m thickness 1mm operating p. 10bar burst p. 50bar t.max. 100°C transparent				

spare parts for 361022				
	GEV No.	361554	Ref. No.	—
pump hose GERMAC detergent hose type thermoplastic hose ø 5x8mm for model G200/G250/G252				
accessories for 361022				
	GEV No.	520090	Ref. No.	—
PVC hose ID ø 4mm ED ø 6mm L 2m thickness 1mm t.max. 60°C transparent				
	GEV No.	520091	Ref. No.	—
nylon hose ID ø 4mm ED ø 6mm L 2m thickness 1mm operating p. 10bar burst p. 50bar t.max. 100°C transparent				

				
1				
GEV No.	361021	Ref. No.	0015108 DW15108	
description	dosing pump GERMAC without control 1.5l/h 230VAC detergent hose ø 4x6mm hose thermoplastic type G150 built-in version dimensions 55x70x88mm			
For models:	Accessories, K45, K50			
spare parts for 361021				
	GEV No.	361263	Ref. No.	—
roller assembly GERMAC suitable for G80/82/150/152/200/202/250/252/600				
	GEV No.	361554	Ref. No.	—
pump hose GERMAC detergent hose type thermoplastic hose ø 5x8mm for model G200/G250/G252				
accessories for 361021				
	GEV No.	520090	Ref. No.	—
PVC hose ID ø 4mm ED ø 6mm L 2m thickness 1mm t.max. 60°C transparent				
	GEV No.	520091	Ref. No.	—
nylon hose ID ø 4mm ED ø 6mm L 2m thickness 1mm operating p. 10bar burst p. 50bar t.max. 100°C transparent				

spare parts				
				
1				
GEV No.	361060	Ref. No.	0015108/E DW15108/E	
description	pump hose GERMAC rinse aid hose type silicone hose ø 4x6mm for model G80/G82/G600			
For models:	Accessories, AQUA-35, AQUA-35-RL09, AQUA-37, AQUA-37-RL09, AQUA-40, AQUA-40-RL09, AQUA-50, AQUA-80, DUPLA-35, DUPLA-37, DUPLA-40, DUPLA-45, DUPLA-50, HOOD-110, HOOD-110-E, HOOD-130, HOOD-130-ELETRONICA, K70, KP130-ELETRONICA, KP149, KP151, KP151-E, KP200-ELETRONICA, KP202-E, KP300-ELETRONICA, KP302-E, KP402-E, KP70-EL, KP85-EL, LUX-40, LUX-40-ELETRONICA, LUX-41-ELETRONICA, LUX-60, LUX-60-ELETRONICA, LUX-61-ELETRONICA, LUX-70-EL, LUX-85, LUX-85-ELETRONICA			

				
1				
GEV No.	361022	Ref. No.	0015108/A DW15108/A	
description	dosing pump GERMAC without control 2l/h 230VAC detergent hose ø 4x6mm hose thermoplastic type G200 built-in version dimensions 55x70x88mm			
spare parts for 361022				
	GEV No.	361263	Ref. No.	—
roller assembly GERMAC suitable for G80/82/150/152/200/202/250/252/600				

SEKO				
built-in version				
with frequency control				
				
1				
GEV No.	361791 ¹	Ref. No.	0015985 DW15985	
description	dosing pump SEKO frequency control 3l/h 230VAC detergent hose ø 4x6mm hose type K hose Santoprene suction level 1.5m type NBR 3			
For models:	AQUA-35, AQUA-35-RL09, AQUA-37, AQUA-37-RL09, AQUA-40, AQUA-40-RL09, AQUA-50, AQUA-80, DUPLA-35, DUPLA-37, DUPLA-40, DUPLA-45, DUPLA-50, HOOD-110, HOOD-110-E, HOOD-130, HOOD-130-ELETRONICA, HOOD800SP-3D-GOGGLES-IMAX, K40-LUX, K41-LUX, K70, KP130-ELETRONICA, KP149, KP151, KP151-E, KP200-ELETRONICA, KP202-E, KP300-ELETRONICA, KP302-E, KP402-E, KP70-EL, KP85-EL, LUX-40, LUX-40-ELETRONICA, LUX-41-ELETRONICA, LUX-60, LUX-60-ELETRONICA, LUX-61-ELETRONICA, LUX-70-EL, LUX-85, LUX-85-ELETRONICA			
spare parts for 361791				
	GEV No.	361815	Ref. No.	15185 DW15185
pump hose detergent hose ø 6x10mm hose ø 4x6mm hose type K hose Santoprene type SEKO				

¹with accessories

spare parts



GEV No.	361815	Ref. No.	15185 DW15185
description	pump hose detergent hose ø 6x10mm hose ø 4x6mm hose type K hose Santoprene type SEKO		
For models:	AQUA-35, AQUA-35-RL09, AQUA-37, AQUA-37-RL09, AQUA-40, AQUA-40-RL09, AQUA-50, AQUA-80, BB-2500, DUPLA-35, DUPLA-37, DUPLA-40, DUPLA-45, DUPLA-50, F, FP, GR300, GR800, HOOD-110, HOOD-110-E, HOOD-130, HOOD-130-ELETRONICA, HOOD-800SP-3D-GOGGLES-IMAX, K1600, K1600-ALTA-VELOCITA, K1700, K1800, K2100, K2200, K2500, K2700, K3000, K3000+K10, K3100, K3100+K10, K3300, K3800, K3800+K10, K4000, K4400, K4400+K10, K5400, K5400+K10, K70, KP130-ELETRONICA, KP149, KP151, KP151-E, KP200-ELETRONICA, KP202-E...(Other models you can see in the webshop)		

various

built-in version



GEV No.	361910	Ref. No.	0015985/B DW15985/B
description	dosing pump TECNOPRO type TP30-60-B frequency control 3l/h 230VAC rinse aid hose ø 4x6mm hose type silicone 8W		
For models:	HOOD800SP-3D-GOGGLES-IMAX		





piston pumps

dosing pumps



GEV No.	361800	Ref. No.	0015108/L DW15108/L
description	dosing pump type EKP-R/E 230V detergent inlet 8x12mm outlet 8x12mm 60 strokes/min		
For models:	Accessories, AQUA-35, AQUA-37, AQUA-40, AQUA-50, AQUA-80, DUPLA-35, DUPLA-37, DUPLA-40, DUPLA-45, DUPLA-50, HOOD-110, HOOD-110-E, HOOD-130, HOOD-130-ELETRONICA, K100, K40, K70, K90, KP130-ELETRONICA, KP149, KP151, KP151-E, KP200-ELETRONICA, KP202-E, KP300-ELETRONICA, KP302-E, KP400-ELETRONICA, KP402-E, KP70-EL, KP85-EL, LUX-40, LUX-40-ELETRONICA, LUX-41-ELETRONICA, LUX-60, LUX-60-ELETRONICA, LUX-61-ELETRONICA, LUX-70-EL, LUX-85, LUX-85-ELETRONICA		

spare parts for	361800			
	GEV No.	361047	Ref. No.	—
				pressure/suction valve suitable for EKP-R L 38.7mm 3/8" WS 22

spare parts for	361800			
	GEV No.	361652	Ref. No.	—
				union nut suitable for EKP-RT1: 3/8"
	GEV No.	361653	Ref. No.	—
				olive suitable for EKP-R
	GEV No.	361654	Ref. No.	—
				hose tail suitable for EKP-R
	GEV No.	361655	Ref. No.	—
				O-ring suitable for EKP-R
	GEV No.	361857	Ref. No.	—
				pump head type EKP-R for dosing pump plastic

spare parts



GEV No.	510298	Ref. No.	0010705/D 0016070 DW10705/D DW16070
description	lip valve dosing pump suitable for DB2/DS5		
For models:	Accessories, AQUA-35, AQUA-37, AQUA-40, AQUA-50, AQUA-80, DUPLA-45, GR300, GR800, HOOD-110, HOOD-110-E, HOOD-130, HOOD-130-ELETRONICA, K100, K36, K37, K40, K40-LUX, K45, K50, K60, K70, K90, KP130-ELETRONICA, KP202-E, KP302-E, KP402-E, KP70-EL, KP85-EL, LUX-40, LUX-40-ELETRONICA, LUX-41-ELETRONICA, LUX-60, LUX-60-ELETRONICA, LUX-61-ELETRONICA, LUX-70-EL, LUX-85-ELETRONICA		

membrane dosing pumps

self-priming

LANG



GEV No.	361009	Ref. No.	0010798 DW10798
description	dosing pump type N6 membrane dosing pump rinse aid p min 0.5bar pressure connection ø straight, 4x6mm suction connection ø straight, 4x6mm LANG		
For models:	AQUA-35, AQUA-37, AQUA-40, AQUA-50, AQUA-80, DUPLA-35, DUPLA-37, DUPLA-40, DUPLA-45, DUPLA-50, K120, K50, K70, KP130-ELETRONICA, KP400, KP400-ELETRONICA, KP70-EL, LUX-40, LUX-40-ELETRONICA, LUX-41-ELETRONICA, LUX-60, LUX-60-ELETRONICA, LUX-61-ELETRONICA, LUX-70-EL		

spare parts for	361009			
	GEV No.	361079	Ref. No.	—
				spring for type N5/N6 for ball

Table continues overleaf



spare parts for		361009	
	GEV No.	361080	Ref. No. —
O-ring EPDM thickness 2mm ID ø 16mm Qty 1 pcs			
	GEV No.	361085	Ref. No. —
O-ring EPDM thickness 2mm ID ø 8mm Qty 1 pcs			
	GEV No.	361309	Ref. No. —
ball for type N5/N6			
	GEV No.	361310	Ref. No. —
bracket for type N6 ball guide			
	GEV No.	361311	Ref. No. —
O-ring EPDM thickness 2mm ID ø 6mm Qty 1 pcs for type N6			
	GEV No.	361314	Ref. No. —
valve ring for type N6 holder for O-ring			
	GEV No.	361317	Ref. No. —
sealing disc for type N6			
	GEV No.	361886	Ref. No. —
non-return valve inletmm outletmm outlet ø 12.4mm L 12.7mm			

various



GEV No.	361731	Ref. No.	001059999 DW1059999
description	dosing pump without auxiliary pressure connection rinse aid inlet 4mm outlet 8mm pressure connection ø 8mm suction connection ø 4mm		
For models:	Accessories, AQUA-35, K100, KP130-ELETTRONICA, KP149, KP150, KP151, KP151-E, KP200, KP200-ELETTRONICA, KP300, KP300-ELETTRONICA		

spare parts

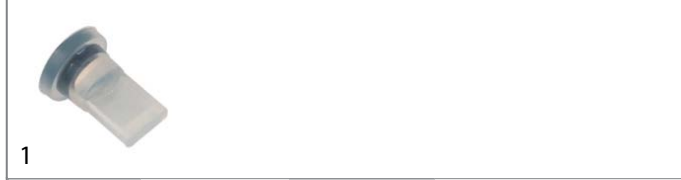

GEV No.	510298	Ref. No.	0010705/D 0016070 DW10705/D DW16070
description	lip valve dosing pump suitable for DB2/DSS		
For models:	Accessories, AQUA-35, AQUA-37, AQUA-40, AQUA-50, AQUA-80, DUPLA-45, GR300, GR800, HOOD-110, HOOD-110-E, HOOD-130, HOOD-130-ELETTRONICA, K100, K36, K37, K40, K40-LUX, K45, K50, K60, K70, K90, KP130-ELETTRONICA, KP202-E, KP302-E, KP402-E, KP70-EL, KP85-EL, LUX-40, LUX-40-ELETTRONICA, LUX-41-ELETTRONICA, LUX-60, LUX-60-ELETTRONICA, LUX-61-ELETTRONICA, LUX-70-EL, LUX-85-ELETTRONICA		



GEV No.	361132	Ref. No.	001059999/A DW1059999/A
description	membrane dosing pump		
For models:	Accessories		

self-priming with supporting pressure



DIHR



GEV No.	361912	Ref. No.	0010799/G DW10799/G
description	dosing pump kit inlet 5mm outlet 8mm suction connection ø 5mm auxiliary pressure connection 10mm		
For models:	AQUA-35, AQUA-37, AQUA-40, AQUA-50, AQUA-80, DUPLA-35, DUPLA-37, DUPLA-40, DUPLA-45, DUPLA-50, GR300, GR800, HOOD-110, HOOD-110-E, HOOD-130, HOOD-130-ELETTRONICA, HOOD-800SP-3D-GOGGLES-IMAX, KP202-E, KP302-E, KP402-E, KP70-EL, KP85-EL, LUX-40, LUX-40-ELETTRONICA, LUX-41-ELETTRONICA, LUX-60, LUX-60-ELETTRONICA, LUX-61-ELETTRONICA, LUX-70-EL, LUX-85-ELETTRONICA		





GEV No.	361744	Ref. No.	0010799 0010799/A DW10799 DW10799/A
description	dosing pump type DW with auxiliary pressure connection rinse aid inlet 4mm outlet 8mm suction connection ø 4mm auxiliary pressure connection 10mm		
For models:	Accessories, AQUA-35, AQUA-35-RL09, AQUA-37, AQUA-37-RL09, AQUA-40, AQUA-40-RL09, AQUA-50, AQUA-80, DUPLA-35, DUPLA-37, DUPLA-40, DUPLA-45, DUPLA-50, HOOD-110, HOOD-110-E, HOOD-130, HOOD-130-ELETTRONICA, HOOD800SP-3D-GOGGLES-IMAX, K100, K35, K36, K37, K40, K40-LUX, K41-LUX, K45, K50, K60, K70, K80, K90, KP130-ELETTRONICA, KP70-EL, KP85-EL, LUX-40, LUX-40-ELETTRONICA, LUX-41-ELETTRONICA, LUX-60, LUX-60-ELETTRONICA, LUX-61-ELETTRONICA, LUX-70-EL, LUX-85, LUX-85-ELETTRONICA		

spare parts for		361744	
	GEV No.	520026	Ref. No. —
PVC hose ID ø 4mm ED ø 6mm L 10m thickness 1mm t.max. 60°C transparent			
	GEV No.	520090	Ref. No. —
PVC hose ID ø 4mm ED ø 6mm L 2m thickness 1mm t.max. 60°C transparent			



1

GEV No.	362012	Ref. No.	0010705 DW10705	
description	dosing pump type DW with auxiliary pressure connection rinse aid inlet 4x6mm outlet M10x1mm auxiliary pressure connection 10mm			
For models:	Accessories, K70			
spare parts for	362012			
	GEV No.	520026	Ref. No.	—
	PVC hose ID ø 4mm ED ø 6mm L 10m thickness 1mm t.max. 60°C transparent			
	GEV No.	520090	Ref. No.	—
	PVC hose ID ø 4mm ED ø 6mm L 2m thickness 1mm t.max. 60°C transparent			

ELETTROBAR



1

GEV No.	510298	Ref. No.	0010705/D 0016070 DW10705/D DW16070
description	lip valve dosing pump suitable for DB2/DS5		
For models:	Accessories, AQUA-35, AQUA-37, AQUA-40, AQUA-50, AQUA-80, DUPLA-45, GR300, GR800, HOOD-110, HOOD-110-E, HOOD-130, HOOD-130-ELETTRONICA, K100, K36, K37, K40, K40-LUX, K45, K50, K60, K70, K90, KP130-ELETTRONICA, KP202-E, KP302-E, KP402-E, KP70-EL, KP85-EL, LUX-40, LUX-40-ELETTRONICA, LUX-41-ELETTRONICA, LUX-60, LUX-60-ELETTRONICA, LUX-61-ELETTRONICA, LUX-70-EL, LUX-85-ELETTRONICA		

GERMAC

spare parts



1

GEV No.	510298	Ref. No.	0010705/D 0016070 DW10705/D DW16070
description	lip valve dosing pump suitable for DB2/DS5		
For models:	Accessories, AQUA-35, AQUA-37, AQUA-40, AQUA-50, AQUA-80, DUPLA-45, GR300, GR800, HOOD-110, HOOD-110-E, HOOD-130, HOOD-130-ELETTRONICA, K100, K36, K37, K40, K40-LUX, K45, K50, K60, K70, K90, KP130-ELETTRONICA, KP202-E, KP302-E, KP402-E, KP70-EL, KP85-EL, LUX-40, LUX-40-ELETTRONICA, LUX-41-ELETTRONICA, LUX-60, LUX-60-ELETTRONICA, LUX-61-ELETTRONICA, LUX-70-EL, LUX-85-ELETTRONICA		



1

GEV No.	510296	Ref. No.	0010705/O DW10705/O
description	membrane silicone		
For models:	Accessories, AQUA-50, AQUA-80, HOOD-110, HOOD-110-E, HOOD-130, HOOD-130-ELETTRONICA, KP70-EL, KP85-EL, LUX-70-EL, LUX-85-ELETTRONICA		

accessories

container filters



1

GEV No.	361062	Ref. No.	N/A
description	container filter hose ø 4mm		



1

GEV No.	361829	Ref. No.	0015058 DW15058
description	container filter complete plastic hose ø 5mm		
For models:	AQUA-35, AQUA-35-RL09, AQUA-37, AQUA-37-RL09, AQUA-40, AQUA-40-RL09, AQUA-50, AQUA-80, BB-2500, DUPLA-35, DUPLA-37, DUPLA-40, DUPLA-45, DUPLA-50, GR300, GR800, HOOD-110, HOOD-110-E, HOOD-130, HOOD-130-ELETTRONICA, HOOD800SP-3D-GOGGLES-IMAX, K100, K35, K36, K37, K40, K40-LUX, K41-LUX, K45, K50, K60, K70, K80, K90, KP130-ELETTRONICA, KP149, KP150, KP151, KP151-E, KP200, KP200-ELETTRONICA, KP202-E, KP300, KP300-ELETTRONICA, KP302-E, KP400, KP400-ELETTRONICA, KP402-E, KP70-EL, KP85-EL...(Other models you can see in the webshop)		

non-return valves



1

GEV No.	361899	Ref. No.	0010805 0010808 DW10805 DW10808
description	non-return valve inletmm outlet ø 7mm L 9mm Qty 2 pcs		
For models:	AQUA-35, AQUA-35-RL09, AQUA-37, AQUA-37-RL09, AQUA-40, AQUA-40-RL09, AQUA-50, AQUA-80, DUPLA-35, DUPLA-37, DUPLA-40, DUPLA-45, DUPLA-50, HOOD-110, HOOD-110-E, HOOD-130, HOOD-130-ELETTRONICA, HOOD800SP-3D-GOGGLES-IMAX, K70, KP130-ELETTRONICA, KP149, KP151, KP151-E, KP200-ELETTRONICA, KP300-ELETTRONICA, KP70-EL, KP85-EL, LUX-40, LUX-40-ELETTRONICA, LUX-41-ELETTRONICA, LUX-60, LUX-60-ELETTRONICA, LUX-61-ELETTRONICA, LUX-70-EL, LUX-85, LUX-85-ELETTRONICA		



intake lances



GEV No.	361911	Ref. No.	00590118 DW590118
description	intake lance plastic L 165mm NC tube ø 9mm hose ø 4.5mm cable length 1750mm		

tank inlets





GEV No.	361057	Ref. No.	0015123 0015148 DW15123 DW15148
description	tank inlet plastic M10 hose ø 4x6mm		
For models:	Accessories, AQUA-35, AQUA-35-RL09, AQUA-37, AQUA-37-RL09, AQUA-40, AQUA-40-RL09, AQUA-50, AQUA-80, BB-2500, DUPLA-35, DUPLA-37, DUPLA-40, DUPLA-45, DUPLA-50, GR300, GR800, HOOD-110, HOOD-110-E, HOOD-130, HOOD-130-ELETRONICA, HOOD-800SP-3D-GOGGLES-IMAX, K40-LUX, K70, K90, KP130-ELETRONICA, KP149, KP151, KP151-E, KP200-ELETRONICA, KP202-E, KP300-ELETRONICA, KP302-E, KP400-ELETRONICA, KP402-E, KP70-EL, KP85-EL, KT-1500, LUX-40, LUX-40-ELETRONICA, LUX-41-ELETRONICA, LUX-60, LUX-60-ELETRONICA, LUX-61-ELETRONICA, LUX-70-EL, LUX-85, LUX-85-ELETRONICA		

hoses

supply hoses

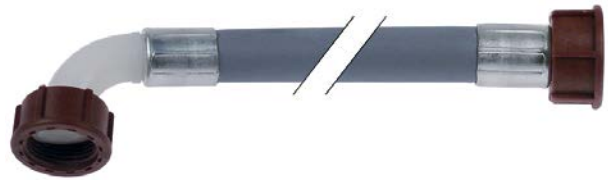
PVC supply hoses



GEV No.	520010	Ref. No.	0010726 DW10726
description	supply hose PVC straight-curved DN13 connections 3/4" L 1500mm operating p. 10bar burst p. 32bar t.max. 90°C blue approval VDE flat seal		
For models:	Accessories, K40-LUX, K41-LUX		
accessories for	520010		
	GEV No.	520053	Ref. No. —
	screen connection 3/4" D1 ø 26mm D2 ø 15mm Qty 10 pcs rubber thickness 8mm		
	GEV No.	520054	Ref. No. —
	flat gasket rubber ED ø 23.5mm ID ø 14mm thickness 2.3mm Qty 10 pcs		

drain hoses



GEV No.	530608	Ref. No.	0010727 DW10727
description	drain hose DN24 L 1500mm A int. ø 24mm A ext. ø 28mm B int. ø 28mm B ext. ø 35mm outer hose ø 29mm temp.-resist. 90°C		
For models:	Accessories, AQUA-35, AQUA-35-RL09, AQUA-37, AQUA-37-RL09, AQUA-40, AQUA-40-RL09, AQUA-50, AQUA-80, BB-2500, DUPLA-35, DUPLA-37, DUPLA-40, DUPLA-45, DUPLA-50, F, FP, HOOD-110, HOOD-110-E, HOOD-130, HOOD-130-ELETRONICA, HOOD800SP-3D-GOGGLES-IMAX, K1600, K1600-ALTA-VELOCITA, K1700, K1800, K2100, K2200, K2500, K2700, K3000, K3000+K10, K3100, K3100+K10, K3300, K35, K36, K37, K3800, K3800+K10, K40, K4000, K40-LUX, K4400, K4400+K10, K5400, K5400+K10, K70, KP130-ELETRONICA, KP2300... (Other models you can see in the webshop)		



GEV No.	530083	Ref. No.	0010200112 DW10200112
description	drain hose DN31 L 1500mm A int. ø 31mm A ext. ø 35mm B int. ø 40mm B ext. ø 46mm outer hose ø 38mm		
For models:	Accessories, BB-2500, F, FP, K1600, K1600-ALTA-VELOCITA, K1700, K1800, K2100, K2200, K2500, K2700, K3000, K3000+K10, K3100, K3100+K10, K3300, K3800, K3800+K10, K4000, K4400, K4400+K10, K5400, K5400+K10, KP2300, KP2300+KP23, KP2800, KP3000, KP4000, KT-1500		

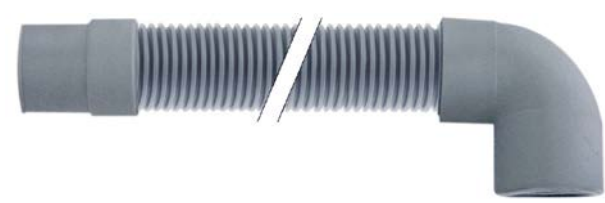

GEV No.	530571	Ref. No.	0015721 0025031 DW15721 DW25031
description	drain hose DN24 L 1500mm straight ø inside 24mm straight ext. ø 29mm elbow ø inside 29mm elbow ext. ø 35mm outer hose ø 28mm		
For models:	AQUA-40, AQUA-50, AQUA-80, DUPLA-40, DUPLA-45, DUPLA-50, HOOD-110, HOOD-130, HOOD-130-ELETRONICA, K1700, K2700, KP130-ELETRONICA, KP151, KP151-E, KP70-EL, KP85-EL, LUX-40, LUX-40-ELETRONICA, LUX-60, LUX-60-ELETRONICA, LUX-61-ELETRONICA, LUX-70-EL, LUX-85, LUX-85-ELETRONICA		

formed hoses

straight



1	GEV No.	517235	Ref. No.	00440718 DW440718
description formed hose				

1				
GEV No.	517231	Ref. No.	0010718 0017215 DW10718 DW17215	
description formed hose D1 ø 36mm D2 ø 28mm L 75mm dishwasher straight equiv. no. 10718, 440718				
For models: AQUA-35, AQUA-37, AQUA-40, F, FP, HOOD-130, HOOD-130-ELETT- RONICA, K2500, K26, K26A, K35, K36, K37, K3800, K3800+K10, K40, K4000, K4400, K4400+K10, K5400, K5400+K10, KP85-EL, LUX-60, LUX-60-ELETTRONICA, LUX-85-ELETTRONICA				

1				
GEV No.	517232	Ref. No.	0016083 DW16083	
description formed hose dishwasher straight				

1				
GEV No.	517246	Ref. No.	0011600048 DW11600048	
description formed hose dishwasher straight equiv. no. 11600048				

1				
GEV No.	517224	Ref. No.	00540005 DW540005	
description formed hose dishwasher straight equiv. no. 540005				
For models: BB-2500, K2100, K2200, K3000, K3000+K10, K3100, K3100+K10, K3300, K40-LUX, K41-LUX, K5400, K5400+K10, LUX-40, LUX-40-ELETT- RONICA, LUX-41-ELETTRONICA				

1				
GEV No.	519272	Ref. No.	0010729 DW10729	
description drain hose DN24 L 1500mm straight ø inside 32mm straight ext. ø 35mm elbow ø inside 40mm elbow ext. ø 46mm outer hose ø 38mm				
For models: K120				

industrial hoses

Niplaflex hoses

1				
GEV No.	530562	Ref. No.	002907350 DW2907350	
description pressure hose ID ø 13mm ED ø 21mm L 5m operating p. 10bar burst p. 30bar t.max. 110°C				
For models: AQUA-40, AQUA-50, AQUA-80, BB-2500, DUPLA-40, DUPLA-45, DUPLA- LA-50, F, FP, HOOD-110, HOOD-110-E, HOOD-130, HOOD-130-ELETT- TRONICA, K1600, K1600-ALTA-VELOCITA, K1700, K1800, K2100, K2200, K2500, K2700, K3000, K3000+K10, K3100, K3100+K10, K3300, K3800, K3800+K10, K4000, K4400, K4400+K10, K5400, K5400+K10, KP130-ELETTRONICA, KP151, KP151-E, KP2300, KP2300+KP23, KP2800, KP3000, KP4000, KP70-EL, KP85-EL, KT-1500, LUX-40, LUX-40-ELETTRONICA, LUX-60, LUX-60-ELETTRONICA, LUX-61-ELETT- RONICA, LUX-70-EL...(Other models you can see in the webshop)				

pressure control hoses

1				
GEV No.	530560	Ref. No.	0014508 DW14508	
description pressure control hose ID ø 5mm ED ø 9mm L 5m operating p. 30bar burst p. 90bar temp.-resist. 60°C				
For models: AQUA-35, AQUA-35-RL09, AQUA-37, AQUA-37-RL09, AQUA-40, AQUA- 40-RL09, AQUA-50, AQUA-80, DUPLA-35, DUPLA-37, DUPLA-40, DUPLA- 45, DUPLA-50, GR300, GR800, HOOD-110, HOOD-110-E, HOOD- 130, HOOD-130-ELETTRONICA, HOOD800SP-3D-GOGGLES-IMAX, K70, KP130-ELETTRONICA, KP149, KP151, KP151-E, KP200-ELETT- RONICA, KP202-E, KP300-ELETTRONICA, KP302-E, KP400-ELETTRO- NICA, KP402-E, KP70-EL, KP85-EL, LUX-40, LUX-40-ELETTRONICA, LUX-41-ELETTRONICA, LUX-60, LUX-60-ELETTRONICA, LUX-61-ELETT- RONICA, LUX-70-EL, LUX-85, LUX-85-ELETTRONICA				

1

GEV No.	517239	Ref. No.	0080502 DW80502
description	formed hose dishwasher straight equiv. no. 80502		
For models:	KP200-ELETRONICA		



1

GEV No.	996015	Ref. No.	92102 DW92102
description	formed hose end piece A ext. ø 61.5mm end piece A int. ø 51mm AD2 ø 55mm ø end piece B 46mm L 390mm		
For models:	KP302-E, KP402-E		



1

GEV No.	517247	Ref. No.	0015034 DW15034
description	formed hose dishwasher straight mounting pos. upper equiv. no. 15034		
For models:	K70, K90		



1

GEV No.	517225	Ref. No.	0010532 0015032 DW10532 DW15032
description	formed hose warewashing L-shape equiv. no. 15032		
For models:	K45, K50		



1

GEV No.	517250	Ref. No.	0010200122/A DW10200122/A
description	formed hose dishwasher straight mounting pos. upper/lower equiv. no. 10200122/A		



1

GEV No.	517228	Ref. No.	0015032/A DW15032/A
description	formed hose warewashing L-shape equiv. no. 15032/A		
For models:	K100, K120, K70, KP149, KP151, KP151-E		

form L



1

GEV No.	524850	Ref. No.	0076078 DW76078
description	formed hose end piece A ext. ø 43mm end piece A int. ø 35mm AD2 ø 58mm ø end piece B 49mm L 450mm Qty 1 warewashing L-shape		
For models:	HOOD-110, HOOD-110-E, HOOD800SP-3D-GOGGLES-IMAX		



1

GEV No.	517245	Ref. No.	0015033/A DW15033/A
description	formed hose warewashing L-shape equiv. no. 15033/A mounting pos. lower		
For models:	HOOD-110, HOOD-110-E, HOOD800SP-3D-GOGGLES-IMAX, K100, K90, KP149, KP151, KP151-E, KP85-EL, LUX-85, LUX-85-ELETRONICA		



1

GEV No.	517230	Ref. No.	0016169 DW16169
description	formed hose warewashing L-shape equiv. no. 16169		



1

GEV No.	517248	Ref. No.	0016170/M DW16170/M
description	formed hose warewashing L-shape equiv. no. 16170/M mounting pos. upper		
For models:	K100, KP149, KP150, KP151, KP151-E		



1

GEV No.	517223	Ref. No.	0018787 DW18787
description	formed hose warewashing L-shape equiv. no. 18787		
For models:	AQUA-35, AQUA-37, AQUA-40, DUPLA-35, K35, K36, K37, K40, KP149		



1

GEV No.	517236	Ref. No.	003002020 DW3002020
description	formed hose warewashing L-shape equiv. no. 3002020		
For models:	BB-2500, F, FP, K120, K1600, K1600-ALTA-VELOCITA, K1800, K2100, K2200, K2500, K3000, K3000+K10, K3100, K3100+K10, K3300, K3800, K3800+K10, K4000, K4400, K4400+K10, K5400, K5400+K10, KP2300, KP2300+KP23, KP2800, KP300, KP3000, KP300-ELETTRONICA, KP400, KP4000, KP400-ELETTRONICA, KP402-E, KT-1500, Optional-Steam		



1

GEV No.	517229	Ref. No.	00550224 DW550224
description	formed hose warewashing L-shape equiv. no. 550224		
For models:	K90		

with branch



1

GEV No.	517364	Ref. No.	0011600101 DW11600101
description	formed hose ext. ø 58 D1 ø 50mm D2 ø 35mm L 455mm black Qty 1		
For models:	HOOD-130, HOOD-130-ELETTRONICA, KP130-ELETTRONICA		

form S



1

GEV No.	517238	Ref. No.	0022015 DW22015
description	formed hose ID ø 50mm ED ø 65mm S-shape warewashing equiv. no. 2202015 hose ext. ø 72mm int. ø 160mm		
For models:	KP150, KP151		



1

GEV No.	517237	Ref. No.	0010200124/A DW10200124/A
description	formed hose S-shape warewashing equiv. no. 10200124/A		
For models:	KP400, KP400-ELETTRONICA		

1

GEV No.	517221	Ref. No.	0016170 DW16170
description	formed hose S-shape warewashing equiv. no. 16170		



1

GEV No.	517227	Ref. No.	0025032 DW25032
description	formed hose S-shape warewashing equiv. no. 25032		
For models:	AQUA-80, HOOD-110, HOOD-110-E, HOOD800SP-3D-GOGGLES-IMAX, K60, K90, LUX-60, LUX-60-ELETTRONICA		



1

GEV No.	517226	Ref. No.	0025032/A DW25032/A
description	formed hose S-shape warewashing equiv. no. 25032/A		
For models:	AQUA-50, DUPLA-45, DUPLA-50, K45, K50, K80, KP70-EL, LUX-60, LUX-60-ELETTRONICA, LUX-61-ELETTRONICA, LUX-70-EL		

form U



1

GEV No.	517252	Ref. No.	0011600048 0015131 0018044 0018767 0018767/A DW11600048 DW15131 DW18044 DW18767 DW18767/A
description	formed hose ext. ø 35 D1 ø 28mm D2 ø 28mm warewashing U-shape		
For models:	AQUA-35-RL09, AQUA-37-RL09, AQUA-40, AQUA-40-RL09, AQUA-50, AQUA-80, DUPLA-37, DUPLA-45, DUPLA-50, F, FP, HOOD-110, HOOD-110-E, K120, K2500, K26, K26A, K3800, K3800+K10, K4000, K41-LUX, K4400, K4400+K10, K5400, K5400+K10, K60, K70, KP130-ELETTRONICA, KP149, KP150, KP151, KP151-E, KP200-ELETTRONICA, KP202-E, KP300-ELETTRONICA, KP302-E, KP70-EL, KP85-EL, LUX-40, LUX-40-ELETTRONICA, LUX-41-ELETTRONICA, LUX-60, LUX-60-ELETTRONICA, LUX-61-ELETTRONICA, LUX-70-EL, LUX-85, LUX-85-ELETTRONICA		



1

GEV No.	517363	Ref. No.	0015033 DW15033
description	formed hose ext. ø 38 D1 ø 30mm L 255mm Qty 1		
For models:	K70		



1

GEV No.	517249	Ref. No.	0011600000 DW11600000
description	formed hose warewashing U-shape equiv. no. 11600000 mounting pos. upper/lower		
For models:	K120		

1

GEV No.	517257	Ref. No.	0030002021 DW30002021
description	formed hose warewashing U-shape equiv. no. 30002021 mounting pos. upper		



1

GEV No.	517255	Ref. No.	00150060 00560008 DW150060 DW560008
description	formed hose warewashing U-shape equiv. no. 560008 mounting pos. upper		
For models:	AQUA-80, K60, K80, LUX-60, LUX-60-ELETTRONICA		



1

GEV No.	517242	Ref. No.	00560014 DW560014
description	formed hose warewashing U-shape equiv. no. 560014 mounting pos. lower		
For models:	K60, LUX-60, LUX-60-ELETTRONICA		

miscellaneous



1

GEV No.	517788	Ref. No.	00150048 DW150048
description	formed hose ID ø 28mm ED ø 36mm L 615mm for wash pump		
For models:	K45, K50, K80		



1

GEV No.	524824	Ref. No.	0092103 DW92103
description	formed hose ID ø 47/53mm ED ø 60/66mm L 340mm warewashing Qty 1 black		
For models:	KP302-E		



1

GEV No.	517256	Ref. No.	00150048/A DW150048/A
description	formed hose warewashing equiv. no. 150048/A mounting pos. upper		
For models:	AQUA-50, DUPLA-45, DUPLA-50, KP70-EL, LUX-60, LUX-60-ELETTRONICA, LUX-70-EL		



1

GEV No.	517243	Ref. No.	00150049 DW150049
description	formed hose warewashing equiv. no. 150049 mounting pos. lower		
For models:	AQUA-50, AQUA-80, DUPLA-45, DUPLA-50, K45, K50, K80, KP70-EL, LUX-60, LUX-60-ELETTRONICA, LUX-70-EL		



1

GEV No.	517241	Ref. No.	0016167 DW16167
description	formed hose warewashing equiv. no. 16167 mounting pos. lower		
For models:	AQUA-37, AQUA-40, K37, K40		



fittings, hose and pipe connectors

hose connectors

without screw connection



1

GEV No.	517233	Ref. No.	0016168 DW16168
description	formed hose warewashing equiv. no. 16168 mounting pos. lower		
For models:	AQUA-40, K37, K40, K40-LUX, K41-LUX, LUX-40, LUX-40-ELETTRONICA, LUX-41-ELETTRONICA		



1

GEV No.	517234	Ref. No.	0018788 DW18788
description	formed hose warewashing equiv. no. 18788 mounting pos. lower		
For models:	HOOD-130, HOOD-130-ELETTRONICA, K40-LUX, KP130-ELETTRONICA		



1

GEV No.	517253	Ref. No.	00540004 DW540004
description	formed hose warewashing equiv. no. 540004 mounting pos. upper		
For models:	DUPLA-40, K41-LUX, LUX-40, LUX-40-ELETTRONICA, LUX-41-ELETTRONICA		



1

GEV No.	501210	Ref. No.	00540090 DW540090
description	Y-piece plastic hose ø 10-10-10mm		
For models:	AQUA-35, AQUA-35-RL09, AQUA-37, AQUA-37-RL09, AQUA-40, AQUA-40-RL09, DUPLA-35, DUPLA-37, DUPLA-40, K1700, K2100, K2200, K2500, K2700, K3000, K3000+K10, K3100, K3100+K10, K3300, K3800, K3800+K10, K4000, K41-LUX, K4400, K4400+K10, K5400, K5400+K10, LUX-40, LUX-40-ELETTRONICA, LUX-41-ELETTRONICA		



1

GEV No.	517166	Ref. No.	00540091 DW540091
description	Y-piece plastic hose ø 10-10-10mm 3-way		
For models:	AQUA-35, AQUA-37, AQUA-40, AQUA-50, AQUA-80, DUPLA-45, DUPLA-50, F, FP, GR300, GR800, HOOD-110, HOOD-130, HOOD-130-ELETTRONICA, K1700, K2500, K2700, K3000, K3000+K10, K3100, K3100+K10, K3300, K3800, K3800+K10, K4000, K4400, K4400+K10, K5400, K5400+K10, KP130-ELETTRONICA, KP200-ELETTRONICA, KP202-E, KP300-ELETTRONICA, KP302-E, KP400-ELETTRONICA, KP402-E, KP70-EL, KP85-EL, LUX-40, LUX-40-ELETTRONICA, LUX-41-ELETTRONICA, LUX-60, LUX-60-ELETTRONICA, LUX-61-ELETTRONICA, LUX-70-EL, LUX-85, LUX-85-ELETTRONICA		



1

GEV No.	501341	Ref. No.	00540094 DW540094
description	Y-piece plastic hose ø 6-6-6mm		

fittings

double nipples



1

GEV No.	517005	Ref. No.	0012006 DW12006
description	double nipple		
For models:	HOOD-110, HOOD-110-E, HOOD-130, HOOD-130-ELETTRONICA, HOOD800SP-3D-GOGGLES-IMAX, K100, K120, K50, K70, K80, K90, KP130-ELETTRONICA, KP149, KP150, KP151, KP151-E		

reducers



1

GEV No.	520177	Ref. No.	0012032 DW12032
description	reducer thread 1/4" ET - 1/8" IT nickel-plated brass total length 13mm WS 17		
For models:	BB-2500, F, FP, K1600, K1600-ALTA-VELOCITA, K1700, K1800, K2100, K2200, K2500, K2700, K3000, K3000+K10, K3100, K3100+K10, K3300, K3800, K3800+K10, K4000, K4400, K4400+K10, K5400, K5400+K10, KP2300, KP2300+KP23, KP2800, KP3000, KP4000, KT-1500		

T-pieces

nickel-plated brass



1

GEV No.	520340	Ref. No.	0012008 DW12008
description	T-piece thread 1/4" IT - 1/4" IT - 1/4" IT nickel-plated brass L 46mm		
For models:	BB-2500, F, FP, K1600, K1600-ALTA-VELOCITA, K1700, K1800, K2100, K2200, K2500, K2700, K3000, K3000+K10, K3100, K3100+K10, K3300, K3800, K3800+K10, K4000, K4400, K4400+K10, K5400, K5400+K10, KP2300, KP2300+KP23, KP2800, KP3000, KP4000, KT-1500		

hose connectors

nickel-plated brass



1

GEV No.	520203	Ref. No.	0012023 DW12023
description	hose connector nickel-plated brass straight thread 1/2" hose ø 12mm Qty 1 pcs		
For models:	BB-2500, F, FP, GR800, K120, K14, K14A, K1600, K1600-ALTA-VELOCITA, K1700, K1800, K2100, K2200, K2500, K26, K26A, K2700, K3000, K3000+K10, K3100, K3100+K10, K3300, K3800, K3800+K10, K4000, K4400, K4400+K10, K5400, K5400+K10, KP2300, KP2300+KP23, KP2800, KP3000, KP4000, KT-1500, Optional-Steam		



1

GEV No.	520201	Ref. No.	0012005 DW12005
description	hose connector nickel-plated brass straight thread 1/4" hose ø 12mm Qty 1 pcs		
For models:	BB-2500, F, FP, HOOD-130, HOOD-130-ELETTRONICA, K100, K120, K14, K1600, K1600-ALTA-VELOCITA, K1700, K1800, K2100, K2200, K2500, K26, K26A, K2700, K3000, K3000+K10, K3100, K3100+K10, K3300, K37, K3800, K3800+K10, K4000, K41-LUX, K4400, K4400+K10, K45, K50, K5400, K5400+K10, KP200, KP200-ELETTRONICA, KP2300, KP2300+KP23, KP2800, KP300, KP3000, KP300-ELETTRONICA, KP400, KP4000, KP400-ELETTRONICA, KT-1500, Optional-Steam		



1

GEV No.	520202	Ref. No.	0010221311 DW10221311
description	hose connector nickel-plated brass straight thread 3/8" hose ø 12mm Qty 1 pcs		
For models:	AQUA-40, AQUA-40-RL09, AQUA-50, AQUA-80, BB-2500, BM100, BM200, BM300, DUPLA-35, DUPLA-40, DUPLA-50, F, FP, HOOD-110, HOOD-110-E, HOOD-130, HOOD-130-ELETTRONICA, K120, K1600, K1600-ALTA-VELOCITA, K1700, K1800, K2100, K2200, K2500, K2700, K3000, K3000+K10, K3100, K3100+K10, K3300, K3800, K3800+K10, K4000, K4400, K4400+K10, K5400, K5400+K10, KP130-ELETTRONICA, KP151, KP151-E, KP2300, KP2300+KP23, KP2800, KP3000, KP400, KP4000, KP400-ELETTRONICA, KP70-EL, KP85-EL...(Other models you can see in the webshop)		





			
1			
GEV No.	517108	Ref. No.	0012030 DW12030
description	hose connector nickel-plated brass angled thread 3/8" ET - M10x1 IT hose ø 12mm Qty 1 pcs		
For models:	AQUA-35, AQUA-37, AQUA-40, BB-2500, DUPLA-35, DUPLA-37, DUPLA-40, F, FP, K1600, K1600-ALTA-VELOCITA, K1700, K1800, K2100, K2200, K2500, K2700, K3000, K3000+K10, K3100, K3100+K10, K3300, K35, K37, K3800, K3800+K10, K40, K4000, K4400, K4400+K10, K45, K5400, K5400+K10, KP2300, KP2300+KP23, KP2800, KP3000, KP4000, KP4000, KT-1500		

water cycle components

pressure reduction valves

pressure reduction valves universal

			
1			
GEV No.	520596	Ref. No.	00391025 DW391025
description	pressure reduction valve Caleffi series 5334 connection 1/2" default setting 3bar setting range 1-6bar p max 16bar t.max. 40°C with filter chrome-plated brass WRAS/ACS		
For models:	K1700, K2700		

			
1			
GEV No.	520789	Ref. No.	002000364 DW2000364
description	pressure reduction valve Caleffi series 5362 connection 1/2" default setting 3bar setting range 0.5 up to 6bar p max 25bar t.max. 80°C brass DVGW/SVGW/WRAS/ACS		
For models:	BB-2500, F, FP, K1600, K1600-ALTA-VELOCITA, K1800, K2100, K2200, K2500, K26, K26A, K3000, K3000+K10, K3100, K3100+K10, K3300, K3800, K3800+K10, K4000, K4400, K4400+K10, K5400, K5400+K10, KP2300, KP2300+KP23, KP2800, KP3000, KP4000, KP4000, KT-1500, Optional-Steam		

supply filters

			
1			
GEV No.	520790	Ref. No.	002000121 DW2000121
description	supply filter thread 3/4" IT - 3/4" ET total length 72mm nickel-plated brass H 66mm W 46mm		
For models:	BB-2500, F, FP, K14, K1600, K1600-ALTA-VELOCITA, K1800, K2100, K2200, K2500, K26, K26A, K3000, K3000+K10, K3100, K3100+K10, K3300, K3800, K3800+K10, K4000, K4400, K4400+K10, K5400, K5400+K10, KP200, KP200-ELETTRONICA, KP2300, KP2300+KP23, KP2800, KP3000, KP300-ELETTRONICA, KP400, KP4000, KP400-ELETTRONICA, KT-1500, Optional-Steam		

ancillary products

thread sealants

			
1			
GEV No.	890135	Ref. No.	Loctite 511
description	thread sealing LOCTITE 511 tube 50ml approval DVGW		
description	LOCTITE® 511™ - tube 50ml It is designed for the locking and sealing of metal threaded pipes and fittings. The product cures rapidly when confined in the absence of air between close fitting metal surfaces.		

			
1			
GEV No.	890128	Ref. No.	Loctite 542
description	thread sealing LOCTITE 542 medium-strength bottle 50ml approval DVGW		
description	LOCTITE® 542™ - bottle 50ml It is designed for the locking and sealing of metal pipes and fittings as well as other cylindrical metal assemblies. The product cures when confined in the absence of air between close-fitting metal surfaces and prevents loosening and leakage due to shock and vibration. The thixotropic nature of LOCTITE 542 reduces the migration of liquid product after application to the part.		

			
1			
GEV No.	890097	Ref. No.	Loctite 577
description	thread sealing LOCTITE 577 medium-strength bottle 50ml pipe thread sealing t.max. 150°C approval BAM and DVGW		
description	LOCTITE® 577™ - bottle 50ml It is designed for the locking and sealing of metal pipes and fittings as well as other cylindrical metal assemblies. The product provides an instant, low-pressure seal for metal pipes and fittings. It will not creep, shrink or block systems by shredding. Suitable for fast application at low temperatures. It has excellent chemical and thermal resistance and offers less migration of liquid product after application to the part.		

silicone

industrial silicones

			
1			
GEV No.	890110	Ref. No.	Silicon UNI9
description	silicone S100 cartridge 300ml transparent		
description	OTTOSEAL S 100 - cartridge 300ml - transparent Used for expansion joints in bathroom areas, sealing of expansion joints in floor and wall areas, sealing and bonding of glass modules and sealing double glazings (e. g. „Profilit“). - 1-component acetate-curing silicone sealant - Excellent weathering, ageing and UV-resistance - Contains fungicide and bacteriostatic - Unique processing characteristics - Surface can be smoothed very easily - Very good adhesion on ceramic substrates - Stress expansion modules at 100% (DIN 53 504, S3A): 0.3N/mm ² - Temperature range -40°C to + 180°C		

clamps

hose clamps

DIN 3017 - W2

			
1			
GEV No.	520112	Ref. No.	0011807 DW11807
description	hose clamp ø 12-20mm width 9mm Qty 10 pcs DIN 3017		
For models:	AQUA-35, AQUA-35-RL09, AQUA-37, AQUA-37-RL09, AQUA-40, AQUA-40-RL09, AQUA-50, AQUA-80, BB-2500, DUPLA-35, DUPLA-37, DUPLA-40, DUPLA-45, DUPLA-50, F, FP, GR300, GR800, HOOD-110, HOOD-110-E, HOOD-130, HOOD-130-ELETRONICA, HOOD-800SP-3D-GOGGLES-IMAX, K100, K120, K1600, K1600-ALTA-VELOCITA, K1700, K1800, K2100, K2200, K2500, K26A, K2700, K3000, K3000+K10, K3100, K3100+K10, K3300, K35, K36, K37, K3800, K3800+K10, K40, K4000, K40-LUX, K41-LUX, K4400, K4400+K10...(Other models you can see in the webshop)		

			
1			
GEV No.	520115	Ref. No.	0011806 DW11806
description	hose clamp ø 25-40mm width 9mm Qty 10 pcs DIN 3017		
For models:	AQUA-35, AQUA-35-RL09, AQUA-37, AQUA-37-RL09, AQUA-40, AQUA-40-RL09, AQUA-50, AQUA-80, BB-2500, DUPLA-35, DUPLA-37, DUPLA-40, DUPLA-45, DUPLA-50, F, FP, HOOD-110, HOOD-110-E, HOOD-130, HOOD-130-ELETRONICA, K120, K1600, K1600-ALTA-VELOCITA, K1700, K1800, K2100, K2200, K2500, K26, K26A, K2700, K3000, K3000+K10, K3100, K3100+K10, K3300, K35, K36, K37, K3800, K3800+K10, K40, K4000, K40-LUX, K41-LUX, K4400, K4400+K10, K45, K50, K5400...(Other models you can see in the webshop)		

measuring equipment

thermometers

built-in thermometers

			
1			
GEV No.	541305	Ref. No.	0010500011 DW10500011
description	thermometer mounting measurements 62x11mm +20 up to +120°C capillary pipe 1500mm probe ø 6.5mm probe L 16mm		
For models:	HOOD-110, HOOD-130, HOOD800SP-3D-GOGGLES-IMAX, K100, K120, K45, K50, K80, KP149, KP150, KP151		



fastening material

screws

sheet metal screws



1

GEV No.	560521	Ref. No.	0011004 DW11004
description	sheet-metal screw ϕ 4mm L 10mm SS Qty 1 pcs 14585 intake Phillips head ϕ 8mm		
For models:	AQUA-40, AQUA-50, AQUA-80, DUPLA-40, DUPLA-45, DUPLA-50, HOOD-110, HOOD-110-E, HOOD-130, HOOD-130-ELETTRONICA, HOOD800SP-3D-GOGGLES-IMAX, K35, K37, K40, K40-LUX, KP130-ELETTRONICA, KP70-EL, KP85-EL, LUX-40, LUX-40-ELETTRONICA, LUX-60, LUX-60-ELETTRONICA, LUX-61-ELETTRONICA, LUX-70-EL, LUX-85, LUX-85-ELETTRONICA		

flat-headed bolts



1

GEV No.	560365	Ref. No.	0011121 DW11121
description	flat-headed bolt thread M4 thread L 8mm SS DIN 7985/ISO 7045 Qty 1 pcs intake Phillips head ϕ 8mm head thickness 3mm		
For models:	AQUA-35, AQUA-35-RL09, AQUA-37, AQUA-37-RL09, AQUA-40, AQUA-40-RL09, AQUA-50, AQUA-80, DUPLA-35, DUPLA-37, DUPLA-40, DUPLA-45, DUPLA-50, HOOD-110, HOOD-110-E, HOOD-130, HOOD-130-ELETTRONICA, K70, KP130-ELETTRONICA		

raised countersunk head screws



1

GEV No.	560541	Ref. No.	00590099 DW590099
description	raised countersunk head screw thread M6 thread L 13mm SS DIN 966/ISO 7047 Qty 1 pcs intake slotted head ϕ 11mm head thickness 5mm		

hexagonal screws



1

GEV No.	560520	Ref. No.	0011109 DW11109
description	hexagonal screw thread M10 thread L 18mm SS WS 17 Qty 1 pcs head thickness 7mm DIN 933 / ISO 4017		
For models:	K1600, K1600-ALTA-VELOCITA, K1700, K1800, K2100, K2200, K2500, K2700, K3000, K3000+K10, K3100, K3100+K10, K3300, K3800, K3800+K10, K4000, K4400, K4400+K10, K5400, K5400+K10, KP2300, KP2300+KP23, KP2800, KP3000, KP4000		



1

GEV No.	560087	Ref. No.	0011104/B DW11104/B
description	hexagonal screw thread M6 thread L 16mm SS WS 10 Qty 20 pcs DIN 933 / ISO 4017		
For models:	KP202-E, KP302-E, KP402-E		



1

GEV No.	560522	Ref. No.	0015159 DW15159
description	hexagonal screw thread M12x1.75 thread L 15mm plastic WS 19 Qty 1 pcs head thickness 10mm		
For models:	AQUA-35, AQUA-37, AQUA-40, AQUA-50, AQUA-80, DUPLA-35, DUPLA-37, DUPLA-40, DUPLA-50, HOOD-110, HOOD-110-E, HOOD-130, HOOD-130-ELETTRONICA, K70, KP130-ELETTRONICA, KP149, KP151, KP151-E, KP200-ELETTRONICA, KP202-E, KP300-ELETTRONICA, KP302-E, KP400-ELETTRONICA, KP402-E, KP85-EL, LUX-40, LUX-40-ELETTRONICA, LUX-41-ELETTRONICA, LUX-60, LUX-60-ELETTRONICA, LUX-61-ELETTRONICA, LUX-85, LUX-85-ELETTRONICA		

side bolts



1

GEV No.	560289	Ref. No.	0011168 DW11168
description	side bolts thread M6 L 12mm SS Qty 1 pcs intake Phillips head ϕ 12.6mm		
For models:	DUPLA-45, DUPLA-50, K120, K40-LUX, K41-LUX, K60		

grub screws

DIN 914/ISO 4027



1

GEV No.	560457	Ref. No.	0011170 DW11170
description	grub screw thread M5 L 25mm stainless steel DIN 914/ISO 4027 intake hexagonal WS 2.5 Qty 1 pcs		
For models:	K36		

DIN 916/ISO 4029



1

GEV No.	560542	Ref. No.	0011505 DW11505
description	grub screw thread M6 L 16mm in stainless steel DIN 916/ISO 4029 intake internal hexagon WS 3 Qty 1 pcs		
For models:	KT-1500		

knurled screws



1

GEV No.	524804	Ref. No.	0010652 DW10652
description	Thumb screw thread M5 thread L 7mm ø 30mm H 5mm SS Qty 1 pcs		
For models:	AQUA-50, AQUA-80, DUPLA-50, HOOD-110, HOOD-110-E, HOOD-130, HOOD-130-ELETTRONICA, KP130-ELETTRONICA, KP149, KP151, KP151-E, KP200-ELETTRONICA, KP202-E, KP300-ELETTRONICA, KP302-E, KP400-ELETTRONICA, KP402-E, KP70-EL, KP85-EL, LUX-40, LUX-40-ELETTRONICA, LUX-41-ELETTRONICA, LUX-60, LUX-60-ELETTRONICA, LUX-61-ELETTRONICA, LUX-70-EL, LUX-85, LUX-85-ELETTRONICA		
accessories for	524804		
	GEV No.	505277	Ref. No.
			0010651 10651 DW10651
	rinse arm shaft warewashing ø 14mm H 38mm thread 1/4"		



1

GEV No.	517075	Ref. No.	0011101/B DW11101/B
description	Thumb screw thread M8 SS ø 30mm H 3mm thread L 8mm		
For models:	K100, K120, K41-LUX, K90, KP149, KP150, KP151, KP151-E, KP200, KP300, KP400, LUX-40, LUX-40-ELETTRONICA, LUX-41-ELETTRONICA		



1

GEV No.	517066	Ref. No.	0011101/A DW11101/A
description	Thumb screw thread M8 thread L 8mm ø 30mm H 3mm SS mounting pos. upper		
For models:	K35, K37, K40, K45		



1

GEV No.	517039	Ref. No.	0011101/I DW11101/I
description	Thumb screw thread M8x1.25 thread L 8mm ø 30mm H 3mm SS mounting pos. lower		
For models:	AQUA-50, AQUA-80, DUPLA-45, DUPLA-50, HOOD-110, HOOD-110-E, HOOD800SP-3D-GOGGLES-IMAX, K100, K35, K37, K40, K45, K50, K60, K70, K80, KP150, KP151, LUX-60, LUX-60-ELETTRONICA, LUX-61-ELETTRONICA		

nuts

cap nuts



1

GEV No.	560138	Ref. No.	0011183 DW11183
description	cap nuts thread M8 WS 13 SS Qty 20 pcs DIN/ISO DIN 1587		

hexagonal nuts

DIN 934 / ISO 4032/8673



1

GEV No.	560340	Ref. No.	0011703 DW11703
description	hexagonal nut thread M4 H 3.2mm WS 7 SS DIN/ISO DIN 934 / ISO 4032/8673 Qty 1 pcs		
For models:	AQUA-35, AQUA-35-RL09, AQUA-37, AQUA-37-RL09, AQUA-40, AQUA-40-RL09, DUPLA-35, DUPLA-37, DUPLA-40, DUPLA-45, DUPLA-50, F120-TK120P, F60-TK60P, K50		



1

GEV No.	560197	Ref. No.	0011719 DW11719
description	nut thread M10 H 8mm WS 17 SS DIN/ISO DIN 934 / ISO 4032/8673 Qty 1 pcs		
For models:	HOOD-110, HOOD-110-E, HOOD-130, HOOD-130-ELETTRONICA, K1600, K1600-ALTA-VELOCITA, K1700, K1800, K2100, K2200, K2500, K2700, K3000, K3000+K10, K3100, K3100+K10, K3300, K3800, K3800+K10, K4000, K4400, K4400+K10, K5400, K5400+K10, KP130-ELETTRONICA, KP2300, KP2300+KP23, KP2800, KP3000, KP4000		





1

GEV No.	517174	Ref. No.	0011702 DW11702
description	nut thread M8 H 6.5mm WS 13 SS DIN/ISO DIN 934 / ISO 4032/8673 Qty 1 pcs		
For models:	AQUA-35, AQUA-35-RL09, AQUA-37, AQUA-37-RL09, AQUA-40, AQUA-40-RL09, AQUA-50, AQUA-80, BB-2500, DUPLA-35, DUPLA-37, DUPLA-40, DUPLA-45, DUPLA-50, F, FP, GR300, GR800, HOOD-110, HOOD-110-E, HOOD-130, HOOD-130-ELETTRONICA, HOOD-800SP-3D-GOGGLES-IMAX, K100, K120, K1600, K1600-ALTA-VELOCITA, K1700, K1800, K2100, K2200, K2500, K2700, K3000, K3000+K10, K3100, K3100+K10, K3300, K36, K3800, K3800+K10, K4000, K40-LUX, K4400, K4400+K10, K5400, K5400+K10, K60, K70, K90...(Other models you can see in the webshop)		





hexagonal nuts metric (without norm)			
			
1			
GEV No.	560519	Ref. No.	0010200205 DW10200205
description	nut thread M12x1 H 5mm WS 17 SS Qty 1 pcs		
For models:	AQUA-35, AQUA-37, AQUA-40, AQUA-50, AQUA-80, DUPLA-35, DUPLA-37, DUPLA-40, DUPLA-50, HOOD-110, HOOD-110-E, HOOD-130, HOOD-130-ELETTRONICA, K70, KP130-ELETTRONICA, KP149, KP151, KP151-E, KP200, KP200-ELETTRONICA, KP202-E, KP300-ELETTRONICA, KP302-E, KP400, KP400-ELETTRONICA, KP402-E, KP85-EL, LUX-40, LUX-40-ELETTRONICA, LUX-41-ELETTRONICA, LUX-60, LUX-60-ELETTRONICA, LUX-61-ELETTRONICA, LUX-85, LUX-85-ELETTRONICA		

hexagonal nuts inch thread			
			
1			
GEV No.	517180	Ref. No.	0011701/A DW11701/A
description	nut thread 1" H 5mm WS 36 SS Qty 1 pcs		
For models:	AQUA-35, AQUA-37, AQUA-40, DUPLA-35, DUPLA-37, DUPLA-40, F, FP, GR300, GR800, HOOD-130, HOOD-130-ELETTRONICA, K2500, K35, K36, K37, K3800, K3800+K10, K40, K4000, K4400, K4400+K10, K5400, K5400+K10, K70, KP202-E, KP302-E, KP402-E, LUX-41-ELETTRONICA, LUX-61-ELETTRONICA		

			
1			
GEV No.	520232	Ref. No.	0010200080 DW10200080
description	nut thread 1 1/4" H 5mm nickel-plated brass WS 47 Qty 1 pcs		

			
1			
GEV No.	520499	Ref. No.	0015042/A DW15042/A
description	nut thread 1 1/4" H 6mm WS 50 brass Qty 1 pcs		
For models:	HOOD-130, HOOD-130-ELETTRONICA, K120, K70, K90, KP130-ELETTRONICA, KP150, KP151, KP151-E		

			
1			
GEV No.	507528	Ref. No.	002200103 DW2200103
description	nut thread 3/4" H 8mm WS 32 brass Qty 1 pcs		
For models:	BB-2500, F, FP, K1600, K1600-ALTA-VELOCITA, K1700, K1800, K2100, K2200, K2500, K26, K26A, K2700, K3000, K3000+K10, K3100, K3100+K10, K3300, K3800, K3800+K10, K4000, K4400, K4400+K10, K5400, K5400+K10, KP2300, KP2300+KP23, KP2800, KP3000, KP302-E, KP4000, KP402-E, KT-1500		

washers			
spring rings			
			
1			
GEV No.	560208	Ref. No.	11609 DW11609
description	lock washer ID ø 8.3mm ED ø 15mm SS Qty 1 pcs		
For models:	K1600, K1600-ALTA-VELOCITA, K1700, K1800, K2100, K2200, K2500, K2700, K3000, K3000+K10, K3100, K3100+K10, K3300, K3800, K3800+K10, K4000, K4400, K4400+K10, K5400, K5400+K10, KP2300, KP2300+KP23, KP2800, KP3000, KP4000		

washers			
miscellaneous			
			
1			
GEV No.	506160	Ref. No.	0011185 0011611 DW11185 DW11611
description	plain washer ID ø 8.6mm ED ø 16mm thickness 1.5mm SS Qty 1 pcs		
For models:	BB-2500, F, FP, HOOD800SP-3D-GOGGLES-IMAX, K100, K1600, K1600-ALTA-VELOCITA, K1700, K1800, K2100, K2200, K2500, K2700, K3000, K3000+K10, K3100, K3100+K10, K3300, K3800, K3800+K10, K4000, K4400, K4400+K10, K5400, K5400+K10, K70, KP149, KP150, KP151, KP151-E		

fasteners			
slot nuts			
			
1			
GEV No.	560285	Ref. No.	002001046 DW2001046
description	slot nut W 8mm H 7mm L 30mm		
For models:	BB-2500, F, FP, GR300, GR800, K1600, K1600-ALTA-VELOCITA, K1700, K1800, K2100, K2200, K2500, K2700, K3000, K3000+K10, K3100, K3100+K10, K3300, K3800, K3800+K10, K4000, K4400, K4400+K10, K5400, K5400+K10, KP2300, KP2300+KP23, KP2800, KP3000, KP4000, KT-1500		



clamps

hose clamps

DIN 3017 - W2



GEV No.	520112	Ref. No.	0011807 DW11807
description	hose clamp ø 12-20mm width 9mm Qty 10 pcs DIN 3017		
For models:	AQUA-35, AQUA-35-RL09, AQUA-37, AQUA-37-RL09, AQUA-40, AQUA-40-RL09, AQUA-50, AQUA-80, BB-2500, DUPLA-35, DUPLA-37, DUPLA-40, DUPLA-45, DUPLA-50, F, FP, GR300, GR800, HOOD-110, HOOD-110-E, HOOD-130, HOOD-130-ELETRONICA, HOOD-800SP-3D-GOGGLES-IMAX, K100, K120, K1600, K1600-ALTA-VELOCITA, K1700, K1800, K2100, K2200, K2500, K26A, K2700, K3000, K3000+K10, K3100, K3100+K10, K3300, K35, K36, K37, K3800, K3800+K10, K40, K4000, K40-LUX, K41-LUX, K4400, K4400+K10...(Other models you can see in the webshop)		



GEV No.	520115	Ref. No.	0011806 DW11806
description	hose clamp ø 25-40mm width 9mm Qty 10 pcs DIN 3017		
For models:	AQUA-35, AQUA-35-RL09, AQUA-37, AQUA-37-RL09, AQUA-40, AQUA-40-RL09, AQUA-50, AQUA-80, BB-2500, DUPLA-35, DUPLA-37, DUPLA-40, DUPLA-45, DUPLA-50, F, FP, HOOD-110, HOOD-110-E, HOOD-130, HOOD-130-ELETRONICA, K120, K1600, K1600-ALTA-VELOCITA, K1700, K1800, K2100, K2200, K2500, K26, K26A, K2700, K3000, K3000+K10, K3100, K3100+K10, K3300, K35, K36, K37, K3800, K3800+K10, K40, K4000, K40-LUX, K41-LUX, K4400, K4400+K10, K45, K50, K5400...(Other models you can see in the webshop)		

consumables

sealants and adhesives

industrial silicones



GEV No.	890110	Ref. No.	Silicon UNI9
description	silicone S100 cartridge 300ml transparent		
description	<p>OTTOSEAL S 100 - cartridge 300ml - transparent</p> <p>Used for expansion joints in bathroom areas, sealing of expansion joints in floor and wall areas, sealing and bonding of glass modules and sealing double glazings (e. g. „Profilit“).</p> <ul style="list-style-type: none"> - 1-component acetate-curing silicone sealant - Excellent weathering, ageing and UV-resistance - Contains fungicide and bacteriostatic - Unique processing characteristics - Surface can be smoothed very easily - Very good adhesion on ceramic substrates - Stress expansion modules at 100% (DIN 53 504, S3A): 0.3N/mm² - Temperature range -40°C to + 180°C 		

screw fixings



GEV No.	890137	Ref. No.	Loctite 243
description	screw fixing LOCTITE 243 medium-strength bottle 5ml		
description	<p>LOCTITE® 243™ - bottle 5ml</p> <p>Is a general purpose threadlocker of medium bond strength. This threadlocker secures and seal bolts, nuts and studs to prevent loosening due to vibration. The product works on all metals, including passive substrates such as stainless steel, aluminium and plated surfaces. It is proven to be tolerant of minor contamination due to industrial oils, e.g. engine oils, corrosion prevention oils and cutting fluids.</p>		

thread sealants





GEV No.	890135	Ref. No.	Loctite 511
description	thread sealing LOCTITE 511 tube 50ml approval DVGW		
description	<p>LOCTITE® 511™ - tube 50ml</p> <p>It is designed for the locking and sealing of metal threaded pipes and fittings. The product cures rapidly when confined in the absence of air between close fitting metal surfaces.</p>		



GEV No.	890128	Ref. No.	Loctite 542
description	thread sealing LOCTITE 542 medium-strength bottle 50ml approval DVGW		
description	<p>LOCTITE® 542™ - bottle 50ml</p> <p>It is designed for the locking and sealing of metal pipes and fittings as well as other cylindrical metal assemblies. The product cures when confined in the absence of air between close-fitting metal surfaces and prevents loosening and leakage due to shock and vibration. The thixotropic nature of LOCTITE 542 reduces the migration of liquid product after application to the part.</p>		



 <p>1</p>			
GEV No.	890097	Ref. No.	Loctite 577
description	thread sealing LOCTITE 577 medium-strength bottle 50ml pipe thread sealing t.max. 150°C approval BAM and DVGW		
description	LOCTITE® 577™ - bottle 50ml It is designed for the locking and sealing of metal pipes and fittings as well as other cylindrical metal assemblies. The product provides an instant, low-pressure seal for metal pipes and fittings. It will not creep, shrink or block systems by shredding. Suitable for fast application at low temperatures. It has excellent chemical and thermal resistance and offers less migration of liquid product after application to the part.		

 <p>1</p>			
GEV No.	358671	Ref. No.	0015163 DW15163
description	fine fuse size ø5x20mm 1A fast-acting rated 250V Qty 10 pcs		
For models:	AQUA-50, BB-2500, F, FP, HOOD-130, K1600, K1600-ALTA-VELOCITA, K1700, K1800, K2100, K2200, K2500, K2700, K3000, K3000+K10, K3100, K3100+K10, K3300, K3800, K3800+K10, K4000, K4400, K4400+K10, K5400, K5400+K10, KP2300, KP2300+KP23, KP2800, KP3000, KP4000, KP70-EL, KT-1500, LUX-60, LUX-60-ELETTRONICA, LUX-70-EL		

lubricants

high-temperature greases

 <p>1</p>			
GEV No.	890120	Ref. No.	Grease High Temp
description	lubricant GM 5 up to +450°C 100g tubeml		
description	Turmopast GM 5 - tube 100g Special thermally stable paste with synergetic solid lubricant combination, generates low coefficients of friction. The extremely effective lubricant paste has a good pressure capability, protects reliably against friction and wear, and thus results in lowered lubricant consumption. Paste-like lubricant film at temperatures < 200 °C, transition to dry lubrication > 200 °C. Temperature resistance: -40°C to +450°C		

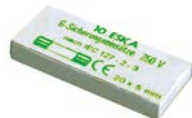
 <p>1</p>			
GEV No.	358607	Ref. No.	0015212 DW15212
description	fine fuse size ø5x20mm 6.3A slow-acting rated 250V Qty 10 pcs		

ø10x38mm 500V

 <p>1</p>			
GEV No.	358027	Ref. No.	003006095 DW3006095
description	fine fuse size ø10x38mm 16A rated 500V type Gg fast-acting Qty 1 pcs		
For models:	K2500, K3800, K4400, K5400		

fuses

fine fuses

 <p>1</p>			
GEV No.	358610	Ref. No.	0015160 DW15160
description	fine fuse size ø5x20mm 10A fast-acting rated 250V Qty 10 pcs		
For models:	BB-2500, F, FP, K1600, K1600-ALTA-VELOCITA, K1800, K2100, K2200, K2500, K3000, K3000+K10, K3100, K3100+K10, K3300, K3800, K3800+K10, K4000, K4400, K4400+K10, K5400, K5400+K10, KP202-E, KP2300, KP2300+KP23, KP2800, KP3000, KP302-E, KP4000, KP402-E, KT-1500		

A			
axial fans	41		
B			
bi-metal thermostats	9, 9		
booster pumps I	59		
booster pumps II	60		
C			
cables	61		
cam switches	17		
cap nuts	114		
clamps	112, 116		
coil heating elements	4		
condensators & interference suppression filters	60		
consumables	116		
contactors	27		
container filters	102		
control equipment	20		
control thermostats	9, 10		
D			
door seals for dishwashers	94		
dosing pumps	98		
double nipples	110		
drain hoses	103		
drain pumps	60		
E			
electric accessories	61		
electronic controllers	31		
energy regulators	9		
espagnolette locks	85		
F			
fans	41		
fasteners	115		
fastening material	113		
fine fuses	117		
fittings	110		
flat-headed bolts	113		
flow meters	41		
formed hoses	104		
fuses	61, 117		
G			
grub screws	113		
H			
heating elements	3	hexagonal nuts	114
heating elements for contact grills	3	hexagonal screws	113
heating elements for salamanders/toasters	4	high-temperature greases	117
		hose clamps	112, 116
		hose connectors	109, 110
		hoses	103
		hot air fans	41
		I	
		immersion heating elements	4
		indicator lights	22
		indicator lights (complete)	22
		industrial hoses	104
		industrial silicones	112, 116
		intake lances	103
		K	
		knurled screws	114
		L	
		lamps	22
		LED	23
		light bulbs	24
		lubricants	117
		M	
		magnetic switches	19
		measuring equipment	112
		mechanical timers	27
		microswitches	13
		motors	41
		N	
		Niplaflex hoses	104
		non-return valves	102
		nuts	114
		O	
		operating capacitors	60
		O-rings	89
		P	
		plunger sockets	11
		position switches	14
		pressure control hoses	104
		pressure reduction valves	111, 111
		pressure switches	39
		probes	31
		programme timers	24
		pumps	42
		push/momentary push switches	11
		PVC supply hoses	103

Q

quartz heating elements 4

R

radiation heaters 9
 raised countersunk head screws 113
 reducers 110
 relays 29
 ribbon cables 61
 rocker/momentary rocker switches 11
 rotary switches 18

S

safety bi-metal thermostats 9
 safety thermostats 10
 screw fixings 116
 screws 113
 sealants and adhesives 116
 sealing discs 95
 sealing washers 92
 shaft gaskets 94
 sheet metal screws 113
 side bolts 113
 silicone 112, 116
 slot nuts 115
 solenoid valves 36
 spring rings 115
 supply filters 111, 111
 supply hoses 103
 switches and momentary switches 11
 system switches (ROLD) 14

T

tank inlets 103
 temperature probes 31
 terminals 62
 thermostats 9
 thread sealants 62, 111, 116
 time relays 30
 timers 24

U

universal probes 31

W

wash and rinse pumps 42
 washers 115
 water cycle components 111