



GAS COMPONENTS



ELECTRIC COMPONENTS



WATER TECHNOLOGY



MECHANICAL COMPONENTS



TOOLS

Spare parts suitable for

KREFFT

Find the complete and up-to-date range of products in our GEV Webshop



Manufacturer catalogue

The most important spare parts and accessories arranged clearly for every manufacturer

- ✓ Complete product range and all appliance data always up to date in the GEV Webshop
- ✓ Alphabetical Index at the end of the catalogue

GEV Webshop

www.gev-online.co.uk

www.gev-online.com



- 🔍 Add to Favourites
- 🔍 Sign In with email address and usual password
- 🔍 Easy-order – place several items in your basket at the same time
- 🔍 Quick Item search – no login needed



heating elements

heating elements for ovens

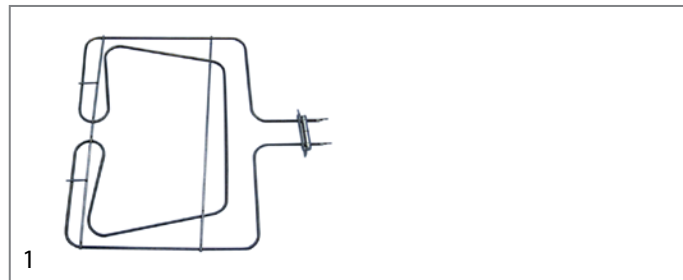

GEV No.	415995	Ref. No.	49-182322
description	heating element 1500W 400V heating circuits 1 L 460mm W 484mm L1 107mm L2 360mm W1 211mm W2 62mm flange length 104mm flange width 32mm hole distance 96/39mm hole ø 4mm tube ø 6.4mm connection male faston 6.3mm connection length 51mm tilt flange dry heating element		
For models:	GEH6030, GEH6050		

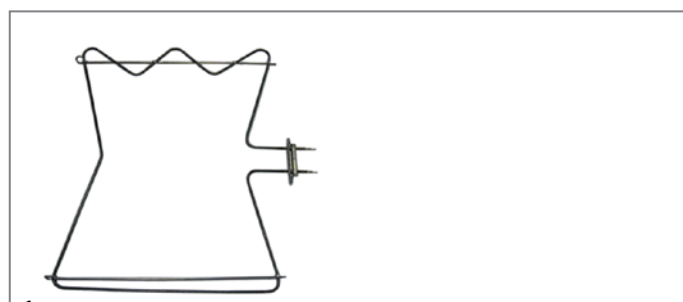

GEV No.	415795	Ref. No.	49-182325
description	heating element 2000W 400V heating circuits 1 L 490mm W 575mm L1 40mm L2 450mm W1 257mm W2 60mm flange length 105mm flange width 34mm hole distance 38mm hole ø 4mm tube ø 6.5mm connection male faston 6.3mm tilt flange dry heating element oven		

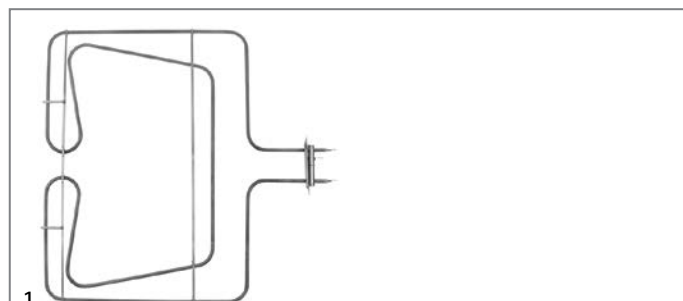

GEV No.	417605	Ref. No.	49-160631
description	heating element 2100W 400V L 465mm W 480mm H 10mm tube ø 6.5mm heating circuits 1 oven		

heating elements for bain maries

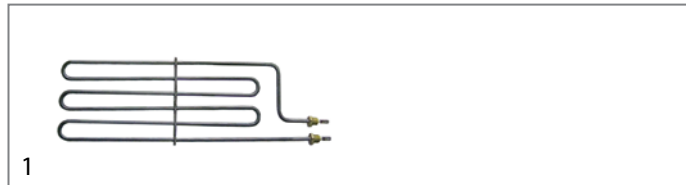



GEV No.	415608	Ref. No.	49-182403
description	heating element 2000W 230V heating circuits 1 L 430mm W 135mm connection length 20mm connection male faston 6.3mm tube ø 6.3mm 2 hole fixing thread M14x1.5 dry heating element L1 50mm L2 380mm W1 100mm W2 38mm mounting distance 32mm		

spare parts for	415608			
	GEV No.	510417	Ref. No.	—
	flat gasket fibre ED ø 20mm ID ø 14mm thickness 2mm Qty 1 pcs			

accessories for	415608			
	GEV No.	520228	Ref. No.	76-30041405
	tooth lock washer ID ø 15.3mm ED ø 24mm steel Qty 1 pcs for thread M14			

	GEV No.	520230	Ref. No.	76-30041406
	nut thread M14x1.5 H 5mm WS 19 zinc-coated steel Qty 1 pcs			

	GEV No.	521101	Ref. No.	—
	nut thread M14x1.5 H 5mm WS 19 SS Qty 1 pcs			

	GEV No.	550262	Ref. No.	—
	flat gasket copper ED ø 20mm ID ø 14mm thickness 2mm			

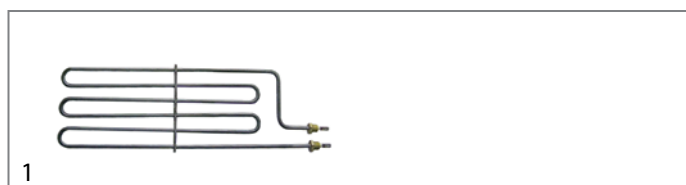

GEV No.	415609	Ref. No.	49-182404
description	heating element 2000W 400V heating circuits 1 L 430mm W 135mm connection male faston 6.3mm tube ø 6.5mm 2 hole fixing thread M14x1.5 immersion heater L1 50mm L2 380mm W1 100mm W2 38mm mounting distance 32mm		

accessories for	415609			
	GEV No.	510417	Ref. No.	—
	flat gasket fibre ED ø 20mm ID ø 14mm thickness 2mm Qty 1 pcs			

	GEV No.	520228	Ref. No.	76-30041405
	tooth lock washer ID ø 15.3mm ED ø 24mm steel Qty 1 pcs for thread M14			



	GEV No.	520230	Ref. No.	76-30041406
	nut thread M14x1.5 H 5mm WS 19 zinc-coated steel Qty 1 pcs			

	GEV No.	521101	Ref. No.	—
	nut thread M14x1.5 H 5mm WS 19 SS Qty 1 pcs			

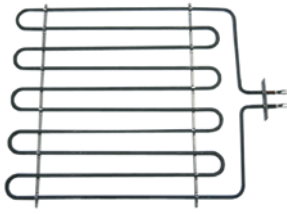
	GEV No.	550262	Ref. No.	—
	flat gasket copper ED ø 20mm ID ø 14mm thickness 2mm			



1

GEV No.	415988	Ref. No.	49-182328
description	heating element 3000W 230V heating circuits 1 L 420mm W 330mm L1 36mm L2 383mm W1 147mm W2 30mm flange length 70mm flange width 23mm hole distance 56mm connection male faston 6.3mm tube ø 6.5mm rectangular flange mounting thread M3 dry heating element		
accessories for	415988		
	GEV No.	527169	Ref. No.
	hexagonal nut thread M3 H 2.8mm WS 5.5 brass Qty 1 pcs		
	GEV No.	560110	Ref. No.
	plain washer ID ø 3.2mm ED ø 7mm thickness 0.5mm SS Qty 20 pcs DIN 125A for thread M3		
	GEV No.	560130	Ref. No.
	hexagonal nut thread M3 H 2.4mm WS 5.5 SS DIN/ISO DIN 934 / ISO 4032/8673 Qty 20 pcs		

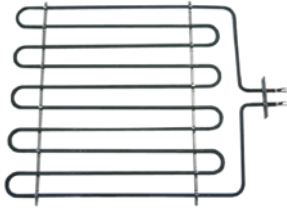

1

GEV No.	415589	Ref. No.	49-182327
description	heating element 3000W 400V heating circuits 1 L 420mm W 330mm flange length 70mm flange width 22mm hole distance 57mm connection male faston 6.3mm tube ø 6.3mm flange 70 x 22mm dry heating element L1 41mm L2 383mm W1 149mm W2 31mm		

heating elements for fryers

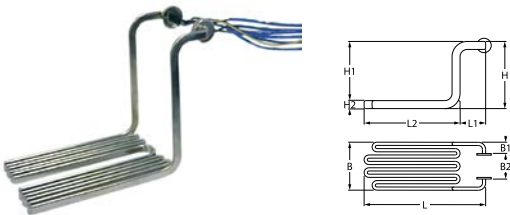



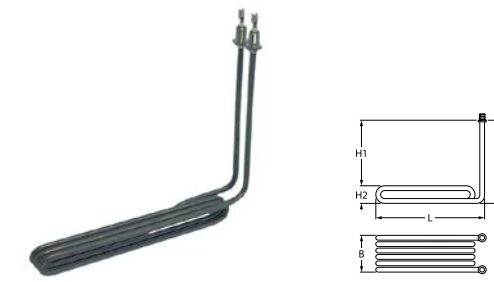

1

GEV No.	415490	Ref. No.	01-214567
description	heating element 5100W 230/400V heating circuits 3 L 345mm W 168mm H 246mm L1 70mm L2 275mm H1 229mm H2 17mm W1 21mm W2 104mm windings 6 flange ø 39mm connection cable rotation flange immersion heater		

2 hole fixing



1

GEV No.	415591	Ref. No.	49-182651
description	heating element 2000W 230V heating circuits 1 L 285mm W 40mm H 240mm H1 200mm H2 40mm mounting pos. 20 thread M14x1.5 tube ø 8.5mm mounting distance 20mm windings 3 2 hole fixing connection male faston 6.3mm immersion heater		
spare parts for	415591		
	GEV No.	510417	Ref. No.
	flat gasket fibre ED ø 20mm ID ø 14mm thickness 2mm Qty 1 pcs		
accessories for	415591		
	GEV No.	520228	Ref. No.
	tooth lock washer ID ø 15.3mm ED ø 24mm steel Qty 1 pcs for thread M14		
	GEV No.	520230	Ref. No.
	nut thread M14x1.5 H 5mm WS 19 zinc-coated steel Qty 1 pcs		
	GEV No.	521101	Ref. No.
	nut thread M14x1.5 H 5mm WS 19 SS Qty 1 pcs		
	GEV No.	550262	Ref. No.
	flat gasket copper ED ø 20mm ID ø 14mm thickness 2mm		

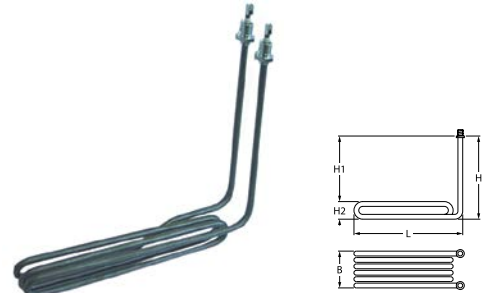

1









GEV No.	415978	Ref. No.	49-182652
description	heating element 3000W 230V heating circuits 1 L 288mm W 48mm H 243mm H1 205mm H2 38mm thread M14x1.5 tube ø 8.5mm windings 3 2 hole fixing connection male faston 6.3mm		
spare parts for	415978		
	GEV No.	510417	Ref. No.
	flat gasket fibre ED ø 20mm ID ø 14mm thickness 2mm Qty 1 pcs		
accessories for	415978		
	GEV No.	510417	Ref. No.
	flat gasket fibre ED ø 20mm ID ø 14mm thickness 2mm Qty 1 pcs		
	GEV No.	520228	Ref. No.
	tooth lock washer ID ø 15.3mm ED ø 24mm steel Qty 1 pcs for thread M14		

Table continues overleaf

accessories for		415978		
GEV No.	520230	Ref. No.	76-30041406	
	nut thread M14x1.5 H 5mm WS 19 zinc-coated steel Qty 1 pcs			
GEV No.	521101	Ref. No.	—	
	nut thread M14x1.5 H 5mm WS 19 SS Qty 1 pcs			
GEV No.	550262	Ref. No.	—	
	flat gasket copper ED ø 20mm ID ø 14mm thickness 2mm			

heating elements for griddles

				
GEV No.	415593	Ref. No.	49-182330	
description	heating element 2565W 230V L 554mm W 125mm H 30mm connection male faston 6.3mm dry heating element heating circuits 1 tube ø 8.5mm W1 40mm W2 45mm rectangular flange hole distance 56mm flange length 70mm flange width 22mm hole ø 5mm connection length 34mm			

				
GEV No.	415594	Ref. No.	49-182329	
description	heating element 2565W 400V L 556mm W 126mm H 33mm connection male faston 6.3mm dry heating element heating circuits 1 tube ø 6.3mm W1 48mm W2 30mm rectangular flange hole distance 56mm flange length 70mm flange width 22mm mounting thread M4			

				
GEV No.	415479	Ref. No.	01-214338	
description	heating element 750W 230V heating circuits 1 L 471mm W 30mm Hmm tube ø 6.35mm rectangular flange connection male faston 6.3mm hole distance 36mm flange length 44mm flange width 20mm hole ø 4.5mm connection length 30mm dry heating element			

heating elements for tilting bratt pan

				
GEV No.	415593	Ref. No.	49-182330	
description	heating element 2565W 230V L 554mm W 125mm H 30mm connection male faston 6.3mm dry heating element heating circuits 1 tube ø 8.5mm W1 40mm W2 45mm rectangular flange hole distance 56mm flange length 70mm flange width 22mm hole ø 5mm connection length 34mm			

				
GEV No.	415594	Ref. No.	49-182329	
description	heating element 2565W 400V L 556mm W 126mm H 33mm connection male faston 6.3mm dry heating element heating circuits 1 tube ø 6.3mm W1 48mm W2 30mm rectangular flange hole distance 56mm flange length 70mm flange width 22mm mounting thread M4			

heating elements for chargrills

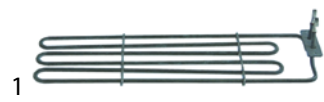
				
GEV No.	415595	Ref. No.	49-182332	
description	heating element 1900W 400V L 410mm W 125mm H 28mm hole distance 56mm windings 3 W1 45mm W2 31mm flange length 70mm flange width 22mm connection male faston 6.3mm heating circuits 1 tube ø 6.3mm mounting thread M4 rectangular flange dry heating element			

				
GEV No.	415592	Ref. No.	49-182653	
description	heating element 2000W 230V L 400mm W 142mm H 64mm thread M14x1.5 mounting distance 94mm tube ø 8.5mm connection male faston 6.3mm windings 3 heating circuits 1 connection length 39mm 2 hole fixing dry heating element W1 21mm W2 102mm			

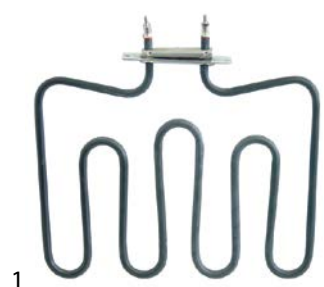

heating elements for salamanders/toast-

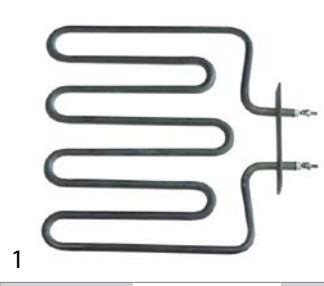



				
GEV No.	416653	Ref. No.	75-3804	
description	heating element 2000W 230V L 225mm W 283mm L1 15mm L2 210mm W1 110mm W2 63mm hole distance 96mm connection M4 tube ø 8.5mm flange length 106mm flange width 32mm heating circuits 1 hole ø 5mm tilt flange dry heating element H 8.5mm			

				
GEV No.	415621	Ref. No.	75-3706	
description	heating element 2000W 230V heating circuits 1 L 228mm W 230mm L1 29mm L2 228mm W1 84mm W2 62mm flange length 116mm flange width 32mm hole distance 96mm tube ø 8.5mm connection length 17mm dry heating element connection M4 rectangular flange hole ø 5mm H 8.5mm			





pilot heating elements





			
1			
GEV No.	415460	Ref. No.	01-214610
description	heating element 1000W 230V heating circuits 1 flange 70x18mm L 230mm W 65mm connection male faston 6.3mm tube ø 8.5mm immersion heater expansion flange connection length 20mm silicone TD ø 8mm		
accessories for	415460		
	GEV No.	375044	Ref. No. —
	safety thermostat switch-off temp. 178°C 1-pole 16A probe ø 4mm probe L 91mm capillary pipe 1730mm capillary pipe isolated 1600mm gland nut probe with sealing sleeve screw connection M8x1 sealing sleeve 8.6x32mm		



			
1			
GEV No.	415607	Ref. No.	49-181729
description	heating element 500W 230V heating circuits 1 thread 3/4" L 295mm W 20mm H 19mm length thermostat sleeves 235mm thermostat sleeves ø 6mm number of thermostat sleeves 1 thermostat sleeve clinging tube ø 6.5mm immersion heater flange with thread connection length 50mm pilot heating element		
spare parts for	415607		
	GEV No.	510403	Ref. No. —
	flat gasket fibre ED ø 36.5mm ID ø 27mm thickness 2mm Qty 1 pcs		
accessories for	415607		
	GEV No.	510421	Ref. No. —
	gasket copper ED ø 31.8mm ID ø 26.4mm thickness 2.2mm for thread 3/4"		
	GEV No.	520234	Ref. No. —
	nut thread 3/4" H 5mm brass WS 30 Qty 1 pcs		



immersion heating elements

3 hole flange ø47.5mm







			
1			
GEV No.	415069	Ref. No.	49-182521
description	heating element 4500W 220V mounting ø 47.5mm heating circuits 3 L 310mm W 30.5mm H 29mm tube ø 6.3mm connection male faston 6.3mm 3 hole flange immersion heater		
accessories for	415069		
	GEV No.	510408	Ref. No. —
	O-ring EPDM thickness 5.34mm ID ø 47mm Qty 1 pcs		
	GEV No.	520235	Ref. No. —
	3 hole flange hole distance 70.5mm perforation ø 6.5mm ID ø 53.5mm		

accessories for	415069		
	GEV No.	520236	Ref. No. —
	flange for heating element ID ø 50mm ED ø 90mm hole ø 6.5mm 3 holes		
	GEV No.	521012	Ref. No. —
	gasket graphite ED ø 15mm ID ø 5mm thickness 1.2mm Qty 1 pcs		
	GEV No.	550002	Ref. No. —
	tension strap H 10mm L 21mm W 10mm hole ø 6.5mm for heating element		
	GEV No.	550362	Ref. No. —
	blind flange ø 64mm mounting ø 47.5mm		



			
1			
GEV No.	416240	Ref. No.	62-230083
description	heating element 6545W 230/400V mounting ø 48mm heating circuits 3 L 355mm W 31mm H 37mm number of thermostat sleeves 1 thermostat sleeves ø 7mm length thermostat sleeves 175mm thermostat sleeve upper centre not clinging tube ø 6.5mm hole distance 63mm hole ø 10mm connection M4 3 hole flange immersion heater		
accessories for	416240		
	GEV No.	510408	Ref. No. —
	O-ring EPDM thickness 5.34mm ID ø 47mm Qty 1 pcs		
	GEV No.	510562	Ref. No. —
	O-ring silicone thickness 5.34mm ID ø 47mm Qty 1 pcs		



			
1			
GEV No.	415668	Ref. No.	62-230090
description	heating element 2625W 230V mounting ø 47.5mm heating circuits 1 L 190mm W 41mm H 54mm number of thermostat sleeves 1 thermostat sleeves ø 7mm length thermostat sleeves 170mm thermostat sleeve eccentric, non clinging tube ø 6.3mm hole distance 62mm hole ø 8mm connection M4 3 hole flange immersion heater		
spare parts for	415668		
	GEV No.	510408	Ref. No. —
	O-ring EPDM thickness 5.34mm ID ø 47mm Qty 1 pcs		
accessories for	415668		
	GEV No.	510562	Ref. No. —
	O-ring silicone thickness 5.34mm ID ø 47mm Qty 1 pcs		





			
GEV No.	415002	Ref. No.	62-230005
description	heating element 3000W 230V mounting \varnothing 47.5mm heating circuits 1 L 198mm W 35mm H 44mm number of thermostat sleeves 1 thermostat sleeves \varnothing 7mm length thermostat sleeves 175mm thermostat sleeve not clinging tube \varnothing 6.3mm hole distance 64mm hole \varnothing 8mm connection M4 3 hole flange immersion heater		
accessories for	415002		
	GEV No.	510408	Ref. No. —
	O-ring EPDM thickness 5.34mm ID \varnothing 47mm Qty 1 pcs		
	GEV No.	510562	Ref. No. —
	O-ring silicone thickness 5.34mm ID \varnothing 47mm Qty 1 pcs		
	GEV No.	521103	Ref. No. —
	nut thread M4 H 3mm WS 7 brass Qty 20 pcs		
	GEV No.	521104	Ref. No. —
	washer ID \varnothing 4.3mm ED \varnothing 8mm thickness 0.5mm brass Qty 20 pcs for thread M4		
	GEV No.	560111	Ref. No. —
	plain washer ID \varnothing 4.3mm ED \varnothing 9mm thickness 0.8mm SS Qty 20 pcs DIN 125A for thread M4		
	GEV No.	560131	Ref. No. —
	hexagonal nut thread M4 H 3.2mm WS 7 SS DIN/ISO DIN 934 / ISO 4032/8673 Qty 20 pcs		

<p>3 hole flange \varnothing57.5mm</p> 			
GEV No.	420159	Ref. No.	63-110392
description	heating element 14000W 230/400V mounting \varnothing 57.5mm heating circuits 3 L 500mm W 36mm H 43mm number of thermostat sleeves 1 thermostat sleeves \varnothing 7.5mm length thermostat sleeves 290mm thermostat sleeve eccentric, non clinging tube \varnothing 8.3mm hole distance 73mm hole \varnothing 10mm connection length 26mm connection M5 3 hole flange		

<p>with compression flange 70 x 26mm</p> 			
GEV No.	415009	Ref. No.	62-230087
description	heating element 2500W 230V heating circuits 1 flange 70x26mm L 280mm W 51mm H mm tube \varnothing 6.3mm connection M4 immersion heater compression flange		
accessories for	415009		
	GEV No.	521128	Ref. No. —
	gasket L 66mm W 21mm \varnothing mm for heating element suitable for ELETTRBAR, WOLK		

<p>with expansion flange 70 x 18mm</p> 			
GEV No.	415460	Ref. No.	01-214610
description	heating element 1000W 230V heating circuits 1 flange 70x18mm L 230mm W 65mm connection male faston 6.3mm tube \varnothing 8.5mm immersion heater expansion flange connection length 20mm silicone TD \varnothing 8mm		
accessories for	415460		
	GEV No.	375044	Ref. No. —
	safety thermostat switch-off temp. 178°C 1-pole 16A probe \varnothing 4mm probe L 91mm capillary pipe 1730mm capillary pipe isolated 1600mm gland nut probe with sealing sleeve screw connection M8x1 sealing sleeve 8.6x32mm		

			
GEV No.	417684	Ref. No.	76-30043506 76-30044103 76-30044306
description	heating element 3000W 230V heating circuits 2 flange 70x18mm L 365mm W 65mm connection male faston 6.3mm tube \varnothing 8.5mm immersion heater expansion flange		

			
GEV No.	417685	Ref. No.	76-30044303
description	heating element 3000W 400V heating circuits 2 flange 70x18mm L 365mm W 64mm connection male faston 6.3mm tube \varnothing 8.5mm immersion heater expansion flange		

			
GEV No.	415557	Ref. No.	01-214087
description	heating element 5600W 400V heating circuits 2 L 272mm W 64mm tube \varnothing 8.5mm connection male faston 6.3mm immersion heater expansion flange flange 70x18mm		

			
GEV No.	417672	Ref. No.	76-30043516 76-30044105 76-30044108 76-30044307
description	heating element 6000W 230V flange 70x18mm L 355mm		

			
GEV No.	417687	Ref. No.	76-30043505 76-30043523 76-30044102 76-30044106 76-30044305
description	heating element 6000W 230V heating circuits 2 flange 70x18mm L 365mm W 65mm connection male faston 6.3mm tube \varnothing 8.5mm immersion heater expansion flange connection length 32mm		





			
GEV No.	417699	Ref. No.	76-30044155 76-30044156
description	heating element 6000W 230V heating circuits 2 flange 70x18mm L 375mm W 65mm connection male faston 6.3mm tube ø 8.5mm immersion heater expansion flange thermostat sleeves ø 2.5mm length thermostat sleeves 105mm number of thermostat sleeves 1		

			
GEV No.	417673	Ref. No.	76-30043518 76-30044304
description	heating element 6000W 400V flange 70x18mm number of thermostat sleeves 1		

			
GEV No.	417686	Ref. No.	76-30043508 76-30044302
description	heating element 6000W 400V heating circuits 2 flange 70x18mm L 365mm W 65mm connection male faston 6.3mm tube ø 8.5mm immersion heater expansion flange		

			
GEV No.	417688	Ref. No.	76-30044157 76-30044158
description	heating element 6000W 400V heating circuits 2 flange 70x18mm L 370mm W 65mm connection male faston 6.3mm tube ø 8.5mm immersion heater expansion flange thermostat sleeves ø 3mm length thermostat sleeves 134mm number of thermostat sleeves 1		

			
GEV No.	415464	Ref. No.	01-214608
description	heating element 6000W 400V heating circuits 2 flange 70x18mm L 380mm W 65mm connection male faston 6.3mm tube ø 8.5mm immersion heater expansion flange		

			
GEV No.	418639	Ref. No.	76-30044159
description	heating element 6000W 440V heating circuits 2 flange 70x18mm L 370mm W 68mm connection male faston 6.3mm tube ø 8.5mm immersion heater expansion flange thermostat sleeves ø 2.5mm length thermostat sleeves 115mm thermostat sleeve clinging number of thermostat sleeves 1		

with round flange ø47.5mm

			
GEV No.	415512	Ref. No.	026233 400229

description	heating element 2790W 230V heating circuits 3 mounting ø 47.5mm L 375mm W 130mm H 23mm tube ø 6.3mm round flange with thread bolt connection male faston immersion heater connection length 17mm		
--------------------	--	--	--

accessories for	415512		
------------------------	--------	--	--

	GEV No.	510408	Ref. No.	—
O-ring EPDM thickness 5.34mm ID ø 47mm Qty 1 pcs				

	GEV No.	510562	Ref. No.	—
O-ring silicone thickness 5.34mm ID ø 47mm Qty 1 pcs				

	GEV No.	550002	Ref. No.	—
tension strap H 10mm L 21mm W 10mm hole ø 6.5mm for heating element				

			
GEV No.	415513	Ref. No.	026227 400222

description	heating element 2800W 230V heating circuits 2 mounting ø 47.5mm L 345mm W 35mm H 28mm round flange connection male faston 6.3mm immersion heater tube ø 6.3mm thermostat sleeves ø 9mm number of thermostat sleeves 1 length thermostat sleeves 235mm thermostat sleeve not clinging		
--------------------	--	--	--

accessories for	415513		
------------------------	--------	--	--

	GEV No.	510562	Ref. No.	—
O-ring silicone thickness 5.34mm ID ø 47mm Qty 1 pcs				

	GEV No.	520235	Ref. No.	—
3 hole flange hole distance 70.5mm perforation ø 6.5mm ID ø 53.5mm				





	GEV No.	520236	Ref. No.	—
flange for heating element ID ø 50mm ED ø 90mm hole ø 6.5mm 3 holes				







	GEV No.	521012	Ref. No.	—
gasket graphite ED ø 15mm ID ø 5mm thickness 1.2mm Qty 1 pcs				









	GEV No.	550002	Ref. No.	—
tension strap H 10mm L 21mm W 10mm hole ø 6.5mm for heating element				







	GEV No.	550362	Ref. No.	—
blind flange ø 64mm mounting ø 47.5mm				









			
1			
GEV No.	415508	Ref. No.	023235 400245
description	heating element 3000W 230V heating circuits 3 mounting \varnothing 47.5mm L 380mm W 125mm H 25mm tube \varnothing 6.3mm round flange with thread bolt connection male faston 6.3mm immersion heater connection length 30mm H1 15mm		
accessories for	415508		
	GEV No.	510562	Ref. No. —
	O-ring silicone thickness 5.34mm ID \varnothing 47mm Qty 1 pcs		
	GEV No.	521012	Ref. No. —
	gasket graphite ED \varnothing 15mm ID \varnothing 5mm thickness 1.2mm Qty 1 pcs		
	GEV No.	550002	Ref. No. —
	tension strap H 10mm L 21mm W 10mm hole \varnothing 6.5mm for heating element		



			
1			
GEV No.	415511	Ref. No.	026231 400244
description	heating element 6000W 220V heating circuits 3 mounting \varnothing 47.5mm L 355mm W 35mm H 113mm round flange connection male faston 6.3mm immersion heater tube \varnothing 6.3mm thermostat sleeves \varnothing 7mm number of thermostat sleeves 1 length thermostat sleeves 235mm thermostat sleeve not clinging		
accessories for	415511		
	GEV No.	510562	Ref. No. —
	O-ring silicone thickness 5.34mm ID \varnothing 47mm Qty 1 pcs		
	GEV No.	520235	Ref. No. —
	3 hole flange hole distance 70.5mm perforation \varnothing 6.5mm ID \varnothing 53.5mm		
	GEV No.	520236	Ref. No. —
	flange for heating element ID \varnothing 50mm ED \varnothing 90mm hole \varnothing 6.5mm 3 holes		
	GEV No.	521012	Ref. No. —
	gasket graphite ED \varnothing 15mm ID \varnothing 5mm thickness 1.2mm Qty 1 pcs		
	GEV No.	550002	Ref. No. —
	tension strap H 10mm L 21mm W 10mm hole \varnothing 6.5mm for heating element		
	GEV No.	550362	Ref. No. —
	blind flange \varnothing 64mm mounting \varnothing 47.5mm		

			
1			
GEV No.	415599	Ref. No.	49-182656
description	heating element 6000W 230V heating circuits 3 L 385mm W 31mm H 36mm tube \varnothing 8.5mm thermostat sleeves \varnothing 6.5mm length thermostat sleeves 180mm number of thermostat sleeves 1 thermostat sleeve centre connection male faston 6.3mm immersion heater round flange mounting \varnothing 47.5mm		
spare parts for	415599		
	GEV No.	510408	Ref. No. —
	O-ring EPDM thickness 5.34mm ID \varnothing 47mm Qty 1 pcs		
accessories for	415599		
	GEV No.	510408	Ref. No. —
	O-ring EPDM thickness 5.34mm ID \varnothing 47mm Qty 1 pcs		
	GEV No.	510562	Ref. No. —
	O-ring silicone thickness 5.34mm ID \varnothing 47mm Qty 1 pcs		
	GEV No.	520235	Ref. No. —
	3 hole flange hole distance 70.5mm perforation \varnothing 6.5mm ID \varnothing 53.5mm		
	GEV No.	520236	Ref. No. —
	flange for heating element ID \varnothing 50mm ED \varnothing 90mm hole \varnothing 6.5mm 3 holes		
	GEV No.	550002	Ref. No. —
	tension strap H 10mm L 21mm W 10mm hole \varnothing 6.5mm for heating element		
	GEV No.	550362	Ref. No. —
	blind flange \varnothing 64mm mounting \varnothing 47.5mm		







			
1			
GEV No.	415405	Ref. No.	49-182416
description	heating element 6000W 230V heating circuits 3 L 465mm W 38mm H 24mm tube \varnothing 6.3mm connection male faston 6.3mm immersion heater round flange mounting \varnothing 47.5mm		
spare parts for	415405		
	GEV No.	504148	Ref. No. —
	boiler		
accessories for	415405		
	GEV No.	520235	Ref. No. —
	3 hole flange hole distance 70.5mm perforation \varnothing 6.5mm ID \varnothing 53.5mm		
	GEV No.	520236	Ref. No. —
	flange for heating element ID \varnothing 50mm ED \varnothing 90mm hole \varnothing 6.5mm 3 holes		
	GEV No.	521012	Ref. No. —
	gasket graphite ED \varnothing 15mm ID \varnothing 5mm thickness 1.2mm Qty 1 pcs		
	GEV No.	550002	Ref. No. —
	tension strap H 10mm L 21mm W 10mm hole \varnothing 6.5mm for heating element		
	GEV No.	550362	Ref. No. —
	blind flange \varnothing 64mm mounting \varnothing 47.5mm		







			
GEV No.	415416	Ref. No.	49-182539
description	heating element 7500W 230V heating circuits 3 L 460mm W 37mm H 26mm tube ø 6.3mm thermostat sleeves ø 7mm length thermostat sleeves 200mm number of thermostat sleeves 1 thermostat sleeve eccentric, non clinging connection male faston 6.3mm immersion heater round flange mounting ø 47.5mm		
spare parts for	415416		
	GEV No.	510408	Ref. No. —
	O-ring EPDM thickness 5.34mm ID ø 47mm Qty 1 pcs		
accessories for	415416		
	GEV No.	520235	Ref. No. —
	3 hole flange hole distance 70.5mm perforation ø 6.5mm ID ø 53.5mm		
	GEV No.	520236	Ref. No. —
	flange for heating element ID ø 50mm ED ø 90mm hole ø 6.5mm 3 holes		
	GEV No.	521012	Ref. No. —
	gasket graphite ED ø 15mm ID ø 5mm thickness 1.2mm Qty 1 pcs		
	GEV No.	550002	Ref. No. —
	tension strap H 10mm L 21mm W 10mm hole ø 6.5mm for heating element		
	GEV No.	550362	Ref. No. —
	blind flange ø 64mm mounting ø 47.5mm		

miscellaneous









			
GEV No.	417695	Ref. No.	76-32011000 76-32011004 76-32011009
description	heating element 9000W 230V heating circuits 3 L 205mm W 38mm H 70mm number of thermostat sleeves 1 thermostat sleeves ø 2.5mm length thermostat sleeves 120mm thermostat sleeve eccentric, clinging tube ø 6.3mm hole distance 64mm hole ø 8mm connection male faston 6.3mm 4 hole flange immersion heater flange width 82mm flange length 82mm		
accessories for	417695		
	GEV No.	512482	Ref. No. 76-51101003
	gasket rubber L 82mm W 82mm thickness 4mm hole ø 9mm hole distance 64mm for heating element suitable for RATIONAL 4 holes		

			
GEV No.	417696	Ref. No.	76-32011200
description	heating element 9000W 230V heating circuits 3 L 232mm W 76mm H 38mm number of thermostat sleeves 1 thermostat sleeves ø 2.5mm length thermostat sleeves 235mm thermostat sleeve eccentric, clinging tube ø 6.5mm hole distance 64mm hole ø 8mm connection length 41mm connection male faston 6.3mm rectangular flange immersion heater flange width 72mm flange length 82mm		

			
GEV No.	415256	Ref. No.	43-0101493
description	heating element 7500W 230V heating circuits 3 L 480mm W 34mm H 32mm tube ø 6.3mm thermostat sleeves ø 7mm length thermostat sleeves 310mm number of thermostat sleeves 1 thermostat sleeve not clinging connection male faston 6.3mm connection length 52mm immersion heater flange with thread 1½"		
spare parts for	415256		
	GEV No.	510406	Ref. No. —
	flat gasket fibre ED ø 60mm ID ø 48mm thickness 3mm for thread 1½" Qty 1 pcs		
accessories for	415256		
	GEV No.	510424	Ref. No. —
	gasket copper ED ø 55mm ID ø 48mm thickness 2.2mm Centellen for thread 1½"		
	GEV No.	520211	Ref. No. —
	reducer thread 2" ET - 1½" IT brass		
	GEV No.	520212	Ref. No. —
	hexagonal nut thread 1½" brass WS 60 H 8mm		
	GEV No.	550361	Ref. No. —
	blind flange ø 58mm thread 1½"		

			
GEV No.	415664	Ref. No.	62-230085
description	heating element 2250W 230V heating circuits 1 L 300mm W 90mm H 25mm thread 1/8" mounting distance 64mm tube ø 6.3mm connection M4 immersion heater 2 hole fixing		
accessories for	415664		
	GEV No.	510893	Ref. No. —
	O-ring EPDM thickness 2.62mm ID ø 9.92mm Qty 1 pcs		
	GEV No.	521103	Ref. No. —
	nut thread M4 H 3mm WS 7 brass Qty 20 pcs		
	GEV No.	521104	Ref. No. —
	washer ID ø 4.3mm ED ø 8mm thickness 0.5mm brass Qty 20 pcs for thread M4		
	GEV No.	521129	Ref. No. —
	nut thread M10 H 6mm SS WS 17 Qty 1 pcs DIN/ISO DIN 439		
	GEV No.	560111	Ref. No. —
	plain washer ID ø 4.3mm ED ø 9mm thickness 0.8mm SS Qty 20 pcs DIN 125A for thread M4		
	GEV No.	560131	Ref. No. —
	hexagonal nut thread M4 H 3.2mm WS 7 SS DIN/ISO DIN 934 / ISO 4032/8673 Qty 20 pcs		





 <p>1</p>			
GEV No.	415665	Ref. No.	62-230086
description	heating element 2750/3250W 220/240V heating circuits 1 L 380mm W 110mm H 30mm thread M10x1 mounting distance 75mm tube ø 6.5mm connection M4 immersion heater 2 hole fixing		
spare parts for	415665		
	GEV No.	510893	Ref. No. —
	O-ring EPDM thickness 2.62mm ID ø 9.92mm Qty 1 pcs		
accessories for	415665		
	GEV No.	510416	Ref. No. —
	flat gasket fibre ED ø 19mm ID ø 10.5mm thickness 1.5mm for thread M10 Qty 1 pcs		
	GEV No.	520231	Ref. No. —
	nut thread M10x1 H 6mm WS 14 zinc-coated steel Qty 1 pcs		
	GEV No.	521103	Ref. No. —
	nut thread M4 H 3mm WS 7 brass Qty 20 pcs		
	GEV No.	521104	Ref. No. —
	washer ID ø 4.3mm ED ø 8mm thickness 0.5mm brass Qty 20 pcs for thread M4		
	GEV No.	521129	Ref. No. —
	nut thread M10 H 6mm SS WS 17 Qty 1 pcs DIN/ISO DIN 439		
	GEV No.	560111	Ref. No. —
	plain washer ID ø 4.3mm ED ø 9mm thickness 0.8mm SS Qty 20 pcs DIN 125A for thread M4		
	GEV No.	560131	Ref. No. —
	hexagonal nut thread M4 H 3.2mm WS 7 SS DIN/ISO DIN 934 / ISO 4032/8673 Qty 20 pcs		

 <p>1</p>			
GEV No.	418795	Ref. No.	602034
description	heating element 3000W 230V heating circuits 1 L 300mm W 70mm H 23mm thread M14x1.5 mounting distance 63mm tube ø 6.4mm		

heating elements for convection

 <p>1</p>			
GEV No.	693548	Ref. No.	76-21501005
description	flange suitable for convection heating element W 23mm mounting pos. outer length 210		

 <p>1</p>			
GEV No.	417675	Ref. No.	76-32001003
description	heating element 15000W 230V heating circuits 6 ID ø 635mm ED ø 650mm L 696mm H 200mm L1 23mm W1 156mm H1 35mm H2 165mm flange length 210mm flange width 24mm hole distance 31mm connection male faston 6.3mm connection length 80mm tube ø 6.3mm convection heating element hole ø 7mm mounting pos. outer rectangular flange		
spare parts for	417675		
	GEV No.	512484	Ref. No. 76-51101009
	gasket L 210mm W 24mm thickness 2mm for heating element		

 <p>1</p>			
GEV No.	417671	Ref. No.	76-30043519
description	heating element 18000W 230V heating circuits 6 ID ø 385mm ED ø 440mm L 460mm H 140mm L1 20mm W1 163mm H1 30mm H2 110mm thread M14x1.5 12 hole fixing connection male faston 6.3mm tube ø 6.3mm convection heating element		

 <p>1</p>			
GEV No.	417674	Ref. No.	76-30043520
description	heating element 18000W 400V heating circuits 6 thread M14x1.5 12 hole fixing connection male faston 6.3mm convection heating element		

 <p>1</p>			
GEV No.	415602	Ref. No.	49-182662
description	heating element 4800W 400V heating circuits 2 ID ø 183mm ED ø 213mm L 265mm H 33mm L1 50mm W1 31mm H1 13mm H2 20mm flange length 70mm flange width 22mm hole distance 56mm connection male faston 6.3mm connection length 28mm tube ø 6.3mm convection heating element mounting thread M5 rectangular flange with thread bolt		





1

GEV No.	415601	Ref. No.	49-182522
description	heating element 6000W 400V heating circuits 1 ID ø 175mm ED ø 210mm L 240mm H 46mm L1 65mm W1 30mm H1 43mm H2 3mm flange length 70mm flange width 22mm hole distance 55mm connection male faston 6.3mm connection length 20mm tube ø 6.5mm convection heating element hole ø 5mm rectangular flange		
spare parts for	415601		
	GEV No.	510368	Ref. No. —
	gasket L 70mm W 23.5mm hole ø 5mm hole distance 56mm FIBER thickness 2mm for heating element		



1

GEV No.	415829	Ref. No.	72-65011540
description	heating element 7500W 230V heating circuits 3 ID ø 248mm ED ø 260mm L 287mm H 88mm L1 20mm W1 105mm H1 23mm H2 65mm flange length 142mm flange width 25mm hole distance 64mm connection M4 connection length 78mm convection heating element hole ø 5mm rectangular flange		
accessories for	415829		
	GEV No.	531270	Ref. No. —
	gasket L 141mm W 22mm D1 ø 10mm D2 ø 9mm 9 holes graphite thickness 1mm suitable for UNOX		



1

GEV No.	417689	Ref. No.	76-30043529
description	heating element 9000W 230V heating circuits 3 ID ø 385mm ED ø 400mm L 420mm H 125mm L1 20mm W1 160mm H1 20mm H2 105mm thread M14x1.5 6 hole fixing connection male faston 6.3mm tube ø 6.3mm mounting pos. inner convection heating element		





1

GEV No.	417691	Ref. No.	76-30043528
description	heating element 9000W 230V heating circuits 3 ID ø 440mm ED ø 453mm L 470mm H 140mm L1 20mm W1 163mm H1 30mm H2 110mm thread M14x1.5 screw mounting connection male faston 6.3mm tube ø 6.5mm mounting pos. outer convection heating element		



1

GEV No.	417692	Ref. No.	76-32001000
description	heating element 9000W 230V heating circuits 3 ID ø 445mm ED ø 458mm L 474mm H 130mm W1 156mm H1 33mm H2 97mm flange length 210mm flange width 25mm hole distance 31mm connection male faston 6.3mm connection length 80mm tube ø 6.5mm dry heating element hole ø 7.5mm mounting pos. inner rectangular flange		
accessories for	417692		
	GEV No.	512484	Ref. No. 76-51101009
	gasket L 210mm W 24mm thickness 2mm for heating element		









1

GEV No.	417693	Ref. No.	76-32001001
description	heating element 9000W 230V heating circuits 3 ID ø 504mm ED ø 516mm L 535mm H 130mm W1 156mm H1 35mm H2 95mm flange length 210mm flange width 25mm hole distance 31mm connection male faston 6.3mm connection length 80mm tube ø 6.5mm dry heating element hole ø 7.5mm mounting pos. outer rectangular flange L1 19mm		









 <p>1</p>			
GEV No.	417697	Ref. No.	76-30043507 76-30043524
description	heating element 9000W 230V heating circuits 4 ID ø 310mm ED ø 333mm L 410mm H 115mm L1 77mm W1 75mm H1 15mm H2 100mm thread M14x1.5 8 hole fixing connection male faston 6.3mm tube ø 8.5mm convection heating element		

 <p>1</p>			
GEV No.	417698	Ref. No.	76-30043531
description	heating element 9000W 400V heating circuits 3 ID ø 385mm ED ø 400mm L 402mm H 112mm L1 30mm W1 170mm H1 15mm H2 107mm thread M14x1.5 6 hole fixing connection male faston 6.3mm tube ø 6.5mm mounting pos. inner convection heating element		

 <p>1</p>			
GEV No.	415239	Ref. No.	76-30043530
description	heating element 9000W 400V heating circuits 3 ID ø 440mm ED ø 453mm L 465mm H 140mm L1 15mm W1 150mm H1 30mm H2 110mm thread M14x1.5 6 hole fixing connection male faston 6.3mm tube ø 6.3mm mounting pos. outer convection heating element		
accessories for	415239		
	GEV No.	510417	Ref. No. —
flat gasket fibre ED ø 20mm ID ø 14mm thickness 2mm Qty 1 pcs			
	GEV No.	520228	Ref. No. 76-30041405
tooth lock washer ID ø 15.3mm ED ø 24mm steel Qty 1 pcs for thread M14			
	GEV No.	520230	Ref. No. 76-30041406
nut thread M14x1.5 H 5mm WS 19 zinc-coated steel Qty 1 pcs			
	GEV No.	521101	Ref. No. —
nut thread M14x1.5 H 5mm WS 19 SS Qty 1 pcs			
	GEV No.	550262	Ref. No. —
flat gasket copper ED ø 20mm ID ø 14mm thickness 2mm			

 <p>1</p>			
GEV No.	417679	Ref. No.	76-30041403
description	heating element 2000W 220V heating circuits 1 L 95mm W 520mm connection length 24mm connection male faston 6.3mm tube ø 6.3mm thread M14x1.5 2 hole fixing convection heating element mounting distance 514mm		

 <p>1</p>			
GEV No.	415556	Ref. No.	76-30044300
description	heating element 2000W 400V heating circuits 1 L 85mm W 530mm connection male faston 6.3mm tube ø 6.5mm thread M14x1.5 2 hole fixing convection heating element mounting distance 525mm		
accessories for	415556		
	GEV No.	520228	Ref. No. 76-30041405
tooth lock washer ID ø 15.3mm ED ø 24mm steel Qty 1 pcs for thread M14			
	GEV No.	520230	Ref. No. 76-30041406
nut thread M14x1.5 H 5mm WS 19 zinc-coated steel Qty 1 pcs			
	GEV No.	521101	Ref. No. —
nut thread M14x1.5 H 5mm WS 19 SS Qty 1 pcs			
	GEV No.	550262	Ref. No. —
flat gasket copper ED ø 20mm ID ø 14mm thickness 2mm			

 <p>1</p>			
GEV No.	417681	Ref. No.	76-30041001 76-30041004
description	heating element 2500W 230V heating circuits 1 L 148mm W 534mm connection male faston 6.3mm tube ø 6.3mm thread M14x1.5 2 hole fixing convection heating element mounting distance 528mm		

 <p>1</p>			
GEV No.	417682	Ref. No.	76-30044301
description	heating element 2500W 400V heating circuits 1 L 148mm W 545mm connection male faston 6.3mm tube ø 6.3mm thread M14x1.5 2 hole fixing convection heating element mounting distance 539mm		



energy regulators

EGO

1-circuit





GEV No.	380015	Ref. No.	49-183149
description	energy regulator 230V 13A single-circuit turn direction right shaft ø 6x4.6mm shaft L 23mm mounting thread M4 power release 6-100% no. 50.57021.010		

thermostats

bi-metal thermostats

safety bi-metal thermostats



GEV No.	390233	Ref. No.	62-236039
description	bi-metal safety thermostat hole distance 24mm switch-off temp. 110°C 1NC 1-pole 16A connection F6.3 2 hole fixing without holder		
accessories for	390233		
	GEV No.	504736	Ref. No. —
	bracket for contact thermostat		
	GEV No.	550388	Ref. No. —
	bracket for contact thermostat mounting distance 24.5mm mounting ø 3.8		

bi-metal thermostats



GEV No.	375160	Ref. No.	76-30140325
description	bi-metal thermostat hole distance mm switch-off temp. 110°C 1NC 1-pole 16A connection F6.3 M4		

control and safety thermostats

EGO

control thermostats

55.10/19_ series



GEV No.	375548	Ref. No.	42-5061609772
description	thermostat t.max. 142°C temperature range fixed 142°C 1-pole 1CO 16A probe ø 4mm probe L 157mm capillary pipe 870mm capillary pipe isolated 870mm gland nut shaft ø 6x4.6mm shaft Lmm shaft position		

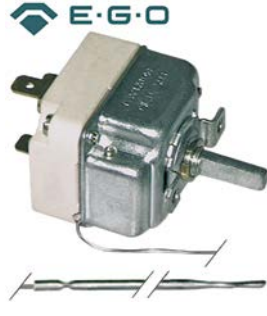

GEV No.	390307	Ref. No.	62-236025 62-236037
description	thermostat t.max. 86°C temperature range 30-82°C 1-pole 1CO 16A probe ø 3mm probe L 156mm capillary pipe 600mm capillary pipe isolated 600mm gland nut shaft ø 6x4.6mm shaft L 8.5mm shaft position left rotation 180° outer switch eccentric 1/2"-3/4" contacts 1CO		



GEV No.	390065	Ref. No.	62-236002
description	thermostat t.max. 90°C temperature range 30-90°C 1-pole 1CO 16A probe ø 11mm probe L 28mm capillary pipe 1000mm capillary pipe isolated 1000mm gland nut shaft ø 6x4.6mm shaft L 23mm shaft position upper° rotation 270° screw-in probe probe thread M14x1		



55.13_series



GEV No.	375086	Ref. No.	76-30140314
description	thermostat t.max. 180°C temperature range 60-180°C 1-pole 1CO 16A probe ø 6mm probe L 90mm capillary pipe 2400mm capillary pipe isolated 2300mm gland nut shaft ø 6x4.6mm shaft L 25mm shaft position upper rotation 270° probe material SS		



GEV No.	390146	Ref. No.	49-176168
description	thermostat t.max. 280°C temperature range 50-280°C 1-pole 1NO 16A probe ø 3.1mm probe L 160mm capillary pipe 1230mm capillary pipe isolated 800mm gland nut shaft L 23mm shaft position upper rotation 270°		

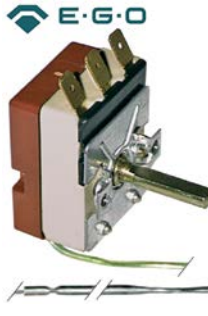

GEV No.	375087	Ref. No.	76-30140311
description	thermostat t.max. 300°C temperature range 50-300°C 1-pole 1CO 16A probe ø 3.03mm probe L 160mm capillary pipe 1130mm capillary pipe isolated 1103mm gland nut shaft L 23mm shaft position upper rotation 270°		



GEV No.	375066	Ref. No.	76-30140166
description	thermostat t.max. 300°C temperature range 60-300°C 1-pole 1CO 16A probe ø 4mm probe L 98mm capillary pipe 1450mm capillary pipe isolated 1450mm gland nut shaft ø 6x4.6mm shaft L 25mm shaft position upper special probe		



GEV No.	375088	Ref. No.	76-30140318
description	thermostat t.max. 300°C temperature range 60-300°C 1-pole 1NO 16A probe ø 4mm probe L 100mm capillary pipe 830mm capillary pipe isolated 800mm gland nut shaft L 15mm shaft position upper rotation 270°		



GEV No.	375145	Ref. No.	602865
description	thermostat t.max. 85°C temperature range 30-85°C 1-pole 1CO 16A probe ø 6mm probe L 113mm capillary pipe 2930mm capillary pipe isolated 500/300mm gland nut shaft L 23mm shaft position upper rotation 270°		

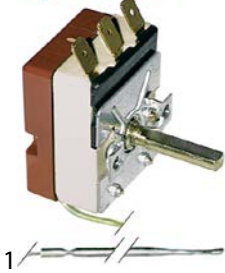

GEV No.	375085	Ref. No.	76-30140312
description	thermostat t.max. 90°C temperature range 0-90°C 1-pole 1CO 16A probe ø 3.1mm probe L 247mm capillary pipe 1430mm capillary pipe isolated 1400mm gland nut shaft ø 6x4.6mm shaft L 18mm shaft position upper probe material SS		

55.34_series



GEV No.	375097	Ref. No.	49-355637
description	thermostat t.max. 195°C temperature range 95-195°C 3-pole 3NO 16A probe ø 6mm probe L 117mm capillary pipe 1780mm capillary pipe isolated 1400mm gland nut M9x1 shaft ø 6x4.6mm shaft L 23mm shaft position upper rotation 270°		



GEV No.	375043	Ref. No.	01-214840
description	thermostat t.max. 200°C temperature range 65-200°C 3-pole 3NO 16A probe ø 6mm probe L 77mm capillary pipe 880mm capillary pipe isolated 800mm gland nut M9x1 shaft ø 6x4.6mm shaft L 23mm shaft position upper rotation 270°		

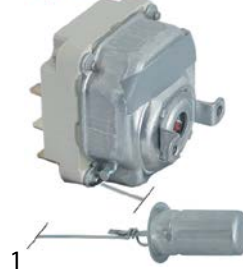

GEV No.	375144	Ref. No.	026213 602959
description	thermostat t.max. 52°C temperature range fixed 45/52°C 2-pole 2CO 16A probe ø 15mm probe L 22.5mm capillary pipe 2280mm capillary pipe isolated gland nut shaft Lmm with knob probe		

For models: B1100X, B650X

accessories for 375144

GEV No.	510165	Ref. No.	—
	gasket for thermostat ED ø 27mm ID ø 11mm thickness 8.5mm		

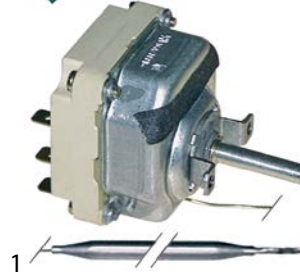

GEV No.	375161	Ref. No.	602715
description	thermostat t.max. 85°C temperature range 15-60/15-85°C 2-pole 2CO 16A probe ø 6mm probe L 113mm capillary pipe 2980mm capillary pipe isolated 300/300mm gland nut shaft ø 6x4.6mm shaft L 23mm shaft position upper rotation 270°		

For models: B1100X, B650X

safety thermostats

51._series



GEV No.	375074	Ref. No.	76-30140322
description	safety thermostat switch-off temp. 365°C 2-pole 16A probe ø 4mm probe L 116mm capillary pipe 1170mm capillary pipe isolated 1100mm gland nut probe with special screwing screw connection M14x1		



E·G·O



1

GEV No.	375090	Ref. No.	76-30140310
description	safety thermostat switch-off temp. 365°C 2-pole 16A probe ø 4mm probe L 120mm capillary pipe 1170mm capillary pipe isolated 1100mm gland nut probe SS		

55.12_series

E·G·O



1

GEV No.	375084	Ref. No.	76-30140300
description	safety thermostat switch-off temp. 135°C 1-pole 10A probe ø 6mm probe L 83mm capillary pipe 1440mm capillary pipe isolated 1360mm gland nut probe SS		

E·G·O



1

GEV No.	375776	Ref. No.	76-30140300
description	safety thermostat switch-off temp. 135°C 1-pole 10A probe ø 6mm probe L 87mm capillary pipe 1440mm capillary pipe isolated 1400mm gland nut probe SS		

55.13_series

E·G·O



1

GEV No.	375149	Ref. No.	025836 602864
description	safety thermostat switch-off temp. 110°C 1-pole 16A probe ø 6mm probe L 98mm capillary pipe 2930mm capillary pipe isolated 500/500mm gland nut probe SS		
For models:	B1100X, B650X		

55.31_series

E·G·O



1

GEV No.	375102	Ref. No.	49-176174
description	safety thermostat switch-off temp. 230°C 3-pole 20A probe ø 6mm probe L 219mm capillary pipe 1730mm capillary pipe isolated 1400mm gland nut probe SS		

55.32_series

E·G·O



1

GEV No.	375045	Ref. No.	99-213149
description	safety thermostat switch-off temp. 315°C 3-pole 3NC 20A probe ø 6mm probe L 77mm capillary pipe 1490mm capillary pipe isolated 1100mm gland nut M9x1 probe SS		

56._ series

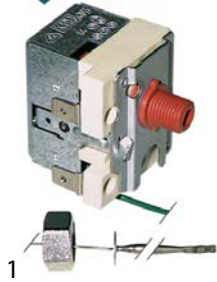



GEV No.	375159	Ref. No.	76-30140326
description	safety thermostat switch-off temp. 365°C 1-pole 16A probe ø 4mm probe L 96mm capillary pipe 1160mm capillary pipe isolated 1100mm gland nut probe with special screwing screw connection M14x1		

control thermostats with operation switch

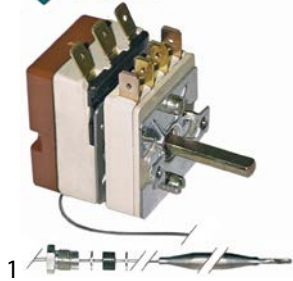
55.13_ series



GEV No.	375406	Ref. No.	49-355693
description	thermostat t.max. 110°C temperature range 30-110°C 1-pole 1CO 16A probe ø 6mm probe L 113mm capillary pipe 2380mm capillary pipe isolated 1700mm gland nut M9x1 shaft ø 6x4.6mm shaft L 18mm shaft position upper rotation 270° outer switch 2NO		
accessories for	375406		
	GEV No.	110545	Ref. No. —
	knob dial plate silver thermostat t.max. 110°C 30-110°C rotation 310° ED ø 59mm ID ø 45.5mm		
	GEV No.	112173	Ref. No. —
	knob universal ø 62mm black without adaptor/dial plate		
	GEV No.	112311	Ref. No. —
	knob adapter shaft ø 6x4.6mm L 0mm with spring		

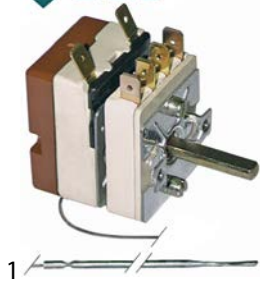

GEV No.	375408	Ref. No.	49-174677
description	thermostat t.max. 320°C temperature range 50-320°C 1-pole 1NO 16A probe ø 3.03mm probe L 160mm capillary pipe 1150mm capillary pipe isolatedmm gland nut shaft ø 6x4.6mm shaft L 23mm shaft position upper rotation 270° outer switch 2NO		

IMIT / TEMPOMATIC / AR THERMO

control thermostats





GEV No.	390914	Ref. No.	63-120515
description	bi-metal thermostat t.max. 90°C temperature range 0-90°C 1-pole 1CO 10A probe ø 6.5mm probe L 97mm capillary pipe 1000mm capillary pipe isolated 950mm gland nut shaft ø 6x4.6mm shaft L 12mm shaft position upper rotation 270° with housing 250V		

CAEM

control thermostats



GEV No.	390672	Ref. No.	62-236042
description	thermostat t.max. 53°C temperature range fixed 53°C 1-pole 1CO 16A probe ø 9.5mm probe L 30mm capillary pipe 600mm capillary pipe isolated 540mm gland nut shaft Lmm screw-in probe probe thread M14x1		
spare parts for	390672		
	GEV No.	510417	Ref. No. —
	flat gasket fibre ED ø 20mm ID ø 14mm thickness 2mm Qty 1 pcs		
	GEV No.	550261	Ref. No. —
	nut thread M14x1 H 4mm WS 19 SS Qty 1 pcs		



GEV No.	390686	Ref. No.	62-236043
description	thermostat t.max. 83°C temperature range°C 1-pole 1CO 20A probe ø 6mm probe L 90mm capillary pipe 630mm capillary pipe isolated 550mm gland nut shaft 6mm shaft Lmm shaft position rotation 270° probe material copper		



TECASA

control thermostats



GEV No.	376071	Ref. No.	42-5061633536
description	thermostat t.max. 300°C temperature range 30-300°C 1-pole 1NO 16A probe ø 4mm probe L 105mm capillary pipe 1600mm capillary pipe isolated 1250mm gland nut shaft ø 6x4.6mm shaft position° shaft position upper		

ø18.2mm



GEV No.	346508	Ref. No.	76-30161352
description	momentary push switch mounting ø 18.2mm black 1NC/1NO 250V 2A connection screw ambient temperature max. 85°C protection IP40		

2 hole fixing



GEV No.	345136	Ref. No.	76-30161405
description	switch combination triple green 240V 16A connection male faston 6.3mm ambient temperature max. 125°C protection IP44		

switches and momentary switches

rocker/momentary rocker switches

30x22mm



GEV No.	301036	Ref. No.	026043
description	protective cover internal size 30x22mm for rocker switch mounting measurementsmm		

microswitches

lever actuated



GEV No.	345257	Ref. No.	62-218002
description	microswitch with lever 250V 16A 1CO connection male faston 6.3mm L 29mm L1 33mm ambient temperature max. 120°C mounting distance 22mm actuating force: 130g lever length 31.5mm		

push/momentary push switches

30x22mm



GEV No.	347178	Ref. No.	76-30161430
description	push switch mounting measurements 30x22mm black 2NO 250V 16A non-illuminated connection male faston 6.3mm ambient temperature max. 85/55°C protection IP40		



GEV No.	345125	Ref. No.	76-30403011
description	microswitch with lever 250V 16A 1CO connection male faston 6.3mm ambient temperature max. 85°C mounting distance 25mm type C99ZP3 actuating force: 25g lever length 63.5mm		



GEV No.	301036	Ref. No.	026043
description	protective cover internal size 30x22mm for rocker switch mounting measurementsmm		

roller-lever actuated

microswitches



GEV No.	345216	Ref. No.	76-30160101
description	microswitch 250V 16A 1CO connection male faston 6.3mm ambient temperature max. 125°C mounting distance 22mm with handle with a switch blue/black		



pin-plunger actuated

M16



GEV No.	345047	Ref. No.	76-30161400 76-30161403
description	microswitch with plunger thread M16x1 thread L 27mm 250V 5A 1NO connection cable stroke 5mm ambient temperature max. 85°C with cable type 837333 actuating force: 400g		
accessories for	345047		
	GEV No.	698490	Ref. No. —
cover ED ø 17mm suitable for 345047			

position switches

ABB/FANAL

extended plungers



GEV No.	345548	Ref. No.	026036
description	position switch		

MOELLER/EATON

extendable with actuators

extended plungers



GEV No.	345549	Ref. No.	026034
description	position switch plastic 2NO 230V 3A L 75mm W 31mm H 33mm protection IP66 actuating force: 700g screw connection M20 mounting distance 22mm marking LS-S20A		
For models:	B1100X, B650X		

PIZZATO

FR series



GEV No.	346624	Ref. No.	026035
description	position switch 2NO		

system switches (ROLD)



GEV No.	345612	Ref. No.	62-480059
description	blank size 23x23mm black		



GEV No.	345602	Ref. No.	62-226073
description	element holder double mounting measurements 28.5x52.6mm black for push buttons 23x23mm		



GEV No.	345601	Ref. No.	62-299035
description	indicator lamp holder V ø 11mm		



GEV No.	345606	Ref. No.	62-226071
description	momentary switch unit 2CO 250V 16A connection male faston 6.3mm		



GEV No.	345613	Ref. No.	62-227030
description	push button size 23x23mm black drain pump		



GEV No.	345607	Ref. No.	62-227025
description	push button size 23x23mm black main switch with lens		

1

GEV No.	345615	Ref. No.	62-227033
description	push button size 23x23mm black programme		



1

GEV No.	345609	Ref. No.	62-227027
description	push button size 23x23mm black START		



1

GEV No.	345608	Ref. No.	62-409001
description	rotary disc green/black disc ø 20.6mm		



1

GEV No.	345605	Ref. No.	62-208010
description	switch 2CO 250V 16A connection male faston 6.3mm		

float switches



1

GEV No.	400023	Ref. No.	76-30020407 76-30161201 76-84241202
description	float switch thread 3/8" 1CO ø 30mm L 170mm mounting ø 3/8"mm 250V 0.5A cable length 2000mm		
accessories for	400023		
	GEV No.	506024	Ref. No. —
	nut thread 3/8" H 6mm SS WS 22 Qty 1 pcs		

cam switches

2 operating positions



1

GEV No.	300240	Ref. No.	081629 840044
description	cam switch 2 operating positions 16A shaft ø 6x4.6mm shaft L 23mm 3-pole		

4 operating positions



1

GEV No.	300046	Ref. No.	76-30161600 76-30161630
description	cam switch 4 operating positions 5NO sequence 0-1-2-3 16A shaft ø 6x4.6mm shaft L 27mm connection male faston 6.3mm		

6 operating positions

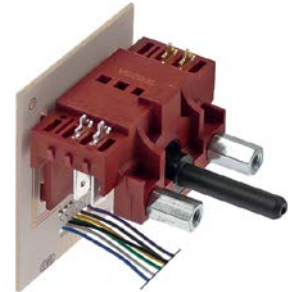

1

GEV No.	300051	Ref. No.	76-30161631
description	cam switch 6 operating positions 2NO sequence 1-0-2-3-4-5 6A shaft ø 6x4.6mm shaft L 33mm connection male faston 6.3mm plastic		

operation switches



1

GEV No.	300361	Ref. No.	42-50609100223
description	cam switch 3 operating positions 4NO 16A sequence 0-1-2 shaft ø 6x4.6mm shaft L 23mm connection screw operation switch ceramic		



rotary switches

KRAUS & NAIMER

rotary switches



GEV No.	347807	Ref. No.	151205
description	rotary switch 3 momentary switch-1-2 sets of contacts 4 type CA10-AT13F623 400V 20A shaft \varnothing 6x4.6mm shaft L 21mm connection screw marking 22/000100 D-47V4*02		

TELEMECANIQUE (Schneider Electric)



GEV No.	300052	Ref. No.	76-30161500
description	rotary switch 2 1-2 sets of contacts 4 type D1155N 400V 12A connection screw		



GEV No.	300047	Ref. No.	76-30161300
description	rotary switch 4 operating positions 9-pole		

magnetic switches

29x19mm

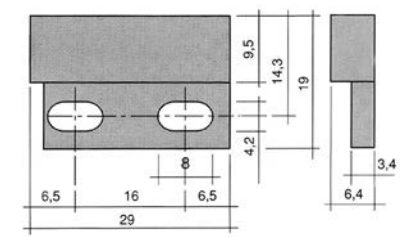

GEV No.	345217	Ref. No.	76-30161415
description	magnetic switch L 29mm W 19mm 1NO 125V 0.5A P max. 10W connection cable cable length 2000mm		

32x15mm

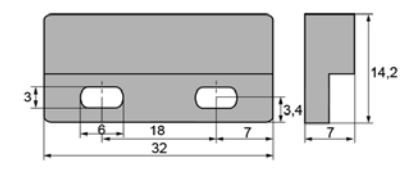

GEV No.	345109	Ref. No.	76-30161415
description	magnetic switch L 32mm W 15mm 1NO 250V 1A P max. 40W connection cable cable length 2000mm		



36x13mm

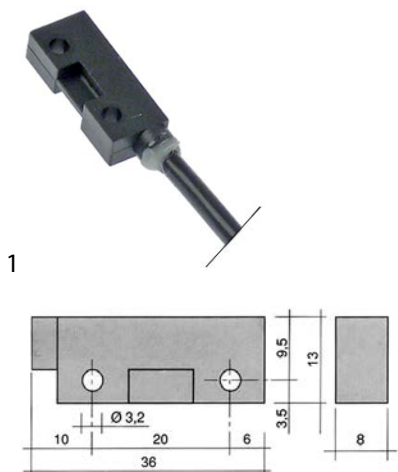

1

GEV No.	345118 ¹	Ref. No.	62-211002
description	magnetic switch L 36mm W 13mm 1NO 250V 1A P max. 50W connection cable length 980mm		
accessories for	345118		
	GEV No.	Ref. No.	—
	345399		
	magnet ø 3.3mm L 40mm H 8mm W 13mm hole distance 30mm M3		

¹with coded connector

accessories

magnets



1

GEV No.	346514	Ref. No.	76-30161409
description	magnet ø 10mm L 40mm H mm W mm		



1

GEV No.	345110	Ref. No.	76-30161412
description	magnet ø mm L 25mm H 9mm W 15mm		

control equipment

JKN (Square D)

push buttons



1

GEV No.	345174	Ref. No.	76-30161354
description	push button mounting measurements ø22mm clear reset		



1

GEV No.	345173	Ref. No.	76-30161353
description	push button mounting measurements ø22mm white reset		

rotary switches



1

GEV No.	110260	Ref. No.	76-30161310
description	rotary selector mounting measurements ø22mm		
accessories for	110260		
	GEV No.	Ref. No.	—
	110261		
	rotary selector		

encoders and potentiometers



1

GEV No.	300196	Ref. No.	76-30350600
description	potentiometer 0-150		





1

GEV No.	300000	Ref. No.	76-30400268
description	potentiometer 5.2KOhm rotation 300° shaft ø 6x4.6mm with switch shaft L 18mm thread M10x0.75		



			
1			
GEV No.	300058	Ref. No.	76-30400150
description	potentiometer 5KOhm rotation 270° shaft ø 6mm shaft L 27mm		

			
1			
GEV No.	300059	Ref. No.	76-30400151
description	potentiometer 5KOhm rotation 310° shaft ø 6mm with switch shaft L 35mm		

			
1			
GEV No.	400106	Ref. No.	76-88171303
description	pulsor KOhm rotation 360° shaft ø 6mm type CPC		

lamps

indicator lights



indicator lights 2-piece (lens and indicator lamp)

indicator light lenses

ø10mm (type SRZ-3)

			
1			
GEV No.	359125	Ref. No.	602401
description	indicator light housings mounting measurements ø10mm red round Qty 1 pcs		

indicator lamps for socket type SQ

			
1			
GEV No.	347476	Ref. No.	63-130196
description	indicator light 5V green connection cable 170mm		
accessories for	347476		
	GEV No.	359806	Ref. No.
			—
	indicator light lens clear Qty 1 pcs ø 6mm		

indicator lamps for socket type SRZ / SDK / SDY / SFK

			
1			
GEV No.	359130	Ref. No.	62-216006
description	indicator lamp 230V clear connection male faston 6.3mm ø 8mm		

indicator lights 3-piece (housing, lens and bulb)

ø19.2mm

			
1			
GEV No.	359107	Ref. No.	01-212570
description	indicator light ø 19.2mm yellow socket E14		

lamps

light bulbs

			
1			
GEV No.	359598	Ref. No.	76-30240300 76-30250306
description	light bulb socket Ba15d 230V 5-7W ø 16mm L 35mm		

			
1			
GEV No.	359608	Ref. No.	76-30250304
description	light bulb socket E14 10/15W 230V ø 16mm L 51mm lens L 31mm Qty 1 pcs		

			
1			
GEV No.	359597	Ref. No.	76-30240210
description	light bulb socket T10 24V 2W ø 10mm L 28mm		

neon light bulbs









			
1			
GEV No.	359600	Ref. No.	76-30240300
description	neon light bulb socket E10 220V 0.35W clear ø 10mm L 28mm		
accessories for	359600		
	GEV No.	359060	Ref. No.
			—
	lamp socket mounting measurements ø16.2mm socket E10 connection screw		
	GEV No.	359063	Ref. No.
			—
	lamp socket mounting measurements ø19.2mm socket E14 connection screw		



Table continues overleaf

accessories for		359600	
	GEV No.	359064	Ref. No. —
lamp socket mounting measurements ø22.3mm socket E14 connection screw 250/380V ambient temperature at 1W 100°C ambient temperature at 2W 85°C			
	GEV No.	359685	Ref. No. —
lamp socket mounting measurements ø16.2mm socket E10			
	GEV No.	359832	Ref. No. —
lamp socket mounting measurements ø16.2mm socket Ba9s connection male faston 6.3mm			
	GEV No.	359853	Ref. No. —
lamp socket mounting measurements ø18.2mm socket Ba9s connection male faston 6.3mm			
	GEV No.	359988	Ref. No. —
lamp socket mounting measurements ø30.5mm 250V connection F6.3 temp.-resist. 55°C E14			

indicator lights (complete)

ø16mm

with screw socket

	1		
GEV No.	359835	Ref. No.	49-184120
description indicator light ø 16mm 230V green connection male faston 6.3mm			
accessories for		359835	
	GEV No.	550559	Ref. No. —
nut thread M16x1 H 5.5mm WS 19			

with plug-in socket

	1		
GEV No.	359166	Ref. No.	49-184118
description indicator light ø 16mm 230V white			

	1		
GEV No.	359197	Ref. No.	49-184124
description indicator light ø 16mm 400V red			

	1		
GEV No.	359198	Ref. No.	49-184125
description indicator light ø 16mm 400V white			

28.5x28.5mm

	1		
GEV No.	345610	Ref. No.	62-207007
description indicator light lens 23x23 orange operating			

	1		
GEV No.	345614	Ref. No.	62-410008
description indicator light lens orange heating			

miscellaneous

	1		
GEV No.	359886	Ref. No.	76-84307110
description indicator light 230V 15W socket Ba15d triple			

	1		
GEV No.	359066	Ref. No.	76-30240309
description indicator light mounting measurements 30x21mm green 230V			

	1		
GEV No.	359883	Ref. No.	76-30240309
description indicator light mounting measurements 30x21mm green 230V			

	1		
GEV No.	359884	Ref. No.	76-30240310
description indicator light mounting measurements 30x21mm red 230V			

	1		
GEV No.	359065	Ref. No.	76-30240310
description indicator light mounting measurements 30x21mm white 230V			

	1		
GEV No.	359887	Ref. No.	76-30230300
description lamp socket socket E10 mounting measurements ø21mm			



screw-on/push-on fit

neon light bulbs



1				
GEV No.	359600	Ref. No.	76-30240300	
description	neon light bulb socket E10 220V 0.35W clear ø 10mm L 28mm			
accessories for	359600			
	GEV No.	359060	Ref. No.	—
	lamp socket mounting measurements ø16.2mm socket E10 connection screw			
	GEV No.	359063	Ref. No.	—
	lamp socket mounting measurements ø19.2mm socket E14 connection screw			
	GEV No.	359064	Ref. No.	—
	lamp socket mounting measurements ø22.3mm socket E14 connection screw 250/380V ambient temperature at 1W 100°C ambient temperature at 2W 85°C			
	GEV No.	359685	Ref. No.	—
	lamp socket mounting measurements ø16.2mm socket E10			
	GEV No.	359832	Ref. No.	—
	lamp socket mounting measurements ø16.2mm socket Ba9s connection male faston 6.3mm			
	GEV No.	359853	Ref. No.	—
	lamp socket mounting measurements ø18.2mm socket Ba9s connection male faston 6.3mm			
	GEV No.	359988	Ref. No.	—
	lamp socket mounting measurements ø30.5mm 250V connection F6.3 temp.-resist. 55°C E14			

light bulbs

for ovens



1			
GEV No.	359610	Ref. No.	76-30240200
description	light bulb t.max. 300°C socket E14 15W 230V ø 22mm L 47mm lens L 20mm for oven lamp type Philips		

for indicator lights



1			
GEV No.	359598	Ref. No.	76-30240300 76-30250306
description	light bulb socket Ba15d 230V 5-7W ø 16mm L 35mm		



1			
GEV No.	359608	Ref. No.	76-30250304
description	light bulb socket E14 10/15W 230V ø 16mm L 51mm lens L 31mm Qty 1 pcs		



1			
GEV No.	359597	Ref. No.	76-30240210
description	light bulb socket T10 24V 2W ø 10mm L 28mm		

halogen lamp

for socket G4 / G6.35 / G9



1			
GEV No.	359596	Ref. No.	76-30240201
description	halogen lamp socket G4 12V 10W temp.-resist. 500°C		

oven lamps

universal oven lamps

mounting diameter 35.5mm



1			
GEV No.	359720	Ref. No.	76-30230501
description	oven lamp mounting ø 35.5mm 230V 15W socket E14 temp.-resist. 300°C connection male faston 6.3mm hard glas		





spare parts for	359720			
	GEV No.	359701	Ref. No.	76-30230502 76-30230506
	lamp socket socket E14 220-230V mounting ø 35.5mm connection male faston 6.3mm 15W			

	GEV No.	359705	Ref. No.	—
	oven lamp glass thr.ø 33.5mm ø 52mm hard glas temp.-resist. 350°C			

	GEV No.	359721	Ref. No.	76-30250003 76-50120509 76-50120535
	gasket silicone ED ø 48mm ID ø 39.5mm thickness 5mm Qty 1 pcs			

	GEV No.	359740	Ref. No.	—
	light bulb t.max. 300°C socket E14 15W 230V ø 22mm L 48mm lens L 20mm for oven lamp IMPORT			



 <p>1</p>			
GEV No.	359701	Ref. No.	76-30230502 76-30230506
description	lamp socket socket E14 220-230V mounting ø 35.5mm connection male faston 6.3mm 15W		
accessories for	359701		
	GEV No.	359705	Ref. No. —
oven lamp glass thr.ø 33.5mm ø 52mm hard glas temp.-resist. 350°C			
	GEV No.	359709	Ref. No. —
oven lamp glass thr.ø 33.5mm ø 42mm hard glas temp.-resist. 350°C			
	GEV No.	359721	Ref. No. 76-30250003 76-50120509 76-50120535
gasket silicone ED ø 48mm ID ø 39.5mm thickness 5mm Qty 1 pcs			
	GEV No.	359942	Ref. No. —
oven lamp glass thr.ø 33.5mm ø 41mm hard glas temp.-resist. 350°C			



 <p>1</p>			
GEV No.	359723	Ref. No.	76-30250002 76-30250004
description	oven lamp glass thr.ø 33.5mm ø 51mm borosilicate glass temp.-resist. 550°C		
accessories for	359723		
	GEV No.	359721	Ref. No. 76-30250003 76-50120509 76-50120535
gasket silicone ED ø 48mm ID ø 39.5mm thickness 5mm Qty 1 pcs			



 <p>1</p>			
GEV No.	359721	Ref. No.	76-30250003 76-50120509 76-50120535
description	gasket silicone ED ø 48mm ID ø 39.5mm thickness 5mm Qty 1 pcs		

lamps			
light bulbs			
 <p>1</p>			
GEV No.	359610	Ref. No.	76-30240200
description	light bulb t.max. 300°C socket E14 15W 230V ø 22mm L 47mm lens L 20mm for oven lamp type Philips		

halogen lamps			
for socket G4 / G6.35 / G9			
 <p>1 500°C</p>			
GEV No.	359596	Ref. No.	76-30240201
description	halogen lamp socket G4 12V 10W temp.-resist. 500°C		

timers



programme timers			
 <p>1</p>			
GEV No.	360349	Ref. No.	61-238053
description	timer CDC 11803 engines 1 chambers 3 operation time 150s 230V shaft ømm shaft Lmm manif. no. 11803F1BEE000.0010 motor type M48R ATS type 11803F1 / 238046		
spare parts for	360349		
	GEV No.	360673	Ref. No. —
motor kit pinion ø 6.8mm teeth 15 230V voltage AC 50/60Hz turn direction clockwise motor ø 48mm H 18.5mm motor type UDS-40NE1RNZ165 cable length 150mm with holder			

 <p>1</p>			
GEV No.	360047	Ref. No.	63-120268
description	timer CDC 4905DV engines 2 chambers 5 operation time 4s / 150s 230V shaft ømm shaft Lmm manif. no. 4905DV / 360047 motor type M48L ATS		
spare parts for	360047		
	GEV No.	360083	Ref. No. —
motor CDC pinion ø 4.9mm teeth 10 230V turn direction left motor ø 47mm H 19.3mm motor type M48L ATS for timer			

electric timers





1

GEV No.	360133	Ref. No.	62-238066
description	timer CDC 7804DV engines 2 chambers 4 operation time 60s / 20min 230V shaft ømm shaft Lmm manuf. no. 7804DV / 360133 motor type M37RN/M37LN		
spare parts for	360133		
	GEV No.	360119	Ref. No. —
	motor CDC pinion ø 5.4mm teeth 12 230V turn direction right motor ø 37mm motor type M37RN for timer		
	GEV No.	360131	Ref. No. —
	motor CDC pinion ø 5.4mm teeth 12 230V turn direction left motor ø 37mm motor type M37LN for timer		



1

GEV No.	360046	Ref. No.	63-120267
description	timer FIBER P25 engines 2 chambers 6 operation time 60s / 85s / 120s 230V shaft ømm shaft Lmm manuf. no. P255J06JD58 motor type M51BJ0R6400 / M51BJ0L6400		
spare parts for	360046		
	GEV No.	360673	Ref. No. —
	motor kit pinion ø 6.8mm teeth 15 230V voltage AC 50/60Hz turn direction clockwise motor ø 48mm H 18.5mm motor type UDS-40NE1RNZ165 cable length 150mm with holder		
	GEV No.	360674	Ref. No. —
	motor kit pinion ø 6.8mm teeth 15 230V voltage AC 50/60Hz turn direction counterclockwise motor ø 48mm H 18.5mm motor type UDS40NE1RNZ165 cable length 150mm with holder		

digital timers





1

GEV No.	379260	Ref. No.	541590
description	timer TEMPOMATIC K-400-2M time range 0-99min 230VAC 16A mounting measurements 66x50mm 1NO connection rear 1-pole front measurements 71.5x55mm		



GEV No.	350001	Ref. No.	76-30130109
description	timer 2CO at 250V 16A permanent position yes impulse electric shaft ø 6x4.6mm shaft L 22mm mounting distance 28mm connection rear 2-pole operation time 120min		



GEV No.	350015	Ref. No.	76-30130101 76-30130109
description	timer MS65 without bell operation time 120min time spreadmin 1CO/1NO at 250V 16A permanent position yes impulse electric shaft ø 6x4.6mm shaft L 23mm mounting distance 28mm connection lateral 2-pole		
accessories for	350015		
	GEV No.	110366	Ref. No. —
	knob switch zero mark t.max. °C ø 44mm shaft ø 6x4.6mm shaft flat upper black		
	GEV No.	111206	Ref. No. —
	dial plate graduation 120min permanent position no rotation 10-300° ø 60mm timers knob ø 45mm		

with time spread





GEV No.	350074	Ref. No.	76-30130104
description	timer MS65 operation time 120min time spread 30min 1CO/2NO/1NC at 250V 16A permanent position yes impulse electric shaft ø 6x4.6mm shaft L 22mm mounting distance 28mm connection lateral Invensys 4-pole shaft position lower°		



alarm devices

buzzers

			
1			
GEV No.	350053	Ref. No.	76-30060107
description	buzzer 12VAC connection male faston 3.2mm screw mounting buzzer		

			
1			
GEV No.	350050	Ref. No.	76-30060101
description	buzzer 230VAC connection male faston 6.3mm screw mounting thread M4 60dB		

			
1			
GEV No.	350091	Ref. No.	76-30060103
description	buzzer 24VAC connection male faston 6.3mm push-in 63dB		

contactors

BENEDIKT & JÄGER

power contactors

			
1			
GEV No.	381501	Ref. No.	76-30280509
description	power contactor resistive load 32A 230VAC (AC3/400V) 17A/7.5kW main contacts 3NO auxiliary contacts 1NC connection screw connection		

			
1			
GEV No.	382001	Ref. No.	76-30280517
description	power contactor resistive load 32A 230VAC (AC3/400V) 17A/7.5kW main contacts 4NO auxiliary contacts connection screw connection		

			
1			
GEV No.	381173	Ref. No.	76-30280101 76-30280123 76-30280511
description	power contactor resistive load 50A 230VAC (AC3/400V) 24A/11kW main contacts 3NO auxiliary contacts 1NO connection torx type K3-24B00 50/60Hz		

GENERAL ELECTRIC (AEG)

power contactors

			
1	Image not available		
GEV No.	380445	Ref. No.	76-30280103 76-30280504 76-30280507 76-30280550
description	contactor resistive load 25A connection screw connection set		

			
1			
GEV No.	380239	Ref. No.	76-30280103 76-30280504 76-30280507 76-30280550
description	power contactor resistive load 20A 230VAC (AC3/400V) 8.4A/4kW main contacts 3NO auxiliary contacts 1NC connection screw connection type LS05 01A type AEG LS05 01A type GE MC1A 301A		



1

GEV No.	380238	Ref. No.	76-30280100 76-30280502 76-30280506 76-30280551
description	power contactor resistive load 20A 230VAC (AC3/400V) 8.4A/4kW main contacts 3NO auxiliary contacts 1NO connection screw connection type LS0510A type AEG LS0510A type GE MC1A 310A		



1

GEV No.	380265	Ref. No.	76-30280512
description	power contactor resistive load 60A 230VAC (AC3/400V) 32A/16kW main contacts 3NO auxiliary contacts 1NO connection screw connection type AEG LS15K 00A type GE CL04A 310 H 98mm L 87mm W 55mm		



1

GEV No.	380245	Ref. No.	76-30280103 76-30280504 76-30280507 76-30280550
description	power contactor resistive load 25A 230VAC (AC3/400V) 9A/4kW main contacts 3NO auxiliary contacts 1NC connection screw connection type AEG LS4K 01A type GE CL00A 301 H 85mm		



1

GEV No.	380396	Ref. No.	76-30280102 76-30280117 76-30280513
description	power contactor resistive load 60A 230VAC main contacts 3NO auxiliary contacts 1NO		



1

GEV No.	380244	Ref. No.	76-30280100 76-30280502 76-30280506 76-30280551
description	power contactor resistive load 25A 230VAC (AC3/400V) 9A/4kW main contacts 3NO auxiliary contacts 1NO connection screw connection type AEG LS4K 10A type GE CL00A 310		



1

GEV No.	380266	Ref. No.	76-30280102 76-30280117 76-30280513
description	power contactor resistive load 90A 230VAC (AC3/400V) 22kW main contacts 3NO connection screw type AEG LS22K 00A type GE CL06A 300		



1

GEV No.	380261	Ref. No.	76-30280552
description	power contactor resistive load 32A 230VAC (AC3/400V) 17A/7.5kW main contacts 3NO auxiliary contacts 1NO connection screw connection type AEG LS7K 10A type GE CL02A 310		

auxiliary contacts



1

GEV No.	380268	Ref. No.	76-30280153
description	auxiliary contact contacts 1NO for contactors CL+LS_K connection screw AC-12 10A type AEG HS07K 10 type GE BCLF 10		



motor protection circuit breakers



1

GEV No.	380169	Ref. No.	76-30310101
description	motor protection circuit breaker		



1

GEV No.	380170	Ref. No.	76-30310103
description	motor protection circuit breaker		

ISKRA (FANAL)

power contactors



1

GEV No.	380212	Ref. No.	63-120461
description	power contactor resistive load 20A 230VAC (AC3/400V) 8.5A/5.5kW main contacts 3NO auxiliary contacts 1NC connection screw connection type Fanal K07M 01 type ISKRA DSL7 01		

auxiliary contactors



1

GEV No.	380208	Ref. No.	025991
description	auxiliary contactor AC1 16A 230VAC AC15 4A contacts 2NO/2NC connection male faston 6.3mm type Fanal DSL7 22/FG type ISKRA K07CF 22		

MOELLER/EATON

power contactors



1

GEV No.	381224	Ref. No.	76-30280104
description	power contactor resistive load 16A main contacts 4NO type DIL04-40 230V		



1

GEV No.	380515	Ref. No.	76-30280100
description	power contactor resistive load 20A 230VAC (AC3/400V) 4kW main contacts 4		



1

GEV No.	380171	Ref. No.	76-30280118
description	power contactor resistive load 20A 230VAC (AC3/400V) 9A/4kW main contacts 3NO auxiliary contacts 1NO connection screw connection type DILEM 10		



1

GEV No.	380497	Ref. No.	76-30280100 76-30280502 76-30280506 76-30280551
description	power contactor resistive load 20A 230VAC (AC3/400V) 9A/4kW main contacts 4NO auxiliary contacts connection screw connection type DILEM 4		



1

GEV No.	380167	Ref. No.	76-30280102 76-30280117 76-30280513
description	power contactor resistive load 66A 230VAC (AC3/400V) 50A/22kW main contacts 3NO auxiliary contacts 1NO connection screw connection type DILM 50		

motor protection circuit breakers



1

GEV No.	380163	Ref. No.	76-30310108
description	motor protection circuit breaker type PKZM		

auxiliary contacts



1

GEV No.	380175	Ref. No.	76-30280151
description	auxiliary contact contacts 1NO/1NC connection screw		

ABL SURSUM

motor protection circuit breakers



1

GEV No.	380300	Ref. No.	76-30310105 76-30310106
description	motor protection circuit breaker type Mbs25-016 setting range 1-1.6A (AC3/400V) 0.55kW		
accessories for	380300		
	GEV No.	Ref. No.	76-30310099 76-30310102
auxiliary contact contacts 1NO/1NC HMS11			



1

GEV No.	380301	Ref. No.	76-30310107
description	motor protection circuit breaker type Mbs25-025 setting range 1.6-2.5A (AC3/400V) 1.1kW		



1

GEV No.	380304	Ref. No.	76-30310108
description	motor protection circuit breaker type MS25-10 setting range 6.3-10A (AC3/400V) 4kW		

accessories



1

GEV No.	380305	Ref. No.	76-30310099 76-30310102
description	auxiliary contact contacts 1NO/1NC HMS11		

TRIPUS (Eichhoff)

small relay switches



1

GEV No.	380397	Ref. No.	76-30280601
description	small relay switch 24V main contacts 1NO/1NC connection Faston 6.3mm resistive load 16A		



miscellaneous

accessories



GEV No.	380841	Ref. No.	76-30281001
description	conversion kit for contactor		

power contactors



GEV No.	380165	Ref. No.	76-30280502 76-30280506 76-30280551
description	power contactor		



GEV No.	380168	Ref. No.	76-30280103 76-30280504 76-30280507 76-30280550
description	power contactor		

solid state relays

CELDUC



GEV No.	400105	Ref. No.	76-30280533 76-4000453P
description	solid state relay CELDUC 2 phase 65A 400V 24VDC L 58mm W 45mm plug-in connection screw type 40.00.453		
accessories for	400105		
GEV No.	401794	Ref. No.	—
	connecting cable L 1440mm 4-pole suitable for RATIONAL		

relays

power relays

with bracket mounting



GEV No.	380312	Ref. No.	62-239023 62-239024
description	power relays FINDER 230VAC 10A 3CO connection male faston 4.8mm bracket mounting dimensions 52x32.2x36.5mm manuf. no. 60.63.8.230.0000		



GEV No.	380311	Ref. No.	62-239030
description	power relays Italiana Relè 230VAC 20A 1NC/1NO connection F6.3 bracket mounting manuf. no. A1B-230AC-FA		

level relays

GICAR



GEV No.	400018	Ref. No.	01-213810
description	level relay 230V voltage AC connection F6.3 type RL30/3ES/F/G		

time relays

time relays



GEV No.	380281	Ref. No.	76-30350401
description	time relay FINDER 82.11.0.240 time range 0.05s-10h 24-240VAC/24-48VDC 5A 1CO		



GEV No.	380283	Ref. No.	76-30350402
description	time relay FINDER 82.41.0.240 time range 0.05s-10h 24-240VAC/24-48VDC 5A		



GEV No.	380319	Ref. No.	76-30350453
description	time relay pickup-delayed 0.06-150s		



GEV No.	380280	Ref. No.	76-30350401
description	time relay WIELAND NGZ11 time range 1.5-30s 24-240V AC/DC 5A connection grip connection		



GEV No.	380282	Ref. No.	76-30350402
description	time relay WIELAND NGZ310 time range 1.5-30s 24-240V AC/DC 5A connection grip connection		



GEV No.	379260	Ref. No.	541590
description	timer TEMPOMATIC K-400-2M time range 0-99min 230VAC 16A mounting measurements 66x50mm 1NO connection rear 1-pole front measurements 71.5x55mm		

transformers

open transformers

with plug connection



GEV No.	400101	Ref. No.	76-30370240
description	transformer primary 200-260VAC secondary 4.2/14.4/11.5VAC 68.4VA		

encapsulated transformers

multiple connections



GEV No.	400117	Ref. No.	76-30370204
description	transformer primary 200-230V secondary 11.5V 20VA 50/60Hz temperature restriction 131°C ambient temperature max. 60°C		



			
1			
GEV No.	400102	Ref. No.	76-30370205
description	transformer primary 230VAC secondary 11.5VAC 10VA		

			
1			
GEV No.	400118	Ref. No.	76-30370203
description	transformer primary 230VAC secondary 21VAC 35VA		

electronic controllers

miscellaneous

universal controllers

			
1			
GEV No.	379020	Ref. No.	76-30140113 76-30140114
description	electronic controller Pt100 steam control		

probes

producer-specific probes

probes

			
1			
GEV No.	381428	Ref. No.	76-30140151
description	temperature probe Pt100 cable silicone probe -100 up to 450°C cable -50 up to +180°C connection 2-wire thread M6 probe ø4x100mm cable length 1.5m		

			
1			
GEV No.	381429	Ref. No.	76-30140156
description	temperature probe Pt100 cable silicone probe -100 up to 450°C cable -50 up to +180°C connection 2-wire thread probe ø3.2x100mm cable length 2.6m		

			
1			
GEV No.	381427	Ref. No.	76-30140120 76-30140150 76-30140152
description	temperature probe Pt100 cable silicone probe -50 up to +250°C cable -50 up to +180°C connection 2-wire thread probe ø4x75mm cable length 1.7m		

			
1			
GEV No.	381431	Ref. No.	76-30140165
description	temperature probe thermocouple K (NiCr-Ni) cable silicone probe -50 up to 1150°C cable -50 up to +180°C connection 2-wire thread probe ø1.5x100mm cable length 1.8m		

			
1			
GEV No.	381430	Ref. No.	76-30141000
description	temperature probe thermocouple K (NiCr-Ni) cable silicone probe -50 up to 1150°C cable -50 up to +180°C connection 2-wire thread probe ø2x100mm cable length 0.25m		

			
1			
GEV No.	381433	Ref. No.	76-30141003 76-30141005
description	temperature probe thermocouple K (NiCr-Ni) cable silicone probe -50 up to 1150°C cable -50 up to +180°C connection 2-wire thread probe ø2x100mm cable length 2.2m		

			
1			
GEV No.	381424	Ref. No.	76-30140160 76-87201003
description	temperature probe thermocouple K (NiCr-Ni) cable silicone probe -50 up to 1150°C cable -50 up to +180°C connection 2-wire thread probe ø2x100mm cable length 2m		

			
1			
GEV No.	381432	Ref. No.	76-30140161 76-30141016 76-87201002
description	temperature probe thermocouple K (NiCr-Ni) cable silicone probe -50 up to 1150°C cable -50 up to +180°C connection 2-wire thread probe ø2x40mm cable length 2.6m		

			
1			
GEV No.	379425	Ref. No.	76-30140157
description	temperature probe thermocouple K (NiCr-Ni) cable silicone probe -50 up to 1150°C cable -50 up to +180°C connection 2-wire thread probe ø3x280mm cable length 2m		

core probes

			
1			
GEV No.	381425	Ref. No.	76-30350604 76-30350605 76-30350607 76-30350608 76-30350623 76-30350703
description	core temperature probe Pt100 cable PTFE probe -40 up to +250°C cable -40 up to +250°C connection 2-wire probe ø3.2x100mm thread M12 cable length 2.8m handle ø 10mm handle length 80mm		



electronics

PCBs



1			
GEV No.	400084	Ref. No.	76-30402050
description	control PCB		



1			
GEV No.	400100	Ref. No.	76-30402040
description	control PCB		



1			
GEV No.	400098	Ref. No.	76-30403000 76-30403001
description	control PCB combi-steamer CD 101/CM 101 without EPROM		





1			
GEV No.	400103	Ref. No.	76-30403020
description	control PCB combi-steamer CM 61-202 L 460mm W 154mm 61-202		



1			
GEV No.	381426	Ref. No.	76-30350700 76-30350701 76-30350709 76-30350710 76-30350713
description	core temperature probe thermocouple K (NiCr-Ni) cable PTFE probe -40 up to +250°C cable -40 up to +250°C connection 2-wire probe ø3.2x100mm thread M12 cable length 1.9m handle ø 10mm handle length 100mm		





1			
GEV No.	379792 ¹	Ref. No.	76-30350717
description	core temperature probe thermocouple K (NiCr-Ni) cable PTFE probe -40 up to +250°C cable -40 up to +250°C connection grip connection probe ø3.2x100mm thread M16x2 cable length 1.9m handle ø 10mm handle length 40mm		
accessories for	379792		
	GEV No.	510179	Ref. No.
			—
	flat gasket fibre ED ø 18mm ID ø 13mm thickness 1.5mm Qty 1 pcs		
	GEV No.	560519	Ref. No.
			—
	nut thread M12x1 H 5mm WS 17 SS Qty 1 pcs		

¹ multipoint probe

accessories

screw connections



1			
GEV No.	550366	Ref. No.	76-30140163
description	screw for thermocouple		
accessories for	550366		
	GEV No.	550365	Ref. No.
			76-30140162
	gasket for thermocouple		

miscellaneous



1			
GEV No.	550365	Ref. No.	76-30140162
description	gasket for thermocouple		



1

GEV No.	400099	Ref. No.	76-30403010
description	control PCB combi-steamer CM101		



1

GEV No.	400107	Ref. No.	76-30402030
description	control PCB combi-steamer CM101 edition CM v. 4.91-97		



1

GEV No.	403319	Ref. No.	76-30403210
description	control PCB combi-steamer CPC-Linie CM 61-202/G model since 10/1997		



1

GEV No.	400109	Ref. No.	76-30400110
description	control PCB regulation and control electronics		



1

GEV No.	401490	Ref. No.	76-30400152
description	keypad PCB		



1

GEV No.	400129	Ref. No.	76-30020407 76-30161201 76-84241202
description	level relay		



1
Image not available

GEV No.	400111	Ref. No.	76-30020400 76-30020408 76-30402060 76-30403100
description	PCB		



1
Image not available

GEV No.	401483	Ref. No.	76-30350601
description	PCB		



1

GEV No.	401493	Ref. No.	76-30400121
description	PCB		

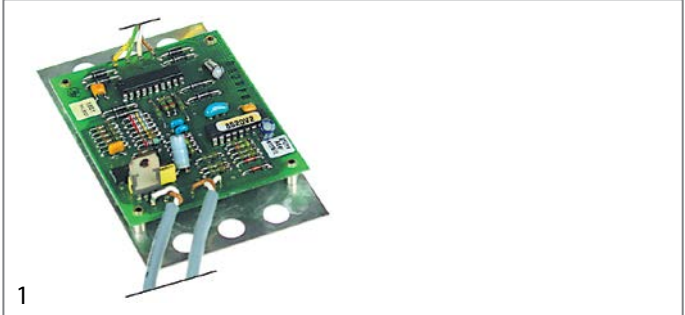

1			
GEV No.	401479	Ref. No.	76-30171001 76-30402602 76-87201293
description	PCB combi-steamer		



1			
GEV No.	400077	Ref. No.	76-30350660
description	PCB combi-steamer CCD 101/201 core temperature		

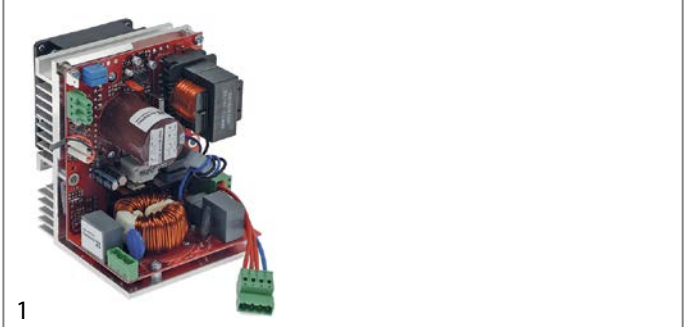

1			
GEV No.	401487	Ref. No.	76-30403040
description	PCB combi-steamer CD 101/CM 101 with axial flow fan for fan motor		

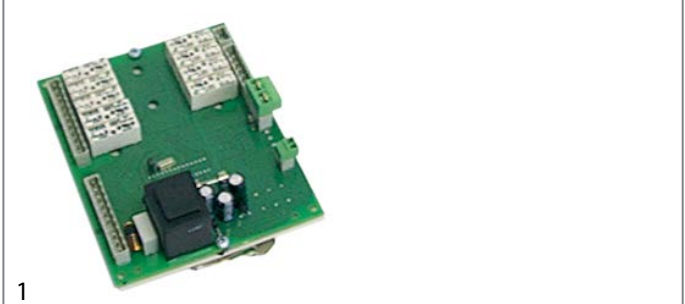

1			
GEV No.	400110	Ref. No.	76-30020400 76-30020408 76-30402060 76-30403100
description	PCB combi-steamer level control		



1			
GEV No.	361366	Ref. No.	62-215001
description	PCB dishwasher 11F suitable for DB2 type DB2/EV1/EKP-M		



1			
GEV No.	400033	Ref. No.	76-30370218
description	PCB for gas valve 240V 28V		

central units



1			
GEV No.	401013	Ref. No.	76-30310201
description	motor break electronic 50/60Hz for RATIONAL breaking duration 4s type ETBO 10 (AC3/380V) 0.5kW		

solenoid valves

solenoid valves (water)

ELBI
straight

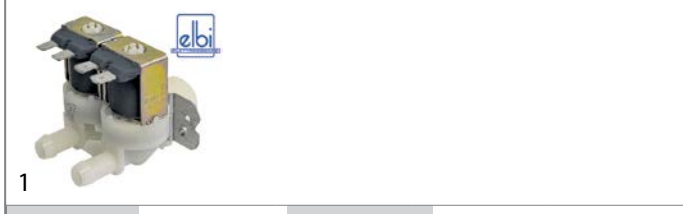

1			
GEV No.	373021	Ref. No.	76-30020330
description	solenoid valve double straight 230VAC inlet 3/4" outlet 11.5mm output 1x 4.7l/min DN10 ELBI		

spare parts for	373021			
	GEV No.	370467	Ref. No.	—
	solenoid valve filter suitable for ELBI			

Table continues overleaf



spare parts for 373021			
	GEV No.	371263	Ref. No. —
reducer ELBI type EATON (INVENSYS) flow rate 4.7l/min pressure range 0 up to 10bar tolerance ±15/25% grey			

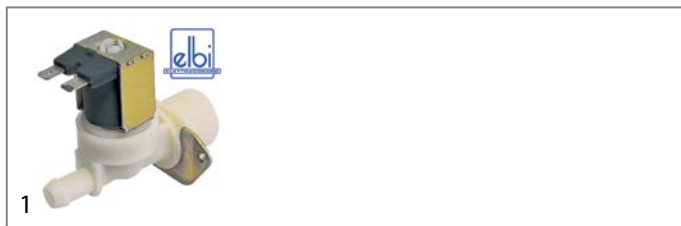

GEV No.	373017	Ref. No.	76-30020331
description	solenoid valve single straight 230VAC inlet 3/4" outlet 11.5mm DN10 ELBI		
spare parts for 373017			
	GEV No.	370467	Ref. No. —
solenoid valve filter suitable for ELBI			









GEV No.	370246	Ref. No.	62-240010
description	solenoid valve double straight 230VAC inlet 3/4" outlet 11.5mm t.max. 90°C ELBI plastic output B 0.5l/min flow regulating valve outlet B red		



MÜLLER

medium temperature: 90°C
duty cycle: 100%



GEV No.	370004	Ref. No.	026334
description	solenoid valve double straight 230VAC inlet 3/4" outlet 14.5mm DN10 t.max. 90°C duty cycle 100% MÜLLER		
For models:	B1100X, B650X		
spare parts for 370004			
	GEV No.	370129	Ref. No. —
solenoid valve body double straight inlet 3/4" outlet 14.5mm DN10 t.max. 90°C duty cycle 100% MÜLLER 230V			
	GEV No.	371002	Ref. No. —
solenoid valve holder MÜLLER flange support			
	GEV No.	371009	Ref. No. —
compression spring for solenoid coil			
	GEV No.	371011	Ref. No. —
spare parts kit membrane with long star star high 8mm MÜLLER			
	GEV No.	371017	Ref. No. —
solenoid coil MÜLLER 230VAC connection male faston 6.3mm			







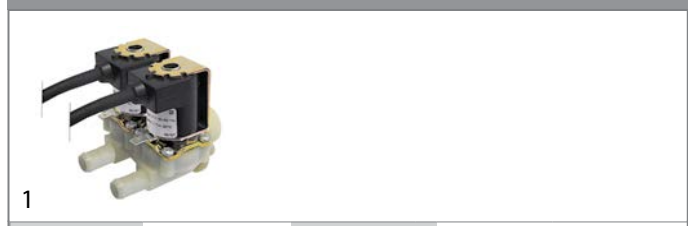



spare parts for 370004			
	GEV No.	371122	Ref. No. —
solenoid valve filter ø 19mm H 10mm suitable for MÜLLER			
	GEV No.	501161	Ref. No. —
tap head for solenoid valve holder for solenoid coils			











accessories for 370004			
	GEV No.	371010	Ref. No. 76-30020324
solenoid coil 230VAC connection with cable cable length 2000mm			
	GEV No.	371037	Ref. No. —
solenoid coil 24VAC 50/60Hz connection male faston 6.3mm			
	GEV No.	371038	Ref. No. —
solenoid coil 230VAC connection appliance plug			





with cable connection



GEV No.	370065	Ref. No.	76-30020327
description	solenoid valve double straight 230VAC inlet 3/4" outlet 11.5mm DN10 t.max. 90°C duty cycle 100% MÜLLER cable length 2000mm		

spare parts for 370065			
	GEV No.	370195	Ref. No. 76-30020314
solenoid valve body double straight inlet 3/4" outlet 11.5mm DN10 t.max. 90°C duty cycle 100% MÜLLER 230V			
	GEV No.	371002	Ref. No. —
solenoid valve holder MÜLLER flange support			
	GEV No.	371009	Ref. No. —
compression spring for solenoid coil			
	GEV No.	371010	Ref. No. 76-30020324
solenoid coil 230VAC connection with cable cable length 2000mm			
	GEV No.	371011	Ref. No. —
spare parts kit membrane with long star star high 8mm MÜLLER			
	GEV No.	371122	Ref. No. —
solenoid valve filter ø 19mm H 10mm suitable for MÜLLER			
	GEV No.	501161	Ref. No. —
tap head for solenoid valve holder for solenoid coils			
accessories for 370065			
	GEV No.	371017	Ref. No. —
solenoid coil MÜLLER 230VAC connection male faston 6.3mm			
	GEV No.	371037	Ref. No. —
solenoid coil 24VAC 50/60Hz connection male faston 6.3mm			
	GEV No.	371038	Ref. No. —
solenoid coil 230VAC connection appliance plug			

			
1			
GEV No.	370368	Ref. No.	76-30020305
description	solenoid valve single straight 230VAC inlet 3/4" outlet 11.5mm DN10 t.max. 90°C duty cycle 100% MÜLLER cable length 2000mm		
spare parts for	370368		
	GEV No.	370133	Ref. No. 76-30020301
	solenoid valve body single straight inlet 3/4" outlet 11.5mm DN10 t.max. 90°C duty cycle 100% MÜLLER 230V		
	GEV No.	371002	Ref. No. —
	solenoid valve holder MÜLLER flange support		
	GEV No.	371009	Ref. No. —
	compression spring for solenoid coil		
	GEV No.	371010	Ref. No. 76-30020324
	solenoid coil 230VAC connection with cable cable length 2000mm		
	GEV No.	371011	Ref. No. —
	spare parts kit membrane with long star star high 8mm MÜLLER		
	GEV No.	371122	Ref. No. —
	solenoid valve filter ø 19mm H 10mm suitable for MÜLLER		
	GEV No.	501161	Ref. No. —
	tap head for solenoid valve holder for solenoid coils		
accessories for	370368		
	GEV No.	371017	Ref. No. —
	solenoid coil MÜLLER 230VAC connection male faston 6.3mm		
	GEV No.	371037	Ref. No. —
	solenoid coil 24VAC 50/60Hz connection male faston 6.3mm		
	GEV No.	371038	Ref. No. —
	solenoid coil 230VAC connection appliance plug		

			
1			
GEV No.	370006	Ref. No.	76-30020328
description	solenoid valve triple straight 230VAC inlet 3/4" outlet 12.5mm DN10 t.max. 90°C duty cycle 100% MÜLLER cable length 2000mm		
spare parts for	370006		
	GEV No.	370132	Ref. No. 76-30020315
	solenoid valve body triple straight inlet 3/4" outlet 11.5mm DN10 t.max. 90°C duty cycle 100% MÜLLER 230V		
	GEV No.	371002	Ref. No. —
	solenoid valve holder MÜLLER flange support		
	GEV No.	371009	Ref. No. —
	compression spring for solenoid coil		

spare parts for	370006		
	GEV No.	371010	Ref. No. 76-30020324
	solenoid coil 230VAC connection with cable cable length 2000mm		
	GEV No.	371011	Ref. No. —
	spare parts kit membrane with long star star high 8mm MÜLLER		
	GEV No.	371122	Ref. No. —
	solenoid valve filter ø 19mm H 10mm suitable for MÜLLER		
	GEV No.	501161	Ref. No. —
	tap head for solenoid valve holder for solenoid coils		
accessories for	370006		
	GEV No.	371017	Ref. No. —
	solenoid coil MÜLLER 230VAC connection male faston 6.3mm		
	GEV No.	371037	Ref. No. —
	solenoid coil 24VAC 50/60Hz connection male faston 6.3mm		
	GEV No.	371038	Ref. No. —
	solenoid coil 230VAC connection appliance plug		

spare parts and accessories

valve bodies

			
1			
GEV No.	370195	Ref. No.	76-30020314
description	solenoid valve body double straight inlet 3/4" outlet 11.5mm DN10 t.max. 90°C duty cycle 100% MÜLLER 230V		

			
1			
GEV No.	370132	Ref. No.	76-30020315
description	solenoid valve body triple straight inlet 3/4" outlet 11.5mm DN10 t.max. 90°C duty cycle 100% MÜLLER 230V		





solenoid coils			
			
GEV No.	371010	Ref. No.	76-30020324
description	solenoid coil 230VAC connection with cable cable length 2000mm		

ROBERTSHAW/INVENSYS

medium temperature: 90°C 90°C 60°C
ambient temperature: 60°C 25°C 60°C
duty cycle: 40% 100% 100%

			
GEV No.	370371	Ref. No.	76-30020304
description	solenoid valve double straight 230VAC inlet 3/4" outlet 11.5mm DN10 EATON (INVENSYS) cable length 2000mm		

			
GEV No.	370370	Ref. No.	76-30020305
description	solenoid valve single straight 230VAC inlet 3/4" outlet 11.5mm DN10 EATON (INVENSYS) cable length 2000mm		

			
GEV No.	370372	Ref. No.	76-30020311
description	solenoid valve triple straight 230VAC inlet 3/4" outlet 11.5mm DN10 EATON (INVENSYS) cable length 2000mm		





with coded terminal			
			
GEV No.	370269	Ref. No.	76-30020330
description	solenoid valve double straight 230VAC inlet 3/4" outlet 11.5mm DN10 EATON (INVENSYS)		















			
GEV No.	370268	Ref. No.	76-30020331
description	solenoid valve single straight 230VAC inlet 3/4" outlet 11.5mm DN10 EATON (INVENSYS)		

TP			
			
GEV No.	370017	Ref. No.	62-240011
description	solenoid valve single straight 230VAC inlet 3/4" outlet 11.5mm DN10 TP p max 10bar		
spare parts for	370017		
	GEV No.	371013	Ref. No.
solenoid coil TP 230VAC 50/60Hz			
accessories for	370017		
	GEV No.	371220	Ref. No.
reducer TP flow rate 3l/min red tolerance ±15%			
	GEV No.	371221	Ref. No.
reducer TP flow rate 5.5l/min yellow tolerance ±15%			
	GEV No.	371222	Ref. No.
reducer TP flow rate 6l/min grey tolerance ±15%			
	GEV No.	371223	Ref. No.
reducer TP flow rate 10l/min white tolerance ±15%			
	GEV No.	371224	Ref. No.
reducer TP flow rate 12l/min bronze tolerance ±15%			
	GEV No.	371225	Ref. No.
reducer TP flow rate 16l/min light brown tolerance ±15%			
	GEV No.	371226	Ref. No.
reducer TP flow rate 20l/min red tolerance ±15%			
	GEV No.	371230	Ref. No.
reducer TP flow rate 0.25l/min red tolerance ±25%			
	GEV No.	371231	Ref. No.
reducer TP flow rate 0.35l/min violet tolerance ±25%			
	GEV No.	371232	Ref. No.
reducer TP flow rate 0.5l/min orange tolerance ±25%			
	GEV No.	371233	Ref. No.
reducer TP flow rate 0.8l/min white tolerance ±25%			
	GEV No.	371234	Ref. No.
reducer TP flow rate 1l/min light blue tolerance ±25%			
	GEV No.	371235	Ref. No.
reducer TP flow rate 1.2l/min brown tolerance ±25%			
	GEV No.	371236	Ref. No.
reducer TP flow rate 1.5l/min light brown tolerance ±25%			

Table continues overleaf



accessories for		370017		
GEV No.		371237	Ref. No.	—
	reducer TP flow rate 2.5l/min yellow tolerance ±25%			
	reducer TP flow rate 3.4l/min dark green tolerance ±25%			
	reducer TP flow rate 5l/min black tolerance ±25%			
	reducer TP flow rate 8l/min blue tolerance ±20%			

  1				
GEV No.	370018	Ref. No.	76-30020331	
description	solenoid valve single straight 230VAC inlet 3/4" outlet 14mm DN10 TP			
spare parts for	370018			
	GEV No.	371013	Ref. No.	—
	solenoid coil TP 230VAC 50/60Hz			
accessories for	370018			
	GEV No.	371220	Ref. No.	—
	reducer TP flow rate 3l/min red tolerance ±15%			
	GEV No.	371221	Ref. No.	—
	reducer TP flow rate 5.5l/min yellow tolerance ±15%			
	GEV No.	371222	Ref. No.	—
	reducer TP flow rate 6l/min grey tolerance ±15%			
	GEV No.	371223	Ref. No.	—
	reducer TP flow rate 10l/min white tolerance ±15%			
	GEV No.	371224	Ref. No.	—
	reducer TP flow rate 12l/min bronze tolerance ±15%			
	GEV No.	371225	Ref. No.	—
	reducer TP flow rate 16l/min light brown tolerance ±15%			
	GEV No.	371226	Ref. No.	—
	reducer TP flow rate 20l/min red tolerance ±15%			
	GEV No.	371230	Ref. No.	—
	reducer TP flow rate 0.25l/min red tolerance ±25%			
	GEV No.	371231	Ref. No.	—
	reducer TP flow rate 0.35l/min violet tolerance ±25%			
	GEV No.	371232	Ref. No.	—
	reducer TP flow rate 0.5l/min orange tolerance ±25%			
	GEV No.	371233	Ref. No.	—
	reducer TP flow rate 0.8l/min white tolerance ±25%			

accessories for		370018		
GEV No.		371234	Ref. No.	—
	reducer TP flow rate 1l/min light blue tolerance ±25%			
	reducer TP flow rate 1.2l/min brown tolerance ±25%			
	reducer TP flow rate 1.5l/min light brown tolerance ±25%			
	reducer TP flow rate 2.5l/min yellow tolerance ±25%			
	reducer TP flow rate 3.4l/min dark green tolerance ±25%			
	reducer TP flow rate 5l/min black tolerance ±25%			
	reducer TP flow rate 8l/min blue tolerance ±20%			

Solenoid valve - accessories

filters



GEV No.	371323	Ref. No.	76-19000202	
description	solenoid valve filter ø 19.5mm H 10.5mm suitable for RATIONAL coarse			

pressure switches

for warewashing

ø 58mm with male faston 6.3mm

with connection horizontal



GEV No.	541003	Ref. No.	62-224003	
description	pressure control pressure range 55/35mbar connection 6mm ø 58mm pressure connection horizontal warewashing pressure connection ø 6mm			

1

GEV No.	541106	Ref. No.	62-224005
description	pressure control pressure range 90/56mbar connection 6mm ø 58mm pressure connection horizontal warewashing pressure connection ø 6mm		

for steam control



1

GEV No.	541016	Ref. No.	49-176197
description	pressure control ø 45mm pressure range 480/430mbar pressure connection vertical steam control pressure range 0.48/0.43bar connection 1/4" pressure connection 1/4"		

for combi-steamers



1

GEV No.	345218	Ref. No.	76-30171002
description	pressure control pressure range 0-3mbar connection 6mm pressure connection 6mm		

electrodes





1

GEV No.	400021	Ref. No.	76-30020401
description	level electrode PG9 total length 110mm probe L 70/47/24mm insulated probe length 62/38/16mm with 3 probes connection grip connection		



1

GEV No.	400022	Ref. No.	76-30020402	
description	level electrode PG9 total length 135mm probe L 89/59/28mm insulated probe length 80mm with 3 probes connection grip connection			
accessories for	400022			
	GEV No.	379729	Ref. No.	—
	connection cable L 1230mm 4-pole for level electrode plug type coded			
	GEV No.	550574	Ref. No.	—
	nut thread PG9 H 3mm WS 28 nickel-plated brass Qty 1 pcs mounting ømm cable ømm			

flow meters and flow sensors

flow sensors



1

GEV No.	402256	Ref. No.	76-30171050
description	flow sensor inlet ø 10mm outlet ø 10mm L 110mm flow rate 1-25l/min		

fans

axial fans

import



1

GEV No.	601080 ¹	Ref. No.	76-31011008	
description	axial fan L 119mm W 119mm H 38mm 230VAC 50/60Hz 23/20W bearing ball bearing connection male faston 2.8mm metal ADDA fan wheel ø 110mm temp.-resist. 70°C			
accessories for	601080			
	GEV No.	550898	Ref. No.	—
	connecting cable cable length 2000mm connection F 2.8 connection distance 7.9mm for axial flow fan			
	GEV No.	692519	Ref. No.	—
	guard L 120mm W 120mm plastic			

¹with ball bearings

cross flow fans

COPREL

with moulded coils



1

GEV No.	601456	Ref. No.	49-178463
description	cross flow fan roller ø 45mm roller length 180mm laminated core thickness 15mm motor position right 230V/50Hz 26W universal bearing silicone connection male faston 6.3mm -30 up to +100°C 230V 50/60Hz		





hot air motors

electric components

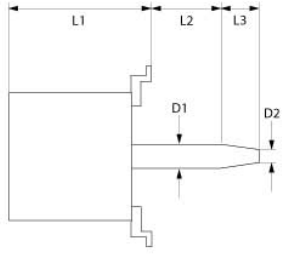
			
GEV No.	510588	Ref. No.	76-20160875
description	counterflange for fan motor ED ϕ 60mm int. ϕ 1 32mm int. ϕ 2 26mm thickness 3mm steel		

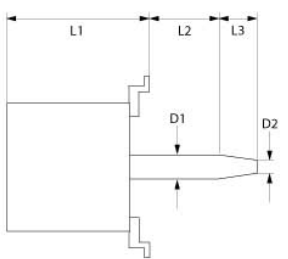

			
			
GEV No.	500158	Ref. No.	76-31001002
description	fan motor 200-240/346-415V 3 phase 50/60Hz 0.4kW 1400/1700rpm speeds 1 L1 160mm L2 30mm L3 35mm M10R IT 2.0/1.15A power input 560W at 50Hz 200-240/346-415V at 60Hz 200-277/346-480V at 50Hz 1400rpm at 60Hz 1700rpm type L7Cw4D-226 no. WN D1 ϕ 17mm D2 ϕ 13mm		

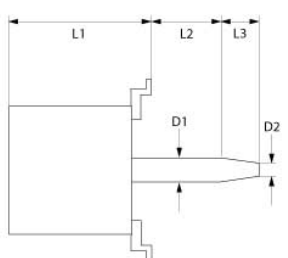
			
			
GEV No.	500100	Ref. No.	76-30010400 76-30010426
description	fan motor 220-240/380-415V 3 phase 50/60Hz 0.25kW 1400rpm speeds 1 L1 150mm L2 32mm L3 40mm M10R IT at 50Hz 1400rpm at 60Hz 1700rpm type L7Aw4D-099 no. X3 D1 ϕ 17mm D2 ϕ 13mm mounting distance 180mm		

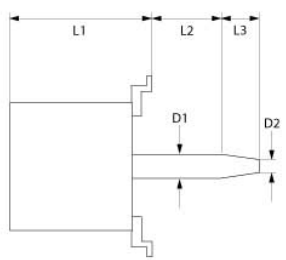
			
			
GEV No.	500167	Ref. No.	76-31001021
description	fan motor 220-240/380-415V 3 phase 50Hz 0.45kW 1400rpm speeds 1 L1 150mm L2 24mm L3 35mm M10R IT 1.1/1.9A power input 650W at 50Hz 1400rpm type L9Cw4D1-304 no. X7 D1 ϕ 17mm D2 ϕ 13mm		

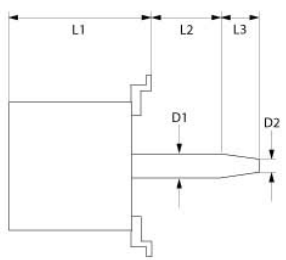
			
			
GEV No.	601310	Ref. No.	76-30010441
description	fan motor 220-240V 1 phase 50/60Hz 0.16kW 1420/1720rpm speeds 1 L1 140mm L2 40mm L3 37mm M10R IT 1.3A suitable capacitor 16 μ F/280V power input 260W Cos(ϕ) 0.96 at 50Hz 1420rpm at 60Hz 1720rpm type L7zAw4D-199 no. W5 D1 ϕ 17mm D2 ϕ 13mm		

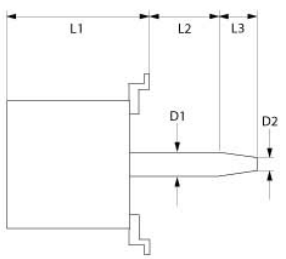
			
			
GEV No.	500159	Ref. No.	76-31001000
description	fan motor 380-415/380-460V 3 phase 50Hz 0.04/0.37kW 710/1350rpm speeds 2 L1 170mm L2 30mm L3 35mm M10R IT 0.3/0.85A power input 100/550W at 50Hz 380-415V at 60Hz 380-460V at 50Hz 710/1350rpm at 60Hz 850/1680rpm Y/YY type L7rw84D-208 no. WN D1 ϕ 17mm D2 ϕ 13mm		

			
			
GEV No.	500162	Ref. No.	76-31001020
description	fan motor 380-415V 3 phase 50Hz 0.08/0.45kW 700/1400rpm speeds 2 L1 147mm L2 35mm L3 35mm ϕ 125mm M10R IT 0.4/1.15A at 50Hz 700/1400rpm Y/YY type L9xw84D-393 no. V2 D1 ϕ 17mm D2 ϕ 13mm		
spare parts for	500162		
	GEV No.	601730	Ref. No. —
fan wheel for motor cooling ED ϕ 180mm H 20mm ID ϕ 20mm			

			
Image not available			
GEV No.	601312	Ref. No.	76-20120510
description	fan wheel		



1

GEV No.	601049	Ref. No.	76-20120602
description	fan wheel D1 ø 280mm H1 125mm blades 12 D2 ø 11mm D3 ø 16mm H2 37mm		



1

GEV No.	601311	Ref. No.	76-20120500
description	fan wheel D1 ø 350mm H1 125mm blades 12 D2 ø 13mm D3 ø 16.5mm H2 37mm		



1

GEV No.	601322	Ref. No.	76-20120507
description	fan wheel D1 ø 350mm H1 125mm blades 12 D2 ø 13mm D3 ø 16mm H2 37mm		



1

GEV No.	510587	Ref. No.	76-20160876
description	flange for fan motor ED ø 60mm int. ø 1 24mm int. ø 2 18.5mm thickness 3mm steel		



1

GEV No.	510573	Ref. No.	76-50010207
description	shaft seal ID ø 17mm ED ø 29mm thickness 4.5mm		

hot air fans

HANNING



1

GEV No.	601149	Ref. No.	49-174193
description	fan motor 230V L1 72mm L2 69mm L4 130mm HANNING type EMB-30-028		



1

GEV No.	601008	Ref. No.	49-174192
description	hot air fan 230V 45W L1 72mm L2 28mm L4 130mm HANNING type EMB-30-027 M6L		

miscellaneous



1

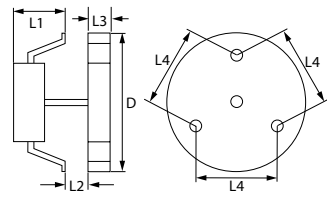

GEV No.	601175	Ref. No.	AN72-65060030
description	hot air fan 230V 47W 50/60Hz L1 73mm L2 28mm L3 29mm L4 87mm fan wheel ø 154mm FIME type C30X0L13/05CLH		



accessories

fan wheels for hot air fans



1

GEV No.	601196	Ref. No.	49-788878002
description	fan wheel \varnothing 150mm W 20mm shaft intake \varnothing 6x5mm blades 6		

radial fans



1

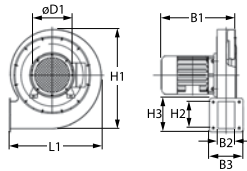

GEV No.	601114	Ref. No.	76-31011011
description	radial fan 24V voltage AC 50Hz 20W H1 141mm L1 130mm D1 \varnothing 27mm W1 86mm W2 23mm H2 42.5mm W3 75.5mm H3 83mm gas burner		

accessories universal



1

GEV No.	401013	Ref. No.	76-30310201
description	motor break electronic 50/60Hz for RATIONAL breaking duration 4s type ETBO 10 (AC3/380V) 0.5kW		

motors

gear motors

for ovens

for flues



1

GEV No.	361999	Ref. No.	76-31011010
description	gear motor CROUZET type 82841042 12V voltage DC shaft \varnothing 4mm L 65mm W 50mm H 51mm for oven		



1

GEV No.	361565	Ref. No.	76-31011007
description	gear motor CROUZET type 82841056 24V voltage DCHz 4.2rpm shaft \varnothing 4mm L 51mm W 66mm H 51mm		



1

GEV No.	361564	Ref. No.	76-31011001
description	gear motor ESCAP type 22N28210E 24V shaft \varnothing 5mm L 50mm W 32mm H 51mm for sliding valve		

motors

for combi-steamers



1

GEV No.	401480	Ref. No.	76-31011002 76-86801006
description	motor for humidity measuring		



pumps

wash and rinse pumps

ALBA (C&A)

pumps



1

GEV No.	500085	Ref. No.	602252
description	pump inlet ø 45mm outlet ø 40mm type C1001 230V 50Hz 1 phase 0.55kW 0.75HP L 200mm rotation direction right capacitor 16µF ALBA PUMPS (C&A)		
spare parts for	500085		
	GEV No.	365014	Ref. No. —
	operating capacitor capacity 12.5µF 450V tolerance 5%Hz ambient temperature max. -25 to +85°C ø 35mm L 70mm M8 plastic connection male faston 6.3mm 45S.C3DS.12.5 protection		
	GEV No.	509021	Ref. No. —
	impellor ø 102mm H 32mm shaft intake ø 9/8mm rotation direction right		
	GEV No.	510693	Ref. No. 61-141002
	mechanical shaft seal for shaft ø 12mm slide ring ext. ø 24mm slide ring H 15.5mm slide ring int. ø 11mm counter ring mounting ø 24mm height counter ring 8mm counter ring int. ø 13.5mm		
	GEV No.	521531	Ref. No. —
	pump cover ALBA PUMPS (C&A) inlet ø 45mm outlet ø 40mm turn direction right ø 153mm ID ø 127mm inner height 24mm		
	GEV No.	521709	Ref. No. —
	O-ring EPDM thickness 3mm ID ø 126mm Qty 1 pcs		

FIR

pumps



1

GEV No.	500558	Ref. No.	64-33542
description	pump inlet ø 33mm outlet ø 30/28mm type B266H1500 230V 50Hz 1 phase 0.22kW 0.3HP L 195mm rotation direction right capacitor 5µF FIR		
spare parts for	500558		
	GEV No.	365017	Ref. No. —
	operating capacitor capacity 5µF 450V tolerance 5% 50/60Hz ambient temperature max. -25 to +85°C ø 28mm L 54mm M8 plastic connection male faston 6.3mm 16.10.08 protection		
	GEV No.	510693	Ref. No. 61-141002
	mechanical shaft seal for shaft ø 12mm slide ring ext. ø 24mm slide ring H 15.5mm slide ring int. ø 11mm counter ring mounting ø 24mm height counter ring 8mm counter ring int. ø 13.5mm		
	GEV No.	521545	Ref. No. —
	pump cover FIR type B226H inlet ø 33mm outlet ø 30/28mm		
	GEV No.	521565	Ref. No. —
	pump cover gasket pump type B226H		
	GEV No.	521566	Ref. No. —
	impellor ø 80mm H 15mm M7L pump type B226H		









1

GEV No.	500127	Ref. No.	63-100399
description	pump inlet \varnothing 37mm outlet \varnothing 41mm type 4247.1900 230V 50Hz 1 phase 0.44kW 0.6HP L 200mm rotation direction right capacitor 10 μ F FIR		
spare parts for	500127		
	GEV No.	365015	Ref. No. —
	operating capacitor capacity 10 μ F 400V tolerance 5%Hz ambient temperature max. -25 to +85°C \varnothing 35.5mm L 59mm M8 plastic connection male faston 6.3mm protection		
	GEV No.	510608	Ref. No. —
	impeller \varnothing 93mm H 32mm shaft intake \varnothing 9/8mm blades 6 inner height 11mm		
	GEV No.	510692	Ref. No. 151021-2
	mechanical shaft seal for shaft \varnothing 11mm slide ring ext. \varnothing 24mm slide ring H 13mm counter ring mounting \varnothing 26mm height counter ring 8mm counter ring int. \varnothing 14mm		
	GEV No.	521505	Ref. No. —
	pump cover FIR inlet \varnothing 37mm outlet \varnothing 40mm turn direction right \varnothing 160mm ID \varnothing 125mm inner height 25mm		
	GEV No.	521702	Ref. No. 151021-3
	pump cover gasket thickness 3.5x4.5mm Qty 1 pcs		



1

GEV No.	500058	Ref. No.	63-100717
description	pump inlet \varnothing 63mm outlet \varnothing 53mm type 2241.2500 230/400V 50Hz 3 phase 0.89kW 1.2HP L 305mm rotation direction left FIR		
spare parts for	500058		
	GEV No.	510531	Ref. No. —
	pump cover FIR inlet \varnothing 63mm outlet \varnothing 53mm auxiliary pressure connection M16x1.5mm supporting pressure open turn direction left \varnothing 185mm ID \varnothing 150mm inner height 37mm		
	GEV No.	510693	Ref. No. 61-141002
	mechanical shaft seal for shaft \varnothing 12mm slide ring ext. \varnothing 24mm slide ring H 15.5mm slide ring int. \varnothing 11mm counter ring mounting \varnothing 24mm height counter ring 8mm counter ring int. \varnothing 13.5mm		
	GEV No.	510834	Ref. No. 63-631667
	impeller \varnothing 110mm H 29mm thread M8R suitable for FIR		
	GEV No.	524416	Ref. No. —
	pump cover gasket thickness 4x4mm Qty 1 pcs		
accessories for	500058		
	GEV No.	504329	Ref. No. —
	blind plug H 17.5mm thread M16x1.5 plastic WS 22 for pump		
	GEV No.	524046	Ref. No. —
	vibration damper L 40mm W 25mm H 25mm for pump		



LGB





1

GEV No.	500480	Ref. No.	63-100802
description	pump inlet ø 28mm outlet ø 28mm type ZF131DX 230V 50Hz 1 phase 0.29kW 0.4HP L 195mm rotation direction left capacitor 6.3µF LGB		
spare parts for	500480		
	GEV No.	510690	Ref. No. —
	mechanical shaft seal for shaft ø 8mm ED ø 24mm mounting ø 24/26mm		
	GEV No.	521083	Ref. No. —
	impellor ø 73mm H 13mm thread M7R blades 3 metal		
	GEV No.	521084	Ref. No. —
	pump cover LGB inlet ø 28mm outlet ø 25mm auxiliary pressure connection 13mm pump type ZF131DX ID ø 78mm		
	GEV No.	528800	Ref. No. —
	O-ring EPDM thickness 2.62mm ID ø 75.87mm Qty 1 pcs		
accessories for	500480		
	GEV No.	365012	Ref. No. 400491 63-631216
	operating capacitor capacity 6.3µF 450V tolerance 5% 50Hz ambient temperature max. -25 to +85°C ø 30mm L 61mm M8 plastic connection male faston 6.3mm protection		



1

GEV No.	500156	Ref. No.	62-130109
description	pump inlet ø 50mm outlet ø 50mm type ZF400SX 230V 50Hz 1 phase 0.6kW 0.8HP L 210mm rotation direction right capacitor 16µF LGB		
For models:	TX312		
spare parts for	500156		
	GEV No.	509020	Ref. No. —
	impellor ø 104mm H 25mm M8L		
	GEV No.	510703	Ref. No. —
	mechanical shaft seal for shaft ø 13mm slide ring H 13mm height counter ring 5.5mm ED ø 26mm		
	GEV No.	521548	Ref. No. —
	pump cover LGB inlet ø 50mm outlet ø 50mm		
	GEV No.	521734	Ref. No. —
	pump cover bottom part		
	GEV No.	523509	Ref. No. —
	deep-groove ball bearing type 6201-2RS shaft ø 12mm ED ø 32mm W 10mm with sealing discs deep-groove ball bearing DIN 625-1		
	GEV No.	532623	Ref. No. —
	O-ring EPDM thickness 2.62mm ID ø 120.32mm Qty 1 pcs		
accessories for	500156		
	GEV No.	365021	Ref. No. —
	operating capacitor capacity 16µF 425V tolerance 5% 50/60Hz ambient temperature max. -25 to +85°C ø 35mm L 73mm single M8 plastic connection male faston 6.3mm 416.10.99 protection		

OLYMPIA

pumps



1

GEV No.	500003	Ref. No.	62-130008
description	pump inlet ø 45mm outlet ø 32mm type T30 230V 50Hz 1 phase 0.29kW 0.39HP L 190mm rotation direction right capacitor 8µF OLYMPIA		
spare parts for	500003		
	GEV No.	365013	Ref. No. 62-206004
	operating capacitor capacity 8µF 400V tolerance 5%Hz ambient temperature max. -25 to +85°C ø 31.5mm L 55mm M8 plastic connection male faston 6.3mm protection		
	GEV No.	510512	Ref. No. 62-116021
	pump cover OLYMPIA inlet ø 45mm outlet ø 31mm outlet 2 ø 24 turn direction right ø 130mm ID ø 124mm inner height 20mm		
	GEV No.	510554	Ref. No. —
	O-ring EPDM thickness 2mm ID ø 120mm Qty 1 pcs		
	GEV No.	510615	Ref. No. 61-124006
	impellor ø 90mm H 22mm rotation direction right thread M10L blades 4		
	GEV No.	510693	Ref. No. 61-141002
	mechanical shaft seal for shaft ø 12mm slide ring ext. ø 24mm slide ring H 15.5mm slide ring int. ø 11mm counter ring mounting ø 24mm height counter ring 8mm counter ring int. ø 13.5mm		

drain pumps

ASKOLL



1

GEV No.	500214	Ref. No.	62-130105
description	drain pump inlet ø 30mm outlet ø 22mm 230/240V 30W 50Hz ASKOLL type R113		

GRE



1

GEV No.	500961	Ref. No.	63-100342
description	drain pump inlet ø 30mm outlet ø 23mm 100W 230V 50Hz GRE		
accessories for	500961		
	GEV No.	524719	Ref. No. —
	formed hose hose ext. ø 40mm hose int. ø 30mm L 65mm warewashing black Qty 1		

HANNING



1

GEV No.	500044	Ref. No.	76-30021000
description	drain pump inlet ø 30mm outlet ø 24mm 230V 100W 50Hz HANNING type BE28B4-017		
spare parts for	500044		
	GEV No.	510168	Ref. No. —
	fan wheel shaft intake ø 5mm ø 62mm H 14mm		



booster pumps II

accessories



1

GEV No.	365012	Ref. No.	400491 63-631216
description	operating capacitor capacity 6.3µF 450V tolerance 5% 50Hz ambient temperature max. -25 to +85°C ø 30mm L 61mm M8 plastic connection male faston 6.3mm protection		

vibration pumps



1

GEV No.	500580	Ref. No.	76-30021003
description	vibration pump 230V 60W 50/60Hz inlet ø 7 outlet ø 1/8" IT CEME type E512 with accessories duty cycle 1/2 ambient temperature max. 60°C medium temp max. 35°C overheating protection 110°C CleanJet		

pumps for ice machines



1

GEV No.	500200	Ref. No.	151033
description	pump GRE 100W 230V 50Hz inlet ø 24mm outlet ø 23mm L 145mm rotation direction right		

condensators & interference suppression filters

operating capacitors

plastic



1

GEV No.	365012	Ref. No.	400491 63-631216
description	operating capacitor capacity 6.3µF 450V tolerance 5% 50Hz ambient temperature max. -25 to +85°C ø 30mm L 61mm M8 plastic connection male faston 6.3mm protection		



1

GEV No.	365013	Ref. No.	62-206004
description	operating capacitor capacity 8µF 400V tolerance 5% 50Hz ambient temperature max. -25 to +85°C ø 31.5mm L 55mm M8 plastic connection male faston 6.3mm protection		

filters

interference suppression filters



1

GEV No.	365217	Ref. No.	76-31021000
description	interference suppression filter capacity 1.5µF 250V for combi-steamer CPC-Linie 61-202		



1

GEV No.	365108	Ref. No.	76-30010455
description	interference suppression filter type 3001.0455 250/440V 50/60Hz conductor 3 with E connection male faston 6.3mm L 52mm ø 60mm Hmm Wmm M8 aluminium Qty 1 pcs		



RC circuits



1

GEV No.	380179	Ref. No.	76-30350514
description	RC circuit		



1

GEV No.	381487	Ref. No.	76-30350509
description	RC circuit 230V connection Faston 6.3mm L 35mm H 30mm W 30mm 470Ohm		



1

GEV No.	380278	Ref. No.	76-30350517
description	RC circuit 72-250V voltage AC for contactors M series type AEG EB05 A60		



1

GEV No.	380272	Ref. No.	76-30280562
description	RC circuit for contactors type 910-304-585-50 130-250V 50-60Hz conductor 2 connection cable plastic Qty 1 pcs for contactors LS4_LS15K type AEG LR2K A250 type GE B52R2R		

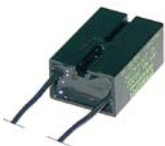

1

GEV No.	380177	Ref. No.	76-30350508
description	RC circuit type 20002 110/220V 50/60/DChz conductor 2 connection cable 230mm L 29mm ømm H 15mm W 20mm adhesive tape plastic Qty 1 pcs		



1

GEV No.	380221	Ref. No.	76-30350515
description	RC circuit type LS4-37 230V voltage AC type AEG LS4-37		

fuses

fine fuses



1

GEV No.	358597	Ref. No.	76-30190400
description	fine fuse size ø5x20mm 0.5A slow-acting rated 250V Qty 10 pcs		



1

GEV No.	358603	Ref. No.	76-30190120
description	fine fuse size ø5x20mm 2A slow-acting rated 250V Qty 10 pcs		



1

GEV No.	358607	Ref. No.	76-30190200
description	fine fuse size ø5x20mm 6.3A slow-acting rated 250V Qty 10 pcs		



1

GEV No.	358735	Ref. No.	76-40010218
description	fine fuse size ø5x30mm 6.3A medium lag rated 500V Qty 10 pcs		

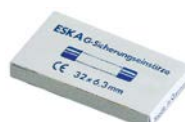

1

GEV No.	358791	Ref. No.	76-40010224
description	fine fuse size ø6.3x32mm 6.3A slow-acting rated 250V Qty 10 pcs		



fine fuse holders

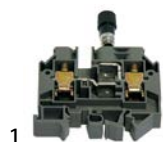

GEV No.	550105	Ref. No.	76-40011228
description	rail-mounted terminal WIELAND type WK10/SIU 5X20 /V0 suitable fuse ø5x20mm 1.0-16mm ² 10A rated 250V		

screw locks

D0-system (NEOZED)



GEV No.	358045	Ref. No.	76-30190403
description	fuse size D02 35A rated 250/400V E18 ø 15mm L 36mm Qty 10 pcs		



GEV No.	358046	Ref. No.	76-30190404
description	fuse size D02 50A rated 250/400V E18 ø 15mm L 36mm Qty 10 pcs		

fuse holders



GEV No.	358060	Ref. No.	76-40011234
description	fuse holder suitable fuse D02 3-pole-pole 63A rated 400V		



GEV No.	358061	Ref. No.	76-40011235
description	fuse holder suitable fuse D02 ø 25mm mounting ø 18mm rated 400V L 30mm		

overload switches



GEV No.	358524	Ref. No.	76-30140400 76-30140402
description	overload switch drop-away current 0.05A		

electric accessories

plugs - couplings - power sockets

CEE plugs



GEV No.	550210	Ref. No.	841534
description	plug CEE straight 5-pole contacts 3P+N+E max. 16A max 400V protection IP44 clamps 1.0-2.5mm ²		

cables

accessories

cable glands

threaded cable glands

screw connections



GEV No.	550303	Ref. No.	76-40070600
description	cable gland thread PG9 cable ø 6.0-8.0mm mounting ø 15.2mm nickel-plated brass Qty 5 pcs		
accessories for	550303		
	GEV No.	550321	Ref. No.
			—

connection cables



GEV No.	403815	Ref. No.	76-88171040
description	connection cable 9-pole RS232/USB L 790mm		



GEV No.	403811	Ref. No.	76-87201302
description	connection cable L 525mm 7-pole for combi-steamer CPC-Linie CPC/CM 61-202 connection plug-in connection plug type coded for PCB		



			
GEV No.	579005	Ref. No.	76-87201300
description	data cable L 550mm 4-pole for combi-steamer suitable for CPC-Linie CPC/CM 61-202 plug type USB		

terminals and connectors

not insulated

female fastons

iron nickel-plated

			
GEV No.	550001	Ref. No.	76-40020100
description	female faston size 6.3x0.8mm 1.0-2.5mm ² straight Fe gal Ni t.max. 340°C Qty 100 pcs		

terminals

PCB terminal blocks

			
GEV No.	550809	Ref. No.	76-30400193 76-30400198
description	PCB terminal block 11-pole raster size 5mm		

rail-mounted terminals

WIELAND

rail-mounted terminals type 9700A

			
GEV No.	550376	Ref. No.	76-40011206
description	rail-mounted terminal WIELAND type 9700A/16 S35 2.5-35mm ² top-hat rail 35mm grey W 16mm L 59mm		















fuse terminal blocks

			
GEV No.	550105	Ref. No.	76-40011228
description	rail-mounted terminal WIELAND type WK10/SIU 5X20 /V0 suitable fuse ø5x20mm 1.0-16mm ² 10A rated 250V		

gas taps

PEL

21S series

			
GEV No.	101913	Ref. No.	41-1031501300
description	gas tap PEL type 21S gas inlet M16x1.5 (tube ø 10mm) bypass nozzle ø 0.9mm gas outlet M16x1.5 (tube ø 10/8mm) thermocouple connection M8x1 pilot connection M10x1 shaft ø 6x4.6mm shaft L 35/28mm shaft flat right		
spare parts for	101913		
	GEV No.	100528	Ref. No. —
bypass nozzle type PEL20/21 bore ø 0.9mm thread M5x0.5			
	GEV No.	101060	Ref. No. 49-407088
magnet unit standard L 39mm D1 ø 15.4mm D2 ø 11mm suitable for PEL20-21/JUNKERS/EGA			
	GEV No.	101230	Ref. No. —
thermocouple nut T1: M8x1 T2: M18x1 aluminium			
	GEV No.	101877	Ref. No. —
gas tap front part shaft ø 6x4.6mm type PEL21			
accessories for	101913		
	GEV No.	100908	Ref. No. —
union screw thread M10x1 for pipe ø 4mm Qty 1 pcs			
	GEV No.	100909	Ref. No. —
union screw thread M10x1 for pipe ø 6mm Qty 1 pcs			
	GEV No.	101246	Ref. No. —
olive for pipe ø 4mm Qty 1 pcs			
	GEV No.	101278	Ref. No. —
olive for pipe ø 10mm Qty 1 pcs			
	GEV No.	101286	Ref. No. —
olive ID ø 6mm Qty 1 pcs			
	GEV No.	101300	Ref. No. —
union nut thread M16x1.5 tube ø 10mm			
	GEV No.	101450	Ref. No. —
olive for pipe ø 8mm L 12.7mm Qty 1 pcs ED ø 10mm			
	GEV No.	101451	Ref. No. —
union nut thread M16x1.5 tube ø 8mm			
	GEV No.	110078	Ref. No. —
knob without symbol ø 70mm shaft ø 6x4.6mm shaft flat universal			
	GEV No.	112206	Ref. No. —
knob dial plate silver gas tap PEL21/22/23 t.max.°C ED ø 63mm ID ø 45.5mm			

















alternatives to EGA

GPEL21 series

with nozzle outlet



1

GEV No.	101668	Ref. No.	01-231553
description	gas tap alternatives to EGA type GPEL21D with nozzle outlet (with nozzle) gas inlet M15x1 (tube ø 10mm) external nozzle ø 1.35mm internal nozzle ø 1.2mm bypass nozzle ø 0.35mm mixing pipe connection M17x1 thermocouple connection M10x1 pilot connection M10x1 shaft ø 8x7mm shaft L 34/15mm shaft flat lower tube ø 10mm shaft length knob 15mm		
spare parts for	101668		
	GEV No.	100300	Ref. No. —
	gas injector thread M12x1 WS 14 bore ø 1.35mm		
	GEV No.	100313	Ref. No. —
	internal nozzle bore ø 1.20mm suitable for EGA26400/26440		
	GEV No.	100908	Ref. No. —
	union screw thread M10x1 for pipe ø 4mm Qty 1 pcs		
	GEV No.	100927	Ref. No. —
	torsion spring L 2.8-8.0mm for internal nozzle ø 3mm bore ø mm		
	GEV No.	101060	Ref. No. 49-407088
	magnet unit standard L 39mm D1 ø 15.4mm D2 ø 11mm suitable for PEL20-21/JUNKERS/EGA		
	GEV No.	101233	Ref. No. —
	union nut thread M10x1 JUNKERS		
	GEV No.	101246	Ref. No. —
	olive for pipe ø 4mm Qty 1 pcs		
	GEV No.	101526	Ref. No. —
	O-ring Viton thickness 1.78mm ID ø 4.48mm Qty 1 pcs		
	GEV No.	101593	Ref. No. —
	adjusting screw for internal nozzle thread M8x0.75		
	GEV No.	101806	Ref. No. —
	gas tap front part shaft ø 8x7mm shaft L 34/15mm shaft flat upper/lower suitable for PEL21		
accessories for	101668		
	GEV No.	100909	Ref. No. —
	union screw thread M10x1 for pipe ø 6mm Qty 1 pcs		
	GEV No.	100926	Ref. No. —
	centring piece thread M17x1		
	GEV No.	100942	Ref. No. —
	union nut thread M15x1 for pipe ø 10mm		
	GEV No.	101278	Ref. No. —
	olive for pipe ø 10mm Qty 1 pcs		

accessories for	101668		
	GEV No.	101286	Ref. No. —
	olive ID ø 6mm Qty 1 pcs		



1















GEV No.	101633	Ref. No.	49-170882
description	gas tap alternatives to EGA type GPEL21D with nozzle outlet (with nozzle) gas inlet M15x1 (tube ø 10mm) external nozzle ø 1.4mm internal nozzle ø 0.8mm bypass nozzle ø 0.35mm mixing pipe connection M17x1 thermocouple connection M8x1 pilot connection M10x1 shaft ø 6x4.6mm shaft L 31/23mm shaft flat left		
spare parts for	101633		
	GEV No.	100307	Ref. No. —
	gas injector thread M12x1 WS 14 bore ø 1.40mm		
	GEV No.	100311	Ref. No. 49-161791
	internal nozzle bore ø 0.80mm suitable for EGA26400/26440		
	GEV No.	100408	Ref. No. —
	bypass nozzle type PEL20/21 bore ø 0.35mm thread M5x0.5		
	GEV No.	100927	Ref. No. —
	torsion spring L 2.8-8.0mm for internal nozzle ø 3mm bore ø mm		
	GEV No.	101060	Ref. No. 49-407088
	magnet unit standard L 39mm D1 ø 15.4mm D2 ø 11mm suitable for PEL20-21/JUNKERS/EGA		
	GEV No.	101230	Ref. No. —
	thermocouple nut T1: M8x1 T2: M18x1 aluminium		
	GEV No.	101526	Ref. No. —
	O-ring Viton thickness 1.78mm ID ø 4.48mm Qty 1 pcs		
	GEV No.	101593	Ref. No. —
	adjusting screw for internal nozzle thread M8x0.75		
	GEV No.	101802	Ref. No. —
	gas tap front part shaft ø 6x4.6mm shaft L 30/23mm shaft flat right/left suitable for PEL21		
accessories for	101633		
	GEV No.	100908	Ref. No. —
	union screw thread M10x1 for pipe ø 4mm Qty 1 pcs		
	GEV No.	100909	Ref. No. —
	union screw thread M10x1 for pipe ø 6mm Qty 1 pcs		
	GEV No.	100926	Ref. No. —
	centring piece thread M17x1		
	GEV No.	100942	Ref. No. —
	union nut thread M15x1 for pipe ø 10mm		

Table continues overleaf

1 gas components

accessories for		101633		
GEV No.		101246	Ref. No.	—
				olive for pipe ø 4mm Qty 1 pcs
				olive for pipe ø 10mm Qty 1 pcs
				olive ID ø 6mm Qty 1 pcs
				knob without symbol ø 70mm shaft ø 6x4.6mm shaft flat universal
				knob dial plate silver gas tap PEL21/22/23 t.max.°C ED ø 63mm ID ø 45.5mm

				
1				
GEV No.	101634	Ref. No.	49-170883	
description	gas tap alternatives to EGA type GPEL21D with nozzle outlet (with nozzle) gas inlet M15x1 (tube ø 10mm) external nozzle ø 1.85mm internal nozzle ø 1.05mm bypass nozzle ø 0.5mm mixing pipe connection M17x1 thermocouple connection M8x1 pilot connection M10x1 shaft ø 6x4.6mm shaft L 31/23mm shaft flat left			
spare parts for	101634			
	GEV No.	100302	Ref. No.	—
	gas injector thread M12x1 WS 14 bore ø 1.85mm			
	GEV No.	100312	Ref. No.	01-230735
	internal nozzle bore ø 1.05mm suitable for EGA26400/26440			
	GEV No.	100526	Ref. No.	—
	bypass nozzle type PEL20/21 bore ø 0.5mm thread M5x0.5			
	GEV No.	100927	Ref. No.	—
	torsion spring L 2.8-8.0mm for internal nozzle ø 3mm bore ømm			
	GEV No.	101060	Ref. No.	49-407088
	magnet unit standard L 39mm D1 ø 15.4mm D2 ø 11mm suitable for PEL20-21/JUNKERS/EGA			
	GEV No.	101230	Ref. No.	—
	thermocouple nut T1: M8x1 T2: M18x1 aluminium			
	GEV No.	101526	Ref. No.	—
	O-ring Viton thickness 1.78mm ID ø 4.48mm Qty 1 pcs			
	GEV No.	101593	Ref. No.	—
	adjusting screw for internal nozzle thread M8x0.75			
	GEV No.	101802	Ref. No.	—
	gas tap front part shaft ø 6x4.6mm shaft L 30/23mm shaft flat right/left suitable for PEL21			
accessories for	101634			
	GEV No.	100908	Ref. No.	—
	union screw thread M10x1 for pipe ø 4mm Qty 1 pcs			



accessories for		101634		
GEV No.		100909	Ref. No.	—
				union screw thread M10x1 for pipe ø 6mm Qty 1 pcs
	GEV No.	100926	Ref. No.	—
	centring piece thread M17x1			
	GEV No.	100942	Ref. No.	—
	union nut thread M15x1 for pipe ø 10mm			
	GEV No.	101246	Ref. No.	—
	olive for pipe ø 4mm Qty 1 pcs			
	GEV No.	101278	Ref. No.	—
	olive for pipe ø 10mm Qty 1 pcs			
	GEV No.	101286	Ref. No.	—
	olive ID ø 6mm Qty 1 pcs			
	GEV No.	110078	Ref. No.	—
	knob without symbol ø 70mm shaft ø 6x4.6mm shaft flat universal			
	GEV No.	112206	Ref. No.	—
	knob dial plate silver gas tap PEL21/22/23 t.max.°C ED ø 63mm ID ø 45.5mm			

with pipe outlet				
				
1				
GEV No.	101646 ¹	Ref. No.	49-170737	
description	gas tap alternatives to EGA type GPEL20RD with pipe outlet with throttle screw gas inlet M15x1 (tube ø 10mm) bypass nozzle ø 0.35mm gas outlet M17x1 (tube ø 10mm) thermocouple connection M8x1 pilot connection M10x1 shaft ø 6x4.6mm shaft L 31/23mm shaft flat upper			
spare parts for	101646			
	GEV No.	100408	Ref. No.	—
	bypass nozzle type PEL20/21 bore ø 0.35mm thread M5x0.5			
	GEV No.	101060	Ref. No.	49-407088
	magnet unit standard L 39mm D1 ø 15.4mm D2 ø 11mm suitable for PEL20-21/JUNKERS/EGA			
	GEV No.	101230	Ref. No.	—
	thermocouple nut T1: M8x1 T2: M18x1 aluminium			
	GEV No.	101526	Ref. No.	—
	O-ring Viton thickness 1.78mm ID ø 4.48mm Qty 1 pcs			
	GEV No.	101552	Ref. No.	—
	throttle screw thread M8x0.75			
accessories for	101646			
	GEV No.	100908	Ref. No.	—
	union screw thread M10x1 for pipe ø 4mm Qty 1 pcs			

¹with reducer for main gas line
Table continues overleaf







accessories for		101646		
	GEV No.	100909	Ref. No.	—
union screw thread M10x1 for pipe ø 6mm Qty 1 pcs				
	GEV No.	100926	Ref. No.	—
centring piece thread M17x1				
	GEV No.	100942	Ref. No.	—
union nut thread M15x1 for pipe ø 10mm				
	GEV No.	101246	Ref. No.	—
olive for pipe ø 4mm Qty 1 pcs				
	GEV No.	101278	Ref. No.	—
olive for pipe ø 10mm Qty 1 pcs				
	GEV No.	101286	Ref. No.	—
olive ID ø 6mm Qty 1 pcs				
	GEV No.	110078	Ref. No.	—
knob without symbol ø 70mm shaft ø 6x4.6mm shaft flat universal				
	GEV No.	112206	Ref. No.	—
knob dial plate silver gas tap PEL21/22/23 t.max.°C ED ø 63mm ID ø 45.5mm				

accessories for		101632		
	GEV No.	101299	Ref. No.	—
nut thread M12x1				
	GEV No.	101400	Ref. No.	—
air mixing tube thread M17x1 suitable for L350, L700				
	GEV No.	110149	Ref. No.	—
knob gas tap without ignition flame t.max.°C temperature range°C ø 50mm shaft ø 6x4.6mm shaft flat right black				



GEV No.	101631	Ref. No.	49-170880
description	gas tap MADEC with nozzle outlet (with nozzle) gas inlet M12x1 (tube ø 8mm) external nozzle ø 2.2mm internal nozzle ø 1.2mm bypass nozzle ø 0.55mm mixing pipe connection M17x1 thermocouple connection M8x1 front fixing M12x1 shaft ø 6x4.6mm shaft L 37/17mm shaft flat lower		





spare parts for		101631		
	GEV No.	100293	Ref. No.	—
gas injector thread M12x1 WS 14 bore ø 2.20mm				
	GEV No.	100422	Ref. No.	—
internal nozzle MADEC bore ø 1.2mm				
	GEV No.	100426	Ref. No.	—
bypass nozzle MADEC bore ø 0.55mm thread M4.5x0.6				
	GEV No.	101051	Ref. No.	49-160860
magnet unit L 27mm D1 ø 12.5mm D2 ø 8.5mm suitable for JUNKERS/EGA/MADEC/SABAF standard				
	GEV No.	101234	Ref. No.	—
union nut T1: M8x1 T2: M15				



MADEC (MP)







with nozzle outlet



GEV No.	101632	Ref. No.	49-170881
description	gas tap MADEC type 170881 with nozzle outlet (with nozzle) gas inlet M12x1 (tube ø 8mm) external nozzle ø 2.2mm internal nozzle ø 1.4mm bypass nozzle ø 0.7mm mixing pipe connection M17x1 thermocouple connection M8x1 front fixing M12x1 shaft ø 6x4.6mm shaft L 37/17mm shaft flat lower		

spare parts for		101632		
	GEV No.	100293	Ref. No.	—
gas injector thread M12x1 WS 14 bore ø 2.20mm				
	GEV No.	100423	Ref. No.	—
internal nozzle MADEC bore ø 1.4mm				
	GEV No.	100427	Ref. No.	—
bypass nozzle MADEC bore ø 0.7mm thread M4.5x0.6				
	GEV No.	101051	Ref. No.	49-160860
magnet unit L 27mm D1 ø 12.5mm D2 ø 8.5mm suitable for JUNKERS/EGA/MADEC/SABAF standard				

accessories for		101632		
	GEV No.	101277	Ref. No.	—
olive ID ø 8mm Qty 1 pcs				
	GEV No.	101296	Ref. No.	—
union nut thread M12x1 for pipe ø 8mm				

accessories for		101631		
	GEV No.	100943	Ref. No.	—
union nut thread M17x1 tube ø 10mm				
	GEV No.	101277	Ref. No.	—
olive ID ø 8mm Qty 1 pcs				
	GEV No.	101296	Ref. No.	—
union nut thread M12x1 for pipe ø 8mm				
	GEV No.	101299	Ref. No.	—
nut thread M12x1				
	GEV No.	101394	Ref. No.	—
nut thread M17x1 H 3mm WS 19 brass Qty 1 pcs				
	GEV No.	101400	Ref. No.	—
air mixing tube thread M17x1 suitable for L350, L700				
	GEV No.	110149	Ref. No.	—
knob gas tap without ignition flame t.max.°C temperature range°C ø 50mm shaft ø 6x4.6mm shaft flat right black				

gas valves and ignition boxes







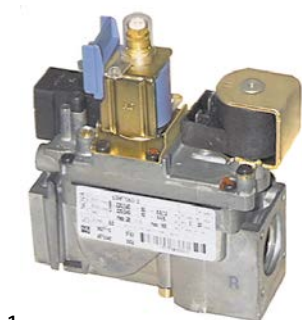



gas control valves

SIT

NOVASIT



1

GEV No.	101163	Ref. No.	76-30390204 76-30390220
description	gas valve SIT series Novasit 827 230V 50Hz gas inlet 1/2" gas outlet 1/2" thermocouple connection pilot connection M10x1 ignition pressure range 3-5mbar pressure range 2-20mbar pressure regulator connection standard equiv. no. 0.827.110 power supply for modulator 28VDC		
spare parts for	101163		
	GEV No.	101313	Ref. No. —
	solenoid coil 230V 50Hz		
accessories for	101163		
	GEV No.	100006	Ref. No. —
	piezoelectric igniter suitable for ELETTROSIT body plastic blowing connection ø2.4mm ø 14mm		
	GEV No.	101305	Ref. No. —
	gas connection straight 1/2" flange 45x45mm ELETTROSIT/V4400/4600/4605 suitable for SIT/HONEYWELL hole distance 36x36mm		
	GEV No.	101306	Ref. No. —
	gas connection angled flange 45x45mm hole distance 36x36mm 1/2" ELETTROSIT/V4400/4600/4605 screw with O-ring suitable for SIT/HONEYWELL		
	GEV No.	101307	Ref. No. —
	gas connection straight flange 45x45mm hole distance 36x36mm 3/4" ELETTROSIT/V4400/4600/4605 screw with O-ring suitable for SIT/HONEYWELL		
	GEV No.	101308	Ref. No. —
	gas connection angled flange 45x45mm hole distance 36x36mm 3/4" ELETTROSIT/V4400/4600/4605 screw with O-ring suitable for SIT/HONEYWELL		
	GEV No.	101312	Ref. No. —
	microswitch		
	GEV No.	101314	Ref. No. —
	solenoid coil 24V 50Hz		
	GEV No.	101317	Ref. No. —
	plug with cable L 1000mm suitable for NOVASIT		
	GEV No.	101318	Ref. No. —
	cover cap for solenoid coil suitable for NOVASIT		

ignition boxes

HONEYWELL



1

GEV No.	101166	Ref. No.	76-30390103
description	ignition box HONEYWELL type S4560B 1006 electrodes 1 waiting time 0s safety time 10s 220-240V 10VA 50Hz		



1

GEV No.	101184	Ref. No.	76-30390105
description	ignition box HONEYWELL type S4565C 1033 equiv. no. S4565C 1033 electrodes 2 waiting times safety time 5s 220-240V 4VA 50/60Hz		

ignition parts

pilot burners

SIT

100 series

accessories

pilot burner nozzles





1

GEV No.	100246	Ref. No.	42-5017208682
description	pilot burner nozzle natural gas bore ø 0.35mm Qty 1 pcs thread M8x0.75		







JUNKERS			
CB 502 series			
pilot burners			
			
1			
GEV No.	100085	Ref. No.	49-161134
description	pilot burner JUNKERS type CB502031 natural gas nozzle no.6 gas connection 6mm with primary air		
spare parts for	100085		
	GEV No.	100227	Ref. No. —
	pilot burner nozzle natural gas gas pressure 25mbar code 6 Qty 1 pcs suitable for JUNKERS CB50203_		
	GEV No.	100704	Ref. No. 49-407123
	ignition electrode D1 ø 9mm connection M4 D2 ø 11mm L1 17mm L2 17mm BL1 13mm BL2 4mm BL3 22mm		
	GEV No.	100909	Ref. No. —
	union screw thread M10x1 for pipe ø 6mm Qty 1 pcs		
	GEV No.	101287	Ref. No. —
	olive for pipe ø 6mm Qty 1 pcs		
	GEV No.	101292	Ref. No. —
	union screw for igniter suitable for CB 502/505 Qty 1 pcs		
	GEV No.	101295	Ref. No. —
	clamping collet for thermocouple suitable for CB 502/505 Qty 1 pcs		
accessories for	100085		
	GEV No.	100220	Ref. No. 49-161141
	pilot burner nozzle LPG gas pressure 50mbar code 2 Qty 1 pcs suitable for JUNKERS CB503_		
	GEV No.	100221	Ref. No. —
	pilot burner nozzle LPG gas pressure 30mbar code 29 Qty 1 pcs suitable for JUNKERS CB50203_		
	GEV No.	100222	Ref. No. —
	pilot burner nozzle LPG gas pressure 50mbar code 5 Qty 1 pcs suitable for JUNKERS CB50203_		
	GEV No.	100223	Ref. No. 49-161140
	pilot burner nozzle natural gas gas pressure 20mbar code 3 Qty 1 pcs suitable for JUNKERS CB503_		
	GEV No.	100224	Ref. No. —
	pilot burner nozzle natural gas gas pressure 25mbar code 26 Qty 1 pcs suitable for JUNKERS CB503_		
	GEV No.	100225	Ref. No. —
	pilot burner nozzle natural gas gas pressure 30mbar code 39 Qty 1 pcs suitable for JUNKERS CB503_		
	GEV No.	100226	Ref. No. —
	pilot burner nozzle LPG gas pressure 30mbar code 39 Qty 1 pcs suitable for JUNKERS CB503_		
	GEV No.	100228	Ref. No. —
	pilot burner nozzle town gas gas pressure 8mbar code 4 Qty 1 pcs suitable for JUNKERS CB50203_		

accessories for	100085		
	GEV No.	101281	Ref. No. —
	olive for pipe ø 4mm L 8.7mm Qty 1 pcs suitable for CB 502/503		
	GEV No.	101283	Ref. No. —
	union screw thread M10x1 for pipe ø 4mm Qty 1 pcs		

			
1			
GEV No.	100061	Ref. No.	49-161136
description	pilot burner JUNKERS type CB502031 natural gas nozzle no.6 gas pressure 25mbar gas connection 6mm with primary air code 6		
spare parts for	100061		
	GEV No.	100227	Ref. No. —
	pilot burner nozzle natural gas gas pressure 25mbar code 6 Qty 1 pcs suitable for JUNKERS CB50203_		
	GEV No.	100909	Ref. No. —
	union screw thread M10x1 for pipe ø 6mm Qty 1 pcs		
	GEV No.	101287	Ref. No. —
	olive for pipe ø 6mm Qty 1 pcs		
	GEV No.	101295	Ref. No. —
	clamping collet for thermocouple suitable for CB 502/505 Qty 1 pcs		
accessories for	100061		
	GEV No.	100220	Ref. No. 49-161141
	pilot burner nozzle LPG gas pressure 50mbar code 2 Qty 1 pcs suitable for JUNKERS CB503_		
	GEV No.	100221	Ref. No. —
	pilot burner nozzle LPG gas pressure 30mbar code 29 Qty 1 pcs suitable for JUNKERS CB50203_		
	GEV No.	100222	Ref. No. —
	pilot burner nozzle LPG gas pressure 50mbar code 5 Qty 1 pcs suitable for JUNKERS CB50203_		
	GEV No.	100223	Ref. No. 49-161140
	pilot burner nozzle natural gas gas pressure 20mbar code 3 Qty 1 pcs suitable for JUNKERS CB503_		
	GEV No.	100224	Ref. No. —
	pilot burner nozzle natural gas gas pressure 25mbar code 26 Qty 1 pcs suitable for JUNKERS CB503_		
	GEV No.	100225	Ref. No. —
	pilot burner nozzle LPG gas pressure 30mbar code 39 Qty 1 pcs suitable for JUNKERS CB503_		
	GEV No.	100226	Ref. No. —
	pilot burner nozzle LPG gas pressure 50mbar code 15 suitable for JUNKERS		
	GEV No.	100228	Ref. No. —
	pilot burner nozzle town gas gas pressure 8mbar code 4 Qty 1 pcs suitable for JUNKERS CB50203_		
	GEV No.	100704	Ref. No. 49-407123
	ignition electrode D1 ø 9mm connection M4 D2 ø 11mm L1 17mm L2 17mm BL1 13mm BL2 4mm BL3 22mm		







Table continues overleaf

accessories for		100061		
	GEV No.	100851	Ref. No.	—
cover for pilot burner suitable for JUNKERS CB502_55				
	GEV No.	100907	Ref. No.	—
screw connection thread M10x1 Qty 1 pcs type SEF 1 ømm for thermocouple				
	GEV No.	101281	Ref. No.	—
olive for pipe ø 4mm L 8.7mm Qty 1 pcs suitable for CB 502/503				
	GEV No.	101283	Ref. No.	—
union screw thread M10x1 for pipe ø 4mm Qty 1 pcs				
	GEV No.	101292	Ref. No.	—
union screw for igniter suitable for CB 502/505 Qty 1 pcs				



POLIDORO

pilot burners

				
1	GEV No.	100079	Ref. No.	42-5024706878
description pilot burner POLIDORO 3 flames code gas connectionmm				
accessories for		100079		
	GEV No.	100000	Ref. No.	—
pilot burner nozzle POLIDORO LPG code 22 bore ø 0.22mm Qty 1 pcs				
	GEV No.	100208	Ref. No.	—
pilot burner nozzle POLIDORO LPG code 20 bore ø 0.2mm Qty 1 pcs				
	GEV No.	100209	Ref. No.	—
pilot burner nozzle POLIDORO natural gas code 40 bore ø 0.4mm Qty 1 pcs				
	GEV No.	100701	Ref. No.	—
ignition electrode connection M4 Qty 1 pcs				
	GEV No.	100906	Ref. No.	—
screw connection thread M10x1 for ignition electrode brass Qty 1 pcs WS 10				
	GEV No.	100907	Ref. No.	—
screw connection thread M10x1 Qty 1 pcs type SEF 1 ømm for thermocouple				
	GEV No.	100908	Ref. No.	—
union screw thread M10x1 for pipe ø 4mm Qty 1 pcs				
	GEV No.	100909	Ref. No.	—
union screw thread M10x1 for pipe ø 6mm Qty 1 pcs				
	GEV No.	102110	Ref. No.	90-000183
pilot tube copper pipe ø 4mm thickness 1mm L 3000mm				
	GEV No.	102111	Ref. No.	—
pilot tube copper pipe ø 6mm thickness 1mm L 3000mm				
	GEV No.	102699	Ref. No.	—
pilot burner nozzle POLIDORO natural gas code 25.2 bore ø 2x0.25mm Qty 1 pcs 2 bores				

accessories for		100079		
	GEV No.	102795	Ref. No.	—
olive for pipe ø 4mm Qty 1 pcs				
	GEV No.	102797	Ref. No.	—
olive for pipe ø 6mm Qty 1 pcs				
	GEV No.	106703	Ref. No.	—
pilot burner nozzle POLIDORO natural gas code 27.2 bore ø 2x0.27mm Qty 1 pcs				
	GEV No.	106704	Ref. No.	—
pilot burner nozzle POLIDORO LPG code 16.2 bore ø 2x0.16mm Qty 1 pcs				
	GEV No.	106763	Ref. No.	—
pilot burner nozzle POLIDORO natural gas code 27.2A bore ø 2x 0.27mm Qty 1 pcs				
	GEV No.	106859	Ref. No.	—
pilot burner nozzle POLIDORO LPG code 24 bore ø 0.24mm Qty 1 pcs				

electrodes

				
1	GEV No.	103301	Ref. No.	76-20680152
description ignition electrode D1 ø 7mm L1 5mm L2 12mm BL1 63mm to clip connection ø 4mm				
				
1	GEV No.	100720	Ref. No.	49-185217
description ignition electrode D1 ø 8mm BL1 42mm connection F 2.8x0.8mm with spring				



GEV No.	100704	Ref. No.	49-407123
description	ignition electrode D1 ø 9mm connection M4 D2 ø 11mm L1 17mm L2 17mm BL1 13mm BL2 4mm BL3 22mm		

GEV No.	102166	Ref. No.	42-3562615504
description	ignition electrode flange length 23mm flange width 15mm D1 ø 7mm L1 85mm L2 40mm BL1 21mm BL2 25mm fixing dimensions ø5x4mm with flange connection ø 4mm		

ignition cables

pre-assembled cables

GEV No.	100193	Ref. No.	42-5061005414
description	ignition cable cable length 1200mm connection ø2.4mm / ø4mm		

thermocouples

plug-in thermocouples

plug-in thermocouples standard

with barrel socket ø5mm - type Junkers with aluminised tip

GEV No.	102202	Ref. No.	162111	
description	thermocouple M8x1 L 320mm plug connection ø5.0mm			
accessories for	102202			
	GEV No.	101260	Ref. No.	—
	thermocouple fitting thread M8x1 Qty 1 pcs			

GEV No.	102204	Ref. No.	49-162112
description	thermocouple M8x1 L 600mm plug connection ø5.0mm		

GEV No.	102205	Ref. No.	49-174413	
description	thermocouple M8x1 L 750mm plug connection ø5.0mm			
accessories for	102205			
	GEV No.	101260	Ref. No.	—
	thermocouple fitting thread M8x1 Qty 1 pcs			

threaded thermocouples

threaded thermocouples with cable link

GEV No.	102088	Ref. No.	49-162153
description	thermocouple with two-conductors L 1500mm M8x1 M10x1		

gas burners

hob burners

accessories

pan supports

GEV No.	210150	Ref. No.	41-1032101000
description	pan support W 340mm L 545mm		



bar burners

bar burners



1

GEV No.	211029	Ref. No.	1829522
----------------	--------	-----------------	---------

description	lava rock grid L 464mm W 310mm
--------------------	--------------------------------

lava rock grids



1

GEV No.	211029	Ref. No.	1829522
----------------	--------	-----------------	---------

description	lava rock grid L 464mm W 310mm
--------------------	--------------------------------

surface burners



1

GEV No.	105948	Ref. No.	76-20680215
----------------	--------	-----------------	-------------

description	surface burner L 330mm W 140mm H 55mm firing range 320x130mm burner rows 18 convection oven
--------------------	---



1

GEV No.	105951	Ref. No.	76-20721001
----------------	--------	-----------------	-------------

description	surface burner number of rows 14 nozzle \varnothing 0.62mm
--------------------	--



1

GEV No.	105952	Ref. No.	76-20721000
----------------	--------	-----------------	-------------

description	surface burner number of rows 14 nozzle \varnothing 1.1mm
--------------------	---



1

GEV No.	105950	Ref. No.	76-20680216
----------------	--------	-----------------	-------------

description	surface burner number of rows 18 nozzle \varnothing 0.65mm LPG
--------------------	--

gas nozzles

pilot burner nozzles

pilot burner nozzles JUNKERS

CB 50203_/503_ series



1

GEV No.	100220	Ref. No.	49-161141
----------------	--------	-----------------	-----------

description	pilot burner nozzle LPG gas pressure 50mbar code 2 Qty 1 pcs suitable for JUNKERS CB503_
--------------------	--



1

GEV No.	100223	Ref. No.	49-161140
----------------	--------	-----------------	-----------

description	pilot burner nozzle natural gas gas pressure 20mbar code 3 Qty 1 pcs suitable for JUNKERS CB503_
--------------------	--

pilot burner nozzles SIT

100 series



1

GEV No.	100246	Ref. No.	42-5017208682
----------------	--------	-----------------	---------------

description	pilot burner nozzle natural gas bore \varnothing 0.35mm Qty 1 pcs thread M8x0.75
--------------------	--

internal nozzles

internal nozzles for EGA gas taps/nozzle holders

EGA 26400/26440/23268



1

GEV No.	100310	Ref. No.	01-230733
----------------	--------	-----------------	-----------

description	internal nozzle bore \varnothing 0.66mm suitable for EGA26400/26440
--------------------	---



1

GEV No.	100319	Ref. No.	49161790
----------------	--------	-----------------	----------

description	internal nozzle bore \varnothing 0.75mm suitable for EGA26400/26440
--------------------	---





1

GEV No.	100311	Ref. No.	49-161791
----------------	--------	-----------------	-----------

description	internal nozzle bore \varnothing 0.80mm suitable for EGA26400/26440
--------------------	---





1			
GEV No.	100315	Ref. No.	01-230734
description	internal nozzle bore ø 0.95mm suitable for EGA26400/26440		

1			
GEV No.	100312	Ref. No.	01-230735
description	internal nozzle bore ø 1.05mm suitable for EGA26400/26440		

auxiliary gas parts

screw connections



union screws

1				
GEV No.	101285	Ref. No.	90-000343	
description	union screw thread M8x1 for pipe ø 4mm Qty 1 pcs JUNKERS			
accessories for	101285			
	GEV No.	101284	Ref. No.	—
	olive for pipe ø 4mm Qty 1 pcs			

gas lines

pilot tubes

universal

1				
GEV No.	102110	Ref. No.	90-000183	
description	pilot tube copper pipe ø 4mm thickness 1mm L 3000mm			
accessories for	102110			
	GEV No.	100908	Ref. No.	—
	union screw thread M10x1 for pipe ø 4mm Qty 1 pcs			
	GEV No.	101246	Ref. No.	—
	olive for pipe ø 4mm Qty 1 pcs			

equipment-specific units

for slicers

blades

standard

1			
GEV No.	697365	Ref. No.	541117
description	slicing machine blade ED ø 250mm seat ø 40mm 3-hole ID ø 210mm H 17.5mm C45 standard		

for convection ovens/combi-steamers

drain units

drip rails

1			
GEV No.	696533	Ref. No.	76-81000116
description	drip rail for combi-steamer L 600mm SS W 34mm hole ø 8mm		

1			
GEV No.	694434	Ref. No.	76-84551315
description	drip rail with bezel L 465mm plastic for combi-steamer hose ø 15mm		

air filters

1			
GEV No.	692695	Ref. No.	76-52141300
description	filter insert L 213mm W 60mm ømm H 90mm		

cleaning system

coupling bushings



1

GEV No. 694486 **Ref. No.** 76-20620348

description coupling bush for cleaning system



1

GEV No. 694487 **Ref. No.** 76-20620347

description coupling bush for cleaning system



1

GEV No. 694488 **Ref. No.** 76-20620350

description coupling bush for cleaning system



1

GEV No. 694489 **Ref. No.** 76-20620349

description coupling bush for cleaning system

cleaning arms



1

GEV No. 541433 **Ref. No.** 76-86552101

description cleaning arm CleanJet suitable for RATIONAL _101-_202

hoses



1

GEV No. 694362 **Ref. No.** 76-20220201

description hose for combi-steamer

service kits



1

GEV No. 530874 **Ref. No.** 76-87201521

description conversion kit - for combi-steamer CPC-Linie 61-102E RATIONAL

spare parts for 530874



GEV No. 692215 **Ref. No.** —

conversion kit for tank inlet fitting

door mechanics

miscellaneous



1

GEV No. 694934 **Ref. No.** 76-29401306

description cover for door latch suitable for combi-steamer CPC-Linie 201/202 aluminium L 96.5mm W 65.5mm

accessories



1

GEV No. 694656 **Ref. No.** 76-20390402

description door bumper silicone ø 13mm L 19mm

vibration pumps



1

GEV No. 500580 **Ref. No.** 76-30021003

description vibration pump 230V 60W 50/60Hz inlet ø 7 outlet ø 1/8" IT CEME type E512 with accessories duty cycle 1/2 ambient temperature max. 60°C medium temp max. 35°C overheating protection 110°C CleanJet

miscellaneous

			
1			
GEV No.	693526	Ref. No.	76-20601210
description	bush for spray gun		

			
1			
GEV No.	510558	Ref. No.	76-20220110
description	connection for pump		

			
1			
GEV No.	510559	Ref. No.	46-21181000 76-21181000
description	connection for pump		

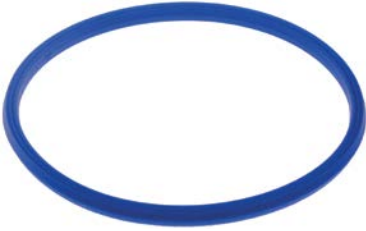



			
1			
GEV No.	694320	Ref. No.	76-50120566
description	gasket for lid ø 145mm		

			
1			
GEV No.	512184	Ref. No.	76-86641301
description	hose connector plastic thread 3/4" Qty 1 pcs connection distance 60mm T-shape		

			
1			
GEV No.	694936	Ref. No.	76-50030300
description	insulating mat for combi-steamer CPC-Linie L 1078mm W 635mm H 11mm foam Qty 2 pcs		

for dishwashers

air traps

			
1			
GEV No.	510103	Ref. No.	61984004
description	air trap L 85mm W 20mm H 80mm hose ø 6mm plastic		
spare parts for	510103		
	GEV No.	505045	Ref. No.
			—
		O-ring EPDM thickness 1.78mm ID ø 5.28mm Qty 1 pcs	
	GEV No.	505094	Ref. No.
			—
		air trap	
	GEV No.	510016	Ref. No.
			—
		eye bolt for rinse aid container connection	
	GEV No.	510105	Ref. No.
			—
		hose connector for air trap	

air trap accessories

			
1			
GEV No.	510761	Ref. No.	63-200944-1
description	flat gasket rubber D1 ø 38mm D2 ø 25mm thickness 2mm Qty 1 pcs		

door mechanics

locks



1

GEV No. 518244 **Ref. No.** 62-994011

description door catch catch

curtains

curtains



Image not available

1

GEV No. 533122 **Ref. No.** 610617

description curtain W 660mm H 430mm warewashing für wash area/rinsing



1

GEV No. 533121 **Ref. No.** 610867

description curtain W 660mm H 485mm warewashing für wash area/rinsing



1

GEV No. 533124 **Ref. No.** 602268

description curtain W 660mm H 500mm warewashing for outlet

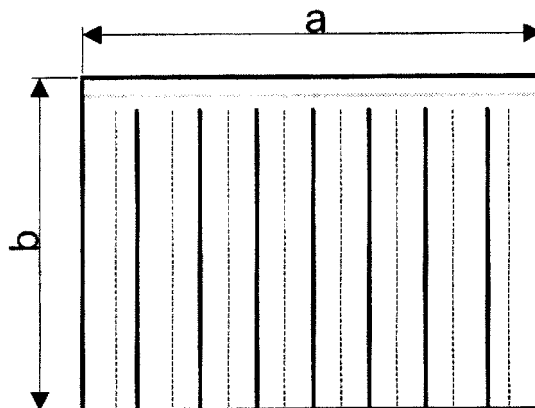

1

GEV No. 533120 **Ref. No.** 610616

description curtain W 660mm H 550mm warewashing for inlet



Image not available

1

GEV No. 533125 **Ref. No.** 500002

description curtain W 690mm H 400mm warewashing for inlet



Image not available

1

GEV No. 533126 **Ref. No.** 500003

description curtain W 696mm H 330mm warewashing für wash area/rinsing



1

GEV No. 533123 **Ref. No.** 610945

description curtain W 696mm H 450mm warewashing for drying



1

GEV No.	533127	Ref. No.	500001
description	curtain W 696mm H 500mm warewashing for wash area/outlet		

washing and rinsing systems



1

GEV No.	510643	Ref. No.	151050
description	rinse jet		



1

GEV No.	521019	Ref. No.	607540
description	union nut wash jet		
For models:	B1100X		



1

GEV No.	521020	Ref. No.	026449
description	wash jet green nozzle ø 4x7mm bore ø 8mm KREFFT		

knobs

universal knobs



1

GEV No.	110245	Ref. No.	76-30130201
description	knob thermostat t.max. 300°C ø 50mm shaft ø 6x4.6mm shaft flat upper black temperature range 50-300°C		



1

GEV No.	110251	Ref. No.	76-30130105
description	knob time 120min + permanent ON t.max.°C°C ø 50mm shaft ø 6x4.6mm shaft flat upper black		



1

GEV No.	110252	Ref. No.	76-30130108
description	knob time 120min + permanent ON t.max.°C°C ø 50mm shaft ø 6x4.6mm shaft flat upper black		

handles and hand wheels

bracket handles



1

GEV No.	700551	Ref. No.	75-3101
description	pull handle L 200mm H 62mm mounting distance 179mm handle M8		

locks



turning lever locks

universal

RAHRBACH





1

GEV No.	700098	Ref. No.	76-20160603
description	door catch mounting pos. right off-set 38mm L 110mm H 74mm W 33mm mounting distance 68/68mm series 1750		
spare parts for	700098		
	GEV No.	Ref. No.	76-20160605
	sliding plate mounting pos. right L 28mm H 3mm W 21mm H2 12.5mm		
accessories for	700098		
	GEV No.	Ref. No.	—
	base plate L 110mm W 35mm for door catch thickness 10mm		

1 			
GEV No.	690136	Ref. No.	76-20160605
description	sliding plate mounting pos. right L 28mm H 3mm W 21mm H2 12.5mm		

STUV

1 			
GEV No.	700098	Ref. No.	76-20160603
description	door catch mounting pos. right off-set 38mm L 110mm H 74mm W 33mm mounting distance 68/68mm series 1750		
spare parts for	700098		
	GEV No.	690136	Ref. No. 76-20160605
description	sliding plate mounting pos. right L 28mm H 3mm W 21mm H2 12.5mm		
accessories for	700098		
	GEV No.	514281	Ref. No. —
description	base plate L 110mm W 35mm for door catch thickness 10mm		



producer-specific

KREFFT

1 			
GEV No.	693519	Ref. No.	76-20161412 76-20161430 76-20161450
description	door handle L 230mm W 55mm H 62mm flange 56mm		

1 			
GEV No.	690102	Ref. No.	76-20161457
description	bearing block L 110mm H 63mm W 35mm mounting distance 1 30mm mounting distance 2 90mm hole ø 20mm type 1750		

1 			
GEV No.	700072	Ref. No.	76-20161300
description	door catch H 17mm L 84mm W 53mm mounting distance 68mm zinc die cast with wedge heated units		

1 			
GEV No.	700098	Ref. No.	76-20160603
description	door catch mounting pos. right off-set 38mm L 110mm H 74mm W 33mm mounting distance 68/68mm series 1750		
spare parts for	700098		
	GEV No.	690136	Ref. No. 76-20160605
description	sliding plate mounting pos. right L 28mm H 3mm W 21mm H2 12.5mm		
accessories for	700098		
	GEV No.	514281	Ref. No. —
description	base plate L 110mm W 35mm for door catch thickness 10mm		

1 			
GEV No.	693592	Ref. No.	76-20161453
description	plain washer for door latch plastic ø 56mm ID ø 40mm H 2.3mm		

1 			
GEV No.	690103	Ref. No.	76-20161452
description	screw cap H 47mm ø 40mm hole ø 10mm type 1750		

1 			
GEV No.	690136	Ref. No.	76-20160605
description	sliding plate mounting pos. right L 28mm H 3mm W 21mm H2 12.5mm		

1 			
GEV No.	690101	Ref. No.	76-20160604
description	snap lock L 85mm W 40mm mounting distance 68mm heated units H 63mm type 1750 series		



edgmount latches

handle latches

STUV

3.30.016x.x series

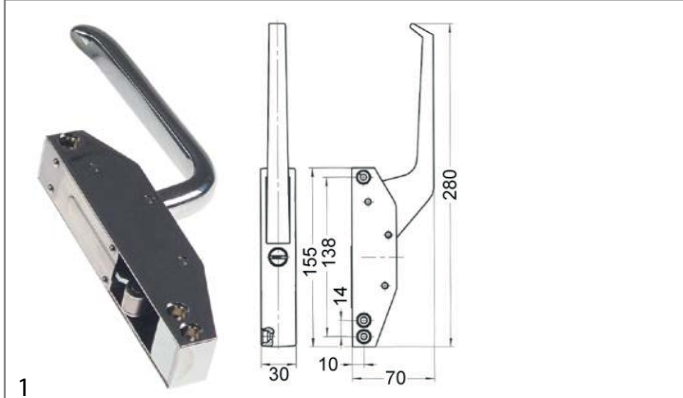

GEV No.	693517	Ref. No.	76-20161110
description	catch		

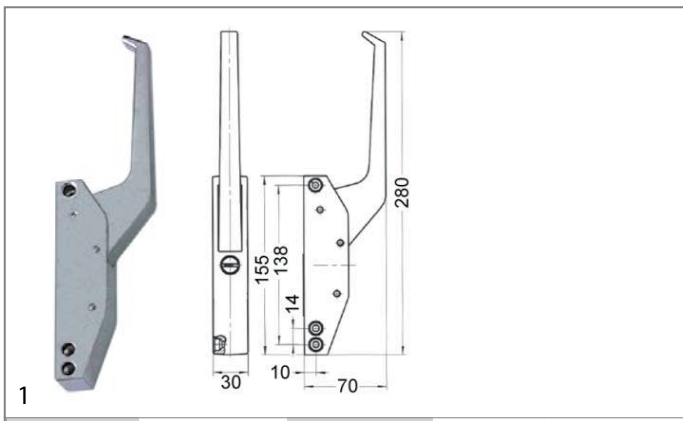

GEV No.	700063	Ref. No.	76-20161100
description	handle latch L 155mm mounting distance 124/138mm non lockable refrigeration units 3.30.0164		
accessories for	700063		
	GEV No.	700064	Ref. No.
			76-20160606 76-20160610
	door catch H 40mm L 28mm W 22mm		

door catches

	GEV No.	700064	Ref. No.
			76-20160606 76-20160610
description	door catch H 40mm L 28mm W 22mm		

walk-in fridge catches

STUV

3.31.015x.x series

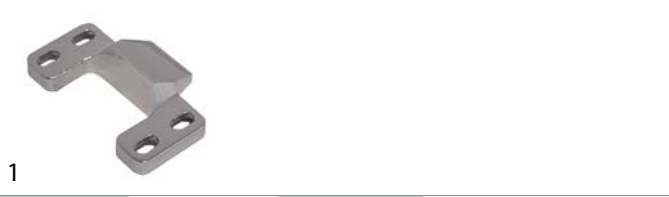

GEV No.	700072	Ref. No.	76-20161300
description	door catch H 17mm L 84mm W 53mm mounting distance 68mm zinc die cast with wedge heated units		

hinges

door bearing



GEV No.	693569	Ref. No.	76-21201254
description	bolt mounting pos. upper		

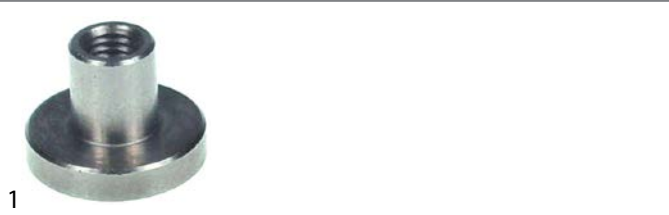

GEV No.	693558	Ref. No.	76-21201009
description	bolt mounting pos. upper for hinge		



GEV No.	693539	Ref. No.	76-20160801
description	bolt mounting pos. upper right		



GEV No.	693568	Ref. No.	76-29401300
description	bush mounting pos. upper		



1

GEV No.	693552	Ref. No.	76-84401001
description	hinge mounting pos. lower		



1

GEV No.	693567	Ref. No.	76-29301307
description	hinge mounting pos. upper		

accessories

miscellaneous



1

GEV No.	693570	Ref. No.	76-29401302
description	sleeve latching		



1

GEV No.	693571	Ref. No.	76-29401303
description	spigot latching		

fittings for catering equipment

drain taps

accessories



1

GEV No.	540083	Ref. No.	49-150301-1
description	pressure bolt for drain tap		

equipment feet and end caps

bullet feet

plastic



1

GEV No.	701589	Ref. No.	76-20390100
description	equipment foot pipe type 35x35 thickness 1-1.5mm H 15-50mm plastic		

zamak/SS



1

GEV No.	700112	Ref. No.	76-20390111
description	equipment foot pipe type 40x40 thickness 1mm H 33-60mm Zamak/SS Qty 1 pcs		

DERBY RUOTE

with bolt hole

chrome-plated steel



1

GEV No.	700200	Ref. No.	76-20050401
description	swivel castor \varnothing 100mm bolt hole bolt hole \varnothing 12mm housing chrome-plated sheet steel capacity 80kg bearing ball bearing wheel body polypropylene tread TPE tyres H 132mm wheel width 30mm Qty 1 pcs		



1

GEV No.	700201 ¹	Ref. No.	76-20050402
description	swivel castor with swivel brake \varnothing 100mm bolt hole bolt hole \varnothing 12mm housing chrome-plated sheet steel capacity 80kg bearing ball bearing wheel body polypropylene tread TPE tyres H 132mm wheel width 30mm Qty 1 pcs		

¹with swivel brake



baskets

fryer baskets

KREFFT



1			
GEV No.	970150	Ref. No.	242375
description	fryer basket L1 300mm W1 180mm H1 130mm		



1			
GEV No.	970159	Ref. No.	49-141427
description	fryer basket L1 305mm W1 175mm H1 125mm L2 515mm H2 195mm		



1			
GEV No.	970151	Ref. No.	01-242385
description	fryer basket L1 320mm W1 180mm H1 210mm		



1			
GEV No.	970149	Ref. No.	242402
description	fryer basket L1 340mm W1 310mm H1 125mm		

warewashing baskets

steel wire baskets square

glass basket



1			
GEV No.	970065	Ref. No.	503786
description	glass basket L 400mm W 400mm H 170mm number of rows 4 rows spacing 90mm		

system baskets GIADOS 500x500mm

universal baskets



1			
GEV No.	976030	Ref. No.	509552
description	tray rack L 500mm W 500mm H 116mm tablets 9		

gaskets

refrigeration gaskets

plug-in gaskets

profile 9048

We offer custom-made gaskets for this profile

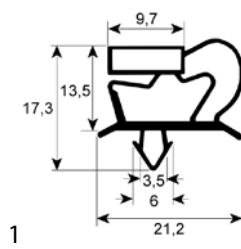

1			
GEV No.	900733	Ref. No.	90-14416800759
description	refrigeration gasket profile 9048 W 684mm L 762mm plug size		

gaskets for heated units

window seals

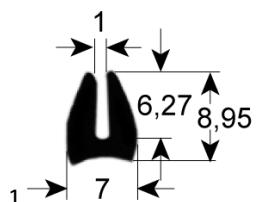

1			
GEV No.	902233	Ref. No.	76-50120201
description	window gasket profile 1560 L 2800mm Qty 1		

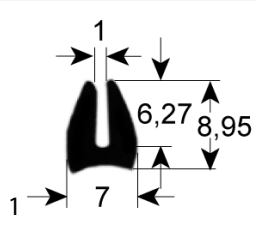

1			
GEV No.	902234	Ref. No.	76-50120202
description	window gasket profile 1560 L 3800mm Qty 1		

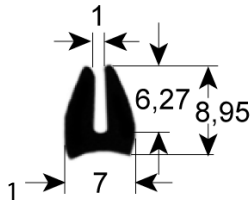

GEV No.	902235	Ref. No.	76-50120203
description	window gasket profile 1560 L 5400mm Qty 1		

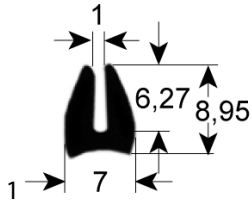

GEV No.	902218	Ref. No.	76-50120204
description	window gasket profile 1560 L 5900mm Qty 1		

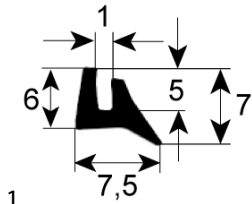

GEV No.	902236	Ref. No.	76-50120200
description	window gasket profile 1570 Qty supplied by meter		

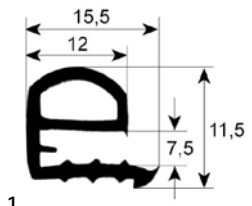

GEV No.	900088	Ref. No.	76-51051005
description	window gasket profile 1860 W 430mm L 1275mm Qty 1 20 x 1/1 external size		

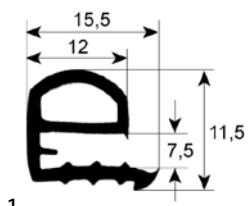

GEV No.	900183	Ref. No.	76-51051000
description	window gasket profile 1860 W 430mm L 485mm Qty 1 external size		

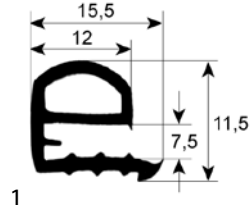

GEV No.	900184	Ref. No.	76-51051003
description	window gasket profile 1860 W 430mm L 745mm Qty 1 external size		

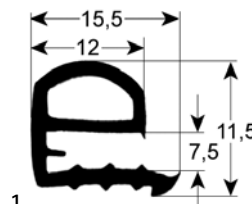

GEV No.	900193	Ref. No.	76-51051017
description	window gasket profile 1860 W 600mm L 715mm Qty 1 external size		

door seals

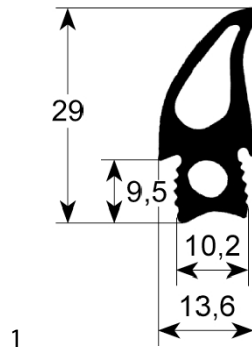

GEV No.	900091	Ref. No.	76-51051021
description	door seal for profile 2720 W 473mm L 785mm external size Qty 1 size 10 x 1/1		

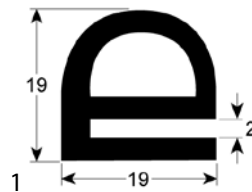

GEV No.	902237	Ref. No.	76-50120701
description	door seal profile 2210 L 3800mm Qty 1		

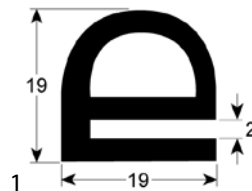

GEV No.	902238	Ref. No.	76-50120702
description	door seal profile 2210 L 4200mm Qty 1		

GEV No.	902240	Ref. No.	76-50120703
description	door seal profile 2230 W 470mm L 485mm external size Qty 1		

GEV No.	900087	Ref. No.	76-51101047
description	door seal profile 2530 W 710mm L 815mm external size Qty 1 10 x 2/1		

GEV No.	902241	Ref. No.	76-50120704
description	door seal profile 2230 W 480mm L 725mm external size Qty 1		

GEV No.	902245	Ref. No.	76-51051008
description	door seal profile 2530 W 720mm L 1410mm external size Qty 1 20 x 2/1		

GEV No.	902242	Ref. No.	76-51051001
description	door seal profile 2250 W 470mm L 520mm external size Qty 1 6 x 1/1		

GEV No.	902219	Ref. No.	76-51051020
description	door seal profile 2730 W 465mm L 520mm external size Qty 1		

GEV No.	902243	Ref. No.	76-51051004
description	door seal profile 2250 W 470mm L 790mm external size 10 x 1/1		

GEV No.	902247	Ref. No.	76-51051021
description	door seal profile 2730 W 470mm L 785mm suitable for RATIONAL for model CPC 101 outer plug size Qty 1		

GEV No.	902244	Ref. No.	76-51051007
description	door seal profile 2530 W 520mm L 1400mm external size Qty 1		

GEV No.	902220	Ref. No.	76-51051022
description	door seal profile 2730 W 685mm L 780mm suitable for RATIONAL for model SCC/CM102 edition since 11/2011 outer plug size		

GEV No.	902223	Ref. No.	76-51051023
description	door seal profile 2732 W 485mm L 1495mm external size Qty 1		

GEV No.	900147	Ref. No.	01-253241
description	door seal profile 2950 Qty supplied by meter		

gaskets for tray rack trolleys

GEV No.	902225	Ref. No.	76-50120551
description	tray rack trolley gasket profile 4020 L 1100mm Qty 1 silicone foam		

GEV No.	902226	Ref. No.	76-50120550
description	tray rack trolley gasket profile 4020 L 750mm Qty 1 silicone foam		

GEV No.	902227	Ref. No.	76-51051009 76-51051015
description	tray rack trolley gasket profile 4060 W 450mm L 170mm Qty 1 3-sided (long side open)		

GEV No.	902228	Ref. No.	76-51051010
description	tray rack trolley gasket profile 4060 W 675mm L 165mm outer plug size Qty 1 suitable for RATIONAL for model C202 3-sided (long side open)		

GEV No.	902229	Ref. No.	76-51051025
description	tray rack trolley gasket profile 4090 L 615mm Qty 1		

gaskets for control panels

GEV No.	900570	Ref. No.	76-51051012
description	gasket for control panel W 305mm L 1000mm external size suitable for RATIONAL short side open		

O-rings

EPDM

GEV No.	532731	Ref. No.	76-50120565
description	O-ring EPDM thickness 2.5mm ID \varnothing 115mm Qty 5 pcs suitable for combi-steamer CPC-Linie		



GEV No.	502036	Ref. No.	63-200805-1
description	O-ring EPDM thickness 2.62mm ID ø 28.25mm Qty 1 pcs		

silicone

GEV No.	512414	Ref. No.	76-50120560
description	O-ring silicone thickness 3mm ID ø 47.5mm Qty 5 pcs		

sealing washers

rubber gaskets

GEV No.	510761	Ref. No.	63-200944-1
description	flat gasket rubber D1 ø 38mm D2 ø 25mm thickness 2mm Qty 1 pcs		

GEV No.	560616	Ref. No.	76-51101024
description	gasket ED ø 24mm ID ø 15mm thickness 3mm Qty 5 pcs for model C-Line, CPC, SCC 61-202		

GEV No.	560617	Ref. No.	76-50120539
description	gasket rubber ED ø 19.5mm ID ø 12mm thickness 2.3mm Qty 5 pcs		

copper gaskets

DIN-7603-A

GEV No.	528197	Ref. No.	76-13150101
description	flat gasket copper ED ø 10mm ID ø 6mm thickness 1mm Qty 1 pcs		

DIN-7603-C

GEV No.	510420	Ref. No.	76-30041404
description	gasket copper ED ø 19.9mm ID ø 14.3mm thickness 2mm Qty 1 pcs		

silicone gaskets

GEV No.	510575	Ref. No.	76-20220100
description	flat gasket silicone ED ø 14.5mm ID ø 4mm thickness 4mm Qty 1 pcs		

GEV No.	359721	Ref. No.	76-30250003 76-50120509 76-50120535
description	gasket silicone ED ø 48mm ID ø 39.5mm thickness 5mm Qty 1 pcs		

sealing cords

round

GEV No.	510572	Ref. No.	76-50020300 76-50020301 76-80068008
description	sealing cord ø 10mm greased L 0.2m Qty 1		

shaft gaskets

shaft gaskets

GEV No.	510574	Ref. No.	76-50010211
description	shaft sealing type 20 for fan motor		



miscellaneous



1			
GEV No.	510573	Ref. No.	76-50010207
description	shaft seal ID ø 17mm ED ø 29mm thickness 4.5mm		

special gaskets

miscellaneous

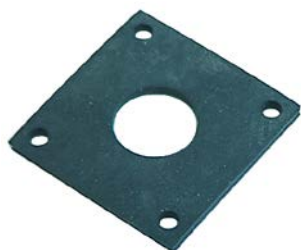

1			
GEV No.	510571	Ref. No.	76-50120528 76-50120537
description	gasket suitable for KÜPPERSBUSCH equiv. no. 407308 level regulator		



1			
GEV No.	510566	Ref. No.	76-50120528 76-50120537
description	gasket suitable for RATIONAL equiv. no. 50120537 L 70mm W 70mm electrode thickness 4mm		



1			
GEV No.	510671	Ref. No.	76-50120525 76-50120555
description	gasket suitable for RATIONAL for drain Qty 1m ED ø 124mm ID ø 51mm rubber thickness 4mm hole distance 87mm		

evaporators

for fridges

producer-specific



1			
GEV No.	750268	Ref. No.	90-14330312410
description	evaporator L 500mm W 70mm H 160mm		

springs

torsion springs

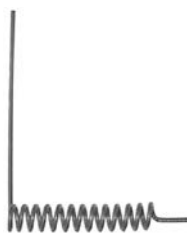

1			
GEV No.	700023	Ref. No.	01-245664
description	torsion spring ø 18.2mm L2 150mm wire gauge ø 3.2mm mounting pos. left L1 100mm L3 24mm		



1			
GEV No.	700022	Ref. No.	01-245663
description	torsion spring ø 18.6mm L2 93mm wire gauge ø 3.4mm mounting pos. right L1 133mm L3 24mm		

compression springs



1			
GEV No.	693541	Ref. No.	76-20010111
description	compression spring ø 11mm L 20mm		









			
1			
GEV No.	693591	Ref. No.	76-20010109 76-20010118
description	compression spring ø 14mm L 27mm wire gauge ø 1.5mm		

			
1			
GEV No.	511323	Ref. No.	43-450232
description	compression spring ø 41.3mm L 57mm wire gauge ø 2mm		

hose reels and spray guns

spray guns

			
1			
GEV No.	540673	Ref. No.	76-20600100
description	spray gun for appliances 1/2" ET L 135mm conversion kit		

			
1			
GEV No.	540302	Ref. No.	76-20010110 76-20600215 76-20600218 76-20601000 76-20601002 76-50120559
description	spray gun for appliances 1/2" ET L 135mm type RATIONAL		
spare parts for	540302		
	GEV No.	517056	Ref. No. —
O-ring EPDM thickness 2mm ID ø 6.5mm Qty 1 pcs			
	GEV No.	532535	Ref. No. —
O-ring EPDM thickness 5mm ID ø 10mm Qty 1 pcs			
	GEV No.	548016	Ref. No. —
compression spring ø 10mm L 17mm wire gauge ø 0.9mm for hand spray			
	GEV No.	548017	Ref. No. —
pressure bolt for hand spray			

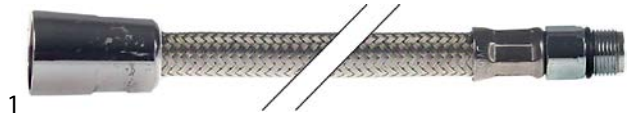
			
1			
GEV No.	530604	Ref. No.	76-20670603
description	shower hose connections 1/2" - M12x1 L 1500mm SS		

			
1			
GEV No.	520730	Ref. No.	76-20670600
description	shower hose connections 1/2" L 2400mm SS operating p. 10bar burst p. 90bar t.max. 90°C approval DVGW with flexible fabric		

			
1			
GEV No.	520729	Ref. No.	76-20670601
description	shower hose connections 1/2" L 2800mm SS operating p. 10bar burst p. 90bar t.max. 90°C approval DVGW with flexible fabric		

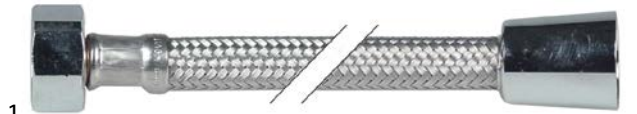
			
1			
GEV No.	520731	Ref. No.	76-20670602
description	shower hose connections 1/2" L 3200mm SS operating p. 10bar burst p. 90bar t.max. 90°C approval DVGW nominal-ø 8mm with flexible fabric		

			
1			
GEV No.	520094	Ref. No.	76-20670605 76-20670610
description	shower hose connections ø12mm - 1/2" L 1500mm for combi-steamer type type 61/101		

			
1			
GEV No.	520099	Ref. No.	76-20670611
description	shower hose connections ø12mm - 1/2" L 1800mm for combi-steamer		

			
1			
GEV No.	520108	Ref. No.	76-20670606 76-20670609
description	shower hose connections ø12mm - 1/2" L 2080mm for combi-steamer		



			
1			
GEV No.	542364	Ref. No.	76-20670710
description	shower hose for combi-steamer CPC-Linie connection 1/2" connection 2: plug-in connection ED ø 12mm L 1345mm		

			
1			
GEV No.	693526	Ref. No.	76-20601210
description	bush for spray gun		

			
1			
GEV No.	540001	Ref. No.	76-20600110
description	screw connection T1: 1/2" T2: 1/2" for spray gun rotary		

hose reels

appliance hose reels

			
1			
GEV No.	541442	Ref. No.	76-86553000
description	hose reel complete		

			
1			
GEV No.	541443	Ref. No.	76-86553003
description	hose reel complete		

			
1			
GEV No.	540662	Ref. No.	76-84101013
description	hose reel complete with spray gun hose length 1.5m		

			
1			
GEV No.	540663	Ref. No.	76-86552006
description	hose reel complete with spray gun hose length 1.5mm		

			
1			
GEV No.	541439	Ref. No.	76-84101016
description	hose reel complete with spray gun hose length 1.5mm		

			
1			
GEV No.	541440	Ref. No.	76-86552000
description	hose reel complete with spray gun hose length 1.5mm		

			
1			
GEV No.	540483	Ref. No.	76-86552020 76-86552021
description	hose reel without spray gun hose length 2.1m		



dosing pumps

peristaltic dosing pumps







GERMAC

built-in version

with frequency control



1

GEV No.	361268	Ref. No.	63-440632
description	dosing pump GERMAC frequency control 3l/h 230VAC detergent hose ø 4x6mm hose thermoplastic type G300 built-in version dimensions 67x72x101mm		
spare parts for	361268		
	GEV No.	361467	Ref. No. 63-200608/1
	pump hose GERMAC detergent hose type thermoplastic hose ø 6x10mm for model G43/G45/G53/G54/G55/G300/G305		
	GEV No.	361557	Ref. No. —
	control PCB type G300/G302/G305 GERMAC		
	GEV No.	361589	Ref. No. —
	roller assembly GERMAC suitable for G42/43/45/53/54/55/300/302/305/705		
accessories for	361268		
	GEV No.	361106	Ref. No. —
	container filter with weight and non-return valve SS hose ø 4x6mm ø 21mm L 51mm non return valve lip valve		
	GEV No.	520090	Ref. No. —
	PVC hose ID ø 4mm ED ø 6mm L 2m thickness 1mm t.max. 60°C transparent		
	GEV No.	520091	Ref. No. —
	nylon hose ID ø 4mm ED ø 6mm L 2m thickness 1mm operating p. 10bar burst p. 50bar t.max. 100°C transparent		

spare parts



1

GEV No.	361554	Ref. No.	63-200608
description	pump hose GERMAC detergent hose type thermoplastic hose ø 5x8mm for model G200/G250/G252		



1

GEV No.	361467	Ref. No.	63-200608/1
description	pump hose GERMAC detergent hose type thermoplastic hose ø 6x10mm for model G43/G45/G53/G54/G55/G300/G305		





SEKO

wall-mounted version

with speed control



1

GEV No.	361157	Ref. No.	150069
description	dosing pump SEKO speed control 1-7l/h 230VAC detergent hose ø 4x6mm hose type K hose Santoprene suction level 1.5m type PR without accessories dimensions 103x82x92mm		
spare parts for	361157		
	GEV No.	361136	Ref. No. —
	roller assembly for dosing pump hole ø 4.8x4mm		
	GEV No.	361815	Ref. No. —
	pump hose detergent hose ø 6x10mm hose ø 4x6mm hose type K hose Santoprene type SEKO		
accessories for	361157		
	GEV No.	361142	Ref. No. —
	mounting set detergent hose type 4x6mm hose length 2m PVC 2x hose/container filter/tank intake transparent		
	GEV No.	520090	Ref. No. —
	PVC hose ID ø 4mm ED ø 6mm L 2m thickness 1mm t.max. 60°C transparent		
	GEV No.	520091	Ref. No. —
	nylon hose ID ø 4mm ED ø 6mm L 2m thickness 1mm operating p. 10bar burst p. 50bar t.max. 100°C transparent		

built-in version

with frequency control



1

GEV No.	361906 ¹	Ref. No.	64-34358
description	dosing pump SEKO frequency control 2.8l/h 230VAC detergent hose ø 4x6mm hose Santoprene type NBR 3 8W CODE NBR0003A1004		

¹with accessories



piston pumps

with solenoid coil

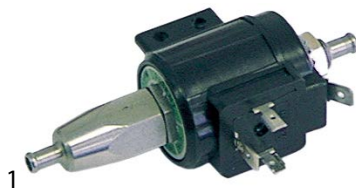

GEV No.	361026	Ref. No.	62-987017
----------------	--------	-----------------	-----------

description dosing pump inlet 5mm outlet 5mm 230V detergent duty cycle 30% type EV1

spare parts for 361026



GEV No.	361365	Ref. No.	62-201020
----------------	--------	-----------------	-----------

solenoid coil 230VAC for type EV1



GEV No.	510298	Ref. No.	62-144012
----------------	--------	-----------------	-----------

lip valve dosing pump suitable for DB2/DS5

spare parts



GEV No.	361113	Ref. No.	62-201002
----------------	--------	-----------------	-----------

description solenoid coil 230VAC for type DB2



GEV No.	361365	Ref. No.	62-201020
----------------	--------	-----------------	-----------

description solenoid coil 230VAC for type EV1



GEV No.	510298	Ref. No.	62-144012
----------------	--------	-----------------	-----------

description lip valve dosing pump suitable for DB2/DS5



GEV No.	361366	Ref. No.	62-215001
----------------	--------	-----------------	-----------

description PCB dishwasher 11F suitable for DB2 type DB2/EV1/EKP-M

membrane dosing pumps

self-priming

LANG



GEV No.	361032	Ref. No.	62-026292 62-400220
----------------	--------	-----------------	------------------------

description dosing pump type N6 membrane dosing pump rinse aid pressure connection ø angled, 4x6mm suction connection ø angled, 4x6mm

spare parts for 361032



GEV No.	361079	Ref. No.	—
----------------	--------	-----------------	---

spring for type N5/N6 for ball



GEV No.	361080	Ref. No.	—
----------------	--------	-----------------	---

O-ring EPDM thickness 2mm ID ø 16mm Qty 1 pcs



GEV No.	361085	Ref. No.	—
----------------	--------	-----------------	---

O-ring EPDM thickness 2mm ID ø 8mm Qty 1 pcs



GEV No.	361309	Ref. No.	—
----------------	--------	-----------------	---

ball for type N5/N6



GEV No.	361310	Ref. No.	—
----------------	--------	-----------------	---

bracket for type N6 ball guide



GEV No.	361311	Ref. No.	—
----------------	--------	-----------------	---

O-ring EPDM thickness 2mm ID ø 6mm Qty 1 pcs for type N6



GEV No.	361314	Ref. No.	—
----------------	--------	-----------------	---

valve ring for type N6 holder for O-ring



GEV No.	361317	Ref. No.	—
----------------	--------	-----------------	---

sealing disc for type N6



GEV No.	361886	Ref. No.	—
----------------	--------	-----------------	---

non-return valve inletmm outletmm outlet ø 12.4mm L 12.7mm



various







1

GEV No.	361015	Ref. No.	63-620120
description	dosing pump membrane dosing pump rinse aid inlet 6x8mm outlet 4x6mm pressure connection ø 4x6mm suction connection ø 6x8mm		
spare parts for	361015		
	GEV No.	361132	Ref. No. —
	membrane dosing pump		
	GEV No.	510298	Ref. No. 62-144012
	lip valve dosing pump suitable for DB2/DS5		



1

GEV No.	361002	Ref. No.	63-620120
description	dosing pump rinse aid inlet 6x8mm outlet 4x6mm pressure connection ø 4x6mm suction connection ø 6x8mm		
spare parts for	361002		
	GEV No.	510297	Ref. No. —
	membrane for dosing pump ED ø 83mm thickness 1mm dosing pump equiv. no. 630614 suitable for COMENDA		
	GEV No.	510298	Ref. No. 62-144012
	lip valve dosing pump suitable for DB2/DS5		
	GEV No.	510299	Ref. No. —
	hose connector for dosing pump		
	GEV No.	510338	Ref. No. —
	union nut dosing pump thread 1/2" ø 32mm H 15mm for dosing pump		
	GEV No.	510847	Ref. No. —
	gasket polishing agent dosing ID ø 22mm ED ø 32mm external high 5mm		
	GEV No.	510870	Ref. No. —
	filter support for dosing pump		
	GEV No.	510916	Ref. No. —
	filter for dosing pump		

spare parts



1

GEV No.	510298	Ref. No.	62-144012
description	lip valve dosing pump suitable for DB2/DS5		

self-priming with supporting pressure

ELETTROBAR



1

GEV No.	510298	Ref. No.	62-144012
description	lip valve dosing pump suitable for DB2/DS5		

GERMAC

spare parts



1

GEV No.	510298	Ref. No.	62-144012
description	lip valve dosing pump suitable for DB2/DS5		

accessories

container filters with non-return valve



1

GEV No.	361058	Ref. No.	802065
description	container filter with non-return valve SS hose ø 4x6mm ø 20mm L 56mm		



hoses

pre-rinse hoses

stainless steel flexi hoses



1

GEV No.	520730	Ref. No.	76-20670600
description	shower hose connections 1/2" L 2400mm SS operating p. 10bar burst p. 90bar t.max. 90°C approval DVGW with flexible fabric		



1

GEV No.	520729	Ref. No.	76-20670601
description	shower hose connections 1/2" L 2800mm SS operating p. 10bar burst p. 90bar t.max. 90°C approval DVGW with flexible fabric		

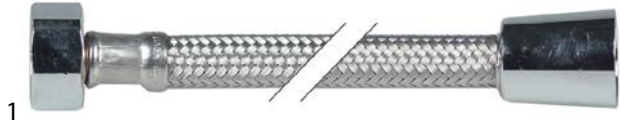

1

GEV No.	520731	Ref. No.	76-20670602
description	shower hose connections 1/2" L 3200mm SS operating p. 10bar burst p. 90bar t.max. 90°C approval DVGW nominal-ø 8mm with flexible fabric		

drain hoses

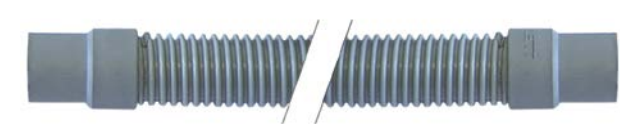

1

GEV No.	530616	Ref. No.	64-27078
description	drain hose L 1500mm A int. ø 25mm B int. ø 25mm outer hose ø 32mm		

industrial hoses

silicone hoses

with fabric

with monofilament braid

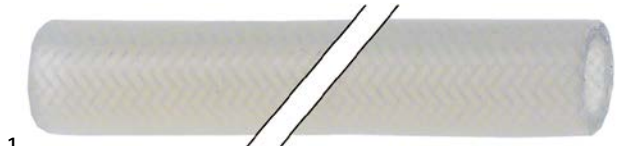

1

GEV No.	530652	Ref. No.	76-20670112
description	silicone hose with monofilament braid ID ø 10mm ED ø 17mm L 1.42m thickness 3.5mm Qty 1.42m		

GEV No.	530693	Ref. No.	76-20670050 76-20670100
description	silicone hose with monofilament braid ID ø 10mm ED ø 17mm L 1m thickness 3.5mm operating p. 4bar t.max. 200°C Qty 1m		

GEV No.	530696	Ref. No.	76-20670302
description	silicone hose with monofilament braid ID ø 13mm ED ø 20mm L 0.29m thickness 4mm Qty 0.29m		

GEV No.	530694	Ref. No.	76-20670300
description	silicone hose with monofilament braid ID ø 13mm ED ø 21mm L 1m thickness 4mm Qty 1m		

GEV No.	530695	Ref. No.	76-20670301
description	silicone hose with monofilament braid ID ø 13mm L 0.15m thickness 4mm		

formed hoses

straight



1

GEV No.	530708	Ref. No.	76-20670202
description	steam hose ID ø 42mm ED ø 58mm L 150mm for combi-steamer		



1

GEV No.	530709	Ref. No.	76-20670203
description	steam hose ID ø 42mm ED ø 58mm L 200mm for combi-steamer		



1

GEV No.	530602	Ref. No.	76-20670201
description	steam hose ID ø 42mm ED ø 60mm L 60mm Qty 1 for combi-steamer		



1

GEV No.	530706	Ref. No.	76-20670200
description	steam hose ID ø 42mm L 1000mm for combi-steamer		



1

GEV No.	530710	Ref. No.	76-20670205
description	steam hose ID ø 42mm L 580mm		



1

GEV No.	530603	Ref. No.	76-20670401
description	steam hose ID ø 60mm ED ø 68mm L 120mm Qty 1 for combi-steamer		

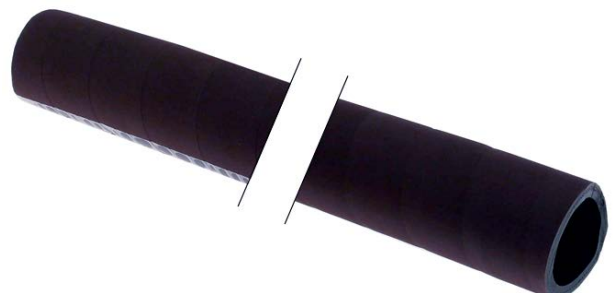

1

GEV No.	530605	Ref. No.	76-20670400
description	steam hose ID ø 60mm L 1000mm steam		

miscellaneous



1

GEV No.	530066	Ref. No.	76-21121302
description	formed hose ID ø 24mm ED ø 30mm L 380mm		

fittings, hose and pipe connectors

hose connectors

without screw connection



1

GEV No.	361683	Ref. No.	76-20620301
description	hose connector plastic hose ø 10-10mm 2-way		

hose connectors

producer-specific



1

GEV No.	698612	Ref. No.	76-84641300
description	T-piece thread 3/4" ET - 1/2" ET - 3/4" IT plastic		



ancillary products

silicone

food-grade silicones



1

GEV No.	890106	Ref. No.	76-50060200
description	silicone TB40 transparent tube 90g -40 up to +160°C		
description	<p>Tomabond - TB40 - tube 90g - transparent For flexible sealing in drinking water, food, water and industrial kitchen areas. Securely joins glass, metal, wood-based materials, ceramic and plastics with high adhesion (1.1 N/mm²). Fungicide-, algicide- and solvent-free, ageing-resistant. Temperature-resistant from -40 °C to +160 °C Tested and approved by KTW / KSW.</p>		

clamps

hose clamps

DIN 3017 - W2



1

GEV No.	520112	Ref. No.	76-20660202
description	hose clamp ø 12-20mm width 9mm Qty 10 pcs DIN 3017		



1

GEV No.	520114	Ref. No.	76-20660506
description	hose clamp ø 20-32mm width 9mm Qty 10 pcs DIN 3017		



1

GEV No.	520118	Ref. No.	081599 76-20660300
description	hose clamp ø 50-70mm width 9mm Qty 5 pcs DIN 3017		



1

GEV No.	520119	Ref. No.	76-20660516
description	hose clamp ø 60-80mm width 9mm Qty 5 pcs DIN 3017		



1

GEV No.	520454	Ref. No.	76-20660505
description	hose clamp ø 70-90mm width 9mm Qty 5 pcs DIN 3017		



1

GEV No.	520117	Ref. No.	76-20660504
description	hose clamp stainless steel ø 40-60mm width 9mm Qty 5 pcs DIN 3017		

DIN 3017 - W4



1

GEV No.	520120	Ref. No.	81594
description	hose clamp SS W4 ø 12-20mm width 9mm Qty 1 pcs DIN 3017		

double wire clamps



1

GEV No.	520916	Ref. No.	76-20660518
description	hose clamp ø 30mm wire gauge ø 2.7mm chrome-plated steel Qty 1 pcs		



1

GEV No.	560570	Ref. No.	76-20660519
description	hose clamp ø 35.6mm wire gauge ø 3mm Qty 1 pcs		



tools

cleaning tools

descaling pumps

descaling pumps

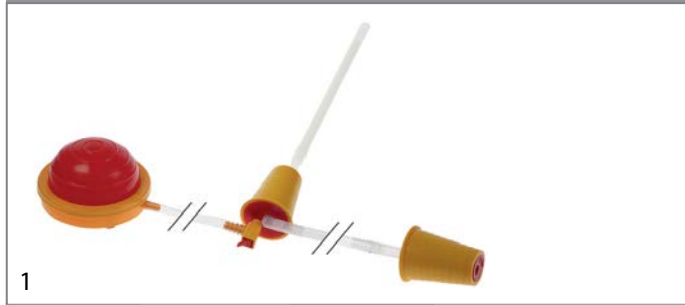

GEV No.	890294	Ref. No.	76-60040203
description	descaling pump manual 12l/min connection stuff		

fastening material

rivets/rivet nuts

sealed blind rivets



GEV No.	560180	Ref. No.	76-16030165
description	sealed blank rivets SS ϕ 3.2mm L 10mm Qty 50 pcs		

screws

countersunk screws



GEV No.	560044	Ref. No.	76-10061960
description	countersunk screw thread M6 L 16mm WS 4 SS DIN 7991/ISO 10642 Qty 20 pcs intake hexagonal		

hexagonal screws

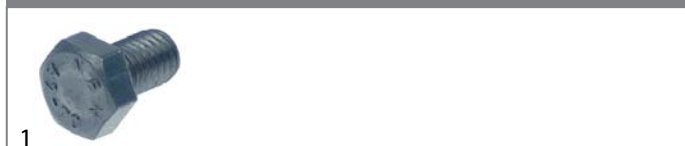

GEV No.	560448	Ref. No.	76-10080753
description	hexagonal screw thread M5 thread L 8mm SS WS 8 Qty 1 pcs head thickness 4mm DIN 933 / ISO 4017		



GEV No.	560079	Ref. No.	76-10060761
description	hexagonal screw thread M6 thread L 12mm SS WS 10 Qty 20 pcs DIN 933 / ISO 4017		

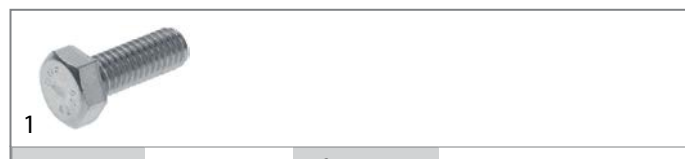

GEV No.	560087	Ref. No.	76-10060760
description	hexagonal screw thread M6 thread L 16mm SS WS 10 Qty 20 pcs DIN 933 / ISO 4017		



GEV No.	560204	Ref. No.	76-10080761
description	hexagonal screw thread M8 thread L 25mm SS WS 13 Qty 1 pcs DIN 933 / ISO 4017		



GEV No.	560205	Ref. No.	76-10080766
description	hexagonal screw thread M8 thread L 30mm SS WS 13 Qty 1 pcs DIN 933 / ISO 4017		



GEV No.	550528	Ref. No.	76-10052000
description	safety screw thread M5 WS 8 Qty 10 pcs L 8mm head ϕ 11mm		

nuts

cap nuts



GEV No.	560137	Ref. No.	76-11060360
description	cap nuts thread M6 WS 10 SS Qty 20 pcs DIN/ISO DIN 1587		

hexagonal nuts

hexagonal nuts metric (without norm)



1

GEV No.	530881	Ref. No.	76-11060220
description	hexagonal nut thread M6 H 3mm WS 10 SS Qty 25 pcs for combi-steamer CPC-Linie		



1

GEV No.	520230	Ref. No.	76-30041406
description	nut thread M14x1.5 H 5mm WS 19 zinc-coated steel Qty 1 pcs		

washers

spring rings



1

GEV No.	560122	Ref. No.	76-12050360
description	lock washer ID ø 5.2mm ED ø 9mm SS DIN127 Qty 20 pcs for thread M5		

spring washers



1

GEV No.	696429	Ref. No.	76-20161455
description	spring washer ID ø 20.5mm ED ø 40mm steel Qty 1 pcs		

washers

DIN 125A



1

GEV No.	560312	Ref. No.	76-13100160
description	plain washer ID ø 10.5mm ED ø 20mm thickness 2mm SS Qty 1 pcs DIN 125A for thread M10		



1

GEV No.	560113	Ref. No.	76-13060120
description	plain washer ID ø 6.4mm ED ø 12mm thickness 1.6mm SS Qty 20 pcs DIN 125A for thread M6		



1

GEV No.	560114	Ref. No.	76-13080160
description	plain washer ID ø 8.4mm ED ø 16mm thickness 1.6mm SS Qty 20 pcs DIN 125A for thread M8		

tooth lock washers

miscellaneous



1

GEV No.	520228	Ref. No.	76-30041405
description	tooth lock washer ID ø 15.3mm ED ø 24mm steel Qty 1 pcs for thread M14		

fasteners

clamps

hose clamps

DIN 3017 - W2



1

GEV No.	520112	Ref. No.	76-20660202
description	hose clamp ø 12-20mm width 9mm Qty 10 pcs DIN 3017		



1

GEV No.	520114	Ref. No.	76-20660506
description	hose clamp ø 20-32mm width 9mm Qty 10 pcs DIN 3017		



1

GEV No.	520118	Ref. No.	081599 76-20660300
description	hose clamp ø 50-70mm width 9mm Qty 5 pcs DIN 3017		



			
1			
GEV No.	520119	Ref. No.	76-20660516
description	hose clamp ø 60-80mm width 9mm Qty 5 pcs DIN 3017		

			
1			
GEV No.	520454	Ref. No.	76-20660505
description	hose clamp ø 70-90mm width 9mm Qty 5 pcs DIN 3017		

			
1			
GEV No.	520117	Ref. No.	76-20660504
description	hose clamp stainless steel ø 40-60mm width 9mm Qty 5 pcs DIN 3017		

DIN 3017 - W4			
			
1			
GEV No.	520120	Ref. No.	81594
description	hose clamp SS W4 ø 12-20mm width 9mm Qty 1 pcs DIN 3017		

double wire clamps			
			
1			
GEV No.	520916	Ref. No.	76-20660518
description	hose clamp ø 30mm wire gauge ø 2.7mm chrome-plated steel Qty 1 pcs		

			
1			
GEV No.	560570	Ref. No.	76-20660519
description	hose clamp ø 35.6mm wire gauge ø 3mm Qty 1 pcs		

consumables

sealants and adhesives

food-grade silicones

			
1			
GEV No.	890106	Ref. No.	76-50060200
description	silicone TB40 transparent tube 90g -40 up to +160°C		
description	<p>Tomabond - TB40 - tube 90g - transparent</p> <p>For flexible sealing in drinking water, food, water and industrial kitchen areas. Securely joins glass, metal, wood-based materials, ceramic and plastics with high adhesion (1.1 N/mm²).</p> <p>Fungicide-, algicide- and solvent-free, ageing-resistant.</p> <p>Temperature-resistant from -40 °C to +160 °C</p> <p>Tested and approved by KTW / KSW.</p>		

fuses

fine fuses

			
1			
GEV No.	358597	Ref. No.	76-30190400
description	fine fuse size ø5x20mm 0.5A slow-acting rated 250V Qty 10 pcs		

			
1			
GEV No.	358603	Ref. No.	76-30190120
description	fine fuse size ø5x20mm 2A slow-acting rated 250V Qty 10 pcs		

			
1			
GEV No.	358607	Ref. No.	76-30190200
description	fine fuse size ø5x20mm 6.3A slow-acting rated 250V Qty 10 pcs		

ø5x30mm 500V

			
1			
GEV No.	358735	Ref. No.	76-40010218
description	fine fuse size ø5x30mm 6.3A medium lag rated 500V Qty 10 pcs		

ø6.3x32mm 250V



1

GEV No.	358791	Ref. No.	76-40010224
description	fine fuse size ø6.3x32mm 6.3A slow-acting rated 250V Qty 10 pcs		

screw locks

D0-system (NEOZED)



1

GEV No.	358045	Ref. No.	76-30190403
description	fuse size D02 35A rated 250/400V E18 ø 15mm L 36mm Qty 10 pcs		



1

GEV No.	358046	Ref. No.	76-30190404
description	fuse size D02 50A rated 250/400V E18 ø 15mm L 36mm Qty 10 pcs		

A			
alarm devices	29		
appliance hose reels	78		
axial fans	43		
B			
bar burners	62		
bi-metal thermostats	14, 14		
booster pumps II	51		
C			
cable glands	53		
cables	53		
cam switches	21		
cap nuts	85		
castors and bumper angles	70		
CEE plugs	53		
clamps	84, 86		
cleaning tools	85		
condensators & interference suppression filters	51		
connection cables	53		
consumables	87		
contactors	29		
container filters	81		
control equipment	23		
control thermostats	14, 18		
countersunk screws	85		
cross flow fans	43		
D			
digital timers	28		
door catches	69		
door seals	72		
dosing pumps	79		
double wire clamps	84, 87		
drain hoses	82		
drain pumps	50		
E			
edgemount latches	69		
electric accessories	53		
electric timers	28		
electrodes	43		
electronic controllers	35		
energy regulators	14		
evaporators	76		
F			
fans	43		
fasteners	86		
fastening material	85		
female fastons	54		
		filters	51
		fine fuses	87
		float switches	21
		flow sensors	43
		food-grade silicones	84, 87
		formed hoses	82
		fuses	52, 87
G			
		gas burners	61
		gas control valves	58
		gas lines	63
		gas nozzles	62
		gas taps	54
		gaskets for control panels	74
		gaskets for heated units	71
		gaskets for tray rack trolleys	74
H			
		halogen lamp	26
		handle latches	69
		heating elements	3
		heating elements for bain maries	3
		heating elements for charrills	5
		heating elements for convection	11
		heating elements for fryers	4
		heating elements for griddles	5
		heating elements for ovens	3
		heating elements for salamanders/toasters	5
		heating elements for tilting bratt pan	5
		hexagonal nuts	86
		hexagonal screws	85
		hob burners	61
		hose clamps	84, 86
		hose connectors	83, 83
		hose reels	78
		hoses	82
		hot air fans	45
		hot air motors	44
I			
		ignition boxes	58
		ignition cables	61
		immersion heating elements	6
		indicator lights	24
		indicator lights (complete)	25
		industrial hoses	82
L			
		lamps	24
		light bulbs	26

M

magnetic switches	22
microswitches	19
motors	46

N

neon light bulbs	24, 26
nuts	85

O

operating capacitors	51
O-rings	74
oven lamps	26

P

pilot burners	58
pilot heating elements	6
plug-in gaskets	71
plugs - couplings - power sockets	53
position switches	20
pre-rinse hoses	82
pressure switches	42
probes	35
programme timers	27
pumps	47
pumps for ice machines	51
push/momentary push switches	19

R

radial fans	46
refrigeration gaskets	71
relays	33
rivets/rivet nuts	85
rocker/momentary rocker switches	19
rotary switches	22

S

safety bi-metal thermostats	14
safety thermostats	16
screw locks	88
screws	85
sealants and adhesives	87
sealing cords	75
sealing washers	75
shaft gaskets	75
silicone	84, 87
silicone hoses	82
solenoid valves	38
solid state relays	33
spray guns	77
spray guns with external thread	77
spring rings	86

spring washers	86
stainless steel flexi hoses	82
surface burners	62
switches and momentary switches	19
system switches (ROLD)	20

T

terminals	54
terminals and connectors	54
thermocouples	61
thermostats	14
threaded cable glands	53
time relays	34
timers	27
tools	85
tooth lock washers	86
transformers	34
turning lever locks	67

V

vibration pumps	51
-----------------	----

W

walk-in fridge catches	69
wash and rinse pumps	47
washers	86
window seals	71