



GAS COMPONENTS



ELECTRIC COMPONENTS



WATER TECHNOLOGY



MECHANICAL COMPONENTS



TOOLS

Spare parts suitable for

KOMEL

Find the complete and up-to-date range of products in our GEV Webshop



Manufacturer catalogue

The most important spare parts and accessories arranged clearly for every manufacturer

- ✓ Complete product range and all appliance data always up to date in the GEV Webshop
- ✓ Alphabetical Index at the end of the catalogue

GEV Webshop

www.gev-online.co.uk

www.gev-online.com



- 🔍 Add to Favourites
- 🔍 Sign In with email address and usual password
- 🔍 Easy-order – place several items in your basket at the same time
- 🔍 Quick Item search – no login needed



heating elements

heating elements for fryers

2 hole fixing

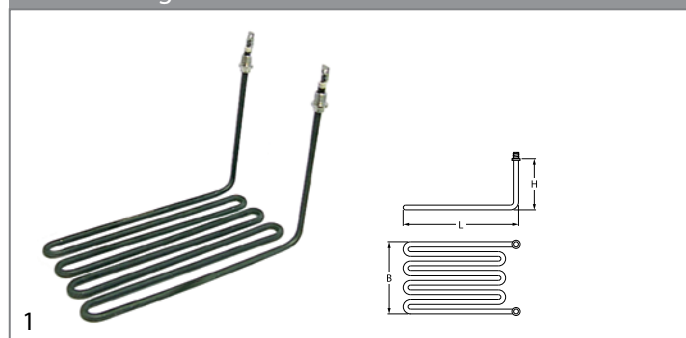

GEV No.	415920	Ref. No.	00033120
description	heating element 2800W 230V heating circuits 1 L 280mm W 160mm H 185mm thread 1/4" tube ø 8.5mm windings 4 connection M4 2 hole fixing fryer heaters		
accessories for	415920		
	GEV No.	510417	Ref. No. —
	flat gasket fibre ED ø 20mm ID ø 14mm thickness 2mm Qty 1 pcs		
	GEV No.	520228	Ref. No. —
	tooth lock washer ID ø 15.3mm ED ø 24mm steel Qty 1 pcs for thread M14		
	GEV No.	520230	Ref. No. —
	nut thread M14x1.5 H 5mm WS 19 zinc-coated steel Qty 1 pcs		
	GEV No.	521101	Ref. No. —
	nut thread M14x1.5 H 5mm WS 19 SS Qty 1 pcs		
	GEV No.	521103	Ref. No. —
	nut thread M4 H 3mm WS 7 brass Qty 20 pcs		
	GEV No.	521104	Ref. No. —
	washer ID ø 4.3mm ED ø 8mm thickness 0.5mm brass Qty 20 pcs for thread M4		
	GEV No.	550262	Ref. No. —
	flat gasket copper ED ø 20mm ID ø 14mm thickness 2mm		
	GEV No.	560111	Ref. No. —
	plain washer ID ø 4.3mm ED ø 9mm thickness 0.8mm SS Qty 20 pcs DIN 125A for thread M4		
	GEV No.	560131	Ref. No. —
	hexagonal nut thread M4 H 3.2mm WS 7 SS DIN/ISO DIN 934 / ISO 4032/8673 Qty 20 pcs		

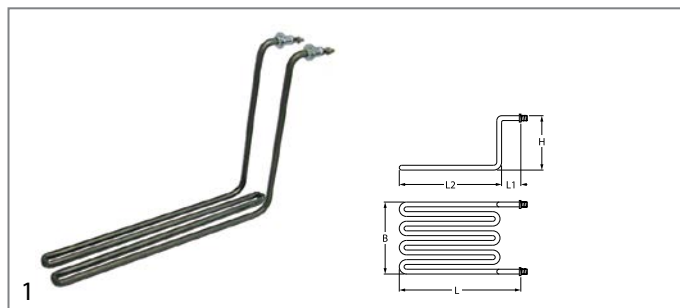

GEV No.	415921	Ref. No.	00033130
description	heating element 1260W 230V heating circuits 1 L 320mm W 48mm H 220mm L1 22mm L2 298mm thread 1/4" tube ø 8.5mm windings 2 2 hole fixing connection M4 fryer heaters		
accessories for	415921		
	GEV No.	521103	Ref. No. —
	nut thread M4 H 3mm WS 7 brass Qty 20 pcs		
	GEV No.	521104	Ref. No. —
	washer ID ø 4.3mm ED ø 8mm thickness 0.5mm brass Qty 20 pcs for thread M4		
	GEV No.	560111	Ref. No. —
	plain washer ID ø 4.3mm ED ø 9mm thickness 0.8mm SS Qty 20 pcs DIN 125A for thread M4		
	GEV No.	560131	Ref. No. —
	hexagonal nut thread M4 H 3.2mm WS 7 SS DIN/ISO DIN 934 / ISO 4032/8673 Qty 20 pcs		

group 7



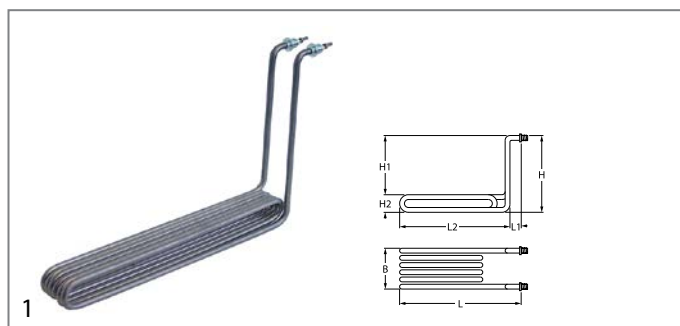

GEV No.	420210	Ref. No.	00039276
description	heating element 1600W 230V heating circuits 1 L 283mm W 75mm H 200mm 2 hole fixing connection male faston 6.3mm immersion heater L1 10mm L2 273mm W1 12.5mm W2 50mm H1 20mm H2 180mm tube ø 8.5mm thread 1/4" mounting distance 41.5mm windings 2		



GEV No.	416783	Ref. No.	00033154 00033155
description	heating element 5500W 230V heating circuits 1 L 250mm W 60mm H 250mm L1 22mm L2 375mm H1 206mm H2 44mm thread M14x1.5 tube ø 8.5mm 2 hole fixing connection M4 fryer heaters windings 6		
accessories for	416783		
	GEV No.	521103	Ref. No. —
	nut thread M4 H 3mm WS 7 brass Qty 20 pcs		

Table continues overleaf





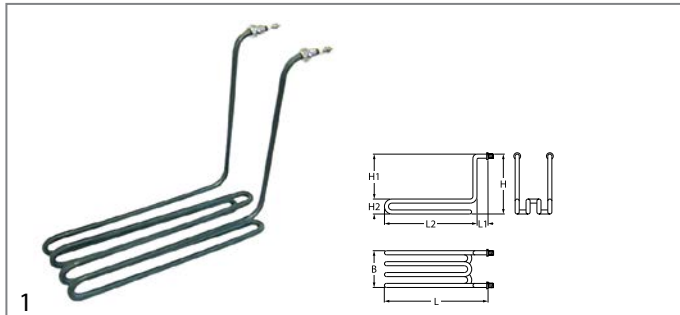

accessories for 416783			
	GEV No.	521104	Ref. No. —
washer ID \varnothing 4.3mm ED \varnothing 8mm thickness 0.5mm brass Qty 20 pcs for thread M4			
	GEV No.	560111	Ref. No. —
plain washer ID \varnothing 4.3mm ED \varnothing 9mm thickness 0.8mm SS Qty 20 pcs DIN 125A for thread M4			
	GEV No.	560131	Ref. No. —
hexagonal nut thread M4 H 3.2mm WS 7 SS DIN/ISO DIN 934 / ISO 4032/8673 Qty 20 pcs			

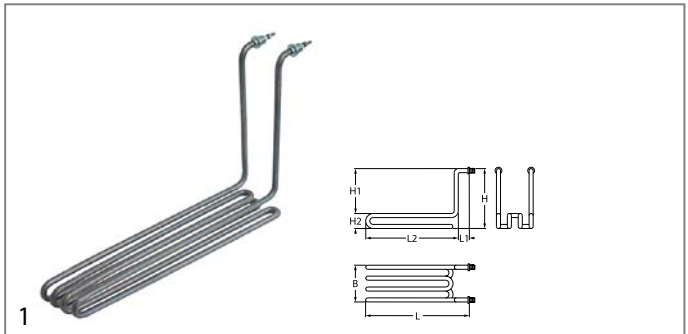

GEV No.	415924	Ref. No.	00033142
description	heating element 3000W 230V heating circuits 1 L 297mm W 86mm H 243mm L1 22mm L2 275mm H1 207mm H2 36mm thread 1/4" mounting distance 34mm tube \varnothing 8.5mm 2 hole fixing connection M4 fryer heaters windings 4		
accessories for 415924			
	GEV No.	361182	Ref. No. —
nut thread 1/4" H 5mm nickel-plated brass WS 17 Qty 1 pcs			
	GEV No.	510417	Ref. No. —
flat gasket fibre ED \varnothing 20mm ID \varnothing 14mm thickness 2mm Qty 1 pcs			
	GEV No.	520228	Ref. No. —
tooth lock washer ID \varnothing 15.3mm ED \varnothing 24mm steel Qty 1 pcs for thread M14			
	GEV No.	521103	Ref. No. —
nut thread M4 H 3mm WS 7 brass Qty 20 pcs			
	GEV No.	521104	Ref. No. —
washer ID \varnothing 4.3mm ED \varnothing 8mm thickness 0.5mm brass Qty 20 pcs for thread M4			
	GEV No.	550262	Ref. No. —
flat gasket copper ED \varnothing 20mm ID \varnothing 14mm thickness 2mm			
	GEV No.	560111	Ref. No. —
plain washer ID \varnothing 4.3mm ED \varnothing 9mm thickness 0.8mm SS Qty 20 pcs DIN 125A for thread M4			
	GEV No.	560131	Ref. No. —
hexagonal nut thread M4 H 3.2mm WS 7 SS DIN/ISO DIN 934 / ISO 4032/8673 Qty 20 pcs			



GEV No.	416782	Ref. No.	00033150 00033151
description	heating element 3333W 230V heating circuits 1 L 395mm W 85mm H 245mm L1 23mm L2 375mm H1 210mm H2 35mm thread 1/4" mounting distance 76mm tube \varnothing 8.5mm 2 hole fixing connection M4 connection length 37mm fryer heaters windings 4		
accessories for 416782			
	GEV No.	521103	Ref. No. —
nut thread M4 H 3mm WS 7 brass Qty 20 pcs			
	GEV No.	521104	Ref. No. —
washer ID \varnothing 4.3mm ED \varnothing 8mm thickness 0.5mm brass Qty 20 pcs for thread M4			
	GEV No.	560111	Ref. No. —
plain washer ID \varnothing 4.3mm ED \varnothing 9mm thickness 0.8mm SS Qty 20 pcs DIN 125A for thread M4			
	GEV No.	560131	Ref. No. —
hexagonal nut thread M4 H 3.2mm WS 7 SS DIN/ISO DIN 934 / ISO 4032/8673 Qty 20 pcs			

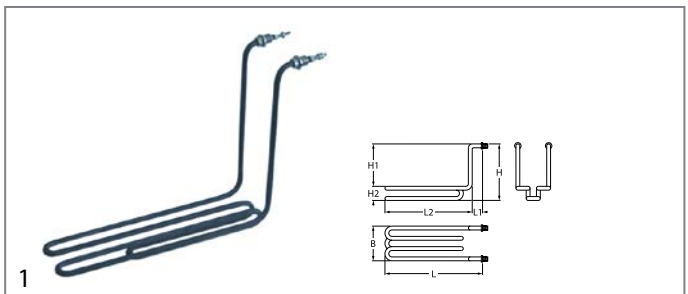

GEV No.	415922	Ref. No.	00033140
description	heating element 1680W 230V windings 2		

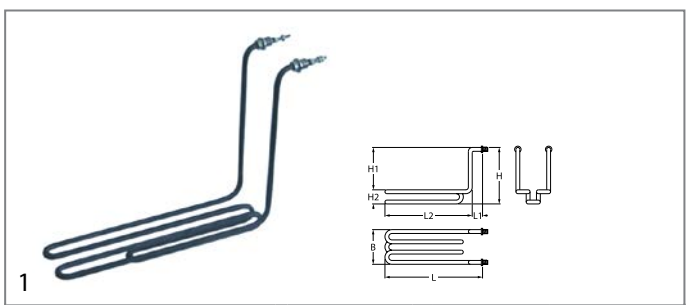

GEV No.	415923	Ref. No.	00033141
description	heating element 2000W 230V heating circuits 1 L 315mm W 74mm H 250mm L1 20mm L2 295mm H1 214mm H2 36mm thread 1/4" mounting distance 66mm tube \varnothing 8.5mm 2 hole fixing connection M4 fryer heaters windings 2 fryer		
spare parts for 415923			
	GEV No.	510417	Ref. No. —
flat gasket fibre ED \varnothing 20mm ID \varnothing 14mm thickness 2mm Qty 1 pcs			

Table continues overleaf



accessories for		415923	
	GEV No.	361182	Ref. No. —
nut thread 1/4" H 5mm nickel-plated brass WS 17 Qty 1 pcs			
	GEV No.	520228	Ref. No. —
tooth lock washer ID ø 15.3mm ED ø 24mm steel Qty 1 pcs for thread M14			
	GEV No.	521103	Ref. No. —
nut thread M4 H 3mm WS 7 brass Qty 20 pcs			
	GEV No.	521104	Ref. No. —
washer ID ø 4.3mm ED ø 8mm thickness 0.5mm brass Qty 20 pcs for thread M4			
	GEV No.	550262	Ref. No. —
flat gasket copper ED ø 20mm ID ø 14mm thickness 2mm			
	GEV No.	560111	Ref. No. —
plain washer ID ø 4.3mm ED ø 9mm thickness 0.8mm SS Qty 20 pcs DIN 125A for thread M4			
	GEV No.	560131	Ref. No. —
hexagonal nut thread M4 H 3.2mm WS 7 SS DIN/ISO DIN 934 / ISO 4032/8673 Qty 20 pcs			

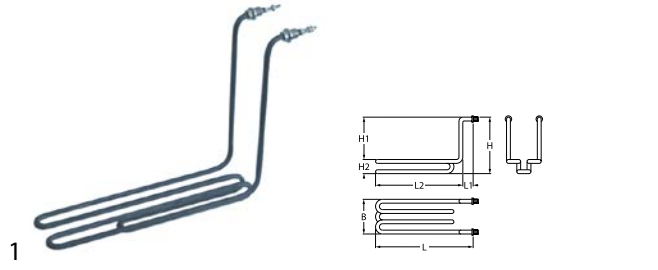

1

GEV No.	419056	Ref. No.	00033145
description	heating element 2000W 240V heating circuits 1 L 315mm W 74mm H 250mm L1 20mm L2 295mm H1 214mm H2 36mm thread 1/4" mounting distance 66mm tube ø 8.5mm 2 hole fixing connection M4 fryer heaters windings 2 fryer		



1

GEV No.	420209	Ref. No.	00039278
description	heating element 9000W 230V heating circuits 3 L 310mm W 180mm H 235mm L1 10mm L2 300mm thread 1/4" mounting distance 34.5mm tube ø 8.5mm 6 hole fixing connection male faston 6.3mm immersion heater fryer		

coil heating elements



1

GEV No.	420345	Ref. No.	00055600 00055640
description	heating element 1400W 230V L 285mm W 135mm ø 19.5mm thread 3/8" connection M5 for drying heating circuits 1 2 hole fixing		

immersion heating elements

miscellaneous



1

GEV No.	418574	Ref. No.	00203052
description	heating element 3000W 230V heating circuits 1 L 233mm W 45mm H 29mm rectangular flange hole distance 50mm hole ø 9.5mm connection male faston 6.3mm tube ø 8.5mm flange length 96mm flange width 80mm immersion heater INCOLOY-800		
accessories for	418574		
	GEV No.	510401	Ref. No. 00003430
gasket rubber L 88mm W 73mm thickness 5mm hole ø 7mm hole distance 65mm for heating element 4 holes ID ø 50mm			





1

GEV No.	415178	Ref. No.	00203049
description	heating element 3000W 230V immersion heater		



1

GEV No.	418548	Ref. No.	00003325
description	heating element 5200W 230V heating circuits 3 L 325mm W 47mm H 50mm tube ø 8.5mm hole distance 62mm hole ø 9.3mm connection M4 4 hole flange immersion heater flange width 81mm flange length 96mm with thermal fuse		
spare parts for	418548		
	GEV No.	510401	Ref. No. 00003430
gasket rubber L 88mm W 73mm thickness 5mm hole ø 7mm hole distance 65mm for heating element 4 holes ID ø 50mm			











1



GEV No.	415031	Ref. No.	00003324
description	heating element 5700W 230V heating circuits 3		
accessories for	415031		
	GEV No.	510401	Ref. No. 00003430
gasket rubber L 88mm W 73mm thickness 5mm hole ø 7mm hole distance 65mm for heating element 4 holes ID ø 50mm			







			
GEV No.	415032	Ref. No.	00003330 00003334
description	heating element 7500W 230V heating circuits 3 4 hole flange immersion heater		
accessories for	415032		
	GEV No.	510401	Ref. No. 00003430
	gasket rubber L 88mm W 73mm thickness 5mm hole ø 7mm hole distance 65mm for heating element 4 holes ID ø 50mm		
	GEV No.	521103	Ref. No. —
	nut thread M4 H 3mm WS 7 brass Qty 20 pcs		
	GEV No.	521104	Ref. No. —
	washer ID ø 4.3mm ED ø 8mm thickness 0.5mm brass Qty 20 pcs for thread M4		
	GEV No.	560111	Ref. No. —
	plain washer ID ø 4.3mm ED ø 9mm thickness 0.8mm SS Qty 20 pcs DIN 125A for thread M4		
	GEV No.	560131	Ref. No. —
	hexagonal nut thread M4 H 3.2mm WS 7 SS DIN/ISO DIN 934 / ISO 4032/8673 Qty 20 pcs		

			
GEV No.	415033	Ref. No.	00003349 old version
description	heating element 9000W 230V heating circuits 3 L 322mm W 37mm H 68mm tube ø 6.3mm hole distance 67/45mm hole ø 10mm connection M4 4 hole flange immersion heater		
accessories for	415033		
	GEV No.	510401	Ref. No. 00003430
	gasket rubber L 88mm W 73mm thickness 5mm hole ø 7mm hole distance 65mm for heating element 4 holes ID ø 50mm		
	GEV No.	521103	Ref. No. —
	nut thread M4 H 3mm WS 7 brass Qty 20 pcs		
	GEV No.	521104	Ref. No. —
	washer ID ø 4.3mm ED ø 8mm thickness 0.5mm brass Qty 20 pcs for thread M4		
	GEV No.	560111	Ref. No. —
	plain washer ID ø 4.3mm ED ø 9mm thickness 0.8mm SS Qty 20 pcs DIN 125A for thread M4		
	GEV No.	560131	Ref. No. —
	hexagonal nut thread M4 H 3.2mm WS 7 SS DIN/ISO DIN 934 / ISO 4032/8673 Qty 20 pcs		

			
GEV No.	420213	Ref. No.	00003335
description	heating element 9000W 240V heating circuits 3 L 483mm W 46mm H 40mm tube ø 8.5mm hole distance 65mm hole ø 9.5mm connection M4 4 hole flange immersion heater flange width 81mm flange length 96mm		
accessories for	420213		
	GEV No.	510401	Ref. No. 00003430
	gasket rubber L 88mm W 73mm thickness 5mm hole ø 7mm hole distance 65mm for heating element 4 holes ID ø 50mm		

			
GEV No.	418879	Ref. No.	00003349
description	heating element 9800W 230V heating circuits 3 L 322mm W 37mm H 68mm number of thermostat sleeves 2 thermostat sleeves ø 6.5/10mm length thermostat sleeves 185/80mm tube ø 6.3mm hole distance 65/45mm hole ø 10mm connection M4 4 hole flange immersion heater flange width 81mm flange length 96mm		
accessories for	418879		
	GEV No.	510401	Ref. No. 00003430
	gasket rubber L 88mm W 73mm thickness 5mm hole ø 7mm hole distance 65mm for heating element 4 holes ID ø 50mm		

1 1/4"			
			
GEV No.	415153	Ref. No.	00003270
description	heating element 5700W 230V heating circuits 3 thread 1 1/4" L 300mm W 85mm H 42mm L1 120mm L2 180mm W1 29mm W2 28mm H1 21mm H2 21mm tube ø 6.3mm connection male faston 6.3mm connection length 40mm flange with thread immersion heater		
spare parts for	415153		
	GEV No.	510405	Ref. No. —
	flat gasket fibre ED ø 56mm ID ø 42mm thickness 2mm for thread 1 1/4" Qty 1 pcs		
accessories for	415153		
	GEV No.	520232	Ref. No. —
	nut thread 1 1/4" H 5mm nickel-plated brass WS 47 Qty 1 pcs		
	GEV No.	528021	Ref. No. —
	flat gasket PTFE ED ø 53mm ID ø 42.5mm thickness 3mm Qty 1 pcs equiv. no. 12001/02286 suitable for Astoria/Aurora/Brasilia/Wega		

			
GEV No.	418981	Ref. No.	00003277
description	heating element 1000/1300/1400W 200/230/240V heating circuits 1 L 213mm W 67mm H 29mm thread 1/4" mounting distance 61mm tube ø 6.3mm connection male faston 6.3mm immersion heater		











			
GEV No.	416281	Ref. No.	00203091
description	heating element 2000W 230V heating circuits 1 L 300mm W 76mm H 30mm thread 1/4" mounting distance 80mm tube ø 6.3mm connection male faston 6.3mm 2 hole fixing connection length 15mm immersion heater		
spare parts for	416281		
	GEV No.	510417	Ref. No. —
	flat gasket fibre ED ø 20mm ID ø 14mm thickness 2mm Qty 1 pcs		

Table continues overleaf



accessories for	416281			
	GEV No.	361182	Ref. No.	—
	nut thread 1/4" H 5mm nickel-plated brass WS 17 Qty 1 pcs			
	GEV No.	520228	Ref. No.	—
	tooth lock washer ID ø 15.3mm ED ø 24mm steel Qty 1 pcs for thread M14			
	GEV No.	550262	Ref. No.	—
	flat gasket copper ED ø 20mm ID ø 14mm thickness 2mm			

	1		
GEV No.	415176	Ref. No.	00203089
description	heating element 2700W 230V heating circuits 1 L 350mm W 70mm thread 1/4" mounting distance 64mm tube ø 6.25mm 2 hole fixing immersion heater connection male faston 6.3mm		

	1			
GEV No.	416282	Ref. No.	00018070	
description	heating element 3200W 230V heating circuits 1 L 350mm W 77mm H 33mm thread 1/4" mounting distance 71mm tube ø 6.3mm connection male faston 6.3mm 2 hole fixing immersion heater			
spare parts for	416282			
	GEV No.	510417	Ref. No.	—
	flat gasket fibre ED ø 20mm ID ø 14mm thickness 2mm Qty 1 pcs			
accessories for	416282			
	GEV No.	361182	Ref. No.	—
	nut thread 1/4" H 5mm nickel-plated brass WS 17 Qty 1 pcs			
	GEV No.	520228	Ref. No.	—
	tooth lock washer ID ø 15.3mm ED ø 24mm steel Qty 1 pcs for thread M14			
	GEV No.	550262	Ref. No.	—
	flat gasket copper ED ø 20mm ID ø 14mm thickness 2mm			

thermostats

bi-metal thermostats

safety bi-metal thermostats

	1		
GEV No.	390748	Ref. No.	22110020
description	bi-metal safety thermostat hole distance 23.5mm switch-off temp. 100°C 1NC 1-poleA connection F6.3		

	1		
GEV No.	390681	Ref. No.	22110021
description	bi-metal safety thermostat hole distance 40mm switch-off temp. 105°C 2NC 2-pole 16A 250V connection F6.3		

	1		
Image not available			
GEV No.	375757	Ref. No.	22110020 old version
description	bi-metal safety thermostat switch-off temp. 100°C 1NC 1-pole 16A connection F6.3		

bi-metal thermostats

	1		
GEV No.	390909	Ref. No.	22180101
description	bi-metal thermostat hole distance 46mm switch-off temp. 56°C 1NC 1-pole 16A 250V connection F6.3 Qty 1 pcs		

control and safety thermostats

EGO

control thermostats

55.10/19_ series

	1		
GEV No.	390731	Ref. No.	22140002
description	thermostat t.max. 195°C temperature range 65-195°C 1-pole 1NO 16A probe ø 4mm probe L 106mm capillary pipe 1470mm capillary pipe isolatedmm gland nut shaft ø 6x4.6mm shaft L 23mm shaft position° shaft position upper rotation 270°		





GEV No.	390174	Ref. No.	22140001 3323
description	thermostat t.max. 204°C temperature range 65-204°C 1-pole 1NO 16A probe ø 4mm probe L 89mm capillary pipe 600mm capillary pipe isolatedmm gland nut shaft ø 6x4.6mm shaft L 23mm shaft position upper rotation 270° probe material SS		

55.34_series

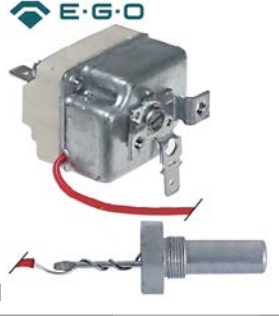

GEV No.	390057	Ref. No.	22160001
description	thermostat t.max. 192°C temperature range 100-192°C 3-pole 3NO 16A probe ø 7mm probe L 200mm capillary pipe 870mm capillary pipe isolatedmm gland nut shaft ø 6x4.6mm shaft L 23mm shaft position upper° rotation 270°		



GEV No.	390172	Ref. No.	00057151
description	thermostat t.max. 50°C temperature range fixed 50°C 1-pole 1CO 16A probe ø 11mm probe L 45mm capillary pipe 850mm capillary pipe isolated 830mm gland nut shaft Lmm shaft position screw-in probe probe thread 3/8"		
accessories for	390172		
	GEV No.	506024	Ref. No. —
	nut thread 3/8" H 6mm SS WS 22 Qty 1 pcs		
	GEV No.	521137	Ref. No. —
	flat gasket fibre ED ø 20mm ID ø 18mm thickness 1.5mm for thread 3/8" Qty 1 pcs		



GEV No.	390043	Ref. No.	00003190
description	thermostat t.max. 80°C temperature range fixed 80°C capillary pipe isolatedmm gland nut		



GEV No.	375534	Ref. No.	22180004
description	thermostat t.max. 90°C temperature range 19-90°C 1-pole 1CO 16A probe ø 6mm probe L 129mm capillary pipe 980mm capillary pipe isolated 960mm gland nut shaft Lmm shaft position rotation 180°		



GEV No.	390042	Ref. No.	0000319A 22190001
description	thermostat t.max. 85°C temperature range 35-85°C 3-pole 3CO 16A probe ø 9.5mm probe L 80mm capillary pipe 870mm capillary pipe isolatedmm gland nut shaft ø 6x4.6mm shaft L 23mm shaft position upper° rotation 180° with disc disc ø 10mm		



safety thermostats

55.10/19_series



GEV No.	390738	Ref. No.	22180100
description	safety thermostat switch-off temp. 107°C 1-pole 1NC 16A probe ø 6mm probe L 77mm capillary pipe 1170mm capillary pipe isolated 1150mm gland nut probe probe material SS		

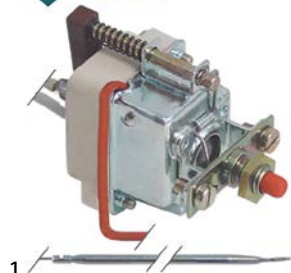

GEV No.	375178	Ref. No.	22170001
description	safety thermostat switch-off temp. 230°C 1-pole 0.5A probe ø 4mm probe L 116mm capillary pipe 1500mm capillary pipe isolatedmm gland nut probe SS		

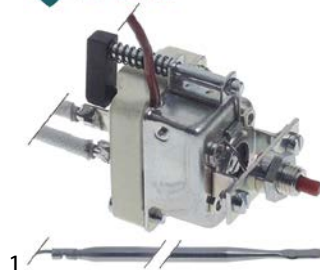

GEV No.	390730	Ref. No.	22170003
description	safety thermostat switch-off temp. 230°C 1-pole 0.5A probe ø 4mm probe L 125mm capillary pipe 1550mm capillary pipe isolated 1410mm gland nut probe		

55.14_series



GEV No.	390176	Ref. No.	22130001 3227
description	safety thermostat switch-off temp. 230°C 1-pole 16A probe ø 6mm probe L 74mm capillary pipe 600mm capillary pipe isolatedmm gland nut probe SS		

55.31_series



GEV No.	390091	Ref. No.	22150001
description	safety thermostat switch-off temp. 230°C 3-pole 20A probe ø 6mm probe L 239mm capillary pipe 830mm capillary pipe isolatedmm gland nut probe SS 380V		

55.32_series

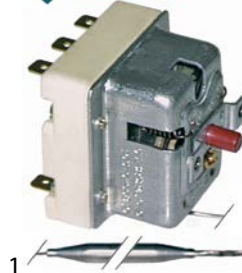

GEV No.	390178	Ref. No.	22100002
description	safety thermostat switch-off temp. 124°C 3-pole 20A probe ø 6mm probe L 74mm capillary pipe 900mm capillary pipe isolated 900mm gland nut probe SS		

55.33_ series



GEV No.	375796	Ref. No.	00032280 22150002 22150003
description	safety thermostat switch-off temp. 220°C 3-pole 3NC 20A probe ø 6mm probe L 107mm capillary pipe 870mm capillary pipe isolated 800mm gland nut probe		

56_ series



GEV No.	390714	Ref. No.	00032270
description	safety thermostat switch-off temp. 230°C 1-pole 1NC 16A probe ø 6mm probe L 75mm capillary pipe 740mm capillary pipe isolated 200mm gland nut probe SS		

IMIT / TEMPOMATIC / ARATHERMO

control thermostats



GEV No.	390173	Ref. No.	00057150
description	thermostat t.max. 87°C temperature range 27-87°C 1-pole 1CO 15A probe ø 6.5mm probe L 95mm capillary pipe 1000mm capillary pipe isolated 1000mm gland nut shaft ø 6x4.6mm shaft L 19mm rotation 270° with disc disc ø 14.5mm		

accessories for 390173



GEV No.	110100	Ref. No.	—
description	knob thermostat t.max. 90°C 0-90°C ø 42mm shaft ø 6x4.6mm shaft flat -135° black		



GEV No.	110310	Ref. No.	—
description	rosette knob up to ø 45mm		

safety thermostats



GEV No.	375850	Ref. No.	22130002
description	safety thermostat switch-off temp. 230°C 1-pole 1NC 15A probe ø 3.5mm probe L 200mm capillary pipe 950mm capillary pipe isolatedmm gland nut probe SS 250V		



GEV No.	375851	Ref. No.	00032610
description	safety thermostat switch-off temp. 230°C 1-pole capillary pipe isolatedmm gland nut probe		

various

control thermostats



GEV No.	390196	Ref. No.	22180004 old version
description	thermostat t.max. 93°C temperature range 35-93°C 1-pole		

accessories

fitting parts

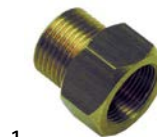



GEV No.	511627	Ref. No.	00003400
description	screw connection for boiler IT M16x1 ET 3/8"		

gland ducts



GEV No.	551076	Ref. No.	00038680
description	gland duct ET M11x1 IT M10x1 probe ø max. 4mm WS 22 copper stainless steel L 30mm		





plunger sockets			
			
1			
GEV No.	550139	Ref. No.	00030500
description	thermowell thread 3/4" L 310mm SS double ø 8mm hole ø 7mm		
accessories for	550139		
			
GEV No.	520234	Ref. No.	—
description	nut thread 3/4" H 5mm brass WS 30 Qty 1 pcs		

miscellaneous			
			
1			
GEV No.	550268	Ref. No.	00032290
description	cover cap for push-button		

switches and momentary switches

push/momentary push switches

17x13mm			
			
1			
GEV No.	345950	Ref. No.	28160041
description	momentary push switch mounting measurements 17x13mm grey 2CO 250V 16A connection male faston 6.3mm ambient temperature max. 150/75°C protection IP40		

20.6x16.4mm			
			
1			
GEV No.	345948	Ref. No.	28160039
description	momentary push switch mounting measurements 20.6x16.4mm grey 2CO 250V 16A outflow connection male faston 6.3mm ambient temperature max. 150°C protection IP40		

			
1			
GEV No.	345949	Ref. No.	28160040
description	push switch mounting ø 20.6x16.4mm grey 2CO 250V 16A connection male faston 6.3mm ambient temperature max. 150°C protection IP40		

28.5x28.5mm			
			
1			
GEV No.	345940	Ref. No.	28160020
description	momentary push switch mounting measurements 28.5x28.5mm grey 2CO 240V 16A connection male faston 6.3mm ambient temperature max. 150°C protection IP40		

			
1			
GEV No.	345942	Ref. No.	28160024
description	push switch mounting measurements 28.5x28.5mm grey 2CO 250V 16A connection male faston 6.3mm ambient temperature max. 150°C protection IP40		

			
1			
GEV No.	345953	Ref. No.	28160273
description	push switch mounting measurements 28.5x28.5mm grey 2CO 250V 16A connection male faston 6.3mm ambient temperature max. 150°C protection IP40		

			
1			
GEV No.	345943	Ref. No.	28160026 28160272
description	momentary push switch mounting measurements 28.5x28.5mm grey 2CO 250V 16A clock connection male faston 6.3mm ambient temperature max. 125/55°C protection IP40		

			
1			
GEV No.	345941	Ref. No.	28160022
description	momentary push switch mounting measurements 28.5x28.5mm grey 2CO 250V 16A drain pump connection male faston 6.3mm ambient temperature max. 150°C protection IP40		

			
1			
GEV No.	345947	Ref. No.	28160037
description	momentary push switch mounting measurements 28.5x28.5mm grey 2CO 250V 16A drain pump connection male faston 6.3mm ambient temperature max. 150°C protection IP40		



28.5x77.5mm



GEV No.	345944	Ref. No.	28160028
description	switch combination latching mounting measurements 28.5x77.5mm grey 2CO 250V 16A main switch connection male faston 6.3mm ambient temperature max. 85°C protection IP40		

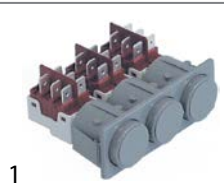

GEV No.	345954	Ref. No.	28160274
description	switch combination latching mounting measurements 28.5x77.5mm grey 2CO/2CO/2CO 250V 16A connection male faston 6.3mm ambient temperature max. 85°C protection IP40		



GEV No.	345945	Ref. No.	28160029
description	switch combination latching mounting measurements 28.5x77.5mm grey 2CO/2CO/2CO 250V 16A main switch/program/drain pump connection male faston 6.3mm ambient temperature max. 85°C protection IP40		



GEV No.	345180	Ref. No.	28160021 28160023
description	switch combination mounting measurements 28.5x77.5mm grey 1CO/1CO/1CO 250V 16A connection male faston 6.3mm ambient temperature max. 85°C protection IP40		



GEV No.	345946	Ref. No.	28160036
description	switch combination mounting measurements 28.5x77.5mm grey 2CO/2CO/2CO 250V 16A double arrow/arrow/main switch connection male faston 6.3mm ambient temperature max. 85°C protection IP40		

miscellaneous



GEV No.	345951	Ref. No.	28160043
description	momentary push switch grey 2CO 250V 16A without frame drain connection male faston 6.3mm ambient temperature max. 85°C		



GEV No.	345952	Ref. No.	28160044
description	momentary push switch grey 2CO 250V 16A without frame rinsing connection male faston 6.3mm ambient temperature max. 85°C		

microswitches

lever actuated



GEV No.	345183	Ref. No.	25190005
description	microswitch with double lever 250V 16A 2CO connection male faston 6.3mm L 50mm ambient temperature max. 125°C mounting distance 22.5mm type N16 actuating force: 290g lever length 47mm		





GEV No.	345178	Ref. No.	25190003
description	microswitch with lever 250V 16A 1CO connection male faston 6.3mm L 28mm L1 37mm ambient temperature max. 125°C mounting distance 22mm actuating force: 220g lever length 33mm		





GEV No.	345255	Ref. No.	25190007
description	microswitch with lever 250V 16A 1CO connection male faston 6.3mm L 35mm L1 28mm ambient temperature max. 125°C mounting distance 22mm actuating force: 136g lever length 27mm		





roller-lever actuated			
non-standard			
 <p>1</p>			
GEV No.	345186	Ref. No.	00006390 25190001
description	microswitch with handle with a switch 250V 15A 1CO connection male faston 6.3mm L 42mm ambient temperature max. 85°C lever length 37mm		

accessories			
 <p>1</p>			
GEV No.	511892	Ref. No.	00011115
description	actuator for microswitch kit		

 <p>1</p>			
GEV No.	511081	Ref. No.	00011100
description	actuator microswitch		

 <p>1</p>			
GEV No.	511111	Ref. No.	00006410
description	actuator microswitch kit		

 <p>1</p>			
GEV No.	511119	Ref. No.	00011090
description	actuator microswitch kit		

 <p>1</p>			
GEV No.	511112	Ref. No.	00006401 640H
description	lever for microswitch		

position switches

LOVATO			
 <p>1</p>			
GEV No.	347579	Ref. No.	25190004
description	position switch plastic 1NO/1NC 400V 3A L 110mm W 30mm H 44mm protection IP66/67 actuating force: 380g screw connection M16 mounting distance 22mm type ZCP21		

TELEMECANIQUE (EFA)			
 <p>1</p>			
GEV No.	347579	Ref. No.	25190004
description	position switch plastic 1NO/1NC 400V 3A L 110mm W 30mm H 44mm protection IP66/67 actuating force: 380g screw connection M16 mounting distance 22mm type ZCP21		

 <p>1</p>			
GEV No.	347903	Ref. No.	00073790 25190002
description	position switch plastic 1NO/1NC 400V 3A L 110mm W 30mm H 44mm protection IP66/67 actuating force: 380g screw connection M16 mounting distance 22mm type ZCP21		

system switches (ROLD)

 <p>1</p>			
GEV No.	347193	Ref. No.	28160253
description	momentary switch unit 1NO 250V 16A connection male faston 6.3mm		

 <p>1</p>			
GEV No.	346256	Ref. No.	28160214
description	push button ø 23mm grey clock no lens		

 <p>1</p>			
GEV No.	346253	Ref. No.	28160213
description	push button ø 23mm grey main switch		

 <p>1</p>			
GEV No.	347504	Ref. No.	28160250
description	switch 2CO 250V 16A connection male faston 6.3mm		

rotary switches

BRETER

rotary switches



1

GEV No.	345165	Ref. No.	25100102 old version
description	rotary switch 16A 2-pole		



1

GEV No.	345015	Ref. No.	00005980
description	rotary switch 16A connection screw clamp 3-pole shaft 5x5mm		



1

GEV No.	345166	Ref. No.	25120001 old version
description	rotary switch 4-pole		

TECNOMATIC



1

GEV No.	345016	Ref. No.	0000597A 25100001
description	rotary switch 2 0-1 sets of contacts 1 type HD1201R000 600V 12A shaft \varnothing 5x5mm shaft L 23mm shaft square connection screw		



1

GEV No.	347055	Ref. No.	25100102
description	rotary switch 2 0-1 sets of contacts 2 type HD1602R000 600V 16A shaft \varnothing 5x5mm shaft L 23mm shaft square connection screw		

magnetic switches

36x13mm



1

GEV No.	345955	Ref. No.	25110113
description	magnetic switch L 36mm W 13mm connection cable		

65x20mm



1

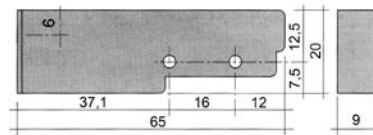

GEV No.	345116	Ref. No.	25240003
description	magnetic switch L 65mm W 20mm 1NO 250V 0.4A P max. 100W connection cable cable length 3000mm		

accessories for 345116

GEV No.	345399	Ref. No.	—
description	magnet \varnothing 3.3mm L 40mm H 8mm W 13mm hole distance 30mm M3		

accessories

magnets

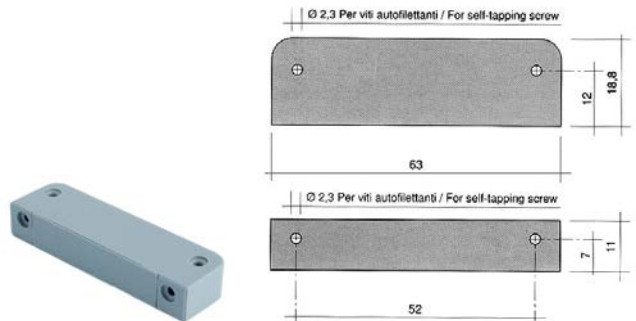

1

GEV No.	519049	Ref. No.	25110115
description	magnet \varnothing mm L 63mm H 10.7mm W 18.8mm hole distance 52mm M2 hole \varnothing 2mm		

accessories for 519049

GEV No.	560095	Ref. No.	—
description	sheet metal screws \varnothing 2.9mm L 9.5mm SS Qty 20 pcs DIN 7981/ISO 7049 head \varnothing 5.6mm oval head		



miscellaneous			
			
1			
GEV No.	347904	Ref. No.	00065606
description	holding plate L 62mm W 26mm for magnetic switch		

control equipment

TELEMECANIQUE (EFA)

ZB4 series			
switches (complete)			
			
1			
GEV No.	346925	Ref. No.	00061070
description	rotary selector mounting measurements ø22mm latching white illuminated rotation 90° sequence 0-1		
spare parts for	346925		
	GEV No.	347385	Ref. No.
	contact block EFA ZBE-101 1NO max 230V 10(6)A black		

			
1			
GEV No.	347905	Ref. No.	00061060
description	rotary selector mounting measurements ø22mm latching white illuminated sequence 0-1		

lamps

indicator lights

indicator lights 3-piece (housing, lens and bulb)			
lamps			
light bulbs			
			
1			
GEV No.	359236	Ref. No.	00006460 28130003
description	light bulb socket E10 24V 3W ø 10mm L 28mm		

indicator lights (complete)			
ø 6mm			
			
1			
GEV No.	359005	Ref. No.	28100006
description	indicator light ø 6mm 230V yellow cable length 400mm		

ø10mm			
with plug-in socket			
			
1			
GEV No.	359140	Ref. No.	28100007
description	indicator light ø 10mm yellow 230V connection male faston 6.3mm Qty 1 pcs		

ø13mm			
with screw socket			
			
1			
GEV No.	359146	Ref. No.	28100011
description	indicator light ø 13mm 230V yellow		
accessories for	359146		
	GEV No.	510302	Ref. No.
	O-ring EPDM ID ø 12.42mm thickness 1.78mm Qty 1 pcs		
	GEV No.	511505	Ref. No.
	O-ring EPDM thickness 1.78mm ID ø 12.42mm Qty 10 pcs		

			
1			
GEV No.	359049	Ref. No.	28100001
description	indicator light ø 13mm 400V green		
accessories for	359049		
	GEV No.	510302	Ref. No.
	O-ring EPDM ID ø 12.42mm thickness 1.78mm Qty 1 pcs		
	GEV No.	511505	Ref. No.
	O-ring EPDM thickness 1.78mm ID ø 12.42mm Qty 10 pcs		

with plug-in socket			
			
1			
GEV No.	359119	Ref. No.	28100004
description	indicator light ø 13mm green 24V connection male faston 6.3mm Qty 1 pcs		

33x10mm



1			28110001
GEV No.	359452	Ref. No.	28110001 + 00038828 3320
description	indicator light mounting measurements 33.1x10.3mm 400V green connection male faston 6.3mm		



1			003321
GEV No.	359451	Ref. No.	28110002 28110002 + 00038828
description	indicator light mounting measurements 33.1x10.3mm 400V yellow connection male faston 6.3mm		

miscellaneous



1			28100014
GEV No.	357123	Ref. No.	28100014
description	indicator light red 230V connection cable ø 8mm		

screw-on/push-on fit

light bulbs

for indicator lights



1			00006460
GEV No.	359236	Ref. No.	28130003
description	light bulb socket E10 24V 3W ø 10mm L 28mm		

timers

programme timers



1			26100024
GEV No.	360654	Ref. No.	26100024
description	timer CDC 11804F1 engines 1 chambers 4 operation time 120s 230V shaft ømm shaft Lmm		



1			26100023
GEV No.	360653	Ref. No.	26100023
description	timer CDC 11804F1 engines 1 chambers 4 operation time 180s 230V		



1			26100017
GEV No.	360069	Ref. No.	26100017
description	timer CROUZET engines 1 chambers 4 operation time 120s 230V shaft ømm shaft Lmm manuf. no. 645/5245 motor type 82340		



1			26100019
GEV No.	360068	Ref. No.	26100019
description	timer CROUZET engines 1 chambers 5 operation time 90s 230V shaft ømm shaft Lmm manuf. no. 645/5238 motor type 82340		





1			00005930
GEV No.	360081	Ref. No.	26100015
description	timer FIBER P25 engines 1 chambers 4 operation time 120s 24V shaft ø 5x5mm shaft L 20mm manuf. no. P255204H313 motor type M51B20L6400		

spare parts for	360081		
	GEV No.	360676	Ref. No. —
	motor kit pinion ø 6.8mm teeth 15 24V voltage AC 50/60Hz turn direction counterclockwise motor ø 48mm H 18.5mm motor type UDS40NE1RNZ165 cable length 150mm with holder		





1

GEV No.	360304	Ref. No.	26100022
description	timer FIBER P25 engines 2 chambers 4 operation time 2min / 7.5min 230V shaft ømm shaft Lmm manif. no. P255J04LXP8 motor type M51BJ0R6400 / M51BJ0L6400		
spare parts for	360304		
	GEV No.	360673	Ref. No. —
	motor kit pinion ø 6.8mm teeth 15 230V voltage AC 50/60Hz turn direction clockwise motor ø 48mm H 18.5mm motor type UDS-40NE1RNZ165 cable length 150mm with holder		
	GEV No.	360674	Ref. No. —
	motor kit pinion ø 6.8mm teeth 15 230V voltage AC 50/60Hz turn direction counterclockwise motor ø 48mm H 18.5mm motor type UDS40NE1RNZ165 cable length 150mm with holder		





1

GEV No.	360305	Ref. No.	26100025
description	timer FIBER PWE engines 1 chambers 1 operation time 20min 230V shaft ømm shaft Lmm manif. no. PWE5J01L103 motor type M51B-J0R6400		
spare parts for	360305		
	GEV No.	360673	Ref. No. —
	motor kit pinion ø 6.8mm teeth 15 230V voltage AC 50/60Hz turn direction clockwise motor ø 48mm H 18.5mm motor type UDS-40NE1RNZ165 cable length 150mm with holder		



1

GEV No.	360303	Ref. No.	26100021
description	timer FIBER P25 engines 2 chambers 5 operation time 72s / 4.8min 230V shaft ømm shaft Lmm manif. no. P255J05ANM0 motor type M51BJ0R6400 / M51BJ0L6400		
spare parts for	360303		
	GEV No.	360673	Ref. No. —
	motor kit pinion ø 6.8mm teeth 15 230V voltage AC 50/60Hz turn direction clockwise motor ø 48mm H 18.5mm motor type UDS-40NE1RNZ165 cable length 150mm with holder		
	GEV No.	360674	Ref. No. —
	motor kit pinion ø 6.8mm teeth 15 230V voltage AC 50/60Hz turn direction counterclockwise motor ø 48mm H 18.5mm motor type UDS40NE1RNZ165 cable length 150mm with holder		



1

GEV No.	360087	Ref. No.	26100011
description	timer FIBER P26 engines 1 chambers 3 operation time 20min 230V shaft ømm shaft Lmm manif. no. P265J03L130 motor type M61B40R6400		

contactors

GENERAL ELECTRIC (AEG)

power contactors



1

GEV No.	380245	Ref. No.	25130028
description	power contactor resistive load 25A 230VAC (AC3/400V) 9A/4kW main contacts 3NO auxiliary contacts 1NC connection screw connection type AEG LS4K 01A type GE CL00A 301 H 85mm		



1

GEV No.	380262	Ref. No.	25130026
description	power contactor resistive load 32A 230VAC (AC3/400V) 17A/7.5kW main contacts 3NO auxiliary contacts 1NC connection screw connection type AEG LS7K01A type GE CL02A 301 H 85mm		



1

GEV No.	380261	Ref. No.	25130025
description	power contactor resistive load 32A 230VAC (AC3/400V) 17A/7.5kW main contacts 3NO auxiliary contacts 1NO connection screw connection type AEG LS7K 10A type GE CL02A 310		

LOVATO

power contactors



1

GEV No.	380083	Ref. No.	25130037
description	power contactor resistive load 25A 230VAC (AC3/400V) 9A/4.2kW main contacts 3NO auxiliary contacts 1NC connection screw connection type BF0901A230		



1

GEV No.	380717	Ref. No.	25130038
description	power contactor resistive load 32A 230VAC (AC3/400V) 18A/7.5kW main contacts 3NO auxiliary contacts 1NC connection screw connection type BF1801A230		

TELEMECANIQUE (Schneider Electric)

power contactors



1

GEV No.	380820	Ref. No.	00006280
description	power contactor resistive load 25A 230VAC (AC3/400V) 9A/4kW main contacts 3NO auxiliary contacts 1NO/1NC connection screw connection type LC1D0900M7		



1

GEV No.	380617	Ref. No.	00060670
description	power contactor resistive load 25A 24VAC (AC3/400V) 9A/4kW main contacts 3NO auxiliary contacts 1NO/1NC connection screw connection type LC1D09B7		



1

GEV No.	380976	Ref. No.	00006270
description	power contactor resistive load 32A 230VAC (AC3/400V) 18A/7.5kW main contacts 3NO auxiliary contacts 1NO/1NC connection screw connection		

auxiliary contacts



1

GEV No.	380821	Ref. No.	00006270 (old version)
description	auxiliary contact contacts 1NO/1NC AC15 10A connection screw type LA1DN11		



relays

power relays

with DIN rail mounting

lateral



1

GEV No.	380629	Ref. No.	25240004
description	power relays FINDER 24VAC 16A 3CO connection male faston 4.8mm DIN rail manuf. no. 60.33.8.024.0008		

accessories for 380629



GEV No.	380703	Ref. No.	—
description	adapter for flange mounting suitable for Finder relay 62 series.		



GEV No.	380811	Ref. No.	—
description	adapter with bracket mounting suitable for Finder relay 62 series.		



GEV No.	380954	Ref. No.	—
description	adapter hole distance 54mm bracket mounting suitable for Finder relay 62 series. L 41mm W 39mm H 49mm		



GEV No.	381003	Ref. No.	—
description	adapter for DIN rail mounting suitable for Finder relay 62 series.		



GEV No.	381039	Ref. No.	—
description	adapter for DIN rail mounting suitable for Finder relay 62 series.		

with bracket mounting



1

GEV No.	380626	Ref. No.	25130101 25130102
description	power relays FINDER 230VAC 10A 2CO connection male faston 4.8mm bracket mounting manuf. no. 62.62.8.230.0000		

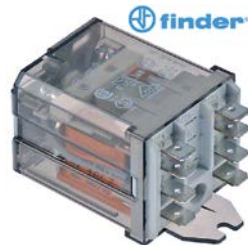

1

GEV No.	380139	Ref. No.	25130100
description	power relays FINDER 230VAC 16A 2CO connection F6.3 bracket mounting dimensions 68x38.2x35.8mm manuf. no. 62.82.8.230.0000		

electronic controllers

EVCO - EVERY CONTROL

universal controllers

built-in version



1

GEV No.	378270	Ref. No.	22192001
description	electronic controller EVERY CONTROL mounting measurements 71x29mm built-in depth 59mm 12/24V voltage AC/DC PTC relay outputs 1 relay with probe protection IP65 -50 up to +150°C display 4 digits cable length 1430mm 16 type EVK411		



1

GEV No.	378280	Ref. No.	22192002 22192005+22192006
description	electronic controller EVERY CONTROL mounting measurements 71x29mm built-in depth 59mm 12V voltage AC/DC PTC with probe protection IP65 -50 up to +150°C display 4 digits cable length 1430mm probe ø 6mm 16 type EVK411		

probes

universal probes

temperature probes



1

GEV No.	379142	Ref. No.	22192003
description	temperature probe PTC 1kOhm cable PVC probe -50 up to +150°C cable -10 up to 100°C probe ø6x30mm cable length 1.5m without screw connection 2-wire		



electric components

producer-specific probes

probes

1			
GEV No.	378343	Ref. No.	25192400
description	temperature probe NTC 10kOhm cable silicone probe -40 up to +110°C cable -50 up to +180°C connection 2-wire thread probe ø7x30mm cable length 1m		

electronics

PCBs

1			
GEV No.	403775	Ref. No.	25192030
description	control PCB warewashing D35/36/45/46/47 L 170mm W 28mm connection coded plug suitable for ELFRAMO		

1			
GEV No.	403163	Ref. No.	25192040
description	PCB dishwasher C34/C44/C66 230V 50/60A		

1			
GEV No.	402990	Ref. No.	25192020
description	PCB dishwasher D35/40		

keypads

control panel

1			
GEV No.	109182	Ref. No.	00038675
description	control panel fryer GW ELT/GWD ELT W 223mm H 70mm D 20mm		

1			
GEV No.	403262	Ref. No.	00222433
description	control panel warewashing BE35 W 178mm H 48mm D 58mm suitable for ELFRAMO		

solenoïd valves









solenoïd valves (water)

ELBI			
1			
GEV No.	370257	Ref. No.	23120003
description	solenoid valve triple straight 230VAC inlet 3/4" outlet 11.5mm t.max. 90°C ELBI plastic output B 2.5l/min flow regulating valve outlet B orange		

TP				
1				
GEV No.	370021	Ref. No.	00003120 23120001	
description	solenoid valve double straight 230VAC inlet 3/4" outlet 11.5mm DN10 TP flow regulating valve inlet white			
spare parts for	370021			
	GEV No.	371013	Ref. No.	—
	solenoid coil TP 230VAC 50/60Hz			
accessories for	370021			
	GEV No.	371220	Ref. No.	—
	reducer TP flow rate 3l/min red tolerance ±15%			
	GEV No.	371221	Ref. No.	—
	reducer TP flow rate 5.5l/min yellow tolerance ±15%			
	GEV No.	371222	Ref. No.	—
	reducer TP flow rate 6l/min grey tolerance ±15%			
	GEV No.	371223	Ref. No.	—
	reducer TP flow rate 10l/min white tolerance ±15%			
	GEV No.	371224	Ref. No.	—
	reducer TP flow rate 12l/min bronze tolerance ±15%			
	GEV No.	371225	Ref. No.	—
	reducer TP flow rate 16l/min light brown tolerance ±15%			
	GEV No.	371226	Ref. No.	—
	reducer TP flow rate 20l/min red tolerance ±15%			
	GEV No.	371230	Ref. No.	—
	reducer TP flow rate 0.25l/min red tolerance ±25%			
	GEV No.	371231	Ref. No.	—
	reducer TP flow rate 0.35l/min violet tolerance ±25%			

Table continues overleaf









accessories for		370021		
	GEV No.	371232	Ref. No.	—
reducer TP flow rate 0.5l/min orange tolerance ±25%				
	GEV No.	371233	Ref. No.	—
reducer TP flow rate 0.8l/min white tolerance ±25%				
	GEV No.	371234	Ref. No.	—
reducer TP flow rate 1l/min light blue tolerance ±25%				
	GEV No.	371235	Ref. No.	—
reducer TP flow rate 1.2l/min brown tolerance ±25%				
	GEV No.	371236	Ref. No.	—
reducer TP flow rate 1.5l/min light brown tolerance ±25%				
	GEV No.	371237	Ref. No.	—
reducer TP flow rate 2.5l/min yellow tolerance ±25%				
	GEV No.	371238	Ref. No.	—
reducer TP flow rate 3.4l/min dark green tolerance ±25%				
	GEV No.	371239	Ref. No.	—
reducer TP flow rate 5l/min black tolerance ±25%				
	GEV No.	371240	Ref. No.	—
reducer TP flow rate 8l/min blue tolerance ±20%				







1

GEV No.	370111	Ref. No.	00003090 23120002
description	solenoid valve double straight 24VAC inlet 3/4" outlet 11.5mm DN10 TP		

spare parts for		370111		
	GEV No.	371035	Ref. No.	—
solenoid coil 24VAC				

accessories for		370111		
	GEV No.	371220	Ref. No.	—
reducer TP flow rate 3l/min red tolerance ±15%				
	GEV No.	371221	Ref. No.	—
reducer TP flow rate 5.5l/min yellow tolerance ±15%				
	GEV No.	371222	Ref. No.	—
reducer TP flow rate 6l/min grey tolerance ±15%				
	GEV No.	371223	Ref. No.	—
reducer TP flow rate 10l/min white tolerance ±15%				
	GEV No.	371224	Ref. No.	—
reducer TP flow rate 12l/min bronze tolerance ±15%				

accessories for		370111		
	GEV No.	371225	Ref. No.	—
reducer TP flow rate 16l/min light brown tolerance ±15%				
	GEV No.	371226	Ref. No.	—
reducer TP flow rate 20l/min red tolerance ±15%				
	GEV No.	371230	Ref. No.	—
reducer TP flow rate 0.25l/min red tolerance ±25%				
	GEV No.	371231	Ref. No.	—
reducer TP flow rate 0.35l/min violet tolerance ±25%				
	GEV No.	371232	Ref. No.	—
reducer TP flow rate 0.5l/min orange tolerance ±25%				
	GEV No.	371233	Ref. No.	—
reducer TP flow rate 0.8l/min white tolerance ±25%				
	GEV No.	371234	Ref. No.	—
reducer TP flow rate 1l/min light blue tolerance ±25%				
	GEV No.	371235	Ref. No.	—
reducer TP flow rate 1.2l/min brown tolerance ±25%				
	GEV No.	371236	Ref. No.	—
reducer TP flow rate 1.5l/min light brown tolerance ±25%				
	GEV No.	371237	Ref. No.	—
reducer TP flow rate 2.5l/min yellow tolerance ±25%				
	GEV No.	371238	Ref. No.	—
reducer TP flow rate 3.4l/min dark green tolerance ±25%				
	GEV No.	371239	Ref. No.	—
reducer TP flow rate 5l/min black tolerance ±25%				
	GEV No.	371240	Ref. No.	—
reducer TP flow rate 8l/min blue tolerance ±20%				



1





















GEV No.	370017	Ref. No.	23120021	
description	solenoid valve single straight 230VAC inlet 3/4" outlet 11.5mm DN10 TP p max 10bar			
spare parts for	370017			
	GEV No.	371013	Ref. No.	—
solenoid coil TP 230VAC 50/60Hz				
accessories for	370017			
	GEV No.	371220	Ref. No.	—
reducer TP flow rate 3l/min red tolerance ±15%				

Table continues overleaf

accessories for		370017	
	GEV No.	371221	Ref. No. —
reducer TP flow rate 5.5l/min yellow tolerance ±15%			
	GEV No.	371222	Ref. No. —
reducer TP flow rate 6l/min grey tolerance ±15%			
	GEV No.	371223	Ref. No. —
reducer TP flow rate 10l/min white tolerance ±15%			
	GEV No.	371224	Ref. No. —
reducer TP flow rate 12l/min bronze tolerance ±15%			
	GEV No.	371225	Ref. No. —
reducer TP flow rate 16l/min light brown tolerance ±15%			
	GEV No.	371226	Ref. No. —
reducer TP flow rate 20l/min red tolerance ±15%			
	GEV No.	371230	Ref. No. —
reducer TP flow rate 0.25l/min red tolerance ±25%			
	GEV No.	371231	Ref. No. —
reducer TP flow rate 0.35l/min violet tolerance ±25%			
	GEV No.	371232	Ref. No. —
reducer TP flow rate 0.5l/min orange tolerance ±25%			
	GEV No.	371233	Ref. No. —
reducer TP flow rate 0.8l/min white tolerance ±25%			
	GEV No.	371234	Ref. No. —
reducer TP flow rate 1l/min light blue tolerance ±25%			
	GEV No.	371235	Ref. No. —
reducer TP flow rate 1.2l/min brown tolerance ±25%			
	GEV No.	371236	Ref. No. —
reducer TP flow rate 1.5l/min light brown tolerance ±25%			
	GEV No.	371237	Ref. No. —
reducer TP flow rate 2.5l/min yellow tolerance ±25%			
	GEV No.	371238	Ref. No. —
reducer TP flow rate 3.4l/min dark green tolerance ±25%			
	GEV No.	371239	Ref. No. —
reducer TP flow rate 5l/min black tolerance ±25%			
	GEV No.	371240	Ref. No. —
reducer TP flow rate 8l/min blue tolerance ±20%			

metal			
SIRAI			
2-way			
L140-B series			
			
1			
GEV No.	370239	Ref. No.	00003130 23140006
description	solenoid valve 2-ways 230VAC connection 1/2" L 41mm DN 10mm slide-on receptacle compact -10 up to +90°C SIRAI type series L140-B coil type Z610A membranes NBR (water) p max 12bar p min 0.35bar		
spare parts for	370239		
	GEV No.	371085	Ref. No. —
solenoid coil 230VAC 4VA SIRAI coil type ZB10A seat ø 10mm 50/60Hz			
	GEV No.	371163	Ref. No. —
membrane connection 1/2" series L140-B membrane type NBR (water)			
accessories for	370239		
	GEV No.	371091	Ref. No. —
power socket plug type DIN 43650B cable lengthmm small			

			
1			
GEV No.	370472	Ref. No.	23140004
description	solenoid valve 2-ways 24VAC inlet 1/2" connection 1/2" L 41mm DN 10mm -10 up to +90°C SIRAI coil type Z610A membranes NBR (water) p max 12bar p min 0.35bar 24V voltage AC		

L180-B series			
			
1			
GEV No.	370329	Ref. No.	00005692 23140003
description	solenoid valve 2-ways 24VAC inlet 1/2" outlet 1/2" connection 1/2" L 66mm DN 13.5mm slide-on receptacle compact -10 up to +90°C SIRAI type series L180-B coil type Z610A membranes NBR (water) p max 12bar p min 0.35bar		
spare parts for	370329		
	GEV No.	371070	Ref. No. 00005661 23160001
solenoid coil 24VAC 10VA SIRAI coil type Z610A seat ø 10mm			
	GEV No.	371171	Ref. No. —
membrane series L180-B membrane type NBR (water)			

Table continues overleaf



accessories for 370329			
	GEV No.	371091	Ref. No. —
power socket plug type DIN 43650B cable lengthmm small			



GEV No.	370252	Ref. No.	00005680 23150002
----------------	--------	-----------------	----------------------

description solenoid valve 2-ways 24VAC inlet 3/4" outlet 3/4" L 79mm DN 18mm slide-on receptacle compact -10 up to +90°C SIRAI type series L180-B coil type Z610A membranes NBR (water) p max 12bar p min 0.35bar

spare parts for 370252

	GEV No.	371070	Ref. No.	00005661 23160001
solenoid coil 24VAC 10VA SIRAI coil type Z610A seat ø 10mm				

	GEV No.	371172	Ref. No.	—
membrane connection 3/4" series L180-B membrane type NBR (water)				

accessories for 370252

	GEV No.	371091	Ref. No.	—
power socket plug type DIN 43650B cable lengthmm small				

solenoid valves steam (water)

2-way

L153-D series



GEV No.	370264	Ref. No.	23150003
----------------	--------	-----------------	----------

description solenoid valve 2-ways 230VAC inlet 1/2" outlet 1/2" connection 1/2" L 66mm DN 11.5mm slide-on receptacle DIN -10 up to 140°C SIRAI type series L153-D coil type Z134A membranes EPDM (steam/water) p max 8bar p min 0.1bar

spare parts for 370264

	GEV No.	371077	Ref. No.	—
solenoid coil 230VAC 24VA SIRAI coil type Z110A/Z114A/Z134A seat ø 14mm				

	GEV No.	371167	Ref. No.	—
membrane connection 1/2" series L153-D membrane type EPDM				

accessories for 370264

	GEV No.	371090	Ref. No.	—
power socket plug type DIN 43650A screw				



GEV No.	370325	Ref. No.	00005660 23150001
----------------	--------	-----------------	----------------------

description solenoid valve 2-ways 24VAC inlet 3/4" outlet 3/4" connection 3/4" L 79mm DN 17mm slide-on receptacle DIN -10 up to 140°C SIRAI type series L153-D coil type Z134A membranes EPDM (steam/water) p max 8bar p min 0.1bar 50Hz

spare parts and accessories

solenoid coils

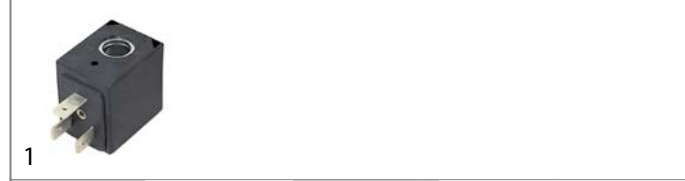

GEV No.	371070	Ref. No.	00005661 23160001
----------------	--------	-----------------	----------------------

description solenoid coil 24VAC 10VA SIRAI coil type Z610A seat ø 10mm

accessories for 371070

	GEV No.	371091	Ref. No.	—
power socket plug type DIN 43650B cable lengthmm small				

solenoid valves (various)



GEV No.	370738	Ref. No.	00065310
----------------	--------	-----------------	----------

description solenoid valve 230VAC inlet 3/4" ET outlet 1" ET L 225mm with in-line particle filter SIRAI coil type Z610A 230V brass warewashing voltage AC

pressure switches for warewashing

ø 58mm with male faston 6.3mm
with connection horizontal



GEV No.	541314	Ref. No.	27100002
----------------	--------	-----------------	----------

description pressure control pressure range 46/26mbar connection 6mm ø 58mm pressure connection horizontal warewashing pressure connection ø 6mm



			
1			
GEV No.	541006	Ref. No.	27100001
description	pressure control pressure range 60/20mbar connection 6mm ø 58mm pressure connection horizontal warewashing pressure connection ø 6mm		

			
1			
GEV No.	541019	Ref. No.	00005960
description	pressure control pressure range 70/30mbar connection 6mm ø 58mm pressure connection horizontal warewashing pressure connection ø 6mm		

electrodes

			
1			
GEV No.	403264	Ref. No.	00013897
description	level electrode total length 125mm angled ø 4mm		

			
1			
GEV No.	403263	Ref. No.	00014133
description	level electrode total length 75mm angled ø 4mm		

pumps

wash and rinse pumps

FIR

pumps



1			
GEV No.	500927	Ref. No.	00002501
description	pump inlet ø 53mm outlet ø 44mm type 0213.1600 230V 50/60Hz 1 phase 1kW 1.36HP L 290mm rotation direction right capacitor 12.5µF FIR		
spare parts for	500927		
	GEV No.	365014	Ref. No. 00002630
	operating capacitor capacity 12.5µF 450V tolerance 5%Hz ambient temperature max. -25 to +85°C ø 35mm L 70mm M8 plastic connection male faston 6.3mm 45S.C3DS.12.5 protection		
	GEV No.	509010	Ref. No. 00002860
	impellor ø 105mm H 20mm M10L rotation direction right blades 4		
	GEV No.	510693	Ref. No. 00003000 06150001 300
	mechanical shaft seal for shaft ø 12mm slide ring ext. ø 24mm slide ring H 15.5mm slide ring int. ø 11mm counter ring mounting ø 24mm height counter ring 8mm counter ring int. ø 13.5mm		
	GEV No.	521543	Ref. No. 00002700
	pump cover ELFRAMO inlet ø 53mm outlet ø 44mm turn direction right ø 160mm ID ø 136mm inner height 34mm		
	GEV No.	521717	Ref. No. 00002900 06140008 06140140 290
	O-ring EPDM thickness 1.78mm ID ø 120.37mm Qty 1 pcs		



GEV No.	500098	Ref. No.	00002520
description	pump inlet ø 62mm outlet ø 49mm type B215.2500 230/400V 50/60Hz 3 phase 1.5kW 2HP L 332mm rotation direction right FIR		
spare parts for	500098		
	GEV No.	510693	Ref. No. 00003000 06150001 300
	mechanical shaft seal for shaft ø 12mm slide ring ext. ø 24mm slide ring H 15.5mm slide ring int. ø 11mm counter ring mounting ø 24mm height counter ring 8mm counter ring int. ø 13.5mm		
	GEV No.	511148	Ref. No. 00002870 287
	impellor ø 118mm H 20mm M10L		
	GEV No.	521544	Ref. No. 00002710
	pump cover inlet ø 63mm outlet ø 50mm turn direction right ø 180mm ID ø 165mm inner height 42mm		
	GEV No.	521718	Ref. No. 00002910 06140010
	O-ring EPDM thickness 3.53mm ID ø 164.7mm Qty 1 pcs		



GEV No.	499051	Ref. No.	00002513
description	pump inlet ø 62mm outlet ø 50mm type B214 230V 50/60Hz 1 phase 1kW rotation direction right capacitor 12.5µF FIR		
spare parts for	499051		
	GEV No.	365014	Ref. No. 00002630
	operating capacitor capacity 12.5µF 450V tolerance 5%Hz ambient temperature max. -25 to +85°C ø 35mm L 70mm M8 plastic connection male faston 6.3mm 455.C3DS.12.5 protection		
	GEV No.	509010	Ref. No. 00002860
	impellor ø 105mm H 20mm M10L rotation direction right blades 4		







spare parts for	499051		
	GEV No.	510693	Ref. No. 00003000 06150001 300
	mechanical shaft seal for shaft ø 12mm slide ring ext. ø 24mm slide ring H 15.5mm slide ring int. ø 11mm counter ring mounting ø 24mm height counter ring 8mm counter ring int. ø 13.5mm		
	GEV No.	517174	Ref. No. —
	nut thread M8 H 6.5mm WS 13 SS DIN/ISO DIN 934 / ISO 4032/8673 Qty 1 pcs		
	GEV No.	521544	Ref. No. 00002710
	pump cover inlet ø 63mm outlet ø 50mm turn direction right ø 180mm ID ø 165mm inner height 42mm		
	GEV No.	521718	Ref. No. 00002910 06140010
	O-ring EPDM thickness 3.53mm ID ø 164.7mm Qty 1 pcs		
	GEV No.	560312	Ref. No. —
	plain washer ID ø 10.5mm ED ø 20mm thickness 2mm SS Qty 1 pcs DIN 125A for thread M10		

INSERT STAR

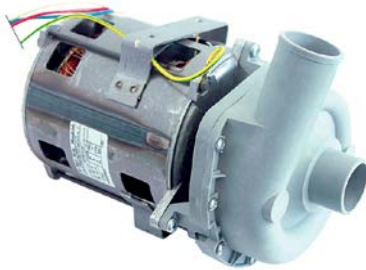
pumps



GEV No.	499270	Ref. No.	20160040
description	pump inlet ø 38mm outlet ø 38mm type 2/102FA15 220/240V 50/60Hz 1 phase 0.26kW L 200mm rotation direction right INSERT-STAR		
spare parts for	499270		
	GEV No.	504578	Ref. No. —
	O-ring EPDM thickness 3.53mm ID ø 94.84mm Qty 1 pcs		
	GEV No.	510693	Ref. No. 00003000 06150001 300
	mechanical shaft seal for shaft ø 12mm slide ring ext. ø 24mm slide ring H 15.5mm slide ring int. ø 11mm counter ring mounting ø 24mm height counter ring 8mm counter ring int. ø 13.5mm		
	GEV No.	650239	Ref. No. —
	impellor ø 75mm H 27mm pump type 2/102FA15 shaft intake ø 8mm rotation direction right thread M8L suitable for INSERTSTAR blades 6		
accessories for	499270		
	GEV No.	365093	Ref. No. —
	operating capacitor capacity 6µF 400V tolerance 5% 50/60Hz ambient temperature max. -25 to +85°C ø 31.5mm L 55mm M8 plastic connection male faston 6.3mm protection		

			
1			
GEV No.	500320	Ref. No.	20160042
description	pump inlet ø 38mm outlet ø 38mm type 2/123/FA30 230V 50Hz 1 phase 0.59kW 0.8HP L 235mm rotation direction right capacitor 10µF INSERTSTAR		
spare parts for	500320		
	GEV No.	510693	Ref. No. 00003000 06150001 300
	mechanical shaft seal for shaft ø 12mm slide ring ext. ø 24mm slide ring H 15.5mm slide ring int. ø 11mm counter ring mounting ø 24mm height counter ring 8mm counter ring int. ø 13.5mm		
	GEV No.	521000	Ref. No. —
	pump cover FAGOR inlet ø 38mm outlet ø 38mm		
	GEV No.	521255	Ref. No. —
	impellor ø 88mm H 33mm M8L pump type 2/123/FA30 shaft ø 12mm		
	GEV No.	532491	Ref. No. —
	O-ring EPDM thickness 3.53mm ID ø 120.2mm Qty 1 pcs		
accessories for	500320		
	GEV No.	365015	Ref. No. —
	operating capacitor capacity 10µF 400V tolerance 5%Hz ambient temperature max. -25 to +85°C ø 35.5mm L 59mm M8 plastic connection male faston 6.3mm protection		
	GEV No.	551227	Ref. No. —
	female faston size 6.3x0.8mm 1.0-2.5mm ² straight CuZn gal Sn t.max. 110°C Qty 10 pcs		

LAFERT

pumps

			
1			
GEV No.	500088	Ref. No.	00002510 00071800
description	pump inlet ø 62mm outlet ø 50mm type AMEE 71Z AA2 230/400V 50/60Hz 3 phase 0.75kW 1HP L 310mm rotation direction right Lafert		
spare parts for	500088		
	GEV No.	509010	Ref. No. 00002860
	impellor ø 105mm H 20mm M10L rotation direction right blades 4		

spare parts for	500088		
	GEV No.	510693	Ref. No. 00003000 06150001 300
	mechanical shaft seal for shaft ø 12mm slide ring ext. ø 24mm slide ring H 15.5mm slide ring int. ø 11mm counter ring mounting ø 24mm height counter ring 8mm counter ring int. ø 13.5mm		
	GEV No.	511132	Ref. No. 00002770
	pump cover bottom part		
	GEV No.	517174	Ref. No. —
	nut thread M8 H 6.5mm WS 13 SS DIN/ISO DIN 934 / ISO 4032/8673 Qty 1 pcs		
	GEV No.	521544	Ref. No. 00002710
	pump cover inlet ø 63mm outlet ø 50mm turn direction right ø 180mm ID ø 165mm inner height 42mm		
	GEV No.	521718	Ref. No. 00002910 06140010
	O-ring EPDM thickness 3.53mm ID ø 164.7mm Qty 1 pcs		
	GEV No.	560312	Ref. No. —
	plain washer ID ø 10.5mm ED ø 20mm thickness 2mm SS Qty 1 pcs DIN 125A for thread M10		

			
1			
GEV No.	500097	Ref. No.	00002523
description	pump inlet ø 62mm outlet ø 50mm type AMM80Z 230V 50Hz 1 phase 1.5kW 2HP L 320mm rotation direction right capacitor 25µF Lafert		
spare parts for	500097		
	GEV No.	511148	Ref. No. 00002870 287
	impellor ø 118mm H 20mm M10L		
	GEV No.	521544	Ref. No. 00002710
	pump cover inlet ø 63mm outlet ø 50mm turn direction right ø 180mm ID ø 165mm inner height 42mm		

LGB



1

GEV No.	499204	Ref. No.	20160048
description	pump inlet \varnothing 28mm outlet \varnothing 26mm type ZF119SX 230V 50Hz 1 phase 0.15kW 0.2HP L 195mm rotation direction right capacitor 5 μ F auxiliary pressure connection 12mm LGB		
spare parts for	499204		
	GEV No.	365017	Ref. No. —
	operating capacitor capacity 5 μ F 450V tolerance 5% 50/60Hz ambient temperature max. -25 to +85°C \varnothing 28mm L 54mm M8 plastic connection male faston 6.3mm 16.10.08 protection		
	GEV No.	510703	Ref. No. 06150006
	mechanical shaft seal for shaft \varnothing 13mm slide ring H 13mm height counter ring 5.5mm ED \varnothing 26mm		
	GEV No.	521057	Ref. No. 20161002
	pump cover LGB inlet \varnothing 28mm outlet \varnothing 26mm auxiliary pressure connection 12mm supporting pressure open turn direction right \varnothing 102mm ID \varnothing 77mm inner height 31mm		
	GEV No.	521114	Ref. No. —
	impellor \varnothing 48mm H 17mm pump type ZF119SX shaft \varnothing 13mm shaft length 12mm		
	GEV No.	528800	Ref. No. —
	O-ring EPDM thickness 2.62mm ID \varnothing 75.87mm Qty 1 pcs		







1

GEV No.	501556	Ref. No.	20160027
description	pump inlet \varnothing 28mm outlet \varnothing 26mm type ZF119SX 230V 50Hz 1 phase 0.2kW 0.27HP L 186mm rotation direction right capacitor 5 μ F LGB		
spare parts for	501556		
	GEV No.	521057	Ref. No. 20161002
	pump cover LGB inlet \varnothing 28mm outlet \varnothing 26mm auxiliary pressure connection 12mm supporting pressure open turn direction right \varnothing 102mm ID \varnothing 77mm inner height 31mm		



1

GEV No.	500094	Ref. No.	20160025
description	pump inlet \varnothing 28mm outlet \varnothing 26mm type ZF131SX 230V 50Hz 1 phase 0.2kW 0.15HP L 195mm rotation direction left capacitor 6.3 μ F LGB		
spare parts for	500094		
	GEV No.	365012	Ref. No. —
	operating capacitor capacity 6.3 μ F 450V tolerance 5% 50Hz ambient temperature max. -25 to +85°C \varnothing 30mm L 61mm M8 plastic connection male faston 6.3mm protection		
	GEV No.	502266	Ref. No. 20161000
	pump cover inlet \varnothing 28mm outlet \varnothing 26mm		
	GEV No.	510703	Ref. No. 06150006
	mechanical shaft seal for shaft \varnothing 13mm slide ring H 13mm height counter ring 5.5mm ED \varnothing 26mm		
	GEV No.	521085	Ref. No. —
	impellor \varnothing 72mm H 17mm thread M7L shaft \varnothing 13mm shaft length 12mm blades 3		
	GEV No.	528800	Ref. No. —
	O-ring EPDM thickness 2.62mm ID \varnothing 75.87mm Qty 1 pcs		



1











GEV No.	500539	Ref. No.	00202481
description	pump inlet \varnothing 28mm outlet \varnothing 26mm type ZF170SX 230V 50Hz 1 phase 0.32kW 0.44HP L 200mm rotation direction right capacitor 8 μ F LGB		
spare parts for	500539		
	GEV No.	509004	Ref. No. 00210036
	impellor \varnothing 71mm H 16mm M7L rotation direction right shaft \varnothing 13mm shaft length 13mm blades 8		
	GEV No.	510703	Ref. No. 06150006
	mechanical shaft seal for shaft \varnothing 13mm slide ring H 13mm height counter ring 5.5mm ED \varnothing 26mm		





Table continues overleaf

spare parts for 500539			
	GEV No.	521057	Ref. No. 20161002
pump cover LGB inlet ø 28mm outlet ø 26mm auxiliary pressure connection 12mm supporting pressure open turn direction right ø 102mm ID ø 77mm inner height 31mm			
	GEV No.	528800	Ref. No. —
O-ring EPDM thickness 2.62mm ID ø 75.87mm Qty 1 pcs			
accessories for 500539			
	GEV No.	365013	Ref. No. —
operating capacitor capacity 8µF 400V tolerance 5%Hz ambient temperature max. -25 to +85°C ø 31.5mm L 55mm M8 plastic connection male faston 6.3mm protection			



1			
GEV No.	500092	Ref. No.	00202480
description	pump inlet ø 50mm outlet ø 44mm type W300SX 230V 50Hz 1 phase 0.3kW 0.5HP L 170mm rotation direction right capacitor 10µF LGB		
spare parts for 500092			
	GEV No.	365015	Ref. No. —
operating capacitor capacity 10µF 400V tolerance 5%Hz ambient temperature max. -25 to +85°C ø 35.5mm L 59mm M8 plastic connection male faston 6.3mm protection			
	GEV No.	510554	Ref. No. 00002900 06140008 06140140
O-ring EPDM thickness 2mm ID ø 120mm Qty 1 pcs			
	GEV No.	510607	Ref. No. —
impellor ø 85mm H 29mm shaft intake ø 9x8mm rotation direction right blades 6			
	GEV No.	510693	Ref. No. 00003000 06150001 300
mechanical shaft seal for shaft ø 12mm slide ring ext. ø 24mm slide ring H 15.5mm slide ring int. ø 11mm counter ring mounting ø 24mm height counter ring 8mm counter ring int. ø 13.5mm			
	GEV No.	511178	Ref. No. 00202460
pump cover bottom part			
	GEV No.	521564	Ref. No. 00210028
pump cover			



1			
GEV No.	500093	Ref. No.	00202486
description	pump inlet ø 50mm outlet ø 44mm type W500SX 230V 50Hz 1 phase 0.5kW 0.7HP L 200mm rotation direction right capacitor 16µF LGB		
spare parts for 500093			
	GEV No.	365021	Ref. No. 24100004
operating capacitor capacity 16µF 425V tolerance 5% 50/60Hz ambient temperature max. -25 to +85°C ø 35mm L 73mm single M8 plastic connection male faston 6.3mm 416.10.99 protection			
	GEV No.	510607	Ref. No. —
impellor ø 85mm H 29mm shaft intake ø 9x8mm rotation direction right blades 6			
	GEV No.	510693	Ref. No. 00003000 06150001 300
mechanical shaft seal for shaft ø 12mm slide ring ext. ø 24mm slide ring H 15.5mm slide ring int. ø 11mm counter ring mounting ø 24mm height counter ring 8mm counter ring int. ø 13.5mm			
	GEV No.	521564	Ref. No. 00210028
pump cover			
	GEV No.	521717	Ref. No. 00002900 06140008 06140140 290
O-ring EPDM thickness 1.78mm ID ø 120.37mm Qty 1 pcs			



booster pumps I

1			
GEV No.	500540	Ref. No.	20160001
description	pump inlet ø 1" IT outlet ø 1" IT type PKM60 230V 50Hz 1 phase 0.37kW PEDRELLO 0.5HP		
accessories for 500540			
	GEV No.	365015	Ref. No. —
operating capacitor capacity 10µF 400V tolerance 5%Hz ambient temperature max. -25 to +85°C ø 35.5mm L 59mm M8 plastic connection male faston 6.3mm protection			





			
1			
GEV No.	499067	Ref. No.	20160003
description	pump inlet ø 1" IT outlet ø 1" IT type PKM60 230V 60Hz 1 phase 0.37kW 0.5HP L 247mm rotation direction left capacitor 10µF PEDRELLO		

			
1			
GEV No.	500395	Ref. No.	20160011 20160016
description	pump inlet ø 3/8" IT outlet ø 3/8" IT type PS45DX 230V 50Hz 0.35kW capacitor 8µF LGB		
spare parts for	500395		
	GEV No.	365013	Ref. No. —
	operating capacitor capacity 8µF 400V tolerance 5%Hz ambient temperature max. -25 to +85°C ø 31.5mm L 55mm M8 plastic connection male faston 6.3mm protection		
	GEV No.	698400	Ref. No. —
	pump cover gasket pump type PS46 thickness 2mm ID ø 66mm Qty 1 pcs		

drain pumps

HANNING			
			
1			
GEV No.	500082	Ref. No.	00002570
description	drain pump 230V 100W		

PLASET

			
1			
GEV No.	500083	Ref. No.	20160014
description	drain pump inlet ø 30mm outlet ø 23mm 220-240V 34W 50Hz PLASET		

miscellaneous			
			
1			
GEV No.	499001	Ref. No.	20160013
description	drain pump inlet ø 30mm outlet ø 22mm 220V 34W 60Hz PLASET		

condensators & interference suppression filters

operating capacitors

plastic			
			
1			
GEV No.	365014	Ref. No.	00002630
description	operating capacitor capacity 12.5µF 450V tolerance 5%Hz ambient temperature max. -25 to +85°C ø 35mm L 70mm M8 plastic connection male faston 6.3mm 45S.C3D5.12.5 protection		

			
1			
GEV No.	365021	Ref. No.	24100004
description	operating capacitor capacity 16µF 425V tolerance 5% 50/60Hz ambient temperature max. -25 to +85°C ø 35mm L 73mm single M8 plastic connection male faston 6.3mm 416.10.99 protection		

filters

interference suppression filters

			
1			
GEV No.	365026	Ref. No.	00002650 24100100
description	interference suppression filter capacity 0.47µF(X2)+2x0.01µF(Y2) 0.68MOhm		

			
1			
GEV No.	365089	Ref. No.	24100102
description	interference suppression filter type X1+100R 250V capacity 0.24µF		





fuses

fine fuses

			
1			
GEV No.	358041	Ref. No.	00060970
description	fine fuse size ø10x38mm 20A slow-acting rated 400V type aM Qty 1 pcs		

			
1			
GEV No.	358030	Ref. No.	00060980
description	fine fuse size ø10x38mm 32A slow-acting rated 400V type aM Qty 1 pcs		

			
1			
GEV No.	358038	Ref. No.	00060960 37130999
description	fine fuse size ø10x38mm 10A slow-acting rated 500V type aM Qty 1 pcs		

			
1			
GEV No.	358040	Ref. No.	00006261
description	fine fuse size ø10x38mm 16A slow-acting rated 500V type aM Qty 1 pcs		

fine fuse holders

			
1			
GEV No.	358075	Ref. No.	00006121 37170001
description	fuse holder for for fuse ø10x38mm suitable fuse ø10x38mm 1-pole 32A rated 690V for DIN rail 35mm cross section 10mm ² suitable for for fuse ø10x38mm		

electric accessories

cables

ribbon cables

group 1

			
1			
GEV No.	403776	Ref. No.	25190105
description	ribbon cable 10-pole L 2600mm plug type FC-10P raster size 2.54mm		

terminals

rail-mounted terminals



miscellaneous

			
1			
GEV No.	358505	Ref. No.	00006260
description	rail-mounted terminal 6-10mm ² 1-pole		

gas thermostats

SIT

710 Minisit series

			
1			
GEV No.	107543	Ref. No.	00034620
description	gas thermostat kit SIT type MINISIT 710 t.max. 190°C 110-190°C gas inlet 1/2" IT gas outlet 3/8" IT thermocouple connection M9x1 probe ø 6mm probe L 105mm capillary pipe 1050mm pressure controller no		
spare parts for	107543		
	GEV No.	101135	Ref. No. 00038639
	gas thermostat SIT type MINISIT 710 t.max. 190°C 110-190°C gas inlet 1/2" gas outlet 3/8" thermocouple connection M9x1 pilot connection M10x1 probe ø 6mm probe L 102mm capillary pipe 1050mm probe type type A3 pressure controller no pressure regulator or bar gland nut		
	GEV No.	390730	Ref. No. 22170003
	safety thermostat switch-off temp. 230°C 1-pole 0.5A probe ø 4mm probe L 125mm capillary pipe 1550mm capillary pipe isolated 1410mm gland nut probe		



GEV No.	101135	Ref. No.	00038639
description	gas thermostat SIT type MINISIT 710 t.max. 190°C 110-190°C gas inlet 1/2" gas outlet 3/8" thermocouple connection M9x1 pilot connection M10x1 probe ø 6mm probe L 102mm capillary pipe 1050mm probe type type A3 pressure controller no pressure regulator mbar gland nut		
spare parts for	101135		
	GEV No.	101053	Ref. No. —
	magnet unit T1: M9x1 T2: M24x1 L 45mm ø 17mm suitable for Minisit		
	GEV No.	102118	Ref. No. —
	probe 110-190°C probe ø 6mm probe L 102mm capillary pipe 1050mm t.max. 190°C fryer probe type type A3 suitable for MINISIT 710		
accessories for	101135		
	GEV No.	100809	Ref. No. —
	O-ring EPDM thickness 2mm ID ø 21mm Qty 1 pcs		
	GEV No.	100820	Ref. No. —
	gland duct ET M14x1.5 IT M10x0.75 probe ø max. 6.5mm WS 22		
	GEV No.	100904	Ref. No. —
	locking screw M10x1 for pipe ø 4mm Qty 1 pcs		
	GEV No.	100905	Ref. No. —
	locking screw M10x1 for pipe ø 6mm Qty 1 pcs		
	GEV No.	101054	Ref. No. —
	magnet unit T1: M10x1 T2: M24x1 L 45mm ø 17mm suitable for Minisit		
	GEV No.	101136	Ref. No. 00032410
	piezoelectric igniter suitable for Minisit with cover cap ømm connection F6.3x0.8		
	GEV No.	101137	Ref. No. —
	cover cap without piezoelectric igniter		
	GEV No.	101267	Ref. No. —
	reducer IT 3/8" ET 1/2" L 21mm		
	GEV No.	101268	Ref. No. —
	gas connection thread 3/8" angled with O-ring MINISIT 710		
	GEV No.	101269	Ref. No. —
	gas connection thread 1/2" angled with O-ring MINISIT 710		
	GEV No.	101270	Ref. No. —
	screw connection IT 3/8" ET 3/8" L 28mm		
	GEV No.	101272	Ref. No. —
	screw connection IT 1/2" ET 3/8" L 57mm		
	GEV No.	101273	Ref. No. —
	olive for pipe ø 12mm L 9.5mm brass Qty 1 pcs suitable for universal		

accessories for	101135		
	GEV No.	101274	Ref. No. —
	olive for pipe ø 16mm Qty 1 pcs		
	GEV No.	101275	Ref. No. —
	union screw thread 1/2" for pipe ø 16mm Qty 1 pcs		
	GEV No.	101276	Ref. No. —
	union screw thread 3/8" tube ø 12mm Qty 1 pcs		
	GEV No.	110068	Ref. No. 16100003
	knob suitable for Minisit ø 37mm		

GEV No.	101434	Ref. No.	00032390
description	gas thermostat without accessories SIT type MINISIT 710 t.max. 190°C 110-190°C gas inlet 1/2" gas outlet 3/8" thermocouple connection M9x1 pilot connection M10x1 probe ø 5mm probe L 102mm capillary pipe 1200mm probe type type G1 pressure controller no pressure regulator mbar gland nut		
spare parts for	101434		
	GEV No.	101053	Ref. No. —
	magnet unit T1: M9x1 T2: M24x1 L 45mm ø 17mm suitable for Minisit		
	GEV No.	102105	Ref. No. 16100030
	probe 110-200°C probe ø 6mm probe L 102mm capillary pipe 1050mm t.max. 200°C fryer probe type type G1 suitable for MINISIT 710		
accessories for	101434		
	GEV No.	100809	Ref. No. —
	O-ring EPDM thickness 2mm ID ø 21mm Qty 1 pcs		
	GEV No.	100904	Ref. No. —
	locking screw M10x1 for pipe ø 4mm Qty 1 pcs		
	GEV No.	100905	Ref. No. —
	locking screw M10x1 for pipe ø 6mm Qty 1 pcs		
	GEV No.	101054	Ref. No. —
	magnet unit T1: M10x1 T2: M24x1 L 45mm ø 17mm suitable for Minisit		
	GEV No.	101136	Ref. No. 00032410
	piezoelectric igniter suitable for Minisit with cover cap ømm connection F6.3x0.8		
	GEV No.	101137	Ref. No. —
	cover cap without piezoelectric igniter		
	GEV No.	101267	Ref. No. —
	reducer IT 3/8" ET 1/2" L 21mm		

Table continues overleaf

accessories for		101434	
	GEV No.	101268	Ref. No. —
gas connection thread 3/8" angled with O-ring MINISIT 710			
	GEV No.	101269	Ref. No. —
gas connection thread 1/2" angled with O-ring MINISIT 710			
	GEV No.	101270	Ref. No. —
screw connection IT 3/8" ET 3/8" L 28mm			
	GEV No.	101272	Ref. No. —
screw connection IT 1/2" ET 3/8" L 57mm			
	GEV No.	101273	Ref. No. —
olive for pipe ø 12mm L 9.5mm brass Qty 1 pcs suitable for universal			
	GEV No.	101274	Ref. No. —
olive for pipe ø 16mm Qty 1 pcs			
	GEV No.	101275	Ref. No. —
union screw thread 1/2" for pipe ø 16mm Qty 1 pcs			
	GEV No.	101276	Ref. No. —
union screw thread 3/8" tube ø 12mm Qty 1 pcs			
	GEV No.	110068	Ref. No. 16100003
knob suitable for Minisit ø 37mm			

accessories

probes



GEV No.	102105	Ref. No.	16100030
description	probe 110-200°C probe ø 6mm probe L 102mm capillary pipe 1050mm t.max. 200°C fryer probe type type G1 suitable for MINISIT 710		







gas valves and ignition boxes

gas control valves

SIT

NOVASIT



GEV No.	101187	Ref. No.	16100005
description	gas valve SIT series Novasit 820 0.17VHz gas inlet 1/2" gas outlet 1/2" thermocouple connection M9x1 pilot connection M10x1 ignition pressurembar pressure range 5-50mbar pressure regulator connection blind equiv. no. 0.820.301 supply Operator millivolt		
spare parts for	101187		
	GEV No.	101065	Ref. No. —
magnet unit with cable L 44mm D1 ø 30mm D2 ø 20mm suitable for NOVASIT			
accessories for	101187		
	GEV No.	100110	Ref. No. —
pilot burner SIT type 190 series 3 flames nozzle ømm gas connectionmm			
	GEV No.	101305	Ref. No. —
gas connection straight 1/2" flange 45x45mm ELETTROSIT/V4400/4600/4605 suitable for SIT/HONEYWELL hole distance 36x36mm			
	GEV No.	101306	Ref. No. —
gas connection angled flange 45x45mm hole distance 36x36mm 1/2" ELETTROSIT/V4400/4600/4605 screw with O-ring suitable for SIT/HONEYWELL			
	GEV No.	101307	Ref. No. —
gas connection straight flange 45x45mm hole distance 36x36mm 3/4" ELETTROSIT/V4400/4600/4605 screw with O-ring suitable for SIT/HONEYWELL			
	GEV No.	101308	Ref. No. —
gas connection angled flange 45x45mm hole distance 36x36mm 3/4" ELETTROSIT/V4400/4600/4605 screw with O-ring suitable for SIT/HONEYWELL			
	GEV No.	102116	Ref. No. 17100002
thermopile ROBERTSHAW L 900mm probe ø 9mm probe L 57mm 250-750mV screw connection 7/16"			



ignition parts















pilot burners



SIT

100 series



1

GEV No.	106906	Ref. No.	33120005
description	pilot burner SIT type 100 series 3 flames nozzle \varnothing 0.2mm gas connection 6mm		
spare parts for	106906		
	GEV No.	100245	Ref. No. —
	pilot burner nozzle LPG code 20 bore \varnothing 0.2mm Qty 1 pcs thread M8x0.75		
	GEV No.	100855	Ref. No. —
	pilot burner bracket triple		
	GEV No.	100885	Ref. No. —
	air mixing sleeve for pilot burner Qty 1 pcs		
	GEV No.	100916	Ref. No. —
	compression spring for pilot burner Qty 1 pcs		
	GEV No.	100917	Ref. No. —
	gasket for pilot burner Qty 1 pcs aluminium		
	GEV No.	100918	Ref. No. —
	screw for pilot burner		
	GEV No.	107162	Ref. No. —
	pilot burner cap SIT 3 flames Hmm Lmm Qty 1 pcs		
	GEV No.	107701	Ref. No. —
	pilot burner bottom part SIT 100 series nozzle \varnothing 0.2mm		
accessories for	106906		
	GEV No.	100245	Ref. No. —
	pilot burner nozzle LPG code 20 bore \varnothing 0.2mm Qty 1 pcs thread M8x0.75		
	GEV No.	100246	Ref. No. —
	pilot burner nozzle natural gas bore \varnothing 0.35mm Qty 1 pcs thread M8x0.75		
	GEV No.	100904	Ref. No. —
	locking screw M10x1 for pipe \varnothing 4mm Qty 1 pcs		
	GEV No.	100905	Ref. No. —
	locking screw M10x1 for pipe \varnothing 6mm Qty 1 pcs		
	GEV No.	102110	Ref. No. —
	pilot tube copper pipe \varnothing 4mm thickness 1mm L 3000mm		
	GEV No.	102111	Ref. No. —
	pilot tube copper pipe \varnothing 6mm thickness 1mm L 3000mm		

accessories for	106906		
	GEV No.	107171	Ref. No. —
	pilot burner nozzle SIT natural/liquid gas bore \varnothing 0.25mm Qty 1 pcs		
	GEV No.	107700	Ref. No. —
	pilot burner bottom part SIT 100 series nozzle \varnothing 0.25mm		
	GEV No.	107702	Ref. No. —
	pilot burner bottom part SIT 100 series nozzle \varnothing 0.35mm		

accessories

ignition electrodes

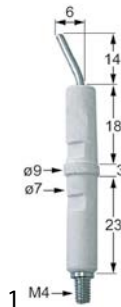

GEV No.	100706	Ref. No.	33110002
description	ignition electrode connection M4 Qty 1 pcs		

160 series



1









GEV No.	100049	Ref. No.	00032790
description	pilot burner SIT type 160 series 2 flames nozzle \varnothing mm gas connectionmm		
spare parts for	100049		
	GEV No.	100907	Ref. No. 33120009
	screw connection thread M10x1 Qty 1 pcs type SEF 1 \varnothing mm for thermocouple		
accessories for	100049		
	GEV No.	100202	Ref. No. —
	pilot burner nozzle natural gas code 41 Qty 1 pcs nozzle \varnothing 0.41mm		
	GEV No.	100203	Ref. No. —
	pilot burner nozzle LPG code 25 Qty 1 pcs nozzle \varnothing 0.25mm		
	GEV No.	100701	Ref. No. 33110001
	ignition electrode connection M4 Qty 1 pcs		
	GEV No.	100869	Ref. No. —
	pilot burner nozzle natural gas code 51 Qty 1 pcs suitable for 160 series nozzle \varnothing 0.51mm		
	GEV No.	100906	Ref. No. 33120004
	screw connection thread M10x1 for ignition electrode brass Qty 1 pcs WS 10		
	GEV No.	100908	Ref. No. —
	union screw thread M10x1 for pipe \varnothing 4mm Qty 1 pcs		

Table continues overleaf



accessories for 100049				
	GEV No.	100909	Ref. No.	—
	union screw thread M10x1 for pipe ø 6mm Qty 1 pcs			
	GEV No.	101282	Ref. No.	—
	olive for pipe ø 4mm L 7.4mm Qty 1 pcs			
	GEV No.	101287	Ref. No.	—
	olive for pipe ø 6mm Qty 1 pcs			
	GEV No.	102110	Ref. No.	—
	pilot tube copper pipe ø 4mm thickness 1mm L 3000mm			
	GEV No.	102111	Ref. No.	—
	pilot tube copper pipe ø 6mm thickness 1mm L 3000mm			
	GEV No.	107650	Ref. No.	00032680
	pilot burner nozzle SIT LPG code 30 Qty 1 pcs			

190 series



	1			
GEV No.	106722	Ref. No.	00038491	
description	pilot burner SIT type 190 series 3 flames natural/liquid gas nozzle 35/51 nozzle ø 0.35/0.51mm gas connection 6mm complete with nozzle			



POLIDORO

pilot burners



	1			
GEV No.	104485	Ref. No.	33120030	
description	pilot burner POLIDORO 2 flames natural gas code 29.2 gas connection 6mm			

miscellaneous

	1			
GEV No.	106966	Ref. No.	00038531	
description	pilot burner 2 flames natural/liquid gas nozzle ø 0.45mm gas connection 6mm			
spare parts for	106966			
	GEV No.	100855	Ref. No.	—
	pilot burner bracket triple			
	GEV No.	100885	Ref. No.	—
	air mixing sleeve for pilot burner Qty 1 pcs			

spare parts for 106966				
	GEV No.	102742	Ref. No.	—
	pilot burner nozzle LPG code 25 bore ø 0.25mm Qty 1 pcs			
	GEV No.	102973	Ref. No.	—
	pilot burner nozzle natural gas bore ø 0.45mm Qty 1 pcs			

electrodes

	1			
GEV No.	100701	Ref. No.	33110001	
description	ignition electrode connection M4 Qty 1 pcs			
accessories for	100701			
	GEV No.	100906	Ref. No.	33120004
	screw connection thread M10x1 for ignition electrode brass Qty 1 pcs WS 10			

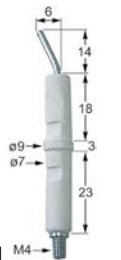
	1			
GEV No.	100706	Ref. No.	33110002	
description	ignition electrode connection M4 Qty 1 pcs			

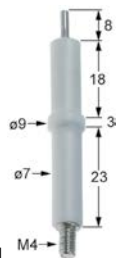
	1			
GEV No.	102871	Ref. No.	33110003	
description	ignition electrode D1 ø 7mm D2 ø 9mm connection M4 L1 8mm BL1 18mm BL2 3mm BL3 23mm to clip			





1

GEV No.	100906	Ref. No.	33120004
description	screw connection thread M10x1 for ignition electrode brass Qty 1 pcs WS 10		

ignition cables

pre-assembled cables



1

GEV No.	100015	Ref. No.	30140002
description	ignition cable cable length 600mm connection $\varnothing 2.4\text{mm}$ / $\varnothing 2.4\text{mm}$		



1

GEV No.	100025	Ref. No.	30140001
description	ignition cable cable length 600mm connection $\varnothing 4\text{mm}$ / F6.3mm		

piezoelectric igniters

mounting diameter 22mm



1

GEV No.	100005	Ref. No.	33100003
description	piezoelectric igniter body plastic blowing mounting $\varnothing 22\text{mm}$ connection $\varnothing 2.4\text{mm}$ cable lengthmm SIT		

miscellaneous



1

GEV No.	nla ¹	Ref. No.	00032460
description	piezoelectric igniter suitable for Minisit connection F6.3x0.8 $\varnothing\text{mm}$		

¹no longer available



1

GEV No.	nla ¹	Ref. No.	00032410	
description	piezoelectric igniter suitable for Minisit with cover cap $\varnothing\text{mm}$ connection F6.3x0.8			
spare parts for	101136			
	GEV No.	100001	Ref. No.	00032460
	piezoelectric igniter suitable for Minisit connection F6.3x0.8 $\varnothing\text{mm}$			

¹no longer available

thermocouples

plug-in thermocouples

plug-in thermocouples with interruption

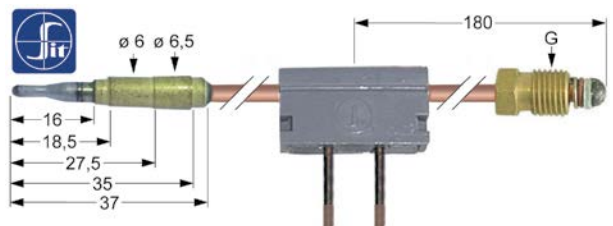

1

GEV No.	107234	Ref. No.	17100003
description	thermocouple SIT with interrupter M9x1 L 400mm plug connection $\varnothing 6.0\text{mm}$ soldering connection		

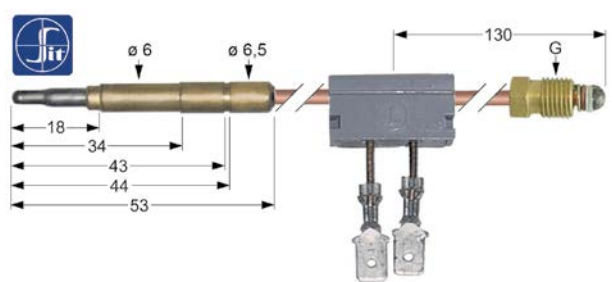

1

GEV No.	107177	Ref. No.	00032580 17100001
description	thermocouple SIT with interrupter M9x1 L 600mm plug connection $\varnothing 6.0\text{mm}$ F 6.3mm		

thermopiles

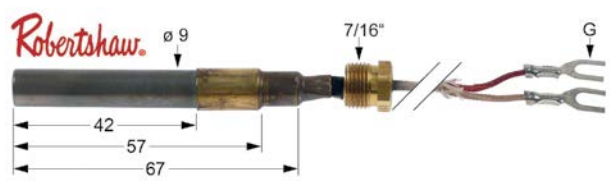

1

GEV No.	102116	Ref. No.	17100002
description	thermopile ROBERTSHAW L 900mm probe $\varnothing 9\text{mm}$ probe L 57mm 250-750mV screw connection 7/16"		

gas burners

bar burners

bar burners



GEV No.	105384	Ref. No.	15100004
description	bar burner 2 row L 450mm W 240mm ømm H 310mm fryer		



GEV No.	104483	Ref. No.	15100010
description	bar burner ø 40mm Wmm Hmm L 340mm flange width 50mm flange length 62mm fryer		



GEV No.	105430	Ref. No.	15100008
description	bar burner ø 40mm Wmm Hmm L 340mm flange width 60mm flange length 76mm fryer		

gas nozzles

main nozzles

gas nozzles M10x1



GEV No.	100067	Ref. No.	18110093 18110121
description	gas injector thread M10x1 WS 12 bore ø 1.1mm G30 gas pressure 30mbar		



GEV No.	107343	Ref. No.	18110111 18110130
description	gas injector thread M10x1 WS 12 bore ø 1.2mm LPG gas pressure 30mbar		



GEV No.	106290	Ref. No.	18110095 18110110
description	gas injector thread M10x1 WS 12 bore ø 1.85mm inner peaked		

pilot burner nozzles

pilot burner nozzles POLIDORO



GEV No.	100000	Ref. No.	18100060
description	pilot burner nozzle POLIDORO LPG code 22 bore ø 0.22mm Qty 1 pcs		



GEV No.	104486	Ref. No.	18100061
description	pilot burner nozzle POLIDORO natural gas code 29.2 bore ø 2x0.29mm Qty 1 pcs		

pilot burner nozzles SIT

160 series



GEV No.	107172	Ref. No.	18100094
description	pilot burner nozzle SIT LPG code 25 Qty 1 pcs		



GEV No.	107650	Ref. No.	00032680
description	pilot burner nozzle SIT LPG code 30 Qty 1 pcs		



GEV No.	107173	Ref. No.	18100095
description	pilot burner nozzle SIT natural gas code 35 Qty 1 pcs suitable for 160 series nozzle ø 0.35mm		





			
1			
GEV No.	107175	Ref. No.	00032690
description	pilot burner nozzle SIT natural gas code 51 Qty 1 pcs suitable for 160 series		

auxiliary gas parts

screw connections

union screws

			
1			
GEV No.	100906	Ref. No.	33120004
description	screw connection thread M10x1 for ignition electrode brass Qty 1 pcs WS 10		

			
1			
GEV No.	100907	Ref. No.	33120009
description	screw connection thread M10x1 Qty 1 pcs type SEF 1 ømm for thermocouple		

angle pieces

			
1			
GEV No.	104484	Ref. No.	12355007
description	angle piece T1: 1/2" ET T2: 1/2" ET		

equipment-specific units

for deep fryers

lids

			
1			
GEV No.	695603	Ref. No.	00030660
description	lid suitable for fryer L 305mm W 210mm with handle		

			
1			
GEV No.	695606	Ref. No.	00030690
description	lid suitable for fryer L 340mm W 270mm		

basket holders

			
1			
GEV No.	970736	Ref. No.	00038567
description	basket support for fryer W 265mm H 220mm suitable for ELFRAMO GW		

miscellaneous



1

GEV No.	550268	Ref. No.	00032290
----------------	--------	-----------------	----------

description	cover cap for push-button
--------------------	---------------------------

for dishwashers

containers

dosing containers



1

GEV No.	511162	Ref. No.	00003730
----------------	--------	-----------------	----------

description	drawer for rinse aid
--------------------	----------------------

accessories for	511162
------------------------	--------



GEV No.	511163	Ref. No.	00003731 373A
----------------	--------	-----------------	------------------

description	screw for rinse aid container
--------------------	-------------------------------



1

GEV No.	361739	Ref. No.	00003740
----------------	--------	-----------------	----------

description	rinse aid container
--------------------	---------------------



1

GEV No.	511126	Ref. No.	00011060
----------------	--------	-----------------	----------

description	rinse aid container
--------------------	---------------------

salt tanks



1

GEV No.	511895	Ref. No.	12145002
----------------	--------	-----------------	----------

description	salt tank
--------------------	-----------



1

GEV No.	510032	Ref. No.	12145002 12145003
----------------	--------	-----------------	----------------------

description	salt tank without gasket new model
--------------------	------------------------------------

spare parts for	510032
------------------------	--------

	GEV No.	506015	Ref. No.	—
	description	O-ring EPDM thickness 3.53mm ID ø 39.69mm Qty 1 pcs		
	GEV No.	510018	Ref. No.	—
	description	nut ø 92mm H 10.5mm for salt tank ID ø 64mm		
	GEV No.	510071	Ref. No.	—
	description	flat gasket rubber ED ø 81mm ID ø 68mm thickness 3mm for salt tank Qty 1 pcs		
	GEV No.	524177	Ref. No.	—
	description	lid ø 69mm H 20mm for salt tank ID ø 50mm		



accessories



1

GEV No.	511487	Ref. No.	00011053
description	funnel		



1

GEV No.	511163	Ref. No.	00003731 373A
description	screw for rinse aid container		

boilers

boilers for dishwashers



1

GEV No.	511899	Ref. No.	00013771
description	boiler		



1

GEV No.	511901	Ref. No.	00003440
description	boiler		



1

GEV No.	511896	Ref. No.	00211009
description	boiler ø 120mm L 270mm		



1

GEV No.	511898	Ref. No.	00210410
description	boiler ø 140mm L 270mm		



1

GEV No.	511897	Ref. No.	00222040
description	boiler ø 140mm L 270mm flange 4 hole inlet ø 50		



1

GEV No.	511900	Ref. No.	00010500
description	boiler ø 170mm L 440mm		

accessories



1

GEV No.	699274	Ref. No.	00010514
description	connecting fitting for boiler thread 1/2" L 75mm W 32mm hose ø 14/5mm		



1

GEV No.	511817	Ref. No.	00010502
description	T-piece connection 1/4" ET - 1/2" IT hose ø 13mm 1/4" ET - 1/2" IT hose ø 13mm		

rotation plates

rotation plate bearings



1

GEV No.	519419	Ref. No.	00005491
description	spindle for rotation plate ø 47mm		

softener cartridges

softening columns



1

GEV No.	530001	Ref. No.	12145001
----------------	--------	-----------------	----------

description	softener 4-fold L 380mm W 180mm		
--------------------	---------------------------------	--	--

housing and bezels

fascias



1

GEV No.	403262	Ref. No.	00222433
----------------	--------	-----------------	----------

description	control panel warewashing BE35 W 178mm H 48mm D 58mm suitable for ELFRAMO		
--------------------	---	--	--

hood mechanics for dishwashers

bolts



1

GEV No.	511888	Ref. No.	00018051
----------------	--------	-----------------	----------

description	screw bolt hood mechanics		
--------------------	---------------------------	--	--

springs



1

GEV No.	511623	Ref. No.	00002320
----------------	--------	-----------------	----------

description	spring for hood mechanics		
--------------------	---------------------------	--	--



1

GEV No.	511625	Ref. No.	00002330
----------------	--------	-----------------	----------

description	spring for hood mechanics		
--------------------	---------------------------	--	--

hood handle supports



1

GEV No.	511560	Ref. No.	00018030 00018049 00018165
----------------	--------	-----------------	----------------------------------

description	handle holder hood mechanics H 42mm ø 90mm		
--------------------	--	--	--

rollers



1

GEV No.	511876	Ref. No.	00013784
----------------	--------	-----------------	----------

description	roller ED ø 40mm ID ø 11mm		
--------------------	----------------------------	--	--



1

GEV No.	511595	Ref. No.	00065842
----------------	--------	-----------------	----------

description	roller set ø 30mm H 24mm for dishwasher hole ø 15mm		
--------------------	---	--	--

cable controls



1

GEV No.	511118	Ref. No.	00002350
----------------	--------	-----------------	----------

description	cable control foot switch for hood		
--------------------	------------------------------------	--	--



1

GEV No.	511152	Ref. No.	00002370
----------------	--------	-----------------	----------

description	hauling cable L 900mm hood mechanics		
--------------------	--------------------------------------	--	--



miscellaneous



1

GEV No.	511887	Ref. No.	00018050
description	bush hood mechanics		



1

GEV No.	511885	Ref. No.	00018026
description	handle holder hood mechanics		



1

GEV No.	511886	Ref. No.	00018021
description	roller hood mechanics		

basket guides

guide bars



1

GEV No.	699273	Ref. No.	00073240
description	guide for rack conveyor dishwashing machine L 50mm W 45mm H 80mm with rollers		

basket holders

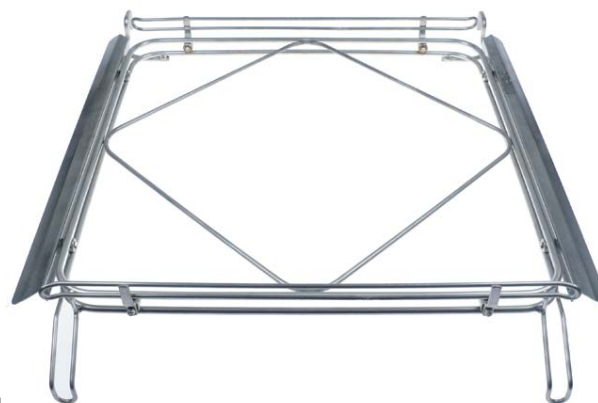

1

GEV No.	971059	Ref. No.	00018060 00018404
description	basket support L 640m W 560mm H 110mm		

air traps

air traps



1

GEV No.	511067	Ref. No.	00002180
description	air trap		



1

GEV No.	511069	Ref. No.	00205750
description	air trap		



1

GEV No.	511820	Ref. No.	00012716
description	air trap		



1

GEV No.	511821	Ref. No.	00013984
description	air trap		



1

GEV No.	511824	Ref. No.	00014098
----------------	--------	-----------------	----------

description	air trap
--------------------	----------



1

GEV No.	519465	Ref. No.	00014087
----------------	--------	-----------------	----------

description	air trap ø 45mm H 160mm thread 3/8" hose ø 6mm
--------------------	--

air trap accessories



1

GEV No.	511823	Ref. No.	00012719
----------------	--------	-----------------	----------

description	hose connector
--------------------	----------------

backflow preventers

backflow preventers



1

GEV No.	511124	Ref. No.	23180200 23180202
----------------	--------	-----------------	----------------------

description	backflow preventer dishwasher
--------------------	-------------------------------



1

GEV No.	516101	Ref. No.	23180203
----------------	--------	-----------------	----------

description	backflow preventer dishwasher hose ø 12mm
--------------------	---

spare parts for	516101
------------------------	--------



GEV No.	506367	Ref. No.	—
----------------	--------	-----------------	---

flat gasket rubber ED ø 40mm ID ø 28mm thickness 1.8mm Qty 1 pcs

door mechanics

springs

roller springs



1

GEV No.	519550	Ref. No.	00079740
----------------	--------	-----------------	----------

description	roller spring W 25.35mm
--------------------	-------------------------



1

GEV No.	519491	Ref. No.	00079730
----------------	--------	-----------------	----------

description	roller spring W 26mm
--------------------	----------------------



1

GEV No.	519543	Ref. No.	00065816
----------------	--------	-----------------	----------

description	roller spring with holder W 46mm ID ømm lug lengthmm
--------------------	--

linkage



1

GEV No.	511906	Ref. No.	00210993
----------------	--------	-----------------	----------

description	door pin L 210mm tie bar
--------------------	--------------------------





1

GEV No.	511881	Ref. No.	00210366
----------------	--------	-----------------	----------

description	door pin mounting pos. left complete tie bar
--------------------	--





1	 Image not available		
	GEV No.	511872	Ref. No.
description tie bar			

2			
	GEV No.	511884	Ref. No.
description tie bar complete			

1			
	GEV No.	511871	Ref. No.
description tie bar L 260mm			

1	 Image not available		
	GEV No.	511883	Ref. No.
description tie bar mounting pos. left complete			

1			
	GEV No.	511880	Ref. No.
description tie bar mounting pos. right complete			

1			
	GEV No.	511882	Ref. No.
description tie bar mounting pos. right complete			

threaded shafts			
1			
	GEV No.	511879	Ref. No.
description threaded part threaded part			

sliding plates			
1			
	GEV No.	511907	Ref. No.
description sliding plate			

1			
	GEV No.	511878	Ref. No.
description sliding plate sliding plate			

rollers			
1			
	GEV No.	501431	Ref. No.
description roller ED ø 9mm for door mechanism shaft diameter 3.5mm W 5mm			

hinges			
1			
	GEV No.	519417	Ref. No.
description door hinge			

1			
	GEV No.	511866	Ref. No.
description door hinge door hinge left mounting pos. left			

			
1			
GEV No.	511874	Ref. No.	00013744
description	door hinge door hinge left mounting pos. left		

			
1			
GEV No.	511865	Ref. No.	00210903
description	door hinge door hinge right mounting pos. right		

			
1			
GEV No.	511873	Ref. No.	00013743
description	door hinge door hinge right mounting pos. right		

door guides			
			
1			
GEV No.	517496	Ref. No.	00065245
description	door guides L 460mm W 34mm H 25mm mounting pos. left/right		

door magnets			
			
1			
GEV No.	694539	Ref. No.	25110108
description	door magnet L 63mm W 7.5mm H 19mm mounting distance 52mm		

door bumpers			
			
1			
GEV No.	511869	Ref. No.	00013791
description	door bumper end stop		

locks			
			
1			
GEV No.	511083	Ref. No.	00011040
description	counterpart door catch		

			
1			
GEV No.	511105	Ref. No.	00001670 00001680
description	counterpart door catch		





1

GEV No.	511104	Ref. No.	00001630 00001640
description	door catch		
accessories for	511104		
	GEV No.	511105	Ref. No.
			00001670 00001680
	counterpart door catch		



1

GEV No.	511082	Ref. No.	00011028
description	door catch complete catch		
accessories for	511082		
	GEV No.	511083	Ref. No.
			00011040
	counterpart door catch		

miscellaneous



1

GEV No.	524047	Ref. No.	00013786
description	hauling cable for door mechanism \varnothing 1.5mm L 475mm		



1

GEV No.	511877	Ref. No.	00222059
description	hauling cable hauling cable		



1

GEV No.	511868	Ref. No.	00013829
description	hinge complete hinge		



1

GEV No.	511594	Ref. No.	00220340
description	hinge for dishwasher door set D1 \varnothing 20mm D2 \varnothing 12mm		



1

GEV No.	519408	Ref. No.	00013909
description	linkage guide for tie bar complete		

screw connections



1

GEV No.	519409	Ref. No.	00013785
description	screw		

curtains

curtains



1

GEV No.	533013	Ref. No.	00076010
description	curtain W 620mm H 550mm warewashing		



1

GEV No.	533021	Ref. No.	00062000 00062030
description	curtain W 650mm H 450mm plastic thickness 1.5mm		

washing and rinsing systems



1

GEV No.	511716	Ref. No.	00222102
description	null		



1

GEV No.	511781	Ref. No.	00202632
description	rinse arm support mounting pos. upper		



1

GEV No.	511728	Ref. No.	00018077
description	rinse pipe		



1

GEV No.	511730	Ref. No.	00014042
description	rinse pipe		



1

GEV No.	511732	Ref. No.	00013779
description	rinse pipe		



1

GEV No.	517503	Ref. No.	00018038 00018261 00018352
description	rinse pipe L 770mm		



1

GEV No.	511720	Ref. No.	00211015
description	rinse pipe mounting pos. lower		



1

GEV No.	511714	Ref. No.	00222103
description	rinse pipe mounting pos. upper		



1

GEV No.	511624	Ref. No.	00005080
description	rinse pipe ø 10mm L 400mm connection 3/8"		



1

GEV No.	511016	Ref. No.	00005010
description	screw connection		



1

GEV No.	511741	Ref. No.	02120040
description	throttle disc		



1

GEV No.	511704	Ref. No.	00018076
description	Thumb screw		



1

GEV No.	511484	Ref. No.	00003950
description	T-piece thread 1/4" H 82mm L 120mm		



1

GEV No.	511713	Ref. No.	00222111
description	wash arm bearing		





1

GEV No.	511729	Ref. No.	00014041
description	wash arm bearing		





			
1			
GEV No.	511592	Ref. No.	00011858 00014286
description	wash pipe L 730mm suitable for ELFRAMO		

			
1			
GEV No.	517505	Ref. No.	00018260
description	wash pipe L 870mm SS		

			
1			
GEV No.	511492	Ref. No.	00005110
description	wash pipe mounting pos. lower ø 34mm L 153mm		

			
1			
GEV No.	511493	Ref. No.	00005120
description	wash pipe mounting pos. lower ø 38mm L 176mm		

			
1			
GEV No.	511489	Ref. No.	00005140
description	wash pipe mounting pos. lower ø 39mm L 233mm		

			
1			
GEV No.	511491	Ref. No.	00005130
description	wash pipe ø 38mm L 214mm		

handles and hand wheels

bracket handles

			
1			
GEV No.	511100	Ref. No.	00001510 00009200
description	pull handle		

			
1			
GEV No.	511115	Ref. No.	00001530 00009220
description	pull handle L 445mm H 62mm mounting distance 425mm		

recessed handles



			
1			
GEV No.	511889	Ref. No.	00205530
description	recessed handle		

			
1			
GEV No.	511890	Ref. No.	00010610
description	recessed handle		

fittings for catering equipment

outlet taps

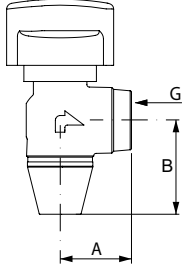
universal

			
			
1			
GEV No.	541609	Ref. No.	00030401
description	outlet tap chrome-plated brass W 46mm H 40mm thread 1" IT		
spare parts for	541609		
	GEV No.	540747	Ref. No. —
	outlet tap chrome-plated brass angled W 30mm H 40mm thread 1/2" IT		

drain taps

brass

drain taps



1

GEV No.	540260	Ref. No.	00030400
description	drain tap		



1

GEV No.	970515	Ref. No.	00007400
description	mix basket ED ø 440mm H 145mm seat ø 445mm		



1

GEV No.	970516	Ref. No.	00007420
description	mix basket ED ø 500mm H 125mm seat ø 445mm		

plate baskets



1

GEV No.	970513	Ref. No.	00007320
description	plate basket ED ø 495mm H 120mm seat ø 445mm plates 18		

steel wire baskets square

glass basket



1

GEV No.	971052	Ref. No.	00206720
description	glass basket L 470mm W 470mm H 150mm number of rows 3 spacing 145mm		

mix baskets



1

GEV No.	970078 ¹	Ref. No.	00007100
description	mix basket		

¹wide-meshed



1

GEV No.	971006 ¹	Ref. No.	00206711
description	mix basket L 345mm W 345mm H 120mm mesh type wide-meshed		

¹wide-meshed

equipment feet and end caps

screw-in feet



1

GEV No.	695604	Ref. No.	00000970
description	equipment foot thread M10 thread L 32mm ø 50mm H 14mm		



1

GEV No.	695601	Ref. No.	00206960
description	equipment foot thread M17 thread L 23mm ø 24mm H 11mm plastic WS 24 Qty 1 pcs		

baskets

warewashing baskets

steel wire baskets round



mix baskets



1

GEV No.	970514	Ref. No.	00206731
description	mix basket ED ø 330mm H 145mm		



			
1			
GEV No.	970068 ¹	Ref. No.	00206712
description	mix basket L 400mm W 400mm H 170mm		
spare parts for	970068		
	GEV No.	970001	Ref. No. —
	sliding corner wire gauge ø 5mm L 120mm W 120mm H 12mm L-shape		

¹wide-meshed

			
1			
GEV No.	971049 ¹	Ref. No.	00206713
description	mix basket L 460mm W 460mm		

¹wide-meshed

			
1			
GEV No.	970074 ¹	Ref. No.	00007120
description	mix basket L 500mm W 500mm H 130mm mesh type close-meshed		

¹fine-meshed

			
1			
GEV No.	970027 ¹	Ref. No.	00007140
description	mix basket L 550mm W 550mm H 125mm mesh type close-meshed		

¹fine-meshed

plate baskets			
			
1			
GEV No.	971051	Ref. No.	00007000
description	plate basket L 470mm W 470mm H 100mm plates 16 plate ø 240mm		

			
1			
GEV No.	971043	Ref. No.	00007040
description	plate basket L 500mm W 500mm H 130mm plates 20 plate ø 240mm		

			
1			
GEV No.	970026	Ref. No.	00007060
description	plate basket L 550mm W 550mm H 130mm plates 24 plate ø 270mm		

accessories

cutlery inserts



			
1			
GEV No.	976011	Ref. No.	00206721
description	cutlery insert Lmm Wmm ø 110mm H 130mm		

plate inserts

			
1			
GEV No.	970047	Ref. No.	00206751 00206752
description	plate insert L 308mm W 100mm plates 15		

gaskets

O-rings

EPDM

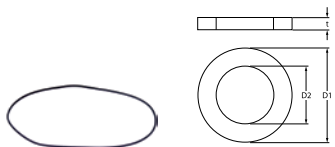
			
1			
GEV No.	521717	Ref. No.	00002900 06140008 06140140
description	O-ring EPDM thickness 1.78mm ID ø 120.37mm Qty 1 pcs		

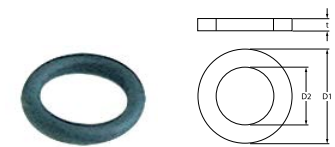
			
1			
GEV No.	529412	Ref. No.	06140003
description	O-ring EPDM thickness 2.62mm ID ø 10.78mm Qty 1 pcs		

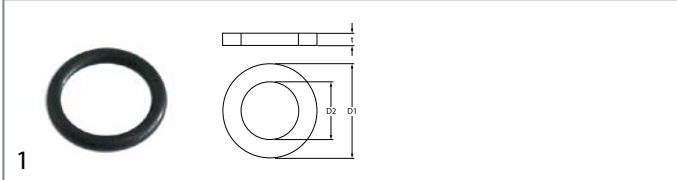

GEV No.	507313	Ref. No.	06140002
description	O-ring EPDM thickness 2.62mm ID ø 13.95mm Qty 1 pcs		

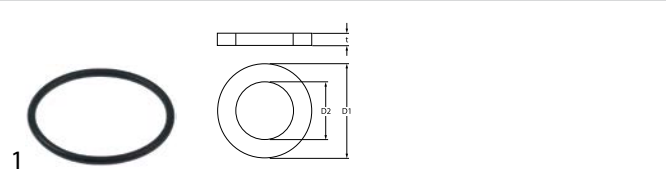

GEV No.	532451	Ref. No.	06140028
description	O-ring EPDM thickness 3.53mm ID ø 53.98mm Qty 1 pcs		

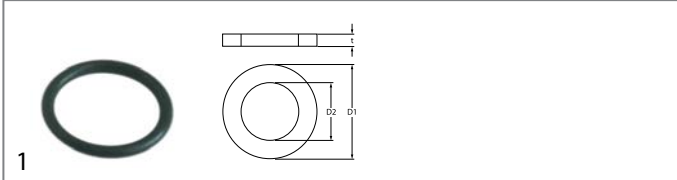

GEV No.	528919	Ref. No.	00004480
description	O-ring EPDM thickness 2.62mm ID ø 20.24mm Qty 1 pcs		

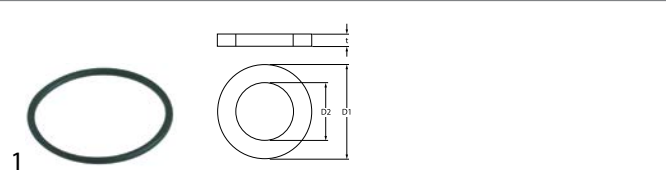

GEV No.	511828	Ref. No.	06140018
description	O-ring EPDM thickness 3.53mm ID ø 56.74mm Qty 1 pcs		

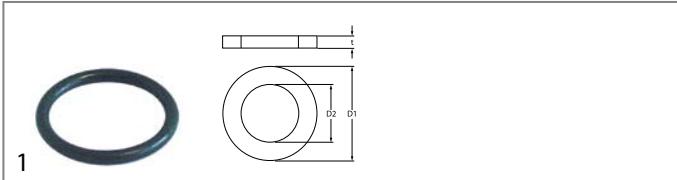

GEV No.	505073	Ref. No.	06140005
description	O-ring EPDM thickness 2.62mm ID ø 20.63mm Qty 1 pcs		

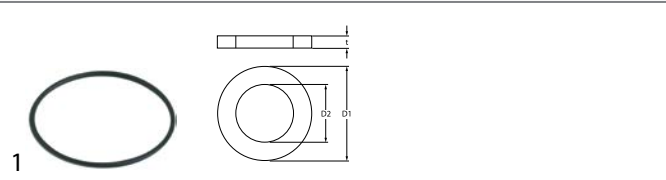

GEV No.	511711	Ref. No.	06140026
description	O-ring EPDM thickness 3.53mm ID ø 78.97mm Qty 1 pcs		

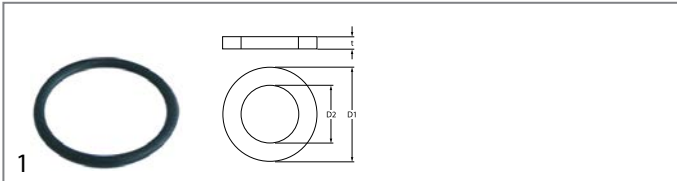

GEV No.	510769	Ref. No.	06140004
description	O-ring EPDM thickness 2.62mm ID ø 25.07mm Qty 1 pcs		

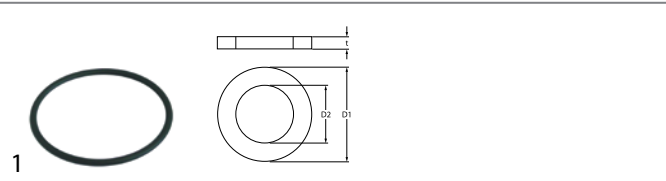

GEV No.	505178	Ref. No.	06140035
description	O-ring EPDM thickness 5.34mm ID ø 85.09mm Qty 1 pcs		

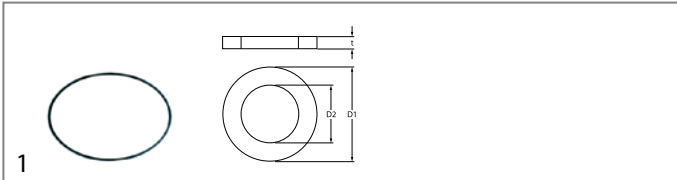

GEV No.	510554	Ref. No.	00002900 06140008 06140140
description	O-ring EPDM thickness 2mm ID ø 120mm Qty 1 pcs		

sealing washers

fibre gaskets

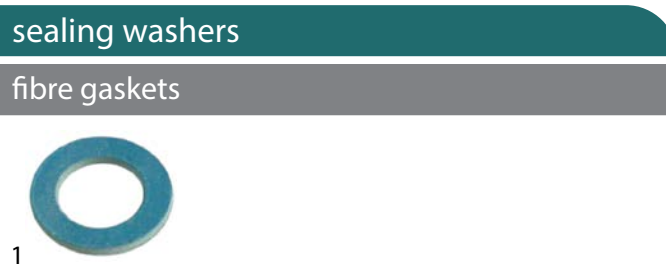

GEV No.	506042	Ref. No.	06110006 06120004
description	flat gasket FIBER ED ø 27mm ID ø 17mm thickness 2mm Qty 1 pcs		

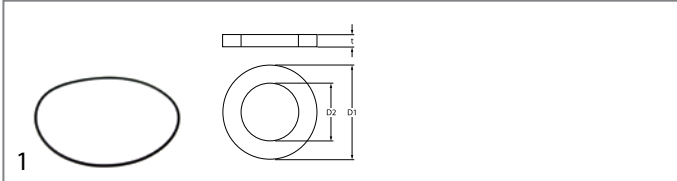

GEV No.	521718	Ref. No.	00002910 06140010
description	O-ring EPDM thickness 3.53mm ID ø 164.7mm Qty 1 pcs		



GEV No.	511490	Ref. No.	06120001
description	flat gasket fibre ED ø 15mm ID ø 8mm thickness 2mm Qty 1 pcs		



plastic gaskets

			
1			
GEV No.	696557	Ref. No.	06113001
description	flat gasket polyoxymethylene ED ø 14mm ID ø 10mm thickness 1.5mm Qty 1 pcs		

			
1			
GEV No.	696375	Ref. No.	00010504
description	gasket plastic ED ø 19mm ID ø 10.5mm thickness 6mm for boiler Qty 1 pcs		

copper gaskets

DIN-7603-A

			
1			
GEV No.	560523	Ref. No.	02150006
description	flat gasket nickel-plated copper ED ø 18.5mm ID ø 12.2mm thickness 2mm Qty 1 pcs		

PTFE gaskets

			
1			
GEV No.	511589	Ref. No.	06112001
description	flat gasket PTFE ED ø 11mm ID ø 4.5mm thickness 2mm Qty 1 pcs		

shaft gaskets

v-rings

			
1			
GEV No.	511213	Ref. No.	00530523
description	V-ring		

special gaskets

miscellaneous

			
1			
GEV No.	511106	Ref. No.	00001470
description	window gasket		

miscellaneous

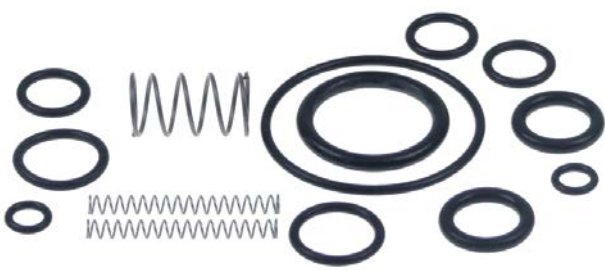
			
1			
GEV No.	551099	Ref. No.	CP11011
description	gasket set cram whipping machine Qty set 14-piece		



springs



compression springs

			
1			
GEV No.	511117	Ref. No.	0000235A 00073718
description	compression spring ø 14.2/8.1mm L 53mm wire gauge ø 1.2mm cone-shaped		

roller springs

roller springs

			
1			
GEV No.	511116	Ref. No.	00002301 0000230A
description	roller spring mounting pos. left complete		
spare parts for	511116		
	GEV No.	511622	Ref. No. 00002310
	roller spring mounting pos. right/left W 40mm		

			
1			
GEV No.	511127	Ref. No.	00002300
description	roller spring mounting pos. right complete		
spare parts for	511127		
	GEV No.	511622	Ref. No. 00002310
roller spring mounting pos. right/left W 40mm			

			
1			
GEV No.	511622	Ref. No.	00002310
description	roller spring mounting pos. right/left W 40mm		

			
1			
GEV No.	519550	Ref. No.	00079740
description	roller spring W 25.35mm		

			
1			
GEV No.	519491	Ref. No.	00079730
description	roller spring W 26mm		

			
1			
GEV No.	519543	Ref. No.	00065816
description	roller spring with holder W 46mm ID 8mm lug lengthmm		

tension springs

			
1			
GEV No.	361593	Ref. No.	812
description	spring		

			
1			
GEV No.	511875	Ref. No.	00013719
description	tension spring		

			
1			
GEV No.	511904	Ref. No.	00013717
description	tension spring ø 15.1mm total length 148mm wire gauge ø 1.7mm		

			
1			
GEV No.	511216	Ref. No.	00018056
description	tension spring ø 25mm total length 790mm wire gauge ø 5mm L1 120mm L2 580mm D1 ø 23mm thread M8 thread L 90mm mounting pos. left/right for hood		

dosing pumps

peristaltic dosing pumps

SEKO
built-in version
with frequency control



1			
GEV No.	361215	Ref. No.	20155100 20155111 old version
description	dosing pump SEKO frequency control 0.3-3.0l/h 230VAC detergent hose ø 4x6mm hose type K hose Santoprene suction level 1.5m type PBR protection IP55 dimensions 100x67x68mm power input 3.5W		

spare parts for 361215

	GEV No.	361136	Ref. No.	—
roller assembly for dosing pump hole ø 4.8x4mm				

	GEV No.	361226	Ref. No.	—
PCB L 59mm W 26mm electronic control				

	GEV No.	361815	Ref. No.	20155112
pump hose detergent hose ø 6x10mm hose ø 4x6mm hose type K hose Santoprene type SEKO				

accessories for 361215









	GEV No.	361142	Ref. No.	—
mounting set detergent hose type 4x6mm hose length 2m PVC 2x hose/container filter/tank intake transparent				

Table continues overleaf



accessories for	361215		
	GEV No.	520090	Ref. No. 07125002
	PVC hose ID ø 4mm ED ø 6mm L 2m thickness 1mm t.max. 60°C transparent		
	GEV No.	520091	Ref. No. 20155110
	nylon hose ID ø 4mm ED ø 6mm L 2m thickness 1mm operating p. 10bar burst p. 50bar t.max. 100°C transparent		

with time control

			
1			
GEV No.	361768 ¹	Ref. No.	00220423 old version 20155104 old version
description	dosing pump SEKO time control 0.4l/h 230VAC rinse aid hose ø 4x6mm hose type D hose Sekobril suction level 1.5m type NBM 0.4 8W with accessories 8VA dosing time 0-30s		
spare parts for	361768		
	GEV No.	361135	Ref. No. 20155109
	pump hose SEKO rinse aid hose ø 3x8mm hose ø 4x6mm hose type D hose Sekobril		
	GEV No.	361141	Ref. No. 20155105
	container filter with weight ceramic hose ø 4mm		
	GEV No.	361821	Ref. No. 00220419
	non-return valve inlet 4x6mm outlet 1/4" L 45mm		
	GEV No.	520091	Ref. No. 20155110
	nylon hose ID ø 4mm ED ø 6mm L 2m thickness 1mm operating p. 10bar burst p. 50bar t.max. 100°C transparent		
	GEV No.	520242	Ref. No. —
	silicone hose for peristaltic pump ID ø 4mm ED ø 7mm L 5m thickness 1.5mm t.max. 200°C Shore A 55° transparent dosing Qty 5m		

¹with accessories

spare parts

			
			
1			
GEV No.	361815	Ref. No.	20155112
description	pump hose detergent hose ø 6x10mm hose ø 4x6mm hose type K hose Santoprene type SEKO		
			
1			
GEV No.	361135	Ref. No.	20155109
description	pump hose SEKO rinse aid hose ø 3x8mm hose ø 4x6mm hose type D hose Sekobril		
spare parts for	361135		
	GEV No.	361866	Ref. No. —
	union nut for hose connector ø 17mm		

membrane dosing pumps



self-priming

SEKO









1			
GEV No.	361594	Ref. No.	20155108
description	dosing pump type DIB3E rinse aid pump rate 0-3cm ³ per stroke pressure connection ø 4x6mm suction connection ø 4x6mm		
spare parts for	361594		
	GEV No.	361240	Ref. No. —
	hose connector 1-way hose ø 6mm plastic connection M10x1		
	GEV No.	361301	Ref. No. —
	hose connector for type DIB3E/DIB5E		
	GEV No.	361302	Ref. No. —
	valve bush for type DIB3E/DIB5E		
	GEV No.	361304	Ref. No. —
	O-ring EPDM ID ø 11.11mm thickness 1.78mm Qty 1 pcs for type DIB3E/DIB5E		
	GEV No.	361305	Ref. No. —
	valve disc for type DIB3E/DIB5E DIB3P/DIB5P		
	GEV No.	361306	Ref. No. —
	membrane for type DIB3E/DIB5E ø 49mm hole ø 5mm		
	GEV No.	361481	Ref. No. —
	lip valve for type DIB3P/DIB5P DIB3E/DIB5E		



1			
GEV No.	361837 ¹	Ref. No.	2015511+00019656 20155117
description	dosing pump type DIB5E conversion kit rinse aid pump rate 0-5cm ³ per stroke pressure connection ø 4x6mm suction connection ø 6mm SEKO		
spare parts for	361837		
	GEV No.	361301	Ref. No. —
	hose connector for type DIB3E/DIB5E		
	GEV No.	361302	Ref. No. —
	valve bush for type DIB3E/DIB5E		

¹auxiliary pressure connection closed
Table continues overleaf

spare parts for		361837	
	GEV No.	361304	Ref. No. —
O-ring EPDM ID ø 11.11mm thickness 1.78mm Qty 1 pcs for type DIB3E/DIB5E			
	GEV No.	361305	Ref. No. —
valve disc for type DIB3E/DIB5E DIB3P/DIB5P			
	GEV No.	361306	Ref. No. —
membrane for type DIB3E/DIB5E ø 49mm hole ø 5mm			
	GEV No.	361307	Ref. No. —
membrane dosing pump ø 68mm hole ø 6mm for type DIB3P/DIB5P			
	GEV No.	361481	Ref. No. —
lip valve for type DIB3P/DIB5P DIB3E/DIB5E			

accessories for		361837	
	GEV No.	361240	Ref. No. —
hose connector 1-way hose ø 6mm plastic connection M10x1			
	GEV No.	361241	Ref. No. —
hose connector 1-way hose ø 9mm plastic connection M10x1			

accessories

	1		
GEV No.	361141	Ref. No.	20155105
description container filter with weight ceramic hose ø 4mm			

non-return valves

	1		
GEV No.	361821	Ref. No.	00220419
description non-return valve inlet 4x6mm outlet 1/4" L 45mm			

	1		
GEV No.	361147	Ref. No.	20155106
description non-return valve inlet 4x6mm outlet 1/8" L 50mm Qty 1 pcs			

hoses

dosing hoses



	1		
GEV No.	511164	Ref. No.	00003780
description dosing hose ED ø 10mm ID ø 6mm L 1800mm dosing			

PVC hoses

	1		
GEV No.	520090	Ref. No.	07125002
description PVC hose ID ø 4mm ED ø 6mm L 2m thickness 1mm t.max. 60°C transparent			
accessories for		520090	
	GEV No.	361058	Ref. No. —
container filter with non-return valve SS hose ø 4x6mm ø 20mm L 56mm			
	GEV No.	361066	Ref. No. —
container filter straight SS hose ø 4x6mm L 37mm non return valve ball valve			
	GEV No.	361106	Ref. No. —
container filter with weight and non-return valve SS hose ø 4x6mm ø 21mm L 51mm non return valve lip valve			
	GEV No.	361141	Ref. No. 20155105
container filter with weight ceramic hose ø 4mm			
	GEV No.	361230	Ref. No. —
container filter with weight stainless steel hose ø 4x6mm			
	GEV No.	361462	Ref. No. —
container filter with weight SS hose ø 4x6mm			
	GEV No.	361728	Ref. No. —
container filter with 4m 4x6 hose SS hose ø 4x6mm hose length 4000mm			

hose couplings

plastic

	1		
GEV No.	511593	Ref. No.	00220440
description hose connector T-shape plastic thread 1/2" ø 13mm for dosing pump			
spare parts for		511593	
	GEV No.	361083	Ref. No. —
union nut T1: M10x1 for hose 6mm			



tank inlets



GEV No.	361416	Ref. No.	20155114
description	tank inlet SS M12 hose ø 6mm		

hoses

supply hoses

stainless steel flexi hoses

universal hoses



GEV No.	520627	Ref. No.	00053360
description	flex hose SS braid straight-straight DN12 connections 3/4" L 2000mm approval DVGW operating p. 10bar test pressure 32bar burst p. 95bar		



GEV No.	520395	Ref. No.	00003540
description	flex hose SS braid straight-straight DN8 connections 3/8"-1/2" L 230mm Qty 2 pcs		



GEV No.	520459	Ref. No.	00003530
description	flex hose SS braid straight-straight DN8 connections 3/8"-1/2" L 740mm approval DVGW operating p. 10bar test pressure 32bar burst p. 95bar		

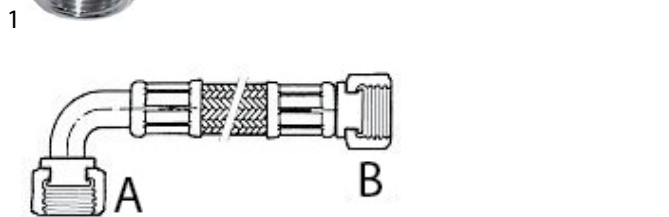

GEV No.	520007	Ref. No.	336A
description	flex hose SS braid straight-curved DN15 connection 1: 3/4" connection 2: 3/4" L 2500mm approval operating p. 10bar test pressure 32bar burst p. 95bar		

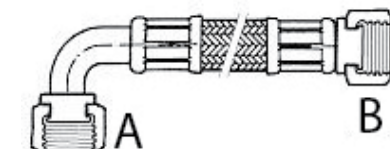
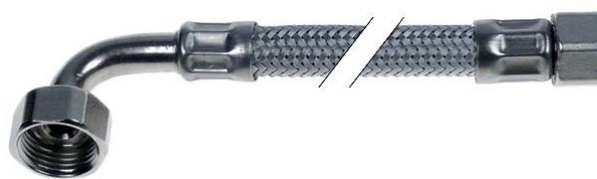

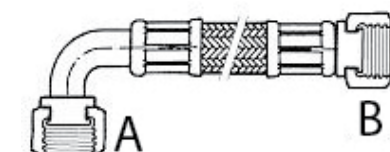

GEV No.	520468	Ref. No.	12160008
description	flex hose SS braid straight-curved DN8 connection 1: 1/2" connection 2: 3/8" L 350mm approval DVGW operating p. 10bar test pressure 32bar burst p. 95bar		



GEV No.	520396	Ref. No.	00003550
description	flex hose SS straight-curved L 170mm connections 3/8"-1/2"		

PVC supply hoses



GEV No.	520010	Ref. No.	00200720 07130001 07130002
description	supply hose PVC straight-curved DN13 connections 3/4" L 1500mm operating p. 10bar burst p. 32bar t.max. 90°C blue approval VDE flat seal		
accessories for	520010		
	GEV No.	520053	Ref. No. —
	screen connection 3/4" D1 ø 26mm D2 ø 15mm Qty 10 pcs rubber thickness 8mm		
	GEV No.	520054	Ref. No. —
	flat gasket rubber ED ø 23.5mm ID ø 14mm thickness 2.3mm Qty 10 pcs		

pre-rinse hoses

stainless steel flexi hoses



GEV No.	542859	Ref. No.	00980050
description	shower hose connections 1/2" L 1200mm SS operating p. 10bar burst p. 90bar t.max. 90°C for pre-rinse units suitable for drinking water rotary with flexible fabric		

drain hoses



GEV No.	511206	Ref. No.	07130157
description	drain hose		



GEV No.	513718	Ref. No.	00003630 00003640 00200652 00200653
description	drain hose DN19 L 1500mm straight ø inside 24mm straight ext. ø 28mm outer hose ø 23mm		

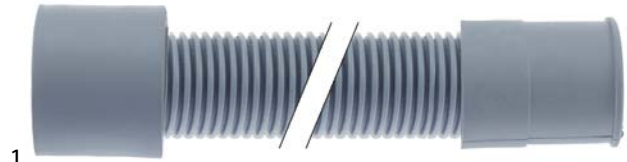

GEV No.	511205	Ref. No.	07130156 364
description	drain hose DN19 L 1500mm A int. ø 23mm A ext. ø 29mm B int. ø 29mm outer hose ø 29mm B ext. ø 35mm		



GEV No.	530399	Ref. No.	07130158
description	drain hose DN31 L 2000mm A int. ø 33mm A ext. ø 39mm B int. ø 33mm B ext. ø 39mm outer hose ø 35mm		

industrial hoses

nylon hoses



GEV No.	520091	Ref. No.	20155110
description	nylon hose ID ø 4mm ED ø 6mm L 2m thickness 1mm operating p. 10bar burst p. 50bar t.max. 100°C transparent		

PVC hoses

PVC hoses without fabric



GEV No.	520090	Ref. No.	07125002
description	PVC hose ID ø 4mm ED ø 6mm L 2m thickness 1mm t.max. 60°C transparent		
accessories for	520090		
	GEV No.	361058	Ref. No. —
	container filter with non-return valve SS hose ø 4x6mm L 56mm		
	GEV No.	361066	Ref. No. —
	container filter straight SS hose ø 4x6mm L 37mm non return valve ball valve		
	GEV No.	361106	Ref. No. —
	container filter with weight and non-return valve SS hose ø 4x6mm ø 21mm L 51mm non return valve lip valve		
	GEV No.	361141	Ref. No. 20155105
	container filter with weight ceramic hose ø 4mm		
	GEV No.	361230	Ref. No. —
	container filter with weight stainless steel hose ø 4x6mm		
	GEV No.	361462	Ref. No. —
	container filter with weight SS hose ø 4x6mm		
	GEV No.	361728	Ref. No. —
	container filter with 4m 4x6 hose SS hose ø 4x6mm hose length 4000mm		

silicone hoses

without fabric

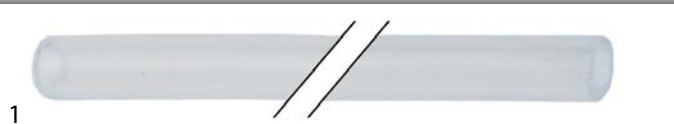

1			
GEV No.	530410	Ref. No.	00003750 00011065
description	silicone hose ID ø 4mm ED ø 7mm L 2m thickness 1.5mm t.max. 200°C transparent		



1			
GEV No.	511140	Ref. No.	00010540
description	formed hose warewashing L-shape equiv. no. 00010540		

formed hoses

straight



1			
GEV No.	511048	Ref. No.	00004060 00200671 00200676 00200678
description	formed hose dishwasher straight equiv. no. 00004060		



1			
GEV No.	511858	Ref. No.	00013827
description	formed hose dishwasher straight equiv. no. 00013827		

form L



1			
GEV No.	511050	Ref. No.	00004070
description	formed hose end piece A int. ø 50mm ø end piece B 70mm L 190mm warewashing L-shape equiv. no. 00004070		

with branch



1			
GEV No.	511859	Ref. No.	00013718
description	formed hose warewashing equiv. no. 00013718 with piggyback		



1			
GEV No.	511056	Ref. No.	00206911
description	formed hose warewashing with piggyback		



1			
GEV No.	511057	Ref. No.	00206912
description	formed hose warewashing with piggyback		



1

GEV No.	511058	Ref. No.	00206909
description	formed hose warewashing with piggyback		



1

GEV No.	511855	Ref. No.	00210956
description	pressure hose		



1

GEV No.	511857	Ref. No.	00222108
description	pressure hose		



1

GEV No.	511863	Ref. No.	00206901
description	pressure hose		

form S



1

GEV No.	517498	Ref. No.	00018312
description	formed hose hose ext. ø 78mm hose int. ø 63mm L 310mm S-shape		



1

GEV No.	511856	Ref. No.	00222109
description	formed hose S-shape warewashing equiv. no. 00222109		

miscellaneous



1

GEV No.	511047	Ref. No.	00004110
description	formed hose warewashing equiv. no. 00004110		

for dishwashers

miscellaneous



1

GEV No.	511468	Ref. No.	00200691
description	pressure hose		



1

GEV No.	511467	Ref. No.	00003520 00013411
description	pressure hose L 1000mm		



1			
GEV No.	511464	Ref. No.	00013340
description	pressure hose L 480mm ø 18mm		

1			
GEV No.	511465	Ref. No.	00200641
description	pressure hose L 690mm ø 25mm		

fittings, hose and pipe connectors

fittings

T-pieces

miscellaneous

1			
GEV No.	511499	Ref. No.	00000350
description	T-piece thread 3/8" brass L 58mm		

hose connectors

producer-specific

1			
GEV No.	511071	Ref. No.	00002140
description	hose connector for drain		

valves and tank inlets

ball valves

producer-specific

KOMEL

1				
GEV No.	514429	Ref. No.	13110004	
description	ball valve connection 1" IT - 1" ET total length 71mm			
accessories for	514429			
	GEV No.	540752	Ref. No.	00030450
	extension for outlet tap L 165mm			
	GEV No.	694062	Ref. No.	00030470
	extension for outlet tap L 400mm			

1				
GEV No.	540751	Ref. No.	003041 13110001	
description	ball valve connection 1" IT - tube ø25mm total length 59mm			
accessories for	540751			
	GEV No.	540752	Ref. No.	00030450
	extension for outlet tap L 165mm			
	GEV No.	540753	Ref. No.	—
	handle L 400mm for outlet tap			
	GEV No.	694062	Ref. No.	00030470
	extension for outlet tap L 400mm			

1			
GEV No.	540752	Ref. No.	00030450
description	extension for outlet tap L 165mm		

1			
GEV No.	694062	Ref. No.	00030470
description	extension for outlet tap L 400mm		



shut-off valves

universal

1				
GEV No.	693107	Ref. No.	00003770 13100001	
description	shut-off valve connection 1/2" 1/2" cold total length 54mm L1 27mm L2 30mm marking blue rosette thread G2 26x19G connection ø M4x0.7 ITmm			
spare parts for	693107			
	GEV No.	514085	Ref. No.	—
	rosette connection 26x19G chrome-plated total lengthmm mounting pos.			
	GEV No.	514086	Ref. No.	—
	hexagonal nut connection 26x19G brass total lengthmm mounting pos. H 6mm WS 34 Qty 1 pcs			
	GEV No.	540672	Ref. No.	—
	gasket suitable for tap head			
	GEV No.	547711	Ref. No.	—
	hood handle shaft intake ø 8mm marking blue metal H2 21mm D1 ø 33mm type D suitable for MONOLITH shaft length H1 8mm			

Table continues overleaf



spare parts for	693107		
	GEV No.	548168	Ref. No. —
	star handle connection hot total lengthmm mounting pos. ø 57mm marking red		
	GEV No.	548169	Ref. No. —
	star handle connection cold total lengthmm mounting pos. chrome-plated ø 57mm		
accessories for	693107		
	GEV No.	514086	Ref. No. —
	hexagonal nut connection 26x19G brass total lengthmm mounting pos. H 6mm WS 34 Qty 1 pcs		

water cycle components

pressure reduction valves

pressure reduction valves

universal



1

GEV No.	520871	Ref. No.	00074380 23200001 23200002
description	pressure reduction valve MALGORANI series Eurobrass 143 connection 1/2" default settingbar setting range 0.5-6bar p max 25bar t.max. 80°C brass		

supply filters



1

GEV No.	511485	Ref. No.	00003480 00003481
description	T-piece thread 1/2"-3/4" brass with filter H 100mm L 175mm		

ancillary products

clamps

hose clamps

DIN 3017 - W2



1

GEV No.	520116	Ref. No.	05100011
description	hose clamp ø 32-50mm width 9mm Qty 5 pcs DIN 3017		



1

GEV No.	520118	Ref. No.	05100002 05100004
description	hose clamp ø 50-70mm width 9mm Qty 5 pcs DIN 3017		



1

GEV No.	520454	Ref. No.	0000407B 05100008
description	hose clamp ø 70-90mm width 9mm Qty 5 pcs DIN 3017		



1

GEV No.	520110	Ref. No.	05100006
description	hose clamp ø 8-12mm width 9mm Qty 10 pcs DIN 3017		

double wire clamps



1

GEV No.	520872	Ref. No.	00003751 05110001
description	hose clamp ø 7mm wire gauge ø 1mm Qty 1 pcs		



measuring equipment

thermometers

built-in thermometers



1

GEV No.	541086	Ref. No.	32110003
description	thermometer mounting measurements 58x25.5mm 0 up to +120°C capillary pipe 2000mm probe ø 6mm probe L 23mm		

ø40mm



1

GEV No.	541037	Ref. No.	32110002
description	thermometer mounting ø 40mm t.max. 120°C 0 up to +120°C probe ø 6.5mm probe L 25mm capillary pipe 2000mm		

ø52mm



1

GEV No.	541065	Ref. No.	00006010
description	thermometer mounting ø 52mm t.max. 120°C 0 up to +120°C probe ø 6.5mm probe L 28mm capillary pipe 1500mm		

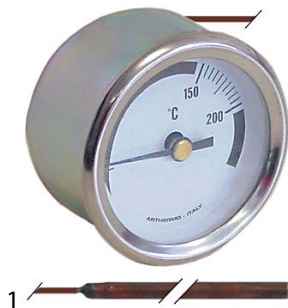

1

GEV No.	541303	Ref. No.	3053 32100002
description	thermometer mounting ø 52mm t.max. 200°C +150 up to +200°C probe ø 4mm probe L 75mm capillary pipe 1370mm		

ø60mm



1

GEV No.	541791	Ref. No.	00074420 32100003
description	thermometer mounting ø 60mm t.max. 120°C 0-120°C probe ø 6mm probe L 39mm capillary pipe 1500mm		

fastening material

screws

countersunk screws



1

GEV No.	560337	Ref. No.	01350001
description	countersunk screw thread M6 L 20mm WS 4 SS DIN 7991/ISO 10642 Qty 1 pcs intake hexagonal		

miscellaneous



1

GEV No.	511494	Ref. No.	00002160
description	flat-headed bolt thread M5x0.8 thread L 7.8mm head ø 18mm intake slotted		



1

GEV No.	519409	Ref. No.	00013785
description	screw		

nuts

hexagonal nuts

DIN 934 / ISO 4032/8673



1

GEV No.	511212	Ref. No.	03100006
description	hexagonal nut thread M6 H 5mm WS 10 SS DIN/ISO DIN 934 / ISO 4032/8673 Qty 1 pcs		



washers

washers

DIN 125A



1

GEV No.	560113	Ref. No.	02120006
description	plain washer ID ø 6.4mm ED ø 12mm thickness 1.6mm SS Qty 20 pcs DIN 125A for thread M6		



1

GEV No.	511481	Ref. No.	02120008
description	plain washer ID ø 8.4mm ED ø 16mm thickness 1.6mm zinc-coated steel Qty 1 pcs DIN 125A for thread M8		

miscellaneous



1

GEV No.	511591	Ref. No.	02160100
description	disc ID ø 16mm ED ø 20mm thickness 1.5mm brass Qty 1 pcs		

fasteners

clamps

hose clamps

DIN 3017 - W2



1

GEV No.	520116	Ref. No.	05100011
description	hose clamp ø 32-50mm width 9mm Qty 5 pcs DIN 3017		



1

GEV No.	520118	Ref. No.	05100002 05100004
description	hose clamp ø 50-70mm width 9mm Qty 5 pcs DIN 3017		



1

GEV No.	520454	Ref. No.	0000407B 05100008
description	hose clamp ø 70-90mm width 9mm Qty 5 pcs DIN 3017		



1

GEV No.	520110	Ref. No.	05100006
description	hose clamp ø 8-12mm width 9mm Qty 10 pcs DIN 3017		

double wire clamps



1

GEV No.	520872	Ref. No.	00003751 05110001
description	hose clamp ø 7mm wire gauge ø 1mm Qty 1 pcs		

consumables

fuses

fine fuses

ø10x38mm 400V



1

GEV No.	358041	Ref. No.	00060970
description	fine fuse size ø10x38mm 20A slow-acting rated 400V type aM Qty 1 pcs		



1

GEV No.	358030	Ref. No.	00060980
description	fine fuse size ø10x38mm 32A slow-acting rated 400V type aM Qty 1 pcs		

ø10x38mm 500V



1

GEV No.	358038	Ref. No.	00060960 37130999
description	fine fuse size ø10x38mm 10A slow-acting rated 500V type aM Qty 1 pcs		



			
1			
GEV No.	358040	Ref. No.	00006261
description	fine fuse size ø10x38mm 16A slow-acting rated 500V type aM Qty 1 pcs		

B			
ball valves	59		
bar burners	36		
bi-metal thermostats	7, 7		
booster pumps I	28		
C			
cables	30		
clamps	60, 62		
coil heating elements	5		
condensators & interference suppression filters	29		
consumables	62		
contactors	17		
container filters	54		
control equipment	15		
control thermostats	7, 10		
countersunk screws	61		
D			
dosing hoses	54		
dosing pumps	52		
double wire clamps	60, 62		
drain hoses	56		
drain pumps	29		
E			
electric accessories	30		
electrodes	24		
electronic controllers	19		
F			
fasteners	62		
fastening material	61		
filters	29		
fine fuses	62		
fittings	59		
formed hoses	57		
fuses	30, 62		
G			
gas burners	36		
gas control valves	32		
gas nozzles	36		
gas thermostats	30		
gland ducts	10		
H			
heating elements	3		
heating elements for fryers	3		
hexagonal nuts	61		
hose clamps	60, 62		
hose connectors	59		
hose couplings	54		
hoses	55		
I			
ignition cables	35		
immersion heating elements	5		
indicator lights	15		
indicator lights (complete)	15		
industrial hoses	56		
L			
lamps	15		
light bulbs	16		
M			
magnetic switches	14		
measuring equipment	61		
microswitches	12		
N			
non-return valves	54		
nuts	61		
nylon hoses	56		
O			
operating capacitors	29		
O-rings	49		
P			
piezoelectric igniters	35		
pilot burners	33		
plunger sockets	11		
position switches	13		
pre-rinse hoses	56		
pressure reduction valves	60, 60		
pressure switches	23		
probes	19		
programme timers	16		
pumps	24		
push/momentary push switches	11		
PVC hoses	56		
PVC supply hoses	56		
R			
relays	19		
ribbon cables	30		
rotary switches	14		
S			
safety bi-metal thermostats	7		
safety thermostats	9, 10		
screws	61		
sealing washers	50		

shaft gaskets	51
shut-off valves	59
silicone hoses	57
solenoid valves	20
stainless steel flexi hoses	55, 56
supply filters	60, 60
supply hoses	55
switches and momentary switches	11
system switches (ROLD)	13

T

tank inlets	55
temperature probes	19
terminals	30
thermocouples	35
thermostats	7
timers	16

U

universal hoses	55
universal probes	19

V

valves and tank inlets	59
------------------------	----

W

wash and rinse pumps	24
washers	62
water cycle components	60