



**GAS COMPONENTS**



**ELECTRIC COMPONENTS**



**WATER TECHNOLOGY**



**MECHANICAL COMPONENTS**



**TOOLS**

Spare parts suitable for

**KSF**

Find the complete and up-to-date range of products in our GEV Webshop



# Manufacturer catalogue

The most important spare parts and accessories arranged clearly for every manufacturer

- ✓ Complete product range and all appliance data always up to date in the GEV Webshop
- ✓ Alphabetical Index at the end of the catalogue

## GEV Webshop

[www.gev-online.co.uk](http://www.gev-online.co.uk)

[www.gev-online.com](http://www.gev-online.com)





- 🔍 Add to Favourites
- 🔍 Sign In with email address and usual password
- 🔍 Easy-order – place several items in your basket at the same time
- 🔍 Quick Item search – no login needed



## heating elements

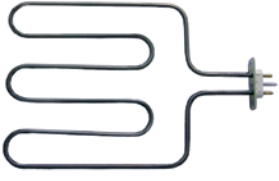

### heating elements for ovens

			
1			
<b>GEV No.</b>	415315	<b>Ref. No.</b>	4.013.03.06
<b>description</b>	heating element 2000W 230V heating circuits 1 L 327mm W 228mm L1 85mm L2 244mm W1 98mm W2 31mm flange length 71mm flange width 23mm hole distance 56mm hole ø M4mm tube ø 6.3mm connection plug-in connection windings 3 rectangular flange grill setting oven		
<b>accessories for</b>	415315		
		<b>GEV No.</b>	550404 <b>Ref. No.</b> —
	power socket I-II phase 240V max. 16A countries I with screw connection for heating element		
		<b>GEV No.</b>	550405 <b>Ref. No.</b> —
	power socket male faston 6.3mm for heating element 2-pole + earthing		

### heating elements for griddles

			
1			
<b>GEV No.</b>	416491	<b>Ref. No.</b>	4.013.03.05
<b>description</b>	heating element 1500W 220V heating circuits 1 L 406mm W 70mm Hmm tube ø 8.5mm connection M4 connection distance 62mm dry heating element		

### heating elements for chicken rotisseries

			
1			
<b>GEV No.</b>	416492	<b>Ref. No.</b>	4.013.03.02
<b>description</b>	heating element 1700W 230V L 780mm W 34mm heating circuits 1 connection M4 dry heating element tube ø 8.5mm connection length 21mm		
			
1			
<b>GEV No.</b>	418066	<b>Ref. No.</b>	4.013.03.01
<b>description</b>	heating element 2000W 230V L 980mm W 30mm dry heating element tube ø 8.5mm chicken rotisserie		

## energy regulators

### accessories

#### knobs

			
1			
<b>GEV No.</b>	110238	<b>Ref. No.</b>	4.013.02.06
<b>description</b>	knob energy regulator 1-10 t.max.°C°C ø 50mm shaft ø 6x4.6mm shaft flat upper black		

## thermostats

### control and safety thermostats

#### EGO

#### safety thermostats

#### 55.13\_series

			
1			
<b>GEV No.</b>	375616	<b>Ref. No.</b>	4.011.03.03
<b>description</b>	safety thermostat capillary pipe isolatedmm gland nut probe		

			
1			
<b>GEV No.</b>	375619	<b>Ref. No.</b>	4.011.03.03
<b>description</b>	safety thermostat switch-off temp. 220°C 1-pole 1NO 16A probe ø 6mm probe L 77mm capillary pipe 830mm capillary pipe isolatedmm gland nut M9x1 probe		



55.32\_series



<b>GEV No.</b>	375393	<b>Ref. No.</b>	4.011.03.03
<b>description</b>	safety thermostat switch-off temp. 235°C 3-pole 1CO/2NC 20A probe ø 6mm probe L 87mm capillary pipe 1790mm capillary pipe isolated 1710mm gland nut M9x1 probe SS		

## switches and momentary switches

### cam switches

4-position



<b>GEV No.</b>	300023	<b>Ref. No.</b>	4.013.02.03
<b>description</b>	cam switch 4 operating positions 1NO/2CO sequence 0-1-2-3 16A shaft ø 6x4.6mm shaft L 23mm connection screw 4-position ceramic		

### rotary switches

SONTHEIMER



<b>GEV No.</b>	345388	<b>Ref. No.</b>	4.013.02.01
<b>description</b>	rotary switch 2 0-1 sets of contacts 2 600V 16A shaft ø 6x6mm shaft L 24mm type A2/12E/Z3/BG/X70S connection screw shaft square		



<b>GEV No.</b>	345393	<b>Ref. No.</b>	4.013.02.02
<b>description</b>	rotary switch 3 0-1-2 sets of contacts 4 600V 16A shaft ø 6x6mm shaft L 23.5mm type GR22/12E/Z3/BG/X70S connection screw shaft square		

## lamps

### linear lamps

#### halogen lamps



<b>GEV No.</b>	359620	<b>Ref. No.</b>	4.013.04.03
<b>description</b>	halogen lamp socket R7s L 117.6mm 230V 300W unjacketed IMPORT CE		

#### infrared lamps

##### with base type X lug



<b>GEV No.</b>	359617	<b>Ref. No.</b>	4.013.04.01
<b>description</b>	infrared lamp 1000W 220V L 365mm lens L 340mm total length 480mm with mounting strap		

##### with base type Z ceramic



<b>GEV No.</b>	359625	<b>Ref. No.</b>	4.013.04.02
<b>description</b>	infrared lamp socket Z-ceramic L 226mm 220-250V 500W cable length 195mm IMPORT		

### sockets for linear lamps

R7s



<b>GEV No.</b>	359648	<b>Ref. No.</b>	4.013.04.06
<b>description</b>	lamp socket socket R7s 250V ø 20mm H 32mm connection cable 320mm mounting distance 24/33mm holder length 42mm Qty 1 pcs		

X lug



<b>GEV No.</b>	359710	<b>Ref. No.</b>	4.013.04.04
<b>description</b>	lamp socket L 70mm W 70mm H 49mm mounting distance 50mm bracket mounting		



Z ceramic

			
1			
<b>GEV No.</b>	359658	<b>Ref. No.</b>	4.013.04.07
<b>description</b>	lamp socket socket Z for length of lamp 218mm L 220mm W 47mm H 62mm mounting distance 120mm mounting thread M4 Qty 1 pcs		

condensators & interference suppression filters

operating capacitors

plastic

			
1			
<b>GEV No.</b>	365030	<b>Ref. No.</b>	12040MK 4.013.01.06
<b>description</b>	operating capacitor capacity 12µF 400V tolerance 5% 50/60Hz ambient temperature max. 40/85/21°C ø 35mm L 95mm M8 plastic connection male faston 6.3mm		

metal











			
1			
<b>GEV No.</b>	365002	<b>Ref. No.</b>	4.013.01.08
<b>description</b>	operating capacitor capacity 4µF 400V tolerance 5% 50/60Hz ambient temperature max. -25 to +85°C ø 30mm L 75mm with cable M8 aluminium connection cable 300mm MKP protection IP65		

			
1			
<b>GEV No.</b>	365004	<b>Ref. No.</b>	4.013.01.07
<b>description</b>	operating capacitor capacity 8µF 400V tolerance 5% 50/60Hz ambient temperature max. -25 to +85°C ø 30mm L 94mm M8 aluminium connection cable 300mm protection IP65		

gas taps

MADEC (MP)

with nozzle outlet

			
1			
<b>GEV No.</b>	101193	<b>Ref. No.</b>	4.011.02.02 4.011.02.03
<b>description</b>	gas tap MADEC with nozzle outlet (without nozzle) gas inlet M12x1 (tube ø 8mm) external nozzle ømm internal nozzle ømm bypass nozzle ø 0.35mm mixing pipe connection M17x1 thermocouple connection M8x1 front fixing M12x1 shaft ø 8x5mm shaft L 23/13.5mm shaft flat left		
<b>spare parts for</b>	101193		
	<b>GEV No.</b>	100360	<b>Ref. No.</b> —
	bypass nozzle MADEC bore ø 0.35mm thread M4.5x0.6 total length 13mm		
	<b>GEV No.</b>	101051	<b>Ref. No.</b> —
	magnet unit L 27mm D1 ø 12.5mm D2 ø 8.5mm suitable for JUNKERS/EGA/MADEC/SABAF standard		
	<b>GEV No.</b>	101234	<b>Ref. No.</b> —
	union nut T1: M8x1 T2: M15		
<b>accessories for</b>	101193		
	<b>GEV No.</b>	100936	<b>Ref. No.</b> —
	gas tap spindle shaft ø 5x8mm MADEC		
	<b>GEV No.</b>	101277	<b>Ref. No.</b> —
	olive ID ø 8mm Qty 1 pcs		
	<b>GEV No.</b>	101296	<b>Ref. No.</b> —
	union nut thread M12x1 for pipe ø 8mm		
	<b>GEV No.</b>	101299	<b>Ref. No.</b> —
	nut thread M12x1		
	<b>GEV No.</b>	101400	<b>Ref. No.</b> —
	air mixing tube thread M17x1 suitable for L350, L700		
	<b>GEV No.</b>	110150	<b>Ref. No.</b> —
	knob gas tap without ignition flame t.max.°C ø 50mm shaft ø 8x5.5mm shaft flat right white		





with pipe outlet



1

<b>GEV No.</b>	101072	<b>Ref. No.</b>	4.011.02.01
<b>description</b>	gas tap MADEC with pipe outlet gas inlet M12x1 (tube ø 8mm) bypass nozzle ø 0.35mm gas outlet M12x1 (tube ø 8mm) thermocouple connection M8x1 front fixing M12x1 shaft ø 8x5mm shaft L 29.5/13.5mm shaft flat left internal nozzle ø 0mm		
<b>spare parts for</b>	101072		
	<b>GEV No.</b>	100360	<b>Ref. No.</b> —
	bypass nozzle MADEC bore ø 0.35mm thread M4.5x0.6 total length 13mm		
	<b>GEV No.</b>	101051	<b>Ref. No.</b> —
	magnet unit L 27mm D1 ø 12.5mm D2 ø 8.5mm suitable for JUNKERS/EGA/MADEC/SABAF standard		
	<b>GEV No.</b>	101234	<b>Ref. No.</b> —
	union nut T1: M8x1 T2: M15		
<b>accessories for</b>	101072		
	<b>GEV No.</b>	100936	<b>Ref. No.</b> —
	gas tap spindle shaft ø 5x8mm MADEC		
	<b>GEV No.</b>	101277	<b>Ref. No.</b> —
	olive ID ø 8mm Qty 1 pcs		
	<b>GEV No.</b>	101296	<b>Ref. No.</b> —
	union nut thread M12x1 for pipe ø 8mm		
	<b>GEV No.</b>	101299	<b>Ref. No.</b> —
	nut thread M12x1		
	<b>GEV No.</b>	110149	<b>Ref. No.</b> —
	knob gas tap without ignition flame t.max.°C temperature range°C ø 50mm shaft ø 6x4.6mm shaft flat right black		
	<b>GEV No.</b>	110153	<b>Ref. No.</b> —
	knob gas tap without ignition flame ø 50mm shaft ø 6x4.6mm shaft flat left white		

## gas thermostats

SIT

## 710 Minisit series



1

















<b>GEV No.</b>	101385	<b>Ref. No.</b>	4.011.02.15
<b>description</b>	gas thermostat SIT type MINISIT 710 t.max. 200°C 60-200°C gas inlet 3/8" gas outlet 3/8" thermocouple connection M10x1 pilot connection M10x1 probe ø 5mm probe L 95mm capillary pipe 1050mm probe type type D2 pressure controller no pressure regulator mbar gland nut M14x1.5 ignition gas 4mm		
<b>spare parts for</b>	101385		
	<b>GEV No.</b>	100809	<b>Ref. No.</b> —
	O-ring EPDM thickness 2mm ID ø 21mm Qty 1 pcs		
	<b>GEV No.</b>	100904	<b>Ref. No.</b> —
	locking screw M10x1 for pipe ø 4mm Qty 1 pcs		
	<b>GEV No.</b>	101054	<b>Ref. No.</b> —
	magnet unit T1: M10x1 T2: M24x1 L 45mm ø 17mm suitable for Minisit		
	<b>GEV No.</b>	101136	<b>Ref. No.</b> —
	piezoelectric igniter suitable for Minisit with cover cap ømm connection F6.3x0.8		
	<b>GEV No.</b>	101268	<b>Ref. No.</b> —
	gas connection thread 3/8" angled with O-ring MINISIT 710		
	<b>GEV No.</b>	101273	<b>Ref. No.</b> —
	olive for pipe ø 12mm L 9.5mm brass Qty 1 pcs suitable for universal		
	<b>GEV No.</b>	101276	<b>Ref. No.</b> —
	union screw thread 3/8" tube ø 12mm Qty 1 pcs		
	<b>GEV No.</b>	102844	<b>Ref. No.</b> —
	probe 60-200°C probe ø 5mm probe L 98mm capillary pipe 1050mm t.max. 200°C fryer probe type type D2 suitable for MINISIT 710 gland nut M14x1.5		
<b>accessories for</b>	101385		
	<b>GEV No.</b>	100905	<b>Ref. No.</b> —
	locking screw M10x1 for pipe ø 6mm Qty 1 pcs		
	<b>GEV No.</b>	101054	<b>Ref. No.</b> —
	magnet unit T1: M10x1 T2: M24x1 L 45mm ø 17mm suitable for Minisit		
	<b>GEV No.</b>	101137	<b>Ref. No.</b> —
	cover cap without piezoelectric igniter		
	<b>GEV No.</b>	101267	<b>Ref. No.</b> —
	reducer IT 3/8" ET 1/2" L 21mm		

Table continues overleaf



accessories for		101385		
	GEV No.	101269	Ref. No.	—
gas connection thread 1/2" angled with O-ring MINISIT 710				
	GEV No.	101270	Ref. No.	—
screw connection IT 3/8" ET 3/8" L 28mm				
	GEV No.	101272	Ref. No.	—
screw connection IT 1/2" ET 3/8" L 57mm				
	GEV No.	101274	Ref. No.	—
olive for pipe ø 16mm Qty 1 pcs				
	GEV No.	101275	Ref. No.	—
union screw thread 1/2" for pipe ø 16mm Qty 1 pcs				

## ignition parts

### pilot burners

#### SIT

#### 160 series

	1		
<b>GEV No.</b>	106270	<b>Ref. No.</b>	N/A
<b>description</b>	pilot burner SIT type 160 series 2 flames LPG nozzle ø 0.3mm gas connection 4mm code 30		

	1		
<b>GEV No.</b>	106279	<b>Ref. No.</b>	4.011.03.42
<b>description</b>	pilot burner SIT type 160 series 2 flames nozzle ø 0.3mm gas connection 4mm		

	1		
<b>GEV No.</b>	106269	<b>Ref. No.</b>	4.011.03.02
<b>description</b>	pilot burner SIT type 160 series 3 flames LPG nozzle ø 0.3mm gas connection 4mm code 30		

### piezoelectric igniters

#### mounting diameter 22mm

	1		
<b>GEV No.</b>	100008	<b>Ref. No.</b>	4.011.03.01
<b>description</b>	piezoelectric igniter body plastic blowing mounting ø 22mm connection ø2mm cable lengthmm		



### thermocouples

#### threaded thermocouples

#### threaded thermocouples standard

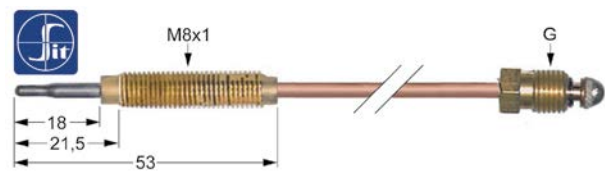
#### with socket with thread M8x1

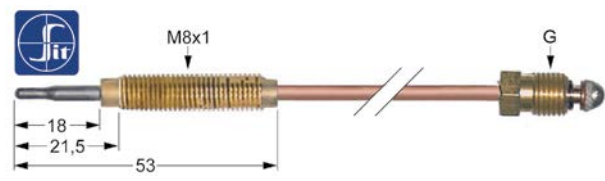
	1		
<b>GEV No.</b>	107627	<b>Ref. No.</b>	4.011.03.04
<b>description</b>	thermocouple SIT M8x1 L 220mm M8x1		

	1			
<b>GEV No.</b>	107629	<b>Ref. No.</b>	4.011.03.05	
<b>description</b>	thermocouple SIT M8x1 L 450mm M8x1			
<b>accessories for</b>	107629			
	GEV No.	102067	Ref. No.	—
nut thread M8x1 H 3mm brass Qty 1 pcs type SEF 1				

### gas burners

#### ceramic burners

#### accessories

#### burner grids

	1		
<b>GEV No.</b>	105897	<b>Ref. No.</b>	3.011.01.35
<b>description</b>	burner grid L 900mm W 70mm for chicken rotisserie		
<b>For models:</b>	MÜNCHEN		



## ceramic plates

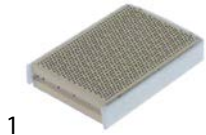

1

<b>GEV No.</b>	105895	<b>Ref. No.</b>	3.011.01.42
<b>description</b>	ceramic plate L 69mm W 49mm H 13mm with 3-sided sealing strip		



1

<b>GEV No.</b>	105896	<b>Ref. No.</b>	3.011.01.42
<b>description</b>	ceramic plate L 69mm W 49mm H 13mm with sealing strip lateral		
<b>For models:</b>	MÜNCHEN		

## ring burners



1

<b>GEV No.</b>	105246	<b>Ref. No.</b>	3.011.01.45
<b>description</b>	ring burner L 355mm W 150mm		



1

<b>GEV No.</b>	105245	<b>Ref. No.</b>	3.011.01.44
<b>description</b>	ring burner L 505mm W 115mm		

## knobs

## universal knobs

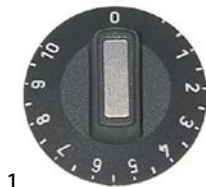

1

<b>GEV No.</b>	110238	<b>Ref. No.</b>	4.013.02.06
<b>description</b>	knob energy regulator 1-10 t.max.°C ø 50mm shaft ø 6x4.6mm shaft flat upper black		

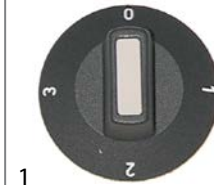

1

<b>GEV No.</b>	110232	<b>Ref. No.</b>	4.013.02.04
<b>description</b>	knob switch 4-position t.max.°C ø 50mm shaft ø 6x4.6mm shaft flat upper black		

## producer-specific knobs

## KSF

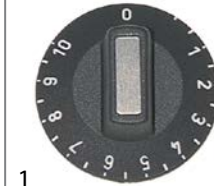

1

<b>GEV No.</b>	110238	<b>Ref. No.</b>	4.013.02.06
<b>description</b>	knob energy regulator 1-10 t.max.°C ø 50mm shaft ø 6x4.6mm shaft flat upper black		



1

<b>GEV No.</b>	110152	<b>Ref. No.</b>	4.011.02.06
<b>description</b>	knob gas tap without ignition flame ø 50mm shaft ø 8x5mm shaft flat left		



1

<b>GEV No.</b>	110737	<b>Ref. No.</b>	3.011.02.14
<b>description</b>	knob gas tap without ignition flame t.max.°C ø 53mm shaft ø 8x5.5mm black		

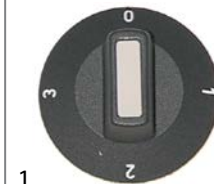

1

<b>GEV No.</b>	110232	<b>Ref. No.</b>	4.013.02.04
<b>description</b>	knob switch 4-position t.max.°C ø 50mm shaft ø 6x4.6mm shaft flat upper black		



**C**

cam switches	4
ceramic burners	7
condensators & interference suppression filters	5

**E**

energy regulators	3
-------------------	---

**G**

gas burners	7
gas taps	5
gas thermostats	6

**H**

heating elements	3
heating elements for griddles	3
heating elements for ovens	3

**I**

infrared lamps	4
----------------	---

**L**

lamps	4
linear lamps	4

**O**

operating capacitors	5
----------------------	---

**P**

piezoelectric igniters	7
pilot burners	7

**R**

ring burners	8
rotary switches	4

**S**

safety thermostats	3
switches and momentary switches	4

**T**

thermocouples	7
thermostats	3