



**GAS COMPONENTS**



**ELECTRIC COMPONENTS**



**WATER TECHNOLOGY**



**MECHANICAL COMPONENTS**



**TOOLS**

Spare parts suitable for

**JUNO**

Find the complete and up-to-date range of products in our GEV Webshop



# Manufacturer catalogue

The most important spare parts and accessories arranged clearly for every manufacturer

- ✓ Complete product range and all appliance data always up to date in the GEV Webshop
- ✓ Alphabetical Index at the end of the catalogue

## GEV Webshop

[www.gev-online.co.uk](http://www.gev-online.co.uk)

[www.gev-online.com](http://www.gev-online.com)



- 🔍 Add to Favourites
- 🔍 Sign In with email address and usual password
- 🔍 Easy-order – place several items in your basket at the same time
- 🔍 Quick Item search – no login needed





## heating elements

### heating elements for ovens

			
1			
<b>GEV No.</b>	417340	<b>Ref. No.</b>	0700214613
<b>description</b>	heating element 2000W 400V L 430mm W 150mm L1 50mm L2 380mm W1 60mm W2 30mm windings 3 connection plug-in connection heating circuits 1 tube ø 6.3mm dry heating element hole distance 56mm flange length 70mm flange width 22mm hole ø 3mm		





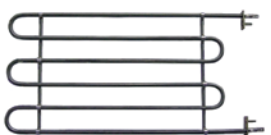



### heating elements for bain maries

			
1			
<b>GEV No.</b>	415051	<b>Ref. No.</b>	0H6163
<b>description</b>	heating element 1500W 230V heating circuits 1 L 390mm W 36mm connection male faston 6.3mm tube ø 6.5mm 2 hole fixing thread M10x1 immersion heater mounting distance 30mm		
<b>accessories for</b>	415051		
	<b>GEV No.</b>	510893	<b>Ref. No.</b> —
	O-ring EPDM thickness 2.62mm ID ø 9.92mm Qty 1 pcs		
	<b>GEV No.</b>	521129	<b>Ref. No.</b> —
	nut thread M10 H 6mm SS WS 17 Qty 1 pcs DIN/ISO DIN 439		

			
1			
<b>GEV No.</b>	415596	<b>Ref. No.</b>	0G2290
<b>description</b>	heating element 1500W 230V heating circuits 1 L 395mm W 198mm tube ø 6.5mm lug length 31mm lug width 16mm connection length 30mm connection male faston 6.3mm dry heating element bracket mounting hole distance 160mm mounting thread M4		

			
1			
<b>GEV No.</b>	415353	<b>Ref. No.</b>	050933
<b>description</b>	heating element 1500W 230V heating circuits 1 L 395mm W 205mm H 25mm L1 50mm L2 345mm connection M4 connection distance 198mm tube ø 8.5mm connection length 20mm dry heating element		

			
1			
<b>GEV No.</b>	415499	<b>Ref. No.</b>	0H6178
<b>description</b>	heating element 1500W 230V heating circuits 1 L 437mm W 227mm L1 37mm L2 400mm W1 147mm W2 80mm connection male faston 6.3mm connection distance 140mm tube ø 6.5mm dry heating element		

			
1			
<b>GEV No.</b>	415212	<b>Ref. No.</b>	0H6201 214678
<b>description</b>	heating element 2000W 400V heating circuits 1 L 320mm W 96mm connection M4 tube ø 8.5mm flange with thread thread 1" immersion heater L1 75mm L2 245mm H1 24mm H 40mm thermostat sleeves ø 5mm number of thermostat sleeves 1 length thermostat sleeves 133mm thermostat sleeve clinging		
<b>accessories for</b>	415212		
	<b>GEV No.</b>	510404	<b>Ref. No.</b> —
	flat gasket fibre ED ø 44mm ID ø 34mm thickness 2mm Qty 1 pcs		
	<b>GEV No.</b>	510422	<b>Ref. No.</b> —
	gasket copper ED ø 37.7mm ID ø 32.5mm thickness 2.7mm for thread 1"		
	<b>GEV No.</b>	520233	<b>Ref. No.</b> —
	nut thread 1" H 6mm brass WS 47 Qty 1 pcs		
	<b>GEV No.</b>	521103	<b>Ref. No.</b> —
	nut thread M4 H 3mm WS 7 brass Qty 20 pcs		
	<b>GEV No.</b>	521104	<b>Ref. No.</b> —
	washer ID ø 4.3mm ED ø 8mm thickness 0.5mm brass Qty 20 pcs for thread M4		
	<b>GEV No.</b>	560111	<b>Ref. No.</b> —
	plain washer ID ø 4.3mm ED ø 9mm thickness 0.8mm SS Qty 20 pcs DIN 125A for thread M4		
	<b>GEV No.</b>	560131	<b>Ref. No.</b> —
	hexagonal nut thread M4 H 3.2mm WS 7 SS DIN/ISO DIN 934 / ISO 4032/8673 Qty 20 pcs		





			
1			
<b>GEV No.</b>	415908	<b>Ref. No.</b>	0G5201
<b>description</b>	heating element 2500W 230V heating circuits 1 L 385mm W 96mm connection M4 tube ø 8.5mm flange with thread thread 1" immersion heater L1 75mm L2 310mm H1 10mm H 40mm thermostat sleeves ø 5mm number of thermostat sleeves 1 length thermostat sleeves 133mm thermostat sleeve clinging		
<b>accessories for</b>	415908		
	<b>GEV No.</b>	510404	<b>Ref. No.</b> —
	flat gasket fibre ED ø 44mm ID ø 34mm thickness 2mm Qty 1 pcs		
	<b>GEV No.</b>	510422	<b>Ref. No.</b> —
	gasket copper ED ø 37.7mm ID ø 32.5mm thickness 2.7mm for thread 1"		



Table continues overleaf



<b>accessories for</b>	415908		
	GEV No.	520233	Ref. No.
	nut thread 1" H 6mm brass WS 47 Qty 1 pcs		



<b>GEV No.</b>	415481	<b>Ref. No.</b>	OK0566
<b>description</b>	heating element 2500W 400V heating circuits 1 L 385mm W 96mm connection M4 flange with thread thread 1" immersion heater L1 75mm L2 310mm H1 20mm H 40mm thermostat sleeves ø 5mm number of thermostat sleeves 1 length thermostat sleeves 133mm thermostat sleeve clinging		

<b>accessories for</b>	415481		
	GEV No.	510404	Ref. No.
	flat gasket fibre ED ø 44mm ID ø 34mm thickness 2mm Qty 1 pcs		
	GEV No.	510422	Ref. No.
	gasket copper ED ø 37.7mm ID ø 32.5mm thickness 2.7mm for thread 1"		
	GEV No.	520233	Ref. No.
	nut thread 1" H 6mm brass WS 47 Qty 1 pcs		



<b>GEV No.</b>	415650	<b>Ref. No.</b>	OK0593
<b>description</b>	heating element 6000W 230V heating circuits 3 L 255mm W 250mm connection length 43mm connection M4 flange with thread thread 1 1/4" immersion heater H1 13mm H 25mm		

<b>spare parts for</b>	415650		
	GEV No.	510405	Ref. No.
	flat gasket fibre ED ø 56mm ID ø 42mm thickness 2mm for thread 1 1/4" Qty 1 pcs		

<b>accessories for</b>	415650		
	GEV No.	520232	Ref. No.
	nut thread 1 1/4" H 5mm nickel-plated brass WS 47 Qty 1 pcs		

## heating elements for frying pans



<b>GEV No.</b>	416974	<b>Ref. No.</b>	OH6156
<b>description</b>	heating element 1100W 230V		

## heating elements for fryers

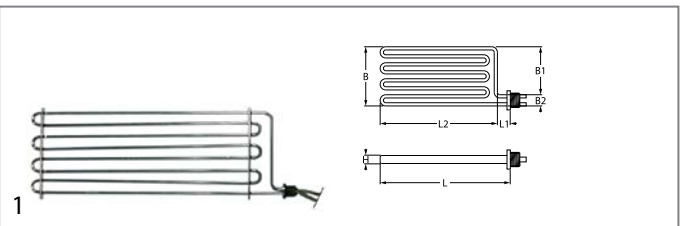

<b>GEV No.</b>	415371	<b>Ref. No.</b>	OH6194 214576
<b>description</b>	heating element 8000W 230/400V heating circuits 3 mounting pos. left thread M26x1.5 L 555mm W 177mm H 27mm L1 20mm L2 535mm W1 160mm W2 15mm mounting ø 26mm tube ø 17x6mm cable length 600mm flange ø 33mm fryer 1 hole fixing connection length 12mm		

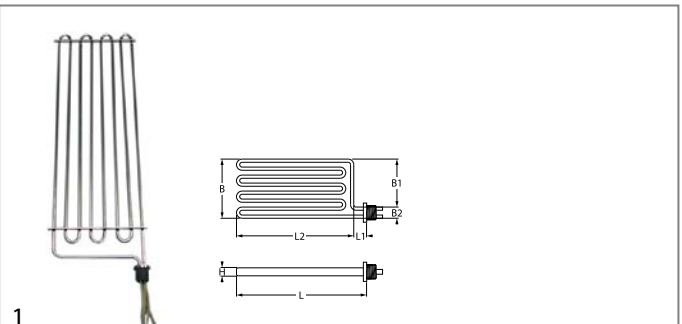

<b>GEV No.</b>	415370	<b>Ref. No.</b>	OK0621
<b>description</b>	heating element 8000W 230/400V heating circuits 3 mounting pos. right thread M26x1.5 L 555mm W 177mm H 27mm L1 20mm L2 535mm W1 160mm W2 15mm mounting ø 26mm tube ø 17x6mm cable length 600mm flange ø 33mm 1 hole fixing connection length 12mm fryer		

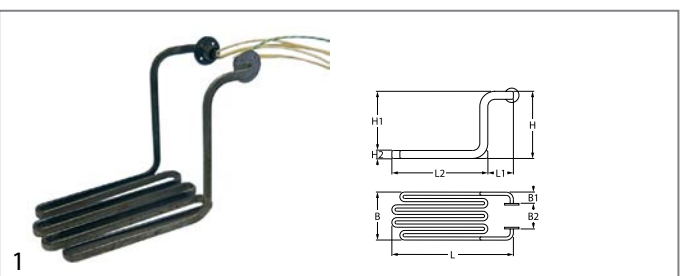

<b>GEV No.</b>	415684	<b>Ref. No.</b>	OK0583
<b>description</b>	heating element 5010W 400V heating circuits 3 L 384mm W 225mm H 245mm L1 84mm L2 300mm H1 227mm H2 18mm W1 31mm W2 148mm windings 4 cable length 860mm rotation flange		

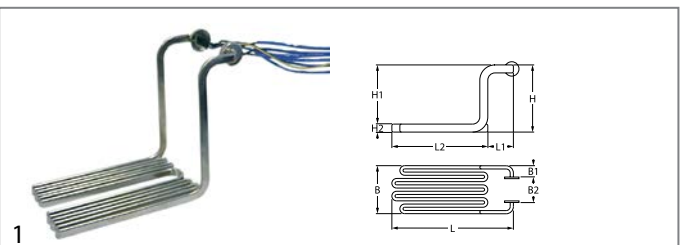

<b>GEV No.</b>	415490	<b>Ref. No.</b>	OH6192
<b>description</b>	heating element 5100W 230/400V heating circuits 3 L 345mm W 168mm H 246mm L1 70mm L2 275mm H1 229mm H2 17mm W1 21mm W2 104mm windings 6 flange ø 39mm connection cable rotation flange immersion heater		



<b>GEV No.</b>	415611	<b>Ref. No.</b>	0H6203
<b>description</b>	heating element 7200W 230/400V heating circuits 3 L 350mm W 168mm H 249mm L1 62mm L2 288mm H1 232mm H2 17mm W1 34mm W2 100mm windings 6 flange ø 42mm tube ø 17x6mm cable length 1730mm rotation flange immersion heater		

<b>GEV No.</b>	415667	<b>Ref. No.</b>	OK0526
<b>description</b>	heating element 4220W 230V heating circuits 1 L 507mm W 45mm H 345mm L1 17mm L2 490mm H1 308mm H2 37mm thread M12x1 mounting distance 37mm tube ø 8.5mm 2 hole fixing connection M4 fryer windings 5		

**2 hole fixing**

<b>GEV No.</b>	415498	<b>Ref. No.</b>	OK0569
<b>description</b>	heating element 2500W 230V heating circuits 1 L 315mm W 40mm H 275mm L1 35mm L2 280mm H1 235mm H2 40mm thread M12x1 mounting distance 25mm tube ø 8.5mm 2 hole fixing connection M4 connection length 18mm fryer windings 4		
<b>spare parts for</b>	415498		
	<b>GEV No.</b>	521110	<b>Ref. No.</b> —
	flat gasket fibre ED ø 20mm ID ø 13mm thickness 2mm Qty 1 pcs		
<b>accessories for</b>	415498		
	<b>GEV No.</b>	520229	<b>Ref. No.</b> —
	nut thread M12x1 H 4mm WS 16 zinc-coated steel Qty 1 pcs		
	<b>GEV No.</b>	521103	<b>Ref. No.</b> —
	nut thread M4 H 3mm WS 7 brass Qty 20 pcs		
	<b>GEV No.</b>	521104	<b>Ref. No.</b> —
	washer ID ø 4.3mm ED ø 8mm thickness 0.5mm brass Qty 20 pcs for thread M4		
	<b>GEV No.</b>	521131	<b>Ref. No.</b> —
	nut thread M12x1 H 3.5mm WS 17 SS Qty 1 pcs		
	<b>GEV No.</b>	528110	<b>Ref. No.</b> —
	O-ring EPDM thickness 2.62mm ID ø 12.37mm Qty 1 pcs		
	<b>GEV No.</b>	560111	<b>Ref. No.</b> —
	plain washer ID ø 4.3mm ED ø 9mm thickness 0.8mm SS Qty 20 pcs DIN 125A for thread M4		
	<b>GEV No.</b>	560131	<b>Ref. No.</b> —
	hexagonal nut thread M4 H 3.2mm WS 7 SS DIN/ISO DIN 934 / ISO 4032/8673 Qty 20 pcs		

**accessories for** 415667

	<b>GEV No.</b>	521103	<b>Ref. No.</b> —
	nut thread M4 H 3mm WS 7 brass Qty 20 pcs		
	<b>GEV No.</b>	521104	<b>Ref. No.</b> —
	washer ID ø 4.3mm ED ø 8mm thickness 0.5mm brass Qty 20 pcs for thread M4		
	<b>GEV No.</b>	560111	<b>Ref. No.</b> —
	plain washer ID ø 4.3mm ED ø 9mm thickness 0.8mm SS Qty 20 pcs DIN 125A for thread M4		
	<b>GEV No.</b>	560131	<b>Ref. No.</b> —
	hexagonal nut thread M4 H 3.2mm WS 7 SS DIN/ISO DIN 934 / ISO 4032/8673 Qty 20 pcs		

<b>GEV No.</b>	415470	<b>Ref. No.</b>	0H6180
<b>description</b>	heating element 2000W 230V heating circuits 1 L 320mm W 36mm H 265mm L1 36mm L2 280mm H1 215mm H2 40mm thread M12x1 tube ø 8.5mm 2 hole fixing connection M4 fryer windings 3		
<b>accessories for</b>	415470		
	<b>GEV No.</b>	521103	<b>Ref. No.</b> —
	nut thread M4 H 3mm WS 7 brass Qty 20 pcs		
	<b>GEV No.</b>	521104	<b>Ref. No.</b> —
	washer ID ø 4.3mm ED ø 8mm thickness 0.5mm brass Qty 20 pcs for thread M4		
	<b>GEV No.</b>	560111	<b>Ref. No.</b> —
	plain washer ID ø 4.3mm ED ø 9mm thickness 0.8mm SS Qty 20 pcs DIN 125A for thread M4		
	<b>GEV No.</b>	560131	<b>Ref. No.</b> —
	hexagonal nut thread M4 H 3.2mm WS 7 SS DIN/ISO DIN 934 / ISO 4032/8673 Qty 20 pcs		



## heating elements for griddles

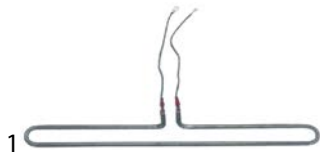

<b>GEV No.</b>	415480	<b>Ref. No.</b>	0H6182
<b>description</b>	heating element 1000W 220V heating circuits 1 L 457mm W 40mm H 70mm tube ø 8.5mm W1 212mm W2 33mm cable length 270mm griddle connection distance 24mm dry heating element		

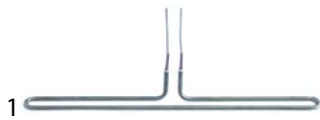

<b>GEV No.</b>	415482	<b>Ref. No.</b>	0H6155
<b>description</b>	heating element 1100W 400V heating circuits 1 L 538mm W 45mm H 67mm tube ø 8.5mm W1 252mm W2 34mm cable length 265mm griddle connection distance 25mm dry heating element		



<b>GEV No.</b>	415079	<b>Ref. No.</b>	053614
<b>description</b>	heating element 1250W 230V heating circuits 1 L 473mm W 52mm H 43mm tube ø 8.5mm griddle connection distance 44mm dry heating element		



<b>GEV No.</b>	415098	<b>Ref. No.</b>	0A2247
<b>description</b>	heating element 2250W 220V heating circuits 1 L 533mm W 75mm H 123mm tube ø 14mm L1 78mm L2 456mm connection cable cable length 2000mm dry heating element		



<b>GEV No.</b>	415479	<b>Ref. No.</b>	0H6183
<b>description</b>	heating element 750W 230V heating circuits 1 L 471mm W 30mm H mm tube ø 6.35mm rectangular flange connection male faston 6.3mm hole distance 36mm flange length 44mm flange width 20mm hole ø 4.5mm connection length 30mm dry heating element		

## heating elements for large hobs

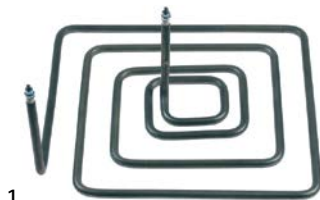

<b>GEV No.</b>	418697	<b>Ref. No.</b>	0K0618
<b>description</b>	heating element 2000W 400V L 270mm W 230mm H 115mm tube ø 8.5mm mounting pos. inner connection M4		

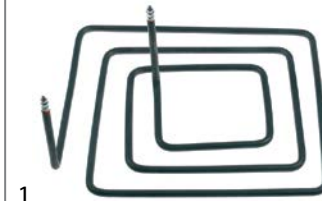

<b>GEV No.</b>	418698	<b>Ref. No.</b>	0K0617
<b>description</b>	heating element 2000W 400V L 300mm W 260mm H 115mm tube ø 8.5mm mounting pos. outer connection M4		

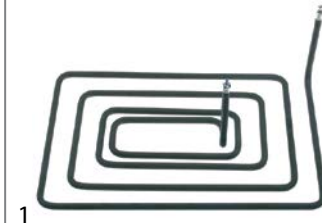

<b>GEV No.</b>	418699	<b>Ref. No.</b>	0H6206
<b>description</b>	heating element 2000W 400V L 345mm W 230mm H 110mm tube ø 8.5mm mounting pos. inner connection M4		

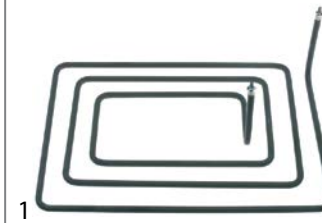

<b>GEV No.</b>	418700	<b>Ref. No.</b>	0H6205
<b>description</b>	heating element 2000W 400V L 380mm W 265mm H 110mm tube ø 8.5mm mounting pos. outer connection M4		

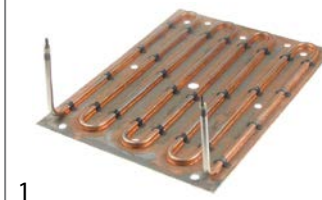

<b>GEV No.</b>	418009	<b>Ref. No.</b>	0K0563
<b>description</b>	heating element 4000W 400V heating circuits 1 L 380mm W 287mm H 116mm tube ø 8.5mm mounting pos. connection M4 dry heating element		

## heating elements for tilting bratt pan

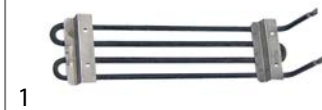



<b>GEV No.</b>	415273	<b>Ref. No.</b>	058345
<b>description</b>	heating element 1500W 220V L 373mm W 82mm H 78mm connection M5 dry heating element heating circuits 1 tube ø 8.5mm with holder connection distance 80mm		



			
<b>GEV No.</b>	415098	<b>Ref. No.</b>	0A2247
<b>description</b>	heating element 2250W 220V heating circuits 1 L 533mm W 75mm H 123mm tube ø 14mm L1 78mm L2 456mm connection cable cable length 2000mm dry heating element		

			
<b>GEV No.</b>	415822	<b>Ref. No.</b>	0H6707 0K2189 249213
<b>description</b>	heating element tilting bratt pan 1800W 230V L 540mm W 105mm Hmm connection male faston dry heating element heating circuits 1 tube ø 8.5mm L1 50mm L2 490mm W1 65mm W2 40mm connection length 10mm		

heating elements for pasta cookers

			
<b>GEV No.</b>	415597	<b>Ref. No.</b>	0C5347
<b>description</b>	heating element 3000W 230V heating circuits 3 L 255mm W 38mm H 26mm 3 hole flange connection male faston tube ø 6.3mm thermostat sleeves ø 7.5mm length thermostat sleeves 199mm hole distance 63mm mounting ø 47.5mm hole ø 8/10mm connection length 15mm immersion heater		
<b>accessories for</b>	415597		
	<b>GEV No.</b>	510408	<b>Ref. No.</b> 067620
	O-ring EPDM thickness 5.34mm ID ø 47mm Qty 1 pcs		
	<b>GEV No.</b>	510562	<b>Ref. No.</b> —
	O-ring silicone thickness 5.34mm ID ø 47mm Qty 1 pcs		

heating elements for chargrills

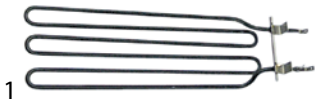
			
<b>GEV No.</b>	415352	<b>Ref. No.</b>	053613
<b>description</b>	heating element 2750W 240V L 480mm W 125mm H 41mm L1 70mm L2 40mm L3 370mm W1 23mm W2 79mm connection M4 connection distance 72mm tube ø 8.5mm heating circuits 1 dry heating element		

heating elements for salamanders/toast-

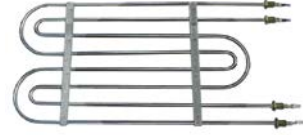

			
<b>GEV No.</b>	415559	<b>Ref. No.</b>	0K4777
<b>description</b>	heating element 2100W 400V heating circuits 1 L 260mm W 217mm H 20mm thread M14x1.25 mounting distance 210mm connection length 14mm tube ø 6.5mm 2 hole fixing dry heating element		

			
<b>GEV No.</b>	415537	<b>Ref. No.</b>	0H6169
<b>description</b>	heating element 3200W 230V heating circuits 2 L 493mm W 250mm thread M14x1.5 mounting distance 35mm connection length 45mm connection male faston 6.3mm tube ø 8.5mm dry heating element 4 hole fixing		

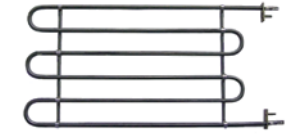
heating elements for heated trolleys

			
<b>GEV No.</b>	415596	<b>Ref. No.</b>	0G2290
<b>description</b>	heating element 1500W 230V heating circuits 1 L 395mm W 198mm tube ø 6.5mm lug length 31mm lug width 16mm connection length 30mm connection male faston 6.3mm dry heating element bracket mounting hole distance 160mm mounting thread M4		

pilot heating elements



			
<b>GEV No.</b>	415460	<b>Ref. No.</b>	0H6199
<b>description</b>	heating element 1000W 230V heating circuits 1 flange 70x18mm L 230mm W 65mm connection male faston 6.3mm tube ø 8.5mm immersion heater expansion flange connection length 20mm silicone TD ø 8mm		
<b>accessories for</b>	415460		
	<b>GEV No.</b>	375044	<b>Ref. No.</b> 0H6141
	safety thermostat switch-off temp. 178°C 1-pole 16A probe ø 4mm probe L 91mm capillary pipe 1730mm capillary pipe isolated 1600mm gland nut probe with sealing sleeve screw connection M8x1 sealing sleeve 8.6x32mm		



## immersion heating elements

## 3 hole flange ø47.5mm



<b>GEV No.</b>	415690	<b>Ref. No.</b>	002835
<b>description</b>	heating element 9000W 230V mounting ø 47.5mm heating circuits 3 L 290mm W 32mm H 38mm number of thermostat sleeves 1 thermostat sleeves ø 5mm length thermostat sleeves 175mm thermostat sleeve centre tube ø 8.5mm hole distance 63mm hole ø 10mm connection M5 3 hole flange immersion heater		
<b>spare parts for</b>	415690		
	<b>GEV No.</b>	510408	<b>Ref. No.</b> 067620
	O-ring EPDM thickness 5.34mm ID ø 47mm Qty 1 pcs		
<b>accessories for</b>	415690		
	<b>GEV No.</b>	510408	<b>Ref. No.</b> 067620
	O-ring EPDM thickness 5.34mm ID ø 47mm Qty 1 pcs		
	<b>GEV No.</b>	510562	<b>Ref. No.</b> —
	O-ring silicone thickness 5.34mm ID ø 47mm Qty 1 pcs		

## with expansion flange 70 x 18mm



<b>GEV No.</b>	415460	<b>Ref. No.</b>	0H6199
<b>description</b>	heating element 1000W 230V heating circuits 1 flange 70x18mm L 230mm W 65mm connection male faston 6.3mm tube ø 8.5mm immersion heater expansion flange connection length 20mm silicone TD ø 8mm		
<b>accessories for</b>	415460		
	<b>GEV No.</b>	375044	<b>Ref. No.</b> 0H6141
	safety thermostat switch-off temp. 178°C 1-pole 16A probe ø 4mm probe L 91mm capillary pipe 1730mm capillary pipe isolated 1600mm gland nut probe with sealing sleeve screw connection M8x1 sealing sleeve 8.6x32mm		



<b>GEV No.</b>	415461	<b>Ref. No.</b>	0H6170
<b>description</b>	heating element 4000W 230V heating circuits 2 flange 80x28mm L 237mm W 64mm connection male faston 6.3mm tube ø 8.5mm immersion heater expansion flange		



<b>GEV No.</b>	415462	<b>Ref. No.</b>	0H6202
<b>description</b>	heating element 4000W 400V heating circuits 2 flange 70x18mm L 256mm W 65mm connection male faston 6.3mm tube ø 8.5mm immersion heater expansion flange silicone		



<b>GEV No.</b>	415459	<b>Ref. No.</b>	0H6146
<b>description</b>	heating element 5600W 230V heating circuits 2 flange 70x18mm L 272mm W 64mm connection male faston 6.3mm tube ø 8.5mm immersion heater expansion flange H 19mm		



<b>GEV No.</b>	415557	<b>Ref. No.</b>	0H6164
<b>description</b>	heating element 5600W 400V heating circuits 2 L 272mm W 64mm tube ø 8.5mm connection male faston 6.3mm immersion heater expansion flange flange 70x18mm		



<b>GEV No.</b>	415463	<b>Ref. No.</b>	0H6171
<b>description</b>	heating element 6000W 230V heating circuits 2 flange 70x18mm L 385mm W 59mm connection male faston 6.3mm tube ø 8.5mm immersion heater expansion flange		



<b>GEV No.</b>	415464	<b>Ref. No.</b>	0H6198
<b>description</b>	heating element 6000W 400V heating circuits 2 flange 70x18mm L 380mm W 65mm connection male faston 6.3mm tube ø 8.5mm immersion heater expansion flange		



<b>GEV No.</b>	415345	<b>Ref. No.</b>	OK0551 214095
<b>description</b>	heating element 6000W 400V heating circuits 2 flange 70x18mm L 534mm W 65mm connection male faston 6.3mm tube ø 6.3mm immersion heater expansion flange connection length 22mm		



special flanges



1

<b>GEV No.</b>	416975	<b>Ref. No.</b>	OK0516
<b>description</b>	heating element 15000W 400V heating circuits 6 L 263mm W 240mm H 80mm tube ø 6.5mm connection cable cable length 1500mm immersion heater special fixing hole distance 48/56mm flange length 335mm flange width 125mm hole ø 10mm		
<b>accessories for</b>	416975		
	<b>GEV No.</b>	510560	<b>Ref. No.</b> OK5577
	gasket EPDM thickness 6mm ID ø 200mm dimensions 280x70mm Qty 1 pcs for heating element		



1

<b>GEV No.</b>	415797	<b>Ref. No.</b>	OK0517
<b>description</b>	heating element 18000W 400V heating circuits 6 L 325mm W 240mm H 45mm tube ø 6.5mm connection cable cable length 1250mm immersion heater rectangular flange hole distance 62mm flange length 336mm flange width 126mm hole ø 10mm		
<b>accessories for</b>	415797		
	<b>GEV No.</b>	510560	<b>Ref. No.</b> OK5577
	gasket EPDM thickness 6mm ID ø 200mm dimensions 280x70mm Qty 1 pcs for heating element		



1

<b>GEV No.</b>	415798	<b>Ref. No.</b>	OK0521
<b>description</b>	heating element 22500W 400V heating circuits 6 immersion heater rectangular flange		
<b>accessories for</b>	415798		
	<b>GEV No.</b>	510560	<b>Ref. No.</b> OK5577
	gasket EPDM thickness 6mm ID ø 200mm dimensions 280x70mm Qty 1 pcs for heating element		





1

<b>GEV No.</b>	415799	<b>Ref. No.</b>	OH6153
<b>description</b>	heating element 25200W 400V heating circuits 6 L 470mm W 235mm H 90mm connection cable cable length 1500mm immersion heater special fixing hole distance 48/56mm hole ø 10mm		
<b>accessories for</b>	415799		
	<b>GEV No.</b>	510560	<b>Ref. No.</b> OK5577
	gasket EPDM thickness 6mm ID ø 200mm dimensions 280x70mm Qty 1 pcs for heating element		

3/4"





1

<b>GEV No.</b>	415580	<b>Ref. No.</b>	OG0334
<b>description</b>	heating element 5000W 400V heating circuits 1 L 404mm W 23mm H 80mm cable length 400mm connection length 85mm immersion heater flange with thread H1 52mm H2 28mm thread 3/4"		
<b>accessories for</b>	415580		
	<b>GEV No.</b>	510403	<b>Ref. No.</b> —
	flat gasket fibre ED ø 36.5mm ID ø 27mm thickness 2mm Qty 1 pcs		
	<b>GEV No.</b>	510421	<b>Ref. No.</b> —
	gasket copper ED ø 31.8mm ID ø 26.4mm thickness 2.2mm for thread 3/4"		
	<b>GEV No.</b>	520234	<b>Ref. No.</b> —
	nut thread 3/4" H 5mm brass WS 30 Qty 1 pcs		







1 1/4"





1

<b>GEV No.</b>	415390	<b>Ref. No.</b>	OH6173
<b>description</b>	heating element 7500W 230V heating circuits 3 thread 1 1/4" L 410mm W 35mm H 28mm tube ø 6.5mm immersion heater flange with thread		
<b>accessories for</b>	415390		
	<b>GEV No.</b>	510405	<b>Ref. No.</b> —
	flat gasket fibre ED ø 56mm ID ø 42mm thickness 2mm for thread 1 1/4" Qty 1 pcs		
	<b>GEV No.</b>	520232	<b>Ref. No.</b> —
	nut thread 1 1/4" H 5mm nickel-plated brass WS 47 Qty 1 pcs		
	<b>GEV No.</b>	528021	<b>Ref. No.</b> —
	flat gasket PTFE ED ø 53mm ID ø 42.5mm thickness 3mm Qty 1 pcs equiv. no. 12001/02286 suitable for Astoria/Aurora/Brasilia/Wega		





1 1/2"			
			
<b>GEV No.</b>	415403	<b>Ref. No.</b>	0H6160
<b>description</b>	heating element 7500W 230V heating circuits 3 thread 1 1/2" L 495mm W 36mm H 33mm thermostat sleeves ø 9mm length thermostat sleeves 400mm thermostat sleeve centre not clinging tube ø 8.5mm connection M4 immersion heater connection length 35mm flange with thread number of thermostat sleeves 1		
<b>accessories for</b>	415403		
	<b>GEV No.</b>	510406	<b>Ref. No.</b> —
	flat gasket fibre ED ø 60mm ID ø 48mm thickness 3mm for thread 1 1/2" Qty 1 pcs		
	<b>GEV No.</b>	510424	<b>Ref. No.</b> —
	gasket copper ED ø 55mm ID ø 48mm thickness 2.2mm Centellen for thread 1 1/2"		
	<b>GEV No.</b>	520211	<b>Ref. No.</b> —
	reducer thread 2" ET - 1 1/2" IT brass		
	<b>GEV No.</b>	520212	<b>Ref. No.</b> —
	hexagonal nut thread 1 1/2" brass WS 60 H 8mm		
	<b>GEV No.</b>	550361	<b>Ref. No.</b> —
	blind flange ø 58mm thread 1 1/2"		

## heating elements for convection

			
<b>GEV No.</b>	415123	<b>Ref. No.</b>	0H6212 214759
<b>description</b>	heating element 1750W 220V heating circuits 1 ID ø 186mm ED ø 199mm L 222mm H 29mm L1 14mm W1 30mm H1 9mm H2 20mm flange length 70mm flange width 22mm hole distance 56mm connection male faston 6.3mm tube ø 6.3mm convection heating element hole ø 5mm rectangular flange		
<b>accessories for</b>	415123		
	<b>GEV No.</b>	510368	<b>Ref. No.</b> —
	gasket L 70mm W 23.5mm hole ø 5mm hole distance 56mm FIBER thickness 2mm for heating element		

			
<b>GEV No.</b>	418468	<b>Ref. No.</b>	0H6210
<b>description</b>	heating element 2000W 230V heating circuits 1 ID ø 192mm ED ø 203mm L 215mm H 32mm L1 8mm H1 12mm H2 18mm flange length 70mm flange width 22mm hole distance 56mm connection male faston 6.3mm tube ø 6.5mm convection heating element hole ø 6.5mm rectangular flange		



			
<b>GEV No.</b>	415116	<b>Ref. No.</b>	0H6157
<b>description</b>	heating element 2600W 230V heating circuits 1 ID ø 190mm ED ø 210mm L 220mm H 28mm L1 10mm W1 31mm H1 5mm H2 23mm flange length 70mm flange width 22mm hole distance 56mm connection male faston 6.3mm tube ø 6.5mm convection heating element hole ø 5mm rectangular flange		
<b>accessories for</b>	415116		
	<b>GEV No.</b>	510368	<b>Ref. No.</b> —
	gasket L 70mm W 23.5mm hole ø 5mm hole distance 56mm FIBER thickness 2mm for heating element		

			
<b>GEV No.</b>	418470	<b>Ref. No.</b>	0H6168
<b>description</b>	heating element 3000W 230V heating circuits 2 ID ø 350mm ED ø 365mm L 390mm H 118mm W1 62mm H1 34mm H2 84mm flange length 85mm flange width 30mm connection length 90mm tube ø 6.5mm dry heating element hole ø 6.5mm rectangular flange L1 40mm		

			
<b>GEV No.</b>	418487	<b>Ref. No.</b>	OK3049 293688
<b>description</b>	heating element 3150W 230V heating circuits 3 ID ø 201mm ED ø 218mm L 275mm H 41mm L1 54mm W1 63mm H1 3mm H2 38mm flange length 93mm flange width 22mm hole distance 78mm connection male faston 6.3mm connection length 65mm tube ø 8.5mm convection heating element hole ø 5mm rectangular flange		







1

<b>GEV No.</b>	415657	<b>Ref. No.</b>	002757
<b>description</b>	heating element 4500W 230V heating circuits 3 L 534mm W 350mm H 70mm L1 96mm L2 438mm W1 160mm W2 33mm H1 37mm H2 33mm flange length 76mm flange width 50mm hole distance 60mm hole ø 6mm tube ø 8.5mm convection heating element connection male faston 6.3mm connection length 103mm rectangular flange		
<b>accessories for</b>	415657		
	<b>GEV No.</b>	550256	<b>Ref. No.</b> 055327
	gasket L 75mm W 50mm hole ø 5mm hole distance 59.5mm rubber thickness 3mm for heating element suitable for JUNO equiv. no. 55327		
	<b>GEV No.</b>	550257	<b>Ref. No.</b> 002689
	gasket L 137mm W 79mm thickness 3.5mm for heating element suitable for JUNO equiv. no. 02689		





1

<b>GEV No.</b>	415654	<b>Ref. No.</b>	002688
<b>description</b>	heating element 5666W 230V heating circuits 2 ID ø 465mm ED ø 480mm L 580mm H 65mm L1 90mm W1 32mm H1 34mm H2 31mm flange length 80mm flange width 45mm hole distance 56mm connection M5 connection length 108mm tube ø 8.5mm convection heating element hole ø 6mm rectangular flange		
<b>accessories for</b>	415654		
	<b>GEV No.</b>	550256	<b>Ref. No.</b> 055327
	gasket L 75mm W 50mm hole ø 5mm hole distance 59.5mm rubber thickness 3mm for heating element suitable for JUNO equiv. no. 55327		
	<b>GEV No.</b>	550257	<b>Ref. No.</b> 002689
	gasket L 137mm W 79mm thickness 3.5mm for heating element suitable for JUNO equiv. no. 02689		





1

<b>GEV No.</b>	415656	<b>Ref. No.</b>	0A5330
<b>description</b>	heating element 8000W 400V heating circuits 2 ID ø 560mm ED ø 580mm L 630mm H 68mm L1 50mm W1 33mm H1 37mm H2 29mm flange length 80mm flange width 45mm hole distance 60mm connection M5 connection length 15mm tube ø 8.5mm convection heating element hole ø 6mm rectangular flange		
<b>accessories for</b>	415656		
	<b>GEV No.</b>	550256	<b>Ref. No.</b> 055327
	gasket L 75mm W 50mm hole ø 5mm hole distance 59.5mm rubber thickness 3mm for heating element suitable for JUNO equiv. no. 55327		
	<b>GEV No.</b>	550257	<b>Ref. No.</b> 002689
	gasket L 137mm W 79mm thickness 3.5mm for heating element suitable for JUNO equiv. no. 02689		





1

<b>GEV No.</b>	415487	<b>Ref. No.</b>	OK0601
<b>description</b>	heating element 1000W 230V heating circuits 1 L 445mm W 65mm flange length 70mm flange width 22mm hole distance 28mm connection length 25mm connection male faston 6.3mm tube ø 6.5mm hole ø 3mm W1 30mm rectangular flange convection heating element		
<b>accessories for</b>	415487		
	<b>GEV No.</b>	510368	<b>Ref. No.</b> —
	gasket L 70mm W 23.5mm hole ø 5mm hole distance 56mm FIBER thickness 2mm for heating element		



1

<b>GEV No.</b>	415488	<b>Ref. No.</b>	0H6195
<b>description</b>	heating element 1500W 230V heating circuits 1 L 435mm W 175mm L1 55mm L2 380mm W2 30mm flange length 70mm flange width 22mm hole distance 56mm connection length 36mm connection male faston 6.3mm tube ø 6.3mm hole ø 3mm W1 72mm rectangular flange for hot air oven		
<b>accessories for</b>	415488		
	<b>GEV No.</b>	510368	<b>Ref. No.</b> —
	gasket L 70mm W 23.5mm hole ø 5mm hole distance 56mm FIBER thickness 2mm for heating element		



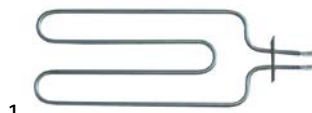

1

<b>GEV No.</b>	418469	<b>Ref. No.</b>	0H6208 214728
<b>description</b>	heating element 1500W 240V heating circuits 1 L 350mm W 95mm L1 30mm L2 320mm W2 80mm flange length 70mm flange width 22mm hole distance 56.5mm connection length 15mm connection male faston 6.3mm tube ø 6.3mm hole ø 3.5mm W1 15mm rectangular flange convection heating element windings 2		





1

<b>GEV No.</b>	415485	<b>Ref. No.</b>	0H6197
<b>description</b>	heating element 2000W 230V heating circuits 1 L 360mm W 155mm L1 35mm L2 325mm W2 30mm flange length 70mm flange width 22mm hole distance 28mm connection length 63mm connection male faston 6.3mm tube ø 6.3mm W1 62mm rectangular flange convection heating element mounting thread M4		
<b>spare parts for</b>	415485		
	<b>GEV No.</b>	510368	<b>Ref. No.</b> —
	gasket L 70mm W 23.5mm hole ø 5mm hole distance 56mm FIBER thickness 2mm for heating element		







1

<b>GEV No.</b>	415242	<b>Ref. No.</b>	0H6213
<b>description</b>	heating element 2x3500W 230V heating circuits 2 L 240mm W 390mm H 30mm W2 50mm flange length 70mm flange width 22mm hole distance 56mm connection length 20mm connection male faston 6.3mm tube ø 6.5mm hole ø 5mm W1 290mm rectangular flange convection heating element		
<b>accessories for</b>	415242		
	<b>GEV No.</b>	510368	<b>Ref. No.</b> —
	gasket L 70mm W 23.5mm hole ø 5mm hole distance 56mm FIBER thickness 2mm for heating element		





1

<b>GEV No.</b>	415457	<b>Ref. No.</b>	0H6166
<b>description</b>	heating element 3000W 230V heating circuits 2 L 330mm W 135mm L1 60mm L2 270mm H 30mm W2 110mm flange length 85mm flange width 30mm connection length 105mm connection male faston 6.3mm tube ø 6.5mm hole ø 6.5mm W1 25mm rectangular flange hot air		
<b>accessories for</b>	415457		
	<b>GEV No.</b>	510561	<b>Ref. No.</b> 0H7021
	O-ring silicone thickness 3mm ID ø 55mm Qty 1 pcs		
	<b>GEV No.</b>	520239	<b>Ref. No.</b> 0H6648
	counterflange L 110mm W 35mm		
	<b>GEV No.</b>	521142	<b>Ref. No.</b> 0H6665
	gasket L 68mm W 13mm for heating element		
	<b>GEV No.</b>	528203	<b>Ref. No.</b> —
	gasket rubber ED ø 18mm ID ø 12mm thickness 3mm Qty 1 pcs		





1

<b>GEV No.</b>	415458	<b>Ref. No.</b>	0H6188
<b>description</b>	heating element 3000W 230V heating circuits 2 L 575mm W 150mm W2 125mm flange length 70mm flange width 22mm hole distance 55mm connection length 20mm connection male faston 6.3mm tube ø 6.5mm hole ø 3mm W1 25mm rectangular flange convection heating element		
<b>spare parts for</b>	415458		
	<b>GEV No.</b>	510368	<b>Ref. No.</b> —
	gasket L 70mm W 23.5mm hole ø 5mm hole distance 56mm FIBER thickness 2mm for heating element		



1

<b>GEV No.</b>	415616	<b>Ref. No.</b>	0H6189
<b>description</b>	heating element 3000W 380V heating circuits 2 L 575mm W 150mm W2 125mm flange length 70mm flange width 22mm hole distance 28mm connection length 20mm connection male faston 6.3mm tube ø 6.3mm hole ø 4mm W1 25mm rectangular flange dry heating element		
<b>accessories for</b>	415616		
	<b>GEV No.</b>	510368	<b>Ref. No.</b> —
	gasket L 70mm W 23.5mm hole ø 5mm hole distance 56mm FIBER thickness 2mm for heating element		



1

<b>GEV No.</b>	415806	<b>Ref. No.</b>	0H6176
<b>description</b>	heating element 5200W 230V heating circuits 2 L 240mm W 390mm H 30mm W2 50mm flange length 70mm flange width 22mm hole distance 56mm connection male faston 6.3mm tube ø 6.5mm hole ø 5mm W1 290mm rectangular flange convection heating element		
<b>accessories for</b>	415806		
	<b>GEV No.</b>	510368	<b>Ref. No.</b> —
	gasket L 70mm W 23.5mm hole ø 5mm hole distance 56mm FIBER thickness 2mm for heating element		

## radiation heaters

### square



1

<b>GEV No.</b>	490159	<b>Ref. No.</b>	0C2128
<b>description</b>	radiation heater L 300mm W 300mm 3500W 230V connections 3 square without pan detection EGO		
<b>spare parts for</b>	490159		
	<b>GEV No.</b>	499157	<b>Ref. No.</b> —
	protection pipe for temperature probe ceramic L 297mm ED ø 7mm ID ø 5mm		

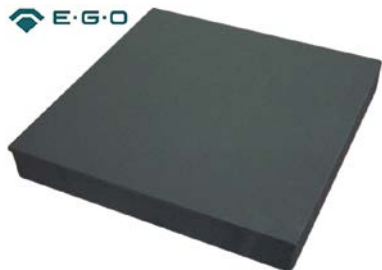

			
1			
<b>GEV No.</b>	490008	<b>Ref. No.</b>	OK0589
<b>description</b>	radiation heater L 300mm W 300mm 4000W 400V heating circuits 2 connections 3 square connection type male faston 6.3mm without pan detection EGO		
<b>spare parts for</b>	490008		
	GEV No.	499157	Ref. No.
	protection pipe for temperature probe ceramic L 297mm ED ø 7mm ID ø 5mm		

			
1			
<b>GEV No.</b>	490086	<b>Ref. No.</b>	0H6083
<b>description</b>	hot plate dimensions 300x300mm 2500W 400V with cast edge tilt boiling plate connection 3 screw clamps H 43mm square		

## hot plates

### square & rectangular

#### with radiused edge

			
1			
<b>GEV No.</b>	490128 <sup>1</sup>	<b>Ref. No.</b>	OK0339
<b>description</b>	hot plate dimensions 300x300mm 2500W 400V with spill ring connection 4 screw clamps protector yes square		

<sup>1</sup>incl. protector

			
1			
<b>GEV No.</b>	490074 <sup>1</sup>	<b>Ref. No.</b>	052200
<b>description</b>	hot plate dimensions 300x300mm 4000W 400V with spill ring connection 4 screw clamps protector yes square		

<sup>1</sup>incl. protector

#### tiltable

			
1			
<b>GEV No.</b>	490085	<b>Ref. No.</b>	OK9761
<b>description</b>	hot plate dimensions 300x300mm 2500W 230V with cast edge tilt boiling plate connection 3 screw clamps H 43mm square		

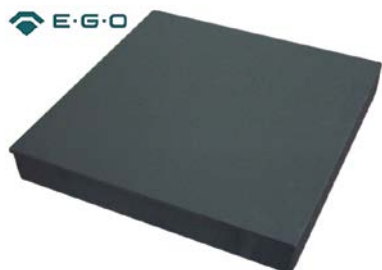
			
1			
<b>GEV No.</b>	490088	<b>Ref. No.</b>	0H6079
<b>description</b>	hot plate dimensions 300x300mm 2500W 400V with cast edge tilt boiling plate connection 4 screw clamps H 43mm square		

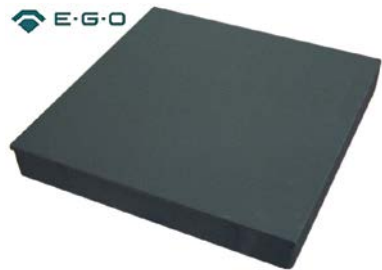
			
1			
<b>GEV No.</b>	490089	<b>Ref. No.</b>	OK0371
<b>description</b>	hot plate dimensions 300x300mm 4000W 230V with cast edge tilt boiling plate connection 4 screw clamps H 43mm square		

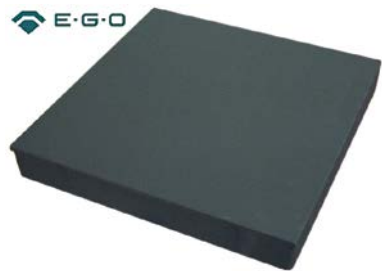
			
1			
<b>GEV No.</b>	490090	<b>Ref. No.</b>	OK0381
<b>description</b>	hot plate dimensions 300x300mm 4000W 400V with cast edge tilt boiling plate connection 4 screw clamps H 43mm square		



round

with radiused edge

for domestic and commercial kitchens



<b>GEV No.</b>	490012	<b>Ref. No.</b>	053406
<b>description</b>	hot plate ø 145mm 1500W 230V connection 4 screw clamps with 8mm spill ring		



<b>GEV No.</b>	490014	<b>Ref. No.</b>	0G6313
<b>description</b>	hot plate ø 180mm 1500W 230V connection 4 screw clamps with 8mm spill ring		



<b>GEV No.</b>	490016	<b>Ref. No.</b>	0K0350
<b>description</b>	hot plate ø 180mm 2000W 230V connection 4 screw clamps with 8mm spill ring		



<b>GEV No.</b>	490017	<b>Ref. No.</b>	0K0343
<b>description</b>	hot plate ø 180mm 2000W 400V connection 4 screw clamps with 8mm spill ring		



<b>GEV No.</b>	490018	<b>Ref. No.</b>	0K0334
<b>description</b>	hot plate ø 220mm 2000W 230V connection 4 screw clamps with 8mm spill ring		

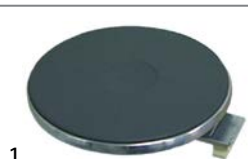

<b>GEV No.</b>	490019	<b>Ref. No.</b>	0K0356
<b>description</b>	hot plate ø 220mm 2000W 400V connection 4 screw clamps with 8mm spill ring		



<b>GEV No.</b>	490020	<b>Ref. No.</b>	053407	
<b>description</b>	hot plate ø 220mm 2600W 230V connection 4 screw clamps with 8mm spill ring			
<b>accessories for</b>	490020			
	<b>GEV No.</b>	550796	<b>Ref. No.</b>	—
	fixing plate for hot plate ø220mm			



<b>GEV No.</b>	490061	<b>Ref. No.</b>	0K0578
<b>description</b>	hot plate ø 300mm 2500W 230V connection 4 screw clamps with 8mm spill ring		



<b>GEV No.</b>	490063	<b>Ref. No.</b>	0H6080
<b>description</b>	hot plate ø 300mm 2500W 400V connection 4 screw clamps with 8mm spill ring		

with cast brim

with screw connection



<b>GEV No.</b>	490100	<b>Ref. No.</b>	0K0374
<b>description</b>	hot plate ø 400mm 5000W 230V connection 2x 3 screw clamps with cast edge H 42mm		

miscellaneous

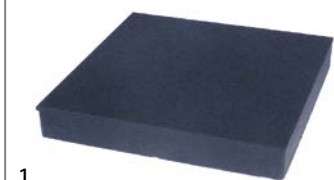

<b>GEV No.</b>	490158	<b>Ref. No.</b>	0K0362
<b>description</b>	hot plate dimensions 300x300mm 2500W 230V		



accessories

fasteners

			
1			
<b>GEV No.</b>	550129	<b>Ref. No.</b>	OG4300
<b>description</b>	bearing screw for tilt boiling plate straight thread M12x80		

energy regulators

EGO

1-circuit

			
1			
<b>GEV No.</b>	380015	<b>Ref. No.</b>	OC1605
<b>description</b>	energy regulator 230V 13A single-circuit turn direction right shaft ø 6x4.6mm shaft L 23mm mounting thread M4 power release 6-100% no. 50.57021.010		

thermostats

control and safety thermostats

EGO

control thermostats

55.10/19\_ series

			
1			
<b>GEV No.</b>	375568	<b>Ref. No.</b>	OH6126
<b>description</b>	thermostat t.max. 140°C temperature range 50-140°C 1-pole 1NO 0.5A probe ø 6mm probe L 107mm capillary pipe 860mm capillary pipe isolatedmm gland nut shaft ø 6x4.6mm shaft L 23mm shaft position° shaft position rotation 270°		

			
1			
<b>GEV No.</b>	390156	<b>Ref. No.</b>	051360
<b>description</b>	thermostat t.max. 260°C temperature range 50-260°C 1-pole 1NO 16A probe ø 4mm probe L 115mm capillary pipe 1300mm capillary pipe isolated 1300mm gland nut shaft ø 6x4.6mm shaft L 23mm shaft position upper rotation 270°		

			
1			
<b>GEV No.</b>	375667	<b>Ref. No.</b>	056384
<b>description</b>	thermostat t.max. 300°C temperature range 68-300°C 1-pole 1NO 16A probe ø 3.1mm probe L 226mm capillary pipe 980mm capillary pipe isolated 980mm gland nut shaft ø 6x4.6mm shaft L 23mm shaft position upper rotation 318°		

			
1			
<b>GEV No.</b>	375809	<b>Ref. No.</b>	OK3061
<b>description</b>	thermostat t.max. 90°C temperature range 30-90°C 1-pole 1NO 16A probe ø 6mm probe L 130mm capillary pipe 1800mm capillary pipe isolated 1800mm gland nut shaft ø 6x4.6mm shaft L 23mm shaft position upper rotation 270°		

			
1			
<b>GEV No.</b>	375042	<b>Ref. No.</b>	OH6440 232909
<b>description</b>	thermostat t.max. 98°C temperature range 50-98°C 1-pole 1CO 16A probe ø 3.1mm probe L 334mm capillary pipe 2410mm capillary pipe isolated 1400mm gland nut M9x1 shaft L 23mm shaft position upper rotation 270° probe material SS		

55.13\_series

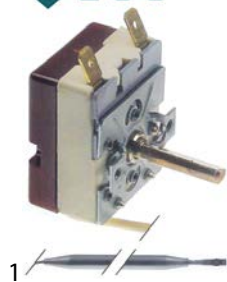

<b>GEV No.</b>	375567	<b>Ref. No.</b>	OK0659
<b>description</b>	thermostat t.max. 110°C temperature range 30-110°C 1-pole 1NO 16A probe ø 6mm probe L 115mm capillary pipe 1130mm capillary pipe isolated 800mm gland nut shaft ø 6x4.6mm shaft L 23mm shaft position upper rotation 270°		



<b>GEV No.</b>	375067	<b>Ref. No.</b>	OK0673
<b>description</b>	thermostat t.max. 125°C temperature range fixed 125°C 1-pole probe ø 3.03mm probe L 147mm capillary pipe 830mm capillary pipe isolatedmm gland nut probe material SS		

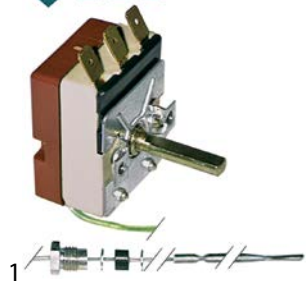

<b>GEV No.</b>	375041	<b>Ref. No.</b>	0H6439
<b>description</b>	thermostat t.max. 250°C temperature range 50-250°C 1-pole 1CO 16A probe ø 3.1mm probe L 160mm capillary pipe 1430mm capillary pipe isolated 800mm gland nut M9x1 shaft L 23mm shaft position upper rotation 270°		

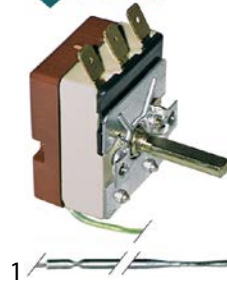

<b>GEV No.</b>	375069	<b>Ref. No.</b>	OK0634
<b>description</b>	thermostat t.max. 255°C temperature range 50-255°C 1-pole 1CO 16A probe ø 3.03mm probe L 160mm capillary pipe 1430mm capillary pipe isolated 800mm gland nut shaft L 23mm probe material SS		

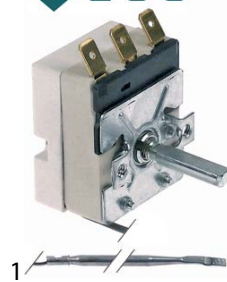

<b>GEV No.</b>	375835	<b>Ref. No.</b>	0H6241
<b>description</b>	thermostat t.max. 280°C temperature range 50-280°C 1-pole 1CO 16A probe ø 3.1mm probe L 160mm capillary pipe 1430mm capillary pipe isolated 800mm gland nut shaft ø 6x4.6mm shaft L 23mm shaft position upper rotation 270°		



<b>GEV No.</b>	375505	<b>Ref. No.</b>	0H2049
<b>description</b>	thermostat t.max. 320°C temperature range 50-320°C 1-pole 1NO 16A probe ø 3mm probe L 160mm capillary pipe 870mm capillary pipe isolatedmm gland nut shaft ø 6x4.6mm shaft L 23mm shaft position upper rotation 270°		



<b>GEV No.</b>	375810	<b>Ref. No.</b>	0H9843
<b>description</b>	thermostat t.max. 80°C temperature range fixed 80°C 1-pole 1NC 16A probe ø 7.5mm probe L 30.5mm capillary pipe 810mm capillary pipe isolatedmm gland nut shaft L 23mm		



55.22\_series

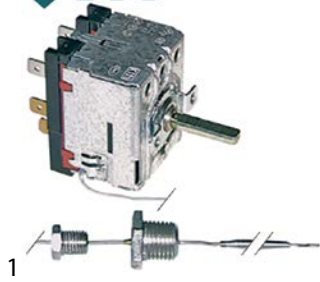

<b>GEV No.</b>	375080	<b>Ref. No.</b>	0H6242 212795
<b>description</b>	thermostat t.max. 102°C temperature range 30-90 / 50-102°C 2-pole 2CO 16A probe ø 3.1mm probe L 334mm capillary pipe 1440mm capillary pipe isolated 1400mm gland nut shaft ø 6x4.6mm shaft L 23mm shaft position upper rotation 270° probe thread 1/4"		

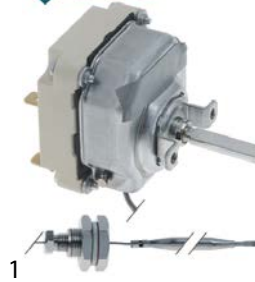

<b>GEV No.</b>	375957	<b>Ref. No.</b>	0H6233 215076
<b>description</b>	thermostat t.max. 180°C temperature range 100-180°C 3-pole 3NO 16A probe ø 6mm probe L 133mm capillary pipe 910mm capillary pipe isolated 770mm gland nut M9x1 shaft ø 6x4.6mm shaft L 23mm shaft position upper rotation 270°		

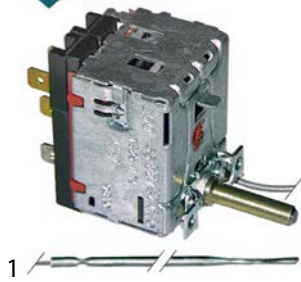

<b>GEV No.</b>	375147	<b>Ref. No.</b>	0H6138
<b>description</b>	thermostat t.max. 255°C temperature range 30-255°C 2-pole 2CO 16A probe ø 3.03mm probe L 147mm capillary pipe 1440mm capillary pipe isolated 1250mm gland nut shaft ø 6x4.6mm shaft L 23mm shaft position right rotation 270°		



<b>GEV No.</b>	375022	<b>Ref. No.</b>	0H6127 212698
<b>description</b>	thermostat t.max. 180°C temperature range 95-180°C 3-pole 3NO 16A probe ø 6mm probe L 133mm capillary pipe 1780mm capillary pipe isolated 1400mm gland nut M9x1 shaft ø 6x4.6mm shaft L 23mm rotation 270°		

55.34\_series



<b>GEV No.</b>	375143	<b>Ref. No.</b>	004911 214948
<b>description</b>	thermostat t.max. 110°C temperature range 32-110°C 3-pole 3NO 16A probe ø 6mm probe L 138mm capillary pipe 1480mm capillary pipe isolated 1100mm gland nut M9x1 shaft ø 6x4.6mm shaft L 23mm shaft position upper rotation 270°		



<b>GEV No.</b>	375043	<b>Ref. No.</b>	0H6221 214840
<b>description</b>	thermostat t.max. 200°C temperature range 65-200°C 3-pole 3NO 16A probe ø 6mm probe L 77mm capillary pipe 880mm capillary pipe isolated 800mm gland nut M9x1 shaft ø 6x4.6mm shaft L 23mm shaft position upper rotation 270°		



<b>GEV No.</b>	375038	<b>Ref. No.</b>	0H6217
<b>description</b>	thermostat t.max. 300°C temperature range 50-300°C 3-pole 3NO 16A probe ø 6mm probe L 79mm capillary pipe 1740mm capillary pipe isolated 800mm gland nut shaft ø 6x4.6mm shaft L 23mm shaft position upper rotation 270°		
<b>accessories for</b>	375038		
	GEV No.	110123	Ref. No. —
	knob thermostat t.max. 300°C ø 50mm shaft ø 6x4.6mm shaft flat upper black temperature range 50-300°C rotation 270°		



<b>GEV No.</b>	375412	<b>Ref. No.</b>	0A2206
<b>description</b>	thermostat t.max. 320°C temperature range 50-320°C 3-pole 3NO 16A probe ø 3.1mm probe L 226mm capillary pipe 1480mm capillary pipe isolated 1400mm gland nut shaft ø 6x4.6mm shaft L 23mm shaft position upper rotation 318°		



<b>GEV No.</b>	375569	<b>Ref. No.</b>	0H6218
<b>description</b>	thermostat t.max. 300°C temperature range 60-300°C 3-pole 3NO 16A probe ø 3.1mm probe L 263mm capillary pipe 1180mm capillary pipe isolated 800mm gland nut shaft ø 6x4.6mm shaft L 23mm shaft position upper rotation 270°		



<b>GEV No.</b>	390038	<b>Ref. No.</b>	0KI260
<b>description</b>	thermostat t.max. 90°C temperature range 30-90°C 3-pole 3CO 16A probe ø 6mm probe L 215mm capillary pipe 900mm capillary pipe isolatedmm gland nut shaft Lmm		



<b>GEV No.</b>	375420	<b>Ref. No.</b>	0H6216
<b>description</b>	thermostat t.max. 320°C temperature range 110-320°C 3-pole 3NO 16A probe ø 6mm probe L 96mm capillary pipe 1780mm capillary pipe isolated 1600mm gland nut shaft ø 6x4.6mm shaft L 23mm shaft position upper rotation 270°		



<b>GEV No.</b>	375411	<b>Ref. No.</b>	052000
<b>description</b>	thermostat t.max. 93°C temperature range 30-93°C 3-pole 3NO 16A probe ø 6mm probe L 129mm capillary pipe 1480mm capillary pipe isolated 1100mm gland nut M10x1 shaft ø 6x4.6mm shaft L 23mm shaft position upper rotation 270°		

safety thermostats

51.\_ series





<b>GEV No.</b>	375078	<b>Ref. No.</b>	0H6145
<b>description</b>	safety thermostat switch-off temp. 313°C 1-pole 0.5A probe ø 3.1mm probe L 160mm capillary pipe 830mm capillary pipe isolatedmm gland nut probe SS		

55.13\_ series

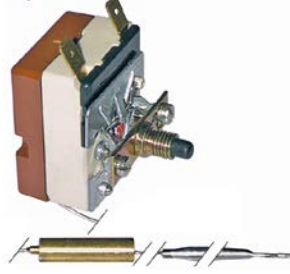

<b>GEV No.</b>	375157	<b>Ref. No.</b>	0K0649
<b>description</b>	safety thermostat switch-off temp. 140°C 1-pole 16A probe ø 5mm probe L 96mm capillary pipe 1470mm capillary pipe isolatedmm gland nut probe		



<b>GEV No.</b>	375044	<b>Ref. No.</b>	0H6141	
<b>description</b>	safety thermostat switch-off temp. 178°C 1-pole 16A probe ø 4mm probe L 91mm capillary pipe 1730mm capillary pipe isolated 1600mm gland nut probe with sealing sleeve screw connection M8x1 sealing sleeve 8.6x32mm			
<b>accessories for</b>	375044			
	<b>GEV No.</b>	102067	<b>Ref. No.</b>	—
	nut thread M8x1 H 3mm brass Qty 1 pcs type SEF 1			
	<b>GEV No.</b>	551083	<b>Ref. No.</b>	—
	cap for safety thermostat thread M8x1			



<b>GEV No.</b>	375106	<b>Ref. No.</b>	0H6142
<b>description</b>	safety thermostat switch-off temp. 190°C 1-pole 16A probe ø 3.1mm probe L 178mm capillary pipe 350mm capillary pipe isolatedmm gland nut M9x1 probe SS		



<b>GEV No.</b>	375156	<b>Ref. No.</b>	0K1877
<b>description</b>	safety thermostat switch-off temp. 291°C 1-pole 16A probe ø 5mm probe L 90mm capillary pipe 870mm capillary pipe isolatedmm gland nut probe SS		



<b>GEV No.</b>	375076	<b>Ref. No.</b>	0H6243
<b>description</b>	safety thermostat switch-off temp. 350°C 1-pole 1NO 16A probe ø 3.03mm probe L 141mm capillary pipe 830mm capillary pipe isolated 450mm gland nut probe SS		

55.31\_ series



<b>GEV No.</b>	390165	<b>Ref. No.</b>	051644
<b>description</b>	safety thermostat switch-off temp. 140°C 3-pole 20A probe ø 6mm probe L 173mm capillary pipe 830mm capillary pipe isolated 800mm gland nut probe SS		



<b>GEV No.</b>	375641	<b>Ref. No.</b>	054932
<b>description</b>	safety thermostat switch-off temp. 250°C 3-pole 20A probe ø 6mm probe L 239mm capillary pipe 2530mm capillary pipe isolated 1600/210mm gland nut probe SS		



<b>GEV No.</b>	375047	<b>Ref. No.</b>	0H6136
<b>description</b>	safety thermostat switch-off temp. 320°C 3-pole 20A probe ø 6mm probe L 177mm capillary pipe 1430mm capillary pipe isolated 800mm gland nut M9x1 probe SS		



<b>GEV No.</b>	375571	<b>Ref. No.</b>	051454
<b>description</b>	safety thermostat switch-off temp. 350°C 3-pole 20A probe ø 6mm probe L 157mm capillary pipe 940mm capillary pipe isolated 890mm gland nut probe SS		



<b>GEV No.</b>	375377	<b>Ref. No.</b>	051643
<b>description</b>	safety thermostat switch-off temp. 350°C 3-pole 3NC 1x20/2x0.5A probe ø 6mm probe L 157mm capillary pipe 1230mm capillary pipe isolated 1100mm gland nut probe		

55.32\_ series



<b>GEV No.</b>	375394	<b>Ref. No.</b>	0K3967
<b>description</b>	safety thermostat switch-off temp. 135°C 3-pole 1CO/2NC 20A probe ø 6mm probe L 73mm capillary pipe 1490mm capillary pipe isolated 1350mm gland nut M9x1 probe SS		



<b>GEV No.</b>	375150	<b>Ref. No.</b>	0H6219
<b>description</b>	safety thermostat switch-off temp. 145°C 3-pole 20A probe ø 3mm probe L 178mm capillary pipe 1790mm capillary pipe isolated 800mm gland nut M9x1 probe		



<b>GEV No.</b>	375170	<b>Ref. No.</b>	002711
<b>description</b>	safety thermostat switch-off temp. 150°C 1-pole 20A probe ø 6mm probe L 74mm capillary pipe 1700mm capillary pipe isolated 1100mm gland nut probe		



<b>GEV No.</b>	375657	<b>Ref. No.</b>	0C1147
<b>description</b>	safety thermostat switch-off temp. 150°C 2-pole 1x20/1x0.5A probe ø 6mm probe L 74mm capillary pipe 1700mm capillary pipe isolated 1100mm gland nut probe SS		

<b>GEV No.</b>	375045	<b>Ref. No.</b>	0H6215 213149 214803
<b>description</b>	safety thermostat switch-off temp. 315°C 3-pole 3NC 20A probe ø 6mm probe L 77mm capillary pipe 1490mm capillary pipe isolated 1100mm gland nut M9x1 probe SS		



<b>GEV No.</b>	375579	<b>Ref. No.</b>	003594
<b>description</b>	safety thermostat switch-off temp. 360°C 1-pole 0.5A probe ø 6mm probe L 74mm capillary pipe 1500mm capillary pipe isolated 1500mm gland nut probe		



<b>GEV No.</b>	375789	<b>Ref. No.</b>	005680
<b>description</b>	safety thermostat switch-off temp. 338°C 2-pole 20A probe ø 11mm probe L 16mm capillary pipe 900mm capillary pipe isolated 900mm gland nut screw-in probe probe thread M14x1		

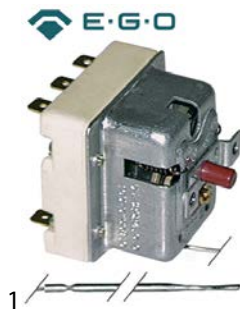

<b>GEV No.</b>	390142	<b>Ref. No.</b>	004919
<b>description</b>	safety thermostat switch-off temp. 360°C 3-pole 20A probe ø 3.1mm probe L 188mm capillary pipe 1490mm capillary pipe isolated 800mm gland nut probe SS		



<b>GEV No.</b>	375455	<b>Ref. No.</b>	002730
<b>description</b>	safety thermostat switch-off temp. 350°C 1-pole 16A probe ø 11mm probe L 16mm capillary pipe 900mm capillary pipe isolated 900mm gland nut probe screw-in probe probe thread M14x1		

control thermostats with operation switch

55.10/19\_ series



<b>GEV No.</b>	390052	<b>Ref. No.</b>	052330
<b>description</b>	thermostat t.max. 185°C temperature range 90-185°C 1-pole 1NO 15A probe ø 4mm probe L 229mm capillary pipe 2500mm capillary pipe isolated 1200/200mm gland nut shaft ø 6x4.6mm shaft L 23mm shaft position upper° rotation 270° outer switch 2NO		



<b>GEV No.</b>	390141	<b>Ref. No.</b>	006826
<b>description</b>	safety thermostat switch-off temp. 350°C 3-pole 3NC 20A probe ø 6mm probe L 77mm capillary pipe 1490mm capillary pipe isolated 800mm gland nut probe SS		

55.34\_ series



<b>GEV No.</b>	375570	<b>Ref. No.</b>	OK0662
<b>description</b>	thermostat t.max. 470°C temperature range 100-470°C 1-pole 1NO 16A probe ø 3.9mm probe L 228mm capillary pipe 1110mm capillary pipe isolated 600mm gland nut shaft ø 6x4.6mm shaft L 24mm shaft position upper rotation 270° outer switch 2NO		



<b>GEV No.</b>	375877	<b>Ref. No.</b>	OG2529
<b>description</b>	thermostat t.max. 530°C temperature range 100-530°C 3-pole 3NO 16A probe ø 3.9mm probe L 228mm capillary pipe 1110mm capillary pipe isolated 1000mm gland nut shaft ø 6x4.6mm shaft L 23mm shaft position shaft position 90° rotation 270° outer switch 0-1 with operation switch		

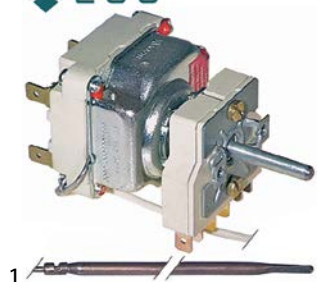

<b>GEV No.</b>	375246	<b>Ref. No.</b>	OK0496
<b>description</b>	thermostat t.max. 645°C temperature range 100-615/645°C 2-pole 2NO 16A probe ø 4mm probe L 230mm capillary pipe 1100mm capillary pipe isolated 600mm gland nut shaft ø 6x4.6mm shaft L 25mm shaft position lower rotation 270° outer switch 2NO probe material copper		

63.\_ series

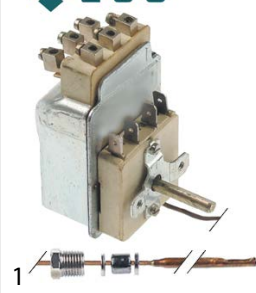

<b>GEV No.</b>	390514	<b>Ref. No.</b>	OK0492
<b>description</b>	thermostat t.max. 300°C temperature range 50-300°C 3-pole 3NO 15A probe ø 4.76mm probe L 293.5mm capillary pipe 1800mm shaft ø 6x4.6mm shaft L 23mm shaft position upper rotation 318° outer switch 2NO		

various

control thermostats with operation switch



<b>GEV No.</b>	375425	<b>Ref. No.</b>	OH6123
<b>description</b>	thermostat t.max. 360°C temperature range 130-400°C 2-pole probe L 228mm		

control thermostats with actual value



<b>GEV No.</b>	379035	<b>Ref. No.</b>	OH6479
<b>description</b>	thermostat t.max. 120°C temperature range 0-120°C 1-pole 1CO 5A probe ø 10mm probe L 32mm capillary pipe 1500mm capillary pipe isolated 1500mm gland nut M10x1 mounting ø 80mm		

accessories

probe clips

spring clips

for safety thermostat



<b>GEV No.</b>	550005	<b>Ref. No.</b>	OH6907
<b>description</b>	probe clip for pipe ø 17x6mm for probe ø 6mm Qty 1 pcs for flat tube heating element		



capillary tube clips			
1			
<b>GEV No.</b>	550004	<b>Ref. No.</b>	0H6906
<b>description</b>	capillary tube clip for pipe ø 17x6mm for flat tube heating element		

1			
<b>GEV No.</b>	550138	<b>Ref. No.</b>	052262
<b>description</b>	capillary tube clip for pipe ø 8.5mm for circular tube heating elements		

connecting bows			
1			
<b>GEV No.</b>	550060	<b>Ref. No.</b>	054376
<b>description</b>	connecting bow long for thermostat Qty 1 pcs		

1			
<b>GEV No.</b>	550059	<b>Ref. No.</b>	0A2205 253566
<b>description</b>	connecting bow short for switch Qty 1 pcs		

## switches and momentary switches

### rocker/momentary rocker switches

30x22mm			
blank			
1			
<b>GEV No.</b>	346297	<b>Ref. No.</b>	056880
<b>description</b>	rocker switch mounting measurements 30x22mm orange 2NO 230V 16A illuminated connection male faston 6.3mm ambient temperature max. 125/55°C protection IP65		
<b>accessories for</b>	346297		
	<b>GEV No.</b>	301036	<b>Ref. No.</b>
			—
	protective cover internal size 30x22mm for rocker switch mounting measurementsmm		

1			
<b>GEV No.</b>	346298	<b>Ref. No.</b>	056879
<b>description</b>	rocker switch mounting measurements 30x22mm yellow 2NO 230V 16A illuminated II connection male faston 6.3mm ambient temperature max. 125/55°C protection IP65 with cover cap		
<b>accessories for</b>	346298		
	<b>GEV No.</b>	301036	<b>Ref. No.</b>
			—
	protective cover internal size 30x22mm for rocker switch mounting measurementsmm		

### push/momentary push switches

30x22mm			
1			
<b>GEV No.</b>	301040 <sup>1</sup>	<b>Ref. No.</b>	0H6697
<b>description</b>	push switch mounting measurements 30x22mm green 2NO 250V 16A illuminated connection male faston 6.3mm ambient temperature max. 85°C protection IP40		

<sup>1</sup>illuminated

ø16mm			
1			
<b>GEV No.</b>	346287 <sup>1</sup>	<b>Ref. No.</b>	002418
<b>description</b>	momentary push switch mounting ø 16mm red 1NO 250V 3A illuminated connection male faston 2.8mm ambient temperature max. 125/55°C protection IP65 with cover cap		

<sup>1</sup>illuminated

ø25mm			
1			
<b>GEV No.</b>	345161 <sup>1</sup>	<b>Ref. No.</b>	054518
<b>description</b>	push switch mounting ø 25mm green 2NO 250V 16A illuminated connection male faston 6.3mm ambient temperature max. 85°C protection IP40		

<sup>1</sup>illuminated

1			
<b>GEV No.</b>	345039	<b>Ref. No.</b>	053979
<b>description</b>	protective cover round ED ø 33mm external size 23mm internal size 21mm H 12mm clear mounting ø 25mm		
<b>accessories for</b>	345039		
	<b>GEV No.</b>	345001	<b>Ref. No.</b>
			—
	momentary push switch mounting ø 25mm yellow 1NO/indicator light 250V 16A cover connection male faston 6.3mm ambient temperature max. 85°C protection IP65		



accessories

protective covers



<b>GEV No.</b>	346577	<b>Ref. No.</b>	0H6588
<b>description</b>	protective cover		

microswitches

lever actuated



<b>GEV No.</b>	346362	<b>Ref. No.</b>	0K2976
<b>description</b>	microswitch with lever connection cable		



<b>GEV No.</b>	345254	<b>Ref. No.</b>	046286
<b>description</b>	microswitch with lever 250V 16A 1CO connection male faston 6.3mm ambient temperature max. 120°C mounting distance 22mm actuating force: 60g lever length 58mm		



<b>GEV No.</b>	345757	<b>Ref. No.</b>	0K1003
<b>description</b>	microswitch with plunger 250V 16A 1CO connection male faston 6.3mm L 28mm ambient temperature max. 125°C mounting distance 22mm type EF83161.3 actuating force: 75g blue/black		

roller-lever actuated

microswitches

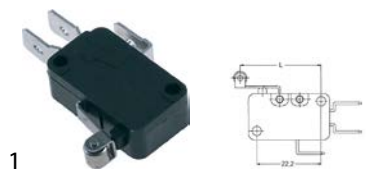

<b>GEV No.</b>	345041	<b>Ref. No.</b>	0H6597 245536
<b>description</b>	microswitch with handle with a switch 250V 16A 1CO connection male faston 6.3mm ambient temperature max. 85°C black lever length 20.5mm		

pin-plunger actuated

M10



<b>GEV No.</b>	345032	<b>Ref. No.</b>	0K1395 245040
<b>description</b>	microswitch with plunger thread M10x1 thread L 12mm 250V 16A 1CO connection male faston 6.3mm stroke 7mm mounting distance 22mm L 28mm ambient temperature max. 125°C type SP9603 actuating force: 180g		

miscellaneous



<b>GEV No.</b>	346289	<b>Ref. No.</b>	0G1767
<b>description</b>	microswitch with plunger thread M12 thread L 14mm 250V 4A 1CO connection cable stroke 5mm ambient temperature max. 85°C cable 5500mm type 101055425 actuating force: 250g		

roller actuated

roller 90°



<b>GEV No.</b>	346574	<b>Ref. No.</b>	0K2153
<b>description</b>	microswitch with roller plunger 250V 10A connection cable ambient temperature max. 85°C		



<b>GEV No.</b>	346290	<b>Ref. No.</b>	0H6583
<b>description</b>	microswitch with roller plunger 250V 6A 1CO connection cable L1 31mm ambient temperature max. 85°C thread L 20mm thread M10 mounting distance 22mm actuating force: 220g MP320 protection IP67		

non-standard

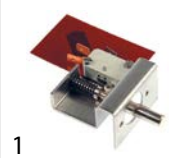

<b>GEV No.</b>	346389	<b>Ref. No.</b>	0G1829
<b>description</b>	microswitch connection male faston		





position switches

BERNSTEIN



1

<b>GEV No.</b>	346296	<b>Ref. No.</b>	0H6698
<b>description</b>	position switch with handle with a switch 1NO/1NC protection IP65 BERNSTEIN		

PIZZATO

FD series



1

<b>GEV No.</b>	345057	<b>Ref. No.</b>	0H6689
<b>description</b>	position switch cast aluminum 1NO/1NC 400V 3A L 98mm W 40mm H 35mm protection IP67 actuating force: 450g screw connection PG13.5 mounting distance 30x60mm		

SIEMENS

3SE3 series

switches (complete)



1

<b>GEV No.</b>	346288	<b>Ref. No.</b>	0K2158
<b>description</b>	position switch		

TELEMECANIQUE (EFA)



1

<b>GEV No.</b>	346807	<b>Ref. No.</b>	0K4382
<b>description</b>	position switch plastic 1NO/1NC 400V 3A L 116.7mm W 40mm H 36mm protection IP67 actuating force: 1800g screw connection M19 mounting distance 30x60mm		

system switches (ROLD)



1

<b>GEV No.</b>	345651	<b>Ref. No.</b>	003766
<b>description</b>	switch 2CO 250V 16A connection male faston 6.3mm		

cam switches

on/off



1

<b>GEV No.</b>	300017	<b>Ref. No.</b>	0A2241
<b>description</b>	cam switch 4 operating positions 4NO sequence 0-1-0-1 16A shaft ø 6x4.6mm shaft L 23mm connection male faston 6.3mm ceramic		



1

<b>GEV No.</b>	300102	<b>Ref. No.</b>	050857 0H6682 247200
<b>description</b>	cam switch 4 operating positions 4NO sequence 0-1-0-1 32A shaft ø 6x4.6mm shaft L 23mm connection screw ceramic		

4-position

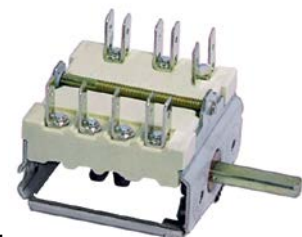

1

<b>GEV No.</b>	300007	<b>Ref. No.</b>	0H6602
<b>description</b>	cam switch 4 operating positions 1NO/2CO sequence 0-1-2-3 16A shaft ø 6x4.6mm shaft L 23mm connection male faston 6.3mm 4-position ceramic		



1

<b>GEV No.</b>	300103	<b>Ref. No.</b>	0H6598
<b>description</b>	cam switch 4 operating positions 1NO/2CO sequence 0-1-2-3 32A shaft ø 6x4.6mm shaft L 23mm connection screw ceramic		

1

<b>GEV No.</b>	300104	<b>Ref. No.</b>	0H6683 247202
<b>description</b>	cam switch 4 operating positions 3NO/1CO sequence 0-1-2-3 32A shaft ø 6x4.6mm shaft L 23mm connection screw ceramic		



1

<b>GEV No.</b>	300106	<b>Ref. No.</b>	0A2022
<b>description</b>	cam switch 7 operating positions 1NO/2CO sequence 0-1-2-3-4-5-6 32A shaft ø 6x4.6mm shaft L 23mm connection screw 7-position shaft flat upper		

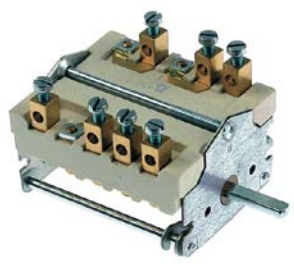

1

<b>GEV No.</b>	300194	<b>Ref. No.</b>	0K2034
<b>description</b>	cam switch 4 operating positions 4NO sequence 0-1-2-3 16A shaft ø 6x4.6mm shaft L 23mm connection screw 4-position ceramic		

2 operating positions



1

<b>GEV No.</b>	300054	<b>Ref. No.</b>	0H6604
<b>description</b>	cam switch 2 operating positions speed sequence 0-1 shaft ø 6x4.6mm connection male faston 9-pole		



1

<b>GEV No.</b>	300224	<b>Ref. No.</b>	0K1380
<b>description</b>	cam switch 4 operating positions sequence 0-1-2-3 3-pole		

3 operating positions



1

<b>GEV No.</b>	300039	<b>Ref. No.</b>	0H6590
<b>description</b>	cam switch 3 operating positions main + selector switch sequence 1-2-3 16A shaft ø 6x4.6mm connection male faston 6-pole		

7-position



1

<b>GEV No.</b>	300004	<b>Ref. No.</b>	0K6627 247243
<b>description</b>	cam switch 7 operating positions 1NO/2CO sequence 0-1-2-3-4-5-6 16A shaft ø 6x4.6mm shaft L 23mm connection male faston 6.3mm 7-position ceramic		

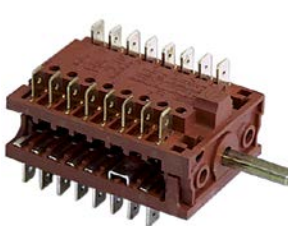

1

<b>GEV No.</b>	300042	<b>Ref. No.</b>	0H6101
<b>description</b>	cam switch 3 operating positions speed/power sequence 1-2-3 shaft ø 6x4.6mm connection male faston 16-pole		

1

<b>GEV No.</b>	300036	<b>Ref. No.</b>	0H6392
<b>description</b>	cam switch 3 operating positions steaming manual sequence 0-1-2 shaft ø 6x4.6mm connection male faston 2-pole		

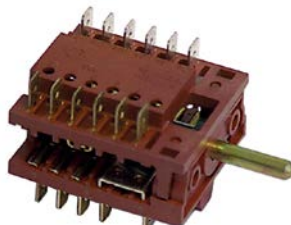

1

<b>GEV No.</b>	300041	<b>Ref. No.</b>	0H6100
<b>description</b>	cam switch 4 operating positions programme 16A shaft ø 6x4.6mm connection male faston 12-pole		

4 operating positions



1

<b>GEV No.</b>	300037	<b>Ref. No.</b>	0H6387
<b>description</b>	cam switch 4 operating positions 4NO sequence 0-1-2-3 16A shaft ø 6x4.6mm shaft L 23mm connection male faston 6.3mm		

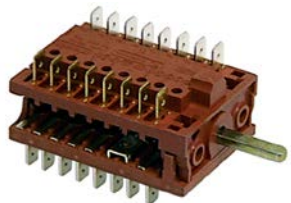

1

<b>GEV No.</b>	300066	<b>Ref. No.</b>	0K1007
<b>description</b>	cam switch 4 operating positions programme shaft ø 6x4.6mm connection male faston 16-pole		

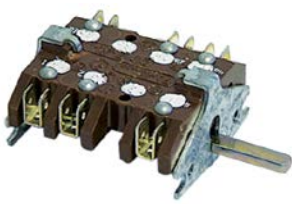

1

<b>GEV No.</b>	300035	<b>Ref. No.</b>	0H6391
<b>description</b>	cam switch 4 operating positions main + selector switch sequence 0-1-2-3 16A shaft ø 6x4.6mm shaft L 23mm connection male faston plastic		



1

<b>GEV No.</b>	345750	<b>Ref. No.</b>	0H6291
<b>description</b>	cam switch 4 operating positions shaft ø 6x4.6mm connection male faston 16-pole		

5 operating positions

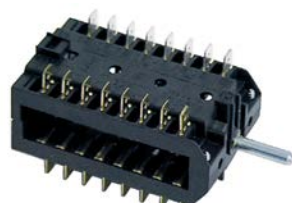

1

<b>GEV No.</b>	300043	<b>Ref. No.</b>	0H6098
<b>description</b>	cam switch 4 operating positions motor performance shaft ø 6x4.6mm connection male faston 16-pole		

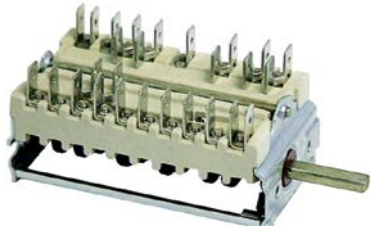

1

<b>GEV No.</b>	300009	<b>Ref. No.</b>	051647
<b>description</b>	cam switch 5 operating positions changeover switch sequence 0-1-2-3-4 16A shaft ø 6x4.6mm connection male faston 8-pole		

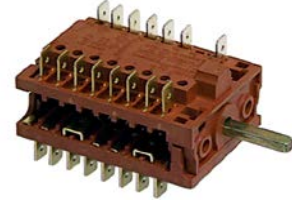

1

<b>GEV No.</b>	300065	<b>Ref. No.</b>	0K2032
<b>description</b>	cam switch 4 operating positions power/ program shaft ø 6x4.6mm connection male faston 16-pole		



7 operating positions

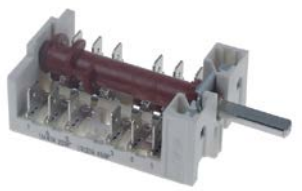

1			
<b>GEV No.</b>	300233	<b>Ref. No.</b>	002661
<b>description</b>	cam switch 7 operating positions shaft ø 6x4.6mm shaft L 23mm 5-pole		

8 operating positions

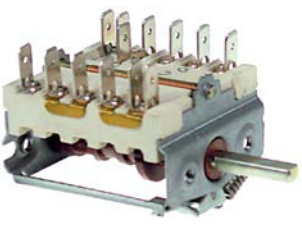

1			
<b>GEV No.</b>	301238	<b>Ref. No.</b>	003761
<b>description</b>	cam switch 8 operating positions shaft ø 6x4.6mm connection male faston 4-pole		

operation switches



1			
<b>GEV No.</b>	300002	<b>Ref. No.</b>	0A2134
<b>description</b>	cam switch 2 operating positions 4NO 16A sequence 0-1 shaft ø 6x4.6mm shaft L 23mm connection male faston 6.3mm ceramic		



1			
<b>GEV No.</b>	300080	<b>Ref. No.</b>	026945
<b>description</b>	cam switch 2 operating positions 4NO 16A sequence 0-1 shaft ø 6x4.6mm shaft L 23mm connection screw operation switch ceramic ambient temperature max. 150°C		

<b>accessories for</b>	300080		
	<b>GEV No.</b>	551456	<b>Ref. No.</b>
	gasket for switch ED ø 14mm ID ø 2.5mm thickness 3.5mm white		

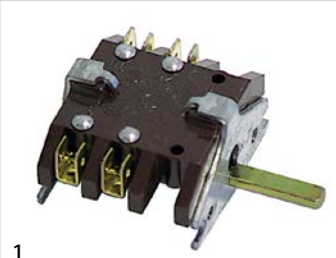

1			
<b>GEV No.</b>	300040	<b>Ref. No.</b>	OK2151
<b>description</b>	cam switch 2 operating positions operation switch 16A sequence 0-1 shaft ø 6x4.6mm connection male faston 2-pole ambient temperature max. 270°C		

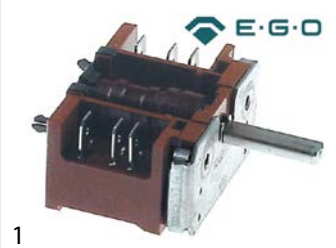

1			
<b>GEV No.</b>	301214	<b>Ref. No.</b>	OK1004
<b>description</b>	cam switch 2 operating positions operation switch 16A sequence 0-1 shaft ø 6x4.6mm shaft L 33mm connection male faston 6.3mm plastic ambient temperature max. 150°C		



1			
<b>GEV No.</b>	300181	<b>Ref. No.</b>	0H6599 245555
<b>description</b>	cam switch 3 operating positions operation switch 32A sequence 0-1-2 shaft ø 6x4.6mm connection screw clamp 4-pole ambient temperature max. 330°C		



1			
<b>GEV No.</b>	345764	<b>Ref. No.</b>	0H6102
<b>description</b>	cam switch 5 operating positions operation switch sequence 0-1-2-3-4 shaft ø 6x4.6mm 5-pole ambient temperature max. 270°C		

1

<b>GEV No.</b>	300200	<b>Ref. No.</b>	054375 247318
<b>description</b>	operation switch 2 operating positions 2NO 16A sequence 0-1 shaft ø 6x4.6mm shaft L 23mm connection male faston 6.3mm operation switch ceramic		



1

<b>GEV No.</b>	300178	<b>Ref. No.</b>	0H6284 220909
<b>description</b>	operation switch 3 operating positions 3NO/2CO 16A sequence 0-1-2 shaft ø 6x4.6mm shaft L 23mm connection male faston 6.3mm ceramic ambient temperature max. 270°C		

rotary switches

KRAUS & NAIMER

rotary switches



1

<b>GEV No.</b>	301206	<b>Ref. No.</b>	0K4923
<b>description</b>	rotary switch 4 0-1-2-3 sets of contacts 8 type CA11-AT08A188 690V 7.5A shaft ø 4.8x6mm shaft L 18mm shaft round connection screw code 37/000100 marking 7BC540		

miscellaneous



1

<b>GEV No.</b>	346390	<b>Ref. No.</b>	0K4925
<b>description</b>	rotary switch sets of contacts 1 2 0-1 250V 16A illuminated connection male faston 6.3mm mounting measurements 25x25mm		

control equipment

MOELLER/EATON

push buttons - signal lamps



1

<b>GEV No.</b>	346294	<b>Ref. No.</b>	0K2149
<b>description</b>	push button mounting measurements ø22mm red		

switch blocks



1

<b>GEV No.</b>	346292	<b>Ref. No.</b>	0K2181
<b>description</b>	contact block screw 1NO		

switches (complete)

push/momentary push switches



1

<b>GEV No.</b>	346291	<b>Ref. No.</b>	0KX188
<b>description</b>	momentary push switch mounting measurements ø22mm red 1NO		



1

<b>GEV No.</b>	346340	<b>Ref. No.</b>	0A2196
<b>description</b>	switch mounting measurements ø22mm red complete EMERGENCY SHUT-DOWN		

SCHLEGEL

symbol plates



1

<b>GEV No.</b>	345752	<b>Ref. No.</b>	0H6290
<b>description</b>	symbol plate white operating temperature		





			
1			
<b>GEV No.</b>	345756	<b>Ref. No.</b>	0K1006
<b>description</b>	symbol plate white reset		

### GEV special

ø16mm

push buttons

			
1			
<b>GEV No.</b>	345754	<b>Ref. No.</b>	005139
<b>description</b>	push button square clear ø 16mm		

			
1			
<b>GEV No.</b>	345265	<b>Ref. No.</b>	0H6287
<b>description</b>	contact block 1NC/1NO 250V 6A equiv. no. 51.971.022		

			
1			
<b>GEV No.</b>	345751	<b>Ref. No.</b>	005138
<b>description</b>	contact block 2NO/2NC		

switches

			
1			
<b>GEV No.</b>	345753	<b>Ref. No.</b>	005137
<b>description</b>	switch mounting measurements ø16mm latching		

			
1			
<b>GEV No.</b>	345755	<b>Ref. No.</b>	0K1005
<b>description</b>	switch mounting measurements ø16mm momentary		

ø22mm

key lock switches

			
1			
<b>GEV No.</b>	345244	<b>Ref. No.</b>	0H6694
<b>description</b>	key lock switch mounting measurements ø22mm latching sequence 0-1		

rotary switches

			
1			
<b>GEV No.</b>	345263	<b>Ref. No.</b>	0K2156
<b>description</b>	rotary selector mounting measurements ø22mm black momentary sequence 0-1		

			
1			
<b>GEV No.</b>	345260	<b>Ref. No.</b>	0H6692
<b>description</b>	rotary selector mounting measurements ø22mm black momentary sequence 1-0-2		

switch blocks

			
1			
<b>GEV No.</b>	345272	<b>Ref. No.</b>	0H6695
<b>description</b>	contact block 1NC/1NO 660V max. 16(4)A connection screw		

			
1			
<b>GEV No.</b>	345261	<b>Ref. No.</b>	0H6693
<b>description</b>	contact block 2NO 660V max. 16(4)A connection screw		



RAFI

Lumotast series

momentary push switches



1

<b>GEV No.</b>	346576	<b>Ref. No.</b>	0H6587
<b>description</b>	momentary push switch mounting measurements ø16mm 230V 3NC/3NO		

TELEMECANIQUE (EFA)

XB2 series

switches (complete)



1

<b>GEV No.</b>	346575	<b>Ref. No.</b>	0H6687
<b>description</b>	momentary push switch mounting measurements ø22mm green 1NC/1NO		

miscellaneous



1

<b>GEV No.</b>	346300	<b>Ref. No.</b>	0K3365
<b>description</b>	indicator socket socket Ba9s		

lamps



1

<b>GEV No.</b>	359606	<b>Ref. No.</b>	0K2043
<b>description</b>	neon light bulb socket Ba9s 220V 2W clear ø 10mm L 28mm		
<b>accessories for</b>	359606		

	<b>GEV No.</b>	359832	<b>Ref. No.</b>	—
	lamp socket mounting measurements ø16.2mm socket Ba9s connection male faston 6.3mm			

	<b>GEV No.</b>	359853	<b>Ref. No.</b>	—
	lamp socket mounting measurements ø18.2mm socket Ba9s connection male faston 6.3mm			

encoders and potentiometers



1

<b>GEV No.</b>	400178	<b>Ref. No.</b>	0H7178
<b>description</b>	potentiometer 47KOhm		

lamps

indicator lights

indicator lights 2-piece (lens and indicator lamp)

indicator light lenses

ø 6mm (type SQ-20)



1

<b>GEV No.</b>	359803	<b>Ref. No.</b>	054151
<b>description</b>	indicator light lens green Qty 1 pcs ø 6mm		

indicator lamps for socket type SQ



1

<b>GEV No.</b>	359109	<b>Ref. No.</b>	054150
<b>description</b>	indicator lamp 230V green connection male faston 6.3mm no lens ø 6mm		

**accessories for** 359109



<b>GEV No.</b>	359806	<b>Ref. No.</b>	—
<b>description</b>	indicator light lens clear Qty 1 pcs ø 6mm		

indicator lights 3-piece (housing, lens and bulb)

ø19.2mm



1

<b>GEV No.</b>	359108	<b>Ref. No.</b>	0H6110 212569
<b>description</b>	indicator light ø 19.2mm green		









1

<b>GEV No.</b>	359107	<b>Ref. No.</b>	0H6111 212570
<b>description</b>	indicator light ø 19.2mm yellow socket E14		

**lamps**

**neon light bulbs**

			
1			
<b>GEV No.</b>	359606	<b>Ref. No.</b>	OK2043
<b>description</b>	neon light bulb socket Ba9s 220V 2W clear ø 10mm L 28mm		
<b>accessories for</b>	359606		
	<b>GEV No.</b>	359832	<b>Ref. No.</b> —
	lamp socket mounting measurements ø16.2mm socket Ba9s connection male faston 6.3mm		
	<b>GEV No.</b>	359853	<b>Ref. No.</b> —
	lamp socket mounting measurements ø18.2mm socket Ba9s connection male faston 6.3mm		

			
1			
<b>GEV No.</b>	359585	<b>Ref. No.</b>	846804
<b>description</b>	neon light bulb socket E10 230V green ø 10mm L 28mm		
<b>accessories for</b>	359585		
	<b>GEV No.</b>	359060	<b>Ref. No.</b> —
	lamp socket mounting measurements ø16.2mm socket E10 connection screw		
	<b>GEV No.</b>	359685	<b>Ref. No.</b> —
	lamp socket mounting measurements ø16.2mm socket E10		

			
1			
<b>GEV No.</b>	359602	<b>Ref. No.</b>	0H7036
<b>description</b>	neon light bulb socket E14 230V clear ø 14mm L 30mm		

			
1			
<b>GEV No.</b>	359603	<b>Ref. No.</b>	0H7037 565628
<b>description</b>	neon light bulb socket E14 380V clear ø 14mm L 30mm		

**indicator lights (complete)**

**ø10mm**

**with screw socket**

			
1			
<b>GEV No.</b>	359378	<b>Ref. No.</b>	0A2224
<b>description</b>	indicator light ø 10mm 230V green connection male faston 6.3mm socket screw base		

**with plug-in socket**



			
1			
<b>GEV No.</b>	359232	<b>Ref. No.</b>	0H6106
<b>description</b>	indicator light ø 10mm clear 230V connection male faston 2.8mm Qty 1 pcs		



			
1			
<b>GEV No.</b>	359139	<b>Ref. No.</b>	058544
<b>description</b>	indicator light ø 10mm green 230V connection male faston 6.3mm Qty 1 pcs		

			
1			
<b>GEV No.</b>	359231	<b>Ref. No.</b>	OK2047
<b>description</b>	indicator light ø 10mm yellow 230V connection male faston 2.8mm Qty 1 pcs		

**ø13mm**

**with screw socket**

			
1			
<b>GEV No.</b>	359145	<b>Ref. No.</b>	0H6619
<b>description</b>	indicator light ø 13mm 230V green t.max. 120°C		
<b>accessories for</b>	359145		
	<b>GEV No.</b>	510302	<b>Ref. No.</b> —
	O-ring EPDM ID ø 12.42mm thickness 1.78mm Qty 1 pcs		
	<b>GEV No.</b>	511505	<b>Ref. No.</b> —
	O-ring EPDM thickness 1.78mm ID ø 12.42mm Qty 10 pcs		

			
1			
<b>GEV No.</b>	359144	<b>Ref. No.</b>	005012
<b>description</b>	indicator light ø 13mm 230V red		
<b>accessories for</b>	359144		
	<b>GEV No.</b>	510302	<b>Ref. No.</b> —
	O-ring EPDM ID ø 12.42mm thickness 1.78mm Qty 1 pcs		
	<b>GEV No.</b>	511505	<b>Ref. No.</b> —
	O-ring EPDM thickness 1.78mm ID ø 12.42mm Qty 10 pcs		





			
1			
<b>GEV No.</b>	359146	<b>Ref. No.</b>	0H6618
<b>description</b>	indicator light ø 13mm 230V yellow		
<b>accessories for</b>	359146		
	<b>GEV No.</b>	510302	<b>Ref. No.</b> —
	O-ring EPDM ID ø 12.42mm thickness 1.78mm Qty 1 pcs		

Table continues overleaf





<b>accessories for</b>	359146		
	<b>GEV No.</b>	511505	<b>Ref. No.</b>
			—
<b>description</b>	O-ring EPDM thickness 1.78mm ID ø 12.42mm Qty 10 pcs		

<b>with plug-in socket</b>			
1			
<b>GEV No.</b>	359364	<b>Ref. No.</b>	005010
<b>description</b>	indicator light ø 13mm green 230V		

<b>ø16mm</b>			
<b>with plug-in socket</b>			
1			
<b>GEV No.</b>	359518	<b>Ref. No.</b>	006849 245888
<b>description</b>	indicator light ø 16mm 230V green		

<b>ø19mm</b>			
1			
<b>GEV No.</b>	345767	<b>Ref. No.</b>	0700212545
<b>description</b>	indicator light ø 19mm 230V green		

1			
<b>GEV No.</b>	345768	<b>Ref. No.</b>	0H6107
<b>description</b>	indicator light ø 19mm 230V red		

<b>ø20mm</b>			
1			
<b>GEV No.</b>	359514	<b>Ref. No.</b>	0K4900
<b>description</b>	indicator light ø 20mm 230V green connection male faston 6.3mm ambient temperature max. 125°C		



<b>31x10mm</b>			
1			
<b>GEV No.</b>	359306	<b>Ref. No.</b>	0H6581
<b>description</b>	indicator light mounting measurements 31x10mm 230V white/red/green		



<b>34x12mm</b>			
1			
<b>GEV No.</b>	359311	<b>Ref. No.</b>	0H6614
<b>description</b>	indicator light mounting measurements 34x12mm 230V green/red		

<b>miscellaneous</b>			
1			
	Image not available		
<b>GEV No.</b>	359301	<b>Ref. No.</b>	0K3357
<b>description</b>	indicator light		

1			
	Image not available		
<b>GEV No.</b>	359758	<b>Ref. No.</b>	0K3095
<b>description</b>	indicator light yellow		

**screw-on/push-on fit**

<b>neon light bulbs</b>			
1			
<b>GEV No.</b>	359606	<b>Ref. No.</b>	0K2043
<b>description</b>	neon light bulb socket Ba9s 220V 2W clear ø 10mm L 28mm		
<b>accessories for</b>	359606		
	<b>GEV No.</b>	359832	<b>Ref. No.</b>
			—
	lamp socket mounting measurements ø16.2mm socket Ba9s connection male faston 6.3mm		
	<b>GEV No.</b>	359853	<b>Ref. No.</b>
			—
	lamp socket mounting measurements ø18.2mm socket Ba9s connection male faston 6.3mm		

1			
<b>GEV No.</b>	359585	<b>Ref. No.</b>	846804
<b>description</b>	neon light bulb socket E10 230V green ø 10mm L 28mm		
<b>accessories for</b>	359585		
	<b>GEV No.</b>	359060	<b>Ref. No.</b>
			—
	lamp socket mounting measurements ø16.2mm socket E10 connection screw		
	<b>GEV No.</b>	359685	<b>Ref. No.</b>
			—
	lamp socket mounting measurements ø16.2mm socket E10		



			
1			
<b>GEV No.</b>	359602	<b>Ref. No.</b>	0H7036
<b>description</b>	neon light bulb socket E14 230V clear ø 14mm L 30mm		

			
1			
<b>GEV No.</b>	359603	<b>Ref. No.</b>	0H7037 565628
<b>description</b>	neon light bulb socket E14 380V clear ø 14mm L 30mm		

## light bulbs

for ovens

			
1			
<b>GEV No.</b>	359610	<b>Ref. No.</b>	0H7035
<b>description</b>	light bulb t.max. 300°C socket E14 15W 230V ø 22mm L 47mm lens L 20mm for oven lamp type Philips		

			
1			
<b>GEV No.</b>	359612	<b>Ref. No.</b>	054840
<b>description</b>	light bulb t.max. 300°C socket E14 25W 230V ø 25mm L 56mm lens L 30mm for oven lamp type Philips		

## halogen lamp

for socket G4 / G6.35 / G9



			
1			
<b>GEV No.</b>	357191	<b>Ref. No.</b>	565729
<b>description</b>	halogen lamp socket G4 12V 10W temp.-resist. 300°C OSRAM HALOSTAR OVEN		

			
1			
<b>GEV No.</b>	359596	<b>Ref. No.</b>	0H7038
<b>description</b>	halogen lamp socket G4 12V 10W temp.-resist. 500°C		

## oven lamps



## universal oven lamps

mounting diameter 28.5mm



			
1			
<b>GEV No.</b>	359317	<b>Ref. No.</b>	0H7040
<b>description</b>	oven lamp mounting ø 28.5mm 12V 5W socket G4 temp.-resist. 300°C cable length 300mm		
<b>spare parts for</b>	359317		
	<b>GEV No.</b>	359308	<b>Ref. No.</b> 0H6582
	oven lamp glass		

			
1			
<b>GEV No.</b>	359308	<b>Ref. No.</b>	0H6582
<b>description</b>	oven lamp glass		

mounting diameter 35.5mm

			
1			
<b>GEV No.</b>	359718	<b>Ref. No.</b>	0H6105
<b>description</b>	oven lamp mounting ø 35.5mm 230V 15W socket E14 temp.-resist. 300°C connection male faston 6.3mm hard glas		
<b>spare parts for</b>	359718		
	<b>GEV No.</b>	359701	<b>Ref. No.</b> —
	lamp socket socket E14 220-230V mounting ø 35.5mm connection male faston 6.3mm 15W		
	<b>GEV No.</b>	359740	<b>Ref. No.</b> —
	light bulb t.max. 300°C socket E14 15W 230V ø 22mm L 48mm lens L 20mm for oven lamp IMPORT		

55x70mm

			
1			
<b>GEV No.</b>	359298	<b>Ref. No.</b>	0K3363
<b>description</b>	lamp socket 230V 25W socket E14 mounting measurements 70x55mm connection male faston 6.3mm		
<b>accessories for</b>	359298		
	<b>GEV No.</b>	359937	<b>Ref. No.</b> —
	lamp glass L 80mm W 65mm mounting measurements 52x67mm		

55x100mm			
			
1			
<b>GEV No.</b>	359716	<b>Ref. No.</b>	0H7118
<b>description</b>	frame for bulb socket		

			
1			
<b>GEV No.</b>	359714	<b>Ref. No.</b>	055022
<b>description</b>	gasket for bulb socket		

			
1			
<b>GEV No.</b>	359715	<b>Ref. No.</b>	0H6989
<b>description</b>	lamp glass L 110mm W 65mm thickness 5mm		

			
1			
<b>GEV No.</b>	101372	<b>Ref. No.</b>	0K7521
<b>description</b>	oven lamp complete L 100mm W 55mm 230V 25W socket E14 rectangular temp.-resist. 300°C connection male faston 6.3mm		
<b>spare parts for</b>	101372		
	<b>GEV No.</b>	359612	<b>Ref. No.</b> 054840
	light bulb t.max. 300°C socket E14 25W 230V ø 25mm L 56mm lens L 30mm for oven lamp type Philips		
	<b>GEV No.</b>	359698	<b>Ref. No.</b> —
	lamp socket L 100mm W 55mm socket E14 connection male faston 6.3mm		
	<b>GEV No.</b>	359714	<b>Ref. No.</b> 055022
	gasket for bulb socket		
	<b>GEV No.</b>	359715	<b>Ref. No.</b> 0H6989
	lamp glass L 110mm W 65mm thickness 5mm		
	<b>GEV No.</b>	359716	<b>Ref. No.</b> 0H7118
	frame for bulb socket		

50x75.5mm			
			
1			
<b>GEV No.</b>	359309	<b>Ref. No.</b>	0K2044
<b>description</b>	oven lamp L 75mm W 50mm 230V 40W socket E14 temp.-resist. 300°C connection male faston 6.3mm		

lamps			
light bulbs			
			
1			
<b>GEV No.</b>	359610	<b>Ref. No.</b>	0H7035
<b>description</b>	light bulb t.max. 300°C socket E14 15W 230V ø 22mm L 47mm lens L 20mm for oven lamp type Philips		

			
1			
<b>GEV No.</b>	359612	<b>Ref. No.</b>	054840
<b>description</b>	light bulb t.max. 300°C socket E14 25W 230V ø 25mm L 56mm lens L 30mm for oven lamp type Philips		

halogen lamps			
for socket G4 / G6.35 / G9			
			
1			
<b>GEV No.</b>	357191	<b>Ref. No.</b>	565729
<b>description</b>	halogen lamp socket G4 12V 10W temp.-resist. 300°C OSRAM HALOSTAR OVEN		

			
1			
<b>GEV No.</b>	359596	<b>Ref. No.</b>	0H7038
<b>description</b>	halogen lamp socket G4 12V 10W temp.-resist. 500°C		

sockets			
G4 / G5,3 / G6,35			
			
1			
<b>GEV No.</b>	359304	<b>Ref. No.</b>	0K3362
<b>description</b>	lamp socket socket G4 24V ø 17mm H 9mm connection cable 120mm mounting distance 12mm with 2 hole fixing mounting thread M3 cable length 120mm Qty 1 pcs		



E14



1

<b>GEV No.</b>	359307	<b>Ref. No.</b>	OK2016
<b>description</b>	lamp socket socket E14 L 28mm with 2 hole fixing		

## lamp accessories

## gaskets



1

<b>GEV No.</b>	359766	<b>Ref. No.</b>	OK2106
<b>description</b>	gasket L 100mm W 76mm		

## timers

## programme timers



1

<b>GEV No.</b>	350017	<b>Ref. No.</b>	0H6755
<b>description</b>	timer		



1

<b>GEV No.</b>	360334	<b>Ref. No.</b>	003833
<b>description</b>	timer FIBER P04 engines 1 chambers 2 operation time 120min 230V shaft $\varnothing$ 6x4.6mm shaft L 20mm manuf. no. P045J02W401 motor type M51BJ0R6400 impulse electric		
<b>spare parts for</b>	360334		
	<b>GEV No.</b>	360673	<b>Ref. No.</b> —
	motor kit pinion $\varnothing$ 6.8mm teeth 15 230V voltage AC 50/60Hz turn direction clockwise motor $\varnothing$ 48mm H 18.5mm motor type UDS-40NE1RNZ165 cable length 150mm with holder		



1

<b>GEV No.</b>	360065	<b>Ref. No.</b>	0700124090
<b>description</b>	timer operation time 85s		

## electric timers



1

<b>GEV No.</b>	350007	<b>Ref. No.</b>	0H6118
<b>description</b>	timer CR5 operation time 120min time spreadmin 2CO at 250V 16A permanent position no impulse electric shaft $\varnothing$ 6x4.6mm shaft L 24mm mounting distance 28mm connection lateral 2-pole		



1

<b>GEV No.</b>	350005	<b>Ref. No.</b>	212622
<b>description</b>	timer MS65 without bell operation time 30min time spreadmin 2CO at 250V 16A permanent position no impulse electric shaft $\varnothing$ 6x4.6mm shaft L 23mm mounting distance 28mm connection lateral 2-pole		

**accessories for** 350005

<b>GEV No.</b>	110366	<b>Ref. No.</b>	—
<b>description</b>	knob switch zero mark t.max. °C $\varnothing$ 44mm shaft $\varnothing$ 6x4.6mm shaft flat upper black		



<b>GEV No.</b>	111207	<b>Ref. No.</b>	—
<b>description</b>	dial plate graduation 30min permanent position no rotation 30-300° $\varnothing$ 60mm timers knob $\varnothing$ 45mm		



1

<b>GEV No.</b>	350143	<b>Ref. No.</b>	0H6117
<b>description</b>	timer MS65 without bell operation time 60min time spreadmin 2CO at 250V 16A permanent position no time range 0-60min impulse electric shaft $\varnothing$ 6x4.6mm shaft L 22mm EATON (INVENSYS) ambient temperature max. 85°C 50Hz 2-pole 230V		



mechanical timers



1

<b>GEV No.</b>	350170	<b>Ref. No.</b>	0H6114
<b>description</b>	timer 600 2-pole operation time 60min impulse mechanical 2NO at 250V 16A permanent position no shaft ø 6x4.6mm shaft L 21mm mounting distance 28mm		



1

<b>GEV No.</b>	350169	<b>Ref. No.</b>	0H6116 212599
<b>description</b>	timer 601 2-pole operation time 60min impulse mechanical 2CO at 250V 16A permanent position no shaft ø 6x4.6mm shaft L 21mm mounting distance 28mm connection lateral		



1

<b>GEV No.</b>	350012	<b>Ref. No.</b>	0K2269
<b>description</b>	timer 601 with bell 2-pole operation time 120min impulse mechanical 2CO at 250V 16A permanent position yes shaft ø 6x4.6mm shaft L 22mm mounting distance 28mm connection lateral		



1

<b>GEV No.</b>	350105	<b>Ref. No.</b>	0H6757
<b>description</b>	timer 601 with bell 2-pole operation time 90min impulse mechanical 1CO/1NO at 250V 16A permanent position yes shaft ø 6x4.6mm shaft L 22mm mounting distance 28mm connection rear		



1

<b>GEV No.</b>	350030	<b>Ref. No.</b>	0K3053	
<b>description</b>	timer M2 2-pole operation time 120min impulse mechanical 2NO at 250V 16A permanent position no shaft ø 6x4.6mm shaft L 23mm mounting distance 28mm connection lateral			
<b>accessories for</b>	350030			
	<b>GEV No.</b>	110366	<b>Ref. No.</b>	—
	knob switch zero mark t.max.°C ø 44mm shaft ø 6x4.6mm shaft flat upper black			
	<b>GEV No.</b>	111199	<b>Ref. No.</b>	—
	dial plate graduation 120min permanent position no rotation 0-330° ø 60mm timers knob ø 45mm			



1

<b>GEV No.</b>	350018	<b>Ref. No.</b>	0H6684	
<b>description</b>	timer M2 2-pole operation time 60min impulse mechanical 2CO at 250V 16A permanent position yes shaft ø 6x4.6mm shaft L 23mm mounting distance 28mm connection lateral			
<b>accessories for</b>	350018			
	<b>GEV No.</b>	110366	<b>Ref. No.</b>	—
	knob switch zero mark t.max.°C ø 44mm shaft ø 6x4.6mm shaft flat upper black			
	<b>GEV No.</b>	111202	<b>Ref. No.</b>	—
	dial plate graduation 60min permanent position yes rotation 0-300° ø 60mm timers knob ø 45mm with permanent position			

alarm devices

buzzers



1

<b>GEV No.</b>	350050	<b>Ref. No.</b>	0H6572 0K2031 244123
<b>description</b>	buzzer 230VAC connection male faston 6.3mm screw mounting thread M4 60dB		



1	<b>GEV No.</b> 350085	<b>Ref. No.</b> 0G1993
<b>description</b> buzzer connection plug-in connection		



1	<b>GEV No.</b> 380675	<b>Ref. No.</b> 0K3383
<b>description</b> power contactor resistive load 25A 230VAC (AC3/400V) 12A/5.5kW main contacts 3NO auxiliary contacts 1NC connection screw connection type K2-12A01230		

## contactors

### ABB

#### auxiliary contactors



1	<b>GEV No.</b> 380122	<b>Ref. No.</b> 0H6545
<b>description</b> auxiliary contactor 230VAC AC1 10A AC15 3A connection screw connection contacts 2NO/2NC N2E		



1	<b>GEV No.</b> 380679	<b>Ref. No.</b> 003598 7511209
<b>description</b> power contactor resistive load 25A 230VAC (AC3/400V) 12A/5.5kW main contacts 3NO auxiliary contacts 1NO connection screw connection type K2-12A01230		

### BENEDIKT & JÄGER

#### power contactors



1	<b>GEV No.</b> 380672	<b>Ref. No.</b> 0H7049
<b>description</b> power contactor resistive load 25A 230VAC (AC3/400V) 10A/4kW main contacts 3NO auxiliary contacts 1NC connection screw connection type K2-09A01230		



1	<b>GEV No.</b> 380674	<b>Ref. No.</b> 0H7051 582310
<b>description</b> power contactor resistive load 25A 230VAC (AC3/400V) 12A/5.5kW main contacts 4NO connection screw connection type K2-12A0040230		



1	<b>GEV No.</b> 380772	<b>Ref. No.</b> 088477
<b>description</b> power contactor resistive load 25A 230VAC (AC3/400V) 10A/4kW main contacts 3NO auxiliary contacts 1NO connection screw connection type K3-10A10230		



1	<b>GEV No.</b> 380673	<b>Ref. No.</b> 0K3384
<b>description</b> power contactor resistive load 45A 230VAC (AC3/400V) 11kW		

1

<b>GEV No.</b>	380521	<b>Ref. No.</b>	0K3385
<b>description</b>	power contactor resistive load 45A 230VAC (AC3/400V) 23A/11kW main contacts 4NO connection screw connection type K2-23A0040230		



1

<b>GEV No.</b>	380676	<b>Ref. No.</b>	OTRA70
<b>description</b>	power contactor resistive load 80A 230VAC (AC3/400V) 45A/20kW main contacts 3NO connection screw connection type K2-45A00230		

auxiliary contacts



1

<b>GEV No.</b>	380677	<b>Ref. No.</b>	047046
<b>description</b>	auxiliary contact contacts 1NC AC15 10A for contactors K2/K3 connection screw type HN01 AC1 25A		



1

<b>GEV No.</b>	380678	<b>Ref. No.</b>	046995
<b>description</b>	auxiliary contact contacts 1NO AC15 10A for contactors K2/K3 connection screw type HN10 AC1 25A		

GENERAL ELECTRIC (AEG)

power contactors



1

<b>GEV No.</b>	380262	<b>Ref. No.</b>	0K3374
<b>description</b>	power contactor resistive load 32A 230VAC (AC3/400V) 17A/7.5kW main contacts 3NO auxiliary contacts 1NC connection screw connection type AEG LS7K01A type GE CL02A 301 H 85mm		

MOELLER/EATON

power contactors



1

<b>GEV No.</b>	380493	<b>Ref. No.</b>	0K3375
<b>description</b>	contactor resistive load 55A 230VAC main contacts 3NO		



1

<b>GEV No.</b>	380511	<b>Ref. No.</b>	0H6623
<b>description</b>	power contactor resistive load 16A 230VAC main contacts 3NO auxiliary contacts 1NC		



1

<b>GEV No.</b>	380518	<b>Ref. No.</b>	0K3371 582250
<b>description</b>	power contactor resistive load 20A 230VAC		

1

<b>GEV No.</b>	380515	<b>Ref. No.</b>	0H7047
<b>description</b>	power contactor resistive load 20A 230VAC (AC3/400V) 4kW main contacts 4		



1

<b>GEV No.</b>	380171	<b>Ref. No.</b>	0H7046 582249
<b>description</b>	power contactor resistive load 20A 230VAC (AC3/400V) 9A/4kW main contacts 3NO auxiliary contacts 1NO connection screw connection type DILEM 10		



1

<b>GEV No.</b>	380519	<b>Ref. No.</b>	0K3373
<b>description</b>	power contactor resistive load 35A 230VAC		



1

<b>GEV No.</b>	380516	<b>Ref. No.</b>	0H7048
<b>description</b>	power contactor resistive load 35A 230VAC (AC3/400V) 7.5kW main contacts 3NO auxiliary contacts NC/NO connection screw connection type DIL00M/11		

auxiliary contactors



1

<b>GEV No.</b>	380669	<b>Ref. No.</b>	0H6543
<b>description</b>	power contactor resistive load 10A 230VAC main contacts 3NO auxiliary contacts 1NC		

TELEMECANIQUE (Schneider Electric)

power contactors



1

<b>GEV No.</b>	380479	<b>Ref. No.</b>	0K2051
<b>description</b>	power contactor resistive load 25A 230VAC (AC3/400V) 9A/4kW main contacts 3NO auxiliary contacts 1NO/1NC connection screw connection type LC1D09P7		

ALLEN BRADLEY

power contactors



1

<b>GEV No.</b>	380517	<b>Ref. No.</b>	0H6547
<b>description</b>	power contactor resistive load 20A 230VAC (AC3/400V) 5.3A/2.2kW main contacts 3NO auxiliary contacts 1NO connection screw connection type 100-M05NKF3S		





TRIPUS (Eichhoff)

small relay switches

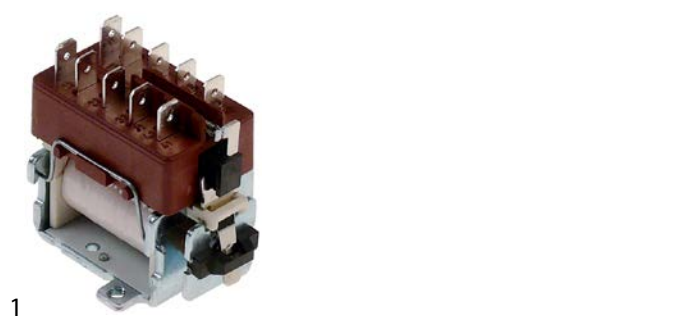

1

<b>GEV No.</b>	380120	<b>Ref. No.</b>	0H6541
<b>description</b>	small relay switch 230V AC1 16A main contacts 4NO connection Faston 6.3mm type 307P002 resistive load 16A		

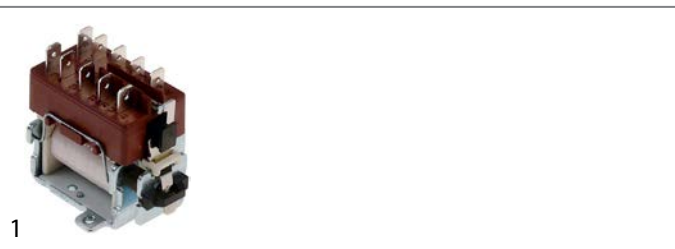

1

<b>GEV No.</b>	380119	<b>Ref. No.</b>	0H7194
<b>description</b>	small relay switch 230V main contacts 2NO/2NC connection Faston 6.3mm resistive load 16A		

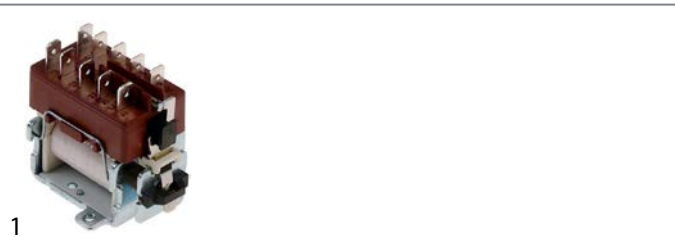

1

<b>GEV No.</b>	380121	<b>Ref. No.</b>	0H6544
<b>description</b>	small relay switch 230V main contacts 3NO/1NC auxiliary contacts knob ø70mm (227-piece) connection Faston 6.3mm type E3250 resistive load 16A		

miscellaneous

accessories



1

<b>GEV No.</b>	400699	<b>Ref. No.</b>	0G1781 249035
<b>description</b>	switching delay SV3/50 3s 50VA type 52159 suitable for JUNO		

power contactors



1

<b>GEV No.</b>	380157	<b>Ref. No.</b>	0K2053
<b>description</b>	power contactor resistive load 32A		

relays

power relays

with bracket mounting



1

<b>GEV No.</b>	380312	<b>Ref. No.</b>	056466
<b>description</b>	power relays FINDER 230VAC 10A 3CO connection male faston 4.8mm bracket mounting dimensions 52x32.2x36.5mm manuf. no. 60.63.8.230.0000		

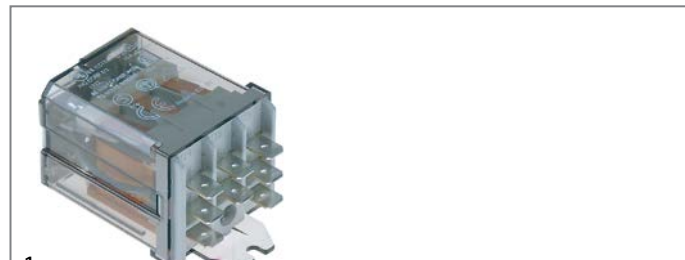

1

<b>GEV No.</b>	380702	<b>Ref. No.</b>	005033
<b>description</b>	power relays FINDER 230VAC 16A 3NO connection male faston 6.3mm flange dimensions 36x38x68mm manuf. no. 62.83.8.230.0300 230V		

with male contacts

bullet connectors, 11 contacts

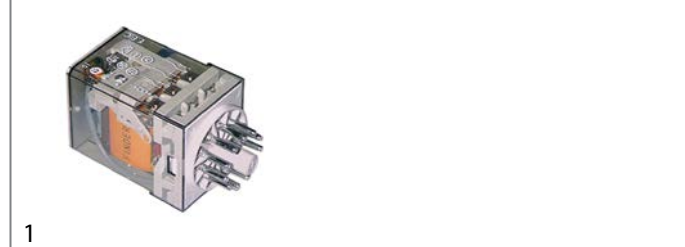

1

<b>GEV No.</b>	380132	<b>Ref. No.</b>	0K3700
<b>description</b>	power relays Italiana Relè 230VAC 10A 3CO connection plug-in connection round 11-pole manuf. no. C43-230AC ZVE11 250V 11-pole		

**accessories for** 380132

<b>GEV No.</b>	380136	<b>Ref. No.</b>	—
<b>description</b>	relay socket 11-pole connection plug-in connection round 11-pole dimensions 65x28x40mm 250V voltage AC 10A Italiana Relè manuf. no. ZVE11		



## level relays

## GICAR



1

<b>GEV No.</b>	400018	<b>Ref. No.</b>	055458
<b>description</b>	level relay 230V voltage AC connection F6.3 type RL30/3ES/F/G		

## miscellaneous



1

<b>GEV No.</b>	400743	<b>Ref. No.</b>	0H6240
<b>description</b>	level relay		



1

<b>GEV No.</b>	400176	<b>Ref. No.</b>	0G1804
<b>description</b>	level relay 1CO 230V voltage AC		



1

<b>GEV No.</b>	400002	<b>Ref. No.</b>	0H6222
<b>description</b>	level relay type FTL 160		

## time relays

## time relays



1

<b>GEV No.</b>	380682	<b>Ref. No.</b>	0H6817
<b>description</b>	time relay CROUZET time range 1s-100h 24VDC		



1

<b>GEV No.</b>	380381	<b>Ref. No.</b>	0H6818
<b>description</b>	time relay DOLD MK7614.32 time range 0.15s-30min 230VAC 2x4A 2CO connection grip connection		



1

<b>GEV No.</b>	380681	<b>Ref. No.</b>	0K2401
<b>description</b>	time relay TESCH E67.3x105 time range 3-60s 230VAC 5A		



1

<b>GEV No.</b>	360357	<b>Ref. No.</b>	0H6122
<b>description</b>	time relay TESCH V333x01 time range 0s-60h 220-240VAC 4x4A 4CO		



## transformers

### encapsulated transformers

#### multiple connections



1

<b>GEV No.</b>	401346	<b>Ref. No.</b>	0H6808
<b>description</b>	transformer 20VA		



1

<b>GEV No.</b>	401546	<b>Ref. No.</b>	0K2761
<b>description</b>	transformer primary 230V secondary 12V 10VA		

#### for lighting



1

<b>GEV No.</b>	401547	<b>Ref. No.</b>	002856
<b>description</b>	transformer primary 230V secondary 11.5V 50W		

## electronic controllers

### DOLD

#### universal controllers

#### mounting measurements 92x92mm



1

<b>GEV No.</b>	379919	<b>Ref. No.</b>	0H6246 A215696
<b>description</b>	electronic controller DOLD DPG 96 C mounting measurements 90x90mm 230V voltage AC Pt100/TC(J/K/S) 0-10V/4-20mA -150 up to +1700°C display 2x 4 digits relay outputs 4 relays 8A 8A 8A 8A TempIn1 yes TempIn2 yes TempIn3 yes DigiIn1 yes DigiIn2 yes DigiIn3 yes built-in depth 140mm		

## JUMO

#### universal controllers

#### built-in version



1

<b>GEV No.</b>	400989	<b>Ref. No.</b>	0H6501 236163
<b>description</b>	electronic controller JUMO type iTRON 04 mounting measurements 92x92mm 110-240V voltage AC Pt100/TC(J/K/S)/V/mA relay outputs 2 relays defr. funct. no -200 up to +1300°C display 4 digits TempIn1 yes 3A 3A		

## STÖRK-TRONIC

#### universal controllers

#### built-in version



1

<b>GEV No.</b>	379339	<b>Ref. No.</b>	0K1206
<b>description</b>	electronic controller STÖRK-TRONIK type ST73-31.10 mounting measurements 60mm 230V voltage AC Pt100 relay outputs 1 NO-12A(6) Pt100 front measurements 72x72mm built-in depth 64mm defr. funct. -60 up to +400°C display 3 digits		

#### refrigeration controllers

#### built-in version



1

<b>GEV No.</b>	379339	<b>Ref. No.</b>	0K1206
<b>description</b>	electronic controller STÖRK-TRONIK type ST73-31.10 mounting measurements 60mm 230V voltage AC Pt100 relay outputs 1 NO-12A(6) Pt100 front measurements 72x72mm built-in depth 64mm defr. funct. -60 up to +400°C display 3 digits		



electric components

miscellaneous

universal controllers



<b>GEV No.</b>	379084	<b>Ref. No.</b>	0H6244
<b>description</b>	electronic controller Pt100 electronic thermostat		

probes

producer-specific probes

probes



<b>GEV No.</b>	379147	<b>Ref. No.</b>	0H6229
<b>description</b>	temperature probe NTC 10kOhm cable silicone probe -40 up to +110°C cable -50 up to +180°C connection F6.3 thread M10x1 probe ø10x10mm cable length 0.08m		



<b>GEV No.</b>	379049	<b>Ref. No.</b>	0H6482
<b>description</b>	temperature probe Pt100 cable PTFE probe -100 up to 450°C cable -40 up to +250°C connection 2-wire thread 1/4" probe ø5x100mm cable length 2m		



<b>GEV No.</b>	379090	<b>Ref. No.</b>	0H6491
<b>description</b>	temperature probe Pt100 cable PTFE probe -70 up to +500°C cable -40 up to +250°C connection 2-wire thread probe ø3x100mm cable length 1.9m		





<b>GEV No.</b>	379144	<b>Ref. No.</b>	0H6481
<b>description</b>	temperature probe Pt100 cable silicone probe -100 up to 450°C cable -50 up to +180°C connection 2-wire thread probe ø3/3.5x40/180mm cable length 1.9m		



<b>GEV No.</b>	401398	<b>Ref. No.</b>	0H6477
<b>description</b>	temperature probe Pt100 cable silicone probe -50 up to +250°C cable -50 up to +180°C connection male faston 6.3mm thread M10x1 probe ø10x10mm cable length 0.07m		



<b>GEV No.</b>	379100	<b>Ref. No.</b>	0C5342 0K0681 215727
<b>description</b>	temperature probe Pt1000 cable silicone probe -70 up to +500°C cable -50 up to +180°C connection male faston 4.8mm thread probe ø4x235mm cable length 1.8m		
<b>accessories for</b>	379100		
	<b>GEV No.</b>	693745	<b>Ref. No.</b> 002624
<b>description</b>	gasket PTFE ED ø 20mm ID ø 15mm thickness 1mm Qty 1 pcs		
	<b>GEV No.</b>	697993	<b>Ref. No.</b> —
<b>description</b>	sleeve for temperature probe ø 11mm ID ø 4.3mm H 22.4mm		



<b>GEV No.</b>	378012	<b>Ref. No.</b>	0K5047
<b>description</b>	temperature probe PTC 2kOhm cable probe -50 up to +150°C cable°C connection F6.3 thread M10x1 cable lengthm		



<b>GEV No.</b>	379146	<b>Ref. No.</b>	0H6247
<b>description</b>	temperature probe thermocouple J (Fe-CuNi) cable Vetrotex probe -50 up to +750°C cable -50 up to +350°C connection 2-wire thread 1/2" probe ø6x5mm cable length 2m		



<b>GEV No.</b>	379148	<b>Ref. No.</b>	0H6267
<b>description</b>	temperature probe thermocouple K (NiCr-Ni) cable Vetrotex probe -50 up to 1150°C cable -50 up to +350°C connection 2-wire thread M8 probe ø8x70mm cable length 1.6m		



<b>GEV No.</b>	379145	<b>Ref. No.</b>	0H6269
<b>description</b>	temperature probe thermocouple K (NiCr-Ni) cable Vetrotex probe -50 up to 1150°C cable -50 up to +350°C connection 2-wire thread probe ø3x100mm cable length 2m		





<b>GEV No.</b>	102272	<b>Ref. No.</b>	0H6237
<b>description</b>	thermocouple		

core probes





<b>GEV No.</b>	379108	<b>Ref. No.</b>	0H6131
<b>description</b>	core temperature probe Pt100 cable PTFE probe -100 up to 450°C cable -40 up to +250°C connection 2-wire probe ø3.5x100mm thread cable length 1.3m handle ø 9mm handle length 85mm		

			
<b>GEV No.</b>	401549	<b>Ref. No.</b>	0H6131
<b>description</b>	core temperature probe Pt100 cable PTFE probe -100 up to 450°C cable -40 up to +250°C connection 2-wire probe ø4.5x80mm thread cable length 1.8m handle ø 8mm handle length 70mm		

			
<b>GEV No.</b>	379091	<b>Ref. No.</b>	0H6492
<b>description</b>	core temperature probe Pt100 cable PTFE probe -40 up to +250°C cable -40 up to +250°C connection 2-wire probe ø4.5x80mm thread cable length 1.3m handle ø 8mm handle length 70mm		

			
<b>GEV No.</b>	379096	<b>Ref. No.</b>	0H6493
<b>description</b>	core temperature probe Pt100 cable PTFE probe -40 up to +250°C cable -40 up to +250°C connection 2-wire probe ø4.5x80mm thread cable length 1.5m handle ø 8mm handle length 70mm		

			
<b>GEV No.</b>	379095	<b>Ref. No.</b>	055472
<b>description</b>	core temperature probe Pt100 cable SS corrugated hose probe -40 up to +250°C cable -40 up to +250°C connection coded plug probe ø4x100mm thread M12 cable length 1.45m handle ø 9mm handle length 85mm		

			
<b>GEV No.</b>	379979	<b>Ref. No.</b>	0H6262
<b>description</b>	core temperature probe Pt100 cable SS tube probe -40 up to +250°C cable -40 up to +250°C connection 2-wire probe ø5x100mm thread cable length 2m handle ø 9mm handle length 45mm		

			
<b>GEV No.</b>	379978	<b>Ref. No.</b>	0H6494
<b>description</b>	core temperature probe Pt100 cable SS/plastic probe -40 up to +250°C cable -40 up to +250°C connection 2-wire probe ø5x100mm thread cable length 1.6m handle ø 9mm handle length 45mm		

			
<b>GEV No.</b>	379061	<b>Ref. No.</b>	003853
<b>description</b>	core temperature probe Pt1000 cable SS corrugated hose probe -40 up to +250°C cable -40 up to +250°C connection 2-wire probe ø4x100mm thread M8 cable length 2.5m handle ø 10mm handle length 45mm		

			
<b>GEV No.</b>	379060	<b>Ref. No.</b>	002673
<b>description</b>	core temperature probe Pt1000 cable SS corrugated hose probe -40 up to +250°C cable -40 up to +250°C connection 2-wire probe ø4x100mm thread M8 cable length 2m handle ø 10mm handle length 45mm		

			
<b>GEV No.</b>	379406	<b>Ref. No.</b>	006192
<b>description</b>	core temperature probe Pt1000 cable SS corrugated hose probe -40 up to +250°C cable -40 up to +250°C connection 2-wire probe ø4x100mm thread M8 cable length 2m handle ø 10mm handle length 50mm		

			
<b>GEV No.</b>	379967	<b>Ref. No.</b>	0C0225
<b>description</b>	core temperature probe thermocouple K (NiCr-Ni) cable PTFE probe -40 up to +250°C cable -40 up to +250°C connection plug probe ø3.5x90mm thread cable length 3.1m handle ø 9mm handle length 45/50mm		

accessories

fasteners

			
<b>GEV No.</b>	693748	<b>Ref. No.</b>	002674
<b>description</b>	bracket for core temperature probe		



# electronics

## PCBs

electric components



1

<b>GEV No.</b>	401527	<b>Ref. No.</b>	0H6957
<b>description</b>	control PCB		



1

<b>GEV No.</b>	400179	<b>Ref. No.</b>	0C3758
<b>description</b>	control PCB combi-steamer FCV/G 101/1 102/1		



1

<b>GEV No.</b>	400188	<b>Ref. No.</b>	002725
<b>description</b>	control PCB combi-steamer FCV/G 101/1 102/1		



1

<b>GEV No.</b>	401526	<b>Ref. No.</b>	0H6128 212766
<b>description</b>	control PCB suitable for JUNO		



1

<b>GEV No.</b>	400184	<b>Ref. No.</b>	0C3765
<b>description</b>	control PCB with keypad		



1

<b>GEV No.</b>	401525	<b>Ref. No.</b>	0H6130
<b>description</b>	keypad PCB		



1

<b>GEV No.</b>	401531	<b>Ref. No.</b>	0K2759
<b>description</b>	keypad PCB		



1

<b>GEV No.</b>	401667	<b>Ref. No.</b>	0C3759
<b>description</b>	keypad PCB		



1

Image not available

<b>GEV No.</b>	401586	<b>Ref. No.</b>	006673
<b>description</b>	main PCB		



1

<b>GEV No.</b>	400189	<b>Ref. No.</b>	006674
<b>description</b>	main PCB combi-steamer 260200-245		

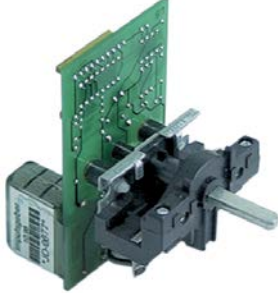

1

<b>GEV No.</b>	400003	<b>Ref. No.</b>	0H6601
<b>description</b>	PCB combi-steamer JUNO		



1

<b>GEV No.</b>	400742	<b>Ref. No.</b>	0K1791
<b>description</b>	PCB		



1

<b>GEV No.</b>	400990	<b>Ref. No.</b>	0K2758
<b>description</b>	PCB for stirrer complete		



1

<b>GEV No.</b>	400744	<b>Ref. No.</b>	003763
<b>description</b>	PCB		



1

<b>GEV No.</b>	400177	<b>Ref. No.</b>	0H6144
<b>description</b>	PCB range JUN90133		



1

<b>GEV No.</b>	401524	<b>Ref. No.</b>	0H6129
<b>description</b>	PCB		



1

<b>GEV No.</b>	401573	<b>Ref. No.</b>	0K4882
<b>description</b>	power PCB		



1

<b>GEV No.</b>	401572	<b>Ref. No.</b>	0C3762
<b>description</b>	power PCB combi-steamer FCV/G 101/1 102/1		

### Triacs



1

<b>GEV No.</b>	400079	<b>Ref. No.</b>	0H7060
<b>description</b>	Triac		

### keypads front foils



1

<b>GEV No.</b>	401347	<b>Ref. No.</b>	0K2622
<b>description</b>	keypad foil		



1

<b>GEV No.</b>	401354	<b>Ref. No.</b>	0K2637
<b>description</b>	keypad foil		



1

<b>GEV No.</b>	401518	<b>Ref. No.</b>	0K1581
<b>description</b>	keypad foil		



1

<b>GEV No.</b>	401519	<b>Ref. No.</b>	0K1582
<b>description</b>	keypad foil		



1

<b>GEV No.</b>	401520	<b>Ref. No.</b>	0K1583
<b>description</b>	keypad foil		



1

<b>GEV No.</b>	401521	<b>Ref. No.</b>	0K1584
<b>description</b>	keypad foil		



1

<b>GEV No.</b>	401522	<b>Ref. No.</b>	0K1585
<b>description</b>	keypad foil		



1

<b>GEV No.</b>	401523	<b>Ref. No.</b>	0K1586
<b>description</b>	keypad foil		



1

<b>GEV No.</b>	401532	<b>Ref. No.</b>	0K2620
<b>description</b>	keypad foil		





1

<b>GEV No.</b>	401533	<b>Ref. No.</b>	0K2617
<b>description</b>	keypad foil		







1 			
<b>GEV No.</b>	401534	<b>Ref. No.</b>	0H6893
<b>description</b>	keypad foil		

1 			
<b>GEV No.</b>	401535	<b>Ref. No.</b>	0K2618
<b>description</b>	keypad foil		

1 			
<b>GEV No.</b>	401536	<b>Ref. No.</b>	0K2619
<b>description</b>	keypad foil		

1 			
<b>GEV No.</b>	401537	<b>Ref. No.</b>	0H6894
<b>description</b>	keypad foil		

1 			
<b>GEV No.</b>	401538	<b>Ref. No.</b>	0K2621
<b>description</b>	keypad foil		

1 			
<b>GEV No.</b>	401539	<b>Ref. No.</b>	0H6895
<b>description</b>	keypad foil		

1 			
<b>GEV No.</b>	401541	<b>Ref. No.</b>	006054
<b>description</b>	keypad foil		

1 			
<b>GEV No.</b>	401543	<b>Ref. No.</b>	005417
<b>description</b>	keypad foil		

1 			
<b>GEV No.</b>	401544	<b>Ref. No.</b>	006050
<b>description</b>	keypad foil		

1 			
<b>GEV No.</b>	401545	<b>Ref. No.</b>	005418
<b>description</b>	keypad foil		

1 			
<b>GEV No.</b>	401551	<b>Ref. No.</b>	005101
<b>description</b>	keypad foil		

1 			
<b>GEV No.</b>	401552	<b>Ref. No.</b>	005287
<b>description</b>	keypad foil		

1 			
<b>GEV No.</b>	401553	<b>Ref. No.</b>	005278
<b>description</b>	keypad foil		

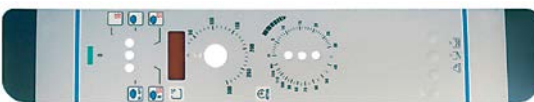
1 			
<b>GEV No.</b>	401554	<b>Ref. No.</b>	005416
<b>description</b>	keypad foil		

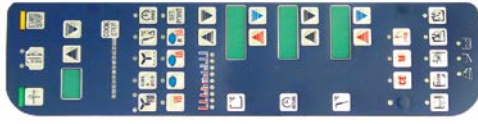
1 			
<b>GEV No.</b>	401555	<b>Ref. No.</b>	006058
<b>description</b>	keypad foil		



### solenoid valves

#### solenoid valves (water)

##### ELBI

			
1			
<b>GEV No.</b>	373020	<b>Ref. No.</b>	049056
<b>description</b>	solenoid valve double angled 230VAC inlet 3/4" outlet 14mm input 10l/min DN10 t.max. 90°C duty cycle 100% ELBI flow regulating valve inlet white		

##### MÜLLER

medium temperature: 90°C  
duty cycle: 100%















				
1				
<b>GEV No.</b>	370117	<b>Ref. No.</b>	OG2196	
<b>description</b>	solenoid valve single straight 230VAC inlet 3/4" outlet 11.5mm DN10 t.max. 90°C duty cycle 100% MÜLLER			
<b>spare parts for</b>	370117			
	<b>GEV No.</b>	370133	<b>Ref. No.</b>	—
	solenoid valve body single straight inlet 3/4" outlet 11.5mm DN10 t.max. 90°C duty cycle 100% MÜLLER 230V			
	<b>GEV No.</b>	371002	<b>Ref. No.</b>	—
	solenoid valve holder MÜLLER flange support			
	<b>GEV No.</b>	371009	<b>Ref. No.</b>	—
	compression spring for solenoid coil			
	<b>GEV No.</b>	371011	<b>Ref. No.</b>	—
	spare parts kit membrane with long star star high 8mm MÜLLER			
	<b>GEV No.</b>	371017	<b>Ref. No.</b>	—
	solenoid coil MÜLLER 230VAC connection male faston 6.3mm			
	<b>GEV No.</b>	371122	<b>Ref. No.</b>	—
	solenoid valve filter ø 19mm H 10mm suitable for MÜLLER			
	<b>GEV No.</b>	501161	<b>Ref. No.</b>	—
	tap head for solenoid valve holder for solenoid coils			
<b>accessories for</b>	370117			
	<b>GEV No.</b>	371010	<b>Ref. No.</b>	—
	solenoid coil 230VAC connection with cable cable length 2000mm			
	<b>GEV No.</b>	371037	<b>Ref. No.</b>	—
	solenoid coil 24VAC 50/60Hz connection male faston 6.3mm			

Table continues overleaf

			
1			
<b>GEV No.</b>	401556	<b>Ref. No.</b>	005452
<b>description</b>	keypad foil		

			
1			
<b>GEV No.</b>	401574	<b>Ref. No.</b>	0K4333
<b>description</b>	keypad foil		

			
1			
<b>GEV No.</b>	401577	<b>Ref. No.</b>	005459
<b>description</b>	keypad foil		

			
1			
<b>GEV No.</b>	401578	<b>Ref. No.</b>	005457
<b>description</b>	keypad foil		

			
1			
<b>GEV No.</b>	401579	<b>Ref. No.</b>	005449
<b>description</b>	keypad foil		

			
1			
<b>GEV No.</b>	401580	<b>Ref. No.</b>	005455
<b>description</b>	keypad foil		

			
1			
<b>GEV No.</b>	401581	<b>Ref. No.</b>	005453
<b>description</b>	keypad foil		

			
1			
<b>GEV No.</b>	401582	<b>Ref. No.</b>	005276
<b>description</b>	keypad foil		

			
1			
<b>GEV No.</b>	401583	<b>Ref. No.</b>	006048
<b>description</b>	keypad foil		

#### accessories

			
1			
<b>GEV No.</b>	400997	<b>Ref. No.</b>	002670
<b>description</b>	push button		



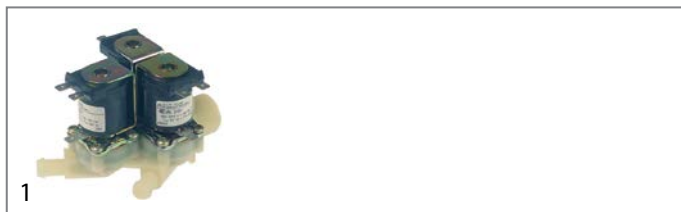

<b>accessories for</b> 370117	
	GEV No. 371038 Ref. No. — solenoid coil 230VAC connection appliance plug





<b>GEV No.</b>	370172	<b>Ref. No.</b>	OH6404
<b>description</b>	solenoid valve triple straight 230VAC inlet 3/4" outlet 11.5mm DN10 t.max. 90°C duty cycle 100% MÜLLER		

<b>spare parts for</b>	370172
------------------------	--------

	GEV No. 370132 Ref. No. — solenoid valve body triple straight inlet 3/4" outlet 11.5mm DN10 t.max. 90°C duty cycle 100% MÜLLER 230V
---	--

	GEV No. 371002 Ref. No. — solenoid valve holder MÜLLER flange support
---	--

	GEV No. 371009 Ref. No. — compression spring for solenoid coil
---	---

	GEV No. 371011 Ref. No. — spare parts kit membrane with long star star high 8mm MÜLLER
---	---

	GEV No. 371017 Ref. No. — solenoid coil MÜLLER 230VAC connection male faston 6.3mm
--	---

	GEV No. 371122 Ref. No. — solenoid valve filter ø 19mm H 10mm suitable for MÜLLER
---	--

	GEV No. 501161 Ref. No. — tap head for solenoid valve holder for solenoid coils
---	--

<b>accessories for</b>	370172
------------------------	--------

	GEV No. 371010 Ref. No. — solenoid coil 230VAC connection with cable cable length 2000mm
---	---

	GEV No. 371037 Ref. No. — solenoid coil 24VAC 50/60Hz connection male faston 6.3mm
---	---

	GEV No. 371038 Ref. No. — solenoid coil 230VAC connection appliance plug
---	---

ROBERTSHAW/INVENSYS

medium temperature: 90°C 90°C 60°C  
 ambient temperature: 60°C 25°C 60°C  
 duty cycle: 40% 100% 100%



<b>GEV No.</b>	372016	<b>Ref. No.</b>	OK3088
<b>description</b>	solenoid valve single angled 230VAC inlet 3/4" outlet 14mm DN10 EATON (INVENSYS)		

solenoid valves with reducers

3-fold



<b>GEV No.</b>	370345	<b>Ref. No.</b>	0C1934
<b>description</b>	solenoid valve triple straight 230VAC inlet 3/4" outlet 11.5mm t.max. 90°C EATON (INVENSYS) plastic output B 0.25l/min output C 1.2l/min flow regulating valve outlet B white flow regulating valve outlet C blue		

TP

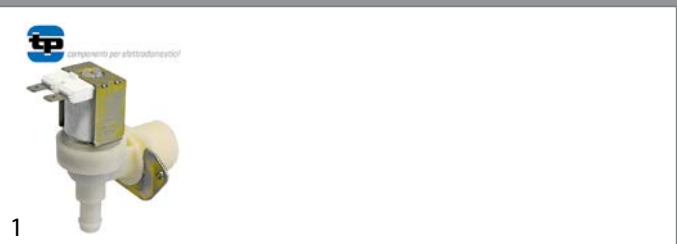



<b>GEV No.</b>	370015	<b>Ref. No.</b>	002613
<b>description</b>	solenoid valve single angled 230VAC inlet 3/4" outlet 11.5mm DN10 TP		

<b>accessories for</b>	370015
------------------------	--------

	GEV No. 371220 Ref. No. — reducer TP flow rate 3l/min red tolerance ±15%
---	---

	GEV No. 371221 Ref. No. — reducer TP flow rate 5.5l/min yellow tolerance ±15%
---	--

	GEV No. 371222 Ref. No. — reducer TP flow rate 6l/min grey tolerance ±15%
---	--

	GEV No. 371223 Ref. No. — reducer TP flow rate 10l/min white tolerance ±15%
---	--

	GEV No. 371224 Ref. No. — reducer TP flow rate 12l/min bronze tolerance ±15%
---	---







	GEV No. 371225 Ref. No. — reducer TP flow rate 16l/min light brown tolerance ±15%
---	--

Table continues overleaf

accessories for		370015		
GEV No.	371226	Ref. No.	—	
	reducer TP flow rate 20l/min red tolerance ±15%			
	reducer TP flow rate 0.25l/min red tolerance ±25%			
	reducer TP flow rate 0.35l/min violet tolerance ±25%			
	reducer TP flow rate 0.5l/min orange tolerance ±25%			
	reducer TP flow rate 0.8l/min white tolerance ±25%			
	reducer TP flow rate 1l/min light blue tolerance ±25%			
	reducer TP flow rate 1.2l/min brown tolerance ±25%			
	reducer TP flow rate 1.5l/min light brown tolerance ±25%			
	reducer TP flow rate 2.5l/min yellow tolerance ±25%			
	reducer TP flow rate 3.4l/min dark green tolerance ±25%			
	reducer TP flow rate 5l/min black tolerance ±25%			
	reducer TP flow rate 8l/min blue tolerance ±20%			

solenoid valves with reducers			
	1		
<b>GEV No.</b>	374034	<b>Ref. No.</b>	0K3047
<b>description</b>	solenoid valve single angled 230VAC inlet 3/4" outlet 11.5mm input 10l/min output 0.25l/min t.max. 90°C RPE plastic flow regulating valve outlet red flow regulating valve inlet white		

	1		
<b>GEV No.</b>	370344	<b>Ref. No.</b>	002712
<b>description</b>	solenoid valve triple angled 230VAC inlet 3/4" outlet 11.5mm t.max. 90°C TP plastic output B 0.25l/min output C 1l/min flow regulating valve outlet B red flow regulating valve outlet C light blue		

	1		
<b>GEV No.</b>	370375	<b>Ref. No.</b>	0F0001
<b>description</b>	solenoid valve triple straight 230VAC inlet 3/4" outlet 11.5mm t.max. 90°C TP plastic output A 2.5l/min output C 0.25l/min flow regulating valve outlet A yellow flow regulating valve outlet C red		

metal			
BÜRKERT			
2-way			
6213 series			
	1		
<b>GEV No.</b>	370335	<b>Ref. No.</b>	0K0670
<b>description</b>	solenoid valve 2-ways 230VAC connection 3/8" DN 10mm slide-on receptacle DIN -30 up to 120°C BÜRKERT type series 6213 membranes EPDM p max 10bar 50Hz		

solenoid valves steam (water)			
2-way			
0407 series			
			
1			
<b>GEV No.</b>	370334	<b>Ref. No.</b>	OK1425
<b>description</b>	solenoid valve 2-ways 230VAC connection 1" DN 25mm slide-on receptacle DIN 180°C BÜRKERT type series 0407 membranes PTFE p max 10bar		

MÜLLER			
2-way			
			
1			
<b>GEV No.</b>	370035	<b>Ref. No.</b>	0H6405
<b>description</b>	solenoid valve 2-ways 230VAC inlet 3/4" ET outlet 1/2" IT L 57mm water MÜLLER		

			
1			
<b>GEV No.</b>	370036	<b>Ref. No.</b>	OK1420
<b>description</b>	solenoid valve 2-ways 230VAC inlet 3/4" ET outlet 1/2" IT L 57mm water MÜLLER		

solenoid valves (various)			
			
1			
<b>GEV No.</b>	370376	<b>Ref. No.</b>	0H6377 231015
<b>description</b>	solenoid valve double 230V		

			
1			
<b>GEV No.</b>	370377	<b>Ref. No.</b>	0H6376
<b>description</b>	solenoid valve inlet 2" outlet 2"		

solenoid valves (gas)			
KROMSCHRÖDER			
			
1			
<b>GEV No.</b>	101472 <sup>1</sup>	<b>Ref. No.</b>	0H6411
<b>description</b>	solenoid valve 230VAC connection M12x1 L 52mm KROMSCHRÖDER p max 0.36bar p min 0bar reg. no. CE-0085AP0975		

<sup>1</sup>aluminium housing

ball valves electric			
			
1			
<b>GEV No.</b>	401140	<b>Ref. No.</b>	005026
<b>description</b>	ball valve inlet 1" IT outlet 1" IT with plug 230V L 152mm 50/60Hz closed off-current mode of operation electric connection cable 200mm size DN25		

			
1			
<b>GEV No.</b>	401139	<b>Ref. No.</b>	0C0882
<b>description</b>	ball valve inlet 3/4" IT outlet 3/4" IT with plug 230V L 65mm 50/60Hz closed off-current mode of operation electric connection cable 200mm		



## pressure switches

for warewashing

ø 58mm with male faston 6.3mm

with connection horizontal



1

<b>GEV No.</b>	541179	<b>Ref. No.</b>	548267
<b>description</b>	pressure control pressure range 240/130mbar connection 6mm ø 58mm pressure connection horizontal warewashing pressure connection ø 6mm		

for gas equipment



1

<b>GEV No.</b>	541182	<b>Ref. No.</b>	0K1397
<b>description</b>	pressure control		



1

<b>GEV No.</b>	541073	<b>Ref. No.</b>	002635
<b>description</b>	pressure control ø 45mm pressure range adjustable 5-20mbar pressure connection vertical gas technology connection 1/4" pressure connection ø 1/4"mm		



1

<b>GEV No.</b>	541446	<b>Ref. No.</b>	005029
<b>description</b>	pressure control pressure range 10-50mbar connection 1/4"		



1

<b>GEV No.</b>	541075	<b>Ref. No.</b>	003772
<b>description</b>	pressure control pressure range adjustable 0.44-0.8mbar gas technology connection 6mm suitable for ZANUSSI		

for steam control



1

<b>GEV No.</b>	541043	<b>Ref. No.</b>	0H6696
<b>description</b>	pressure control ø 45mm pressure connection vertical steam control pressure range 0.44/0.38bar connection 1/4" pressure connection 1/4"		



1

<b>GEV No.</b>	541035	<b>Ref. No.</b>	0H6699
<b>description</b>	pressure control ø 45mm pressure range 0.9mbar pressure connection vertical steam control pressure range 0.75bar connection 1/4" difference 0.16bar pressure connection 1/4"		



1

<b>GEV No.</b>	541026	<b>Ref. No.</b>	0H6402
<b>description</b>	pressure control pressure connection vertical steam control pressure range adjustable 0.1-1.1bar pressure connection ø 3/8" ETmm		



1

<b>GEV No.</b>	541022	<b>Ref. No.</b>	0K1396
<b>description</b>	pressure control steam control pressure connection vertical pressure range adjustable 0.25-4.5bar connection 1/4" pressure connection 1/4" IT		





for boiling pans

			
1			
<b>GEV No.</b>	541459	<b>Ref. No.</b>	0G2935
<b>description</b>	pressure control with cable		

electrodes

			
1			
<b>GEV No.</b>	400698	<b>Ref. No.</b>	0H6629
<b>description</b>	level electrode 1/2" probe L 123mm insulated probe length 107mm		

			
1			
<b>GEV No.</b>	401258	<b>Ref. No.</b>	0A2838
<b>description</b>	level electrode 1/4" total length 120mm probe L 94mm insulated probe length 90mm PTFE insulated connection angled, male faston 6.3mm stainless steel ø 2.5mm		

			
1			
<b>GEV No.</b>	400121	<b>Ref. No.</b>	055346
<b>description</b>	level electrode 1/4" total length 121mm probe L 94mm insulated probe length 90mm PTFE insulated connection angled, male faston 6.3mm stainless steel		

			
1			
<b>GEV No.</b>	401261	<b>Ref. No.</b>	003878
<b>description</b>	level electrode 1/4" total length 138mm probe L 112mm insulated probe length 108mm PTFE insulated connection angled, male faston 6.3mm stainless steel ø 2.5mm		

			
1			
<b>GEV No.</b>	400402	<b>Ref. No.</b>	0H6624
<b>description</b>	level electrode 1/4" total length 193mm probe L 166mm insulated probe length 161mm PTFE insulated connection angled, male faston 6.3mm stainless steel ø 2.5mm		

			
1			
<b>GEV No.</b>	400403	<b>Ref. No.</b>	0H6625
<b>description</b>	level electrode 1/4" total length 210mm probe L 183mm insulated probe length 172mm PTFE insulated connection angled, male faston 6.3mm stainless steel ø 2.5mm		

			
1			
<b>GEV No.</b>	400404	<b>Ref. No.</b>	0H6635
<b>description</b>	level electrode 1/4" total length 240mm probe L 216mm insulated probe length 209mm PTFE insulated connection angled, male faston 6.3mm stainless steel ø 2.5mm		

			
1			
<b>GEV No.</b>	400405	<b>Ref. No.</b>	0H6626 246024
<b>description</b>	level electrode 1/4" total length 345mm probe L 320mm insulated probe length 310mm PTFE insulated connection F6.3 stainless steel ø 2.5mm		

			
1			
<b>GEV No.</b>	400120	<b>Ref. No.</b>	056449
<b>description</b>	level electrode 1/4" total length 83mm probe L 62mm insulated probe length 57mm PTFE insulated connection angled, male faston 6.3mm stainless steel ø 2.5mm		

			
1			
<b>GEV No.</b>	400012	<b>Ref. No.</b>	0H7090
<b>description</b>	level electrode probe L 35/20/11mm insulated probe length 11mm with 3 probes connection M4		

→ electric components

			
1			
<b>GEV No.</b>	400124	<b>Ref. No.</b>	002694
<b>description</b>	level electrode push-in total length 128mm probe L 103mm insulated probe length 93mm PTFE insulated connection F6.3 ø 2.5mm		

			
1			
<b>GEV No.</b>	401548	<b>Ref. No.</b>	005235
<b>description</b>	level electrode push-in total length 175mm probe L 151mm insulated probe length 142mm PTFE insulated connection F6.3 ø 2.5mm		

			
1			
<b>GEV No.</b>	378013	<b>Ref. No.</b>	0K4871
<b>description</b>	level electrode to clip		

			
1			
<b>GEV No.</b>	400011	<b>Ref. No.</b>	0H7101
<b>description</b>	level electrode total length 46mm insulated probe length 40mm with 3 probes connection M4		

			
1			
<b>GEV No.</b>	401260	<b>Ref. No.</b>	002632
<b>description</b>	level electrode total length 75mm probe L 50mm insulated probe length 46mm PTFE insulated connection angled, male faston 6.3mm ø 2.5mm		

			
1			
<b>GEV No.</b>	400123	<b>Ref. No.</b>	002633
<b>description</b>	spacer piece for level electrode		

			
1			
<b>GEV No.</b>	693744	<b>Ref. No.</b>	055435
<b>description</b>	spacer piece for level electrode size 5mm		

			
1			
<b>GEV No.</b>	693743	<b>Ref. No.</b>	055347
<b>description</b>	spacer piece for level electrode size 9mm		

## fans



### axial fans

#### ebm-papst

			
1			
<b>GEV No.</b>	601715 <sup>1</sup>	<b>Ref. No.</b>	002690
<b>description</b>	axial fan L 119mm W 119mm H 38mm 230VAC 50Hz 18W bearing ball bearing manuf. no. 4656ZW metal connection cable 310mm ebm-papst fan wheel ø 110mm temp.-resist. 75°C		

<sup>1</sup>with ball bearings

#### import

			
1			
<b>GEV No.</b>	601080 <sup>1</sup>	<b>Ref. No.</b>	0C4423
<b>description</b>	axial fan L 119mm W 119mm H 38mm 230VAC 50/60Hz 23/20W bearing ball bearing connection male faston 2.8mm metal ADDA fan wheel ø 110mm temp.-resist. 70°C		
<b>accessories for</b>	601080		
		<b>GEV No.</b>	550898
		<b>Ref. No.</b>	—
	connecting cable cable length 2000mm connection F 2.8 connection distance 7.9mm for axial flow fan		
		<b>GEV No.</b>	692519
		<b>Ref. No.</b>	—
	guard L 120mm W 120mm plastic		

<sup>1</sup>with ball bearings



cross flow fans

ebm-papst



1	<b>GEV No.</b>	601047	<b>Ref. No.</b>	0H6923
<b>description</b>	cross flow fan ebm-papst QLZ06/0600-2513 roller $\phi$ 60mm roller length 60mm laminated core thickness 13mm motor position right 230V/50Hz 17W refrigeration bearing rubber connection male faston 6.3mm airflow 40m <sup>3</sup> /h 0 up to +60°C			



1	<b>GEV No.</b>	601505	<b>Ref. No.</b>	0K5059
<b>description</b>	cross flow fan QLN65/2400A17-3030L roller $\phi$ 65mm roller length 240mm laminated core thickness 29mm motor position right 230V/50Hz 22W refrigeration bearing silicone connection F 6.3 0 up to +60°C 230V throughput 200m <sup>3</sup> /h 50Hz			

cross flow fan with heater battery

roller diameter  $\phi$ 60mm



1	<b>GEV No.</b>	601191	<b>Ref. No.</b>	0H6474
<b>description</b>	cross flow fan roller length 180mm roller $\phi$ 60mm motor position right 230V 50Hz 17W heat output 2000W bearing silicone with temperature limiter			

hot air motors

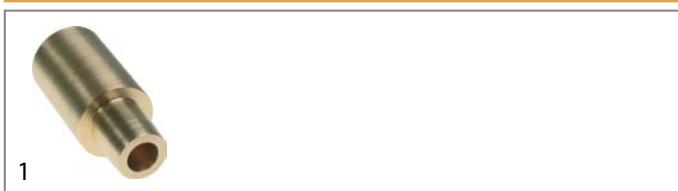

1	<b>GEV No.</b>	511313	<b>Ref. No.</b>	005132
<b>description</b>	centring piece for fan motor			



1	<b>GEV No.</b>	511302	<b>Ref. No.</b>	0H6643
<b>description</b>	engine shaft gasket ID $\phi$ 16mm ED $\phi$ 40mm for 55/56 series			



1	<b>GEV No.</b>	511314	<b>Ref. No.</b>	0H6862
<b>description</b>	engine shaft gasket ID $\phi$ 19mm ED $\phi$ 30mm for 54 series			



1	<b>GEV No.</b>	511303	<b>Ref. No.</b>	0H6644
<b>description</b>	engine shaft gasket ID $\phi$ 27mm ED $\phi$ 40mm for 55/56 series			



1	<b>GEV No.</b>	511315	<b>Ref. No.</b>	0H6513
<b>description</b>	engine shaft gasket ID $\phi$ 29mm ED $\phi$ 40mm for 54 series			

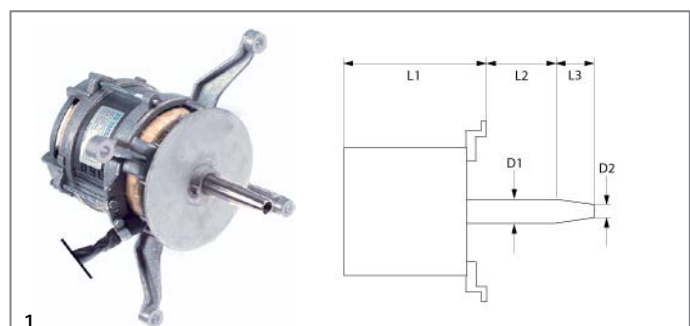

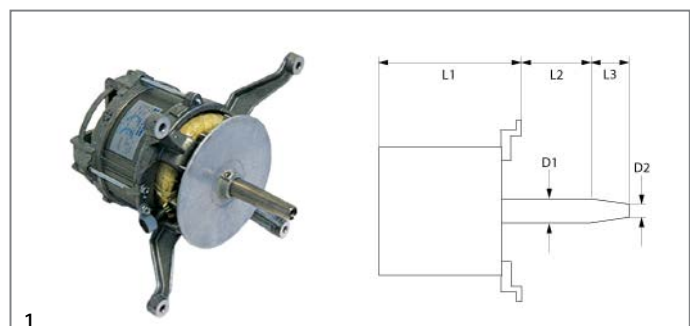

1	<b>GEV No.</b>	601351	<b>Ref. No.</b>	0K1912
<b>description</b>	fan motor 220-230V 3 phase 50Hz 0.02/0.16kW 710/1390rpm speeds 2 L1 150mm L2 27mm L3 35mm M10R IT 0.35/0.9A power input 60/250W at 50Hz 710/1390rpm type L7mw84D-149 no. R2 D1 $\phi$ 17mm D2 $\phi$ 13mm			

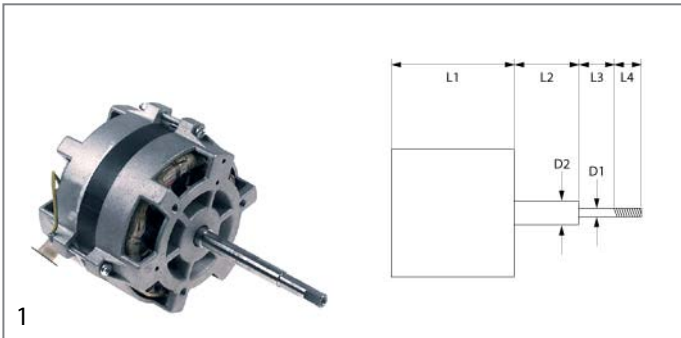

1	<b>GEV No.</b>	500103	<b>Ref. No.</b>	0H6929
<b>description</b>	fan motor 220-240/380-415V 3 phase 50/60Hz 0.25kW 1400rpm speeds 1 L1 150mm L2 32mm L3 40mm $\phi$ 125mm M10R IT at 50Hz 1400rpm at 60Hz 1700rpm type L7Aw4D-099 no. X3 D1 $\phi$ 17mm D2 $\phi$ 14mm			



<b>GEV No.</b>	601449	<b>Ref. No.</b>	058667
<b>description</b>	fan motor 220-240/380-415V 3 phase 50Hz 0.19kW 1350rpm speeds 1 L1 105mm L2 74mm L3 35mm L4 12mm D1 $\varnothing$ 9x10mm D2 $\varnothing$ 12mm M6R IT 0.58/1A type FIR1092 no. 1092 shaft flat length 9mm		
<b>accessories for</b>	601449		
	<b>GEV No.</b>	693846	<b>Ref. No.</b> —
	spacer piece for fan motor		
	<b>GEV No.</b>	693847	<b>Ref. No.</b> —
	fixing plate for hot air motors ED $\varnothing$ 230mm H 2.5mm ID $\varnothing$ 16mm		
	<b>GEV No.</b>	694297	<b>Ref. No.</b> —
	flange for hot air motors ED $\varnothing$ 270mm H 3.5mm ID $\varnothing$ 16mm		

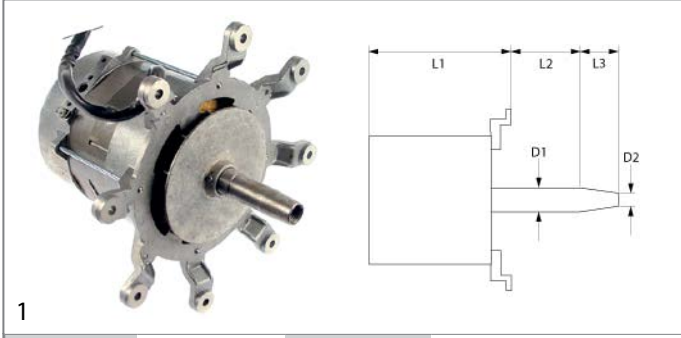

<b>GEV No.</b>	500836	<b>Ref. No.</b>	0H6925 280125
<b>description</b>	fan motor 220-240/380-415V 3 phase 50Hz 0.37kW 1400rpm speeds 1 L1 175mm L2 47mm L3 31mm M14R IT 2.85/1.65A power input 580W Cos(fi) 0.55 at 50Hz 1400rpm type L9Cw4D-037 no. S2 D1 $\varnothing$ 23mm D2 $\varnothing$ 20mm		

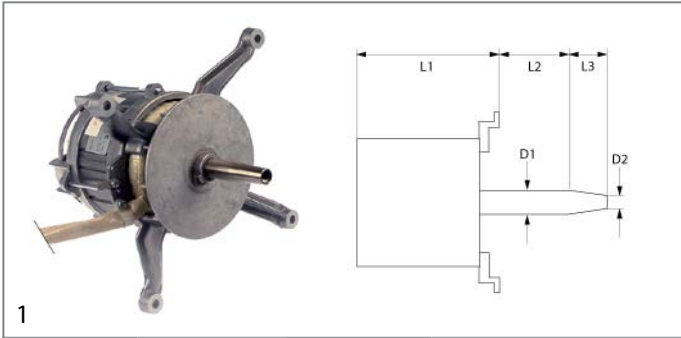

<b>GEV No.</b>	601366	<b>Ref. No.</b>	0K2720 280159
<b>description</b>	fan motor 220-240V 3 phase 50/60HzkW speeds 1 L1 140mm L2 27mm L3 35mm M10R IT Y/YY type L7mw84D-098 no. RD D1 $\varnothing$ 17mm D2 $\varnothing$ 13mm		

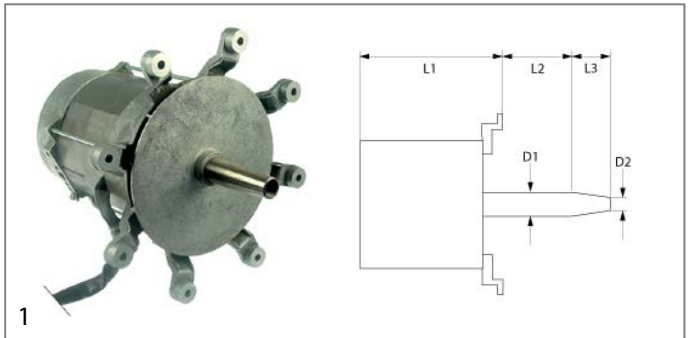

<b>GEV No.</b>	601370	<b>Ref. No.</b>	0K2716
<b>description</b>	fan motor 220-240V 3 phase 50HzkWrpm speeds 2 L1 221mm L2 27mm L3 50mm D1 $\varnothing$ 25mm D2 $\varnothing$ 20mm M14R IT Y/YY type L9UWID-13		

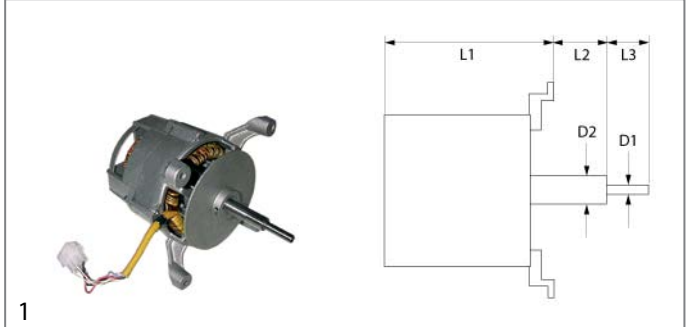

<b>GEV No.</b>	500141	<b>Ref. No.</b>	0F0007
<b>description</b>	fan motor 230V 1 phase 50/60Hz 0.19kW 1450/1750rpm speeds 1 L1 150mm L2 52mm L3 35mm D1 $\varnothing$ 9/10mm D2 $\varnothing$ 14mm M6R IT 1.3A Cos(fi) 0.91 at 50Hz 1450rpm at 60Hz 1750rpm type LM80/4 no. 596477 shaft flat length 12mm		

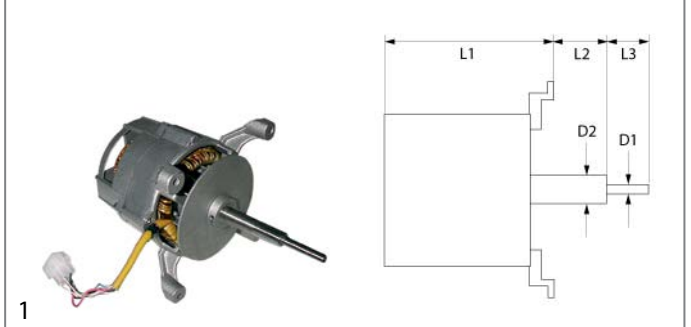

<b>GEV No.</b>	500143	<b>Ref. No.</b>	002739
<b>description</b>	fan motor 230V 1 phase 50/60Hz 0.35kW 1400/1700rpm speeds 1 L1 165mm L2 91mm L3 35mm D1 $\varnothing$ 9/10mm D2 $\varnothing$ 16mm M6R IT 2.7A Cos(fi) 0.9 at 50Hz 230V at 60Hz 230V at 50Hz 1400rpm at 60Hz 1700rpm suitable capacitor 16 $\mu$ F/450V type LM80/4 no. 556749 shaft flat length 13mm		

1

<b>GEV No.</b>	500142	<b>Ref. No.</b>	005028
<b>description</b>	fan motor 230V 1 phase 50Hz 0.06/0.19kW 930/1380rpm speeds 2 L1 160mm L2 52mm L3 35mm D1 $\varnothing$ 9/10mm D2 $\varnothing$ 16mm M6R IT 1.5/0.7A Cos(f) 0.9 at 50Hz 930/1380rpm at 60Hz 1100/1700rpm suitable capacitor 12.5 $\mu$ F/400V 4P/6P type LM/FB80 no. 552059 shaft flat length 12mm		

1

<b>GEV No.</b>	500108	<b>Ref. No.</b>	0H6930
<b>description</b>	fan motor 380-415V 3 phase 50/60Hz 0.03/0.2kWrpm speeds 2 L1 155mm L2 30mm L3 31mm M10R IT Y/YY type L7mw84D-097 no. V5 D1 $\varnothing$ 17mm D2 $\varnothing$ 13mm		

2

<b>GEV No.</b>	500144	<b>Ref. No.</b>	002748
<b>description</b>	fan motor 230V 1 phase 50Hz 0.11/0.35kW 900/1400rpm speeds 2 L1 165mm L2 91mm L3 35mm D1 $\varnothing$ 9/10mm D2 $\varnothing$ 16mm M6R IT 2.7/1.3A at 50Hz 230V at 60Hz 230V at 50Hz 900/1400rpm at 60Hz 1080/1680rpm suitable capacitor 16 $\mu$ F/450V 4P/6P type LM/FB80 no. 358008 shaft flat length 12mm		

1

<b>GEV No.</b>	601367	<b>Ref. No.</b>	0H6933
<b>description</b>	fan motor 380-415V 3 phase 50/60HzkWrpm speeds 2 L1 175mm L2 25mm L3 48mm M14R IT Y/YY type L9rw84D-094 no. U3 D1 $\varnothing$ 25mm D2 $\varnothing$ 20mm		

1

<b>GEV No.</b>	601352	<b>Ref. No.</b>	0H6555
<b>description</b>	fan motor 380-400V 3 phase 50Hz 0.02/0.16kW 710/1390rpm speeds 2 L1 140mm L2 27mm L3 35mm M10R IT 0.2/0.5A power input 60/250W at 50Hz 710/1390rpm Y/YY type L7mw84D-148 no. T1 D1 $\varnothing$ 17mm D2 $\varnothing$ 13mm		

1

<b>GEV No.</b>	602139	<b>Ref. No.</b>	0H6932	
<b>description</b>	fan motor 440-480V 3 phase 60Hz 0.37kW 1600rpm L1 185mm L2 26mm L3 50mm type L9Cw4D-157 D1 $\varnothing$ 25mm D2 $\varnothing$ 20mm			
<b>accessories for</b>	602139			
	<b>GEV No.</b>	510574	<b>Ref. No.</b>	—
	shaft sealing type 20 for fan motor			



1

<b>GEV No.</b>	601365	<b>Ref. No.</b>	0G1989
<b>description</b>	fan wheel D1 ø 225mm H1 60mm blades 12 D2 ø 19,5mm D3 ø 23mm H2 25,5mm		



1

<b>GEV No.</b>	601220	<b>Ref. No.</b>	0C6462
<b>description</b>	fan wheel D1 ø 280mm H1 100mm blades 6 D2 ø 10mm D3 ø 10mm H2 37mm H3 22mm		



1

<b>GEV No.</b>	601371	<b>Ref. No.</b>	002871 0C8325
<b>description</b>	fan wheel D1 ø 280mm H1 100mm blades 6 D2 ø 10mm D3 ø 10mm H2 37mm H3 23mm		



1

<b>GEV No.</b>	601344	<b>Ref. No.</b>	0H6507
<b>description</b>	fan wheel D1 ø 280mm H1 127mm blades 12 D2 ø 13mm D3 ø 16mm H2 37mm		



1

<b>GEV No.</b>	601343	<b>Ref. No.</b>	0H6510 237146
<b>description</b>	fan wheel D1 ø 350mm H1 127mm blades 6 D2 ø 13mm D3 ø 16mm H2 37mm		



1

<b>GEV No.</b>	601342	<b>Ref. No.</b>	0H6947
<b>description</b>	fan wheel D1 ø 450mm H1 178mm blades 6 D2 ø 19,5mm D3 ø 23,5mm H2 45mm		



1

<b>GEV No.</b>	511300	<b>Ref. No.</b>	002873
<b>description</b>	O-ring Viton thickness 3.53mm ID ø 28.17mm for 57 series for motor shaft		



1

<b>GEV No.</b>	511301	<b>Ref. No.</b>	002699
<b>description</b>	shaft seal ID ø 16mm ED ø 38mm thickness 18mm		

hot air fans

HEIDOLPH



1

<b>GEV No.</b>	500147	<b>Ref. No.</b>	0H6926
<b>description</b>	hot air fan 230V 37W D 85mm distance fan wheel - fixing 40mm mounting distance 28mm HEIDOLPH type 113.30.000431B		



miscellaneous

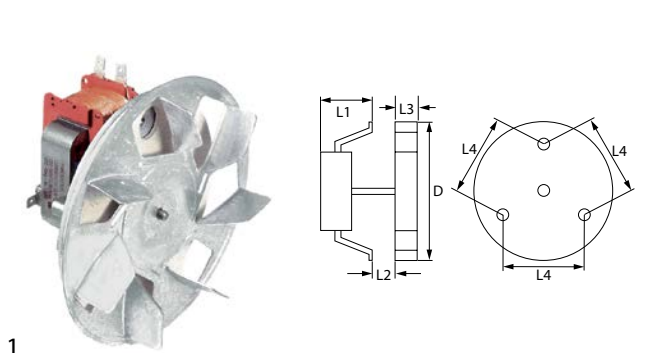

1

<b>GEV No.</b>	601273	<b>Ref. No.</b>	OK3048
<b>description</b>	hot air fan 220-240V 32W 50/60Hz L1 60mm L2 10mm L3 25mm L4 87mm fan wheel ø 155mm FIME type C20X0E01/15CLH		

accessories

fan wheels for hot air fans



1

<b>GEV No.</b>	601346	<b>Ref. No.</b>	0H6951
<b>description</b>	fan wheel ø 180mm W 27mm shaft intake ø 7mm blades 8		

radial fans

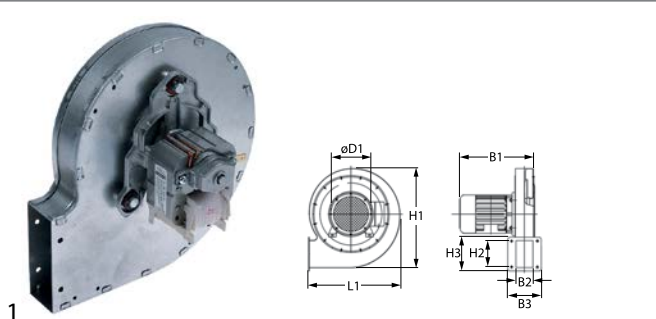

1

<b>GEV No.</b>	601238	<b>Ref. No.</b>	002639
<b>description</b>	radial fan 230V voltage AC 50Hz 40W H1 205mm L1 205mm D1 ø 150mm W1 103mm W2 32mm H2 83mm W3 34mm H3 86mm		

motors

gear motors

for tilting bratt pans



1

<b>GEV No.</b>	500618	<b>Ref. No.</b>	OK2747 280793
<b>description</b>	gear motor for tilting bratt pan		

miscellaneous



1

<b>GEV No.</b>	500620	<b>Ref. No.</b>	OK4843
<b>description</b>	gear motor for kettle		

spindle motors

MAGNETIC



1

<b>GEV No.</b>	500672	<b>Ref. No.</b>	0H6953
<b>description</b>	spindle motor type DSP4550-200-01 280W 400V 50Hz 3 phase shaft ø 30mm for tilting bratt pan L 450mm W 100mm H 185mm hub 200mm MAGNETIC		

condensators & interference suppression filters

operating capacitors

metal



1

<b>GEV No.</b>	365140	<b>Ref. No.</b>	047541
<b>description</b>	operating capacitor capacity 12.5µF 450V tolerance 5% 60Hz ambient temperature max. -25 up to +70°C ø 40mm L 83mm M8 aluminium connection male faston 6.3mm C.87.8BF2 MKP protection		



1

<b>GEV No.</b>	365003	<b>Ref. No.</b>	OK2387
<b>description</b>	operating capacitor capacity 6µF 400V tolerance 5% 50/60Hz ambient temperature max. -25 to +85°C ø 30mm L 85mm M8 aluminium connection cable 300mm MKP protection IP65		



## fuses

### fine fuses

			
1			
<b>GEV No.</b>	358610	<b>Ref. No.</b>	058869
<b>description</b>	fine fuse size ø5x20mm 10A fast-acting rated 250V Qty 10 pcs		

			
1			
<b>GEV No.</b>	358611	<b>Ref. No.</b>	005136
<b>description</b>	fine fuse size ø5x20mm 16A fast-acting rated 250V Qty 10 pcs		

			
1			
<b>GEV No.</b>	358695	<b>Ref. No.</b>	005032
<b>description</b>	fine fuse size ø5x20mm 3.15A medium lag rated 250V Qty 10 pcs		

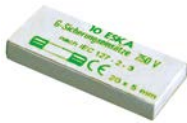
			
1			
<b>GEV No.</b>	358594	<b>Ref. No.</b>	002820
<b>description</b>	fine fuse size ø5x20mm 0.16A slow-acting rated 250V Qty 10 pcs		

			
1			
<b>GEV No.</b>	358596	<b>Ref. No.</b>	002920
<b>description</b>	fine fuse size ø5x20mm 0.25A slow-acting rated 250V Qty 10 pcs		

### fine fuse holders

			
1			
<b>GEV No.</b>	358396	<b>Ref. No.</b>	056582
<b>description</b>	fuse holder suitable fuse ø5x20mm ø 15mm mounting ø 12.5mm 16A rated 250V L 46mm connection male faston 4.8mm		

			
1			
<b>GEV No.</b>	358394	<b>Ref. No.</b>	0H6523
<b>description</b>	fuse holder suitable fuse ø5x30mm mounting ø 18.3mm 6.3A rated 500V connection F2.8		

			
1			
<b>GEV No.</b>	358395	<b>Ref. No.</b>	0H6526
<b>description</b>	screw cap suitable fuse ø 14.5mm mounting ømm thread M9x1 6.3A rated 250V connection suitable for fuse holder		

### overload switches

			
1			
<b>GEV No.</b>	358519	<b>Ref. No.</b>	0H6691
<b>description</b>	overload switch drop-away current 0.05A		

			
1			
<b>GEV No.</b>	358523	<b>Ref. No.</b>	0H6104
<b>description</b>	overload switch drop-away current 0.6A		

## electric accessories

### cables

#### copper wire

up to 200°C

			
1			
<b>GEV No.</b>	550081	<b>Ref. No.</b>	0K3285
<b>description</b>	copper wire 1.5mm <sup>2</sup> permanent temperature -60 up to +200°C conductor nickel-plated copper wire insulation glass fibre braiding/silicone rubber Qty 10m green/yellow t.max. 250°C rated 300/500V test voltage 2000V		

#### cable harnesses

			
1			
<b>GEV No.</b>	401849	<b>Ref. No.</b>	002763
<b>description</b>	connecting cable		



terminals and connectors

insulated

ring terminals



<b>GEV No.</b>	550166	<b>Ref. No.</b>	OK2459
<b>description</b>	ring terminal size M6 ø6.5mm 1.5-2.5mm <sup>2</sup> Qty 100 pcs insulation PVC Cu gal Sn blue t.max. 75°C		

not insulated

bullet connectors



<b>GEV No.</b>	550334	<b>Ref. No.</b>	0H7029
<b>description</b>	plug connector size 3.5mm 0.25-1.5mm <sup>2</sup> Cu gal Sn t.max. 125°C Qty 1 pcs		

plug connectors



<b>GEV No.</b>	550328	<b>Ref. No.</b>	0H7030
<b>description</b>	female bullet ø 3.5mm		



<b>GEV No.</b>	550330	<b>Ref. No.</b>	0H7027
<b>description</b>	plug connector 12-pole		



<b>GEV No.</b>	550333	<b>Ref. No.</b>	0H7028
<b>description</b>	plug connector 12-pole		



<b>GEV No.</b>	550334	<b>Ref. No.</b>	0H7029
<b>description</b>	plug connector size 3.5mm 0.25-1.5mm <sup>2</sup> Cu gal Sn t.max. 125°C Qty 1 pcs		

electronic components

resistors



<b>GEV No.</b>	359929	<b>Ref. No.</b>	058872
<b>description</b>	resistor 100Ohm		

gas taps

PEL

20S series



<b>GEV No.</b>	101094	<b>Ref. No.</b>	054109
<b>description</b>	gas tap PEL type 20S gas inlet M16x1.5 (tube ø 10mm) bypass nozzle ø 0.35mm gas outlet M16x1.5 (tube ø 10/8mm) thermocouple connection M8x1 pilot connection shaft ø 8x6.5mm shaft L 22/15mm shaft flat lower		

<b>spare parts for</b>	101094		
<b>GEV No.</b>	100408	<b>Ref. No.</b>	—

<b>description</b>	bypass nozzle type PEL20/21 bore ø 0.35mm thread M5x0.5		
--------------------	---	--	--

<b>GEV No.</b>	101060	<b>Ref. No.</b>	056595
<b>description</b>	magnet unit standard L 39mm D1 ø 15.4mm D2 ø 11mm suitable for PEL20-21/JUNKERS/EGA		

<b>GEV No.</b>	101205	<b>Ref. No.</b>	—
<b>description</b>	gas tap front part shaft ø 8x6.5mm shaft L 22/15mm shaft flat upper/lower suitable for PEL20		

<b>GEV No.</b>	101230	<b>Ref. No.</b>	—
<b>description</b>	thermocouple nut T1: M8x1 T2: M18x1 aluminium		

<b>accessories for</b>	101094		
<b>GEV No.</b>	101278	<b>Ref. No.</b>	060325

<b>description</b>	olive for pipe ø 10mm Qty 1 pcs		
--------------------	---------------------------------	--	--

<b>GEV No.</b>	101300	<b>Ref. No.</b>	—
<b>description</b>	union nut thread M16x1.5 tube ø 10mm		

<b>GEV No.</b>	101450	<b>Ref. No.</b>	—
<b>description</b>	olive for pipe ø 8mm L 12.7mm Qty 1 pcs ED ø 10mm		

<b>GEV No.</b>	101451	<b>Ref. No.</b>	—
<b>description</b>	union nut thread M16x1.5 tube ø 8mm		



<b>GEV No.</b>	110081	<b>Ref. No.</b>	—
<b>description</b>	knob ø 70mm shaft ø 8x6.5mm shaft flat universal		

<b>GEV No.</b>	110083	<b>Ref. No.</b>	—
<b>description</b>	knob dial plate gas tap without ignition flame silver		



## 22S/V series

			
1			
<b>GEV No.</b>	101087	<b>Ref. No.</b>	053192
<b>description</b>	gas tap PEL type 22S/V gas inlet M20x1.5 (tube ø 12mm) bypass nozzle ø 0.35mm gas outlet M20x1.5 (tube ø 12/10mm) thermocouple connection M9x1 pilot connection M10x1 shaft ø 10x8mm shaft L 25/17mm shaft flat upper		
<b>spare parts for</b>	101087		
	<b>GEV No.</b>	100259	<b>Ref. No.</b> —
	bypass nozzle type PEL22 bore ø 0.35mm thread M6x0.5		
	<b>GEV No.</b>	101058	<b>Ref. No.</b> 056594
	magnet unit L 39mm D1 ø 15.4mm D2 ø 13.5mm suitable for PEL22/EGA24197 standard		
	<b>GEV No.</b>	101201	<b>Ref. No.</b> —
	gas tap front part shaft ø 10x8mm shaft L 25/17mm shaft flat upper/lower suitable for PEL22		
	<b>GEV No.</b>	101231	<b>Ref. No.</b> —
	thermocouple nut T1: M9x1 T2: M18x1		
	<b>GEV No.</b>	101241	<b>Ref. No.</b> —
	gas connection thread M20x1.5 tube ø 12/10mm for PEL gas taps vertical		
	<b>GEV No.</b>	101460	<b>Ref. No.</b> —
	O-ring ø 12.37mm D1 ø 2.62mm suitable for PEL22		
	<b>GEV No.</b>	101461	<b>Ref. No.</b> —
	screw kit suitable for PEL22 Qty 4 pcs		
<b>accessories for</b>	101087		
	<b>GEV No.</b>	100908	<b>Ref. No.</b> 052125
	union screw thread M10x1 for pipe ø 4mm Qty 1 pcs		
	<b>GEV No.</b>	100909	<b>Ref. No.</b> —
	union screw thread M10x1 for pipe ø 6mm Qty 1 pcs		
	<b>GEV No.</b>	101240	<b>Ref. No.</b> —
	gas connection thread M20x1.5 tube ø 12/10mm for PEL gas taps with gasket and screws horizontal		
	<b>GEV No.</b>	101246	<b>Ref. No.</b> —
	olive for pipe ø 4mm Qty 1 pcs		
	<b>GEV No.</b>	101248	<b>Ref. No.</b> 050682
	olive for pipe ø 12mm Qty 1 pcs suitable for PEL		
	<b>GEV No.</b>	101249	<b>Ref. No.</b> —
	olive for pipe ø 10mm Qty 1 pcs		
	<b>GEV No.</b>	101250	<b>Ref. No.</b> —
	union nut thread M20x1.5 for pipe ø 10mm		
	<b>GEV No.</b>	101251	<b>Ref. No.</b> —
	union nut thread M20x1.5 for pipe ø 12mm		

<b>accessories for</b>	101087		
	<b>GEV No.</b>	101286	<b>Ref. No.</b> —
	olive ID ø 6mm Qty 1 pcs		
	<b>GEV No.</b>	110080	<b>Ref. No.</b> —
	knob ø 70mm shaft ø 10x8mm shaft flat universal		
	<b>GEV No.</b>	112206	<b>Ref. No.</b> —
	knob dial plate silver gas tap PEL21/22/23 t.max.°C ED ø 63mm ID ø 45.5mm		

## 23S/O series

















			
1			
<b>GEV No.</b>	101091	<b>Ref. No.</b>	054811
<b>description</b>	gas tap PEL type 23S/O gas inlet M28x1.5 (tube ø 20mm) bypass nozzle ø 0.35mm gas outlet M24x1.5 (tube ø 16mm) thermocouple connection M9x1 pilot connection M10x1 shaft ø 10x8mm shaft L 35/19mm shaft flat upper		
<b>spare parts for</b>	101091		
	<b>GEV No.</b>	100455	<b>Ref. No.</b> —
	bypass nozzle type PEL23/24 bore ø 0.35mm thread M8x0.5		
	<b>GEV No.</b>	101045	<b>Ref. No.</b> —
	magnet unit T1: M9x1 T2: M22x1 L 46mm ø 18mm suitable for PEL23S M9x1		
	<b>GEV No.</b>	101244	<b>Ref. No.</b> —
	gas connection thread M24x1.5 tube ø 12/16mm horizontal for PEL gas taps		
	<b>GEV No.</b>	101336	<b>Ref. No.</b> —
	gas tap front part shaft ø 10x8mm shaft L 35/17mm shaft flat upper/lower suitable for PEL23S		
	<b>GEV No.</b>	101463	<b>Ref. No.</b> —
	screw suitable for PEL23S Qty 4 pcs		
	<b>GEV No.</b>	528455	<b>Ref. No.</b> —
	O-ring Viton thickness 2.62mm ID ø 18.72mm Qty 1 pcs		
<b>accessories for</b>	101091		
	<b>GEV No.</b>	100908	<b>Ref. No.</b> 052125
	union screw thread M10x1 for pipe ø 4mm Qty 1 pcs		
	<b>GEV No.</b>	100909	<b>Ref. No.</b> —
	union screw thread M10x1 for pipe ø 6mm Qty 1 pcs		
	<b>GEV No.</b>	101246	<b>Ref. No.</b> —
	olive for pipe ø 4mm Qty 1 pcs		
	<b>GEV No.</b>	101252	<b>Ref. No.</b> —
	union nut thread M24x1.5 for pipe ø 12mm		
	<b>GEV No.</b>	101253	<b>Ref. No.</b> —
	union nut thread M24x1.5 PEL for pipe ø 16mm		

Table continues overleaf













accessories for		101091		
	GEV No.	101254	Ref. No.	—
union nut thread M28x1.5 tube ø 20mm				
	GEV No.	101255	Ref. No.	—
olive for pipe ø 12mm Qty 1 pcs				
	GEV No.	101256	Ref. No.	—
olive for pipe ø 16mm Qty 1 pcs				
	GEV No.	101257	Ref. No.	—
olive for pipe ø 20mm Qty 1 pcs				
	GEV No.	101286	Ref. No.	—
olive ID ø 6mm Qty 1 pcs				
	GEV No.	110080	Ref. No.	—
knob ø 70mm shaft ø 10x8mm shaft flat universal				
	GEV No.	112206	Ref. No.	—
knob dial plate silver gas tap PEL21/22/23 t.max.°C ED ø 63mm ID ø 45.5mm				









accessories for		101630		
	GEV No.	101246	Ref. No.	—
olive for pipe ø 4mm Qty 1 pcs				
	GEV No.	101286	Ref. No.	—
olive ID ø 6mm Qty 1 pcs				
	GEV No.	110064	Ref. No.	—
knob				
	GEV No.	110066	Ref. No.	—
knob screw				
	GEV No.	550396	Ref. No.	—
shaft extension L 25mm JUNKERS				

## alternatives to EGA

### GPEL20 series

#### with pipe outlet

				
1				
<b>GEV No.</b>	101608	<b>Ref. No.</b>	0H6700	
<b>description</b>	gas tap alternatives to EGA type GPEL20R with pipe outlet without ignition flame connection gas inlet M15x1 (tube ø 10mm) bypass nozzle ø 0.35mm gas outlet M17x1 (tube ø 10mm) thermocouple connection M8x1 shaft ø 8x7mm shaft L 34/15mm shaft flat lower			
<b>spare parts for</b>	101608			
	GEV No.	100408	Ref. No.	—
bypass nozzle type PEL20/21 bore ø 0.35mm thread M5x0.5				
	GEV No.	101060	Ref. No.	056595
magnet unit standard L 39mm D1 ø 15.4mm D2 ø 11mm suitable for PEL20-21/JUNKERS/EGA				
	GEV No.	101230	Ref. No.	—
thermocouple nut T1: M8x1 T2: M18x1 aluminium				
<b>accessories for</b>	101608			
	GEV No.	100926	Ref. No.	—
centring piece thread M17x1				
	GEV No.	100942	Ref. No.	—
union nut thread M15x1 for pipe ø 10mm				
	GEV No.	100943	Ref. No.	—
union nut thread M17x1 tube ø 10mm				
	GEV No.	101278	Ref. No.	060325
olive for pipe ø 10mm Qty 1 pcs				

23S/V series				
				
1				
<b>GEV No.</b>	101630	<b>Ref. No.</b>	0K9985	
<b>description</b>	gas tap PEL type 23S/V gas inlet 1/2" IT bypass nozzle ø 0.35mm gas outlet 1/2" MT (tube ø 14mm) thermocouple connection M10x1 pilot connection M10x1 shaft ø 10mm shaft L 25mm shaft flat			
<b>spare parts for</b>	101630			
	GEV No.	100455	Ref. No.	—
bypass nozzle type PEL23/24 bore ø 0.35mm thread M8x0.5				
	GEV No.	101059	Ref. No.	—
magnet unit T1: M10x1 T2: M22x1 L 46mm ø 18mm suitable for PEL23S M10x1				
	GEV No.	102767	Ref. No.	—
gas tap front part shaft ø 10mm shaft L 26.5mm shaft flat suitable for PEL23S				
<b>accessories for</b>	101630			
	GEV No.	100908	Ref. No.	052125
union screw thread M10x1 for pipe ø 4mm Qty 1 pcs				
	GEV No.	100909	Ref. No.	—
union screw thread M10x1 for pipe ø 6mm Qty 1 pcs				
	GEV No.	100945	Ref. No.	—
roll pin ø 3.2mm L 10mm				
	GEV No.	101218	Ref. No.	—
shaft extension JUNKERS				
	GEV No.	101219	Ref. No.	—
shaft extension L 25mm JUNKERS				

















## GPEL21 series

with nozzle outlet

















1

GEV No.	101983	Ref. No.	0H6397
<b>description</b>	gas tap alternatives to EGA type GPEL21D with nozzle outlet (with nozzle) gas inlet M15x1 (tube ø 10mm) external nozzle ø 1.35mm internal nozzle ø 0.66mm bypass nozzle ø 0.35mm mixing pipe connection M17x1 thermocouple connection M10x1 pilot connection M10x1 shaft ø 8x7mm shaft L 34/15mm shaft flat lower		
<b>spare parts for</b>	101983		
	GEV No.	100300	Ref. No. 0G1792
	gas injector thread M12x1 WS 14 bore ø 1.35mm		
	GEV No.	100310	Ref. No. 0H6356
	internal nozzle bore ø 0.66mm suitable for EGA26400/26440		
	GEV No.	100408	Ref. No. —
	bypass nozzle type PEL20/21 bore ø 0.35mm thread M5x0.5		
	GEV No.	100908	Ref. No. 052125
	union screw thread M10x1 for pipe ø 4mm Qty 1 pcs		
	GEV No.	100927	Ref. No. —
	torsion spring L 2.8-8.0mm for internal nozzle ø 3mm bore ømm		
	GEV No.	101233	Ref. No. 0K2512
	union nut thread M10x1 JUNKERS		
	GEV No.	101246	Ref. No. —
	olive for pipe ø 4mm Qty 1 pcs		
	GEV No.	101526	Ref. No. —
	O-ring Viton thickness 1.78mm ID ø 4.48mm Qty 1 pcs		
	GEV No.	101593	Ref. No. —
	adjusting screw for internal nozzle thread M8x0.75		
	GEV No.	101806	Ref. No. —
	gas tap front part shaft ø 8x7mm shaft L 34/15mm shaft flat upper/lower suitable for PEL21		
<b>accessories for</b>	101983		
	GEV No.	100909	Ref. No. —
	union screw thread M10x1 for pipe ø 6mm Qty 1 pcs		
	GEV No.	100926	Ref. No. —
	centring piece thread M17x1		
	GEV No.	100942	Ref. No. —
	union nut thread M15x1 for pipe ø 10mm		
	GEV No.	101278	Ref. No. 060325
	olive for pipe ø 10mm Qty 1 pcs		
	GEV No.	101286	Ref. No. —
	olive ID ø 6mm Qty 1 pcs		







1

GEV No.	101668	Ref. No.	0H6399
<b>description</b>	gas tap alternatives to EGA type GPEL21D with nozzle outlet (with nozzle) gas inlet M15x1 (tube ø 10mm) external nozzle ø 1.35mm internal nozzle ø 1.2mm bypass nozzle ø 0.35mm mixing pipe connection M17x1 thermocouple connection M10x1 pilot connection M10x1 shaft ø 8x7mm shaft L 34/15mm shaft flat lower tube ø 10mm shaft length knob 15mm		
<b>spare parts for</b>	101668		
	GEV No.	100300	Ref. No. 0G1792
	gas injector thread M12x1 WS 14 bore ø 1.35mm		
	GEV No.	100313	Ref. No. 0K1252
	internal nozzle bore ø 1.20mm suitable for EGA26400/26440		
	GEV No.	100908	Ref. No. 052125
	union screw thread M10x1 for pipe ø 4mm Qty 1 pcs		
	GEV No.	100927	Ref. No. —
	torsion spring L 2.8-8.0mm for internal nozzle ø 3mm bore ømm		
	GEV No.	101060	Ref. No. 056595
	magnet unit standard L 39mm D1 ø 15.4mm D2 ø 11mm suitable for PEL20-21/JUNKERS/EGA		
	GEV No.	101233	Ref. No. 0K2512
	union nut thread M10x1 JUNKERS		
	GEV No.	101246	Ref. No. —
	olive for pipe ø 4mm Qty 1 pcs		
	GEV No.	101526	Ref. No. —
	O-ring Viton thickness 1.78mm ID ø 4.48mm Qty 1 pcs		
	GEV No.	101593	Ref. No. —
	adjusting screw for internal nozzle thread M8x0.75		
	GEV No.	101806	Ref. No. —
	gas tap front part shaft ø 8x7mm shaft L 34/15mm shaft flat upper/lower suitable for PEL21		
<b>accessories for</b>	101668		
	GEV No.	100909	Ref. No. —
	union screw thread M10x1 for pipe ø 6mm Qty 1 pcs		
	GEV No.	100926	Ref. No. —
	centring piece thread M17x1		
	GEV No.	100942	Ref. No. —
	union nut thread M15x1 for pipe ø 10mm		
	GEV No.	101278	Ref. No. 060325
	olive for pipe ø 10mm Qty 1 pcs		
	GEV No.	101286	Ref. No. —
	olive ID ø 6mm Qty 1 pcs		



			
1			
<b>GEV No.</b>	101642	<b>Ref. No.</b>	0H6395
<b>description</b>	gas tap alternatives to EGA type GPEL21D with nozzle outlet (with nozzle) gas inlet M15x1 (tube ø 10mm) external nozzle ø 1.55mm internal nozzle ø 0.8mm bypass nozzle ø 0.45mm mixing pipe connection M17x1 thermocouple connection M10x1 pilot connection M10x1 shaft ø 8x7mm shaft L 34/15mm shaft flat lower		
<b>spare parts for</b>	101642		
	<b>GEV No.</b>	100301	<b>Ref. No.</b> —
	gas injector thread M12x1 WS 14 bore ø 1.55mm		
	<b>GEV No.</b>	100311	<b>Ref. No.</b> 0H6372
	internal nozzle bore ø 0.80mm suitable for EGA26400/26440		
	<b>GEV No.</b>	100554	<b>Ref. No.</b> —
	bypass nozzle type PEL20/21 bore ø 0.45mm thread M5x0.5		
	<b>GEV No.</b>	100908	<b>Ref. No.</b> 052125
	union screw thread M10x1 for pipe ø 4mm Qty 1 pcs		
	<b>GEV No.</b>	100927	<b>Ref. No.</b> —
	torsion spring L 2.8-8.0mm for internal nozzle ø 3mm bore ømm		
	<b>GEV No.</b>	101060	<b>Ref. No.</b> 056595
	magnet unit standard L 39mm D1 ø 15.4mm D2 ø 11mm suitable for PEL20-21/JUNKERS/EGA		
	<b>GEV No.</b>	101233	<b>Ref. No.</b> 0K2512
	union nut thread M10x1 JUNKERS		
	<b>GEV No.</b>	101246	<b>Ref. No.</b> —
	olive for pipe ø 4mm Qty 1 pcs		
	<b>GEV No.</b>	101526	<b>Ref. No.</b> —
	O-ring Viton thickness 1.78mm ID ø 4.48mm Qty 1 pcs		
	<b>GEV No.</b>	101593	<b>Ref. No.</b> —
	adjusting screw for internal nozzle thread M8x0.75		
	<b>GEV No.</b>	101806	<b>Ref. No.</b> —
	gas tap front part shaft ø 8x7mm shaft L 34/15mm shaft flat upper/lower suitable for PEL21		
<b>accessories for</b>	101642		
	<b>GEV No.</b>	100909	<b>Ref. No.</b> —
	union screw thread M10x1 for pipe ø 6mm Qty 1 pcs		
	<b>GEV No.</b>	100926	<b>Ref. No.</b> —
	centring piece thread M17x1		
	<b>GEV No.</b>	100942	<b>Ref. No.</b> —
	union nut thread M15x1 for pipe ø 10mm		
	<b>GEV No.</b>	101278	<b>Ref. No.</b> 060325
	olive for pipe ø 10mm Qty 1 pcs		
	<b>GEV No.</b>	101286	<b>Ref. No.</b> —
	olive ID ø 6mm Qty 1 pcs		

			
1			
<b>GEV No.</b>	101767	<b>Ref. No.</b>	0H6400
<b>description</b>	gas tap alternatives to EGA type GPEL21D with nozzle outlet (with nozzle) gas inlet M15x1 (tube ø 10mm) external nozzle ø 1.55mm internal nozzle ø 1.4mm bypass nozzle ø 0.45mm mixing pipe connection M17x1 thermocouple connection M10x1 pilot connection M10x1 shaft ø 8x7mm shaft L 34/15mm shaft flat lower		
<b>spare parts for</b>	101767		
	<b>GEV No.</b>	100301	<b>Ref. No.</b> —
	gas injector thread M12x1 WS 14 bore ø 1.55mm		
	<b>GEV No.</b>	100322	<b>Ref. No.</b> 0K1254
	internal nozzle bore ø 1.40mm suitable for EGA26400/26440		
	<b>GEV No.</b>	100554	<b>Ref. No.</b> —
	bypass nozzle type PEL20/21 bore ø 0.45mm thread M5x0.5		



































			
1			
<b>GEV No.</b>	101731	<b>Ref. No.</b>	0H6396
<b>description</b>	gas tap alternatives to EGA type GPEL21D with nozzle outlet (with nozzle) gas inlet M15x1 (tube ø 10mm) external nozzle ø 2.05mm internal nozzle ø 1.05mm bypass nozzle ø 0.55mm mixing pipe connection M17x1 thermocouple connection M10x1 pilot connection M10x1 shaft ø 8x7mm shaft L 34/15mm shaft flat lower		
<b>spare parts for</b>	101731		
	<b>GEV No.</b>	100303	<b>Ref. No.</b> 0G1794
	gas injector thread M12x1 WS 14 bore ø 2.05mm		
	<b>GEV No.</b>	100312	<b>Ref. No.</b> 0H6357
	internal nozzle bore ø 1.05mm suitable for EGA26400/26440		
	<b>GEV No.</b>	100550	<b>Ref. No.</b> —
	bypass nozzle type PEL20/21 bore ø 0.55mm thread M5x0.5		
	<b>GEV No.</b>	100908	<b>Ref. No.</b> 052125
	union screw thread M10x1 for pipe ø 4mm Qty 1 pcs		
	<b>GEV No.</b>	100927	<b>Ref. No.</b> —
	torsion spring L 2.8-8.0mm for internal nozzle ø 3mm bore ømm		
	<b>GEV No.</b>	101060	<b>Ref. No.</b> 056595
	magnet unit standard L 39mm D1 ø 15.4mm D2 ø 11mm suitable for PEL20-21/JUNKERS/EGA		
	<b>GEV No.</b>	101233	<b>Ref. No.</b> 0K2512
	union nut thread M10x1 JUNKERS		
	<b>GEV No.</b>	101246	<b>Ref. No.</b> —
	olive for pipe ø 4mm Qty 1 pcs		
	<b>GEV No.</b>	101526	<b>Ref. No.</b> —
	O-ring Viton thickness 1.78mm ID ø 4.48mm Qty 1 pcs		

Table continues overleaf



spare parts for		101731		
GEV No.		101593	Ref. No.	—
	adjusting screw for internal nozzle thread M8x0.75			
GEV No.		101806	Ref. No.	—
	gas tap front part shaft ø 8x7mm shaft L 34/15mm shaft flat upper/lower suitable for PEL21			
accessories for		101731		
GEV No.		100909	Ref. No.	—
	union screw thread M10x1 for pipe ø 6mm Qty 1 pcs			
GEV No.		100926	Ref. No.	—
	centring piece thread M17x1			
GEV No.		100942	Ref. No.	—
	union nut thread M15x1 for pipe ø 10mm			
GEV No.		101278	Ref. No.	060325
	olive for pipe ø 10mm Qty 1 pcs			
GEV No.		101286	Ref. No.	—
	olive ID ø 6mm Qty 1 pcs			

				
1				
GEV No.	101641	Ref. No.	0H6401	
description	gas tap alternatives to EGA type GPEL21D with nozzle outlet (with nozzle) gas inlet M15x1 (tube ø 10mm) external nozzle ø 2.05mm internal nozzle ø 1.9mm bypass nozzle ø 0.55mm mixing pipe connection M17x1 thermocouple connection M10x1 pilot connection M10x1 shaft ø 7x8mm shaft L 34/15mm shaft flat lower			
spare parts for		101641		
GEV No.		100303	Ref. No.	0G1794
	gas injector thread M12x1 WS 14 bore ø 2.05mm			
GEV No.		100310	Ref. No.	0H6356
	internal nozzle bore ø 0.66mm suitable for EGA26400/26440			
GEV No.		100550	Ref. No.	—
	bypass nozzle type PEL20/21 bore ø 0.55mm thread M5x0.5			
GEV No.		100908	Ref. No.	052125
	union screw thread M10x1 for pipe ø 4mm Qty 1 pcs			
GEV No.		100927	Ref. No.	—
	torsion spring L 2.8-8.0mm for internal nozzle ø 3mm bore ø mm			
GEV No.		101060	Ref. No.	056595
	magnet unit standard L 39mm D1 ø 15.4mm D2 ø 11mm suitable for PEL20-21/JUNKERS/EGA			
GEV No.		101233	Ref. No.	0K2512
	union nut thread M10x1 JUNKERS			
GEV No.		101246	Ref. No.	—
	olive for pipe ø 4mm Qty 1 pcs			

spare parts for		101641		
GEV No.		101526	Ref. No.	—
	O-ring Viton thickness 1.78mm ID ø 4.48mm Qty 1 pcs			
GEV No.		101593	Ref. No.	—
	adjusting screw for internal nozzle thread M8x0.75			
GEV No.		101806	Ref. No.	—
	gas tap front part shaft ø 8x7mm shaft L 34/15mm shaft flat upper/lower suitable for PEL21			
accessories for		101641		
GEV No.		100909	Ref. No.	—
	union screw thread M10x1 for pipe ø 6mm Qty 1 pcs			
GEV No.		100926	Ref. No.	—
	centring piece thread M17x1			
GEV No.		100942	Ref. No.	—
	union nut thread M15x1 for pipe ø 10mm			
GEV No.		101278	Ref. No.	060325
	olive for pipe ø 10mm Qty 1 pcs			
GEV No.		101286	Ref. No.	—
	olive ID ø 6mm Qty 1 pcs			

## with pipe outlet











				
1				
GEV No.	101618	Ref. No.	0K1392	
description	gas tap alternatives to EGA type GPEL21R with pipe outlet gas inlet M15x1 (tube ø 10mm) bypass nozzle ø 0.35mm gas outlet M17x1 (tube ø 10mm) thermocouple connection M10x1 pilot connection M10x1 shaft ø 8x7mm shaft L 34/15mm shaft flat lower			
spare parts for		101618		
GEV No.		100408	Ref. No.	—
	bypass nozzle type PEL20/21 bore ø 0.35mm thread M5x0.5			
GEV No.		101060	Ref. No.	056595
	magnet unit standard L 39mm D1 ø 15.4mm D2 ø 11mm suitable for PEL20-21/JUNKERS/EGA			
GEV No.		101290	Ref. No.	—
	thermocouple nut T1: M10x1 T2: M18x1 suitable for PEL20/21			
GEV No.		101806	Ref. No.	—
	gas tap front part shaft ø 8x7mm shaft L 34/15mm shaft flat upper/lower suitable for PEL21			
accessories for		101618		
GEV No.		100908	Ref. No.	052125
	union screw thread M10x1 for pipe ø 4mm Qty 1 pcs			
GEV No.		100909	Ref. No.	—
	union screw thread M10x1 for pipe ø 6mm Qty 1 pcs			













Table continues overleaf















accessories for		101618		
	GEV No.	100926	Ref. No.	—
centring piece thread M17x1				
	GEV No.	100942	Ref. No.	—
union nut thread M15x1 for pipe ø 10mm				
	GEV No.	100943	Ref. No.	—
union nut thread M17x1 tube ø 10mm				
	GEV No.	101246	Ref. No.	—
olive for pipe ø 4mm Qty 1 pcs				
	GEV No.	101278	Ref. No.	060325
olive for pipe ø 10mm Qty 1 pcs				
	GEV No.	101286	Ref. No.	—
olive ID ø 6mm Qty 1 pcs				
	GEV No.	110227	Ref. No.	0H6789
knob gas tap with ignition flame t.max.°C°C ø 77mm shaft ø 8x7mm shaft flat lower silver				

				
1				
<b>GEV No.</b>	101643	<b>Ref. No.</b>	0H6054	
<b>description</b>	gas tap alternatives to EGA type GPEL21R with pipe outlet gas inlet M15x1 (tube ø 10mm) bypass nozzle ø 0.45mm gas outlet M17x1 (tube ø 10mm) thermocouple connection M10x1 pilot connection M10x1 shaft ø 8x7mm shaft L 34/15mm shaft flat lower			
<b>spare parts for</b>	101643			
	GEV No.	100554	Ref. No.	—
bypass nozzle type PEL20/21 bore ø 0.45mm thread M5x0.5				
	GEV No.	100908	Ref. No.	052125
union screw thread M10x1 for pipe ø 4mm Qty 1 pcs				
	GEV No.	101060	Ref. No.	056595
magnet unit standard L 39mm D1 ø 15.4mm D2 ø 11mm suitable for PEL20-21/JUNKERS/EGA				
	GEV No.	101246	Ref. No.	—
olive for pipe ø 4mm Qty 1 pcs				
	GEV No.	101290	Ref. No.	—
thermocouple nut T1: M10x1 T2: M18x1 suitable for PEL20/21				
	GEV No.	101806	Ref. No.	—
gas tap front part shaft ø 8x7mm shaft L 34/15mm shaft flat upper/lower suitable for PEL21				
<b>accessories for</b>	101643			
	GEV No.	100909	Ref. No.	—
union screw thread M10x1 for pipe ø 6mm Qty 1 pcs				
	GEV No.	100926	Ref. No.	—
centring piece thread M17x1				

accessories for		101643		
	GEV No.	100942	Ref. No.	—
union nut thread M15x1 for pipe ø 10mm				
	GEV No.	101278	Ref. No.	060325
olive for pipe ø 10mm Qty 1 pcs				
	GEV No.	101286	Ref. No.	—
olive ID ø 6mm Qty 1 pcs				

				
1				
<b>GEV No.</b>	101664	<b>Ref. No.</b>	0K0215	
<b>description</b>	gas tap alternatives to EGA type GPEL21R with pipe outlet gas inlet M15x1 (tube ø 10mm) bypass nozzle ø 0.55mm gas outlet M17x1 (tube ø 10mm) thermocouple connection M10x1 pilot connection M10x1 shaft ø 8x7mm shaft L 34/15mm shaft flat lower			
<b>spare parts for</b>	101664			
	GEV No.	100550	Ref. No.	—
bypass nozzle type PEL20/21 bore ø 0.55mm thread M5x0.5				
	GEV No.	100908	Ref. No.	052125
union screw thread M10x1 for pipe ø 4mm Qty 1 pcs				
	GEV No.	101060	Ref. No.	056595
magnet unit standard L 39mm D1 ø 15.4mm D2 ø 11mm suitable for PEL20-21/JUNKERS/EGA				
	GEV No.	101246	Ref. No.	—
olive for pipe ø 4mm Qty 1 pcs				
	GEV No.	101290	Ref. No.	—
thermocouple nut T1: M10x1 T2: M18x1 suitable for PEL20/21				
	GEV No.	101806	Ref. No.	—
gas tap front part shaft ø 8x7mm shaft L 34/15mm shaft flat upper/lower suitable for PEL21				
<b>accessories for</b>	101664			
	GEV No.	100909	Ref. No.	—
union screw thread M10x1 for pipe ø 6mm Qty 1 pcs				
	GEV No.	100942	Ref. No.	—
union nut thread M15x1 for pipe ø 10mm				
	GEV No.	100943	Ref. No.	—
union nut thread M17x1 tube ø 10mm				
	GEV No.	101278	Ref. No.	060325
olive for pipe ø 10mm Qty 1 pcs				
	GEV No.	101286	Ref. No.	—
olive ID ø 6mm Qty 1 pcs				



			
1			
<b>GEV No.</b>	101644	<b>Ref. No.</b>	OK0214
<b>description</b>	gas tap alternatives to EGA type GPEL21R with pipe outlet gas inlet M15x1 (tube ø 10mm) bypass nozzle ø 0.65mm gas outlet M17x1 (tube ø 10mm) thermocouple connection M10x1 pilot connection M10x1 shaft ø 8x7mm shaft L 34/15mm shaft flat lower		
<b>spare parts for</b>	101644		
	GEV No.	100548	Ref. No. —
	bypass nozzle type PEL20/21 bore ø 0.65mm thread M5x0.5		
	GEV No.	100908	Ref. No. 052125
	union screw thread M10x1 for pipe ø 4mm Qty 1 pcs		
	GEV No.	101060	Ref. No. 056595
	magnet unit standard L 39mm D1 ø 15.4mm D2 ø 11mm suitable for PEL20-21/JUNKERS/EGA		
	GEV No.	101246	Ref. No. —
	olive for pipe ø 4mm Qty 1 pcs		
	GEV No.	101290	Ref. No. —
	thermocouple nut T1: M10x1 T2: M18x1 suitable for PEL20/21		
	GEV No.	101806	Ref. No. —
	gas tap front part shaft ø 8x7mm shaft L 34/15mm shaft flat upper/lower suitable for PEL21		
<b>accessories for</b>	101644		
	GEV No.	100909	Ref. No. —
	union screw thread M10x1 for pipe ø 6mm Qty 1 pcs		
	GEV No.	100926	Ref. No. —
	centring piece thread M17x1		
	GEV No.	100942	Ref. No. —
	union nut thread M15x1 for pipe ø 10mm		
	GEV No.	101278	Ref. No. 060325
	olive for pipe ø 10mm Qty 1 pcs		
	GEV No.	101286	Ref. No. —
	olive ID ø 6mm Qty 1 pcs		



## GPEL22 series

with nozzle outlet

			
1			
<b>GEV No.</b>	101659	<b>Ref. No.</b>	OK1359
<b>description</b>	gas tap alternatives to EGA type GPEL22D with nozzle outlet (with nozzle) gas inlet M18x1.5 (tube ø 12mm) external nozzle ø 2.2mm internal nozzle ø 1.15mm bypass nozzle ø 0.35mm mixing pipe connection M22x1 thermocouple connection M8x1 pilot connection M10x1 shaft ø 8x7mm shaft L 34/15mm shaft flat lower		
<b>spare parts for</b>	101659		
	GEV No.	100259	Ref. No. —
	bypass nozzle type PEL22 bore ø 0.35mm thread M6x0.5		
	GEV No.	100330	Ref. No. —
	gas injector thread M15x1 bore ø 2.20mm WS 17		
	GEV No.	100341	Ref. No. OK1274
	internal nozzle bore ø 1.15mm type EGA/PEL22		
	GEV No.	100908	Ref. No. 052125
	union screw thread M10x1 for pipe ø 4mm Qty 1 pcs		
	GEV No.	100927	Ref. No. —
	torsion spring L 2.8-8.0mm for internal nozzle ø 3mm bore ømm		
	GEV No.	101058	Ref. No. 056594
	magnet unit L 39mm D1 ø 15.4mm D2 ø 13.5mm suitable for PEL22/EGA24197 standard		
	GEV No.	101230	Ref. No. —
	thermocouple nut T1: M8x1 T2: M18x1 aluminium		
	GEV No.	101246	Ref. No. —
	olive for pipe ø 4mm Qty 1 pcs		
	GEV No.	101460	Ref. No. —
	O-ring ø 12.37mm D1 ø 2.62mm suitable for PEL22		
	GEV No.	101527	Ref. No. —
	O-ring Viton thickness 1.78mm ID ø 6.75mm Qty 1 pcs		
	GEV No.	101594	Ref. No. —
	adjusting screw for internal nozzle thread M10x0.75		
	GEV No.	101820	Ref. No. —
	gas tap front part shaft ø 7x8mm shaft L 34/15mm shaft flat upper/lower		
<b>accessories for</b>	101659		
	GEV No.	100909	Ref. No. —
	union screw thread M10x1 for pipe ø 6mm Qty 1 pcs		
	GEV No.	100944	Ref. No. —
	union nut thread M18x1.5 for pipe ø 12mm		

Table continues overleaf



<b>accessories for</b>	101659			
	GEV No.	101273	Ref. No.	—
	olive for pipe ø 12mm L 9.5mm brass Qty 1 pcs suitable for universal			
	GEV No.	101286	Ref. No.	—
	olive ID ø 6mm Qty 1 pcs			







<b>GEV No.</b>	101649	<b>Ref. No.</b>	OK1360
----------------	--------	-----------------	--------

**description**  
gas tap alternatives to EGA type GPEL22D with nozzle outlet (with nozzle) gas inlet M18x1.5 (tube ø 12mm) external nozzle ø 2.6mm internal nozzle ø 1.35mm bypass nozzle ø 0.4mm mixing pipe connection M22x1 thermocouple connection M8x1 pilot connection M10x1 shaft ø 8x7mm shaft L 34/15mm shaft flat upper

<b>spare parts for</b>	101649			
------------------------	--------	--	--	--

	GEV No.	100281	Ref. No.	—
	bypass nozzle type PEL22 bore ø 0.4mm thread M6x0.5			
	GEV No.	100457	Ref. No.	—
	gas injector thread M15x1 bore ø 2.60mm WS 17			
	GEV No.	100648	Ref. No.	—
	internal nozzle bore ø 1.35mm type EGA/PEL22			
	GEV No.	100908	Ref. No.	052125
	union screw thread M10x1 for pipe ø 4mm Qty 1 pcs			
	GEV No.	100927	Ref. No.	—
	torsion spring L 2.8-8.0mm for internal nozzle ø 3mm bore ømm			
	GEV No.	101058	Ref. No.	056594
	magnet unit L 39mm D1 ø 15.4mm D2 ø 13.5mm suitable for PEL22/ EGA24197 standard			
	GEV No.	101230	Ref. No.	—
	thermocouple nut T1: M8x1 T2: M18x1 aluminium			
	GEV No.	101246	Ref. No.	—
	olive for pipe ø 4mm Qty 1 pcs			
	GEV No.	101460	Ref. No.	—
	O-ring ø 12.37mm D1 ø 2.62mm suitable for PEL22			
	GEV No.	101527	Ref. No.	—
	O-ring Viton thickness 1.78mm ID ø 6.75mm Qty 1 pcs			
	GEV No.	101594	Ref. No.	—
	adjusting screw for internal nozzle thread M10x0.75			
	GEV No.	101820	Ref. No.	—
	gas tap front part shaft ø 7x8mm shaft L 34/15mm shaft flat upper/ lower			

<b>accessories for</b>	101649			
	GEV No.	100909	Ref. No.	—
	union screw thread M10x1 for pipe ø 6mm Qty 1 pcs			
	GEV No.	100944	Ref. No.	—
	union nut thread M18x1.5 for pipe ø 12mm			
	GEV No.	101273	Ref. No.	—
	olive for pipe ø 12mm L 9.5mm brass Qty 1 pcs suitable for universal			
	GEV No.	101286	Ref. No.	—
	olive ID ø 6mm Qty 1 pcs			





**with pipe outlet**



<b>GEV No.</b>	101621	<b>Ref. No.</b>	OK1351
----------------	--------	-----------------	--------

**description**  
gas tap alternatives to EGA type GPEL22R with pipe outlet gas inlet M18x1.5 (tube ø 12mm) gas outlet M18x1.5 (tube ø 12mm) thermo-couple connection M8x1 shaft ø 8x7mm shaft L 34/15mm shaft flat lower

<b>spare parts for</b>	101621			
------------------------	--------	--	--	--

	GEV No.	100259	Ref. No.	—
	bypass nozzle type PEL22 bore ø 0.35mm thread M6x0.5			
	GEV No.	101058	Ref. No.	056594
	magnet unit L 39mm D1 ø 15.4mm D2 ø 13.5mm suitable for PEL22/ EGA24197 standard			
	GEV No.	101290	Ref. No.	—
	thermocouple nut T1: M10x1 T2: M18x1 suitable for PEL20/21			
	GEV No.	101460	Ref. No.	—
	O-ring ø 12.37mm D1 ø 2.62mm suitable for PEL22			
	GEV No.	101820	Ref. No.	—
	gas tap front part shaft ø 7x8mm shaft L 34/15mm shaft flat upper/ lower			

<b>accessories for</b>	101621			
------------------------	--------	--	--	--







	GEV No.	100908	Ref. No.	052125
	union screw thread M10x1 for pipe ø 4mm Qty 1 pcs			
	GEV No.	100909	Ref. No.	—
	union screw thread M10x1 for pipe ø 6mm Qty 1 pcs			
	GEV No.	100944	Ref. No.	—
	union nut thread M18x1.5 for pipe ø 12mm			
	GEV No.	101246	Ref. No.	—
	olive for pipe ø 4mm Qty 1 pcs			
	GEV No.	101273	Ref. No.	—
	olive for pipe ø 12mm L 9.5mm brass Qty 1 pcs suitable for universal			

Table continues overleaf

<b>accessories for</b>	101621			
	GEV No.	101286	Ref. No.	—
	olive ID ø 6mm Qty 1 pcs			







alternatives to JUNKERS

	1			
<b>GEV No.</b>	101630	<b>Ref. No.</b>	OK9985	
<b>description</b>	gas tap PEL type 235/V gas inlet 1/2" IT bypass nozzle ø 0.35mm gas outlet 1/2" MT (tube ø 14mm) thermocouple connection M10x1 pilot connection M10x1 shaft ø 10mm shaft L 25mm shaft flat			
<b>spare parts for</b>	101630			
	GEV No.	100455	Ref. No.	—
	bypass nozzle type PEL23/24 bore ø 0.35mm thread M8x0.5			
	GEV No.	101059	Ref. No.	—
	magnet unit T1: M10x1 T2: M22x1 L 46mm ø 18mm suitable for PEL23S M10x1			
	GEV No.	102767	Ref. No.	—
	gas tap front part shaft ø 10mm shaft L 26.5mm shaft flat suitable for PEL23S			
<b>accessories for</b>	101630			
	GEV No.	100908	Ref. No.	052125
	union screw thread M10x1 for pipe ø 4mm Qty 1 pcs			
	GEV No.	100909	Ref. No.	—
	union screw thread M10x1 for pipe ø 6mm Qty 1 pcs			
	GEV No.	100945	Ref. No.	—
	roll pin ø 3.2mm L 10mm			
	GEV No.	101218	Ref. No.	—
	shaft extension JUNKERS			
	GEV No.	101219	Ref. No.	—
	shaft extension L 25mm JUNKERS			
	GEV No.	101246	Ref. No.	—
	olive for pipe ø 4mm Qty 1 pcs			
	GEV No.	101286	Ref. No.	—
	olive ID ø 6mm Qty 1 pcs			
	GEV No.	110064	Ref. No.	—
	knob			
	GEV No.	110066	Ref. No.	—
	knob screw			
	GEV No.	550396	Ref. No.	—
	shaft extension L 25mm JUNKERS			

EGA

24197 series

gas taps





	1			
<b>GEV No.</b>	101150	<b>Ref. No.</b>	OK0213	
<b>description</b>	gas tap EGA type 24197 series with pipe outlet			
<b>spare parts for</b>	101150			
	GEV No.	101058	Ref. No.	056594
	magnet unit L 39mm D1 ø 15.4mm D2 ø 13.5mm suitable for PEL22/EGA24197 standard			
	GEV No.	101230	Ref. No.	—
	thermocouple nut T1: M8x1 T2: M18x1 aluminium			
<b>accessories for</b>	101150			
	GEV No.	100944	Ref. No.	—
	union nut thread M18x1.5 for pipe ø 12mm			
	GEV No.	101273	Ref. No.	—
	olive for pipe ø 12mm L 9.5mm brass Qty 1 pcs suitable for universal			
	GEV No.	101284	Ref. No.	OK2491
	olive for pipe ø 4mm Qty 1 pcs			
	GEV No.	101285	Ref. No.	OKL220
	union screw thread M8x1 for pipe ø 4mm Qty 1 pcs JUNKERS			



	1			
Image not available				
<b>GEV No.</b>	106251	<b>Ref. No.</b>	OK1389	
<b>description</b>	gas tap type EGA24197			
<b>spare parts for</b>	106251			
	GEV No.	100238	Ref. No.	—
	internal nozzle bore ø 1.35mm suitable for EGA 23268,26400,26440			
	GEV No.	100457	Ref. No.	—
	gas injector thread M15x1 bore ø 2.60mm WS 17			
	GEV No.	100927	Ref. No.	—
	torsion spring L 2.8-8.0mm for internal nozzle ø 3mm bore ømm			
	GEV No.	101058	Ref. No.	056594
	magnet unit L 39mm D1 ø 15.4mm D2 ø 13.5mm suitable for PEL22/EGA24197 standard			
	GEV No.	101230	Ref. No.	—
	thermocouple nut T1: M8x1 T2: M18x1 aluminium			

Table continues overleaf





accessories for		106251		
GEV No.		100944	Ref. No.	—
	union nut thread M18x1.5 for pipe ø 12mm			
	olive for pipe ø 12mm L 9.5mm brass Qty 1 pcs suitable for universal	101273	Ref. No.	—
	olive for pipe ø 4mm Qty 1 pcs	101284	Ref. No.	0K2491
	union screw thread M8x1 for pipe ø 4mm Qty 1 pcs JUNKERS	101285	Ref. No.	0KL220









accessories for		101915		
GEV No.		110357	Ref. No.	—
	gas tap spindle shaft ø 8x6.5mm shaft L 36/12mm suitable for 630 Eurosit series			
	adapter shaft ø 10x8mm shaft L 29/18mm suitable for 630 Eurosit series	110358	Ref. No.	—

## gas thermostats





### SIT

#### 630 Eurosit series



GEV No.	101915	Ref. No.	0C6235	
<b>description</b>	gas thermostat type 630 Eurosit series t.max. 320°C 80-320°C gas inlet 3/8" gas outlet 3/8" thermocouple connection M9x1 pilot connection M10x1 probe ø 4mm probe L 72mm capillary pipe 1050mm SIT			
<b>accessories for</b> 101915				
	GEV No.	100825	Ref. No.	—
	gas tap spindle shaft ø 8x6.5mm shaft L 22/14mm suitable for EUROSIT			
	GEV No.	100904	Ref. No.	0K2497
	locking screw M10x1 for pipe ø 4mm Qty 1 pcs			
	GEV No.	100905	Ref. No.	—
	locking screw M10x1 for pipe ø 6mm Qty 1 pcs			
	GEV No.	100949	Ref. No.	—
	gasket suitable for 630 Eurosit series			
	GEV No.	101273	Ref. No.	—
	olive for pipe ø 12mm L 9.5mm brass Qty 1 pcs suitable for universal			
	GEV No.	101276	Ref. No.	—
	union screw thread 3/8" tube ø 12mm Qty 1 pcs			
	GEV No.	101333	Ref. No.	—
	plug thread 3/8" with O-ring			
	GEV No.	101390	Ref. No.	—
	gas tap spindle shaft ø 6x4.6mm shaft L 32/15mm gas tap with ignition flame suitable for ZANUSSI, MARENO for gas thermostat EUROSIT			
	GEV No.	101392	Ref. No.	—
	adapter suitable for 630 Eurosit series			



GEV No.	101769	Ref. No.	0K2004	
<b>description</b>	gas thermostat type 630 Eurosit series t.max. 340°C 100-340°C gas inlet 3/8" gas outlet 3/8" thermocouple connection M10x1 pilot connection M10x1 probe ø 4mm probe L 72mm capillary pipe 1050mm SIT			
<b>accessories for</b> 101769				
	GEV No.	100904	Ref. No.	0K2497
	locking screw M10x1 for pipe ø 4mm Qty 1 pcs			
	GEV No.	100905	Ref. No.	—
	locking screw M10x1 for pipe ø 6mm Qty 1 pcs			
	GEV No.	101273	Ref. No.	—
	olive for pipe ø 12mm L 9.5mm brass Qty 1 pcs suitable for universal			
	GEV No.	101276	Ref. No.	—
	union screw thread 3/8" tube ø 12mm Qty 1 pcs			
	GEV No.	101333	Ref. No.	—
	plug thread 3/8" with O-ring			

#### 710 Minisit series

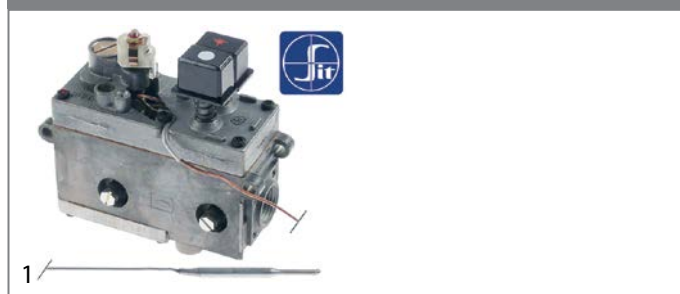

GEV No.	101132	Ref. No.	056833	
<b>description</b>	gas thermostat SIT type MINISIT 710 t.max. 340°C 100-340°C gas inlet 1/2" gas outlet 3/8" thermocouple connection M9x1 pilot connection M10x1 probe ø 5mm probe L 68mm capillary pipe 1050mm probe type type B1 pressure controller no pressure regulator mbar gland nut ignition gas no			
<b>spare parts for</b> 101132				
	GEV No.	101053	Ref. No.	—
	magnet unit T1: M9x1 T2: M24x1 L 45mm ø 17mm suitable for Minisit			

Table continues overleaf

spare parts for		101132	
	GEV No.	102102	Ref. No. —
	probe 100-340°C probe ø 5mm probe L 68mm capillary pipe 1750mm t.max. 340°C oven/grill probe type type B1 suitable for MINISIT 710		
accessories for		101132	
	GEV No.	100809	Ref. No. —
	O-ring EPDM thickness 2mm ID ø 21mm Qty 1 pcs		
	GEV No.	100904	Ref. No. 0K2497
	locking screw M10x1 for pipe ø 4mm Qty 1 pcs		
	GEV No.	100905	Ref. No. —
	locking screw M10x1 for pipe ø 6mm Qty 1 pcs		
	GEV No.	101054	Ref. No. 0K0669
	magnet unit T1: M10x1 T2: M24x1 L 45mm ø 17mm suitable for Minisit		
	GEV No.	101136	Ref. No. 054269
	piezoelectric igniter suitable for Minisit with cover cap ømm connection F6.3x0.8		
	GEV No.	101137	Ref. No. —
	cover cap without piezoelectric igniter		
	GEV No.	101267	Ref. No. —
	reducer IT 3/8" ET 1/2" L 21mm		
	GEV No.	101268	Ref. No. —
	gas connection thread 3/8" angled with O-ring MINISIT 710		
	GEV No.	101269	Ref. No. —
	gas connection thread 1/2" angled with O-ring MINISIT 710		
	GEV No.	101270	Ref. No. —
	screw connection IT 3/8" ET 3/8" L 28mm		
	GEV No.	101272	Ref. No. —
	screw connection IT 1/2" ET 3/8" L 57mm		
	GEV No.	101273	Ref. No. —
	olive for pipe ø 12mm L 9.5mm brass Qty 1 pcs suitable for universal		
	GEV No.	101274	Ref. No. —
	olive for pipe ø 16mm Qty 1 pcs		
	GEV No.	101275	Ref. No. —
	union screw thread 1/2" for pipe ø 16mm Qty 1 pcs		
	GEV No.	101276	Ref. No. —
	union screw thread 3/8" tube ø 12mm Qty 1 pcs		
	GEV No.	110068	Ref. No. 054268
	knob suitable for Minisit ø 37mm		























			
1			
GEV No.	101796	Ref. No.	0H6235
<b>description</b>	gas thermostat SIT type MINISIT 710 t.max. 340°C 100-340°C gas inlet 1/2" gas outlet 3/8" thermocouple connection M9x1 pilot connection M10x1 probe ø 5mm probe L 68mm capillary pipe 1800mm probe type type B1 pressure controller yes pressure regulator 3-18mbar gland nut		
spare parts for		101796	
	GEV No.	100026	Ref. No. —
	ignition cable cable length 1000mm connection ø4mm / F6.3mm		
	GEV No.	100809	Ref. No. —
	O-ring EPDM thickness 2mm ID ø 21mm Qty 1 pcs		
	GEV No.	101053	Ref. No. —
	magnet unit T1: M9x1 T2: M24x1 L 45mm ø 17mm suitable for Minisit		
	GEV No.	101136	Ref. No. 054269
	piezoelectric igniter suitable for Minisit with cover cap ømm connection F6.3x0.8		
	GEV No.	101268	Ref. No. —
	gas connection thread 3/8" angled with O-ring MINISIT 710		
	GEV No.	102102	Ref. No. —
	probe 100-340°C probe ø 5mm probe L 68mm capillary pipe 1750mm t.max. 340°C oven/grill probe type type B1 suitable for MINISIT 710		
	GEV No.	107564	Ref. No. —
	piezoelectric igniter body plastic blowing connection F6.3x0.8 ø 22mm		
	GEV No.	110269	Ref. No. 0H6734
	knob thermostat t.max. 100°C 50-100°C ø 72mm shaft ø 6x4.6mm shaft flat lower		
accessories for		101796	
	GEV No.	100904	Ref. No. 0K2497
	locking screw M10x1 for pipe ø 4mm Qty 1 pcs		
	GEV No.	100905	Ref. No. —
	locking screw M10x1 for pipe ø 6mm Qty 1 pcs		
	GEV No.	101054	Ref. No. 0K0669
	magnet unit T1: M10x1 T2: M24x1 L 45mm ø 17mm suitable for Minisit		
	GEV No.	101267	Ref. No. —
	reducer IT 3/8" ET 1/2" L 21mm		
	GEV No.	101270	Ref. No. —
	screw connection IT 3/8" ET 3/8" L 28mm		
	GEV No.	101272	Ref. No. —
	screw connection IT 1/2" ET 3/8" L 57mm		

Table continues overleaf



<b>accessories for</b>	101796		
	GEV No.	101273	Ref. No. —
	olive for pipe ø 12mm L 9.5mm brass Qty 1 pcs suitable for universal		
	GEV No.	101274	Ref. No. —
	olive for pipe ø 16mm Qty 1 pcs		
	GEV No.	101275	Ref. No. —
	union screw thread 1/2" for pipe ø 16mm Qty 1 pcs		
	GEV No.	101276	Ref. No. —
	union screw thread 3/8" tube ø 12mm Qty 1 pcs		
	GEV No.	110068	Ref. No. 054268
	knob suitable for Minisit ø 37mm		



<b>GEV No.</b>	102872	<b>Ref. No.</b>	0H6570
<b>description</b>	gas thermostat SIT type MINISIT 710 t.max. 340°C 120-340°C gas inlet 3/8" gas outlet 3/8" thermocouple connection M10x1 pilot connection M10x1 probe ø 5mm probe L 68mm capillary pipe 1050mm probe type type B2 pressure controller no pressure regulator gland nut		
<b>spare parts for</b>	102872		
	GEV No.	100068	Ref. No. —
	pilot burner 2 flames gas connection 6mm		
	GEV No.	100809	Ref. No. —
	O-ring EPDM thickness 2mm ID ø 21mm Qty 1 pcs		
	GEV No.	101054	Ref. No. 0K0669
	magnet unit T1: M10x1 T2: M24x1 L 45mm ø 17mm suitable for Minisit		
	GEV No.	101136	Ref. No. 054269
	piezoelectric igniter suitable for Minisit with cover cap ømm connection F6.3x0.8		
	GEV No.	101505	Ref. No. —
	gas connection thread 3/8" angled without O-ring MINISIT 710		
	GEV No.	101516	Ref. No. —
	flat-headed bolt thread M4 thread L 16mm SS DIN 7985/ISO 7045 Qty 1 pcs		

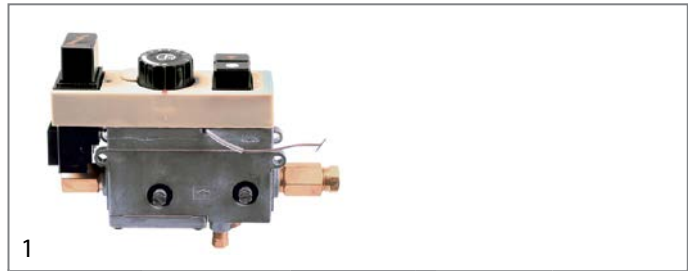

<b>GEV No.</b>	101768	<b>Ref. No.</b>	0H6571
<b>description</b>	gas thermostat SIT type MINISIT 710 t.max. 380°C 160-380°C gas inlet 3/8" gas outlet 3/8" thermocouple connection M10x1 probe ø 5mm probe L 68mm capillary pipe 1050mm probe type type B2 pressure controller no		
<b>spare parts for</b>	101768		
	GEV No.	101054	Ref. No. 0K0669
	magnet unit T1: M10x1 T2: M24x1 L 45mm ø 17mm suitable for Minisit		
	GEV No.	101136	Ref. No. 054269
	piezoelectric igniter suitable for Minisit with cover cap ømm connection F6.3x0.8		
	GEV No.	110068	Ref. No. 054268
	knob suitable for Minisit ø 37mm		
<b>accessories for</b>	101768		
	GEV No.	101273	Ref. No. —
	olive for pipe ø 12mm L 9.5mm brass Qty 1 pcs suitable for universal		
	GEV No.	101276	Ref. No. —
	union screw thread 3/8" tube ø 12mm Qty 1 pcs		
	GEV No.	101278	Ref. No. 060325
	olive for pipe ø 10mm Qty 1 pcs		
	GEV No.	101279	Ref. No. —
	union screw thread 3/8" for pipe ø 10mm Qty 1 pcs		





<b>GEV No.</b>	101133	<b>Ref. No.</b>	0H6231
<b>description</b>	gas thermostat without accessories SIT type MINISIT 710 t.max. 200°C 60-200°C gas inlet 1/2" gas outlet 3/8" thermocouple connection M10x1 pilot connection M10x1 probe ø 5mm probe L 95mm capillary pipe 1050mm probe type type D2 pressure controller no pressure regulator gland nut M14x1.5 ignition gas 4mm		
<b>spare parts for</b>	101133		
	GEV No.	101054	Ref. No. 0K0669
	magnet unit T1: M10x1 T2: M24x1 L 45mm ø 17mm suitable for Minisit		
	GEV No.	102844	Ref. No. —
	probe 60-200°C probe ø 5mm probe L 98mm capillary pipe 1050mm t.max. 200°C fryer probe type type D2 suitable for MINISIT 710 gland nut M14x1.5		

Table continues overleaf







accessories for		101133	
	GEV No.	100809	Ref. No. —
	O-ring EPDM thickness 2mm ID ø 21mm Qty 1 pcs		
	GEV No.	100820	Ref. No. —
	gland duct ET M14x1.5 IT M10x0.75 probe ø max. 6.5mm WS 22		
	GEV No.	100904	Ref. No. 0K2497
	locking screw M10x1 for pipe ø 4mm Qty 1 pcs		
	GEV No.	100905	Ref. No. —
	locking screw M10x1 for pipe ø 6mm Qty 1 pcs		
	GEV No.	101053	Ref. No. —
	magnet unit T1: M9x1 T2: M24x1 L 45mm ø 17mm suitable for Minisit		
	GEV No.	101136	Ref. No. 054269
	piezoelectric igniter suitable for Minisit with cover cap ømm connection F6.3x0.8		
	GEV No.	101137	Ref. No. —
	cover cap without piezoelectric igniter		
	GEV No.	101267	Ref. No. —
	reducer IT 3/8" ET 1/2" L 21mm		
	GEV No.	101268	Ref. No. —
	gas connection thread 3/8" angled with O-ring MINISIT 710		
	GEV No.	101269	Ref. No. —
	gas connection thread 1/2" angled with O-ring MINISIT 710		
	GEV No.	101270	Ref. No. —
	screw connection IT 3/8" ET 3/8" L 28mm		
	GEV No.	101272	Ref. No. —
	screw connection IT 1/2" ET 3/8" L 57mm		
	GEV No.	101273	Ref. No. —
	olive for pipe ø 12mm L 9.5mm brass Qty 1 pcs suitable for universal		
	GEV No.	101274	Ref. No. —
	olive for pipe ø 16mm Qty 1 pcs		
	GEV No.	101275	Ref. No. —
	union screw thread 1/2" for pipe ø 16mm Qty 1 pcs		
	GEV No.	101276	Ref. No. —
	union screw thread 3/8" tube ø 12mm Qty 1 pcs		
	GEV No.	110068	Ref. No. 054268
	knob suitable for Minisit ø 37mm		

## gas valves and ignition boxes

### gas control valves

#### HONEYWELL



1		0H6536	
GEV No.	106059	Ref. No.	0H6536
description	gas valve type V4600C 220/240V 50Hz gas inlet flange 45x45mm gas outlet flange 45x45mm thermocouple connection 11/32" pilot connection M1 1x1 pressure range 2.5-20mbar operator type 220/240V (V404A 1071 4) pressure controller type V5306E suitable for HONEYWELL		
accessories for	106059		
	GEV No.	101305	Ref. No. —
	gas connection straight 1/2" flange 45x45mm ELETTROSIT/V4400/4600/4605 suitable for SIT/HONEYWELL hole distance 36x36mm		
	GEV No.	101306	Ref. No. —
	gas connection angled flange 45x45mm hole distance 36x36mm 1/2" ELETTROSIT/V4400/4600/4605 screw with O-ring suitable for SIT/HONEYWELL		
	GEV No.	101307	Ref. No. —
	gas connection straight flange 45x45mm hole distance 36x36mm 3/4" ELETTROSIT/V4400/4600/4605 screw with O-ring suitable for SIT/HONEYWELL		
	GEV No.	101308	Ref. No. —
	gas connection angled flange 45x45mm hole distance 36x36mm 3/4" ELETTROSIT/V4400/4600/4605 screw with O-ring suitable for SIT/HONEYWELL		
	GEV No.	101494	Ref. No. —
	locking screw thread M11x1 for pipe ø 6mm Qty 1 pcs		













SIT

ELETTROSIT



1

<b>GEV No.</b>	101993	<b>Ref. No.</b>	0H6072
<b>description</b>	gas valve SIT type ELETTROSIT 230V gas inlet 1/2" gas outlet 1/2" thermocouple connection M9x1 pilot connection M10x1 lateral equiv. no. 0.810.126		
<b>spare parts for</b>	101993		
	<b>GEV No.</b>	101312	<b>Ref. No.</b> 054539
	microswitch		
	<b>GEV No.</b>	101352	<b>Ref. No.</b> —
	solenoid coil 230V 50Hz suitable for ELETTROSIT		
<b>accessories for</b>	101993		
	<b>GEV No.</b>	100006	<b>Ref. No.</b> —
	piezoelectric igniter suitable for ELETTROSIT body plastic blowing connection ø2.4mm ø 14mm		
	<b>GEV No.</b>	100904	<b>Ref. No.</b> 0K2497
	locking screw M10x1 for pipe ø 4mm Qty 1 pcs		
	<b>GEV No.</b>	100905	<b>Ref. No.</b> —
	locking screw M10x1 for pipe ø 6mm Qty 1 pcs		
	<b>GEV No.</b>	101301	<b>Ref. No.</b> —
	gas connection thread 1/2" straight ELETTROSIT screw with O-ring		
	<b>GEV No.</b>	101303	<b>Ref. No.</b> —
	gas connection straight thread 3/4" ELETTROSIT		
	<b>GEV No.</b>	101309	<b>Ref. No.</b> —
	extension		
	<b>GEV No.</b>	103104	<b>Ref. No.</b> —
	ignition switch		
	<b>GEV No.</b>	541504	<b>Ref. No.</b> —
	double nipple thread 1/2" - 1/2"		

NOVASIT



1

<b>GEV No.</b>	101980	<b>Ref. No.</b>	0K3021
<b>description</b>			
<b>spare parts for</b>	101980		
	<b>GEV No.</b>	101065	<b>Ref. No.</b> 056589
	<b>GEV No.</b>	101313	<b>Ref. No.</b> 0K3020
<b>accessories for</b>	101980		
	<b>GEV No.</b>	100006	<b>Ref. No.</b> —
	<b>GEV No.</b>	101305	<b>Ref. No.</b> —
	<b>GEV No.</b>	101306	<b>Ref. No.</b> —
	<b>GEV No.</b>	101307	<b>Ref. No.</b> —
	<b>GEV No.</b>	101308	<b>Ref. No.</b> —
	<b>GEV No.</b>	101312	<b>Ref. No.</b> 054539
	<b>GEV No.</b>	101314	<b>Ref. No.</b> —
	<b>GEV No.</b>	101317	<b>Ref. No.</b> 0K3022
	<b>GEV No.</b>	101318	<b>Ref. No.</b> —



TANDEM



1	
<b>GEV No.</b> 101189	<b>Ref. No.</b> 002340
<b>description</b>	
<b>spare parts for</b> 101189	
	GEV No. 101379 Ref. No. 002452
<b>accessories for</b> 101189	
	GEV No. 100904 Ref. No. 0K2497
	GEV No. 100905 Ref. No. —
	GEV No. 101274 Ref. No. —
	GEV No. 101275 Ref. No. —
	GEV No. 101925 Ref. No. —
	GEV No. 102845 Ref. No. —
	GEV No. 102846 Ref. No. —
	GEV No. 102847 Ref. No. —



1	
<b>GEV No.</b> 101984	<b>Ref. No.</b> 002714
<b>description</b>	
<b>spare parts for</b> 101984	
	GEV No. 101379 Ref. No. 002452

<b>accessories for</b> 101984			
	GEV No. 101274	Ref. No.	—
	GEV No. 101275	Ref. No.	—
	GEV No. 101925	Ref. No.	—
	GEV No. 102845	Ref. No.	—
	GEV No. 102846	Ref. No.	—
	GEV No. 102847	Ref. No.	—

ignition boxes

HONEYWELL



1			
<b>GEV No.</b> 101165	<b>Ref. No.</b> 002351		
<b>description</b>			
<b>spare parts for</b> 101165			
	GEV No. 358696	Ref. No.	—



1	
<b>GEV No.</b> 101166	<b>Ref. No.</b> 0K0326
<b>description</b>	



			
1			
<b>GEV No.</b>	102347	<b>Ref. No.</b>	002641
<b>description</b>			







gas solenoid valves





KROMSCHRÖDER			
			
1			
<b>GEV No.</b>	101472 <sup>1</sup>	<b>Ref. No.</b>	0H6411
<b>description</b>			

<sup>1</sup>aluminium housing

ignition parts

pilot burners

SIT			
100 series			
			
1			
<b>GEV No.</b>	106901	<b>Ref. No.</b>	0H6314
<b>description</b>			
<b>spare parts for</b>	106901		
	<b>GEV No.</b>	100854	<b>Ref. No.</b> —
	<b>GEV No.</b>	100916	<b>Ref. No.</b> —
	<b>GEV No.</b>	100917	<b>Ref. No.</b> —
	<b>GEV No.</b>	100918	<b>Ref. No.</b> —
<b>accessories for</b>	106901		
	<b>GEV No.</b>	100904	<b>Ref. No.</b> 0K2497

<b>accessories for</b>	106901		
	<b>GEV No.</b>	100905	<b>Ref. No.</b> —
	<b>GEV No.</b>	102110	<b>Ref. No.</b> —
	<b>GEV No.</b>	102111	<b>Ref. No.</b> —
	<b>GEV No.</b>	102742	<b>Ref. No.</b> —





























			
1			
<b>GEV No.</b>	106906	<b>Ref. No.</b>	0H6331
<b>description</b>			
<b>spare parts for</b>	106906		
	<b>GEV No.</b>	100245	<b>Ref. No.</b> 056799
	<b>GEV No.</b>	100855	<b>Ref. No.</b> —
	<b>GEV No.</b>	100885	<b>Ref. No.</b> —
	<b>GEV No.</b>	100916	<b>Ref. No.</b> —
	<b>GEV No.</b>	100917	<b>Ref. No.</b> —
	<b>GEV No.</b>	100918	<b>Ref. No.</b> —
	<b>GEV No.</b>	107162	<b>Ref. No.</b> —
	<b>GEV No.</b>	107701	<b>Ref. No.</b> —
<b>accessories for</b>	106906		
	<b>GEV No.</b>	100245	<b>Ref. No.</b> 056799
	<b>GEV No.</b>	100246	<b>Ref. No.</b> 056656
	<b>GEV No.</b>	100904	<b>Ref. No.</b> 0K2497
	<b>GEV No.</b>	100905	<b>Ref. No.</b> —

Table continues overleaf





accessories for 106906				
	GEV No.	102110	Ref. No.	—
	GEV No.	102111	Ref. No.	—
	GEV No.	107171	Ref. No.	058330
	GEV No.	107700	Ref. No.	—
	GEV No.	107702	Ref. No.	—

accessories for 106907				
	GEV No.	102110	Ref. No.	—
	GEV No.	102111	Ref. No.	—
	GEV No.	107171	Ref. No.	058330
	GEV No.	107700	Ref. No.	—
	GEV No.	107701	Ref. No.	—

				
1	GEV No.	106907	Ref. No.	058329
description				
spare parts for 106907				
	GEV No.	100246	Ref. No.	056656
	GEV No.	100855	Ref. No.	—
	GEV No.	100885	Ref. No.	—
	GEV No.	100916	Ref. No.	—
	GEV No.	100917	Ref. No.	—
	GEV No.	100918	Ref. No.	—
	GEV No.	107162	Ref. No.	—
	GEV No.	107702	Ref. No.	—
accessories for 106907				
	GEV No.	100245	Ref. No.	056799
	GEV No.	100904	Ref. No.	0K2497
	GEV No.	100905	Ref. No.	—

accessories				
pilot burner caps				
				
1	GEV No.	100833	Ref. No.	0H6050
description				





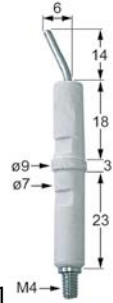











pilot burner nozzles				
				
1	GEV No.	100245	Ref. No.	056799
description				

				
1	GEV No.	100246	Ref. No.	056656
description				

ignition electrodes				
				
1	GEV No.	100706	Ref. No.	056754
description				





140 - 145 -150 series				
				
1				
<b>GEV No.</b>	107114 <sup>1</sup>	<b>Ref. No.</b>	059379	
<b>description</b>				
<b>spare parts for</b>	107114			
	<b>GEV No.</b>	100907	<b>Ref. No.</b>	—
<b>accessories for</b>	107114			
	<b>GEV No.</b>	100204	<b>Ref. No.</b>	059216
	<b>GEV No.</b>	100205	<b>Ref. No.</b>	—
	<b>GEV No.</b>	100206	<b>Ref. No.</b>	—
	<b>GEV No.</b>	100207	<b>Ref. No.</b>	059215
	<b>GEV No.</b>	100216	<b>Ref. No.</b>	—
	<b>GEV No.</b>	100701	<b>Ref. No.</b>	059380
	<b>GEV No.</b>	100801	<b>Ref. No.</b>	—
	<b>GEV No.</b>	100897	<b>Ref. No.</b>	059161
	<b>GEV No.</b>	100898	<b>Ref. No.</b>	—
	<b>GEV No.</b>	100906	<b>Ref. No.</b>	057960
	<b>GEV No.</b>	100908	<b>Ref. No.</b>	052125
	<b>GEV No.</b>	100909	<b>Ref. No.</b>	—
	<b>GEV No.</b>	102110	<b>Ref. No.</b>	—
	<b>GEV No.</b>	102111	<b>Ref. No.</b>	—

<sup>1</sup>incl. thermocouple fitting

160 series				
				
1				
<b>GEV No.</b>	100105	<b>Ref. No.</b>	0H6336 338208	
<b>description</b>				
<b>spare parts for</b>	100105			
	<b>GEV No.</b>	100907	<b>Ref. No.</b>	—
<b>accessories for</b>	100105			
	<b>GEV No.</b>	100202	<b>Ref. No.</b>	—
	<b>GEV No.</b>	100203	<b>Ref. No.</b>	—
	<b>GEV No.</b>	100701	<b>Ref. No.</b>	059380
	<b>GEV No.</b>	100801	<b>Ref. No.</b>	—
	<b>GEV No.</b>	100869	<b>Ref. No.</b>	—
	<b>GEV No.</b>	100906	<b>Ref. No.</b>	057960
	<b>GEV No.</b>	100908	<b>Ref. No.</b>	052125
	<b>GEV No.</b>	100909	<b>Ref. No.</b>	—
	<b>GEV No.</b>	101282	<b>Ref. No.</b>	—
	<b>GEV No.</b>	101287	<b>Ref. No.</b>	—
	<b>GEV No.</b>	102110	<b>Ref. No.</b>	—
	<b>GEV No.</b>	102111	<b>Ref. No.</b>	—
	<b>GEV No.</b>	107650	<b>Ref. No.</b>	—



			
<b>1</b>			
<b>GEV No.</b>	100109	<b>Ref. No.</b>	0A2472
<b>description</b>			
<b>spare parts for</b>	100109		
	<b>GEV No.</b>	100907	<b>Ref. No.</b> —
<b>accessories for</b>	100109		
	<b>GEV No.</b>	100202	<b>Ref. No.</b> —
	<b>GEV No.</b>	100203	<b>Ref. No.</b> —
	<b>GEV No.</b>	100701	<b>Ref. No.</b> 059380
	<b>GEV No.</b>	100801	<b>Ref. No.</b> —
	<b>GEV No.</b>	100869	<b>Ref. No.</b> —
	<b>GEV No.</b>	100906	<b>Ref. No.</b> 057960
	<b>GEV No.</b>	100908	<b>Ref. No.</b> 052125
	<b>GEV No.</b>	100909	<b>Ref. No.</b> —
	<b>GEV No.</b>	101282	<b>Ref. No.</b> —
	<b>GEV No.</b>	101287	<b>Ref. No.</b> —
	<b>GEV No.</b>	102110	<b>Ref. No.</b> —
	<b>GEV No.</b>	102111	<b>Ref. No.</b> —
	<b>GEV No.</b>	107650	<b>Ref. No.</b> —

JUNKERS



CB 502 series

pilot burners













			
<b>1</b>			
<b>GEV No.</b>	100085	<b>Ref. No.</b>	0K1206
<b>description</b>			
<b>spare parts for</b>	100085		
	<b>GEV No.</b>	100227	<b>Ref. No.</b> —
	<b>GEV No.</b>	100704	<b>Ref. No.</b> —
	<b>GEV No.</b>	100909	<b>Ref. No.</b> —
	<b>GEV No.</b>	101287	<b>Ref. No.</b> —
	<b>GEV No.</b>	101292	<b>Ref. No.</b> —
	<b>GEV No.</b>	101295	<b>Ref. No.</b> —
<b>accessories for</b>	100085		
	<b>GEV No.</b>	100220	<b>Ref. No.</b> 0K1176
	<b>GEV No.</b>	100221	<b>Ref. No.</b> —
	<b>GEV No.</b>	100222	<b>Ref. No.</b> 0K1126
	<b>GEV No.</b>	100223	<b>Ref. No.</b> —
	<b>GEV No.</b>	100224	<b>Ref. No.</b> —
	<b>GEV No.</b>	100225	<b>Ref. No.</b> —
	<b>GEV No.</b>	100226	<b>Ref. No.</b> —
	<b>GEV No.</b>	100228	<b>Ref. No.</b> —

Table continues overleaf



<b>accessories for</b> 100085				
	GEV No.	101281	Ref. No.	—
	GEV No.	101283	Ref. No.	—

**CB 503 series**  
pilot burners

				
1	<b>GEV No.</b>	100058	<b>Ref. No.</b>	OK0205
<b>description</b>				
<b>spare parts for</b> 100058				
	GEV No.	100224	Ref. No.	—
	GEV No.	101281	Ref. No.	—
	GEV No.	101283	Ref. No.	—
<b>accessories for</b> 100058				
	GEV No.	100220	Ref. No.	OK1176
	GEV No.	100221	Ref. No.	—
	GEV No.	100222	Ref. No.	OK1126
	GEV No.	100223	Ref. No.	—
	GEV No.	100226	Ref. No.	—
	GEV No.	100227	Ref. No.	—
	GEV No.	100228	Ref. No.	—
	GEV No.	100909	Ref. No.	—
	GEV No.	101287	Ref. No.	—
	GEV No.	102110	Ref. No.	—















<b>accessories for</b> 100058				
	GEV No.	102111	Ref. No.	—

**CB 505 series**  
pilot burners

				
1	<b>GEV No.</b>	100059	<b>Ref. No.</b>	OK0204
<b>description</b>				
<b>spare parts for</b> 100059				
	GEV No.	100231	Ref. No.	—
	GEV No.	100703	Ref. No.	203190
	GEV No.	100805	Ref. No.	—
	GEV No.	101282	Ref. No.	—
	GEV No.	101283	Ref. No.	—
	GEV No.	101292	Ref. No.	—
<b>accessories for</b> 100059				
	GEV No.	100217	Ref. No.	—
	GEV No.	100230	Ref. No.	OK1189
	GEV No.	100232	Ref. No.	—
	GEV No.	100233	Ref. No.	—
	GEV No.	100234	Ref. No.	—
	GEV No.	100907	Ref. No.	—
	GEV No.	100909	Ref. No.	—
	GEV No.	101288	Ref. No.	—

1 gas components



			
1			
<b>GEV No.</b>	100060	<b>Ref. No.</b>	0H6333
<b>description</b>			
<b>spare parts for</b>	100060		
	GEV No.	100231	Ref. No. —
	GEV No.	100703	Ref. No. 203190
	GEV No.	100805	Ref. No. —
	GEV No.	100907	Ref. No. —
	GEV No.	101282	Ref. No. —
	GEV No.	101283	Ref. No. —
	GEV No.	101292	Ref. No. —
<b>accessories for</b>	100060		
	GEV No.	100217	Ref. No. —
	GEV No.	100230	Ref. No. 0K1189
	GEV No.	100232	Ref. No. —
	GEV No.	100233	Ref. No. —
	GEV No.	100234	Ref. No. —
	GEV No.	100909	Ref. No. —
	GEV No.	101288	Ref. No. —

<b>PRO-GAS</b>			
100 series			
pilot burners			
			
1			
<b>GEV No.</b>	100071	<b>Ref. No.</b>	0H6338
<b>description</b>			
<b>spare parts for</b>	100071		
	GEV No.	100086	Ref. No. —
	GEV No.	100245	Ref. No. 056799
	GEV No.	100804	Ref. No. —
	GEV No.	100833	Ref. No. 0H6050
	GEV No.	100881	Ref. No. —
	GEV No.	100885	Ref. No. —
	GEV No.	100907	Ref. No. —
	GEV No.	100916	Ref. No. —
	GEV No.	100917	Ref. No. —
	GEV No.	100918	Ref. No. —
<b>accessories for</b>	100071		
	GEV No.	100246	Ref. No. 056656
	GEV No.	100904	Ref. No. 0K2497
	GEV No.	100905	Ref. No. —
	GEV No.	102110	Ref. No. —

Table continues overleaf



<b>accessories for</b>	100071			
	GEV No.	102111	Ref. No.	—

<b>accessories for</b>	100093			
	GEV No.	102110	Ref. No.	—

**140 - 145 -150 series**

**pilot burners**

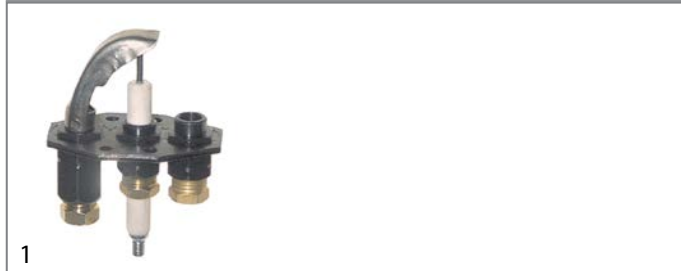

<b>GEV No.</b>	100093	<b>Ref. No.</b>	0H6311
----------------	--------	-----------------	--------

**description**

**spare parts for**

<b>GEV No.</b>	100216	Ref. No.	—
----------------	--------	----------	---



<b>GEV No.</b>	100701	Ref. No.	059380
----------------	--------	----------	--------

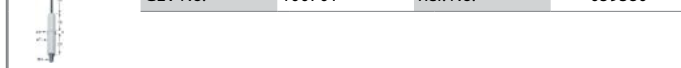

<b>GEV No.</b>	100897	Ref. No.	059161
----------------	--------	----------	--------



<b>GEV No.</b>	100906	Ref. No.	057960
----------------	--------	----------	--------



<b>GEV No.</b>	100907	Ref. No.	—
----------------	--------	----------	---

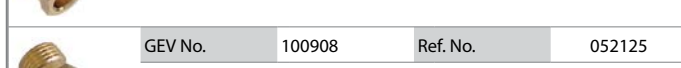

<b>GEV No.</b>	100908	Ref. No.	052125
----------------	--------	----------	--------

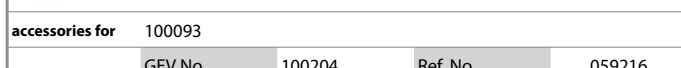

**accessories for**

<b>GEV No.</b>	100204	Ref. No.	059216
----------------	--------	----------	--------

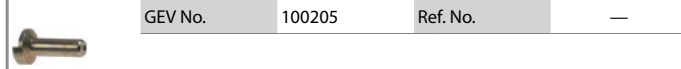

<b>GEV No.</b>	100205	Ref. No.	—
----------------	--------	----------	---

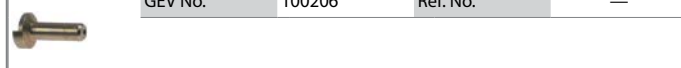

<b>GEV No.</b>	100206	Ref. No.	—
----------------	--------	----------	---



<b>GEV No.</b>	100207	Ref. No.	059215
----------------	--------	----------	--------



<b>GEV No.</b>	100803	Ref. No.	—
----------------	--------	----------	---

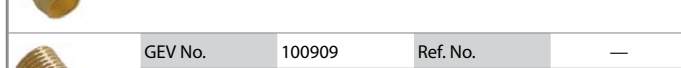

<b>GEV No.</b>	100898	Ref. No.	—
----------------	--------	----------	---



<b>GEV No.</b>	100909	Ref. No.	—
----------------	--------	----------	---



**producer-specific pilot burners**

**JUNO**



<b>GEV No.</b>	100856	<b>Ref. No.</b>	OK1210
----------------	--------	-----------------	--------

**description**

**spare parts for**

<b>GEV No.</b>	100806	Ref. No.	0H6645
----------------	--------	----------	--------



<b>GEV No.</b>	100847	Ref. No.	0H6343
----------------	--------	----------	--------



<b>GEV No.</b>	100853	Ref. No.	0H6342
----------------	--------	----------	--------

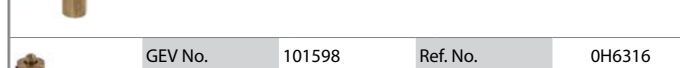

<b>GEV No.</b>	101598	Ref. No.	0H6316
----------------	--------	----------	--------

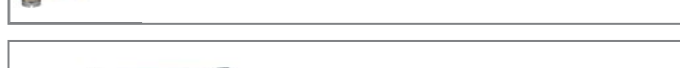

<b>GEV No.</b>	100857	<b>Ref. No.</b>	OK1211
----------------	--------	-----------------	--------

**description**

**spare parts for**

<b>GEV No.</b>	100806	Ref. No.	0H6645
----------------	--------	----------	--------



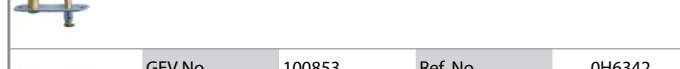

<b>GEV No.</b>	100847	Ref. No.	0H6343
----------------	--------	----------	--------





<b>GEV No.</b>	100853	Ref. No.	0H6342
----------------	--------	----------	--------



Table continues overleaf

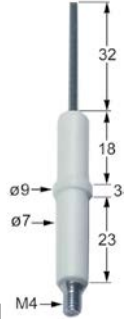

<b>spare parts for</b> 100857				
	GEV No.	100962	Ref. No.	—
	GEV No.	101599	Ref. No.	0G2024

electrodes

				
<b>GEV No.</b>	100701	<b>Ref. No.</b>	059380	
<b>description</b>				
<b>accessories for</b>	100701			
	GEV No.	100906	Ref. No.	057960

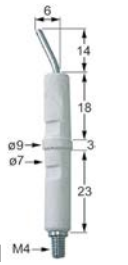
				
<b>GEV No.</b>	100703	<b>Ref. No.</b>	203190	
<b>description</b>				

				
<b>GEV No.</b>	100706	<b>Ref. No.</b>	056754	
<b>description</b>				

				
<b>GEV No.</b>	100724	<b>Ref. No.</b>	0H6257	
<b>description</b>				
<b>accessories for</b>	100724			
	GEV No.	519546	Ref. No.	—

				
<b>GEV No.</b>	100742	<b>Ref. No.</b>	0H6313	
<b>description</b>				

				
<b>GEV No.</b>	100906	<b>Ref. No.</b>	057960	
<b>description</b>				





1

<b>GEV No.</b>	nla'	<b>Ref. No.</b>	054269
<b>description</b>			
<b>spare parts for</b>	101136		
	<b>GEV No.</b>	100001	<b>Ref. No.</b> —

'no longer available

### ignition units



1

<b>GEV No.</b>	101016	<b>Ref. No.</b>	OK3019
<b>description</b>			



1

<b>GEV No.</b>	102485	<b>Ref. No.</b>	004240
<b>description</b>			



1

<b>GEV No.</b>	106571	<b>Ref. No.</b>	OK2374
<b>description</b>			

### thermocouples

#### plug-in thermocouples

#### plug-in thermocouples standard

with barrel socket ø5mm - type Junkers with aluminised tip



<b>GEV No.</b>	102205	<b>Ref. No.</b>	058332
----------------	--------	-----------------	--------

**description**

**accessories for** 102205

	<b>GEV No.</b>	101260	<b>Ref. No.</b> —
---	----------------	--------	-------------------

with barrel socket ø6mm

type Junkers with aluminised tip

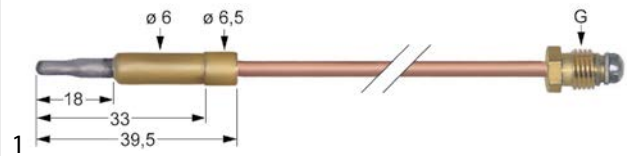

<b>GEV No.</b>	102218	<b>Ref. No.</b>	OK0682
----------------	--------	-----------------	--------

**description**

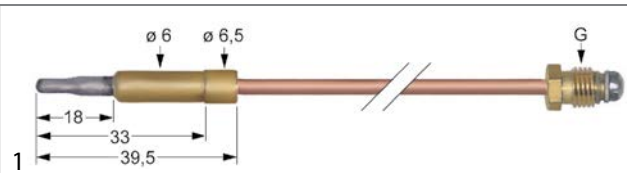

<b>GEV No.</b>	102221	<b>Ref. No.</b>	OK0686
----------------	--------	-----------------	--------

**description**

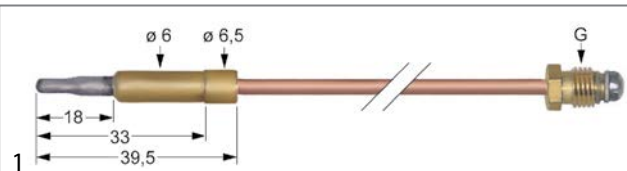

<b>GEV No.</b>	102223	<b>Ref. No.</b>	OK0654
----------------	--------	-----------------	--------

**description**

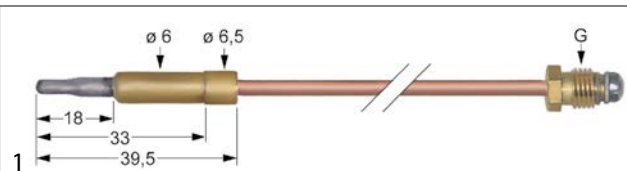

<b>GEV No.</b>	102228	<b>Ref. No.</b>	OK6175
----------------	--------	-----------------	--------

**description**





<b>GEV No.</b>	102229	<b>Ref. No.</b>	0H6174
<b>description</b>			

<b>GEV No.</b>	102231	<b>Ref. No.</b>	0K0687
<b>description</b>			

with barrel socket  $\varnothing 6(6.5)$ mm

thermocouples SIT

<b>GEV No.</b>	107605	<b>Ref. No.</b>	051119
<b>description</b>			

<b>GEV No.</b>	107609	<b>Ref. No.</b>	025031
<b>description</b>			

<b>GEV No.</b>	107612	<b>Ref. No.</b>	0H6255
<b>description</b>			

<b>GEV No.</b>	107613	<b>Ref. No.</b>	0K3464
<b>description</b>			

<b>GEV No.</b>	107619	<b>Ref. No.</b>	0H6253
<b>description</b>			

<b>GEV No.</b>	107619	<b>Ref. No.</b>	0H6253
<b>description</b>			

<b>GEV No.</b>	107621	<b>Ref. No.</b>	0H6252
<b>description</b>			

<b>GEV No.</b>	107621	<b>Ref. No.</b>	0H6252
<b>description</b>			

plug-in thermocouples with interruption

<b>GEV No.</b>	107863	<b>Ref. No.</b>	0C3162
<b>description</b>			





threaded thermocouples

threaded thermocouples standard

with socket with thread M8x1

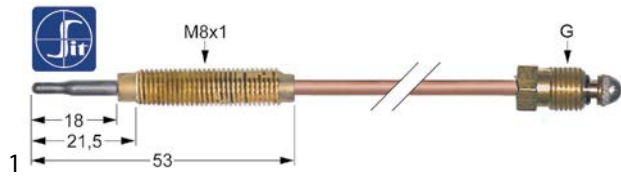
SIT



<b>GEV No.</b>	107631	<b>Ref. No.</b>	0K0652
<b>description</b>			
<b>accessories for</b>	107631		
	GEV No.	102067	Ref. No. —

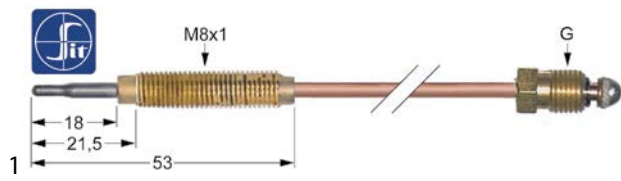

<b>GEV No.</b>	107643	<b>Ref. No.</b>	0H6256
<b>description</b>			
<b>accessories for</b>	107643		
	GEV No.	102067	Ref. No. —

extensions



<b>GEV No.</b>	102265	<b>Ref. No.</b>	055032
<b>description</b>			

accessories

interrupters



<b>GEV No.</b>	101258	<b>Ref. No.</b>	0H6263
<b>description</b>			

miscellaneous

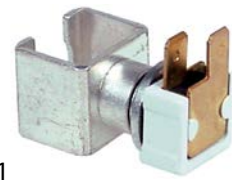

<b>GEV No.</b>	102273	<b>Ref. No.</b>	OTR930
<b>description</b>			







gas burners

hob burners

producer-specific hob burners

JUNO

46, 71, 72 series

<b>GEV No.</b>	103001	<b>Ref. No.</b>	0H6325
<b>description</b>			
<b>accessories for</b>	103001		
	GEV No.	103004	Ref. No. 0H6344
	GEV No.	103007	Ref. No. 0H6863
	GEV No.	104001	Ref. No. 0H6308
	GEV No.	104057	Ref. No. 0H7089
	GEV No.	104231	Ref. No. 0H7096
	GEV No.	104233	Ref. No. —





<b>GEV No.</b>	103002	<b>Ref. No.</b>	0H6326
<b>description</b>			
<b>accessories for</b>	103002		
	GEV No.	103005	Ref. No. 0H6323
	GEV No.	103007	Ref. No. 0H6863
	GEV No.	104002	Ref. No. 0H6309

Table continues overleaf



<b>accessories for</b>	103002			
	GEV No.	104057	Ref. No.	0H7089





<b>GEV No.</b>	103003	<b>Ref. No.</b>	0H6327	
----------------	--------	-----------------	--------	--

**description**

<b>accessories for</b>	103003			
------------------------	--------	--	--	--

	GEV No.	103006	Ref. No.	0H6324
---	---------	--------	----------	--------

	GEV No.	103007	Ref. No.	0H6863
---	---------	--------	----------	--------

	GEV No.	104003	Ref. No.	0H6310
---	---------	--------	----------	--------

	GEV No.	104232	Ref. No.	0H7095
---	---------	--------	----------	--------

	GEV No.	104234	Ref. No.	0KC813
---	---------	--------	----------	--------



<b>GEV No.</b>	103004	<b>Ref. No.</b>	0H6344	
----------------	--------	-----------------	--------	--

**description**

<b>accessories for</b>	103004			
------------------------	--------	--	--	--

	GEV No.	103001	Ref. No.	0H6325
---	---------	--------	----------	--------

	GEV No.	103007	Ref. No.	0H6863
---	---------	--------	----------	--------

	GEV No.	104001	Ref. No.	0H6308
---	---------	--------	----------	--------

	GEV No.	104057	Ref. No.	0H7089
---	---------	--------	----------	--------

	GEV No.	104231	Ref. No.	0H7096
---	---------	--------	----------	--------

	GEV No.	104233	Ref. No.	—
---	---------	--------	----------	---





<b>GEV No.</b>	103005	<b>Ref. No.</b>	0H6323	
----------------	--------	-----------------	--------	--

**description**

<b>accessories for</b>	103005			
------------------------	--------	--	--	--

	GEV No.	103002	Ref. No.	0H6326
---	---------	--------	----------	--------

<b>accessories for</b>	103005			
	GEV No.	103007	Ref. No.	0H6863

	GEV No.	104002	Ref. No.	0H6309
---	---------	--------	----------	--------

	GEV No.	104057	Ref. No.	0H7089
---	---------	--------	----------	--------

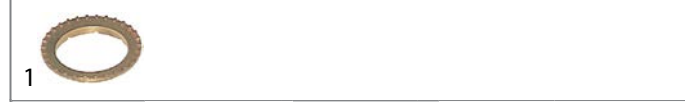



<b>GEV No.</b>	103006	<b>Ref. No.</b>	0H6324	
----------------	--------	-----------------	--------	--

**description**

<b>accessories for</b>	103006			
------------------------	--------	--	--	--

	GEV No.	103003	Ref. No.	0H6327
---	---------	--------	----------	--------

	GEV No.	103007	Ref. No.	0H6863
---	---------	--------	----------	--------

	GEV No.	104003	Ref. No.	0H6310
---	---------	--------	----------	--------

	GEV No.	104232	Ref. No.	0H7095
--	---------	--------	----------	--------

	GEV No.	104234	Ref. No.	0KC813
---	---------	--------	----------	--------



<b>GEV No.</b>	103007	<b>Ref. No.</b>	0H6863	
----------------	--------	-----------------	--------	--

**description**



<b>GEV No.</b>	104001	<b>Ref. No.</b>	0H6308	
----------------	--------	-----------------	--------	--

**description**



<b>GEV No.</b>	104002	<b>Ref. No.</b>	0H6309	
----------------	--------	-----------------	--------	--

**description**





<b>GEV No.</b>	104003	<b>Ref. No.</b>	0H6310	
----------------	--------	-----------------	--------	--

**description**



			
1			
<b>GEV No.</b>	104057	<b>Ref. No.</b>	0H7089
<b>description</b>			

			
1			
<b>GEV No.</b>	104231	<b>Ref. No.</b>	0H7096
<b>description</b>			

			
1			
<b>GEV No.</b>	104232	<b>Ref. No.</b>	0H7095
<b>description</b>			

			
1			
<b>GEV No.</b>	104234	<b>Ref. No.</b>	0KC813
<b>description</b>			

74, 75, 85, 90, 92, 95, 97 series

			
1			
<b>GEV No.</b>	103007	<b>Ref. No.</b>	0H6863
<b>description</b>			

			
1			
<b>GEV No.</b>	103086	<b>Ref. No.</b>	0H6319
<b>description</b>			

			
1			
<b>GEV No.</b>	103087	<b>Ref. No.</b>	0H6320
<b>description</b>			

			
1			
<b>GEV No.</b>	103088	<b>Ref. No.</b>	0H6321
<b>description</b>			

			
1			
<b>GEV No.</b>	104027	<b>Ref. No.</b>	0G1593
<b>description</b>			

			
1			
<b>GEV No.</b>	104028	<b>Ref. No.</b>	0H6340
<b>description</b>			

			
1			
<b>GEV No.</b>	104029	<b>Ref. No.</b>	0H6341
<b>description</b>			

			
1			
<b>GEV No.</b>	104042	<b>Ref. No.</b>	0H7154
<b>description</b>			

			
1			
<b>GEV No.</b>	104043	<b>Ref. No.</b>	0H7155
<b>description</b>			

1

<b>GEV No.</b>	104044	<b>Ref. No.</b>	0G1811
<b>description</b>			



1

<b>GEV No.</b>	210130	<b>Ref. No.</b>	0K2331
<b>description</b>			

pan supports



1

<b>GEV No.</b>	210122	<b>Ref. No.</b>	0KC890
<b>description</b>			



1

<b>GEV No.</b>	210131	<b>Ref. No.</b>	0K1983
<b>description</b>			



1

<b>GEV No.</b>	210123	<b>Ref. No.</b>	0KC891
<b>description</b>			

reducers for pan supports



1

<b>GEV No.</b>	210001	<b>Ref. No.</b>	025056
<b>description</b>			



1

<b>GEV No.</b>	210126	<b>Ref. No.</b>	0K2329
<b>description</b>			



1

<b>GEV No.</b>	210014	<b>Ref. No.</b>	0H6849
<b>description</b>			



1

<b>GEV No.</b>	210127	<b>Ref. No.</b>	0K2330
<b>description</b>			



1

<b>GEV No.</b>	210020	<b>Ref. No.</b>	0H6780
<b>description</b>			

accessories

reducers for pan supports



1

<b>GEV No.</b>	210001	<b>Ref. No.</b>	025056
<b>description</b>			

1

<b>GEV No.</b>	210014	<b>Ref. No.</b>	0H6849
<b>description</b>			



1

<b>GEV No.</b>	210127	<b>Ref. No.</b>	0K2330
<b>description</b>			



1

<b>GEV No.</b>	210020	<b>Ref. No.</b>	0H6780
<b>description</b>			



1

<b>GEV No.</b>	210130	<b>Ref. No.</b>	0K2331
<b>description</b>			

pan supports



1

<b>GEV No.</b>	210122	<b>Ref. No.</b>	0KC890
<b>description</b>			



1

<b>GEV No.</b>	210131	<b>Ref. No.</b>	0K1983
<b>description</b>			



1

<b>GEV No.</b>	210123	<b>Ref. No.</b>	0KC891
<b>description</b>			



1

<b>GEV No.</b>	210211	<b>Ref. No.</b>	0G2033
<b>description</b>			



1

<b>GEV No.</b>	210126	<b>Ref. No.</b>	0K2329
<b>description</b>			

air mixers



1

<b>GEV No.</b>	104372	<b>Ref. No.</b>	0G6309
<b>description</b>			



bar burners

bar burners



1			
<b>GEV No.</b>	104185	<b>Ref. No.</b>	OK1193
<b>description</b>			



1			
<b>GEV No.</b>	104186	<b>Ref. No.</b>	0H6337
<b>description</b>			



1			
<b>GEV No.</b>	104188	<b>Ref. No.</b>	0H6335
<b>description</b>			



1			
<b>GEV No.</b>	104580	<b>Ref. No.</b>	0A5124
<b>description</b>			



1			
<b>GEV No.</b>	105970	<b>Ref. No.</b>	OKD090
<b>description</b>			



1			
<b>GEV No.</b>	105971	<b>Ref. No.</b>	OKD091
<b>description</b>			

ring burners



1			
<b>GEV No.</b>	104189	<b>Ref. No.</b>	0H7082
<b>description</b>			



1			
<b>GEV No.</b>	104196	<b>Ref. No.</b>	OKC724
<b>description</b>			

accessories

nozzle holders



1			
<b>GEV No.</b>	101152	<b>Ref. No.</b>	0C3158
<b>description</b>			

air slides



1			
<b>GEV No.</b>	104193	<b>Ref. No.</b>	0H6880
<b>description</b>			



1			
<b>GEV No.</b>	104194	<b>Ref. No.</b>	OK2561
<b>description</b>			



# gas nozzles

## main nozzles

### gas nozzles M10x1



1	<b>GEV No.</b>	100150	<b>Ref. No.</b>	054630
<b>description</b>				



1	<b>GEV No.</b>	100151	<b>Ref. No.</b>	054127
<b>description</b>				



1	<b>GEV No.</b>	100155	<b>Ref. No.</b>	056470
<b>description</b>				



1	<b>GEV No.</b>	100670	<b>Ref. No.</b>	002265
<b>description</b>				



1	<b>GEV No.</b>	101975	<b>Ref. No.</b>	003722
<b>description</b>				



1	<b>GEV No.</b>	106328	<b>Ref. No.</b>	002393
<b>description</b>				



1	<b>GEV No.</b>	106469	<b>Ref. No.</b>	059382
<b>description</b>				



1	<b>GEV No.</b>	106474	<b>Ref. No.</b>	0A2102
<b>description</b>				



1	<b>GEV No.</b>	106475	<b>Ref. No.</b>	0A2083
<b>description</b>				



1	<b>GEV No.</b>	100387	<b>Ref. No.</b>	0A2091
<b>description</b>				

### gas nozzles M12x1



1	<b>GEV No.</b>	100283	<b>Ref. No.</b>	0K1241
<b>description</b>				



1	<b>GEV No.</b>	100284	<b>Ref. No.</b>	0K1245
<b>description</b>				





1	<b>GEV No.</b>	100285	<b>Ref. No.</b>	0G2774
<b>description</b>				







			
1			
<b>GEV No.</b>	100286	<b>Ref. No.</b>	0K1246
<b>description</b>			

			
1			
<b>GEV No.</b>	100302	<b>Ref. No.</b>	0H6355
<b>description</b>			

			
1			
<b>GEV No.</b>	100288	<b>Ref. No.</b>	0K1229
<b>description</b>			

			
1			
<b>GEV No.</b>	100303	<b>Ref. No.</b>	0G1794
<b>description</b>			

			
1			
<b>GEV No.</b>	100289	<b>Ref. No.</b>	0G3001
<b>description</b>			

			
1			
<b>GEV No.</b>	100306	<b>Ref. No.</b>	0G2027
<b>description</b>			

			
1			
<b>GEV No.</b>	100290	<b>Ref. No.</b>	0K1215
<b>description</b>			

			
1			
<b>GEV No.</b>	100307	<b>Ref. No.</b>	0K1224
<b>description</b>			

			
1			
<b>GEV No.</b>	100291	<b>Ref. No.</b>	0G2914
<b>description</b>			

			
1			
<b>GEV No.</b>	100308	<b>Ref. No.</b>	0K1144
<b>description</b>			

			
1			
<b>GEV No.</b>	100292	<b>Ref. No.</b>	0G2030
<b>description</b>			

			
1			
<b>GEV No.</b>	100309	<b>Ref. No.</b>	0K1230
<b>description</b>			

			
1			
<b>GEV No.</b>	100300	<b>Ref. No.</b>	0G1792
<b>description</b>			

			
1			
<b>GEV No.</b>	100326	<b>Ref. No.</b>	0U4101
<b>description</b>			





			
1			
<b>GEV No.</b>	100662	<b>Ref. No.</b>	0K1249
<b>description</b>			

			
1			
<b>GEV No.</b>	100665	<b>Ref. No.</b>	0K1214
<b>description</b>			

gas nozzles M15x1

			
1			
<b>GEV No.</b>	100329	<b>Ref. No.</b>	230890
<b>description</b>			

			
1			
<b>GEV No.</b>	100331	<b>Ref. No.</b>	230887
<b>description</b>			

			
1			
<b>GEV No.</b>	100333	<b>Ref. No.</b>	230886
<b>description</b>			

			
1			
<b>GEV No.</b>	100334	<b>Ref. No.</b>	230888
<b>description</b>			

			
1			
<b>GEV No.</b>	100339	<b>Ref. No.</b>	230889
<b>description</b>			

gas nozzles (other)

			
1			
<b>GEV No.</b>	100561	<b>Ref. No.</b>	026720
<b>description</b>			

			
1			
<b>GEV No.</b>	100565	<b>Ref. No.</b>	050501
<b>description</b>			

			
1			
<b>GEV No.</b>	100567	<b>Ref. No.</b>	025983
<b>description</b>			

			
1			
<b>GEV No.</b>	100569	<b>Ref. No.</b>	026717
<b>description</b>			

			
1			
<b>GEV No.</b>	100571	<b>Ref. No.</b>	025867
<b>description</b>			

			
1			
<b>GEV No.</b>	100574	<b>Ref. No.</b>	026786
<b>description</b>			



			
1			
<b>GEV No.</b>	100575	<b>Ref. No.</b>	026213
<b>description</b>			

			
1			
<b>GEV No.</b>	100580	<b>Ref. No.</b>	026788
<b>description</b>			

			
1			
<b>GEV No.</b>	100581	<b>Ref. No.</b>	026622
<b>description</b>			

			
1			
<b>GEV No.</b>	100592	<b>Ref. No.</b>	051460
<b>description</b>			

			
1			
<b>GEV No.</b>	100595	<b>Ref. No.</b>	050750
<b>description</b>			

**pilot burner nozzles**

**pilot burner nozzles JUNKERS**

**CB 50203\_/503\_ series**

			
1			
<b>GEV No.</b>	100220	<b>Ref. No.</b>	0K1176
<b>description</b>			

			
1			
<b>GEV No.</b>	100222	<b>Ref. No.</b>	0K1126
<b>description</b>			

**CB 5050\_ series**

			
1			
<b>GEV No.</b>	100230	<b>Ref. No.</b>	0K1189
<b>description</b>			

**pilot burner nozzles SIT**

**100 series**

			
1			
<b>GEV No.</b>	100245	<b>Ref. No.</b>	056799
<b>description</b>			

			
1			
<b>GEV No.</b>	100246	<b>Ref. No.</b>	056656
<b>description</b>			

			
1			
<b>GEV No.</b>	107170	<b>Ref. No.</b>	058525
<b>description</b>			

			
1			
<b>GEV No.</b>	107171	<b>Ref. No.</b>	058330
<b>description</b>			

**140/150 series**

			
1			
<b>GEV No.</b>	100204	<b>Ref. No.</b>	059216
<b>description</b>			

			
1			
<b>GEV No.</b>	100207	<b>Ref. No.</b>	059215
<b>description</b>			

160 series



1			
<b>GEV No.</b>	107172	<b>Ref. No.</b>	054593
<b>description</b>	pilot burner nozzle SIT LPG code 25 Qty 1 pcs		



1			
<b>GEV No.</b>	107174	<b>Ref. No.</b>	053670
<b>description</b>	pilot burner nozzle SIT natural gas code 41 Qty 1 pcs		



1			
<b>GEV No.</b>	107175	<b>Ref. No.</b>	053668
<b>description</b>	pilot burner nozzle SIT natural gas code 51 Qty 1 pcs suitable for 160 series		

bypass nozzles

bypass nozzles EGA



1			
<b>GEV No.</b>	106825	<b>Ref. No.</b>	0K1226
<b>description</b>	bypass nozzle EGA bore ø 0.37mm		



1			
<b>GEV No.</b>	100355	<b>Ref. No.</b>	0K1236
<b>description</b>	bypass nozzle EGA type 31248 series bore ø 0.52mm		



1			
<b>GEV No.</b>	100356	<b>Ref. No.</b>	0H6068
<b>description</b>	bypass nozzle EGA type 31248 series bore ø 0.55mm total length 23mm ø 5mm thread M5x0.5		



1			
<b>GEV No.</b>	100354	<b>Ref. No.</b>	0H6369
<b>description</b>	bypass nozzle EGA type 31248 series bore ø 0.5mm		



1			
<b>GEV No.</b>	100361	<b>Ref. No.</b>	0H6370
<b>description</b>	bypass nozzle EGA type 31248 series bore ø 0.65mm		



1			
<b>GEV No.</b>	100368	<b>Ref. No.</b>	0H6349
<b>description</b>	bypass nozzle EGA type 31248 series bore ø 0.6mm		



1			
<b>GEV No.</b>	100358	<b>Ref. No.</b>	0H6347
<b>description</b>	bypass nozzle EGA type 31248 series bore ø 0.75mm		



1			
<b>GEV No.</b>	100357	<b>Ref. No.</b>	0H6066
<b>description</b>	bypass nozzle EGA type 31248 series bore ø 0.7mm		



1			
<b>GEV No.</b>	100346	<b>Ref. No.</b>	0K0241
<b>description</b>	bypass nozzle EGA type 31248 series bore ø 0.85mm		



1			
<b>GEV No.</b>	100328	<b>Ref. No.</b>	0K0246
<b>description</b>	bypass nozzle EGA type 31248 series bore ø 0.8mm		



1			
<b>GEV No.</b>	100347	<b>Ref. No.</b>	0K1213
<b>description</b>	bypass nozzle EGA type 31248 series bore ø 0.9mm		



1			
<b>GEV No.</b>	100359	<b>Ref. No.</b>	0K1293
<b>description</b>	bypass nozzle EGA type 31248 series bore ø 1.2mm		



1			
<b>GEV No.</b>	100363	<b>Ref. No.</b>	0K0261
<b>description</b>	bypass nozzle EGA type 31248 series bore ø 1.5mm		

bypass nozzles PEL22



1			
<b>GEV No.</b>	100409	<b>Ref. No.</b>	056743
<b>description</b>	bypass nozzle type PEL22 bore ø 0.8mm thread M6x0.5		



internal nozzles

internal nozzles for EGA gas taps/nozzle holders

EGA 24197/24362

1	
<b>GEV No.</b>	100341
<b>Ref. No.</b>	OK1274
<b>description</b>	internal nozzle bore ø 1.15mm type EGA/PEL22

1	
<b>GEV No.</b>	100344
<b>Ref. No.</b>	OK1298
<b>description</b>	internal nozzle bore ø 1.2mm type EGA/PEL22

1	
<b>GEV No.</b>	100342
<b>Ref. No.</b>	230812
<b>description</b>	internal nozzle bore ø 1.4mm type EGA/PEL22

1	
<b>GEV No.</b>	100323
<b>Ref. No.</b>	OK1302
<b>description</b>	internal nozzle bore ø 1.85mm type EGA/PEL22

1	
<b>GEV No.</b>	100324
<b>Ref. No.</b>	230830
<b>description</b>	internal nozzle bore ø 2.1mm type PEL22

1	
<b>GEV No.</b>	100327
<b>Ref. No.</b>	230904
<b>description</b>	internal nozzle bore ø 2.35mm type EGA/PEL22

EGA 26400/26440/23268

1	
<b>GEV No.</b>	100310
<b>Ref. No.</b>	0H6356
<b>description</b>	internal nozzle bore ø 0.66mm suitable for EGA26400/26440

1	
<b>GEV No.</b>	100319
<b>Ref. No.</b>	OK1282
<b>description</b>	internal nozzle bore ø 0.75mm suitable for EGA26400/26440

1	
<b>GEV No.</b>	100311
<b>Ref. No.</b>	0H6372
<b>description</b>	internal nozzle bore ø 0.80mm suitable for EGA26400/26440

1	
<b>GEV No.</b>	100321
<b>Ref. No.</b>	OK1283
<b>description</b>	internal nozzle bore ø 0.90mm suitable for EGA26400/26440

1	
<b>GEV No.</b>	100315
<b>Ref. No.</b>	OG1786
<b>description</b>	internal nozzle bore ø 0.95mm suitable for EGA26400/26440

1	
<b>GEV No.</b>	100312
<b>Ref. No.</b>	0H6357
<b>description</b>	internal nozzle bore ø 1.05mm suitable for EGA26400/26440

1	
<b>GEV No.</b>	100313
<b>Ref. No.</b>	OK1252
<b>description</b>	internal nozzle bore ø 1.20mm suitable for EGA26400/26440

1	
<b>GEV No.</b>	100322
<b>Ref. No.</b>	OK1254
<b>description</b>	internal nozzle bore ø 1.40mm suitable for EGA26400/26440

1	
<b>GEV No.</b>	100316
<b>Ref. No.</b>	OK1272
<b>description</b>	internal nozzle bore ø 1.70mm suitable for EGA26400/26440

1	
<b>GEV No.</b>	100314
<b>Ref. No.</b>	OG1791
<b>description</b>	internal nozzle bore ø 1.90mm suitable for EGA26400/26440

1	
<b>GEV No.</b>	100317
<b>Ref. No.</b>	OK1232
<b>description</b>	internal nozzle bore ø 2.20mm suitable for EGA26400/26440

auxiliary gas parts

screw connections

with rotating joint

1	
<b>GEV No.</b>	102758
<b>Ref. No.</b>	OG3754
<b>description</b>	rotating joint for ignition gas approval without DVGW complete



1 gas components





<b>GEV No.</b>	102748	<b>Ref. No.</b>	0K2578
<b>description</b>	rotating joint T1: M22 T2: 3/4" L 69mm W 57mm for main gas approval without DVGW complete		

**olives**



<b>GEV No.</b>	101278	<b>Ref. No.</b>	060325
<b>description</b>	olive for pipe ø 10mm Qty 1 pcs		
<b>accessories for</b>	101278		
	<b>GEV No.</b>	100943	<b>Ref. No.</b> —
	union nut thread M17x1 tube ø 10mm		
	<b>GEV No.</b>	101300	<b>Ref. No.</b> —
	union nut thread M16x1.5 tube ø 10mm		
	<b>GEV No.</b>	101478	<b>Ref. No.</b> —
	union nut thread 3/8" for pipe ø 10mm		







<b>GEV No.</b>	101248	<b>Ref. No.</b>	050682
<b>description</b>	olive for pipe ø 12mm Qty 1 pcs suitable for PEL		
<b>accessories for</b>	101248		
	<b>GEV No.</b>	101251	<b>Ref. No.</b> —
	union nut thread M20x1.5 for pipe ø 12mm		



<b>GEV No.</b>	102517	<b>Ref. No.</b>	0K2859 293299
<b>description</b>	olive for pipe ø 15mm brass Qty 1 pcs		



<b>GEV No.</b>	101284	<b>Ref. No.</b>	0K2491
<b>description</b>	olive for pipe ø 4mm Qty 1 pcs		
<b>accessories for</b>	101284		
	<b>GEV No.</b>	101259	<b>Ref. No.</b> —
	union nut thread M8x1 for pipe ø 4mm		
	<b>GEV No.</b>	101285	<b>Ref. No.</b> 0KL220
	union screw thread M8x1 for pipe ø 4mm Qty 1 pcs JUNKERS		
	<b>GEV No.</b>	101294	<b>Ref. No.</b> —
	union nut thread M10x1 for pipe ø 4mm WS 14 L 12mm Qty 1 pcs		



<b>GEV No.</b>	100897	<b>Ref. No.</b>	059161
<b>description</b>	olive for pipe ø 4mm Qty 1 pcs for pilot burner		

**union screws**







<b>GEV No.</b>	100904	<b>Ref. No.</b>	0K2497
<b>description</b>	locking screw M10x1 for pipe ø 4mm Qty 1 pcs		



<b>GEV No.</b>	100906	<b>Ref. No.</b>	057960
<b>description</b>	screw connection thread M10x1 for ignition electrode brass Qty 1 pcs WS 10		



<b>GEV No.</b>	100908	<b>Ref. No.</b>	052125
<b>description</b>	union screw thread M10x1 for pipe ø 4mm Qty 1 pcs		
<b>accessories for</b>	100908		
	<b>GEV No.</b>	100897	<b>Ref. No.</b> 059161
	olive for pipe ø 4mm Qty 1 pcs for pilot burner		
	<b>GEV No.</b>	101246	<b>Ref. No.</b> —
	olive for pipe ø 4mm Qty 1 pcs		
	<b>GEV No.</b>	101280	<b>Ref. No.</b> —
	olive for pipe ø 4mm Qty 1 pcs		
	<b>GEV No.</b>	101282	<b>Ref. No.</b> —
	olive for pipe ø 4mm L 7.4mm Qty 1 pcs		



<b>GEV No.</b>	101285	<b>Ref. No.</b>	0KL220
<b>description</b>	union screw thread M8x1 for pipe ø 4mm Qty 1 pcs JUNKERS		
<b>accessories for</b>	101285		
	<b>GEV No.</b>	101284	<b>Ref. No.</b> 0K2491
	olive for pipe ø 4mm Qty 1 pcs		





gas hoses

miscellaneous

			
1			
<b>GEV No.</b>	250000	<b>Ref. No.</b>	0H6831 263346
<b>description</b>	gas hose L 790mm nominal-ø 12mm for tilting bratt pan SS		

pressure switches

			
1			
<b>GEV No.</b>	541182	<b>Ref. No.</b>	0K1397
<b>description</b>	pressure control		

			
1			
<b>GEV No.</b>	541073	<b>Ref. No.</b>	002635
<b>description</b>	pressure control ø 45mm pressure range adjustable 5-20mbar pressure connection vertical gas technology connection 1/4" pressure connection ø 1/4"mm		

			
1			
<b>GEV No.</b>	541446	<b>Ref. No.</b>	005029
<b>description</b>	pressure control pressure range 10-50mbar connection 1/4"		

			
1			
<b>GEV No.</b>	541075	<b>Ref. No.</b>	003772
<b>description</b>	pressure control pressure range adjustable 0.44-0.8mbar gas technology connection 6mm suitable for ZANUSSI		

equipment-specific units

for convection ovens/combi-steamers

steam generators

			
1			
<b>GEV No.</b>	694312	<b>Ref. No.</b>	005234
<b>description</b>	steam generator L 615mm W 100mm H 425mm		

spare parts and accessories

			
1			
<b>GEV No.</b>	550917	<b>Ref. No.</b>	0K2769
<b>description</b>	flange		

			
1			
<b>GEV No.</b>	550900	<b>Ref. No.</b>	0KD350
<b>description</b>	flange L 60mm W 40mm H 1mm		

			
1			
<b>GEV No.</b>	550899	<b>Ref. No.</b>	0KD286
<b>description</b>	flange L 60mm W 40mm H 2mm		

			
1			
<b>GEV No.</b>	690878	<b>Ref. No.</b>	0K2793
<b>description</b>	taper nut		

filters

			
1			
<b>GEV No.</b>	514377	<b>Ref. No.</b>	0H6299
<b>description</b>	drain filter		

frame



1

<b>GEV No.</b>	693398	<b>Ref. No.</b>	057382
<b>description</b>	frame for level glass		

cleaning system

nozzles



1

<b>GEV No.</b>	510239	<b>Ref. No.</b>	0H6675
<b>description</b>	rinse jet for humidifier		

miscellaneous



1

<b>GEV No.</b>	693429	<b>Ref. No.</b>	002662
<b>description</b>	bush		



1

<b>GEV No.</b>	550697	<b>Ref. No.</b>	0K2358
<b>description</b>	bush for knob		



1

<b>GEV No.</b>	693432	<b>Ref. No.</b>	002663
<b>description</b>	gasket for knob		



1

<b>GEV No.</b>	693430	<b>Ref. No.</b>	051263
<b>description</b>	nut thread M22x1.5 H 5mm WS 26 zinc-coated steel Qty 1 pcs		



1

<b>GEV No.</b>	693431	<b>Ref. No.</b>	002727
<b>description</b>	plain washer		

for tilting bratt pans

miscellaneous



1

<b>GEV No.</b>	693243	<b>Ref. No.</b>	0K1817
<b>description</b>	roller for cable		

for boiling pans

filters



1

<b>GEV No.</b>	541370	<b>Ref. No.</b>	0G5198
<b>description</b>	drain filter		



1

<b>GEV No.</b>	514379	<b>Ref. No.</b>	027114
<b>description</b>	drain filter kettle		



gearboxes

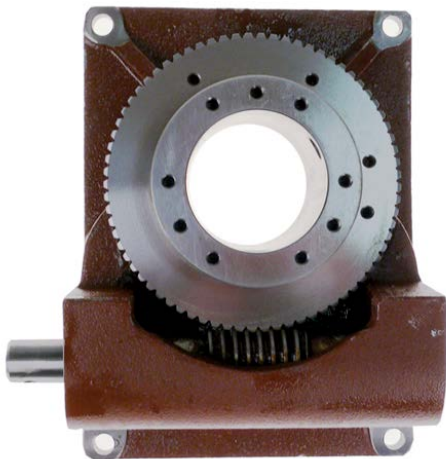

1

<b>GEV No.</b>	520400	<b>Ref. No.</b>	OG1613 280794
<b>description</b>	auger gear		

level glasses

complete



1

<b>GEV No.</b>	540200	<b>Ref. No.</b>	0H7003
<b>description</b>	level glass for kettle complete thread 1½"		

for dishwashers

hood mechanics for dishwashers

cable controls



1

<b>GEV No.</b>	693244	<b>Ref. No.</b>	0K1802
<b>description</b>	hauling cable		

knobs

producer-specific knobs

JUNO



1

<b>GEV No.</b>	112127	<b>Ref. No.</b>	0K2265
<b>description</b>	knob		



1

<b>GEV No.</b>	111823	<b>Ref. No.</b>	0H6749
<b>description</b>	knob energy regulator 1-3 ø 63mm shaft ø 6x4.6mm shaft flat upper silver		



1

<b>GEV No.</b>	111820	<b>Ref. No.</b>	0K2245
<b>description</b>	knob gas tap with ignition flame ø 63mm shaft ø 8x7mm shaft flat lower black		



1

<b>GEV No.</b>	111822	<b>Ref. No.</b>	0K2242
<b>description</b>	knob gas thermostat 1-8 ø 63mm shaft ø 8x6.5mm shaft flat lower		



1

<b>GEV No.</b>	110175	<b>Ref. No.</b>	0H6679
<b>description</b>	knob oven TH/BH/TH+BH ø 63mm shaft ø 6x4.6mm shaft flat upper silver/red		



1

<b>GEV No.</b>	111588	<b>Ref. No.</b>	OK2303
<b>description</b>	knob thermostat 1-10 ø 63mm shaft ø 6x4.6mm shaft flat upper		



1

<b>GEV No.</b>	110177	<b>Ref. No.</b>	0H6676
<b>description</b>	knob thermostat t.max. 200°C ø 63mm shaft ø 6x4.6mm shaft flat upper silver temperature range 60-200°C rotation 270°		



1

<b>GEV No.</b>	110180	<b>Ref. No.</b>	0H6746
<b>description</b>	knob time 60min ø 63mm shaft ø 6x4.6mm shaft flat upper silver		



1

<b>GEV No.</b>	110268	<b>Ref. No.</b>	0H6735
<b>description</b>	knob power ø 72mm shaft ø 6x4.6mm shaft flat horizontal		



1

<b>GEV No.</b>	110267	<b>Ref. No.</b>	0H6736
<b>description</b>	knob programme ø 72mm shaft ø 6x4.6mm shaft flat lower		



1

<b>GEV No.</b>	110273	<b>Ref. No.</b>	0H6726
<b>description</b>	knob speed ø 72mm shaft ø 6x4.6mm shaft flat horizontal		



1

<b>GEV No.</b>	110274	<b>Ref. No.</b>	0H6779
<b>description</b>	knob speed/power ø 72mm shaft ø 6x4.6mm shaft flat horizontal		



1

<b>GEV No.</b>	110270	<b>Ref. No.</b>	0H6733
<b>description</b>	knob thermostat 1-9 ø 72mm shaft ø 6x4.6mm shaft flat lower		



1

<b>GEV No.</b>	110269	<b>Ref. No.</b>	0H6734
<b>description</b>	knob thermostat t.max. 100°C 50-100°C ø 72mm shaft ø 6x4.6mm shaft flat lower		



1

<b>GEV No.</b>	110265	<b>Ref. No.</b>	0H6731
<b>description</b>	knob thermostat t.max. 250°C ø 72mm shaft ø 6x4.6mm shaft flat lower white/black temperature range 50-250°C rotation 270°		





1

<b>GEV No.</b>	110266	<b>Ref. No.</b>	0H6732
<b>description</b>	knob time 120min ø 72mm shaft ø 6x4.6mm shaft flat lower black		

			
1			
<b>GEV No.</b>	110272	<b>Ref. No.</b>	0H6725
<b>description</b>	knob time 120min ø 72mm shaft ø 6x4.6mm shaft flat lower black		

			
1			
<b>GEV No.</b>	110225	<b>Ref. No.</b>	0H6785
<b>description</b>	knob switch 4-position t.max.°C ø 77mm shaft ø 6x4.6mm shaft flat upper silver		

			
1			
<b>GEV No.</b>	111589	<b>Ref. No.</b>	0H6790
<b>description</b>	knob energy regulator 1-12 t.max.°C ø 77mm shaft ø 6x4.6mm shaft flat upper white/black		

			
1			
<b>GEV No.</b>	110221	<b>Ref. No.</b>	0H6788
<b>description</b>	knob switch 7-position t.max.°C ø 77mm shaft ø 6x4.6mm shaft flat upper white/black		

			
1			
<b>GEV No.</b>	110227	<b>Ref. No.</b>	0H6789
<b>description</b>	knob gas tap with ignition flame t.max.°C ø 77mm shaft ø 8x7mm shaft flat lower silver		

			
1			
<b>GEV No.</b>	110220	<b>Ref. No.</b>	0H6787
<b>description</b>	knob thermostat 1-10 t.max.°C ø 77mm shaft ø 6x4.6mm shaft flat upper		

			
1			
<b>GEV No.</b>	110222	<b>Ref. No.</b>	0K2333
<b>description</b>	knob oven TH/BH/TH+BH t.max.°C ø 77mm shaft ø 6x4.6mm shaft flat upper white/black		

			
1			
<b>GEV No.</b>	110228	<b>Ref. No.</b>	0K2335
<b>description</b>	knob thermostat t.max. 100°C ø 77mm shaft ø 6x4.6mm shaft flat lower white/black temperature range 50-100°C		

			
1			
<b>GEV No.</b>	110226	<b>Ref. No.</b>	0H6786
<b>description</b>	knob switch 0-1-0-1 t.max.°C ø 77mm shaft ø 6x4.6mm shaft flat upper silver		

			
1			
<b>GEV No.</b>	110223	<b>Ref. No.</b>	0H6783
<b>description</b>	knob thermostat t.max. 110°C ø 77mm shaft ø 6x4.6mm shaft flat upper white/black temperature range 30-110°C		



1

<b>GEV No.</b>	110229	<b>Ref. No.</b>	0H6782
<b>description</b>	knob thermostat t.max. 180°C ø 77mm shaft ø 6x4.6mm shaft flat upper white/black temperature range 100-180°C rotation 270°		



1

<b>GEV No.</b>	110185	<b>Ref. No.</b>	0H6461
<b>description</b>	knob thermostat t.max. 250°C ø 55mm shaft ø 6x4.6mm shaft flat lower black temperature range 50-250°C rotation 270°		



1

<b>GEV No.</b>	110224	<b>Ref. No.</b>	0H6784
<b>description</b>	knob thermostat t.max. 300°C ø 77mm shaft ø 6x4.6mm shaft flat upper silver temperature range 50-300°C rotation 270°		



1

<b>GEV No.</b>	112046	<b>Ref. No.</b>	0H6751
<b>description</b>	knob time 120min t.max. °C ø 55mm shaft ø 6x4.6mm shaft flat lower black		



1

<b>GEV No.</b>	112047	<b>Ref. No.</b>	0H6457
<b>description</b>	knob 1-2 ø 55mm shaft ø 6x4.6mm shaft flat lower		



1

<b>GEV No.</b>	111828	<b>Ref. No.</b>	0H6740
<b>description</b>	knob time 30min ø 55mm shaft ø 6x4.6mm shaft flat lower black		



1

<b>GEV No.</b>	110183	<b>Ref. No.</b>	0H6460
<b>description</b>	knob manual/automatic ø 55mm shaft ø 6x4.6mm shaft flat upper		



1

<b>GEV No.</b>	110184	<b>Ref. No.</b>	0H6462
<b>description</b>	knob time 60min ø 55mm shaft ø 6x4.6mm shaft flat lower black		



1

<b>GEV No.</b>	110182	<b>Ref. No.</b>	0H6463
<b>description</b>	knob steaming ø 55mm shaft ø 6x4.6mm shaft flat upper		





1

<b>GEV No.</b>	110188	<b>Ref. No.</b>	0H6724
<b>description</b>	knob time 60min ø 55mm shaft ø 6x4.6mm shaft flat lower black		

			
1			
<b>GEV No.</b>	110181	<b>Ref. No.</b>	0H6748
<b>description</b>	knob switch zero mark ø 45mm shaft ø 6x4.6mm shaft flat lower black		

			
1			
<b>GEV No.</b>	110858	<b>Ref. No.</b>	0H6795
<b>description</b>	knob switch zero mark ø 55mm shaft ø 6x4.6mm shaft flat lower black		

			
1			
<b>GEV No.</b>	110204	<b>Ref. No.</b>	0H6796
<b>description</b>	knob switch zero mark ø 55mm shaft ø 6x4.6mm shaft flat upper black		

			
1			
<b>GEV No.</b>	112045	<b>Ref. No.</b>	0H6721
<b>description</b>	knob time 90min ø 43mm shaft ø 6x4.6mm shaft flat upper black		

miscellaneous			
			
1			
<b>GEV No.</b>	112105	<b>Ref. No.</b>	0H9730
<b>description</b>	knob ø 21mm shaft ø 6mm		



accessories			
covers			
			
1			
<b>GEV No.</b>	112107	<b>Ref. No.</b>	0G3399
<b>description</b>	lid knob		

fascias			
			
1			
<b>GEV No.</b>	112106	<b>Ref. No.</b>	0K5794
<b>description</b>	bezel zero mark		

gaskets			
			
1			
<b>GEV No.</b>	693432	<b>Ref. No.</b>	002663
<b>description</b>	gasket for knob		

			
1			
<b>GEV No.</b>	110202	<b>Ref. No.</b>	0H6984
<b>description</b>	gasket switch shaft		

			
1			
<b>GEV No.</b>	110271	<b>Ref. No.</b>	0H6667
<b>description</b>	gasket switch shaft		

miscellaneous			
			
1			
<b>GEV No.</b>	693429	<b>Ref. No.</b>	002662
<b>description</b>	bush		
			
1			
<b>GEV No.</b>	550697	<b>Ref. No.</b>	0K2358
<b>description</b>	bush for knob		

1			
<b>GEV No.</b>	693430	<b>Ref. No.</b>	051263
<b>description</b>	nut thread M22x1.5 H 5mm WS 26 zinc-coated steel Qty 1 pcs		

1			
<b>GEV No.</b>	693431	<b>Ref. No.</b>	002727
<b>description</b>	plain washer		

## handles and hand wheels

### hand wheels

#### hand wheels

1					
<b>GEV No.</b>	693317	<b>Ref. No.</b>	0H6470		
<b>description</b>	hand wheel ø 160mm D1 ø 40mm bore ø 20mm L1 30mm L2 50mm without handle aluminium				
<b>accessories for</b>	693317				
		<b>GEV No.</b>	514256	<b>Ref. No.</b>	0K2472
	cone handle ø 26mm total length 97mm thread M10 aluminium L1 82mm L2 15mm L 82mm				

1					
<b>GEV No.</b>	690085	<b>Ref. No.</b>	0K5532 234850		
<b>description</b>	hand wheel ø 200mm D1 ø 48mm bore ø 20mm thread groove widthmm L1 30mm L2 60mm handle length 82mm with folding handle				
<b>spare parts for</b>	690085				
		<b>GEV No.</b>	514255	<b>Ref. No.</b>	0K2348
	folding handle ø 26mm total length 85mm seat ø 20mm shaft ømm thread M6 with pin L 85mm				

1			
<b>GEV No.</b>	690551	<b>Ref. No.</b>	0H6472
<b>description</b>	hand wheel ø 200mm D1 ø 48mm bore ø 20mm thread M8 groove widthmm L1 30mm L2 60mm handle length 80mm no fold-away handle		

### spare parts and accessories

1			
<b>GEV No.</b>	514254	<b>Ref. No.</b>	0H6791 256612
<b>description</b>	folding handle ø 26mm total length 102mm seat ø 20mm shaft ømm thread M6 L 102mm		

1			
<b>GEV No.</b>	514255	<b>Ref. No.</b>	0K2348
<b>description</b>	folding handle ø 26mm total length 85mm seat ø 20mm shaft ømm thread M6 with pin L 85mm		

1			
<b>GEV No.</b>	514256	<b>Ref. No.</b>	0K2472
<b>description</b>	cone handle ø 26mm total length 97mm thread M10 aluminium L1 82mm L2 15mm L 82mm		

### cone handles

1			
<b>GEV No.</b>	514256	<b>Ref. No.</b>	0K2472
<b>description</b>	cone handle ø 26mm total length 97mm thread M10 aluminium L1 82mm L2 15mm L 82mm		



star handles

 <p>1</p>			
<b>GEV No.</b>	541361	<b>Ref. No.</b>	0H6469
<b>description</b>	star handle shaft 10x10mm ø 100mm L 28mm black thermoplastic		

 <p>1</p>			
<b>GEV No.</b>	540365	<b>Ref. No.</b>	0H6468
<b>description</b>	star handle shaft 6x6mm ø 50mm L 18mm black thermoplastic		

 <p>1</p>			
<b>GEV No.</b>	540228	<b>Ref. No.</b>	0K1704
<b>description</b>	star handle shaft 8x8mm ø 80mm		

locks

handle latches

producer-specific

ELECTROLUX/JUNO

group 1

 <p>1</p>			
<b>GEV No.</b>	693751	<b>Ref. No.</b>	0H6882
<b>description</b>	door handle metal		

 <p>1</p>			
<b>GEV No.</b>	693750	<b>Ref. No.</b>	253497
<b>description</b>	snap lock		

edgemount latches

handle latches

CAFF/FERMOD

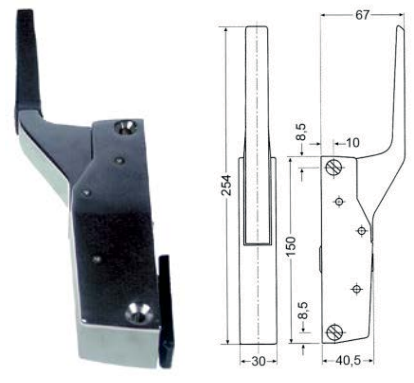
 <p>1</p>			
<b>GEV No.</b>	700631	<b>Ref. No.</b>	0K3058
<b>description</b>	catch complete with door catch		



producer-specific

INOXTREND

 <p>1</p>				
<b>GEV No.</b>	690146	<b>Ref. No.</b>	0K1669 234663	
<b>description</b>	handle latch L 172mm mounting distance 134mm non lockable heated units 6200 H 65mm type DUPLO total length 248mm			
<b>accessories for</b>	690146			
	<b>GEV No.</b>	690123	<b>Ref. No.</b>	—
door catch with roller				
	<b>GEV No.</b>	693777	<b>Ref. No.</b>	0K2347
gasket H 6.6mm L 105mm W 45mm L1 78mm W1 25mm for handle				
	<b>GEV No.</b>	693778	<b>Ref. No.</b>	0K1952
door catch				



MODULAR

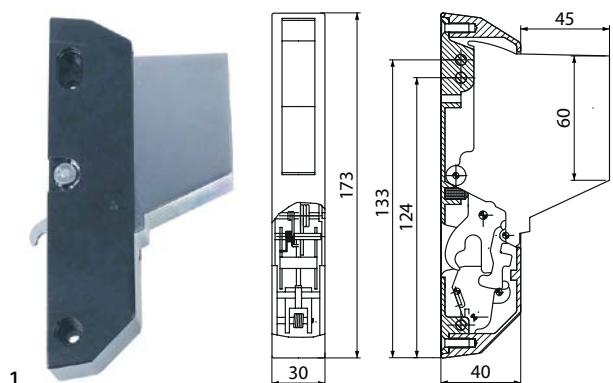

<b>GEV No.</b>	690146	<b>Ref. No.</b>	0K1669 234663
<b>description</b>	handle latch L 172mm mounting distance 134mm non lockable heated units 6200 H 65mm type DUPLO total length 248mm		
<b>accessories for</b>	690146		
	<b>GEV No.</b>	690123	<b>Ref. No.</b> —
	door catch with roller		
	<b>GEV No.</b>	693777	<b>Ref. No.</b> 0K2347
	gasket H 6.6mm L 105mm W 45mm L1 78mm W1 25mm for handle		
	<b>GEV No.</b>	693778	<b>Ref. No.</b> 0K1952
	door catch		

ZANUSSI



<b>GEV No.</b>	700467	<b>Ref. No.</b>	002647
<b>description</b>	catch L 173mm H 40mm mounting distance 133/124mm W 30mm non lockable 6200 total length 170mm overall height 85mm		
<b>accessories for</b>	700467		
	<b>GEV No.</b>	693937	<b>Ref. No.</b> 0F0029
	door handle H 44mm L 220mm W 50mm plastic black		
	<b>GEV No.</b>	700468	<b>Ref. No.</b> —
	door catch with roller		
	<b>GEV No.</b>	701412	<b>Ref. No.</b> —
	cover cap plastic round ø 11mm black for catch thickness 8mm		

door catches



<b>GEV No.</b>	693778	<b>Ref. No.</b>	0K1952
<b>description</b>	door catch		

snap locks

producer-specific

JUNO



<b>GEV No.</b>	690876	<b>Ref. No.</b>	0H6771
<b>description</b>	snap lock		



<b>GEV No.</b>	693750	<b>Ref. No.</b>	253497
<b>description</b>	snap lock		

espagnolette locks

universal



<b>GEV No.</b>	690837	<b>Ref. No.</b>	056551
<b>description</b>	bolt piece L 75mm W 29mm H 28mm cam length 17.5mm cam width 10mm mounting distance 20/40mm		



<b>GEV No.</b>	690041	<b>Ref. No.</b>	0K2246
<b>description</b>	cam L 148mm mounting distance 32mm		



<b>GEV No.</b>	693797	<b>Ref. No.</b>	004104 234701
<b>description</b>	console upper/lower for cam		





1			
<b>GEV No.</b>	690838	<b>Ref. No.</b>	056571
<b>description</b>	door catch with roller H 48mm L 50mm W 26mm mounting distance 28mm rollerø 10mm		

1			
<b>GEV No.</b>	690836	<b>Ref. No.</b>	056550
<b>description</b>	latch gear L 17mm W 26mm H 1.5mm mounting distance 42mm shaft diameter 7x7mm		

miscellaneous

1			
<b>GEV No.</b>	693771	<b>Ref. No.</b>	0K2290
<b>description</b>	bolt piece		

1			
<b>GEV No.</b>	700089	<b>Ref. No.</b>	0H6771
<b>description</b>	catch		



1			
<b>GEV No.</b>	693772	<b>Ref. No.</b>	0H6566
<b>description</b>	door catch		

1			
<b>GEV No.</b>	693749	<b>Ref. No.</b>	0K2697
<b>description</b>	spring for snap lock		

hinges

piano hinges

producer-specific

ELECTROLUX/JUNO

1			
<b>GEV No.</b>	690025	<b>Ref. No.</b>	0H6454
<b>description</b>	hinge L 90mm W 43mm H 11mm mounting distance 26mm mounting distance 1 18mm hole ø 5,5/8mm thickness 3.5mm Zamak VC		

oven hinges

1			
<b>GEV No.</b>	700436	<b>Ref. No.</b>	0KC554
<b>description</b>	hook for hinge		

1			
<b>GEV No.</b>	701561	<b>Ref. No.</b>	050766
<b>description</b>	oven hinge mounting distance 173mm mounting distance 2mm lug mounting 14mm lever length 112mm groove distance 10mm spring thickness 3mm mounting ear position left/right spring length 111mm L 205mm W 25mm with opposite support		

1			
<b>GEV No.</b>	701414	<b>Ref. No.</b>	0C3129
<b>description</b>	oven hinge mounting distance 173mm mounting distance 2mm lug mounting 14mm lever length 113mm groove distance 10mm spring thickness 4mm mounting ear position left/right spring length 111mm L 205mm W 25mm with opposite support		

door bearing



1

<b>GEV No.</b>	693775	<b>Ref. No.</b>	0H7181
<b>description</b>	hinge L 70mm W 45mm H 60mm mounting pos. lower		



1

<b>GEV No.</b>	693774	<b>Ref. No.</b>	0H7182
<b>description</b>	hinge L 70mm W 45mm H 60mm mounting pos. upper		



1

<b>GEV No.</b>	693776	<b>Ref. No.</b>	005241
<b>description</b>	hinge mounting pos. bottom right		



1

<b>GEV No.</b>	693783	<b>Ref. No.</b>	005112
<b>description</b>	hinge mounting pos. bottom right		



1

<b>GEV No.</b>	693756	<b>Ref. No.</b>	0H7063
<b>description</b>	hinge mounting pos. left		



1

<b>GEV No.</b>	693754	<b>Ref. No.</b>	0G5216
<b>description</b>	hinge mounting pos. lower		



1

<b>GEV No.</b>	693767	<b>Ref. No.</b>	005110
<b>description</b>	hinge mounting pos. lower		



1

<b>GEV No.</b>	693768	<b>Ref. No.</b>	0KC901
<b>description</b>	hinge mounting pos. lower		



1

<b>GEV No.</b>	693769	<b>Ref. No.</b>	0H7112
<b>description</b>	hinge mounting pos. lower		



1

<b>GEV No.</b>	693755	<b>Ref. No.</b>	0H7064
<b>description</b>	hinge mounting pos. right		



1

<b>GEV No.</b>	700029	<b>Ref. No.</b>	0G5222
<b>description</b>	hinge mounting pos. right		





1

<b>GEV No.</b>	693765	<b>Ref. No.</b>	005111
<b>description</b>	hinge mounting pos. upper		



			
1			
<b>GEV No.</b>	693766	<b>Ref. No.</b>	OKC899
<b>description</b>	hinge mounting pos. upper		

			
1			
<b>GEV No.</b>	693770	<b>Ref. No.</b>	OH7114
<b>description</b>	hinge mounting pos. upper		

			
1			
<b>GEV No.</b>	693782	<b>Ref. No.</b>	005242
<b>description</b>	hinge mounting pos. upper right		

accessories

shafts

			
1			
<b>GEV No.</b>	700028	<b>Ref. No.</b>	OK1653
<b>description</b>	hinge pin		

			
1			
<b>GEV No.</b>	693742	<b>Ref. No.</b>	OH6456
<b>description</b>	shaft for hinge mounting pos. right/left		



miscellaneous

			
1			
<b>GEV No.</b>	700474	<b>Ref. No.</b>	002653
<b>description</b>	disc for hinge corrugated		

			
1			
<b>GEV No.</b>	700478	<b>Ref. No.</b>	002645
<b>description</b>	protector for glass door for hinge		

fittings for catering equipment  
 aerators and air bleeders

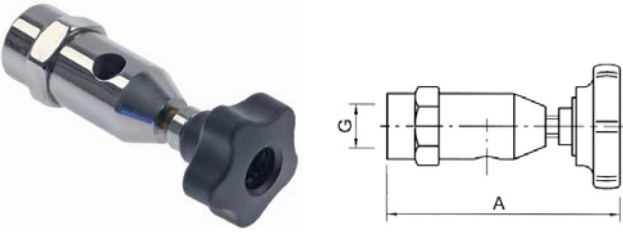
			
1			
<b>GEV No.</b>	540014	<b>Ref. No.</b>	OK5787
<b>description</b>	aerator and air bleeder thread 1/2" ET chrome-plated L 78mm		
<b>spare parts for</b>	540014		
		<b>GEV No.</b>	112777
		<b>Ref. No.</b>	—
	star handle shaft 6x6mm ø 50mm L 18mm black plastic		
		<b>GEV No.</b>	540365
		<b>Ref. No.</b>	OH6468
	star handle shaft 6x6mm ø 50mm L 18mm black thermoplastic		

			
1			
<b>GEV No.</b>	540016	<b>Ref. No.</b>	OK1865 240061
<b>description</b>	aerator and air bleeder thread 1/2" IT chrome-plated L 78mm		
<b>spare parts for</b>	540016		
		<b>GEV No.</b>	112777
		<b>Ref. No.</b>	—
	star handle shaft 6x6mm ø 50mm L 18mm black plastic		
		<b>GEV No.</b>	540365
		<b>Ref. No.</b>	OH6468
	star handle shaft 6x6mm ø 50mm L 18mm black thermoplastic		



1

<b>GEV No.</b>	540013	<b>Ref. No.</b>	0G3246
<b>description</b>	aerator and air bleeder thread 3/8" ET WS 27 chrome-plated L 86mm		
<b>spare parts for</b>	540013		
	<b>GEV No.</b>	112777	<b>Ref. No.</b> —
	star handle shaft 6x6mm ø 50mm L 18mm black plastic		
	<b>GEV No.</b>	540365	<b>Ref. No.</b> 0H6468
	star handle shaft 6x6mm ø 50mm L 18mm black thermoplastic		

spare parts



1

<b>GEV No.</b>	540365	<b>Ref. No.</b>	0H6468
<b>description</b>	star handle shaft 6x6mm ø 50mm L 18mm black thermoplastic		



1

<b>GEV No.</b>	540949	<b>Ref. No.</b>	0H9729
<b>description</b>	aerator and air bleeder thread 1/2" ET chrome-plated with O-ring L 15mm ø 25mm		



1

<b>GEV No.</b>	540826	<b>Ref. No.</b>	0KC081
<b>description</b>	aerator and air bleeder thread 1/2" ET WS 24 chrome-plated brass L 30mm		

steam valves



1

<b>GEV No.</b>	541542	<b>Ref. No.</b>	0KD952
<b>description</b>	steam valve straight connection 1" IT total length 90mm H 140mm brass		
<b>spare parts for</b>	541542		
	<b>GEV No.</b>	540229	<b>Ref. No.</b> —
	star handle shaft 9x9mm ø 80mm L 23mm black thermoplastic		
	<b>GEV No.</b>	541546	<b>Ref. No.</b> —
	screw chrome-plated brass thread M5 thread L 10mm		
	<b>GEV No.</b>	541548	<b>Ref. No.</b> —
	gasket PTFE ID ø 15mm H 7mm for thread 1 1/4" ED ø 35mm		
	<b>GEV No.</b>	541554	<b>Ref. No.</b> —
	gasket copper ext. ø 49 ID ø 42mm H 2mm for thread 1 1/4"		
	<b>GEV No.</b>	541557	<b>Ref. No.</b> —
	tap head chrome-plated thread 1 1/4" for steam tap 1"		

lid hinges

type ECHTERMANN

10 series

10.61

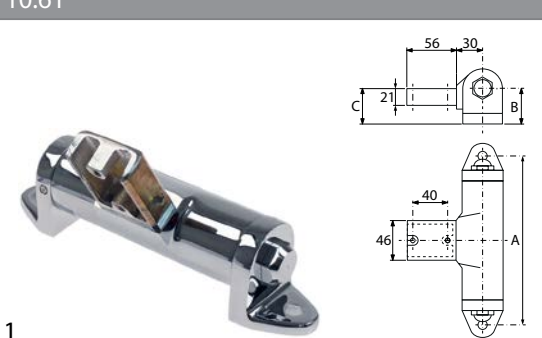

1

<b>GEV No.</b>	693241	<b>Ref. No.</b>	0K2589
<b>description</b>	lid hinge type 6910.61 level of centre of rotation 35mm load capacity 20-30NM opening angle 60° closing angle 10° mounting distance 198mm square pipe 50x25x2mm		
<b>spare parts for</b>	693241		
	<b>GEV No.</b>	691612	<b>Ref. No.</b> —
	repair kit for lid hinge load capacity 20-30NM		



1

<b>GEV No.</b>	693242	<b>Ref. No.</b>	OK2590
<b>description</b>	lid hinge type 6910.61 level of centre of rotation 35mm load capacity 30-50NM opening angle 60° closing angle 10° mounting distance 198mm bore ø 11mm chrome-plated square pipe 50x25x2mm		
<b>spare parts for</b>	693242		
	<b>GEV No.</b>	<b>Ref. No.</b>	—
	repair kit for lid hinge load capacity 30-50NM		

1

<b>GEV No.</b>	691265	<b>Ref. No.</b>	OK2571
<b>description</b>	lid hinge type 6910.61 level of centre of rotation 35mm load capacity 50-60NM opening angle 55° mounting distance 198mm chrome-plated square pipe 50x25x2mm		
<b>spare parts for</b>	691265		
	<b>GEV No.</b>	<b>Ref. No.</b>	—
	repair kit for lid hinge load capacity 50-60NM		

1

<b>GEV No.</b>	693246	<b>Ref. No.</b>	OK2591
<b>description</b>	lid hinge type 6910.61 level of centre of rotation 35mm load capacity 50-60NM opening angle 60° closing angle 10° mounting distance 198mm bore ø 11mm square pipe 50x25x2mm		
<b>spare parts for</b>	693246		
	<b>GEV No.</b>	<b>Ref. No.</b>	—
	repair kit for lid hinge load capacity 50-60NM		

10.62

1

<b>GEV No.</b>	693245	<b>Ref. No.</b>	OK2593
<b>description</b>	lid hinge type 10.62 level of centre of rotation 45mm load capacity 50-60NM opening angle 75° mounting distance 198mm bore ø 11mm chrome-plated		
<b>spare parts for</b>	693245		
	<b>GEV No.</b>	<b>Ref. No.</b>	—
	repair kit for lid hinge load capacity 50-60NM		

1

<b>GEV No.</b>	693234	<b>Ref. No.</b>	OK2587
<b>description</b>	lid hinge type 1062 level of centre of rotation 45mm load capacity 10-20NM opening angle 75° closing angle 10° mounting distance 198mm bore ø 11mm MD lid 36mm chrome-plated brass		
<b>spare parts for</b>	693234		
	<b>GEV No.</b>	<b>Ref. No.</b>	—
	repair kit for lid hinge load capacity 10-20NM		

1

<b>GEV No.</b>	693235	<b>Ref. No.</b>	OH6887
<b>description</b>	lid hinge type 1062 level of centre of rotation 45mm load capacity 20-30NM opening angle 75° closing angle 10° mounting distance 198mm bore ø 11mm MD lid 36mm chrome-plated brass		
<b>spare parts for</b>	693235		
	<b>GEV No.</b>	<b>Ref. No.</b>	—
	repair kit for lid hinge load capacity 20-30NM		

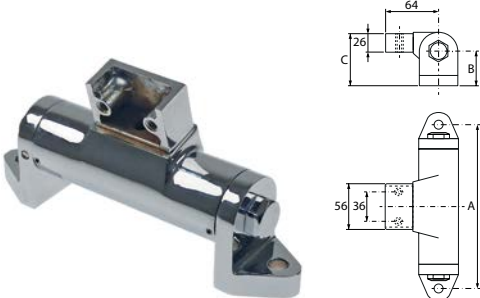

1

<b>GEV No.</b>	693237	<b>Ref. No.</b>	OK2588
<b>description</b>	lid hinge type 1062 level of centre of rotation 45mm load capacity 30-50NM opening angle 75° closing angle 10° mounting distance 198mm bore ø 11mm MD lid 36mm chrome-plated brass		
<b>spare parts for</b>	693237		
	<b>GEV No.</b>	691613	<b>Ref. No.</b> —
repair kit for lid hinge load capacity 30-50NM			

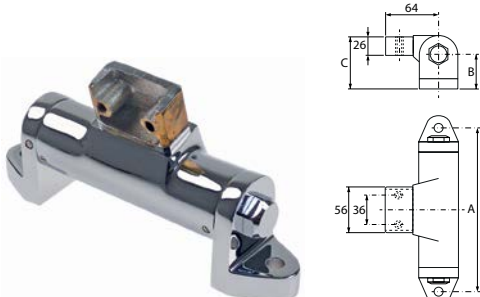

1

<b>GEV No.</b>	693240	<b>Ref. No.</b>	OK2586
<b>description</b>	lid hinge type 1062 level of centre of rotation 45mm load capacity up to 10NM opening angle 75° MT lid M8mm chrome-plated square pipe 60x30x2mm hole distance 198mm		
<b>spare parts for</b>	693240		
	<b>GEV No.</b>	691610	<b>Ref. No.</b> —
repair kit for lid hinge load capacity 10NM			

10.86

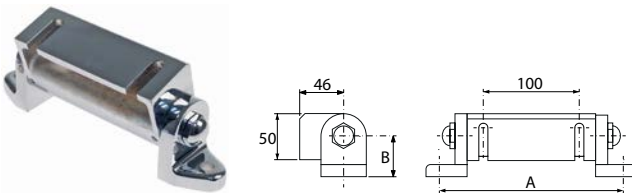

1

<b>GEV No.</b>	693236	<b>Ref. No.</b>	OK2585
<b>description</b>	lid hinge type 6910.86 level of centre of rotation 40mm load capacity 20-30NM opening angle 75° closing angle 10° mounting distance 198mm bore ø 11mm MD lid 100mm chrome-plated brass		
<b>spare parts for</b>	693236		
	<b>GEV No.</b>	691612	<b>Ref. No.</b> —
repair kit for lid hinge load capacity 20-30NM			

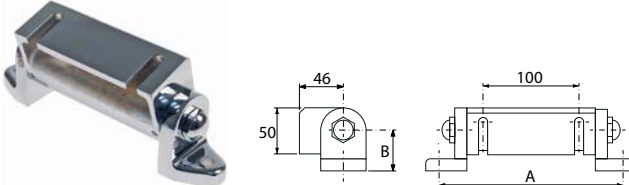

1

<b>GEV No.</b>	693238	<b>Ref. No.</b>	OK2594
<b>description</b>	lid hinge type 6910.86 level of centre of rotation 65mm load capacity 20-30NM opening angle 75° closing angle 10° mounting distance 198mm bore ø 11mm MD lid 100mm chrome-plated brass		
<b>spare parts for</b>	693238		
	<b>GEV No.</b>	691612	<b>Ref. No.</b> —
repair kit for lid hinge load capacity 20-30NM			

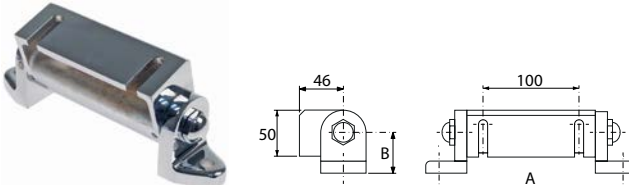

1

<b>GEV No.</b>	693239	<b>Ref. No.</b>	OK2595
<b>description</b>	lid hinge type 6910.86 level of centre of rotation 65mm load capacity 30-50NM opening angle 75° closing angle 10° mounting distance 198mm bore ø 11mm MD lid 100mm chrome-plated brass		
<b>spare parts for</b>	693239		
	<b>GEV No.</b>	691613	<b>Ref. No.</b> —
repair kit for lid hinge load capacity 30-50NM			

ELECTROLUX

spare parts



1

<b>GEV No.</b>	693299	<b>Ref. No.</b>	052894
<b>description</b>	torsion spring ø 28.6mm L2 103mm wire gauge ø 3.6mm L1 45mm		

drain taps

accessories



1

<b>GEV No.</b>	540082	<b>Ref. No.</b>	OK2137
<b>description</b>	handle for drain tap L 110mm		

1

<b>GEV No.</b>	540119	<b>Ref. No.</b>	0K3046
<b>description</b>	O-ring EPDM thickness 2.5mm ID ø 59mm Qty 1 pcs		



1

<b>GEV No.</b>	540222	<b>Ref. No.</b>	053809
<b>description</b>	O-ring EPDM thickness 2.62mm ID ø 47.3mm Qty 1 pcs		



1

<b>GEV No.</b>	540083	<b>Ref. No.</b>	0K1469
<b>description</b>	pressure bolt for drain tap		

## steam traps

### steam traps



1

<b>GEV No.</b>	541356	<b>Ref. No.</b>	0H6413
<b>description</b>	thermostatic steam trap thread 1/2" 60-100°C type ST 1730		

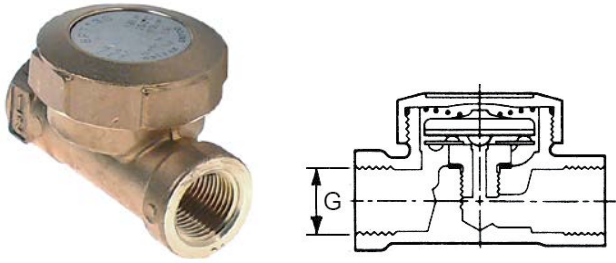

1

<b>GEV No.</b>	541461	<b>Ref. No.</b>	0K5388
<b>description</b>	thermostatic steam trap thread 1/2" type BPT13S brass		

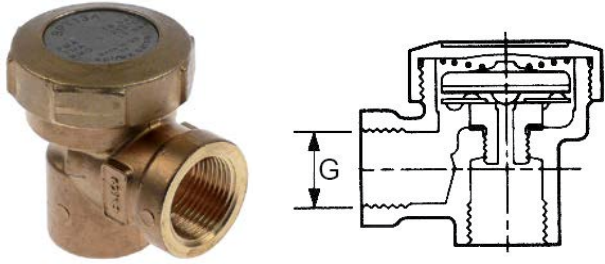

1

<b>GEV No.</b>	540994	<b>Ref. No.</b>	0H6537	
<b>description</b>	thermostatic steam trap thread 3/4" type BPT13A brass			
<b>spare parts for</b>	540994			
	<b>GEV No.</b>	540219	<b>Ref. No.</b>	—
	repair kit thread 1/2" -3/4" type BPT13			

## safety valves



1

<b>GEV No.</b>	541357	<b>Ref. No.</b>	0H6302
<b>description</b>	safety valve		



1

<b>GEV No.</b>	541458	<b>Ref. No.</b>	0K5784
<b>description</b>	safety valve T1: 1/2" T2: 1/2" triggering pressure 1.3bar		

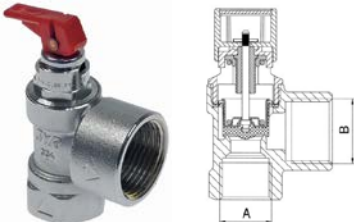

1

<b>GEV No.</b>	540915	<b>Ref. No.</b>	0H6534
<b>description</b>	safety valve T1: 3/4" T2: 1" triggering pressure 1.1bar 6104 R		



1

<b>GEV No.</b>	514376	<b>Ref. No.</b>	0H6434
<b>description</b>	safety valve triggering pressure 1bar thread 1"-3/4"		

## filters

### grease filters

#### grease filter



<b>GEV No.</b>	970602	<b>Ref. No.</b>	0H7138
<b>description</b>	grease filter W 520mm H 465mm thickness 20mm SS outer grids 2 inner grids 3 for range hoods		

## crumb screens



<b>GEV No.</b>	970728	<b>Ref. No.</b>	241203
<b>description</b>	crumb screen L 338mm W 194mm H 180mm suitable for ELECTROLUX for fryer		

## baskets

### fryer baskets

#### JUNO



<b>GEV No.</b>	970150	<b>Ref. No.</b>	0H5970
<b>description</b>	fryer basket L1 300mm W1 180mm H1 130mm		



<b>GEV No.</b>	970151	<b>Ref. No.</b>	0H5971
<b>description</b>	fryer basket L1 320mm W1 180mm H1 210mm		



<b>GEV No.</b>	970410	<b>Ref. No.</b>	0G2206
<b>description</b>	fryer basket L1 325mm W1 225mm H1 90mm chrome-plated steel		



<b>GEV No.</b>	970149	<b>Ref. No.</b>	0K1946
<b>description</b>	fryer basket L1 340mm W1 310mm H1 125mm		

## shelves and shelf rails

### grid attachments



<b>GEV No.</b>	690806	<b>Ref. No.</b>	082317
<b>description</b>	rack support L 540mm H 26mm W 17.5mm plastic suitable for ELECTROLUX, ZANUSSI		

## gaskets

### gaskets for heated units

#### window seals

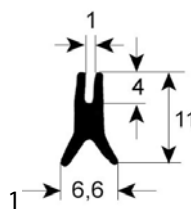

<b>GEV No.</b>	900752	<b>Ref. No.</b>	0K2281
<b>description</b>	window gasket profile 1550 Qty 3m		

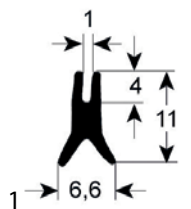

<b>GEV No.</b>	900591	<b>Ref. No.</b>	0H6761
<b>description</b>	window gasket profile 1550 Wmm L 3000mm		



1

<b>GEV No.</b>	900144	<b>Ref. No.</b>	0H6828
<b>description</b>	window gasket profile 1790 Qty supplied by meter		

1

<b>GEV No.</b>	900036	<b>Ref. No.</b>	0H6663
<b>description</b>	window gasket profile 1800 Qty supplied by meter		

1

<b>GEV No.</b>	900154	<b>Ref. No.</b>	OK2079
<b>description</b>	window gasket profile 1840 perimeter 1700mm Qty 1		

1

<b>GEV No.</b>	900176	<b>Ref. No.</b>	OK2081
<b>description</b>	window gasket profile 1840 perimeter 2000mm Qty 1		

1

<b>GEV No.</b>	900175	<b>Ref. No.</b>	OK2080
<b>description</b>	window gasket profile 1840 perimeter 2100mm Qty 1		

1

<b>GEV No.</b>	900155	<b>Ref. No.</b>	OK2082
<b>description</b>	window gasket profile 1841 perimeter 1700mm Qty 1		

1

<b>GEV No.</b>	900181	<b>Ref. No.</b>	0H6637
<b>description</b>	window gasket profile 1841 perimeter 2000mm Qty 1		

1

<b>GEV No.</b>	900180	<b>Ref. No.</b>	0H6636
<b>description</b>	window gasket profile 1841 perimeter 2200mm Qty 1		

1

<b>GEV No.</b>	900185	<b>Ref. No.</b>	002837
<b>description</b>	window gasket profile 1875 perimeter 1500mm Qty 1		

1

<b>GEV No.</b>	900186	<b>Ref. No.</b>	002878
<b>description</b>	window gasket profile 1875 perimeter 2000mm Qty 1		

door seals

1

<b>GEV No.</b>	900499	<b>Ref. No.</b>	0H6854 268187
<b>description</b>	door seal		

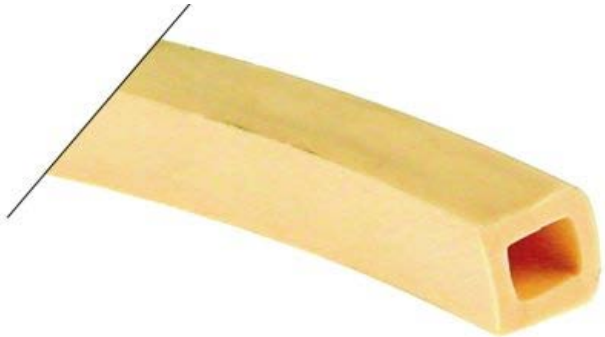

1

<b>GEV No.</b>	900593	<b>Ref. No.</b>	0H7007
<b>description</b>	door seal L 1000mm		



1

<b>GEV No.</b>	900582	<b>Ref. No.</b>	0H6855
<b>description</b>	door seal L 495mm		

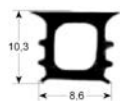

1

<b>GEV No.</b>	900037	<b>Ref. No.</b>	0H6976
<b>description</b>	door seal profile 2020 Qty supplied by meter		



1

<b>GEV No.</b>	900044	<b>Ref. No.</b>	0H6655
<b>description</b>	door seal profile 2030 W 414mm L 620mm external size Qty 1		



1

<b>GEV No.</b>	900042 <sup>1</sup>	<b>Ref. No.</b>	0H6653
<b>description</b>	door seal profile 2030 W 414mm L 620mm external size Qty 1 long side open		

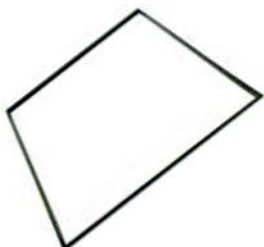

1

<b>GEV No.</b>	900588	<b>Ref. No.</b>	0H6973
<b>description</b>	door seal profile 2030 W 428mm L 431mm external size Qty 1		



1

<b>GEV No.</b>	900045	<b>Ref. No.</b>	0H6656
<b>description</b>	door seal profile 2030 W 620mm L 699mm external size Qty 1		



1

<b>GEV No.</b>	900041 <sup>1</sup>	<b>Ref. No.</b>	0H6654
<b>description</b>	door seal profile 2030 W 620mm L 699mm external size Qty 1 short side open		

<sup>1</sup>3-sided (short side open)

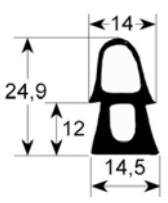

1

<b>GEV No.</b>	900152	<b>Ref. No.</b>	0K2083
<b>description</b>	door seal profile 2445 W 430mm L 630mm external size Qty 1		



1

<b>GEV No.</b>	900586 <sup>1</sup>	<b>Ref. No.</b>	0K1832
<b>description</b>	door seal profile 2445 W 445mm L 630mm external size Qty 1		

<sup>1</sup>3-sided (long side open)

<sup>1</sup>3-sided (long side open)



1

<b>GEV No.</b>	900587 <sup>1</sup>	<b>Ref. No.</b>	OK1833
<b>description</b>	door seal profile 2445 W 620mm L 715mm external size Qty 1		

<sup>1</sup>3-sided (short side open)

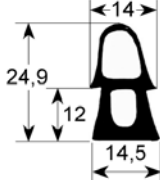

1

<b>GEV No.</b>	900153	<b>Ref. No.</b>	OG2086
<b>description</b>	door seal profile 2445 W 630mm L 735mm external size Qty 1		

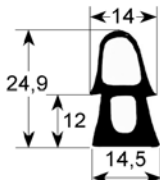

1

<b>GEV No.</b>	900170	<b>Ref. No.</b>	0H6641
<b>description</b>	door seal profile 2445 W 650mm L 1350mm external size Qty 1		

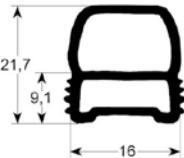

1

<b>GEV No.</b>	900040	<b>Ref. No.</b>	0H6657
<b>description</b>	door seal profile 2447 W 627mm L 1321mm external size Qty 1		

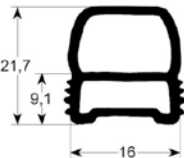

1

<b>GEV No.</b>	900039	<b>Ref. No.</b>	0H6660
<b>description</b>	door seal profile 2447 W 777mm L 1321mm external size Qty 1		

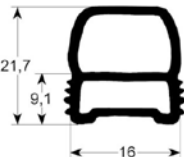

1

<b>GEV No.</b>	900043	<b>Ref. No.</b>	0H6659
<b>description</b>	door seal profile 2447 W 777mm L 861mm external size Qty 1		

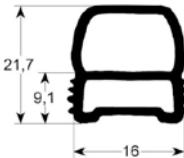

1

<b>GEV No.</b>	900589	<b>Ref. No.</b>	0H6658
<b>description</b>	door seal profile 2447 W 800mm L 880mm external size Qty 1		



1

<b>GEV No.</b>	900496	<b>Ref. No.</b>	0700268258
<b>description</b>	door seal profile 2447 W 810mm L 900mm		

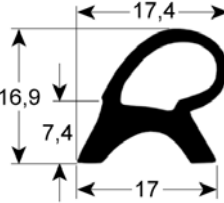

1

<b>GEV No.</b>	900188	<b>Ref. No.</b>	055315
<b>description</b>	door seal profile 2450 W 640mm H 720mm external size Qty 1 suitable for ELECTROLUX 640x720		

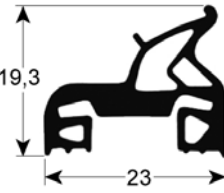

1

<b>GEV No.</b>	900433	<b>Ref. No.</b>	005713
<b>description</b>	door seal profile 2520 W 430mm L 635mm external size Qty 1 suitable for ELECTROLUX, JUNO, ZANUSSI 635x430		

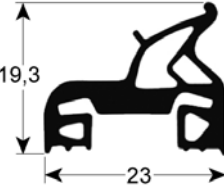

1

<b>GEV No.</b>	900161	<b>Ref. No.</b>	005705
<b>description</b>	door seal profile 2520 W 640mm L 1400mm external size Qty 1 suitable for ELECTROLUX 640x1400		

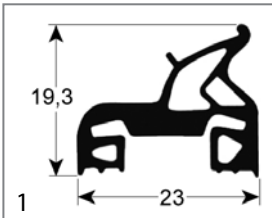

<b>GEV No.</b>	900590	<b>Ref. No.</b>	005706
<b>description</b>	door seal profile 2520 W 640mm L 730mm external size Qty 1 suitable for ELECTROLUX 640x730		

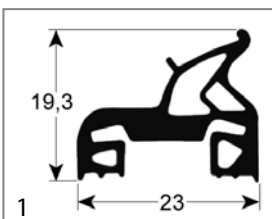

<b>GEV No.</b>	900160	<b>Ref. No.</b>	005712
<b>description</b>	door seal profile 2520 W 655mm L 725mm external size Qty 1 suitable for ELECTROLUX		

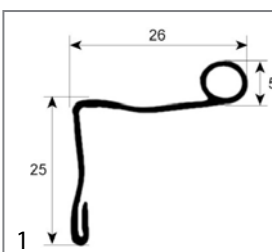

<b>GEV No.</b>	900047	<b>Ref. No.</b>	0H6768
<b>description</b>	door seal profile 2924 W 50mm L 570mm external size Qty 1 mounting pos. upper		

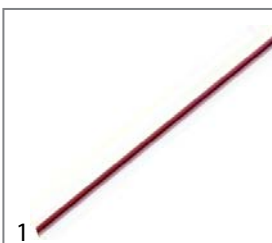

<b>GEV No.</b>	900516	<b>Ref. No.</b>	unbekannt
<b>description</b>	door seal profile 2940 Qty supplied by meter		

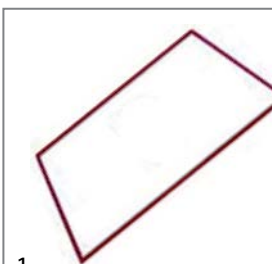

<b>GEV No.</b>	900148	<b>Ref. No.</b>	0T3708
<b>description</b>	door seal profile 2940 W 430mm L 600mm external size Qty 1		

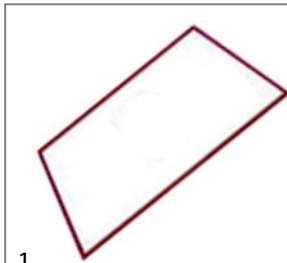

<b>GEV No.</b>	900145	<b>Ref. No.</b>	003384
<b>description</b>	door seal profile 2940 W 600mm L 670mm external size Qty 1		



<b>GEV No.</b>	900146 <sup>1</sup>	<b>Ref. No.</b>	0H6516
<b>description</b>	door seal profile 2940 W 600mm L 670mm external size Qty 1		

<sup>1</sup>3-sided (long side open)

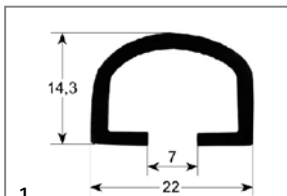

<b>GEV No.</b>	900038	<b>Ref. No.</b>	0H6986
<b>description</b>	door seal profile 2945 W 605mm L 1310mm external size Qty 1		

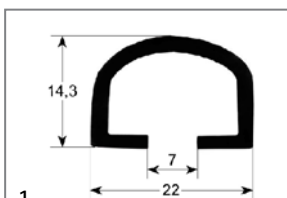

<b>GEV No.</b>	900149	<b>Ref. No.</b>	0H6865
<b>description</b>	door seal profile 2945 W 905mm L 1370mm external size Qty 1		



<b>GEV No.</b>	900147	<b>Ref. No.</b>	0H6760
<b>description</b>	door seal profile 2950 Qty supplied by meter		

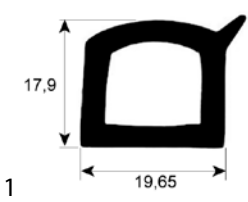

1

<b>GEV No.</b>	900051	<b>Ref. No.</b>	0H6767
<b>description</b>	door seal profile 2955 Qty supplied by meter		



1

<b>GEV No.</b>	900583	<b>Ref. No.</b>	0H6975
<b>description</b>	door seal W 435mm L 660mm		

door seals with tension springs

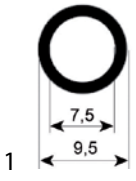

1

<b>GEV No.</b>	900046	<b>Ref. No.</b>	0H6762
<b>description</b>	oven gasket profile 2958 L 290mm Qty 1 mounting pos. lateral		



1

<b>GEV No.</b>	690003	<b>Ref. No.</b>	0H6606
<b>description</b>	spring L 310mm for gasket mounting pos. lateral		

gaskets for tray rack trolleys

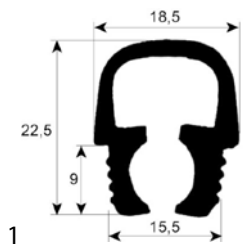

1

<b>GEV No.</b>	900150	<b>Ref. No.</b>	0H6661
<b>description</b>	tray rack trolley gasket profile 4040 L 510mm Qty 1		

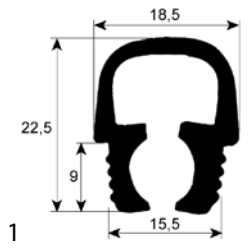

1

<b>GEV No.</b>	900592	<b>Ref. No.</b>	0H6662
<b>description</b>	tray rack trolley gasket profile 4040 L 658mm Qty 1		



1

<b>GEV No.</b>	900495	<b>Ref. No.</b>	0H6985
<b>description</b>	tray rack trolley gasket profile 4045 L 460mm Qty 1		

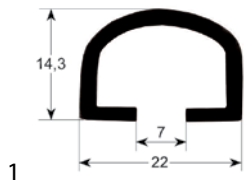

1

<b>GEV No.</b>	900584	<b>Ref. No.</b>	0H6866
<b>description</b>	tray rack trolley gasket profile 4045 L 900mm Qty 1		

boiling pan gaskets

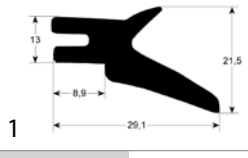

1

<b>GEV No.</b>	693249	<b>Ref. No.</b>	0H6980
<b>description</b>	boiling pan gasket profile 3030 L 770mm W 690mm suitable for JUNO		

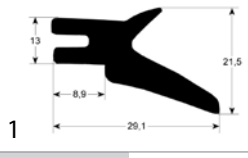

1

<b>GEV No.</b>	693248	<b>Ref. No.</b>	0K2806
<b>description</b>	boiling pan gasket profile 3030 suitable for JUNO		



<b>GEV No.</b>	693251	<b>Ref. No.</b>	0H6982
<b>description</b>	boiling pan gasket profile 3030 suitable for JUNO		



<b>GEV No.</b>	900609	<b>Ref. No.</b>	0K5574
<b>description</b>	door seal profile 3030 ø 430mm		

### O-rings

#### EPDM

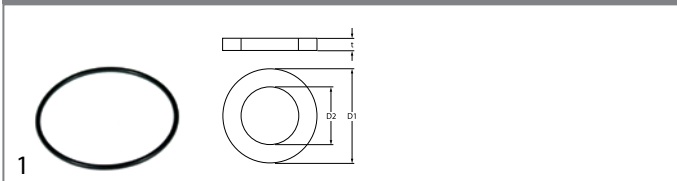

<b>GEV No.</b>	540119	<b>Ref. No.</b>	0K3046
<b>description</b>	O-ring EPDM thickness 2.5mm ID ø 59mm Qty 1 pcs		

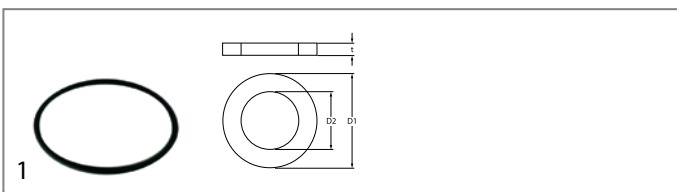

<b>GEV No.</b>	540222	<b>Ref. No.</b>	053809
<b>description</b>	O-ring EPDM thickness 2.62mm ID ø 47.3mm Qty 1 pcs		

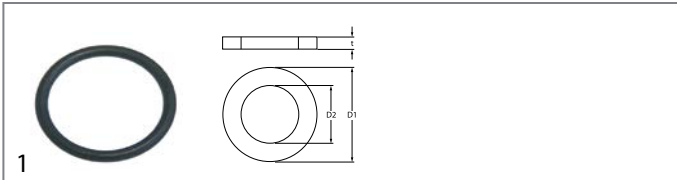

<b>GEV No.</b>	510408	<b>Ref. No.</b>	067620
<b>description</b>	O-ring EPDM thickness 5.34mm ID ø 47mm Qty 1 pcs		

#### silicone

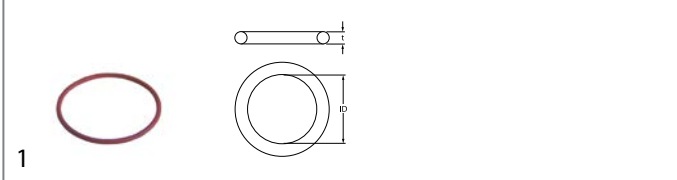

<b>GEV No.</b>	510561	<b>Ref. No.</b>	0H7021
<b>description</b>	O-ring silicone thickness 3mm ID ø 55mm Qty 1 pcs		

### Viton

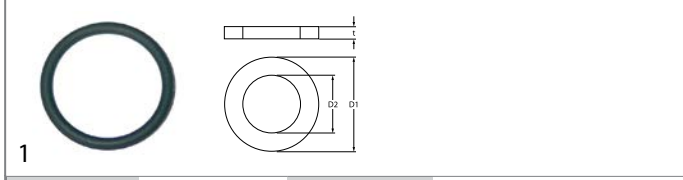

<b>GEV No.</b>	511300	<b>Ref. No.</b>	002873
<b>description</b>	O-ring Viton thickness 3.53mm ID ø 28.17mm for 57 series for motor shaft		

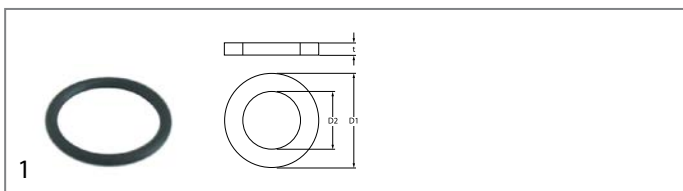

<b>GEV No.</b>	528412	<b>Ref. No.</b>	002874
<b>description</b>	O-ring Viton thickness 3.53mm ID ø 31.34mm Qty 1 pcs		

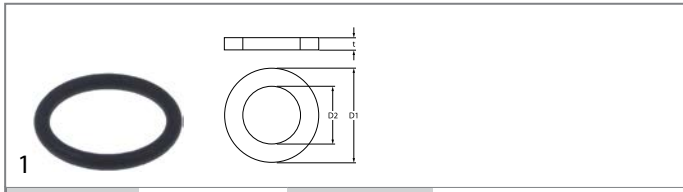

<b>GEV No.</b>	550530	<b>Ref. No.</b>	055323
<b>description</b>	O-ring Viton thickness 5.34mm ID ø 37.8mm Qty 1 pcs		

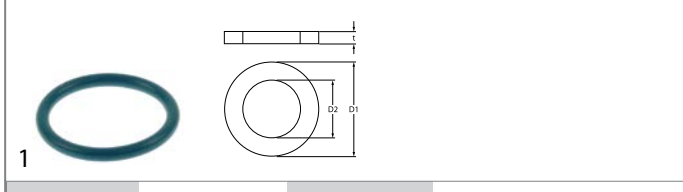

<b>GEV No.</b>	103007	<b>Ref. No.</b>	0H6863
<b>description</b>	O-ring Viton thickness 5mm ID ø 42.5mm Qty 1 pcs		

### sealing washers

#### rubber gaskets

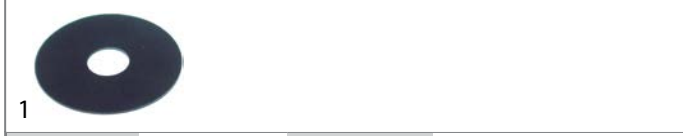

<b>GEV No.</b>	693757	<b>Ref. No.</b>	0H6852
<b>description</b>	flat gasket rubber ED ø 60mm ID ø 17mm thickness 1.5mm Qty 1 pcs		

#### PTFE gaskets



<b>GEV No.</b>	693745	<b>Ref. No.</b>	002624
<b>description</b>	gasket PTFE ED ø 20mm ID ø 15mm thickness 1mm Qty 1 pcs		



sealing cords

square



<b>GEV No.</b>	693739	<b>Ref. No.</b>	058404
<b>description</b>	sealing cord square size 12x12mm t.max. 550°C braided L 5m		

round



<b>GEV No.</b>	691362	<b>Ref. No.</b>	0K3197
<b>description</b>	sealing cord round $\phi$ 6mm t.max. 550°C braided L 5m Qty 1		

shaft gaskets

shaft gaskets



<b>GEV No.</b>	693747	<b>Ref. No.</b>	0H6857
<b>description</b>	shaft sealing		

miscellaneous



<b>GEV No.</b>	511301	<b>Ref. No.</b>	002699
<b>description</b>	shaft seal ID $\phi$ 16mm ED $\phi$ 38mm thickness 18mm		



<b>GEV No.</b>	511905	<b>Ref. No.</b>	0H6853 268134
<b>description</b>	shaft seal ID $\phi$ 23mm ED $\phi$ 58mm thickness 22mm		

special gaskets

miscellaneous



<b>GEV No.</b>	693402	<b>Ref. No.</b>	002706
<b>description</b>	boiler gasket		



<b>GEV No.</b>	550916	<b>Ref. No.</b>	0H6666
<b>description</b>	gasket		



<b>GEV No.</b>	693396	<b>Ref. No.</b>	057402
<b>description</b>	gasket level glass L 30mm W 30mm thickness 0.8mm equiv. no. 250617 suitable for JUNO		

<b>accessories for</b>	693396		
<b>GEV No.</b>	693398	<b>Ref. No.</b>	057382
<b>description</b>	frame for level glass		



<b>GEV No.</b>	693403	<b>Ref. No.</b>	003874
<b>description</b>	gasket suitable for ZANUSSI hot air		

miscellaneous



<b>GEV No.</b>	900757	<b>Ref. No.</b>	0K2603
<b>description</b>	strengthening for gasket		

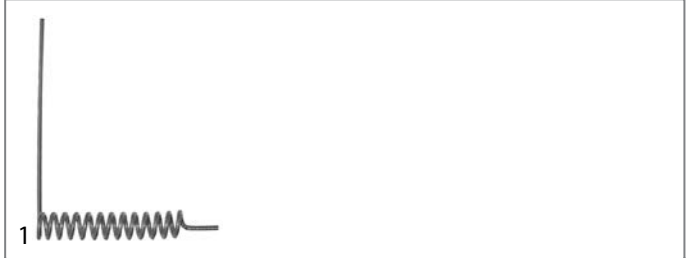

<b>GEV No.</b>	700023	<b>Ref. No.</b>	0H6608
<b>description</b>	torsion spring $\phi$ 18.2mm L2 150mm wire gauge $\phi$ 3.2mm mounting pos. left L1 100mm L3 24mm		



<b>GEV No.</b>	700022	<b>Ref. No.</b>	0H6607 245663
<b>description</b>	torsion spring $\phi$ 18.6mm L2 93mm wire gauge $\phi$ 3.4mm mounting pos. right L1 133mm L3 24mm		

springs

torsion springs



<b>GEV No.</b>	700426	<b>Ref. No.</b>	0H6915
<b>description</b>	torsion spring $\phi$ 12.9mm L2 64mm wire gauge $\phi$ 2.6mm mounting pos. right L1 100mm L3 11mm		

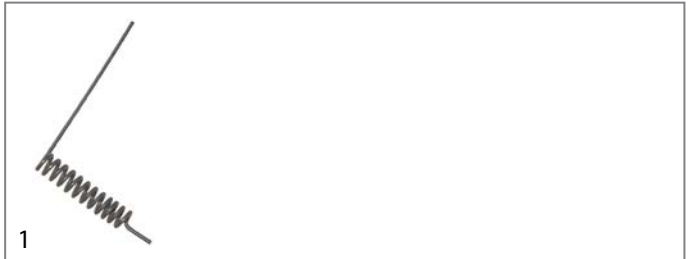

<b>GEV No.</b>	700027	<b>Ref. No.</b>	0K2680
<b>description</b>	torsion spring $\phi$ 19.2mm L2 86mm wire gauge $\phi$ 3.8mm mounting pos. left L1 131mm L3 26mm		



<b>GEV No.</b>	700427	<b>Ref. No.</b>	0H6914
<b>description</b>	torsion spring $\phi$ 13mm L2 64mm wire gauge $\phi$ 2.7mm mounting pos. left L1 101mm L3 9mm		

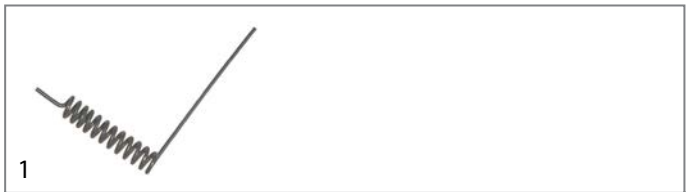

<b>GEV No.</b>	700026	<b>Ref. No.</b>	0K2679 279449
<b>description</b>	torsion spring $\phi$ 19mm L2 88mm wire gauge $\phi$ 3.4mm mounting pos. right L1 132mm L3 26mm		

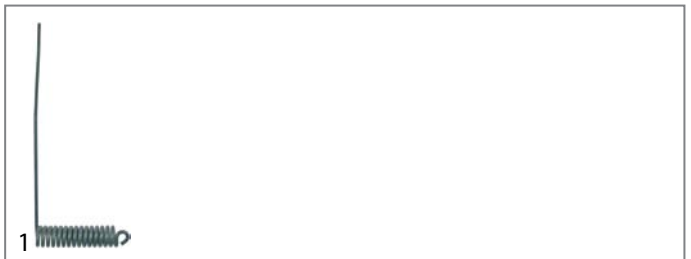

<b>GEV No.</b>	690880	<b>Ref. No.</b>	0KL682
<b>description</b>	torsion spring $\phi$ 20.9mm L2 75mm wire gauge $\phi$ 3.7mm L1 200mm L3 20mm		



			
1			
<b>GEV No.</b>	693299	<b>Ref. No.</b>	052894
<b>description</b>	torsion spring ø 28.6mm L2 103mm wire gauge ø 3.6mm L1 45mm		

			
1			
<b>GEV No.</b>	690879	<b>Ref. No.</b>	0K2675
<b>description</b>	torsion spring ø 43mm L2 117mm wire gauge ø 7.2mm L1 80mm L3 18mm		

miscellaneous

			
1			
<b>GEV No.</b>	691220	<b>Ref. No.</b>	053342
<b>description</b>	spring clip shaft diameter 6mm ømm L 17mm W 14mm H 5mm wire gauge ø 1.5mm		

tension springs

 <p>Image not available</p>			
1			
<b>GEV No.</b>	540916	<b>Ref. No.</b>	0K1647
<b>description</b>	tension spring		

 <p>Image not available</p>			
1			
<b>GEV No.</b>	540918	<b>Ref. No.</b>	0K2685
<b>description</b>	tension spring		

 <p>Image not available</p>			
1			
<b>GEV No.</b>	540919	<b>Ref. No.</b>	0K2686
<b>description</b>	tension spring		

			
1			
<b>GEV No.</b>	700418	<b>Ref. No.</b>	0G1777 279268
<b>description</b>	tension spring for double-wall lid		

			
1			
<b>GEV No.</b>	700419	<b>Ref. No.</b>	0G1778 279258
<b>description</b>	tension spring for double-wall lid		

			
1			
<b>GEV No.</b>	700414	<b>Ref. No.</b>	0K2703
<b>description</b>	tension spring for single-wall lid		

			
1			
<b>GEV No.</b>	700415	<b>Ref. No.</b>	0H6903
<b>description</b>	tension spring for single-wall lid		

 <p>Image not available</p>			
1			
<b>GEV No.</b>	700416	<b>Ref. No.</b>	0G1779
<b>description</b>	tension spring for single-wall lid		

			
1			
<b>GEV No.</b>	700417	<b>Ref. No.</b>	0H6918
<b>description</b>	tension spring for single-wall lid		

			
1			
<b>GEV No.</b>	540859	<b>Ref. No.</b>	0K2682
<b>description</b>	tension spring ø 25mm total length 274mm wire gauge ø 4.1mm		

			
1			
<b>GEV No.</b>	700413	<b>Ref. No.</b>	0K2039
<b>description</b>	tension spring ø 29mm total length 210mm wire gauge ø 4.1mm		

			
1			
<b>GEV No.</b>	540858	<b>Ref. No.</b>	0K2683
<b>description</b>	tension spring ø 34.4mm total length 285mm wire gauge ø 5.3mm		

## manometers

			
1			
<b>GEV No.</b>	541365	<b>Ref. No.</b>	0H6500
<b>description</b>	manometer ø 100mm pressure range 0 up to 1.6bar thread 1/2" marking 0.40 bar		

			
1			
<b>GEV No.</b>	541579	<b>Ref. No.</b>	017055
<b>description</b>	manometer ø 52mm pressure range 0 up to 1bar connection marking 0.5 thread 1/4"		

			
1			
<b>GEV No.</b>	541337	<b>Ref. No.</b>	0H6495
<b>description</b>	manometer ø 60mm pressure range -1.5 up to +1.5bar connection on the backside marking 1.1 thread 1/4"		

			
1			
<b>GEV No.</b>	541355	<b>Ref. No.</b>	0H6486
<b>description</b>	manometer ø 63mm pressure range 0 up to 1.6bar connection on the backside marking 1 thread 1/4"		

			
1			
<b>GEV No.</b>	541336	<b>Ref. No.</b>	0K1796 236110
<b>description</b>	manometer ø 63mm pressure range 0 up to 1bar thread 1/4"		

			
1			
<b>GEV No.</b>	541460	<b>Ref. No.</b>	0K5402
<b>description</b>	manometer pressure range 0 up to 2.5bar marking 1.3		

## hose reels and spray guns



### spray guns

			
1			
<b>GEV No.</b>	542038	<b>Ref. No.</b>	003175
<b>description</b>	spray gun for appliances 3/8" IT L 135mm		

## hoses

### supply hoses

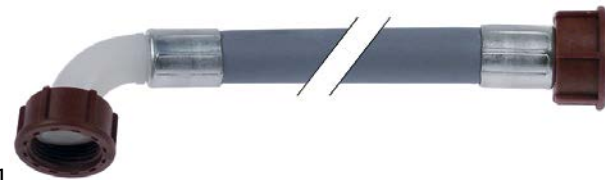
#### PVC supply hoses

				
1				
<b>GEV No.</b>	520010	<b>Ref. No.</b>	0C5562	
<b>description</b>	supply hose PVC straight-curved DN13 connections 3/4" L 1500mm operating p. 10bar burst p. 32bar t.max. 90°C blue approval VDE flat seal			
<b>accessories for</b>	520010			
	<b>GEV No.</b>	520053	<b>Ref. No.</b>	—
	screen connection 3/4" D1 ø 26mm D2 ø 15mm Qty 10 pcs rubber thickness 8mm			
	<b>GEV No.</b>	520054	<b>Ref. No.</b>	—
	flat gasket rubber ED ø 23.5mm ID ø 14mm thickness 2.3mm Qty 10 pcs			

### industrial hoses

#### Niplaflex hoses

			
1			
<b>GEV No.</b>	530561	<b>Ref. No.</b>	0C4158
<b>description</b>	pressure hose ID ø 10mm ED ø 17mm L 5m thickness 3.5mm operating p. 10bar burst p. 30bar t.max. 110°C		



pressure hoses (other)

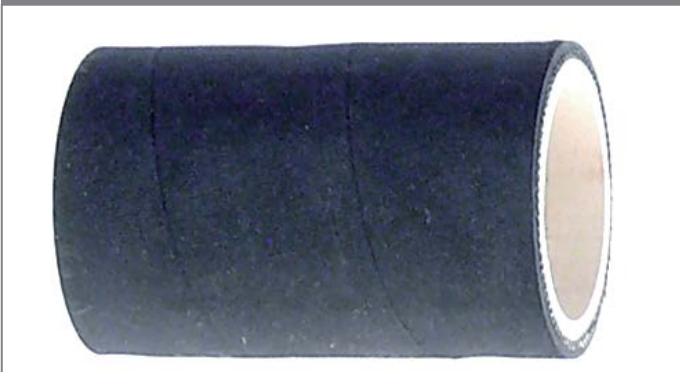

1

<b>GEV No.</b>	530601	<b>Ref. No.</b>	OK2454
<b>description</b>	pressure hose ID ø 40mm ED ø 52mm thickness 6mm L 80mm		

fittings, hose and pipe connectors

hose connectors

without screw connection



1

<b>GEV No.</b>	501210	<b>Ref. No.</b>	047431
<b>description</b>	Y-piece plastic hose ø 10-10-10mm		

valves and tank inlets

ball valves

universal

mini ball valves



1

<b>GEV No.</b>	520296	<b>Ref. No.</b>	231201
<b>description</b>	ball valve connection 1/2" IT - 1/2" IT DN10 total length 47mm chrome-plated brass		
<b>accessories for</b>	520296		

	<b>GEV No.</b>	515040	<b>Ref. No.</b>	—
	drain fitting size 1/2" usable heightmm overall height 16mm ED ø 28mm chrome-plated brass			

ball valves with butterfly handle



1

<b>GEV No.</b>	520726	<b>Ref. No.</b>	OK1391
<b>description</b>	ball valve connection 1/2" IT - 1/2" ET DN15 total length 56mm		

ball valves with lever handle



1

<b>GEV No.</b>	520282	<b>Ref. No.</b>	004729
<b>description</b>	ball valve connection 1" IT - 1" IT DN25 total length 67mm with lever handle		



1

<b>GEV No.</b>	520280	<b>Ref. No.</b>	0H6385 231205
<b>description</b>	ball valve connection 1/2" IT - 1/2" IT DN15 total length 50mm with lever handle handle length 85mm		

ball valves electric



1

<b>GEV No.</b>	401140	<b>Ref. No.</b>	005026
<b>description</b>	ball valve inlet 1" IT outlet 1" IT with plug 230V L 152mm 50/60Hz closed off-current mode of operation electric connection cable 200mm size DN25		



1

<b>GEV No.</b>	401139	<b>Ref. No.</b>	0C0882
<b>description</b>	ball valve inlet 3/4" IT outlet 3/4" IT with plug 230V L 65mm 50/60Hz closed off-current mode of operation electric connection cable 200mm		

### steam valves



1

<b>GEV No.</b>	541542	<b>Ref. No.</b>	OKD952	
<b>description</b>	steam valve straight connection 1" IT total length 90mm H 140mm brass			
<b>spare parts for</b>	541542			
	<b>GEV No.</b>	540229	<b>Ref. No.</b>	—
	star handle shaft 9x9mm ø 80mm L 23mm black thermoplastic			
	<b>GEV No.</b>	541546	<b>Ref. No.</b>	—
	screw chrome-plated brass thread M5 thread L 10mm			
	<b>GEV No.</b>	541548	<b>Ref. No.</b>	—
	gasket PTFE ID ø 15mm H 7mm for thread 1 1/4" ED ø 35mm			
	<b>GEV No.</b>	541554	<b>Ref. No.</b>	—
	gasket copper ext. ø 49 ID ø 42mm H 2mm for thread 1 1/4"			
	<b>GEV No.</b>	541557	<b>Ref. No.</b>	—
	tap head chrome-plated thread 1 1/4" for steam tap 1"			

## drain systems and wash basins

### HT drain pipes

#### rubber sleeves



1

<b>GEV No.</b>	515085	<b>Ref. No.</b>	0H6650 246238
<b>description</b>	rubber sleeve suitable for high temperature pipe ED ø 40mm ID ø 20-32mm		

## ancillary products

### fitting greases



1

<b>GEV No.</b>	890116	<b>Ref. No.</b>	0G1994 400191
<b>description</b>	fitting grease FERMIT GLISSA tube 60g -20 up to +140°C approval complies with KTW recommendation		
<b>description</b>	<p>Fermit GLISSA - tube 60g</p> <p>Non-dripping lubricating grease for hot and cold water valves and fittings</p> <p>Ductile, smooth, non-dripping lubricating grease for valves and fittings, that with regard to food law is beyond reproach and is therefore also suitable for drinking water pipes. Can also be used for machines and equipment where Glissa valve and fitting grease comes into contact with food or drinking water.</p> <p>Temperature range: -20°C to +140°C</p> <p>Approved by NSF-H 1 and DIN 51502</p>		

### clamps

#### hose clamps

#### DIN 3017 - W2



1

<b>GEV No.</b>	520112	<b>Ref. No.</b>	048126
<b>description</b>	hose clamp ø 12-20mm width 9mm Qty 10 pcs DIN 3017		



## fastening material

### nuts

#### hexagonal nuts

##### hexagonal nuts metric (without norm)



1

**GEV No.** 101345 **Ref. No.** 020997

**description** nut thread M15x1 H 3mm WS 19 brass Qty 1 pcs



1

**GEV No.** 693430 **Ref. No.** 051263

**description** nut thread M22x1.5 H 5mm WS 26 zinc-coated steel Qty 1 pcs

### washers

#### washers

##### miscellaneous



1

**GEV No.** 693431 **Ref. No.** 002727

**description** plain washer



1

**GEV No.** 690844 **Ref. No.** 056416

**description** plain washer plastic

### fasteners

#### clamps

##### hose clamps

##### DIN 3017 - W2



1

**GEV No.** 520112 **Ref. No.** 048126

**description** hose clamp ø 12-20mm width 9mm Qty 10 pcs DIN 3017

### cable clamps



1

**GEV No.** 693247 **Ref. No.** 0K0194

**description** cable clamp wire gauge ø 5mm

### retaining rings

##### DIN 6799



1

**GEV No.** 507015 **Ref. No.** 068293  
0H6035  
117584

**description** retaining ring E D1 ø 7mm D2 ø 14mm SS DIN 6799 thickness 0.9mm for shaft ø 8-11mm

### roll pins



1

**GEV No.** 692013 **Ref. No.** 0H6043  
159510

**description** roll pin ø 3mm L 16mm

## consumables

### sealants and adhesives

#### high temperature silicone



1

**GEV No.** 890059 **Ref. No.** 0G1878

**description** high temperature silicone FERMITOPP 300 neutral curing -40 up to +265°C black cartridge 310ml

**description** Fermittopp HN 300 - cartridge 310ml - black  
Is used for sealing expansion joints on heating flues, ovens, reactors, chimneys, stacks, etc. The sealant is neutrally cross-linking, reacts with the moisture in the air and is characterised by extremely good hot air-resistance. The adhesive surfaces must be dry, clean and free of loose parts and in the case of porous substrates they should, if necessary, be given a first coat of primer. Post-smoothing e.g. with soap solution must take place before skinning.  
Highly refractory, odourless, UV/water/colour/hot-air resistant  
Temperature range -50°C to +250°C

**lubricants**

**fitting greases**



1			
<b>GEV No.</b>	890116	<b>Ref. No.</b>	OG1994 400191
<b>description</b>	fitting grease FERMIT GLISSA tube 60g -20 up to +140°C approval complies with KTW recommendation		
<b>description</b>	<p>Fermit GLISSA - tube 60g Non-dripping lubricating grease for hot and cold water valves and fittings</p> <p>Ductile, smooth, non-dripping lubricating grease for valves and fittings, that with regard to food law is beyond reproach and is therefore also suitable for drinking water pipes. Can also be used for machines and equipment where Glissa valve and fitting grease comes into contact with food or drinking water.</p> <p>Temperature range: -20°C to +140°C Approved by NSF-H 1 and DIN 51502</p>		

**silicone fats**



1			
<b>GEV No.</b>	890101	<b>Ref. No.</b>	0H7004
<b>description</b>	silicone grease FERMIT GLISSA tube 60g -40 to +200°C approval		
<b>description</b>	<p>Fermit GLISSA - tube 60g Non-drip lubricating grease for drinking water valves and fittings Glissa silicone grease is suitable as a lubricant and sealant for drinking water valves and fittings (e.g. cartridges of single-lever mixers, switching valves and swivel spouts). Water-repellent, physiologically safe, sealing and has a high temperature resistance up to 200°C. Complies with the guidelines of the UBA for sanitary lubricants, tested by TZW for suitability for drinking water and approved in accordance with DIN ISO 21469. Temperature range: -40°C to +200°C</p>		

**fuses**

**fine fuses**



1			
<b>GEV No.</b>	358610	<b>Ref. No.</b>	058869
<b>description</b>	fine fuse size ø5x20mm 10A fast-acting rated 250V Qty 10 pcs		



1			
<b>GEV No.</b>	358611	<b>Ref. No.</b>	005136
<b>description</b>	fine fuse size ø5x20mm 16A fast-acting rated 250V Qty 10 pcs		



1			
<b>GEV No.</b>	358695	<b>Ref. No.</b>	005032
<b>description</b>	fine fuse size ø5x20mm 3.15A medium lag rated 250V Qty 10 pcs		



1			
<b>GEV No.</b>	358594	<b>Ref. No.</b>	002820
<b>description</b>	fine fuse size ø5x20mm 0.16A slow-acting rated 250V Qty 10 pcs		



1			
<b>GEV No.</b>	358596	<b>Ref. No.</b>	002920
<b>description</b>	fine fuse size ø5x20mm 0.25A slow-acting rated 250V Qty 10 pcs		

**fine fuse holders**



1			
<b>GEV No.</b>	358394	<b>Ref. No.</b>	0H6523
<b>description</b>	fuse holder suitable fuse ø5x30mm mounting ø 18.3mm 6.3A rated 500V connection F2.8		



1			
<b>GEV No.</b>	358395	<b>Ref. No.</b>	0H6526
<b>description</b>	screw cap suitable fuse ø 14.5mm mounting ømm thread M9x1 6.3A rated 250V connection suitable for fuse holder		

<b>A</b>			
alarm devices	37		
axial fans	56		
<b>B</b>			
ball valves	131		
ball valves electric	53, 131		
bar burners	95		
boiling pan gaskets	125		
bullet connectors	63		
<b>C</b>			
cable clamps	133		
cables	62		
cam switches	25		
capillary tube clips	23		
clamps	132, 133		
condensators & interference suppression filters	61		
consumables	133		
contactors	38		
control equipment	29		
control thermostats	15		
copper wire	62		
cross flow fans	57		
<b>D</b>			
door catches	112		
door seals	121		
door seals with tension springs	125		
drain systems and wash basins	132		
<b>E</b>			
edgemount latches	111		
electric accessories	62		
electric timers	36		
electrodes	55		
electronic controllers	43		
energy regulators	15		
espagnolette locks	112		
<b>F</b>			
fans	56		
fasteners	133		
fastening material	133		
fine fuses	134		
fitting greases	132, 134		
fuses	62, 134		
<b>G</b>			
gas burners	90		
gas control valves	76		
gas hoses	103		
		gas nozzles	96
		gas solenoid valves	79
		gas taps	63
		gas thermostats	73
		gaskets for heated units	120
		gaskets for tray rack trolleys	125
<b>H</b>			
		halogen lamp	34
		handle latches	111
		heating elements	3, 7
		heating elements for bain maries	3
		heating elements for chargrills	7
		heating elements for convection	10
		heating elements for fryers	4
		heating elements for frying pans	4
		heating elements for griddles	6
		heating elements for heated trolleys	7
		heating elements for large hobs	6
		heating elements for ovens	3
		heating elements for pasta cookers	7
		heating elements for salamanders/toasters	7
		heating elements for tilting bratt pan	6
		hexagonal nuts	133
		high temperature silicone	133
		hob burners	90
		hose clamps	132, 133
		hose connectors	131
		hoses	130
		hot air fans	60
		hot air motors	57
		hot plates	13
		HT drain pipes	132
<b>I</b>			
		ignition boxes	78
		ignition cables	87
		ignition units	88
		immersion heating elements	8
		indicator lights	31
		indicator lights (complete)	32
		industrial hoses	130
<b>L</b>			
		lamp accessories	36
		lamps	31
		light bulbs	34
		lubricants	134
<b>M</b>			
		mechanical timers	37
		microswitches	24
		motors	61

<b>N</b>			
neon light bulbs	32, 33		
Niplaflex hoses	130		
nuts	133		
<b>O</b>			
operating capacitors	61		
O-rings	126		
oven hinges	113		
oven lamps	34		
<b>P</b>			
piano hinges	113		
piezoelectric igniters	87		
pilot burners	79		
pilot heating elements	7		
plug connectors	63		
position switches	25		
pressure switches	54, 103		
probe clips	22		
probes	44		
programme timers	36		
push/momentary push switches	23		
PVC supply hoses	130		
<b>R</b>			
radial fans	61		
radiation heaters	12		
relays	41		
retaining rings	133		
ring burners	95		
ring terminals	63		
rocker/momentary rocker switches	23		
roll pins	133		
rotary switches	29		
rubber sleeves	132		
<b>S</b>			
safety thermostats	19		
sealants and adhesives	133		
sealing cords	127		
sealing washers	126		
shaft gaskets	127		
shelves and shelf rails	120		
silicone	133		
silicone fats	134		
snap locks	112		
solenoid valves	50		
spray guns	130		
spring clips	22		
steam valves	132		
supply hoses	130		
		switches and momentary switches	23
		system switches (ROLD)	25
<b>T</b>			
		terminals and connectors	63
		thermocouples	88
		thermostats	15
		time relays	42
		timers	36
		transformers	43
<b>V</b>			
		valves and tank inlets	131
<b>W</b>			
		washers	133
		window seals	120