



**GAS COMPONENTS**



**ELECTRIC COMPONENTS**



**WATER TECHNOLOGY**



**MECHANICAL COMPONENTS**



**TOOLS**

Spare parts suitable for

**JÜNGER**

Find the complete and up-to-date range of products in our GEV Webshop



# Manufacturer catalogue

The most important spare parts and accessories arranged clearly for every manufacturer

- ✓ Complete product range and all appliance data always up to date in the GEV Webshop
- ✓ Alphabetical Index at the end of the catalogue

## GEV Webshop

[www.gev-online.co.uk](http://www.gev-online.co.uk)

[www.gev-online.com](http://www.gev-online.com)



- 🔍 Add to Favourites
- 🔍 Sign In with email address and usual password
- 🔍 Easy-order – place several items in your basket at the same time
- 🔍 Quick Item search – no login needed



## heating elements

### heating elements for fryers

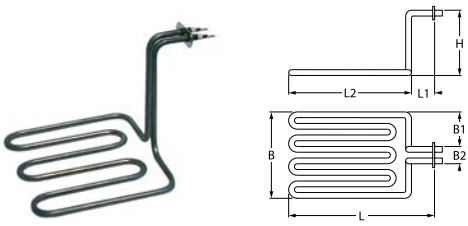

1

<b>GEV No.</b>	415342	<b>Ref. No.</b>	445258
<b>description</b>	heating element 2000W 230V heating circuits 1 L 213mm W 202mm H 155mm L1 38mm L2 175mm W1 85mm W2 26mm flange length 50mm flange width 22mm hole distance 40mm windings 3 connection male faston 6.3mm hole ø 4mm rectangular flange		
<b>For models:</b>	258		

### heating elements for hot dog machines



1

<b>GEV No.</b>	415754	<b>Ref. No.</b>	420000
<b>description</b>	heating element 600W 230V L 138mm W 134mm H 29mm tube ø 6.5mm connection cable connection length 45mm cable length 300mm dry heating element rectangular flange heating circuits 1 hole distance 51mm flange length 60mm flange width 22mm mounting thread M4		
<b>For models:</b>	250, 252, 253, 254		

### heating elements for chargrills

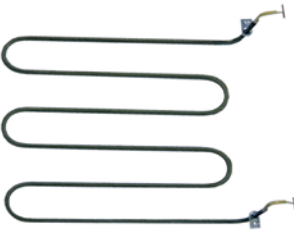

1

<b>GEV No.</b>	415343	<b>Ref. No.</b>	421000
<b>description</b>	heating element 1500W 230V L 300mm W 285mm H 30mm heating circuits 1 hole distance 305mm windings 3 mounting thread 1/8" cable length 280mm sausage roaster dry heating element lug length 26mm lug width 24mm bracket mounting connection length 42mm tube ø 6.3mm		
<b>For models:</b>	271, 272		

## energy regulators

### DIAMOND



1

<b>GEV No.</b>	380032	<b>Ref. No.</b>	423100
<b>description</b>	energy regulator 230V 13.5A turn direction right shaft ø 6x4.6mm shaft L 23mm mounting thread M4 equiv. no. 45ER104C1		
<b>For models:</b>	271, 272, 273, 274, 276		

### accessories

#### knobs



1

<b>GEV No.</b>	110238	<b>Ref. No.</b>	423120
<b>description</b>	knob energy regulator 1-10 t.max. °C ø 50mm shaft ø 6x4.6mm shaft flat upper black		
<b>For models:</b>	271, 272, 273, 274, 276		

## thermostats

### control and safety thermostats

#### EGO

#### safety thermostats

#### 55.13\_ series



1

<b>GEV No.</b>	375115	<b>Ref. No.</b>	422000	
<b>description</b>	safety thermostat switch-off temp. 145°C 1-pole 1NO 16A probe ø 6mm probe L 73mm capillary pipe 830mm capillary pipe isolatedmm gland nut probe SS			
<b>accessories for</b>	375115			
	<b>GEV No.</b>	551083	<b>Ref. No.</b>	—
	cap for safety thermostat thread M8x1			



control thermostats with operation switch

55.10/19\_ series

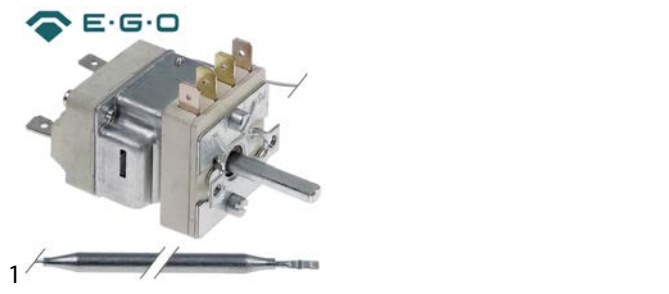

<b>GEV No.</b>	375473	<b>Ref. No.</b>	422100
<b>description</b>	thermostat t.max. 110°C temperature range 37-110°C 1-pole 1NO 16A probe ø 6mm probe L 129mm capillary pipe 570mm capillary pipe isolatedmm gland nut shaft ø 6x4.6mm shaft L 23mm shaft position upper rotation 270° outer switch 2NO		

RATHGEBER

control thermostats with operation switch



<b>GEV No.</b>	375931	<b>Ref. No.</b>	422100 422111
<b>description</b>	thermostat t.max. 110°C temperature range 30-110°C 1-pole 1NC 16A probe ø 6mm probe L 140mm capillary pipe 860mm capillary pipe isolated 65mm shaft ø 6x4.6mm shaft L 26.5mm outer switch 2-pole		
<b>For models:</b>	250, 252, 253, 254		

various

safety thermostats

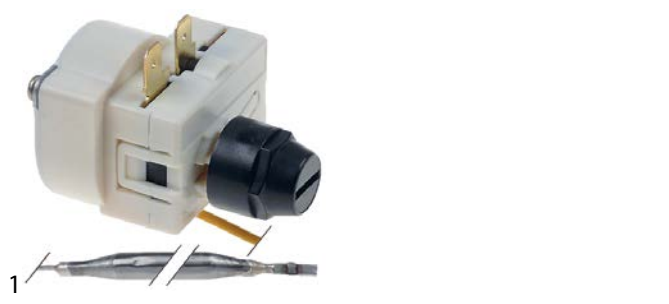

<b>GEV No.</b>	375932	<b>Ref. No.</b>	422200 422211
<b>description</b>	safety thermostat switch-off temp. 146°C temperature range°C 1-pole 1NCA probe ø 6mm probe L 86mm capillary pipe 850mm capillary pipe isolated 50mm gland nut shaft ømm probe SS screw connection M10x1		
<b>For models:</b>	250, 252, 253, 254, 258		

lamps

indicator lights

indicator lights (complete)

ø10mm

with plug-in socket



<b>GEV No.</b>	359140	<b>Ref. No.</b>	426000
<b>description</b>	indicator light ø 10mm yellow 230V connection male faston 6.3mm Qty 1 pcs		
<b>For models:</b>	271, 272, 273, 274, 276		

miscellaneous



<b>GEV No.</b>	359018	<b>Ref. No.</b>	426000
<b>description</b>	indicator light		

gas taps

MADEC (MP)

with nozzle outlet



<b>GEV No.</b>	101193	<b>Ref. No.</b>	431310
<b>description</b>	gas tap MADEC with nozzle outlet (without nozzle) gas inlet M12x1 (tube ø 8mm) external nozzle ømm internal nozzle ømm bypass nozzle ø 0.35mm mixing pipe connection M17x1 thermocouple connection M8x1 front fixing M12x1 shaft ø 8x5mm shaft L 23/13.5mm shaft flat left		
<b>For models:</b>	280000, 282000, 285000, 286000		

<b>spare parts for</b>	101193		
------------------------	--------	--	--

	<b>GEV No.</b>	100360	<b>Ref. No.</b>	—
	bypass nozzle MADEC bore ø 0.35mm thread M4.5x0.6 total length 13mm			

	<b>GEV No.</b>	101051	<b>Ref. No.</b>	431440
	magnet unit L 27mm D1 ø 12.5mm D2 ø 8.5mm suitable for JUNKERS/EGA/MADEC/SABAF standard			

	<b>GEV No.</b>	101234	<b>Ref. No.</b>	—
	union nut T1: M8x1 T2: M15			

<b>accessories for</b>	101193		
------------------------	--------	--	--



	<b>GEV No.</b>	100936	<b>Ref. No.</b>	—
	gas tap spindle shaft ø 5x8mm MADEC			

	<b>GEV No.</b>	101277	<b>Ref. No.</b>	—
	olive ID ø 8mm Qty 1 pcs			



	<b>GEV No.</b>	101296	<b>Ref. No.</b>	—
	union nut thread M12x1 for pipe ø 8mm			







Table continues overleaf



<b>accessories for</b>	101193			
	GEV No.	101299	Ref. No.	—
	nut thread M12x1			
	GEV No.	101400	Ref. No.	431430
	air mixing tube thread M17x1 suitable for L350, L700			
	GEV No.	110150	Ref. No.	—
	knob gas tap without ignition flame t.max.°C°C ø 50mm shaft ø 8x5.5mm shaft flat right white			



<b>GEV No.</b>	101073	<b>Ref. No.</b>	431200	
<b>description</b>	gas tap MADEC with nozzle outlet (without nozzle) gas inlet M12x1 (tube ø 8mm) external nozzle ømm internal nozzle ømm bypass nozzle ø 0.35mm mixing pipe connection M17x1 thermocouple connection M8x1 front fixing M12x1 shaft ø 8x5mm shaft L 23/13.5mm shaft flat right gas outlet M17x1			
<b>For models:</b>	260, 269, 270			
<b>spare parts for</b>	101073			
	GEV No.	100936	Ref. No.	—
	gas tap spindle shaft ø 5x8mm MADEC			
	GEV No.	101051	Ref. No.	431440
	magnet unit L 27mm D1 ø 12.5mm D2 ø 8.5mm suitable for JUNKERS/EGA/MADEC/SABAF standard			
	GEV No.	101234	Ref. No.	—
	union nut T1: M8x1 T2: M15			

<b>accessories for</b>	101073			
	GEV No.	100927	Ref. No.	—
	torsion spring L 2.8-8.0mm for internal nozzle ø 3mm bore ømm			
	GEV No.	101277	Ref. No.	—
	olive ID ø 8mm Qty 1 pcs			
	GEV No.	101296	Ref. No.	—
	union nut thread M12x1 for pipe ø 8mm			
	GEV No.	101299	Ref. No.	—
	nut thread M12x1			
	GEV No.	101400	Ref. No.	431430
	air mixing tube thread M17x1 suitable for L350, L700			
	GEV No.	110148	Ref. No.	431220
	knob gas tap without ignition flame ø 50mm shaft ø 8x5mm shaft flat left black			
	GEV No.	110150	Ref. No.	—
	knob gas tap without ignition flame t.max.°C°C ø 50mm shaft ø 8x5.5mm shaft flat right white			



<b>GEV No.</b>	101194	<b>Ref. No.</b>	431110	
<b>description</b>	gas tap MADEC with nozzle outlet (without nozzle) gas inlet M12x1 (tube ø 8mm) external nozzle ømm internal nozzle ømm bypass nozzle ø 0.35mm mixing pipe connection M17x1 thermocouple connection M8x1 front fixing M12x1 shaft ø 8x6mm shaft L 17/9mm shaft flat upper and bottom			
<b>For models:</b>	251, 255, 256, 257			
<b>spare parts for</b>	101194			
	GEV No.	100360	Ref. No.	—
	bypass nozzle MADEC bore ø 0.35mm thread M4.5x0.6 total length 13mm			
	GEV No.	101051	Ref. No.	431440
	magnet unit L 27mm D1 ø 12.5mm D2 ø 8.5mm suitable for JUNKERS/EGA/MADEC/SABAF standard			
	GEV No.	101234	Ref. No.	—
	union nut T1: M8x1 T2: M15			
<b>accessories for</b>	101194			
	GEV No.	101277	Ref. No.	—
	olive ID ø 8mm Qty 1 pcs			
	GEV No.	101296	Ref. No.	—
	union nut thread M12x1 for pipe ø 8mm			
	GEV No.	101299	Ref. No.	—
	nut thread M12x1			
	GEV No.	101400	Ref. No.	431430
	air mixing tube thread M17x1 suitable for L350, L700			

## ignition parts

### electrodes



<b>GEV No.</b>	100743	<b>Ref. No.</b>	401120	
<b>description</b>	ignition electrode D1 ø 6mm L1 21mm BL1 18mm BL2 8mm BL3 19mm connection F 2.8x0.8mm M10x1			
<b>For models:</b>	260, 269, 270			
<b>accessories for</b>	100743			
	GEV No.	101860	Ref. No.	—
	nut thread M10x1 H 4mm WS 14 chrome-plated brass Qty 1 pcs			



### piezoelectric igniters

mounting diameter 22mm



<b>GEV No.</b>	100005	<b>Ref. No.</b>	401000
<b>description</b>	piezoelectric igniter body plastic blowing mounting ø 22mm connection ø2.4mm cable lengthmm SIT		
<b>For models:</b>	260, 269, 270		

### thermocouples

threaded thermocouples

threaded thermocouples standard

with socket with thread M8x1

SIT

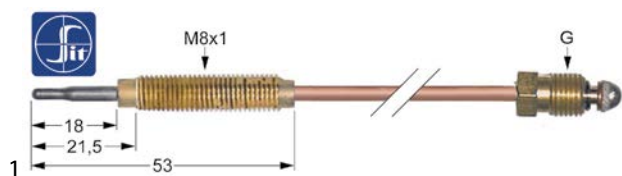

<b>GEV No.</b>	107628	<b>Ref. No.</b>	431410
<b>description</b>	thermocouple SIT M8x1 L 320mm M8x1		
<b>For models:</b>	251, 255, 256, 257, 260, 269, 270, 280000, 282000, 285000, 286000		
<b>accessories for</b>	107628		
	<b>GEV No.</b>	102067	<b>Ref. No.</b>
			—
	nut thread M8x1 H 3mm brass Qty 1 pcs type SEF 1		

### bar burners

bar burners



<b>GEV No.</b>	104220	<b>Ref. No.</b>	433280
<b>description</b>	bar burner 3 row L 425mm W 110mm ø 20mm Hmm chargrill		
<b>For models:</b>	280000, 285000, 286000		



<b>GEV No.</b>	104218	<b>Ref. No.</b>	433282
<b>description</b>	bar burner 3 row L 440mm W 185mm ø 20mm Hmm chargrill		
<b>For models:</b>	282000		

### ring burners



<b>GEV No.</b>	104222	<b>Ref. No.</b>	433270
<b>description</b>	ring burner L 290mm W 180mm		
<b>For models:</b>	269, 270		

### gas burners

hob burners

accessories

air mixers



<b>GEV No.</b>	101400	<b>Ref. No.</b>	431430
<b>description</b>	air mixing tube thread M17x1 suitable for L350, L700		
<b>For models:</b>	260, 269, 270, 280000, 282000, 285000, 286000		



## auxiliary gas parts

### gas pressure regulators

Standard pressure according to country:

Germany 50mbar  
France 37mbar  
Italy 30mbar  
Spain 37/50mbar  
UK 20mbar



<b>GEV No.</b>	250005	<b>Ref. No.</b>	402110
<b>description</b>	gas pressure regulator EN61 connection small gas cylinders - 1/4" left 50mbar/1.5kg/h countries DE input pressure up to 16bar propane/butane CE 0085		
<b>description</b>	low pressure gas regulator type EN61-DS - 50mbar, 1.5kg/h with excess pressure protection and hose rupture protection for external commercial installations inlet for small gas cylinders (3/8" left), outlet 1/4" conical left hand thread		
<b>For models:</b>	260, 269, 270, 280000, 282000		

### gas hoses

#### DIN 4815 with DVGW approval

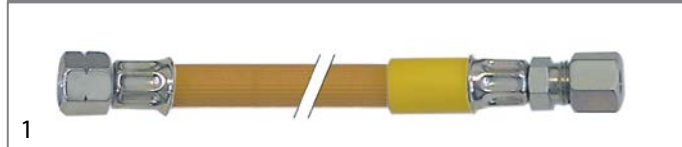

<b>GEV No.</b>	250004	<b>Ref. No.</b>	403120
<b>description</b>	gas hose DIN 4815 rubber with textile insertion L 400mm 1/4" left - tube ø 12mm temp.-resist. up to -30°C flexible conduit at intermediate pressure		
<b>For models:</b>	285000, 286000		

## equipment-specific units

### for hot dog machines

#### lids

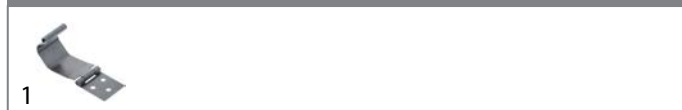

<b>GEV No.</b>	697927	<b>Ref. No.</b>	414000
<b>description</b>	clamp for lid L 35mm W 20mm thickness 0.6mm		
<b>For models:</b>	250, 251, 252, 253, 254, 255, 256, 257, 258		

## knobs

### universal knobs



<b>GEV No.</b>	110238	<b>Ref. No.</b>	423120
<b>description</b>	knob energy regulator 1-10 t.max. °C ø 50mm shaft ø 6x4.6mm shaft flat upper black		
<b>For models:</b>	271, 272, 273, 274, 276		



<b>GEV No.</b>	110119	<b>Ref. No.</b>	422120
<b>description</b>	knob thermostat t.max. 110°C ø 50mm shaft ø 6x4.6mm shaft flat upper black temperature range 30-110°C rotation 270°		
<b>For models:</b>	250, 252, 253, 254		
<b>accessories for</b>	110119		
<b>GEV No.</b>	110135	<b>Ref. No.</b>	—
<b>description</b>	rosette knob up to ø 52mm		

### producer-specific knobs

#### JÜNGER

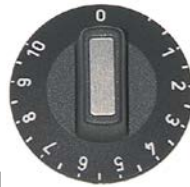

<b>GEV No.</b>	110238	<b>Ref. No.</b>	423120
<b>description</b>	knob energy regulator 1-10 t.max. °C ø 50mm shaft ø 6x4.6mm shaft flat upper black		
<b>For models:</b>	271, 272, 273, 274, 276		

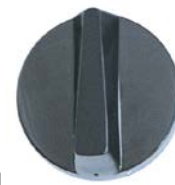

<b>GEV No.</b>	110148	<b>Ref. No.</b>	431220
<b>description</b>	knob gas tap without ignition flame ø 50mm shaft ø 8x5mm shaft flat left black		
<b>For models:</b>	260, 269, 270		



1

<b>GEV No.</b>	110149	<b>Ref. No.</b>	431320
<b>description</b>	knob gas tap without ignition flame t.max.°C temperature range°C ø 50mm shaft ø 6x4.6mm shaft flat right black		
<b>For models:</b>	280000, 282000, 285000, 286000		



1

<b>GEV No.</b>	110119	<b>Ref. No.</b>	422120
<b>description</b>	knob thermostat t.max. 110°C ø 50mm shaft ø 6x4.6mm shaft flat upper black temperature range 30-110°C rotation 270°		
<b>For models:</b>	250, 252, 253, 254		
<b>accessories for</b>	110119		
	<b>GEV No.</b>	110135	<b>Ref. No.</b> —
	rosette knob up to ø 52mm		

miscellaneous



1

<b>GEV No.</b>	111409	<b>Ref. No.</b>	417000
<b>description</b>	handle L 51mm W 89mm with mounting kit Qty 1 pcs		
<b>For models:</b>	250, 251, 252, 253, 254, 255, 256, 257, 258		

## handles and hand wheels

### mushroom cap handles



1

<b>GEV No.</b>	111408	<b>Ref. No.</b>	416000
<b>description</b>	lid handle with screw thread M5 handle ø 48mm L 28mm black		
<b>For models:</b>	250, 251, 252, 253, 254, 255, 256, 257, 258		



**B**

bar burners 6

**E**

energy regulators 3

**G**

gas burners 6

gas hoses 7

gas pressure regulators 7

gas taps 4

**H**

heating elements 3

heating elements for chargrills 3

heating elements for fryers 3

hob burners 6

**I**

indicator lights 4

indicator lights (complete) 4

**L**

lamps 4

**P**

piezoelectric igniters 6

**R**

ring burners 6

**S**

safety thermostats 3

**T**

thermocouples 6

thermostats 3