



**GAS COMPONENTS**



**ELECTRIC COMPONENTS**



**WATER TECHNOLOGY**



**MECHANICAL COMPONENTS**



**TOOLS**

Spare parts suitable for

**ISA**

Find the complete and up-to-date range of products in our GEV Webshop



# Manufacturer catalogue

The most important spare parts and accessories arranged clearly for every manufacturer

- ✓ Complete product range and all appliance data always up to date in the GEV Webshop
- ✓ Alphabetical Index at the end of the catalogue

## GEV Webshop

[www.gev-online.co.uk](http://www.gev-online.co.uk)

[www.gev-online.com](http://www.gev-online.com)



- 🔍 Add to Favourites
- 🔍 Sign In with email address and usual password
- 🔍 Easy-order – place several items in your basket at the same time
- 🔍 Quick Item search – no login needed



## heating elements

### heating cartridges

1 

<b>GEV No.</b>	419216	<b>Ref. No.</b>	41850002800 418500028000
<b>description</b>	heating cartridge 250W 230V ø 11mm L 116mm cable length 2000mm connection male faston 6.3mm refrigeration		

1 

<b>GEV No.</b>	419218	<b>Ref. No.</b>	418500030100
<b>description</b>	heating cartridge 400W 230V ø 11mm L 240mm thread 3/8" cable length 550mm connection female faston 6.3mm refrigeration		

1 

<b>GEV No.</b>	419217	<b>Ref. No.</b>	418500020000
<b>description</b>	heating cartridge 700W 230V ø 11mm L 355mm cable length 1500mm connection female faston 6.3mm		

## thermostats

### bi-metal thermostats

#### bi-metal thermostats

1 

<b>GEV No.</b>	390930	<b>Ref. No.</b>	50501404000
<b>description</b>	bi-metal thermostat switch-off temp. 10°C 1-pole starting temperature -1°C cable length 2500mm		

## timers

### programme timers

1 

<b>GEV No.</b>	360590	<b>Ref. No.</b>	50502800200
<b>description</b>	timer EI30/15.5 engines chambers operation time 25s 230V 50/60Hz shaft ømm shaft Lmm RITARDAT.RT-123/00		

## relays

### power relays

#### with bracket mounting

1 

<b>GEV No.</b>	380687	<b>Ref. No.</b>	30506030 50500601400
<b>description</b>	power relays FINDER 230VAC 30A 2NO connection F6.3 bracket mounting manuf. no. 66.82.8.230.0300		

## electronic controllers

### CAREL

#### refrigeration controllers

##### built-in version

1 

71 x 29mm

<b>GEV No.</b>	378491	<b>Ref. No.</b>	418200090000
<b>description</b>	electronic controller CAREL PZIAC0H010K mounting measurements 71x29mm built-in depth 59mm 230V voltage AC NTC relay outputs 3 NO-12A CO-8A NO-8A NTC NTC protection IP65 ISA-TASSELLI -40 up to +99°C display 3½ digits		

### DIXELL

#### refrigeration controllers

##### built-in version

1 

71 x 29mm

<b>GEV No.</b>	378492	<b>Ref. No.</b>	41825755200
<b>description</b>	electronic controller DIXELL XR72CX mounting measurements 71x29mm built-in depth 59mm 12V voltage AC/DC NTC/PTC relay outputs 4 NO-16A NO-8A NO-8A NO-5A DI NTC/PTC NTC/PTC yes protection IP65 dependend on probe°C display 3½ digits		



## built-in version 2-piece



1

<b>GEV No.</b>	378490	<b>Ref. No.</b>	418249561100 418249561200
<b>description</b>	power PCB DIXELL XM470K-510C1 mounting measurements 132x152mm built-in depth 40mm 230V voltage AC NTC relay outputs 5 NO-20A NO-16A NO-8A NO-8A NO-8A NTC NTC NTC digital digital yes protection°C display		
<b>accessories for</b>	378490		
	<b>GEV No.</b>	378278	<b>Ref. No.</b> —
	keypad unit DIXELL T640 mounting measurements 150x30mm built-in depth 23mmV voltage relay outputs°C display 3½ digits		







## ELIWELL











## refrigeration controllers

## built-in version



1

<b>GEV No.</b>	381403	<b>Ref. No.</b>	418200073000 418200073100
<b>description</b>	electronic controller ELIWELL type EWPlus 974 mounting measurements 71x29mm 230V voltage AC NTC relay outputs 4 NO-12A(8) NO-8A(4) NC-6A(3) NO-5A(2) NTC NTC DI defr. funct. yes -50 up to +110°C display 3½ digits		
<b>accessories for</b>	381403		
	<b>GEV No.</b>	379052	<b>Ref. No.</b> —
	temperature probe PTC 1kOhm cable silicone probe -50 up to +150°C cable -50 up to +180°C probe ø6x40mm cable length 1.5m without screw connection 2-wire		
	<b>GEV No.</b>	379053	<b>Ref. No.</b> —
	temperature probe PTC 1kOhm cable PVC probe -50 up to +150°C cable -10 up to 100°C probe ø6x30mm cable length 3m without screw connection 2-wire		
	<b>GEV No.</b>	379064	<b>Ref. No.</b> —
	temperature probe PTC 1kOhm cable silicone probe -50 up to +150°C cable -50 up to +180°C probe ø6x40mm cable length 3m without screw connection 2-wire		
	<b>GEV No.</b>	379142	<b>Ref. No.</b> —
	temperature probe PTC 1kOhm cable PVC probe -50 up to +150°C cable -10 up to 100°C probe ø6x30mm cable length 1.5m without screw connection 2-wire		
	<b>GEV No.</b>	379160	<b>Ref. No.</b> —
	temperature probe NTC 10kOhm cable thermoplastic probe -40 up to +110°C cable -40 up to +110°C probe ø6x14mm cable length 1.5m without screw connection 2-wire		
	<b>GEV No.</b>	379161	<b>Ref. No.</b> —
	temperature probe NTC 10kOhm cable thermoplastic probe -40 up to +110°C cable -40 up to +110°C probe ø6x14mm cable length 3m without screw connection 2-wire		

<b>accessories for</b>	381403		
	<b>GEV No.</b>	379162	<b>Ref. No.</b> —
	temperature probe NTC 10kOhm cable thermoplastic probe -40 up to +110°C cable -40 up to +110°C probe ø6x14mm cable length 6m 2-wire		
	<b>GEV No.</b>	379169	<b>Ref. No.</b> —
	temperature probe NTC 10kOhm cable thermoplastic probe -40 up to +110°C cable -40 up to +110°C probe ø6x14mm cable length 2m without screw connection 2-wire		
	<b>GEV No.</b>	379199	<b>Ref. No.</b> —
	temperature probe PTC 1kOhm cable PVC probe -50 up to +150°C cable -10 up to 100°C probe ø6x30mm cable length 5m without screw connection 2-wire		
	<b>GEV No.</b>	379343	<b>Ref. No.</b> —
	temperature probe NTC 10kOhm cable silicone probe -40 up to +110°C cable -50 up to +180°C probe ø6x40mm cable length 3m 2-wire		
	<b>GEV No.</b>	379458	<b>Ref. No.</b> —
	temperature probe NTC 10kOhm cable silicone probe -40 up to +110°C cable -50 up to +180°C probe ø6x40mm cable length 1.5m without screw connection 2-wire		
	<b>GEV No.</b>	379630	<b>Ref. No.</b> —
	temperature probe NTC 10kOhm cable thermoplastic probe -40 up to +110°C cable -40 up to +110°C probe ø6x14mm cable length 2.5m without screw connection 2-wire resistor 10kOhm		
	<b>GEV No.</b>	379804	<b>Ref. No.</b> —
	protector for electronic controller 71x29 L 93mm W 65mm plexiglas		
	<b>GEV No.</b>	381407	<b>Ref. No.</b> —
	temperature probe Pt1000 probe -50 up to +110°C cable silicone°C probe ø5x20mm cable length 3m protection IP68		
	<b>GEV No.</b>	550802	<b>Ref. No.</b> —
	PCB terminal block 4-pole raster size 5mm		
	<b>GEV No.</b>	550805	<b>Ref. No.</b> —
	PCB terminal block 7-pole raster size 5mm		

## probes

## universal probes

## temperature probes



1

<b>GEV No.</b>	381222	<b>Ref. No.</b>	418303463100
<b>description</b>	temperature probe PTC 1kOhm cable silicone probe -50 up to +150°C cable -50 up to +180°C probe ø6x30mm cable length 3m cable colours grey 2-wire		



1

<b>GEV No.</b>	381221	<b>Ref. No.</b>	418316740000
<b>description</b>	temperature probe PTC 1kOhm cable silicone probe -50 up to +150°C cable -50 up to +180°C probe ø6x40mm cable length 1.5m 2-wire		



## electronics

### PCBs



1

<b>GEV No.</b>	360636	<b>Ref. No.</b>	418221547100
<b>description</b>	PCB ON-OFF L 120mm W 40mm suitable for ISA		

## keypads

### keypad units



1

<b>GEV No.</b>	403576	<b>Ref. No.</b>	418294090000
<b>description</b>	keypad PCB buttons 12 grey suitable for ISA		

## compressors

### EMBRACO / ASPERA

#### R290A

#### LBP monophase

Lower evaporation temperature below -20°C



1

<b>GEV No.</b>	605202	<b>Ref. No.</b>	452500000000
<b>description</b>	compressor coolant R290 type NT2170U 220-240V 50Hz LBP 17kg 3/4HP cylinder capacity 20.44cm <sup>3</sup> CSR H 220mm 544W 698W 883W 1097W 1340WWWWWW test method ASHRAE		

#### R404a/R507

#### LBP monophase

Lower evaporation temperature below -20°C



1

<b>GEV No.</b>	605152	<b>Ref. No.</b>	452500001000
<b>description</b>	compressor coolant R404a/R507 type NEK2134GK 220-240V 50Hz LBP 11kg 1/2HP cylinder capacity 8.77cm <sup>3</sup> CSR H 180mm 227W 302W 394W 501W 621W 753WWWWWW test method ASHRAE		



1

<b>GEV No.</b>	605144	<b>Ref. No.</b>	452400001000
<b>description</b>	compressor coolant R404a/R507 type NEK2168GK 220-240V 50Hz LBP 22.9kg 3/4HP cylinder capacity 14.28cm <sup>3</sup> CSR H 200mm 345W 454W 587W 742W 921W 1123WWWWWW		



1

<b>GEV No.</b>	605174	<b>Ref. No.</b>	452400055000 452452284000
<b>description</b>	compressor coolant R404a/R507 type NJ2192GK 220-240V 50Hz LBP 20.4kg 1 1/4HP cylinder capacity 26.2cm <sup>3</sup> CSR H 265mm 685W 989W 1342W 1745W 2196W 2196WWWWWW		



1

<b>GEV No.</b>	605081	<b>Ref. No.</b>	452447789000 452452285000 452452286000
<b>description</b>	compressor coolant R404a/R507 type NJ2212GK 220-240V 50Hz LBP fully hermetic 21.5kg 1 1/2HP power input 1150W cylinder capacity 34cm <sup>3</sup> CSR H 277mm 880W 1269W 1738W 2289W 2921W 2921W test method ASHRAE		

HMBP monophase

High/Medium evaporation temperature above -20/-15 °C



1

<b>GEV No.</b>	605161	<b>Ref. No.</b>	452500003000
<b>description</b>	compressor coolant R404a/R507 type NEK6210GK 220-240V 50Hz HMBP fully hermetic 8.5kg 3/8HP cylinder capacity 8.78cm <sup>3</sup> CSIR H 200mmW 566W 674W 815W 988W 1195W 1435W 1707W		



1

<b>GEV No.</b>	605177	<b>Ref. No.</b>	452447774000
<b>description</b>	compressor coolant R404a/R507 type NJ9238GK 220-240V 50Hz HMBP 22.1kg 1 1/2HP cylinder capacity 32.7cm <sup>3</sup> CSR H 277mmW 2016W 2640W 3315W 4045W 4830W 5668W 6560W		

fans

refrigeration fans

cold air circulating fans (complete)

ELCO



1

<b>GEV No.</b>	602030	<b>Ref. No.</b>	41812963100
<b>description</b>	fan fan wheel ø 100mm 230V 50-60Hz 10W 2500rpm connection Faston without fan wheel		
<b>spare parts for</b>	602030		
	<b>GEV No.</b>	601563	<b>Ref. No.</b> —
	fan wheel sucking ø 96mm shaft intake ø 4mm blade angle 26° W 18mm aluminium suitable for 601039		
	<b>GEV No.</b>	601564	<b>Ref. No.</b> —
	fan wheel blowing ø 96mm shaft intake ø 4mm blade angle 26° W 18mm aluminium suitable for 601056		
<b>accessories for</b>	602030		
	<b>GEV No.</b>	602062	<b>Ref. No.</b> —
	connector cable ELCO cable length 1500mm 0.75mm <sup>2</sup> protection IP44 for Plug-In		

miscellaneous



1

<b>GEV No.</b>	601857	<b>Ref. No.</b>	30413698 4152.0518 52A-20001/16 R400002486000 R400064297000
<b>description</b>	fan 230V 50/60Hz 15W ø 96mm type 52A-20001/16 2500rpm blowing fan wheel ø 96mm cable length 3000mm connection with cable mounting ø 110mm built-in depth 98mm		



## equipment-specific units

### for refrigerated counters

#### lid hinges



1

<b>GEV No.</b>	696667	<b>Ref. No.</b>	442700041005
<b>description</b>	bracket aluminium for hinge for door mounting pos. left		



1

<b>GEV No.</b>	696668	<b>Ref. No.</b>	442700042005
<b>description</b>	bracket aluminium for hinge for door mounting pos. left		



1

<b>GEV No.</b>	696665	<b>Ref. No.</b>	442700044005
<b>description</b>	bracket aluminium for hinge for door mounting pos. right		



1

<b>GEV No.</b>	696666	<b>Ref. No.</b>	442700043005
<b>description</b>	bracket aluminium for hinge for door mounting pos. right		

## handles and hand wheels

### bracket handles



1

<b>GEV No.</b>	701479	<b>Ref. No.</b>	491094841000
<b>description</b>	pull handle L1 320mm L2 230mm H 43mm mounting distance 275mm W 30mm grey/white		

## locks

### snap locks

#### producer-specific

#### ISA



1

<b>GEV No.</b>	692857	<b>Ref. No.</b>	50230200300
<b>description</b>	snap lock L 82mm W 38mm H 35mm mounting distance 27mm spring thickness 1.6mm		

## hinges

### edgemoount hinges

#### miscellaneous



1

<b>GEV No.</b>	692599	<b>Ref. No.</b>	50230102300
<b>description</b>	edgemoount hinge L 102mm W 19mm mounting distance 62mm hinging left/right without lift plastic grey refrigeration units centre of rotation 24mm		

spring assisted hinges

universal

INTERKLIMAT

hinges



1

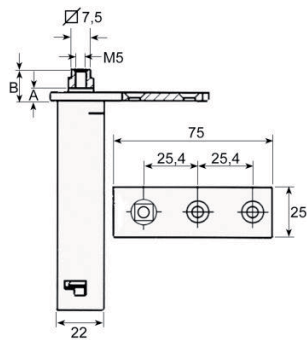

**GEV No.** 690622 **Ref. No.** 24563

**description** spring assisted hinge series 28L mounting pos. left/right L 75mm W 25mm H 103mm A 13mm B 18mm mounting measurements 22x22mm intake 7.5x7.5 refrigeration units

producer-specific

ISA



1

**GEV No.** 692600 **Ref. No.** 24563

**description** spring assisted hinge right/left L 73mm W 24mm H 100mm refrigeration units mounting distance 26mm

door bearing

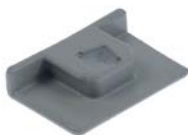

1

**GEV No.** 692601 **Ref. No.** 442700045005

**description** hinge L 40mm W 25mm mounting pos. bottom left thickness 7mm



1

**GEV No.** 692598 **Ref. No.** 442700040005

**description** hinge L 40mm W 25mm mounting pos. bottom right thickness 7mm Qty 1 pcs

gaskets

refrigeration gaskets

plug-in gaskets

profile 9048

We offer custom-made gaskets for this profile

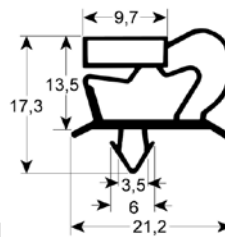

1

**GEV No.** 901619 **Ref. No.** 42403329900

**description** refrigeration gasket profile 9048 W 675mm L 1535mm plug size

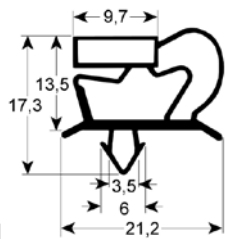

1

**GEV No.** 902258 **Ref. No.** N/A

**description** refrigeration gasket profile 9048 Wmm L 2500mm

profile 9703

We offer custom-made gaskets for this profile

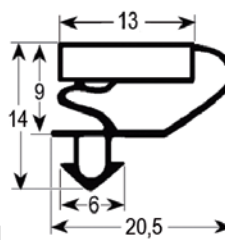

1

**GEV No.** 970884 **Ref. No.** 29013

**description** refrigeration gasket profile 9703 W 172mm L 426mm plug size



<b>GEV No.</b>	970819	<b>Ref. No.</b>	29011
<b>description</b>	refrigeration gasket profile 9703 W 281mm L 424mm plug size		

<b>GEV No.</b>	970885	<b>Ref. No.</b>	29014
<b>description</b>	refrigeration gasket profile 9703 W 390mm L 424mm plug size		

<b>GEV No.</b>	900933	<b>Ref. No.</b>	29012 30546
<b>description</b>	refrigeration gasket profile 9703 W 436mm L 616mm plug size L1 606mm W1 426mm external size		

<b>GEV No.</b>	901058	<b>Ref. No.</b>	424019211000
<b>description</b>	refrigeration gasket profile 9703 W 632mm L 1320mm plug size L1 1314mm W1 626mm external size		

<b>GEV No.</b>	901056	<b>Ref. No.</b>	N/A
<b>description</b>	refrigeration gasket profile 9703 W 685mm L 1560mm plug size		

<b>GEV No.</b>	901057	<b>Ref. No.</b>	29010
<b>description</b>	refrigeration gasket profile 9703 W 685mm L 756mm plug size		

<b>GEV No.</b>	901668	<b>Ref. No.</b>	424000017000
<b>description</b>	refrigeration gasket profile 9703 W 755mm L 910mm plug size		

profile 9704

We offer custom-made gaskets for this profile

<b>GEV No.</b>	901978	<b>Ref. No.</b>	29015
<b>description</b>	refrigeration gasket profile 9704 W 398mm L 278mm plug size equiv. no. 29015		

<b>GEV No.</b>	901680	<b>Ref. No.</b>	29017
<b>description</b>	refrigeration gasket profile 9704 W 525mm L 615mm plug size L1 606mm W1 516mm external size		

<b>GEV No.</b>	901976	<b>Ref. No.</b>	29009
<b>description</b>	refrigeration gasket profile 9704 W 689mm L 1565mm plug size L1 1555mm W1 675mm external size suitable for ISA		

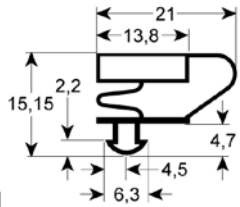

<b>GEV No.</b>	902299	<b>Ref. No.</b>	N/A
<b>description</b>	refrigeration gasket profile 9704 Wmm L 2500mm		

**profile 9753**

We offer custom-made gaskets for this profile

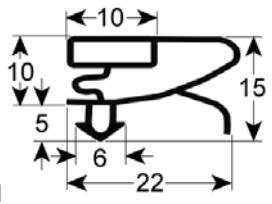

<b>GEV No.</b>	900875	<b>Ref. No.</b>	N/A
<b>description</b>	refrigeration gasket profile 9753 Wmm L 2500mm		

**profile 9333**

We offer custom-made gaskets for this profile

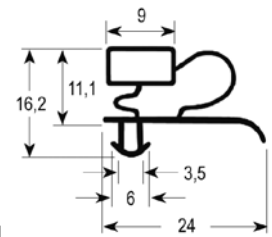

<b>GEV No.</b>	900992	<b>Ref. No.</b>	N/A
<b>description</b>	refrigeration gasket profile 9333 W 612mm L 1457mm plug size		

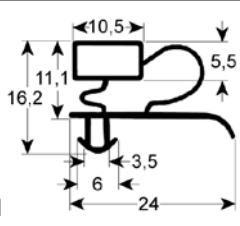

<b>GEV No.</b>	902167	<b>Ref. No.</b>	N/A
<b>description</b>	refrigeration gasket profile 9333 Wmm L 2500mm		

**profile 9012**

We offer custom-made gaskets for this profile

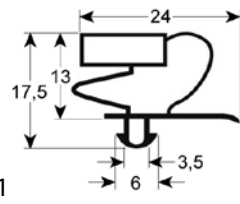

<b>GEV No.</b>	901620	<b>Ref. No.</b>	28047721
<b>description</b>	refrigeration gasket profile 9012 W 625mm L 1595mm plug size		

**screw-in gaskets**

**profile 9106**

We offer custom-made gaskets for this profile

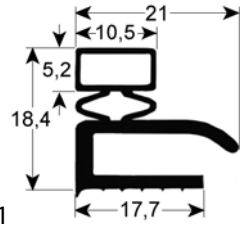

<b>GEV No.</b>	902262	<b>Ref. No.</b>	N/A
<b>description</b>	refrigeration gasket profile 9106 Wmm L 2500mm		

**O-rings**

**EPDM**

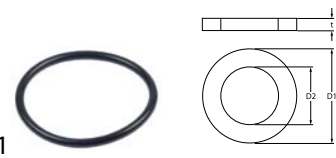

<b>GEV No.</b>	528632	<b>Ref. No.</b>	18025
<b>description</b>	O-ring EPDM thickness 3.53mm ID ø 44.04mm Qty 1 pcs		





## refrigeration cycle components

### valves

#### reversing valves



1

<b>GEV No.</b>	370791	<b>Ref. No.</b>	50600401200
<b>description</b>	reversing valve 4-way RANCO type V2-408060200 inlet 1/2" (12.84mm) outlet 3/8" (9.67mm) power range (R407C) 2.81-6.33 kW power range (R410A) 3.17-7.74 kW power range (R134A) 2.46-4.92 kW		
<b>accessories for</b>	370791		
	<b>GEV No.</b>	371302	<b>Ref. No.</b> 50504200500
	solenoid coil RANCO model LDK-41 230 50/60Hz 5/4W cable length 1200mm green		
	<b>GEV No.</b>	371306	<b>Ref. No.</b> —
	solenoid coil RANCO model LDK-41 208/240VAC 50/60Hz 5/4W cable length 2000mm		

#### spare parts and accessories



1

<b>GEV No.</b>	371302 <sup>1</sup>	<b>Ref. No.</b>	50504200500
<b>description</b>	solenoid coil RANCO model LDK-41 230 50/60Hz 5/4W cable length 1200mm green		

<sup>1</sup>incl. cable 1200mm

## evaporators

### for fridges

#### producer-specific



1

<b>GEV No.</b>	750590	<b>Ref. No.</b>	420081399000
<b>description</b>	evaporator L 345mm W 120mm D 280mm total length 390mm suitable for ISA-TASSELLI		



1

<b>GEV No.</b>	750544	<b>Ref. No.</b>	420181938000
<b>description</b>	evaporator L 390mm W 355mm H 100mm suitable for ISA		

## evaporation and condensing trays

### unheated condensing trays



1

<b>GEV No.</b>	750542	<b>Ref. No.</b>	442254412000
<b>description</b>	condensing tray L 400mm W 290mm H 88mm plastic		



1

<b>GEV No.</b>	750541	<b>Ref. No.</b>	442241872100
<b>description</b>	condensing tray L 475mm W 265mm H 90mm plastic		



**B**

bi-metal thermostats 3,3

**C**

cold air circulating fans (complete) 6

compressors 5

**E**

edgemount hinges 7

electronic controllers 3

evaporators 11

**F**

fans 6

**H**

heating cartridges 3

heating elements 3

**O**

O-rings 10

**P**

plug-in gaskets 8

probes 4

programme timers 3

**R**

refrigeration cycle components 11

refrigeration fans 6

refrigeration gaskets 8

relays 3

reversing valves 11

**S**

screw-in gaskets 10

snap locks 7

spring assisted hinges 8

**T**

temperature probes 4

thermostats 3

timers 3

**U**

universal probes 4