



GAS COMPONENTS



ELECTRIC COMPONENTS



WATER TECHNOLOGY



MECHANICAL COMPONENTS



TOOLS

Spare parts suitable for

INTIMPEX

Find the complete and up-to-date range of products in our GEV Webshop



Manufacturer catalogue

The most important spare parts and accessories arranged clearly for every manufacturer

- ✓ Complete product range and all appliance data always up to date in the GEV Webshop
- ✓ Alphabetical Index at the end of the catalogue

GEV Webshop

www.gev-online.co.uk

www.gev-online.com



- 🔍 Add to Favourites
- 🔍 Sign In with email address and usual password
- 🔍 Easy-order – place several items in your basket at the same time
- 🔍 Quick Item search – no login needed



thermostats

refrigeration thermostats

RANCO

K22 series

RANCO



1

GEV No.	390345	Ref. No.	1006
description	thermostat RANCO type K22L1034 probe ømm probe Lmm capillary pipe 2000mm T war -13.5°C T cold -20.5°C		

K36 series

RANCO



1

GEV No.	390342	Ref. No.	0901
description	thermostat RANCO type K36L7257 capillary pipe 450mm probe ø6.5x110mm		

K50 series

RANCO



1

GEV No.	390340	Ref. No.	1068
description	thermostat RANCO type K50L3209 probe ømm probe Lmm capillary pipe 2000mm		

RANCO



1

GEV No.	390341	Ref. No.	0876
description	thermostat RANCO type K50-L3251 capillary pipe 2000mm		

K61 series

RANCO



1

GEV No.	390344	Ref. No.	0950
description	thermostat RANCO type K61L1505 probe ømm probe Lmm capillary pipe 1500mm		

switches and momentary switches

rocker/momentary rocker switches

30x22mm



1

GEV No.	345356	Ref. No.	1050
description	momentary rocker switch mounting measurements 30x22mm white 1CO 250V 16A connection male faston 6.3mm ambient temperature max. 125/55°C protection IP40		

relays

power relays

with male contacts

bullet connectors, 8 contacts



1

GEV No.	380343	Ref. No.	1056
description	time relay CET 220VACA 1CO connection plug-in connection round 8-pole KF00		

relay sockets



1

GEV No.	380344	Ref. No.	1060
description	relay socket 8-pole		



1

GEV No.	380638	Ref. No.	1060
description	relay socket 8-pole dimensions 51x41x23mm 250V 10A FINDER manuf. no. 90.26		

solenoïd valves

solenoïd valves (refrigeration)

PARKER

valve bodies



1

GEV No.	370148	Ref. No.	3122
description	solenoid valve body NC PARKER type VE-115L p max 35bar DN 8mm -40 up to +105°C refrigeration		

various

valve bodies



1

GEV No.	370146	Ref. No.	2657
description	solenoid valve body angled DN 1.9mm refrigeration		



1

GEV No.	370147	Ref. No.	3059
description	solenoid valve body angled DN 2.5mm refrigeration		

pressure switches

for refrigeration

SAGI NO MIYA



1

GEV No.	541114	Ref. No.	3416
description	pressure control reset automatic refrigeration connection male faston 6.3mm switch-on pressure 10bar		

fans

refrigeration fans

refrigeration motors universal

accessories

fan wheels

aluminium



1

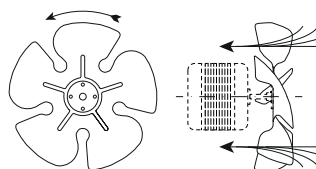

GEV No.	601387	Ref. No.	0527
description	fan wheel sucking ø 254mm fan wheel mounting 25.4mm blade angle 34° W 50mm aluminium		



motors

motors

for ice-cube maker

complete



Image not available

1

GEV No.	601141	Ref. No.	6029
description	motor type S280		

universal



1

GEV No.	601140	Ref. No.	6028
description	motor 180W 230V 50Hz 1 phase shaft ø 11mm 1400rpm type MDE63C4 ø 120mm H 170mm L 190mm fixing dimensions 80x100mm CARPANELLI 0.18kW		



Image not available

1

GEV No.	601141	Ref. No.	6029
description	motor type S280		

equipment-specific units

for ice-cube maker

drain systems

overflow pipes



1

GEV No.	695149	Ref. No.	2337
description	overflow pipe for ice maker tube ø 12mm pipe length 33.5mm		

gearboxes



1

GEV No.	601143	Ref. No.	2622
description	gearbox transmission I=60 type S150		



1

GEV No.	601144	Ref. No.	3190
description	gearbox transmission I=68 type S280		

spray systems

FAG/INTEMPEX

spray arms



Image not available

1

GEV No.	695124	Ref. No.	2490
description	spray arm for ice maker		



1

GEV No.	695120	Ref. No.	2278
----------------	--------	-----------------	------

description	spray arm L 270mm nozzles 4 for ice maker		
--------------------	---	--	--

spare parts for	695120		
------------------------	--------	--	--



GEV No.	695126	Ref. No.	0776
----------------	--------	-----------------	------

description	end cap for spray arm insertion size 13x13mm		
--------------------	--	--	--



1

GEV No.	695123	Ref. No.	2264
----------------	--------	-----------------	------

description	spray arm L 398mm nozzles 8 for ice maker		
--------------------	---	--	--



1

GEV No.	695121	Ref. No.	2265
----------------	--------	-----------------	------

description	spray arm L 316mm nozzles 6 for ice maker		
--------------------	---	--	--



1

GEV No.	695122	Ref. No.	2263
----------------	--------	-----------------	------

description	spray arm L 398mm nozzles 6 for ice maker		
--------------------	---	--	--

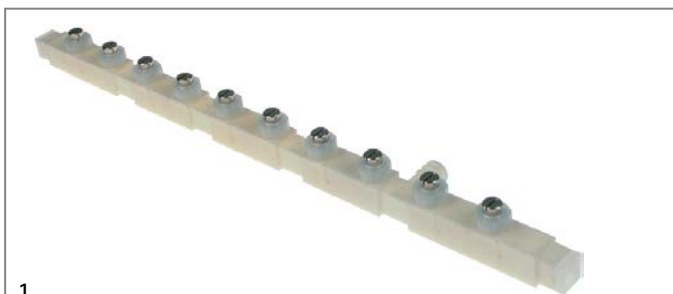

1

GEV No.	695412	Ref. No.	2285
----------------	--------	-----------------	------

description	spray arm L 467mm nozzles 10 for ice maker		
--------------------	--	--	--

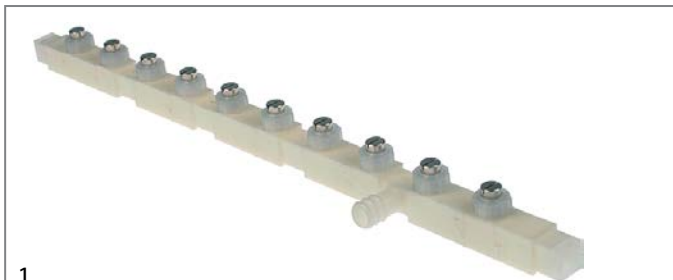

1

GEV No.	695413	Ref. No.	2286
----------------	--------	-----------------	------

description	spray arm L 467mm nozzles 10 for ice maker		
--------------------	--	--	--



1

GEV No.	695174	Ref. No.	4710
description	spray arm L 600mm nozzles 13 for ice maker		



1

GEV No.	695125	Ref. No.	2267
description	spray arm L 605mm nozzles 13 for ice maker		

accessories



1

GEV No.	695126	Ref. No.	0776
description	end cap for spray arm insertion size 13x13mm		



1

GEV No.	695127	Ref. No.	2495
description	spray nozzle for ice maker		



1

GEV No.	695128	Ref. No.	2452
description	union nut for nozzle		

doors



1

GEV No.	695157	Ref. No.	3569
description	flap for ice-cube maker		



1

GEV No.	695158	Ref. No.	3652
description	flap for ice-cube maker		



1

GEV No.	695160	Ref. No.	4246
description	flap for ice-cube maker		

curtains
with holder



1

GEV No.	695175	Ref. No.	2200
description	curtain for ice maker W 620mm H 165mm with holder shaft length 620mm shaft ø 6mm		



1

GEV No.	695611	Ref. No.	3314
----------------	--------	-----------------	------

description	curtain for ice-cube maker
--------------------	----------------------------

without holder



1

GEV No.	695151	Ref. No.	1370
----------------	--------	-----------------	------

description	curtain for ice maker W 230mm H 115mm shaft length 260mm shaft ø 6mm
--------------------	--



1

GEV No.	695152	Ref. No.	1371
----------------	--------	-----------------	------

description	curtain for ice maker W 275mm H 115mm shaft length 303mm shaft ø 6mm
--------------------	--



1

GEV No.	695153	Ref. No.	2026
----------------	--------	-----------------	------

description	curtain for ice maker W 355mm H 115mm shaft length 380mm shaft ø 6mm
--------------------	--

mechanics for evaporators

gear motors

motors



1

GEV No.	601140	Ref. No.	6028
----------------	--------	-----------------	------

description	motor 180W 230V 50Hz 1 phase shaft ø 11mm 1400rpm type MDE63C4 ø 120mm H 170mm L 190mm fixing dimensions 80x100mm CARPANELLI 0.18kW
--------------------	---

hoses

formed hoses

form S



1

GEV No.	695130	Ref. No.	2255
----------------	--------	-----------------	------

description	formed hose S-shape for ice-cube maker ID ø 14mm ED ø 20mm L 160mm W 100mm
--------------------	--



1

GEV No.	695134	Ref. No.	2262
----------------	--------	-----------------	------

description	formed hose S-shape insulated for ice-cube maker ID ø 14/19mm ED ø 19/24mm L 225mm W 45mm
--------------------	---



1

GEV No.	695161	Ref. No.	2269
----------------	--------	-----------------	------

description	supply hose for evaporator
--------------------	----------------------------



1

GEV No.	695162	Ref. No.	2470
----------------	--------	-----------------	------

description	supply hose for evaporator
--------------------	----------------------------

miscellaneous



1

GEV No.	695131	Ref. No.	2470
----------------	--------	-----------------	------

description	formed hose for ice-cube maker ID ø 15mm ED ø 18mm L 120mm W 80mm
--------------------	---

1

GEV No.	695132	Ref. No.	2475
description	formed hose for ice-cube maker ID ø 15mm ED ø 18mm L 150mm W 85mm		



1

GEV No.	695139	Ref. No.	2472
description	formed hose for ice-cube maker ID ø 15mm ED ø 19mm L 160mm W 100mm		



1

GEV No.	695141	Ref. No.	2253
description	formed hose for ice-cube maker ID ø 15mm ED ø 19mm L 350mm W 90mm		



1

GEV No.	695142	Ref. No.	3378
description	formed hose for ice-cube maker ID ø 16/20mm ED ø 20/23mm L 540mm W 75mm		

floats

float containers



1

GEV No.	695165	Ref. No.	4186
description	float container for ice-cube maker complete		



1

GEV No.	695166	Ref. No.	4187
description	float container for ice-cube maker complete		

for ice crusher

V-belts



1

GEV No.	695171	Ref. No.	2580
description	V-belt pulley single disc ø 100mm shaft intake ø 11mm groove depth 13mm disc width 16mm groove width 5mm overall width 26mm aluminium		



1

GEV No.	695172	Ref. No.	3023
description	V-belt pulley single disc ø 100mm shaft intake ø 16mm groove depth 13mm disc width 16mm groove width 5mm overall width 26mm aluminium		



1

GEV No.	695170	Ref. No.	3244
description	V-belt pulley single disc ø 60mm shaft intake ø 11mm groove depth 13mm disc width 16mm groove width 5mm overall width 26mm aluminium		



1

GEV No.	695173	Ref. No.	3245
description	V-belt pulley single disc ϕ 60mm shaft intake ϕ 14mm groove depth 13mm disc width 16mm groove width 5mm overall width 26mm aluminium shaft ϕ 14mm		

evaporators

for ice-cube maker

for ice cube maker



1

GEV No.	750180	Ref. No.	3084
description	evaporator for ice-cube maker 104 cubes L 600mm W 425mm H 45mm D110/CP120		

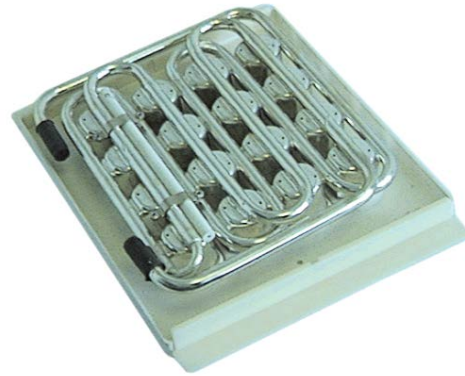

1

GEV No.	750134	Ref. No.	4143
description	evaporator for ice-cube maker 16 cubes L 275mm W 212mm H 45mm D22/CP22		



1

GEV No.	750135	Ref. No.	4263
description	evaporator for ice-cube maker 24 cubes L 314mm W 212mm H 45mm D27/CP30SC		





1

GEV No.	750136	Ref. No.	4263 CP30E
description	evaporator for ice-cube maker 24 cubes L 398mm W 213mm H 45mm D31/CP30		



			
1			
GEV No.	750139	Ref. No.	3009
description	evaporator for ice-cube maker 52 cubes L 600mm W 213mm H 45mm D71/CP70		

for flake ice maker			
 Image not available			
1			
GEV No.	750130	Ref. No.	4190
description	evaporator		

 Image not available			
1			
GEV No.	750132	Ref. No.	2680
description	evaporator complete		

			
1			
GEV No.	750131	Ref. No.	3254
description	evaporator for flake ice maker S80/ITS80 W 175mm H 320mm ø 98mm with auger complete		

			
1			
GEV No.	750133	Ref. No.	3255
description	evaporator for flake ice maker W 220mm H 420mm ø 105mm with auger complete		

transmission technology and ball bearings

drive belts

V-belts

profile A/13

			
1			
GEV No.	695164	Ref. No.	2659
description	V-belt belt width 13mm L 730mm H 8mm CODE A29 profile A/13		

E

evaporators 10

F

fans 4

M

motors 5

P

pressure switches 4

R

refrigeration fans 4

refrigeration motors universal 4

refrigeration thermostats 3

relays 3

rocker/momentary rocker switches 3

S

solenoid valves 4

switches and momentary switches 3

T

thermostats 3