



GAS COMPONENTS



ELECTRIC COMPONENTS



WATER TECHNOLOGY



MECHANICAL COMPONENTS



TOOLS

Spare parts suitable for

ILSA

Find the complete and up-to-date range of products in our GEV Webshop



Manufacturer catalogue

The most important spare parts and accessories arranged clearly for every manufacturer

- ✓ Complete product range and all appliance data always up to date in the GEV Webshop
- ✓ Alphabetical Index at the end of the catalogue

GEV Webshop

www.gev-online.co.uk

www.gev-online.com





- 🔍 Add to Favourites
- 🔍 Sign In with email address and usual password
- 🔍 Easy-order – place several items in your basket at the same time
- 🔍 Quick Item search – no login needed





heating elements

heating elements for pasta cookers

			
1			
GEV No.	416671	Ref. No.	R241061
description	heating element 1800W 230V heating circuits 1 L 315mm flange with thread thread 1½" ø 30mm flange ø 70mm flange width 60mm thermostat sleeves ø 6.5mm length thermostat sleeves 255mm cable length 1000mm number of thermostat sleeves 1 pasta cooker thermostat sleeve eccentric, non clinging immersion heater		

			
1			
GEV No.	416670	Ref. No.	R241050
description	heating element 1800W 230V heating circuits 1 L 315mm Wmm Hmm flange with thread thread 1" ø 30mm flange ø 50mm flange width 45mm cable length 1000mm immersion heater		

			
1			
GEV No.	416686	Ref. No.	R210061
description	heating element 2500W 230V heating circuits 1 L 490mm flange with thread thread 1½" ø 30mm flange ø 70mm flange width 60mm thermostat sleeves ø 6.5mm length thermostat sleeves 255mm cable length 1000mm number of thermostat sleeves 1 pasta cooker immersion heater		

			
1			
GEV No.	416685	Ref. No.	R210050
description	heating element 2500W 230V heating circuits 1 L 490mm Wmm Hmm thread 1" ø 30mm flange ø 50mm flange width 45mm cable length 1000mm pasta cooker immersion heater		

heating cables

connection on both sides

with wire end ferrules

			
1			
GEV No.	420385	Ref. No.	29789
description	heating cable 23W 220V L 4500mm for blast chiller		

			
1			
GEV No.	420388	Ref. No.	27417 R_27417
description	heating cable 26W 230V L 6000mm for blast chiller		

			
1			
GEV No.	420386	Ref. No.	27957
description	heating cable 32W 220V L 4450mm for blast chiller		

			
1			
GEV No.	420387	Ref. No.	27956
description	heating cable 37W 220V L 4900mm for blast chiller		

heating cartridges

			
1			
GEV No.	416671	Ref. No.	R241061
description	heating element 1800W 230V heating circuits 1 L 315mm flange with thread thread 1½" ø 30mm flange ø 70mm flange width 60mm thermostat sleeves ø 6.5mm length thermostat sleeves 255mm cable length 1000mm number of thermostat sleeves 1 pasta cooker thermostat sleeve eccentric, non clinging immersion heater		

			
1			
GEV No.	416670	Ref. No.	R241050
description	heating element 1800W 230V heating circuits 1 L 315mm Wmm Hmm flange with thread thread 1" ø 30mm flange ø 50mm flange width 45mm cable length 1000mm immersion heater		

			
1			
GEV No.	416686	Ref. No.	R210061
description	heating element 2500W 230V heating circuits 1 L 490mm flange with thread thread 1½" ø 30mm flange ø 70mm flange width 60mm thermostat sleeves ø 6.5mm length thermostat sleeves 255mm cable length 1000mm number of thermostat sleeves 1 pasta cooker immersion heater		

			
1			
GEV No.	416685	Ref. No.	R210050
description	heating element 2500W 230V heating circuits 1 L 490mm Wmm Hmm thread 1" ø 30mm flange ø 50mm flange width 45mm cable length 1000mm pasta cooker immersion heater		

accessories

sealing washers

O-rings

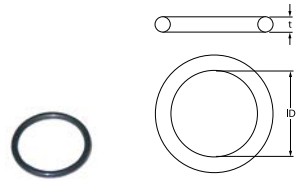
			
1			
GEV No.	510072	Ref. No.	ID0087
description	O-ring EPDM thickness 3.53mm ID ø 32.93mm Qty 1 pcs		

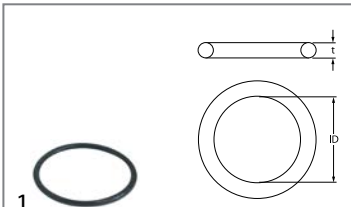
GEV No.	532545	Ref. No.	ID0088
description	O-ring Viton thickness 3.53mm ID ø 49.21mm Qty 1 pcs		

flange gaskets



GEV No.	520324	Ref. No.	EL0058
description	counterflange ID ø 160mm ED ø 200mm hole distance 90/180mm hole ø 7mm SS for bottom heaters		
accessories for	520324		
	GEV No.	520323	Ref. No.
			—
	gasket ID ø 160mm ED ø 200mm hole distance 90/180mm hole ø 7mm silicone for bottom heaters		

counterflanges



GEV No.	520324	Ref. No.	EL0058
description	counterflange ID ø 160mm ED ø 200mm hole distance 90/180mm hole ø 7mm SS for bottom heaters		
accessories for	520324		
	GEV No.	520323	Ref. No.
			—
	gasket ID ø 160mm ED ø 200mm hole distance 90/180mm hole ø 7mm silicone for bottom heaters		

energy regulators

EGO

1-circuit



GEV No.	380015	Ref. No.	61137
description	energy regulator 230V 13A single-circuit turn direction right shaft ø 6x4.6mm shaft L 23mm mounting thread M4 power release 6-100% no. 50.57021.010		

thermostats

bi-metal thermostats

bi-metal thermostats



GEV No.	390772	Ref. No.	29587
description	bi-metal thermostat hole distance 23.8mm switch-off temp. 110°C 1NC 1-pole 16A 230V connection F6.3		

control and safety thermostats

EGO

control thermostats

55.10/19_ series



GEV No.	375237	Ref. No.	60775
description	thermostat t.max. 190°C temperature range 100-190°C 1-pole 1NO 16A probe ø 6mm probe L 130mm capillary pipe 1800mm capillary pipe isolated 1200mm gland nut M9x1 shaft L 23mm shaft position upper rotation 270°		



GEV No.	375979	Ref. No.	31482
description	thermostat t.max. 70°C temperature range 30-70°C 1-pole 1NO 16A probe ø 6mm probe L 129mm capillary pipe 900mm capillary pipe isolated 900mm gland nut shaft ø 6x4.6mm shaft L 23mm shaft position upper rotation 270°		



E-G-O



GEV No.	390040	Ref. No.	60780
description	thermostat t.max. 90°C temperature range 30-90°C 1-pole 1CO 16A probe ø 6mm probe L 130mm capillary pipe 2040mm capillary pipe isolated 1940mm gland nut shaft ø 6x4.6mm shaft L 23mm shaft position upper rotation 270° probe material SS		

55.13_ series

E-G-O



GEV No.	375492	Ref. No.	31229
description	thermostat t.max. 190°C temperature range 94-190°C 1-pole 1NO 16A probe ø 6mm probe L 94mm capillary pipe 1090mm capillary pipe isolated 960mm gland nut M10x1 shaft ø 6x4.6mm shaft L 23mm shaft position upper rotation 310° probe material SS		

55.34_ series

E-G-O





GEV No.	375362	Ref. No.	843735
description	thermostat t.max. 320°C temperature range 55-320°C 3-pole 3NO 10A probe ø 4mm probe L 128mm capillary pipe 900mm capillary pipe isolatedmm gland nut shaft ø 6x4.6mm shaft L 23mm shaft position upper rotation 270°		

safety thermostats

55.10/19_ series

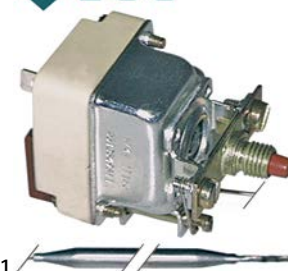
E-G-O



GEV No.	375250	Ref. No.	34440
description	safety thermostat capillary pipe 870mm probe ø 6mm 1-pole probe L 129mm 16A capillary pipe isolatedmm gland nut switch-off temp. 130°C probe SS		
spare parts for	375250		
	GEV No.	551083	Ref. No. —
	cap for safety thermostat thread M8x1		

E-G-O



GEV No.	390062	Ref. No.	60986 821167 R_60986
description	safety thermostat switch-off temp. 235°C 1-pole 0.5A probe ø 6mm probe L 130mm capillary pipe 1800mm capillary pipe isolated 1500mm gland nut M9x1 probe SS		
accessories for	390062		
	GEV No.	551083	Ref. No. —
	cap for safety thermostat thread M8x1		

E-G-O







GEV No.	375378	Ref. No.	60761
description	safety thermostat switch-off temp. 350°C 1-pole 16A probe ø 6mm probe L 74mm capillary pipe 900mm capillary pipe isolatedmm gland nut probe SS		
accessories for	375378		
	GEV No.	102067	Ref. No. —
	nut thread M8x1 H 3mm brass Qty 1 pcs type SEF 1		

Table continues overleaf





accessories for	375378			
	GEV No.	102500	Ref. No.	—
	nut thread M8x1 Qty 10 pcs			

55.31_series			
			
			
			
GEV No.	375104	Ref. No.	5531542120
description	safety thermostat switch-off temp. 230°C 3-pole 20A probe ø 6mm probe L 167mm capillary pipe 830mm capillary pipe isolated 600mm gland nut M10x1 probe		

55.32_series			
			
			
			
GEV No.	376090	Ref. No.	210044 62249
description	safety thermostat switch-off temp. 160°C 3-pole 20A probe ø 6mm probe L 87mm capillary pipe 1490mm capillary pipe isolated 580mm gland nut starting temperature 160°C probe		

			
			
			
GEV No.	375375	Ref. No.	31230
description	safety thermostat switch-off temp. 230°C 3-pole 20A probe ø 6mm probe L 94mm capillary pipe 900mm capillary pipe isolated 670mm gland nut M10x1 probe SS		

			
			
			
GEV No.	375393	Ref. No.	60776
description	safety thermostat switch-off temp. 235°C 3-pole 1CO/2NC 20A probe ø 6mm probe L 87mm capillary pipe 1790mm capillary pipe isolated 1710mm gland nut M9x1 probe SS		

			
			
			
GEV No.	375228	Ref. No.	843737
description	safety thermostat switch-off temp. 350°C 3-pole 20A probe ø 3mm probe L 188mm capillary pipe 900mm capillary pipe isolated 900mm gland nut probe SS		

accessories



connecting bows

			
GEV No.	550060	Ref. No.	60340
description	connecting bow long for thermostat Qty 1 pcs		

switches and momentary switches



rocker/momentary rocker switches

25.5x25mm

				
GEV No.	347624 ¹	Ref. No.	00263	
description	rocker switch mounting measurements 25x25mm green 2NO 250V 16A illuminated connection male faston 6.3mm ambient temperature max. 85°C protection IP40			
accessories for	347624			
	GEV No.	301323	Ref. No.	—
	protective cover external size 35x35mm H 11mm transparent suitable for rocker switch mounting measurements 25.5x25mm L 35mm W 35mm			

¹illuminated





30x22mm							
 <p>1</p>							
GEV No.	301003	Ref. No.	01382 EL0006				
description	rocker switch mounting measurements 30x22mm green 2NO 250V 16A illuminated 0-I connection male faston 6.3mm ambient temperature max. 125/55°C protection IP65						
accessories for	301003						
 <table border="1"> <tr> <td>GEV No.</td> <td>301036</td> <td>Ref. No.</td> <td>—</td> </tr> </table> <p>protective cover internal size 30x22mm for rocker switch mounting measurementsmm</p>				GEV No.	301036	Ref. No.	—
GEV No.	301036	Ref. No.	—				

ø25mm			
 <p>1</p>			
GEV No.	347623	Ref. No.	32760
description	push switch mounting ø 25mm blue 2NO 250V 16A illuminated connection male faston 6.3mm ambient temperature max. 85°C protection IP40		

 <p>1</p>			
GEV No.	345161 ¹	Ref. No.	29583 30656
description	push switch mounting ø 25mm green 2NO 250V 16A illuminated connection male faston 6.3mm ambient temperature max. 85°C protection IP40		

push/momentary push switches

19x13mm			
 <p>1</p>			
GEV No.	347627	Ref. No.	61286 62240
description	momentary push switch mounting measurements 19x13mm black 2NO 250V 16A connection male faston 6.3mm ambient temperature max. 85°C protection IP65 with cover cap		

30x22mm			
 <p>1</p>			
GEV No.	301146	Ref. No.	27783
description	momentary push switch mounting measurements 30x22mm red 2NO 250V 16A illuminated connection male faston 6.3mm ambient temperature max. 125/55°C protection IP40		

 <p>1</p>			
GEV No.	301082	Ref. No.	18686 18869
description	push switch mounting measurements 30x22mm green 2NO 250V 12A connection male faston 6.3mm ambient temperature max. 85/55°C protection IP54 with protective collar		

 <p>1</p>			
GEV No.	301083	Ref. No.	18687 18870
description	push switch mounting measurements 30x22mm orange 2NO 250V 12A connection male faston 6.3mm ambient temperature max. 85/55°C protection IP54 with protective collar		

¹illuminated

cam switches

7-position							
 <p>1</p>							
GEV No.	300025	Ref. No.	843751				
description	cam switch 7 operating positions 1NO/2CO sequence 0-1-2-3-4-5-6 16A shaft ø 6x4.6mm shaft L 23mm connection screw 7-position ceramic						
accessories for	300025						
 <table border="1"> <tr> <td>GEV No.</td> <td>112172</td> <td>Ref. No.</td> <td>—</td> </tr> </table> <p>knob universal ø 70mm black without adaptor/dial plate</p>				GEV No.	112172	Ref. No.	—
GEV No.	112172	Ref. No.	—				
 <table border="1"> <tr> <td>GEV No.</td> <td>112213</td> <td>Ref. No.</td> <td>—</td> </tr> </table> <p>knob dial plate silver switch 7-position t.max.°C ED ø 63mm ID ø 45.5mm</p>				GEV No.	112213	Ref. No.	—
GEV No.	112213	Ref. No.	—				
 <table border="1"> <tr> <td>GEV No.</td> <td>112311</td> <td>Ref. No.</td> <td>—</td> </tr> </table> <p>knob adapter shaft ø 6x4.6mm L 0mm with spring</p>				GEV No.	112311	Ref. No.	—
GEV No.	112311	Ref. No.	—				



4 operating positions



1			
GEV No.	300210	Ref. No.	60773
description	cam switch 4 operating positions 4NO sequence 0-1-2-3 16A shaft \varnothing 6x4.6mm shaft L 23mm connection screw ceramic		
accessories for	300210		
	GEV No.	Ref. No.	
	551456	—	
	gasket for switch ED \varnothing 14mm ID \varnothing 2.5mm thickness 3.5mm white		



1			
GEV No.	300200	Ref. No.	60898
description	operation switch 2 operating positions 2NO 16A sequence 0-1 shaft \varnothing 6x4.6mm shaft L 23mm connection male faston 6.3mm operation switch ceramic		

rotary switches

TECNOMATIC



1			
GEV No.	346102	Ref. No.	R_C8162-00-IN
description	rotary switch 6 2-1-0-3-4-5 sets of contacts 10 type HD12X303R000 600V 12A shaft \varnothing 6mm shaft L 22mm shaft round connection male faston 6.3mm		



1			
GEV No.	300364	Ref. No.	60897
description	cam switch 4 operating positions sequence 0-1-2-3 16A shaft \varnothing 6x4.6mm shaft L 23mm		

magnetic switches

65x20mm

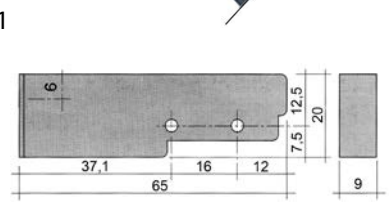
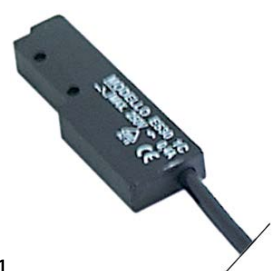

1			
GEV No.	345116	Ref. No.	18762
description	magnetic switch L 65mm W 20mm 1NO 250V 0.4A P max. 100W connection cable cable length 3000mm		
accessories for	345116		
	GEV No.	Ref. No.	
	345399	—	
	magnet \varnothing 3.3mm L 40mm H 8mm W 13mm hole distance 30mm M3		

operation switches



1			
GEV No.	300080	Ref. No.	60777
description	cam switch 2 operating positions 4NO 16A sequence 0-1 shaft \varnothing 6x4.6mm shaft L 23mm connection screw operation switch ceramic ambient temperature max. 150°C		
accessories for	300080		
	GEV No.	Ref. No.	
	551456	—	
	gasket for switch ED \varnothing 14mm ID \varnothing 2.5mm thickness 3.5mm white		



encoders and potentiometers

			
1			
GEV No.	402175	Ref. No.	26507
description	potentiometer 100KOhm shaft ø 6x4.6mm thread M10x0.75 cable length 800mm		

lamps

indicator lights

indicator lights 2-piece (lens and indicator lamp)

indicator light lenses



ø 6mm (type SQ-20)

			
1			
GEV No.	359803	Ref. No.	18871
description	indicator light lens green Qty 1 pcs ø 6mm		

			
1			
GEV No.	359805	Ref. No.	18872
description	indicator light lens red Qty 1 pcs ø 6mm		



ø10mm (type SRZ-3)

			
1			
GEV No.	359228	Ref. No.	60144 EL0030
description	indicator light housings mounting measurements ø10mm clear round Qty 1 pcs		

			
1			
GEV No.	359123	Ref. No.	60119 EL0028 R60119
description	indicator light housings mounting measurements ø10mm green round Qty 1 pcs		
accessories for	359123		
	GEV No.	359132	Ref. No.
			—
	 indicator lamp green 250V connection male faston 6.3mm protection IP54 ambient temperature max. 85°C		

			
1			
GEV No.	359125	Ref. No.	60120 EL0027 R60120
description	indicator light housings mounting measurements ø10mm red round Qty 1 pcs		

indicator lamps for socket type SRZ / SDK / SDY / SFK

			
1			
GEV No.	359430	Ref. No.	61307 EL0007 R61307
description	indicator lamp 230V clear connection cable 400mm		
accessories for	359430		
	GEV No.	359260	Ref. No.
			—
	 indicator light housings mounting measurements ø12mm yellow round Qty 1 pcs		

			
1			
GEV No.	359431	Ref. No.	60145 R60145
description	indicator lamp 230V green connection cable 400mm cable material silicone		

indicator lights (complete)

26.5x25.6mm

			
1			
GEV No.	357097	Ref. No.	00264
description	indicator light mounting measurements 27.8x25mm yellow 250V connection male faston 6.3mm		

fluorescent lamps

fluorescent lamps

G13

			
1			
GEV No.	359386	Ref. No.	18659
description	fluorescent lamp socket G13 L 1198mm 36W 230V Qty 1 pcs		



accessories

ballasts



1

GEV No.	401440	Ref. No.	18664
description	electrical ballast 15W 230V for fluorescent lamps		



1

GEV No.	401505	Ref. No.	18665
description	electrical ballast 36W 230V Qty 1 pcs		



1

GEV No.	401448	Ref. No.	27665
description	electrical ballast 8W for fluorescent lamps		

timers

electric timers



1

GEV No.	362006	Ref. No.	537019301-LO
description	timer ITS operation time 120min 2NO at 250V 16A permanent position no shaft ø 6x4.6mm shaft L 24mm mounting distance 25mm mounting thread M4 connection 6.3x0.8 ambient temperature max. 125°C		

contactors

ALLEN BRADLEY

power contactors



1

GEV No.	380458	Ref. No.	60028
description	power contactor resistive load 20A 230VAC (AC3/400V) 9A/4kW main contacts 3NO auxiliary contacts 1NO connection screw connection type 100-K09KF10		



1

GEV No.	381121	Ref. No.	31280
description	power contactor resistive load 32A 230VAC (AC3/400V) 16A/7.5kW main contacts 3NO auxiliary contacts 1NO connection screw connection type 100-C16KF10		

OMRON

power contactors



1

GEV No.	381227	Ref. No.	63655 R_63655
description	power contactor resistive load 25A 240VAC (AC3/400V) 14A/5.5kW main contacts 3NO auxiliary contacts 1NO connection screw connection type J7KN-14D-10		

relays

power relays

with bracket mounting



1

GEV No.	380139	Ref. No.	26510
description	power relays FINDER 230VAC 16A 2CO connection F6.3 bracket mounting dimensions 68x38.2x35.8mm manuf. no. 62.82.8.230.0000		



electronic controllers

CAREL

refrigeration controllers

built-in version



1				
GEV No.	378283	Ref. No.	28320 31384 34986 R_34986	
description	electronic controller CAREL PYIL1U05B9 mounting measurements 71x29mm built-in depth 74mm 230V voltage AC NTC relay outputs 3 NO-10A(10) CO-12A(2) NO-8A(4) NTC NTC DI yes protection IP54 -50 up to +90°C display 3 digits			
spare parts for	378283			
	GEV No.	379160	Ref. No.	20286
	description	temperature probe NTC 10kOhm cable thermoplastic probe -40 up to +110°C cable -40 up to +110°C probe ø6x14mm cable length 1.5m without screw connection 2-wire		
	GEV No.	379161	Ref. No.	29657
	description	temperature probe NTC 10kOhm cable thermoplastic probe -40 up to +110°C cable -40 up to +110°C probe ø6x14mm cable length 3m without screw connection 2-wire		
	GEV No.	379343	Ref. No.	—
	description	temperature probe NTC 10kOhm cable silicone probe -40 up to +110°C cable -50 up to +180°C probe ø6x40mm cable length 3m 2-wire		
	GEV No.	379458	Ref. No.	—
	description	temperature probe NTC 10kOhm cable silicone probe -40 up to +110°C cable -50 up to +180°C probe ø6x40mm cable length 1.5m without screw connection 2-wire		

probes

universal probes

temperature probes

1				
GEV No.	379160	Ref. No.	20286	
description	temperature probe NTC 10kOhm cable thermoplastic probe -40 up to +110°C cable -40 up to +110°C probe ø6x14mm cable length 1.5m without screw connection 2-wire			
1				
GEV No.	379161	Ref. No.	29657	
description	temperature probe NTC 10kOhm cable thermoplastic probe -40 up to +110°C cable -40 up to +110°C probe ø6x14mm cable length 3m without screw connection 2-wire			

1				
GEV No.	379142	Ref. No.	29799	
description	temperature probe PTC 1kOhm cable PVC probe -50 up to +150°C cable -10 up to 100°C probe ø6x30mm cable length 1.5m without screw connection 2-wire			

1				
GEV No.	379053	Ref. No.	01074 01889 27474	
description	temperature probe PTC 1kOhm cable PVC probe -50 up to +150°C cable -10 up to 100°C probe ø6x30mm cable length 3m without screw connection 2-wire			

core probes

1				
GEV No.	379549	Ref. No.	31155	
description	core temperature probe PTC 1kOhm cable PVC probe -50 up to +150°C cable -10 up to 100°C probe ø6x110mm cable length 3.5m handle ø 8mm handle length 120x35mm 2-wire L1 120mm L2 130mm			

producer-specific probes

probes

1				
GEV No.	378289	Ref. No.	26508	
description	temperature probe NTC 10kOhm cable PVC probe -40 up to +110°C cable -10 up to 100°C connection 2-wire thread probe ø5x20mm cable length 2m			

core probes

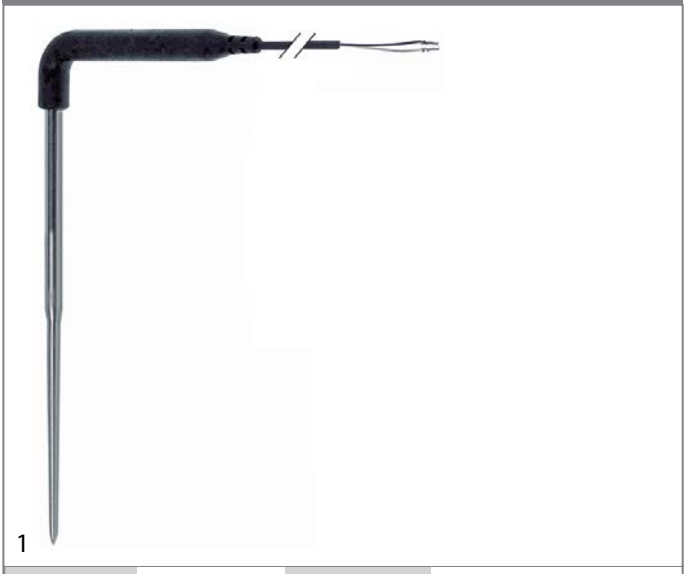

GEV No.	379549	Ref. No.	31155
description	core temperature probe PTC 1kOhm cable PVC probe -50 up to +150°C cable -10 up to 100°C probe ø6x110mm cable length 3.5m handle ø 8mm handle length 120x35mm 2-wire L1 120mm L2 130mm		

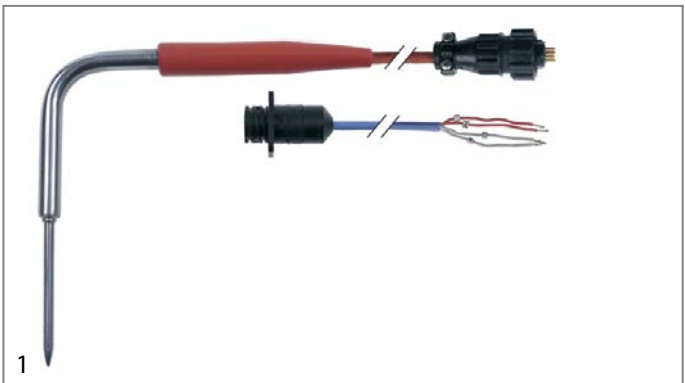

GEV No.	379547	Ref. No.	30600
description	core temperature probe PTC 1kOhm cable silicone probe -40 up to +120°C cable -50 up to +180°C connection 4-wire probe ø5x70mm thread cable length 1.2m handle ø 10mm handle length 120mm L1 150mm L2 80mm		



GEV No.	378287	Ref. No.	27395
description	core temperature probe PTC 1kOhm cable silicone probe -40 up to +120°C cable -50 up to +180°C connection plug probe ø5x100mm cable length 0.7m L1 70mm L2 120mm		

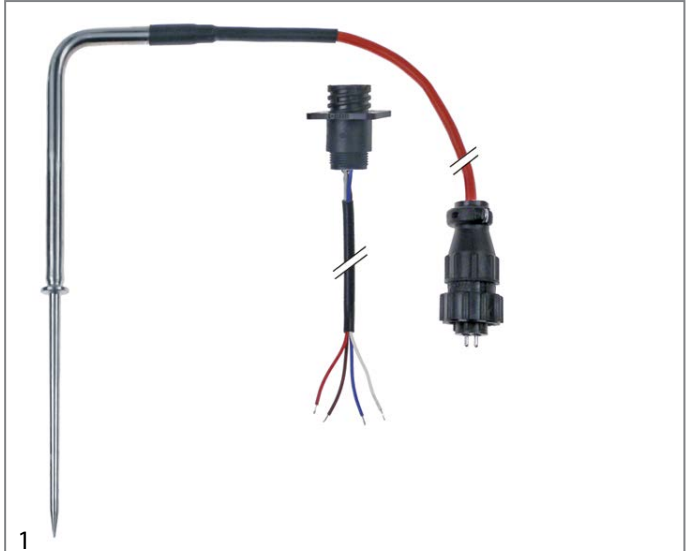

GEV No.	378288	Ref. No.	28623
description	core temperature probe PTC 1kOhm cable silicone probe -40 up to +120°C cable -50 up to +180°C connection plug probe ø5x100mm thread cable length 1.2m handle ø 8mm handle length 120/40mm		

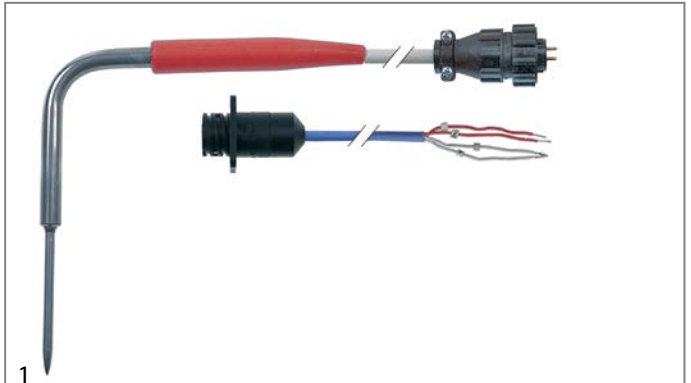

GEV No.	379548	Ref. No.	30599
description	core temperature probe PTC 1kOhm cable silicone probe -50 up to +150°C cable -50 up to +180°C connection 4-wire probe ø5x70mm thread cable length 1.2m handle ø 10mm handle length 120mm L1 150mm L2 80mm		

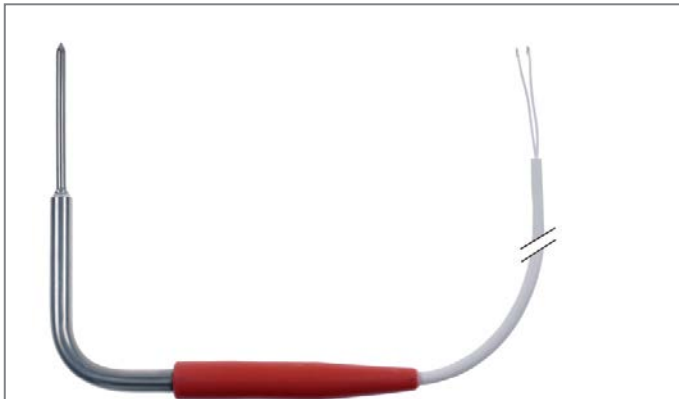

1

GEV No.	379791	Ref. No.	31928
description	core temperature probe PTC cable silicone probe -40 up to +120°C cable -50 up to +180°C connection 2-wire probe ø4.5x70mm thread cable length 3m handle ø 16mm handle length 120mm L1 157mm L2 87mm		

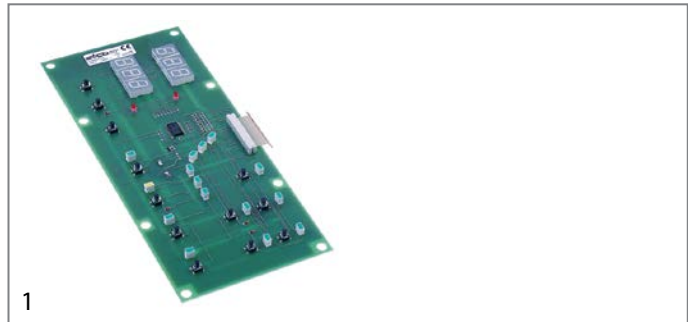

1

GEV No.	401779	Ref. No.	28203 R_28203
description	keypad PCB L 252mm W 112mm horizontal		
accessories for	401779		
	GEV No.	401782	Ref. No. 28706
description	keypad foil horizontal L 250mm W 110mm		

electronics

PCBs



1

GEV No.	401780	Ref. No.	28707 31410
description	keypad PCB blast chiller L 160mm W 85mm suitable for ILSA vertical		
accessories for	401780		
	GEV No.	401781	Ref. No. 27776
description	keypad foil vertical L 138mm W 68mm		

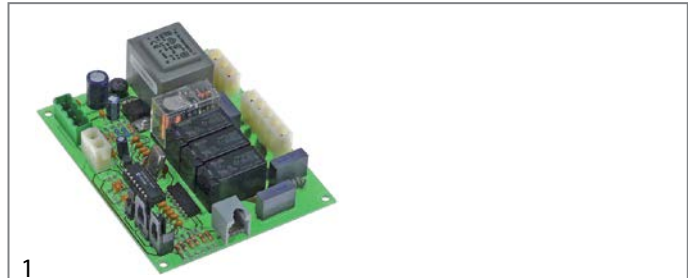

1

GEV No.	401873	Ref. No.	26478
description	PCB		

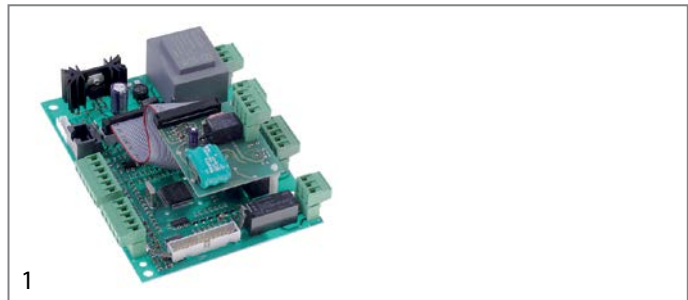

1

GEV No.	401778	Ref. No.	28202 31412
description	power PCB		

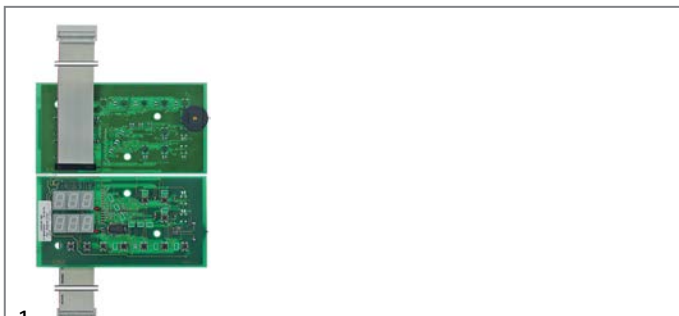

1

GEV No.	403885	Ref. No.	31411
description	keypad PCB L 252mm W 112mm		

keypads

front foils



1

GEV No.	694386	Ref. No.	32957 R_37221
description	front foil frame black L 227mm W 60mm		



1

GEV No.	401782	Ref. No.	28706
description	keypad foil horizontal L 250mm W 110mm		



1

GEV No.	401781	Ref. No.	27776
description	keypad foil vertical L 138mm W 68mm		

solenoid valves

solenoid valves (water)

RPE



1

GEV No.	370123	Ref. No.	34130
description	solenoid valve single straight 230VAC inlet 1/2" outlet 1/2" DN10		

solenoid valves with reducers

single



1

GEV No.	374042	Ref. No.	34129
description	solenoid valve single straight 230VAC inlet 3/4" outlet 1/4" input 10-12l/min output 0.7-1l/min 10 RPE flow regulating valve outlet light green flow regulating valve inlet white		

solenoid valves (refrigeration)

CASTEL

valves



1

GEV No.	370403	Ref. No.	18024
description	solenoid valve NC CASTEL 230V p max 45bar connection 10mm soldering connection -35 up to +105°C refrigeration		

valve bodies





STANDARD series

suitable for refrigerants R22, R134a, R404A, R407C, R410A, R507



1



GEV No.	370151	Ref. No.	00713
description	solenoid valve body NC type 1028/2 S p max 45bar connection 1/4" soldering connection DN 2.2mm -35 up to +105°C L 125mm refrigeration straight CASTEL		

accessories for	370151			
	GEV No.	371084	Ref. No.	—
	solenoid coil CASTEL 230VAC 8VA 50/60Hz connection cable 1000mm type CM2			
	GEV No.	371090	Ref. No.	—
	power socket plug type DIN 43650A screw			
	GEV No.	371301	Ref. No.	—
	solenoid coil CASTEL 110VAC 8VA 50/60Hz seat ø 11.5mm connection DIN 43650A type HF2			
	GEV No.	371314	Ref. No.	—
	solenoid coil CASTEL 240VAC 8VA 50/60Hz seat ø 11.5mm			
	GEV No.	371321	Ref. No.	—
	solenoid coil CASTEL 12/24VAC 50/60Hz seat ø 11.5mm connection DIN 43650A type HF2			



spare parts and accessories



1			
GEV No.	371041	Ref. No.	32348
description	solenoid coil CASTEL 240VAC 8VA 50/60Hz seat ø 11.5mm connection DIN 43650A type HM2		
accessories for	371041		
	GEV No.	371090	Ref. No.
			—
	power socket plug type DIN 43650A screw		
	GEV No.	371092	Ref. No.
			—
	power socket plug type DIN large cable length 1000mm		

compressors

ACC/ZEL

R134A

HMBP monophase

High/Medium evaporation temperature above -20/-15 °C



1			
GEV No.	605007	Ref. No.	26056
description	compressor coolant R134a type GL60TB 220-240V 50Hz HMBP fully hermetic 9.5kg 1/5HP power input 437W cylinder capacity 5.7cm ³ CSIR H 175.5mm 95W 128W 170W 222W 284W 355W 437W 528W test method ASHRAE ambient temperature max. 43°C		

R404a/R507

LBP monophase

Lower evaporation temperature below -20°C



1			
GEV No.	605127	Ref. No.	32712
description	compressor coolant R404a/R507 type MX18FB 220-240V 50Hz LBP 17.3kg 5/8HP cylinder capacity 18.4cm ³ CSR H 230mm 575W 750W 985W 1219W 1498W test method ASHRAE ambient temperature max. 43°C		

HMBP monophase

High/Medium evaporation temperature above -20/-15 °C



1			
GEV No.	605014	Ref. No.	30014
description	compressor coolant R404a/R507 type ML80TB 220-240V 50Hz HMBP fully hermetic 11.4kg 3/8HP cylinder capacity 7.57cm ³ CSIR H 175.5mmW 261W 346W 446W 561W 691W 835W 993W 1167W test method ASHRAE ambient temperature max. 43°C		

CUBIGEL

R404a/R507

LBP monophase

Lower evaporation temperature below -20°C



1			
GEV No.	605180	Ref. No.	32714
description	compressor coolant R404a/R507 type MX23FB 220-240V 50Hz LBP 17.5kg 1HP power input 7/8W cylinder capacity 23.2cm ³ CSR H 221mm 749W 982W 1246W 1541W 1868W test method ASHRAE ambient temperature max. 43°C		

HMBP monophase

High/Medium evaporation temperature above -20/-15 °C



GEV No.	605013	Ref. No.	28931
description	compressor coolant R404a/R507 type ML60TB 220-240V 50Hz HMBP fully hermetic 10.1kg 1/4HP power input 647W cylinder capacity 5.68cm ³ CSIR H 175.5mmW 244W 319W 407W 511W 628W 760W 906W 1067W test method ASHRAE		

EMBRACO / ASPERA

R404a/R507

LBP monophase

Lower evaporation temperature below -20°C



GEV No.	605078	Ref. No.	27403
description	compressor coolant R404a/R507 type NT2180GK 220-240V 50Hz LBP fully hermetic 17.3kg 1HP cylinder capacity 20.44cm ³ CSIR H 221mm 515W 598W 682W 769W 859W 956W test method ASHRAE		

fans

refrigeration fans

refrigeration motors universal

ebm-papst

multi fit fan motors





GEV No.	601758	Ref. No.	28674
description	fan motor 16W 230V 50/60Hz L1 43.5mm L3 87mm W 72mm cable length 1500mm 1300/1550rpm ebm-papst M4Q045-CF01-75 5 mounting options bearing slide bearing		
spare parts for	601758		
	GEV No.	601413	Ref. No. —
	fixing plate suitable for fanwheel ED ø 32mm shaft ø 7 mounting distance 26mm		

cold air circulating fans (complete)

ebm-papst

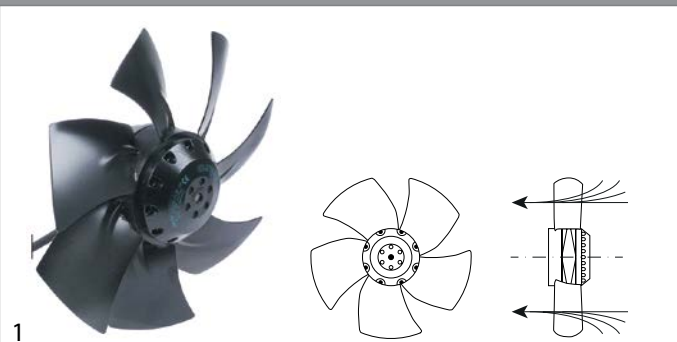
A2E series



GEV No.	601750	Ref. No.	27574 31316
description	fan A2E250-AL06-09 fan wheel ø 250mm blades 7 230V 50/60Hz 120/160W 2500rpm cable length 200mm ebm-papst sucking suitable capacitor 3µF		
accessories for	601750		
	GEV No.	365137	Ref. No. —
	capacitor capacity 3µF 450V tolerance 5% 50/60Hz ambient temperature max. -25 to +85°C ø 25mm L 56mm M8 plastic connection cable 250mm 416.17.77GF protection		



A4E series

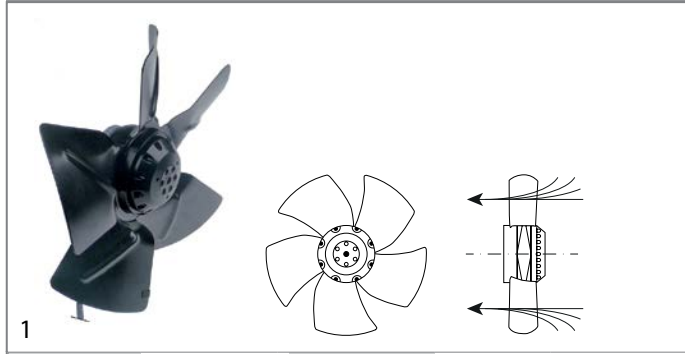

GEV No.	601623	Ref. No.	30221 30311 31311
description	fan A4E315-AC08-19 fan wheel ø 315mm blades 5 230V 50Hz 95W 1370rpm cable length 450mm ebm-papst sucking suitable capacitor 3µF		
accessories for	601623		
	GEV No.	365137	Ref. No. —
	capacitor capacity 3µF 450V tolerance 5% 50/60Hz ambient temperature max. -25 to +85°C ø 25mm L 56mm M8 plastic connection cable 250mm 416.17.77GF protection		

R2E series

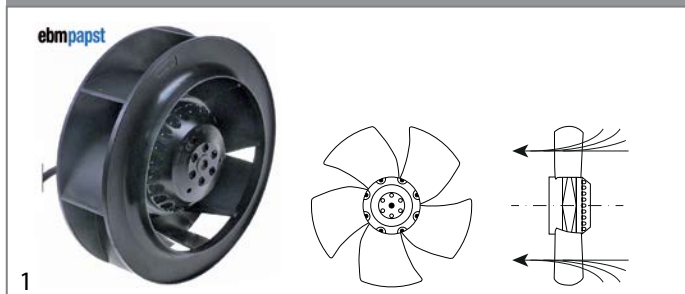

GEV No.	601617	Ref. No.	00543 30631
description	fan R2E190-A026-66 fan wheel ø 190mm blades 6 230V 50Hz 58W ø 190mm H 70mm hole ø 8mm 2500rpm cable length 450mm rotation direction right ebm-papst sucking suitable capacitor 2µF		

hot air fans

miscellaneous



GEV No.	601125	Ref. No.	00755
description	hot air fan 220-240V 45W 50/60Hz L1 70mm L2 11mm L3 25mm L4 87mm fan wheel ø 150mm FIME type C30R0479CLF		
accessories for	601125		
	GEV No.	550879	Ref. No. —
	insulation ø 130mm thickness 3mm hole ø 20mm for hot air fan		

gas taps

PEL

21S series

















GEV No.	101397	Ref. No.	401101
description	gas tap PEL type 21S gas inlet M16x1.5 (tube ø 10mm) bypass nozzle ø 0.35mm gas outlet M16x1.5 (tube ø 10/8mm) thermocouple connection M9x1 pilot connection M10x1 shaft ø 8x6.5mm shaft L 22/15mm shaft flat lower		
spare parts for	101397		
	GEV No.	100408	Ref. No. —
	bypass nozzle type PEL20/21 bore ø 0.35mm thread M5x0.5		
	GEV No.	101060	Ref. No. —
	magnet unit standard L 39mm D1 ø 15.4mm D2 ø 11mm suitable for PEL20-21/JUNKERS/EGA		
	GEV No.	101206	Ref. No. —
	gas tap front part shaft ø 8x6.5mm shaft L 22/15mm shaft flat upper/lower suitable for PEL21		

Table continues overleaf



spare parts for 101397	
	GEV No. 101231 Ref. No. — thermocouple nut T1: M9x1 T2: M18x1
accessories for 101397	
	GEV No. 100908 Ref. No. — union screw thread M10x1 for pipe ø 4mm Qty 1 pcs
	GEV No. 100909 Ref. No. ID0103 union screw thread M10x1 for pipe ø 6mm Qty 1 pcs
	GEV No. 101246 Ref. No. — olive for pipe ø 4mm Qty 1 pcs
	GEV No. 101278 Ref. No. — olive for pipe ø 10mm Qty 1 pcs
	GEV No. 101286 Ref. No. — olive ID ø 6mm Qty 1 pcs
	GEV No. 101300 Ref. No. — union nut thread M16x1.5 tube ø 10mm
	GEV No. 101450 Ref. No. — olive for pipe ø 8mm L 12.7mm Qty 1 pcs ED ø 10mm
	GEV No. 101451 Ref. No. — union nut thread M16x1.5 tube ø 8mm
	GEV No. 110081 Ref. No. — knob ø 70mm shaft ø 8x6.5mm shaft flat universal
	GEV No. 112206 Ref. No. — knob dial plate silver gas tap PEL21/22/23 t.max.°C ED ø 63mm ID ø 45.5mm

accessories for 101188	
	GEV No. 100905 Ref. No. ID0097 locking screw M10x1 for pipe ø 6mm Qty 1 pcs
	GEV No. 101273 Ref. No. — olive for pipe ø 12mm L 9.5mm brass Qty 1 pcs suitable for universal
	GEV No. 101276 Ref. No. — union screw thread 3/8" tube ø 12mm Qty 1 pcs
	GEV No. 101333 Ref. No. 61066 plug thread 3/8" with O-ring

			
GEV No.	101992	Ref. No.	821161
description	gas thermostat type 630 Eurosit series t.max. 190°C 110-190°C gas inlet 3/8" gas outlet 3/8" thermocouple connection M9x1 pilot connection M10x1 probe ø 4mm probe L 202mm capillary pipe 1050mm SIT		
accessories for 101992			
	GEV No. 100904 Ref. No. — locking screw M10x1 for pipe ø 4mm Qty 1 pcs		
	GEV No. 100905 Ref. No. ID0097 locking screw M10x1 for pipe ø 6mm Qty 1 pcs		
	GEV No. 101273 Ref. No. — olive for pipe ø 12mm L 9.5mm brass Qty 1 pcs suitable for universal		
	GEV No. 101276 Ref. No. — union screw thread 3/8" tube ø 12mm Qty 1 pcs		
	GEV No. 101333 Ref. No. 61066 plug thread 3/8" with O-ring		
	GEV No. 510655 Ref. No. — gasket silicone ø 7.8mm L 5mm blue Shore 55° Qty 10 pcs		





			
GEV No.	101696	Ref. No.	60249
description	gas thermostat type 630 Eurosit series t.max. 300°C 60-300°C gas inlet 3/8" gas outlet 3/8" thermocouple connection M9x1 pilot connection M10x1 probe ø 4mm probe L 72mm capillary pipe 1050mm SIT		
spare parts for 101696			
	GEV No. 101333 Ref. No. 61066 plug thread 3/8" with O-ring		

Table continues overleaf



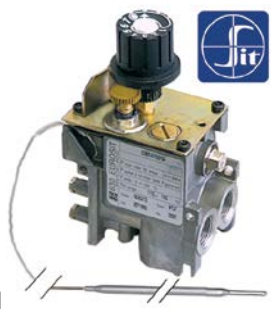

gas thermostats

SIT











630 Eurosit series

			
GEV No.	101188	Ref. No.	60142 R_60142
description	gas thermostat type 630 Eurosit series t.max. 190°C 110-190°C gas inlet 3/8" gas outlet 3/8" thermocouple connection M9x1 pilot connection M10x1 probe ø 4mm probe L 202mm capillary pipe 1050mm SIT		
accessories for 101188			
	GEV No. 100904 Ref. No. — locking screw M10x1 for pipe ø 4mm Qty 1 pcs		



accessories for	101696		
	GEV No.	100904	Ref. No. —
locking screw M10x1 for pipe ø 4mm Qty 1 pcs			
	GEV No.	100905	Ref. No. ID0097
locking screw M10x1 for pipe ø 6mm Qty 1 pcs			
	GEV No.	101273	Ref. No. —
olive for pipe ø 12mm L 9.5mm brass Qty 1 pcs suitable for universal			
	GEV No.	101276	Ref. No. —
union screw thread 3/8" tube ø 12mm Qty 1 pcs			







GEV No.	101915	Ref. No.	64357
description	gas thermostat type 630 Eurosit series t.max. 320°C 80-320°C gas inlet 3/8" gas outlet 3/8" thermocouple connection M9x1 pilot connection M10x1 probe ø 4mm probe L 72mm capillary pipe 1050mm SIT		
accessories for	101915		
	GEV No.	100825	Ref. No. —
gas tap spindle shaft ø 8x6.5mm shaft L 22/14mm suitable for EUROSIT			
	GEV No.	100904	Ref. No. —
locking screw M10x1 for pipe ø 4mm Qty 1 pcs			
	GEV No.	100905	Ref. No. ID0097
locking screw M10x1 for pipe ø 6mm Qty 1 pcs			
	GEV No.	100949	Ref. No. —
gasket suitable for 630 Eurosit series			
	GEV No.	101273	Ref. No. —
olive for pipe ø 12mm L 9.5mm brass Qty 1 pcs suitable for universal			
	GEV No.	101276	Ref. No. —
union screw thread 3/8" tube ø 12mm Qty 1 pcs			
	GEV No.	101333	Ref. No. 61066
plug thread 3/8" with O-ring			
	GEV No.	101390	Ref. No. —
gas tap spindle shaft ø 6x4.6mm shaft L 32/15mm gas tap with ignition flame suitable for ZANUSSI, MARENO for gas thermostat EUROSIT			
	GEV No.	101392	Ref. No. —
adapter suitable for 630 Eurosit series			
	GEV No.	110357	Ref. No. —
gas tap spindle shaft ø 8x6.5mm shaft L 36/12mm suitable for 630 Eurosit series			
	GEV No.	110358	Ref. No. —
adapter shaft ø 10x8mm shaft L 29/18mm suitable for 630 Eurosit series			

PEL

24ST series



GEV No.	101076	Ref. No.	401201
description	gas thermostat PEL type 24ST 120-320°C gas inlet M20x1.5 (tube ø 12mm) bypass nozzle ø 0.35mm gas outlet M20x1.5 (tube ø 12/10mm) thermocouple connection M9x1 pilot connection M10x1 capillary pipe 1200mm probe ø 6mm probe L 100mm shaft ø 10x8mm shaft L 27/17mm shaft flat upper		
spare parts for	101076		
	GEV No.	100455	Ref. No. —
bypass nozzle type PEL23/24 bore ø 0.35mm thread M8x0.5			
	GEV No.	101058	Ref. No. —
magnet unit L 39mm D1 ø 15.4mm D2 ø 13.5mm suitable for PEL22/ EGA24197 standard			
	GEV No.	106200	Ref. No. —
nut thread M9x1 suitable for PEL 24/25S			
accessories for	101076		
	GEV No.	100908	Ref. No. —
union screw thread M10x1 for pipe ø 4mm Qty 1 pcs			
	GEV No.	100909	Ref. No. ID0103
union screw thread M10x1 for pipe ø 6mm Qty 1 pcs			
	GEV No.	101246	Ref. No. —
olive for pipe ø 4mm Qty 1 pcs			
	GEV No.	101248	Ref. No. —
olive for pipe ø 12mm Qty 1 pcs suitable for PEL			
	GEV No.	101249	Ref. No. —
olive for pipe ø 10mm Qty 1 pcs			
	GEV No.	101250	Ref. No. —
union nut thread M20x1.5 for pipe ø 10mm			
	GEV No.	101251	Ref. No. —
union nut thread M20x1.5 for pipe ø 12mm			
	GEV No.	101286	Ref. No. —
olive ID ø 6mm Qty 1 pcs			
	GEV No.	110079	Ref. No. —
knob dial plate gas thermostat 1-8 silver			
	GEV No.	110080	Ref. No. —
knob ø 70mm shaft ø 10x8mm shaft flat universal			



gas valves and ignition boxes











gas control valves

SIT

NOVASIT



1

GEV No.	101956	Ref. No.	60309 921161
description	gas valve SIT series Novasit 820 230V 50Hz gas inlet 1/2" gas outlet 1/2" thermocouple connection M9x1 pilot connection M10x1 ignition pressure range 5-50mbar pressure regulator connection blind equiv. no. 0.820.031		
spare parts for	101956		
	GEV No.	101065	Ref. No. —
	magnet unit with cable L 44mm D1 ø 30mm D2 ø 20mm suitable for NOVASIT		
	GEV No.	101313	Ref. No. —
	solenoid coil 230V 50Hz		
accessories for	101956		
	GEV No.	100006	Ref. No. —
	piezoelectric igniter suitable for ELETTROSIT body plastic blowing connection ø2.4mm ø 14mm		
	GEV No.	101305	Ref. No. —
	gas connection straight 1/2" flange 45x45mm ELETTROSIT/V4400/4600/4605 suitable for SIT/HONEYWELL hole distance 36x36mm		
	GEV No.	101306	Ref. No. —
	gas connection angled flange 45x45mm hole distance 36x36mm 1/2" ELETTROSIT/V4400/4600/4605 screw with O-ring suitable for SIT/HONEYWELL		
	GEV No.	101307	Ref. No. —
	gas connection straight flange 45x45mm hole distance 36x36mm 3/4" ELETTROSIT/V4400/4600/4605 screw with O-ring suitable for SIT/HONEYWELL		
	GEV No.	101308	Ref. No. —
	gas connection angled flange 45x45mm hole distance 36x36mm 3/4" ELETTROSIT/V4400/4600/4605 screw with O-ring suitable for SIT/HONEYWELL		
	GEV No.	101312	Ref. No. —
	microswitch		
	GEV No.	101314	Ref. No. —
	solenoid coil 24V 50Hz		
	GEV No.	101317	Ref. No. —
	plug with cable L 1000mm suitable for NOVASIT		
	GEV No.	101318	Ref. No. —
	cover cap for solenoid coil suitable for NOVASIT		

accessories



1

GEV No.	100905	Ref. No.	ID0097
description	locking screw M10x1 for pipe ø 6mm Qty 1 pcs		

ignition parts







pilot burners

SIT

100 series



1

GEV No.	107140	Ref. No.	61603
description	pilot burner SIT type 100 series 3 flames nozzle ø 20mm gas connectionmm		
spare parts for	107140		
	GEV No.	100855	Ref. No. —
	pilot burner bracket triple		
	GEV No.	100885	Ref. No. —
	air mixing sleeve for pilot burner Qty 1 pcs		
	GEV No.	100916	Ref. No. —
	compression spring for pilot burner Qty 1 pcs		
	GEV No.	107162	Ref. No. —
	pilot burner cap SIT 3 flames Hmm Lmm Qty 1 pcs		
accessories for	107140		
	GEV No.	100904	Ref. No. —
	locking screw M10x1 for pipe ø 4mm Qty 1 pcs		
	GEV No.	100905	Ref. No. ID0097
	locking screw M10x1 for pipe ø 6mm Qty 1 pcs		



accessories			
ignition electrodes			
GEV No.	100706	Ref. No.	61602
description	ignition electrode connection M4 Qty 1 pcs		

140 - 145 - 150 series			
GEV No.	107134	Ref. No.	60354
description	pilot burner SIT type 140 series 1 flame nozzle \emptyset mm gas connectionmm		
accessories for	107134		
	GEV No.	100204	Ref. No. —
	pilot burner nozzle SIT LPG code 14 bore \emptyset 0.18/0.20mm Qty 1 pcs suitable for 140 series		
	GEV No.	100205	Ref. No. —
	pilot burner nozzle SIT LPG code 19 bore \emptyset 0.23/0.26mm Qty 1 pcs suitable for SIT 150 series		
	GEV No.	100206	Ref. No. 111006 61070
	pilot burner nozzle SIT natural gas code 36 bore \emptyset 0.60/0.55mm Qty 1 pcs suitable for SIT 150 series		
	GEV No.	100207	Ref. No. 111008 61243
	pilot burner nozzle SIT natural gas code 27 bore \emptyset 0.40/0.38mm suitable for SIT 140 series		
	GEV No.	100216	Ref. No. —
	pilot burner nozzle SIT natural gas code 38 bore \emptyset 0.45mm Qty 1 pcs suitable for SIT 150 series		
	GEV No.	100701	Ref. No. 61067
	ignition electrode connection M4 Qty 1 pcs		
	GEV No.	100897	Ref. No. —
	olive for pipe \emptyset 4mm Qty 1 pcs for pilot burner		
	GEV No.	100898	Ref. No. 111007
	olive for pipe \emptyset 6mm Qty 1 pcs for pilot burner		
	GEV No.	100906	Ref. No. 110163
	screw connection thread M10x1 for ignition electrode brass Qty 1 pcs WS 10		
	GEV No.	100907	Ref. No. —
	screw connection thread M10x1 Qty 1 pcs type SEF 1 \emptyset mm for thermocouple		
	GEV No.	100908	Ref. No. —
	union screw thread M10x1 for pipe \emptyset 4mm Qty 1 pcs		







accessories for	107134		
	GEV No.	100909	Ref. No. ID0103
	union screw thread M10x1 for pipe \emptyset 6mm Qty 1 pcs		

GEV No.	107132	Ref. No.	111003
description	pilot burner SIT type 140 series 2 flames nozzle \emptyset mm gas connectionmm		
accessories for	107132		
	GEV No.	100204	Ref. No. —
	pilot burner nozzle SIT LPG code 14 bore \emptyset 0.18/0.20mm Qty 1 pcs suitable for 140 series		
	GEV No.	100205	Ref. No. —
	pilot burner nozzle SIT LPG code 19 bore \emptyset 0.23/0.26mm Qty 1 pcs suitable for SIT 150 series		
	GEV No.	100206	Ref. No. 111006 61070
	pilot burner nozzle SIT natural gas code 36 bore \emptyset 0.60/0.55mm Qty 1 pcs suitable for SIT 150 series		
	GEV No.	100207	Ref. No. 111008 61243
	pilot burner nozzle SIT natural gas code 27 bore \emptyset 0.40/0.38mm suitable for SIT 140 series		
	GEV No.	100216	Ref. No. —
	pilot burner nozzle SIT natural gas code 38 bore \emptyset 0.45mm Qty 1 pcs suitable for SIT 150 series		
	GEV No.	100701	Ref. No. 61067
	ignition electrode connection M4 Qty 1 pcs		
	GEV No.	100897	Ref. No. —
	olive for pipe \emptyset 4mm Qty 1 pcs for pilot burner		
	GEV No.	100898	Ref. No. 111007
	olive for pipe \emptyset 6mm Qty 1 pcs for pilot burner		
	GEV No.	100906	Ref. No. 110163
	screw connection thread M10x1 for ignition electrode brass Qty 1 pcs WS 10		
	GEV No.	100907	Ref. No. —
	screw connection thread M10x1 Qty 1 pcs type SEF 1 \emptyset mm for thermocouple		
	GEV No.	100908	Ref. No. —
	union screw thread M10x1 for pipe \emptyset 4mm Qty 1 pcs		
	GEV No.	100909	Ref. No. ID0103
	union screw thread M10x1 for pipe \emptyset 6mm Qty 1 pcs		
	GEV No.	102110	Ref. No. —
	pilot tube copper pipe \emptyset 4mm thickness 1mm L 3000mm		
	GEV No.	102111	Ref. No. —
	pilot tube copper pipe \emptyset 6mm thickness 1mm L 3000mm		



160 series



GEV No.	100056	Ref. No.	110159
description	pilot burner SIT type 160 series 3 flames nozzle \varnothing mm gas connectionmm		
spare parts for	100056		
	GEV No.	100907	Ref. No. —
	screw connection thread M10x1 Qty 1 pcs type SEF 1 \varnothing mm for thermocouple		
accessories for	100056		
	GEV No.	100202	Ref. No. —
	pilot burner nozzle natural gas code 41 Qty 1 pcs nozzle \varnothing 0.41mm		
	GEV No.	100203	Ref. No. —
	pilot burner nozzle LPG code 25 Qty 1 pcs nozzle \varnothing 0.25mm		
	GEV No.	100701	Ref. No. 61067
	ignition electrode connection M4 Qty 1 pcs		
	GEV No.	100801	Ref. No. —
	gasket for pilot burner Qty 1 pcs		
	GEV No.	100869	Ref. No. —
	pilot burner nozzle natural gas code 51 Qty 1 pcs suitable for 160 series nozzle \varnothing 0.51mm		
	GEV No.	100870	Ref. No. —
	olive for pipe \varnothing 4mm Qty 1 pcs suitable for 160 series for pilot burner		
	GEV No.	100906	Ref. No. 110163
	screw connection thread M10x1 for ignition electrode brass Qty 1 pcs WS 10		
	GEV No.	100908	Ref. No. —
	union screw thread M10x1 for pipe \varnothing 4mm Qty 1 pcs		
	GEV No.	100909	Ref. No. ID0103
	union screw thread M10x1 for pipe \varnothing 6mm Qty 1 pcs		
	GEV No.	101287	Ref. No. —
	olive for pipe \varnothing 6mm Qty 1 pcs		
	GEV No.	102110	Ref. No. —
	pilot tube copper pipe \varnothing 4mm thickness 1mm L 3000mm		
	GEV No.	102111	Ref. No. —
	pilot tube copper pipe \varnothing 6mm thickness 1mm L 3000mm		
	GEV No.	107650	Ref. No. —
	pilot burner nozzle SIT LPG code 30 Qty 1 pcs		

electrodes



GEV No.	100701	Ref. No.	61067
description	ignition electrode connection M4 Qty 1 pcs		
accessories for	100701		
	GEV No.	100906	Ref. No. 110163
	screw connection thread M10x1 for ignition electrode brass Qty 1 pcs WS 10		

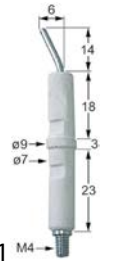

GEV No.	100706	Ref. No.	61602
description	ignition electrode connection M4 Qty 1 pcs		



GEV No.	100871	Ref. No.	61068
description	ignition electrode D1 \varnothing 7mm connection M4 to clip		

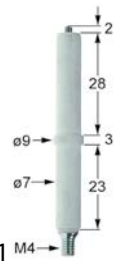

GEV No.	102314	Ref. No.	6010061-GI
description	ignition electrode D1 \varnothing 7mm D2 \varnothing 9mm connection M4 L1 2mm BL1 28mm BL2 3mm BL3 23mm to clip		

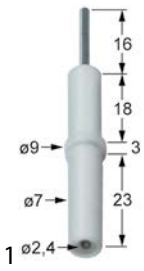
GEV No.	102330	Ref. No.	110262
description	ignition electrode D1 ø 7mm D2 ø 9mm L1 16mm BL1 18mm BL2 3mm BL3 23mm to clip connection ø 2.4mm		





GEV No.	100906	Ref. No.	110163
description	screw connection thread M10x1 for ignition electrode brass Qty 1 pcs WS 10		

piezoelectric igniters

mounting diameter 18mm



GEV No.	100009	Ref. No.	60829	
description	piezoelectric igniter body plastic blowing mounting ø 18mm connection ø2.4mm front measurements 26mm M18x1.5			
accessories for	100009			
	GEV No.	101339	Ref. No.	—
	cover cap for piezoelectric igniter			
	GEV No.	106869	Ref. No.	—
	cover cap for piezoelectric igniter ID ø 22mm ED ø 35mm H 25mm			
	GEV No.	107931	Ref. No.	—
	cover cap for piezoelectric igniter ID ø 21mm ED ø 36mm			

thermocouples

plug-in thermocouples

plug-in thermocouples standard

with barrel socket ø6(6.5)mm

thermocouples SIT

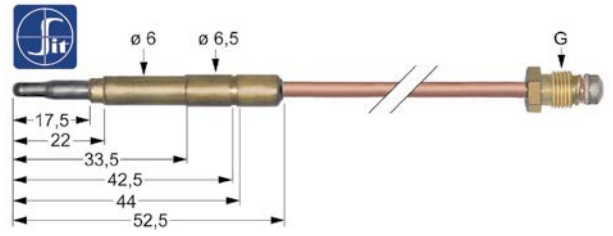

GEV No.	107614	Ref. No.	61061
description	thermocouple SIT M9x1 L 1500mm plug connection ø6.0(6.5)mm		

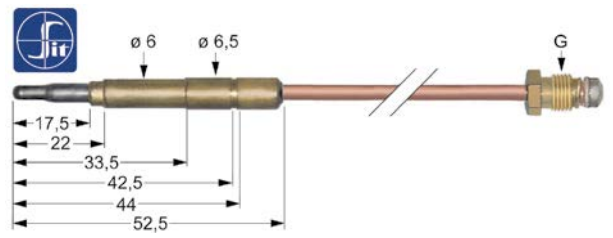

GEV No.	107606	Ref. No.	837233
description	thermocouple SIT M9x1 L 320mm plug connection ø6.0(6.5)mm		

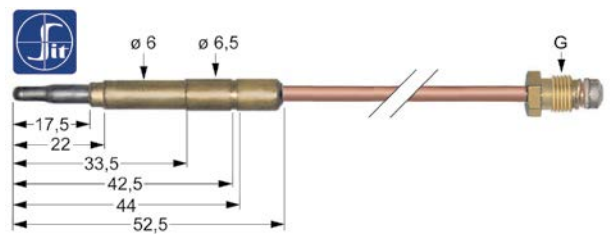

GEV No.	107610	Ref. No.	61060
description	thermocouple SIT M9x1 L 750mm plug connection ø6.0(6.5)mm		

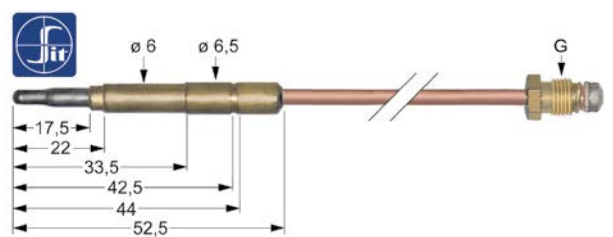

GEV No.	107611	Ref. No.	6010057-GI
description	thermocouple SIT M9x1 L 850mm plug connection ø6.0(6.5)mm		

plug-in thermocouples with aluminised tip

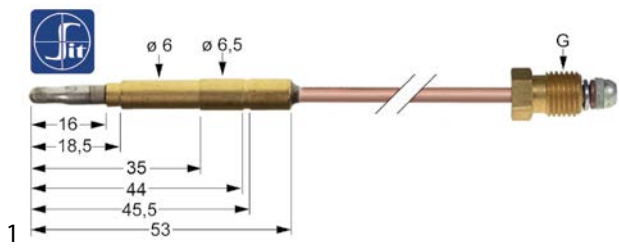

GEV No.	102681	Ref. No.	R_61074
description	thermocouple fast closing M9x1 L 850mm plug connection ø6.5mm		

accessories

screws



GEV No.	102464	Ref. No.	110176
description	thermocouple fitting thread M10x1 brass Qty 1 pcs		

gas burners

hob burners

accessories

reducers for pan supports

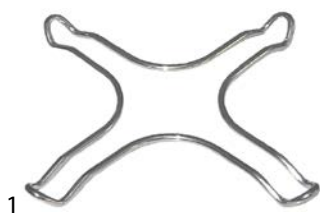

GEV No.	210050	Ref. No.	61320
description	reducer for pan support L 260mm W 260mm chrome-plated steel suitable for universal		

spillage trays



GEV No.	105465	Ref. No.	440081
description	drain tray L 380mm W 350mm for burner cap ø 110mm		



GEV No.	105466	Ref. No.	440083
description	drain tray L 380mm W 350mm for burner cap ø 130mm		

gas nozzles

pilot burner nozzles

pilot burner nozzles SIT

140/150 series



GEV No.	100207	Ref. No.	111008 61243
description	pilot burner nozzle SIT natural gas code 27 bore ø 0.40/0.38mm suitable for SIT 140 series		



GEV No.	100206	Ref. No.	111006 61070
description	pilot burner nozzle SIT natural gas code 36 bore ø 0.60/0.55mm Qty 1 pcs suitable for SIT 150 series		

auxiliary gas parts

screw connections

olives



GEV No.	100898	Ref. No.	111007
description	olive for pipe ø 6mm Qty 1 pcs for pilot burner		

accessories for





GEV No.	100909	Ref. No.	ID0103
description	union screw thread M10x1 for pipe ø 6mm Qty 1 pcs		



union screws

			
1			
GEV No.	100905	Ref. No.	ID0097
description	locking screw M10x1 for pipe ø6mm Qty 1 pcs		

			
1			
GEV No.	100906	Ref. No.	110163
description	screw connection thread M10x1 for ignition electrode brass Qty 1 pcs WS 10		

			
1			
GEV No.	100909	Ref. No.	ID0103
description	union screw thread M10x1 for pipe ø6mm Qty 1 pcs		
accessories for	100909		
	GEV No.	100898	Ref. No. 111007
	olive for pipe ø6mm Qty 1 pcs for pilot burner		
	GEV No.	101286	Ref. No. —
	olive ID ø6mm Qty 1 pcs		
	GEV No.	101287	Ref. No. —
	olive for pipe ø6mm Qty 1 pcs		
	GEV No.	101288	Ref. No. —
	olive for pipe ø6mm L 6mm aluminium Qty 1 pcs ED ø 8.5mm		

equipment-specific units

for fridges

housing and bezels

miscellaneous

			
1			
GEV No.	694387	Ref. No.	32810
description	frame L 179mm W 44mm H 6.5mm		

knobs

producer-specific knobs

ILSA

			
1			
GEV No.	112508	Ref. No.	18633
description	knob switch zero mark ø19mm shaft ø6x4.6mm black		

			
1			
GEV No.	112666	Ref. No.	01434 31051
description	knob thermostat 30-90°C ø48.5mm shaft ø6x4.6mm shaft flat upper black		

handles and hand wheels

cone handles

			
1			
GEV No.	691395	Ref. No.	62510
description	cone handle thread M8 ø24mm L 59mm black		

locks

edgemoat latches

handle latches

producer-specific

INOXTREND



1	GEV No.	690536	Ref. No.	R_C8118-00-IN
	description	catch L 172mm mounting distance 133mm non lockable chrome-plated 6200 total length 248mm		
	accessories for	690536		
	GEV No.	690123	Ref. No.	—
		door catch with roller		

hinges

spring assisted hinges

producer-specific

ILSA



1	GEV No.	691964	Ref. No.	14842 30876
	description	spring assisted hinge L 170mm mounting pos. bottom left/upper right		
	spare parts for	691964		
	GEV No.	692081	Ref. No.	00782
		torsion spring ø 16mm total length 123mm wire gauge ø 2mm L1 100mm mounting pos. left		



1	GEV No.	692071	Ref. No.	14841 30875
	description	spring assisted hinge L 170mm mounting pos. bottom right/upper left		
	spare parts for	692071		
	GEV No.	692082	Ref. No.	00781
		torsion spring ø 16mm total length 123mm wire gauge ø 2mm L1 100mm		

door bearing



1	GEV No.	694384	Ref. No.	32080
	description	hinge L 110mm W 66mm H 23mm mounting pos. bottom left with bolt		



1	GEV No.	694385	Ref. No.	32888 R32888
	description	hinge L 110mm W 66mm H 24mm mounting pos. upper left with bolt		



1	GEV No.	692078	Ref. No.	26403
	description	hinge mounting pos. bottom left		



1	GEV No.	692076	Ref. No.	26402
	description	hinge mounting pos. bottom right		





1	GEV No.	692577	Ref. No.	27348
	description	hinge camp L 110mm W 66mm mounting pos. left bottom thickness 3mm		





1	GEV No.	692576	Ref. No.	19456 29132
	description	hinge camp L 110mm W 66mm mounting pos. right bottom thickness 3mm kit		





			
1			
GEV No.	692072	Ref. No.	31282
description	hinge camp mounting pos. centre/right		

			
1			
GEV No.	691965	Ref. No.	30874
description	hinge camp mounting pos. lower		

			
1			
GEV No.	692074	Ref. No.	26401
description	hinge camp mounting pos. upper left		

			
1			
GEV No.	692085	Ref. No.	30379
description	hinge camp mounting pos. upper left		

			
1			
GEV No.	692073	Ref. No.	26400
description	hinge camp mounting pos. upper right		

			
1			
GEV No.	692075	Ref. No.	30344
description	hinge camp mounting pos. upper right		

shelves and shelf rails

grates

universal

without upstand



1			
GEV No.	970122	Ref. No.	GRI0012
description	grate W 325mm D 530mm GN 1/1 H 8mm stainless steel wire gauge frame 7mm lengthwise wires gauge 4mm crossing wires 1		
accessories for	970122		
	GEV No.	690330	Ref. No.
			—
	rack L 1000mm W 22mm H 4mm aperture 3x8mm hole distance 12.5mm stainless steel		
	GEV No.	694700	Ref. No.
			—
	shelf support L 31/28mm W 22mm H 18mm SS Qty 12 pcs		
	GEV No.	694701	Ref. No.
			—
	shelf support L 31/28mm W 22mm H 17mm SS with hook Qty 12 pcs		

with upstand

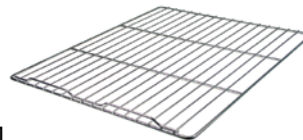



1			
GEV No.	970527	Ref. No.	20370
description	grate W 530mm D 650mm GN 2/1 chrome-plated steel with hinge camp crossing wires 2 suitable for refrigerator		
accessories for	970527		
	GEV No.	690330	Ref. No.
			—
	rack L 1000mm W 22mm H 4mm aperture 3x8mm hole distance 12.5mm stainless steel		
	GEV No.	694700	Ref. No.
			—
	shelf support L 31/28mm W 22mm H 18mm SS Qty 12 pcs		
	GEV No.	694701	Ref. No.
			—
	shelf support L 31/28mm W 22mm H 17mm SS with hook Qty 12 pcs		

			
1			
GEV No.	970556	Ref. No.	GRI0011
description	grate W 530mm D 650mm GN 2/1 plastic-coated steel with hinge camp wire gauge frame 9mm lengthwise wires gauge 5mm crossing wires 2 white suitable for refrigerator		
accessories for	970556		
	GEV No.	690330	Ref. No. —
	rack L 1000mm W 22mm H 4mm aperture 3x8mm hole distance 12.5mm stainless steel		
	GEV No.	690332	Ref. No. —
	shelf support L 31/28mm W 22mm H 17mm SS with hook Qty 1 pcs		
	GEV No.	694700	Ref. No. —
	shelf support L 31/28mm W 22mm H 18mm SS Qty 12 pcs		
	GEV No.	694701	Ref. No. —
	shelf support L 31/28mm W 22mm H 17mm SS with hook Qty 12 pcs		

shelf rails and supports

producer-specific

			
1			
GEV No.	692084	Ref. No.	26412
description	guide U-shape L 660mm W 27mm inner height 25mm mounting pos. left		

			
1			
GEV No.	692083	Ref. No.	26413
description	guide U-shape L 660mm W 27mm inner height 25mm mounting pos. right		

gaskets

refrigeration gaskets

plug-in gaskets

profile 9792

			
1			
GEV No.	902439	Ref. No.	36475
description	refrigeration gasket profile 9792 W 172mm L 387mm plug size		

profile 9048

We offer custom-made gaskets for this profile

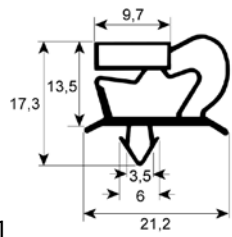
			
1			
GEV No.	900925	Ref. No.	19827
description	refrigeration gasket profile 9048 W 170mm L 385mm plug size		

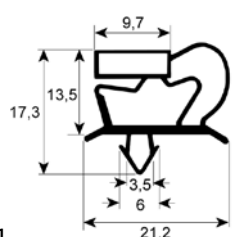
			
1			
GEV No.	900924	Ref. No.	19102 36473
description	refrigeration gasket profile 9048 W 210mm L 385mm plug size		

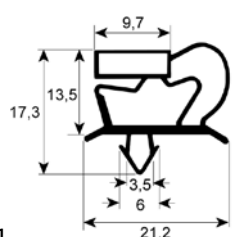
			
1			
GEV No.	901047	Ref. No.	19100
description	refrigeration gasket profile 9048 W 282mm L 390mm plug size		

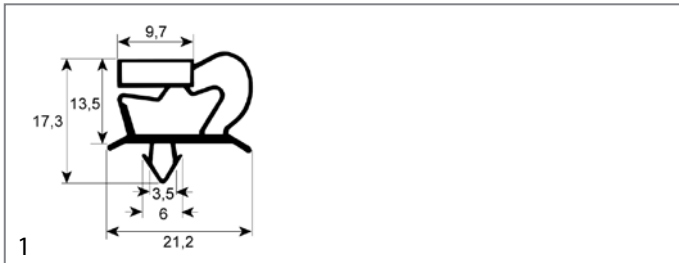

GEV No.	901477	Ref. No.	34574
description	refrigeration gasket profile 9048 W 365mm L 705mm plug size		

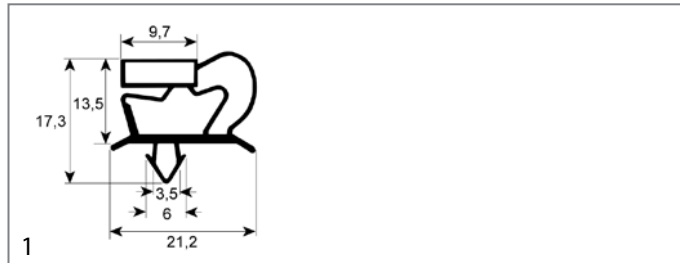

GEV No.	901046	Ref. No.	19259
description	refrigeration gasket profile 9048 W 386mm L 389mm plug size		

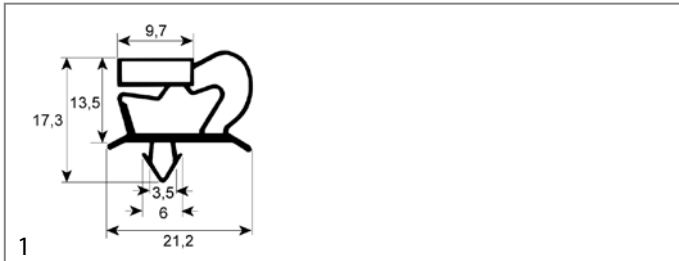

GEV No.	901463	Ref. No.	00779
description	refrigeration gasket profile 9048 W 375mm L 175mm plug size		

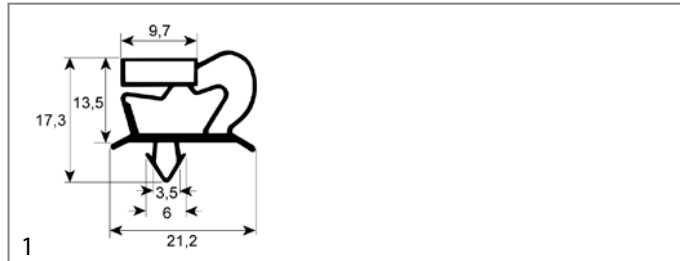

GEV No.	900926	Ref. No.	19099
description	refrigeration gasket profile 9048 W 388mm L 610mm plug size		

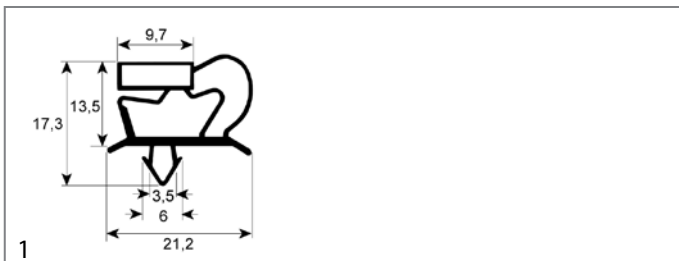

GEV No.	901464	Ref. No.	00778
description	refrigeration gasket profile 9048 W 375mm L 275mm plug size		

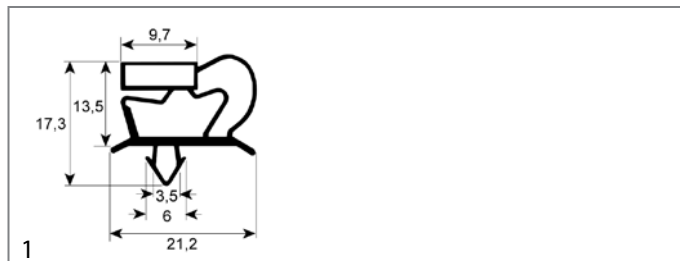

GEV No.	901048	Ref. No.	30485
description	refrigeration gasket profile 9048 W 400mm L 500mm plug size		

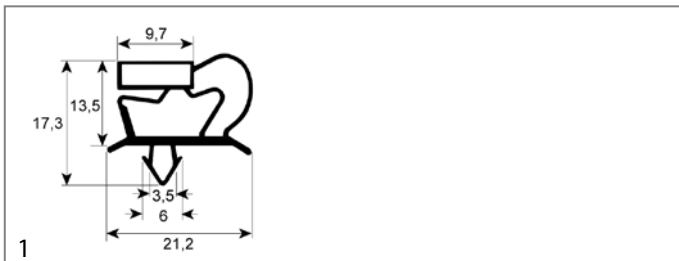

GEV No.	901465	Ref. No.	00780
description	refrigeration gasket profile 9048 W 375mm L 390mm plug size		

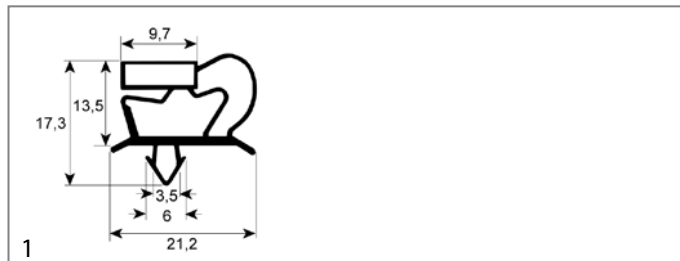

GEV No.	901222	Ref. No.	29715
description	refrigeration gasket profile 9048 W 415mm L 709mm plug size for blast chiller		

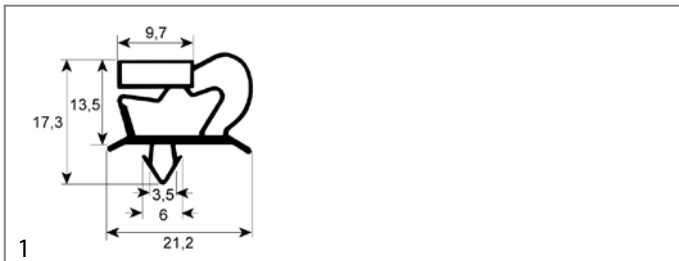

GEV No.	900929	Ref. No.	00777
description	refrigeration gasket profile 9048 W 375mm L 610mm plug size		

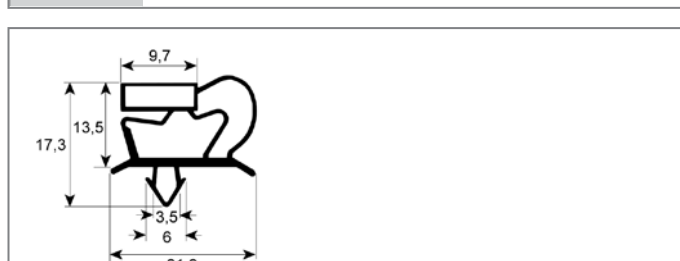

GEV No.	900928	Ref. No.	00776
description	refrigeration gasket profile 9048 W 456mm L 621mm plug size		

GEV No.	901045	Ref. No.	19098
description	refrigeration gasket profile 9048 W 465mm L 615mm plug size		

GEV No.	901221	Ref. No.	27375
description	refrigeration gasket profile 9048 W 612mm L 725mm plug size for blast chiller		

GEV No.	901044	Ref. No.	18567
description	refrigeration gasket profile 9048 W 640mm L 725mm plug size		

GEV No.	900927	Ref. No.	18565
description	refrigeration gasket profile 9048 W 645mm L 1535mm plug size		

GEV No.	901219	Ref. No.	27573
description	refrigeration gasket profile 9048 W 721mm L 1154mm plug size blast chiller		

GEV No.	901220	Ref. No.	27572
description	refrigeration gasket profile 9048 W 721mm L 929mm plug size for blast chiller		

profile 9773

We offer custom-made gaskets for this profile

GEV No.	902443	Ref. No.	R_34516
description	refrigeration gasket profile 9773 W 640mm L 1475mm plug size		

GEV No.	901472	Ref. No.	33993 34517
description	refrigeration gasket profile 9773 W 655mm L 700mm external size W1 642mm L1 687mm plug size		

GEV No.	901136	Ref. No.	33992 34516
description	refrigeration gasket profile 9773 W 658mm L 1498mm external size W1 645mm L1 1485mm plug size		

GEV No.	901471	Ref. No.	33842
description	refrigeration gasket profile 9773 W 675mm L 1490mm external size W1 662mm L1 1477mm plug size		

GEV No.	901039	Ref. No.	30799 33696
description	refrigeration gasket profile 9773 W 658mm L 723mm external size W1 645mm L1 710mm plug size		

GEV No.	901040	Ref. No.	31262 33697 R_33697
description	refrigeration gasket profile 9773 W 698mm L 1538mm external size W1 685mm L1 1525mm plug size		

GEV No.	901038	Ref. No.	30313 30798 33695
description	refrigeration gasket profile 9773 W 659mm L 1539mm external size W1 646mm L1 1526mm plug size		

GEV No.	901041	Ref. No.	33698
description	refrigeration gasket profile 9773 W 699mm L 724mm external size W1 686mm L1 711mm plug size		

GEV No.	901042	Ref. No.	31262
description	refrigeration gasket profile 9773 W 669mm L 1539mm external size W1 656mm L1 1526mm plug size		

GEV No.	901155	Ref. No.	33994 34518 R_34518
description	refrigeration gasket profile 9773 W 700mm L 1505mm external size W1 687mm L1 1492mm plug size		

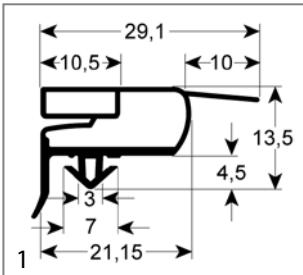

GEV No.	902305	Ref. No.	N/A
description	refrigeration gasket profile 9773 Wmm L 2500mm		

profile 9753
We offer custom-made gaskets for this profile

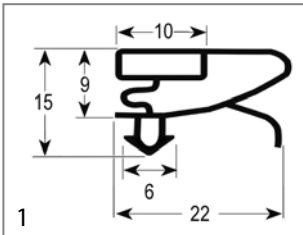

GEV No.	901466	Ref. No.	00103
description	refrigeration gasket profile 9753 W 405mm L 640mm plug size		

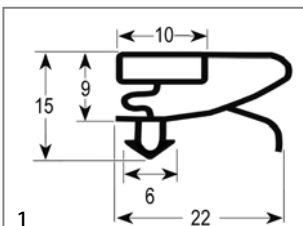

GEV No.	901467	Ref. No.	00104
description	refrigeration gasket profile 9753 W 475mm L 635mm plug size		

profile 9010
We offer custom-made gaskets for this profile

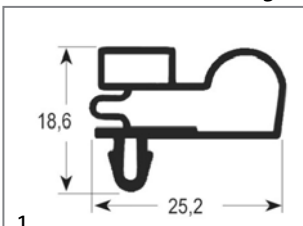

GEV No.	901468	Ref. No.	34520
description	refrigeration gasket profile 9010 W 675mm L 1520mm plug size		

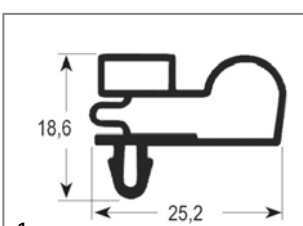

GEV No.	901469	Ref. No.	31443
description	refrigeration gasket profile 9010 W 675mm L 1555mm plug size		

profile 9794

We offer custom-made gaskets for this profile

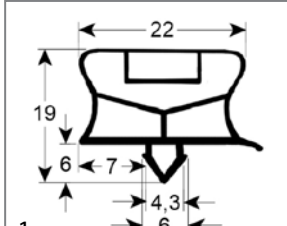

GEV No.	901870	Ref. No.	R_36474
description	refrigeration gasket profile 9794 W 274mm L 385mm plug size refrigerated counter		

GEV No.	901364	Ref. No.	36472 R_36472
description	refrigeration gasket profile 9794 W 390mm L 615mm plug size		

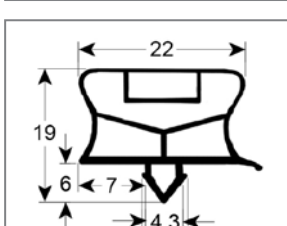

GEV No.	901183	Ref. No.	36471 R_36471
description	refrigeration gasket profile 9794 W 461mm L 613mm plug size		

GEV No.	902144	Ref. No.	R_35840
description	refrigeration gasket profile 9794 W 665mm L 1505mm plug size L1 1485mm W1 645mm external size suitable for ILSA		

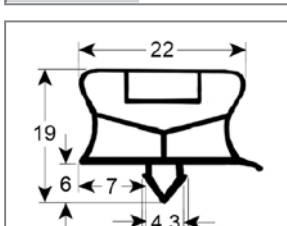

GEV No.	902144	Ref. No.	R_35840
description	refrigeration gasket profile 9794 W 665mm L 1505mm plug size L1 1485mm W1 645mm external size suitable for ILSA		

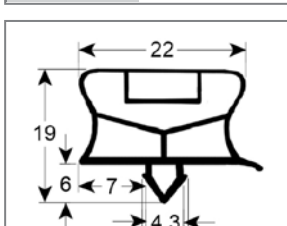

GEV No.	902144	Ref. No.	R_35840
description	refrigeration gasket profile 9794 W 665mm L 1505mm plug size L1 1485mm W1 645mm external size suitable for ILSA		



GEV No.	902308	Ref. No.	N/A
description	refrigeration gasket profile 9794 Wmm L 2500mm		

profile 9195

We offer custom-made gaskets for this profile

GEV No.	901470	Ref. No.	34285
description	refrigeration gasket profile 9195 W 760mm L 1900mm plug size		

gaskets for heated units

door seals with fixing hook

GEV No.	692546 ¹	Ref. No.	60045 R_60045
description	door seal L 255mm W 630mm 3-sided long side open with 6 mounting clips		

¹3-sided, long side open

O-rings

EPDM

GEV No.	540682	Ref. No.	18595
description	O-ring EPDM thickness 1.78mm ID ø 18.77mm Qty 1 pcs		

GEV No.	510072	Ref. No.	ID0087
description	O-ring EPDM thickness 3.53mm ID ø 32.93mm Qty 1 pcs		

GEV No.	532545	Ref. No.	ID0088
description	O-ring Viton thickness 3.53mm ID ø 49.21mm Qty 1 pcs		

evaporators

for fridges

producer-specific

GEV No.	750455	Ref. No.	30321 R_30321
description	evaporator L 140mm W 330mm H 170mm D 170mm refrigerator suitable for ILSA		

GEV No.	750454	Ref. No.	R_34010
description	evaporator L 260mm W 340mm H 140mm Dmm refrigerator suitable for ILSA		

GEV No.	750450	Ref. No.	19619
description	evaporator L 490mm H 70mm W 395mm for refrigerated counters suitable for ILSA		

			
1			
GEV No.	750449	Ref. No.	31455 R_19302
description	evaporator L 490mm W 295mm H 70mm refrigerated counter suitable for ILSA		

evaporation and condensing trays

unheated condensing trays

			
1			
GEV No.	750453	Ref. No.	30085 R_30085
description	condensing tray L 590mm W 105mm H 26mm plastic		

springs

tension springs





			
1			
GEV No.	692082	Ref. No.	00781
description	torsion spring ø 16mm total length 123mm wire gauge ø 2mm L1 100mm		



			
1			
GEV No.	692081	Ref. No.	00782
description	torsion spring ø 16mm total length 123mm wire gauge ø 2mm L1 100mm mounting pos. left		

valves and tank inlets



shut-off valves

universal

				
1				
GEV No.	514060	Ref. No.	60902	
description	shut-off valve connection 1/2" 1/2" without handle total length 45mm mounting pos. left shaft L 47mm rosette thread G2 26x19G shaft ø 8x10mm			
spare parts for	514060			
	GEV No.	112763	Ref. No.	—
	knob connection hot total lengthmm ø 70mm black/silver shaft ø 10x8mm shaft flat universal t.max.°C			
	GEV No.	112764	Ref. No.	—
	knob connection cold total lengthmm ø 70mm black/silver shaft ø 10x8mm shaft flat universal t.max.°C			
	GEV No.	514085	Ref. No.	—
	rosette connection 26x19G chrome-plated total lengthmm mounting pos.			
	GEV No.	514086	Ref. No.	—
	hexagonal nut connection 26x19G brass total lengthmm mounting pos. H 6mm WS 34 Qty 1 pcs			
	GEV No.	548423	Ref. No.	—
	tap head connection 1/2" total length 110mm mounting pos. shaft ø 10x8mm			

				
1				
GEV No.	540935	Ref. No.	110120	
description	shut-off valve connection tube ø 10mm total length 110mm shaft 7x7mm			
accessories for	540935			
	GEV No.	110287	Ref. No.	—
	knob water t.max.°C temperature range°C ø 50mm shaft ø 7x7mm shaft flat black			



			
1			
GEV No.	541982	Ref. No.	115120
description	slide connection 1/2" IT - 1/2" IT mounting thread M27x1,5		
accessories for	541982		
			
GEV No.	547713	Ref. No.	—
description	cross handle shaft intake ø 8mm marking blue type F suitable for MONOLITH		

measuring equipment

thermometers

built-in thermometers

			
1			
GEV No.	541670	Ref. No.	18683
description	thermometer mounting measurements 58x25,5mm -40 up to +40°C capillary pipe 1500mm probe ø 6mm probe L 35mm		

B		M	
ballasts	10	magnetic switches	8
bi-metal thermostats	4, 4	measuring equipment	35
C		O	
cam switches	7	O-rings	33
cold air circulating fans (complete)	16	P	
compressors	15	piezoelectric igniters	23
contactors	10	pilot burners	20
control thermostats	4	plug-in gaskets	28
core probes	11	probes	11
D		push/momentary push switches	7
door seals with fixing hook	33	R	
E		refrigeration fans	16
edgemount latches	26	refrigeration gaskets	28
electric timers	10	refrigeration motors universal	16
electronic controllers	11	relays	10
energy regulators	4	rocker/momentary rocker switches	6
evaporators	33	rotary switches	8
F		S	
fans	16	safety thermostats	5
fluorescent lamps	9, 9	shelves and shelf rails	27
G		shut-off valves	34
gas burners	24	solenoid valves	14
gas control valves	20	spring assisted hinges	26
gas nozzles	24	switches and momentary switches	6
gas taps	17	T	
gas thermostats	18	temperature probes	11
gaskets for heated units	33	thermocouples	23
grates	27	thermostats	4
H		timers	10
handle latches	26	U	
heating cables	3	universal probes	11
heating cartridges	3	V	
heating elements	3	valves and tank inlets	34
heating elements for pasta cookers	3		
hob burners	24		
hot air fans	17		
I			
indicator lights	9		
indicator lights (complete)	9		
L			
lamps	9		