



GAS COMPONENTS



ELECTRIC COMPONENTS



WATER TECHNOLOGY



MECHANICAL COMPONENTS



TOOLS

Spare parts suitable for

ICEMATIC

Find the complete and up-to-date range of products in our GEV Webshop



Manufacturer catalogue

The most important spare parts and accessories arranged clearly for every manufacturer

- ✓ Complete product range and all appliance data always up to date in the GEV Webshop
- ✓ Alphabetical Index at the end of the catalogue

GEV Webshop

www.gev-online.co.uk

www.gev-online.com



- 🔍 Add to Favourites
- 🔍 Sign In with email address and usual password
- 🔍 Easy-order – place several items in your basket at the same time
- 🔍 Quick Item search – no login needed



heating elements

heating cables

drain heating cables

			
GEV No.	417615	Ref. No.	33575155/0 CM33575155/0
description	drain heating cable 25W 230V 50Hz ø 6.3mm L 3000mm L1 (unheated) 1300mm L2 (heated) 1700mm silicone		

thermostats

control and safety thermostats

RANCO

safety thermostats

			
GEV No.	375832	Ref. No.	CMNM62044300
description	safety thermostat t.max. 70°C temperature range 0-70°C 1-pole 1N0 16A probe ø 8mm probe L 60mm capillary pipe 870mm capillary pipe isolatedmm gland nut shaft ømm shaft Lmm shaft position rotation° probe material copper switch-off temp. 70°C		

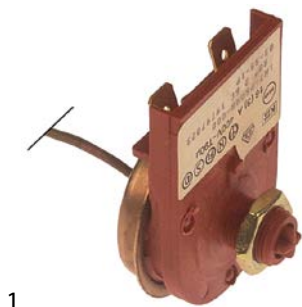
			
GEV No.	390583	Ref. No.	19797023/0 CM19797023/0
description	safety thermostat t.max. 80°C temperature range°C 1-pole 1NC 16A probe ø 9mm probe L 50mm capillary pipe 800mm capillary pipe isolatedmm gland nut shaft ømm shaft Lmm shaft position rotation° probe material copper with coiled probe screw connection M10x0.75 switch-off temp. 80°C		
For models:	N21S, N25SW, N45L, N45S, N45SW, N70SW, N90SW		

refrigeration thermostats

DANFOSS

service thermostats DANFOSS

All Danfoss thermostats are supplied with fastening material application:
 390552 - **fridges
 390553 - **Refrigerators with defrosting push button
 390554 - **/**Refrigerators with automatic defrosting
 390555 - absorption refrigerators
 390557 - Deep cooler with active signal
 390558 - Freezing with passive signal
 390559 - bottle cooler 390559

			
GEV No.	390559	Ref. No.	077B7008 19797007/0 19797012/0 CM19797007/0 CM19797012/0
description	thermostat type 077B7008 capillary pipe 2000mm temperature range -8.5 up to +11.5°C probe ømm probe Lmm		

control thermostats

			
GEV No.	390268	Ref. No.	19797012/0 CM19797012/0
description	thermostat type 077B0070L capillary pipe 2000mm		

			
GEV No.	390269	Ref. No.	19797011/0 CM19797011/0
description	thermostat type 077B2033 capillary pipe 2000mm temperature range -34 up to -15°C		

RANCO

K22 series



1 

GEV No.	390582	Ref. No.	19797025/0 CM19797025/0
description	thermostat RANCO type K22-L1529 probe ø 7mm probe L 108mm capillary pipe 1400mm		
For models:	N25L, N25LBI, N25LW, N35BI, N35S, N35SW, N45L, N45S, N45SW, N55L, N55LW, N55S, N55SW, N70S, N70SW, N90L, N90LW, N90S, N90SW		



1 

GEV No.	390646	Ref. No.	nicht in Preisliste
description	thermostat RANCO type K22-L1075 capillary pipe 2900mm probe ø9.5x107mm		



1 

GEV No.	390644	Ref. No.	nicht in Preisliste
description	thermostat RANCO type A22-1297-000 capillary pipe 1500mm probe ø10x100mm		



1 

GEV No.	390209	Ref. No.	19797009/0 CM19797009/0
description	thermostat RANCO type K22L1020 probe ø 9mm probe L 40mm capillary pipe 2000mm temperature range -20.5 up to -1.5°C		
For models:	N21S		



1 

GEV No.	390737	Ref. No.	62020101 CMCS62020101 CMNM62020101 CMNX62020101
description	thermostat RANCO type K22-L1074 probe ø 9mm probe L 42mm capillary pipe 1450mm temperature range -19 up to -1°C		



1 

GEV No.	390279	Ref. No.	N/A
description	thermostat RANCO type K22L3022 probe ø 9mm probe L 35mm capillary pipe 1600mm		

K50 series



1 

GEV No.	390642	Ref. No.	19797019/0 CM19797019/0
description	thermostat RANCO type K50-L3218 probe ø 2mm probe Lmm capillary pipe 1230mm refrigeration 1NO M10x0.75		





1 

GEV No.	390581	Ref. No.	19797026/0 CM19797026/0 I-35
description	thermostat RANCO type K50-S3595 probe ø 2mm probe Lmm capillary pipe 2000mm		
For models:	N21S		





			
GEV No.	390444	Ref. No.	N/A
description	thermostat RANCO type K50-L3074 probe ø 9mm probe L 40mm capillary pipe 560mm		

<p>K55 series</p> 			
GEV No.	390210	Ref. No.	3824917
description	thermostat RANCO type K55L1042 capillary pipe 1100mm temperature range +1.7 up to +9.5°C probe ø10x110mm		

			
GEV No.	390283	Ref. No.	19797017/0 19797302/0 CM19797017/0 CM19797302/0
description	thermostat RANCO type K55L5081 capillary pipe 1100mm temperature range°C probe ø10x110mm		
For models:	N140, N20L, N20WL, N25BI, N25L, N25LBI, N25LW, N25S, N25SW, N35BI, N35S, N35SW, N45L, N45S, N45SW, N50BI, N50BIW, N55L, N55LW, N55S, N55SW		

			
GEV No.	390284	Ref. No.	19797018/0 19797303 CM19797018/0
description	thermostat RANCO type K55L5082 capillary pipe 1500mm temperature range°C probe ø10x110mm		
For models:	N70S, N70SW, N90L, N90LW, N90S, N90SW		

<p>K61 series</p> 			
GEV No.	390212	Ref. No.	29090002/0 CM29090002/0
description	thermostat RANCO type K61L1500 probe ømm probe Lmm capillary pipe 750mm T war -11.5°C T cold 22°C		

			
GEV No.	390586	Ref. No.	19797031/0 CM19797031/0
description	thermostat RANCO type K61L1504 probe ø 2mm probe Lmm capillary pipe 1800mm T war 11.5°C T cold 22°C		

			
GEV No.	379516	Ref. No.	62026416 CF62026416 CMCF62026416 CMNM62026416
description	thermostat RANCO type K61L1508 probe ø 2mm probe Lmm capillary pipe 1800mm		

<p>miscellaneous producers</p> 			
GEV No.	390485	Ref. No.	nicht in Preisliste
description	thermostat		



			
1			
GEV No.	390659	Ref. No.	nicht in Preisliste
description	thermostat probe ø 2.5mm capillary pipe 90mm		

accessories

probe clips

clamps

for thermostat

			
1			
GEV No.	695672	Ref. No.	25726140/0 CM25726140/0
description	probe clip L 12mm W 27mm H 18mm hole ø 9.5mm		
For models:	N140, N25L, N25LBI, N25LW, N35BI, N35S, N35SW, N45S, N45SW, N50BI, N50BIW, N55L, N55LW, N55S, N55SW, N70S, N70SW, N90L, N90LW, N90S, N90SW		

			
1			
GEV No.	695661	Ref. No.	25726141/0 CM25726141/0
description	probe clip L 40mm W 25mm H 18mm hole ø 9.5mm		
For models:	N140, N25L, N25LBI, N25LW, N35BI, N35S, N35SW, N45S, N45SW, N50BI, N50BIW, N55L, N55LW, N55S, N55SW, N70S, N70SW, N90L, N90LW, N90S, N90SW		

switches and momentary switches

rocker/momentary rocker switches

25.5x25mm

			
1			
GEV No.	347115 ¹	Ref. No.	33400044/0 CM33400044/0
description	rocker switch mounting measurements 25.5x25mm clear 2CO 250V 16A illuminated connection male faston 6.3mm ambient temperature max. 85°C protection IP40		

¹illuminated

30x11mm

			
1			
GEV No.	348107	Ref. No.	33400046/0 CM33400046/0
description	momentary rocker switch mounting measurements 30x11mm black 1NO 250V 16A I connection male faston 6.3mm ambient temperature max. 85/125°C protection IP40		
For models:	N401M, N501M		

30x11mm

			
1			
GEV No.	301013	Ref. No.	33400049/0 62024202 CM33400049/0
description	rocker switch mounting measurements 30x11mm black 1CO 250V 16A connection male faston 6.3mm ambient temperature max. 85/125°C protection IP40		
For models:	N21S		



30x11mm

			
1			
GEV No.	301012	Ref. No.	33400053/0 CM33400053/0
description	rocker switch mounting measurements 30x11mm green 1NO/indicator light 250V 16A 0-I connection male faston 6.3mm ambient temperature max. 85/125°C protection IP40		
For models:	N21S, N25L, N25LW, N25S, N25SW, N35S, N35SW, N45L, N45S, N45SW, N55L, N55LW, N55S, N55SW, N70S, N70SW, N90L, N90LW, N90S, N90SW		

30x22mm

			
1			
GEV No.	347074	Ref. No.	nicht in Preisliste
description	rocker switch mounting measurements 30x22mm black/orange 1NO/indicator light 250V 16A cold connection male faston 6.3mm ambient temperature max. 125/55°C protection IP65 with cover cap		

miscellaneous

			
1			
GEV No.	347064	Ref. No.	nicht in Preisliste
description	rocker switch mounting measurements 40x18mm black 1CO 250V 10A		
accessories for	347064		
	GEV No.	694188	Ref. No. —
cable harness 3-pole L 170mm permanent temperature 105°C plug type Faston 6.3mm			



push/momentary push switches

19x13mm



1

GEV No.	347079 ¹	Ref. No.	nicht in Preisliste
description	push switch mounting measurements 19x13mm green 2NO 250V 16A illuminated connection male faston 6.3mm ambient temperature max. 125°C protection IP65 with cover cap		

¹illuminated

20.6x16.4mm



1

GEV No.	348108	Ref. No.	33400060/0 CM33400060/0
description	push switch mounting measurements 20.6x16.4mm chrome 1NO 250V 16A connection male faston 6.3mm ambient temperature max. 85°C protection IP40		



1

GEV No.	347205	Ref. No.	33400060/0 CM33400060/0
description	push switch mounting measurements 20.6x16.4mm chrome 2NO 250V 16A connection male faston 6.3mm ambient temperature max. 85°C protection IP40		

ø 7mm



1

GEV No.	347069	Ref. No.	I-1682
description	momentary push switch mounting ø 7mm red 1NO 24V 4A with cable 500mm connection cable ambient temperature max. 85°C protection IP40 for ice maker		

toggle switches

M12x0.75



1

GEV No.	347068	Ref. No.	33400019/0 33400027/0 81453376/0 CM33400019/0 CM33400027/0 CM81453376/0
description	toggle switch thread M12x0.75 2NO 250V 16A ON-OFF-ON male faston 6.3mm with neutral position		

microswitches

lever actuated



1

GEV No.	347063	Ref. No.	25474581/0 CM25474581/0
description	microswitch 250V 15A 1CO connection male faston 6.3mm ambient temperature max. 105°C lever length 37mm		



1

GEV No.	345345	Ref. No.	19410207/0 CM19410207/0
description	microswitch with lever 250V 16A 1CO connection male faston 6.3mm L 78mm ambient temperature max. 85°C mounting distance 22mm type X662-88-J27 actuating force: 40g lever length 69mm		



1

GEV No.	346875	Ref. No.	19410200/0 CM19410200/0
description	microswitch 3 with lever 250V 15A 1CO connection screw L 112mm L1 49mm ambient temperature max. 125°C mounting distance 25mm type Z-15HW24-B actuating force: 5g lever length 125mm		



1

GEV No.	345270	Ref. No.	19410200/0 CM19410200/0
description	microswitch with lever 250V 16A 1CO connection male faston 6.3mm ambient temperature max. 85°C mounting distance 25mm type C99ZP3 actuating force: 30g lever length 140mm		



1

GEV No.	346887	Ref. No.	nicht in Preisliste
description	microswitch with lever 250V 15A 1NC connection male faston 6.3mm ambient temperature max. 125°C lever length 60mm		



			
1			
GEV No.	347077	Ref. No.	nicht in Preisliste
description	microswitch with lever 250V 15A 2CO connection male faston 6.3mm ambient temperature max. 85°C lever length 62mm		

			
1			
GEV No.	345361	Ref. No.	19410205/0 CM19410205/0
description	microswitch with lever 250V 5A 1NO/1NC connection soldering connection ambient temperature max. 85°C type 83109004 lever length 43mm		

roller-lever actuated

microswitches

			
1			
GEV No.	345253	Ref. No.	19410201/0 19410209/0 CM19410201/0 CM19410209/0
description	microswitch with handle with a switch 250V 15A 1CO connection male faston 6.3mm L 28mm L1 37mm ambient temperature max. 125°C mounting distance 22mm type RL6-1-F-GE-P12-5-L actuating force: 80g grey lever length 28mm		
For models:	N140, N20L, N20WL, N25BI, N25L, N25LBI, N25LW, N25S, N25SW, N35BI, N35S, N35SW, N45L, N45S, N45SW, N50BI, N50BIW, N55L, N55LW, N55S, N55SW, N70S, N70SW, N90L, N90LW, N90S, N90SW		

heavy duty version

			
1			
GEV No.	346874	Ref. No.	19410300/0 CM19410300/0
description	microswitch with handle with a switch 250V 16A 1CO connection screw L 29mm L1 49mm ambient temperature max. 85°C mounting distance 26mm type Z-15GW22-B actuating force: 120g lever length 25mm		

with mounting components



			
1			
GEV No.	346876	Ref. No.	19410208/0 81401140 CM19410208/0
description	microswitch with handle with a switch 250V 16A 1CO connection male faston L 35mm L1 28mm ambient temperature max. 125°C mounting distance 22mm type V-166-1CR5 actuating force: 86g		
For models:	N20L, N20WL, N25BI, N25L, N25LBI, N25LW, N25S, N25SW, N35BI, N35S, N35SW		

roller actuated

roller 0°

			
1			
GEV No.	347080	Ref. No.	33400026/0 CM33400026/0
description	microswitch with roller plunger 10A 1CO connection screw ambient temperature max. 85°C thread M12x1		

float switches

				
1				
GEV No.	403551	Ref. No.	81300027/0 CM81300027/0	
description	float switch 1CO 250V 4A F6.3			
accessories for	403551			
	GEV No.	403552	Ref. No.	25725558/0 CM25725558/0
bracket for float switch L 100mm W 37mm H 41mm stainless steel thickness 2mm				

			
1			
GEV No.	345365	Ref. No.	81404080/0 81409179/0 CM81404080/0 CM81409179/0
description	float switch 250V 16A 1CO male faston 6.3mm L 150mm ambient temperature max. 125°C mounting distance 23mm type EF83161.5 actuating force: 5g black		
For models:	N20L, N20WL, N25BI, N25L, N25LBI, N25LW, N25S, N25SW, N35BI, N35S, N35SW, N45L, N45S, N45SW, N50BI, N50BIW, N55L, N55LW, N55S, N55SW, N70S, N70SW, N90L, N90LW, N90S, N90SW		

1

GEV No.	347088	Ref. No.	81449091/0 CM81449091/0
description	float switch with plunger 250V 16A 1CO male faston 6.3mm L 130mm ambient temperature max. 125°C mounting distance 23mm type EF83161.5 actuating force: 5g black		
For models:	N140		

floats



1

GEV No.	695036	Ref. No.	29025013/0 CF66058500 CF78312700 CM29025013/0 CMCF66058500 CMCF78312700
description	float for ice maker ø 75mm L 115mm H 40mm plastic		
For models:	F100, F120, F125C, F200, F80C, F80WC, SF300, SF500, SFN1000, SFN1000W		



1

GEV No.	696637	Ref. No.	25360110/3 CM25360110/3
description	float without magnet ø 18.5mm L 77mm W 19mm H 34mm PVC suitable for ICEMATIC		

centrifugal switches



1

GEV No.	346986	Ref. No.	nicht in Preisliste
description	centrifugal switch		

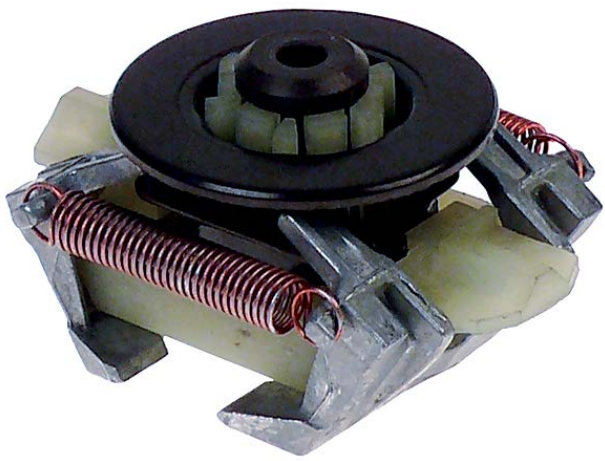

1

GEV No.	347062	Ref. No.	nicht in Preisliste
description	centrifugal switch		

touch sensitive light switches



1

GEV No.	402018	Ref. No.	nicht in Preisliste
description	light barrier for ice thickness set		



1

GEV No.	402043	Ref. No.	CF65067402 CMCF65067402
description	light barrier L 180mm W 35mm H 46mm		
For models:	F100, F120, F200, SF300, SF500, SFN1000, SFN1000W		





1

GEV No.	402009	Ref. No.	29040018 29040018/0 33580175/0 CF65067400 CM29040018/0 CM33580175/0 CMCF65067400
description	light barrier L 310mm W 35mm H 47mm		
For models:	F80C, F80WC		

magnetic switches

26x12.5mm



1

GEV No.	348110 ¹	Ref. No.	33210022/0 CM33210022/0
description	magnetic switch L 26mm W 12.5mm 1NO 300V 0.5A P max. 10W connection coded plug cable length 1500mm		

¹with coded connector

36x13mm



1

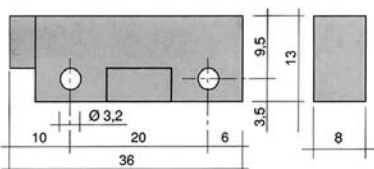

GEV No.	345118 ¹	Ref. No.	33210018/0 33210019/0 CM33210018/0 CM33210019/0	
description	magnetic switch L 36mm W 13mm 1NO 250V 1A P max. 50W connection cable length 980mm			
For models:	N131M, N200M, N200MW, N201M, N300M, N300MW, N301M, N401M, N500M, N501M			
accessories for	345118			
	GEV No.	345399	Ref. No.	19355004/0 CM19355004/0
	magnet ø 3.3mm L 40mm H 8mm W 13mm hole distance 30mm M3			

¹with coded connector

M10x0.75

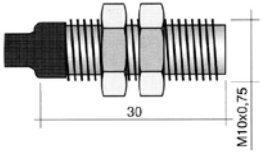



1

GEV No.	345632	Ref. No.	33580132/0 CM33580132/0	
description	magnetic switch thread M10x0.75 1NO 250V 0.5A P max. 50W connection cable length 2000mm type 102			
For models:	T20, T20C, T20R			
accessories for	345632			
	GEV No.	100779	Ref. No.	—
	nut thread M10x0.75 H 3mm WS 14 SS Qty 2 pcs			

accessories

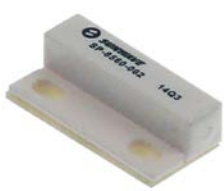
magnets



1

GEV No.	348111	Ref. No.	19355010/0 193550101/0 CM19355010/0 CM193550101/0
description	magnet L 26mm H 7.45mm W 12.45mm hole distance 17.5mm M3 hole ø 3.2mm		



1

GEV No.	347059	Ref. No.	19355007/0 CM19355007/0
description	magnet L 40mm H 8mm W 13.2mm hole distance 30mm		
For models:	N131M, N201M, N301M, N401M, N501M		

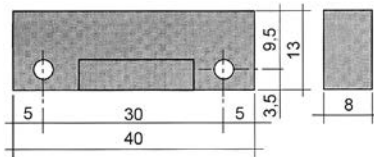
1

GEV No.	345399	Ref. No.	19355004/0 CM19355004/0
description	magnet ø 3.3mm L 40mm H 8mm W 13mm hole distance 30mm M3		
For models:	N200M, N200MW, N300M, N300MW		



miscellaneous



1

GEV No.	347066	Ref. No.	nicht in Preisliste
description	safety switch 250V ø 58mm H 40mm 15A		

lamps

indicator lights

indicator lights (complete)

ø10mm

with screw socket



1

GEV No.	359380	Ref. No.	33470507/0 CM33470507/0
description	indicator light ø 10mm 230V red connection male faston 6.3mm socket screw base		
For models:	N21S, N25L, N25LW, N25S, N25SW, N35S, N35SW, N45L, N45S, N45SW, N55L, N55LW, N55S, N55SW, N70S, N70SW, N90L, N90LW, N90S, N90SW		

ø13mm

with plug-in socket



1

GEV No.	359141	Ref. No.	33576295
description	indicator light ø 13mm red 230V connection male faston 6.3mm temp.-resist. 120°C Qty 1 pcs		

30x22mm



1

GEV No.	359155	Ref. No.	33400002 33400002/0 CM33400002/0
description	indicator light mounting measurements 30x22mm 230V red connection male faston 6.3mm temp.-resist. 125°C type RL2		

timers

programme timers



1

GEV No.	360377	Ref. No.	nicht in Preisliste
description	timer		



1

GEV No.	360754	Ref. No.	19800012/0
description	timer CDC engines 1 chambers 2 operation time 12min 230V 50-60Hz shaft ømm shaft Lmm motor type 4902F1		



1

GEV No.	360665 ¹	Ref. No.	81414561/0 81414562/0 CM19800012/0 CM81414561/0 CM81414562/0
description	timer CDC kit engines 1 chambers 2 operation time 12min 230V 50-60Hz shaft ømm shaft Lmm motor type 4902F1		

¹with cable kit

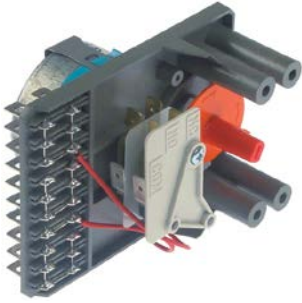

1

GEV No.	360370	Ref. No.	19800001/0 CM19800001/0
description	timer FIBER P36 engines 1 chambers 2 operation time 12min 230V 50-60Hz shaft ømm shaft Lmm manuf. no. P365JR2J536 motor type M51BJ0R6400		
For models:	N215		
spare parts for	360370		
	GEV No.	360673	Ref. No. —
	motor kit pinion ø 6.8mm teeth 15 230V voltage AC 50/60Hz turn direction clockwise motor ø 48mm H 18.5mm motor type UDS-40NE1RNZ165 cable length 150mm with holder		



1

GEV No.	380888	Ref. No.	33730712 33730712/0 CM33730712/0
description	power contactor resistive load 20A 230VAC (AC3/400V) 12A/5.7kW main contacts 3NO auxiliary contacts 1NC connection screw connection type 11BG1201A230		
For models:	N131M, N201M, N301M, N401M		



1

GEV No.	380574	Ref. No.	nicht in Preisliste
description	power contactor resistive load 25A 230VAC (AC3/400V) 12A/5.7kW main contacts 3NO auxiliary contacts 1NO connection screw connection type B12		

miscellaneous

power contactors



1

GEV No.	380578	Ref. No.	nicht in Preisliste
description	power contactor 208/240V resistive load 30A main contacts 2NO connection male faston 6.3mm		

contactors

GENERAL ELECTRIC (AEG)

power contactors



1

GEV No.	380859	Ref. No.	33730609/0 CM33730609/0
description	power contactor resistive load 25A 230VAC (AC3/400V) 12A/5.5kW main contacts 3NO auxiliary contacts 1NC connection screw connection type AEG LS701E		

LOVATO

power contactors



1

GEV No.	380579	Ref. No.	I-1673
description	power contactor resistive load 16A 230VAC (AC3/400V) 9A/4kW main contacts 3NO auxiliary contacts 1NO connection screw connection type 11MC9102205060		



relays

power relays

with bracket mounting



1

GEV No.	380312	Ref. No.	19620107/0 CM19620107/0
description	power relays FINDER 230VAC 10A 3CO connection male faston 4.8mm bracket mounting dimensions 52x32.2x36.5mm manif. no. 60.63.8.230.0000		
For models:	N140, N20L, N20WL, N25BI, N25L, N25LBI, N25LW, N25S, N25SW, N35BI, N35S, N35SW, N45L, N45S, N45SW, N50BI, N50BIW, N55L, N55LW, N55S, N55SW, N70S, N70SW, N90L, N90LW, N90S, N90SW		



1



GEV No.	380185	Ref. No.	19620103/0 CM19620103/0
description	power relays Italiana Relè 230VAC 30A 1NO connection F6.3 bracket mounting dimensions 36.5x32.2x51.8mm manif. no. A10-230AC-FA		
For models:	T14, T5		

with male contacts

bullet connectors, 8 contacts



1

GEV No.	380134	Ref. No.	19620100/0 CM19620100/0
description	power relays Italiana Relè 230VAC 10A 2CO connection plug-in connection round 8-pole manif. no. C42-230VAC 90.26/ZVE8 250V		
accessories for	380134		
	GEV No.	380137	Ref. No. —
	relay socket 8-pole connection plug-in connection round 8-pole dimensions: 65x28x40mm 380V voltage AC 10A Italiana Relè manif. no. ZVE8		
	GEV No.	380638	Ref. No. 19050010/0 CM19050010/0
	relay socket 8-pole dimensions 51x41x23mm 250V 10A FINDER manif. no. 90.26		

relay sockets



1

GEV No.	380638	Ref. No.	19050010/0 CM19050010/0
description	relay socket 8-pole dimensions 51x41x23mm 250V 10A FINDER manif. no. 90.26		

time relays

time relays



1

GEV No.	350129	Ref. No.	nicht in Preisliste
description	time relay FIBER R11B52307F0 time range 6s-30min 230VAC 2x6A 1NO/1CO connection male faston 6.3mm		



1

GEV No.	380584	Ref. No.	nicht in Preisliste
description	time relay SYRELEC BAR.F time range 0-10min 220-240VAC 5A 1CO connection screw		

miscellaneous



1

GEV No.	380580	Ref. No.	33580057/0 CM33580057/0
description	relay connection with cable for pump		



transformers

open transformers

with plug connection



GEV No.	401827	Ref. No.	nicht in Preisliste
description	transformer primary 230V secondary 24V 75VA 50/60Hz		

electronic controllers

CAREL

refrigeration controllers

built-in version



GEV No.	381365	Ref. No.	26118434/0 CM26118434/0
description	electronic controller CAREL IR3350EN00 mounting measurements 71x29mm built-in depth 56mm 230V voltage AC relay outputs 1 CO-8A(4) NTC NTC DI yes yes yes yes yes protection IP65 display 3 digits		

miscellaneous

refrigeration controllers



GEV No.	378230	Ref. No.	26117881/0 CM26117881/0
description	electronic controller type HTW311 mounting measurements 71x29mm 12V voltage AC sensor 1 NTC/RTC AC1 (R1) 10A		

probes

universal probes

temperature probes



GEV No.	379557	Ref. No.	33580115/0 33580116/0 CM33580115/0 CM33580116/0
description	temperature probe NTC 10kOhm cable silicone probe -40 up to +110°C cable -50 up to +180°C probe ø6x35mm cable length 1.5m without screw connection 2-wire		

GEV No.	379162	Ref. No.	33580099/0 CM33580099/0
description	temperature probe NTC 10kOhm cable thermoplastic probe -40 up to +110°C cable -40 up to +110°C probe ø6x14mm cable length 6m 2-wire		
For models:	T14, T20, T20C, T20R, T5		

GEV No.	381343	Ref. No.	33580099/1 CM33580099/1
description	temperature probe PTC 1kOhm cable thermoplastic probe -50 up to +150°C cable -40 up to +110°C probe ø6x14mm cable length 4.8m 2-wire		

core probes



GEV No.	379549	Ref. No.	33580149 33580149/0 CM33580149/0
description	core temperature probe PTC 1kOhm cable PVC probe -50 up to +150°C cable -10 up to 100°C probe ø6x110mm cable length 3.5m handle ø 8mm handle length 120x35mm 2-wire L1 120mm L2 130mm		
For models:	T14, T20, T20C, T20R, T5		

producer-specific probes

probes





GEV No.	381339	Ref. No.	33580298/0 CF62051900 CM33580298/0 CMCF62051900
description	probe NTC 10kOhm cable PVC probe -40 up to +110°C cable -10 up to 100°C connection plug thread probe ø5x50mm cable length 1.2m		





1 			
GEV No.	381338	Ref. No.	33580135/0 CM33580135/0
description	probe NTC 2.2kOhm cable PVC probe -40 up to +110°C cable -10 up to 100°C connection plug thread probe ø5x50mm cable length 2m		
For models:	N500M		

1 			
GEV No.	381336	Ref. No.	33580265/0 CM33580265/0
description	probe NTC 2kOhm cable PVC probe -40 up to +110°C cable -10 up to 100°C connection plug probe ø6x60mm cable length 1.5m		

1 			
GEV No.	381344	Ref. No.	CF62040411 CMCF62040411
description	probe PTC 2kOhm cable PVC probe -50 up to +150°C cable -10 up to 100°C connection plug probe ø5x50mm cable length 1.7m		
For models:	SFN1000, SFN1000W		

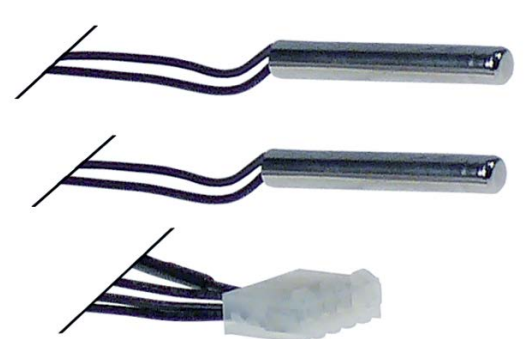
1 			
GEV No.	379628	Ref. No.	nicht in Preisliste
description	temperature probe 2x NTC 10K cable PVC probe -40 up to +110°C cable -10 up to 100°C connection coded plug thread probe ø6.5x45mm cable length 0.4/0.55m		

1 			
GEV No.	379564	Ref. No.	nicht in Preisliste
description	temperature probe 2x NTC 10K cable PVC probe -40 up to +110°C cable -10 up to 100°C connection coded plug thread probe ø6.5x45mm cable length 0.7/1.3m		

1 			
GEV No.	381337	Ref. No.	33580297/0 CF62051901 CM33580297/0 CMCF62051901
description	temperature probe NTC 10kOhm cable PVC probe -40 up to +110°C cable -10 up to 100°C connection plug thread probe ø5x40mm cable length 1.5m		

1 			
GEV No.	402139	Ref. No.	33580101/0 CM33580101/0
description	temperature probe NTC 2.2kOhm cable PVC probe -40 up to +110°C cable -10 up to 100°C connection plug thread probe ø5x60mm cable length 1m		
For models:	N131M, N200M, N200MW, N201M, N300M, N300MW, N301M, N401M, N501M		

1 			
GEV No.	402006	Ref. No.	29070010 33580065/0 33580065/1 CM33580065/0 CM33580065/1
description	temperature probe PTC 2kOhm cable PVC probe -50 up to +150°C cable -10 up to 100°C connection plug thread probe ø5x60mm cable length 1.5m		

1 			
GEV No.	378231	Ref. No.	33580066/1 CM33580066/1
description	temperature probe PTC 2kOhm cable PVC probe -50 up to +150°C cable -10 up to 100°C connection plug thread probe ø5x60mm cable length 1.9m		

1 			
GEV No.	402191	Ref. No.	29070014/0 CF62040401 CM29070014/0 CMCF62040401
description	temperature probe PTC 2kOhm cable TPE probe -50 up to +150°C cable -40 up to +110°C connection plug thread probe ø5x20mm cable length 1.8m		
For models:	F100, F100C, F120, F125C, F200, F80C, F80WC, SF300, SF500		

1 			
GEV No.	402005	Ref. No.	29070013 29070013/0 620404.10 CF62040410 CM29070013/0 CMCF62040410
description	temperature probe PTC 2kOhm cable TPE probe -50 up to +150°C cable -40 up to +110°C connection plug thread probe ø6x50mm cable length 1.6m		
For models:	F100, F100C, F120, F125C, F200, F80C, F80WC, SF300, SF500, SFN1000, SFN1000W		



core probes



GEV No.	379549	Ref. No.	33580149 33580149/0 CM33580149/0
description	core temperature probe PTC 1k0hm cable PVC probe -50 up to +150°C cable -10 up to 100°C probe ø6x110mm cable length 3.5m handle ø 8mm handle length 120x35mm 2-wire L1 120mm L2 130mm		
For models:	T14, T20, T20C, T20R, T5		

Hall sensors



GEV No.	402141	Ref. No.	I-1636
description	Hall sensor cable length 550mm		

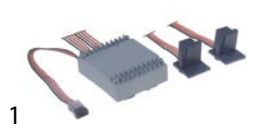

GEV No.	402140	Ref. No.	I-1637
description	Hall sensor double L 29mm W 26mm H 26mm mounting distance 10mm cable length 700mm		



GEV No.	402044	Ref. No.	29070015/0 CF62040403 CM29070015/0 CMCF62040403
description	Hall sensor L 29mm W 26mm H 26mm mounting distance 10mm cable length 1250mm		
For models:	F100, F100C, F120, F125C, F200, F80C, F80WC, SF300, SF500, SFN1000, SFN1000W		



GEV No.	402146	Ref. No.	I-1638
description	Hall sensor L 29mm W 26mm H 26mm mounting distance 10mm cable length 700mm		

accessories

miscellaneous



GEV No.	402040	Ref. No.	29015055 29015055/0 29070016 CF62040404 CM29015055/0 CMCF62040404
description	cable for level electrode cable length 1800mm		
For models:	F100, F120, F125C, F200, SF300, SF500, SFN1000, SFN1000W		

electronics

housing for PCBs

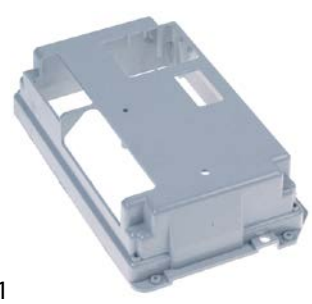

GEV No.	695663	Ref. No.	29070021/0 CF66054600 CM29070021/0 CMCF66054600
description	housing PCB L 230mm W 142mm H 57mm		
For models:	F100C		

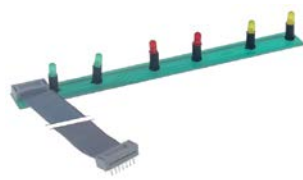

			
1			
GEV No.	694206	Ref. No.	19190397/0 CF66054700 CM19190397/0 CMCF66054700
description	lid PCB L 180mm W 110mm H 9mm		
For models:	F100, F120, F200, SF300, SF500		
accessories for	694206		
			
GEV No.	694205	Ref. No.	—
description	housing PCB L 180mm W 110mm H 40mm		

			
1			
GEV No.	401806	Ref. No.	I-1666
description	display PCB		

			
1			
GEV No.	402145	Ref. No.	33580084/0 CM33580084/0
description	display PCB for ice maker cable length 1500mm with LED		

			
1			
GEV No.	694796	Ref. No.	29015057/0 CM29015057/0
description	lid PCB L 205mm W 125mm H 14mm plastic		

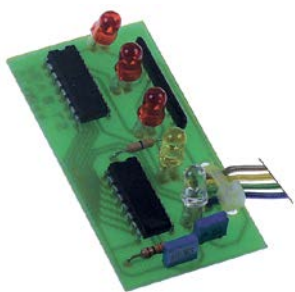
			
1			
GEV No.	401803	Ref. No.	33580174/0 CM33580174/0
description	display PCB ice maker F80C cable length 900mm with LED		
For models:	F80C, F80WC		

PCBs

			
1			
GEV No.	403455	Ref. No.	33580167/0 CM33580167/0
description	auxiliary PCB blast freezer T14 suitable for ICEMATIC		
For models:	T14, T20, T20C, T20R, T5		

			
1			
GEV No.	401805	Ref. No.	33580151/0 CM33580151/0
description	display PCB ice maker N201/N301//N501 L 170mm W 25mm		
For models:	N131M, N201M, N301M, N401M, N501M		

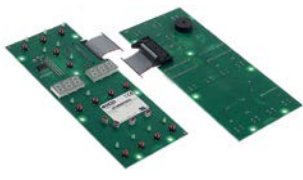
			
1			
GEV No.	403454	Ref. No.	33580168/0 CM33580168/0
description	control PCB blast freezer T5 suitable for ICEMATIC		
For models:	T14, T5		

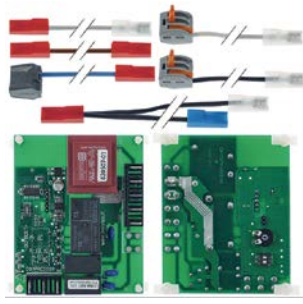
			
1			
GEV No.	403687	Ref. No.	CMCS62044100
description	electronic timer for ice maker Simag mounting measurements 90x70mm 230		

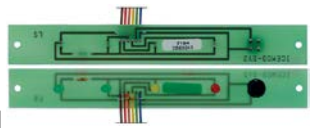

1	GEV No.	401801	Ref. No.	33580024/0 CM33580024/0
	description	keypad PCB ice maker N200/N300/N500		
	For models:	N200M, N200MW, N300M, N300MW, N500M		



1	GEV No.	401824	Ref. No.	33580123/0 CM33580123/0
	description	PCB		



1	GEV No.	401825	Ref. No.	nicht in Preisliste
	description	PCB		



1	GEV No.	401826	Ref. No.	nicht in Preisliste
	description	PCB		



1	GEV No.	402034	Ref. No.	62045602
	description	PCB		



1	GEV No.	403499	Ref. No.	33580173 33580173/0 CM33580173/0
	description	PCB 230V L 90mm W 60mm for ice maker		
	For models:	N401M, N501M		



1	GEV No.	402815	Ref. No.	33580166/0 CM33580166/0
	description	PCB blast chiller suitable for ICEMATIC		
	For models:	T14, T20, T20C, T20R, T5		



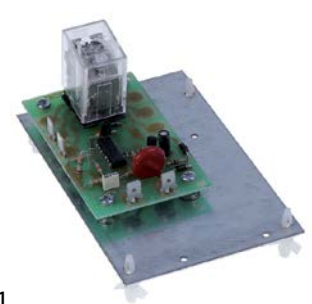

1	GEV No.	403564	Ref. No.	33580166/4 CM33580166/4
	description	PCB for blast chiller L 145mm W 120mm suitable for ICEMATIC CT1MA0802100 50/60Hz voltage input 230V		



1	GEV No.	401833	Ref. No.	nicht in Preisliste
	description	PCB for ice maker with holder 24V		





			
1			
GEV No.	401828	Ref. No.	nicht in Preisliste
description	PCB for ice maker with housing		

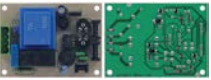

			
1			
GEV No.	401823	Ref. No.	33580056/0 CM33580056/0
description	PCB for ice-cube maker		

			
1			
GEV No.	402003	Ref. No.	CMXP62040316
description	PCB ice maker AC045/055		

			
1			
GEV No.	400055	Ref. No.	CF62047000 CMCF62047000
description	PCB ice maker ECO 45 230V		

			
1			
GEV No.	401799	Ref. No.	33580150/0 33580250/0 CM33580150/0 CM33580250/0
description	PCB ice maker N201/N301//N501 230V		
For models:	N131M, N201M, N301M, N401M, N501M		
accessories for	401799		
			
GEV No.	701450	Ref. No.	81455102/0 CM81455102/0
description	connection cable L 1300mm 2-pole level sensor suitable for ice maker connection plug plug type coded plug		

			
1			
GEV No.	403548	Ref. No.	33580191/0 CM33580191/0
description	PCB L 140mm W 92mm		

			
1			
GEV No.	403485	Ref. No.	81400124/0 CM81400124/0
description	PCB L 160mm W 95mm 230V H 45mm		
accessories for	403485		
			
GEV No.	381336	Ref. No.	33580265/0 CM33580265/0
description	probe NTC 2kOhm cable PVC probe -40 up to +110°C cable -10 up to 100°C connection plug probe ø6x60mm cable length 1.5m		
			
GEV No.	381338	Ref. No.	33580135/0 CM33580135/0
description	probe NTC 2.2kOhm cable PVC probe -40 up to +110°C cable -10 up to 100°C connection plug thread probe ø5x50mm cable length 2m		

			
1			
GEV No.	402035	Ref. No.	33580103/0 CM33580103/0
description	PCB L 190mm W 110mm 230V		

			
1			
GEV No.	403021	Ref. No.	33580064/0 CM33580064/0
description	PCB suitable for Scotsman type WSCM0252		



central units



GEV No.	402004	Ref. No.	29070012/0 81469134/0 CM29070012/0 CM81469134/0
----------------	--------	-----------------	--

description control box

For models: F100, F100C, F120, F125C, F200, F80C, F80WC, SF300, SF500, SFN1000, SFN1000W

accessories for 402004

	GEV No.	402005	Ref. No.	29070013 29070013/0 620404.10 CF62040410 CM29070013/0 CMCF62040410
--	----------------	--------	-----------------	---

temperature probe PTC 2kOhm cable TPE probe -50 up to +150°C cable -40 up to +110°C connection plug thread probe ø6x50mm cable length 1.6m

	GEV No.	402044	Ref. No.	29070015/0 CF62040403 CM29070015/0 CMCF62040403
--	----------------	--------	-----------------	--

Hall sensor L 29mm W 26mm H 26mm mounting distance 10mm cable length 1250mm

	GEV No.	402191	Ref. No.	29070014/0 CF62040401 CM29070014/0 CMCF62040401
--	----------------	--------	-----------------	--

temperature probe PTC 2kOhm cable TPE probe -50 up to +150°C cable -40 up to +110°C connection plug thread probe ø5x20mm cable length 1.8m



GEV No.	403028	Ref. No.	62040318 CMXG62040318
----------------	--------	-----------------	--------------------------

description control box



GEV No.	401841	Ref. No.	nicht in Preisliste
----------------	--------	-----------------	---------------------

description control box for ice-cube maker 24V 50-60Hz



GEV No.	401842	Ref. No.	33580122/0 CM33580122/0
----------------	--------	-----------------	----------------------------

description control box for ice-cube maker 24V 50-60Hz



GEV No.	403836	Ref. No.	81414543/0 CF62046213 CF62046215 CM81414543/0 CMCF62046213 CMCF62046215
----------------	--------	-----------------	--

description control box ice maker suitable for ICEMATIC/SCOTSMAN/SIMAG



GEV No.	403837	Ref. No.	81400264/0 CM81400264/0
----------------	--------	-----------------	----------------------------

description control box ice maker suitable for ICEMATIC/SCOTSMAN/SIMAG

1

GEV No.	403604	Ref. No.	81449089/0 CM81449089/0
description	control box kit		



1

GEV No.	402042	Ref. No.	CMXG06071100
description	control box suitable for SFT 012		



1

GEV No.	401829	Ref. No.	CF62040409 CMCF62040409
description	control box with housing for ice maker		



1

GEV No.	401832	Ref. No.	nicht in Preisliste
description	control box with housing for ice-cube maker 230V		

keypads

front foils



1

GEV No.	403447	Ref. No.	33489551 33489551/0 CM33489551/0 CM33489553/0
description	front foil blast chiller ICEMATIC		
For models:	T14, T5		

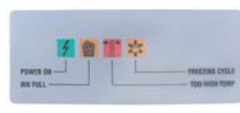

1

GEV No.	694118	Ref. No.	nicht in Preisliste enthalten
description	front foil for ice-cube maker L 134mm W 52mm		

solenoïd valves

solenoïd valves (water)

ELBI

straight



1

GEV No.	370529	Ref. No.	nicht in Preisliste
description	solenoïd valve single straight 120VAC inlet 3/4" outlet 11.5mm DN10 t.max. 60°C ELBI		
spare parts for	370529		
GEV No.	370467	Ref. No.	—
description	solenoïd valve filter suitable for ELBI		



1

GEV No.	373000	Ref. No.	19865537/0 CM19865537/0
description	solenoïd valve single straight 24V inlet 3/4" outlet 11.5mm DN10 t.max. 90°C ELBI plastic		
spare parts for	373000		
GEV No.	370467	Ref. No.	—
description	solenoïd valve filter suitable for ELBI		

angled



1

GEV No.	370530	Ref. No.	nicht in Preisliste
description	solenoïd valve single angled 120VAC inlet 3/4" outlet 11.5mm input 16l/min DN10 t.max. 60°C ELBI plastic		
spare parts for	370530		
GEV No.	370467	Ref. No.	—
description	solenoïd valve filter suitable for ELBI		



1

GEV No.	374072	Ref. No.	19863019/0 CM19863019/0
description	solenoid valve single angled 24VAC inlet 3/4" outlet 11.5mm input/ min flow regulating valve outlet blue		



1

GEV No.	374073	Ref. No.	19865534/0 CM19865534/0
description	solenoid valve single straight 24VAC inlet 3/4" outlet 13.5mm flow regulating valve inlet yellow		



1

GEV No.	374074	Ref. No.	19865507/0 CM19865507/0
description	solenoid valve single straight 220-240VAC inlet 3/4" outlet 11.5mm flow regulating valve outlet red		
For models:	N25LBI, N35BI		



1

GEV No.	370499	Ref. No.	nicht in Preisliste
description	solenoid valve 2-fold, with reducer straight 230VAC inlet 3/4" outlet 11.5mm t.max. 60°C output A 2.5 orange/min output B 2 whitel/min		



1

GEV No.	373001	Ref. No.	nicht in Preisliste
description	solenoid valve single straight 230VAC inlet 3/4" outlet 11.5mm input/min output 2l/min 50/60Hz DN10 t.max. 90°C duty cycle 100% ELBI plastic		



1

GEV No.	370461	Ref. No.	19865509/0 CM19865509/0
description	solenoid valve double straight 230VAC inlet 3/4" outlet 11.5mm input/min output -/4,7l/min DN10 t.max. 90°C ELBI plastic output B 4.7l/min flow regulating valve outlet B grey output A w/t membrane (constantly open)		
For models:	N140, N20L, N20WL, N45S, N45SW, N50BI, N50BIW, N55SW, N70SW, N90LW, N90SW		



1

GEV No.	370431	Ref. No.	19865518/0 CM19865518/0
description	solenoid valve single straight 230VAC inlet 3/4" outlet 11.5mm input/min output 2l/min DN10 t.max. 90°C ELBI plastic		
For models:	N21S		



1

GEV No.	370462	Ref. No.	19865538/0 CM19865538/0
description	solenoid valve double straight 230VAC inlet 3/4" outlet 11.5mm input/min output 0,5/-l/min DN10 plastic output A 0.5l/min		
For models:	F80C, F80WC, N21S, N45S, N45SW, N55LW		



1

GEV No.	370414	Ref. No.	19865502/0 CM19865502/0
description	solenoid valve single straight 230VAC inlet 3/4" outlet 11.5mm output 2l/min 50/60Hz t.max. 90°C ELBI plastic flow regulating valve outlet white		
For models:	N131M, N140, N201M, N20L, N20WL, N25BI, N25L, N25LW, N25S, N25SW, N301M, N35S, N35SW, N401M, N45S, N45SW, N501M, N50BI, N50BIW, N55L, N55LW, N55S, N55SW, N70S, N70SW, N90L, N90LW, N90S, N90SW		



1

GEV No.	370433	Ref. No.	65010551
description	solenoid valve double straight 230VAC inlet 3/4" outlet 11.5mm input/min output 2/2.5l/min DN10 t.max. 90°C ELBI plastic output A 2l/min output B 2.5l/min flow regulating valve outlet A white flow regulating valve outlet B orange		

1

GEV No.	370526	Ref. No.	nicht in Preisliste
description	solenoid valve double straight 230VAC inlet 3/4" outlet 11.5mm input/min output 2.2l/min DN10 t.max. 60°C ELBI output A 2 whitel/min output B 2 whitel/min		



1

GEV No.	370494	Ref. No.	nicht in Preisliste
description	solenoid valve single angled 240VAC outlet 14.5mm inlet 1/4"mm		

ROBERTSHAW/INVENSYS

medium temperature: 90°C 90°C 60°C
 ambient temperature: 60°C 25°C 60°C
 duty cycle: 40% 100% 100%

various



1

GEV No.	371105	Ref. No.	nicht in Preisliste
description	solenoid valve angled 240VAC inlet 3/8" outlet 3/8" EATON (INVENSYS) type K-63314-12		



1

GEV No.	371104	Ref. No.	nicht in Preisliste
description	solenoid valve angled 240VAC inlet 3/8" outlet 3/8" SINGER		



1

GEV No.	371259	Ref. No.	nicht in Preisliste
description	solenoid valve single angled 230VAC inlet 11.5 outlet 11.5mm DN7 plastic		

RPE

special outlet



1

GEV No.	370453	Ref. No.	19865532/0 19865598/0 CM19865532/0 CM19865598/0
description	solenoid valve single angled 230VAC inlet 11.5mm outlet 11.5mm RPE		
For models:	N131M, N200M, N200MW, N300M, N300MW		

solenoid valves with reducers

single



1

GEV No.	374075	Ref. No.	400UMIVALV CM400UMIVALV
description	solenoid valve single angled 230VAC inlet 3/4" outlet 10mm input 18.5-20l/min output 1.0-1.25l/min DN10 RPE flow regulating valve outlet white flow regulating valve inlet white		

TP

solenoid valves with reducers



1

GEV No.	370416	Ref. No.	19865530/0 CM19865530/0
description	solenoid valve double straight 230VAC inlet 3/4" input/min output 1.2/1.2l/min DN10 t.max. 90°C TP plastic outlet 11.5mm output A 1.2l/min output B 1.2l/min flow regulating valve outlet A dark brown flow regulating valve outlet B dark brown		
For models:	N20L, N20WL, N25LW, N25SW, N35SW		

1

GEV No.	370422	Ref. No.	nicht in Preisliste enthalten
description	solenoid valve double straight 230VAC inlet 3/4" t.max. 90°C TP plastic outlet 11.5mm output A 2.5l/min flow regulating valve outlet A yellow flow regulating valve outlet B brown		



1

GEV No.	370527	Ref. No.	nicht in Preisliste
description	solenoid valve single straight 220-240VAC inlet 3/4" outlet 11.5mm output 0.8l/min TP plastic flow regulating valve outlet white 8VA		

various



1

GEV No.	370491	Ref. No.	nicht in Preisliste
description	solenoid valve single 240VAC inlet 3/4" outlet 11.5mm		



1

GEV No.	370493	Ref. No.	nicht in Preisliste
description	solenoid valve single angled 24V outlet 11.5mm EATON (INVENSYS) plastic inlet 5/8" UNFmm		



1

GEV No.	370496	Ref. No.	19865525/0 CM19865525/0
description	solenoid valve straight 220VAC outlet 14mm plastic inlet 14mm		
For models:	N401M, N501M		

metal

PARKER

spare parts and accessories

solenoid coils



1

GEV No.	371098	Ref. No.	CF62030648 CMCF62030648
description	solenoid coil 220-230VAC 50/60Hz seat ø 14mm cable length 1000mm 14W		



1

GEV No.	371029	Ref. No.	19053102/0 CM19053102/0	
description	solenoid coil PARKER 230VAC 9VA coil type ZB09 seat ø 14mm H 33mm W 34mm D 43mm			
For models:	N21S, N25BI			
accessories for	371029			
	GEV No.	371090	Ref. No.	—
	power socket plug type DIN 43650A screw			

drain valves



1

GEV No.	371106	Ref. No.	nicht in Preisliste
description	drain solenoid valve 208/230V single inlet 17.5mm outlet 16mm EATON (INVENSYS) plastic		





1

GEV No.	370790 ¹	Ref. No.	19863018/0 CM19863018/0 KITVSCOMPO
description	drain solenoid valve 24V 50/60Hz inlet 12.5mm outlet 15.5mm t.max. 40°C CEME brass L 110mm 1/1-ways DN 8mm voltage AC coil type 5704 kit p max 0.2bar p min 0bar slide-on receptacle compact 20°C body plastic incl. hose clamp and mounting screws		

¹with accessories



 <p>1</p>			
GEV No.	370620	Ref. No.	19865597/0 CM19865597/0
description	solenoid valve 220-240V inlet 17.5mm outlet 15.5mm EATON (INVENSYS)		

 <p>1</p>			
GEV No.	370691	Ref. No.	19865525 19865597 19865597/0 81454760/0 CM19865597/0 CM81454760/0
description	solenoid valve angled 220-240V kit inlet 17.5mm outlet 16mm		
For models:	N201M, N301M, N500M, N501M		

 <p>1</p>			
GEV No.	370540	Ref. No.	nicht in Preisliste
description	solenoid valve angled 240V 50/60Hz outlet 9/16" UNF plastic inlet 9/16" UNF		

solenoid valves (refrigeration)

ALCO

valves

with pipe clamp

 <p>1</p>			
GEV No.	370492	Ref. No.	nicht in Preisliste
description	solenoid valve 24V		

 <p>1</p>			
GEV No.	370535	Ref. No.	nicht in Preisliste
description	solenoid valve straight type 200RB5T4 230V p max 34.5bar connection 12.7mm soldering connection		

 <p>1</p>			
GEV No.	370534	Ref. No.	nicht in Preisliste
description	solenoid valve type 200RB3T3 230V tube ø 9.5mm L 118mm hot gas		

CASTEL

valves

 <p>1</p>			
GEV No.	370403	Ref. No.	19863034/0 CM19863034/0
description	solenoid valve NC CASTEL 230V p max 45bar connection 10mm soldering connection -35 up to +105°C refrigeration		
For models:	N131M, N200M, N200MW, N201M, N300M, N300MW, N301M, N401M, N500M, N501M		



valve bodies

STANDARD series

suitable for refrigerants R22, R134a, R404A, R407C, R410A, R507



GEV No.	370382	Ref. No.	19863034/0 19863037/0 CM19863034/0 CM19863037/0
description	solenoid valve body NC type 1028/M105 p max 45bar connection 10mm soldering connection DN 3mm -35 up to +105°C L 125mm refrigeration straight CASTEL		
For models:	T14		
accessories for	370382		
	GEV No.	371084	Ref. No. —
	solenoid coil CASTEL 230VAC 8VA 50/60Hz connection cable 1000mm type CM2		
	GEV No.	371090	Ref. No. —
	power socket plug type DIN 43650A screw		
	GEV No.	371301	Ref. No. —
	solenoid coil CASTEL 110VAC 8VA 50/60Hz seat ø 11.5mm connection DIN 43650A type HF2		
	GEV No.	371314	Ref. No. —
	solenoid coil CASTEL 240VAC 8VA 50/60Hz seat ø 11.5mm		
	GEV No.	371321	Ref. No. —
	solenoid coil CASTEL 12/24VAC 50/60Hz seat ø 11.5mm connection DIN 43650A type HF2		

PARKER

valves



GEV No.	370415	Ref. No.	19053101/0 19863032/0 19863033/0 19863033/0+19053101/0 CM19053101/0 CM19863032/0 CM19863033/0 CM19863033/0+CM19053101/0
description	solenoid valve straight 230V pressure range 0-10bar DN2.5 connection 4mm soldering connection PARKER refrigeration		
For models:	N140, N20L, N20WL, N25BI, N25L, N25LBI, N25LW, N25S, N25SW, N35BI, N35S, N35SW, N45L, N45S, N45SW, N55L, N55LW, N55S, N55SW, N70S, N70SW, N90L, N90LW, N90S, N90SW		



GEV No.	370490	Ref. No.	19870611/0 CM19870611/0
description	solenoid valve type VE-145 230V 8 refrigeration		



GEV No.	370495	Ref. No.	19863031/0 CM19863031/0
description	solenoid valve type VE-145 230V p max 10bar pressure range 0-10bar 8 PARKER straight		

valve bodies



GEV No.	370536	Ref. No.	nicht in Preisliste
description	solenoid valve body p max 35bar connection 3/8" US PARKER for ice maker tube ø 10mm hot gas		

	GEV No.	371098	Ref. No.	CF62030648 CMCF62030648
	solenoid coil 220-230VAC 50/60Hz seat ø 14mm cable length 1000mm 14W			



GEV No.	370539	Ref. No.	nicht in Preisliste
description	solenoid valve body straight p max 35bar pressure range 21bar connection 10mm soldering connection PARKER tube ø 10mm L 150mm hot gas		





various

valve bodies



1

GEV No.	370429	Ref. No.	CF62030627 CMCF62030627 CMNM62030627
description	solenoid valve body angled DN 2.5mm connection 6mm soldering connection refrigeration		
accessories for	370429		
	GEV No.	371098	Ref. No.
			CF62030648 CMCF62030648
	solenoid coil 220-230VAC 50/60Hz seat ø 14mm cable length 1000mm 14W		



1

GEV No.	370430	Ref. No.	nicht in Preisliste
description	solenoid valve body connection 6mm soldering connection refrigeration angled 90°		



1

GEV No.	370458	Ref. No.	nicht in Preisliste
description	solenoid valve body connection 6mm soldering connection refrigeration angled 90°		



1

GEV No.	370463	Ref. No.	19863041/0 CM19863041/0
description	solenoid valve body DN 1.6mm connection 4mm soldering connection refrigeration angled 90°		
For models:	N21S		



1

GEV No.	370424	Ref. No.	CF62030622 CMCF62030622
description	solenoid valve body DN 1.9mm connection 6mm soldering connection refrigeration angled 90°		
For models:	F100C		



1

GEV No.	370454	Ref. No.	CMNM62030646
description	solenoid valve body DN 3mm connection 6mm soldering connection refrigeration angled 90°		
accessories for	370454		
	GEV No.	371033	Ref. No.
			—
	solenoid coil PARKER 230VAC 9VA coil type YB09 with cable seat ø 14mm		

Solenoid valve - accessories

filters



1

GEV No.	371101	Ref. No.	nicht in Preisliste
description	solenoid valve filter ø 20mm H 17mm suitable for ELBI		



1

GEV No.	371108	Ref. No.	nicht in Preisliste
description	body for reducer H 10mm ø 15.7mm		





1

Image not available

GEV No.	371296	Ref. No.	19190202/0 CM19190202/0
description	reducer flow rate 1.8l/min		



			
1			
GEV No.	371087	Ref. No.	nicht in Preisliste
description	solenoid coil cable length 1100mm seat ø 6.5mm		

			
1			
GEV No.	541626	Ref. No.	19550623/0 CM19550623/0
description	pressure control switching diff. 30bar reset manual pressure connection 6mm soldering connection 250V cable length 1500mm 1NC 6A		
For models:	T14, T5		

pressure switches

for refrigeration

DANFOSS

			
1			
GEV No.	541462	Ref. No.	19550371/0 19550372/0 CM19550371/0 CM19550372/0
description	pressure control DANFOSS type KP5 60-1171 pressure connection vertical HD refrigeration reset automatic switching diff. 1.8-6bar pressure range 8-32bar connection 7/16" UNF (1/4" SAE)		
For models:	F80C, F80WC, N140, N20L, N20WL, N21S, N25LW, N25SW, N35SW, N45L, N45S, N45SW, N50BI, N50BIW, N55LW, N55S, N55SW, N70S, N70SW, N90S, N90SW		

SAGI NO MIYA

			
1			
GEV No.	541610	Ref. No.	81453749/0 CM81453749/0
description	pressure control p max 45bar type ACB-2UB135MW switch-off pressure 30bar switch-on pressure 22bar		
For models:	N131M		

JOHNSON CONTROLS

			
1			
GEV No.	541116	Ref. No.	CMXP62007500
description	pressure control HD switch pressure 10bar reset automatic switching diff. 1.1bar pressure range 7-29bar p max 38bar refrigeration type P20EA-9950C connection soldering connection 6.35mm CO JOHNSON CONTROLS pressure connection soldering connection 6.35mm		

			
1			
GEV No.	694092	Ref. No.	19550618/0 CM19550618/0
description	pressure control DANFOSS type KP5 60-5133 pressure connection vertical refrigeration reset manual switching diff. 3bar pressure range 8-32bar connection 7/16" UNF (1/4" SAE)		
For models:	T20, T20C, T20R		

			
1			
GEV No.	541117	Ref. No.	CMCF62023101 CMCS62023101
description	pressure control HD switch pressure 24bar reset manual switching diff. 4.7bar pressure range 7-29bar p max 38bar refrigeration type P20GA-9950T connection male faston 6.3mm CO JOHNSON CONTROLS pressure connection soldering connection 6.35mm		

miscellaneous

			
1			
GEV No.	542178	Ref. No.	19550628/0 CM19550628/0
description	pressure control DANFOSS pressure range 45bar pressure connection 6mm soldering connection reset low pressure 23.5 high pressure 32.5bar type ACB-2UB178 6A 250V		

			
1			
GEV No.	542135	Ref. No.	25474402/0 CM25474402/0
description	pressure control reset manual pressure connection 6mm soldering connection switching diff. 45bar 250V cable length 230mm 1NC 6A		
For models:	N201M, N301M, N401M, N501M		



electrodes



1

GEV No.	403562	Ref. No.	81455065/0 CM81455065/0
description	level electrode push-in type A39030-21 total length 120mm probe L 95mm triple connection male faston 6.3mm SS		

compressors

ACC/ZEL

R134A

HMBP monophase

High/Medium evaporation temperature above -20/-15 °C



1

GEV No.	605012	Ref. No.	19165497/0 CM19165497/0
description	compressor coolant R134a type GL45TB 220-240V 50Hz HMBP fully hermetic 8.4kg 1/6HP power input 342W cylinder capacity 4.5cm ³ CSIR H 175.5mmW 76W 101W 134W 175W 223W 278W 342W 413W test method ASHRAE ambient temperature max. 43°C		
For models:	N20L, N20WL, N25SW		



1

GEV No.	605008	Ref. No.	CM19165851/0
description	compressor coolant R134a type GL80TB 220-240V 50Hz HMBP fully hermetic 9.5kg 1/5HP power input 554W cylinder capacity 7.6cm ³ CSIR H 175.5mm 165W 215W 290W 390W 500W 615W 727W 840W test method ASHRAE ambient temperature max. 43°C		



1

GEV No.	605009	Ref. No.	19165548/0 CM19165548/0
description	compressor coolant R134a type GL90TB 220-240V 50Hz HMBP fully hermetic 10.8kg 1/4HP power input 293W cylinder capacity 8.8cm ³ CSIR H 175.5mmW 143W 194W 259W 339W 432W 539W 661W 796W test method ASHRAE		
For models:	F100C, F80C, F80WC, N35BI, N35S, N35SW, N45L, N45S, N45SW		

CUBIGEL

accessories



1

GEV No.	380576	Ref. No.	CF62005731 CMCF62005731
description	start relay		
For models:	F100, F120		



1

GEV No.	380586	Ref. No.	CM62005732 CMCM62005732
description	start relay 120/240V voltage AC 8A 1NO		
For models:	N21S, N25L, N25LBI, N25LW		



1

GEV No.	380822	Ref. No.	nicht in Preisliste
description	start relay 120/240V voltage AC 8A 1NO		



1

GEV No.	380575	Ref. No.	nicht in Preisliste
description	start relay MTRP5631		

EMBRACO / ASPERA

R404a/R507

LBP monophase

Lower evaporation temperature below -20°C



1

GEV No.	605174	Ref. No.	CM19165559/0
description	compressor coolant R404a/R507 type NJ2192GK 220-240V 50Hz LBP 20.4kg 1 1/4HP cylinder capacity 26.2cm ³ CSR H 265mm 685W 989W 1342W 1745W 2196W 2196WWWWW		



1

GEV No.	605081	Ref. No.	CM19166082/0
description	compressor coolant R404a/R507 type NJ2212GK 220-240V 50Hz LBP fully hermetic 21.5kg 1 1/2HP power input 1150W cylinder capacity 34cm ³ CSR H 277mm 880W 1269W 1738W 2289W 2921W 2921WWWWW test method ASHRAE		



1

GEV No.	605164	Ref. No.	CM19166086/0
description	compressor coolant R404a/R507 type NT2178GK 220-240V 50Hz LBP 17kg 1HP cylinder capacity 17.4cm ³ CSR H 220mm 442W 610W 808W 1032W 1285W 1565WWWWW		

HMBP monophase

High/Medium evaporation temperature above -20/-15 °C



1

GEV No.	605139	Ref. No.	CM19166076/0
description	compressor coolant R404a/R507 type EMT6165GK 220-240V 50Hz HMBP 7.92kg 1/4HP cylinder capacity 5.19cm ³ CSIR H 180mmWW 315W 384W 477W 570W 689W 808W test method ASHRAE		

L'UNITE HERMETIQUE / TECUMSEH

R134A

HBP monophase

High evaporation temperature above -15°C



1

GEV No.	605095	Ref. No.	19165556/0 19165643/0 CM19165643/0
description	compressor coolant R134a type AE4450Y-FZ 220-240V 50Hz HBP fully hermetic 11.5kg 3/8HP cylinder capacity 13.2cm ³ CSIR H 206mmWWW 526W 672W 843W 1042W 1273W 1540W test method EN 12900		
For models:	N55L, N55LW, N55S, N55SW, N70S, N70SW		



1

GEV No.	605184	Ref. No.	CM19165587/0
description	compressor coolant R134a type THB4419YFZ 220-240V 50Hz HBP fully hermetic 7kg 1/6HP power input 227W cylinder capacity 5.2cm ³ CSIR H 228mmWWW 195W 245W 300W 362W 408W 499W ambient temperature max. 32°C		



HMBP monophase

High/Medium evaporation temperature above -20/-15 °C



1

GEV No.	605173	Ref. No.	CM19165636/0
description	compressor coolant R134a type AE4430Y-FZ1A 220-240V 50Hz HMBP 9.7kg 1/4HP cylinder capacity 8cm ³ CSIR H 200mmWW 294W 382W 488W 613W 760W 930W 1127W		



1

GEV No.	605172	Ref. No.	CM19165569/0
description	compressor coolant R134a type CAJ4492Y-F 220-240V 50Hz HMBP 22kg 3/4HP cylinder capacity 25.95cm ³ CSIR H 271mmWW 584W 871W 1215W 1617W 2078WW		
spare parts for	605172		
	GEV No.	501548	Ref. No. —
	terminal box for compressor		



1

GEV No.	605098	Ref. No.	19165570/0 CM19165570/0
description	compressor coolant R134a type AE4460Y-FZ 220-240V 50Hz HMBP fully hermetic 12.2kg 1/2HP cylinder capacity 15.09cm ³ CSR H 211mmWWW 660W 838W 1040W 1280W 1540W 1840W test method EN 12900		
For models:	N90L, N90LW, N90S, N90SW		

R404A

HMBP monophase

High/Medium evaporation temperature above -20/-15 °C



1

GEV No.	605158	Ref. No.	CM19165644/0
description	compressor coolant R404A type AE4470Z 220-240V 50Hz HMBP fully hermetic 13.7kg 1/2HP cylinder capacity 12cm ³ CSR H 207mmW 670W 843W 1035W 1251W 1495W 1773W 2088W 2447W		



1

GEV No.	605137	Ref. No.	19165591/0 CM19165591/0
description	compressor coolant R134a type AEZ4430Y 220-240V 50Hz HMBP fully hermetic 10.2kg 1/4HP power input 330W cylinder capacity 8.8cm ³ CSIR H 199mmWW 245W 328W 432W 558W 698WW		



1

GEV No.	605027	Ref. No.	CM19165630/0
description	compressor coolant R404A type CAJ4517Z 220-240V 50Hz HMBP fully hermetic 24kg 1.2HP cylinder capacity 25.95cm ³ CSR H 282mmWW 1588W 1987W 2451W 2971W 3536W 4132W test method EN 12900 4742W		



GEV No.	605065	Ref. No.	81453661 81453661/0 CF67009905 CM19165594/0 CM81453661/0 CMCF67009905
description	compressor coolant R404A type CAJ4519Z 220-240V 50Hz HMBP 24kg 1.5HP cylinder capacity 34.4cm ³ CSR H 282mmWWW 1769W 2353W 3009W 3756W 4360W 5200W		
For models:	N301M, SF500		



GEV No.	605070	Ref. No.	CM19165631/0
description	compressor coolant R404A type CAJ9513Z 220-240V 50Hz HMBP fully hermetic 23kg 1.1HP cylinder capacity 24.2cm ³ CSR H 282mmW 930W 1269W 1654W 2086W 2568W 3096W 3671W test method EN 12900 4278W		



GEV No.	605026	Ref. No.	CM19165632/0
description	compressor coolant R404A type CAJ9480Z 220-240V 50Hz HMBP fully hermetic 22kg 3/4HP cylinder capacity 15.2cm ³ CSR H 271mm 393W 571W 774W 1009W 1284W 1607W 1989W 2334W test method EN 12900 2699W		

accessories

starting relays

klixons



GEV No.	380582	Ref. No.	nicht in Preisliste
description	start relay Klixon 131 15A series 9660B		



GEV No.	605032	Ref. No.	CM19165554/0 CM19165596/0
description	compressor coolant R404A type CAJ9510Z 220-240V 50Hz HMBP fully hermetic 23kg 1HP cylinder capacity 18.3cm ³ CSR H 282mm 527W 732W 970W 1252W 1583W 1972W 2437W 2826W test method EN 12900 3220W		



GEV No.	380583	Ref. No.	nicht in Preisliste
description	start relay Klixon 145 series 9660B		



GEV No.	380586	Ref. No.	nicht in Preisliste
description	start relay Klixon 170 15A series 9660A		

RBM





GEV No.	380595	Ref. No.	nicht in Preisliste
description	start relay RBM 128306-1645PB		



			
1			
GEV No.	380594	Ref. No.	nicht in Preisliste
description	start relay RBM 128306-1653VB		

miscellaneous

			
1			
GEV No.	380587	Ref. No.	nicht in Preisliste
description	start relay 230V 1NC connection male faston 6.3mm		

			
1			
GEV No.	380581	Ref. No.	nicht in Preisliste
description	start relay 230V 1NO/1NC connection male faston 6.3mm with strap dimensions 45x50x42mm		

overload protector (klixon)

			
1			
GEV No.	390654	Ref. No.	nicht in Preisliste
description	overload protector		

			
1			
GEV No.	390651	Ref. No.	nicht in Preisliste
description	overload protector for engine protective circuit breaker MRA38031-3007 with cable t.max. 145°C reset automatic		

			
1			
GEV No.	390544	Ref. No.	nicht in Preisliste
description	overload protector for engine protective circuit breaker T0168/22 with cable t.max. 150°C reset automatic		

			
1			
GEV No.	390608	Ref. No.	nicht in Preisliste
description	overload protector for engine protective circuit breaker T0418/A4		

			
1			
GEV No.	390640	Ref. No.	CF62005878 CMCF62005878
description	overload protector for engine protective circuit breaker with cable reset automatic		
For models:	SF300		

			
1			
GEV No.	390666	Ref. No.	nicht in Preisliste
description	overload protector for engine protective circuit breaker L140-20F 8926 cable length 90mm		



fans

refrigeration fans

refrigeration motors universal

ELCO

N series - multi fit



1

GEV No.	601427	Ref. No.	18562496/0 29020001 29020003 CF62041902 CM18562496/0 CMCF62041902
description	fan motor ELCO 10W 230V 50/60Hz bearing slide bearing L1 49mm L2 59mm L3 86.5mm W 83mm connection cable 500mm 1300/1550rpm 5 mounting options VNT10-20/028		
For models:	F100, F100C, F120, F200, N35S, N35SW, N45L		
spare parts for	601427		
	GEV No.	560140	Ref. No. —
	hexagonal nut thread M4 H 4.8mm SS WS 7 Qty 20 pcs DIN/ISO DIN 985 self-locking		
	GEV No.	560332	Ref. No. —
	plain washer ID ø 4.3mm ED ø 9mm thickness 0.8mm SS Qty 1 pcs		
	GEV No.	560340	Ref. No. —
	hexagonal nut thread M4 H 3.2mm WS 7 SS DIN/ISO DIN 934 / ISO 4032/8673 Qty 1 pcs		
	GEV No.	601413	Ref. No. —
	fixing plate suitable for fanwheel ED ø 32mm shaft ø 7 mounting distance 26mm		



1

GEV No.	601528	Ref. No.	CF62041904 CMCF62041904
description	fan motor ELCO 16W 230V 50/60Hz bearing slide bearing L1 48mm L2 64mm L3 91.5mm W 83mm connection cable 500mm 1300/1550rpm 5 mounting options VNT16-25/029		
For models:	SF300		
spare parts for	601528		
	GEV No.	601413	Ref. No. —
	fixing plate suitable for fanwheel ED ø 32mm shaft ø 7 mounting distance 26mm		



1

GEV No.	601530	Ref. No.	29020005
description	fan motor ELCO 34W 230V 50/60Hz bearing slide bearing L1 55.5mm L2 91.5mm L3 119mm W 83mm connection cable 500mm 1300/1550rpm 5 mounting options VNT34-45/031		
spare parts for	601530		
	GEV No.	601413	Ref. No. —
	fixing plate suitable for fanwheel ED ø 32mm shaft ø 7 mounting distance 26mm		

N series - standard



1

GEV No.	601527	Ref. No.	18562058/0 CM18562058/0
description	fan motor 16W 230V 50/60Hz W 84mm 1300rpm VN16-38		
For models:	N200M, N200MW, N300M, N300MW		

miscellaneous



1

GEV No.	601431	Ref. No.	29020005 CF62041906 CMCF62041906
description	fan motor 35W 230V		
For models:	SF500		

1

GEV No.	601524	Ref. No.	18562524 18562524/0 CM18562524/0
description	fan motor 35W 230V 50/60Hz L3 153mm W 83mm cable length 1600mm 1300rpm with capacitor capacitor 2.5µF		
For models:	N131M, N201M, N301M, N401M, N501M		



1

GEV No.	601545	Ref. No.	I-1013
description	fan motor 7W 220-240V 50-60Hz L3 101mm W 85mm		
spare parts for	601545		
	GEV No.	601413	Ref. No. —
	fixing plate suitable for fanwheel ED ø 32mm shaft ø 7 mounting distance 26mm		

accessories

fan wheels

aluminium

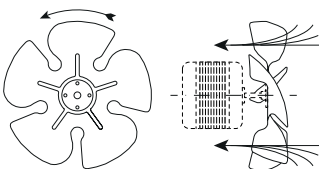



1

GEV No.	601282	Ref. No.	18740031/0 CM18740031/0
description	fan wheel sucking ø 200mm fan wheel mounting 25.4mm blade angle 34° W 44mm aluminium		

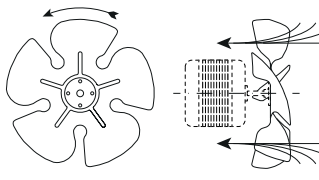

1

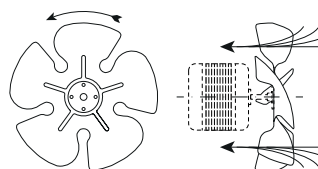

GEV No.	601387	Ref. No.	62041934
description	fan wheel sucking ø 254mm fan wheel mounting 25.4mm blade angle 34° W 50mm aluminium		

1

GEV No.	601555	Ref. No.	CF62000001 CF62041936 CMCF62000001 CMCF62041936
description	fan wheel sucking ø 300mm fan wheel mounting 25.4mm blade angle 25° W 45mm aluminium		
For models:	SF500		

1

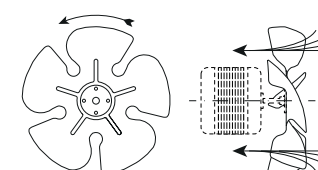
GEV No.	601410	Ref. No.	18740032/0 CM18740032/0
description	fan wheel sucking ø 300mm fan wheel mounting 25.4mm blade angle 28° W 45mm aluminium		
For models:	N401M, N501M		

aluminium

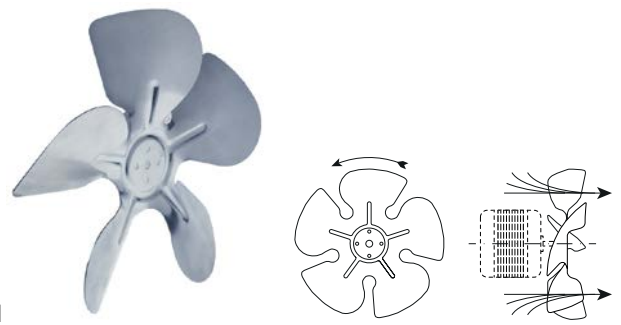

1

GEV No.	601556	Ref. No.	18740040/0 CM18740040/0
description	fan wheel blowing ø 254mm fan wheel mounting 25.4mm blade angle 31° W 46mm aluminium		

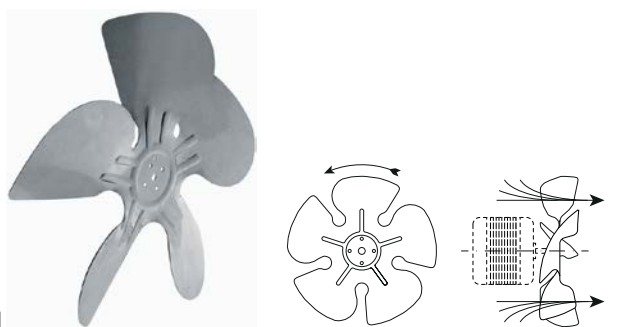

1

GEV No.	602041	Ref. No.	18740042/0 CM18740042/0
description	fan wheel blowing ø 300mm fan wheel mounting 25.4mm blade angle 31° W 58mm aluminium		

cooling motors (complete)



1

GEV No.	601526	Ref. No.	18562065/0 CM18562065/0
description	fan 230V 10W 50Hz fan wheel ø 200mm shaft L 13mm L 76mm W 83mm connection cable cable length 500mm		
For models:	N500M		
spare parts for	601526		
	GEV No.	601070	Ref. No. —
	fan wheel sucking ø 200mm fan wheel mounting 25.4mm blade angle 28° W 38mm aluminium		



1

GEV No.	601557	Ref. No.	I-160
description	fan 230V 5W 50-60Hz fan wheel ø 200mm feet depth 60mm L 83mm W 92mm H 66mm blade angle 28° connection with cable mounting distance 75mm		
For models:	N1, N1W, N2, N2W, N3, N3S, N3W, N4, N5		



1

GEV No.	694178	Ref. No.	18562517/0 CM18562517/0
description	fan 220-240V 16W 50-60Hz fan wheel ø 250mm connection with cable mounting distance 300mm		
For models:	N140, T5		

cold air circulating fans (complete)

ebm-papst

A4E series

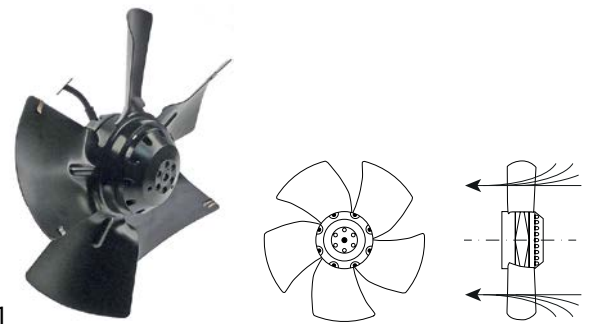

1

GEV No.	602026	Ref. No.	18562532/0 CM18562532/0
description	fan A4E300-AA01-57 fan wheel ø 300mm blades 5 230V 50/60Hz 95/105W 1350/1450rpm cable length 2030mm ebm-papst sucking suitable capacitor 3µF		
For models:	T14, T20, T20C, T20R, T5		
spare parts for	602026		
	GEV No.	365137	Ref. No. —
	capacitor capacity 3µF 450V tolerance 5% 50/60Hz ambient temperature max. -25 to +85°C ø 25mm L 56mm M8 plastic connection cable 250mm 416.17.77GF protection		

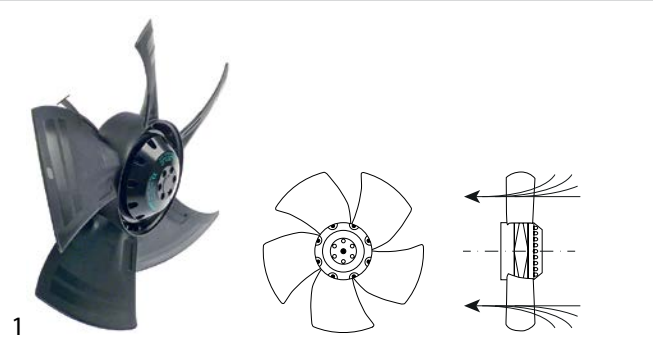
GEV No.	602024	Ref. No.	18562576/0 CM18562576/0
description	fan A4E300-AS72-07 fan wheel ø 300mm blades 5 230V 50/60Hz 72/90W 1320/1500rpm cable length 2030mm ebm-papst sucking suitable capacitor 2µF		
spare parts for	602024		
	GEV No.	365170	Ref. No. —
	 capacitor capacity 2µF 425V tolerance 5% 50/60Hz ambient temperature max. -25 to +85°C ø 25mm L 49mm M8 plastic connection cable 250mm 416.17.74 protection		

COPREL

MAP series

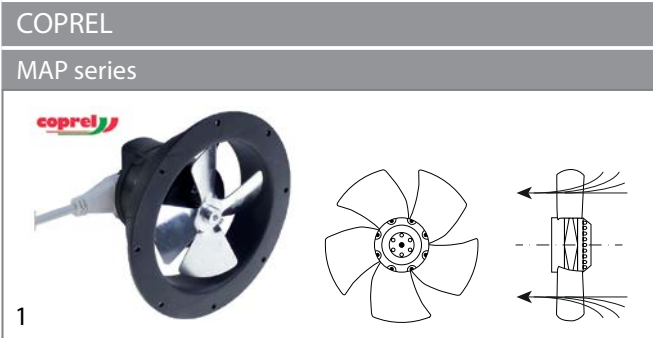

GEV No.	601039	Ref. No.	185602055
description	fan sucking 230V 9W 50/60Hz fan wheel ø 96mm shaft L 20mm connection with cable for saladette		

HIDRIA



GEV No.	602029	Ref. No.	18562559/2 CM18562559/2 CM18562559/3
description	fan type R09R-30SPB-4M-3509 fan wheel ø 300mm 230V 50/60Hz 80W ø 105mm suitable capacitor 2.5µF HIDRIA suitable for blast chiller 1370rpm H 90mm cable length 1800mm mounting distance 255mm		

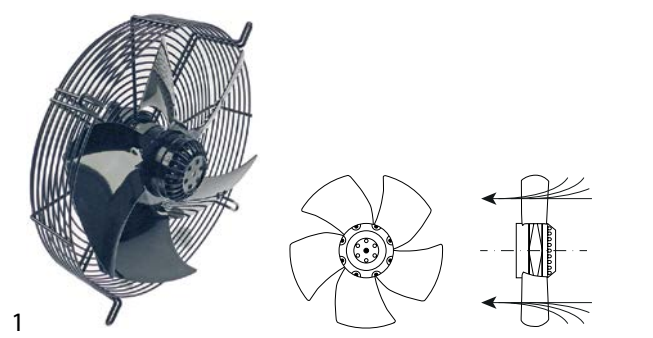

GEV No.	602009	Ref. No.	18562519/0 CM18562519/0
description	fan type R09R-3530HA-4M-4237 fan wheel ø 350mm 230V 50/60Hz 130/165W HIDRIA 1290/1380rpm sucking H 155mm cable lengthmm mounting distance 315mm		
For models:	T14, T20, T20C, T20R		

cold air circulating fans (other)



GEV No.	601554	Ref. No.	29020006/0 CF62027300 CM29020006/0 CMCF62027300
description	fan motor 230V 50-60Hz 100W W 105mm H 105mm D 220mm shaft L 80mm shaft ø 12mm EURO MOTORS type 10111-40100 cable length 1500mm 1100rpm		
For models:	SFN1000, SFN1000W		

cooling fans



GEV No.	602025	Ref. No.	18562012/0 CM18562012/0
description	fan 230V 50Hz 27.5W W 110mm H 125mm D 110mm Emmevi type 202001		



radial fans

miscellaneous



1

GEV No.	601523	Ref. No.	18562480/0 CM18562480/0
description	radial fan 230V voltage AC 50Hz 50W H1 175mm L1 165mm D1 ø 83mm W1 160mm W2 73mm H2 60mm W3 82mm H3 96mm		
For models:	N50BI, N50BIW		



1

GEV No.	500786	Ref. No.	81404024/0 CM81404024/0
description	float motor LIP 11W 230V 50Hz 1rpm shaft ø 8mm W 100mm H 90mm for ice maker L 130mm		
For models:	N20L, N20WL, N25BI, N25L, N25LBI, N25LW, N25S, N25SW, N35BI, N35S, N35SW, N45L		
spare parts for	500786		
	GEV No.	695670	Ref. No. 25260000/0 CM25260000/0
disc for pan tilting ø 100mm shaft intake ø 7mm			

motors

gear motors

for ice-cube maker

for paddles



1

GEV No.	500407	Ref. No.	19440059/0 19440059/1 CM19440059/0 CM19440059/1
description	gear motor LIP type 123MR 8W 220/240V voltage AC 50/60Hz 50rpm turn direction counterclockwise shaft ø 4mm shaft intake ø 6.2mm groove width 2.3mm shaft L 8mm shaft ø 4mm W 74mm		
For models:	N140, N20L, N20WL, N25BI, N25L, N25LBI, N25LW, N25S, N25SW, N35BI, N35S, N35SW, N45L, N45S, N45SW, N50BI, N50BIW, N55L, N55LW, N55S, N55SW, N70S, N70SW, N90L, N90LW, N90S, N90SW		



1

GEV No.	500409	Ref. No.	19440058 19440063/0 19440069/0 81404001/0 CM19440063/0 CM19440069/0 CM81404001/0
description	float motor LIP type 001 11W 220/240V voltage 50/60 0.7rpm shaft ø 7mm shaft length 20mm W 71mm H 62mm L 110mm		

for sumps



1

GEV No.	500410	Ref. No.	19440065/0 CM19440065/0
description	float motor LIP 11W 230V 50Hz 0.7rpm shaft ø 7mm shaft length 20mm W 72mm H 110mm 010		
For models:	N140, N70S, N70SW, N90L, N90LW, N90S, N90SW		



1

GEV No.	500411	Ref. No.	19440057/0 CM19440057/0
description	gear motor BITRON type 97103 11W 230V 50Hz 0.7rpm shaft ø 7mm shaft length 30mm W 72mm H 60mm L 116mm		

1

GEV No.	500412	Ref. No.	19440073/0 CM19440073/0
description	gear motor LIP type 021B 11W 230V 50Hz 1rpm shaft ø 7mm shaft length 20mm W 74mm D 67mm H 110mm for sump		



1

GEV No.	499089	Ref. No.	81413011/0 CM81413011/0
description	gear motor LIP type 10 11W 220/240V 50/60Hz 0.7rpm shaft ø 8mm for ice maker		



1

GEV No.	500756	Ref. No.	81442072/0 CM81442072/0
description	gear motor LIP type 10 11W 220/240V voltage AC 50/60Hz 0.7rpm shaft ø 8mm W 118mm H 88mm for ice maker L 130mm		
For models:	N140		



1

GEV No.	501480	Ref. No.	81400006/0 CM81400006/0
description	gear motor type ST0676 11W 220/240V voltage AC 50/60Hz 1rpm shaft ø 8mm W 80mm D 93mm H 112mm for ice maker		

miscellaneous



1

GEV No.	601539	Ref. No.	81401520/0 CM81401520/0
description	gear motor LIP type 049E 80W 230V 50Hz 13rpm shaft ø 18mm L 160mm W 74mm H 160mm for auger		



1

GEV No.	499077	Ref. No.	29030005/0 79422513 79422513R CF79422513 CF79422513R CM29030005/0 CMCF79422513 CMCF79422513R
description	gear motor type 794225 220V voltage AC 50/60Hz shaft ø 22.2mm L 260mm W 150mm H 245mm for ice maker 120W		
For models:	F100, F100C, F120, F125C, F200, F80C, F80WC		

motors

for ice-cube maker

rotors



1

GEV No.	500751	Ref. No.	nicht in Preislisten enthalten
description	rotor ø 65mm shaft ø 13mm shaft length 180mm for flake ice maker		



stators



1

GEV No.	695826	Ref. No.	29000010/0 CF62029500 CM29000010/0 CMCF62029500
description	stator 230V 50/60Hz 1 phase ø 135mm ID ø 80mm H 45mm with housing		
For models:	SF300, SF500, SFN1000, SFN1000W		

pumps for ice machines



1

GEV No.	500781	Ref. No.	I-1029
description	fan motor 11W 230V 50-60Hz L 83mm W 83mm H 75mm shaft ø 7mm		

pumps

drain pumps

HANNING



1

GEV No.	500757	Ref. No.	95005643/0 CM95005643/0
description	drain pump inlet ø 18mm outlet ø 20mm 230V 50Hz HANNING		



1

GEV No.	501491	Ref. No.	18562001/0 CM18562001/0
description	pump 230V 50/60Hz connection cable TRIAL L 218mm W 60mm H 60mm shaft ø 6mm shaft length 155mm		



1

GEV No.	500759	Ref. No.	nicht in Preisliste enthalten
description	pump GRE 30W 230V 60Hz outlet ø 12.5mm L 137mm rotation direction right for ice maker		

miscellaneous



1

GEV No.	501490	Ref. No.	CMUMPOMPA943
description	drain pump inlet ø 24mm outlet ø 24mm		



1

GEV No.	500597	Ref. No.	19550109 19550109/0 CM19550109/0 CMXG62043003
description	pump GRE type MH50F 60W 230V 50Hz outlet ø 21mm L 110mm rotation direction right for ice maker		





1

GEV No.	500763	Ref. No.	nicht in Preisliste
description	pump HARTELL type U21B 25W 230V 50/60Hz outlet ø 19mm L 120mm for ice maker 0.33HP capacitor 12.5µF		



1

GEV No.	499005	Ref. No.	nicht in Preisliste
description	pump HARTELL type U21B 75W 240V 50/60Hz outlet ø 12mm L 120mm for ice maker		



1

GEV No.	500047	Ref. No.	19550113/0 CM19550113/0 CMCS62043300 CMNM62043300 CMXG62043300
description	pump REBO type MH30F1 30W 230V 50Hz outlet ø 12.7mm L 135mm rotation direction left		
For models:	N131M, N201M, N21S, N301M, N401M, N501M		



1

GEV No.	500761	Ref. No.	19535157 19535157/0 CM19535157/0
description	pump REBO type MH30F1 30W 230V 50Hz outlet ø 13mm L 135mm rotation direction right for ice maker		
For models:	N200M, N200MW, N300M, N300MW		



1

GEV No.	500754	Ref. No.	19580001/0 CM19580001/0
description	pump REBO type MH50F 50W 230V 50Hz outlet ø 18mm L 135mm for ice maker		
For models:	N500M		



1

GEV No.	500048	Ref. No.	19550112/0 CM19550112/0
description	pump REBO type MH50F 60W 230V 50Hz outlet ø 18mm L 137mm rotation direction right for ice maker		



1

GEV No.	500203	Ref. No.	67000212 nicht in Preisliste
description	pump REBO type MH50F 60W 230V 50Hz outlet ø 21mm L 110mm rotation direction right for ice maker		



1

GEV No.	501481	Ref. No.	81452001/0 CM81452001/0
description	pump REBO type NR40 40W 220/240V 50Hz outlet ø 12.7mm L 275mm rotation direction left		



1

GEV No.	500046	Ref. No.	nicht in Preisliste
description	pump REBO type NR40 40W 230V 50Hz inlet ø 12mm outlet ø 12mm L 75mm rotation direction right for ice-cube maker		



pumps for drink dispensers

pump motors



GEV No.	500781	Ref. No.	I-1029
description	fan motor 11W 230V 50-60Hz L 83mm W 83mm H 75mm shaft ø 7mm		

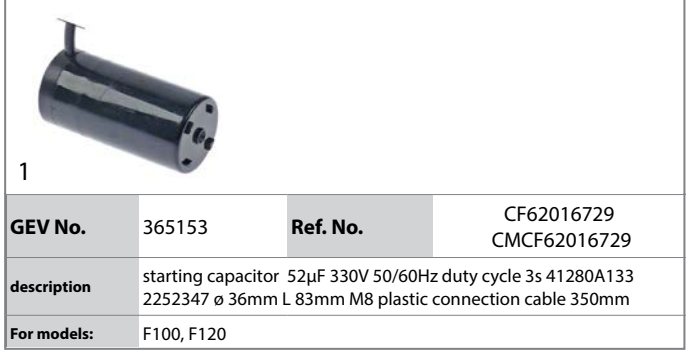

GEV No.	365153	Ref. No.	CF62016729 CMCF62016729
description	starting capacitor 52µF 330V 50/60Hz duty cycle 3s 41280A133 2252347 ø 36mm L 83mm M8 plastic connection cable 350mm		
For models:	F100, F120		

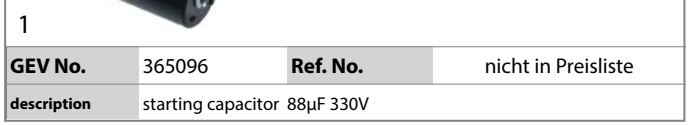

GEV No.	365096	Ref. No.	nicht in Preisliste
description	starting capacitor 88µF 330V		

condensators & interference suppression filters

starting capacitors

starting capacitors

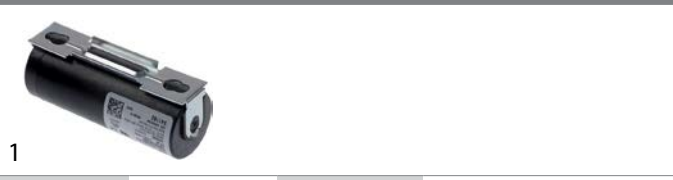

GEV No.	365102	Ref. No.	19180567/0 CM19180567/0
description	starting capacitor 330V 50Hz with resistor duty cycle 3/1.7% capacity 88µF		

starting capacitors electrolytic

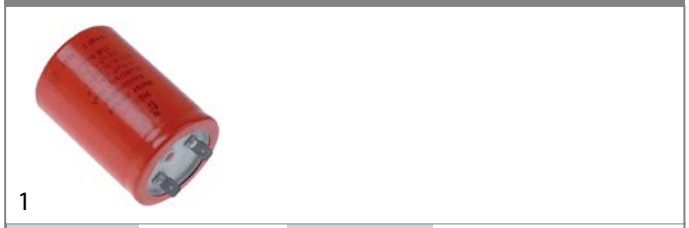

GEV No.	365098	Ref. No.	nicht in Preisliste
description	starting capacitor 320V 50/60Hz electrolytic capacity 125µF		

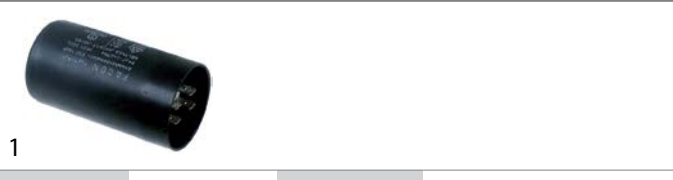

GEV No.	365094	Ref. No.	nicht in Preisliste
description	starting capacitor 330V capacity 64µF		

operating capacitors

plastic

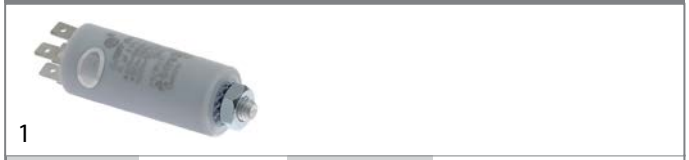

GEV No.	365031	Ref. No.	29015023/0 CF62029204 CM29015023/0 CMCF62029204
description	operating capacitor capacity 4µF 450V tolerance 5% 50/60Hz ambient temperature max. -25 to +85°C ø 31mm L 58mm M8 plastic connection male faston 6.3mm protection		
For models:	F100, F120, F125C, F200, F80C, F80WC		

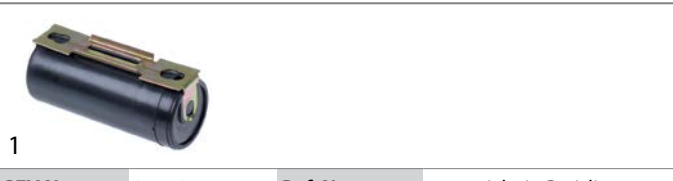

GEV No.	365101	Ref. No.	nicht in Preisliste
description	starting capacitor 330V duty cycle 1.7% capacity 125µF		

metal

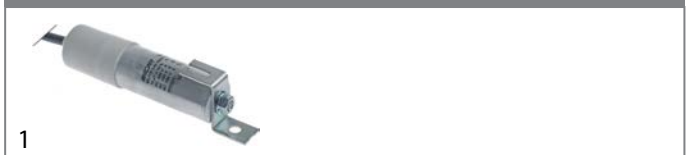



GEV No.	365204	Ref. No.	19180501/0 CM19180501/0
description	operating capacitor capacity 15µF 400V tolerance 10% 50-60Hz ambient temperature max. -40 up to +85°C ø 35mm L 135mm M8 aluminium connection cable 630mm		



GEV No.	365095	Ref. No.	CF62016729 old CMCF62016729 old
description	starting capacitor 43µF 330V 50/60Hz duty cycle 3 60A1D-330043NXET ø 36mm L 80mm M8 plastic connection cable 350mm 04P.5523CM		



			
1			
GEV No.	365099	Ref. No.	nicht in Preisliste
description	operating capacitor capacity 15µF 440V with metal case		

			
1			
GEV No.	365097	Ref. No.	19180593/0 CM19180593/0
description	operating capacitor capacity 35µF 450V with metal case 50/60Hz		
For models:	N301M		

fuses

fine fuses

			
1			
GEV No.	358509	Ref. No.	CMXP63001511
description	fine fuse size ø5x20mm 0.05A slow-acting rated 250V Qty 1 pcs		

electric accessories

cables

ribbon cables

group 1

			
1			
GEV No.	403565	Ref. No.	33580172/0 CM33580172/0
description	ribbon cable 26-pole L 1000mm		
For models:	T14, T20, T20C, T20R, T5		

group 7

			
1			
GEV No.	694212	Ref. No.	29015064/0 CM29015064/0
description	ribbon cable 3-pole L 150mm for test		

			
1			
GEV No.	401818	Ref. No.	nicht in Preisliste
description	ribbon cable 4-pole L 1000mm		

cable harnesses

			
1			
GEV No.	551435	Ref. No.	81414570/0
description	cable harness for 360665		

connection cables

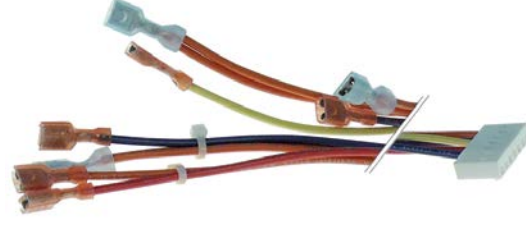
			
1			
GEV No.	401796	Ref. No.	nicht in Preisliste
description	connecting cable L 690mm connection male faston 6.3mm		

			
1			
GEV No.	701450	Ref. No.	81455102/0 CM81455102/0
description	connection cable L 1300mm 2-pole level sensor suitable for ice maker connection plug plug type coded plug		

terminals and connectors

not insulated

protective coverings

			
1			
GEV No.	358002	Ref. No.	nicht in Preisliste
description	protective covering size 6.3mm for male faston plastic		

electronic components

photo cells

			
1			
GEV No.	541608	Ref. No.	33580091/0 CM33580091/0
description	photo cell left square connection black L 40mm W 25mm H 40mm for ice maker		



			
1			
GEV No.	541611	Ref. No.	33580092/0 CM33580092/0
description	photo cell right square connection blue L 40mm W 25mm H 40mm for ice maker		

equipment-specific units

for fridges

housing and bezels

handles

			
1			
GEV No.	692590	Ref. No.	26116360/0 CM26116360/0
description	handle rod L 265mm W 16mm H 5.6mm inner part SS Qty 1 pcs		

miscellaneous

			
1			
GEV No.	694821	Ref. No.	26104012/0 CM26104012/0
description	guide bar mounting pos. left L 400mm W 45mm		

			
1			
GEV No.	694822	Ref. No.	26104013/0 CM26104013/0
description	guide bar mounting pos. right L 400mm W 45mm		

			
Image not available			
1			
GEV No.	695802	Ref. No.	81502101/0 CM81502101/0
description	sump for fridge W 585mm H 150mm D 440mm stainless steel		

for ice-cube maker

drain systems

drain fittings

			
1			
GEV No.	696583	Ref. No.	25685310/0 25685311/0 25685313/0 CM25685310/0 CM25685311/0 CM25685313/0
description	drain fitting ø 50mm thread 3/4 hose ø 21mm L 55mm straight for ice-cube maker		

drain pans

			
1			
GEV No.	696616	Ref. No.	25820129/0 CM25820129/0
description	drain pan L 160mm W 55mm H 200mm plastic		

filters

			
1			
GEV No.	695769	Ref. No.	25339002/0 CM25339002/0 CMNX66021101 CMXG66021101
description	drain filter thread 7/8" ø 32mm H 10mm		

overflow pipes

			
1			
GEV No.	695735	Ref. No.	25780153/0 CM25780153/0
description	PVC hose ID ø 10mm ED ø 14mm L 165mm chamfered		
For models:	N20L, N20WL, N25BI, N25S, N25SW		



ice breakers



1

GEV No.	695629	Ref. No.	CF75400102 CMCF75400102
description	ice breaker ID ø 26mm ED ø 51mm H 59mm brass		
For models:	F100, F100C, F120, F125C, F200, F80C, F80WC		



1

GEV No.	696436	Ref. No.	29015001 29060000 CF06072000 CMCF06072000
description	ice breaker ID ø 26mm ED ø 51mm H 59mm brass with ball bearing		



1

GEV No.	694788	Ref. No.	CF00102807 CMCF00102807
description	ice breaker ID ø 26mm ED ø 51mm H 59mm brass with ball bearing and shaft sealing		
For models:	F100, F120, F125C, F200, F80C, F80WC		

ice chutes

ice chutes



1

GEV No.	695595	Ref. No.	25250099/0 25260462/0 CM25250099/0 CM25260462/0
description	ice chute for door L 345mm W 205mm white		
For models:	N20L, N20WL, N25BI, N25S, N25SW		



1

GEV No.	695596	Ref. No.	25250106/0 CM25250106/0
description	ice chute for door L 423mm W 205mm		



1

GEV No.	694193	Ref. No.	81480086/0 CM81480086/0
description	ice chute for evaporator L 170mm W 100mm H 160mm stainless steel		
For models:	SF300, SF500		



1

GEV No.	694915	Ref. No.	25250186/0 CM25250186/0
description	ice chute for ice maker L 255mm W 205mm H 85mm plastic		



1

GEV No.	694790	Ref. No.	25250185/0 CM25250185/0
description	ice chute for ice maker L 320mm W 205mm H 85mm plastic white		



1

GEV No.	694792	Ref. No.	25250187/0 CM25250187/0
description	ice chute for ice maker L 370mm W 205mm H 85mm plastic white		

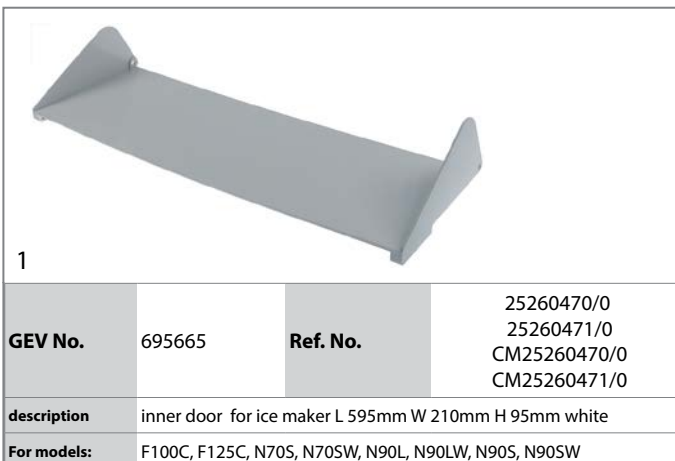
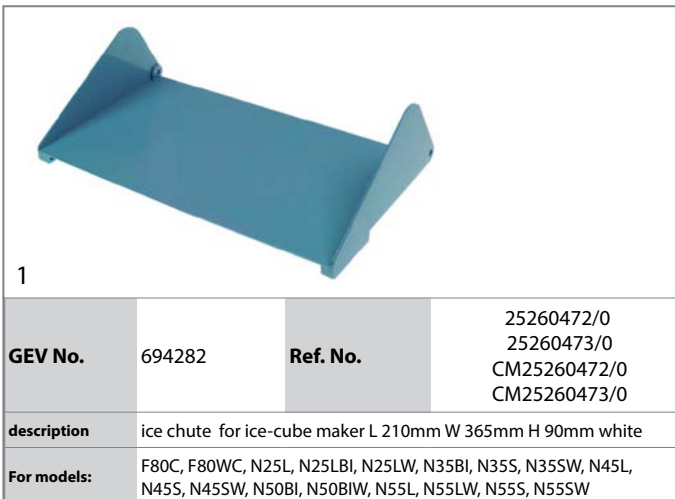



slide grates







			
1			
GEV No.	694145	Ref. No.	19680501/0 CM19680501/0
description	slide grate for ice-cube maker L 250mm W 170mm H 25mm		
For models:	N21S		

ice scoops			
			
1			
GEV No.	694819	Ref. No.	19500099/0 CM19500099/0
description	ice scoop L 155mm W 80mm H 55mm		

			
1			
GEV No.	694820	Ref. No.	19500101/0 CM19500101/0
description	ice scoop L 240mm W 150mm H 90mm		

			
1			
GEV No.	691802	Ref. No.	19500102/0 CM19500102/0
description	ice scoop L 240mm W 150mm H 92mm		
For models:	N131M, N200M, N200MW, N201M, N300M, N300MW, N301M, N401M, N501M		

			
1			
GEV No.	692591	Ref. No.	19500100/0 CM19500100/0
description	ice scoop middle L 220mm W 112mm H 70mm plastic Qty 1		
For models:	F100C, F125C, F80C, F80WC, N140, N20L, N20WL, N25L, N25LW, N25S, N25SW, N35S, N35SW, N45L, N45S, N45SW, N50BI, N50BIW, N55L, N55LW, N55S, N55SW, N70S, N70SW, N90L, N90LW, N90S, N90SW		

spare parts and accessories			
			
1			
GEV No.	695020	Ref. No.	25654016/0 CM25654016/0
description	disc for pan tilting		
For models:	N140, N20L, N20WL, N25S, N25SW, N45S, N45SW, N50BI, N50BIW, N55L, N55LW, N55S, N55SW, N70S, N70SW		

probes			
			
1			
GEV No.	694555	Ref. No.	25725450/0 CM25725450/0
description	bracket for probe L 60mm W 56mm H 18mm zinc-plated sheet steel thickness 1mm		
For models:	N131M, N200M, N200MW, N201M, N300M, N300MW, N301M, N401M, N500M, N501M		

			
1			
GEV No.	698720	Ref. No.	81400044/0 CM81400044/0
description	probe for ice maker 1-pole cable length 350mm		

			
1			
GEV No.	401764	Ref. No.	81453007 81453114/0 81453434/0 CM81453114/0 CM81453434/0
description	probe for ice thickness		
For models:	N131M, N200M, N200MW, N201M, N300M, N300MW, N301M, N401M, N500M, N501M		

			
1			
GEV No.	401800	Ref. No.	81453860/0 CM81453860/0
description	probe for ice thickness		

			
1			
GEV No.	695707	Ref. No.	81453782/0 CM81453782/0
description	probe for ice thickness		

			
1			
GEV No.	401837	Ref. No.	81453796/0 CM81453796/0
description	probe for water level 2-pole cable length 85mm		
For models:	N401M, N501M		

			
1			
GEV No.	696613	Ref. No.	81455094/0 CM81455094/0
description	sensor for ice maker		

spray systems

ICEMATIC

spray arms

			
1			
GEV No.	695705	Ref. No.	25791456/0 CM25791456/0
description	spray arm L 240mm nozzles 6 for ice maker		
For models:	N21S		

			
1			
GEV No.	694793	Ref. No.	81453460/0 CM81453460/0
description	spray arm L 335mm nozzles 15 for ice maker		
For models:	N131M		

			
1			
GEV No.	694313	Ref. No.	81453009/0 81453575/0 CM81453009/0 CM81453575/0
description	spray arm L 490mm nozzles 18 for ice maker		
For models:	N200M, N200MW, N201M, N300M, N300MW, N301M, N401M, N500M, N501M		

accessories

			
1			
GEV No.	695068	Ref. No.	25728011/0 CM25728011/0
description	end cap for ice maker insertion size 13x13mm		
For models:	N21S		

			
1			
GEV No.	695714	Ref. No.	25799001/0 CM25799001/0
description	nozzle for ice maker		
For models:	N21S		

doors

bushes

			
1			
GEV No.	695782	Ref. No.	CMNX66028600
description	bush for door ED ø 12.5mm ID ø 8.2mm L 10.8mm plastic		





 <p>1</p>			
GEV No.	694190	Ref. No.	25110805/0 CM25110805/0
description	bush for door ED \varnothing 15.6mm ID \varnothing 6mm L 10.8mm plastic		
For models:	N140		

 <p>1</p>			
GEV No.	695700	Ref. No.	25110919/0 CM25110919/0
description	bush for door ED \varnothing 8mm ID \varnothing 4.4mm L 9mm plastic		

 <p>1</p>			
GEV No.	696639	Ref. No.	19060311/0 CM19060311/0
description	bush for door hinge ED \varnothing 14mm ID \varnothing 7.2mm L 4mm plastic		

 <p>1</p>			
GEV No.	696638	Ref. No.	19060310/0 CM19060310/0
description	bush for door hinge ED \varnothing 16.8mm ID \varnothing 6.5mm L 9.5mm plastic		

 <p>1</p>			
GEV No.	696640	Ref. No.	25725554/0 CM25725554/0
description	bush for door hinge ID \varnothing 6mm L 22mm W 22mm H 14mm plastic		

 <p>1</p>			
GEV No.	695883	Ref. No.	25110114/0 CM25110114/0
description	spacer ring for door L 3.6mm stainless steel D1 \varnothing 8mm D2 \varnothing 10mm M4 with thread		
For models:	N140		

inner doors			
 <p>1</p> <p>Image not available</p>			
GEV No.	695596	Ref. No.	25250106/0 CM25250106/0
description	ice chute for door L 423mm W 205mm		

 <p>1</p>			
GEV No.	695702	Ref. No.	25260475/0 CM25260475/0
description	inner door for ice maker L 256mm W 159mm H 65mm		
For models:	N21S		

magnets			
 <p>1</p>			
GEV No.	691806	Ref. No.	19354010/0 CM19354010/0
description	door magnet \varnothing 22mm Lmm thread M5 thread L 10mm		
For models:	N140		

 <p>1</p>			
GEV No.	694787	Ref. No.	19355002/0 CM19355002/0
description	door magnet \varnothing mm L 35mm W 12mm H 15mm mounting distance 26mm thread thread Lmm		
For models:	N25BI		

			
1			
GEV No.	691808	Ref. No.	41109519/0 CM41109519/0
description	door magnet with disc ø 12mm L 13mm thread thread Lmm		
For models:	F100C, F125C, F80C, F80WC, N20L, N20WL, N25L, N25LBI, N25LW, N25S, N25SW, N35BI, N35S, N35SW, N45L, N45S, N45SW, N50BI, N50BIW, N55L, N55LW, N55S, N55SW, N70S, N70SW, N90L, N90LW, N90S, N90SW		

			
2			
GEV No.	691809	Ref. No.	19355005/0 CM19355005/0
description	door magnet with disc ø 9mm L 11mm		
For models:	N21S		

hinges

			
1			
GEV No.	694221	Ref. No.	81566732/0 CM181566732/0
description	hinge mounting pos. right shaft ø 6mm L 45mm W 40mm H 22mm		

			
1			
GEV No.	694189	Ref. No.	25130124/0 CM25130124/0
description	hinge mounting pos. upper shaft ø 4mm L 81mm		
For models:	D310		

doors

			
1			
GEV No.	694325	Ref. No.	81400692/R 81400699/0 81400699/R 81401649/0 CM81400692/R CM81400699/0 CM81400699/R CM81401649/0
description	door complete for ice maker W 400mm H 347mm thickness 25mm		
For models:	N20L, N20WL, N25S, N25SW		

			
1			
GEV No.	695679	Ref. No.	81401572/0 81401650/0 CM81401650/0
description	door complete for ice-cube maker W 448mm H 347mm thickness 20mm		
For models:	F80C, F80WC, N25L, N25LW, N35S, N35SW, N45L, N45S, N45SW, N55L, N55LW, N55S, N55SW		

			
1			
GEV No.	695743	Ref. No.	81460184/0 81460326/0 CM81460184/0 CM81460326/0
description	door for ice maker W 1080mm H 275mm thickness 16mm		

			
1			
GEV No.	696654	Ref. No.	81420505/0 81420527/0 81420528/0 CM81420528/0
description	door for ice maker W 680mm H 345mm thickness 20mm		
For models:	N70S, N70SW, N90L, N90LW, N90S, N90SW		

			
1			
GEV No.	695793	Ref. No.	81420524/0 CM81420524/0
description	door for ice maker W 680mm H 350mm thickness 20mm complete		
For models:	F100C, F125C		

1



GEV No.	695794	Ref. No.	81440455/1 81440456/0 CM81440455/1 CM81440456/0
description	door for ice maker W 880mm H 310mm thickness 20mm complete		
For models:	N140		

1



GEV No.	695669	Ref. No.	25600186/0 CM25600186/0
description	door for ice-cube maker W 335mm H 210mm thickness 20mm		
For models:	N21S		

1



GEV No.	695458	Ref. No.	nicht in Preisliste enthalten
description	door for ice-cube maker W 345mm H 195mm thickness 14mm		

1



GEV No.	695462	Ref. No.	nicht in Preisliste
description	door for ice-cube maker W 395mm H 215mm thickness 18mm		

1



GEV No.	695695	Ref. No.	25600141/0 25600174/0 25600187/0 CM25600141/0 CM25600174/0 CM25600187/0
description	door for ice-cube maker W 398mm H 345mm thickness 25mm suitable for N25S		
For models:	N20L, N20WL		

1



GEV No.	695457	Ref. No.	nicht in Preisliste
description	door for ice-cube maker W 505mm H 270mm thickness 21mm		

1



GEV No.	695716	Ref. No.	81460325/0 CM81460325/0
description	door for ice-cube maker W 805mm H 295mm		

1



GEV No.	695717	Ref. No.	81440455/1 81440456/0 CM81440455/1 CM81440456/0
description	door for ice-cube maker W 880mm H 310mm		



1

GEV No.	695461	Ref. No.	nicht in Preisliste enthalten
description	door kit for ice-cube maker W 655mm H 260mm thickness 19mm		



1

GEV No.	696611	Ref. No.	28180009/0 CM28180009 CM28180009/0 CMCM28180009
description	drip rail for ice maker W 590mm H 690mm thickness 25mm		



1

GEV No.	694283	Ref. No.	81460172/0 CM81460172/0
description	flap W 500mm H 295mm		

door frames



1

GEV No.	694328	Ref. No.	81460057/0 CM81460057/0
description	door frame W 1082mm H 442mm		
For models:	D310		



1

GEV No.	695668	Ref. No.	25165499/0 CM25165499/0
description	door frame W 430mm H 440mm thickness 30mm		
For models:	F80C, F80WC, N25L, N25LBI, N25LW, N35BI, N35S, N35SW, N45L, N45S, N45SW, N50BI, N50BIW, N55L, N55LW, N55S, N55SW		



1

GEV No.	694327	Ref. No.	81460359/0 CM81460359/0
description	door frame W 502mm H 770mm		
For models:	D201		



1

GEV No.	694160	Ref. No.	25165550/0 CM25165550/0
description	door frame W 565mm H 510mm thickness 60mm		

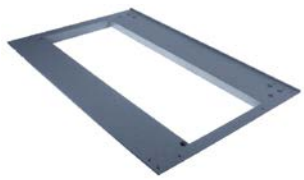

1

GEV No.	695682	Ref. No.	25165494/0 CM25165494/0
description	frame W 655mm H 440mm thickness 30mm		
For models:	F100C, F125C, N70S, N70SW, N90L, N90LW, N90S, N90SW		

door shafts



1

GEV No.	695701	Ref. No.	25085096/0 CM25085096/0
description	door shaft		
For models:	N20L, N20WL, N25BI, N25S, N25SW		



1

GEV No.	695667	Ref. No.	25560141/0 CM25560141/0
description	door shaft for ice maker ø 4mm L 1025mm stainless steel		
For models:	D310		



1

GEV No.	695706	Ref. No.	25560142/0 CM25560142/0
description	door shaft for ice maker ø 4mm L 485mm stainless steel		

1

GEV No.	695710	Ref. No.	25560135/0 CM25560135/0
description	door shaft for ice maker ø 4mm L 755mm stainless steel		

1

GEV No.	695703	Ref. No.	25030019/0 CM25030019/0
description	door shaft for ice maker ø 6mm L 360mm stainless steel		
For models:	F80C, F80WC, N25L, N25LBI, N25LW, N35BI, N35S, N35SW, N45L, N45S, N45SW, N50BI, N50BIW, N55L, N55LW, N55S, N55SW		

1

GEV No.	695704	Ref. No.	25030020/0 CM25030020/0
description	door shaft for ice maker ø 6mm L 585mm stainless steel		
For models:	F125C, N70S, N70SW, N90L, N90LW, N90S, N90SW		

1

GEV No.	695711	Ref. No.	25560285/0 CM25560285/0
description	door shaft for ice maker ø 6mm L 890mm thread M4 stainless steel		
For models:	N140		

curtains

without holder

1

GEV No.	695726	Ref. No.	81401600/0 CM81401600/0
description	curtain for ice maker W 250mm H 70mm shaft length 270mm shaft ø 6mm		
For models:	N21S		

1

GEV No.	695429	Ref. No.	nicht in Preisliste enthalten
description	curtain for ice maker W 250mm H 70mm shaft length 280mm shaft ø 6mm		

1

GEV No.	695440	Ref. No.	nicht in Preisliste
description	curtain for ice maker W 283mm H 115mm shaft length 305mm shaft ø 6mm		

1

GEV No.	695076	Ref. No.	nicht in Preisliste enthalten
description	curtain for ice maker W 284mm H 83mm		

1

GEV No.	695075	Ref. No.	nicht in Preisliste
description	curtain for ice maker W 305mm H 115mm shaft length 323mm shaft ø 6mm		

1

GEV No.	695439	Ref. No.	nicht in preisliste enthalten
description	curtain for ice maker W 407mm H 84mm shaft length 458mm shaft ø 6mm		

1



GEV No.	695441	Ref. No.	nicht in Preisliste
description	curtain for ice maker W 574mm H 115mm shaft length 610mm shaft ø 6mm		

accessories

holders

1



GEV No.	695080	Ref. No.	19797108/0 19797111/0 CM19797108/0 CM19797111/0
description	curtain holder for ice maker W 15mm H 80mm left		
For models:	N21S		

1



GEV No.	695079	Ref. No.	19797109/0 19797112/0 CM19797109/0 CM19797112/0 CMXP66038801
description	curtain holder for ice maker W 15mm H 80mm right		
For models:	N21S		

pan mechanics

sumps

1



GEV No.	695014	Ref. No.	25098060/0 81403005/0 CM25098060/0 CM81403005/0
description	sump complete for ice maker L 180mm W 125mm H 80mm shaft L 205mm N20 blue		
For models:	N20L, N20WL, N25S, N25SW		

1

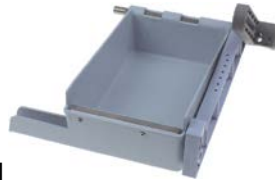

GEV No.	696414	Ref. No.	81401621/0 CM81401621/0
description	sump complete for ice maker L 180mm W 125mm H 80mm shaft L 210mm N25 blue		
For models:	N25BI, N25L, N25LBI, N25LW, N25S, N25SW		

1



GEV No.	696751	Ref. No.	CM81400064/0
description	sump complete for ice maker L 182mm W 160mm ICEMATIC white		

1

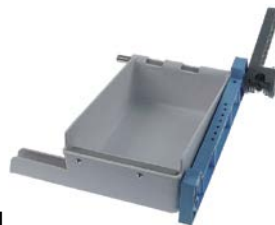

GEV No.	696649	Ref. No.	81400004/0 CM81400004/0
description	sump complete for ice maker L 220mm W 130mm H 80mm white/blue		

1



GEV No.	696650	Ref. No.	25098057/0 CM25098057/0
description	sump complete for ice maker L 220mm W 167mm H 80mm white		

1



GEV No.	695015	Ref. No.	81403007/0 CM81403007/0
description	sump complete for ice maker L 225mm W 165mm H 80mm shaft L 255mm for modell N30/N35 white		
For models:	N35BI, N35S, N35SW		



			
1			
GEV No.	699148	Ref. No.	81414467/0 CM81414467/0
description	sump complete for ice maker L 275mm W 200mm H 60mm grey		
For models:	N45L		

			
1			
GEV No.	699147	Ref. No.	81426054/0 CM81426054/0
description	sump complete for ice maker L 630mm W 355mm H 100mm grey		
For models:	N90L, N90LW		

			
1			
GEV No.	695017	Ref. No.	81413001/0 CM81413001/0
description	sump complete for ice maker L 275mm W 220mm H 75mm ICEMATIC white		
For models:	N45S, N45SW, N50BI, N50BIW, N55S, N55SW		

			
1			
GEV No.	695019	Ref. No.	81442008/0 CM81442008/0
description	sump complete for ice maker L 690mm W 230mm H 65mm ICEMATIC		

			
1			
GEV No.	695016	Ref. No.	81414519/0 81423003/0 CM81414519/0 CM81423003/0
description	sump complete for ice maker L 275mm W 220mm white		
For models:	N55L, N55LW		

			
1			
GEV No.	694818	Ref. No.	81400278/0 CM81400278/0
description	sump complete for ice-cube maker L 275mm W 223mm H 80mm white		

			
1			
GEV No.	699146	Ref. No.	81400154/0 CM81400154/0
description	sump complete for ice maker L 450mm W 200mm H 60mm grey		

			
1			
GEV No.	695018	Ref. No.	81423002/0 CM81423002/0
description	sump complete L 455mm W 180mm H 60mm ICEMATIC		
For models:	N70S, N70SW, N90S, N90SW		

			
1			
GEV No.	699149	Ref. No.	81453705/0 CM81453705/0
description	sump complete for ice maker L 490mm W 150mm H 260mm white		
For models:	N131M		

			
1			
GEV No.	696618	Ref. No.	81300066 81300066/0 81300067 81300067/0 CM81300066/0 CM81300067/0
description	sump for ice maker L 360mm W 175mm H 70mm white		

			
1			
GEV No.	696619	Ref. No.	81300090/0 81300091/0 CM81300090/0 CM81300091/0
description	sump for ice maker L 450mm W 185mm H 70mm white		

			
1			
GEV No.	696648	Ref. No.	25820132/0 CM25820132/0
description	sump for ice maker L 490mm W 235mm H 160mm white		

			
1			
GEV No.	696647	Ref. No.	25820130/0 CM25820130/0
description	sump for ice maker L 680mm W 240mm H 150mm white		

			
1			
GEV No.	695657	Ref. No.	81442008/0 CM81442008/0
description	sump for ice maker L 690mm W 230mm H 75mm		
For models:	N140		

			
1			
GEV No.	696682	Ref. No.	81453588/0 CM81453588/0
description	sump for ice maker L 697mm W 230mm H 150mm white		

			
1			
GEV No.	695662	Ref. No.	25820125/0 CM25820125/0
description	water container for ice maker L 697mm W 260mm H 148mm white		
For models:	N201M, N301M, N401M, N501M		

spare parts and accessories

			
1			
GEV No.	695376	Ref. No.	25110924/0 CM25110924/0
description	adjusting ring for spindle H 7mm ID ø 6mm ED ø 12mm thread M4 stainless steel		

			
1			
GEV No.	695720	Ref. No.	25725429/0 CM25725429/0
description	bracket for float motor L 92mm W 92mm metal		
For models:	N20L, N20WL, N25L, N25LBI, N25LW, N35BI, N35S, N35SW, N45L, N45S, N45SW, N50BI, N50BIW, N55L, N55LW, N55S, N55SW, N70S, N70SW, N90L, N90LW, N90S, N90SW		

			
1			
GEV No.	695646	Ref. No.	25726279/0 25726478/0 CM25726279/0 CM25726478/0
description	bracket for inner door L 44mm W 20mm H 18mm shaft intake ø 6.3mm mounting distance 30mm		
For models:	F125C, F80C, F80WC, N20L, N20WL, N25BI, N25L, N25LBI, N25LW, N25S, N25SW, N35BI, N35S, N35SW, N45L, N45S, N45SW, N50BI, N50BIW, N55L, N55LW, N55S, N55SW, N70S, N70SW, N90L, N90LW, N90S, N90SW		

			
1			
GEV No.	695651	Ref. No.	25525419/0 CM25525419/0
description	bracket for pulser L 34mm W 15mm H 60mm		
For models:	N140, N20L, N20WL, N25BI, N25L, N25LBI, N25LW, N25S, N25SW, N35BI, N35S, N35SW, N45L, N45S, N45SW, N50BI, N50BIW, N55L, N55LW, N55S, N55SW, N70S, N70SW, N90L, N90LW, N90S, N90SW		





 <p>1</p>			
GEV No.	695414	Ref. No.	25726121/0 CM25726121/0 CM25726123/0
description	bracket for sump mounting pos. left L 237mm W 15mm H 50mm ICEMATIC		
For models:	N140, N20L, N20WL, N25BI, N25L, N25LBI, N25LW, N25S, N25SW, N35BI, N35S, N35SW, N45L, N45S, N45SW, N50BI, N50BIW, N55L, N55LW, N55S, N55SW, N70S, N70SW, N90L, N90LW, N90S, N90SW		

 <p>1</p>			
GEV No.	695415	Ref. No.	25726122/0 25726124/0 CM25726122/0 CM25726124/0
description	bracket for sump mounting pos. right ICEMATIC		
For models:	N140, N20L, N20WL, N25BI, N25L, N25LBI, N25LW, N25S, N25SW, N35BI, N35S, N35SW, N45L, N45S, N45SW, N50BI, N50BIW, N55L, N55LW, N55S, N55SW, N70S, N70SW, N90L, N90LW, N90S, N90SW		

 <p>1</p>			
GEV No.	695009	Ref. No.	25726115 25726115/3 CM25726115/3
description	bracket paddle L 50mm W 17mm H 23mm shaft intake ø 6.5mm mounting distance 30mm		
For models:	N140, N20L, N20WL, N25BI, N25L, N25LBI, N25LW, N25S, N25SW, N35BI, N35S, N35SW, N45L, N45S, N45SW, N50BI, N50BIW, N55L, N55LW, N55S, N55SW, N70S, N70SW, N90L, N90LW, N90S, N90SW		

 <p>1</p>			
GEV No.	695681	Ref. No.	19800179/0 25110914/0 CM19800179/0 CM25110914/0
description	bush for spindle ED ø 10mm ID ø 6.2mm L 20mm plastic ICEMATIC		
For models:	N20L, N20WL, N25L, N25LW, N25S, N25SW, N35S, N35SW, N45L, N45S, N45SW, N50BI, N50BIW, N55L, N55LW, N55S, N55SW, N70S, N70SW, N90L, N90LW, N90S, N90SW		

 <p>1</p>			
GEV No.	695670	Ref. No.	25260000/0 CM25260000/0
description	disc for pan tilting ø 100mm shaft intake ø 7mm		
For models:	N20L, N20WL, N25BI, N25L, N25LBI, N25LW, N25S, N25SW, N35BI, N35S, N35SW, N45L		

 <p>1</p>			
GEV No.	695479	Ref. No.	81413043/0 CM81413043/0
description	disc for pan tilting ø 100mm shaft ø 7mm		
For models:	N140, N45S, N45SW, N50BI, N50BIW, N55L, N55LW, N55S, N55SW, N70S, N70SW, N90L, N90LW, N90S, N90SW		

 <p>1</p>			
GEV No.	695671	Ref. No.	25260001/1 CM25260001/1
description	disc for pan tilting ø 100mm shaft ø 7mm		

 <p>1</p>			
GEV No.	695023	Ref. No.	25325953 25325953/1 CM25325953/1
description	guide for lever L 30mm W 12mm H 15mm		
For models:	N140, N20L, N20WL, N25L, N25LW, N25S, N25SW, N35S, N35SW, N45S, N45SW, N50BI, N50BIW, N55L, N55LW, N55S, N55SW, N70S, N70SW, N90L, N90LW, N90S, N90SW		

 <p>1</p>			
GEV No.	695025	Ref. No.	25440110/0 81403011/0 CM25440110/0 CM81403011/0
description	lever for sump L 143mm W 29mm H 37mm shaft intake ø 10mm plastic ICEMATIC		
For models:	N20L, N20WL, N25BI, N25L, N25LBI, N25LW, N25S, N25SW, N35BI, N35S, N35SW, N45L, N45S, N45SW, N50BI, N50BIW, N55L, N55LW, N55S, N55SW, N70S, N70SW, N90L, N90LW, N90S, N90SW		

 <p>1</p>			
GEV No.	695645	Ref. No.	81442071/0 CM81442071/0
description	lever for sump L 143mm W 38mm H 29mm SS		
For models:	N140		

 <p>1</p>			
GEV No.	695653	Ref. No.	81443045/2 CM81443045/2
description	lever for sump L 90mm W 20mm shaft intake ø 10mm		
For models:	N140		

			
1			
GEV No.	696612	Ref. No.	25545509/0 CM25545509/0
description	paddle for ice maker ø 150mm shaft intake ø 6mm 1		

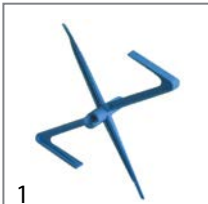
			
1			
GEV No.	695027	Ref. No.	24555520 24555522 25545520/2 25545522 CM25545520/2
description	paddle ø 145mm shaft intake ø 6mm		
For models:	N140, N20L, N20WL, N25BI, N25L, N25LBI, N25LW, N25S, N25SW, N35BI, N35S, N35SW, N45L, N45S, N45SW, N50BI, N50BIW, N55L, N55LW, N55S, N55SW, N70S, N70SW, N90L, N90LW, N90S, N90SW		

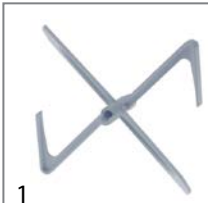
			
1			
GEV No.	696527	Ref. No.	25545521/0 CM25545521/0
description	paddle ø 145mm shaft intake ø 6mm shaft lengthmm 1		

			
1			
GEV No.	695026	Ref. No.	25560254/1 25560256/0 CM25560254/1 CM25560256/0
description	pin for lever L 38mm ø 4.5mm metal		
For models:	N140, N20L, N20WL, N25BI, N25L, N25LBI, N25LW, N25S, N25SW, N35BI, N35S, N35SW, N45L, N45S, N45SW, N50BI, N50BIW, N55L, N55LW, N55S, N55SW, N70S, N70SW, N90L, N90LW, N90S, N90SW		

			
1			
GEV No.	695024	Ref. No.	25110910 25110910/0 25110911/0 CM25110910/0 CM25110911/0
description	roller for pan tilting ø 26.7mm shaft intake ø 8.1mm		
For models:	N140, N20L, N20WL, N25S, N25SW, N45S, N45SW, N50BI, N50BIW, N55L, N55LW, N55S, N55SW, N70S, N70SW		

			
1			
GEV No.	697880	Ref. No.	25030004/0 CM25030004/0
description	shaft for sump for ice-cube maker L 205mm ø 10mm		
For models:	N20L, N20WL, N25BI, N25S, N25SW		

			
1			
GEV No.	695035	Ref. No.	25725433/0 25725439/0 CM25725433/0 CM25725439/0
description	shaft intake for paddle motor L 30mm W 17mm H 60mm shaft intake ø 4mm mounting distance 17mm		
For models:	N140, N20L, N20WL, N25BI, N25L, N25LBI, N25LW, N25S, N25SW, N35BI, N35S, N35SW, N45L, N45S, N45SW, N50BI, N50BIW, N55L, N55LW, N55S, N55SW, N70S, N70SW, N90L, N90LW, N90S, N90SW		

			
1			
GEV No.	695882	Ref. No.	19644000/0 CM19644000/0
description	spacer ring for spindle ED ø 12mm ID ø 6.2mm L 2mm rubber		

			
1			
GEV No.	695004	Ref. No.	25030006/0 CM25030006/0
description	spindle for ice maker ø 6mm L 165mm SS		
For models:	N20L, N20WL, N25BI, N25S, N25SW		

			
1			
GEV No.	695005	Ref. No.	25030007/0 CM25030007/0
description	spindle for ice maker ø 6mm L 206mm		
For models:	N35BI, N35S, N35SW		

			
1			
GEV No.	695006	Ref. No.	25030010/0 CM25030010/0
description	spindle for ice maker ø 6mm L 315mm SS		
For models:	N45S, N45SW, N50BI, N50BIW, N55L, N55LW, N55S, N55SW		

			
1			
GEV No.	695007	Ref. No.	25030011/0 CM25030011/0
description	spindle for paddle L 495mm		
For models:	N70S, N70SW, N90L, N90LW, N90S, N90SW		



1 			
GEV No.	695008	Ref. No.	25085011/0 CM25085011/0
description	spindle for paddle L 740mm		
For models:	N140		

1 			
GEV No.	695674	Ref. No.	25475400/0 CM25475400/0
description	tension spring for sump ø 13mm wire gauge ø 1.7mm L1 80mm		
For models:	N140		

1 			
GEV No.	695021	Ref. No.	25474600/0 CM25474600/0
description	torsion spring ø 20.8mm L1 23.2mm L2 37mm wire gauge ø 2.3mm for ice maker		
For models:	N20L, N20WL, N25BI, N25L, N25LBI, N25LW, N25S, N25SW, N35BI, N35S, N35SW		

1 			
GEV No.	695022	Ref. No.	25474602/0 CM25474602/0
description	torsion spring ø 21.2mm L1 26mm L2 37mm wire gauge ø 2.6mm for ice maker		
For models:	N45L, N45S, N45SW, N50BI, N50BIW, N55L, N55LW, N55S, N55SW, N70S, N70SW, N90L, N90LW, N90S, N90SW		

1 			
GEV No.	695676	Ref. No.	25474601/0 CM25474601/0
description	torsion spring ø 23.5mm L1 29mm L2 38mm wire gauge ø 3mm for ice maker		
For models:	N140		

gear wheels

1 			
GEV No.	698584	Ref. No.	CF65115700 CMCF65115700
description	gear wheel ø 101mm shaft intake ø 12.72mm transmission 16/94 double for ice maker		
For models:	SF300, SF500, SFN1000, SFN1000W		

1 			
GEV No.	691787	Ref. No.	29028004
description	gear wheel ø 27/101mm shaft intake ø 13mm teeth 15/94		

suction system

drain pans

1 			
GEV No.	695666	Ref. No.	25820080/0 CM25820080/0 CM25820115/0
description	sump for ice maker L 220mm W 34mm H 290mm		
For models:	N25L, N25LBI, N25LW, N35BI, N35S, N35SW, N45L, N45S, N45SW, N50BI, N50BIW, N55L, N55LW, N55S, N55SW, N70S, N70SW, N90L, N90LW, N90S, N90SW		
accessories for	695666		
	GEV No.	695713	Ref. No. 81443002/0 CM81443002/0
	guard for drain pan		

intake pans

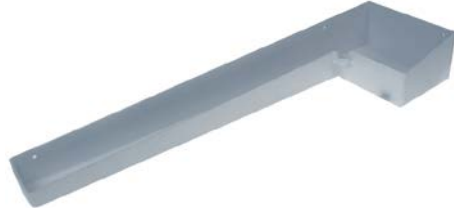
1 			
GEV No.	695732	Ref. No.	81453116/0 CM81453116/0
description	water container for ice maker L 698mm W 195mm H 93mm		
For models:	N200M, N200MW, N300M, N300MW		

drive technology

gear wheels



1

GEV No.	694780	Ref. No.	29028005 65115800 CF65115800 CMCF65115800
description	gear wheel ø 135mm shaft ø 25mm W 19mm teeth 83		
For models:	SF300, SF500, SFN1000, SFN1000W		



1

GEV No.	695586	Ref. No.	CF65116000 CMCF65116000
description	gear wheel ø 21.3mm teeth 18-41 D1 ø 58mm shaft ø 8 shaft L 55mm		
For models:	F100, F100C, F120, F125C, F200, F80C, F80WC		



1

GEV No.	697919	Ref. No.	CF65116100 CMCF65116100
description	gear wheel ø 62/20mm shaft ø 9.5mm teeth 56/10 for gearbox		
For models:	F100, F100C, F120, F125C, F200, F80C, F80WC		



1

GEV No.	695582	Ref. No.	290286006 CF65115600 CMCF65115600
description	gear wheel teeth 65 tooth width 14.5mm ED ø 74mm H 72mm shaft ø 12.7mm		
For models:	SF300, SF500, SFN1000, SFN1000W		

gaskets

shaft gaskets



1

GEV No.	694191	Ref. No.	CF13070902 CMCF13070902
description	gasket for evaporator ED ø 48mm ID ø 23mm H 7mm rubber		
For models:	SF300, SF500, SFN1000, SFN1000W		



1

GEV No.	696651	Ref. No.	CF02001607 CF02160701 CMCF02001607 CMCF02160701
description	shaft bearing for ice maker ED ø 33.5mm ID ø 25.7mm H 3mm for shaft bearing metal		
For models:	SF300, SF500, SFN1000, SFN1000W		



1

GEV No.	695589	Ref. No.	29000003/0 CF64004000 CM29000003/0 CMCF64004000
description	shaft sealing ED ø 48mm ID ø 25mm H 22mm suitable for augers		
For models:	F100, F100C, F120, F125C, F200, F80C, F80WC		



1

GEV No.	695428	Ref. No.	CF65040200 CMCF65040200
description	shaft sealing for auger ED ø 45mm ID ø 30mm		
For models:	SF300, SF500, SFN1000, SFN1000W		

miscellaneous

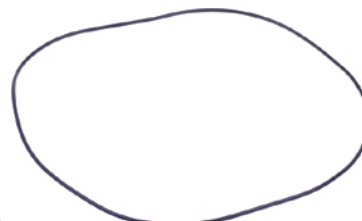

1

GEV No.	697879	Ref. No.	1300061738 CM1300061738
description	O-ring NBR thickness 2.62mm ID ø 219mm Qty 1 pcs		
For models:	SF300, SF500		

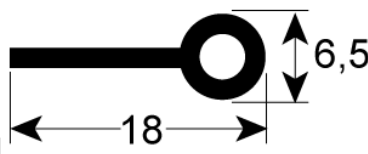

1

GEV No.	900912	Ref. No.	38581100/0 CM38581100/0
description	refrigeration gasket W 18mm for door Qty supplied by meter		
For models:	N140		

housing and bezels

fascias

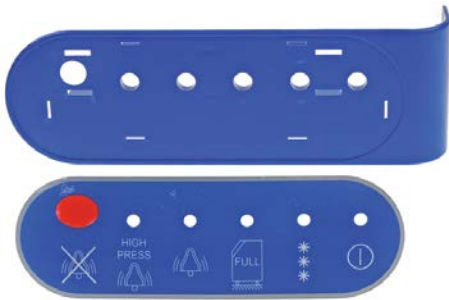

1

GEV No.	696581	Ref. No.	81453604/0 CM81453604/0
description	bezel for LEDs H 75mm suitable for ICEMATIC N501M L 240mm		
For models:	N131M, N201M, N301M, N401M, N501M		



1

GEV No.	692219	Ref. No.	81453613/0 CM81453613/0
description	bezel W 180mm H 46mm D 48mm		

housings



1

GEV No.	696653	Ref. No.	25165522/0 CM25165522/0
description	frame for ice maker L 610mm W 405mm H 100mm		



1

GEV No.	696685	Ref. No.	25702906/0 CM25702906/0
description	frame for ice maker L 765mm W 495mm H 110mm plastic anthracite		



1

GEV No.	696646	Ref. No.	25161164/0 CM25161143 CM25161164/0
description	housing for contol L 245mm W 245mm H 140mm		



1

GEV No.	696635	Ref. No.	25160731/0 CM25160731/0
description	housing for contol L 255mm W 225mm H 98mm		



1

GEV No.	696656	Ref. No.	25161138/0 CM25161138/0
description	lid for contol L 99mm W 38.4mm H 9mm plastic model N25 silver		
For models:	F80C, F80WC, N21S, N25L, N25LW, N25S, N25SW, N35S, N35SW, N45L, N45S, N45SW, N55L, N55LW, N55S, N55SW, N70S, N70SW, N90L, N90LW, N90S, N90SW		

ventilation grilles



1

GEV No.	694142	Ref. No.	25547146/0 CM25547146/0
description	ventilation grille L 335mm W 20mm H 335mm		



1

GEV No.	696655	Ref. No.	25295030/0 CM25295030/0
description	ventilation grille plastic black H 233mm L 233mm		

model name plates



1

GEV No.	696636	Ref. No.	19262800/0 CM19262800/0
description	model name plate Scotsman MV 1000 L 265mm W 76mm self-adhesive		



1

GEV No.	694824	Ref. No.	19263215/0 CM19263215/0
description	type plate ICEMATIC self-adhesive blue/white L 120mm W 120mm		

insulation



1

GEV No.	694112	Ref. No.	CF06055101 CF6055101 CMCF06055101 CMCF6055101
description	insulation for discharge chute L 190mm W 200mm H 175mm		



1

GEV No.	695989	Ref. No.	CF06055104 CMCF06055104
description	insulation for ice maker H 230mm ø 117mm		

flaps



1

GEV No.	695728	Ref. No.	25260474/0 25260485/0 CM25260474/0 CM25260485/0
description	flap for ice maker W 265mm H 130mm		
For models:	N21S		



1

GEV No.	696644	Ref. No.	81453466/0 CM81453466/0	
description	flap for ice maker W 365mm L 410mm for evaporator			
spare parts for	696644			
	GEV No.	347059	Ref. No.	19355007/0 CM19355007/0
magnet L 40mm H 8mm W 13.2mm hole distance 30mm				



1

GEV No.	696641	Ref. No.	81453692/0 CM81453692/0
description	flap for ice maker W 365mm L 420mm for evaporator		
For models:	N131M		
spare parts for	696641		
	GEV No.	347059	Ref. No. 19355007/0 CM19355007/0
magnet L 40mm H 8mm W 13.2mm hole distance 30mm			



1

GEV No.	696392	Ref. No.	25820114/0 81453008/0 81453130/0 CM25820114/0 CM81453008/0 CM81453130/0
description	flap for ice maker W 493mm L 423mm for evaporator		



1

GEV No.	696645	Ref. No.	25550400/0 CM25550400/0
description	flap for ice maker W 473mm L 420mm for evaporator		



1

GEV No.	696642	Ref. No.	25820126/0 CM25820126/0
description	flap for ice maker W 493mm L 423mm for evaporator		
For models:	N201M, N301M		
accessories for	696642		
	GEV No.	347059	Ref. No. 19355007/0 CM19355007/0
magnet L 40mm H 8mm W 13.2mm hole distance 30mm			



1

GEV No.	695693	Ref. No.	81453630/0 CM81453630/0
description	flap for ice maker W 493mm L 423mm for evaporator		
For models:	N201M, N301M		
spare parts for	695693		
	GEV No.	347059	Ref. No. 19355007/0 CM19355007/0
magnet L 40mm H 8mm W 13.2mm hole distance 30mm			



1

GEV No.	695697	Ref. No.	81453261/0 CM81453261/0
description	flap for ice maker W 495mm H 560mm thickness 38mm		
For models:	N500M		

			
1			
GEV No.	695698	Ref. No.	81453262/0 CM81453262/0
description	flap for ice maker W 495mm H 560mm thickness 38mm		
For models:	N500M		

			
1			
GEV No.	696643	Ref. No.	81453651/0 CM81453651/0
description	flap for ice maker W 525mm L 640mm for evaporator		
For models:	N501M		
spare parts for	696643		
	GEV No.	347059	Ref. No. 19355007/0 CM19355007/0
magnet L 40mm H 8mm W 13.2mm hole distance 30mm			

			
1			
GEV No.	696610	Ref. No.	81453072 81453131/0 CM81453131/0
description	sump for ice maker W 500mm H 70mm L 540mm for evaporator		

mechanics for evaporators

screw conveyors

			
1			
GEV No.	691788	Ref. No.	CF72405207 CMCF72405207
description	screw conveyor \varnothing 46mm L 260mm		
For models:	F100, F100C, F120, F125C, F80C, F80WC		

			
1			
GEV No.	691789	Ref. No.	CF72405206 CMCF72405206
description	screw conveyor \varnothing 46mm L 330mm		
For models:	F200		

holders

			
1			
GEV No.	694437	Ref. No.	06068800 29015012 29070002 65105900 CF06052700 CF06068800 CF65105900 CF75400801 CMCF06052700 CMCF06068800 CMCF65105900 CMCF75400801
description	bearing block for evaporator kit with holder mounting pos. lower		
For models:	SF300, SF500		



miscellaneous



1

GEV No.	694598	Ref. No.	CF78447601 CMCF78447601
description	magnet holder with magnet H 37mm ED ø 42mm plastic		
For models:	SFN1000, SFN1000W		



1

GEV No.	560568	Ref. No.	CF02167900 CF02168100 CMCF02001681 CMCF02167900 CMCF02168100
description	plain washer ID ø 25.6mm ED ø 39mm thickness 0.85mm SS Qty 1 pcs		
For models:	SF300, SF500, SFN1000, SFN1000W		

gear motors

gearboxes



1

GEV No.	694352	Ref. No.	CF00101501 CMCF00101501
description	housing for gearbox		
For models:	F100, F100C, F120, F125C, F200, F80C, F80WC		



1

GEV No.	695607	Ref. No.	29070007 CFA3123001 CMCFA3123001
description	housing for gearbox		
For models:	SF300, SF500, SFN1000, SFN1000W		

hoses

formed hoses

form S



1

GEV No.	694093	Ref. No.	nicht in Preisliste enthalten
description	formed hose S-shape for ice-cube maker ID ø 18mm ED ø 22mm L 300mm W 100mm		



1

GEV No.	695885	Ref. No.	25778366/0 CM25778366/0
description	formed hose S-shape for ice-cube maker ID ø 20mm ED ø 25mm L 800mm W 130mm H 80mm		
For models:	N140		

miscellaneous



1

GEV No.	695813	Ref. No.	29090034/0 CM29090034/0
description	formed hose ID ø 11mm ED ø 15mm L 500mm W 110mm		



1

GEV No.	694104	Ref. No.	nicht in Preisliste enthalten
description	formed hose ID ø 16mm ED ø 20mm L 440mm W 210mm PVC		

hose connectors

with thread



1

GEV No.	695045	Ref. No.	CF66022400 CM25631035 CMCF66022400
description	hose connector 3-way ID ø 15mm ED ø 21mm L 91mm		
For models:	F100, F120, F125C, F200, F80C, F80WC, SF300, SF500		



1

GEV No.	695048	Ref. No.	nicht in Preisliste enthalten
description	hose connector for ice-cube maker		



1

GEV No.	361796	Ref. No.	nicht in Preisliste
description	hose connector thread 3/4" ET grommet ø 13.5mm ID ø 10mm grommet length 20mm WS 27 thread L 22mm		

without thread



1

GEV No.	696615	Ref. No.	25631050/0 CM25631050/0
description	drain connection hose ø 25mm L 100mm plastic for ice maker		



1

GEV No.	695737	Ref. No.	25631035/0 CM25631035/0
description	hose connector straight plastic L 60mm ø 20mm		
For models:	N215		



1

GEV No.	695050	Ref. No.	25690803 25690806/0 CM25690806/0
description	hose connector straight plastic L 70mm ø 21mm		
For models:	F100C, F125C, F80C, F80WC, N200M, N200MW, N20L, N20WL, N25BI, N25L, N25LW, N25S, N25SW, N300M, N300MW, N35S, N35SW, N45L, N45S, N45SW, N500M, N55L, N55LW, N55S, N55SW, N70S, N70SW, N90L, N90LW, N90S, N90SW		

water dispersions



1

GEV No.	694823	Ref. No.	25790075/0 81454208/0 CM25790075/0 CM81454208/0
description	hose T-piece L 580mm for ice maker		



1

GEV No.	694791	Ref. No.	81453791/0 CM81453791/0
description	hose T-piece L 80mm		
For models:	N501M		



1

GEV No.	696617	Ref. No.	81453698/0 CM81453698/0
description	hose set for ice maker ID ø 12mm ED ø 16mm L 600mm W 20mm rubber H 116mm		

miscellaneous



1

GEV No.	520447	Ref. No.	73320400 CF73320400 CMCF73320400
description	double nipple thread 3/8" - 3/4" L1 24mm L2 12mm		
For models:	F100, F120, F200, SF300, SF500, SFN1000W		

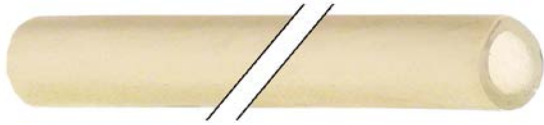

			
1			
GEV No.	530768	Ref. No.	25791018/0 CM25791018/0
description	hose for ice-cube maker ID ø 10mm ED ø 16mm L 800mm		
For models:	N20L, N20WL, N25BI, N25S, N25SW		

			
1			
GEV No.	530769	Ref. No.	25790880/0 CM25790880/0
description	silicone hose for ice-cube maker ID ø 14mm ED ø 20mm L 650mm		

floats

container lids

			
1			
GEV No.	695038	Ref. No.	CF66036300 CMCF66036300
description	lid L 150mm W 102mm for float container		
For models:	F100, F120, F125C, F200, F80C, F80WC, SF300, SF500, SFN1000, SFN1000W		

float containers

			
1			
GEV No.	695037	Ref. No.	29087022/0 79312601 CF79312601 CM29087022/0 CMCF79312601
description	float container for ice maker plastic		
For models:	F100, F120, F125C, F200, F80C, F80WC, SFN1000, SFN1000W		

miscellaneous

			
1			
GEV No.	691665	Ref. No.	25726470/0 25726473/0 CM25726470/0 CM25726473/0
description	bracket for evaporator flap		
For models:	N131M, N200M, N200MW, N201M, N300M, N300MW, N301M, N401M, N500M, N501M		

			
1			
GEV No.	695715	Ref. No.	25620289/0 CM25620289/0
description	bracket for ice maker L 515mm W 70mm		

			
1			
GEV No.	694815	Ref. No.	25725607/0 CM25725607/0
description	bracket L 128mm W 90mm H 30mm plastic		

			
1			
GEV No.	694816	Ref. No.	25725606/0 CM25725606/0
description	bracket L 243mm W 149mm H 40mm plastic		

			
1			
GEV No.	696620	Ref. No.	25110913/0 CM25110913/0
description	bush for ice maker L 13mm W 8mm H 9mm ID ø 4mm ED ø 8mm plastic		
For models:	N21S, N45S, N45SW, N50BI, N50BIW		

			
1			
GEV No.	696684	Ref. No.	25702875/0 CM25702875/0
description	bush ID ø 4.4mm D1 ø 28mm D2 ø 12.75mm L1 25mm		



1

GEV No.	696621	Ref. No.	25560151/0 25560152/0 CM25560151/0 CM25560152/0
description	bush L 9mm W 14mm H 19mm ID ø 4.5mm plastic		
For models:	N55L, N55LW, N55S, N55SW, N70S, N70SW, N90L, N90LW, N90S, N90SW		



1

GEV No.	695588	Ref. No.	CF06052700 CF65015900 CMCF06052700 CMCF65015900
description	bushing complete H 31.5mm ID ø 30mm ED ø 89mm mounting pos. lower		
For models:	SF300, SF500, SFN1000, SFN1000W		



1

GEV No.	695733	Ref. No.	CF66050700 CMCF66050700
description	cap for ice maker H 18mm ID ø 56mm ED ø 61mm		
For models:	SF300, SF500, SFN1000, SFN1000W		



1

GEV No.	695630	Ref. No.	CF06035900 CMCF06035900
description	coupling set ø 37mm		
For models:	F100, F100C, F120, F125C, F200, F80C, F80WC		



1

GEV No.	695709	Ref. No.	81462028/0 CM81462028/0
description	discharge chute for ice maker L 135mm W 80mm H 80mm		
For models:	F100C		



1

GEV No.	696652	Ref. No.	25260525/0 CM25260525/0
description	distance washer for ice maker H 1.5mm ID ø 4mm ED ø 10mm SS Qty 1 pcs		
For models:	N140, N20L, N20WL		



1

GEV No.	695675	Ref. No.	25730502/0 CM25730502/0
description	end cap for water dispersion H 19mm ID ø 16mm ED ø 27mm mounting pos. right		



1

GEV No.	695731	Ref. No.	81453015/0 CM81453015/0
description	flow regulating valve L 42mm W 14mm		
For models:	N131M, N200M, N200MW, N201M, N300M, N300MW, N301M, N401M, N501M		



1

GEV No.	695719	Ref. No.	I-1611
description	gasket for ice maker L 80mm W 36mm silicone		



1

GEV No.	695673	Ref. No.	25730501/0 CM25730501/0
description	gasket for water dispersion H 19mm ID ø 16mm ED ø 27mm mounting pos. left		



1

GEV No.	695713	Ref. No.	81443002/0 CM81443002/0
description	guard for drain pan		
For models:	N140		



1

GEV No.	696624	Ref. No.	19120415/0 CM19120415/0
description	hinge for ice maker L 78mm W 38mm H 57mm mounting pos. left		



 <p>1</p>			
GEV No.	696623	Ref. No.	19120414/0 CM19120414/0
description	hinge for ice maker L 78mm W 38mm H 57mm mounting pos. right		

 <p>1</p>			
GEV No.	695660	Ref. No.	25300000/0 CM25300000/0
description	inlet spout for ice maker ICEMATIC		
For models:	N20L, N20WL, N25BI, N25L, N25LBI, N25LW, N25S, N25SW, N35BI, N35S, N35SW, N45L, N45S, N45SW, N50BI, N50BIW, N55L, N55LW, N55S, N55SW, N70S, N70SW, N90L, N90LW, N90S, N90SW		

 <p>1</p>			
GEV No.	695723	Ref. No.	25410055/0 CM25410055/0
description	insulation for control valve L 120mm W 52mm H 105mm		

 <p>1</p>			
GEV No.	696683	Ref. No.	25410096/0 CM25410096/0
description	insulation for control valve L 85mm W 50mm H 70mm		

 <p>1</p>			
GEV No.	695744	Ref. No.	CF66013200 CMCF65088700 CMCF66013200
description	insulation L 150mm W 100mm H 140mm ID ø 55mm		
For models:	F100, F120, F200		

 <p>1</p>			
GEV No.	692612	Ref. No.	19690418/0 CM19690418/0
description	lid H 12mm ID ø 38mm ED ø 44mm		

 <p>1</p>			
GEV No.	692840	Ref. No.	81414560/0
description	mounting plate L 62mm W 60mm H 10mm for 360665		

 <p>1</p>			
GEV No.	695046	Ref. No.	19305022/0 CF66053500 CM19305022/0 CMCF66053500 nicht in Preisliste
description	nut H 5mm thread M24x1.5 plastic		
For models:	F100, F120, F125C, F200, F80C, F80WC, N21S, SF300, SF500		

 <p>1</p>			
GEV No.	691807	Ref. No.	25730503/0 CM25730503/0
description	outflow plug for water container L 12mm ø 12mm		
For models:	N131M, N200M, N200MW, N201M, N300M, N300MW, N301M, N401M, N500M, N501M		

 <p>1</p>			
GEV No.	696614	Ref. No.	25728007/0 CM25728007/0 CMNM66074100
description	plug for ice maker H 40mm ID ø 83mm ED ø 88mm		

 <p>1</p>			
GEV No.	696622	Ref. No.	19270501/0 CM19270501/0
description	plunger for ice maker L 63mm W 48mm H 88mm 230VAC for model N202M/N302M/M192/M202/M302		

			
1			
GEV No.	698719	Ref. No.	19270502/0 CM19270502/0
description	plunger for ice maker L 63mm W 48mm H 88mm 230VAC for model N402M/N502M/M402/M502		

			
1			
GEV No.	695764	Ref. No.	29070018/0 CF72421506 CM29070018/0 CMCF72421506
description	probe L 100mm ED \varnothing 4mm thread M3		
For models:	F100, F100C, F120, F125C, F200, F80C, F80WC, SF300, SF500, SFN1000, SFN1000W		

			
1			
GEV No.	695672	Ref. No.	25726140/0 CM25726140/0
description	probe clip L 12mm W 27mm H 18mm hole \varnothing 9.5mm		
For models:	N140, N25L, N25LBI, N25LW, N35BI, N35S, N35SW, N45S, N45SW, N50BI, N50BIW, N55L, N55LW, N55S, N55SW, N70S, N70SW, N90L, N90LW, N90S, N90SW		

			
1			
GEV No.	695661	Ref. No.	25726141/0 CM25726141/0
description	probe clip L 40mm W 25mm H 18mm hole \varnothing 9.5mm		
For models:	N140, N25L, N25LBI, N25LW, N35BI, N35S, N35SW, N45S, N45SW, N50BI, N50BIW, N55L, N55LW, N55S, N55SW, N70S, N70SW, N90L, N90LW, N90S, N90SW		

			
1			
GEV No.	695753	Ref. No.	29090049/0 CM29090049/0
description	rubber sleeve L 25mm W 18mm H 18mm ID \varnothing 7mm ED \varnothing 18mm		

			
1			
GEV No.	695584	Ref. No.	nicht in Preisliste
description	spring clip L 28mm W 10mm hole \varnothing 4.5mm tube \varnothing 31mm		

			
1			
GEV No.	695585	Ref. No.	CF72418000 CF72418002 CMCF72418000 CMCF72418002
description	threaded rod thread M4 L1 130mm L2 22mm		
For models:	F100, F120, F200, SF300, SF500, SFN1000, SFN1000W		

			
1			
GEV No.	694438	Ref. No.	nicht in Preisliste
description	tray L 205mm W 100mm H 19mm		

			
1			
GEV No.	695734	Ref. No.	25360200/0 CM25360200/0
description	union nut H 15mm ED \varnothing 46mm		

			
1			
GEV No.	695730	Ref. No.	29090000/0 CM29090000/0
description	water level tube for ice maker L 20mm W 19mm H 130mm		

valves

intake valves



1

GEV No.	695685	Ref. No.	19864010/0 19864011/0 CM19864010/0 CM19864011/0
description	intake valve thread M11 L 130mm ø 37mm plastic		
For models:	N200M, N200MW, N300M, N300MW, N500M		

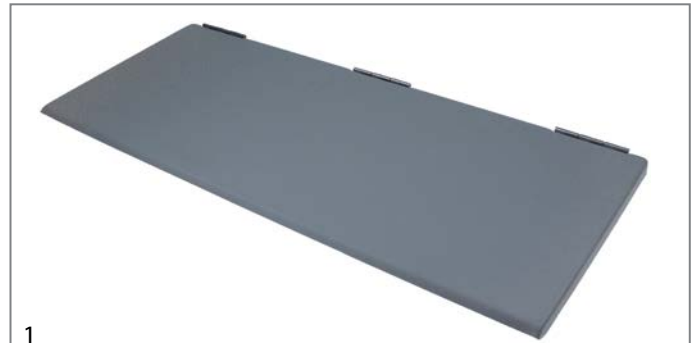

1

GEV No.	696389	Ref. No.	81430351/0 81460351/0 CM81430351/0 CM81460351/0
description	lid for ice container L 720mm W 300mm H 23mm		
For models:	D201		

for ice containers

lids

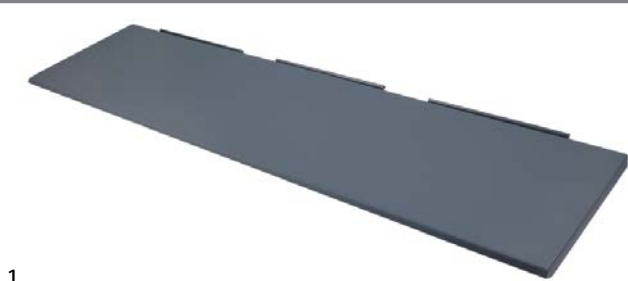

1

GEV No.	696382	Ref. No.	81460239/0 CM81460239/0
description	lid for ice container for model D 310 L 1050mm W 280mm H 30mm		
For models:	D310		

frame



1

GEV No.	696657	Ref. No.	81460378/0 CM81460378/0
description	frame for ice container for model D 101 L 570mm W 500mm H 70mm		
For models:	D101		

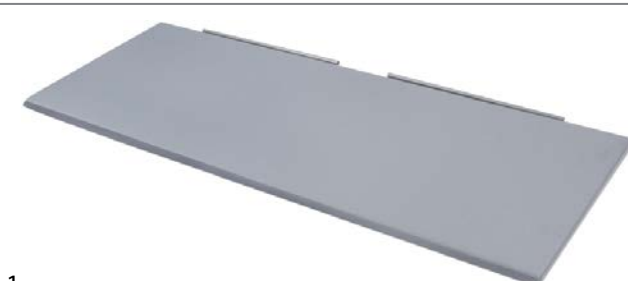

1

GEV No.	696426	Ref. No.	81460183/0 CM81460183/0
description	lid for ice container for model D200 L 768mm W 294mm H 25mm		



1

GEV No.	695664	Ref. No.	81460341/0 CM81460341/0
description	frame for ice container L 565mm W 465mm H 70mm for model D 100		



doors



for proving cabinets

drain hose systems



steam generators





1

GEV No.	698569	Ref. No.	19120427/0 CM19120427/0 F401TA0000
description	humidifier type F401TA0000 H 300mm ø 150mm conductivity 125-1250µS/cm ² 1 phase incl. gasket		



1

GEV No.	698568	Ref. No.	19120431/0 CM19120431/0 L401TA0000
description	humidifier type L401TA0000 H 28mm ø 160mm conductivity 125-1250µS/cm ² 1 phase incl. gasket		



1

GEV No.	698567	Ref. No.	19120429/0 CM19120429/0 L201MA0000
description	humidifier type L201MA0000 H 28mm ø 160mm conductivity 125-1250µS/cm ² 1 phase incl. gasket		

handles and hand wheels

star handles

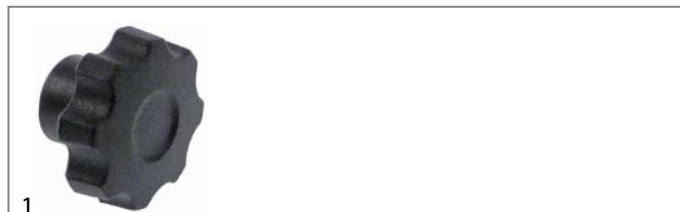

1

GEV No.	698606	Ref. No.	19950003/0 CM19950003/0
description	star handle thread M4 ø 25.3mm L 16.5mm black		

bracket handles

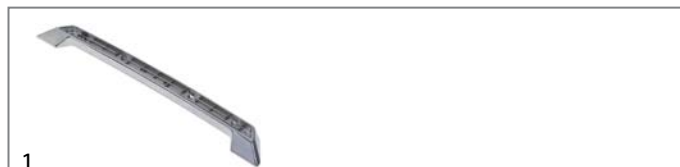

1

GEV No.	700989	Ref. No.	28190005/0 CM28190005/0
description	pull handle L 325mm H 16mm mounting distance 254mm W 36.5mm chrome-plated		

accessories for	700989			
	GEV No.	692526	Ref. No.	28040018 28040018/0 CM28040018/0
	cover for handle plastic			

covers



1			
GEV No.	692526	Ref. No.	28040018 28040018/0 CM28040018/0
description	cover for handle plastic		

fasteners

locking screws



1			
GEV No.	697742	Ref. No.	19950006/0 CM19950006/0
description	locking screw thread M4 handle ø 17mm black L 10mm		



1			
GEV No.	697519	Ref. No.	19950004/0 CM19950004/0
description	locking screw thread M5 handle ø 21mm black L 10mm		

recessed handles

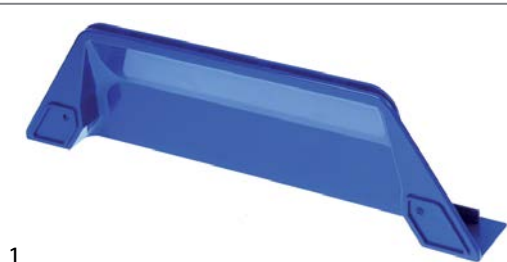

1			
GEV No.	695721	Ref. No.	28000096/0 CM28000096/0
description	grip shell L 330mm W 44mm H 96mm		

hinges

piano hinges

producer-specific

CASTEL



1			
GEV No.	701030	Ref. No.	19120045/0 CM19120045/0
description	hinge controllable L 43mm W 37mm hole ø 4mm for ice container mounting distance 26/32mm plastic		

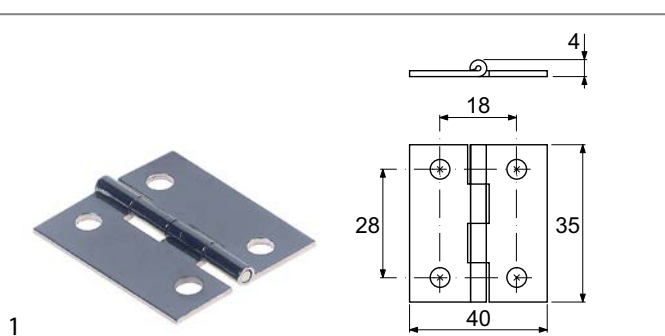

1			
GEV No.	691804	Ref. No.	19120050/0 CM19120050/0
description	hinge L 40mm W 35mm H 4mm mounting distance 28mm hole ø 5mm thickness 1.3mm brass ICEMATIC		
For models:	F100C, F125C, F80C, F80WC, N20L, N20WL, N25BI, N25L, N25LBI, N25LW, N25S, N25SW, N35BI, N35S, N35SW, N45L, N45S, N45SW, N50BI, N50BIW, N55L, N55LW, N55S, N55SW, N70S, N70SW, N90L, N90LW, N90S, N90SW		

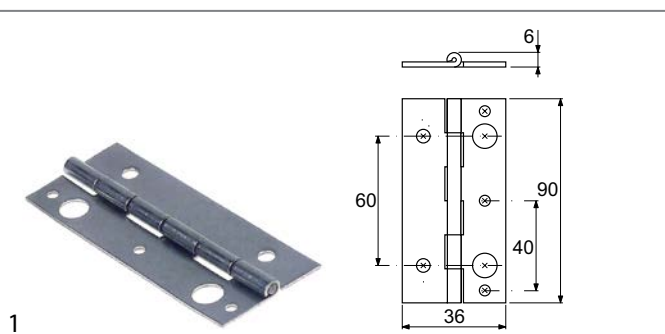

1			
GEV No.	691805	Ref. No.	25130137/0 CM25130137/0
description	hinge L 90mm W 36mm H 6mm mounting distance 60mm mounting distance 1 40mm mounting distance 2 40mm hole ø 3/5mm thickness 1.2mm stainless steel		
For models:	D101, D201		



spring assisted hinges

universal

CAFF/FERMOD

group 2



1

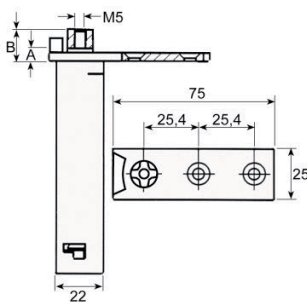

GEV No.	690494	Ref. No.	19120054/0 CM19120054/0
description	spring assisted hinge series 175 mounting pos. left/right torx L 75mm W 25.6mm H 100mm A 4mm B 11mm mounting measurements 22x22mm intake torx refrigeration units mounting distance 25mm		

door bearing



1

GEV No.	690583	Ref. No.	28294982/0 28294990/0 CM28294982/0 CM28294990/0
description	hinge bearing without bolt		

miscellaneous



1

GEV No.	695727	Ref. No.	25130130/0 CM25130130/0
description	hinge		

filters

air filters

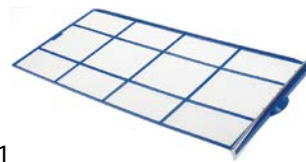

1

GEV No.	970890	Ref. No.	81400187/0 CM81400187/0
description	air filter L 540mm W 250mm H 6mm		
For models:	N25LBI, N35BI		

device filters

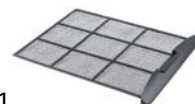

1

GEV No.	970877	Ref. No.	25339013/0 CM25339013/0
description	air filter L 335mm W 238mm H 3mm plastic for ice maker		

equipment feet and end caps

equipment feet

with screw mounting

universal



1

GEV No.	701458	Ref. No.	25570707/0 CM25570707/0
description	equipment foot tube ø 52mm thread M10 thread L 25mm H 104-115mm stainless steel size 2" Qty 1 pcs		

components



1

GEV No.	701093	Ref. No.	25570880/0 CM25570880/0
description	equipment foot tube ø 47mm H 68mm plastic thread 1¼" ET		
For models:	F100C, F125C, N140, N45L, N45S, N45SW, N55L, N55LW, N55S, N55SW, N70S, N70SW, N90L, N90LW, N90S, N90SW		

components



1

GEV No.	701093	Ref. No.	25570880/0 CM25570880/0
description	equipment foot tube ø 47mm H 68mm plastic thread 1¼" ET		
For models:	F100C, F125C, N140, N45L, N45S, N45SW, N55L, N55LW, N55S, N55SW, N70S, N70SW, N90L, N90LW, N90S, N90SW		



1

GEV No.	700103	Ref. No.	19490020/0 81502140/0 CM19490020/0 CM81502140/0
description	equipment foot tube ø 56mm plate size mm hole distance mm H 130mm SS size 2" Qty 1 pcs		
For models:	D101, D201, D310		



1

GEV No.	700103	Ref. No.	19490020/0 81502140/0 CM19490020/0 CM81502140/0
description	equipment foot tube ø 56mm plate size mm hole distance mm H 130mm SS size 2" Qty 1 pcs		
For models:	D101, D201, D310		

with fixing plate



1

GEV No.	700823	Ref. No.	81502140/0 CM81502140/0
description	equipment foot tube ø 64mm plate size 80x100mm hole distance 56x78mm H 130-185mm SS size 2 1/2" Qty 1 pcs		



1

GEV No.	691803	Ref. No.	81400690/0 95000100/0 CM81400690/0 CM95000100/0
description	equipment foot tube ø 68mm plate size 45x50mm hole distance mm H 175-190mm plastic Qty 1 pcs		



1

GEV No.	695917	Ref. No.	25460020/0 CM25460020/0
description	equipment foot tube ø 63mm plate size mm hole distance mm H 100mm plastic size 2 1/3" Qty 1 pcs		
For models:	F100C, F125C, N140, N25L, N25LBI, N25LW, N35BI, N35S, N35SW, N45S, N45SW, N55L, N55LW, N55S, N55SW, N70S, N70SW, N90L, N90LW, N90S, N90SW		



miscellaneous



1

GEV No.	695677	Ref. No.	25570870/0 CM25570870/0
description	equipment foot tube ø 46/68mm H 175-190mm plastic thread 1¼" IT		
For models:	N25L, N25LBI, N25LW, N35BI, N35S, N35SW		

screw-in feet



1

GEV No.	695738	Ref. No.	81502119/0 CM81502119/0
description	equipment foot thread M8 thread L 27mm ø 30mm H 12mm Qty 1 pcs		
For models:	F80C, F80WC, N25L, N25LBI, N25LW, N35BI, N35S, N35SW, N45L		

end caps and plugs

for square pipes

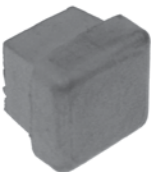

1

GEV No.	695068	Ref. No.	25728011/0 CM25728011/0
description	end cap for ice maker insertion size 13x13mm		
For models:	N21S		

miscellaneous



1

GEV No.	695722	Ref. No.	81400690/0 CM81400690/0
description	mounting plate thread 1¼" L 55mm W 50mm H 27mm hole ø 9.5mm		
For models:	N25L, N25LBI, N25LW, N35BI, N35S, N35SW		

shelves and shelf rails

grates

universal

without upstand



1

GEV No.	970689	Ref. No.	26107225/0 CM26107225/0
description	grate W 325mm D 530mm GN 1/1 stainless steel		

with upstand



1

GEV No.	970556	Ref. No.	28174022 28174028 28174028/0 CM28174028/0
----------------	--------	-----------------	--

description	grate W 530mm D 650mm GN 2/1 plastic-coated steel with hinge camp wire gauge frame 9mm lengthwise wires gauge 5mm crossing wires 2 white suitable for refrigerator		
--------------------	--	--	--

accessories for	970556		
------------------------	--------	--	--

GEV No.	690330	Ref. No.	—
description	rack L 1000mm W 22mm H 4mm aperture 3x8mm hole distance 12.5mm stainless steel		

GEV No.	690332	Ref. No.	—
description	shelf support L 31/28mm W 22mm H 17mm SS with hook Qty 1 pcs		

GEV No.	694700	Ref. No.	—
description	shelf support L 31/28mm W 22mm H 18mm SS Qty 12 pcs		

GEV No.	694701	Ref. No.	—
description	shelf support L 31/28mm W 22mm H 17mm SS with hook Qty 12 pcs		

shelf rails and supports

producer-specific



1

GEV No.	695908	Ref. No.	98000700/1 CM98000700/1
----------------	--------	-----------------	----------------------------

description	pair of setting bar U-shape L 620mm W 15mm inner height 22mm		
--------------------	--	--	--

gaskets

refrigeration gaskets

plug-in gaskets

profile 9048

We offer custom-made gaskets for this profile

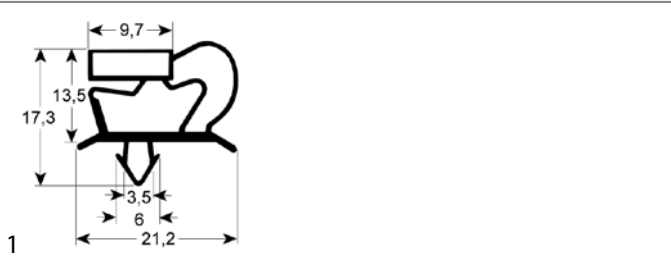

GEV No.	901970	Ref. No.	26100379/0 CM26100379/0
description	refrigeration gasket profile 9048 W 1130mm L 755mm plug size		

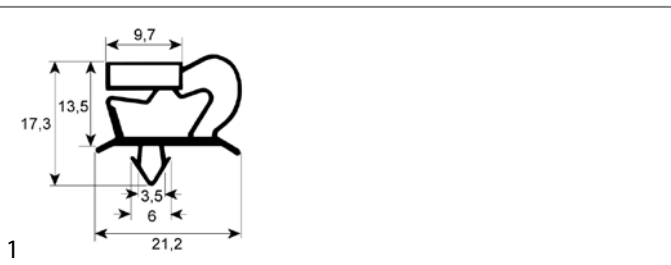

GEV No.	901218	Ref. No.	19352024 19352024/0 CM19352024/0
description	refrigeration gasket profile 9048 W 301mm L 367mm plug size for blast chiller		

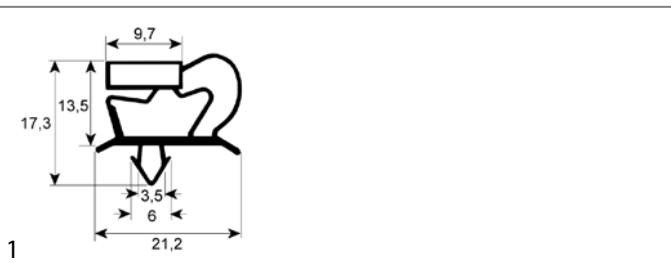

GEV No.	901217	Ref. No.	26107202 26107202/0 CM26107202/0
description	refrigeration gasket profile 9048 W 395mm L 711mm plug size for blast chiller		
For models:	T5		

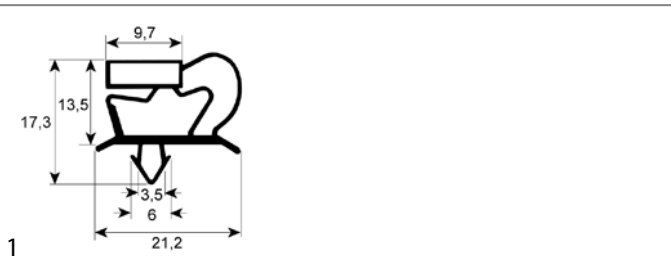

GEV No.	901216	Ref. No.	26107203 26107203/0 CM26107203/0
description	refrigeration gasket profile 9048 W 705mm L 1030mm plug size for blast chiller		
For models:	T14		

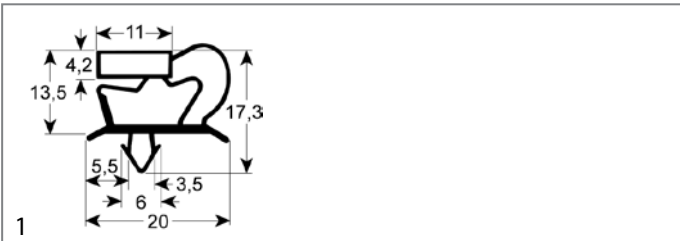

GEV No.	902442	Ref. No.	CM26100291/0
description	refrigeration gasket profile 9048 W 751mm L 766mm plug size Qty 1 blast freezer		

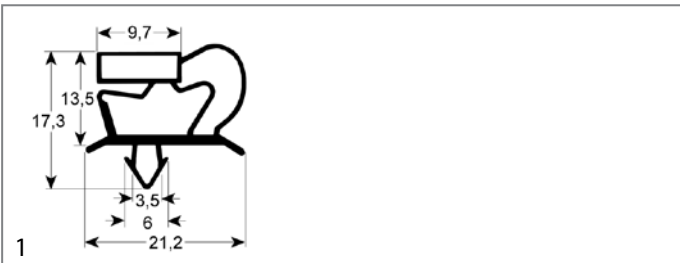

GEV No.	901969	Ref. No.	26103838/0 CM26103838/0
description	refrigeration gasket profile 9048 W 752mm L 395mm plug size		

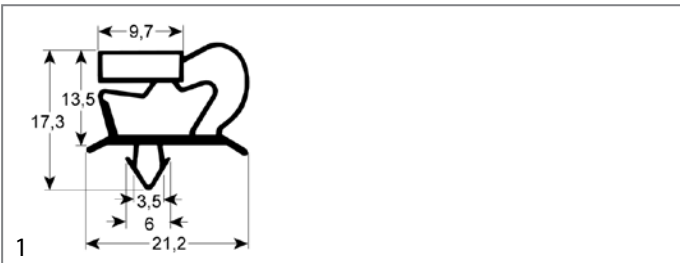

GEV No.	901973	Ref. No.	19350510/0 CM19350510/0
description	refrigeration gasket profile 9048 W 875mm L 715mm plug size		

profile 9773

We offer custom-made gaskets for this profile

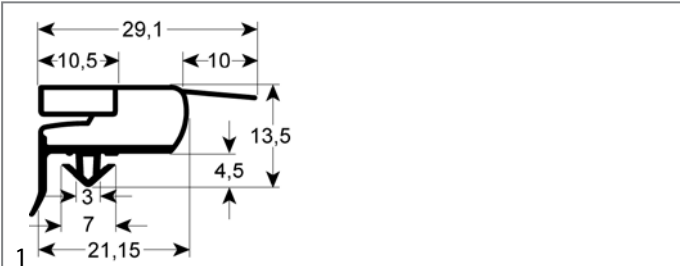

GEV No.	901089	Ref. No.	CM4612038
description	refrigeration gasket profile 9773 W 640mm L 1540mm external size W1 627mm L1 1527mm plug size		

mechanical components, equipment accessories

profile 9704

We offer custom-made gaskets for this profile

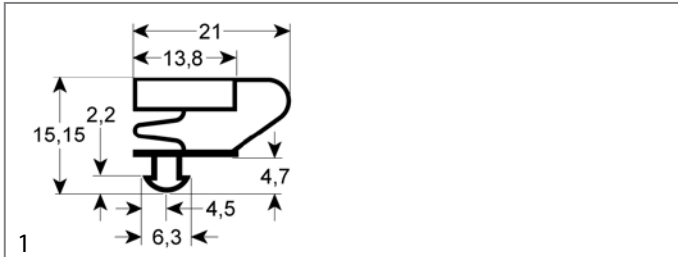

GEV No.	901974	Ref. No.	19352010/0 CM19352010/0
description	refrigeration gasket profile 9704 W 605mm L 475mm plug size		

profile 9151

We offer custom-made gaskets for this profile

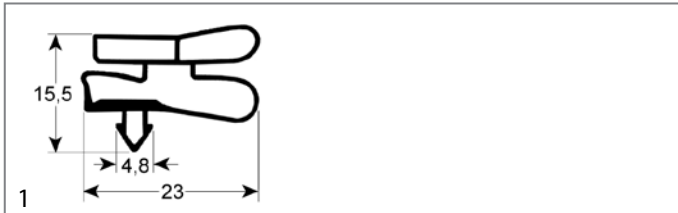

GEV No.	900878	Ref. No.	28175018/0 CM28175018/0
description	refrigeration gasket profile 9151 W 705mm L 770mm rectangular		

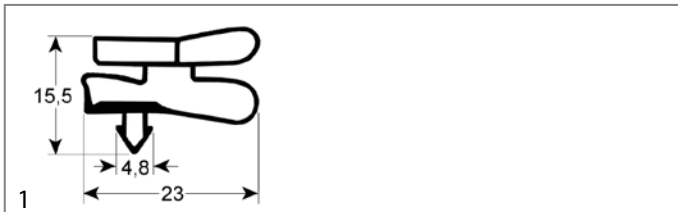

GEV No.	900368	Ref. No.	28175017/0 CM28175017/0
description	refrigeration gasket profile 9151 W 715mm L 1580mm plug size L1 1570mm W1 705mm external size		

profile 9251

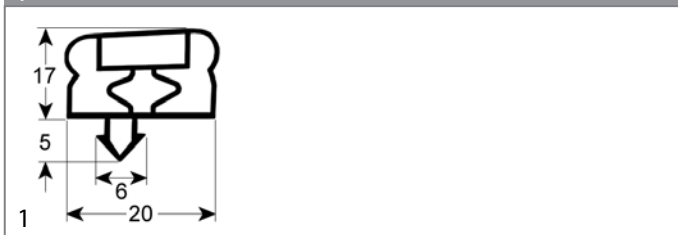

GEV No.	901972	Ref. No.	19350506/0 CM19350506/0
description	refrigeration gasket profile 9251 W 1000mm L 2750mm plug size 3-sided		



GEV No.	901971	Ref. No.	19350157/0 CM19350157/0
description	refrigeration gasket profile 9251 W 850mm L 662mm plug size		

miscellaneous



GEV No.	902010	Ref. No.	19550126/0 CM19550126/0
description	gasket plug-in gasket size 7x13		

O-rings

EPDM

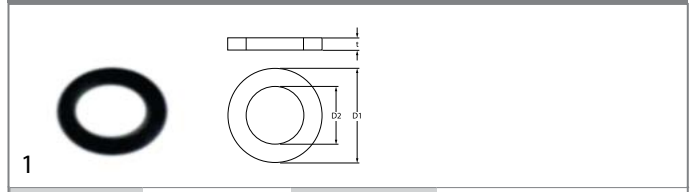

GEV No.	528485	Ref. No.	CF64010000 CMCF64010000
description	O-ring EPDM thickness 1.78mm ID ø 6.07mm Qty 1 pcs		
For models:	F100, F120, F125C, F200, F80C, F80WC, SF300, SF500, SFN1000, SFN1000W		

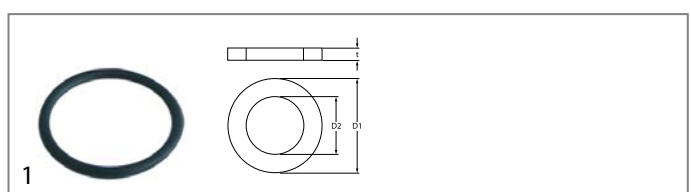

GEV No.	510769	Ref. No.	CF64004101 CMCF64004101
description	O-ring EPDM thickness 2.62mm ID ø 25.07mm Qty 1 pcs		
For models:	F100, F100C, F120, F125C, F200, F80C, F80WC		

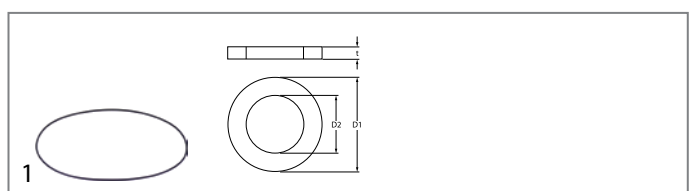

GEV No.	528094	Ref. No.	CF64008400 CMCF64008400
description	O-ring EPDM thickness 2mm ID ø 171mm Qty 1 pcs		
For models:	F100, F100C, F120, F125C, F80C, F80WC		



GEV No.	361085	Ref. No.	41020448 41020448/0 CM41020448/0
description	O-ring EPDM thickness 2mm ID ø 8mm Qty 1 pcs		
For models:	N200M, N200MW, N300M, N300MW, N500M		

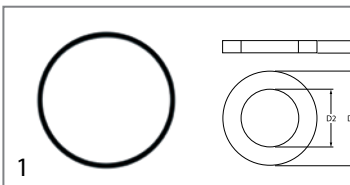

GEV No.	510009	Ref. No.	CF64009303 CMCF64009303
description	O-ring EPDM thickness 3.53mm ID ø 101.2mm Qty 1 pcs		
For models:	SF300, SF500, SFN1000, SFN1000W		

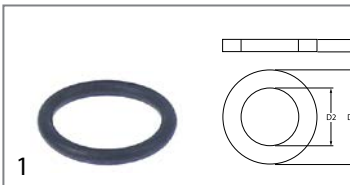

GEV No.	517087	Ref. No.	19035151/0 CM19035151/0
description	O-ring EPDM thickness 3.53mm ID ø 23.4mm Qty 1 pcs		
For models:	N21S		

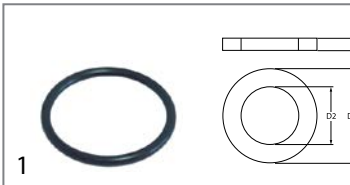

GEV No.	510895	Ref. No.	29000023 CF64009302 CMCF64009302
description	O-ring EPDM thickness 3.53mm ID ø 34.52mm Qty 1 pcs		
For models:	SF300, SF500, SFN1000, SFN1000W		

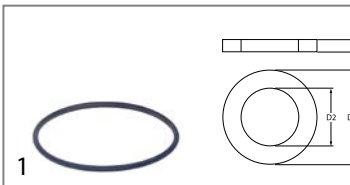

GEV No.	532534	Ref. No.	29000002/0 CM29000002/0
description	O-ring EPDM thickness 3.53mm ID ø 82.14mm Qty 1 pcs		

silicone



GEV No.	695064	Ref. No.	29000022 CF64004120 CMCF64004120
description	O-ring silicone thickness 2mm ID ø 66.4mm Qty 1 pcs		

Viton



GEV No.	528250	Ref. No.	I-1087
description	O-ring Viton thickness 2mm ID ø 8mm Qty 1 pcs		

NBR



GEV No.	697879	Ref. No.	1300061738 CM1300061738
description	O-ring NBR thickness 2.62mm ID ø 219mm Qty 1 pcs		
For models:	SF300, SF500		

sealing washers

rubber gaskets



GEV No.	510764	Ref. No.	19350158/0 CM19350158/0
description	flat gasket rubber ED ø 24mm ID ø 12mm thickness 2mm Qty 1 pcs		
For models:	N20L, N20WL, N25L, N25LW, N25SW, N35S, N35SW, N45L, N45S, N45SW, N55L, N55LW, N55S, N55SW, N70S, N70SW, N90L, N90LW, N90S, N90SW		

foam rubber gaskets



GEV No.	691329	Ref. No.	19535169/0 CM19535169/0
description	foam rubber gasket W 10mm thickness 5mm self-adhesive Qty supplied by meter		



 <p>1</p>			
GEV No.	508418	Ref. No.	19350201/0 CM19350201/0
description	foam rubber gasket W 15mm thickness 8mm self-adhesive Qty 1m		

 <p>1</p>			
GEV No.	695758	Ref. No.	nicht in Preisliste
description	foam rubber gasket W 15mm thickness 8mm self-adhesive Qty 3m profile half-round		

 <p>1</p>			
GEV No.	901292	Ref. No.	nicht in Preisliste enthalten
description	foam rubber gasket W 15mm thickness 8mm self-adhesive Qty supplied by meter		

 <p>1</p>			
GEV No.	693787	Ref. No.	19352049/0 CM19352049/0
description	foam rubber gasket ø 6mm Qty supplied by meter		

shaft gaskets

shaft gaskets

 <p>1</p>			
GEV No.	698239	Ref. No.	29040001 CF64008300 CMCF64008300
description	shaft seal ID ø 11.91mm ED ø 18.24mm thickness 5mm		
For models:	F100, F100C, F120, F125C, F80C, F80WC		

 <p>1</p>			
GEV No.	511532	Ref. No.	CF02160600 CM02001606 CMCF02160600
description	shaft seal ID ø 15mm ED ø 25.5mm thickness 6.5mm for ice-cube maker		
For models:	SF300, SF500, SFN1000, SFN1000W		

 <p>1</p>			
GEV No.	511534	Ref. No.	64001901 CF02160700 CF64001901 CMCF02160700 CMCF64001901
description	shaft seal ID ø 22mm ED ø 32mm thickness 5.5mm		
For models:	F100, F100C, F120, F125C, F200, F80C, F80WC		

 <p>1</p>			
GEV No.	511533	Ref. No.	CF02285301 CMCF02002853 CMCF02285301
description	shaft seal ID ø 25mm ED ø 34mm thickness 5mm for ice maker		
For models:	SF300, SF500, SFN1000, SFN1000W		

special gaskets

for ice cube maker

 <p>1</p>			
GEV No.	901968	Ref. No.	19350507/0 CM19350507/0
description	door seal for ice-cube maker L 515mm W 45mm thickness 10mm silicone		

for vacuum packers

 <p>1</p>			
GEV No.	693787	Ref. No.	19352049/0 CM19352049/0
description	foam rubber gasket ø 6mm Qty supplied by meter		

refrigeration cycle components

cooling water regulators

JOHNSON CONTROLS



GEV No.	541189	Ref. No.	19865611/0 CM19865611/0
description	cooling water regulator 3/8" type V46AA-9608 connection 7/16" UNF (1/4" SAE) pressure range 5-18bar water pressure max. 10bar water temperature max. 90°C capillary pipe 750mm L 160mm 0.9kg		
For models:	F100C, F125C, N131M, N140, N200MW, N201M, N300MW, N301M, N401M, N45S, N45SW, N500M, N501M, N50BI, N50BIW, N70SW, N90LW, N90SW		



GEV No.	541483	Ref. No.	19870815/0 29087021/0 CF62011100 CM19870815/0 CM29087021/0 CMCF62011100
description	cooling water regulator 3/8" type V46AA-9950 connection 6mm soldering connection pressure range 5-18bar water pressure max. 10bar water temperature max. 90°C capillary pipe 750mm L 160mm 0.9kg		
For models:	F100, F120, F200, N20L, N20WL, SF300, SF500, SFN1000W		

valves

expansion valves

DANFOSS

valves

type TS2/TE52



GEV No.	750178	Ref. No.	19870826/0 CM19870826/0
description	expansion valve DANFOSS type TS2 coolant R404a/R507 angled 90° inlet 3/8" SAE outlet 1/2" SAE p max 28bar -40 up to -5°C capillary pipe 1500mm		
For models:	N200M, N200MW, N300M, N300MW		



GEV No.	750530	Ref. No.	81453620/0 CM81453620/0
description	expansion valve DANFOSS type TS2 coolant R404a/R507 angled nozzle 068-2006 inlet 3/8" SAE outlet 1/2" SAE p max 34bar -30 up to +10°C capillary pipe 1500mm		
For models:	N201M, N301M, N500M		



GEV No.	750545	Ref. No.	81453840/0 CM81453840/0
description	expansion valve DANFOSS type TS2 coolant R404a/R507 angled nozzle 068-2008 inlet 3/8" SAE outlet 1/2" SAE p max 34bar -30 up to +10°C capillary pipe 1500mm		
For models:	N501M		



GEV No.	750529	Ref. No.	81453621/0 CM81453621/0
description	expansion valve DANFOSS type TS2 coolant R404a/R507 angled nozzle 068-2015 inlet 3/8" SAE outlet 1/2" SAE p max 34bar -30 up to +10°C capillary pipe 1500mm		
For models:	N131M		

type TUA/TUB/TUC





GEV No.	750531	Ref. No.	19870401/0 CM19870401/0
description	expansion valve DANFOSS type TUC coolant R404a/R507 straight inlet 6mm soldering connection outlet 10mm soldering connection p max 34bar -30 up to +10°C capillary pipe 800mm		





GEV No.	750532	Ref. No.	19870312/0 CM19870312/0
description	expansion valve DANFOSS type TUC coolant R404a/R507 straight inlet 6mm soldering connection outlet 13mm soldering connection p max 34bar -25 up to +10°C capillary pipe 800mm		



nozzle inserts			
			
1			
GEV No.	750484	Ref. No.	19470964/0 CM19470964/0
description	nozzle insert size 05 type 068-2008 T2/TE2 DANFOSS		

HONEYWELL			
valves			
			
1			
GEV No.	750425	Ref. No.	19870622/0 19870627 19870627/0 CM19870622/0 CM19870627/0
description	expansion valve HONEYWELL type TMV-00001 coolant R22 angled 90° thermostatically controlled inlet 5/8" UNF (3/8" SAE) outlet 3/4" UNF (1/2" SAE) -45 up to +15°C		

filter driers			
GMC			
			
1			
GEV No.	750086	Ref. No.	19300357/0 CM19300357/0
description	dryer type SC032S connection ODF 1/4"-ODM 3/8" 50cm ³ p max 45bar -40 up to +80°C 261g total length 95mm ø 57.5mm		
For models:	N131M, N140, N201M, N301M		

			
1			
GEV No.	750525	Ref. No.	19301257/0 CM19301257/0
description	dryer type SC053M10S connection ODF 10mm-ODM 12mm 80cm ³ p max 45bar -40 up to +80°C 325g total length 109mm ø 57.5mm		
For models:	N200M, N200MW, N300M, N300MW, N301M		

			
1			
GEV No.	750526	Ref. No.	19300355/0 CM19300355/0
description	dryer type SC083M10S connection ODF 10mm-ODM 12mm 130cm ³ p max 45bar -40 up to +85°C 399g total length 134mm ø 57.5mm		
For models:	N200M, N200MW, N300M, N300MW, N401M, N500M, N501M		

miscellaneous			
			
1			
GEV No.	750068	Ref. No.	63000303
description	dryer size 25g ø 24mm L 140mm connection 3.5/7mm		

evaporators			
for fridges			
producer-specific			
			
1			
GEV No.	750698	Ref. No.	19270072/0
description	evaporator		
For models:	T5		

			
1			
GEV No.	694180	Ref. No.	191477077/0 CM191477077/0
description	evaporator L 525mm W 50mm H 442mm		

for ice-cube maker

for ice cube maker



1

GEV No.	750127	Ref. No.	81402037/0 CM81402037/0
description	evaporator for ice-cube maker 15 cubes L 185mm W 155mm H 60mm total length 400mm overall width 225mm overall height 115mm		
For models:	N20L, N20WL		



1

GEV No.	750128	Ref. No.	81412031/0 CM81412031/0
description	evaporator for ice-cube maker 35 cubes L 295mm W 185mm H 60mm overall height 130mm		
For models:	N45L, N45S, N45SW, N50BI, N50BIW, N55L, N55LW, N55S, N55SW		

for flake ice maker



1

GEV No.	695712	Ref. No.	I-1721
description	evaporator for flake ice maker W 180mm H 225mm ø 90mm		
For models:	F100		



1

GEV No.	695751	Ref. No.	CF79423704 CF79423706 CMCF79423704 CMCF79423705 CMCF79423706 CMCF79423706R
description	evaporator for flake ice maker Wmm H 375mm ø 73mm		
For models:	F200		

accessories

housings



1

GEV No.	696383	Ref. No.	25820123/0 CM25820123/0
description	lid for evaporator for ice maker for N120 L 422mm W 336mm H 60mm		
For models:	N131M		

condensors

filters



1

GEV No.	691796	Ref. No.	nicht in Preisliste
description	air filter for condenser L 495mm W 270mm		



1

GEV No.	692589	Ref. No.	25339007/0 CM25339007/0
description	air filter for condenser L 510mm W 313mm H 6mm		
For models:	N131M		

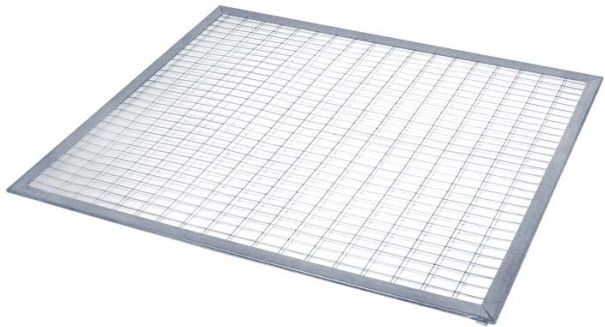

1

GEV No.	695736	Ref. No.	25339006/0 CM25339006/0
description	filter for condenser L 510mm W 410mm H 6mm		
For models:	N201M, N301M		

condensers

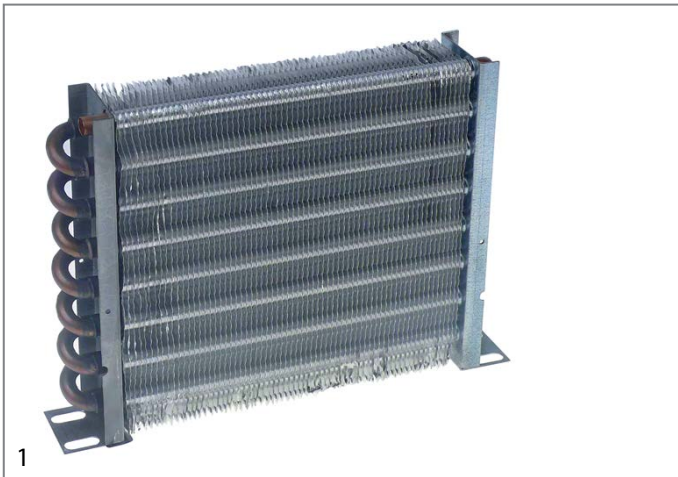

GEV No.	750089	Ref. No.	29015033/0 CF62027602 CM29015033/0 CMCF62027602
description	condenser for ice maker W 280mm D 46mm H 230mm		
For models:	F100, F120		



GEV No.	750451	Ref. No.	19177072/0 CM19177072/0
description	condenser for ice maker W 530mm D 80mm H 550mm		
For models:	N301M		



GEV No.	750527	Ref. No.	19177073/0 CM19177073/0
description	condenser for ice maker W 525mm D 62mm H 490mm		
For models:	N201M		



GEV No.	750092	Ref. No.	19177507/0 CM19177507/0
description	condenser for ice maker W 550mm D 70mm H 455mm		
For models:	N200M, N200MW, N300M, N300MW		



1

GEV No.	750090	Ref. No.	19177058/0 CM19177058/0
description	condenser for ice maker W 665mm D 113mm H 285mm		
For models:	N140		

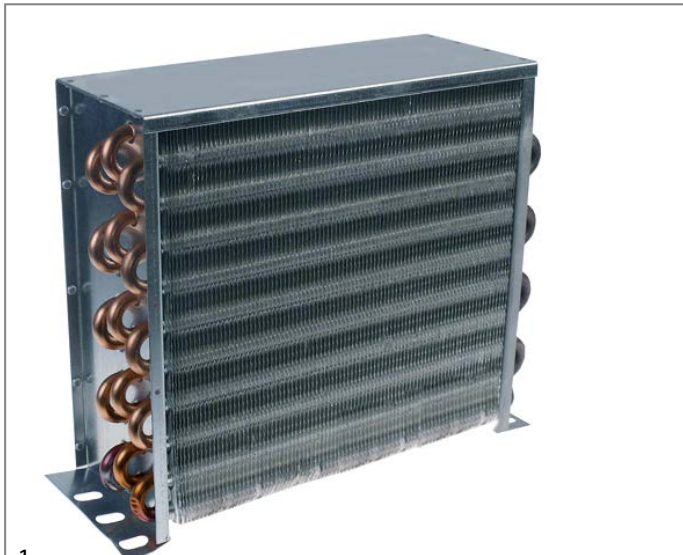

1

GEV No.	750122	Ref. No.	29015035/0 62040500 CF62040500 CM29015035/0 CMCF62040500
description	condenser W 290mm D 120mm H 270mm		
For models:	F200		



1

GEV No.	750087	Ref. No.	19177509/0 CM19177509/0
description	condenser W 190mm D 60mm H 200mm		
For models:	N20L, N20WL, N25BI, N25S, N25SW		



1

GEV No.	750125	Ref. No.	CF62043900 CMCF62043900
description	condenser W 290mm D 85mm H 260mm		
For models:	F100, F120		

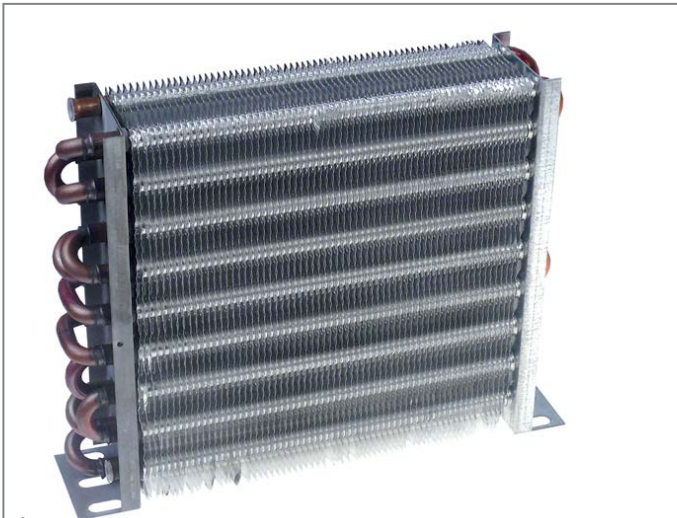

1

GEV No.	750088	Ref. No.	19180085/0 CM19180085/0
description	condenser W 280mm D 70mm H 230mm		



condensers water-cooled



1

GEV No.	695718	Ref. No.	81407536/0 CM81407536/0
description	condenser for ice maker W 190mm H 220mm L 100mm		
For models:	N25SW		



1

GEV No.	695022	Ref. No.	25474602/0 CM25474602/0
description	torsion spring ø 21.2mm L1 26mm L2 37mm wire gauge ø 2.6mm for ice maker		
For models:	N45L, N45S, N45SW, N50BI, N50BIW, N55L, N55LW, N55S, N55SW, N70S, N70SW, N90L, N90LW, N90S, N90SW		



1

GEV No.	695676	Ref. No.	25474601/0 CM25474601/0
description	torsion spring ø 23.5mm L1 29mm L2 38mm wire gauge ø 3mm for ice maker		
For models:	N140		

evaporation and condensing trays

evaporation trays



1

GEV No.	695916	Ref. No.	28300013/0 CM28300013/0
description	evaporation tray for fridge L 680mm W 325mm H 40mm		



1

GEV No.	694179	Ref. No.	26105003/0 CM26105003/0
description	evaporation tray L 520mm W 320mm H 50mm for blast freezer		
For models:	T14, T5		

springs

torsion springs



1

GEV No.	695021	Ref. No.	25474600/0 CM25474600/0
description	torsion spring ø 20.8mm L1 23.2mm L2 37mm wire gauge ø 2.3mm for ice maker		
For models:	N20L, N20WL, N25BI, N25L, N25LBI, N25LW, N25S, N25SW, N35BI, N35S, N35SW		

tension springs



1

GEV No.	695674	Ref. No.	25475400/0 CM25475400/0
description	tension spring for sump ø 13mm wire gauge ø 1.7mm L1 80mm		
For models:	N140		

hoses

drain hoses



1

GEV No.	530473	Ref. No.	19810114/0 CM19810114/0
description	drain hose DN19 L 1900mm straight ø inside 19mm straight ext. ø 25mm elbow ø inside 23mm elbow ext. ø 27mm outer hose ø 24mm for ice maker		
For models:	F100C, F125C, F80WC, N131M, N140, N200M, N200MW, N201M, N20L, N20WL, N25BI, N25SW, N300M, N300MW, N301M, N401M, N501M, N55L, N55LW, N55S, N55SW, N70S, N70SW, N90L, N90LW, N90S, N90SW		



industrial hoses

silicone hoses

without fabric

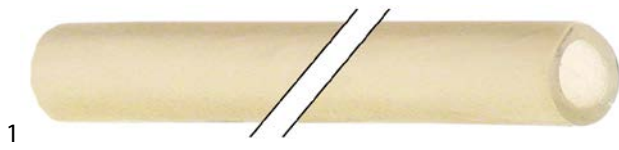

GEV No.	530769	Ref. No.	25790880/0 CM25790880/0
description	silicone hose for ice-cube maker ID ø 14mm ED ø 20mm L 650mm		

1			
GEV No.	695050	Ref. No.	25690803 25690806/0 CM25690806/0
description	hose connector straight plastic L 70mm ø 21mm		
For models:	F100C, F125C, F80C, F80WC, N200M, N200MW, N20L, N20WL, N25BI, N25L, N25LW, N25S, N25SW, N300M, N300MW, N35S, N35SW, N45L, N45S, N45SW, N500M, N55L, N55LW, N55S, N55SW, N70S, N70SW, N90L, N90LW, N90S, N90SW		

fittings, hose and pipe connectors

fittings

double nipples



GEV No.	520447	Ref. No.	73320400 CF73320400 CMCF73320400
description	double nipple thread 3/8" - 3/4" L1 24mm L2 12mm		
For models:	F100, F120, F200, SF300, SF500, SFN1000W		

1			
GEV No.	361796	Ref. No.	nicht in Preisliste
description	hose connector thread 3/4" ET grommet ø 13.5mm ID ø 10mm grommet length 20mm WS 27 thread L 22mm		

hose connectors

producer-specific



GEV No.	501340	Ref. No.	25690807/0 CM25690807/0
description	connecting piece straight plastic ø 22mm		
For models:	F80C, F80WC, N131M, N201M, N25LBI, N301M, N35BI, N401M, N501M		

push-in fittings

JOHN GUEST



GEV No.	440561	Ref. No.	CM2521375 CMCM2521375
description	push-in fitting John Guest straight thread 1/8" BSP pipe connection ø8mm		
accessories for	440561		
	GEV No.	520972	Ref. No. —
hose John Guest thickness 1mm LLDPE blue ID ø 6mm ED ø 8mm			



GEV No.	695737	Ref. No.	25631035/0 CM25631035/0
description	hose connector straight plastic L 60mm ø 20mm		
For models:	N21S		

1			
GEV No.	520452	Ref. No.	CM2521366 CMCM2521366
description	push-in fitting John Guest straight thread 7/16" UNS pipe connection 5/16" sealing conical		



ancillary products

clamps

hose clamps

DIN 3017 - W4



1

GEV No.	520444	Ref. No.	nicht in Preisliste enthalten
description	hose clamp SS W4 ø 11-19mm width 9mm Qty 1 pcs DIN 3017		

double wire clamps



1

GEV No.	520449	Ref. No.	nicht in der Preisliste
description	hose clamp ø 22mm wire gauge ø 3mm Qty 1 pcs		



1

GEV No.	520407	Ref. No.	19281324/0 CM19281324/0
description	hose clamp ø 26mm wire gauge ø 2.5mm Qty 1 pcs		
For models:	N45L, N45S, N45SW, N55L, N55LW, N55S, N55SW, N70S, N70SW, N90L, N90LW, N90S, N90SW		



1

GEV No.	520406	Ref. No.	19281332/0 CM19281332/0
description	hose clamp ø 28mm wire gauge ø 2.5mm Qty 1 pcs		
For models:	N45S, N45SW, N50BI, N50BIW, N55L, N55LW, N55S, N55SW, N70S, N70SW, N90L, N90LW, N90S, N90SW		

locking clamps



1

GEV No.	520443	Ref. No.	nicht in Preisliste enthalten
description	hose clamp ø 14-18mm plastic Qty 1 pcs width 7mm for ice maker		

fastening material

screws

sheet metal screws



1

GEV No.	560108	Ref. No.	12728106/0 CM12728106/0
description	sheet metal screws ø 4.2mm L 13mm SS Qty 20 pcs DIN 7981/ISO 7049 head ø 8.2mm oval head		
For models:	N140, N20L, N20WL, N90L, N90LW, N90S, N90SW		



1

GEV No.	560109	Ref. No.	12728101/0 CM12728101/0
description	sheet metal screws ø 4.2mm L 16mm SS Qty 20 pcs DIN 7981/ISO 7049 head ø 8.2mm oval head		
For models:	N20L, N20WL		



1

GEV No.	560059	Ref. No.	12726235/0 CM12726235/0
description	sheet-metal screw ø 4.2mm L 38mm SS Qty 20 pcs 7983		
For models:	N140		

flat-headed bolts



1

GEV No.	560063	Ref. No.	12726408/0 CM12726408/0
description	flat-headed bolt thread M4 thread L 16mm SS DIN 7985/ISO 7045 Qty 20 pcs intake Phillips head ø 8mm head thickness 2mm		
For models:	N140		



1

GEV No.	560058	Ref. No.	12727301/0 CM12727301/0
description	flat-headed bolt thread M4 thread L 45mm SS Qty 20 pcs intake Phillips		
For models:	N20L, N20WL, N90L, N90LW, N90S, N90SW		

hexagonal screws



1

GEV No.	560453	Ref. No.	CF42391500 CMCF42391500
description	hexagonal screw thread M12x1.25 thread L 31mm SS WS 19 Qty 1 pcs DIN 933 / ISO 4017		
For models:	SF300, SF500, SFN1000, SFN1000W		

grub screws

miscellaneous



1

GEV No.	560458	Ref. No.	12712002/0 CM12712002/0
description	grub screw thread M4 L 5mm intake slotted Qty 1 pcs		
For models:	N20L, N20WL, N25S, N25SW		

washers

washers

miscellaneous



1

GEV No.	560093	Ref. No.	CF44180008 CMCF44180008
description	plain washer ID ø 10mm ED ø 19mm thickness 0.3mm steel Qty 1 pcs		
For models:	F100, F100C, F120, F125C, F80C, F80WC		



1

GEV No.	560092	Ref. No.	CF44180007 CMCF44180007
description	plain washer ID ø 10mm ED ø 19mm thickness 0.8mm steel Qty 1 pcs		
For models:	F100, F100C, F120, F125C, F80C, F80WC		



1

GEV No.	560144	Ref. No.	CF03140824 CMCF03140824
description	plain washer ID ø 13mm ED ø 22mm thickness 0.8mm steel Qty 1 pcs		
For models:	SF300, SF500, SFN1000, SFN1000W		



1

GEV No.	560166	Ref. No.	nicht in Preisliste enthalten
description	plain washer ID ø 16.2mm ED ø 21mm thickness 0.8mm SS Qty 1 pcs		



1

GEV No.	560152	Ref. No.	CF44180800 CMCF44180800
description	plain washer ID ø 23mm ED ø 29mm thickness 1.5mm steel Qty 1 pcs		
For models:	F100, F100C, F120, F125C, F200, F80C, F80WC		



1

GEV No.	560568	Ref. No.	CF02167900 CF02168100 CMCF02001681 CMCF02167900 CMCF02168100
description	plain washer ID ø 25.6mm ED ø 39mm thickness 0.85mm SS Qty 1 pcs		
For models:	SF300, SF500, SFN1000, SFN1000W		



1

GEV No.	560074	Ref. No.	CF44180005 CMCF44180005
description	plain washer ID ø 8.5mm ED ø 14mm thickness 0.3mm steel Qty 1 pcs		
For models:	F100, F100C, F120, F125C, F80C, F80WC		



1

GEV No.	560091	Ref. No.	CF44180006 CMCF44180006
description	plain washer ID ø 8.5mm ED ø 14mm thickness 0.8mm steel Qty 1 pcs		
For models:	F100, F100C, F120, F125C, F80C, F80WC		

fasteners

mounting clips



1

GEV No.	524029	Ref. No.	19430104/0 CM19430104/0
description	mounting clip nominal-ø 3mm L 26mm W 12mm mounting distance 18mm		



mounting spigots

			
1			
GEV No.	524030	Ref. No.	nicht in Preisliste enthalten
description	spigot nominal-ø 7mm thread M4x0.8 L 13mm		

pipe clips

			
1			
GEV No.	695584	Ref. No.	nicht in Preisliste
description	spring clip L 28mm W 10mm hole ø 4.5mm tube ø 31mm		

clamps

hose clamps

DIN 3017 - W4

			
1			
GEV No.	520444	Ref. No.	nicht in Preisliste enthalten
description	hose clamp SS W4 ø 11-19mm width 9mm Qty 1 pcs DIN 3017		

double wire clamps

			
1			
GEV No.	520449	Ref. No.	nicht in der Preisliste
description	hose clamp ø 22mm wire gauge ø 3mm Qty 1 pcs		

			
1			
GEV No.	520407	Ref. No.	19281324/0 CM19281324/0
description	hose clamp ø 26mm wire gauge ø 2.5mm Qty 1 pcs		
For models:	N45L, N45S, N45SW, N55L, N55LW, N55S, N55SW, N70S, N70SW, N90L, N90LW, N90S, N90SW		

			
1			
GEV No.	520406	Ref. No.	19281332/0 CM19281332/0
description	hose clamp ø 28mm wire gauge ø 2.5mm Qty 1 pcs		
For models:	N45S, N45SW, N50BI, N50BIW, N55L, N55LW, N55S, N55SW, N70S, N70SW, N90L, N90LW, N90S, N90SW		

locking clamps

			
1			
GEV No.	520443	Ref. No.	nicht in Preisliste enthalten
description	hose clamp ø 14-18mm plastic Qty 1 pcs width 7mm for ice maker		

retaining rings

DIN 472

			
1			
GEV No.	523002	Ref. No.	CF65029700 CMCF65029700 I-1684
description	retaining ring bore ø 45mm thickness 1.6mm steel DIN 472		
For models:	F100, F100C, F120, F125C, F200, F500, F80C, F80WC		

DIN 6799

			
1			
GEV No.	507015	Ref. No.	CF46003802 CMCF46003802
description	retaining ring E D1 ø 7mm D2 ø 14mm SS DIN 6799 thickness 0.9mm for shaft ø 8-11mm		
For models:	F100, F120, F125C, F200, F80C, F80WC, SF300, SF500, SFN1000, SFN1000W		

roll pins

			
1			
GEV No.	692013	Ref. No.	12639300/0 CM12639300/0
description	roll pin ø 3mm L 16mm		
For models:	N140, N20L, N20WL, N25BI, N25L, N25LBI, N25LW, N25S, N25SW, N35BI, N35S, N35SW, N45L, N45S, N45SW, N50BI, N50BIW, N55L, N55LW, N55S, N55SW, N70S, N70SW, N90L, N90LW, N90S, N90SW		

consumables

lubricants

machine lubricants



1			
GEV No.	890003	Ref. No.	CF06029401 CMCF06029401
description	machine lubricant 1000g		
description			
For models:	F100, F120, F125C, F200, F80C, F80WC, SF300, SF500, SFN1000, SFN1000W		



1			
GEV No.	890029	Ref. No.	CF06029404 CMCF06029404
description	machine lubricant Mobilux EP004 can 500g for gearbox -25 up to +120°C		
description	<p>Mobilux EP004 - can 500g</p> <p>Suitable for lubricating enclosed gears and bearings in poorly sealed gear cases with the exception of electric motor bearings. Can also be used for many other industrial applications, e.g. gear cases and chains, in which conventional gear oils would escape due to leaks caused by worn or missing seals. Meets requirements of SEW 1008 hour gear test, DR.EM.2003 mod.</p> <p>Temperature resistance: -25°C to +120°C</p>		



1			
GEV No.	890002	Ref. No.	31415301/0 CF26361200 CM31415301/0 CMCF26361200
description	machine lubricant White Food Grade food-safe -25 up to +150°C approval NSF 200g		
description			
For models:	F100, F120, F125C, F200, F80C, F80WC, SF300, SF500, SFN1000, SFN1000W		

cleaning agents

descalers



1			
GEV No.	802164	Ref. No.	nicht in Preisliste enthalten
description	descaler 4.8l phosphoric acid for ice maker		

fuses

fine fuses



1			
GEV No.	358509	Ref. No.	CMXP63001511
description	fine fuse size ø5x20mm 0.05A slow-acting rated 250V Qty 1 pcs		

C			
cables	43		
centrifugal switches	9		
clamps	6, 89, 91		
cleaning agents	92		
cold air circulating fans (complete)	36		
compressors	29		
condensators & interference suppression filters	42		
connection cables	43		
consumables	92		
contactors	12		
cooling fans	37		
cooling water regulators	82		
core probes	14		
D			
descalers	92		
double nipples	88		
double wire clamps	89, 91		
drain hoses	87		
drain pumps	40		
E			
electric accessories	43		
electrodes	29		
electronic controllers	14		
end caps and plugs	77		
evaporators	83		
expansion valves	82		
F			
fans	34		
fasteners	90		
fastening material	89		
filter driers	83		
fine fuses	92		
fittings	88		
flat-headed bolts	89		
float switches	8		
foam rubber gaskets	80		
fuses	43, 92		
G			
grates	77		
grub screws	90		
H			
Hall sensors	16		
heating cables	3		
heating elements	3		
hexagonal screws	90		
hose clamps	89, 91		
hose connectors	88		
hoses	87		
I			
indicator lights	11		
indicator lights (complete)	11		
industrial hoses	88		
L			
lamps	11		
locking clamps	89, 91		
lubricants	92		
M			
machine lubricants	92		
magnetic switches	10		
microswitches	7		
motors	38		
mounting clips	90		
mounting spigots	91		
O			
operating capacitors	42		
O-rings	79		
P			
piano hinges	74		
pipe clips	91		
plug-in gaskets	78		
pressure switches	28		
probe clips	6		
probes	14		
programme timers	11		
protective coverings	43		
pumps	40		
pumps for drink dispensers	42		
pumps for ice machines	40		
push/momentary push switches	7		
push-in fittings	88		
R			
radial fans	38		
refrigeration cycle components	82		
refrigeration fans	34		
refrigeration gaskets	78		
refrigeration motors universal	34		
refrigeration thermostats	3		
relays	13		
retaining rings	91		
ribbon cables	43		
rocker/momentary rocker switches	6		
roll pins	91		

S

screws	89
sealing washers	80
shaft gaskets	81
sheet metal screws	89
shelves and shelf rails	77
silicone hoses	88
solenoid valves	21
spring assisted hinges	75
starting capacitors	42
switches and momentary switches	6

T

temperature probes	14
terminals and connectors	43
thermostats	3
time relays	13
timers	11
toggle switches	7
touch sensitive light switches	9
transformers	14

U

universal probes	14
------------------	----

W

washers	90
---------	----