



**GAS COMPONENTS**



**ELECTRIC COMPONENTS**



**WATER TECHNOLOGY**



**MECHANICAL COMPONENTS**



**TOOLS**

Spare parts suitable for

**IBERITAL-MACCHINE**

Find the complete and up-to-date range of products in our GEV Webshop



# Manufacturer catalogue

The most important spare parts and accessories arranged clearly for every manufacturer

- ✓ Complete product range and all appliance data always up to date in the GEV Webshop
- ✓ Alphabetical Index at the end of the catalogue

## GEV Webshop

[www.gev-online.co.uk](http://www.gev-online.co.uk)

[www.gev-online.com](http://www.gev-online.com)



- 🔍 Add to Favourites
- 🔍 Sign In with email address and usual password
- 🔍 Easy-order – place several items in your basket at the same time
- 🔍 Quick Item search – no login needed



## heating elements

### heating elements for coffee machine

1 

<b>GEV No.</b>	417258	<b>Ref. No.</b>	9938
<b>description</b>	heating element 1800/1960W 230/240V heating circuits 3 mounting $\varnothing$ 38.5mm hole distance 68mm L 184mm W 30mm H 28mm hole $\varnothing$ 11mm length thermostat sleeves 156mm thermostat sleeves $\varnothing$ 6mm number of thermostat sleeves 1 thermostat sleeve centred, adjacent tube $\varnothing$ 8.3mm connection M4 immersion heater 3 hole flange		

1 

<b>GEV No.</b>	417496	<b>Ref. No.</b>	2415
<b>description</b>	heating element 2600W 220V heating circuits 2 mounting $\varnothing$ 37mm hole distance 52mm L 415mm W 30mm H 58mm L1 25mm L2 50mm L3 340mm H1 25mm H2 28mm hole $\varnothing$ 10mm tube $\varnothing$ 8mm connection male faston 6.3mm immersion heater		

1 

<b>GEV No.</b>	417260	<b>Ref. No.</b>	9939
<b>description</b>	heating element 2600W 230V heating circuits 2 mounting $\varnothing$ 38.5mm hole distance 58mm L 385mm W 40mm H 46mm L1 25mm L2 45mm L3 315mm H1 26mm H2 20mm hole $\varnothing$ 11mm tube $\varnothing$ 8mm thermostat sleeves $\varnothing$ 6.5mm length thermostat sleeves 191mm thermostat sleeve centred, adjacent number of thermostat sleeves 1 connection M6 immersion heater 3 hole flange		

1 

<b>GEV No.</b>	417261	<b>Ref. No.</b>	9941
<b>description</b>	heating element 3700W 230V heating circuits 2 mounting $\varnothing$ 38.5mm hole distance 56mm L 580mm W 39mm H 45mm L1 22mm L2 36mm L3 520mm H1 25mm H2 20mm hole $\varnothing$ 11mm tube $\varnothing$ 8mm thermostat sleeves $\varnothing$ 6.5mm length thermostat sleeves 191mm thermostat sleeve centred, adjacent number of thermostat sleeves 1 connection M6 immersion heater 3 hole flange		

1 

<b>GEV No.</b>	417259	<b>Ref. No.</b>	9940
<b>description</b>	heating element 3800W 230V heating circuits 3 mounting $\varnothing$ 38.5mm hole distance 58mm L 388mm W 33mm H 34mm hole $\varnothing$ 11mm length thermostat sleeves 195mm thermostat sleeves $\varnothing$ 6mm number of thermostat sleeves 1 thermostat sleeve centred, adjacent tube $\varnothing$ 8mm connection M4 immersion heater 3 hole flange		

## immersion heating elements

### 3 hole flange $\varnothing$ 35.0mm

1 

<b>GEV No.</b>	416211	<b>Ref. No.</b>	23361	
<b>description</b>	heating element 2700W 230V heating circuits 1 mounting $\varnothing$ 35mm L 300mm W 25mm H 24mm tube $\varnothing$ 6.3mm hole distance 44mm hole $\varnothing$ 10mm connection male faston 6.3mm immersion heater 3 hole flange connection length 15mm			
<b>accessories for</b>	416211			
	<b>GEV No.</b>	507048	<b>Ref. No.</b>	—
	gasket ID $\varnothing$ 30mm silicone thickness 3mm hole $\varnothing$ 10mm hole distance 41mm for heating element warewashing			

## accessories

### flange gaskets

1 

<b>GEV No.</b>	528013	<b>Ref. No.</b>	11374
<b>description</b>	gasket ID $\varnothing$ 40mm fibre thickness 4mm hole $\varnothing$ 11mm hole distance 57mm for heating element coffee machine parts		

1 

<b>GEV No.</b>	528012	<b>Ref. No.</b>	6671
<b>description</b>	gasket suitable for VIBIEMME for heating element		

## thermostats

### bi-metal thermostats

#### bi-metal thermostats

1 

<b>GEV No.</b>	390450	<b>Ref. No.</b>	5299	
<b>description</b>	bi-metal thermostat hole distance 6mm switch-off temp. 66/57°C NC/NO 2-pole 16A connection F6.3			
<b>accessories for</b>	390450			
	<b>GEV No.</b>	505093	<b>Ref. No.</b>	—
	gasket for thermostat ED $\varnothing$ 35mm ID $\varnothing$ 24mm thickness 7mm equiv. no. N503017			

control and safety thermostats

EGO

safety thermostats

55.13\_ series



<b>GEV No.</b>	375898	<b>Ref. No.</b>	19433
<b>description</b>	safety thermostat switch-off temp. 140°C 1-pole 16A probe ø 4mm probe L 125mm capillary pipe 900mm capillary pipe isolated 420mm gland nut probe		



<b>GEV No.</b>	390804	<b>Ref. No.</b>	43261
<b>description</b>	safety thermostat switch-off temp. 340°C 1-pole 1NC 16A probe ø 3mm probe L 160mm capillary pipe 870mm capillary pipe isolated 600mm gland nut probe connection male faston 6.3mm		

55.32\_ series

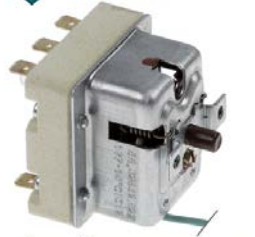

<b>GEV No.</b>	390324	<b>Ref. No.</b>	10028 16508
<b>description</b>	safety thermostat switch-off temp. 169°C 3-pole 3NC 20A probe ø 4mm probe L 128mm capillary pipe 890mm capillary pipe isolated 210/210mm gland nut probe SS		

switches and momentary switches

rocker/momentary rocker switches

30x22mm



<b>GEV No.</b>	301002	<b>Ref. No.</b>	6952
<b>description</b>	rocker switch mounting measurements 30x22mm orange 2NO 250V 16A illuminated 0-I connection male faston 6.3mm ambient temperature max. 85/125°C protection IP65		
<b>accessories for</b>	301002		
	<b>GEV No.</b>	301036	<b>Ref. No.</b> —
	protective cover internal size 30x22mm for rocker switch mounting measurementsmm		



<b>GEV No.</b>	301060	<b>Ref. No.</b>	5828
<b>description</b>	rocker switch mounting measurements 30x22mm red 2NO 250V 16A illuminated connection male faston 6.3mm ambient temperature max. 125/55°C protection IP40		

push/momentary push switches

19x13mm



<b>GEV No.</b>	347377	<b>Ref. No.</b>	19078
<b>description</b>	momentary push switch mounting measurements 19x13mm red 2NO 250V 16A ambient temperature max. 125°C protection IP40		

ø25mm



<b>GEV No.</b>	345151 <sup>1</sup>	<b>Ref. No.</b>	1660
<b>description</b>	push switch mounting ø 25mm orange 2NO 250V 16A illuminated connection male faston 6.3mm ambient temperature max. 85°C protection IP40		

<sup>1</sup>illuminated

miscellaneous



<b>GEV No.</b>	347317	<b>Ref. No.</b>	9420
<b>description</b>	microswitch mounting measurements 12x15mm black 1NO 240V 4A connection soldering connection ambient temperature max. 85°C protection IP40		



microswitches

roller actuated

roller 90°



<b>GEV No.</b>	345104	<b>Ref. No.</b>	399
<b>description</b>	microswitch with roller plunger 250V 16A 1CO connection male faston 6.3mm L 24mm ambient temperature max. 125°C thread L 12mm thread M10x0.75 mounting distance 22mm actuating force: 280g type EF83161.1		

cam switches

on/off



<b>GEV No.</b>	300021	<b>Ref. No.</b>	40704
<b>description</b>	cam switch 4 operating positions 4NO sequence 0-1-0-1 16A shaft ø 6x4.6mm shaft L 23mm connection screw ceramic		

rotary switches

GIOVENZANA

rotary switches



<b>GEV No.</b>	347975	<b>Ref. No.</b>	9177
<b>description</b>	rotary switch 3 0-1-2 sets of contacts 3 type P106 690V 20A shaft ø 5x5mm shaft L 15mm shaft square connection screw		

GOTTAK



<b>GEV No.</b>	347380	<b>Ref. No.</b>	11255
<b>description</b>	rotary switch 3 0-1-2 sets of contacts 2 400V 16A shaft ø 6x4.6mm shaft L 22mm shaft oval connection male faston 6.3mm		



<b>GEV No.</b>	345148	<b>Ref. No.</b>	2877
<b>description</b>	rotary switch 3 0-1-2 sets of contacts 6 type 4RH 400V 10A shaft ø 4.8x6mm shaft L 21mm shaft oval connection male faston 6.3mm		



<b>GEV No.</b>	347378	<b>Ref. No.</b>	24989
<b>description</b>	rotary switch 4 0-1-2-3 sets of contacts 4 400V 16A shaft ø 6x4.6mm shaft L 22mm shaft oval connection male faston 6.3mm		

TELERGON



<b>GEV No.</b>	347693	<b>Ref. No.</b>	43294
<b>description</b>	rotary switch 2 0-1 sets of contacts 1 type T-0002000011E1N1 300V 20A shaft ø 5x5mm shaft L 15mm shaft square with knob connection screw clamp		



<b>GEV No.</b>	347479	<b>Ref. No.</b>	1430
<b>description</b>	rotary switch 3 0-1-2 sets of contacts 6 type T-0002021589 400V 20A shaft ø 5x5mm shaft L 15mm connection screw TELERGON		

lamps

indicator lights

indicator lights (complete)

ø10mm

with plug-in socket



<b>GEV No.</b>	359139	<b>Ref. No.</b>	19457
<b>description</b>	indicator light ø 10mm green 230V connection male faston 6.3mm Qty 1 pcs		





			
1			
<b>GEV No.</b>	359138	<b>Ref. No.</b>	19458
<b>description</b>	indicator light ø 10mm red 230V connection male faston 6.3mm Qty 1 pcs		

ø13mm  
with screw socket

			
1			
<b>GEV No.</b>	357125	<b>Ref. No.</b>	43040
<b>description</b>	indicator light ø 13mm red 400V connection screw clamp		

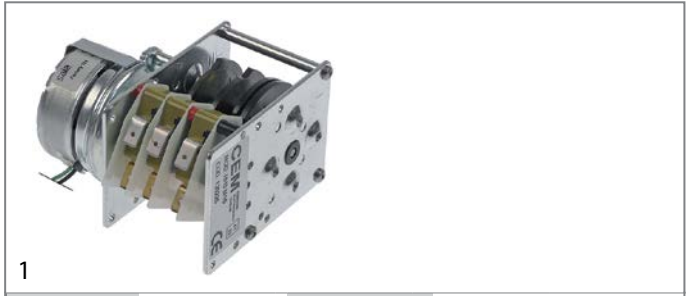

miscellaneous

			
1			
<b>GEV No.</b>	357124	<b>Ref. No.</b>	43292
<b>description</b>	indicator light green/red 230V connection screw		



1			
<b>GEV No.</b>	360011	<b>Ref. No.</b>	6363
<b>description</b>	timer CEM HH3M16 engines 1 chambers 3 operation time 120s 230V manuf. no. HH3M16 / 120225 motor type UDS40NE1RNZ165		
<b>spare parts for</b>	360011		
	<b>GEV No.</b>	360112	<b>Ref. No.</b> —
	motor SAIA pinion ø 4mm teeth 12 230V turn direction right motor ø 48mm motor type UDS11NE1RHZ for timer		



1			
<b>GEV No.</b>	360271	<b>Ref. No.</b>	14472
<b>description</b>	timer FIBER P25 engines 2 chambers 5 operation time 6s / 2min 230V shaft ømm shaft Lmm manuf. no. P25J05JDN7 motor type M51BJ0R6400 / M51BJ0L6400		
<b>spare parts for</b>	360271		
	<b>GEV No.</b>	360673	<b>Ref. No.</b> —
	motor kit pinion ø 6.8mm teeth 15 230V voltage AC 50/60Hz turn direction clockwise motor ø 48mm H 18.5mm motor type UDS-40NE1RNZ165 cable length 150mm with holder		
	<b>GEV No.</b>	360674	<b>Ref. No.</b> —
	motor kit pinion ø 6.8mm teeth 15 230V voltage AC 50/60Hz turn direction counterclockwise motor ø 48mm H 18.5mm motor type UDS40NE1RNZ165 cable length 150mm with holder		

timers

programme timers



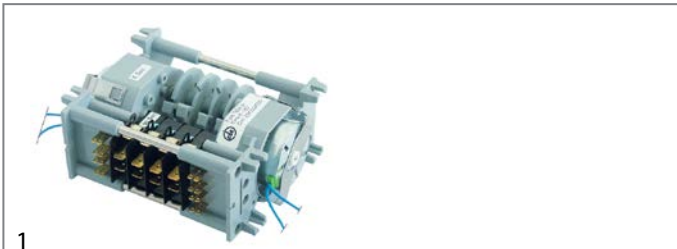

1			
<b>GEV No.</b>	360048	<b>Ref. No.</b>	13588
<b>description</b>	timer CDC 4904DV/4905DV engines 2 chambers 5 operation time 4s / 180s 230V shaft ømm shaft Lmm motor type M48L ATS		
<b>spare parts for</b>	360048		
	<b>GEV No.</b>	360083	<b>Ref. No.</b> —
	motor CDC pinion ø 4.9mm teeth 10 230V turn direction left motor ø 47mm H 19.3mm motor type M48L ATS for timer		

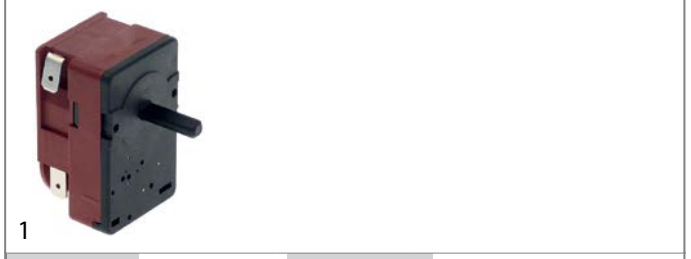

1			
<b>GEV No.</b>	361355	<b>Ref. No.</b>	14343
<b>description</b>	timer CDC 7804DV engines 2 chambers 4 operation time 6s / 3min 230V shaft ømm shaft Lmm motor type M37RN/M37LN		

mechanical timers



1			
<b>GEV No.</b>	350176	<b>Ref. No.</b>	10560
<b>description</b>	timer C20 2-pole operation time 5min 2NO at 250V 16A permanent position no shaft ø 6x4.6mm shaft 6x4.6mm shaft L 20mm mounting distance 28mm		
<b>accessories for</b>	350176		
	<b>GEV No.</b>	110366	<b>Ref. No.</b> —
	knob switch zero mark t.max. °C ø 44mm shaft ø 6x4.6mm shaft flat upper black		
	<b>GEV No.</b>	112138	<b>Ref. No.</b> —
	dial plate graduation 5min permanent position no rotation 0-290° ø 60mm		



contactors

LS Industrial Systems

power contactors



1

<b>GEV No.</b>	380922	<b>Ref. No.</b>	19036
<b>description</b>	power contactor resistive load 20A 230VAC (AC3/400V) 5A/2.2kW main contacts 3NO auxiliary contacts 1NO connection screw connection type GMC-6M		



1

<b>GEV No.</b>	380923	<b>Ref. No.</b>	19428 (old version)
<b>description</b>	power contactor resistive load 25A 230VAC (AC3/400V) 18A/7.5kW main contacts 4NO connection screw connection type GMC-18/4		



1

<b>GEV No.</b>	380924	<b>Ref. No.</b>	13353 19428
<b>description</b>	power contactor resistive load 32A 230VAC (AC3/400V) 22A/11kW main contacts 4NO connection screw connection type UKC1-22/KR4S		

GENERAL ELECTRIC (AEG)

power contactors



1

<b>GEV No.</b>	380846	<b>Ref. No.</b>	8736
<b>description</b>	contactor resistive load 16A 230VAC (AC3/400V) 9A/4kW main contacts 3NO auxiliary contacts 1NC connection male faston 6.3mm type AEG LS05 01A type GE MC1A 301A		

ALLEN BRADLEY

power contactors



1

<b>GEV No.</b>	380458	<b>Ref. No.</b>	8365
<b>description</b>	power contactor resistive load 20A 230VAC (AC3/400V) 9A/4kW main contacts 3NO auxiliary contacts 1NO connection screw connection type 100-K09KF10		

solid state relays

CELDUC



1

<b>GEV No.</b>	400521	<b>Ref. No.</b>	19030
<b>description</b>	solid state relay CELDUC 2 phase 50A 400V 10-30VDC L 58mm W 45mm screw type SCB965600 10-30VDC		

relays

power relays

with DIN rail mounting

lateral



1

<b>GEV No.</b>	380379	<b>Ref. No.</b>	6690
<b>description</b>	power relays SCHRACK 230VAC 25A 2CO connection male faston 6.3mm DIN rail manuf. no. RM809730		



## level relays

## GICAR



1

<b>GEV No.</b>	402103	<b>Ref. No.</b>	9625
<b>description</b>	level controller 230/240V voltage AC 50/60Hz connection F6.3 type NRL30/1E-2C/F		



1

<b>GEV No.</b>	528636	<b>Ref. No.</b>	13391
<b>description</b>	level controller 230V voltage AC 50/60Hz 16/5A connection F6.3 type RL30 MICRO ST		



1

<b>GEV No.</b>	402623	<b>Ref. No.</b>	21475
<b>description</b>	level controller 230V voltage AC 50/60Hz type 30μZ 3L S.T.		

## miscellaneous



1

<b>GEV No.</b>	400264	<b>Ref. No.</b>	7145
<b>description</b>	level relay 230V		

## probes

## producer-specific probes

## probes



1

<b>GEV No.</b>	525376	<b>Ref. No.</b>	13375
<b>description</b>	temperature probe NTC cable PVC probe -40 up to +110°C cable -10 up to 100°C connection plug thread 1/4" probe ø8x20mm cable length 0.37m		

## keypads

## front foils



1

<b>GEV No.</b>	525373	<b>Ref. No.</b>	19441
<b>description</b>	keypad foil black/silver suitable for IBERITAL L 27mm W 103mm buttons 5		



1

<b>GEV No.</b>	525374	<b>Ref. No.</b>	19092
<b>description</b>	keypad foil black/yellow suitable for FAEMA L 107mm W 51mm buttons 5		



1

<b>GEV No.</b>	525212	<b>Ref. No.</b>	19025
<b>description</b>	keypad foil silver/black suitable for IBERITAL L 103mm W 27mm buttons 5		

## membrane keypads



1

<b>GEV No.</b>	400509	<b>Ref. No.</b>	9998
<b>description</b>	membrane keypad coffee machine IBERITAL L 103mm W 27mm		



1

<b>GEV No.</b>	401408	<b>Ref. No.</b>	21934
<b>description</b>	membrane keypad coffee machine parts buttons 6 suitable for FAEMA L 176mm W 49mm		



1

<b>GEV No.</b>	402635	<b>Ref. No.</b>	11641
<b>description</b>	membrane keypad suitable for IBERITAL L 110mm W 30mm		







			
1			
<b>GEV No.</b>	402634	<b>Ref. No.</b>	19093
<b>description</b>	membrane keypad suitable for IBERITAL L 110mm W 55mm		

keypad units

			
1			
<b>GEV No.</b>	400226	<b>Ref. No.</b>	21476 21960
<b>description</b>	keypad unit buttons 5		

			
1			
<b>GEV No.</b>	402628	<b>Ref. No.</b>	11361
<b>description</b>	keypad unit buttons 5 black type TH SMT 1GR+RL lighting LED 230V L 120mm W 50mm		

			
1			
<b>GEV No.</b>	402626	<b>Ref. No.</b>	19424
<b>description</b>	keypad unit buttons 5 black/silver type 1d5e GRCZ NKP S10 lighting LED 230V L 117mm W 46mm		

			
1			
<b>GEV No.</b>	402627	<b>Ref. No.</b>	13349
<b>description</b>	keypad unit buttons 5 black/silver type 1d5e GRCZ NKP S10 lighting LED 230V L 117mm W 46mm with jumpers		

			
1			
<b>GEV No.</b>	402624	<b>Ref. No.</b>	9997
<b>description</b>	keypad unit buttons 5 black/silver type TH SMT 1GR+TEA 230V		

			
1			
<b>GEV No.</b>	402636	<b>Ref. No.</b>	19042
<b>description</b>	keypad unit buttons 5 black/white type TH SMT 1GR+RL 230V L 120mm W 50mm with jumper		

			
1			
<b>GEV No.</b>	402632	<b>Ref. No.</b>	21451
<b>description</b>	keypad unit buttons 5 black/yellow type 1d5e GRCZ NKP S10 no c/m 230V L 120mm W 50mm with jumper		

			
1			
<b>GEV No.</b>	402631	<b>Ref. No.</b>	21981
<b>description</b>	keypad unit buttons 5 black/yellow type 1d5e GRCZ NKP S10 no c/m 230V L 132mm W 64mm		

			
1			
<b>GEV No.</b>	400441	<b>Ref. No.</b>	11440
<b>description</b>	keypad unit buttons 5 L 91mm W 51mm		

			
1			
<b>GEV No.</b>	402630	<b>Ref. No.</b>	19439
<b>description</b>	keypad unit buttons 5 type 1d5e GRCZ NKP S10 230V L 120mm W 50mm with jumper		

			
1			
<b>GEV No.</b>	402629	<b>Ref. No.</b>	13381
<b>description</b>	keypad unit buttons 5 type 1d5e GRCZ NKP S10 lighting LED 230V L 120mm W 50mm		

			
1			
<b>GEV No.</b>	400354	<b>Ref. No.</b>	7633
<b>description</b>	keypad unit coffee machine AIRY/ATLAS/COMBI NOVA/JUNIOR buttons 5		

			
1			
<b>GEV No.</b>	402633	<b>Ref. No.</b>	21769
<b>description</b>	keypad unit temperature controller type CONTROL d, SSR HEATING C/L		

## solenoid valves

### solenoid valves (water)

metal

M&M

2-way



D267 series





			
1			
<b>GEV No.</b>	370598	<b>Ref. No.</b>	19072
<b>description</b>	solenoid valve brass 2-ways 230VAC inlet 1/4" outlet 1/4" connection 1/4" slide-on receptacle DIN -10 up to 180°C M&M type series D267 coil type 7701 membranes PTFE (steam) p max 9bar p min 0bar voltage 50/60		

PARKER

3-way

VE-128 series

			
1			
<b>GEV No.</b>	370057	<b>Ref. No.</b>	8259
<b>description</b>	solenoid valve 3-ways 230VAC body outer cone DN 1.2mm slide-on receptacle DIN -20° up to 140°C PARKER type series VE-128 coil type ZB09 membranes ruby p max 10bar brass flange 32x32mm		
<b>spare parts for</b>	370057		
	<b>GEV No.</b>	370062	<b>Ref. No.</b> —
solenoid valve body PARKER 3-ways outer cone			

<b>spare parts for</b>	370057		
	<b>GEV No.</b>	371029	<b>Ref. No.</b> —
solenoid coil PARKER 230VAC 9VA coil type ZB09 seat ø 14mm H 33mm W 34mm D 43mm			
<b>accessories for</b>	370057		
	<b>GEV No.</b>	371090	<b>Ref. No.</b> —
power socket plug type DIN 43650A screw			
	<b>GEV No.</b>	371095	<b>Ref. No.</b> —
O-ring Viton thickness 1.78mm ID ø 6.07mm Qty 1 pcs			
	<b>GEV No.</b>	371100	<b>Ref. No.</b> —
O-ring silicone thickness 1.78mm ID ø 6.07mm Qty 1 pcs			

## pressure switches

### for coffee machines

ø 38mm

			
1			
<b>GEV No.</b>	541104	<b>Ref. No.</b>	21463
<b>description</b>	pressure control ø 38mm pressure range 0.2-1.2bar 10A 250V connection male faston 6.3mm 1CO pressure connection 1/4"		

## electrodes

			
1			
<b>GEV No.</b>	401363	<b>Ref. No.</b>	21480
<b>description</b>	level electrode 1/4" total length 110mm probe L 85mm insulated probe length 26mm connection male faston 6.3mm stainless steel ø 2.5mm		

			
1			
<b>GEV No.</b>	401157	<b>Ref. No.</b>	5277
<b>description</b>	level electrode 1/4" total length 150mm probe L 122mm insulated probe length 26mm connection male faston 6.3mm stainless steel ø 2.5mm		

			
1			
<b>GEV No.</b>	400404	<b>Ref. No.</b>	21479
<b>description</b>	level electrode 1/4" total length 240mm probe L 216mm insulated probe length 209mm PTFE insulated connection angled, male faston 6.3mm stainless steel ø 2.5mm		



## flow meters and flow sensors

### flow meters

#### GICAR



1

**GEV No.** 541750 **Ref. No.** 21456

**description** flow meter hose ø 7mm plastic approval NSF

## motors

### motors

#### for ice-cube maker

#### complete



1

**GEV No.** 500793 **Ref. No.** 23735

**description** motor with belt pulley 120W 230V 50/60Hz 1 phase shaft ø 10mm 1390/1600rpm type RM63/50 ø 90mm H 160mm REBO 0.12kW

**spare parts for** 500793

	<b>GEV No.</b> 695279	<b>Ref. No.</b>	—
round belt pulley disc ø 49mm single shaft intake ø 10mm groove depth 5mm disc width 12mm groove width 10mm overall width 19mm shaft ø 18mm			

## pumps

### wash and rinse pumps

#### ALBA (C&A)

#### pumps







1





**GEV No.** 500299 **Ref. No.** 17240

**description** pump inlet ø 28mm outlet ø 28mm type C9035X 230V 50Hz 1 phase 0.11kW 0.15HP L 200mm rotation direction right capacitor 6.3µF ALBA PUMPS (C&A)

**spare parts for** 500299

	<b>GEV No.</b> 365012	<b>Ref. No.</b>	—
operating capacitor capacity 6.3µF 450V tolerance 5% 50Hz ambient temperature max. -25 to +85°C ø 30mm L 61mm M8 plastic connection male faston 6.3mm protection			
	<b>GEV No.</b> 510692	<b>Ref. No.</b>	—
mechanical shaft seal for shaft ø 11mm slide ring ext. ø 24mm slide ring H 13mm counter ring mounting ø 26mm height counter ring 8mm counter ring int. ø 14mm			
	<b>GEV No.</b> 521222	<b>Ref. No.</b>	—
impellor ø 72mm H 19mm thread M7L shaft ø 11mm shaft length 29mm blades 3			
	<b>GEV No.</b> 521518	<b>Ref. No.</b>	—
pump cover ALBA PUMPS (C&A) inlet ø 28mm outlet ø 28mm turn direction right ø 93mm ID ø 76mm inner height 31mm			
	<b>GEV No.</b> 532490	<b>Ref. No.</b>	—
O-ring EPDM thickness 2.62mm ID ø 72.69mm Qty 1 pcs			



1			
<b>GEV No.</b>	500938	<b>Ref. No.</b>	4603
<b>description</b>	pump inlet $\varnothing$ 30mm outlet $\varnothing$ 30mm type IM1629030 230V 50Hz 1 phase 0.22kW 0.3HP L 175mm rotation direction right capacitor 10 $\mu$ F auxiliary pressure connection 10mm supporting pressure open ALBA PUMPS (C&A)		
<b>spare parts for</b>	500938		
	<b>GEV No.</b>	507065	<b>Ref. No.</b> —
	pump cover		
	<b>GEV No.</b>	509018	<b>Ref. No.</b> —
	O-ring EPDM thickness 3.53mm ID $\varnothing$ 107.5mm Qty 1 pcs		
	<b>GEV No.</b>	509028	<b>Ref. No.</b> —
	impellor $\varnothing$ 87mm H 21mm rotation direction right thread M7L shaft $\varnothing$ 12mm		
	<b>GEV No.</b>	510693	<b>Ref. No.</b> —
	mechanical shaft seal for shaft $\varnothing$ 12mm slide ring ext. $\varnothing$ 24mm slide ring H 15.5mm slide ring int. $\varnothing$ 11mm counter ring mounting $\varnothing$ 24mm height counter ring 8mm counter ring int. $\varnothing$ 13.5mm		
<b>accessories for</b>	500938		
	<b>GEV No.</b>	365014	<b>Ref. No.</b> —
	operating capacitor capacity 12.5 $\mu$ F 450V tolerance 5%Hz ambient temperature max. -25 to +85°C $\varnothing$ 35mm L 70mm M8 plastic connection male faston 6.3mm 45S.C3DS.12.5 protection		

FIR

pumps

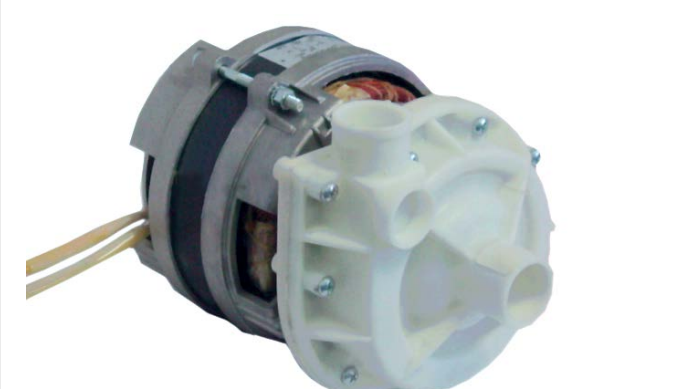

1			
<b>GEV No.</b>	500261	<b>Ref. No.</b>	23481
<b>description</b>	pump inlet $\varnothing$ 30mm outlet $\varnothing$ 30mm type 1267.1405 230V 50Hz 1 phase 0.18kW 0.25HP L 180mm rotation direction right capacitor 10 $\mu$ F FIR		
<b>spare parts for</b>	500261		
	<b>GEV No.</b>	365015	<b>Ref. No.</b> —
	operating capacitor capacity 10 $\mu$ F 400V tolerance 5%Hz ambient temperature max. -25 to +85°C $\varnothing$ 35.5mm L 59mm M8 plastic connection male faston 6.3mm protection		
	<b>GEV No.</b>	510605	<b>Ref. No.</b> —
	impellor $\varnothing$ 80mm H 21mm M7L		
	<b>GEV No.</b>	510702	<b>Ref. No.</b> —
	mechanical shaft seal height counter ring 5.5mm ID $\varnothing$ 12mm		
	<b>GEV No.</b>	521571	<b>Ref. No.</b> —
	pump cover FIR inlet $\varnothing$ 30mm outlet $\varnothing$ 30mm turn direction right $\varnothing$ 128mm ID $\varnothing$ 100mm inner height 21mm		
	<b>GEV No.</b>	521701	<b>Ref. No.</b> —
	pump cover gasket		



LGB



1	<b>GEV No.</b>	500153	<b>Ref. No.</b>	14812
	<b>description</b>	pump inlet ø outlet ø type W180SX 230V 50Hz 1 phase 0.19kW 0.26HP L 220mm rotation direction right capacitor 5µF LGB		
	<b>spare parts for</b>	500153		
	<b>GEV No.</b>	365017	<b>Ref. No.</b>	—
	<b>description</b>	operating capacitor capacity 5µF 450V tolerance 5% 50/60Hz ambient temperature max. -25 to +85°C ø 28mm L 54mm M8 plastic connection male faston 6.3mm 16.10.08 protection		
	<b>GEV No.</b>	510703	<b>Ref. No.</b>	—
	<b>description</b>	mechanical shaft seal for shaft ø 13mm slide ring H 13mm height counter ring 5.5mm ED ø 26mm		
	<b>GEV No.</b>	513267	<b>Ref. No.</b>	—
	<b>description</b>	end cap for wash pump suitable for pump casing		
	<b>GEV No.</b>	518177	<b>Ref. No.</b>	—
	<b>description</b>	drain unit thread 3/4" ID ø 35mm hose ø 24mm		
	<b>GEV No.</b>	518204	<b>Ref. No.</b>	—
	<b>description</b>	screw connection for filter ø 67mm		
	<b>GEV No.</b>	518205	<b>Ref. No.</b>	—
	<b>description</b>	flat gasket rubber ED ø 61mm ID ø 47mm thickness 2mm Qty 1 pcs		
	<b>GEV No.</b>	521147	<b>Ref. No.</b>	—
	<b>description</b>	flange		
	<b>GEV No.</b>	521221	<b>Ref. No.</b>	—
	<b>description</b>	impellor ø 67mm H 16mm rotation direction right thread M7L shaft ø 13mm shaft length 12mm blades 8		
	<b>GEV No.</b>	528800	<b>Ref. No.</b>	—
	<b>description</b>	O-ring EPDM thickness 2.62mm ID ø 75.87mm Qty 1 pcs		

vibration pumps

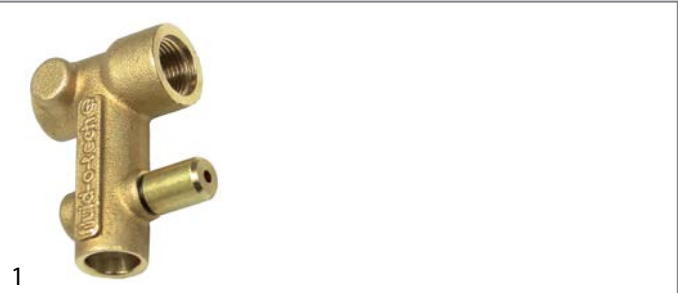

1	<b>GEV No.</b>	520250	<b>Ref. No.</b>	4112
	<b>description</b>	by-pass thread 1/8" IT T2: M12x1 IG		



1	<b>GEV No.</b>	499054	<b>Ref. No.</b>	6072
	<b>description</b>	vibration pump type 1108PAALM3N 220/240V 70W 50Hz inlet ø 1/8" outlet ø 1/8" FLUID-O-TECH L 129mm		









1	<b>GEV No.</b>	500124	<b>Ref. No.</b>	20021
	<b>description</b>	vibration pump type EX 5 230V 48W 50/60Hz inlet ø 6 outlet ø 1/8" IT flat seal ULKA brass L 123mm		
	<b>accessories for</b>	500124		
	<b>GEV No.</b>	520152	<b>Ref. No.</b>	—
	<b>description</b>	hose connector Santoprene grommet ø 7mm grommet length 14mm		
	<b>GEV No.</b>	520330	<b>Ref. No.</b>	—
	<b>description</b>	bracket rubber dimensions 69x44x4mm		



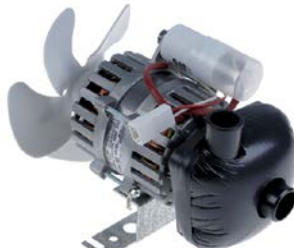

pumps for ice machines

			
1			
<b>GEV No.</b>	500590	<b>Ref. No.</b>	30166
<b>description</b>	pump FIR type 4240.2300 120W 230V 50/60Hz inlet ø 22mm outlet ø 22mm L 240mm rotation direction right for ice-cube maker capacitor 5µF		
<b>spare parts for</b>	500590		
	<b>GEV No.</b>	601412	<b>Ref. No.</b> —
	fan wheel sucking ø 154mm fan wheel mounting 25.4mm blade angle 28° W 34mm plastic		
	<b>GEV No.</b>	601413	<b>Ref. No.</b> —
	fixing plate suitable for fanwheel ED ø 32mm shaft ø 7 mounting distance 26mm		

			
1			
<b>GEV No.</b>	500165	<b>Ref. No.</b>	30165
<b>description</b>	pump REBO type 63/35 120W 230V 50/60Hz inlet ø 28mm outlet ø 26mm L 180mm rotation direction right for ice-cube maker capacitor 5µF		
<b>spare parts for</b>	500165		
	<b>GEV No.</b>	365017	<b>Ref. No.</b> —
	operating capacitor capacity 5µF 450V tolerance 5% 50/60Hz ambient temperature max. -25 to +85°C ø 28mm L 54mm M8 plastic connection male faston 6.3mm 16.10.08 protection		
	<b>GEV No.</b>	601412	<b>Ref. No.</b> —
	fan wheel sucking ø 154mm fan wheel mounting 25.4mm blade angle 28° W 34mm plastic		
	<b>GEV No.</b>	601413	<b>Ref. No.</b> —
	fixing plate suitable for fanwheel ED ø 32mm shaft ø 7 mounting distance 26mm		

electric accessories

cables

ribbon cables







group 5

			
1			
<b>GEV No.</b>	402568	<b>Ref. No.</b>	21477
<b>description</b>	ribbon cable 16-pole L 550mm plug type 2 row coded Qty 1m		

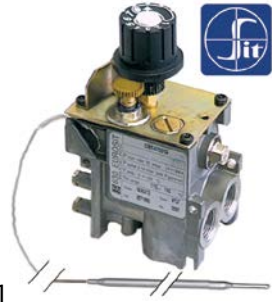
gas thermostats

SIT

630 Eurosit series

			
1			
<b>GEV No.</b>	101188	<b>Ref. No.</b>	40499
<b>description</b>	gas thermostat type 630 Eurosit series t.max. 190°C 110-190°C gas inlet 3/8" gas outlet 3/8" thermocouple connection M9x1 pilot connection M10x1 probe ø 4mm probe L 202mm capillary pipe 1050mm SIT		
<b>accessories for</b>	101188		
	<b>GEV No.</b>	100904	<b>Ref. No.</b> —
	locking screw M10x1 for pipe ø 4mm Qty 1 pcs		
	<b>GEV No.</b>	100905	<b>Ref. No.</b> 42509
	locking screw M10x1 for pipe ø 6mm Qty 1 pcs		
	<b>GEV No.</b>	101273	<b>Ref. No.</b> —
	olive for pipe ø 12mm L 9.5mm brass Qty 1 pcs suitable for universal		
	<b>GEV No.</b>	101276	<b>Ref. No.</b> —
	union screw thread 3/8" tube ø 12mm Qty 1 pcs		
	<b>GEV No.</b>	101333	<b>Ref. No.</b> —
	plug thread 3/8" with O-ring		





			
1			
<b>GEV No.</b>	101125	<b>Ref. No.</b>	40430
<b>description</b>	gas thermostat type 630 Eurosit series t.max. 340°C 100-340°C gas inlet 3/8" gas outlet 3/8" thermocouple connection M9x1 pilot connection M10x1 probe ø 4mm probe L 72mm capillary pipe 1050mm SIT		
<b>accessories for</b>	101125		
	<b>GEV No.</b>	100825	<b>Ref. No.</b> —
	gas tap spindle shaft ø 8x6.5mm shaft L 22/14mm suitable for EUROSIT		
	<b>GEV No.</b>	100904	<b>Ref. No.</b> —
	locking screw M10x1 for pipe ø 4mm Qty 1 pcs		
	<b>GEV No.</b>	100905	<b>Ref. No.</b> 42509
	locking screw M10x1 for pipe ø 6mm Qty 1 pcs		

Table continues overleaf





accessories for		101125		
	GEV No.	100949	Ref. No.	—
gasket suitable for 630 Eurosit series				
	GEV No.	101273	Ref. No.	—
olive for pipe ø 12mm L 9.5mm brass Qty 1 pcs suitable for universal				
	GEV No.	101276	Ref. No.	—
union screw thread 3/8" tube ø 12mm Qty 1 pcs				
	GEV No.	101333	Ref. No.	—
plug thread 3/8" with O-ring				
	GEV No.	101390	Ref. No.	—
gas tap spindle shaft ø 6x4.6mm shaft L 32/15mm gas tap with ignition flame suitable for ZANUSSI, MARENO for gas thermostat EUROSIT				
	GEV No.	101392	Ref. No.	—
adapter suitable for 630 Eurosit series				
	GEV No.	110357	Ref. No.	—
gas tap spindle shaft ø 8x6.5mm shaft L 36/12mm suitable for 630 Eurosit series				
	GEV No.	110358	Ref. No.	—
adapter shaft ø 10x8mm shaft L 29/18mm suitable for 630 Eurosit series				

accessories for		101132		
	GEV No.	101136	Ref. No.	—
piezoelectric igniter suitable for Minisit with cover cap ømm connection F6.3x0.8				
	GEV No.	101137	Ref. No.	—
cover cap without piezoelectric igniter				
	GEV No.	101267	Ref. No.	—
reducer IT 3/8" ET 1/2" L 21mm				
	GEV No.	101268	Ref. No.	—
gas connection thread 3/8" angled with O-ring MINISIT 710				
	GEV No.	101269	Ref. No.	—
gas connection thread 1/2" angled with O-ring MINISIT 710				
	GEV No.	101270	Ref. No.	—
screw connection IT 3/8" ET 3/8" L 28mm				
	GEV No.	101272	Ref. No.	—
screw connection IT 1/2" ET 3/8" L 57mm				
	GEV No.	101273	Ref. No.	—
olive for pipe ø 12mm L 9.5mm brass Qty 1 pcs suitable for universal				
	GEV No.	101274	Ref. No.	—
olive for pipe ø 16mm Qty 1 pcs				
	GEV No.	101275	Ref. No.	—
union screw thread 1/2" for pipe ø 16mm Qty 1 pcs				
	GEV No.	101276	Ref. No.	—
union screw thread 3/8" tube ø 12mm Qty 1 pcs				
	GEV No.	110068	Ref. No.	—
knob suitable for Minisit ø 37mm				

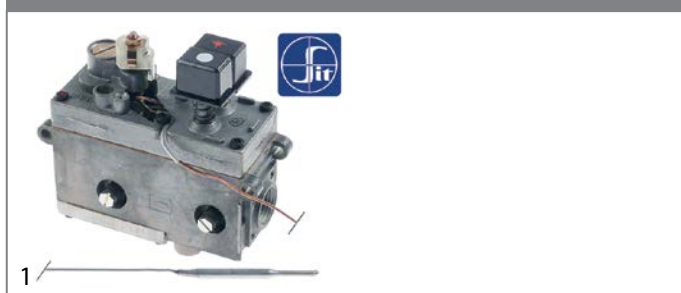
710 Minisit series



GEV No.	101132	Ref. No.	40495
<b>description</b>	gas thermostat SIT type MINISIT 710 t.max. 340°C 100-340°C gas inlet 1/2" gas outlet 3/8" thermocouple connection M9x1 pilot connection M10x1 probe ø 5mm probe L 68mm capillary pipe 1050mm probe type type B1 pressure controller no pressure regulator mbar gland nut ignition gas no		
<b>spare parts for</b>	101132		
	GEV No.	101053	Ref. No.
magnet unit T1: M9x1 T2: M24x1 L 45mm ø 17mm suitable for Minisit			
	GEV No.	102102	Ref. No.
probe 100-340°C probe ø 5mm probe L 68mm capillary pipe 1750mm t.max. 340°C oven/grill probe type type B1 suitable for MINISIT 710			
<b>accessories for</b>	101132		
	GEV No.	100809	Ref. No.
O-ring EPDM thickness 2mm ID ø 21mm Qty 1 pcs			
	GEV No.	100904	Ref. No.
locking screw M10x1 for pipe ø 4mm Qty 1 pcs			
	GEV No.	100905	Ref. No.
locking screw M10x1 for pipe ø 6mm Qty 1 pcs 42509			
	GEV No.	101054	Ref. No.
magnet unit T1: M10x1 T2: M24x1 L 45mm ø 17mm suitable for Minisit			



GEV No.	101131	Ref. No.	40494
<b>description</b>	gas thermostat without cap, button and angle SIT type MINISIT 710 t.max. 190°C 50-190°C gas inlet 1/2" gas outlet 3/8" thermocouple connection M9x1 pilot connection M10x1 probe ø 5mm probe L 98mm capillary pipe 1200mm probe type type A2 pressure controller no pressure regulator mbar gland nut		
<b>spare parts for</b>	101131		
	GEV No.	101053	Ref. No.
magnet unit T1: M9x1 T2: M24x1 L 45mm ø 17mm suitable for Minisit			
	GEV No.	102103	Ref. No.
probe 60-200°C probe ø 5mm probe L 98mm capillary pipe 1050mm t.max. 200°C fryer probe type type A2 suitable for MINISIT 710			

Table continues overleaf

accessories for		101131	
	GEV No.	100809	Ref. No. —
O-ring EPDM thickness 2mm ID ø 21mm Qty 1 pcs			
	GEV No.	100820	Ref. No. —
gland duct ET M14x1.5 IT M10x0.75 probe ø max. 6.5mm WS 22			
	GEV No.	100904	Ref. No. —
locking screw M10x1 for pipe ø 4mm Qty 1 pcs			
	GEV No.	100905	Ref. No. 42509
locking screw M10x1 for pipe ø 6mm Qty 1 pcs			
	GEV No.	101054	Ref. No. —
magnet unit T1: M10x1 T2: M24x1 L 45mm ø 17mm suitable for Minisit			
	GEV No.	101136	Ref. No. —
piezoelectric igniter suitable for Minisit with cover cap ømm connection F6.3x0.8			
	GEV No.	101137	Ref. No. —
cover cap without piezoelectric igniter			
	GEV No.	101267	Ref. No. —
reducer IT 3/8" ET 1/2" L 21mm			
	GEV No.	101268	Ref. No. —
gas connection thread 3/8" angled with O-ring MINISIT 710			
	GEV No.	101269	Ref. No. —
gas connection thread 1/2" angled with O-ring MINISIT 710			
	GEV No.	101270	Ref. No. —
screw connection IT 3/8" ET 3/8" L 28mm			
	GEV No.	101272	Ref. No. —
screw connection IT 1/2" ET 3/8" L 57mm			
	GEV No.	101273	Ref. No. —
olive for pipe ø 12mm L 9.5mm brass Qty 1 pcs suitable for universal			
	GEV No.	101274	Ref. No. —
olive for pipe ø 16mm Qty 1 pcs			
	GEV No.	101275	Ref. No. —
union screw thread 1/2" for pipe ø 16mm Qty 1 pcs			
	GEV No.	101276	Ref. No. —
union screw thread 3/8" tube ø 12mm Qty 1 pcs			
	GEV No.	110068	Ref. No. —
knob suitable for Minisit ø 37mm			

accessories			
probes			
			
1			
GEV No.	106225 <sup>1</sup>	Ref. No.	40973
description	probe 120-200°C probe ø 6mm probe L 102mm capillary pipe 1050mm t.max. 200°C fryer probe type type D1 suitable for MINISIT 710		

<sup>1</sup>gland box M14x1,5





**PEL**

**24STS series**

			
1			
GEV No.	101161	Ref. No.	41264
description	gas thermostat PEL type 24STS 120-320°C gas inlet M20x1.5 (tube ø 12/10mm) bypass nozzle ø 0.35mm gas outlet M20x1.5 (tube ø 12/10mm) thermocouple connection M9x1 pilot connection M10x1 capillary pipe 1200mm probe ø 6mm probe L 100mm shaft ø 10x8mm shaft L 27/17mm shaft flat upper		
spare parts for	101161		
	GEV No.	101058	Ref. No. —
magnet unit L 39mm D1 ø 15.4mm D2 ø 13.5mm suitable for PEL22/ EGA24197 standard			
accessories for	101161		
	GEV No.	101235	Ref. No. —
gas connection thread M20x1.5 tube ø 12/10mm for PEL gas taps horizontal			
	GEV No.	101236	Ref. No. —
gas connection thread M20x1.5 tube ø 12/10mm for PEL gas taps vertical			
	GEV No.	101240	Ref. No. —
gas connection thread M20x1.5 tube ø 12/10mm for PEL gas taps with gasket and screws horizontal			
	GEV No.	101241	Ref. No. —
gas connection thread M20x1.5 tube ø 12/10mm for PEL gas taps vertical			
	GEV No.	101248	Ref. No. —
olive for pipe ø 12mm Qty 1 pcs suitable for PEL			
	GEV No.	101249	Ref. No. —
olive for pipe ø 10mm Qty 1 pcs			
	GEV No.	101250	Ref. No. —
union nut thread M20x1.5 for pipe ø 10mm			
	GEV No.	101251	Ref. No. —
union nut thread M20x1.5 for pipe ø 12mm			
	GEV No.	101365	Ref. No. —
gas connection thread M20x1.5 tube ø 12mm for PEL gas taps horizontal			

Table continues overleaf











<b>accessories for</b>	101161		
	GEV No.	101460	Ref. No. —
	O-ring ø 12.37mm D1 ø 2.62mm suitable for PEL22		
	GEV No.	101461	Ref. No. —
	screw kit suitable for PEL22 Qty 4 pcs		
	GEV No.	110079	Ref. No. —
	knob dial plate gas thermostat 1-8 silver		
	GEV No.	110080	Ref. No. —
	knob ø 70mm shaft ø 10x8mm shaft flat universal		









## gas valves and ignition boxes

### gas control valves

#### SIT

#### ELETTROSIT

	1		
<b>GEV No.</b>	101123	<b>Ref. No.</b>	40492
<b>description</b>	gas valve SIT type ELETTROSIT 230V gas inlet 3/4" gas outlet 3/4" thermocouple connection M9x1 pilot connection M10x1 bottom equiv. no. 0.810.138		
<b>spare parts for</b>	101123		
	GEV No.	101312	Ref. No. —
	microswitch		
	GEV No.	101352	Ref. No. —
	solenoid coil 230V 50Hz suitable for ELETTROSIT		
<b>accessories for</b>	101123		
	GEV No.	100006	Ref. No. —
	piezoelectric igniter suitable for ELETTROSIT body plastic blowing connection ø2.4mm ø 14mm		
	GEV No.	100904	Ref. No. —
	locking screw M10x1 for pipe ø 4mm Qty 1 pcs		
	GEV No.	100905	Ref. No. 42509
	locking screw M10x1 for pipe ø 6mm Qty 1 pcs		
	GEV No.	101301	Ref. No. —
	gas connection thread 1/2" straight ELETTROSIT screw with O-ring		
	GEV No.	101303	Ref. No. —
	gas connection straight thread 3/4" ELETTROSIT		
	GEV No.	101309	Ref. No. —
	extension		





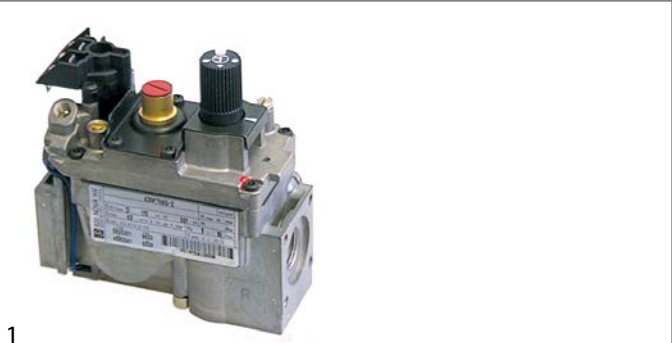

	1		
<b>GEV No.</b>	101127	<b>Ref. No.</b>	40422
<b>description</b>	gas valve SIT type ELETTROSIT 230V gas inlet 3/4" gas outlet 3/4" thermocouple connection M9x1 pilot connection M10x1 lateral equiv. no. 0.810.175		
<b>spare parts for</b>	101127		
	GEV No.	101312	Ref. No. —
	microswitch		
	GEV No.	101352	Ref. No. —
	solenoid coil 230V 50Hz suitable for ELETTROSIT		
<b>accessories for</b>	101127		
	GEV No.	100006	Ref. No. —
	piezoelectric igniter suitable for ELETTROSIT body plastic blowing connection ø2.4mm ø 14mm		
	GEV No.	100904	Ref. No. —
	locking screw M10x1 for pipe ø 4mm Qty 1 pcs		
	GEV No.	100905	Ref. No. 42509
	locking screw M10x1 for pipe ø 6mm Qty 1 pcs		
	GEV No.	101301	Ref. No. —
	gas connection thread 1/2" straight ELETTROSIT screw with O-ring		
	GEV No.	101303	Ref. No. —
	gas connection straight thread 3/4" ELETTROSIT		
	GEV No.	101309	Ref. No. —
	extension		



NOVASIT











1

<b>GEV No.</b>	101187	<b>Ref. No.</b>	40498
<b>description</b>	gas valve SIT series Novasit 820 0.17VHz gas inlet 1/2" gas outlet 1/2" thermocouple connection M9x1 pilot connection M10x1 ignition pressurebar pressure range 5-50mbar pressure regulator connection blind equiv. no. 0.820.301 supply Operator millivolt		
<b>spare parts for</b>	101187		
	<b>GEV No.</b>	101065	<b>Ref. No.</b> —
	magnet unit with cable L 44mm D1 ø 30mm D2 ø 20mm suitable for NOVASIT		
<b>accessories for</b>	101187		
	<b>GEV No.</b>	100110	<b>Ref. No.</b> —
	pilot burner SIT type 190 series 3 flames nozzle ømm gas connectionmm		
	<b>GEV No.</b>	101305	<b>Ref. No.</b> —
	gas connection straight 1/2" flange 45x45mm ELETTROSIT/V4400/4600/4605 suitable for SIT/HONEYWELL hole distance 36x36mm		
	<b>GEV No.</b>	101306	<b>Ref. No.</b> —
	gas connection angled flange 45x45mm hole distance 36x36mm 1/2" ELETTROSIT/V4400/4600/4605 screw with O-ring suitable for SIT/HONEYWELL		
	<b>GEV No.</b>	101307	<b>Ref. No.</b> —
	gas connection straight flange 45x45mm hole distance 36x36mm 3/4" ELETTROSIT/V4400/4600/4605 screw with O-ring suitable for SIT/HONEYWELL		
	<b>GEV No.</b>	101308	<b>Ref. No.</b> —
	gas connection angled flange 45x45mm hole distance 36x36mm 3/4" ELETTROSIT/V4400/4600/4605 screw with O-ring suitable for SIT/HONEYWELL		
	<b>GEV No.</b>	102116	<b>Ref. No.</b> —
	thermopile ROBERTSHAW L 900mm probe ø 9mm probe L 57mm 250-750mV screw connection 7/16"		





1

<b>GEV No.</b>	101914	<b>Ref. No.</b>	40421
<b>description</b>	gas valve SIT series Novasit 822 230V 50Hz gas inlet 1/2" gas outlet 1/2" thermocouple connection pilot connection closed ignition pressurebar pressure range 3-30mbar pressure regulator connection blind equiv. no. 0.822.144		
<b>spare parts for</b>	101914		
	<b>GEV No.</b>	101313	<b>Ref. No.</b> 42623
	solenoid coil 230V 50Hz		

<b>spare parts for</b>	101914		
	<b>GEV No.</b>	101542	<b>Ref. No.</b> —
	solenoid coil 50Hz NOVA 822/826/827 suitable for NOVASIT 230V		
<b>accessories for</b>	101914		
	<b>GEV No.</b>	101305	<b>Ref. No.</b> —
	gas connection straight 1/2" flange 45x45mm ELETTROSIT/V4400/4600/4605 suitable for SIT/HONEYWELL hole distance 36x36mm		
	<b>GEV No.</b>	101306	<b>Ref. No.</b> —
	gas connection angled flange 45x45mm hole distance 36x36mm 1/2" ELETTROSIT/V4400/4600/4605 screw with O-ring suitable for SIT/HONEYWELL		
	<b>GEV No.</b>	101307	<b>Ref. No.</b> —
	gas connection straight flange 45x45mm hole distance 36x36mm 3/4" ELETTROSIT/V4400/4600/4605 screw with O-ring suitable for SIT/HONEYWELL		
	<b>GEV No.</b>	101308	<b>Ref. No.</b> —
	gas connection angled flange 45x45mm hole distance 36x36mm 3/4" ELETTROSIT/V4400/4600/4605 screw with O-ring suitable for SIT/HONEYWELL		
	<b>GEV No.</b>	101503	<b>Ref. No.</b> —
	O-ring EPDM thickness 2mm ID ø 32mm Qty 1 pcs		
	<b>GEV No.</b>	101924	<b>Ref. No.</b> —
	plug with cable L 1090mm suitable for NOVA 822/826/827		

<b>accessories</b>			
	1		
<b>GEV No.</b>	100905	<b>Ref. No.</b>	42509
<b>description</b>	locking screw M10x1 for pipe ø 6mm Qty 1 pcs		

	1		
<b>GEV No.</b>	101313	<b>Ref. No.</b>	42623
<b>description</b>	solenoid coil 230V 50Hz		
<b>accessories for</b>	101313		
	<b>GEV No.</b>	550896	<b>Ref. No.</b> —
	gasket with screw gas valves NOVASIT		





# ignition parts









## pilot burners

SIT

100 series



1

<b>GEV No.</b>	106901	<b>Ref. No.</b>	40471
<b>description</b>	pilot burner SIT type 100 series 1 flame nozzle $\varnothing$ 0.2mm gas connection 6mm		
<b>spare parts for</b>	106901		
	GEV No.	100854	Ref. No. —
	pilot burner bracket double		
	GEV No.	100916	Ref. No. —
	compression spring for pilot burner Qty 1 pcs		
	GEV No.	100917	Ref. No. —
	gasket for pilot burner Qty 1 pcs aluminium		
	GEV No.	100918	Ref. No. —
	screw for pilot burner		
<b>accessories for</b>	106901		
	GEV No.	100904	Ref. No. —
	locking screw M10x1 for pipe $\varnothing$ 4mm Qty 1 pcs		
	GEV No.	100905	Ref. No. 42509
	locking screw M10x1 for pipe $\varnothing$ 6mm Qty 1 pcs		
	GEV No.	102110	Ref. No. —
	pilot tube copper pipe $\varnothing$ 4mm thickness 1mm L 3000mm		
	GEV No.	102111	Ref. No. —
	pilot tube copper pipe $\varnothing$ 6mm thickness 1mm L 3000mm		
	GEV No.	102742	Ref. No. —
	pilot burner nozzle LPG code 25 bore $\varnothing$ 0.25mm Qty 1 pcs		



1

<b>GEV No.</b>	106902	<b>Ref. No.</b>	40014
<b>description</b>	pilot burner SIT type 100 series 2 flames nozzle $\varnothing$ 0.2mm gas connection 6mm		
<b>spare parts for</b>	106902		
	GEV No.	100245	Ref. No. —
	pilot burner nozzle LPG code 20 bore $\varnothing$ 0.2mm Qty 1 pcs thread M8x0.75		

<b>spare parts for</b>	106902		
	GEV No.	100842	Ref. No. —
	pilot burner cap 2 flames Qty 1 pcs		
	GEV No.	100885	Ref. No. —
	air mixing sleeve for pilot burner Qty 1 pcs		
	GEV No.	100916	Ref. No. —
	compression spring for pilot burner Qty 1 pcs		
	GEV No.	100917	Ref. No. —
	gasket for pilot burner Qty 1 pcs aluminium		
	GEV No.	100918	Ref. No. —
	screw for pilot burner		
	GEV No.	107161	Ref. No. —
	pilot burner cap SIT 2 flames Hmm Lmm Qty 1 pcs		
	GEV No.	107701	Ref. No. —
	pilot burner bottom part SIT 100 series nozzle $\varnothing$ 0.2mm		
<b>accessories for</b>	106902		
	GEV No.	100246	Ref. No. —
	pilot burner nozzle natural gas bore $\varnothing$ 0.35mm Qty 1 pcs thread M8x0.75		
	GEV No.	100904	Ref. No. —
	locking screw M10x1 for pipe $\varnothing$ 4mm Qty 1 pcs		
	GEV No.	100905	Ref. No. 42509
	locking screw M10x1 for pipe $\varnothing$ 6mm Qty 1 pcs		
	GEV No.	102110	Ref. No. —
	pilot tube copper pipe $\varnothing$ 4mm thickness 1mm L 3000mm		
	GEV No.	102111	Ref. No. —
	pilot tube copper pipe $\varnothing$ 6mm thickness 1mm L 3000mm		
	GEV No.	107171	Ref. No. —
	pilot burner nozzle SIT natural/liquid gas bore $\varnothing$ 0.25mm Qty 1 pcs		
	GEV No.	107700	Ref. No. —
	pilot burner bottom part SIT 100 series nozzle $\varnothing$ 0.25mm		
	GEV No.	107702	Ref. No. —
	pilot burner bottom part SIT 100 series nozzle $\varnothing$ 0.35mm		

1 gas components



			
1			
<b>GEV No.</b>	106903	<b>Ref. No.</b>	41703
<b>description</b>	pilot burner SIT type 100 series 3 flames nozzle ø 0.2mm gas connection 6mm		
<b>spare parts for</b>	106903		
	GEV No.	100245	Ref. No. —
	pilot burner nozzle LPG code 20 bore ø 0.2mm Qty 1 pcs thread M8x0.75		
	GEV No.	100854	Ref. No. —
	pilot burner bracket double		
	GEV No.	100885	Ref. No. —
	air mixing sleeve for pilot burner Qty 1 pcs		
	GEV No.	100916	Ref. No. —
	compression spring for pilot burner Qty 1 pcs		
	GEV No.	100917	Ref. No. —
	gasket for pilot burner Qty 1 pcs aluminium		
	GEV No.	100918	Ref. No. —
	screw for pilot burner		
	GEV No.	107162	Ref. No. —
	pilot burner cap SIT 3 flames Hmm Lmm Qty 1 pcs		
	GEV No.	107701	Ref. No. —
	pilot burner bottom part SIT 100 series nozzle ø 0.2mm		
<b>accessories for</b>	106903		
	GEV No.	100245	Ref. No. —
	pilot burner nozzle LPG code 20 bore ø 0.2mm Qty 1 pcs thread M8x0.75		
	GEV No.	100246	Ref. No. —
	pilot burner nozzle natural gas bore ø 0.35mm Qty 1 pcs thread M8x0.75		
	GEV No.	100904	Ref. No. —
	locking screw M10x1 for pipe ø 4mm Qty 1 pcs		
	GEV No.	100905	Ref. No. 42509
	locking screw M10x1 for pipe ø 6mm Qty 1 pcs		
	GEV No.	102110	Ref. No. —
	pilot tube copper pipe ø 4mm thickness 1mm L 3000mm		
	GEV No.	102111	Ref. No. —
	pilot tube copper pipe ø 6mm thickness 1mm L 3000mm		
	GEV No.	107171	Ref. No. —
	pilot burner nozzle SIT natural/liquid gas bore ø 0.25mm Qty 1 pcs		
	GEV No.	107700	Ref. No. —
	pilot burner bottom part SIT 100 series nozzle ø 0.25mm		

<b>accessories for</b>	106903		
	GEV No.	107702	Ref. No. —
	pilot burner bottom part SIT 100 series nozzle ø 0.35mm		



































			
1			
<b>GEV No.</b>	106906	<b>Ref. No.</b>	40016
<b>description</b>	pilot burner SIT type 100 series 3 flames nozzle ø 0.2mm gas connection 6mm		
<b>spare parts for</b>	106906		
	GEV No.	100245	Ref. No. —
	pilot burner nozzle LPG code 20 bore ø 0.2mm Qty 1 pcs thread M8x0.75		
	GEV No.	100855	Ref. No. —
	pilot burner bracket triple		
	GEV No.	100885	Ref. No. —
	air mixing sleeve for pilot burner Qty 1 pcs		
	GEV No.	100916	Ref. No. —
	compression spring for pilot burner Qty 1 pcs		
	GEV No.	100917	Ref. No. —
	gasket for pilot burner Qty 1 pcs aluminium		
	GEV No.	100918	Ref. No. —
	screw for pilot burner		
	GEV No.	107162	Ref. No. —
	pilot burner cap SIT 3 flames Hmm Lmm Qty 1 pcs		
	GEV No.	107701	Ref. No. —
	pilot burner bottom part SIT 100 series nozzle ø 0.2mm		
<b>accessories for</b>	106906		
	GEV No.	100245	Ref. No. —
	pilot burner nozzle LPG code 20 bore ø 0.2mm Qty 1 pcs thread M8x0.75		
	GEV No.	100246	Ref. No. —
	pilot burner nozzle natural gas bore ø 0.35mm Qty 1 pcs thread M8x0.75		
	GEV No.	100904	Ref. No. —
	locking screw M10x1 for pipe ø 4mm Qty 1 pcs		
	GEV No.	100905	Ref. No. 42509
	locking screw M10x1 for pipe ø 6mm Qty 1 pcs		
	GEV No.	102110	Ref. No. —
	pilot tube copper pipe ø 4mm thickness 1mm L 3000mm		
	GEV No.	102111	Ref. No. —
	pilot tube copper pipe ø 6mm thickness 1mm L 3000mm		

Table continues overleaf





accessories for		106906	
	GEV No.	107171	Ref. No. —
pilot burner nozzle SIT natural/liquid gas bore ø 0.25mm Qty 1 pcs			
	GEV No.	107700	Ref. No. —
pilot burner bottom part SIT 100 series nozzle ø 0.25mm			
	GEV No.	107702	Ref. No. —
pilot burner bottom part SIT 100 series nozzle ø 0.35mm			

accessories for		107114	
	GEV No.	100909	Ref. No. —
union screw thread M10x1 for pipe ø 6mm Qty 1 pcs			
	GEV No.	102110	Ref. No. —
pilot tube copper pipe ø 4mm thickness 1mm L 3000mm			
	GEV No.	102111	Ref. No. —
pilot tube copper pipe ø 6mm thickness 1mm L 3000mm			

140 - 145 -150 series			
			
1			
GEV No.	107114 <sup>1</sup>	Ref. No.	40472
description pilot burner SIT type 140 series 2 flames nozzle ømm gas connecti- onmm			
spare parts for 107114			
	GEV No.	100907	Ref. No. —
screw connection thread M10x1 Qty 1 pcs type SEF 1 ømm for thermocouple			
accessories for 107114			
	GEV No.	100204	Ref. No. 41007
pilot burner nozzle SIT LPG code 14 bore ø 0.18/0.20mm Qty 1 pcs suitable for 140 series			
	GEV No.	100205	Ref. No. —
pilot burner nozzle SIT LPG code 19 bore ø 0.23/0.26mm Qty 1 pcs suitable for SIT 150 series			
	GEV No.	100206	Ref. No. —
pilot burner nozzle SIT natural gas code 36 bore ø 0.60/0.55mm Qty 1 pcs suitable for SIT 150 series			
	GEV No.	100207	Ref. No. 40292
pilot burner nozzle SIT natural gas code 27 bore ø 0.40/0.38mm suitable for SIT 140 series			
	GEV No.	100216	Ref. No. —
pilot burner nozzle SIT natural gas code 38 bore ø 0.45mm Qty 1 pcs suitable for SIT 150 series			
	GEV No.	100701	Ref. No. 9611
ignition electrode connection M4 Qty 1 pcs			
	GEV No.	100801	Ref. No. —
gasket for pilot burner Qty 1 pcs			
	GEV No.	100897	Ref. No. —
olive for pipe ø 4mm Qty 1 pcs for pilot burner			
	GEV No.	100898	Ref. No. —
olive for pipe ø 6mm Qty 1 pcs for pilot burner			
	GEV No.	100906	Ref. No. —
screw connection thread M10x1 for ignition electrode brass Qty 1 pcs WS 10			
	GEV No.	100908	Ref. No. —
union screw thread M10x1 for pipe ø 4mm Qty 1 pcs			

<sup>1</sup>incl. thermocouple fitting

## electrodes

			
1			
GEV No.	100701	Ref. No.	9611
description ignition electrode connection M4 Qty 1 pcs			
accessories for 100701			
	GEV No.	100906	Ref. No. —
screw connection thread M10x1 for ignition electrode brass Qty 1 pcs WS 10			

## ignition cables

pre-assembled cables			
			
1			
GEV No.	102155	Ref. No.	41698
description ignition cable cable length 900mm connection ø4mm / F2.8mm			

## piezoelectric igniters

mounting diameter 18mm			
			
1			
GEV No.	100009	Ref. No.	4182 70473
description piezoelectric igniter body plastic blowing mounting ø 18mm con- nection ø2.4mm front measurements 26mm M18x1.5			
accessories for 100009			
	GEV No.	101339	Ref. No. —
cover cap for piezoelectric igniter			
	GEV No.	106869	Ref. No. —
cover cap for piezoelectric igniter ID ø 22mm ED ø 35mm H 25mm			

Table continues overleaf



<b>accessories for</b>	100009		
	<b>GEV No.</b>	107931	<b>Ref. No.</b> —
cover cap for piezoelectric igniter ID $\varnothing$ 21mm ED $\varnothing$ 36mm			

## miscellaneous

	1		
<b>GEV No.</b>	nla <sup>1</sup>	<b>Ref. No.</b>	41192
<b>description</b>	piezoelectric igniter suitable for Minisit connection F6.3x0.8 $\varnothing$ mm		

<sup>1</sup>no longer available

## thermocouples

### plug-in thermocouples

#### plug-in thermocouples standard

with barrel socket  $\varnothing$ 6(6.5)mm

#### thermocouples SIT

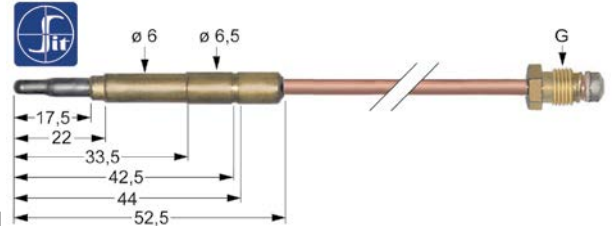
	1		
<b>GEV No.</b>	107612	<b>Ref. No.</b>	41550
<b>description</b>	thermocouple SIT M9x1 L 1000mm plug connection $\varnothing$ 6.0(6.5)mm		

<b>GEV No.</b>	107612	<b>Ref. No.</b>	41550
<b>description</b>	thermocouple SIT M9x1 L 1000mm plug connection $\varnothing$ 6.0(6.5)mm		

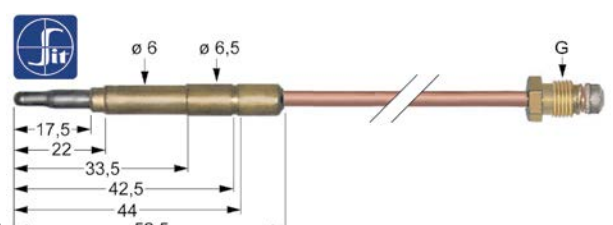
	1		
<b>GEV No.</b>	107613	<b>Ref. No.</b>	40535
<b>description</b>	thermocouple SIT M9x1 L 1200mm plug connection $\varnothing$ 6.0(6.5)mm		

<b>GEV No.</b>	107613	<b>Ref. No.</b>	40535
<b>description</b>	thermocouple SIT M9x1 L 1200mm plug connection $\varnothing$ 6.0(6.5)mm		

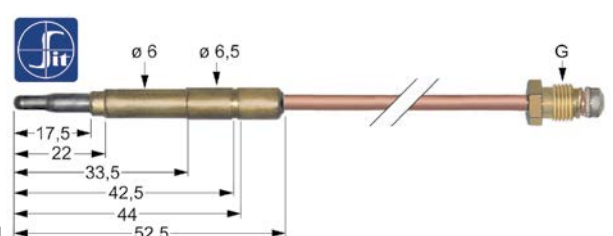
	1		
<b>GEV No.</b>	107614	<b>Ref. No.</b>	40362
<b>description</b>	thermocouple SIT M9x1 L 1500mm plug connection $\varnothing$ 6.0(6.5)mm		

<b>GEV No.</b>	107614	<b>Ref. No.</b>	40362
<b>description</b>	thermocouple SIT M9x1 L 1500mm plug connection $\varnothing$ 6.0(6.5)mm		

## thermocouples with aluminised tip

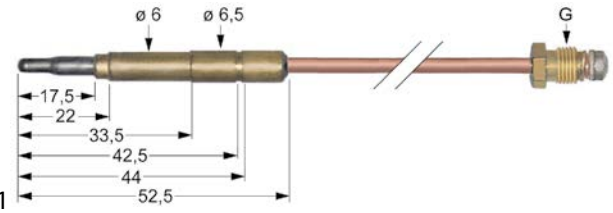
	1		
<b>GEV No.</b>	102036	<b>Ref. No.</b>	70551
<b>description</b>	thermocouple M8x1 L 1000mm plug connection $\varnothing$ 6.0(6.5)mm		

<b>GEV No.</b>	102036	<b>Ref. No.</b>	70551
<b>description</b>	thermocouple M8x1 L 1000mm plug connection $\varnothing$ 6.0(6.5)mm		

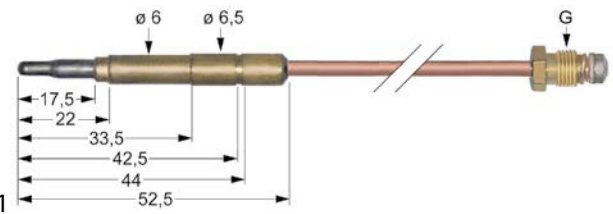
	1		
<b>GEV No.</b>	102035	<b>Ref. No.</b>	43057
<b>description</b>	thermocouple M8x1 L 850mm plug connection $\varnothing$ 6.0(6.5)mm		

<b>GEV No.</b>	102035	<b>Ref. No.</b>	43057
<b>description</b>	thermocouple M8x1 L 850mm plug connection $\varnothing$ 6.0(6.5)mm		

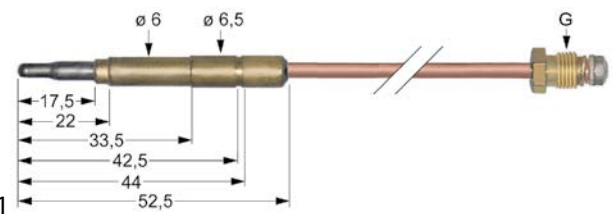
	1		
<b>GEV No.</b>	102041	<b>Ref. No.</b>	40534
<b>description</b>	thermocouple M9x1 L 600mm plug connection $\varnothing$ 6.0(6.5)mm		

<b>GEV No.</b>	102041	<b>Ref. No.</b>	40534
<b>description</b>	thermocouple M9x1 L 600mm plug connection $\varnothing$ 6.0(6.5)mm		

## accessories

### nuts

	1		
<b>GEV No.</b>	102067	<b>Ref. No.</b>	40540
<b>description</b>	nut thread M8x1 H 3mm brass Qty 1 pcs type SEF 1		

<b>GEV No.</b>	102067	<b>Ref. No.</b>	40540
<b>description</b>	nut thread M8x1 H 3mm brass Qty 1 pcs type SEF 1		

	1		
<b>GEV No.</b>	102500	<b>Ref. No.</b>	40540
<b>description</b>	nut thread M8x1 Qty 10 pcs		

<b>GEV No.</b>	102500	<b>Ref. No.</b>	40540
<b>description</b>	nut thread M8x1 Qty 10 pcs		



## gas burners

### hob burners

#### accessories

#### reducers for pan supports



1

<b>GEV No.</b>	104499	<b>Ref. No.</b>	43158
<b>description</b>	reducer for pan support L 175mm W 114mm		

## gas nozzles

### main nozzles

#### gas nozzles M9x1



1

<b>GEV No.</b>	107345	<b>Ref. No.</b>	43081
<b>description</b>	gas injector thread M9x1 WS 10 bore ø 0.9mm		



1

<b>GEV No.</b>	107347	<b>Ref. No.</b>	43192
<b>description</b>	gas injector thread M9x1 WS 10 bore ø 2.4mm		

### pilot burner nozzles

#### pilot burner nozzles SIT

#### 140/150 series



1

<b>GEV No.</b>	100204	<b>Ref. No.</b>	41007
<b>description</b>	pilot burner nozzle SIT LPG code 14 bore ø 0.18/0.20mm Qty 1 pcs suitable for 140 series		



1

<b>GEV No.</b>	100207	<b>Ref. No.</b>	40292
<b>description</b>	pilot burner nozzle SIT natural gas code 27 bore ø 0.40/0.38mm suitable for SIT 140 series		

#### 160 series



1

<b>GEV No.</b>	107650	<b>Ref. No.</b>	41009
<b>description</b>	pilot burner nozzle SIT LPG code 30 Qty 1 pcs		

## auxiliary gas parts

### screw connections

#### union screws



1

<b>GEV No.</b>	100905	<b>Ref. No.</b>	42509
<b>description</b>	locking screw M10x1 for pipe ø 6mm Qty 1 pcs		

#### angle pieces



1

<b>GEV No.</b>	104490	<b>Ref. No.</b>	43167
<b>description</b>	angle piece T1: 1/2" IT T2: 1/2" ET grommet ø 13.5mm grommet length 22mm WS 24 brass		



1

<b>GEV No.</b>	104489	<b>Ref. No.</b>	43168
<b>description</b>	angle piece T1: 3/4" IT T2: 1/2" ET grommet ø 13.5mm grommet length 22mm WS 24 brass		

## tools

### reamers

#### reamer set



1

<b>GEV No.</b>	800050	<b>Ref. No.</b>	70565
<b>description</b>	nozzle reamers set size 0.5/0.6/0.7/0.8/0.9mm size 1 1.0/1.1/1.2/1.4/1.6/1.8/2.0mm 12-piece with holder		
<b>description</b>	reamer set with holder 12-piece 0.5mm / 0.6mm / 0.7mm / 0.8mm / 0.9mm / 1.0mm 1.1mm / 1.2mm / 1.4mm / 1.6mm / 1.8mm / 2.0mm		



## equipment-specific units

## for ice-cube maker

## mechanics for evaporators

## gear motors

## motors



1

<b>GEV No.</b>	500793	<b>Ref. No.</b>	23735
<b>description</b>	motor with belt pulley 120W 230V 50/60Hz 1 phase shaft $\varnothing$ 10mm 1390/1600rpm type RM63/50 $\varnothing$ 90mm H 160mm REBO 0.12kW		
<b>spare parts for</b>	500793		
	<b>GEV No.</b>	695279	<b>Ref. No.</b>
			—
<b>description</b>	round belt pulley disc $\varnothing$ 49mm single shaft intake $\varnothing$ 10mm groove depth 5mm disc width 12mm groove width 10mm overall width 19mm shaft $\varnothing$ 18mm		

## for espresso machines

## filter holders

## filter holders standard

## filter holder without spout



1

<b>GEV No.</b>	525997	<b>Ref. No.</b>	N/A
<b>description</b>	filter holder suitable for IBERITAL without outlet mounting $\varnothing$ 83mm hole $\varnothing$ 7.5mm outlet 3/8" ID $\varnothing$ 56.5mm wedge height 8mm wedge position horizontal number of wedges 3 lever inclined chrome-plated brass		



1

<b>GEV No.</b>	525998	<b>Ref. No.</b>	N/A
<b>description</b>	filter holder suitable for IBERITAL without outlet mounting $\varnothing$ 83mm hole $\varnothing$ 7.5mm outlet 3/8" ID $\varnothing$ 62mm wedge height 10.2mm wedge position horizontal number of wedges 2 lever straight chrome-plated brass		

## filter holders short



1

<b>GEV No.</b>	525231	<b>Ref. No.</b>	19412
<b>description</b>	filter holder mounting $\varnothing$ 83mm outlet 3/8" ID $\varnothing$ 56.5mm handle M12x1.75 wedge height 8mm wedge position horizontal number of wedges 2 lever inclined chrome-plated brass		



1

<b>GEV No.</b>	525230	<b>Ref. No.</b>	2966 9699
<b>description</b>	filter holder mounting $\varnothing$ 83mm outlet 3/8" ID $\varnothing$ 62mm handle M12x1.75 wedge height 10.2mm wedge position horizontal number of wedges 2 lever straight chrome-plated brass		

## filters

## for 1 cup



1

<b>GEV No.</b>	525234	<b>Ref. No.</b>	19786
<b>description</b>	coffee filter $\varnothing$ 66mm mounting $\varnothing$ 55mm H 23mm cups 1 perforation $\varnothing$ 0.45mm		



1

<b>GEV No.</b>	525235	<b>Ref. No.</b>	19787
<b>description</b>	coffee filter $\varnothing$ 66mm mounting $\varnothing$ 55mm H 25mm cups 1 perforation $\varnothing$ 0.45mm		

## for 2 cups



1

<b>GEV No.</b>	529030	<b>Ref. No.</b>	19788
<b>description</b>	coffee filter $\varnothing$ 65mm mounting $\varnothing$ 55mm H 27.5mm cups 2 amount of coffee 14g		



blind filters			
			
1			
<b>GEV No.</b>	525232	<b>Ref. No.</b>	6551
<b>description</b>	blind filter ø 65mm mounting ø 55.2mm H 25.5mm		

with upstand			
			
1			
<b>GEV No.</b>	529132	<b>Ref. No.</b>	288
<b>description</b>	shower screen ø 58mm H 18mm		

brewing units			
shower screens			
flat			
			
1			
<b>GEV No.</b>	529088	<b>Ref. No.</b>	2181
<b>description</b>	shower screen ø 48mm hole ø 5.5mm flat		

			
1			
<b>GEV No.</b>	529084	<b>Ref. No.</b>	1194
<b>description</b>	shower screen ø 52mm hole ø 6.4mm		

with upstand and central hole			
			
1			
<b>GEV No.</b>	525233	<b>Ref. No.</b>	19079
<b>description</b>	shower screen ø 52mm H 5mm hole ø 5mm		

 <p>Image not available</p>			
1			
<b>GEV No.</b>	531287	<b>Ref. No.</b>	ID-103
<b>description</b>	shower screen ø 57.5mm		

filter holder gaskets			
flat			
with internal notch			
			
1			
<b>GEV No.</b>	525385	<b>Ref. No.</b>	19077
<b>description</b>	filter holder gasket inner cone D1 ø 73.5mm D2 ø 55.5mm H 10.5mm with inside notch Qty 1 pcs		

standard			
			
1			
<b>GEV No.</b>	528030	<b>Ref. No.</b>	142
<b>description</b>	filter holder gasket D1 ø 72.7mm D2 ø 57.2mm H 8mm Qty 1 pcs		

			
1			
<b>GEV No.</b>	528060	<b>Ref. No.</b>	1280
<b>description</b>	filter holder gasket D1 ø 73.5mm D2 ø 59.5mm H 7.5mm Qty 1 pcs		

			
1			
<b>GEV No.</b>	525607	<b>Ref. No.</b>	142 30260
<b>description</b>	filter holder gasket D1 ø 73mm D2 ø 57mm H 8.2mm Qty 1 pcs		

			
1			
<b>GEV No.</b>	525371	<b>Ref. No.</b>	145
<b>description</b>	filter holder gasket D1 ø 73mm D2 ø 57mm H 9.2mm Qty 1 pcs		

brewing units with solenoid valve

filters

filters

			
1			
<b>GEV No.</b>	526738	<b>Ref. No.</b>	22042
<b>description</b>	filter set for brewing unit		

brewing units manual

components

gaskets

			
1			
<b>GEV No.</b>	526856	<b>Ref. No.</b>	2243
<b>description</b>	gasket D1 ø 13mm ID ø 4mm thickness 4mm Viton		

			
1			
<b>GEV No.</b>	525368	<b>Ref. No.</b>	172
<b>description</b>	gasket ED ø 13mm ID ø 4mm H 4mm Qty 1 pcs EPDM		

			
1			
<b>GEV No.</b>	525369	<b>Ref. No.</b>	163
<b>description</b>	gasket ED ø 15.5mm ID ø 7.5mm H 4mm Qty 1 pcs EPDM		

			
1			
<b>GEV No.</b>	525378	<b>Ref. No.</b>	449
<b>description</b>	gasket ED ø 15.5mm ID ø 7.5mm H 4mm Qty 1 pcs Viton		

			
1			
<b>GEV No.</b>	528494	<b>Ref. No.</b>	2243
<b>description</b>	gasket rubber ED ø 13mm ID ø 4mm thickness 4mm Qty 1 pcs		

miscellaneous

			
1			
<b>GEV No.</b>	528531	<b>Ref. No.</b>	216
<b>description</b>	bolt square brass thread M3 L 12mm W 6mm H 6mm thread L 10mm		

levers

levers

			
1			
<b>GEV No.</b>	525398	<b>Ref. No.</b>	21541 7090
<b>description</b>	lever for IBERITAL		

camshafts

			
1			
<b>GEV No.</b>	525763	<b>Ref. No.</b>	151 2518
<b>description</b>	camshaft shaft ø 8mm shaft intake ø 10mm L 78.3mm W 19.6mm H 16.7mm thread M6 brass suitable for IBERITAL		

valves

			
1			
<b>GEV No.</b>	525761	<b>Ref. No.</b>	180
<b>description</b>	valve for brewing unit L 57.7mm round ED ø 16mm shaft ø 4mm		



			
1			
<b>GEV No.</b>	525759	<b>Ref. No.</b>	178
<b>description</b>	valve for drain unit L 20.5mm ED ø 16mm shaft 5x5		

			
1			
<b>GEV No.</b>	525760	<b>Ref. No.</b>	179
<b>description</b>	valve for drain unit L 59.5mm square ED ø 16mm shaft 5x5		

components

nozzles

with thread

			
1			
<b>GEV No.</b>	526441	<b>Ref. No.</b>	21609
<b>description</b>	nozzle bore ø 0.5mm thread M6x0.75 L 9mm		

			
1			
<b>GEV No.</b>	528486	<b>Ref. No.</b>	267
<b>description</b>	nozzle bore ø 0.7mm thread M6x0.75 L 9mm WS 7		

water dispersions

water dispersions

group 2

			
1			
<b>GEV No.</b>	525756	<b>Ref. No.</b>	175
<b>description</b>	water distributor ø 30mm hole ø 1.5mm H 15mm ET M10x1 grooves 6 2.6mm brass 2 holes perforation ø 1mm		

			
1			
<b>GEV No.</b>	525757	<b>Ref. No.</b>	19449
<b>description</b>	water distributor ø 30mm hole ø 3mm H 14.5mm ET M10x1 IT M5 grooves 6 2.8mm brass 2 holes perforation ø 1mm		

safety valves

safety valves

3/8"

			
1			
<b>GEV No.</b>	529302	<b>Ref. No.</b>	3596
<b>description</b>	safety valve connection 3/8" triggering pressure 1.8bar		

			
1			
<b>GEV No.</b>	529312	<b>Ref. No.</b>	1314
<b>description</b>	safety valve connection 3/8" triggering pressure 1.8bar		

expansion valves

gaskets

			
1			
<b>GEV No.</b>	526692	<b>Ref. No.</b>	160
<b>description</b>	gasket ED ø 15mm seat ø 6mm H 4mm overall height 9mm		

drain pans

drain pans

			
1			
<b>GEV No.</b>	525217	<b>Ref. No.</b>	9937
<b>description</b>	drain pan L 78mm W 70mm H 54mm hose ø 12mm suitable for IBERITAL		

			
1			
<b>GEV No.</b>	525214	<b>Ref. No.</b>	6000
<b>description</b>	drain pan L 85mm ø 65mm hose ø 19mm suitable for IBERITAL		



			
1			
<b>GEV No.</b>	525216	<b>Ref. No.</b>	23891
<b>description</b>	drain pan L 90mm W 70mm H 43mm hole ø 27mm hose ø 12mm		

## accessories

			
1			
<b>GEV No.</b>	525215	<b>Ref. No.</b>	22116 9188 9435
<b>description</b>	drain hose L 290mm ID ø 6mm ED ø 9mm		

## aerators and air bleeders

			
1			
<b>GEV No.</b>	529326	<b>Ref. No.</b>	3319
<b>description</b>	aerator and air bleeder		

			
1			
<b>GEV No.</b>	529303	<b>Ref. No.</b>	3319
<b>description</b>	aerator and air bleeder connection 1/4" only steam		
<b>spare parts for</b>	529303		
	<b>GEV No.</b>	528687	<b>Ref. No.</b> —
	O-ring Viton thickness 1.78mm ID ø 3.69mm Qty 1 pcs		

## boilers

## pipes

			
1			
<b>GEV No.</b>	525762	<b>Ref. No.</b>	9242
<b>description</b>	aspiration tube tube ø 8mm pipe length 135mm T1: 1/4" T2: 1/4" copper conical seal		

## steam/water taps

## steam/water taps

## steam/water taps

			
1			
<b>GEV No.</b>	525389	<b>Ref. No.</b>	11300
<b>description</b>	steam/water tap swing lever inlet 1/4" outlet 3/8" suitable for IBERITAL		

## steam taps

## steam taps (complete)

			
1			
<b>GEV No.</b>	525392	<b>Ref. No.</b>	11017
<b>description</b>	steam tap with steam pipe inlet 1/4" suitable for IBERITAL		

## components

## gaskets

			
1			
<b>GEV No.</b>	526856	<b>Ref. No.</b>	2243
<b>description</b>	gasket D1 ø 13mm ID ø 4mm thickness 4mm Viton		

## gasket supports

			
1			
<b>GEV No.</b>	525175	<b>Ref. No.</b>	1973
<b>description</b>	valve ø hexagon 16mm L 14mm brass		





valve bodies

			
1			
<b>GEV No.</b>	525764	<b>Ref. No.</b>	6783
<b>description</b>	valve body for steam-/water-tap		

water taps

water taps

			
1			
<b>GEV No.</b>	525391	<b>Ref. No.</b>	11277
<b>description</b>	water tap with pipe inlet 1/4" suitable for IBERITAL		

steam/water pipes

steam pipes

			
1			
<b>GEV No.</b>	525396	<b>Ref. No.</b>	8302
<b>description</b>	steam pipe thread 3/8" H 175mm L 210mm $\phi$ 14.2mm tube $\phi$ 10mm suitable for FAEMA		

			
1			
<b>GEV No.</b>	525395	<b>Ref. No.</b>	19084
<b>description</b>	steam pipe thread 3/8" H 225mm L 255mm $\phi$ 14.2mm tube $\phi$ 10mm suitable for IBERITAL		

water pipes

			
1			
<b>GEV No.</b>	525397	<b>Ref. No.</b>	19085
<b>description</b>	water pipe thread 3/8" $\phi$ 14.2mm L 65mm suitable for IBERITAL		

accessories

bushes

			
1			
<b>GEV No.</b>	528786	<b>Ref. No.</b>	7506
<b>description</b>	bush		

			
1			
<b>GEV No.</b>	525324	<b>Ref. No.</b>	19051
<b>description</b>	bush D1 $\phi$ 14.3mm D2 $\phi$ 11.4mm H 6mm PTFE ID $\phi$ 7.1mm		

			
1			
<b>GEV No.</b>	525357	<b>Ref. No.</b>	7321
<b>description</b>	bush D1 $\phi$ 15mm D2 $\phi$ 10.4mm H 10.3mm PTFE ID $\phi$ 7.6mm		

tube handles

			
1			
<b>GEV No.</b>	525152	<b>Ref. No.</b>	10493
<b>description</b>	handle for pipe $\phi$ 10mm L 40mm rubber		

fine filters

fine filters

			
1			
<b>GEV No.</b>	529911	<b>Ref. No.</b>	10971 263
<b>description</b>	fine filter flat $\phi$ 11mm H 0.25mm		

			
1			
<b>GEV No.</b>	528946	<b>Ref. No.</b>	5232
<b>description</b>	fine filter pipe $\phi$ 8.5mm H 22mm		

## intake valves

## intake valves



1

<b>GEV No.</b>	525394	<b>Ref. No.</b>	19065
----------------	--------	-----------------	-------

<b>description</b>	intake valve centre for IBERITAL		
--------------------	----------------------------------	--	--



1

<b>GEV No.</b>	525390	<b>Ref. No.</b>	10001
----------------	--------	-----------------	-------

<b>description</b>	intake valve front for IBERITAL		
--------------------	---------------------------------	--	--



1

<b>GEV No.</b>	525393	<b>Ref. No.</b>	11646
----------------	--------	-----------------	-------

<b>description</b>	intake valve rear for IBERITAL		
--------------------	--------------------------------	--	--

## accessories

## bushes



1

<b>GEV No.</b>	525758	<b>Ref. No.</b>	4075
----------------	--------	-----------------	------

<b>description</b>	bush for filling valve D1 ø 15mm int. ø 1 12.9mm int. ø 2 10.8mm H 12.8mm brass		
--------------------	---	--	--

## gaskets



1

<b>GEV No.</b>	528596	<b>Ref. No.</b>	316
----------------	--------	-----------------	-----

<b>description</b>	gasket ED ø 12mm ID ø 4mm overall height 4mm conical		
--------------------	--	--	--

## level glasses

## level glasses

## gaskets



1

<b>GEV No.</b>	525379	<b>Ref. No.</b>	19794
----------------	--------	-----------------	-------

<b>description</b>	gasket D1 ø 15mm D2 ø 10mm ID ø 6mm		
--------------------	-------------------------------------	--	--

## pressure rings



1

<b>GEV No.</b>	525238	<b>Ref. No.</b>	2501
----------------	--------	-----------------	------

<b>description</b>	press ring D1 ø 15mm D2 ø 11.5mm thickness 1.5mm brass for level glass		
--------------------	--	--	--

## level glass pipes



1

<b>GEV No.</b>	525218	<b>Ref. No.</b>	9602
----------------	--------	-----------------	------

<b>description</b>	water level tube ø 11mm H 140mm ID ø 6.5mm marking Min/Max red/blue		
--------------------	---	--	--



1

<b>GEV No.</b>	529351	<b>Ref. No.</b>	95
----------------	--------	-----------------	----

<b>description</b>	water level tube ø 12mm H 135mm		
--------------------	---------------------------------	--	--

## non-return valves

## balls



1

<b>GEV No.</b>	528419	<b>Ref. No.</b>	158
----------------	--------	-----------------	-----

<b>description</b>	ball ø 11mm SS		
--------------------	----------------	--	--

## for coffee grinders

## grinding burrs

## grinding burrs conical



1

<b>GEV No.</b>	526890	<b>Ref. No.</b>	709
----------------	--------	-----------------	-----

<b>description</b>	grinding burrs pair turn direction right D1 ø 38mm D2 ø 30mm H 18/20mm shaft ø 7mm suitable for IBERITAL		
--------------------	--	--	--

## miscellaneous



1

<b>GEV No.</b>	530534	<b>Ref. No.</b>	14572
----------------	--------	-----------------	-------

<b>description</b>	equipment foot rectangular L 30mm plastic for coffee grinder		
--------------------	--	--	--



dosing containers

dosing container lids



1

**GEV No.** 527458 **Ref. No.** 4186

**description** lid for dosing container ø 126mm

automatic grinding

automatic grinding



1

**GEV No.** 698757 **Ref. No.** 23621

**description** housing for microswitch H 26mm L 102mm

**accessories for** 698757

**GEV No.** 698756 **Ref. No.** 23620



lid for microswitch H 20mm



1

**GEV No.** 698756 **Ref. No.** 23620

**description** lid for microswitch H 20mm

miscellaneous



1

**GEV No.** 526541 **Ref. No.** 8161

**description** frame for lid L 73.5mm W 44mm H 8mm mounting pos. lower plastic

support for filter holder



1

**GEV No.** 527891 **Ref. No.** 5854

**description** filter holder support for dosing unit L 71mm W 98mm H 25mm plastic

for dishwashers

air traps

air traps



1

**GEV No.** 517171 **Ref. No.** 16147

**description** air trap L 90mm W 55mm H 31mm

**accessories for** 517171



**GEV No.** 517173 **Ref. No.** —

flat gasket FIBER ED ø 14mm ID ø 8mm thickness 1.5mm Qty 1 pcs



**GEV No.** 517174 **Ref. No.** —

nut thread M8 H 6.5mm WS 13 SS DIN/ISO DIN 934 / ISO 4032/8673 Qty 1 pcs

door mechanics

miscellaneous



1

**GEV No.** 528224 **Ref. No.** 3163

**description** gasket PTFE gasket

washing and rinsing systems



1

**GEV No.** 505040 **Ref. No.** 6277

**description** bush for wash arm



1

**GEV No.** 517103 **Ref. No.** 16152

**description** cover

knobs

steam/water taps

steam/water taps



1			
<b>GEV No.</b>	111109	<b>Ref. No.</b>	2163
<b>description</b>	knob ø 46mm shaft ø lead: 2mm black		



1			
<b>GEV No.</b>	111372	<b>Ref. No.</b>	9468
<b>description</b>	knob ø 50mm L 32mm shaft 8mm black		

knob dial plates



1			
<b>GEV No.</b>	111376	<b>Ref. No.</b>	9472
<b>description</b>	knob dial plate for water filling ø 24mm black		

handles and hand wheels

miscellaneous



1			
<b>GEV No.</b>	111373	<b>Ref. No.</b>	10930
<b>description</b>	handle for sliding valve shaft ø 6x5mm black suitable for IBERITAL		

accessories



1			
<b>GEV No.</b>	525213	<b>Ref. No.</b>	11010
<b>description</b>	bezel for sliding valve steam suitable for IBERITAL		



1			
<b>GEV No.</b>	525399	<b>Ref. No.</b>	11009
<b>description</b>	bezel for sliding valve water suitable for IBERITAL		

hinges

oven hinges



1			
<b>GEV No.</b>	701137	<b>Ref. No.</b>	43037
<b>description</b>	cover mounting distance 95mm L 112mm W 26mm thickness 1mm cut-out 9x66mm for oven hinge		



1			
<b>GEV No.</b>	701135	<b>Ref. No.</b>	43033
<b>description</b>	opposite support mounting distance 94mm L 110mm W 19mm for oven hinge		



1			
<b>GEV No.</b>	701134	<b>Ref. No.</b>	43032
<b>description</b>	oven hinge mounting distance 173mm mounting distance 2mm lug mounting 14mm lever length 123mm groove distance 10mm spring thickness 3.5mm mounting ear position left/right spring length 112mm L 207mm W 25mm		



**gaskets**

**O-rings**

**EPDM**

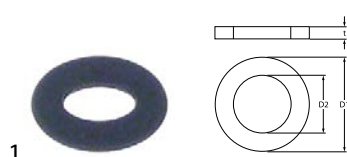

1

<b>GEV No.</b>	525310	<b>Ref. No.</b>	330
<b>description</b>	O-ring EPDM thickness 1.9mm ID ø 4.2mm Qty 1 pcs		

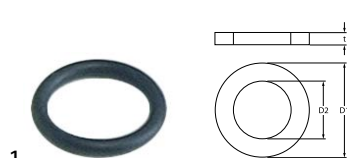

1

<b>GEV No.</b>	529251	<b>Ref. No.</b>	19426
<b>description</b>	O-ring EPDM thickness 2.62mm ID ø 15.08mm Qty 1 pcs		



1

<b>GEV No.</b>	528583	<b>Ref. No.</b>	1293
<b>description</b>	O-ring EPDM thickness 2.62mm ID ø 9.13mm Qty 1 pcs		



1

<b>GEV No.</b>	510951	<b>Ref. No.</b>	176
<b>description</b>	O-ring EPDM thickness 3.53mm ID ø 18.64mm Qty 1 pcs		

**silicone**

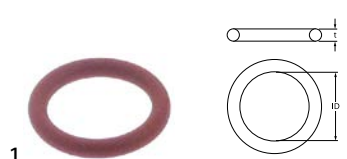

1

<b>GEV No.</b>	525388	<b>Ref. No.</b>	2350
<b>description</b>	O-ring silicone thickness 1.78mm ID ø 9.25mm Qty 1 pcs		

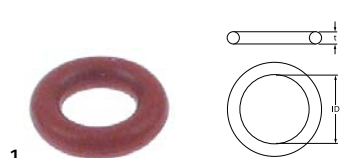

1

<b>GEV No.</b>	525384	<b>Ref. No.</b>	2179
<b>description</b>	O-ring silicone thickness 1.9mm ID ø 4.2mm Qty 1 pcs		



1

<b>GEV No.</b>	528222	<b>Ref. No.</b>	1019
<b>description</b>	O-ring silicone thickness 2.62mm ID ø 10.78mm Qty 1 pcs		

**Viton**



1

<b>GEV No.</b>	528226	<b>Ref. No.</b>	1287
<b>description</b>	O-ring Viton thickness 2.62mm ID ø 9.92mm Qty 1 pcs		



1

<b>GEV No.</b>	528525	<b>Ref. No.</b>	10242
<b>description</b>	O-ring Viton thickness 3.53mm ID ø 18.64mm Qty 1 pcs		

**sealing washers**

**rubber gaskets**



1

<b>GEV No.</b>	528494	<b>Ref. No.</b>	2243
<b>description</b>	gasket rubber ED ø 13mm ID ø 4mm thickness 4mm Qty 1 pcs		

**copper gaskets**

**DIN-7603-A**



1

<b>GEV No.</b>	525386	<b>Ref. No.</b>	1565
<b>description</b>	flat gasket copper ED ø 26mm ID ø 21mm thickness 1mm Qty 1 pcs		

**DIN-7603-C**



1

<b>GEV No.</b>	528520	<b>Ref. No.</b>	270
<b>description</b>	gasket copper ED ø 22mm ID ø 16mm thickness 2mm		







			
1			
<b>GEV No.</b>	525381	<b>Ref. No.</b>	10622
<b>description</b>	gasket copper ED ø 27mm ID ø 21mm thickness 3mm Qty 1 pcs		

PTFE gaskets

			
1			
<b>GEV No.</b>	525380	<b>Ref. No.</b>	11345
<b>description</b>	flat gasket PTFE ED ø 14mm ID ø 9.5mm thickness 0.5mm Qty 1 pcs		

			
1			
<b>GEV No.</b>	526661	<b>Ref. No.</b>	10002
<b>description</b>	flat gasket PTFE ED ø 17mm ID ø 13mm thickness 2mm Qty 1 pcs		

			
1			
<b>GEV No.</b>	525611	<b>Ref. No.</b>	4216 9559
<b>description</b>	flat gasket PTFE ED ø 22mm ID ø 17mm thickness 2mm Qty 1 pcs		

			
1			
<b>GEV No.</b>	528683	<b>Ref. No.</b>	4215
<b>description</b>	flat gasket PTFE ED ø 26mm ID ø 21mm thickness 2mm Qty 1 pcs suitable for GAGGIA, SPAZIALE		

			
1			
<b>GEV No.</b>	528918	<b>Ref. No.</b>	4199
<b>description</b>	flat gasket PTFE ED ø 36mm ID ø 30mm thickness 2mm Qty 1 pcs suitable for VIBIEMME		

special gaskets

group gaskets

			
1			
<b>GEV No.</b>	525377	<b>Ref. No.</b>	9193
<b>description</b>	group gasket L 77mm W 66mm thickness 2mm aperture 24x6mm fibre		

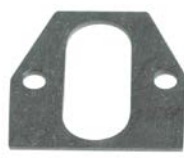
			
1			
<b>GEV No.</b>	528943	<b>Ref. No.</b>	7685
<b>description</b>	group gasket L 77mm W 74mm thickness 2mm aperture 27x66mm hole distance 56mm fibre		

springs

compression springs

			
1			
<b>GEV No.</b>	525359	<b>Ref. No.</b>	10415
<b>description</b>	compression spring ø 10.7mm L 30mm wire gauge ø 1.2mm windings 8		

			
1			
<b>GEV No.</b>	525360	<b>Ref. No.</b>	11050
<b>description</b>	compression spring ø 11.5mm L 26mm wire gauge ø 2mm windings 7		

			
1			
<b>GEV No.</b>	525370	<b>Ref. No.</b>	248
<b>description</b>	compression spring ø 13.5mm L 40.5mm wire gauge ø 1.1mm windings 7		

			
1			
<b>GEV No.</b>	525236	<b>Ref. No.</b>	156
<b>description</b>	compression spring ø 14.5mm L 31.5mm wire gauge ø 2mm windings 7		

			
1			
<b>GEV No.</b>	525372	<b>Ref. No.</b>	162
<b>description</b>	compression spring ø 15mm L 27.5mm wire gauge ø 1.8mm windings 4		

			
1			
<b>GEV No.</b>	525361	<b>Ref. No.</b>	148
<b>description</b>	compression spring ø 8.3mm L 32mm wire gauge ø 0.4mm windings 10		





coffee accessories

supports for filter holders

			
1			
<b>GEV No.</b>	531293	<b>Ref. No.</b>	—
<b>description</b>	bracket for filter holder W 90mm D 70mm H 65mm SS/rubber		

manometers

			
1			
<b>GEV No.</b>	541763	<b>Ref. No.</b>	9679
<b>description</b>	manometer double scale ø 58mm pressure range 0-2.5 / 0-16bar connection on the backside thread 1/8"		

			
1			
<b>GEV No.</b>	541223	<b>Ref. No.</b>	21731
<b>description</b>	manometer double scale ø 60mm pressure range 0-2.5 / 0-16bar connection on the backside thread 1/8"		

			
1			
<b>GEV No.</b>	541764	<b>Ref. No.</b>	11267
<b>description</b>	manometer ø 39mm pressure range 0-16bar thread 1/8" marking 0.8-9 connection on the backside		

			
1			
<b>GEV No.</b>	525375	<b>Ref. No.</b>	11268
<b>description</b>	manometer ø 39mm pressure range 0-3bar thread 1/8" marking 0.8-1 connection on the backside		

			
1			
<b>GEV No.</b>	525645	<b>Ref. No.</b>	24976
<b>description</b>	manometer ø 57mm pressure range 0-16bar CARIMALI connection 1/8"		

			
1			
<b>GEV No.</b>	525644	<b>Ref. No.</b>	24975
<b>description</b>	manometer ø 57mm pressure range 0-2.5bar without glass connection 1/8"		

dosing pumps

membrane dosing pumps

self-priming

LANG











			
1			
<b>GEV No.</b>	361221	<b>Ref. No.</b>	4211
<b>description</b>	dosing pump type N6 rinse aid pressure connection ø 4x6mm suction connection ø 6x8mm LANG		
<b>spare parts for</b>	361221		
	<b>GEV No.</b>	361079	<b>Ref. No.</b>
			—
		spring for type N5/N6 for ball	
	<b>GEV No.</b>	361080	<b>Ref. No.</b>
			—
		O-ring EPDM thickness 2mm ID ø 16mm Qty 1 pcs	
	<b>GEV No.</b>	361085	<b>Ref. No.</b>
			—
		O-ring EPDM thickness 2mm ID ø 8mm Qty 1 pcs	
	<b>GEV No.</b>	361309	<b>Ref. No.</b>
			—
		ball for type N5/N6	
	<b>GEV No.</b>	361310	<b>Ref. No.</b>
			—
		bracket for type N6 ball guide	
	<b>GEV No.</b>	361311	<b>Ref. No.</b>
			—
		O-ring EPDM thickness 2mm ID ø 6mm Qty 1 pcs for type N6	
	<b>GEV No.</b>	361314	<b>Ref. No.</b>
			—
		valve ring for type N6 holder for O-ring	

Table continues overleaf



spare parts for		361221	
	GEV No.	361317	Ref. No. —
sealing disc for type N6			
	GEV No.	361886	Ref. No. —
non-return valve inletmm outletmm outlet ø 12.4mm L 12.7mm			
	GEV No.	505228	Ref. No. —
spacer bush ID ø 4.5mm ED ø 10mm L 16mm for dosing pump			

## hoses

### supply hoses

#### stainless steel flexi hoses

#### universal hoses



1



GEV No.	520602	Ref. No.	351
description	flex hose SS braid straight-straight DN8 connections 3/8" L 1500mm conical seal approval DVGW operating p. 10bar test pressure 32bar burst p. 95bar		



1



GEV No.	520572	Ref. No.	3052
description	flex hose SS braid straight-straight DN8 connections 3/8" L 500mm conical seal approval DVGW operating p. 10bar test pressure 32bar burst p. 95bar		

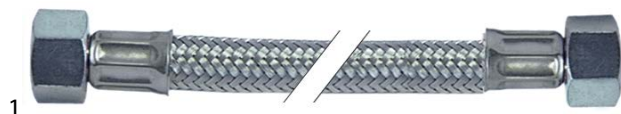

1



GEV No.	520600	Ref. No.	520600
description	flex hose SS braid straight-straight DN8 connections 3/8" L 750mm conical seal approval DVGW operating p. 10bar test pressure 32bar burst p. 95bar		

## industrial hoses

### hoses wire reinforced

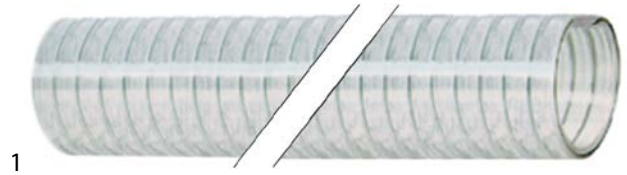

1

GEV No.	520489	Ref. No.	7074
description	drain hose ID ø 14mm ED ø 20mm L 1.5m wire reinforced		

## fittings, hose and pipe connectors

### hose connectors

#### without screw connection



1

GEV No.	510843	Ref. No.	22975
description	T-piece plastic hose ø 10-6-10mm		

## fittings

### double nipples



1

GEV No.	520164	Ref. No.	959
description	double nipple nickel-plated brass thread 1/4" - 3/8" Qty 1 pcs		

## valves and tank inlets

### ball valves

#### universal

#### mini ball valves



1

GEV No.	520723	Ref. No.	8263
description	ball valve connection 3/8" IT - 3/8" ET DN8 total length 40mm brass		



tools

machining

reamers

reamer set



1	<b>GEV No.</b>	800050	<b>Ref. No.</b>	70565
<b>description</b>	nozzle reamers set size 0.5/0.6/0.7/0.8/0.9mm size 1 1.0/1.1/1.2/1.4/1.6/1.8/2.0mm 12-piece with holder			
<b>description</b>	reamer set with holder 12-piece 0.5mm / 0.6mm / 0.7mm / 0.8mm / 0.9mm / 1.0mm 1.1mm / 1.2mm / 1.4mm / 1.6mm / 1.8mm / 2.0mm			

fastening material

screws

hexagonal screws



1	<b>GEV No.</b>	560085	<b>Ref. No.</b>	11270
<b>description</b>	hexagonal screw thread M5 thread L 20mm SS WS 8 Qty 20 pcs DIN 933 / ISO 4017			

nuts

hexagonal nuts

hexagonal nuts metric (without norm)



1	<b>GEV No.</b>	102067	<b>Ref. No.</b>	40540
<b>description</b>	nut thread M8x1 H 3mm brass Qty 1 pcs type SEF 1			

washers

washers

miscellaneous



1	<b>GEV No.</b>	525382	<b>Ref. No.</b>	8978
<b>description</b>	plain washer ID ø 14.5mm ED ø 18.5mm thickness 1.5mm Qty 1 pcs			



1	<b>GEV No.</b>	525383	<b>Ref. No.</b>	21582
<b>description</b>	plain washer ID ø 7mm ED ø 15mm thickness 0.5mm brass Qty 1 pcs			



1	<b>GEV No.</b>	525387	<b>Ref. No.</b>	11079
<b>description</b>	plain washer ID ø 8mm ED ø 14mm thickness 0.5mm brass Qty 1 pcs			





<b>B</b>			
ball valves	36		
bi-metal thermostats	3, 3		
<b>C</b>			
cables	14		
cam switches	5		
contactors	7		
<b>D</b>			
dosing pumps	35		
double nipples	36		
<b>E</b>			
electric accessories	14		
electrodes	10		
<b>F</b>			
fastening material	37		
fittings	36		
flow meters	11		
<b>G</b>			
gas burners	23		
gas control valves	17		
gas nozzles	23		
gas thermostats	14		
<b>H</b>			
heating elements	3		
heating elements for coffee machine	3		
hexagonal nuts	37		
hexagonal screws	37		
hob burners	23		
hose connectors	36		
hoses	36		
hoses wire reinforced	36		
<b>I</b>			
ignition cables	21		
immersion heating elements	3		
indicator lights	5		
indicator lights (complete)	5		
industrial hoses	36		
<b>L</b>			
lamps	5		
<b>M</b>			
machining	37		
mechanical timers	6		
microswitches	5		
motors			11
<b>N</b>			
nuts			37
<b>O</b>			
O-rings			33
oven hinges			32
<b>P</b>			
piezoelectric igniters			21
pilot burners			19
pressure switches			10
probes			8
programme timers			6
pumps			11
pumps for ice machines			14
push/momentary push switches			4
<b>R</b>			
reamers			23, 37
relays			7
ribbon cables			14
rocker/momentary rocker switches			4
rotary switches			5
<b>S</b>			
safety thermostats			4
screws			37
sealing washers			33
solenoid valves			10
solid state relays			7
stainless steel flexi hoses			36
supply hoses			36
switches and momentary switches			4
<b>T</b>			
thermocouples			22
thermostats			3
timers			6
tools			37
<b>U</b>			
universal hoses			36
<b>V</b>			
valves and tank inlets			36
vibration pumps			13
<b>W</b>			
wash and rinse pumps			11
washers			37