



GAS COMPONENTS



ELECTRIC COMPONENTS



WATER TECHNOLOGY



MECHANICAL COMPONENTS



TOOLS

Spare parts suitable for

IGF

Find the complete and up-to-date range of products in our GEV Webshop



Manufacturer catalogue

The most important spare parts and accessories arranged clearly for every manufacturer

- ✓ Complete product range and all appliance data always up to date in the GEV Webshop
- ✓ Alphabetical Index at the end of the catalogue

GEV Webshop

www.gev-online.co.uk

www.gev-online.com



- 🔍 Add to Favourites
- 🔍 Sign In with email address and usual password
- 🔍 Easy-order – place several items in your basket at the same time
- 🔍 Quick Item search – no login needed



switches and momentary switches

rocker/momentary rocker switches

30x22mm



1

GEV No.	301003	Ref. No.	2300/L40PZ24
description	rocker switch mounting measurements 30x22mm green 2NO 250V 16A illuminated 0-I connection male faston 6.3mm ambient temperature max. 125/55°C protection IP65		
For models:	2300-L40P		
accessories for	301003		
	GEV No.	301036	Ref. No. —
	protective cover internal size 30x22mm for rocker switch mounting measurementsmm		

push/momentary push switches

ø22.3mm



1

GEV No.	346444	Ref. No.	2300/B30Z06 2300/B40PZ05 2300/B40Z06
description	push switch mounting ø 22mm blue 1NO 240V 3A		
For models:	2300-B30, 2300-B40, 2300-B40P		

rotary switches

GIOVENZANA

rotary switches



1

GEV No.	347612	Ref. No.	2200/ S162Z35
description	rotary switch 2 0-1 sets of contacts 3 type PO20 690V 12A shaft ø 8x8mm shaft L 25mm shaft square connection screw		
For models:	2200-S162		

foot switches



1

GEV No.	346442	Ref. No.	2300/B30Z22 2300/B40PZ20 2300/B40Z22 2300/L30Z22 2300/L40PZ20 2300/L40Z22
description	foot switch		
For models:	2300-B30, 2300-B40, 2300-B40P, 2300-L30, 2300-L40, 2300-L40P		

electronics

PCBs



1

GEV No.	697124	Ref. No.	2200/S25TZ2
description	PCB 230/400V		



1

GEV No.	346446	Ref. No.	2300/B30Z10 2300/B40PZ07 2300/B40Z10
description	PCB dough rolling machine 2300-B30/B40 230V		
For models:	2300-B30, 2300-B40, 2300-B40P		



1

GEV No.	346445	Ref. No.	2300/L30Z10 2300/L40PZ07 2300/L40Z10
description	PCB dough rolling machine 2300-L30/L40 B202031 110-240V		
For models:	2300-L30, 2300-L40, 2300-L40P		



keypads

membrane keypads



1

GEV No.	346443	Ref. No.	2300/L30Z06 2300/L40PZ05 2300/L40Z06
description	membrane keypad dough rolling machine L30-B30-L40-B40 L 70mm W 60mm		
For models:	2300-L30, 2300-L40, 2300-L40P		

motors

motors

universal



1

GEV No.	500870	Ref. No.	2300/B30Z15 2300/B40pZ15 2300/B40Z15 2300/L30Z15 2300/L40pZ15 2300/L40Z15
description	motor 370W 230V 50Hz 1 phase shaft ϕ 14mm 1400rpm type M71BL4T ϕ 140mm H 180mm L 210mm fixing dimensions 90x112mm ICME 0.37kW		
For models:	2300-B30, 2300-B40, 2300-L30, 2300-L40		
spare parts for	500870		
	GEV No.	Ref. No.	—
fanwheel cover ID ϕ 137mm ED ϕ 142mm H 70mm for wash pump			

equipment-specific units

for dough mixers

drive shafts



1

GEV No.	698188	Ref. No.	2400/S25Z43
description	drive shaft D1 ϕ 38mm for dough hook ϕ 35mm L 110mm ID ϕ 20mm		
For models:	2400-S25		

spacer rings



1

GEV No.	698189	Ref. No.	2400/S25Z40
description	spacer ring ϕ 40mm ID ϕ 35mm H 22mm		
For models:	2400-S25		

gear wheels



1

GEV No.	698187	Ref. No.	2400/S25Z38
description	sprocket-wheel DIN/ISO 06 B-1 splitting 3/8" teeth 15 shaft intake ϕ 35mm H 27mm 25		
For models:	2400-S25		

1

GEV No.	697776	Ref. No.	2200/S38Z01
description	sprocket-wheel DIN/ISO 08 B-1 splitting 1/2" teeth 15 shaft intake ϕ 20mm H 28mm		
For models:	2200-S38		

for dough roller

wipers



1

GEV No.	693694	Ref. No.	2300/B30Z31 2300/L30Z31
description	wiper for dough roller L 305mm mounting pos. front L30-B30		
For models:	2300-B30, 2300-L30		

1

GEV No.	693693	Ref. No.	2300/B30Z32 2300/L30Z32
description	wiper for dough roller L 305mm mounting pos. rear L30-B30		
For models:	2300-B30, 2300-L30		



 <p>1</p>			
GEV No.	693696	Ref. No.	2300/B40PZ29 2300/B40Z31 2300/L40PZ29 2300/L40Z31
description	wiper for dough roller L 405mm mounting pos. front total length 450mm L40-B40-L40P-B40P		
For models:	2300-B40, 2300-B40P, 2300-L40, 2300-L40P		

 <p>1</p>			
GEV No.	693695	Ref. No.	2300/B40PZ30 2300/B40Z32 2300/L40PZ30 2300/L40Z32
description	wiper for dough roller L 405mm mounting pos. rear total length 450mm L40-B40-L40P-B40P		
For models:	2300-B40, 2300-B40P, 2300-L40, 2300-L40P		

rollers

 <p>1</p>			
GEV No.	693680	Ref. No.	2300/B30Z46 2300/L30Z46
description	roller for dough roller L 176mm ø 48mm mounting pos. upper at the back		
For models:	2300-B30, 2300-L30		

 <p>1</p>			
GEV No.	693681	Ref. No.	2300/B30Z50 2300/L30Z50
description	roller for dough roller L 176mm ø 48mm mounting pos. upper in the front		
For models:	2300-B30, 2300-L30		

 <p>1</p>			
GEV No.	693682	Ref. No.	2300/B40Z46 2300/L40Z46
description	roller for dough roller L 218mm ø 48mm mounting pos. upper at the back		
For models:	2300-B40, 2300-L40		

 <p>1</p>			
GEV No.	693683	Ref. No.	2300/B40Z50 2300/L40Z50
description	roller for dough roller L 218mm ø 48mm mounting pos. upper in the front		
For models:	2300-B40, 2300-L40		

 <p>1</p>			
GEV No.	693684	Ref. No.	2300/B40PZ44 2300/L40PZ44
description	roller for dough roller L 308mm ø 46mm mounting pos. upper at the back		
For models:	2300-B40P, 2300-L40P		

 <p>1</p>			
GEV No.	693685	Ref. No.	2300/B40PZ48 2300/L40PZ48
description	roller for dough roller L 308mm ø 46mm mounting pos. upper in the front		
For models:	2300-B40P, 2300-L40P		

 <p>1</p>			
GEV No.	693675	Ref. No.	2300/B30Z29 2300/L30Z29
description	roller for dough roller L 308mm ø 49mm mounting pos. bottom at the back		
For models:	2300-B30, 2300-L30		

 <p>1</p>			
GEV No.	693676	Ref. No.	2300/B30Z30 2300/L30Z30
description	roller for dough roller L 308mm ø 49mm mounting pos. bottom in the front		
For models:	2300-B30, 2300-L30		

1 			
GEV No.	693677	Ref. No.	2300/B40PZ27 2300/B40Z29 2300/L40PZ27 2300/L40Z29
description	roller for dough roller L 408mm ø 49mm mounting pos. bottom at the back		
For models:	2300-B40, 2300-B40P, 2300-L40, 2300-L40P		

1 			
GEV No.	693659	Ref. No.	2300/B40PZ28 2300/B40Z30 2300/L40PZ28 2300/L40Z30
description	roller for dough roller L 408mm ø 49mm mounting pos. bottom in the front		
For models:	2300-B40, 2300-B40P, 2300-L40, 2300-L40P		

holders

1 			
GEV No.	693667	Ref. No.	2300/B30Z40 2300/B40PZ38 2300/B40Z40 2300/L30Z40 2300/L40PZ38 2300/L40Z40
description	lever hole ø 10mm H 21mm hole distance 31mm		
For models:	2300-B30, 2300-B40, 2300-B40P, 2300-L30, 2300-L40, 2300-L40P		

couplings

1 			
GEV No.	693661	Ref. No.	2300/B30Z35 2300/B40PZ33 2300/B40Z35 2300/L30/L40/B30/B40 Pos.35 2300/L30Z35 2300/L40PZ33 2300/L40Z35
description	coupling set ø 42mm ID ø 26mm H 23mm		
For models:	2300-B30, 2300-B40, 2300-B40P, 2300-L30, 2300-L40, 2300-L40P		

pulleys

1 			
GEV No.	693697 ¹	Ref. No.	2300/B30Z12 2300/B40PZ9 2300/B40Z12 2300/L30Z12 2300/L40PZ9 2300/L40Z12
description	V-belt pulley double disc ø 73mm shaft intake ø 14mm groove depth 10mm disc width 32mm groove width 6mm overall width 32mm metal L30-B30-L40-B40		
For models:	2300-B30, 2300-B40, 2300-L30, 2300-L40		

¹double

1 			
GEV No.	693699	Ref. No.	2300/B40PZ17 2300/L40PZ17
description	V-belt pulley single disc ø 85mm shaft intake ø 14mm groove depth 11mm disc width 25mm groove width 9mm overall width 29mm metal L40P-B40P shaft ø 35mm		
For models:	2300-B40P, 2300-L40P		

1 			
GEV No.	693698	Ref. No.	2300/B30Z13 2300/B40PZ10 2300/B40Z13 2300/L30Z13 2300/L40PZ10 2300/L40Z13
description	V-belt pulley single disc ø 98mm shaft intake ø 14mm groove depth 11mm disc width 13mm groove width 9mm overall width 24mm metal L30-B30-L40-B40 shaft ø 35mm		
For models:	2300-B30, 2300-B40, 2300-B40P, 2300-L30, 2300-L40, 2300-L40P		

pinions

rear mounting



1			
GEV No.	693664	Ref. No.	2300/B30Z43 2300/B40PZ41 2300/B40Z43 2300/L30Z43 2300/L40PZ41 2300/L40Z43
description	pinion ø 47mm H 33.5mm mounting pos. rear ID ø 25mm for dough roller		
For models:	2300-B30, 2300-B40, 2300-B40P, 2300-L30, 2300-L40, 2300-L40P		

front mounting



1			
GEV No.	693662	Ref. No.	2300/B30Z36 2300/B40PZ34 2300/B40Z36 2300/L30/L40/B30/B40Pos.36 2300/L30Z36 2300/L40PZ34 2300/L40Z36
description	pinion ø 47mm H 33.5mm mounting pos. front ID ø 14mm for dough roller		
For models:	2300-B30, 2300-B40, 2300-B40P, 2300-L30, 2300-L40, 2300-L40P		

roller covers

bottom



1			
GEV No.	697521	Ref. No.	2300/L30Z01
description	hand protection mounting pos. lower L 350mm W 58mm H 86mm L30-B30		
For models:	2300-L30		



1			
GEV No.	697520	Ref. No.	2300/B40Z01 2300/L40Z01
description	hand protection mounting pos. lower L 450mm W 58mm H 86mm L40-B40-L40P-B40P		
For models:	2300-B40, 2300-L40		

side parts





1			
GEV No.	693665	Ref. No.	2300/B30Z42 2300/B40PZ40 2300/L30Z42 2300/L40PZ40 2300/L40Z42
description	side panel for dough roller mounting pos. bottom right W 40mm L 125mm H 100mm L30-B30-L40-B40		
For models:	2300-B30, 2300-B40P, 2300-L30, 2300-L40, 2300-L40P		





1			
GEV No.	693679	Ref. No.	2300/B30Z48 2300/B40PZ46 2300/B40Z48 2300/L30Z48 2300/L40PZ46 2300/L40Z48
description	side panel for dough roller mounting pos. upper right W 40mm L 125mm H 100mm L30-B30-L40-B40		
For models:	2300-B30, 2300-B40, 2300-B40P, 2300-L30, 2300-L40, 2300-L40P		

			
1			
GEV No.	693669	Ref. No.	2300/B30Z28 2300/B40PZ26 2300/B40Z28 2300/L30Z28 2300/L40PZ26 2300/L40Z28
description	side panel for dough roller mounting pos. bottom left W 25mm L 122mm H 80mm L30-B30-L40-B40		
For models:	2300-B30, 2300-B40, 2300-B40P, 2300-L30, 2300-L40, 2300-L40P		

spindles			
eccentric			
1 			
GEV No.	693689	Ref. No.	2300/B30Z49 2300/L30Z49
description	spindle ø 25mm L 248mm mounting pos. upper in the front eccentric for dough roller		
For models:	2300-B30, 2300-L30		

1 			
GEV No.	693690	Ref. No.	2300/B40Z49 2300/L40Z49
description	spindle ø 25mm L 288mm mounting pos. upper in the front eccentric for dough roller		
For models:	2300-B40, 2300-L40		

1 			
GEV No.	693660	Ref. No.	2300/B30Z34 2300/L30Z34
description	spindle ø 25mm L 378mm mounting pos. bottom in the front eccentric for dough roller		
For models:	2300-B30, 2300-L30		

1 			
GEV No.	693691	Ref. No.	2300/B40PZ47 2300/L40PZ47
description	spindle ø 25mm L 378mm mounting pos. upper in the front eccentric for dough roller		
For models:	2300-B40P, 2300-L40P		

1 			
GEV No.	693674	Ref. No.	2300/B40Z34 2300/L40PZ32 2300/L40Z34
description	spindle ø 25mm L 478mm mounting pos. bottom in the front eccentric for dough roller		
For models:	2300-B40, 2300-L40, 2300-L40P		

cylindric			
1 			
GEV No.	693686	Ref. No.	2300/B30Z47 2300/L30Z47
description	spindle ø 25mm L 218mm mounting pos. upper at the back cylindrical for dough roller		
For models:	2300-B30, 2300-L30		

1 			
GEV No.	693687	Ref. No.	2300/B40Z47 2300/L40Z47
description	spindle ø 25mm L 260mm mounting pos. upper at the back cylindrical for dough roller		
For models:	2300-B40, 2300-L40		

spindles

1 			
GEV No.	693666	Ref. No.	2300/B30Z39 2300/B40PZ37 2300/B40Z39 2300/L30Z39 2300/L40PZ37 2300/L40Z39
description	spindle ø 24mm L 161mm		
For models:	2300-B30, 2300-B40, 2300-B40P, 2300-L30, 2300-L40, 2300-L40P		

bars

1 			
GEV No.	693670	Ref. No.	2300/B30Z33 2300/L30Z33
description	bar ø 5mm L 328mm L30-B30		
For models:	2300-B30, 2300-L30		

1 			
GEV No.	693671	Ref. No.	2300/B40PZ31 2300/B40Z33 2300/L40PZ31 2300/L40Z33
description	bar ø 5mm L 428mm L40-B40-L40P-B40P		
For models:	2300-B40, 2300-B40P, 2300-L40, 2300-L40P		



1 			
GEV No.	693673	Ref. No.	2300/B30Z44 2300/L30Z44
description	spindle ø 25mm L 350mm mounting pos. bottom at the back cylindrical for dough roller		
For models:	2300-B30, 2300-L30		

1 			
GEV No.	693688	Ref. No.	2300/B40PZ45 2300/L40PZ45
description	spindle ø 25mm L 350mm mounting pos. upper at the back cylindrical for dough roller		
For models:	2300-B40P, 2300-L40P		

1 			
GEV No.	693672	Ref. No.	2300/B40PZ44 2300/B40Z44 2300/L40PZ44 2300/L40Z44
description	spindle ø 25mm L 450mm mounting pos. bottom at the back cylindrical for dough roller		
For models:	2300-B40, 2300-L40		

miscellaneous



1			
GEV No.	693706	Ref. No.	2300/B30Z18 2300/B40PZ15 2300/B40Z18 2300/L30Z18 2300/L40PZ15 2300/L40Z18
description	fan wheel ø 110mm H 16mm		
For models:	2300-B30, 2300-B40, 2300-B40P, 2300-L30, 2300-L40, 2300-L40P		

1 			
GEV No.	693668	Ref. No.	2300/B30Z38 2300/B40PZ36 2300/B40Z38 2300/L30Z38 2300/L40PZ36 2300/L40Z38
description	lid for side part ø 30.5mm H 7mm		
For models:	2300-B30, 2300-B40, 2300-B40P, 2300-L30, 2300-L40, 2300-L40P		

for tilting bratt pans

miscellaneous

1 			
GEV No.	523510	Ref. No.	2300/B30Z41 2300/B40PZ39 2300/B40Z41 2300/L30Z41 2300/L40PZ39 2300/L40Z41
description	deep-groove ball bearing type 6202-2RS shaft ø 15mm ED ø 35mm W 11mm with sealing discs deep-groove ball bearing DIN 625-1		
For models:	2300-B30, 2300-B40, 2300-B40P, 2300-L30, 2300-L40, 2300-L40P		

for pizza ovens

firebricks

1 			
GEV No.	850092	Ref. No.	K65/105 14
description	firebrick L 1025mm W 605mm H 15mm mounting pos. lower delivery freight forwarding company only		

transmission technology and ball bearings

ball bearings

deep-groove ball bearings 2RS

1 			
GEV No.	523528	Ref. No.	2400/S25Z39 2400/S25Z41
description	deep-groove ball bearing type 6007-2RS shaft ø 35mm ED ø 62mm W 14mm with sealing discs deep-groove ball bearing DIN 625-1		
For models:	2400-S25		



GEV No.	523510	Ref. No.	2300/B30Z41 2300/B40PZ39 2300/B40Z41 2300/L30Z41 2300/L40PZ39 2300/L40Z41
description	deep-groove ball bearing type 6202-2RS shaft ϕ 15mm ED ϕ 35mm W 11mm with sealing discs deep-groove ball bearing DIN 625-1		
For models:	2300-B30, 2300-B40, 2300-B40P, 2300-L30, 2300-L40, 2300-L40P		



GEV No.	523512	Ref. No.	2200/S38Z04
description	deep-groove ball bearing type 6204-2RS shaft ϕ 20mm ED ϕ 47mm W 14mm with sealing discs deep-groove ball bearing DIN 625-1		
For models:	2200-S38		

deep-groove ball bearings 2Z



GEV No.	523508	Ref. No.	2300/B30Z37 2300/B40PZ35 2300/B40Z37 2300/L30/L40/B30/B40 Pos.37 2300/L30Z37 2300/L40PZ35 2300/L40Z37
description	deep-groove ball bearing shaft ϕ 10mm ED ϕ 30mm W 9mm type 6200-2Z DIN 625-1		
For models:	2300-B30, 2300-B40, 2300-B40P, 2300-L30, 2300-L40, 2300-L40P		

angular contact ball bearings



GEV No.	697116	Ref. No.	2200/S38Z02
description	angular contact ball bearing shaft ϕ 20mm ED ϕ 47mm W 20.6mm type 3204-2RS DIN 628		
For models:	2200-S38		

drive belts

round belts

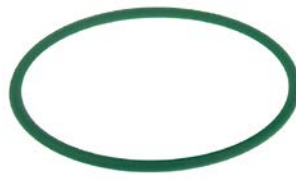

GEV No.	693701	Ref. No.	2300/B30Z19 2300/L30Z19
description	round belt ϕ 8mm L 540mm		
For models:	2300-B30, 2300-L30		



GEV No.	693705	Ref. No.	2300/B40PZ16 2300/L40PZ16
description	round belt ϕ 8mm L 620mm		
For models:	2300-B40P, 2300-L40P		



GEV No.	693703	Ref. No.	2300/B40Z19 2300/L40Z19
description	round belt ϕ 8mm L 635mm		
For models:	2300-B40, 2300-L40		





GEV No.	693700	Ref. No.	2300/B30Z14 2300/L30Z14
description	round belt ϕ 8mm L 645mm		
For models:	2300-B30, 2300-L30		



GEV No.	693704	Ref. No.	2300/B40PZ11 2300/L40PZ11
description	round belt ϕ 8mm L 884mm		
For models:	2300-B40P, 2300-L40P		



			
1			
GEV No.	693702	Ref. No.	2300/B40Z14 2300/L40Z14
description	round belt ø 8mm L 895mm		
For models:	2300-B40, 2300-L40		

			
1			
GEV No.	694512	Ref. No.	2300/B30Z27 2300/B40PZ25 2300/B40Z27 2300/L30Z27 2300/L40PZ25 2300/L40Z27
description	spring ø 14mm for dough roller L2 60mm mounting pos. in the front/ at the back L 80mm wire gauge ø 2mm L1 4mm L3 20mm Qty 1 pcs		
For models:	2300-B30, 2300-B40, 2300-B40P, 2300-L30, 2300-L40, 2300-L40P		

springs

torsion springs

			
1			
GEV No.	693692	Ref. No.	2300/B30Z27 2300/B40PZ25 2300/B40Z27 2300/L30Z27 2300/L40PZ25 2300/L40Z27
description	spring for dough roller mounting pos. in the front/at the back		

F

foot switches 3

M

motors 4

P

push/momentary push switches 3

R

rocker/momentary rocker switches 3

rotary switches 3

S

switches and momentary switches 3