



GAS COMPONENTS



ELECTRIC COMPONENTS



WATER TECHNOLOGY



MECHANICAL COMPONENTS



TOOLS

Spare parts suitable for

IARP

Find the complete and up-to-date range of products in our GEV Webshop



Manufacturer catalogue

The most important spare parts and accessories arranged clearly for every manufacturer

- ✓ Complete product range and all appliance data always up to date in the GEV Webshop
- ✓ Alphabetical Index at the end of the catalogue

GEV Webshop

www.gev-online.co.uk

www.gev-online.com



- 🔍 Add to Favourites
- 🔍 Sign In with email address and usual password
- 🔍 Easy-order – place several items in your basket at the same time
- 🔍 Quick Item search – no login needed



heating elements

heating elements for refrigeration

heating elements for defrosting



| | | | |
|--------------------|--|-----------------|---------|
| GEV No. | 417669 | Ref. No. | 0205376 |
| description | heating element 233W 230V L 195mm W 122mm connection male faston 6.3mm cable length 1000mm tube ø 8.5mm defrosting | | |

heating cables

connection on both sides (metal braided)



| | | | |
|--------------------|---|-----------------|---------|
| GEV No. | 417516 | Ref. No. | 0231005 |
| description | heating cable 40.6W 230V ø 2.6mm L 4600mm 10W/m | | |

thermostats

refrigeration thermostats

DANFOSS

control thermostats



| | | | |
|--------------------|---|-----------------|--------------------|
| GEV No. | 390774 | Ref. No. | 0225093 0225178 |
| description | thermostat type 077B3317L capillary pipe 2000mm temperature range -13.6 up to -30.0°C probe ø 2mm | | |

RANCO

K22 series

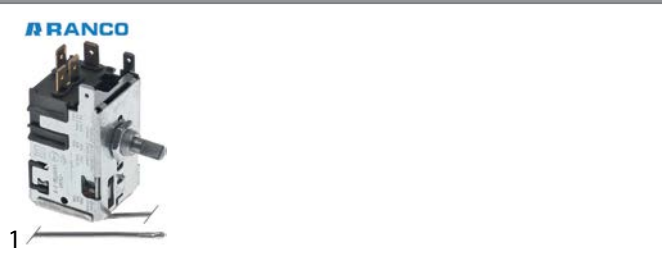

| | | | |
|--------------------|---|-----------------|--------------------------------|
| GEV No. | 391000 | Ref. No. | 0225095 3305084 I3305084 |
| description | thermostat RANCO type K22L1067 probe ø 2mm probe L 7mm capillary pipe 1500mm T war 10.5°C T cold -32°C shaft L 11mm shaft 6x4mm | | |

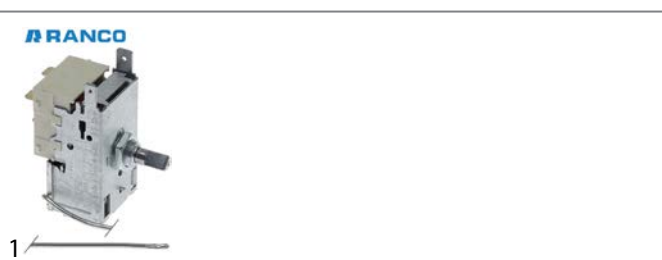

| | | | |
|--------------------|---|-----------------|---------|
| GEV No. | 391003 | Ref. No. | 0225008 |
| description | thermostat RANCO type K22L1067 probe ø 2mm probe Lmm capillary pipe 1500mm T war -10°C T cold -34°C | | |



| | | | |
|--------------------|--|-----------------|---------|
| GEV No. | 390775 | Ref. No. | 0225105 |
| description | thermostat RANCO type K22L2088 probe ø 2mm capillary pipe 2500mm temperature range -10 up to -20°C | | |



| | | | |
|--------------------|--|-----------------|---------|
| GEV No. | 391007 | Ref. No. | 3304241 |
| description | thermostat RANCO type K22-L8103 probe ø 2mm probe L 48mm capillary pipe 1500mm T war 10°C T cold -5°C for fridge | | |

→ electric components

K50 series



| | | | |
|--------------------|---|-----------------|---------|
| GEV No. | 391008 | Ref. No. | 3304724 |
| description | thermostat RANCO type K50B-S3492 probe ø 2mm probe Lmm capillary pipe 2500mm T war -19°C T cold -26°C ice maker | | |



| | | | |
|--------------------|---|-----------------|----------|
| GEV No. | 390990 | Ref. No. | I0225186 |
| description | thermostat RANCO type K50B-S3528 capillary pipe 800mm | | |



| | | | |
|--------------------|---|-----------------|---------|
| GEV No. | 390760 | Ref. No. | 3301323 |
| description | thermostat RANCO type K50-L3210 probe ø 2mm probe Lmm capillary pipe 2500mm temperature range -30 up to -23°C refrigeration | | |

accessories for 390760

| | | | | |
|---|----------------|--------|-----------------|---------|
|  | GEV No. | 112654 | Ref. No. | 3301324 |
| knob ø 22.5mm shaft ø 6x4mm blue for thermostat | | | | |



| | | | |
|--------------------|--|-----------------|---------|
| GEV No. | 391004 | Ref. No. | 3300683 |
| description | thermostat RANCO type K50-L3313 probe ø 2mm probe Lmm capillary pipe 1500mm for display refrigerator | | |



| | | | |
|--------------------|--|-----------------|--------------------------------|
| GEV No. | 391002 | Ref. No. | 0225088 3306115 I3306115 |
| description | thermostat RANCO type K50-L3319 probe ø 2mm probe L 7mm capillary pipe 1000mm temperature range -4,5 up to +7,5°C shaft L 11mm shaft 6x4mm | | |



| | | | |
|--------------------|---|-----------------|---------|
| GEV No. | 390757 | Ref. No. | 0225090 |
| description | thermostat RANCO type K50-L3337 probe ø 2mm probe Lmm capillary pipe 1500mm refrigeration | | |



| | | | |
|--------------------|---|-----------------|---------|
| GEV No. | 391005 | Ref. No. | 3303610 |
| description | thermostat RANCO type K50-L3425 probe ø 2mm probe Lmm capillary pipe 1000mm T war -10°C T cold -30°C for display refrigerator | | |





| | | | |
|--------------------|---|-----------------|--------------------|
| GEV No. | 391006 | Ref. No. | 0225081 0225185 |
| description | thermostat RANCO type K50L7201 probe ø 2mm probe L 36mm capillary pipe 900mm for fridge | | |







| K57 series | | | |
|---|---|-----------------|--------------------|
|  | | | |
| 1 | | | |
| GEV No. | 390665 | Ref. No. | 3302297 3304195 |
| description | thermostat RANCO type K57-L2852 probe ø 10mm probe L 40mm capillary pipe 1200mm | | |

switches and momentary switches

rocker/momentary rocker switches

| 30x22mm | | | |
|---|---|-----------------|-------------------|
|  | | | |
| 1 | | | |
| GEV No. | 301003 | Ref. No. | 0202083 |
| description | rocker switch mounting measurements 30x22mm green 2NO 250V 16A illuminated 0-I connection male faston 6.3mm ambient temperature max. 125/55°C protection IP65 | | |
| accessories for | 301003 | | |
|  | GEV No. | 301036 | Ref. No. — |
| | protective cover internal size 30x22mm for rocker switch mounting measurementsmm | | |

| | | | |
|---|--|-----------------|---------------------|
|  | | | |
| 1 | | | |
| GEV No. | 301002 | Ref. No. | 3305916 I3305916 |
| description | rocker switch mounting measurements 30x22mm orange 2NO 250V 16A illuminated 0-I connection male faston 6.3mm ambient temperature max. 85/125°C protection IP65 | | |
| accessories for | 301002 | | |
|  | GEV No. | 301036 | Ref. No. — |
| | protective cover internal size 30x22mm for rocker switch mounting measurementsmm | | |

| | | | |
|---|---|-----------------|--------------------|
|  | | | |
| 1 | | | |
| GEV No. | 301009 | Ref. No. | 0202008 0202030 |
| description | rocker switch mounting measurements 30x22mm white 2NO 250V 16A illuminated 0-I connection male faston 6.3mm ambient temperature max. 125/55°C protection IP65 | | |
| For models: | GAYA20-TOP-DOOR | | |
| accessories for | 301009 | | |
|  | GEV No. | 301036 | Ref. No. — |
| | protective cover internal size 30x22mm for rocker switch mounting measurementsmm | | |

push/momentary push switches

27.2x22.2mm

| | | | |
|---|---|-----------------|---------|
|  | | | |
| 1 | | | |
| GEV No. | 348112 | Ref. No. | 3301934 |
| description | push switch mounting measurements 27.2x22.2mm 2NO 250V 16A without cap connection male faston 6.3mm ambient temperature max. 55°C | | |

ø25mm

| | | | |
|---|---|-----------------|--------------------|
|  | | | |
| 1 | | | |
| GEV No. | 348109 | Ref. No. | 0202088 3300972 |
| description | push switch mounting ø 25mm white 2NO 250V 16A light connection male faston 6.3mm ambient temperature max. 55°C | | |

| | | | |
|---|--|-----------------|---------|
|  | | | |
| 1 | | | |
| GEV No. | 347536 | Ref. No. | 0202007 |
| description | push switch mounting ø 25mm white 2NO 250V 16A connection male faston 6.3mm ambient temperature max. 125°C protection IP40 | | |

| | | | |
|---|---|-----------------|---------|
|  | | | |
| 1 | | | |
| GEV No. | 346003 | Ref. No. | 0202084 |
| description | momentary push switch mounting ø 25mm red 1NO/indicator light 250V 16A illuminated connection male faston 6.3mm ambient temperature max. 85°C protection IP65 | | |

| | | | |
|---|---|-----------------|---------|
|  | | | |
| 1 | | | |
| GEV No. | 345161 ¹ | Ref. No. | 3303454 |
| description | push switch mounting ø 25mm green 2NO 250V 16A illuminated connection male faston 6.3mm ambient temperature max. 85°C protection IP40 | | |

¹illuminated

| | | | |
|---|--|-----------------|---------|
|  | | | |
| 1 | | | |
| GEV No. | 345151 ¹ | Ref. No. | 0202000 |
| description | push switch mounting ø 25mm orange 2NO 250V 16A illuminated connection male faston 6.3mm ambient temperature max. 85°C protection IP40 | | |

¹illuminated



1

| | | | |
|--------------------|---|-----------------|---------|
| GEV No. | 347537 | Ref. No. | 0202087 |
| description | push switch mounting ø 25mm green 2NO 250V 16A illuminated main switch connection male faston 6.3mm ambient temperature max. 55/120°C protection IP40 | | |

microswitches

with push button

switches with snap-fit



1

| | | | |
|--------------------|--|-----------------|--------|
| GEV No. | 345249 | Ref. No. | 020270 |
| description | microswitch with push button 250V 0.25A 1NO connection male faston 6.3mm L 26x12mm ambient temperature max. 85°C actuating force: 500g | | |



1

| | | | |
|--------------------|---|-----------------|---------------------|
| GEV No. | 348192 | Ref. No. | 0202070 10202070 |
| description | microswitch with push button 250VA 1NO connection male faston 6.3mm L 26x12mm ambient temperature max. 85°C actuating force: 500g | | |

lamps

indicator lights

indicator lights (complete)

30x22mm



1

| | | | |
|---|---|-----------------|-----------------|
| GEV No. | 359157 | Ref. No. | 0200008 |
| description | indicator light mounting measurements 30x22mm 230V green connection male faston 6.3mm temp.-resist. 125/55°C type RL2 | | |
| For models: | GAYA20-TOP-DOOR | | |
| accessories for | 359157 | | |
|  | GEV No. | 301036 | Ref. No. |
| | | | — |
| | protective cover internal size 30x22mm for rocker switch mounting measurementsmm | | |



1

| | | | |
|---|---|-----------------|-----------------|
| GEV No. | 359178 | Ref. No. | N/A |
| description | indicator light mounting measurements 30x22mm 230V green connection male faston 6.3mm temp.-resist. 85°C type Marquardt 1667.. IP44 | | |
| accessories for | 359178 | | |
|  | GEV No. | 301036 | Ref. No. |
| | | | — |
| | protective cover internal size 30x22mm for rocker switch mounting measurementsmm | | |



1

| | | | |
|--------------------|--|-----------------|---------|
| GEV No. | 359155 | Ref. No. | 0200007 |
| description | indicator light mounting measurements 30x22mm 230V red connection male faston 6.3mm temp.-resist. 125°C type RL2 | | |

fluorescent lamps

accessories

ballasts



1

| | | | |
|--------------------|---------------------------------------|-----------------|--------------------|
| GEV No. | 401504 | Ref. No. | 0206009 3303896 |
| description | electrical ballast 18W 230V Qty 1 pcs | | |
| For models: | GAYA20-TOP-DOOR | | |



1

| | | | |
|--------------------|---------------------------------------|-----------------|--------------------|
| GEV No. | 401505 | Ref. No. | 0206012 3303897 |
| description | electrical ballast 36W 230V Qty 1 pcs | | |
| For models: | GAYA20-TOP-DOOR | | |

timers

programme timers



1

| | | | |
|--------------------|--|-----------------|---------|
| GEV No. | 403659 | Ref. No. | 3306879 |
| description | timer CDC 4901F1 engines 1 chambers 1 operation time 20s 230V 50Hz shaft ø 6x4.6mm shaft Lmm | | |

defrost timers

BIGATTI



1

| | | | |
|--------------------|--|-----------------|---------|
| GEV No. | 360520 | Ref. No. | 3301867 |
| description | defrost timer BIGATTI type D94.44 defrosting interval 4x per 24h defrosting time 12.5min 230V 50Hz | | |

CDC



1

| | | | |
|--------------------|--|-----------------|----------|
| GEV No. | 403603 | Ref. No. | I3306873 |
| description | defrost timer CDC type 4901F1CME000.1000 defrosting interval 4x per 24h defrosting time 12.5min 230V 50/60Hz | | |

miscellaneous



1

| | | | |
|--------------------|---|-----------------|---------|
| GEV No. | 360187 | Ref. No. | 3300736 |
| description | defrost timer type RZ-2001-21 defrosting interval 4H defrosting time 15min fan delay 5min 230V 50Hz defr. funct. 4x per 24h | | |

relays

power relays

with bracket mounting

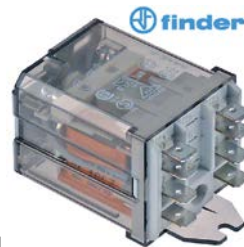

1

| | | | |
|--------------------|---|-----------------|--------------------|
| GEV No. | 380139 | Ref. No. | 3301894 3301895 |
| description | power relays FINDER 230VAC 16A 2CO connection F6.3 bracket mounting dimensions 68x38.2x35.8mm manuf. no. 62.82.8.230.0000 | | |



1

| | | | |
|--------------------|---|-----------------|---------|
| GEV No. | 380687 | Ref. No. | 3300702 |
| description | power relays FINDER 230VAC 30A 2NO connection F6.3 bracket mounting manuf. no. 66.82.8.230.0300 | | |
| For models: | GAYA20-TOP-DOOR | | |



1

| | | | |
|--------------------|---|-----------------|---------|
| GEV No. | 381252 | Ref. No. | 3301814 |
| description | relay OMRON 230VAC 25A 2NO connection male faston 6.3mm bracket mounting at 250V 25A manuf. no. G7L-2A-TUB 230VAC | | |



electronic controllers

EUREMA

refrigeration controllers



1

| | | | |
|--------------------|---|-----------------|--------------------------------|
| GEV No. | 378471 | Ref. No. | 3304410 3306508 I3306508 |
| description | electronic controller EUREMA type TE11E mounting measurements 58x25mm 230V voltage AC PTC relay outputs 1 NO-16A PTC built-in depth 82mm protection IP65 built-in version -50 up to +50°C display 2 digit | | |



1

| | | | |
|--------------------|---|-----------------|--------------------|
| GEV No. | 378281 | Ref. No. | 0233096 3303605 |
| description | electronic controller EUREMA type TE32E mounting measurements 64x32mm 230V voltage AC PTC relay outputs 3 NO-16A NO-8A NO-5A PTC PTC protection IP65 built-in version -50 up to +50°C display 2 digit | | |



1

| | | | |
|--------------------|---|-----------------|-------|
| GEV No. | 378486 | Ref. No. | TE32F |
| description | electronic controller EUREMA type TE32F mounting measurements 58x25mm 230V voltage AC PTC/NTC relay outputs 3 NO-16A CO-10A NO-10A PTC/NTC PTC/NTC DI front measurements 64x32mm built-in depth 82mm protection IP65 accuracy 1% built-in version incl. adaptor 71x29 defr. funct. yes -50 up to +99°C display 2½ digit | | |

thermometers



1

| | | | |
|--------------------|---|-----------------|--------------------|
| GEV No. | 379778 | Ref. No. | 0205115 TE01DEF |
| description | thermometer EUREMA type TE01 mounting measurements 58x25mm 230V voltage AC -10 up to +55°C PTC display 2 digit front measurements 63x32mm protection IP65 accuracy 1% | | |



1

| | | | |
|--------------------|---|-----------------|---------------------|
| GEV No. | 378472 | Ref. No. | 3301028 I3301028 |
| description | thermometer EUREMA type TE01DEF mounting measurements 58x25mm 230V voltage AC°C measuring input PTC display 2½ digit front measurements 64x32mm protection IP65 accuracy 1% PTC | | |

accessories



1

| | | | |
|------------------------|--|-----------------|---------|
| GEV No. | 378306 | Ref. No. | 3303038 |
| description | load module EUREMA type EWEM036 mounting measurements 115x37mm 230V voltage AC relay outputs 3 CO-20A CO-16A CO-10A front measurementsmm built-in depth 70mm protection IPx0 wall-mounted version defr. funct.°C display | | |
| accessories for | 378306 | | |
| |  | GEV No. | 403555 |
| | | Ref. No. | 3303049 |
| | ribbon cable 5-pole L 1000mm plug type IDC-AUTOCOM HE14, 90° raster size 2.54mm | | |

probes

universal probes

temperature probes



1

| | | | |
|--------------------|--|-----------------|---------|
| GEV No. | 379343 | Ref. No. | 0205610 |
| description | temperature probe NTC 10kOhm cable silicone probe -40 up to +110°C cable -50 up to +180°C probe ø6x40mm cable length 3m 2-wire | | |

producer-specific probes

probes



1

| | | | |
|--------------------|--|-----------------|----------|
| GEV No. | 403910 | Ref. No. | I0205805 |
| description | temperature probe NTC 10kOhm cable PVC probe -40 up to +110°C connection 2-wire probe 5x20 cable length 1.475m | | |



electronics

PCBs

| | | | |
|---|---|-----------------|----------------------|
|  | | | |
| 1 | | | |
| GEV No. | 403736 | Ref. No. | 43845000 I9R00462 |
| description | control PCB refrigeration IARP L 222mm W 40mm | | |

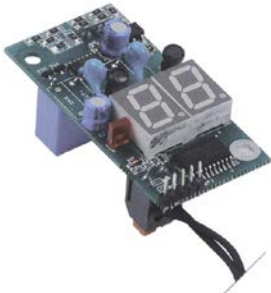
| | | | |
|---|--|-----------------|---------|
|  | | | |
| 1 | | | |
| GEV No. | 402976 | Ref. No. | 0205600 |
| description | PCB thermometer L 68mm W 33mm cable length 2000mm with probe 230V voltage AC | | |

keypads

front foils



| | | | |
|---|---|-----------------|----------|
|  | | | |
| 1 | | | |
| GEV No. | 403764 | Ref. No. | 49357000 |
| description | front foil blast freezer L 165mm W 45mm | | |

solenoid valves

solenoid valves (refrigeration)

DANFOSS

valve bodies

| | | | |
|---|--|-----------------|---------------------|
|  | | | |
| 1 | | | |
| GEV No. | 370160 | Ref. No. | 0189035 I0189035 |
| description | solenoid valve body NC type EVR 3 p max 45.2bar DN 3.2mm connection 6mm soldering connection -40° up to 105°C refrigeration straight DANFOSS | | |
| accessories for | 370160 | | |
|  | | | |
| GEV No. | 371046 | Ref. No. | — |
| description | console for solenoid valve for EVR2,3,6,10 | | |

compressors

EMBRACO / ASPERA

R134A

HBP monophase

High evaporation temperature above -15°C

| | | | |
|--|--|-----------------|---------|
|  | | | |
| 1 | | | |
| GEV No. | 605181 | Ref. No. | 0210607 |
| description | compressor coolant R134a type EMT50HDP 220-240V 50Hz HBP 7.8kg 1/6HP cylinder capacity 4.5cm ³ RSIR H 166mmWWW 161 W 207W 261W 324W 396W 476W | | |

HMBP monophase

High/Medium evaporation temperature above -20/-15 °C

| | | | |
|---|--|-----------------|---------|
|  | | | |
| 1 | | | |
| GEV No. | 605016 | Ref. No. | 0210611 |
| description | compressor coolant R134a type EM65HHR 220-240V 50Hz HBP fully hermetic 7.62kg 1/6HP cylinder capacity 5.54cm ³ CSIRWWW 287W 389W 499W 617W 742W test method ASHRAE 842W | | |



R290A

LBP monophase

Lower evaporation temperature below -20°C



| | | | |
|--------------------|--|-----------------|----------|
| GEV No. | 605258 | Ref. No. | I0210981 |
| description | compressor coolant R290 type EMTE2134U 220-240V 50Hz LBP 9kg 3/8HP cylinder capacity 9.5cm ³ CSIR H 187mm 250W 278W 305W 330W 366WWWWWW | | |



| | | | |
|--------------------|--|-----------------|---------|
| GEV No. | 605274 | Ref. No. | 0210809 |
| description | compressor coolant R290 type NEK2134U 220-240V 50Hz LBP 11kg 1/2HP cylinder capacity 9.99cm ³ CSIR 351W 441W 552W 682W 833WWWWWW test method ASHRAE | | |



| | | | |
|--------------------|--|-----------------|---------|
| GEV No. | 605204 | Ref. No. | 0210951 |
| description | compressor coolant R290 type NEK2160U 220-240V 50Hz LBP 11.9kg 3/4HP cylinder capacity 16.8cm ³ CSR H 206mm 508W 646W 808W 995W 1206WWWWWW test method ASHRAE | | |

R600A

LBP monophase

Lower evaporation temperature below -20°C



| | | | |
|--------------------|--|-----------------|----------|
| GEV No. | 605257 | Ref. No. | 45004031 |
| description | compressor coolant R600a type EMD46CLT 220-240V 50Hz LBP 7.5kg cylinder capacity 7.96cm ³ RSCR H 210mm 88W 118W 154W 196W 246WWWWWW | | |

SECOPI DANFOSS

R134A

HMBP monophase

High/Medium evaporation temperature above -20/-15 °C



| | | | |
|--------------------|--|-----------------|---------|
| GEV No. | 605076 | Ref. No. | 0210109 |
| description | compressor coolant R134a type SC18G 220-240V 50Hz HMBP fully hermetic 13.7kg 1/2HP power input 495W cylinder capacity 17.7cm ³ CSIR H 219mmW 348W 485W 649W 844W 1074W 1343W 1655W 2014W test method ASHRAE | | |

| | | | | |
|---|---------------------------------------|--------|-----------------|---|
| spare parts for | 605076 | | | |
|  | GEV No. | 380058 | Ref. No. | — |
| | start relay DANFOSS 117U6019/F278 HST | | | |



1

| | | | |
|--------------------|---|-----------------|---------|
| GEV No. | 605194 | Ref. No. | 0210107 |
| description | compressor coolant R134a type SC21G 220-240V 50Hz HMBP 13.5kg 5/8HP power input 643W cylinder capacity 20.95cm ³ CSR H 219mmW 410W 558W 746W 977W 1250W 1568W 1931W 2343W test method ASHRAE | | |



1

| | | | | |
|---|---|-----------------|-----------------|---------------------|
| GEV No. | 601055 ¹ | Ref. No. | 0221007 | |
| description | axial fan L 92mm W 92mm H 25mm 230VAC 50/60Hz 14.5/14W bearing ball bearing connection male faston 2.8mm metal ADDA fan wheel ø 85mm temp.-resist. 70°C | | | |
| accessories for | 601055 | | | |
|  | GEV No. | 550898 | Ref. No. | 0221181 I0221181 |
| | connecting cable cable length 2000mm connection F 2.8 connection distance 7.9mm for axial flow fan | | | |
|  | GEV No. | 691103 | Ref. No. | — |
| | guard ø 90mm mounting distance 83mm for axial fan 92mm | | | |

fans

axial fans

import



1

| | | | | |
|---|--|-----------------|--------------------------------|---------------------|
| GEV No. | 601131 ¹ | Ref. No. | 0221005 0221151 I0221151 | |
| description | axial fan L 119mm W 119mm H 25mm 230VAC 50/60Hz 19/18W bearing ball bearing connection male faston 2.8mm metal ADDA fan wheel ø 110mm temp.-resist. 70°C | | | |
| accessories for | 601131 | | | |
|  | GEV No. | 550898 | Ref. No. | 0221181 I0221181 |
| | connecting cable cable length 2000mm connection F 2.8 connection distance 7.9mm for axial flow fan | | | |

¹with ball bearings



1

| | | | |
|--------------------|---|-----------------|----------|
| GEV No. | 601909 ¹ | Ref. No. | 45003031 |
| description | axial fan L 119mm W 119mm H 38mm 220-240 50/60Hz 31/29W bearing ball bearing connection male faston 2.8mm | | |

¹with ball bearings

¹with ball bearings

accessories

fan guards



1

| | | | |
|--------------------|---|-----------------|---------------------|
| GEV No. | 691104 | Ref. No. | 0427017 I0427017 |
| description | guard ø 115mm mounting distance 105mm for axial fan 119mm | | |

connecting cables



1

| | | | |
|--------------------|--|-----------------|---------------------|
| GEV No. | 550898 | Ref. No. | 0221181 I0221181 |
| description | connecting cable cable length 2000mm connection F 2.8 connection distance 7.9mm for axial flow fan | | |



refrigeration fans

refrigeration motors universal

ELCO

N series - standard



| | | | |
|---|---|-----------------|---------------------|
| GEV No. | 601442 | Ref. No. | 0220067 I0220067 |
| description | fan motor ELCO 10W 230V 50-60Hz bearing slide bearing L1 45mm L3 83mm W 83mm cable length 1800mm 1300/1550rpm 3 mounting options VN10-20/507 triple | | |
| spare parts for | 601442 | | |
|  | GEV No. | 601413 | Ref. No. — |
| | fixing plate suitable for fanwheel ED ø 32mm shaft ø 7 mounting distance 26mm | | |



| | | | |
|---|---|-----------------|-------------------|
| GEV No. | 601762 | Ref. No. | 0221141 |
| description | fan motor ELCO 10W 230V 50Hz bearing ball bearing L1 49mm L2 59mm L3 86.5mm W 83mm connection cable 500mm cable length 500mm 1300/1550rpm 3 mounting options VN10-20/1456 | | |
| spare parts for | 601762 | | |
|  | GEV No. | 601413 | Ref. No. — |
| | fixing plate suitable for fanwheel ED ø 32mm shaft ø 7 mounting distance 26mm | | |



| | | | |
|---|--|-----------------|-------------------|
| GEV No. | 601763 | Ref. No. | 0221140 |
| description | fan motor ELCO 16W 230V 50/60Hz bearing ball bearing L1 48mm L2 64mm L3 91.5mm W 83mm connection cable 500mm cable length 500mm 1300/1550rpm 3 mounting options VN16-25/1457 | | |
| spare parts for | 601763 | | |
|  | GEV No. | 601413 | Ref. No. — |
| | fixing plate suitable for fanwheel ED ø 32mm shaft ø 7 mounting distance 26mm | | |



| | | | |
|--------------------|--|-----------------|--------------------|
| GEV No. | 601735 | Ref. No. | 0221115 3604962 |
| description | fan motor ELCO 5W 230V 50/60Hz bearing slide bearing L3 71mm W 59mm connection Kabel 1430mm cable length 1500mm 1300/1550rpm 3 mounting options VN5-13/249 | | |

IQ series



| | | | |
|--------------------|--|-----------------|---------|
| GEV No. | 601886 | Ref. No. | 0220087 |
| description | fan motor 14W 230V 50/60Hz L2 35-56mm L3 95mm W 80mm cable length 1000mm 1400rpm ELCO IQ motor 3 mounting options bearing ball bearing | | |



| | | | |
|--------------------|---|-----------------|---------|
| GEV No. | 601887 | Ref. No. | 0220088 |
| description | fan motor 25W 230V 50/60Hz L2 46-66mm L3 115mm W 90mm cable length 1000mm 1400rpm ELCO IQ motor 3 mounting options bearing ball bearing | | |



FMI



1

| | | | |
|---|---|-----------------|---------------------|
| GEV No. | 601332 | Ref. No. | 0220072 I0220072 |
| description | fan motor 16W 230V 50Hz L1 65mm L2 54mm L3 94mm W 77mm cable length 500mm 1300/1550rpm ABS12 5 mounting options bearing slide bearing | | |
| For models: | GAYA20-TOP-DOOR | | |
| spare parts for | 601332 | | |
|  | GEV No. | 601413 | Ref. No. — |
| | fixing plate suitable for fanwheel ED ø 32mm shaft ø 7 mounting distance 26mm | | |

accessories

fan wheels

aluminium

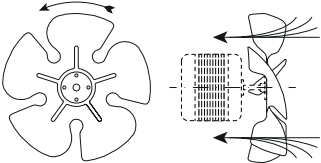
1

| | | | |
|--------------------|---|-----------------|---------|
| GEV No. | 601069 | Ref. No. | 0407004 |
| description | fan wheel sucking ø 172mm turn direction left fan wheel mounting 25.4mm blade angle 25° W 32mm aluminium | | |

mounting rings



1

| | | | |
|--------------------|---|-----------------|---------|
| GEV No. | 601586 | Ref. No. | 0221128 |
| description | ring for fan wheel ø 172mm sucking ø 220mm H 49mm mounting distance 1 208mm mounting distance 2 94.5mm | | |



1

| | | | |
|--------------------|---|-----------------|---------|
| GEV No. | 601587 | Ref. No. | 0221116 |
| description | ring for fan wheel ø 200mm sucking ø 246mm H 49mm mounting distance 1 236mm mounting distance 2 94.5mm | | |

cross flow fans

COPREL

double fans



1

| | | | |
|--------------------|---|-----------------|-----|
| GEV No. | 602107 | Ref. No. | N/A |
| description | cross flow fan COPREL TFD roller ø 60mm roller length 2x300mm laminated core thickness 30mm motor position centre 230V/50-60Hz 35W universal bearing silicone connection cable 1600mm airflow 333m ³ /h -10 up to +50°C | | |

condensators & interference sup-
pression filters

starting capacitors

starting capacitors



1

| | | | |
|--------------------|---|-----------------|---------|
| GEV No. | 365153 | Ref. No. | 0210402 |
| description | starting capacitor 52µF 330V 50/60Hz duty cycle 3s 41280A133 2252347 ø 36mm L 83mm M8 plastic connection cable 350mm | | |



fuses

line circuit breakers

miscellaneous



1

| | | | |
|--------------------|---|-----------------|----------|
| GEV No. | 356000 | Ref. No. | I3301770 |
| description | circuit breaker 2 20A with fault current switch | | |

electric accessories

cables

power supply cables



1

| | | | |
|--------------------|---|-----------------|----------|
| GEV No. | 552002 | Ref. No. | I3306470 |
| description | power lead CEE7/7 type E+F contacts P+N+E 1mm ² max. 16A max 230V 2.5m | | |

ribbon cables

group 6



1

| | | | |
|--------------------|---|-----------------|---------|
| GEV No. | 403555 | Ref. No. | 3303049 |
| description | ribbon cable 5-pole L 1000mm plug type IDC-AUTOCOM HE14, 90° raster size 2.54mm | | |

terminal boxes



1

| | | | |
|--------------------|---|-----------------|-------|
| GEV No. | 551086 | Ref. No. | 01009 |
| description | terminal box 6-pole L 117mm W 67mm H 22mm protection IP30 | | |

equipment-specific units

for fridges

spare parts and accessories



1

| | | | |
|--------------------|--|-----------------|-----------|
| GEV No. | 551346 | Ref. No. | I0534005R |
| description | bush refrigerator compressor ø 9mm ID ø 6.5mm L 17mm Qty 1 pcs | | |



1

| | | | |
|--------------------|--------------------------------------|-----------------|----------|
| GEV No. | 699232 | Ref. No. | I0535012 |
| description | strain relief L 56mm W 14.5mm H 20mm | | |

housing and bezels

covers



1

| | | | |
|--------------------|--|-----------------|----------|
| GEV No. | 998252 | Ref. No. | 44037000 |
| description | cover for ventilation L 72mm W 62mm H 10mm Qty 1 pcs | | |

control panel



1

| | | | |
|--------------------|---|-----------------|----------|
| GEV No. | 699234 | Ref. No. | 44027000 |
| description | bezel L 780mm W 67mm H 62mm mounting pos. upper | | |

housings



1

| | | | |
|--------------------|---------------------------------------|-----------------|----------|
| GEV No. | 699233 | Ref. No. | I9500323 |
| description | terminal box L 98mm W 74mm H 35mm kit | | |

knobs

producer-specific knobs

IARP



1

| | | | |
|--------------------|---|-----------------|---------|
| GEV No. | 112654 | Ref. No. | 3301324 |
| description | knob ø 22.5mm shaft ø 6x4mm blue for thermostat | | |

locks

locking devices

producer-specific

IARP



1

| | | | |
|--------------------|---|-----------------|---------|
| GEV No. | 701114 | Ref. No. | 0423002 |
| description | door catch plastic H 15mm L 40mm W 15mm hole ø 4.2mm mounting distance 14mm for catch | | |



1

| | | | |
|--------------------|--|-----------------|----------|
| GEV No. | 702100 | Ref. No. | 44373000 |
| description | key cylinder ø 19mm rotation 180° cam length 42.5mm cam width 14mm | | |



1

| | | | |
|--------------------|---|-----------------|---------|
| GEV No. | 701113 | Ref. No. | 0423001 |
| description | key cylinder rotation 180° cam length 32mm cam width 17mm mounting ø 19mm | | |

hinges

door bearing



1

| | | | |
|--------------------|--|-----------------|----------|
| GEV No. | 701562 | Ref. No. | 44447000 |
| description | bolt L 36mm W 22mm thread M6 bolt 12mm bolt ø 12mm | | |



1

| | | | |
|------------------------|---|-----------------|---------|
| GEV No. | 701025 | Ref. No. | 0530022 |
| description | bolt L 45mm mounting pos. upper thread M8x1.25 ø 12mm for hinge | | |
| accessories for | 701025 | | |



| | | | |
|--------------------|---|-----------------|---------|
| GEV No. | 701026 | Ref. No. | 0162886 |
| description | hinge L 56mm W 50mm mounting pos. upper thickness 3mm | | |



1

| | | | |
|--------------------|-------------------------------------|-----------------|----------|
| GEV No. | 701567 | Ref. No. | 41649000 |
| description | bush L 11mm ø 11/15mm thickness 2mm | | |



1

| | | | |
|--------------------|-------------------------|-----------------|----------|
| GEV No. | 701572 | Ref. No. | I0534002 |
| description | bush ø 18.5mm ID ø 12mm | | |



1

| | | | |
|--------------------|---|-----------------|---------------------|
| GEV No. | 692537 | Ref. No. | 0415134 I0415134 |
| description | door hinge L 68mm W 25mm mounting pos. upper right with plunger | | |





1

| | | | |
|--------------------|--|-----------------|----------|
| GEV No. | 701564 | Ref. No. | 46996000 |
| description | hinge L 130mm W 85mm H 38mm mounting distance 48mm mounting distance 2 33mm thread M6 ø 8mm bolt 13mm bolt ø 8mm | | |



1

| | | | |
|---|---|-----------------|-------------------------|
| GEV No. | 701026 | Ref. No. | 0162886 |
| description | hinge L 56mm W 50mm mounting pos. upper thickness 3mm | | |
| accessories for | 701026 | | |
|  | GEV No. | 701025 | Ref. No. 0530022 |
| description | bolt L 45mm mounting pos. upper thread M8x1.25 ø 12mm for hinge | | |



1

| | | | |
|--------------------|--|-----------------|---------|
| GEV No. | 701027 | Ref. No. | 0415122 |
| description | hinge L 58mm W 28mm H 73mm mounting pos. lower with bolt | | |



1

| | | | |
|--------------------|---|-----------------|---------|
| GEV No. | 701039 | Ref. No. | 0160434 |
| description | hinge L 67mm W 43mm H 22mm mounting pos. bottom right | | |



1

| | | | |
|--------------------|--|-----------------|----------|
| GEV No. | 701563 | Ref. No. | 43870000 |
| description | hinge L 98mm W 48mm H 38mm mounting distance 40mm mounting distance 2 20mm thread M6 | | |



1

| | | | |
|--------------------|---|-----------------|----------|
| GEV No. | 701565 | Ref. No. | 48205000 |
| description | hinge bearing L 72mm W 39mm H 30mm mounting distance 25mm mounting distance 2 25mm mounting pos. left | | |



1

| | | | |
|--------------------|--|-----------------|----------|
| GEV No. | 701566 | Ref. No. | 46997000 |
| description | hinge bearing L 72mm W 39mm H 30mm mounting distance 25mm mounting distance 2 25mm mounting pos. right | | |

equipment feet and end caps

screw-in feet



1

| | | | |
|--------------------|---|-----------------|---------------------|
| GEV No. | 701112 | Ref. No. | 0403014 10403014 |
| description | equipment foot thread M10 thread L 43mm ø 29mm H 52mm plastic WS 35 Qty 1 pcs | | |

shelves and shelf rails

grates

universal

with upstand



1

| | | | |
|--------------------|---|-----------------|---------|
| GEV No. | 970824 | Ref. No. | 0427743 |
| description | grate W 526mm D 418mm plastic-coated steel with hinge camp crossing wires 2 | | |



1







| | | | |
|---|--|-----------------|--------------------------|
| GEV No. | 970556 | Ref. No. | 0427396 |
| description | grate W 530mm D 650mm GN 2/1 plastic-coated steel with hinge camp wire gauge frame 9mm lengthwise wires gauge 5mm crossing wires 2 white suitable for refrigerator | | |
| accessories for | 970556 | | |
|  | GEV No. | 690330 | Ref. No. — |
| description | rack L 1000mm W 22mm H 4mm aperture 3x8mm hole distance 12.5mm stainless steel | | |
|  | GEV No. | 690332 | Ref. No. 10402138 |
| description | shelf support L 31/28mm W 22mm H 17mm SS with hook Qty 1 pcs | | |
|  | GEV No. | 694700 | Ref. No. — |
| description | shelf support L 31/28mm W 22mm H 18mm SS Qty 12 pcs | | |

Table continues overleaf





| | | | |
|---|---|--------|-------------------|
| accessories for | 970556 | | |
|  | GEV No. | 694701 | Ref. No. — |
| | shelf support L 31/28mm W 22mm H 17mm SS with hook Qty 12 pcs | | |

| | | | |
|---|--|-----------------|---------|
|  | 1 | | |
| GEV No. | 970874 | Ref. No. | 0427709 |
| description | grate W 650mm D 540mm GN 2/1 H 30mm plastic-coated steel with hinge camp for fridge wire gauge frame 7.3mm lengthwise wires gauge 3.2mm crossing wires 2 white | | |

| | | | |
|---|--|-----------------|----------|
| producer-specific | | | |
|  | 1 | | |
| GEV No. | 970930 | Ref. No. | 44714000 |
| description | grate W 650mm D 330mm H 9mm wire gauge frame 7mm lengthwise wires gauge 3mm crossing wires 1 | | |

| | | | |
|--|---|-----------------|----------|
|  | 1 | | |
| GEV No. | 970929 | Ref. No. | 44379000 |
| description | grate W 665mm D 560mm H 30mm wire gauge frame 7mm lengthwise wires gauge 3mm crossing wires 2 | | |

shelf rails and supports

| | | | |
|---|--|-----------------|-------------------|
| universal | | | |
|  | 1 | | |
| GEV No. | 690332 | Ref. No. | I0402138 |
| description | shelf support L 31/28mm W 22mm H 17mm SS with hook Qty 1 pcs | | |
| accessories for | 690332 | | |
|  | GEV No. | 690330 | Ref. No. — |
| | rack L 1000mm W 22mm H 4mm aperture 3x8mm hole distance 12.5mm stainless steel | | |

| | | | |
|---|---|-----------------|----------|
| producer-specific | | | |
|  | 1 | | |
| GEV No. | 699231 | Ref. No. | I0402137 |
| description | guide white L 1350mm W 20mm H 5mm Qty 1 | | |

| | | | |
|---|---------------------------------------|-----------------|---------|
|  | 1 | | |
| GEV No. | 691835 | Ref. No. | 0160741 |
| description | shelf support L 28/25mm W 35mm H 19mm | | |

gaskets

refrigeration gaskets

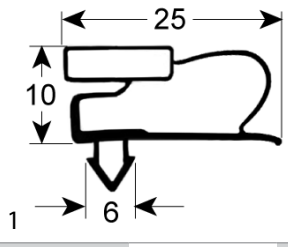
| | | | |
|--|--|-----------------|---------|
| plug-in gaskets | | | |
| profile 9050 | | | |
|  | 1 | | |
| GEV No. | 902152 | Ref. No. | 0313225 |
| description | refrigeration gasket profile 9050 W 560mm L 1585mm plug size | | |

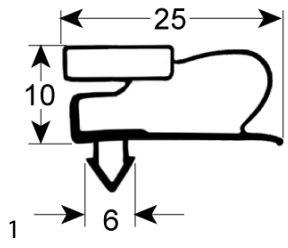
| | | | |
|---|--|-----------------|---------|
|  | 1 | | |
| GEV No. | 902051 | Ref. No. | 0313220 |
| description | refrigeration gasket profile 9050 W 700mm L 1505mm plug size | | |

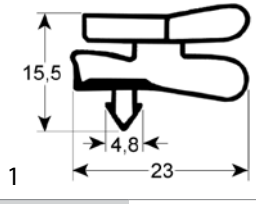
| | | | |
|--|--|-----------------|---------|
| profile 9151 | | | |
| <i>We offer custom-made gaskets for this profile</i> | | | |
|  | 1 | | |
| GEV No. | 901457 | Ref. No. | 3303310 |
| description | refrigeration gasket profile 9151 W 495mm L 1440mm plug size | | |

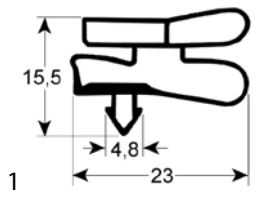
| | | | |
|--|--|-----------------|---------|
|  | 1 | | |
| GEV No. | 901458 | Ref. No. | 0313223 |
| description | refrigeration gasket profile 9151 W 535mm L 1690mm plug size | | |

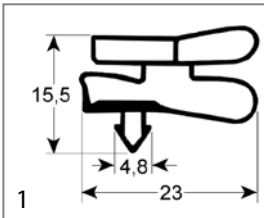

| | | | |
|--------------------|---|-----------------|---------|
| GEV No. | 901083 | Ref. No. | 0313205 |
| description | refrigeration gasket profile 9151 W 550mm L 1722mm plug size L1 1712mm W1 540mm external size | | |

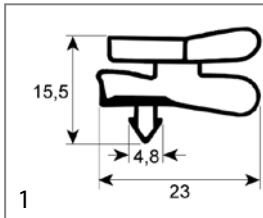

| | | | |
|--------------------|---|-----------------|--------------------|
| GEV No. | 901096 | Ref. No. | 0313191 3300917 |
| description | refrigeration gasket profile 9151 W 620mm L 890mm plug size | | |

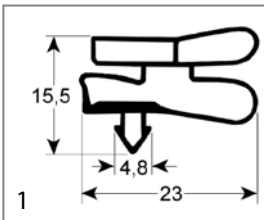

| | | | |
|--------------------|---|-----------------|---------------------|
| GEV No. | 901179 | Ref. No. | 3302200 I3302200 |
| description | refrigeration gasket profile 9151 W 555mm L 1555mm plug size L1 1545mm W1 545mm external size | | |

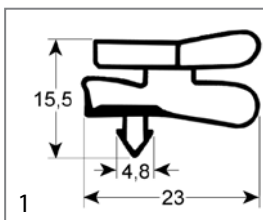

| | | | |
|--------------------|---|-----------------|---------|
| GEV No. | 901081 | Ref. No. | 0313010 |
| description | refrigeration gasket profile 9151 W 634mm L 1391mm external size L1 1381mm W1 624mm plug size | | |

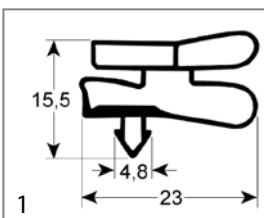

| | | | |
|--------------------|---|-----------------|---------------------|
| GEV No. | 901080 | Ref. No. | 0313007 I0313007 |
| description | refrigeration gasket profile 9151 W 558mm L 1713mm plug size L1 1703mm W1 548mm external size | | |

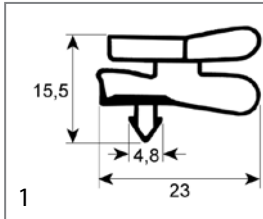

| | | | |
|--------------------|---|-----------------|---------|
| GEV No. | 901097 | Ref. No. | 3300913 |
| description | refrigeration gasket profile 9151 W 637mm L 576mm plug size | | |

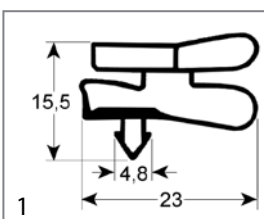

| | | | |
|--------------------|---|-----------------|---------|
| GEV No. | 901082 | Ref. No. | 0313178 |
| description | refrigeration gasket profile 9151 W 585mm L 1390mm plug size L1 1380mm W1 575mm external size | | |

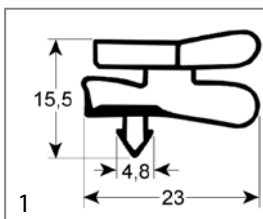

| | | | |
|--------------------|--|-----------------|---------|
| GEV No. | 901796 | Ref. No. | 0313221 |
| description | refrigeration gasket profile 9151 W 655mm L 1534mm | | |

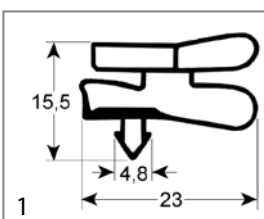

| | | | |
|--------------------|---|-----------------|---------|
| GEV No. | 901086 | Ref. No. | 0313206 |
| description | refrigeration gasket profile 9151 W 620mm L 1522mm plug size L1 1532mm W1 630mm external size | | |

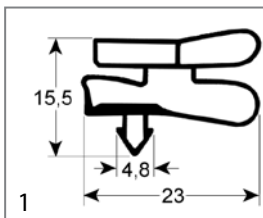

| | | | |
|--------------------|---|-----------------|---------|
| GEV No. | 901377 | Ref. No. | 0313291 |
| description | refrigeration gasket profile 9151 W 715mm L 1674mm plug size L1 1686mm W1 722mm external size | | |



| | | | |
|--------------------|---|-----------------|---------|
| GEV No. | 901322 | Ref. No. | 0313233 |
| description | refrigeration gasket profile 9151 W 717mm L 1515mm plug size L1 1505mm W1 707mm external size | | |

| | | | |
|--------------------|---|-----------------|---------|
| GEV No. | 901085 | Ref. No. | 0313200 |
| description | refrigeration gasket profile 9151 W 730mm L 1550mm plug size L1 1540mm W1 720mm external size | | |

| | | | |
|--------------------|---|-----------------|--------------------|
| GEV No. | 901084 | Ref. No. | 0313202 0313207 |
| description | refrigeration gasket profile 9151 W 740mm L 1619mm plug size L1 1609mm W1 730mm external size length external size 1625mm width external size 740mm | | |

profile 9058

| | | | |
|--------------------|--|-----------------|----------|
| GEV No. | 902395 | Ref. No. | 44404000 |
| description | refrigeration gasket profile 9058 W 770mm L 1810mm plug size Qty 1 | | |

refrigeration cycle components

filter driers

miscellaneous

| | | | |
|--------------------|--|-----------------|---------|
| GEV No. | 750311 | Ref. No. | 0145040 |
| description | dryer size 20g ø 19mm L 149mm connection 3,2/6,2mm | | |

| | | | |
|--------------------|--|-----------------|---------|
| GEV No. | 750310 | Ref. No. | 0145015 |
| description | dryer size 20g ø 19mm L 150mm connection 3.2/5/6.2mm | | |

evaporators

for fridges

producer-specific

| | | | |
|--------------------|--|-----------------|---------|
| GEV No. | 750621 | Ref. No. | 0119189 |
| description | evaporator for fridge L 390mm W 325mm IARP | | |

| | | | |
|--------------------|---|-----------------|---------|
| GEV No. | 750342 | Ref. No. | 0130010 |
| description | evaporator L 1580mm W 660mm suitable for AB500P | | |

condensors

condensors

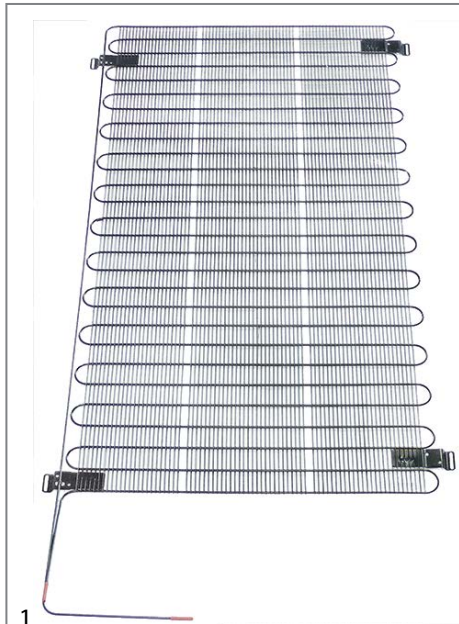

| | | | |
|--------------------|-----------------------------------|-----------------|----------|
| GEV No. | 750703 | Ref. No. | 44918000 |
| description | condenser W 790mm D 10mm H 1360mm | | |

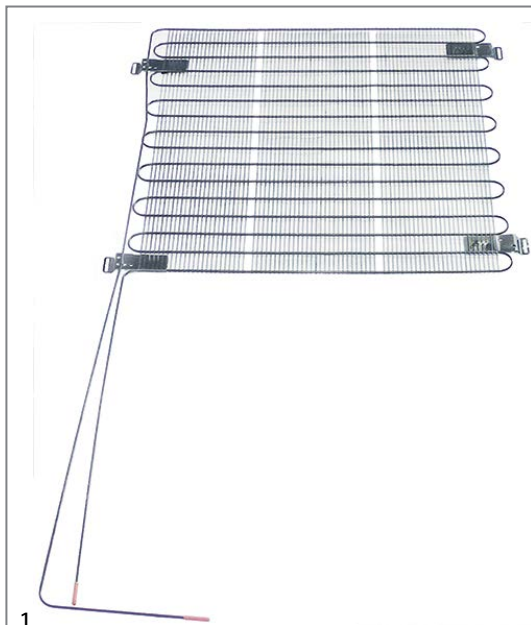

| | | | |
|--------------------|--|-----------------|----------|
| GEV No. | 750699 | Ref. No. | 45034000 |
| description | condenser W 790mm D 10mm H 750mm Qty 1 pcs | | |

evaporation and condensing trays

evaporation trays



| | | | |
|--------------------|---|-----------------|----------|
| GEV No. | 699211 | Ref. No. | I0425088 |
| description | evaporation tray L 230mm W 144mm H 45mm | | |

measuring equipment

thermometers

built-in thermometers



| | | | |
|--------------------|--|-----------------|--------------------|
| GEV No. | 541080 | Ref. No. | 0406018 3303276 |
| description | thermometer mounting measurements 58x25.5mm -40 up to +40°C capillary pipe 2500mm probe ø 6mm probe L 30mm | | |
| For models: | GAYA20-TOP-DOOR | | |

external power supply



| | | | |
|--------------------|--|-----------------|---------|
| GEV No. | 378274 ¹ | Ref. No. | 0406046 |
| description | thermometer ARTHERMO type ROF-DIG/230 mounting measurements 58x25.5mm front measurements 64x31mm 230V voltage AC -30 jusqu'à +110°C probe ø6x40mm cable length 2500mm display 3 digits | | |

¹incl. 1x NTC probe

fastening material

washers

washers

miscellaneous



| | | | |
|--------------------|--|-----------------|---------|
| GEV No. | 560486 | Ref. No. | 0521000 |
| description | plain washer ID ø 14.1mm ED ø 22mm thickness 2mm plastic Qty 1 pcs | | |
| For models: | GAYA20-TOP-DOOR | | |

| | | | |
|---|----|----|--|
| A | | | |
| axial fans | 11 | | |
| B | | | |
| ballasts | 6 | | |
| C | | | |
| cables | 14 | | |
| compressors | 9 | | |
| condensators & interference suppression filters | 13 | | |
| cross flow fans | 13 | | |
| D | | | |
| defrost timers | 7 | | |
| E | | | |
| electric accessories | 14 | | |
| electronic controllers | 8 | | |
| evaporators | 19 | | |
| F | | | |
| fans | 11 | | |
| fastening material | 20 | | |
| filter driers | 19 | | |
| fluorescent lamps | 6 | | |
| fuses | 14 | | |
| G | | | |
| grates | 16 | | |
| H | | | |
| heating cables | 3 | | |
| heating elements | 3 | | |
| heating elements for defrosting | 3 | | |
| heating elements for refrigeration | 3 | | |
| I | | | |
| indicator lights | 6 | | |
| indicator lights (complete) | 6 | | |
| L | | | |
| lamps | 6 | | |
| M | | | |
| measuring equipment | 20 | | |
| microswitches | 6 | | |
| P | | | |
| plug-in gaskets | 17 | | |
| power supply cables | 14 | | |
| probes | 8 | | |
| programme timers | 7 | | |
| push/momentary push switches | | 5 | |
| R | | | |
| refrigeration cycle components | | 19 | |
| refrigeration fans | | 12 | |
| refrigeration gaskets | | 17 | |
| refrigeration motors universal | | 12 | |
| refrigeration thermostats | | 3 | |
| relays | | 7 | |
| ribbon cables | | 14 | |
| rocker/momentary rocker switches | | 5 | |
| S | | | |
| shelves and shelf rails | | 16 | |
| solenoid valves | | 9 | |
| starting capacitors | | 13 | |
| switches and momentary switches | | 5 | |
| T | | | |
| temperature probes | | 8 | |
| terminal boxes | | 14 | |
| thermostats | | 3 | |
| timers | | 7 | |
| U | | | |
| universal probes | | 8 | |
| W | | | |
| washers | | 20 | |