



**GAS COMPONENTS**



**ELECTRIC COMPONENTS**



**WATER TECHNOLOGY**



**MECHANICAL COMPONENTS**



**TOOLS**

Spare parts suitable for

**HENKELMAN**

Find the complete and up-to-date range of products in our GEV Webshop



# Manufacturer catalogue

The most important spare parts and accessories arranged clearly for every manufacturer

- ✓ Complete product range and all appliance data always up to date in the GEV Webshop
- ✓ Alphabetical Index at the end of the catalogue

## GEV Webshop

[www.gev-online.co.uk](http://www.gev-online.co.uk)

[www.gev-online.com](http://www.gev-online.com)



- 🔍 Add to Favourites
- 🔍 Sign In with email address and usual password
- 🔍 Easy-order – place several items in your basket at the same time
- 🔍 Quick Item search – no login needed



## heating elements

### accessories

#### washers



<b>GEV No.</b>	560333	<b>Ref. No.</b>	0010026
<b>description</b>	plain washer ID ø 6.4mm ED ø 12mm thickness 1.6mm SS Qty 1 pcs DIN 125A for thread M6		
<b>For models:</b>	Boxer42, Boxer42XL, DT100, DT60, Falcon2-60, Falcon2-70, Falcon52, Falcon80, H220, H220-2, H220-A, H220-A-2, H300-1, H300-2, H300-A-1, H300-A-2, H300-AA, H300-RVS, H400-AA, H400-RVS, H500, H600, H700, H800, Lynx32, Lynx42, Marlin42XL, Marlin46, Marlin52, Marlin90, Polar2-40, Polar2-50, Polar2-75, Polar2-85, Polar2-95, Polar52, Polar80, Toucan42, Vortex		



<b>GEV No.</b>	560113	<b>Ref. No.</b>	0010026
<b>description</b>	plain washer ID ø 6.4mm ED ø 12mm thickness 1.6mm SS Qty 20 pcs DIN 125A for thread M6		

## switches and momentary switches

### rocker/momentary rocker switches

#### 28x13.5mm



<b>GEV No.</b>	347039	<b>Ref. No.</b>	0220010
<b>description</b>	rocker switch mounting measurements 27.4x12.4mm black/orange 2NO 250V 16A illuminated O connection male faston 6.3mm ambient temperature max. 100/55°C protection IP40		
<b>For models:</b>	JumboPlus, MiniJumbo		

### microswitches

#### lever actuated



<b>GEV No.</b>	347033	<b>Ref. No.</b>	0900461
<b>description</b>	microswitch with lever 250V 10A 1CO connection with cable L 38mm ambient temperature max. 85°C mounting distance 16mm actuating force: 60g lever length 40mm		
<b>For models:</b>	Polar2-40, Polar2-50, Polar2-75, Polar2-85, Polar2-95, Polar80		

<b>GEV No.</b>	347032	<b>Ref. No.</b>	0900460
<b>description</b>	microswitch with lever 250V 10A 1NO connection with cable L 40mm ambient temperature max. 85°C actuating force: 10g		
<b>For models:</b>	Falcon52, Falcon80, JumboPlus, Marlin46, Marlin90, MiniJumbo, Polar2-40, Polar2-50, Polar2-75, Polar2-85, Polar2-95, Polar52		

<b>GEV No.</b>	347035	<b>Ref. No.</b>	0900466
<b>description</b>	microswitch with lever 30V 1A 1CO connection with cable L 25mm ambient temperature max. 85°C type D2FW-G 271M actuating force: 80g lever length 21mm		
<b>For models:</b>	Falcon2-60, Falcon2-70, Polar2-40, Polar2-50, Polar2-75, Polar2-85, Polar2-95		

<b>GEV No.</b>	347034	<b>Ref. No.</b>	0900465
<b>description</b>	microswitch with lever 30V 1A 1NO connection with cable L 18mm ambient temperature max. 85°C type D2FW-G 271M actuating force: 100g lever length 25mm		
<b>For models:</b>	Boxer35, Boxer42, Boxer42XL, Boxer52, Boxer62, Falcon2-60, Falcon2-70, Falcon52, Falcon80, Jumbo30, Jumbo35, Jumbo42, Jumbo50, JumboPlus, Lynx32, Lynx42, Marlin42, Marlin42XL, Marlin46, Marlin52, Marlin90, MiniJumbo, Polar2-40, Polar2-50, Polar2-75, Polar2-85, Polar2-95, Polar52, Polar80, Toucan42		

### float switches

<b>GEV No.</b>	348087	<b>Ref. No.</b>	0220114
<b>description</b>	float switch length external size 110mm thread 1/8" 1NC/Temp ø 30mm L 110mm mounting ø 10mm 300V 0.5A cable, 4-wire cable length 1600mm with temperature probe		
<b>For models:</b>	DT100, DT60		

rotary switches

producer-specific rotary switches

DIHR / KROMO



<b>GEV No.</b>	345896	<b>Ref. No.</b>	0065736 0065788
<b>description</b>	O-ring EPDM thickness 1.5mm ID ø 37mm Qty 1 pcs		
<b>For models:</b>	Falcon2-60, Falcon2-70, Polar2-40, Polar2-50		

miscellaneous



<b>GEV No.</b>	347040	<b>Ref. No.</b>	0220060
<b>description</b>	rotary switch sets of contacts 3 2 0-1 momentary type 400V 32A shaft ø 5x5mm shaft Lmm connection screw		
<b>For models:</b>	Falcon2-60, Falcon52, Falcon80, Marlin46, Marlin52, Marlin90, Polar2-40, Polar2-50, Polar2-75, Polar2-85, Polar2-95, Polar52, Polar80		

accessories

levers



<b>GEV No.</b>	347041	<b>Ref. No.</b>	0220065
<b>description</b>	knob 2 0-1 typeVA shaft ømm shaft Lmm connection for rotary switch		
<b>For models:</b>	DT100, DT60, Falcon2-60, Falcon2-70, Falcon52, Falcon80, Marlin46, Marlin52, Marlin90, Polar2-40, Polar2-50, Polar2-75, Polar2-85, Polar2-95, Polar52, Polar80, Vortex		

control equipment

ABB

ø22mm

switches (complete)



<b>GEV No.</b>	347153	<b>Ref. No.</b>	0220006
<b>description</b>	push switch mounting measurements ø22mm black 2NO 300V 5A connection screw ambient temperature max. 85°C protection IP40		
<b>For models:</b>	Boxer35, Boxer42, Boxer42XL, Boxer52, Boxer62, Falcon2-60, Falcon2-70, Falcon52, Falcon80, Jumbo30, Jumbo35, Jumbo42, Jumbo42XL, Jumbo50, JumboPlus, Marlin42XL, Marlin46, Marlin52, Marlin90, MiniJumbo, Polar2-40, Polar2-50, Polar2-75, Polar2-85, Polar2-95, Polar52, Polar80, Toucan42, Vortex		

GEV special

ø22mm

switches (complete)



<b>GEV No.</b>	347036	<b>Ref. No.</b>	0220017
<b>description</b>	push switch mounting measurements ø22mm 2NO 230V main switch clear connection screw 6A protection IP40 ambient temperature max. 55°C		
<b>For models:</b>	DT100, DT60, H100, H150, H200, H200-2, H200-A, H200-A-2, H200-XL, H200-XL-2, H220, H220-2, H220-A, H220-A-2, H300-1, H300-2, H300-A-1, H300-A-2, H300-AA, H300-RVS, H400-AA, H400-RVS, H500, H600, H700, H800		

<b>accessories for</b>	347036	<b>GEV No.</b>	347038	<b>Ref. No.</b>	0220042
------------------------	--------	----------------	--------	-----------------	---------



protection cap for pressure switch

button plates



<b>GEV No.</b>	347038	<b>Ref. No.</b>	0220042
<b>description</b>	protection cap for pressure switch		
<b>For models:</b>	H100, H150, H200, H200-2, H200-A, H200-A-2, H200-XL, H200-XL-2, H220, H220-2, H220-A, H220-A-2, H300-1, H300-2, H300-A-1, H300-A-2, H300-AA, H300-RVS, H400-AA, H400-RVS, H500, H600, H700, H800		

miscellaneous



<b>GEV No.</b>	347037	<b>Ref. No.</b>	0220005
<b>description</b>	push switch mounting measurements ø22mm black 2NO 10A		
<b>For models:</b>	Boxer35, Boxer42, Boxer42XL, Falcon2-60, Falcon2-70, Falcon52, Falcon80, Jumbo35, Jumbo42, JumboPlus, Marlin42, Marlin42XL, Marlin46, Marlin52, Marlin90, MiniJumbo, Polar2-40, Polar2-50, Polar2-75, Polar2-85, Polar2-95, Polar52, Polar80		



contactors

LOVATO

power contactors



1

<b>GEV No.</b>	381102	<b>Ref. No.</b>	0221005 0221007
<b>description</b>	power contactor resistive load 20A 24VAC (AC3/400V) 9A/4kW main contacts 4NO auxiliary contacts connection screw connection type 11BG09T4A24		
<b>For models:</b>	Boxer35, Boxer42, Boxer42XL, Boxer52, Boxer62, H100, Jumbo42XL, Lynx32, Lynx42, Marlin42, Marlin42XL, Vortex		



1

<b>GEV No.</b>	380525	<b>Ref. No.</b>	0221108
<b>description</b>	power contactor resistive load 25A 230VAC (AC3/400V) 9A/4.2kW main contacts 4NO auxiliary contacts connection screw connection type BF09T4A230		
<b>For models:</b>	DT60, Marlin42XL		



1

<b>GEV No.</b>	381103	<b>Ref. No.</b>	0221006 0221106
<b>description</b>	power contactor resistive load 25A 24VAC (AC3/400V) 9A/4.2kW main contacts 4NO auxiliary contacts connection screw connection type BF09T4A024		
<b>For models:</b>	Falcon2-60, Falcon2-70, Falcon52, Falcon80, H100, H150, H200, H200-2, H200-A, H200-A-2, H200-XL, H200-XL-2, H220, H220-2, H220-A, H220-A-2, H300-1, H300-2, H300-A-1, H300-A-2, H300-AA, H300-RVS, H400-AA, H400-RVS, H500, H600, H700, H800, Marlin46, Marlin52, Marlin90, Polar2-40, Polar2-50, Polar2-75, Polar2-85, Polar2-95, Polar52, Polar80		

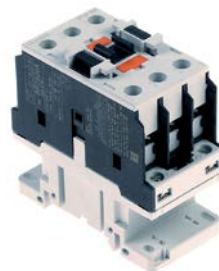

1

<b>GEV No.</b>	380722	<b>Ref. No.</b>	0221013
<b>description</b>	power contactor resistive load 56A 230VAC (AC3/400V) 32A/16kW main contacts 3NO auxiliary contacts connection screw connection type BF3200A230		
<b>For models:</b>	DT100, DT60		

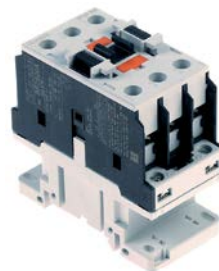

1

<b>GEV No.</b>	381104	<b>Ref. No.</b>	0221112
<b>description</b>	power contactor resistive load 56A 24VAC (AC3/400V) 32A/16kW main contacts 3NO auxiliary contacts connection screw connection type BF3200A024		
<b>For models:</b>	Polar2-75, Polar2-85, Polar2-95		

overload switches



1

<b>GEV No.</b>	381099	<b>Ref. No.</b>	0221133
<b>description</b>	overload switch setting range 13-18A for contactors BF (09-38) series connection screw		
<b>For models:</b>	Polar2-85, Polar2-95		



1

<b>GEV No.</b>	381100	<b>Ref. No.</b>	0221134
<b>description</b>	overload switch setting range 17-23A for contactors BF (09-38) series connection screw		



1

<b>GEV No.</b>	380753	<b>Ref. No.</b>	0221123
<b>description</b>	overload switch setting range 2.5-4A for contactors BF (09-38) series connection screw		



1

<b>GEV No.</b>	381101	<b>Ref. No.</b>	0221136
<b>description</b>	overload switch setting range 24-32A for contactors BF (09-38) series connection screw		
<b>For models:</b>	Polar2-95		



1

<b>GEV No.</b>	380754	<b>Ref. No.</b>	0221124
<b>description</b>	overload switch setting range 4-6.5A for contactors BF (09-38) series connection screw		
<b>For models:</b>	DT60, Falcon2-60, Falcon2-70, Falcon52, Falcon80, Marlin52, Marlin90, Polar2-40, Polar2-50, Polar52		



1

<b>GEV No.</b>	381097	<b>Ref. No.</b>	0221129
<b>description</b>	overload switch setting range 6.3-10A for contactors BF (09-38) series connection screw		
<b>For models:</b>	Polar2-40		



1

<b>GEV No.</b>	381098	<b>Ref. No.</b>	0221130
<b>description</b>	overload switch setting range 9-14A for contactors BF (09-38) series connection screw		

## transformers

### open transformers

#### with clamp terminal



1

<b>GEV No.</b>	403683	<b>Ref. No.</b>	0223017
<b>description</b>	transformer primary 220 secondary 10 500VA Mini Jumbo/ Jumbo35 / Boxer35		
<b>For models:</b>	JumboPlus, Lynx32, MiniJumbo		



1

<b>GEV No.</b>	403684	<b>Ref. No.</b>	0223019
<b>description</b>	transformer primary 220 secondary 15 700VA Boxer 42		
<b>For models:</b>	Boxer52, Lynx32, Lynx42		



1

<b>GEV No.</b>	402080	<b>Ref. No.</b>	0223026
<b>description</b>	transformer primary 220/380VAC secondary 0-20VAC 600VA connection screw connection 50/60Hz		
<b>For models:</b>	Falcon2-60, Marlin46, Marlin90		

1

<b>GEV No.</b>	402081	<b>Ref. No.</b>	0223032
<b>description</b>	transformer primary 220/380VAC secondary 0-21.4VAC 900VA connection screw connection 50/60Hz		
<b>For models:</b>	Falcon2-70, Falcon52, Falcon80, Jumbo50, Marlin52, Marlin90, Polar2-40, Polar2-50, Polar2-75, Polar2-85, Polar52, Polar80		



1

<b>GEV No.</b>	402083	<b>Ref. No.</b>	0223042
<b>description</b>	transformer primary 380/400VAC secondary 0-46VAC 1150VA connection screw connection 50/60Hz		
<b>For models:</b>	Polar2-95		



1

<b>GEV No.</b>	402086	<b>Ref. No.</b>	0223011 0223011001
<b>description</b>	transformer primary 230/400VAC secondary 0-9/0-24VAC 64.5VA connection screw 50/60Hz		
<b>For models:</b>	Boxer35, Boxer42, Boxer42XL, Boxer52, Boxer62, Falcon2-60, Falcon2-70, Falcon52, Falcon80, H100, H150, H200, H200-2, H200-A, H200-A-2, H200-XL, H200-XL-2, H220, H220-2, H220-A, H220-A-2, H300-1, H300-2, H300-A-1, H300-A-2, H300-AA, H300-RVS, H400-AA, H400-RVS, H500, H600, H700, H800, Jumbo30, Jumbo35, Jumbo42, JumboPlus, Lynx32, Lynx42, Marlin42, Marlin42XL, Marlin46, Marlin52, Marlin90, MiniJumbo, Polar2-40, Polar2-50, Polar2-75, Polar2-85, Polar2-95...(Other models you can see in the webshop)		

encapsulated transformers

multiple connections



1

<b>GEV No.</b>	402085	<b>Ref. No.</b>	0223004
<b>description</b>	transformer primary 230VAC secondary 24VAC 30VA secondary 1.25A connection male faston 6.3mm 50/60Hz type 65.16.230.323.224.05		
<b>For models:</b>	Jumbo30, Jumbo35, Jumbo42, Jumbo42XL, Jumbo50, JumboPlus, MiniJumbo		



1

<b>GEV No.</b>	402084	<b>Ref. No.</b>	0223049
<b>description</b>	transformer primary 380/400VAC secondary 0-24VAC 1150VA connection screw connection 50/60Hz		
<b>For models:</b>	Marlin90, Polar2-40, Polar2-50, Polar2-75		

electronics

PCBs



1

<b>GEV No.</b>	402000	<b>Ref. No.</b>	0230000
<b>description</b>	PCB suitable for JUMBO analog		
<b>For models:</b>	JumboPlus, MiniJumbo		



1

<b>GEV No.</b>	402082	<b>Ref. No.</b>	0223035
<b>description</b>	transformer primary 380/400VAC secondary 0-33,1VAC 1150VA connection screw connection 50/60Hz		
<b>For models:</b>	Falcon80, Polar2-75, Polar2-85, Polar2-95, Polar80		

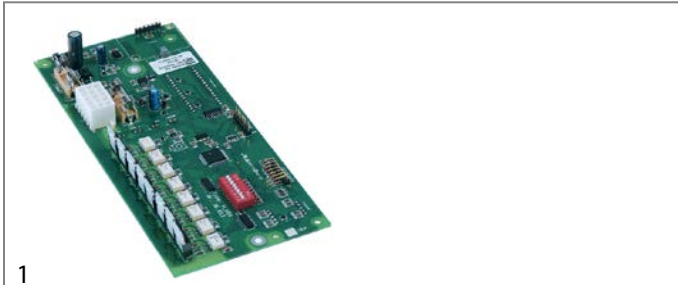

1			
<b>GEV No.</b>	402093	<b>Ref. No.</b>	0230020 0230040
<b>description</b>	PCB vacuum packing machine B35 / B-M 42/42XL H_HD4		
<b>For models:</b>	Boxer35, Boxer42, Boxer42XL, Boxer52, Boxer62, Falcon2-60, Falcon2-70, Falcon52, Falcon80, H100, H150, H200, H200-2, H200-A, H200-A-2, H200-XL, H200-XL-2, H220, H220-2, H220-A, H220-A-2, H300-1, H300-2, H300-A-1, H300-A-2, H300-AA, H300-RVS, H400-AA, H400-RVS, H500, H600, H700, H800, Marlin42, Marlin42XL, Marlin46, Marlin52, Marlin90, Polar2-40, Polar2-50, Polar2-75, Polar2-85, Polar2-95, Polar52, Polar80, Toucan42		

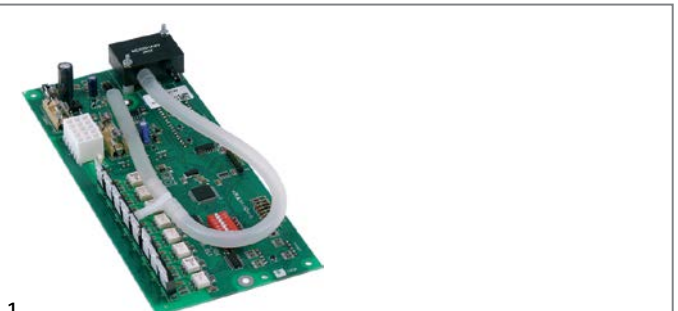

1			
<b>GEV No.</b>	402095	<b>Ref. No.</b>	0230042
<b>description</b>	PCB vacuum packing machine B35 / B-M 42/42XL H_HD4 with sensor		
<b>For models:</b>	Boxer35, Boxer42, Boxer42XL, Boxer52, Boxer62, Falcon2-60, Falcon2-70, Falcon52, Falcon80, Marlin42, Marlin42XL, Marlin46, Marlin52, Marlin90, Polar2-40, Polar2-50, Polar2-75, Polar2-85, Polar2-95, Polar52, Polar80, Toucan42		

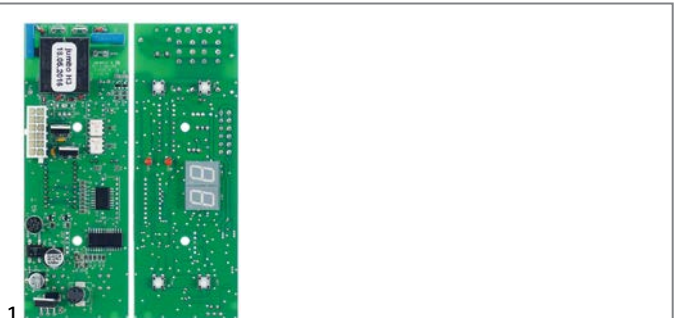

1			
<b>GEV No.</b>	402092	<b>Ref. No.</b>	0230036
<b>description</b>	PCB vacuum packing machine JUMBO		
<b>For models:</b>	Jumbo35, Jumbo42, Jumbo42XL, Jumbo50, JumboPlus, MiniJumbo		

## keypads

### membrane keypads



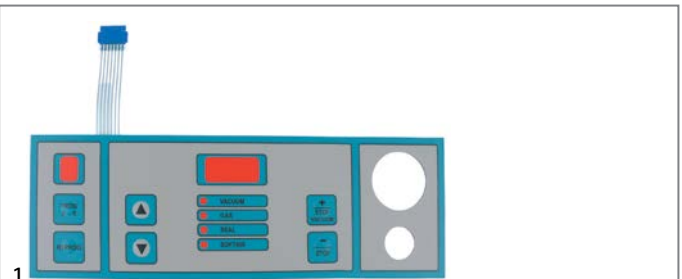

1			
<b>GEV No.</b>	402098	<b>Ref. No.</b>	0810018 0810052 + 0330110 0900102 8000400
<b>description</b>	membrane keypad vacuum packing machine B35-16 with frame		
<b>For models:</b>	H100, H150, H200, H200-2, H200-A, H200-A-2, H200-XL, H200-XL-2, H220, H220-2, H220-A, H220-A-2, H300-1, H300-2, H300-A-1, H300-A-2, H300-AA, H300-RVS, H400-AA, H400-RVS, H500, H600, H700, H800		



1			
<b>GEV No.</b>	402094	<b>Ref. No.</b>	0810050
<b>description</b>	membrane keypad vacuum packing machine H100		
<b>For models:</b>	H100, H150, H200, H200-2, H200-A, H200-A-2, H200-XL, H200-XL-2, H220, H220-2, H220-A, H220-A-2, H300-1, H300-2, H300-A-1, H300-A-2, H300-AA, H300-RVS, H400-AA, H400-RVS, H500, H600, H700, H800		



1			
<b>GEV No.</b>	402097	<b>Ref. No.</b>	0330105 0900101 8000102
<b>description</b>	membrane keypad vacuum packing machine JUMBO complete		
<b>For models:</b>	Jumbo35, Jumbo42, JumboPlus, MiniJumbo		

<b>spare parts for</b>	402097			
	<b>GEV No.</b>	347153	<b>Ref. No.</b>	0220006
	push switch mounting measurements ø22mm black 2NO 300V 5A connection screw ambient temperature max. 85°C protection IP40			
	<b>GEV No.</b>	402092	<b>Ref. No.</b>	0230036
	PCB vacuum packing machine JUMBO			
	<b>GEV No.</b>	541528	<b>Ref. No.</b>	0810101
	manometer ø 40mm pressure range 0 up to 1bar connection angled connection ø 5mm			







			
1			
<b>GEV No.</b>	402099	<b>Ref. No.</b>	0900104 8000401
<b>description</b>	membrane keypad vacuum packing machine with frame		

			
1			
<b>GEV No.</b>	402100	<b>Ref. No.</b>	0900105
<b>description</b>	membrane keypad vacuum packing machine with frame		
<b>For models:</b>	Falcon2-60, Falcon2-70, Falcon52, Falcon80, Marlin46, Marlin52, Marlin90, Polar2-40, Polar2-50, Polar2-85, Polar2-95, Polar52		

			
1			
<b>GEV No.</b>	402096	<b>Ref. No.</b>	0900100
<b>description</b>	membrane keypad with frame		
<b>For models:</b>	Jumbo30, Jumbo35, Jumbo42, Jumbo42XL, Jumbo50, JumboPlus, MiniJumbo		

control panel

			
1			
<b>GEV No.</b>	504870	<b>Ref. No.</b>	8001900
<b>description</b>	control panel vacuum packing machine H100 L 355mm grey H 155mm D 50mm		

			
1			
<b>GEV No.</b>	692175	<b>Ref. No.</b>	0330124 0600000
<b>description</b>	front panel vacuum packing machine JUMBO L 293mm W 91mm thickness 34mm analogue		
<b>For models:</b>	JumboPlus, MiniJumbo		

			
1			
<b>GEV No.</b>	692142	<b>Ref. No.</b>	0065110 0330120
<b>description</b>	housing vacuum packing machine 200/220		
<b>For models:</b>	Falcon2-60, Falcon2-70, Falcon52, Falcon80, H100, H150, H200, H200-2, H200-A, H200-A-2, H200-XL, H200-XL-2, H220, H220-2, H220-A, H220-A-2, H300-1, H300-2, H300-A-1, H300-A-2, H300-AA, H300-RVS, H400-AA, H400-RVS, H500, H600, H700, H800, Lynx32, Lynx42, Polar2-40, Polar2-50, Polar2-75, Polar2-85, Polar2-95, Polar52, Polar80, Vortex		

			
1			
<b>GEV No.</b>	692068	<b>Ref. No.</b>	0600020 0600020000
<b>description</b>	switch panel vacuum packing machine JUMBO Combivac L 258mm W 55mm thickness 2.3mm		

			
1			
<b>GEV No.</b>	692069	<b>Ref. No.</b>	0600011 0600011000
<b>description</b>	switch panel vacuum packing machine JUMBO L 288mm W 88mm thickness 20mm digital		

			
1			
<b>GEV No.</b>	692168	<b>Ref. No.</b>	8000100
<b>description</b>	switch panel vacuum packing machine JUMBO L 289mm W 91mm thickness 20mm		



## solenoid valves

## solenoid valves (water)

metal

ASCO

2-way



1

<b>GEV No.</b>	370509	<b>Ref. No.</b>	0280040 0280042
<b>description</b>	solenoid valve 2-ways 24VAC inlet 1/2" outlet 1/2" connection 1/2" L 52mm DN 12.5mm slide-on receptacle DIN -20° up to 85°C membranes NBR (water) p max 7bar 1/2" brass		
<b>For models:</b>	Boxer62, Falcon2-60, Falcon2-70, Falcon52, Falcon80, H300-1, H300-2, H300-A-1, H300-A-2, H300-AA, H300-RVS, H400-AA, H400-RVS, H500, H600, H700, H800, Marlin46, Marlin52, Marlin90, Polar2-40, Polar2-50, Polar2-75, Polar2-85, Polar2-95, Polar52, Polar80, Vortex		

3-way



1

<b>GEV No.</b>	370510	<b>Ref. No.</b>	0280052
<b>description</b>	solenoid valve brass 3-ways 24VAC connection 1/4" L 43mm DN 4.4mm -20 up to +90°C membranes NBR (water) p max 3bar p min 0bar 1/4"		
<b>For models:</b>	Falcon2-60, Falcon2-70, Falcon80, Polar2-40, Polar2-50, Polar2-75, Polar2-85, Polar2-95, Polar52, Polar80		

## Solenoid valve - accessories



1

<b>GEV No.</b>	370516	<b>Ref. No.</b>	0280072
<b>description</b>	nut thread M8x0.75 for solenoid coil		
<b>For models:</b>	Boxer35, Boxer42, Boxer42XL, Boxer42XL-BA, Jumbo35, Jumbo42, JumboPlus, MiniJumbo		



1

<b>GEV No.</b>	370515	<b>Ref. No.</b>	0280071
<b>description</b>	solenoid coil 24V voltage AC seat ø 9mm		
<b>For models:</b>	Boxer35, Boxer42, Boxer42XL, Boxer42XL-BA, H300-1, H300-2, H300-A-1, H300-A-2, H300-AA, H300-RVS, H800, Jumbo35, Jumbo42, JumboPlus, Lynx32, Lynx42, Marlin52, MiniJumbo, Polar2-75, Polar2-85, Polar2-95		



1

<b>GEV No.</b>	370508	<b>Ref. No.</b>	0280024
<b>description</b>	solenoid coil 3-way 24V 6mm		
<b>For models:</b>	JumboPlus, MiniJumbo		



1

<b>GEV No.</b>	370517	<b>Ref. No.</b>	0280075
<b>description</b>	solenoid valve body nominal dimension 2.8mm		
<b>For models:</b>	Boxer35, Boxer42, Boxer42XL, Boxer42XL-BA, JumboPlus, MiniJumbo		



1

<b>GEV No.</b>	370519	<b>Ref. No.</b>	0280080
<b>description</b>	solenoid valve body nominal dimension 2.8mm		
<b>For models:</b>	Boxer35, Boxer42, Boxer42XL, Boxer42XL-BA, Jumbo35, Jumbo42, JumboPlus, MiniJumbo		





1

<b>GEV No.</b>	370518	<b>Ref. No.</b>	0280078
<b>description</b>	solenoid valve body nominal dimension 6mm		
<b>For models:</b>	Boxer35, Boxer42, Boxer42XL, Boxer42XL-BA, Jumbo35, Jumbo42, Lynx32, Lynx42		

## solenoid valves for vacuum machines

			
1			
<b>GEV No.</b>	370520	<b>Ref. No.</b>	0900858
<b>description</b>	solenoid valve 2-way 24VACV inlet 1/4"mm outlet ø4 vacuum packing machine		

			
1			
<b>GEV No.</b>	370507	<b>Ref. No.</b>	0280021
<b>description</b>	solenoid valve 2-ways 24VAC inlet 1/8" outlet 1/8"mm L 31mm DN 3.3mm 1/8" brass		
<b>For models:</b>	Boxer35, Boxer42, Boxer42XL, Falcon2-60, Falcon2-70, Falcon52, Falcon80, H100, Lynx32, Lynx42, Marlin42, Marlin42XL, Marlin46, Marlin52, Marlin90, Polar2-40, Polar2-50, Polar2-75, Polar2-85, Polar2-95, Polar52, Polar80, Toucan42		

			
1			
<b>GEV No.</b>	370506	<b>Ref. No.</b>	0280010
<b>description</b>	solenoid valve 3-ways 24VAC inlet 1/8" outlet 1/8"mm L 35mm body inner cone DN 2.8mm 1/8" 24V brass		
<b>For models:</b>	Falcon52, H300-A-1, H300-A-2, H300-AA, H300-RVS, H500, H700, Marlin46, Marlin52, Marlin90		

			
1			
<b>GEV No.</b>	370514	<b>Ref. No.</b>	0280029
<b>description</b>	solenoid valve assembly 24VAC inlet 1/2" 3 coils coil type VA12 24V thread 1/2" hose ø 21mm H200+SA		
<b>For models:</b>	Boxer35		

			
1			
<b>GEV No.</b>	370513	<b>Ref. No.</b>	0280027
<b>description</b>	solenoid valve assembly 24VAC inlet 1/2" outlet 10.5mm 2 coils coil type VA12 thread 1/2" JP		
<b>For models:</b>	JumboPlus		

			
1			
<b>GEV No.</b>	370800	<b>Ref. No.</b>	0280035
<b>description</b>	solenoid valve assembly 24VAC inlet 1/2" outlet 10.5mm 2 coils coil type VA12 thread 1/2" JP		

			
1			
<b>GEV No.</b>	370512	<b>Ref. No.</b>	0280026 (old version)
<b>description</b>	solenoid valve assembly 24VAC inlet 1/2" outlet 21mm 2 coils coil type VA12 24V thread 1/2" hose ø 21mm J35/J42/B35		

			
1			
<b>GEV No.</b>	370816	<b>Ref. No.</b>	0280026
<b>description</b>	solenoid valve assembly 24VAC inlet 1/2" outlet 21mm 2 coils coil type VA12 24V thread 1/2" hose ø 21mm J35/J42/B35		
<b>For models:</b>	Boxer35, Boxer42, Boxer42XL, H100, Jumbo35, Jumbo42, Marlin42, Marlin42XL		

			
1			
<b>GEV No.</b>	370511	<b>Ref. No.</b>	0280025
<b>description</b>	solenoid valve assembly 24VAC inlet 1/2" outlet 7.5mm 2 coils coil type VA12 thread 1/2" MJ		
<b>For models:</b>	JumboPlus, MiniJumbo		

			
1			
<b>GEV No.</b>	370787	<b>Ref. No.</b>	0280039
<b>description</b>	solenoid valve assembly 24VAC inlet 1/2" outlet 7.5mm 2 coils coil type VA12 thread 1/2" MJ		

			
1			
<b>GEV No.</b>	370503	<b>Ref. No.</b>	0900833
<b>description</b>	solenoid valve assembly thread 1/2" hose ø 21mm 24V coil type VA12 J42		

			
1			
<b>GEV No.</b>	370505	<b>Ref. No.</b>	0900836
<b>description</b>	solenoid valve assembly 3 coils 24V thread 1/2" hose ø 21mm coil type VA12 B42(XL)+SA		

			
1			
<b>GEV No.</b>	692064	<b>Ref. No.</b>	0280032 0280032000
<b>description</b>	solenoid valve assembly thread 1/2" hose ø 6mm 24V H200		
<b>For models:</b>	H100, H150, H200, H200-2, H200-A, H200-A-2, H200-XL, H200-XL-2, H220, H220-2, H220-A, H220-A-2		

			
1			
<b>GEV No.</b>	370501	<b>Ref. No.</b>	0900831
<b>description</b>	solenoid valve assembly thread 1/2" hose ø 10mm 24V coil type VA12 JP		

			
1			
<b>GEV No.</b>	370500	<b>Ref. No.</b>	0900830
<b>description</b>	solenoid valve assembly thread 1/2" hose ø 7.5mm 24V coil type VA12 MJ		

			
1			
<b>GEV No.</b>	370504	<b>Ref. No.</b>	0900835
<b>description</b>	solenoid valve assembly thread 1/2" hose ø 21mm 24V coil type VA12 B35+SA 3 coils		

			
1			
<b>GEV No.</b>	370502	<b>Ref. No.</b>	0900832
<b>description</b>	solenoid valve assembly thread 1/2" hose ø 21mm 24V coil type VA12 J35		

## fans

### hot air motors

			
1			
<b>GEV No.</b>	601497	<b>Ref. No.</b>	0939130
<b>description</b>	fan wheel for motor cooling ø 206mm		

pumps

vacuum pumps

vacuum pumps



1

<b>GEV No.</b>	500990	<b>Ref. No.</b>	0431600 0431600001
<b>description</b>	vacuum pump 16m <sup>3</sup> /h 230V 0.55kW 50Hz type KB 0016 E 3Z0		
<b>For models:</b>	Boxer35, Jumbo35, Jumbo42, Jumbo42XL, Jumbo50, Lynx42		
<b>spare parts for</b>	500990		
	<b>GEV No.</b>	691537	<b>Ref. No.</b> 0939003 0939163
oil separator filter flow rate 16m <sup>3</sup> /h ø 52mm L 120mm			



1

<b>GEV No.</b>	500987	<b>Ref. No.</b>	0430100 0430130 0430130000
<b>description</b>	vacuum pump 4m <sup>3</sup> /h 230V 0.1kW 50Hz type PB 0004 B 000		
<b>For models:</b>	MiniJumbo		
<b>spare parts for</b>	500987		
	<b>GEV No.</b>	500988	<b>Ref. No.</b> 0438010
level glass thread 1/2" plastic			



1

<b>GEV No.</b>	499006	<b>Ref. No.</b>	0431300 old version 04313000
<b>description</b>	vacuum pump 8m <sup>3</sup> /h 220/240V 0.35kW 50/60Hz type PB0008		
<b>For models:</b>	Jumbo30		



1

<b>GEV No.</b>	499346	<b>Ref. No.</b>	0431300
<b>description</b>	vacuum pump 8m <sup>3</sup> /h 220-240V 0.55/0.66kW 50/60Hz type J21TV513		
<b>For models:</b>	JumboPlus, Lynx32		

rotor vanes



1

<b>GEV No.</b>	691992	<b>Ref. No.</b>	0939056
<b>description</b>	rotor vane for vacuum pumps L 20mm W 14mm H 3mm		

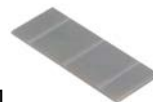

1

<b>GEV No.</b>	691585	<b>Ref. No.</b>	0939065
<b>description</b>	rotor vane L 100mm W 40mm H 4mm		



1

<b>GEV No.</b>	692070	<b>Ref. No.</b>	0939054 0939054000
<b>description</b>	rotor vane L 28mm W 14mm H 3mm		



1

<b>GEV No.</b>	691584	<b>Ref. No.</b>	0939060
<b>description</b>	rotor vane L 70mm W 18mm H 4mm		

level glasses



1

<b>GEV No.</b>	691563	<b>Ref. No.</b>	0438015
<b>description</b>	level glass thread 1"		
<b>For models:</b>	H800, Polar2-75, Polar2-85, Polar2-95		





1

<b>GEV No.</b>	691561	<b>Ref. No.</b>	0438000
<b>description</b>	level glass thread 1/2"		
<b>For models:</b>	H220, H220-2, H220-A, H220-A-2, MiniJumbo		



1

<b>GEV No.</b>	500988	<b>Ref. No.</b>	0438010
<b>description</b>	level glass thread 1/2" plastic		
<b>For models:</b>	JumboPlus, MiniJumbo		



1

<b>GEV No.</b>	691562	<b>Ref. No.</b>	0438005
<b>description</b>	level glass thread 3/4"		
<b>For models:</b>	Boxer35, Boxer42, Boxer42XL, Boxer62, Falcon2-60, Falcon2-70, Falcon52, Falcon80, H300-1, H300-2, H300-A-1, H300-A-2, H300-AA, H300-RVS, H400-AA, H400-RVS, H600, Jumbo35, Jumbo42, Jumbo50, Lynx42, Marlin42, Marlin42XL, Marlin46, Marlin52, Marlin90, Polar2-40, Polar2-50, Polar52, Polar80		

## electric accessories

### terminals and connectors

#### not insulated

#### male fastons



1

<b>GEV No.</b>	699267	<b>Ref. No.</b>	0200090
<b>description</b>	male faston size 6.3mm with bore brass hole ø 4mmmm		
<b>For models:</b>	Boxer35, Boxer42, Boxer42XL, Boxer42XL-BA, Boxer52, Boxer62, H100, H150, H200, H200-2, H200-A, H200-A-2, H200-XL, H200-XL-2, H220, H220-2, H220-A, H220-A-2, H300-1, H300-2, H300-A-1, H300-A-2, H300-AA, H300-RVS, H400-AA, H400-RVS, H500, H600, H700, H800, Jumbo30, Jumbo35, Jumbo42, Jumbo42XL, Jumbo50, JumboPlus, Lynx32, Lynx42, Marlin42, Marlin42XL, Marlin46, Marlin52, Marlin90, MiniJumbo		

## electronic components

### software

#### service sets



Image not available

1

<b>GEV No.</b>	401862	<b>Ref. No.</b>	0940306
<b>description</b>	service kit suitable for Henkelman Max Falcon/Polar		



Image not available

1

<b>GEV No.</b>	401858	<b>Ref. No.</b>	0940302
<b>description</b>	service kit suitable for Henkelman Max Jumbo/Boxer		



Image not available

1

<b>GEV No.</b>	401860	<b>Ref. No.</b>	0940304
<b>description</b>	service kit suitable for Henkelman Max Marlin/Falcon/Polar		



Image not available

1

<b>GEV No.</b>	401861	<b>Ref. No.</b>	0940305
<b>description</b>	service kit suitable for Henkelman Min Falcon/Polar		



Image not available

1

<b>GEV No.</b>	401857	<b>Ref. No.</b>	0940301
<b>description</b>	service kit suitable for Henkelman Min Jumbo/Boxer		



 <p>Image not available</p>			
1			
<b>GEV No.</b>	401859	<b>Ref. No.</b>	0940303
<b>description</b>	service kit suitable for Henkelman Min Marlin/Falcon/Polar		

## equipment-specific units

### for vacuum packers



#### connection pieces

			
1			
<b>GEV No.</b>	699264	<b>Ref. No.</b>	0262200
<b>description</b>	connecting fitting L 71mm 2" hose ø 50mm WS 55		
<b>For models:</b>	H800, Polar2-75, Polar2-85, Polar2-95		

#### air valves

			
1			
<b>GEV No.</b>	691551	<b>Ref. No.</b>	0281005
<b>description</b>	air valve connection 1" 24VAC		
<b>For models:</b>	Falcon2-60, Falcon2-70, Falcon80, H300-1, H300-2, H300-A-1, H300-A-2, H300-AA, H300-RVS, H500, H600, H700, Marlin46, Marlin52, Marlin90, Polar2-40, Polar2-50, Polar52, Polar80		

			
1			
<b>GEV No.</b>	691555	<b>Ref. No.</b>	0900852
<b>description</b>	air valve connection 1 1/4"		

			
1			
<b>GEV No.</b>	691553	<b>Ref. No.</b>	0281025
<b>description</b>	air valve connection 2"		
<b>For models:</b>	H800, Polar2-75, Polar2-85, Polar2-95		
<b>spare parts for</b>	691553		
	<b>GEV No.</b>	691573	<b>Ref. No.</b>
			0931205
	maintenance set for air valve size 2"		

#### lids

			
1			
<b>GEV No.</b>	692242	<b>Ref. No.</b>	0600100
<b>description</b>	lid L 378mm W 315mm H 20mm JUMBO		
<b>For models:</b>	JumboPlus, MiniJumbo		

			
1			
<b>GEV No.</b>	691586	<b>Ref. No.</b>	0900738
<b>description</b>	lid L 670mm W 670mm H 300 II		

			
1			
<b>GEV No.</b>	692062	<b>Ref. No.</b>	0620010 0620010000 0620011
<b>description</b>	lid with gasket L 475mm W 460mm H 75mm B42/J42/H-200		
<b>For models:</b>	Boxer42, H200, H200-2, H200-A, H200-A-2, H220, H220-2, H220-A, H220-A-2, Jumbo42, Marlin42		

air cylinders

air cylinders



1

<b>GEV No.</b>	691547	<b>Ref. No.</b>	0286015
<b>description</b>	air cylinder ø 110mm H 47mm shaft length 29mm		
<b>For models:</b>	H300-1, H300-2, H300-A-1, H300-A-2, Jumbo50, Marlin46, Marlin52		



1

<b>GEV No.</b>	691548	<b>Ref. No.</b>	0286017
<b>description</b>	air cylinder ø 110mm H 47mm shaft length 29mm		
<b>For models:</b>	Boxer42XLBA, Marlin52, Toucan42		



1

<b>GEV No.</b>	691549	<b>Ref. No.</b>	0286020
<b>description</b>	air cylinder ø 110mm shaft length 47mm		
<b>For models:</b>	Marlin46, Marlin90		



1

<b>GEV No.</b>	691544	<b>Ref. No.</b>	0286000
<b>description</b>	air cylinder ø 50mm H 25mm		
<b>For models:</b>	JumboPlus, MiniJumbo		

EQUIPMENT-SPECIFIC UNITS HENKELMAN



1

<b>GEV No.</b>	691545	<b>Ref. No.</b>	0286005
<b>description</b>	air cylinder ø 80mm H 30mm		
<b>For models:</b>	JumboPlus, MiniJumbo		



1

<b>GEV No.</b>	691546	<b>Ref. No.</b>	0286010
<b>description</b>	air cylinder ø 80mm H 48mm		
<b>For models:</b>	Boxer42, Boxer42XL, Boxer42XL-BA, H200, H200-2, H200-A, H200-A-2, H200-XL, H200-XL-2, H220, H220-2, H220-A, H220-A-2, Jumbo42, Jumbo42XL, Marlin42, Marlin42XL, Marlin90, Toucan42		

**spare parts for** 691546

<b>GEV No.</b>	691581	<b>Ref. No.</b>	0931405
	membrane ø 80mm H 24mm		

accessories



1

<b>GEV No.</b>	699265	<b>Ref. No.</b>	0287050 0330162
<b>description</b>	nut ø 44mm H 10mm ID ø 22.5mm		
<b>For models:</b>	Boxer35, Boxer42, Boxer42XL, Boxer52, H100, H150, H200, H200-2, H200-A, H200-A-2, H200-XL, H200-XL-2, H220, H220-2, H220-A, H220-A-2, H300-1, H300-2, H300-A-1, H300-A-2, Jumbo30, Jumbo35, Jumbo42, Jumbo42XL, Jumbo50, JumboPlus, Marlin42, Marlin42XL, Marlin46, Marlin52, Marlin90, MiniJumbo		



1

<b>GEV No.</b>	699266	<b>Ref. No.</b>	0287030
<b>description</b>	valve support ø 58mm H 8mm ID ø 25mm		
<b>For models:</b>	Boxer42, Boxer42XL, Boxer42XL-BA, Falcon2-60, Falcon2-70, Falcon80, H100, H150, H200, H200-2, H200-A, H200-A-2, H200-XL, H200-XL-2, H220, H220-2, H220-A, H220-A-2, H300-1, H300-2, H300-A-1, H300-A-2, H300-AA, H300-RVS, Jumbo42, Marlin42, Marlin42XL, Marlin46, Marlin52, Marlin90, Polar2-40, Polar2-50, Polar2-75, Polar2-85, Polar2-95, Polar52, Polar80, Toucan42		

### insert plates



1

<b>GEV No.</b>	692063	<b>Ref. No.</b>	0307050 0307050000
<b>description</b>	insert plate L 740mm W 490mm thickness 20mm F80 KL		
<b>For models:</b>	Falcon80, Polar80		

### rubber bumper



1

<b>GEV No.</b>	691570	<b>Ref. No.</b>	0940205 094020500
<b>description</b>	rubber pad type H200		



1

<b>GEV No.</b>	691571	<b>Ref. No.</b>	0940210
<b>description</b>	rubber pad type H300		



1

<b>GEV No.</b>	691569	<b>Ref. No.</b>	0940203
<b>description</b>	rubber pad type JUMBO		

### oil separator filters

#### with thread



1

<b>GEV No.</b>	691534	<b>Ref. No.</b>	0939000 0939160
<b>description</b>	oil separator filter flow rate 4m <sup>3</sup> /h ø 35mm L 52mm thread 3/8"		
<b>For models:</b>	MiniJumbo		



1

<b>GEV No.</b>	691954	<b>Ref. No.</b>	0939162
<b>description</b>	oil separator filter flow rate 8m <sup>3</sup> /h ø 35mm L 85mm thread 3/8"		
<b>For models:</b>	Jumbo30, JumboPlus, Lynx32		



1

<b>GEV No.</b>	691536	<b>Ref. No.</b>	0939001 0939161
<b>description</b>	oil separator filter flow rate 8m <sup>3</sup> /h ø 40mm L 70mm thread 1/2"		
<b>For models:</b>	JumboPlus		

#### without thread



1

<b>GEV No.</b>	691540	<b>Ref. No.</b>	0939010 0939170
<b>description</b>	oil separator filter flow rate 100m <sup>3</sup> /h ø 72mm L 248mm		
<b>For models:</b>	Falcon2-60, Falcon2-70, Falcon52, Falcon80, Marlin42XL, Marlin46, Marlin52, Marlin90, Polar2-40, Polar2-50, Polar52, Polar80		



air cushions



1	<b>GEV No.</b>	572001	<b>Ref. No.</b>	0301310
	<b>description</b>	air cushion L 310mm W 85mm		
	<b>For models:</b>	H500		



1	<b>GEV No.</b>	572002	<b>Ref. No.</b>	0301330
	<b>description</b>	air cushion L 330mm W 85mm		



1	<b>GEV No.</b>	572003	<b>Ref. No.</b>	0301370
	<b>description</b>	air cushion L 370mm W 85mm		
	<b>For models:</b>	Falcon52, H300-AA, H300-RVS, Polar52		



1	<b>GEV No.</b>	572004	<b>Ref. No.</b>	0301390
	<b>description</b>	air cushion L 390mm W 85mm		
	<b>For models:</b>	Falcon2-60		



1	<b>GEV No.</b>	691541	<b>Ref. No.</b>	0939015 0939175
	<b>description</b>	oil separator filter flow rate 160m <sup>3</sup> /h ø 72mm L 375mm		
	<b>For models:</b>	Polar2-75, Polar2-85, Polar2-95		



1	<b>GEV No.</b>	691537	<b>Ref. No.</b>	0939003 0939163
	<b>description</b>	oil separator filter flow rate 16m <sup>3</sup> /h ø 52mm L 120mm		
	<b>For models:</b>	Boxer35, Boxer62, Jumbo35, Jumbo42, Jumbo42XL, Jumbo50, Lynx42		



1	<b>GEV No.</b>	691538	<b>Ref. No.</b>	0939005 0939165
	<b>description</b>	oil separator filter flow rate 21m <sup>3</sup> /h ø 72mm L 128mm		
	<b>For models:</b>	Boxer35, Boxer42, Boxer42XL, Boxer52, H100, Marlin42, Marlin42XL, Toucan42, Vortex		



1	<b>GEV No.</b>	691539	<b>Ref. No.</b>	0939011 0939171
	<b>description</b>	oil separator filter flow rate 63m <sup>3</sup> /h ø 72mm L 206mm		
	<b>For models:</b>	Falcon2-60, Falcon52, Marlin42XL, Marlin46, Marlin52, Marlin90, Polar2-40, Polar2-50, Polar52		





1

<b>GEV No.</b>	572005	<b>Ref. No.</b>	0301410
<b>description</b>	air cushion L 410mm W 85mm		
<b>For models:</b>	Falcon80, Polar80		



1

<b>GEV No.</b>	572008	<b>Ref. No.</b>	0301550
<b>description</b>	air cushion L 550mm W 85mm		



1

<b>GEV No.</b>	572006	<b>Ref. No.</b>	0301440
<b>description</b>	air cushion L 440mm W 85mm		
<b>For models:</b>	Falcon52, Polar52		



1

<b>GEV No.</b>	572009	<b>Ref. No.</b>	0301580
<b>description</b>	air cushion L 580mm W 85mm		
<b>For models:</b>	H600, Polar2-40, Polar2-50, Polar2-75		



1

<b>GEV No.</b>	572007	<b>Ref. No.</b>	0301490
<b>description</b>	air cushion L 490mm W 85mm		
<b>For models:</b>	Falcon2-60, Falcon2-70, Falcon80, Polar80		



1

<b>GEV No.</b>	572010	<b>Ref. No.</b>	0301620 0301640
<b>description</b>	air cushion L 620mm W 85mm		
<b>For models:</b>	Polar2-40, Polar2-50, Polar2-75		



1

<b>GEV No.</b>	572011	<b>Ref. No.</b>	0301660
<b>description</b>	air cushion L 660mm W 85mm		
<b>For models:</b>	H400-AA, H400-RVS, H700		



1

<b>GEV No.</b>	572015	<b>Ref. No.</b>	0301860
<b>description</b>	air cushion L 860mm W 85mm		
<b>For models:</b>	Polar2-85		



1

<b>GEV No.</b>	572012	<b>Ref. No.</b>	0301740
<b>description</b>	air cushion L 740mm W 85mm		
<b>For models:</b>	Falcon80, Polar2-75, Polar2-85, Polar80		

membranes



1

<b>GEV No.</b>	691582	<b>Ref. No.</b>	0931410
<b>description</b>	membrane ø 110mm H 34mm		
<b>For models:</b>	H300-1, H300-2, H300-A-1, H300-A-2, H300-AA, H300-RVS, Marlin46, Marlin52, Marlin90		



1

<b>GEV No.</b>	572013	<b>Ref. No.</b>	0301800
<b>description</b>	air cushion L 800mm W 85mm		
<b>For models:</b>	Polar2-95		



1

<b>GEV No.</b>	691579	<b>Ref. No.</b>	0931226
<b>description</b>	membrane ø 48mm H 5mm		
<b>For models:</b>	H300-1, H300-2, H300-A-1, H300-A-2, H300-AA, H300-RVS, Marlin52		



1

<b>GEV No.</b>	691580	<b>Ref. No.</b>	0931400
<b>description</b>	membrane ø 50mm H 19mm		
<b>For models:</b>	Boxer35, H300-1, H300-2, H300-A-1, H300-A-2, H300-AA, H300-RVS, Jumbo35, Marlin52		



1

<b>GEV No.</b>	572014	<b>Ref. No.</b>	0301850
<b>description</b>	air cushion L 850mm W 85mm		
<b>For models:</b>	H800		



1

<b>GEV No.</b>	691581	<b>Ref. No.</b>	0931405
<b>description</b>	membrane ø 80mm H 24mm		
<b>For models:</b>	Boxer42, Boxer42XL, Boxer42XL-BA, H200, H200-2, H200-A, H200-A-2, H200-XL, H200-XL-2, H220, H220-2, H220-A, H220-A-2, Jumbo42, Lynx32, Lynx42, Marlin42, Marlin42XL, Polar2-75, Polar2-85, Polar2-95		



1

<b>GEV No.</b>	691578	<b>Ref. No.</b>	0931206
<b>description</b>	membrane ø 90mm H 1mm		
<b>For models:</b>	H800, Polar2-75, Polar2-85, Polar2-95		

## oils



1

<b>GEV No.</b>	890296	<b>Ref. No.</b>	0439510
<b>description</b>	oil type V32 1l for vacuum packing machine		
<b>For models:</b>	Lynx32, Lynx42		



1

<b>GEV No.</b>	890253	<b>Ref. No.</b>	0439520
<b>description</b>	oil type VM100 1l for vacuum packing machine		



1

<b>GEV No.</b>	890247	<b>Ref. No.</b>	0439500
<b>description</b>	oil type VM22 0.05l for vacuum packing machine		
<b>For models:</b>	MiniJumbo		



1

<b>GEV No.</b>	890248	<b>Ref. No.</b>	0439501
<b>description</b>	oil type VM22 1l for vacuum packing machine		



1

<b>GEV No.</b>	890200	<b>Ref. No.</b>	0439502
<b>description</b>	oil type VM32 0.25l for vacuum packing machine		
<b>For models:</b>	JumboPlus, Lynx32		



1

<b>GEV No.</b>	890250	<b>Ref. No.</b>	0439503
<b>description</b>	oil type VM32 0.3l for vacuum packing machine		
<b>For models:</b>	Lynx42		



1

<b>GEV No.</b>	890251	<b>Ref. No.</b>	0439505
<b>description</b>	oil type VM32 0.5l for vacuum packing machine		



1

<b>GEV No.</b>	890252	<b>Ref. No.</b>	0439510 old version
<b>description</b>	oil type VM32 1l for vacuum packing machine		

oil filter



1

<b>GEV No.</b>	691543	<b>Ref. No.</b>	0939091
<b>description</b>	oil filter size 160-300		
<b>For models:</b>	H800, Polar2-75, Polar2-85, Polar2-95		



1

<b>GEV No.</b>	691542	<b>Ref. No.</b>	0939090
<b>description</b>	oil filter size 63-100 ø 78mm L 78mm		
<b>For models:</b>	Falcon2-60, Falcon2-70, Falcon52, Falcon80, Marlin42XL, Marlin46, Marlin52, Marlin90, Polar2-40, Polar52, Polar80		

PTFE tapes



1

<b>GEV No.</b>	691526	<b>Ref. No.</b>	0305505
<b>description</b>	PTFE tape W 15mm thickness 0.25mm Qty supplied by meter		
<b>For models:</b>	Boxer35, Boxer42, Boxer42XL, Boxer42XL-BA, Falcon2-60, Falcon2-70, Falcon52, Falcon80, Jumbo35, Jumbo42, Marlin42, Marlin42XL, Marlin46, Marlin52, Marlin90, Polar2-40, Polar2-50, Polar2-75, Polar2-85, Polar2-95, Polar52, Polar80		



1

<b>GEV No.</b>	691953	<b>Ref. No.</b>	0305513
<b>description</b>	PTFE tape W 46mm		
<b>For models:</b>	Lynx32, Lynx42		



1

<b>GEV No.</b>	693842	<b>Ref. No.</b>	0305015 0305510 0305515 030551500
<b>description</b>	PTFE tape W 46mm thickness 0.1mm Qty supplied by meter		
<b>For models:</b>	Boxer35, Boxer42, Boxer42XL, Falcon2-60, Falcon2-70, Falcon52, Falcon80, H100, H150, H200, H200-2, H200-A, H200-A-2, H200-XL, H200-XL-2, H220, H220-2, H220-A, H220-A-2, H300-1, H300-2, H300-A-1, H300-A-2, H300-AA, H300-RVS, H400-AA, H400-RVS, H500, H600, H700, H800, Jumbo35, Jumbo42, JumboPlus, Lynx32, Lynx42, Marlin42, Marlin42XL, Marlin46, Marlin52, Marlin90, MiniJumbo, Polar2-40, Polar2-50, Polar2-75, Polar2-85, Polar2-95, Polar52, Polar80		



1

<b>GEV No.</b>	691831	<b>Ref. No.</b>	0300020 0300020000
<b>description</b>	sealing bar L 277mm W 15mm H 31mm double weld		



1

<b>GEV No.</b>	691997	<b>Ref. No.</b>	0300041 0300041000
<b>description</b>	sealing bar L 280mm W 16mm H 34mm double		
<b>For models:</b>	JumboPlus, MiniJumbo		

### sealing bars



1

<b>GEV No.</b>	691587	<b>Ref. No.</b>	0380590
<b>description</b>	bracket for sealing bar L 365mm W 25mm H 50mm aluminium		
<b>For models:</b>	Falcon2-60, H500		



1

<b>GEV No.</b>	692207	<b>Ref. No.</b>	0300110
<b>description</b>	sealing bar L 323mm W 16mm H 34mm double		
<b>For models:</b>	H100, Marlin90		



1

<b>GEV No.</b>	691632	<b>Ref. No.</b>	0300010 0300011
<b>description</b>	sealing bar L 277mm W 15mm H 31mm		
<b>For models:</b>	JumboPlus, MiniJumbo		



1

<b>GEV No.</b>	692469	<b>Ref. No.</b>	0300116 0300116(DS)
<b>description</b>	sealing bar L 355mm W 15mm H 31mm double welding		
<b>For models:</b>	Boxer35, Jumbo30, Jumbo35		



1

<b>GEV No.</b>	692103	<b>Ref. No.</b>	0300210
<b>description</b>	sealing bar L 420mm W 16mm H 34mm double		
<b>For models:</b>	Boxer42, Boxer42XL, Jumbo42, Jumbo42XL, Marlin42, Marlin42XL, Toucan42		





1 

<b>GEV No.</b>	691998	<b>Ref. No.</b>	0300215 0300215000
<b>description</b>	sealing bar L 425mm W 16mm H 34mm cut-off seal		
<b>For models:</b>	Boxer42, Boxer42XL, Jumbo42, Jumbo42XL, Marlin42, Marlin42XL, Marlin52		

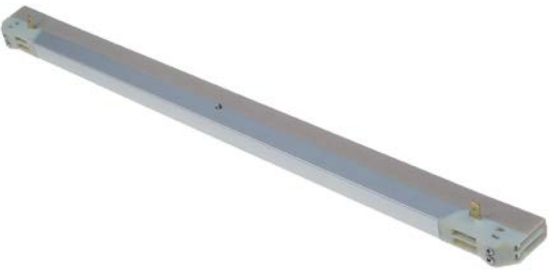
1 

<b>GEV No.</b>	697922	<b>Ref. No.</b>	0300405
<b>description</b>	sealing bar L 466mm W 15mm H 30mm		
<b>For models:</b>	Falcon2-60		

1 

<b>GEV No.</b>	691816	<b>Ref. No.</b>	0300337 0300337000
<b>description</b>	sealing bar L 500mm W 16mm H 34mm double		
<b>For models:</b>	Falcon80, Polar80		

1 

<b>GEV No.</b>	692468	<b>Ref. No.</b>	0300320
<b>description</b>	sealing bar L 520mm W 15.5mm H 31mm		
<b>For models:</b>	Marlin52		

1 

<b>GEV No.</b>	691999	<b>Ref. No.</b>	0300332 0300332000
<b>description</b>	sealing bar L 525mm W 16mm H 35mm double		
<b>For models:</b>	Falcon52, Polar52		

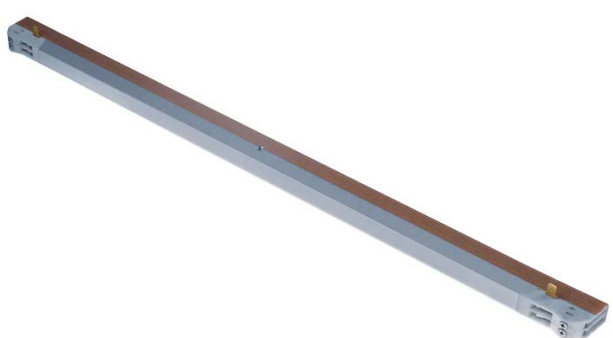
1 

<b>GEV No.</b>	691801	<b>Ref. No.</b>	0300510
<b>description</b>	sealing bar L 565mm W 15mm H 33mm double weld		
<b>For models:</b>	Falcon2-60, Falcon2-70, Falcon80, Polar80		

1 

<b>GEV No.</b>	692126	<b>Ref. No.</b>	0300310
<b>description</b>	sealing bar L 605mm W 15mm H 32mm		
<b>For models:</b>	Marlin52		

contacts for sealing bars

1 

<b>GEV No.</b>	691559	<b>Ref. No.</b>	0900170
<b>description</b>	terminal for sealing bar mounting pos. left type DS		

1 

<b>GEV No.</b>	691557	<b>Ref. No.</b>	0900152 0900160
<b>description</b>	terminal for sealing bar mounting pos. left type TS		
<b>For models:</b>	Lynx32, Lynx42		

1

<b>GEV No.</b>	691556	<b>Ref. No.</b>	0330025 0900150 0900151
<b>description</b>	terminal for sealing bar mounting pos. left/right type table DS		
<b>For models:</b>	Boxer35, Boxer42, Boxer42XL, Falcon2-60, Falcon2-70, Falcon52, Falcon80, Jumbo35, Jumbo42, Lynx32, Lynx42, Marlin42, Marlin42XL, Marlin46, Marlin52, Marlin90, Polar2-40, Polar2-50, Polar2-75, Polar2-85, Polar2-95, Polar52, Polar80		



1

<b>GEV No.</b>	691560	<b>Ref. No.</b>	0900172
<b>description</b>	terminal for sealing bar mounting pos. right type DS		



1

<b>GEV No.</b>	691558	<b>Ref. No.</b>	0900154 0900161
<b>description</b>	terminal for sealing bar mounting pos. right type TS		
<b>For models:</b>	Lynx32, Lynx42		

miscellaneous



1

<b>GEV No.</b>	696531	<b>Ref. No.</b>	0330093
<b>description</b>	end cap for sealing bar L 32mm W 25mm H 50mm		
<b>For models:</b>	Polar2-85		

heating wires



1

<b>GEV No.</b>	572016	<b>Ref. No.</b>	0305003
<b>description</b>	heating wire W 3.5mm L 3000mm Qty 1		
<b>For models:</b>	Lynx32, Lynx42		



1

<b>GEV No.</b>	572050	<b>Ref. No.</b>	0305000
<b>description</b>	heating wire W 3.5mm thickness 0.3mm Qty supplied by meter		
<b>For models:</b>	Boxer35, Boxer42, Boxer42XL, Boxer42XL-BA, Falcon2-60, Falcon2-70, Falcon52, Falcon80, H100, H150, H200, H200-2, H200-A, H200-A-2, H200-XL, H200-XL-2, H220, H220-2, H220-A, H220-A-2, H300-1, H300-2, H300-A-1, H300-A-2, H300-AA, H300-RVS, H400-AA, H400-RVS, H500, H600, H700, H800, Jumbo35, Jumbo42, JumboPlus, Lynx32, Lynx42, Marlin42, Marlin42XL, Marlin46, Marlin52, Marlin90, Mini-Jumbo, Polar2-40, Polar2-50, Polar2-75, Polar2-85, Polar2-95, Polar52, Polar80		



1

<b>GEV No.</b>	572052	<b>Ref. No.</b>	0305019 0305020
<b>description</b>	heating wire W 5mm L 3000mm thickness 0.2mm Qty 1		
<b>For models:</b>	Boxer42XL-BA, Lynx32, Lynx42		



1

<b>GEV No.</b>	572053	<b>Ref. No.</b>	0305025 0305028
<b>description</b>	heating wire W 8mm L 3000mm thickness 0.2mm Qty 1		
<b>For models:</b>	Lynx32, Lynx42		

service kits



1

<b>GEV No.</b>	890254	<b>Ref. No.</b>	0940100 094010000
<b>description</b>	service kit container capacity 0.05l for vacuum packing machine type MJ		



1

<b>GEV No.</b>	890255	<b>Ref. No.</b>	0940110
<b>description</b>	service kit container capacity 0.2l for vacuum packing machine type JP		
<b>For models:</b>	Lynx32		



1

<b>GEV No.</b>	890262	<b>Ref. No.</b>	0940120 0940120000
<b>description</b>	service kit for vacuum packing machine type B35 / B-M 42/42XL		



1

<b>GEV No.</b>	890261	<b>Ref. No.</b>	0940125 0940125000
<b>description</b>	service kit for vacuum packing machine type B42 XL BA/Toucan BA		



1

<b>GEV No.</b>	890263	<b>Ref. No.</b>	0940140 0940140000
<b>description</b>	service kit for vacuum packing machine type F80/P80 LL		



1

<b>GEV No.</b>	890256	<b>Ref. No.</b>	0940115
<b>description</b>	service kit for vacuum packing machine type J35/J42/B35		
<b>For models:</b>	Lynx42		



1

<b>GEV No.</b>	890264	<b>Ref. No.</b>	0940130 0940130000
<b>description</b>	service kit for vacuum packing machine type M46-M/F/P 52		



1

<b>GEV No.</b>	890265	<b>Ref. No.</b>	0940160 0940160000
<b>description</b>	service kit for vacuum packing machine type P2-40/50/75		

### cut off wires



1

<b>GEV No.</b>	572018	<b>Ref. No.</b>	0305009
<b>description</b>	cut off wire ø 1.1mm Qty 3m		
<b>For models:</b>	Lynx32, Lynx42		



1

<b>GEV No.</b>	572051	<b>Ref. No.</b>	0305010
<b>description</b>	cut off wire ø 1.1mm Qty supplied by meter		
<b>For models:</b>	Boxer35, Boxer42, Boxer42XL, Falcon2-60, Falcon2-70, Falcon52, Falcon80, Lynx32, Lynx42, Marlin42, Marlin42XL, Marlin46, Marlin52, Marlin90, Polar2-40, Polar2-50, Polar2-75, Polar2-85, Polar2-95, Polar52, Polar80		

### vacuum valves



1

<b>GEV No.</b>	691550	<b>Ref. No.</b>	0281000
<b>description</b>	vacuum valve connection 1"		
<b>For models:</b>	Falcon2-60, Falcon2-70, Falcon52, Falcon80, H300-1, H300-2, H300-A-1, H300-A-2, H300-AA, H300-RVS, H500, H600, H700, Marlin46, Marlin52, Marlin90, Polar2-40, Polar2-50, Polar52, Polar80		



1

<b>GEV No.</b>	691554	<b>Ref. No.</b>	0900850
<b>description</b>	vacuum valve connection 1/4"		



1

<b>GEV No.</b>	691552	<b>Ref. No.</b>	0281020
<b>description</b>	vacuum valve connection 2"		
<b>For models:</b>	H800, Polar2-75, Polar2-85, Polar2-95		

### locking screws



1

<b>GEV No.</b>	691568	<b>Ref. No.</b>	0939115
<b>description</b>	locking screw thread 1" plastic		
<b>For models:</b>	Polar2-75, Polar2-85, Polar2-95		



1

<b>GEV No.</b>	691566	<b>Ref. No.</b>	0939110
<b>description</b>	locking screw thread 1/2" plastic		
<b>For models:</b>	Boxer35, Boxer62, Falcon2-60, Falcon2-70, Falcon52, Falcon80, H300-1, H300-2, H300-A-1, H300-A-2, H300-AA, H300-RVS, H400-AA, H400-RVS, H500, H600, H700, H800, Jumbo35, Jumbo42, Jumbo50, Lynx32, Lynx42, Marlin42XL, Marlin46, Marlin52, Marlin90, Polar2-40, Polar2-50, Polar2-75, Polar2-85, Polar2-95, Polar52, Polar80		

			
1			
<b>GEV No.</b>	691565	<b>Ref. No.</b>	0939105
<b>description</b>	locking screw thread 1/4" SS		
<b>For models:</b>	JumboPlus, Lynx42		

			
1			
<b>GEV No.</b>	691564	<b>Ref. No.</b>	0939102
<b>description</b>	locking screw thread 1/8" SS		
<b>For models:</b>	MiniJumbo		

			
1			
<b>GEV No.</b>	691567	<b>Ref. No.</b>	0939113
<b>description</b>	locking screw thread 3/4" plastic		
<b>For models:</b>	Boxer35, Boxer42, Boxer42XL, Boxer62, Falcon2-60, Falcon2-70, Falcon52, Falcon80, H100, H300-1, H300-2, H300-A-1, H300-A-2, H300-AA, H300-RVS, H400-AA, H400-RVS, H500, H600, H700, H800, Jumbo35, Jumbo42, Jumbo50, Lynx42, Marlin42, Marlin42XL, Marlin46, Marlin52, Marlin90, Polar2-40, Polar52, Polar80		

**maintenance sets**

			
1			
<b>GEV No.</b>	691577	<b>Ref. No.</b>	0931225
<b>description</b>	maintenance set for air valve size 1"		
<b>For models:</b>	H300-1, H300-2, H300-A-1, H300-A-2, H300-AA, H300-RVS, Marlin52		

			
1			
<b>GEV No.</b>	691575	<b>Ref. No.</b>	0900872
<b>description</b>	maintenance set for air valve size 1 1/4"		

			
1			
<b>GEV No.</b>	691573	<b>Ref. No.</b>	0931205
<b>description</b>	maintenance set for air valve size 2"		
<b>For models:</b>	H800, Polar2-75, Polar2-85, Polar2-95		

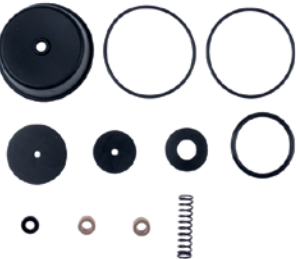
			
1			
<b>GEV No.</b>	691576	<b>Ref. No.</b>	0931220
<b>description</b>	maintenance set for vacuum valve size 1"		
<b>For models:</b>	H300-1, H300-2, H300-A-1, H300-A-2, H300-AA, H300-RVS, Marlin52		

			
1			
<b>GEV No.</b>	691574	<b>Ref. No.</b>	0900870
<b>description</b>	maintenance set for vacuum valve size 1 1/4"		

			
1			
<b>GEV No.</b>	691572	<b>Ref. No.</b>	0931200
<b>description</b>	maintenance set for vacuum valve size 2"		
<b>For models:</b>	Polar2-75, Polar2-85, Polar2-95		





## miscellaneous



1

<b>GEV No.</b>	699619	<b>Ref. No.</b>	0070020
<b>description</b>	ball ED $\varnothing$ 35.5mm		
<b>For models:</b>	DT100, DT60		



1

<b>GEV No.</b>	692104	<b>Ref. No.</b>	0065225
<b>description</b>	connection head		
<b>For models:</b>	Falcon52, H300-1, H300-2, H300-A-1, H300-A-2, JumboPlus, Marlin46, Marlin52, Marlin90, MiniJumbo		



1

<b>GEV No.</b>	692473	<b>Ref. No.</b>	0400730
<b>description</b>	flange ID $\varnothing$ 37mm L 60mm W 60mm H 14mm for pipe		
<b>For models:</b>	Falcon2-60, Falcon2-70, Polar2-40, Polar2-50		



1

<b>GEV No.</b>	691955	<b>Ref. No.</b>	0400732 0400735 0400735000
<b>description</b>	flange ID $\varnothing$ 54mm L 80mm W 40mm H 14mm		
<b>For models:</b>	Polar2-75, Polar2-85, Polar2-95		



1

<b>GEV No.</b>	692470	<b>Ref. No.</b>	0380710
<b>description</b>	guide bar L 425mm W 25mm H 25mm for vacuum packing machine		
<b>For models:</b>	Boxer42, Boxer42XL, H200, H200-2, H200-A, H200-A-2, H200-XL, H200-XL-2, H220, H220-2, H220-A, H220-A-2, Jumbo42XL, Marlin42, Marlin42XL, Toucan42		



1

<b>GEV No.</b>	697923	<b>Ref. No.</b>	0401020
<b>description</b>	intake body ID $\varnothing$ 5mm ED $\varnothing$ 27mm L 24mm for vacuum packing machine		
<b>For models:</b>	Boxer35, Boxer42, Boxer42XL, Boxer52, Boxer62, H100, H150, H200, H200-2, H200-A, H200-A-2, H200-XL, H200-XL-2, H220, H220-2, H220-A, H220-A-2, Jumbo30, Jumbo35, Jumbo42, Jumbo42XL, Jumbo50, JumboPlus, Marlin42, Marlin42XL, MiniJumbo		

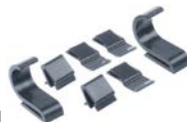

1

<b>GEV No.</b>	697921	<b>Ref. No.</b>	0330115 0330116
<b>description</b>	mounting clip set plastic for front panel		
<b>For models:</b>	Boxer35, Boxer42, Boxer42XL, Boxer52, Boxer62, Falcon2-60, Falcon2-70, Falcon52, Falcon80, Jumbo30, Jumbo35, Jumbo42, Jumbo42XL, Jumbo50, JumboPlus, Lynx32, Lynx42, Marlin42, Marlin42XL, Marlin46, Marlin52, Marlin90, MiniJumbo, Polar2-40, Polar2-50, Polar2-75, Polar2-85, Polar2-95, Polar52, Polar80, Toucan42		



1

<b>GEV No.</b>	699263	<b>Ref. No.</b>	0810110
<b>description</b>	non-return valve ID $\varnothing$ 5mm ED $\varnothing$ 7mm L 39.5mm W 19.2mm		
<b>For models:</b>	Falcon2-60, Falcon2-70, Falcon52, Falcon80, Marlin42XL, Marlin46, Marlin52, Marlin90, MiniJumbo, Polar2-40, Polar52, Polar80		

			
1			
<b>GEV No.</b>	692471	<b>Ref. No.</b>	0810112
<b>description</b>	non-return valve ID $\varnothing$ 8mm ED $\varnothing$ 10mm L 39.5mm for vacuum packing machine		
<b>For models:</b>	JumboPlus, Lynx32		

			
1			
<b>GEV No.</b>	696530	<b>Ref. No.</b>	0390614
<b>description</b>	nozzle ID $\varnothing$ 5mm ED $\varnothing$ 8mm L 28mm H 50mm for vacuum packing machine thread M8x0.75		
<b>For models:</b>	Falcon2-60, Falcon2-70, Falcon52, Falcon80, Polar2-40, Polar2-50, Polar2-75, Polar2-85, Polar2-95, Polar52, Polar80		

			
1			
<b>GEV No.</b>	690977	<b>Ref. No.</b>	0380702
<b>description</b>	rail for gasket L 280mm aluminium		
<b>For models:</b>	JumboPlus, MiniJumbo		

			
1			
<b>GEV No.</b>	697924	<b>Ref. No.</b>	0940207
<b>description</b>	repair kit ED $\varnothing$ 18mm L 33mm Food preparation equipment		

			
1			
<b>GEV No.</b>	692065	<b>Ref. No.</b>	0065250 0065250000
<b>description</b>	retaining ring for vacuum packing machine shaft $\varnothing$ 6mm thickness 0.7mm SS DIN 471		
<b>For models:</b>	Boxer35, Boxer42, Boxer42XL, Boxer52, Boxer62, H100, H150, H200, H200-2, H200-A, H200-A-2, H200-XL, H200-XL-2, H220, H220-2, H220-A, H220-A-2, Jumbo30, Jumbo35, Jumbo42, Jumbo42XL, Jumbo50, JumboPlus, Marlin42, Marlin42XL, MiniJumbo, Toucan42		

			
1			
<b>GEV No.</b>	697925	<b>Ref. No.</b>	0065221
<b>description</b>	screw ED $\varnothing$ 10mm W 22mm thread M4		
<b>For models:</b>	Boxer35, Boxer42, Boxer42XL, Falcon2-60, Falcon80, H100, H150, H200, H200-2, H200-A, H200-A-2, H200-XL, H200-XL-2, H220, H220-2, H220-A, H220-A-2, Jumbo35, Jumbo42, Marlin42XL, Polar52, Toucan42		

			
1			
<b>GEV No.</b>	691583	<b>Ref. No.</b>	0931230
<b>description</b>	sound damper ID $\varnothing$ 51.5mm ED $\varnothing$ 57mm H 32mm		
<b>For models:</b>	H800, Polar2-75, Polar2-85, Polar2-95		

			
1			
<b>GEV No.</b>	692066	<b>Ref. No.</b>	0390500 0390500000
<b>description</b>	spindle ED $\varnothing$ 6mm L 127mm		
<b>For models:</b>	JumboPlus, MiniJumbo		

## gaskets

### O-rings

#### EPDM

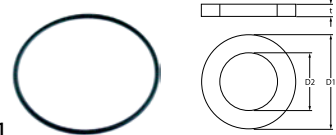
			
1			
<b>GEV No.</b>	345896	<b>Ref. No.</b>	0065736 0065788
<b>description</b>	O-ring EPDM thickness 1.5mm ID $\varnothing$ 37mm Qty 1 pcs		
<b>For models:</b>	Falcon2-60, Falcon2-70, Polar2-40, Polar2-50		

			
1			
<b>GEV No.</b>	517004	<b>Ref. No.</b>	0065730
<b>description</b>	O-ring EPDM thickness 2.62mm ID $\varnothing$ 34.6mm Qty 1 pcs		
<b>For models:</b>	Falcon2-60, Falcon2-70, Polar2-40, Polar2-50, Toucan42		

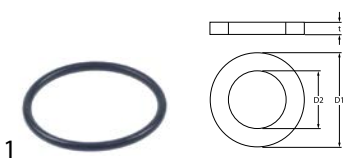
<b>GEV No.</b>	532672	<b>Ref. No.</b>	0065741
<b>description</b>	O-ring EPDM thickness 2mm ID $\varnothing$ 25mm Qty 1 pcs		
<b>For models:</b>	Falcon2-60, Falcon2-70, Falcon52, Falcon80, Polar2-40, Polar2-50, Polar2-75, Polar2-85, Polar2-95, Polar52, Polar80		

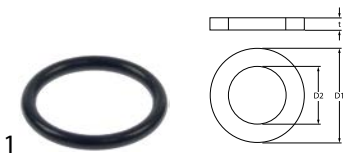

<b>GEV No.</b>	527561	<b>Ref. No.</b>	0065740
<b>description</b>	O-ring EPDM thickness 3mm ID $\varnothing$ 22mm Qty 1 pcs		
<b>For models:</b>	Boxer35, Boxer42, Boxer42XL, Boxer42XL-BA, Boxer52, Boxer62, H100, Jumbo30, Jumbo35, Jumbo42, Jumbo42XL, Jumbo50, JumboPlus, Marlin42, Marlin42XL, MiniJumbo		

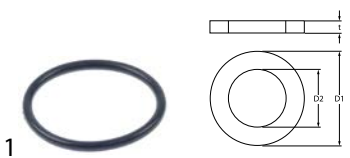

<b>GEV No.</b>	532671	<b>Ref. No.</b>	0065732
<b>description</b>	O-ring EPDM thickness 3mm ID $\varnothing$ 34mm Qty 1 pcs		
<b>For models:</b>	Boxer62, Jumbo42XL, Jumbo50, Lynx32, Lynx42, Marlin46, Marlin52		

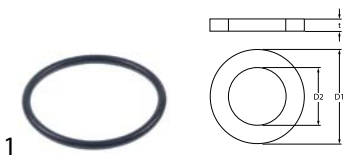

<b>GEV No.</b>	532670	<b>Ref. No.</b>	0065729 0287000
<b>description</b>	O-ring EPDM thickness 3mm ID $\varnothing$ 40mm Qty 1 pcs		
<b>For models:</b>	Boxer35, Boxer42, Boxer42XL, Boxer52, Boxer62, H100, H150, H200, H200-2, H200-A, H200-A-2, H200-XL, H200-XL-2, H220, H220-2, H220-A, H220-A-2, H300-1, H300-2, Jumbo35, Jumbo42, Jumbo42XL, Jumbo50, JumboPlus, Lynx32, Lynx42, Marlin42, Marlin42XL, Marlin46, Marlin52, Marlin90		

### NBR

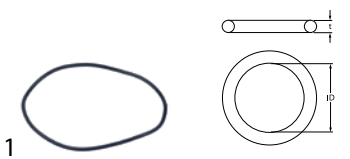

<b>GEV No.</b>	532692	<b>Ref. No.</b>	0065734 0065786
<b>description</b>	O-ring NBR thickness 1.5mm ID $\varnothing$ 52mm		
<b>For models:</b>	Polar2-75, Polar2-85, Polar2-95		

## sealing washers

### rubber gaskets



<b>GEV No.</b>	696391	<b>Ref. No.</b>	0065600
<b>description</b>	rubber gasket rubber ED $\varnothing$ 25mm ID $\varnothing$ 5.5mm thickness 2.5mm Qty 1 pcs		
<b>For models:</b>	Boxer35, Boxer42XL, H100, H150, H200, H200-2, H200-A, H200-A-2, H200-XL, H200-XL-2, H220, H220-2, H220-A, H220-A-2, Jumbo35, Jumbo42, JumboPlus, Marlin42XL, MiniJumbo, Toucan42		

### foam rubber gaskets



<b>GEV No.</b>	696390	<b>Ref. No.</b>	0320110
<b>description</b>	foam rubber gasket $\varnothing$ 3mm Qty supplied by meter		
<b>For models:</b>	Boxer35, Boxer42, Boxer42XL, Falcon2-60, Falcon2-70, Falcon52, Falcon80, Jumbo35, Jumbo42, JumboPlus, Lynx32, Lynx42, Marlin42, Marlin42XL, Marlin46, Marlin52, Marlin90, MiniJumbo, Polar2-40, Polar2-50, Polar2-75, Polar2-85, Polar2-95, Polar52, Polar80		



<b>GEV No.</b>	693787	<b>Ref. No.</b>	0320100 0320100001
<b>description</b>	foam rubber gasket $\varnothing$ 6mm Qty supplied by meter		
<b>For models:</b>	JumboPlus, MiniJumbo, Vortex		

## shaft gaskets

### v-rings



<b>GEV No.</b>	696559	<b>Ref. No.</b>	0065063
<b>description</b>	V-ring for shaft $\varnothing$ 32mm ID $\varnothing$ 31mm ED $\varnothing$ 39mm thickness 7mm		
<b>For models:</b>	Falcon2-60, Falcon2-70, Polar2-40, Polar2-50		



<b>GEV No.</b>	692067	<b>Ref. No.</b>	0065068 0065068000
<b>description</b>	V-ring ID $\varnothing$ 45mm ED $\varnothing$ 55mm thickness 9mm		
<b>For models:</b>	Polar2-75, Polar2-85, Polar2-95		

special gaskets

for vacuum packers



<b>GEV No.</b>	693787	<b>Ref. No.</b>	0320100 0320100001
<b>description</b>	foam rubber gasket ø 6mm Qty supplied by meter		
<b>For models:</b>	JumboPlus, MiniJumbo, Vortex		

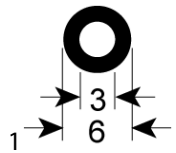

<b>GEV No.</b>	570200	<b>Ref. No.</b>	0320220
<b>description</b>	gasket ø 6mm ID ø 3mm silicone for vacuum packing machine		
<b>For models:</b>	H100, H150, H200, H200-2, H200-A, H200-A-2, H200-XL, H200-XL-2, H220, H220-2, H220-A, H220-A-2, Toucan42		

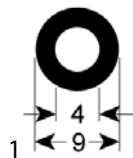

<b>GEV No.</b>	570201	<b>Ref. No.</b>	0320227 0320228
<b>description</b>	gasket ø 9mm ID ø 4mm silicone Qty supplied by meter for vacuum packing machine		
<b>For models:</b>	H600, H800, Polar2-40, Polar2-50, Polar2-75, Polar2-85, Polar2-95		

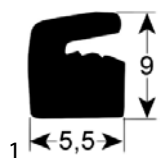

<b>GEV No.</b>	570002	<b>Ref. No.</b>	0320216
<b>description</b>	lid gasket W 5.5mm H 9mm silicone Qty 10m		
<b>For models:</b>	Lynx32, Lynx42		

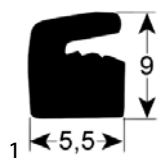

<b>GEV No.</b>	900958	<b>Ref. No.</b>	0320217
<b>description</b>	lid gasket W 5.5mm H 9mm silicone Qty 20m for vacuum packing machine		
<b>For models:</b>	Lynx32, Lynx42		

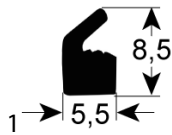

<b>GEV No.</b>	900809	<b>Ref. No.</b>	0320215 0320217000 0320219
<b>description</b>	lid gasket W 5.5mm H 9mm silicone Qty supplied by meter for vacuum packing machine		
<b>For models:</b>	Boxer35, Boxer42, Boxer42XL, Boxer42XLBA, Boxer42XL-BA, Boxer52, Boxer62, H100, Jumbo35, Jumbo42, Jumbo42XL, Jumbo50, Jumbo-Plus, Lynx32, Lynx42, Marlin42, Marlin42XL, MiniJumbo, Toucan42		

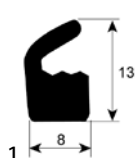

<b>GEV No.</b>	570003	<b>Ref. No.</b>	0320208
<b>description</b>	lid gasket W 8mm H 13mm silicone Qty 12m		

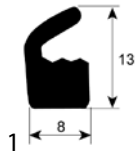

<b>GEV No.</b>	900964	<b>Ref. No.</b>	0320209
<b>description</b>	lid gasket W 8mm H 13mm silicone Qty 20m for vacuum packing machine		

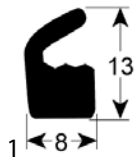

<b>GEV No.</b>	900807	<b>Ref. No.</b>	0320210
<b>description</b>	lid gasket W 8mm H 13mm silicone Qty supplied by meter for vacuum packing machine		
<b>For models:</b>	Falcon2-60, Falcon2-70, Falcon52, Falcon80, H300-1, H300-2, H300-A-1, H300-A-2, H300-AA, H300-RVS, H400-AA, H400-RVS, H500, H600, H700, H800, Marlin46, Marlin52, Marlin90, Polar2-40, Polar2-50, Polar2-75, Polar2-85, Polar2-95, Polar52, Polar80		

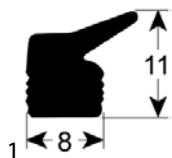

<b>GEV No.</b>	900965	<b>Ref. No.</b>	0320214
<b>description</b>	lid gasket W 8mm H 11mm silicone Qty 20m for vacuum packing machine		

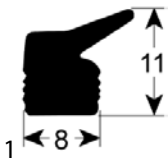

<b>GEV No.</b>	900808	<b>Ref. No.</b>	0320212
<b>description</b>	lid gasket W 8mm H 11mm silicone supplied by meter for vacuum packing machine		
<b>For models:</b>	Polar2-40, Polar2-50, Polar2-75, Polar2-85		

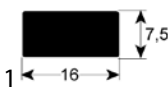

<b>GEV No.</b>	900806	<b>Ref. No.</b>	0220200 0320200 0320201 0320202
<b>description</b>	gasket W 16mm H 7.5mm silicone Qty supplied by meter for vacuum packing machine		
<b>For models:</b>	Boxer35, Boxer42, Boxer42XL, Boxer62, Falcon2-60, Falcon2-70, Falcon52, Falcon80, H100, H150, H200, H200-2, H200-A, H200-A-2, H200-XL, H200-XL-2, H220, H220-2, H220-A, H220-A-2, H300-1, H300-2, H300-A-1, H300-A-2, H300-AA, H300-RVS, H400-AA, H400-RVS, H500, H600, H700, H800, Jumbo30, Jumbo35, Jumbo42, Jumbo42XL, Jumbo50, JumboPlus, Lynx32, Lynx42, Marlin42, Marlin42XL, Marlin46, Marlin52, Marlin90, MiniJumbo, Polar2-40, Polar2-50, Polar2-75, Polar2-85...(Other models you can see in the webshop)		

## springs

### torsion springs



<b>GEV No.</b>	691532	<b>Ref. No.</b>	0080035
<b>description</b>	compression spring $\phi$ 46mm L2 87mm wire gauge $\phi$ 10mm L1 340mm L3 87mm		
<b>For models:</b>	Falcon80		



<b>GEV No.</b>	691533	<b>Ref. No.</b>	0080036
<b>description</b>	compression spring $\phi$ 46mm L2 87mm wire gauge $\phi$ 10mm L1 340mm L3 87mm		
<b>For models:</b>	Falcon80		

### compression springs



<b>GEV No.</b>	697920	<b>Ref. No.</b>	0080005
<b>description</b>	compression spring $\phi$ 11.2mm L 16mm wire gauge $\phi$ 1.5mm windings 3		
<b>For models:</b>	H600, H800, Polar2-40, Polar2-50, Polar2-75, Polar2-85, Polar2-95		



<b>GEV No.</b>	691531	<b>Ref. No.</b>	0080020
<b>description</b>	compression spring $\phi$ 15.2mm L 52mm wire gauge $\phi$ 2mm for vacuum packing machine		
<b>For models:</b>	Falcon2-60, Falcon2-70, Falcon52, H300-AA, H300-RVS, H500, H600, H700, H800, Polar2-40, Polar2-50, Polar2-75, Polar2-85, Polar2-95, Polar52		



<b>GEV No.</b>	691530	<b>Ref. No.</b>	0080030
<b>description</b>	compression spring $\phi$ 32.7mm L 240mm wire gauge $\phi$ 5.2mm for vacuum packing machine		
<b>For models:</b>	H400-AA		

### gas tension springs

#### gas tension springs



<b>GEV No.</b>	698531	<b>Ref. No.</b>	0810201
<b>description</b>	gas tension spring 385N hub 40mm D1 $\phi$ 8mm D2 $\phi$ 18mm hole distance 145mm hole $\phi$ 6.4mm L 155mm		



<b>GEV No.</b>	701302	<b>Ref. No.</b>	0955003
<b>description</b>	gas tension spring 450N hub 90mm D1 $\phi$ 6mm D2 $\phi$ 15mm hole distance 230mm hole $\phi$ 6mm L 240mm		



<b>GEV No.</b>	691528	<b>Ref. No.</b>	0810200
<b>description</b>	gas tension spring for vacuum packing machine 370N hub 40mm D1 $\phi$ 18mm D2 $\phi$ 8mm hole distance 145mm hole $\phi$ 6.2mm L 155mm		
<b>For models:</b>	Boxer35, Boxer42, H100, H150, H200, H200-2, H200-A, H200-A-2, H220, H220-2, H220-A, H220-A-2, Jumbo30, Jumbo35, Jumbo42, JumboPlus, Marlin42, MiniJumbo		



<b>GEV No.</b>	691529	<b>Ref. No.</b>	0810205 0810215
<b>description</b>	gas tension spring for vacuum packing machine 500N hub 65mm D1 $\phi$ 18mm D2 $\phi$ 8mm hole distance 225mm hole $\phi$ 6.3mm L 235mm		
<b>For models:</b>	Boxer42, Boxer42XL, H200-XL, H200-XL-2, Jumbo50, Marlin42XL, Marlin46, Marlin52, Marlin90		

### tension springs



<b>GEV No.</b>	504449	<b>Ref. No.</b>	0080107
<b>description</b>	tension spring $\phi$ 70mm total length 340mm wire gauge $\phi$ 8mm for vacuum packing machine Qty 1 pcs		
<b>For models:</b>	Polar2-85		



## manometers

 <p>1</p>			
<b>GEV No.</b>	541528	<b>Ref. No.</b>	0810101
<b>description</b>	manometer ø 40mm pressure range 0 up to 1bar connection angled connection ø 5mm		
<b>For models:</b>	Boxer35, Boxer42, Boxer42XL, Boxer52, Boxer62, Falcon52, H100, H150, H200, H200-2, H200-A, H200-A-2, H200-XL, H200-XL-2, H220, H220-2, H220-A, H220-A-2, H300-1, H300-2, H300-A-1, H300-A-2, H300-AA, H300-RVS, H400-AA, H400-RVS, H500, H600, H700, H800, Jumbo30, Jumbo35, Jumbo42, Jumbo42XL, Jumbo50, JumboPlus, Marlin42, Marlin42XL, Marlin46, Marlin52, Marlin90, MiniJumbo, Polar2-40, Polar2-50, Polar2-75, Polar2-85, Polar2-95, Polar52, Polar80, Toucan42		

## hoses

### industrial hoses

#### extraction and pressure hoses

 <p>1</p>			
<b>GEV No.</b>	570202 <sup>1</sup>	<b>Ref. No.</b>	0322052
<b>description</b>	pressure hose ID ø 7mm ED ø 13mm Lm operating p. 10bar burst p. 30bar temp.-resist. -30 up to +80°C		
<b>For models:</b>	Boxer35, Boxer42, Boxer42XL, Boxer52, Falcon2-60, Falcon2-70, Falcon52, Falcon80, H100, H150, H200, H200-2, H200-A, H200-A-2, H200-XL, H200-XL-2, H220, H220-2, H220-A, H220-A-2, H300-1, H300-2, H300-A-1, H300-A-2, H300-AA, H300-RVS, H400-AA, H400-RVS, H500, H600, H700, H800, Lynx32, Lynx42, Marlin42, Marlin42XL, Marlin46, Marlin52, Marlin90, MiniJumbo, Polar2-40, Polar2-50, Polar2-75, Polar2-85, Polar2-95, Polar52, Polar80, Toucan42		

<sup>1</sup>by the meter

## fittings, hose and pipe connectors

### hose connectors

#### plastic

 <p>1</p>			
<b>GEV No.</b>	361696	<b>Ref. No.</b>	0260255
<b>description</b>	hose connector plastic straight thread 3/8" hose ø 8mm Qty 1 pcs		
<b>For models:</b>	Falcon2-60, Falcon2-70, Falcon52, Marlin52, Polar52		

 <p>1</p>			
<b>GEV No.</b>	361752	<b>Ref. No.</b>	0260005
<b>description</b>	hose connector plastic angled thread 1/8" hose ø 4mm Qty 1 pcs		
<b>For models:</b>	Boxer35, Boxer42, Boxer42XL, Boxer42XL-BA, Boxer52, Boxer62, Falcon2-60, Falcon2-70, Falcon52, Falcon80, H100, H150, H200, H200-2, H200-A, H200-A-2, H200-XL, H200-XL-2, H220, H220-2, H220-A, H220-A-2, H300-1, H300-2, H300-A-1, H300-A-2, H300-AA, H300-RVS, H400-AA, H400-RVS, H500, H600, H700, H800, Jumbo30, Jumbo35, Jumbo42, Jumbo42XL, Jumbo50, JumboPlus, Lynx32, Lynx42, Marlin42, Marlin42XL, Marlin46, Marlin52, Marlin90, MiniJumbo, Polar2-40, Polar2-50...(Other models you can see in the webshop)		

## measuring equipment

### meters

#### pressure measurement

#### digital manometers

#### absolute-pressure measurement

 <p>1</p>			
<b>GEV No.</b>	800002	<b>Ref. No.</b>	0930300
<b>description</b>	pressure meter 0 up to 1300mbar type GMH 3161-12 vacuum + barometric pressure probe type absolute pressure sensor measurement unit mbar,bar,kPa,MPa,PSI,mmHg,mH2O connections 1 min/max value, tare, hold resolution 1mbar hose ø 4mm accuracy (temperature) ±0.4%FS accuracy (hysteresis) ±0.2%FS overload max. 4 bar interface serial (adapter not included) sensor piezoresistant gauge pressure sensor, int. dimensions 142x71x26mm incl. battery		

## fastening material

### screws

#### countersunk screws

 <p>1</p>			
<b>GEV No.</b>	560076	<b>Ref. No.</b>	0042115
<b>description</b>	countersunk screw thread M4 L 10mm SS DIN 963/ISO 2009 Qty 20 pcs intake slotted head ø 7.5mm		
<b>For models:</b>	Boxer35, Boxer42, Boxer42XL, DT100, DT60, H100, H150, H200, H200-2, H200-A, H200-A-2, H200-XL, H200-XL-2, H220, H220-2, H220-A, H220-A-2, H300-1, H300-2, H300-A-1, H300-A-2, Jumbo35, Marlin42, Marlin42XL, Marlin46, Marlin90, Toucan42		



			
1			
<b>GEV No.</b>	560263	<b>Ref. No.</b>	0042118
<b>description</b>	countersunk screw thread M4 L 25mm SS DIN 963/ISO 2009 Qty 20 pcs intake slotted head ø 7.5mm		
<b>For models:</b>	Boxer52, Boxer62, Falcon52, Jumbo42, JumboPlus, Marlin46, Marlin52, MiniJumbo, Vortex		

flat-headed bolts			
			
1			
<b>GEV No.</b>	560061	<b>Ref. No.</b>	0041100
<b>description</b>	flat-headed bolt thread M4 thread L 6mm SS DIN 7985/ISO 7045 Qty 20 pcs intake Phillips head ø 8mm head thickness 2mm		
<b>For models:</b>	Boxer52, Falcon2-60, Falcon2-70, Falcon52, Falcon80, H300-AA, H300-RVS, H500, H700, Jumbo50, JumboPlus, Lynx32, Lynx42, Marlin46, Marlin52, MiniJumbo, Polar80, Vortex		

hexagonal screws			
			
1			
<b>GEV No.</b>	560090	<b>Ref. No.</b>	0031259
<b>description</b>	hexagonal screw thread M6 thread L 30mm SS WS 10 Qty 20 pcs DIN 933 / ISO 4017		
<b>For models:</b>	DT100, DT60, Falcon2-60, Falcon2-70, H300-1, H300-2, H300-A-1, H300-A-2, H600, H800, Marlin46, Marlin52, Marlin90, Polar2-40, Polar2-50, Polar2-75, Polar2-85, Polar2-95, Vortex		

side bolts			
			
1			
<b>GEV No.</b>	560298	<b>Ref. No.</b>	0065016
<b>description</b>	flat-headed bolt thread M6 L 20mm SS Qty 1 pcs intake hexagonal 4mm		
<b>For models:</b>	Boxer35, Boxer42, Boxer42XL, Boxer42XLBA, Boxer42XL-BA, Boxer52, Boxer62, Falcon2-60, Falcon2-70, H100, H150, H200, H200-2, H200-A, H200-A-2, H200-XL, H200-XL-2, H220, H220-2, H220-A, H220-A-2, Jumbo30, Jumbo35, Jumbo42, Jumbo42XL, Jumbo50, Marlin42, Marlin42XL		

knurled screws			
			
1			
<b>GEV No.</b>	560421	<b>Ref. No.</b>	0065010
<b>description</b>	Thumb screw thread M4 thread L 10mm ø 16mm H 13mm SS		
<b>For models:</b>	H100, H150, H200, H200-2, H200-A, H200-A-2, H200-XL, H200-XL-2, H220, H220-2, H220-A, H220-A-2, JumboPlus, MiniJumbo, Vortex		

nuts			
cap nuts			
			
1			
<b>GEV No.</b>	560137	<b>Ref. No.</b>	0020096
<b>description</b>	cap nuts thread M6 WS 10 SS Qty 20 pcs DIN/ISO DIN 1587		
<b>For models:</b>	Falcon2-60, Falcon2-70, Polar2-40, Polar2-50, Polar2-75, Polar2-85, Polar2-95		

hexagonal nuts			
DIN 934 / ISO 4032/8673			
			
1			
<b>GEV No.</b>	511212	<b>Ref. No.</b>	0020030
<b>description</b>	hexagonal nut thread M6 H 5mm WS 10 SS DIN/ISO DIN 934 / ISO 4032/8673 Qty 1 pcs		
<b>For models:</b>	Boxer35, Boxer42, Boxer42XL, Boxer42XL-BA, Boxer52, Boxer62, DT100, DT60, Falcon2-60, Falcon2-70, Falcon52, Falcon80, H100, H150, H200, H200-2, H200-A, H200-A-2, H200-XL, H200-XL-2, H220, H220-2, H220-A, H220-A-2, H300-1, H300-2, H300-A-1, H300-A-2, H300-AA, H400-AA, Jumbo30, Jumbo35, Jumbo42, Jumbo42XL, Jumbo50, JumboPlus, Lynx32, Lynx42, Marlin42, Marlin42XL, Marlin46, Marlin52, Marlin90, MiniJumbo, Polar2-40, Polar2-50, Polar2-75, Polar2-85, Polar2-95, Polar52...(Other models you can see in the webshop)		

DIN 985			
			
1			
<b>GEV No.</b>	560142	<b>Ref. No.</b>	0020035
<b>description</b>	hexagonal nut thread M6 H 6mm SS WS 10 Qty 20 pcs DIN/ISO DIN 985 self-locking		
<b>For models:</b>	Boxer35, Boxer42, Boxer42XL, DT100, DT60, Falcon2-60, Falcon2-70, Falcon52, H100, H150, H200, H200-2, H200-A, H200-A-2, H200-XL, H200-XL-2, H220, H220-2, H220-A, H220-A-2, H300-1, H300-2, H300-A-1, H300-A-2, H300-AA, H500, H700, Jumbo30, Jumbo35, Jumbo42, Jumbo42XL, Jumbo50, JumboPlus, Lynx32, Lynx42, Marlin42, Marlin42XL, Marlin46, Marlin90, MiniJumbo, Polar2-40, Polar2-50, Polar2-75, Polar2-85, Polar2-95, Polar52, Polar80, Vortex		

washers

washers

DIN 125A



1

<b>GEV No.</b>	560333	<b>Ref. No.</b>	0010026
<b>description</b>	plain washer ID ø 6.4mm ED ø 12mm thickness 1.6mm SS Qty 1 pcs DIN 125A for thread M6		
<b>For models:</b>	Boxer42, Boxer42XL, DT100, DT60, Falcon2-60, Falcon2-70, Falcon52, Falcon80, H220, H220-2, H220-A, H220-A-2, H300-1, H300-2, H300-A-1, H300-A-2, H300-AA, H300-RVS, H400-AA, H400-RVS, H500, H600, H700, H800, Lynx32, Lynx42, Marlin42XL, Marlin46, Marlin52, Marlin90, Polar2-40, Polar2-50, Polar2-75, Polar2-85, Polar2-95, Polar52, Polar80, Toucan42, Vortex		



2

<b>GEV No.</b>	560113	<b>Ref. No.</b>	0010026
<b>description</b>	plain washer ID ø 6.4mm ED ø 12mm thickness 1.6mm SS Qty 20 pcs DIN 125A for thread M6		

fasteners

retaining rings

DIN 471



1

<b>GEV No.</b>	692065	<b>Ref. No.</b>	0065250 0065250000
<b>description</b>	retaining ring for vacuum packing machine shaft ø 6mm thickness 0.7mm SS DIN 471		
<b>For models:</b>	Boxer35, Boxer42, Boxer42XL, Boxer52, Boxer62, H100, H150, H200, H200-2, H200-A, H200-A-2, H200-XL, H200-XL-2, H220, H220-2, H220-A, H220-A-2, Jumbo30, Jumbo35, Jumbo42, Jumbo42XL, Jumbo50, JumboPlus, Marlin42, Marlin42XL, MiniJumbo, Toucan42		



1

<b>GEV No.</b>	523025	<b>Ref. No.</b>	0065260
<b>description</b>	retaining ring shaft ø 24mm thickness 1mm SS DIN 471		
<b>For models:</b>	H500, H600, H700, H800, Polar2-40, Polar2-50, Polar2-75, Polar2-85, Polar2-95		



1

<b>GEV No.</b>	560302	<b>Ref. No.</b>	0065251
<b>description</b>	retaining ring shaft ø 8mm thickness 0.8mm SS DIN 471		
<b>For models:</b>	Boxer35, Boxer42, Boxer42XL, Boxer52, Boxer62, H100, H150, H200, H200-2, H200-A, H200-A-2, H200-XL, H200-XL-2, H220, H220-2, H220-A, H220-A-2, Jumbo30, Jumbo35, Jumbo42, Jumbo42XL, Jumbo50, Lynx32, Lynx42, Marlin42, Marlin42XL, Toucan42		

consumables

lubricants

oils

for vacuum pumps



1

<b>GEV No.</b>	890296	<b>Ref. No.</b>	0439510
<b>description</b>	oil type V32 1l for vacuum packing machine		
<b>For models:</b>	Lynx32, Lynx42		



1

<b>GEV No.</b>	890253	<b>Ref. No.</b>	0439520
<b>description</b>	oil type VM100 1l for vacuum packing machine		





1

<b>GEV No.</b>	890247	<b>Ref. No.</b>	0439500
<b>description</b>	oil type VM22 0.05l for vacuum packing machine		
<b>For models:</b>	MiniJumbo		



			
1			
<b>GEV No.</b>	890248	<b>Ref. No.</b>	0439501
<b>description</b>	oil type VM22 1l for vacuum packing machine		

			
1			
<b>GEV No.</b>	890251	<b>Ref. No.</b>	0439505
<b>description</b>	oil type VM32 0.5l for vacuum packing machine		

			
1			
<b>GEV No.</b>	890200	<b>Ref. No.</b>	0439502
<b>description</b>	oil type VM32 0.25l for vacuum packing machine		
<b>For models:</b>	JumboPlus, Lynx32		

			
1			
<b>GEV No.</b>	890252	<b>Ref. No.</b>	0439510 old version
<b>description</b>	oil type VM32 1l for vacuum packing machine		

			
1			
<b>GEV No.</b>	890250	<b>Ref. No.</b>	0439503
<b>description</b>	oil type VM32 0.3l for vacuum packing machine		
<b>For models:</b>	Lynx42		





<b>C</b>			
cap nuts	35		
consumables	36		
contactors	5		
control equipment	4		
countersunk screws	34		
<b>E</b>			
electric accessories	14		
extraction and pressure hoses	34		
<b>F</b>			
fans	12		
fasteners	36		
fastening material	34		
flat-headed bolts	35		
float switches	3		
foam rubber gaskets	31		
<b>H</b>			
heating elements	3		
hexagonal nuts	35		
hexagonal screws	35		
hose connectors	34		
hoses	34		
hot air motors	12		
<b>I</b>			
industrial hoses	34		
<b>K</b>			
knurled screws	35		
<b>L</b>			
lubricants	36		
<b>M</b>			
male fastons	14		
measuring equipment	34		
meters	34		
microswitches	3		
<b>N</b>			
nuts	35		
<b>O</b>			
oils	36		
O-rings	30		
<b>P</b>			
pressure measurement	34		
pumps	13		
<b>R</b>			
retaining rings	36		
rocker/momentary rocker switches	3		
rotary switches	4		
<b>S</b>			
screws	34		
sealing washers	31		
shaft gaskets	31		
side bolts	35		
solenoid valves	10		
switches and momentary switches	3		
<b>T</b>			
terminals and connectors	14		
transformers	6		
<b>V</b>			
vacuum pumps	13		
<b>W</b>			
washers	36		