



GAS COMPONENTS



ELECTRIC COMPONENTS



WATER TECHNOLOGY



MECHANICAL COMPONENTS



TOOLS

Spare parts suitable for

HEMERSON

Find the complete and up-to-date range of products in our GEV Webshop



Manufacturer catalogue

The most important spare parts and accessories arranged clearly for every manufacturer

- ✓ Complete product range and all appliance data always up to date in the GEV Webshop
- ✓ Alphabetical Index at the end of the catalogue

GEV Webshop

www.gev-online.co.uk

www.gev-online.com



- 🔍 Add to Favourites
- 🔍 Sign In with email address and usual password
- 🔍 Easy-order – place several items in your basket at the same time
- 🔍 Quick Item search – no login needed



heating elements

immersion heating elements

3 hole flange ø38.5mm

GEV No.	418883	Ref. No.	041129 140008
description	heating element 2700W 230V mounting ø 38.5mm heating circuits 2 L 295mm W 21mm H 32mm number of thermostat sleeves 1 thermostat sleeves ø 6.5mm length thermostat sleeves 225mm thermostat sleeve not clinging tube ø 6.3mm hole distance 56.5mm hole ø 11mm connection male faston 6.3mm immersion heater		
accessories for	418883		
	GEV No.	508398	Ref. No. 011008
	flat gasket silicone ED ø 48mm ID ø 38mm thickness 3mm Qty 1 pcs		

GEV No.	418882	Ref. No.	140217
description	heating element 3990W 230V mounting ø 38.5mm heating circuits 3 L 300mm W 32mm H 27mm number of thermostat sleeves 1 thermostat sleeves ø 6.5mm length thermostat sleeves 220mm thermostat sleeve not clinging tube ø 6.5mm hole distance 57mm hole ø 10.5mm connection male faston 6.3mm immersion heater		
accessories for	418882		
	GEV No.	508398	Ref. No. 011008
	flat gasket silicone ED ø 48mm ID ø 38mm thickness 3mm Qty 1 pcs		

GEV No.	418884	Ref. No.	141303
description	heating element 6000W 230V mounting ø 38.5mm heating circuits 3 L 370mm W 23mm H 33mm number of thermostat sleeves 1 thermostat sleeves ø 6.5mm length thermostat sleeves 225mm thermostat sleeve not clinging tube ø 6.5mm hole distance 56mm hole ø 11mm connection male faston 6.3mm immersion heater boiler		

1 1/4"

GEV No.	415271	Ref. No.	141101
description	heating element 4500W 230V heating circuits 3 thread 1 1/4" L 88mm W 285mm H 60mm L1 100mm L2 185mm W1 33mm W2 272mm H1 35mm H2 25mm tube ø 6.3mm connection male faston 6.3mm connection length 36mm flange with thread immersion heater		
accessories for	415271		
	GEV No.	510405	Ref. No. —
	flat gasket fibre ED ø 56mm ID ø 42mm thickness 2mm for thread 1 1/4" Qty 1 pcs		
	GEV No.	520232	Ref. No. —
	nut thread 1 1/4" H 5mm nickel-plated brass WS 47 Qty 1 pcs		
	GEV No.	528021	Ref. No. —
	flat gasket PTFE ED ø 53mm ID ø 42.5mm thickness 3mm Qty 1 pcs equiv. no. 12001/02286 suitable for Astoria/Aurora/Brasilia/Wega		

GEV No.	418881	Ref. No.	041007
description	heating element 2000W 230V heating circuits 1 L 245mm W 120mm H 25mm thread M12x1 mounting distance 45mm tube ø 6.3mm connection male faston 6.3mm 2 hole fixing connection length 25mm immersion heater tank		
accessories for	418881		
	GEV No.	504512	Ref. No. 011014
	O-ring EPDM thickness 1.78mm ID ø 14mm Qty 1 pcs		

thermostats

control and safety thermostats

EGO

safety thermostats

55.32_ series

GEV No.	375863	Ref. No.	041033
description	safety thermostat switch-off temp. 177°C 3-pole 20A probe ø 4mm probe L 128mm capillary pipe 2050mm capillary pipe isolated 2x110mm gland nut probe standard probe material SS		

electric components



switches and momentary switches

push/momentary push switches

28.5x28.5mm



1

GEV No.	346491	Ref. No.	041044
description	push switch mounting measurements 28.5x28.5mm green/black 2NO 250V 16A connection male faston 6.3mm ambient temperature max. 150°C protection IP40 with indicator		

34.1x23.1mm



1

GEV No.	347489	Ref. No.	041032
description	push switch mounting measurements 34.1x23.1mm black 2NO 250V 16A connection male faston 6.3mm with indicator		

miscellaneous



1

GEV No.	347171	Ref. No.	041016
description	momentary push switch mounting measurements 23x32mm black NO 230V 16A connection male faston 6.3mm ambient temperature max. 85°C protection IP40		

accessories for 347171



GEV No.	345739	Ref. No.	—
description	push button L 25mm W 19.5mm black		



1

GEV No.	347170	Ref. No.	041014
description	push switch mounting measurements 23x32mm black 2NO 250V 16A with indicator connection male faston 6.3mm ambient temperature max. 85°C protection IP40 with indicator		

accessories

push buttons



1

GEV No.	347172	Ref. No.	131613
description	push button mounting ø 12mm silver		

microswitches

pin-plunger actuated

M10



1

GEV No.	345224	Ref. No.	041002
description	microswitch with plunger thread M10x0.75 250V 16A 1CO connection male faston 6.3mm stroke 6mm		

non-standard



1

GEV No.	347165	Ref. No.	131735 141201
description	microswitch complete incl. holder mounting distance 49mm 250V 16A 1NO connection male faston 6.3mm ambient temperature max. 125°C with plunger door contact switch actuating force: 140g 1-pole		

magnetic switches

M10x0.75



1

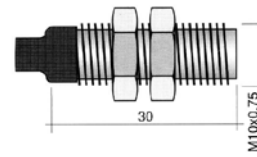

GEV No.	345632	Ref. No.	131446
description	magnetic switch thread M10x0.75 1NO 250V 0.5A P max. 50W connection cable cable length 2000mm type 102		

accessories for 345632



GEV No.	100779	Ref. No.	—
description	nut thread M10x0.75 H 3mm WS 14 SS Qty 2 pcs		



accessories

magnets

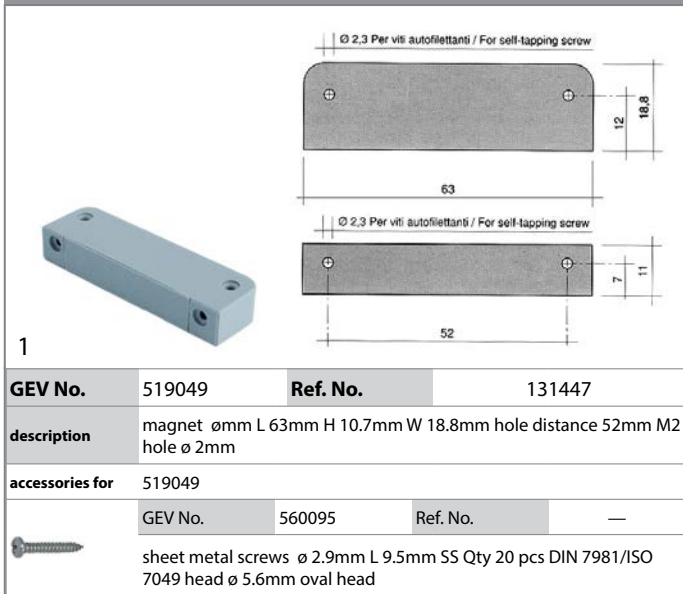

1

GEV No.	519049	Ref. No.	131447
description	magnet ømm L 63mm H 10.7mm W 18.8mm hole distance 52mm M2 hole ø 2mm		
accessories for	519049		
	GEV No.	560095	Ref. No.
			—
	sheet metal screws ø 2.9mm L 9.5mm SS Qty 20 pcs DIN 7981/ISO 7049 head ø 5.6mm oval head		

lamps

indicator lights

indicator lights (complete)

34.1x23.1mm

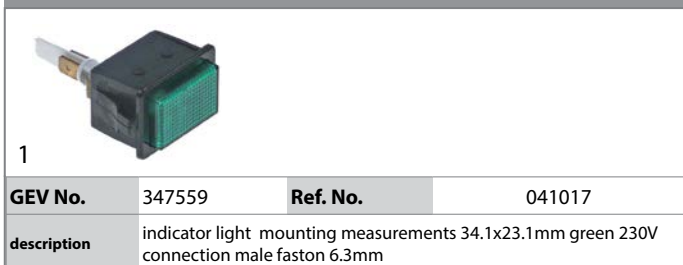

1

GEV No.	347559	Ref. No.	041017
description	indicator light mounting measurements 34.1x23.1mm green 230V connection male faston 6.3mm		

timers

programme timers



1

GEV No.	360706	Ref. No.	984374
description	timer CDC 4804M1 engines 1 chambers 4 operation time 120s 230V shaft ømm shaft Lmm manuf. no. 4804M10ADE000.1000		

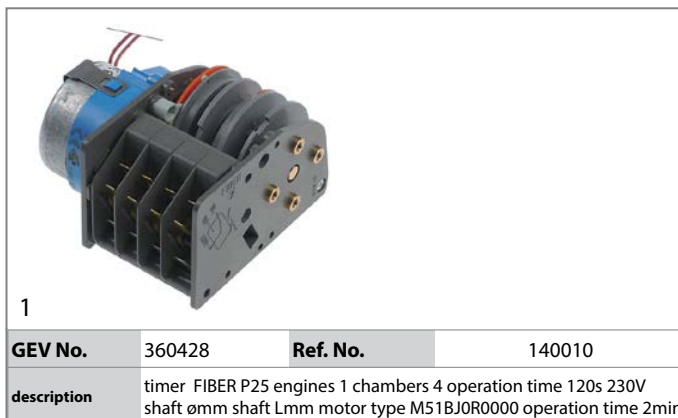

1

GEV No.	360428	Ref. No.	140010
description	timer FIBER P25 engines 1 chambers 4 operation time 120s 230V shaft ømm shaft Lmm motor type M51BJ0R0000 operation time 2min		

contactors

LOVATO

overload switches

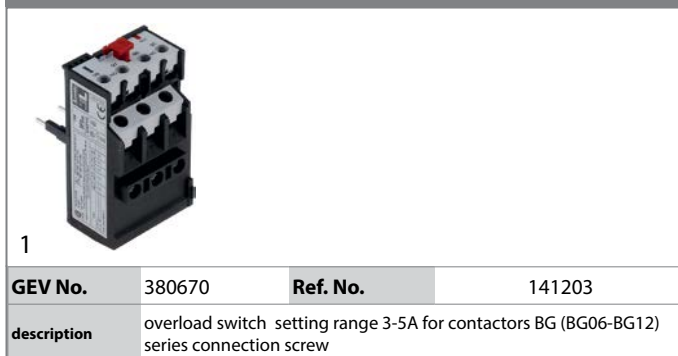

1

GEV No.	380670	Ref. No.	141203
description	overload switch setting range 3-5A for contactors BG (BG06-BG12) series connection screw		

solenoid valves

solenoid valves (water)

ROBERTSHAW/INVENSYS

medium temperature: 90°C 90°C 60°C
 ambient temperature: 60°C 25°C 60°C
 duty cycle: 40% 100% 100%

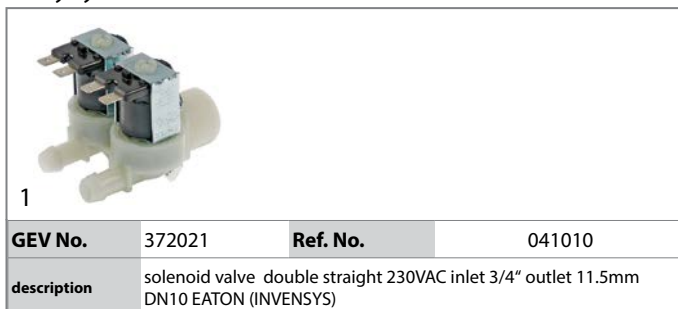

1

GEV No.	372021	Ref. No.	041010
description	solenoid valve double straight 230VAC inlet 3/4" outlet 11.5mm DN10 EATON (INVENSYS)		

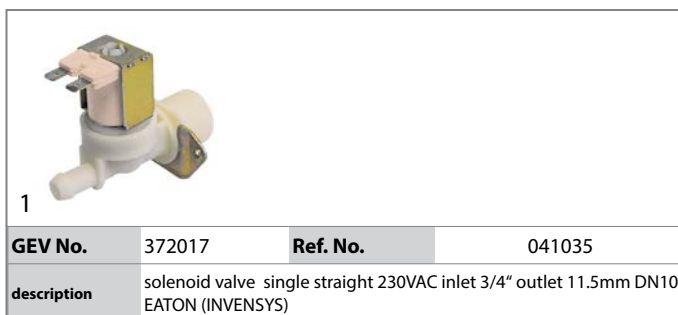

1

GEV No.	372017	Ref. No.	041035
description	solenoid valve single straight 230VAC inlet 3/4" outlet 11.5mm DN10 EATON (INVENSYS)		



TP

solenoid valves with reducers



1

GEV No.	370250	Ref. No.	140003
description	solenoid valve triple straight 230VAC inlet 3/4" outlet 11.5mm t.max. 90°C TP plastic output B 0.25l/min flow regulating valve outlet B red		

pressure switches

for warewashing

ø 58mm with male faston 6.3mm

with connection horizontal



1

GEV No.	541165	Ref. No.	140007
description	pressure control pressure range 60/30mbar connection 6mm ø 58mm pressure connection horizontal warewashing pressure connection ø 6mm		



1

GEV No.	541577	Ref. No.	131343
description	pressure control pressure range 83/33mbar connection 6mm ø 58mm pressure connection horizontal pressure connection ø 6mm		



1

GEV No.	541017	Ref. No.	040009
description	pressure control with mounting strap pressure range 40/20mbar connection 6mm ø 58mm pressure connection horizontal warewashing		

pumps





wash and rinse pumps

FIR







pumps



1

GEV No.	499105	Ref. No.	040001	
description	pump inlet ø 30mm outlet ø 30mm type 2286D1405 220/240V 50Hz 1 phase 0.18kW 0.25HP L 180mm rotation direction right capacitor 10µF FIR			
spare parts for	499105			
	GEV No.	365015	Ref. No.	—
	operating capacitor capacity 10µF 400V tolerance 5%Hz ambient temperature max. -25 to +85°C ø 35.5mm L 59mm M8 plastic connection male faston 6.3mm protection			
	GEV No.	510605	Ref. No.	—
	impellor ø 80mm H 21mm M7L			
	GEV No.	510702	Ref. No.	N/A
	mechanical shaft seal height counter ring 5.5mm ID ø 12mm			
	GEV No.	521571	Ref. No.	—
	pump cover FIR inlet ø 30mm outlet ø 30mm turn direction right ø 128mm ID ø 100mm inner height 21mm			
	GEV No.	521701	Ref. No.	—
	pump cover gasket			



GEV No.	500038	Ref. No.	140216
description	pump inlet ø 45mm outlet ø 40mm type 3911.1425 230V 50Hz 1 phase 0.55kW 0.75HP L 205mm rotation direction right capacitor 10µF FIR		
spare parts for	500038		
	GEV No.	365015	Ref. No. —
	operating capacitor capacity 10µF 400V tolerance 5%Hz ambient temperature max. -25 to +85°C ø 35.5mm L 59mm M8 plastic connection male faston 6.3mm protection		
	GEV No.	510508	Ref. No. —
	pump cover FIR inlet ø 45mm outlet ø 40mm pump type PU 0.5/3911 turn direction right ø 160mm ID ø 125mm inner high 25mm		
	GEV No.	510610	Ref. No. —
	impellor ø 95.5mm H 23mm shaft intake ø 9/8mm rotation direction right seat ø 16mm blades 6		
	GEV No.	510692	Ref. No. 110003
	mechanical shaft seal for shaft ø 11mm slide ring ext. ø 24mm slide ring H 13mm counter ring mounting ø 26mm height counter ring 8mm counter ring int. ø 14mm		
	GEV No.	521702	Ref. No. —
	pump cover gasket thickness 3.5x4.5mm Qty 1 pcs		
accessories for	500038		
	GEV No.	551286	Ref. No. —
	adapter L 120mm 4-pole for Meiko pump suitable for 500038 plug type dependent on equipment		



GEV No.	499285	Ref. No.	041100
description	pump inlet ø 45mm outlet ø 43mm type 4242.1400 230V 50Hz 1 phase 0.37kW 0.5HP L 270mm rotation direction right FIR		



GEV No.	500989	Ref. No.	141020 8415000
description	pump inlet ø 45mm outlet ø 43mm type 4242.1500 230V 50Hz 1 phase 0.55kW 0.75HP L 275mm rotation direction right capacitor 12.5µF FIR 2800rpm		
spare parts for	500989		
	GEV No.	365014	Ref. No. —
	operating capacitor capacity 12.5µF 450V tolerance 5%Hz ambient temperature max. -25 to +85°C ø 35mm L 70mm M8 plastic connection male faston 6.3mm 45S.C3DS.12.5 protection		



drain pumps

GRE



1	GEV No.	500961	Ref. No.	041036
	description	drain pump inlet ø 30mm outlet ø 23mm 100W 230V 50Hz GRE		
	accessories for	500961		
	GEV No.	524719	Ref. No.	—
	description	formed hose hose ext. ø 40mm hose int. ø 30mm L 65mm warewashing black Qty 1		

overflow pipes



1	GEV No.	510049	Ref. No.	131130
	description	overflow pipe L 103mm ø 34mm stainless steel ID ø 30mm thickness 2mm		



1	GEV No.	519584	Ref. No.	131039
	description	overflow pipe L 90mm ø 27mm		

equipment-specific units

for dishwashers

drain and intake components

miscellaneous

drain /intake bodies



1	GEV No.	524041	Ref. No.	020009
	description	drain fitting thread 1" H 45mm hose ø 27mm		



1	GEV No.	510124	Ref. No.	021210
	description	drain fitting thread 1¼" ED ø 56mm ID ø 26mm hose ø 32mm L 66mm end piece ext. ø 38mm		

containers

salt tanks









1	GEV No.	510929	Ref. No.	021038
	description	salt tank ø 120mm H 117mm hose ø 10mm mounting ø 70mm overall height 157mm		
	spare parts for	510929		
	GEV No.	506015	Ref. No.	—
	description	O-ring EPDM thickness 3.53mm ID ø 39.69mm Qty 1 pcs		
	GEV No.	510018	Ref. No.	—
	description	nut ø 92mm H 10.5mm for salt tank ID ø 64mm		
	GEV No.	524177	Ref. No.	—
	description	lid ø 69mm H 20mm for salt tank ID ø 50mm		
	accessories for	510929		
	GEV No.	510071	Ref. No.	—
	description	flat gasket rubber ED ø 81mm ID ø 68mm thickness 3mm for salt tank Qty 1 pcs		
	GEV No.	510654	Ref. No.	—
	description	gasket H 6mm D1 ø 82mm D2 ø 68mm		

Table continues overleaf



accessories for	510929		
	GEV No.	510883	Ref. No. —
	gasket rubber ED ø 86mm ID ø 66mm thickness 2mm for salt tank Qty 1 pcs		





boilers

boilers for dishwashers

	1		
GEV No.	510126	Ref. No.	131390
description	boiler insulated ø 150mm L 465mm flange 3 hole flange inlet ø 40		

air traps

air traps

	1		
GEV No.	503113	Ref. No.	020052
description	air trap		
accessories for	503113		
	GEV No.	503114	Ref. No. —
	silicone hose ED ø 7mm ID ø 4mm for pressure switch warewashing		
	GEV No.	503115	Ref. No. —
	nut		
	GEV No.	503116	Ref. No. —
	screw connection		
	GEV No.	503117	Ref. No. —
	hose connector		
	GEV No.	503118	Ref. No. —
	gasket ø 16x24mm H 2mm rubber		
	GEV No.	503119	Ref. No. —
	gasket ø 24x36mm H 2mm rubber		

door mechanics

locks

	1		
GEV No.	506157	Ref. No.	131012 131640
description	door catch catch		

screw connections

	1		
GEV No.	507056	Ref. No.	085412
description	nut thread 1" H 14mm WS 46 ø 52mm		

	1		
GEV No.	506027	Ref. No.	191112
description	nut thread 2" for intake body		

	1		
GEV No.	507058	Ref. No.	085415
description	screw connection thread 1¼" H 14mm WS 55		

baskets

warewashing baskets

steel wire baskets square

mix baskets

	1		
GEV No.	971001 ¹	Ref. No.	090200
description	mix basket L 350mm W 350mm H 120mm mesh type wide-meshed		

¹wide-meshed

accessories

cutlery inserts



1			
GEV No.	970349	Ref. No.	090001
description	cutlery insert L 130mm W 57mm ømm H 110mm		

sealing washers

rubber gaskets



1			
GEV No.	504507	Ref. No.	111007
description	flat gasket rubber ED ø 49.5mm ID ø 39mm thickness 2mm Qty 1 pcs equiv. no. 049038 suitable for ZANUSSI		



1			
GEV No.	517205	Ref. No.	111105
description	flat gasket rubber ED ø 75mm ID ø 58mm thickness 3mm Qty 1 pcs		



1			
GEV No.	510878	Ref. No.	9011000
description	gasket rubber ED ø 23.5mm ID ø 14mm thickness 2.3mm Qty 1 pcs size 3/4"		



1			
GEV No.	510006	Ref. No.	011013
description	gasket rubber ED ø 49mm ID ø 32mm thickness 1.5mm Qty 1 pcs		

PTFE gaskets



1			
GEV No.	506164	Ref. No.	111002
description	flat gasket PTFE ED ø 57mm ID ø 41mm thickness 2mm Qty 1 pcs		

silicone gaskets



1			
GEV No.	508398	Ref. No.	011008
description	flat gasket silicone ED ø 48mm ID ø 38mm thickness 3mm Qty 1 pcs		

gaskets

O-rings

EPDM

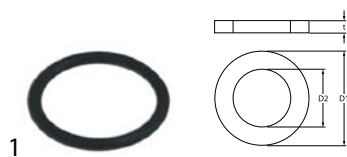

1			
GEV No.	504512	Ref. No.	011014
description	O-ring EPDM thickness 1.78mm ID ø 14mm Qty 1 pcs		

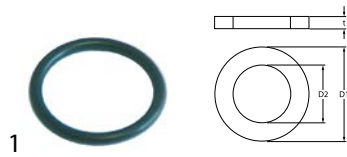

1			
GEV No.	511522	Ref. No.	011001
description	O-ring EPDM thickness 3.53mm ID ø 29.75mm Qty 10 pcs		

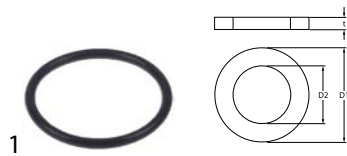

1			
GEV No.	519179	Ref. No.	011003
description	O-ring EPDM thickness 3.53mm ID ø 41.28mm Qty 1 pcs		

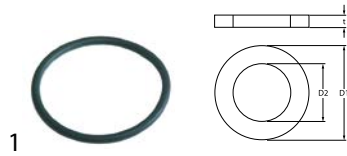

1			
GEV No.	505180	Ref. No.	011200
description	O-ring EPDM thickness 3.53mm ID ø 47.22mm Qty 1 pcs		





dosing pumps

membrane dosing pumps

self-priming

various



GEV No.	361015	Ref. No.	191002
description	dosing pump membrane dosing pump rinse aid inlet 6x8mm outlet 4x6mm pressure connection ø 4x6mm suction connection ø 6x8mm		
spare parts for	361015		
	GEV No.	361132	Ref. No. 011021
	membrane dosing pump		
	GEV No.	510298	Ref. No. —
	lip valve dosing pump suitable for DB2/DS5		

spare parts



GEV No.	361132	Ref. No.	011021
description	membrane dosing pump		

hoses

drain hoses

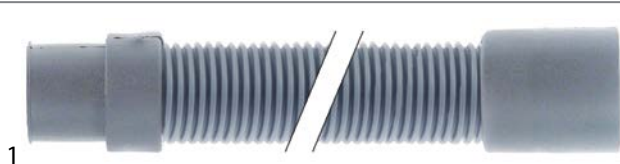

GEV No.	530607	Ref. No.	021004
description	drain hose DN24 L 2000mm A int. ø 24mm A ext. ø 28mm B int. ø 28mm B ext. ø 35mm outer hose ø 29mm temp.-resist. 90°C		

industrial hoses

pressure control hoses



GEV No.	530563	Ref. No.	020005
description	pressure hose ID ø 4mm ED ø 8.5mm L 5m operating p. 30bar burst p. 90bar temp.-resist. 60°C		

formed hoses

form L



GEV No.	530164	Ref. No.	121008 HEM121008
description	formed hose end piece A ext. ø 34mm end piece A int. ø 26mm AD2 ø 34mm ø end piece B 26mm L 110mm Qty 1 L-shape		

drain systems and wash basins

drain fittings



GEV No.	524041	Ref. No.	020009
description	drain fitting thread 1" H 45mm hose ø 27mm		

ancillary products

clamps

hose clamps

DIN 3017 - W2



GEV No.	520115	Ref. No.	021043
description	hose clamp ø 25-40mm width 9mm Qty 10 pcs DIN 3017		



1

GEV No.	520117	Ref. No.	091205
description	hose clamp stainless steel ø 40-60mm width 9mm Qty 5 pcs DIN 3017		

fasteners

clamps

hose clamps

DIN 3017 - W2



1

GEV No.	520115	Ref. No.	021043
description	hose clamp ø 25-40mm width 9mm Qty 10 pcs DIN 3017		

measuring equipment

thermometers

built-in thermometers



1

GEV No.	541095	Ref. No.	140214
description	thermometer mounting measurements 58x25.5mm 0 up to +120°C capillary pipe 3000mm probe ø 6.5mm probe L 20mm		



1

GEV No.	520117	Ref. No.	091205
description	hose clamp stainless steel ø 40-60mm width 9mm Qty 5 pcs DIN 3017		

fastening material

screws

grub screws

DIN 913/ISO 4026



1

GEV No.	560177	Ref. No.	131579
description	grub screw thread M6 L 6mm SS DIN 913 intake internal hexagon WS 3 Qty 10 pcs		

C

clamps	11, 12
contactors	5

D

dosing pumps	11
drain fittings	11
drain hoses	11
drain pumps	8
drain systems and wash basins	11

F

fasteners	12
fastening material	12
formed hoses	11

G

grub screws	12
-------------	----

H

heating elements	3
hose clamps	11, 12
hoses	11

I

immersion heating elements	3
indicator lights	5
indicator lights (complete)	5
industrial hoses	11

L

lamps	5
-------	---

M

magnetic switches	4
measuring equipment	12
microswitches	4

O

O-rings	10
---------	----

P

pressure control hoses	11
pressure switches	6
programme timers	5
pumps	6
push/momentary push switches	4

S

safety thermostats	3
screws	12
sealing washers	10

solenoid valves	5
switches and momentary switches	4

T

thermostats	3
timers	5

W

wash and rinse pumps	6
----------------------	---