



GAS COMPONENTS



ELECTRIC COMPONENTS



WATER TECHNOLOGY



MECHANICAL COMPONENTS



TOOLS

Spare parts suitable for

HEIDEBRENNER

Find the complete and up-to-date range of products in our GEV Webshop



Manufacturer catalogue

The most important spare parts and accessories arranged clearly for every manufacturer

- ✓ Complete product range and all appliance data always up to date in the GEV Webshop
- ✓ Alphabetical Index at the end of the catalogue

GEV Webshop

www.gev-online.co.uk

www.gev-online.com







- 🔍 Add to Favourites
- 🔍 Sign In with email address and usual password
- 🔍 Easy-order – place several items in your basket at the same time
- 🔍 Quick Item search – no login needed



heating elements

heating elements for ovens

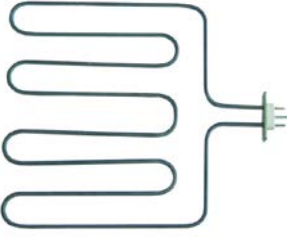
 <p>1</p>			
GEV No.	415318	Ref. No.	92732
description	heating element 2000W 230V L 427mm W 138mm L1 50mm L2 377mm W1 54mm W2 30mm windings 2 connection plug-in connection heating circuits 1 tube ø 6.3mm rectangular flange dry heating element hole distance 56mm flange length 70mm flange width 23mm hole ø M4mm		
accessories for	415318		
	GEV No.	550404	Ref. No. —
	power socket I-II phase 240V max. 16A countries I with screw connection for heating element		
	GEV No.	550405	Ref. No. —
	power socket male faston 6.3mm for heating element 2-pole + earthing		

 <p>1</p>			
GEV No.	415320	Ref. No.	92734
description	heating element 3000W 230V L 350mm W 313mm L1 75mm L2 275mm W1 138mm W2 31mm connection plug-in connection heating circuits 1 tube ø 6.3mm rectangular flange dry heating element hole distance 57mm flange length 70mm flange width 22mm hole ø M4mm connection length 34mm		
accessories for	415320		
	GEV No.	550404	Ref. No. —
	power socket I-II phase 240V max. 16A countries I with screw connection for heating element		
	GEV No.	550405	Ref. No. —
	power socket male faston 6.3mm for heating element 2-pole + earthing		

radiation heaters

<p>1-circuit</p>  <p>1</p>			
GEV No.	490150	Ref. No.	94706
description	radiation heater ø 250mm 2500W 230V heating circuits 1 energy regulation with temperature signalization with heating coil connections 2+2 connection type male faston 6.3mm EGO		

hot plates

round

with cast brim

with screw connection

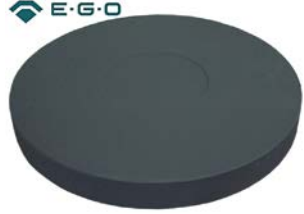
 <p>1</p>			
GEV No.	490107	Ref. No.	94201
description	hot plate ø 400mm 5000W 400V connection 4x 2 screw clamps with cast edge screw bolt H 42mm		

energy regulators

EGO

1-circuit

 <p>1</p>			
GEV No.	380015	Ref. No.	94707
description	energy regulator 230V 13A single-circuit turn direction right shaft ø 6x4.6mm shaft L 23mm mounting thread M4 power release 6-100% no. 50.57021.010		

thermostats

control and safety thermostats

EGO

control thermostats

55.10/19_ series

 <p>1</p>			
GEV No.	375313	Ref. No.	94229
description	thermostat t.max. 358°C temperature range 60-358°C 1-pole 1NO 16A probe ø 3.03mm probe L 178mm capillary pipe 870mm capillary pipe isolated 870mm gland nut shaft L 23mm shaft position upper rotation 270°		

safety thermostats

55.10/19_ series



GEV No.	390061	Ref. No.	94306
description	safety thermostat switch-off temp. 220°C 1-pole 0.5A probe ø 6mm probe L 140mm capillary pipe 900mm capillary pipe isolatedmm gland nut probe M9x1		

accessories

gland nut accessories

ducts



GEV No.	550271	Ref. No.	26001
description	gland duct ET M12x0.75 IT M9x1 with gasket and nut		

switches and momentary switches

cam switches

5-position



GEV No.	300105	Ref. No.	94202
description	cam switch 5 operating positions 3NO/1CO sequence 0-1-2-3-4 32A shaft ø 6x4.6mm shaft L 23mm connection screw 5-position ceramic		

7-position



GEV No.	300031	Ref. No.	94214
description	cam switch 7 operating positions 1NO/2CO sequence 0-1-2-3-4-5-6 16A shaft ø 6x4.6mm shaft L 23mm connection male faston 6.3mm 7-position plastic		

operation switches



GEV No.	300067	Ref. No.	94215
description	cam switch 3 operating positions 4NO 16A sequence 0-1-2 shaft ø 6x4.6mm shaft L 23mm connection male faston 6.3mm plastic		

lamps

indicator lights

indicator lights 3-piece (housing, lens and bulb)

lamps

neon light bulbs



GEV No.	359602	Ref. No.	94232
description	neon light bulb socket E14 230V clear ø 14mm L 30mm		

screw-on/push-on fit

neon light bulbs



GEV No.	359602	Ref. No.	94232
description	neon light bulb socket E14 230V clear ø 14mm L 30mm		

electric accessories

cables

copper wire

up to 200°C



GEV No.	550074	Ref. No.	94428
description	copper wire 1mm ² permanent temperature -60 up to +200°C conductor nickel-plated copper wire insulation glass fibre braiding/silicone rubber Qty 10m brown t.max. 250°C rated 300/500V test voltage 2000V		



terminals and connectors

not insulated

female fastons

iron nickel-plated



1

GEV No.	550001	Ref. No.	26009 93284
description	female faston size 6.3x0.8mm 1.0-2.5mm ² straight Fe gal Ni t.max. 340°C Qty 100 pcs		

terminals

connection terminals with screw/faston connections



1

GEV No.	550109	Ref. No.	94351
description	power terminal block 3-pole max. 40A max 250V connection M6/ male faston 6.3mm temp.-resist. 130°C		





gas taps

PEL

23S/V series



1

GEV No.	101630	Ref. No.	94600
description	gas tap PEL type 23S/V gas inlet 1/2" IT bypass nozzle \varnothing 0.35mm gas outlet 1/2" MT (tube \varnothing 14mm) thermocouple connection M10x1 pilot connection M10x1 shaft \varnothing 10mm shaft L 25mm shaft flat		
spare parts for	101630		
	GEV No.	100455	Ref. No. —
	bypass nozzle type PEL23/24 bore \varnothing 0.35mm thread M8x0.5		
	GEV No.	101059	Ref. No. 94615
	magnet unit T1: M10x1 T2: M22x1 L 46mm \varnothing 18mm suitable for PEL23S M10x1		
	GEV No.	102767	Ref. No. —
	gas tap front part shaft \varnothing 10mm shaft L 26.5mm shaft flat suitable for PEL23S		
accessories for	101630		
	GEV No.	100908	Ref. No. —
	union screw thread M10x1 for pipe \varnothing 4mm Qty 1 pcs		

accessories for	101630		
	GEV No.	100909	Ref. No. —
	union screw thread M10x1 for pipe \varnothing 6mm Qty 1 pcs		
	GEV No.	100945	Ref. No. —
	roll pin \varnothing 3.2mm L 10mm		
	GEV No.	101218	Ref. No. —
	shaft extension JUNKERS		
	GEV No.	101219	Ref. No. —
	shaft extension L 25mm JUNKERS		
	GEV No.	101246	Ref. No. —
	olive for pipe \varnothing 4mm Qty 1 pcs		
	GEV No.	101286	Ref. No. —
	olive ID \varnothing 6mm Qty 1 pcs		
	GEV No.	110064	Ref. No. 93207
	knob		
	GEV No.	110066	Ref. No. —
	knob screw		
	GEV No.	550396	Ref. No. —
	shaft extension L 25mm JUNKERS		

alternatives to EGA

GPEL22 series

with nozzle outlet



1





















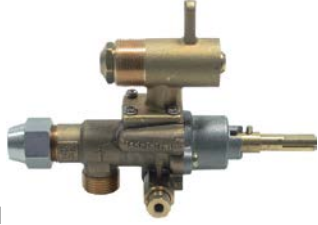



GEV No.	106676	Ref. No.	94444 Düse 2,0mm
description	gas tap alternatives to EGA type GPEL22D nozzle outlet gas inlet M18x1.5 (tube \varnothing 12mm) external nozzle \varnothing 2mm internal nozzle \varnothing 1.3mm bypass nozzle \varnothing 0.55mm mixing pipe connection M22x1 thermocouple connection M8x1 pilot connection closed shaft \varnothing 9x6.5mm shaft L 26/15mm shaft flat upper and bottom		
spare parts for	106676		
	GEV No.	100927	Ref. No. —
	torsion spring L 2.8-8.0mm for internal nozzle \varnothing 3mm bore \varnothing mm		
	GEV No.	101058	Ref. No. 93122
	magnet unit L 39mm D1 \varnothing 15.4mm D2 \varnothing 13.5mm suitable for PEL22/ EGA24197 standard		
	GEV No.	101230	Ref. No. —
	thermocouple nut T1: M8x1 T2: M18x1 aluminium		
	GEV No.	101460	Ref. No. —
	O-ring \varnothing 12.37mm D1 \varnothing 2.62mm suitable for PEL22		

Table continues overleaf















spare parts for 106676				
	GEV No.	101527	Ref. No.	—
O-ring Viton thickness 1.78mm ID ø 6.75mm Qty 1 pcs				
	GEV No.	101594	Ref. No.	—
adjusting screw for internal nozzle thread M10x0.75				
accessories for 106676				
	GEV No.	100944	Ref. No.	—
union nut thread M18x1.5 for pipe ø 12mm				
	GEV No.	101273	Ref. No.	93107
olive for pipe ø 12mm L 9.5mm brass Qty 1 pcs suitable for universal				
	GEV No.	112173	Ref. No.	N/A
knob universal ø 62mm black without adaptor/dial plate				
	GEV No.	112179	Ref. No.	N/A
knob adapter shaft ø 9x6.5mm L 0mm				
	GEV No.	112285	Ref. No.	—
knob dial plate silver gas tap without ignition flame PEL20 t.max.°C ED ø 59mm ID ø 45.5mm				

				
1				
GEV No.	106960	Ref. No.	94443	
description	gas tap alternatives to EGA type GPEL22D with nozzle outlet (with nozzle) gas inlet M18x1.5 (tube ø 12mm) external nozzle ø 3.1mm internal nozzle ø 1.8mm bypass nozzle ø 0.5mm mixing pipe connection M22x1 thermocouple connection M8x1 pilot connection M10x1 shaft ø 6.5x9mm shaft L 26/15mm shaft flat upper and bottom			
spare parts for 106960				
	GEV No.	100390	Ref. No.	94452
bypass nozzle type PEL22 bore ø 0.5mm thread M6x0.5				
	GEV No.	100908	Ref. No.	—
union screw thread M10x1 for pipe ø 4mm Qty 1 pcs				
	GEV No.	100927	Ref. No.	—
torsion spring L 2.8-8.0mm for internal nozzle ø 3mm bore ømm				
	GEV No.	101058	Ref. No.	93122
magnet unit L 39mm D1 ø 15.4mm D2 ø 13.5mm suitable for PEL22/ EGA24197 standard				
	GEV No.	101230	Ref. No.	—
thermocouple nut T1: M8x1 T2: M18x1 aluminium				
	GEV No.	101246	Ref. No.	—
olive for pipe ø 4mm Qty 1 pcs				
	GEV No.	101460	Ref. No.	—
O-ring ø 12.37mm D1 ø 2.62mm suitable for PEL22				
	GEV No.	101527	Ref. No.	—
O-ring Viton thickness 1.78mm ID ø 6.75mm Qty 1 pcs				

spare parts for 106960				
	GEV No.	101594	Ref. No.	—
adjusting screw for internal nozzle thread M10x0.75				
accessories for 106960				
	GEV No.	100944	Ref. No.	—
union nut thread M18x1.5 for pipe ø 12mm				
	GEV No.	101273	Ref. No.	93107
olive for pipe ø 12mm L 9.5mm brass Qty 1 pcs suitable for universal				
	GEV No.	110217	Ref. No.	—
knob gas tap with ignition flame ø 64mm shaft ø 9x7mm shaft flat horizontal black				



				
1				
GEV No.	106040	Ref. No.	N/A	
description	gas tap alternatives to EGA type GPEL22D with nozzle outlet (without nozzle) gas inlet M18x1.5 (tube ø 12mm) external nozzle ømm internal nozzle ømm bypass nozzle ø 0.35mm mixing pipe connection M22x1 thermocouple connection M8x1 pilot connection closed shaft ø 9x6.5mm shaft L 34/15mm shaft flat upper and bottom			
spare parts for 106040				
	GEV No.	100259	Ref. No.	—
bypass nozzle type PEL22 bore ø 0.35mm thread M6x0.5				
	GEV No.	101058	Ref. No.	93122
magnet unit L 39mm D1 ø 15.4mm D2 ø 13.5mm suitable for PEL22/ EGA24197 standard				
	GEV No.	101230	Ref. No.	—
thermocouple nut T1: M8x1 T2: M18x1 aluminium				
	GEV No.	101823	Ref. No.	—
gas tap front part shaft ø 6x4.6mm shaft L 35/21mm shaft flat upper/lower suitable for PEL22				
accessories for 106040				
	GEV No.	100944	Ref. No.	—
union nut thread M18x1.5 for pipe ø 12mm				
	GEV No.	101273	Ref. No.	93107
olive for pipe ø 12mm L 9.5mm brass Qty 1 pcs suitable for universal				



			
1			
GEV No.	101625	Ref. No.	94412
description	gas tap alternatives to EGA type GPEL22D with nozzle outlet (without nozzle) gas inlet M18x1.5 (tube ø 12mm) external nozzle ømm internal nozzle ømm bypass nozzle ø 0.35mm mixing pipe connection M22x1 thermocouple connection M8x1 pilot connection M10x1 shaft ø 6.5x9mm shaft L 34/15mm shaft flat right and left		
spare parts for	101625		
	GEV No.	100259	Ref. No. —
	bypass nozzle type PEL22 bore ø 0.35mm thread M6x0.5		
	GEV No.	100927	Ref. No. —
	torsion spring L 2.8-8.0mm for internal nozzle ø 3mm bore ømm		
	GEV No.	101058	Ref. No. 93122
	magnet unit L 39mm D1 ø 15.4mm D2 ø 13.5mm suitable for PEL22/ EGA24197 standard		
	GEV No.	101230	Ref. No. —
	thermocouple nut T1: M8x1 T2: M18x1 aluminium		
	GEV No.	101460	Ref. No. —
	O-ring ø 12.37mm D1 ø 2.62mm suitable for PEL22		
	GEV No.	101527	Ref. No. —
	O-ring Viton thickness 1.78mm ID ø 6.75mm Qty 1 pcs		
	GEV No.	101594	Ref. No. —
	adjusting screw for internal nozzle thread M10x0.75		
	GEV No.	101822	Ref. No. —
	gas tap front part shaft ø 10x6.5mm shaft L 34/15mm shaft flat right/ left suitable for PEL22		
accessories for	101625		
	GEV No.	100908	Ref. No. —
	union screw thread M10x1 for pipe ø 4mm Qty 1 pcs		
	GEV No.	100909	Ref. No. —
	union screw thread M10x1 for pipe ø 6mm Qty 1 pcs		
	GEV No.	100944	Ref. No. —
	union nut thread M18x1.5 for pipe ø 12mm		
	GEV No.	101246	Ref. No. —
	olive for pipe ø 4mm Qty 1 pcs		
	GEV No.	101273	Ref. No. 93107
	olive for pipe ø 12mm L 9.5mm brass Qty 1 pcs suitable for universal		
	GEV No.	101286	Ref. No. —
	olive ID ø 6mm Qty 1 pcs		

			
1			
GEV No.	106395	Ref. No.	94701
description	gas tap alternatives to EGA type GPEL22D with nozzle outlet (without nozzle) gas inlet M18x1.5 (tube ø 12mm) external nozzle ømm internal nozzle ømm bypass nozzle ø 0.35mm mixing pipe connection M22x1 thermocouple connection M8x1 pilot connection M10x1 shaft ø 6.5x9mm shaft L 34/15mm shaft flat right and left		
spare parts for	106395		
	GEV No.	100259	Ref. No. —
	bypass nozzle type PEL22 bore ø 0.35mm thread M6x0.5		
	GEV No.	100927	Ref. No. —
	torsion spring L 2.8-8.0mm for internal nozzle ø 3mm bore ømm		
	GEV No.	101058	Ref. No. 93122
	magnet unit L 39mm D1 ø 15.4mm D2 ø 13.5mm suitable for PEL22/ EGA24197 standard		
	GEV No.	101230	Ref. No. —
	thermocouple nut T1: M8x1 T2: M18x1 aluminium		
	GEV No.	101460	Ref. No. —
	O-ring ø 12.37mm D1 ø 2.62mm suitable for PEL22		
	GEV No.	101527	Ref. No. —
	O-ring Viton thickness 1.78mm ID ø 6.75mm Qty 1 pcs		
	GEV No.	101594	Ref. No. —
	adjusting screw for internal nozzle thread M10x0.75		
accessories for	106395		
	GEV No.	100908	Ref. No. —
	union screw thread M10x1 for pipe ø 4mm Qty 1 pcs		
	GEV No.	100909	Ref. No. —
	union screw thread M10x1 for pipe ø 6mm Qty 1 pcs		
	GEV No.	100944	Ref. No. —
	union nut thread M18x1.5 for pipe ø 12mm		
	GEV No.	101246	Ref. No. —
	olive for pipe ø 4mm Qty 1 pcs		
	GEV No.	101273	Ref. No. 93107
	olive for pipe ø 12mm L 9.5mm brass Qty 1 pcs suitable for universal		
	GEV No.	101286	Ref. No. —
	olive ID ø 6mm Qty 1 pcs		

			
GEV No.	106678	Ref. No.	94701-01
description	gas tap alternatives to EGA type GPEL22D with nozzle outlet (without nozzle) gas inlet M18x1.5 (tube ø 12mm) external nozzle ømm internal nozzle ømm bypass nozzle ø 0.35mm mixing pipe connection M22x1 thermocouple connection M8x1 pilot connection M10x1 shaft ø 9x6.5mm shaft L 29/12mm shaft flat right and left shaft length knob 15mm		
spare parts for	106678		
	GEV No.	100390	Ref. No. 94452
	bypass nozzle type PEL22 bore ø 0.5mm thread M6x0.5		
	GEV No.	101058	Ref. No. 93122
	magnet unit L 39mm D1 ø 15.4mm D2 ø 13.5mm suitable for PEL22/ EGA24197 standard		
	GEV No.	101230	Ref. No. —
	thermocouple nut T1: M8x1 T2: M18x1 aluminium		
accessories for	106678		
	GEV No.	100908	Ref. No. —
	union screw thread M10x1 for pipe ø 4mm Qty 1 pcs		
	GEV No.	100909	Ref. No. —
	union screw thread M10x1 for pipe ø 6mm Qty 1 pcs		
	GEV No.	100944	Ref. No. —
	union nut thread M18x1.5 for pipe ø 12mm		
	GEV No.	101246	Ref. No. —
	olive for pipe ø 4mm Qty 1 pcs		
	GEV No.	101273	Ref. No. 93107
	olive for pipe ø 12mm L 9.5mm brass Qty 1 pcs suitable for universal		
	GEV No.	101286	Ref. No. —
	olive ID ø 6mm Qty 1 pcs		

			
GEV No.	106679	Ref. No.	94700-01
description	gas tap alternatives to EGA type GPEL22D with nozzle outlet (without nozzle) gas inlet M18x1.5 (tube ø 12mm) external nozzle ømm internal nozzle ømm bypass nozzle ø 0.35mm mixing pipe connection M22x1 thermocouple connection M8x1 pilot connection M10x1 shaft ø 9x6.5mm shaft L 34/15mm shaft flat upper and bottom		
spare parts for	106679		
	GEV No.	100390	Ref. No. 94452
	bypass nozzle type PEL22 bore ø 0.5mm thread M6x0.5		

spare parts for	106679		
	GEV No.	101058	Ref. No. 93122
	magnet unit L 39mm D1 ø 15.4mm D2 ø 13.5mm suitable for PEL22/ EGA24197 standard		
	GEV No.	101230	Ref. No. —
	thermocouple nut T1: M8x1 T2: M18x1 aluminium		
	GEV No.	101823	Ref. No. —
	gas tap front part shaft ø 6x4.6mm shaft L 35/21mm shaft flat upper/lower suitable for PEL22		
accessories for	106679		
	GEV No.	100908	Ref. No. —
	union screw thread M10x1 for pipe ø 4mm Qty 1 pcs		
	GEV No.	101246	Ref. No. —
	olive for pipe ø 4mm Qty 1 pcs		















			
GEV No.	106394	Ref. No.	94700
description	gas tap alternatives to EGA type GPEL22D with nozzle outlet (without nozzle) gas inlet M18x1.5 (tube ø 12mm) external nozzle ømm internal nozzle ømm bypass nozzle ø 0.5mm mixing pipe connection M22x1 thermocouple connection M8x1 pilot connection M10x1 shaft ø 9x6.5mm shaft L 26/15mm shaft flat upper and bottom		
spare parts for	106394		
	GEV No.	100259	Ref. No. —
	bypass nozzle type PEL22 bore ø 0.35mm thread M6x0.5		
	GEV No.	100927	Ref. No. —
	torsion spring L 2.8-8.0mm for internal nozzle ø 3mm bore ømm		
	GEV No.	101058	Ref. No. 93122
	magnet unit L 39mm D1 ø 15.4mm D2 ø 13.5mm suitable for PEL22/ EGA24197 standard		
	GEV No.	101230	Ref. No. —
	thermocouple nut T1: M8x1 T2: M18x1 aluminium		
	GEV No.	101460	Ref. No. —
	O-ring ø 12.37mm D1 ø 2.62mm suitable for PEL22		
	GEV No.	101527	Ref. No. —
	O-ring Viton thickness 1.78mm ID ø 6.75mm Qty 1 pcs		
	GEV No.	101594	Ref. No. —
	adjusting screw for internal nozzle thread M10x0.75		
accessories for	106394		
	GEV No.	100908	Ref. No. —
	union screw thread M10x1 for pipe ø 4mm Qty 1 pcs		
	GEV No.	100909	Ref. No. —
	union screw thread M10x1 for pipe ø 6mm Qty 1 pcs		

Table continues overleaf



accessories for		106394		
GEV No.		100944	Ref. No.	—
	union nut thread M18x1.5 for pipe ø 12mm			
	olive for pipe ø 4mm Qty 1 pcs	101246	Ref. No.	—
	olive for pipe ø 12mm L 9.5mm brass Qty 1 pcs suitable for universal	101273	Ref. No.	93107
	olive ID ø 6mm Qty 1 pcs	101286	Ref. No.	—
	knob gas tap with ignition flame ø 64mm shaft ø 9x7mm shaft flat horizontal black	110217	Ref. No.	—

accessories for		101624		
GEV No.		100944	Ref. No.	—
	union nut thread M18x1.5 for pipe ø 12mm			
	olive for pipe ø 4mm Qty 1 pcs	101246	Ref. No.	—
	olive for pipe ø 12mm L 9.5mm brass Qty 1 pcs suitable for universal	101273	Ref. No.	93107
	olive ID ø 6mm Qty 1 pcs	101286	Ref. No.	—
	knob gas tap with ignition flame ø 64mm shaft ø 9x7mm shaft flat horizontal black	110217	Ref. No.	—

				
1				
GEV No.	101624	Ref. No.	94411	
description	gas tap alternatives to EGA type PEL22S with nozzle outlet (without nozzle) gas inlet M18x1.5 (tube ø 12mm) external nozzle ømm internal nozzle ømm bypass nozzle ø 0.35mm mixing pipe connection M22x1 thermocouple connection M8x1 pilot connection M10x1 shaft ø 9x6.5mm shaft L 34/15mm shaft flat upper and bottom			
spare parts for	101624			
	GEV No.	100259	Ref. No.	—
	bypass nozzle type PEL22 bore ø 0.35mm thread M6x0.5			
	GEV No.	100927	Ref. No.	—
	torsion spring L 2.8-8.0mm for internal nozzle ø 3mm bore ømm			
	GEV No.	101058	Ref. No.	93122
	magnet unit L 39mm D1 ø 15.4mm D2 ø 13.5mm suitable for PEL22/ EGA24197 standard			
	GEV No.	101230	Ref. No.	—
	thermocouple nut T1: M8x1 T2: M18x1 aluminium			
	GEV No.	101460	Ref. No.	—
	O-ring ø 12.37mm D1 ø 2.62mm suitable for PEL22			
	GEV No.	101527	Ref. No.	—
	O-ring Viton thickness 1.78mm ID ø 6.75mm Qty 1 pcs			
	GEV No.	101594	Ref. No.	—
	adjusting screw for internal nozzle thread M10x0.75			
	GEV No.	101821	Ref. No.	—
	gas tap front part shaft ø 9x6.5mm shaft L 34/15mm shaft flat upper/ lower suitable for PEL22			
accessories for	101624			
	GEV No.	100908	Ref. No.	—
	union screw thread M10x1 for pipe ø 4mm Qty 1 pcs			
	GEV No.	100909	Ref. No.	—
	union screw thread M10x1 for pipe ø 6mm Qty 1 pcs			







with pipe outlet				
				
1				
GEV No.	101666	Ref. No.	94413	
description	gas tap alternatives to EGA type GPEL22R with pipe outlet gas inlet M18x1.5 (tube ø 12mm) bypass nozzle ø 0.35mm gas outlet M18x1.5 (tube ø 12mm) thermocouple connection M8x1 pilot connection M10x1 shaft ø 9x6.5mm shaft L 34/15mm shaft flat right/left			
spare parts for	101666			
	GEV No.	100259	Ref. No.	—
	bypass nozzle type PEL22 bore ø 0.35mm thread M6x0.5			
	GEV No.	101058	Ref. No.	93122
	magnet unit L 39mm D1 ø 15.4mm D2 ø 13.5mm suitable for PEL22/ EGA24197 standard			
	GEV No.	101230	Ref. No.	—
	thermocouple nut T1: M8x1 T2: M18x1 aluminium			
	GEV No.	101460	Ref. No.	—
	O-ring ø 12.37mm D1 ø 2.62mm suitable for PEL22			
	GEV No.	101822	Ref. No.	—
	gas tap front part shaft ø 10x6.5mm shaft L 34/15mm shaft flat right/left suitable for PEL22			
accessories for	101666			
	GEV No.	100908	Ref. No.	—
	union screw thread M10x1 for pipe ø 4mm Qty 1 pcs			
	GEV No.	100909	Ref. No.	—
	union screw thread M10x1 for pipe ø 6mm Qty 1 pcs			
	GEV No.	100944	Ref. No.	—
	union nut thread M18x1.5 for pipe ø 12mm			
	GEV No.	101246	Ref. No.	—
	olive for pipe ø 4mm Qty 1 pcs			

Table continues overleaf

accessories for	101666		
	GEV No.	101273	Ref. No. 93107
	olive for pipe ø 12mm L 9.5mm brass Qty 1 pcs suitable for universal		
	GEV No.	101286	Ref. No. —
	olive ID ø 6mm Qty 1 pcs		











alternatives to JUNKERS

	1		
GEV No.	101630	Ref. No.	94600
description	gas tap PEL type 23S/V gas inlet 1/2" IT bypass nozzle ø 0.35mm gas outlet 1/2" MT (tube ø 14mm) thermocouple connection M10x1 pilot connection M10x1 shaft ø 10mm shaft L 25mm shaft flat		
spare parts for	101630		
	GEV No.	100455	Ref. No. —
	bypass nozzle type PEL23/24 bore ø 0.35mm thread M8x0.5		
	GEV No.	101059	Ref. No. 94615
	magnet unit T1: M10x1 T2: M22x1 L 46mm ø 18mm suitable for PEL23S M10x1		
	GEV No.	102767	Ref. No. —
	gas tap front part shaft ø 10mm shaft L 26.5mm shaft flat suitable for PEL23S		
accessories for	101630		
	GEV No.	100908	Ref. No. —
	union screw thread M10x1 for pipe ø 4mm Qty 1 pcs		
	GEV No.	100909	Ref. No. —
	union screw thread M10x1 for pipe ø 6mm Qty 1 pcs		
	GEV No.	100945	Ref. No. —
	roll pin ø 3.2mm L 10mm		
	GEV No.	101218	Ref. No. —
	shaft extension JUNKERS		
	GEV No.	101219	Ref. No. —
	shaft extension L 25mm JUNKERS		
	GEV No.	101246	Ref. No. —
	olive for pipe ø 4mm Qty 1 pcs		
	GEV No.	101286	Ref. No. —
	olive ID ø 6mm Qty 1 pcs		
	GEV No.	110064	Ref. No. 93207
	knob		
	GEV No.	110066	Ref. No. —
	knob screw		
	GEV No.	550396	Ref. No. —
	shaft extension L 25mm JUNKERS		

MADEC (MP)

with nozzle outlet



GEV No.	101073	Ref. No.	93618
description	gas tap MADEC with nozzle outlet (without nozzle) gas inlet M12x1 (tube ø 8mm) external nozzle ømm internal nozzle ømm bypass nozzle ø 0.35mm mixing pipe connection M17x1 thermocouple connection M8x1 front fixing M12x1 shaft ø 8x5mm shaft L 23/13.5mm shaft flat right gas outlet M17x1		
spare parts for	101073		
	GEV No.	100936	Ref. No. —
	gas tap spindle shaft ø 5x8mm MADEC		
	GEV No.	101051	Ref. No. —
	magnet unit L 27mm D1 ø 12.5mm D2 ø 8.5mm suitable for JUNKERS/EGA/MADEC/SABAF standard		
	GEV No.	101234	Ref. No. —
	union nut T1: M8x1 T2: M15		
accessories for	101073		
	GEV No.	100927	Ref. No. —
	torsion spring L 2.8-8.0mm for internal nozzle ø 3mm bore ømm		
	GEV No.	101277	Ref. No. 93106
	olive ID ø 8mm Qty 1 pcs		
	GEV No.	101296	Ref. No. —
	union nut thread M12x1 for pipe ø 8mm		
	GEV No.	101299	Ref. No. —
	nut thread M12x1		
	GEV No.	101400	Ref. No. —
	air mixing tube thread M17x1 suitable for L350, L700		
	GEV No.	110148	Ref. No. —
	knob gas tap without ignition flame ø 50mm shaft ø 8x5mm shaft flat left black		
	GEV No.	110150	Ref. No. 93118
	knob gas tap without ignition flame t.max.°C ø 50mm shaft ø 8x5.5mm shaft flat right white		







gas thermostats

SIT

710 Minisit series



GEV No.	101385	Ref. No.	93201
description	gas thermostat SIT type MINISIT 710 t.max. 200°C 60-200°C gas inlet 3/8" gas outlet 3/8" thermocouple connection M10x1 pilot connection M10x1 probe ø 5mm probe L 95mm capillary pipe 1050mm probe type type D2 pressure controller no pressure regulator mbar gland nut M14x1.5 ignition gas 4mm		
spare parts for	101385		
	GEV No.	100809	Ref. No. —
	O-ring EPDM thickness 2mm ID ø 21mm Qty 1 pcs		
	GEV No.	100904	Ref. No. —
	locking screw M10x1 for pipe ø 4mm Qty 1 pcs		
	GEV No.	101054	Ref. No. —
	magnet unit T1: M10x1 T2: M24x1 L 45mm ø 17mm suitable for Minisit		
	GEV No.	101136	Ref. No. —
	piezoelectric igniter suitable for Minisit with cover cap ømm connection F6.3x0.8		
	GEV No.	101268	Ref. No. —
	gas connection thread 3/8" angled with O-ring MINISIT 710		
	GEV No.	101273	Ref. No. 93107
	olive for pipe ø 12mm L 9.5mm brass Qty 1 pcs suitable for universal		
	GEV No.	101276	Ref. No. —
	union screw thread 3/8" tube ø 12mm Qty 1 pcs		
	GEV No.	102844	Ref. No. —
	probe 60-200°C probe ø 5mm probe L 98mm capillary pipe 1050mm t.max. 200°C fryer probe type type D2 suitable for MINISIT 710 gland nut M14x1.5		
accessories for	101385		
	GEV No.	100905	Ref. No. —
	locking screw M10x1 for pipe ø 6mm Qty 1 pcs		
	GEV No.	101054	Ref. No. —
	magnet unit T1: M10x1 T2: M24x1 L 45mm ø 17mm suitable for Minisit		
	GEV No.	101137	Ref. No. —
	cover cap without piezoelectric igniter		
	GEV No.	101267	Ref. No. —
	reducer IT 3/8" ET 1/2" L 21mm		
	GEV No.	101269	Ref. No. —
	gas connection thread 1/2" angled with O-ring MINISIT 710		

accessories for	101385		
	GEV No.	101270	Ref. No. —
	screw connection IT 3/8" ET 3/8" L 28mm		
	GEV No.	101272	Ref. No. —
	screw connection IT 1/2" ET 3/8" L 57mm		
	GEV No.	101274	Ref. No. —
	olive for pipe ø 16mm Qty 1 pcs		
	GEV No.	101275	Ref. No. —
	union screw thread 1/2" for pipe ø 16mm Qty 1 pcs		









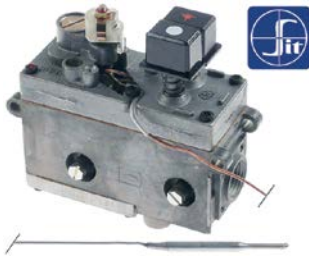

	GEV No.	101132	Ref. No.	26001
description	gas thermostat SIT type MINISIT 710 t.max. 340°C 100-340°C gas inlet 1/2" gas outlet 3/8" thermocouple connection M9x1 pilot connection M10x1 probe ø 5mm probe L 68mm capillary pipe 1050mm probe type type B1 pressure controller no pressure regulator mbar gland nut ignition gas no			
spare parts for	101132			
	GEV No.	101053	Ref. No.	—
	magnet unit T1: M9x1 T2: M24x1 L 45mm ø 17mm suitable for Minisit			
	GEV No.	102102	Ref. No.	—
	probe 100-340°C probe ø 5mm probe L 68mm capillary pipe 1750mm t.max. 340°C oven/grill probe type type B1 suitable for MINISIT 710			
accessories for	101132			
	GEV No.	100809	Ref. No.	—
	O-ring EPDM thickness 2mm ID ø 21mm Qty 1 pcs			
	GEV No.	100904	Ref. No.	—
	locking screw M10x1 for pipe ø 4mm Qty 1 pcs			
	GEV No.	100905	Ref. No.	—
	locking screw M10x1 for pipe ø 6mm Qty 1 pcs			
	GEV No.	101054	Ref. No.	—
	magnet unit T1: M10x1 T2: M24x1 L 45mm ø 17mm suitable for Minisit			
	GEV No.	101136	Ref. No.	—
	piezoelectric igniter suitable for Minisit with cover cap ømm connection F6.3x0.8			
	GEV No.	101137	Ref. No.	—
	cover cap without piezoelectric igniter			
	GEV No.	101267	Ref. No.	—
	reducer IT 3/8" ET 1/2" L 21mm			
	GEV No.	101268	Ref. No.	—
	gas connection thread 3/8" angled with O-ring MINISIT 710			

Table continues overleaf





accessories for		101132	
	GEV No.	101269	Ref. No. —
gas connection thread 1/2" angled with O-ring MINISIT 710			
	GEV No.	101270	Ref. No. —
screw connection IT 3/8" ET 3/8" L 28mm			
	GEV No.	101272	Ref. No. —
screw connection IT 1/2" ET 3/8" L 57mm			
	GEV No.	101273	Ref. No. 93107
olive for pipe ø 12mm L 9.5mm brass Qty 1 pcs suitable for universal			
	GEV No.	101274	Ref. No. —
olive for pipe ø 16mm Qty 1 pcs			
	GEV No.	101275	Ref. No. —
union screw thread 1/2" for pipe ø 16mm Qty 1 pcs			
	GEV No.	101276	Ref. No. —
union screw thread 3/8" tube ø 12mm Qty 1 pcs			
	GEV No.	110068	Ref. No. 26001
knob suitable for Minisit ø 37mm			

gas valves and ignition boxes

safety valves

ORKLI/JUNKERS



accessories for		101196	
	GEV No.	101196	Ref. No. 93273
description safety valve type CV101015 front fixing M12x0.75 pressure rangem-bar pressure range 2.1bar gas inlet M14x1.5 ET gas outlet ø 8mm thermocouple connection M8x1			
spare parts for 101196			
	GEV No.	101046	Ref. No. —
magnet unit L 27mm D1 ø 12.5mm D2 ø 9.5mm pressure range 2.1bar suitable for JUNKERS			
accessories for 101196			
	GEV No.	101499	Ref. No. 93822
protection cap for safety valve thread M12x0.75 ID ø 18mm L 24mm aluminium			
	GEV No.	101501	Ref. No. 93282
nut thread M12x0.75 H 2mm WS 16 brass Qty 1 pcs			

ignition parts

pilot burners

JUNKERS

CB 503 series

pilot burners



accessories for		100101	
	GEV No.	100101	Ref. No. 93269
description pilot burner JUNKERS type CB503003 LPG nozzle no.2 gas connection 4mm with primary air			
spare parts for 100101			
	GEV No.	100224	Ref. No. —
pilot burner nozzle natural gas gas pressure 25mbar code 26 Qty 1 pcs suitable for JUNKERS CB503_			
	GEV No.	101281	Ref. No. 91606
olive for pipe ø 4mm L 8.7mm Qty 1 pcs suitable for CB 502/503			
	GEV No.	101283	Ref. No. —
union screw thread M10x1 for pipe ø 4mm Qty 1 pcs			
accessories for 100101			
	GEV No.	100220	Ref. No. —
pilot burner nozzle LPG gas pressure 50mbar code 2 Qty 1 pcs suitable for JUNKERS CB503_			
	GEV No.	100221	Ref. No. —
pilot burner nozzle LPG gas pressure 30mbar code 29 Qty 1 pcs suitable for JUNKERS CB50203_			
	GEV No.	100222	Ref. No. —
pilot burner nozzle LPG gas pressure 50mbar code 5 Qty 1 pcs suitable for JUNKERS CB50203_			
	GEV No.	100223	Ref. No. —
pilot burner nozzle natural gas gas pressure 20mbar code 3 Qty 1 pcs suitable for JUNKERS CB503_			
	GEV No.	100226	Ref. No. —
pilot burner nozzle LPG gas pressure 50mbar code 15 suitable for JUNKERS			
	GEV No.	100227	Ref. No. —
pilot burner nozzle natural gas gas pressure 25mbar code 6 Qty 1 pcs suitable for JUNKERS CB50203_			
	GEV No.	100228	Ref. No. —
pilot burner nozzle town gas gas pressure 8mbar code 4 Qty 1 pcs suitable for JUNKERS CB50203_			
	GEV No.	100909	Ref. No. —
union screw thread M10x1 for pipe ø 6mm Qty 1 pcs			
	GEV No.	101287	Ref. No. —
olive for pipe ø 6mm Qty 1 pcs			
	GEV No.	102110	Ref. No. —
pilot tube copper pipe ø 4mm thickness 1mm L 3000mm			

Table continues overleaf



accessories for	100101		
GEV No.	102111	Ref. No.	—
pilot tube copper pipe \varnothing 6mm thickness 1mm L 3000mm			

producer-specific pilot burners

HEIDEBRENNER



GEV No.	102859	Ref. No.	8620FG
description	pilot burner LPG		



GEV No.	102860	Ref. No.	8620EG
description	pilot burner natural gas		



GEV No.	106959	Ref. No.	8618
description	pilot burner without nozzle		

electrodes

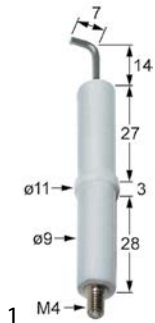

GEV No.	102863	Ref. No.	93292
description	ignition electrode D1 \varnothing 9mm connection M4 D2 \varnothing 11mm L1 14mm L2 7mm BL1 27mm BL2 3mm BL3 28mm to clip		
For models:	AGK 13		

piezoelectric igniters

mounting diameter 22mm



GEV No.	100008	Ref. No.	93285
description	piezoelectric igniter body plastic blowing mounting \varnothing 22mm connection \varnothing 2mm cable lengthmm		
For models:	AGK 13		

thermocouples

plug-in thermocouples

plug-in thermocouples standard

with barrel socket \varnothing 6mm

type Junkers with aluminised tip

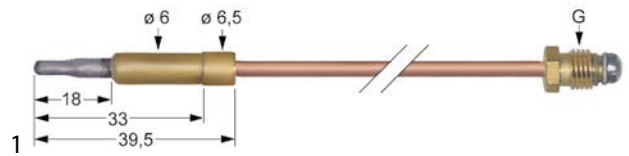

GEV No.	102229	Ref. No.	93262
description	thermocouple M10x1 L 1000mm plug connection \varnothing 6.0mm		

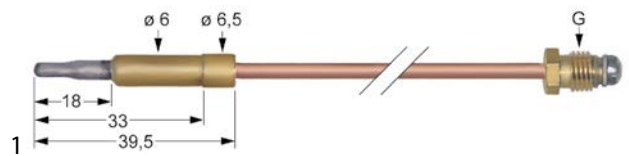

GEV No.	102230	Ref. No.	93263
description	thermocouple M10x1 L 1200mm plug connection \varnothing 6.0mm		

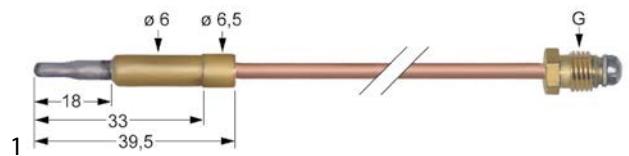

GEV No.	102231	Ref. No.	93264
description	thermocouple M10x1 L 1500mm plug connection \varnothing 6.0mm		

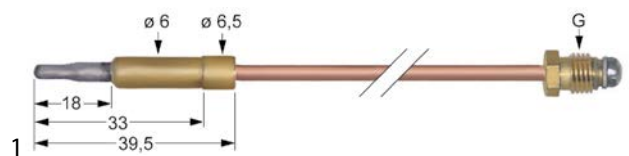

GEV No.	102225	Ref. No.	93258
description	thermocouple M10x1 L 320mm plug connection \varnothing 6.0mm		

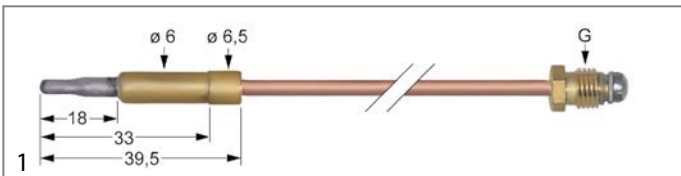

GEV No.	102226	Ref. No.	93259
description	thermocouple M10x1 L 450mm plug connection ø6.0mm		

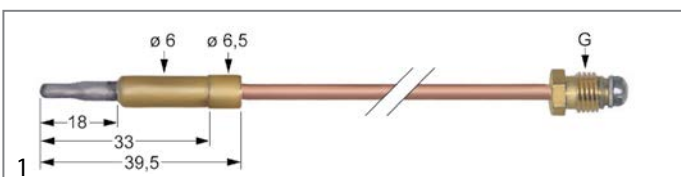

GEV No.	102227	Ref. No.	93260
description	thermocouple M10x1 L 600mm plug connection ø6.0mm		

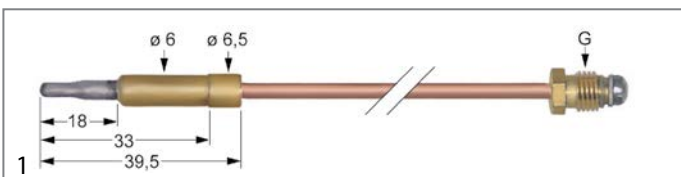

GEV No.	102228	Ref. No.	93261
description	thermocouple M10x1 L 750mm plug connection ø6.0mm		

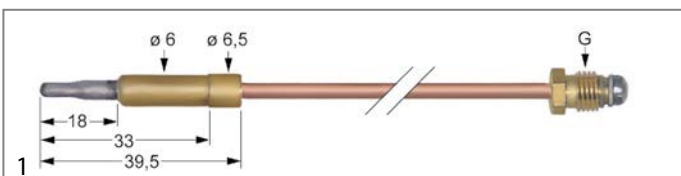

GEV No.	102222	Ref. No.	93250
description	thermocouple M8x1 L 1000mm plug connection ø6.0mm		

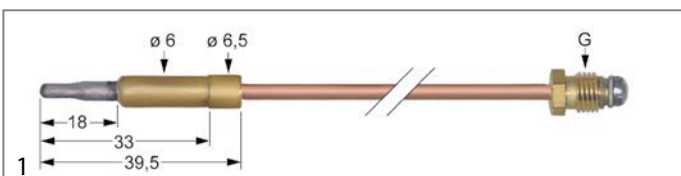

GEV No.	102223	Ref. No.	93251
description	thermocouple M8x1 L 1200mm plug connection ø6.0mm		

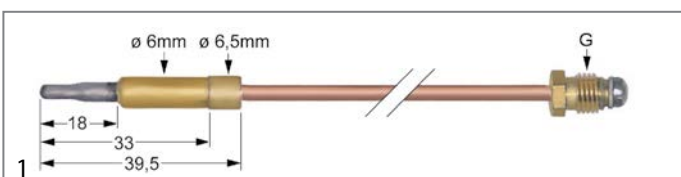

GEV No.	102217	Ref. No.	93243
description	thermocouple M8x1 L 220mm plug connection ø6.0mm		

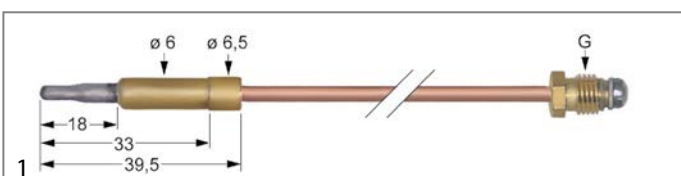

GEV No.	102218	Ref. No.	93245
description	thermocouple M8x1 L 320mm plug connection ø6.0mm		

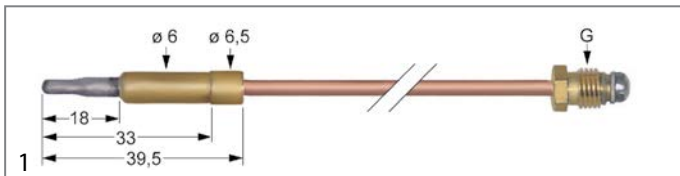

GEV No.	102219	Ref. No.	93246
description	thermocouple M8x1 L 450mm plug connection ø6.0mm		

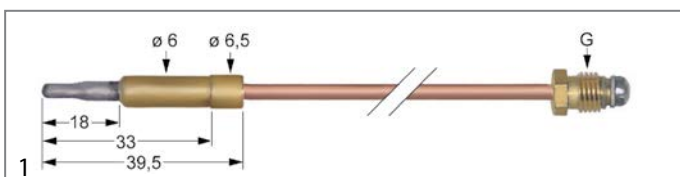

GEV No.	102220	Ref. No.	93247
description	thermocouple M8x1 L 600mm plug connection ø6.0mm		

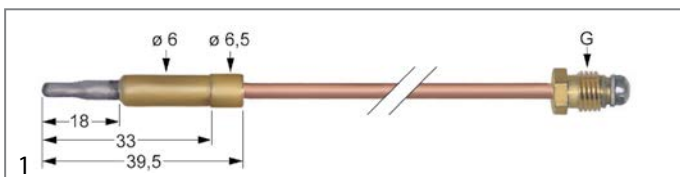

GEV No.	102221	Ref. No.	93248
description	thermocouple M8x1 L 750mm plug connection ø6.0mm		

threaded thermocouples

threaded thermocouples standard

with socket with thread M8x1

SIT

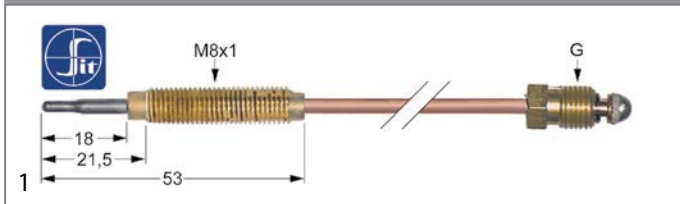

GEV No.	107645	Ref. No.	93256 93257
description	thermocouple SIT M10x1 L 1500mm M8x1		

accessories for 107645

	GEV No.	102067	Ref. No.	93123
	nut thread M8x1 H 3mm brass Qty 1 pcs type SEF 1			

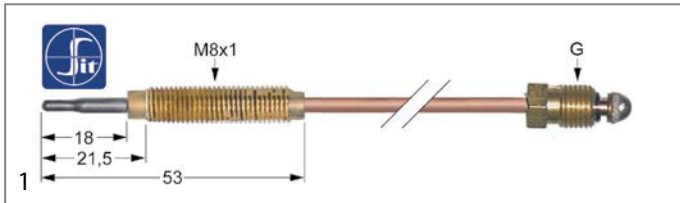

GEV No.	107642	Ref. No.	93253
description	thermocouple SIT M10x1 L 450mm M8x1		

accessories for 107642

	GEV No.	102067	Ref. No.	93123
	nut thread M8x1 H 3mm brass Qty 1 pcs type SEF 1			



GEV No.	107643	Ref. No.	93254
description	thermocouple SIT M10x1 L 600mm M8x1		
accessories for	107643		
	GEV No.	102067	Ref. No.
			93123
	nut thread M8x1 H 3mm brass Qty 1 pcs type SEF 1		

GEV No.	107634	Ref. No.	93240
description	thermocouple SIT M8x1 L 1500mm M8x1		
accessories for	107634		
	GEV No.	102067	Ref. No.
			93123
	nut thread M8x1 H 3mm brass Qty 1 pcs type SEF 1		

GEV No.	107644	Ref. No.	93255
description	thermocouple SIT M10x1 L 750mm M8x1		
accessories for	107644		
	GEV No.	102067	Ref. No.
			93123
	nut thread M8x1 H 3mm brass Qty 1 pcs type SEF 1		

GEV No.	107627	Ref. No.	93255
description	thermocouple SIT M8x1 L 220mm M8x1		

GEV No.	107632	Ref. No.	93241
description	thermocouple SIT M8x1 L 1000mm M8x1		
accessories for	107632		
	GEV No.	102067	Ref. No.
			93123
	nut thread M8x1 H 3mm brass Qty 1 pcs type SEF 1		

GEV No.	107628	Ref. No.	93236
description	thermocouple SIT M8x1 L 320mm M8x1		
accessories for	107628		
	GEV No.	102067	Ref. No.
			93123
	nut thread M8x1 H 3mm brass Qty 1 pcs type SEF 1		

GEV No.	107633	Ref. No.	93242
description	thermocouple SIT M8x1 L 1200mm M8x1		
accessories for	107633		
	GEV No.	102067	Ref. No.
			93123
	nut thread M8x1 H 3mm brass Qty 1 pcs type SEF 1		

GEV No.	107629	Ref. No.	93237
description	thermocouple SIT M8x1 L 450mm M8x1		
accessories for	107629		
	GEV No.	102067	Ref. No.
			93123
	nut thread M8x1 H 3mm brass Qty 1 pcs type SEF 1		

GEV No.	107640	Ref. No.	93206
description	thermocouple SIT M9x1 L 1500mm M8x1		

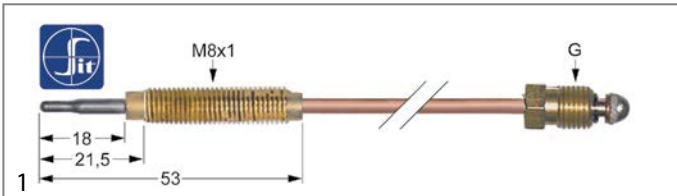

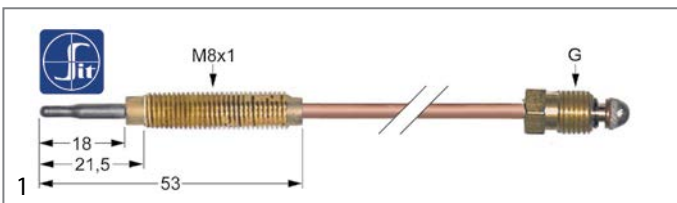

GEV No.	107636	Ref. No.	93271
description	thermocouple SIT M9x1 L 600mm M8x1		
accessories for	107636		
	GEV No.	Ref. No.	93123
	nut thread M8x1 H 3mm brass Qty 1 pcs type SEF 1		



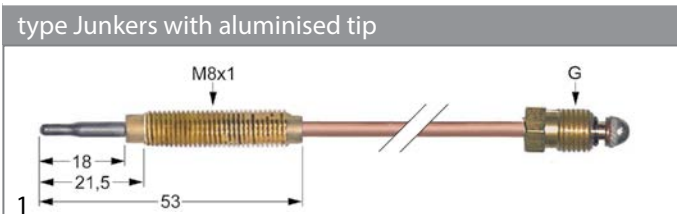

GEV No.	107637	Ref. No.	93244
description	thermocouple SIT M9x1 L 850mm M8x1		
accessories for	107637		
	GEV No.	Ref. No.	93123
	nut thread M8x1 H 3mm brass Qty 1 pcs type SEF 1		

type Junkers with aluminised tip

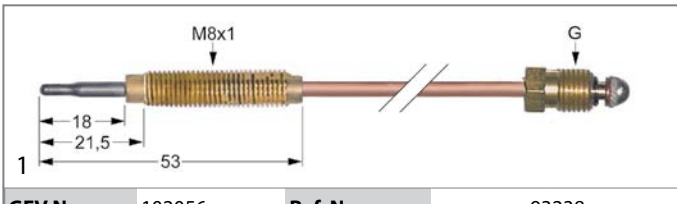

GEV No.	102234	Ref. No.	93252
description	thermocouple M10x1 L 320mm M8x1		
accessories for	102234		
	GEV No.	Ref. No.	93123
	nut thread M8x1 H 3mm brass Qty 1 pcs type SEF 1		



GEV No.	102056	Ref. No.	93238
description	thermocouple M8x1 L 600mm M8x1		
accessories for	102056		
	GEV No.	Ref. No.	93123
	nut thread M8x1 H 3mm brass Qty 1 pcs type SEF 1		

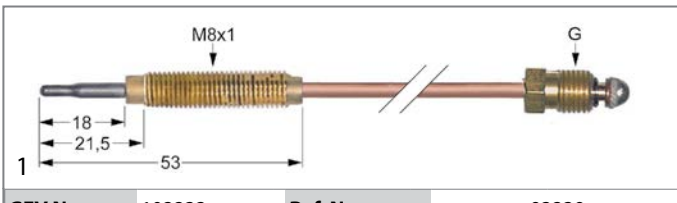

GEV No.	102233	Ref. No.	93239
description	thermocouple M8x1 L 750mm M8x1		
accessories for	102233		
	GEV No.	Ref. No.	93123
	nut thread M8x1 H 3mm brass Qty 1 pcs type SEF 1		

accessories

nuts



GEV No.	102067	Ref. No.	93123
description	nut thread M8x1 H 3mm brass Qty 1 pcs type SEF 1		

screws



GEV No.	102561	Ref. No.	91230
description	thermocouple fitting thread M9x1 Qty 10 pcs		

gas burners
hob burners

producer-specific hob burners

HEIDEBRENNER

Universal series

burner caps



GEV No.	105945	Ref. No.	8643
description	burner cap cross-shaped		





GEV No.	105941	Ref. No.	8637
description	burner cap ø 115mm for burner cap ø 94mm		





GEV No.	105944	Ref. No.	8638
description	burner cap ø 115mm slotted		





 1			
GEV No.	105942	Ref. No.	8640
description	burner cap ø 155mm		
spare parts for	105942		
	GEV No.	100222	Ref. No. —
	pilot burner nozzle LPG gas pressure 50mbar code 5 Qty 1 pcs suitable for JUNKERS CB50203_		
	GEV No.	100227	Ref. No. —
	pilot burner nozzle natural gas gas pressure 25mbar code 6 Qty 1 pcs suitable for JUNKERS CB50203_		
	GEV No.	102067	Ref. No. 93123
	nut thread M8x1 H 3mm brass Qty 1 pcs type SEF 1		
	GEV No.	102232	Ref. No. —
	thermocouple M8x1 L 220mm M8x1		
	GEV No.	102859	Ref. No. 8620FG
	pilot burner LPG		
	GEV No.	102860	Ref. No. 8620EG
	pilot burner natural gas		
	GEV No.	105942	Ref. No. 8640
	burner cap ø 155mm		

 1			
GEV No.	105946	Ref. No.	8641
description	burner cap ø 155mm slotted		

 1			
GEV No.	105947	Ref. No.	8658
description	burner cap ø 155mm slotted		

 1			
GEV No.	104534	Ref. No.	98642
description	burner cap ø 62mm 3.5kW		

 1			
GEV No.	105943	Ref. No.	8634
description	burner cap ø 91mm for burner cap ø 77mm 5.8kW		
spare parts for	105943		
	GEV No.	104612	Ref. No. 8607
	burner unit 5.8kW without piezoelectric igniter, with pilot burner		

 1			
GEV No.	104611	Ref. No.	8635
description	burner cap ø 95mm slotted		

burner assemblies























 1			
GEV No.	104728	Ref. No.	8606
description	burner unit 12.8kW with piezoelectric igniter, with pilot burner		
spare parts for	104728		
	GEV No.	100013	Ref. No. —
	piezoelectric igniter body plastic blowing mounting ø 22mm connection ø2.4mm cable lengthmm		
	GEV No.	100017	Ref. No. —
	ignition cable cable length 300mm connection ø2.4mm / ø4mm permanent temperature 200°C		
	GEV No.	100656	Ref. No. 94476
	internal nozzle bore ø 1.6mm type EGA/PEL22		
	GEV No.	100698	Ref. No. 94466
	gas injector thread M15x1 bore ø 3.00mm WS 17		
	GEV No.	102054	Ref. No. —
	thermocouple M8x1 L 320mm M8x1		
	GEV No.	102067	Ref. No. 93123
	nut thread M8x1 H 3mm brass Qty 1 pcs type SEF 1		
	GEV No.	102859	Ref. No. 8620FG
	pilot burner LPG		
	GEV No.	102863	Ref. No. 93292
	ignition electrode D1 ø 9mm connection M4 D2 ø 11mm L1 14mm L2 7mm BL1 27mm BL2 3mm BL3 28mm to clip		
	GEV No.	105942	Ref. No. 8640
	burner cap ø 155mm		
	GEV No.	106042	Ref. No. —
	gas tap type PEL22S thermocouple connection M8x1		

Table continues overleaf

spare parts for 104728			
	GEV No.	106043	Ref. No. —
gas tap type PEL22S thermocouple connection M8x1			

			
1			
GEV No.	104727	Ref. No.	8609
description burner unit 12.8kW without piezoelectric igniter, with pilot burner			
spare parts for 104727			
	GEV No.	100656	Ref. No. 94476
internal nozzle bore ø 1.6mm type EGA/PEL22			
	GEV No.	100698	Ref. No. 94466
gas injector thread M15x1 bore ø 3.00mm WS 17			
	GEV No.	102054	Ref. No. —
thermocouple M8x1 L 320mm M8x1			
	GEV No.	102067	Ref. No. 93123
nut thread M8x1 H 3mm brass Qty 1 pcs type SEF 1			
	GEV No.	102859	Ref. No. 8620FG
pilot burner LPG			
	GEV No.	105942	Ref. No. 8640
burner cap ø 155mm			
	GEV No.	106042	Ref. No. —
gas tap type PEL22S thermocouple connection M8x1			

			
1			
GEV No.	104725	Ref. No.	8603
description burner unit 3.5kW with piezoelectric igniter, no pilot burner			
spare parts for 104725			
	GEV No.	100013	Ref. No. —
piezoelectric igniter body plastic blowing mounting ø 22mm connection ø 2.4mm cable length mm			
	GEV No.	100017	Ref. No. —
ignition cable cable length 300mm connection ø 2.4mm / ø 4mm permanent temperature 200°C			
	GEV No.	100451	Ref. No. 94461
gas injector thread M15x1 bore ø 1.50mm WS 17			
	GEV No.	100492	Ref. No. 94471
internal nozzle bore ø 0.8mm type EGA/PEL22			
	GEV No.	102054	Ref. No. —
thermocouple M8x1 L 320mm M8x1			
	GEV No.	102067	Ref. No. 93123
nut thread M8x1 H 3mm brass Qty 1 pcs type SEF 1			

spare parts for 104725			
	GEV No.	102863	Ref. No. 93292
ignition electrode D1 ø 9mm connection M4 D2 ø 11mm L1 14mm L2 7mm BL1 27mm BL2 3mm BL3 28mm to clip			
	GEV No.	104534	Ref. No. 98642
burner cap ø 62mm 3.5kW			
	GEV No.	106040	Ref. No. N/A
gas tap alternatives to EGA type GP222D with nozzle outlet (without nozzle) gas inlet M18x1.5 (tube ø 12mm) external nozzle ø mm internal nozzle ø mm bypass nozzle ø 0.35mm mixing pipe connection M22x1 thermocouple connection M8x1 pilot connection closed shaft ø 9x6.5mm shaft L 34/15mm shaft flat upper and bottom			
	GEV No.	106041	Ref. No. —
gas tap alternatives to EGA type GP222D with nozzle outlet (without nozzle) gas inlet M18x1.5 (tube ø 12mm) external nozzle ø mm internal nozzle ø mm bypass nozzle ø 0.35mm mixing pipe connection M22x1 thermocouple connection M8x1 pilot connection closed shaft ø 9x6.5mm shaft L 34/15mm shaft flat right and left			

			
1			
GEV No.	104609	Ref. No.	8604
description burner unit 5.8kW with piezoelectric igniter, no pilot burner			

			
1			
GEV No.	104612	Ref. No.	8607
description burner unit 5.8kW without piezoelectric igniter, with pilot burner			

			
1			
GEV No.	104610	Ref. No.	8605
description burner unit 9.3kW with piezoelectric igniter, no pilot burner			











			
1			
GEV No.	104726	Ref. No.	8608
description burner unit 9.3kW without piezoelectric igniter, with pilot burner			
spare parts for 104726			
	GEV No.	100101	Ref. No. 93269
pilot burner JUNKERS type CB503003 LPG nozzle no.2 gas connection 4mm with primary air			
	GEV No.	100220	Ref. No. —
pilot burner nozzle LPG gas pressure 50mbar code 2 Qty 1 pcs suitable for JUNKERS CB503_			
	GEV No.	100456	Ref. No. 94464
gas injector thread M15x1 bore ø 2.50mm WS 17			

Table continues overleaf



spare parts for		104726	
	GEV No.	100647	Ref. No. 94474
	internal nozzle bore ø 1.3mm type EGA/PEL22		
	GEV No.	102019	Ref. No. —
	thermocouple M8x1 L 320mm plug connection ø6.0mm		
	GEV No.	105941	Ref. No. 8637
	burner cap ø 115mm for burner cap ø 94mm		
	GEV No.	106042	Ref. No. —
	gas tap type PEL22S thermocouple connection M8x1		
	GEV No.	106043	Ref. No. —
	gas tap type PEL22S thermocouple connection M8x1		

pan supports	
	1
GEV No.	210234 Ref. No. 8324
description	pan support W 360mm L 365mm

	1
GEV No.	210233 Ref. No. 8319
description	pan support W 370mm L 370mm

reducers for pan supports	
	1
GEV No.	210001 Ref. No. 98.801
description	reducer for pan support L 265mm W 265mm SS suitable for universal

spillage trays	
	1
GEV No.	210232 Ref. No. 90601
description	drain tray L 410mm W 410mm H 70mm

height extensions	
	1
GEV No.	210235 Ref. No. 8360
description	attachment ring ø 255mm

	1
GEV No.	210236 Ref. No. 70648
description	attachment ring ø 255mm

accessories	
reducers for pan supports	
	1
GEV No.	210001 Ref. No. 98.801
description	reducer for pan support L 265mm W 265mm SS suitable for universal

pan supports	
	1
GEV No.	210234 Ref. No. 8324
description	pan support W 360mm L 365mm

	1
GEV No.	210233 Ref. No. 8319
description	pan support W 370mm L 370mm



spillage trays



1

GEV No.	210232	Ref. No.	90601
description	drain tray L 410mm W 410mm H 70mm		

air mixers



1

GEV No.	104608	Ref. No.	Mischhülse
description	air mixing sleeve		

ring burners



1

GEV No.	104607	Ref. No.	8670
description	ring burner L 488mm W 150mm 2.9kW		

gas nozzles

main nozzles

gas nozzles M12x1



1

GEV No.	100307	Ref. No.	94402
description	gas injector thread M12x1 WS 14 bore ø 1.40mm		

gas nozzles M15x1



1

GEV No.	100451	Ref. No.	94461
description	gas injector thread M15x1 bore ø 1.50mm WS 17		



1

GEV No.	100453	Ref. No.	94462
description	gas injector thread M15x1 bore ø 2.00mm WS 17		



1

GEV No.	100330	Ref. No.	94463
description	gas injector thread M15x1 bore ø 2.20mm WS 17		



1

GEV No.	100456	Ref. No.	94464
description	gas injector thread M15x1 bore ø 2.50mm WS 17		



1

GEV No.	100457	Ref. No.	94465
description	gas injector thread M15x1 bore ø 2.60mm WS 17		



1

GEV No.	100698	Ref. No.	94466
description	gas injector thread M15x1 bore ø 3.00mm WS 17		



1

GEV No.	100339	Ref. No.	94467
description	gas injector thread M15x1 bore ø 3.40mm WS 17		



bypass nozzles

bypass nozzles PEL22



1			
GEV No.	100281	Ref. No.	94451
description	bypass nozzle type PEL22 bore ø 0.4mm thread M6x0.5		



1			
GEV No.	100391	Ref. No.	94453
description	bypass nozzle type PEL22 bore ø 0.55mm thread M6x0.5		



1			
GEV No.	100390	Ref. No.	94452
description	bypass nozzle type PEL22 bore ø 0.5mm thread M6x0.5		



1			
GEV No.	100392	Ref. No.	94454
description	bypass nozzle type PEL22 bore ø 0.6mm thread M6x0.5		



1			
GEV No.	100407	Ref. No.	94455
description	bypass nozzle type PEL22 bore ø 1mm thread M6x0.5		

bypass nozzles PEL23/24



1			
GEV No.	100459	Ref. No.	94472
description	bypass nozzle type PEL23/24 bore ø 0.65mm thread M8x0.5		

internal nozzles

internal nozzles for EGA gas taps/nozzle holders

EGA 24197/24362



1			
GEV No.	100492	Ref. No.	94471
description	internal nozzle bore ø 0.8mm type EGA/PEL22		



1			
GEV No.	100495	Ref. No.	94472
description	internal nozzle bore ø 1.05mm type EGA/PEL22		



1			
GEV No.	100344	Ref. No.	94473
description	internal nozzle bore ø 1.2mm type EGA/PEL22		



1			
GEV No.	100648	Ref. No.	94475
description	internal nozzle bore ø 1.35mm type EGA/PEL22		



1			
GEV No.	100647	Ref. No.	94474
description	internal nozzle bore ø 1.3mm type EGA/PEL22		



1			
GEV No.	100656	Ref. No.	94476
description	internal nozzle bore ø 1.6mm type EGA/PEL22		



1			
GEV No.	100658	Ref. No.	94477
description	internal nozzle bore ø 1.8mm type EGA/PEL22		

internal nozzles for gas tap MADEC



1			
GEV No.	100421	Ref. No.	94401
description	internal nozzle MADEC bore ø 0.8mm		

auxiliary gas parts

screw connections

end caps



1			
GEV No.	101590	Ref. No.	94482
description	locking screw thread M10x1		

olives



1			
GEV No.	101273	Ref. No.	93107
description	olive for pipe ø 12mm L 9.5mm brass Qty 1 pcs suitable for universal		
accessories for	101273		









	GEV No.	100944	Ref. No.	—
	union nut thread M18x1.5 for pipe ø 12mm			

Table continues overleaf





accessories for	101273		
	GEV No.	101276	Ref. No. —
union screw thread 3/8" tube ø 12mm Qty 1 pcs			

1			
GEV No.	101281	Ref. No.	91606
description	olive for pipe ø 4mm L 8.7mm Qty 1 pcs suitable for CB 502/503		
accessories for	101281		
	GEV No.	101283	Ref. No. —
union screw thread M10x1 for pipe ø 4mm Qty 1 pcs			

1			
GEV No.	101284	Ref. No.	93105
description	olive for pipe ø 4mm Qty 1 pcs		
accessories for	101284		
	GEV No.	101259	Ref. No. —
union nut thread M8x1 for pipe ø 4mm			
	GEV No.	101285	Ref. No. 26009
union screw thread M8x1 for pipe ø 4mm Qty 1 pcs JUNKERS			
	GEV No.	101294	Ref. No. —
union nut thread M10x1 for pipe ø 4mm WS 14 L 12mm Qty 1 pcs			

union screws

1			
GEV No.	101285	Ref. No.	26009
description	union screw thread M8x1 for pipe ø 4mm Qty 1 pcs JUNKERS		
accessories for	101285		
	GEV No.	101284	Ref. No. 93105
olive for pipe ø 4mm Qty 1 pcs			

knobs

universal knobs



1			
GEV No.	110236	Ref. No.	94231
description	knob graduated t.max.°C ø 50mm shaft ø 6x4.6mm shaft flat upper black		

1			
GEV No.	110253	Ref. No.	94714
description	knob switch zero mark t.max.°C ø 50mm shaft ø 6x4.6mm shaft flat upper black		

producer-specific knobs

HEIDEBRENNER

1			
GEV No.	110064	Ref. No.	93207
description	knob		
accessories for	110064		
	GEV No.	110066	Ref. No. —
knob screw			

1			
GEV No.	110065	Ref. No.	93208
description	knob		
accessories for	110065		
	GEV No.	110067	Ref. No. —
knob screw			

1

GEV No.	111941	Ref. No.	93116
description	knob gas tap with ignition flame ø 60mm shaft ø 9x6mm shaft flat horizontal black		



1

GEV No.	111939	Ref. No.	93117
description	knob gas tap without ignition flame ø 60mm shaft ø 9x6.5mm shaft flat horizontal black		









1

GEV No.	110150	Ref. No.	93118
description	knob gas tap without ignition flame t.max.°C ø 50mm shaft ø 8x5.5mm shaft flat right white		



1

GEV No.	112489	Ref. No.	N/A
description	knob universal ø 55.2mm black without adaptor/dial plate		
accessories for	112489		
	GEV No.	Ref. No.	—
	110500		
	knob dial plate gas tap without ignition flame EGA26400 t.max.°C ED ø 45mm silver		
	GEV No.	Ref. No.	—
	110501		
	knob dial plate gas tap with ignition flame EGA24197 t.max.°C ED ø 45mm silver		
	GEV No.	Ref. No.	—
	110502		
	knob dial plate gas tap with ignition flame EGA24197 t.max.°C ED ø 45mm silver		
	GEV No.	Ref. No.	—
	110503		
	knob dial plate gas tap with ignition flame EGA26440 t.max.°C ED ø 45mm silver		
	GEV No.	Ref. No.	94652
	110504		
	knob dial plate gas tap PEL21/22/23 t.max.°C ED ø 45mm silver		
	GEV No.	Ref. No.	—
	110505		
	knob dial plate gas tap PEL21/22/23 t.max.°C ED ø 45mm red		
	GEV No.	Ref. No.	—
	110506		
	knob dial plate gas thermostat EGA 1-8 t.max.°C ED ø 45mm red		





















accessories for	112489		
	GEV No.	Ref. No.	—
	110507		
	knob dial plate switch 4-position t.max.°C ED ø 45mm silver		
	GEV No.	Ref. No.	—
	110508		
	knob dial plate switch 4-position t.max.°C ED ø 45mm silver		
	GEV No.	Ref. No.	—
	110509		
	knob dial plate switch 7-position t.max.°C ED ø 45mm silver		
	GEV No.	Ref. No.	—
	110510		
	knob dial plate switch 7-position t.max.°C ED ø 45mm silver		
	GEV No.	Ref. No.	—
	110511		
	knob dial plate switch 0-1-0-1 t.max.°C ED ø 45mm red		
	GEV No.	Ref. No.	—
	110512		
	knob dial plate oven TH/BH/TH+BH t.max.°C ED ø 45mm turn direction anti clockwise red		
	GEV No.	Ref. No.	—
	110513		
	knob dial plate oven ED ø 45mm red		
	GEV No.	Ref. No.	—
	110514		
	knob dial plate thermostat t.max. 110°C 30-110°C rotation 310° ED ø 45mm red		
	GEV No.	Ref. No.	—
	110515		
	knob dial plate thermostat t.max. 220°C 100-220°C rotation 310° ED ø 45mm silver		
	GEV No.	Ref. No.	—
	110516		
	knob dial plate thermostat t.max. 300°C 50-300°C ED ø 45mm red		
	GEV No.	Ref. No.	—
	110517		
	knob dial plate thermostat t.max. 110°C 30-110°C rotation 270° ED ø 45mm silver		
	GEV No.	Ref. No.	—
	110518		
	knob dial plate thermostat t.max. 180°C 100-180°C rotation 270° ED ø 45mm silver		
	GEV No.	Ref. No.	—
	110519		
	knob dial plate thermostat t.max. 250°C 50-250°C rotation 270° ED ø 45mm silver		
	GEV No.	Ref. No.	—
	110520		
	knob dial plate thermostat t.max. 300°C 50-300°C rotation 270° ED ø 45mm silver		
	GEV No.	Ref. No.	—
	110521		
	knob dial plate switch 4-position t.max.°C ED ø 45mm silver		
	GEV No.	Ref. No.	—
	110522		
	knob dial plate switch 7-position t.max.°C ED ø 45mm silver		
	GEV No.	Ref. No.	—
	110523		
	knob dial plate thermostat t.max. 110°C 30-110°C rotation 310° ED ø 45mm silver		
	GEV No.	Ref. No.	—
	110524		
	knob dial plate thermostat t.max. 300°C 50-300°C rotation 310° ED ø 45mm silver		
	GEV No.	Ref. No.	—
	110658		
	knob dial plate time 120min ED ø 45mm blue		
	GEV No.	Ref. No.	—
	110663		
	knob dial plate thermostat 1-10 rotation 310° ED ø 45mm blue		

Table continues overleaf

accessories for		112489	
GEV No.	Ref. No.	GEV No.	Ref. No.
	110739	—	—
knob dial plate switch 0-1-0-1 ED ø 45mm blue			
	110742	—	—
knob dial plate switch 4-position ED ø 45mm blue			
	110883	—	—
knob dial plate thermostat t.max. 300°C ED ø 45mm blue			
	110885	—	—
knob dial plate thermostat t.max. 110°C ED ø 45mm blue			
	110886	—	—
knob dial plate thermostat t.max. 180°C ED ø 45mm blue			
	111743	—	—
knob dial plate energy regulator 1-3 t.max.°C ED ø 45mm silver			
	111744	—	—
knob dial plate thermostat t.max. 85°C 30-85°C ED ø 45mm silver			
	111879	—	—
knob dial plate energy regulator 1-10 2-circuit t.max.°C ED ø 45mm silver			
	111880	—	—
knob dial plate switch 0-1-0-1 t.max.°C ED ø 45mm silver			
	111881	—	—
knob dial plate energy regulator 1-3 ED ø 45mm silver			
	111882	—	—
knob dial plate time 120min + permanent ON ED ø 45mm silver			
	112174	Ref. No.	N/A
knob adapter shaft ø 10x8mm L 0mm			
	112175	Ref. No.	—
knob adapter shaft ø 8x6.5mm L 0mm			
	112177	Ref. No.	—
knob adapter shaft ø 8x7mm L 0mm			
	112178	Ref. No.	N/A
knob adapter shaft ø 8x5mm L 0mm			
	112179	Ref. No.	N/A
knob adapter shaft ø 9x6.5mm L 0mm			
	112269	Ref. No.	93979
washer shaft ø 6x4.6mm ø 16mm H 1mm Qty 10 pcs			
	112270	Ref. No.	—
washer shaft ø 8x5/8x6.5/8x7/7x7mm ø 16mm H 1mm Qty 10 pcs			
	112271	Ref. No.	—
washer shaft ø 9x6.5/10x8/10x9/8x8mm ø 16mm H 1mm Qty 10 pcs			
	112304	Ref. No.	—
knob adapter shaft ø 7x7mm L 0mm			



















accessories for		112489	
GEV No.	Ref. No.	GEV No.	Ref. No.
	112305	—	—
knob adapter shaft ø 8x8mm L 0mm			
	112311	Ref. No.	N/A
knob adapter shaft ø 6x4.6mm L 0mm with spring			
	112312	Ref. No.	—
knob adapter shaft ø 10x9mm L 0mm			
	112342	Ref. No.	—
knob adapter shaft ø 8mm L 0mm with screw			
	112343	Ref. No.	N/A
knob adapter shaft ø 10mm L 0mm with screw			
	112414	Ref. No.	—
knob dial plate switch 0-1 t.max.°C ED ø 45mm silver			
	112416	Ref. No.	—
knob dial plate switch 5-position t.max.°C ED ø 45mm silver			
	112420	Ref. No.	—
knob dial plate thermostat t.max. 90°C 30-90°C rotation 270° ED ø 45mm silver			
	112421	Ref. No.	—
knob dial plate thermostat t.max. 90°C 30-90°C rotation 310° ED ø 45mm silver			
	112423	Ref. No.	—
knob dial plate thermostat t.max. 185°C 100-185°C rotation 270° ED ø 45mm silver			
	112424	Ref. No.	—
knob dial plate thermostat t.max. 195°C 100-195°C rotation 270° ED ø 45mm silver			
	112425	Ref. No.	—
knob dial plate thermostat t.max. 200°C 60-200°C rotation 270° ED ø 45mm silver			
	112426	Ref. No.	—
knob dial plate thermostat t.max. 270°C 0-270°C rotation 250° ED ø 45mm silver			
	112427	Ref. No.	—
knob dial plate thermostat t.max. 350°C 100-350°C rotation 270° ED ø 45mm silver			
	112428	Ref. No.	—
knob dial plate thermostat t.max. 500°C 50-500°C rotation 270° ED ø 45mm silver			
	112429	Ref. No.	—
knob dial plate thermostat t.max. 500°C 50-500°C rotation 310° ED ø 45mm silver			
	112430	Ref. No.	—
knob dial plate energy regulator 1-3 t.max.°C energy regulator°C ED ø 45mm turn direction clockwise silver			
	112431	Ref. No.	—
knob dial plate energy regulator 1-3 2-circuit t.max.°C ED ø 45mm silver			
	112432	Ref. No.	—
knob dial plate gas tap with ignition flame COPRECI t.max.°C ED ø 45mm silver			

Table continues overleaf



accessories for		112489	
	GEV No.	112433	Ref. No. —
	knob dial plate gas tap with ignition flame STN3R t.max.°C ED ø 45mm silver		
	GEV No.	112434	Ref. No. N/A
	knob dial plate gas tap without ignition flame PEL20 t.max.°C ED ø 45mm silver		
	GEV No.	112435	Ref. No. —
	knob dial plate gas tap without ignition flame SIRAL t.max.°C ED ø 45mm silver		
	GEV No.	112436	Ref. No. —
	knob dial plate gas tap without ignition flame STN3R t.max.°C ED ø 45mm silver		
	GEV No.	112437	Ref. No. —
	knob dial plate gas thermostat COPRECI 1-8 t.max.°C ED ø 45mm silver		
	GEV No.	112438	Ref. No. —
	knob dial plate gas thermostat EGA 1-8 t.max.°C ED ø 45mm silver		
	GEV No.	112439	Ref. No. —
	knob dial plate gas thermostat EUROSIT 1-8 t.max.°C ED ø 45mm silver		
	GEV No.	112440	Ref. No. —
	knob dial plate gas thermostat PEL 1-8 t.max.°C ED ø 45mm silver		
	GEV No.	112441	Ref. No. —
	knob dial plate gas thermostat SABAF 1-8 t.max.°C ED ø 45mm silver		
	GEV No.	112442	Ref. No. —
	knob dial plate gas valves NOVASIT ED ø 45mm silver		
	GEV No.	112443	Ref. No. —
	knob dial plate switch zero mark t.max.°C ED ø 45mm silver		
	GEV No.	112444	Ref. No. —
	knob dial plate thermostat 1-10 t.max.°C rotation 270° ED ø 45mm silver		
	GEV No.	112445	Ref. No. —
	knob dial plate thermostat 1-10 t.max.°C rotation 310° silver		
	GEV No.	112446	Ref. No. —
	knob dial plate water tap cold t.max.°C ED ø 45mm silver		
	GEV No.	112447	Ref. No. —
	knob dial plate water tap hot t.max.°C ED ø 45mm silver		
	GEV No.	112450	Ref. No. —
	knob adapter shaft ø 8x6.5mm L 0mm		
	GEV No.	112490	Ref. No. —
	knob dial plate gas tap with ignition flame EGA26440 t.max.°C EGA26440 ED ø 45mm silver		
	GEV No.	112514	Ref. No. —
	knob adapter shaft ø 10x8mm L 6mm		
	GEV No.	112515	Ref. No. —
	knob adapter shaft ø 8x6.5mm L 6mm		
	GEV No.	112516	Ref. No. —
	knob adapter shaft ø 6x4.6mm L 6mm		

accessories for		112489	
	GEV No.	112521	Ref. No. —
	knob dial plate energy regulator 1-3 t.max.°C turn direction anti clockwise ED ø 45mm silver		

1			
GEV No.	111592	Ref. No.	94651
description	knob universal shaft ø 10mm		

1			
GEV No.	112343	Ref. No.	N/A
description	knob adapter shaft ø 10mm L 0mm with screw		

1			
GEV No.	112174	Ref. No.	N/A
description	knob adapter shaft ø 10x8mm L 0mm		

1			
GEV No.	112311	Ref. No.	N/A
description	knob adapter shaft ø 6x4.6mm L 0mm with spring		

1			
GEV No.	112178	Ref. No.	N/A
description	knob adapter shaft ø 8x5mm L 0mm		

1			
GEV No.	112179	Ref. No.	N/A
description	knob adapter shaft ø 9x6.5mm L 0mm		





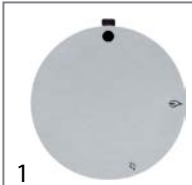



























GEV No.	110504	Ref. No.	94652
description	knob dial plate gas tap PEL21/22/23 t.max.°C ED ø 45mm silver		



GEV No.	112434	Ref. No.	N/A
description	knob dial plate gas tap without ignition flame PEL20 t.max.°C ED ø 45mm silver		



GEV No.	112173 ¹	Ref. No.	N/A	
description	knob universal ø 62mm black without adaptor/dial plate			
accessories for	112173			
	GEV No.	110530	Ref. No.	—
	knob dial plate silver thermostat t.max. 300°C 60-300°C rotation 270° ED ø 59mm ID ø 45.5mm			
	GEV No.	110531	Ref. No.	—
	knob dial plate silver time 120min + permanent ON t.max.°C ED ø 59mm ID ø 45.5mm			
	GEV No.	110532	Ref. No.	—
	knob dial plate red thermostat t.max. 300°C 0-300°C rotation 270° ED ø 59mm ID ø 45.5mm			
	GEV No.	110533	Ref. No.	—
	knob dial plate red thermostat t.max. 100°C 0-100°C rotation 270° ED ø 59mm ID ø 45.5mm			
	GEV No.	110534	Ref. No.	—
	knob dial plate silver time 120min + permanent ON t.max.°C ED ø 59mm ID ø 45.5mm			
	GEV No.	110535	Ref. No.	—
	knob dial plate red thermostat t.max. 250°C 50-250°C rotation 270° ED ø 59mm ID ø 45.5mm			
	GEV No.	110536	Ref. No.	—
	knob dial plate silver thermostat t.max. 195°C 100-195°C rotation 270° ED ø 59mm ID ø 45.5mm			
	GEV No.	110537	Ref. No.	—
	knob dial plate silver switch zero mark t.max.°C ED ø 59mm ID ø 45.5mm			
	GEV No.	110538	Ref. No.	—
	knob dial plate red gas tap with ignition flame EGA24197 t.max.°C ED ø 59mm ID ø 45.5mm			
	GEV No.	110539	Ref. No.	—
	knob dial plate silver switch 2-0-1 t.max.°C 1-2°C ED ø 59mm ID ø 45.5mm			
	GEV No.	110540	Ref. No.	94222
	knob dial plate silver thermostat 1-10 t.max.°C 1-10°C rotation 270° ED ø 59mm ID ø 45.5mm			

accessories for	112173			
	GEV No.	110541	Ref. No.	—
	knob dial plate silver gas tap without ignition flame EGA26400 t.max.°C ED ø 59mm ID ø 45.5mm			
	GEV No.	110542	Ref. No.	N/A
	knob dial plate silver switch 0-1-0-1 t.max.°C ED ø 59mm ID ø 45.5mm			
	GEV No.	110543	Ref. No.	—
	knob dial plate silver gas thermostat EGA 1-8 t.max.°C ED ø 59mm ID ø 45.5mm			
	GEV No.	110544	Ref. No.	—
	knob dial plate silver 0-FRITTIEREN-0-SCHMELZEN t.max.°C ED ø 59mm ID ø 45.5mm			
	GEV No.	110545	Ref. No.	—
	knob dial plate silver thermostat t.max. 110°C 30-110°C rotation 310° ED ø 59mm ID ø 45.5mm			
	GEV No.	110546	Ref. No.	—
	knob dial plate red thermostat t.max. 110°C 30-110°C rotation 270° ED ø 59mm ID ø 45.5mm			
	GEV No.	110547	Ref. No.	—
	knob dial plate red gas thermostat EGA 1-8 t.max.°C ED ø 59mm ID ø 45.5mm			
	GEV No.	110548	Ref. No.	—
	knob dial plate red switch 1-2-1-2 t.max.°C ED ø 59mm ID ø 45.5mm			
	GEV No.	110549	Ref. No.	N/A
	knob dial plate red thermostat t.max. 300°C 50-300°C rotation 270° ED ø 59mm ID ø 45.5mm			
	GEV No.	110550	Ref. No.	—
	knob dial plate silver gas tap with ignition flame EGA26440 t.max.°C ED ø 59mm ID ø 45.5mm			
	GEV No.	110551	Ref. No.	N/A
	knob dial plate silver energy regulator 1-3 t.max.°C turn direction clockwise ED ø 59mm ID ø 45.5mm			
	GEV No.	110552	Ref. No.	N/A
	knob dial plate silver switch 7-position t.max.°C ED ø 59mm ID ø 45.5mm			
	GEV No.	110553	Ref. No.	—
	knob dial plate silver switch 4-position t.max.°C ED ø 59mm ID ø 45.5mm			
	GEV No.	110554	Ref. No.	—
	knob dial plate silver thermostat t.max. 300°C 0-300°C rotation 270° ED ø 59mm ID ø 45.5mm			
	GEV No.	110555	Ref. No.	—
	knob dial plate silver time 120min + permanent ON t.max.°C ED ø 59mm ID ø 45.5mm			
	GEV No.	110556	Ref. No.	—
	knob dial plate silver thermostat t.max. 100°C 0-100°C rotation 270° ED ø 59mm ID ø 45.5mm			
	GEV No.	110557	Ref. No.	—
	knob dial plate silver thermostat t.max. 270°C 0-270°C rotation 250° ED ø 59mm ID ø 45.5mm			
	GEV No.	110558	Ref. No.	—
	knob dial plate silver gas tap PEL21/22/23 t.max.°C ED ø 59mm ID ø 45.5mm PEL			
	GEV No.	111553	Ref. No.	N/A
	knob dial plate silver switch 5-position t.max.°C ED ø 59mm ID ø 45.5mm			
	GEV No.	111560	Ref. No.	—
	knob dial plate silver energy regulator 1-3 2-circuit t.max.°C ED ø 59mm ID ø 45.5mm			

¹matching adapter and symbol must be ordered separately





















Table continues overleaf



accessories for 112173		GEV No.	Ref. No.	
	knob dial plate silver thermostat t.max. 195°C 100-195°C rotation 270° ED ø 59mm ID ø 45.5mm	111563	—	
	knob dial plate silver thermostat t.max. 185°C 100-185°C rotation 270° ED ø 59mm ID ø 45.5mm	111564	—	
	knob dial plate silver thermostat t.max. 110°C 60-110°C rotation 180° ED ø 59mm ID ø 45.5mm	111565	—	
	knob dial plate silver switch 2-0-1 t.max.°C ED ø 59mm ID ø 45.5mm	111566	—	
	knob dial plate black manual/automatic t.max.°C	111567	—	
	knob dial plate red gas thermostat ROBERTSHAW t.max.°C ED ø 59mm ID ø 45.5mm	111568	—	
	knob dial plate silver switch 1-2-1-2 t.max.°C ED ø 59mm ID ø 45.5mm	111711	—	
	knob dial plate silver thermostat t.max. 110°C 30-110°C rotation 270° ED ø 59mm ID ø 45.5mm	111878	—	
	knob dial plate silver oven t.max.°C ED ø 59mm ID ø 45.5mm	111946	—	
	knob dial plate silver thermostat t.max. 250°C 50-250°C rotation 270° ED ø 59mm ID ø 45.5mm	111947	—	
	knob dial plate silver thermostat t.max. 300°C 50-300°C rotation 310° ED ø 59mm ID ø 45.5mm	111961	—	
	knob adapter shaft ø 10x8mm L 0mm	112174	N/A	
	knob adapter shaft ø 8x6.5mm L 0mm	112175	—	
	knob adapter shaft ø 8x7mm L 0mm	112177	—	
	knob adapter shaft ø 8x5mm L 0mm	112178	N/A	
	knob adapter shaft ø 9x6.5mm L 0mm	112179	N/A	
	knob dial plate red switch 0-1-0-1 t.max.°C ED ø 59mm ID ø 45.5mm	112252	—	
	knob dial plate red switch 4-position t.max.°C ED ø 59mm ID ø 45.5mm	112254	—	
	knob dial plate red switch 7-position t.max.°C ED ø 59mm ID ø 45.5mm	112256	—	
	knob dial plate red thermostat t.max. 90°C 30-90°C rotation 270° ED ø 59mm ID ø 45.5mm	112258	—	

accessories for 112173		GEV No.	Ref. No.	
	knob dial plate silver thermostat t.max. 90°C 30-90°C rotation 270° ED ø 59mm ID ø 45.5mm	112259	—	
	knob dial plate red thermostat t.max. 90°C 30-90°C rotation 310° ED ø 59mm ID ø 45.5mm	112260	—	
	knob dial plate silver thermostat t.max. 90°C 30-90°C rotation 310° ED ø 59mm ID ø 45.5mm	112261	—	
	knob dial plate red thermostat t.max. 110°C 30-110°C rotation 310° ED ø 59mm ID ø 45.5mm	112264	—	
	knob dial plate red thermostat t.max. 180°C 100-180°C rotation 270° ED ø 59mm ID ø 45.5mm	112266	—	
	knob dial plate silver thermostat t.max. 180°C 100-180°C rotation 270° ED ø 59mm ID ø 45.5mm	112267	N/A	
	knob dial plate red thermostat t.max. 195°C 100-195°C rotation 270° ED ø 59mm ID ø 45.5mm	112268	—	
	washer shaft ø 6x4.6mm ø 16mm H 1mm Qty 10 pcs	112269	93979	
	washer shaft ø 8x5/8x6.5/8x7/7x7mm ø 16mm H 1mm Qty 10 pcs	112270	—	
	washer shaft ø 9x6.5/10x8/10x9/8x8mm ø 16mm H 1mm Qty 10 pcs	112271	—	
	knob dial plate red thermostat t.max. 300°C 50-300°C rotation 310° ED ø 59mm ID ø 45.5mm	112272	—	
	knob dial plate red thermostat t.max. 320°C 50-320°C rotation 270° ED ø 59mm ID ø 45.5mm	112276	—	
	knob dial plate silver thermostat t.max. 320°C 50-320°C rotation 270° ED ø 59mm ID ø 45.5mm	112277	—	
	knob dial plate red energy regulator 1-3 t.max.°C turn direction clockwise ED ø 59mm ID ø 45.5mm	112278	—	
	knob dial plate silver gas tap with ignition flame EGA24197 t.max.°C ED ø 59mm ID ø 45.5mm	112281	—	
	knob dial plate red gas tap PEL21/22/23 t.max.°C ED ø 59mm ID ø 45.5mm	112282	—	
	knob dial plate red gas tap without ignition flame PEL20 t.max.°C ED ø 59mm ID ø 45.5mm	112284	—	
	knob dial plate silver gas tap without ignition flame PEL20 t.max.°C ED ø 59mm ID ø 45.5mm	112285	—	
	knob dial plate red gas thermostat PEL 1-8 t.max.°C ED ø 59mm ID ø 45.5mm	112288	—	
	knob dial plate silver gas thermostat PEL 1-8 t.max.°C ED ø 59mm ID ø 45.5mm	112289	—	

Table continues overleaf

accessories for		112173		
GEV No.	Ref. No.	Ref. No.	Ref. No.	Ref. No.
	112290	—	—	—
knob dial plate red switch zero mark t.max.°C ED ø 59mm ID ø 45.5mm				
	112292	—	—	—
knob dial plate red thermostat 1-10 t.max.°C rotation 270° ED ø 59mm ID ø 45.5mm				
	112294	—	—	—
knob dial plate red thermostat 1-10 t.max.°C rotation 310° ED ø 59mm ID ø 45.5mm				
	112295	—	—	—
knob dial plate silver thermostat 1-10 t.max.°C rotation 310° ED ø 59mm ID ø 45.5mm				
	112298	93972	—	—
knob dial plate red switch 5-position t.max.°C ED ø 59mm ID ø 45.5mm				
	112299	—	—	—
knob dial plate red thermostat t.max. 185°C 100-185°C rotation 270° ED ø 59mm ID ø 45.5mm				
	112300	—	—	—
knob dial plate red thermostat t.max. 300°C 60-300°C rotation 270° ED ø 59mm ID ø 45.5mm				
	112301	—	—	—
knob dial plate red energy regulator 1-3 2-circuit t.max.°C ED ø 59mm ID ø 45.5mm				
	112304	—	—	—
knob adapter shaft ø 7x7mm L 0mm				
	112305	—	—	—
knob adapter shaft ø 8x8mm L 0mm				
	112308	—	—	—
knob dial plate red gas tap with ignition flame STN3R t.max.°C ED ø 59mm ID ø 45.5mm				
	112309	—	—	—
knob dial plate silver gas tap with ignition flame STN3R t.max.°C ED ø 59mm ID ø 45.5mm				
	112311	N/A	—	—
knob adapter shaft ø 6x4.6mm L 0mm with spring				
	112312	—	—	—
knob adapter shaft ø 10x9mm L 0mm				
	112332	—	—	—
knob dial plate red gas thermostat EUROSIT 1-8 t.max.°C ED ø 59mm ID ø 45.5mm				
	112333	—	—	—
knob dial plate silver gas thermostat EUROSIT 1-8 t.max.°C ED ø 59mm ID ø 45.5mm				
	112334	—	—	—
knob dial plate red gas thermostat SABAF 1-8 t.max.°C ED ø 59mm ID ø 45.5mm				
	112335	—	—	—
knob dial plate silver gas thermostat SABAF 1-8 t.max.°C ED ø 59mm ID ø 45.5mm				
	112336	—	—	—
knob dial plate red oven TH/BH/TH+BH t.max.°C turn direction anti clockwise ED ø 59mm ID ø 45.5mm				
	112337	—	—	—
knob dial plate silver oven TH/BH/TH+BH t.max.°C turn direction anti clockwise ED ø 59mm ID ø 45.5mm				





















accessories for		112173		
GEV No.	Ref. No.	Ref. No.	Ref. No.	Ref. No.
	112338	—	—	—
knob dial plate red oven TH/BH/TH+BH t.max.°C turn direction clockwise ED ø 59mm ID ø 45.5mm				
	112339	—	—	—
knob dial plate silver oven TH/BH/TH+BH t.max.°C turn direction clockwise ED ø 59mm ID ø 45.5mm				
	112342	—	—	—
knob adapter shaft ø 8mm L 0mm with screw				
	112343	N/A	—	—
knob adapter shaft ø 10mm L 0mm with screw				
	112344	—	—	—
knob dial plate red switch 0-1 t.max.°C ED ø 59mm ID ø 45.5mm				
	112345	—	—	—
knob dial plate silver switch 0-1 t.max.°C ED ø 59mm ID ø 45.5mm				
	112348	—	—	—
knob dial plate red switch 0-1-2 t.max.°C ED ø 59mm ID ø 45.5mm				
	112349	—	—	—
knob dial plate silver switch 0-1-2 t.max.°C ED ø 59mm ID ø 45.5mm				
	112352	—	—	—
knob dial plate red gas tap with ignition flame COPRECI t.max.°C ED ø 59mm ID ø 45.5mm				
	112353	—	—	—
knob dial plate silver gas tap with ignition flame COPRECI t.max.°C ED ø 59mm ID ø 45.5mm				
	112360	—	—	—
knob dial plate red gas thermostat COPRECI 1-8 t.max.°C ED ø 59mm ID ø 45.5mm				
	112361	—	—	—
knob dial plate silver gas thermostat COPRECI 1-8 t.max.°C ED ø 59mm ID ø 45.5mm				
	112365	—	—	—
knob dial plate silver gas valves NOVASIT t.max.°C ED ø 59mm ID ø 45.5mm				
	112369	—	—	—
knob dial plate silver water tap cold t.max.°C ED ø 59mm ID ø 45.5mm				
	112377	—	—	—
knob dial plate silver oven TH/BH/TH+BH t.max.°C turn direction anti clockwise ED ø 59mm ID ø 45.5mm				
	112382	—	—	—
knob dial plate red gas tap with ignition flame EGA26440 t.max.°C ED ø 59mm ID ø 45.5mm				
	112384	—	—	—
knob dial plate silver thermostat t.max. 150°C 40-150°C rotation 270° ED ø 59mm ID ø 45.5mm				
	112387	—	—	—
knob dial plate universal red				
	112388	—	—	—
knob dial plate universal silver				

Table continues overleaf























accessories for		112173	
GEV No.	112391	Ref. No.	—
	knob dial plate silver thermostat t.max. 85°C 30-85°C rotation 270° ED ø 59mm ID ø 45.5mm		
GEV No.	112394	Ref. No.	—
	knob dial plate red thermostat t.max. 200°C 60-200°C rotation 270° ED ø 59mm ID ø 45.5mm		
GEV No.	112395	Ref. No.	—
	knob dial plate silver thermostat t.max. 200°C 60-200°C rotation 270° ED ø 59mm ID ø 45.5mm		
GEV No.	112398	Ref. No.	—
	knob dial plate red thermostat t.max. 220°C 100-220°C rotation 310° ED ø 59mm ID ø 45.5mm		
GEV No.	112399	Ref. No.	—
	knob dial plate silver thermostat t.max. 220°C 100-220°C rotation 310° ED ø 59mm ID ø 45.5mm		
GEV No.	112402	Ref. No.	—
	knob dial plate red thermostat t.max. 350°C 100-350°C rotation 310° ED ø 59mm ID ø 45.5mm		
GEV No.	112403	Ref. No.	—
	knob dial plate silver thermostat t.max. 350°C 100-350°C rotation 310° ED ø 59mm ID ø 45.5mm		
GEV No.	112406	Ref. No.	—
	knob dial plate red thermostat t.max. 500°C 50-500°C rotation 270° ED ø 59mm ID ø 45.5mm		
GEV No.	112407	Ref. No.	—
	knob dial plate silver thermostat t.max. 500°C 50-500°C rotation 270° ED ø 59mm ID ø 45.5mm		
GEV No.	112411	Ref. No.	—
	knob dial plate silver thermostat t.max. 500°C 50-500°C rotation 310° ED ø 59mm ID ø 45.5mm		
GEV No.	112448	Ref. No.	—
	knob dial plate silver thermostat t.max. 100°C 40-100°C rotation 270° ED ø 59mm ID ø 45.5mm		
GEV No.	112450	Ref. No.	—
	knob adapter shaft ø 8x6.5mm L 0mm		
GEV No.	112457	Ref. No.	—
	knob dial plate black/yellow energy regulator 1-circuit t.max.°C turn direction clockwise ED ø 59mm ID ø 45.5mm		
GEV No.	112461	Ref. No.	—
	knob dial plate silver thermostat t.max. 190°C 120-190°C rotation 270° ED ø 59mm ID ø 45.5mm		
GEV No.	112514	Ref. No.	—
	knob adapter shaft ø 10x8mm L 6mm		
GEV No.	112515	Ref. No.	—
	knob adapter shaft ø 8x6.5mm L 6mm		
GEV No.	112516	Ref. No.	—
	knob adapter shaft ø 6x4.6mm L 6mm		
GEV No.	112522	Ref. No.	—
	knob dial plate silver energy regulator 1-3 t.max.°C turn direction anti clockwise ED ø 59mm ID ø 45.5mm		
GEV No.	112601	Ref. No.	—
	knob dial plate silver gas thermostat MERTIK 1-8 t.max.°C ED ø 59mm ID ø 45.5mm		
GEV No.	112602	Ref. No.	—
	knob dial plate red gas thermostat MERTIK 1-8 t.max.°C ED ø 59mm ID ø 45.5mm		

accessories for		112173	
GEV No.	112651	Ref. No.	—
	knob dial plate universal black		

 1			
GEV No.	112568 ¹	Ref. No.	94651-001
description	knob universal ø 62mm silver-coloured without adaptor/dial plate zamak		
accessories for	112568		
GEV No.	110530	Ref. No.	—
	knob dial plate silver thermostat t.max. 300°C 60-300°C rotation 270° ED ø 59mm ID ø 45.5mm		
GEV No.	110531	Ref. No.	—
	knob dial plate silver time 120min + permanent ON t.max.°C ED ø 59mm ID ø 45.5mm		
GEV No.	110532	Ref. No.	—
	knob dial plate red thermostat t.max. 300°C 0-300°C rotation 270° ED ø 59mm ID ø 45.5mm		
GEV No.	110533	Ref. No.	—
	knob dial plate red thermostat t.max. 100°C 0-100°C rotation 270° ED ø 59mm ID ø 45.5mm		
GEV No.	110534	Ref. No.	—
	knob dial plate silver time 120min + permanent ON t.max.°C ED ø 59mm ID ø 45.5mm		
GEV No.	110535	Ref. No.	—
	knob dial plate red thermostat t.max. 250°C 50-250°C rotation 270° ED ø 59mm ID ø 45.5mm		
GEV No.	110536	Ref. No.	—
	knob dial plate silver thermostat t.max. 195°C 100-195°C rotation 270° ED ø 59mm ID ø 45.5mm		
GEV No.	110537	Ref. No.	—
	knob dial plate silver switch zero mark t.max.°C ED ø 59mm ID ø 45.5mm		
GEV No.	110538	Ref. No.	—
	knob dial plate red gas tap with ignition flame EGA24197 t.max.°C ED ø 59mm ID ø 45.5mm		
GEV No.	110539	Ref. No.	—
	knob dial plate silver switch 2-0-1 t.max.°C 1-2°C ED ø 59mm ID ø 45.5mm		
GEV No.	110540	Ref. No.	94222
	knob dial plate silver thermostat 1-10 t.max.°C 1-10°C rotation 270° ED ø 59mm ID ø 45.5mm		
GEV No.	110541	Ref. No.	—
	knob dial plate silver gas tap without ignition flame EGA26400 t.max.°C ED ø 59mm ID ø 45.5mm		
GEV No.	110542	Ref. No.	N/A
	knob dial plate silver switch 0-1-0-1 t.max.°C ED ø 59mm ID ø 45.5mm		
GEV No.	110543	Ref. No.	—
	knob dial plate silver gas thermostat EGA 1-8 t.max.°C ED ø 59mm ID ø 45.5mm		
GEV No.	110544	Ref. No.	—
	knob dial plate silver 0-FRITTIEREN-0-SCHMELZEN t.max.°C ED ø 59mm ID ø 45.5mm		

¹matching adapter and symbol must be ordered separately
Table continues overleaf

accessories for		112568		
GEV No.	Ref. No.	Ref. No.	Ref. No.	Ref. No.
	110545	—	—	—
knob dial plate silver thermostat t.max. 110°C 30-110°C rotation 310° ED ø 59mm ID ø 45.5mm				
	110546	—	—	—
knob dial plate red thermostat t.max. 110°C 30-110°C rotation 270° ED ø 59mm ID ø 45.5mm				
	110547	—	—	—
knob dial plate red gas thermostat EGA 1-8 t.max.°C°C ED ø 59mm ID ø 45.5mm				
	110548	—	—	—
knob dial plate red switch 1-2-1-2 t.max.°C°C ED ø 59mm ID ø 45.5mm				
	110549	N/A	—	—
knob dial plate red thermostat t.max. 300°C 50-300°C rotation 270° ED ø 59mm ID ø 45.5mm				
	110550	—	—	—
knob dial plate silver gas tap with ignition flame EGA26440 t.max.°C°C ED ø 59mm ID ø 45.5mm				
	110551	N/A	—	—
knob dial plate silver energy regulator 1-3 t.max.°C°C turn direction clockwise ED ø 59mm ID ø 45.5mm				
	110552	N/A	—	—
knob dial plate silver switch 7-position t.max.°C°C ED ø 59mm ID ø 45.5mm				
	110553	—	—	—
knob dial plate silver switch 4-position t.max.°C°C ED ø 59mm ID ø 45.5mm				
	110554	—	—	—
knob dial plate silver thermostat t.max. 300°C 0-300°C rotation 270° ED ø 59mm ID ø 45.5mm				
	110555	—	—	—
knob dial plate silver time 120min + permanent ON t.max.°C°C ED ø 59mm ID ø 45.5mm				
	110556	—	—	—
knob dial plate silver thermostat t.max. 100°C 0-100°C rotation 270° ED ø 59mm ID ø 45.5mm				
	110557	—	—	—
knob dial plate silver thermostat t.max. 270°C 0-270°C rotation 250° ED ø 59mm ID ø 45.5mm				
	110558	—	—	—
knob dial plate silver gas tap PEL21/22/23 t.max.°C°C ED ø 59mm ID ø 45.5mm PEL				
	111553	N/A	—	—
knob dial plate silver switch 5-position t.max.°C°C ED ø 59mm ID ø 45.5mm				
	111560	—	—	—
knob dial plate silver energy regulator 1-3 2-circuit t.max.°C°C ED ø 59mm ID ø 45.5mm				
	111563	—	—	—
knob dial plate silver thermostat t.max. 195°C 100-195°C rotation 270° ED ø 59mm ID ø 45.5mm				
	111564	—	—	—
knob dial plate silver thermostat t.max. 185°C 100-185°C rotation 270° ED ø 59mm ID ø 45.5mm				
	111565	—	—	—
knob dial plate silver thermostat t.max. 110°C 60-110°C rotation 180° ED ø 59mm ID ø 45.5mm				
	111566	—	—	—
knob dial plate silver switch 2-0-1 t.max.°C°C ED ø 59mm ID ø 45.5mm				



accessories for		112568		
GEV No.	Ref. No.	Ref. No.	Ref. No.	Ref. No.
	111567	—	—	—
knob dial plate black manual/automatic t.max.°C°C				
	111568	—	—	—
knob dial plate red gas thermostat ROBERTSHAW t.max.°C°C ED ø 59mm ID ø 45.5mm				
	111711	—	—	—
knob dial plate silver switch 1-2-1-2 t.max.°C°C ED ø 59mm ID ø 45.5mm				
	111878	—	—	—
knob dial plate silver thermostat t.max. 110°C 30-110°C rotation 270° ED ø 59mm ID ø 45.5mm				
	111946	—	—	—
knob dial plate silver oven t.max.°C°C ED ø 59mm ID ø 45.5mm				
	111947	—	—	—
knob dial plate silver thermostat t.max. 250°C 50-250°C rotation 270° ED ø 59mm ID ø 45.5mm				
	111961	—	—	—
knob dial plate silver thermostat t.max. 300°C 50-300°C rotation 310° ED ø 59mm ID ø 45.5mm				
	112174	N/A	—	—
knob adapter shaft ø 10x8mm L 0mm				
	112175	—	—	—
knob adapter shaft ø 8x6.5mm L 0mm				
	112177	—	—	—
knob adapter shaft ø 8x7mm L 0mm				
	112178	N/A	—	—
knob adapter shaft ø 8x5mm L 0mm				
	112179	N/A	—	—
knob adapter shaft ø 9x6.5mm L 0mm				
	112252	—	—	—
knob dial plate red switch 0-1-0-1 t.max.°C ED ø 59mm ID ø 45.5mm				
	112254	—	—	—
knob dial plate red switch 4-position t.max.°C ED ø 59mm ID ø 45.5mm				
	112256	—	—	—
knob dial plate red switch 7-position t.max.°C ED ø 59mm ID ø 45.5mm				
	112258	—	—	—
knob dial plate red thermostat t.max. 90°C 30-90°C rotation 270° ED ø 59mm ID ø 45.5mm				
	112259	—	—	—
knob dial plate silver thermostat t.max. 90°C 30-90°C rotation 270° ED ø 59mm ID ø 45.5mm				
	112260	—	—	—
knob dial plate red thermostat t.max. 90°C 30-90°C rotation 310° ED ø 59mm ID ø 45.5mm				
	112261	—	—	—
knob dial plate silver thermostat t.max. 90°C 30-90°C rotation 310° ED ø 59mm ID ø 45.5mm				
	112264	—	—	—
knob dial plate red thermostat t.max. 110°C 30-110°C rotation 310° ED ø 59mm ID ø 45.5mm				

Table continues overleaf



















accessories for 112568		GEV No.	Ref. No.	
	knob dial plate red thermostat t.max. 180°C 100-180°C rotation 270° ED ø 59mm ID ø 45.5mm	112266	—	
	knob dial plate silver thermostat t.max. 180°C 100-180°C rotation 270° ED ø 59mm ID ø 45.5mm	112267	N/A	
	knob dial plate red thermostat t.max. 195°C 100-195°C rotation 270° ED ø 59mm ID ø 45.5mm	112268	—	
	washer shaft ø 6x4.6mm ø 16mm H 1mm Qty 10 pcs	112269	93979	
	washer shaft ø 8x5/8x6.5/8x7/7x7mm ø 16mm H 1mm Qty 10 pcs	112270	—	
	washer shaft ø 9x6.5/10x8/10x9/8x8mm ø 16mm H 1mm Qty 10 pcs	112271	—	
	knob dial plate red thermostat t.max. 300°C 50-300°C rotation 310° ED ø 59mm ID ø 45.5mm	112272	—	
	knob dial plate red thermostat t.max. 320°C 50-320°C rotation 270° ED ø 59mm ID ø 45.5mm	112276	—	
	knob dial plate silver thermostat t.max. 320°C 50-320°C rotation 270° ED ø 59mm ID ø 45.5mm	112277	—	
	knob dial plate red energy regulator 1-3 t.max.°C turn direction clockwise ED ø 59mm ID ø 45.5mm	112278	—	
	knob dial plate silver gas tap with ignition flame EGA24197 t.max.°C ED ø 59mm ID ø 45.5mm	112281	—	
	knob dial plate red gas tap PEL21/22/23 t.max.°C ED ø 59mm ID ø 45.5mm	112282	—	
	knob dial plate red gas tap without ignition flame PEL20 t.max.°C ED ø 59mm ID ø 45.5mm	112284	—	
	knob dial plate silver gas tap without ignition flame PEL20 t.max.°C ED ø 59mm ID ø 45.5mm	112285	—	
	knob dial plate red gas thermostat PEL 1-8 t.max.°C ED ø 59mm ID ø 45.5mm	112288	—	
	knob dial plate silver gas thermostat PEL 1-8 t.max.°C ED ø 59mm ID ø 45.5mm	112289	—	
	knob dial plate red switch zero mark t.max.°C ED ø 59mm ID ø 45.5mm	112290	—	
	knob dial plate red thermostat 1-10 t.max.°C rotation 270° ED ø 59mm ID ø 45.5mm	112292	—	
	knob dial plate red thermostat 1-10 t.max.°C rotation 310° ED ø 59mm ID ø 45.5mm	112294	—	
	knob dial plate silver thermostat 1-10 t.max.°C rotation 310° ED ø 59mm ID ø 45.5mm	112295	—	

accessories for 112568		GEV No.	Ref. No.	
	knob dial plate red switch 5-position t.max.°C ED ø 59mm ID ø 45.5mm	112298	93972	
	knob dial plate red thermostat t.max. 185°C 100-185°C rotation 270° ED ø 59mm ID ø 45.5mm	112299	—	
	knob dial plate red thermostat t.max. 300°C 60-300°C rotation 270° ED ø 59mm ID ø 45.5mm	112300	—	
	knob dial plate red energy regulator 1-3 2-circuit t.max.°C ED ø 59mm ID ø 45.5mm	112301	—	
	knob adapter shaft ø 7x7mm L 0mm	112304	—	
	knob adapter shaft ø 8x8mm L 0mm	112305	—	
	knob dial plate red gas tap with ignition flame STN3R t.max.°C ED ø 59mm ID ø 45.5mm	112308	—	
	knob dial plate silver gas tap with ignition flame STN3R t.max.°C ED ø 59mm ID ø 45.5mm	112309	—	
	knob adapter shaft ø 6x4.6mm L 0mm with spring	112311	N/A	
	knob adapter shaft ø 10x9mm L 0mm	112312	—	
	knob dial plate red gas thermostat EUROSIT 1-8 t.max.°C ED ø 59mm ID ø 45.5mm	112332	—	
	knob dial plate silver gas thermostat EUROSIT 1-8 t.max.°C ED ø 59mm ID ø 45.5mm	112333	—	
	knob dial plate red gas thermostat SABAF 1-8 t.max.°C ED ø 59mm ID ø 45.5mm	112334	—	
	knob dial plate silver gas thermostat SABAF 1-8 t.max.°C ED ø 59mm ID ø 45.5mm	112335	—	
	knob dial plate red oven TH/BH/TH+BH t.max.°C turn direction anti clockwise ED ø 59mm ID ø 45.5mm	112336	—	
	knob dial plate silver oven TH/BH/TH+BH t.max.°C turn direction anti clockwise ED ø 59mm ID ø 45.5mm	112337	—	
	knob dial plate red oven TH/BH/TH+BH t.max.°C turn direction clockwise ED ø 59mm ID ø 45.5mm	112338	—	
	knob dial plate silver oven TH/BH/TH+BH t.max.°C turn direction clockwise ED ø 59mm ID ø 45.5mm	112339	—	
	knob adapter shaft ø 8mm L 0mm with screw	112342	—	

Table continues overleaf

accessories for		112568		
GEV No.	Ref. No.	Ref. No.	Ref. No.	Ref. No.
	112343			N/A
knob adapter shaft ø 10mm L 0mm with screw				
	112344			—
knob dial plate red switch 0-1 t.max.°C ED ø 59mm ID ø 45,5mm				
	112345			—
knob dial plate silver switch 0-1 t.max.°C ED ø 59mm ID ø 45,5mm				
	112348			—
knob dial plate red switch 0-1-2 t.max.°C ED ø 59mm ID ø 45,5mm				
	112349			—
knob dial plate silver switch 0-1-2 t.max.°C ED ø 59mm ID ø 45,5mm				
	112352			—
knob dial plate red gas tap with ignition flame COPRECI t.max.°C ED ø 59mm ID ø 45,5mm				
	112353			—
knob dial plate silver gas tap with ignition flame COPRECI t.max.°C ED ø 59mm ID ø 45,5mm				
	112360			—
knob dial plate red gas thermostat COPRECI 1-8 t.max.°C ED ø 59mm ID ø 45,5mm				
	112361			—
knob dial plate silver gas thermostat COPRECI 1-8 t.max.°C ED ø 59mm ID ø 45,5mm				
	112365			—
knob dial plate silver gas valves NOVASIT t.max.°C ED ø 59mm ID ø 45,5mm				
	112369			—
knob dial plate silver water tap cold t.max.°C ED ø 59mm ID ø 45,5mm				
	112377			—
knob dial plate silver oven TH/BH/TH+BH t.max.°C turn direction anti clockwise ED ø 59mm ID ø 45,5mm				
	112382			—
knob dial plate red gas tap with ignition flame EGA26440 t.max.°C ED ø 59mm ID ø 45,5mm				
	112384			—
knob dial plate silver thermostat t.max. 150°C 40-150°C rotation 270° ED ø 59mm ID ø 45,5mm				
	112387			—
knob dial plate universal red				
	112388			—
knob dial plate universal silver				
	112391			—
knob dial plate silver thermostat t.max. 85°C 30-85°C rotation 270° ED ø 59mm ID ø 45,5mm				
	112394			—
knob dial plate red thermostat t.max. 200°C 60-200°C rotation 270° ED ø 59mm ID ø 45,5mm				
	112395			—
knob dial plate silver thermostat t.max. 200°C 60-200°C rotation 270° ED ø 59mm ID ø 45,5mm				
	112398			—
knob dial plate red thermostat t.max. 220°C 100-220°C rotation 310° ED ø 59mm ID ø 45,5mm				

accessories for		112568		
GEV No.	Ref. No.	Ref. No.	Ref. No.	Ref. No.
	112399			—
knob dial plate silver thermostat t.max. 220°C 100-220°C rotation 310° ED ø 59mm ID ø 45,5mm				
	112402			—
knob dial plate red thermostat t.max. 350°C 100-350°C rotation 310° ED ø 59mm ID ø 45,5mm				
	112403			—
knob dial plate silver thermostat t.max. 350°C 100-350°C rotation 310° ED ø 59mm ID ø 45,5mm				
	112406			—
knob dial plate red thermostat t.max. 500°C 50-500°C rotation 270° ED ø 59mm ID ø 45,5mm				
	112407			—
knob dial plate silver thermostat t.max. 500°C 50-500°C rotation 270° ED ø 59mm ID ø 45,5mm				
	112411			—
knob dial plate silver thermostat t.max. 500°C 50-500°C rotation 310° ED ø 59mm ID ø 45,5mm				
	112448			—
knob dial plate silver thermostat t.max. 100°C 40-100°C rotation 270° ED ø 59mm ID ø 45,5mm				
	112450			—
knob adapter shaft ø 8x6,5mm L 0mm				
	112457			—
knob dial plate black/yellow energy regulator 1-circuit t.max.°C turn direction clockwise ED ø 59mm ID ø 45,5mm				
	112461			—
knob dial plate silver thermostat t.max. 190°C 120-190°C rotation 270° ED ø 59mm ID ø 45,5mm				
	112514			—
knob adapter shaft ø 10x8mm L 6mm				
	112515			—
knob adapter shaft ø 8x6,5mm L 6mm				
	112516			—
knob adapter shaft ø 6x4,6mm L 6mm				
	112522			—
knob dial plate silver energy regulator 1-3 t.max.°C turn direction anti clockwise ED ø 59mm ID ø 45,5mm				
	112601			—
knob dial plate silver gas thermostat MERTIK 1-8 t.max.°C ED ø 59mm ID ø 45,5mm				
	112602			—
knob dial plate red gas thermostat MERTIK 1-8 t.max.°C ED ø 59mm ID ø 45,5mm				
	112651			—
knob dial plate universal black				



<p>1</p>			
GEV No.	112343	Ref. No.	N/A
description	knob adapter shaft ø 10mm L 0mm with screw		

<p>1</p>			
GEV No.	112174	Ref. No.	N/A
description	knob adapter shaft ø 10x8mm L 0mm		

<p>1</p>			
GEV No.	112311	Ref. No.	N/A
description	knob adapter shaft ø 6x4.6mm L 0mm with spring		

<p>1</p>			
GEV No.	112178	Ref. No.	N/A
description	knob adapter shaft ø 8x5mm L 0mm		

<p>1</p>			
GEV No.	112179	Ref. No.	N/A
description	knob adapter shaft ø 9x6.5mm L 0mm		

<p>1</p>			
GEV No.	110549	Ref. No.	N/A
description	knob dial plate red thermostat t.max. 300°C 50-300°C rotation 270° ED ø 59mm ID ø 45.5mm		

<p>1</p>			
GEV No.	110551	Ref. No.	N/A
description	knob dial plate silver energy regulator 1-3 t.max.°C turn direction clockwise ED ø 59mm ID ø 45.5mm		

<p>1</p>			
GEV No.	110542	Ref. No.	N/A
description	knob dial plate silver switch 0-1-0-1 t.max.°C ED ø 59mm ID ø 45.5mm		

<p>1</p>			
GEV No.	111553	Ref. No.	N/A
description	knob dial plate silver switch 5-position t.max.°C ED ø 59mm ID ø 45.5mm		

<p>1</p>			
GEV No.	110552	Ref. No.	N/A
description	knob dial plate silver switch 7-position t.max.°C ED ø 59mm ID ø 45.5mm		

<p>1</p>			
GEV No.	112267	Ref. No.	N/A
description	knob dial plate silver thermostat t.max. 180°C 100-180°C rotation 270° ED ø 59mm ID ø 45.5mm		

baskets

fryer baskets

HEIDEBRENNER



1

GEV No.	970149	Ref. No.	98856
description	fryer basket L1 340mm W1 310mm H1 125mm		

gaskets

sealing washers

aluminium gaskets



1

GEV No.	101293	Ref. No.	94481
description	flat gasket aluminium ED ø 14mm ID ø 10.3mm for pilot burner Qty 1 pcs		

fastening material

nuts

hexagonal nuts

hexagonal nuts metric (without norm)



1

GEV No.	101501	Ref. No.	93282
description	nut thread M12x0.75 H 2mm WS 16 brass Qty 1 pcs		



1

GEV No.	102067	Ref. No.	93123
description	nut thread M8x1 H 3mm brass Qty 1 pcs type SEF 1		

C

cables	4
cam switches	4
control thermostats	3
copper wire	4

E

electric accessories	4
energy regulators	3

F

fastening material	34
female fastons	5

G

gas burners	16
gas nozzles	20
gas taps	5
gas thermostats	11

H

heating elements	3
heating elements for ovens	3
hexagonal nuts	34
hob burners	16
hot plates	3

I

indicator lights	4
------------------	---

L

lamps	4
-------	---

N

neon light bulbs	4, 4
nuts	34

P

piezoelectric igniters	13
pilot burners	12

R

radiation heaters	3
ring burners	20

S

safety thermostats	4
safety valves	12
sealing washers	34
switches and momentary switches	4

T

terminals	5
terminals and connectors	5
thermocouples	13
thermostats	3