



GAS COMPONENTS



ELECTRIC COMPONENTS



WATER TECHNOLOGY



MECHANICAL COMPONENTS



TOOLS

Spare parts suitable for

HAGOLA

Find the complete and up-to-date range of products in our GEV Webshop



Manufacturer catalogue

The most important spare parts and accessories arranged clearly for every manufacturer

- ✓ Complete product range and all appliance data always up to date in the GEV Webshop
- ✓ Alphabetical Index at the end of the catalogue

GEV Webshop

www.gev-online.co.uk

www.gev-online.com



- 🔍 Add to Favourites
- 🔍 Sign In with email address and usual password
- 🔍 Easy-order – place several items in your basket at the same time
- 🔍 Quick Item search – no login needed



electronic controllers

STÖRK-TRONIC

refrigeration controllers

built-in version



GEV No.	378196	Ref. No.	HKASL21 HKASM16
description	electronic controller STÖRK-TRONIK type ST181 mounting measurements 158x44mm 230V voltage AC PTC 1x PTC probe and 1x power supply inclusive -55 up to +99°C		

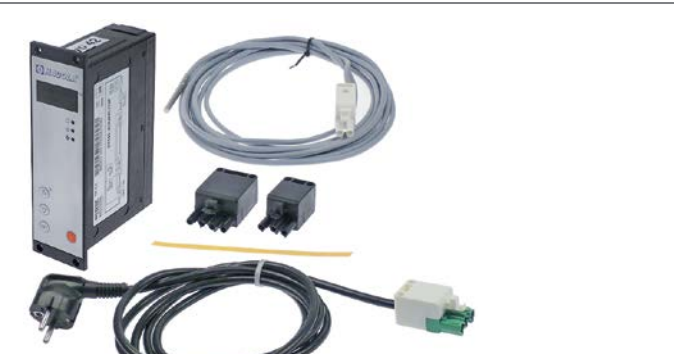

GEV No.	378518	Ref. No.	hkasl43
description	electronic controller STÖRK-TRONIK type ST185-JC4JAR.112F mounting measurements 158x44mm 230V voltage AC PTC relay outputs 2 NO-16A(6) NO-16A(6) PTC front measurements 180x52mm 1x PTC probe and 1x power supply inclusive X defr. funct. defrosting function/time control		

locks

edgemoat latches

drawer latches

producer-specific







HAGOLA

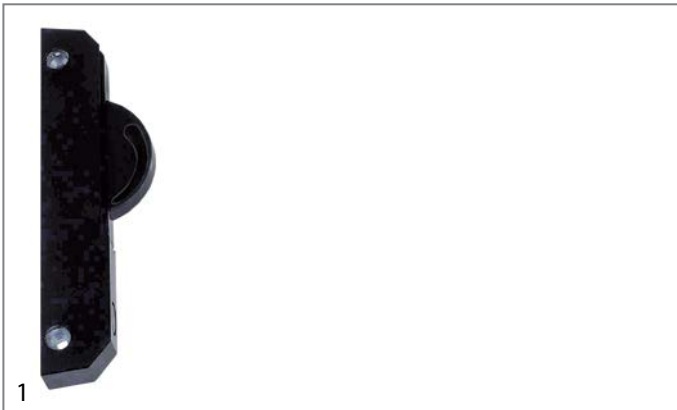

GEV No.	700788	Ref. No.	ectdkv5
description	drawer latch L 185mm mounting distance 150mm lockable refrigeration units HAGOLA half-round series 6190		

accessories for	700788			
	GEV No.	690110	Ref. No.	—
	base plate H 1mm L 38mm W 11mm mounting distance 26mm plastic			
	GEV No.	690111	Ref. No.	—
	base plate H 2mm L 38mm W 11mm mounting distance 26mm plastic			
	GEV No.	690947	Ref. No.	—
	base plate H 5mm L 38mm W 11mm mounting distance 26mm plastic			
	GEV No.	700082	Ref. No.	ectdiv3
	door catch L 38mm W 18mm mounting distance 26mm			
	GEV No.	700790	Ref. No.	ectdgs2
	handle rod L 515mm aluminium half-round			
	GEV No.	700856	Ref. No.	ettdi-v10(825mm)
	handle rod L 825mm aluminium half-round			



GEV No.	700789	Ref. No.	ectdkv6
description	drawer latch L 185mm mounting distance 150mm non lockable refrigeration units HAGOLA half-round series 6190		
accessories for	700789		
	GEV No.	690110	Ref. No. —
	base plate H 1mm L 38mm W 11mm mounting distance 26mm plastic		
	GEV No.	690111	Ref. No. —
	base plate H 2mm L 38mm W 11mm mounting distance 26mm plastic		
	GEV No.	690947	Ref. No. —
	base plate H 5mm L 38mm W 11mm mounting distance 26mm plastic		
	GEV No.	700082	Ref. No. ectdiv3
	door catch L 38mm W 18mm mounting distance 26mm		
	GEV No.	700790	Ref. No. ectdgs2
	handle rod L 515mm aluminium half-round		
	GEV No.	700856	Ref. No. ettdi-v10(825mm)
	handle rod L 825mm aluminium half-round		

door catches

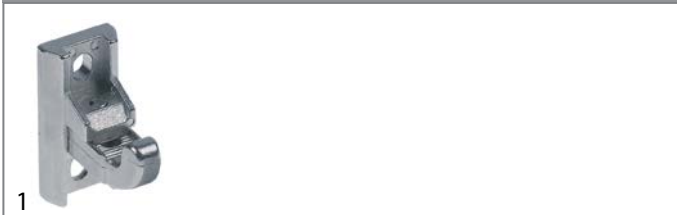

GEV No.	700082	Ref. No.	ectdiv3
description	door catch L 38mm W 18mm mounting distance 26mm		

hinges

edgemount hinges

RAHRBACH

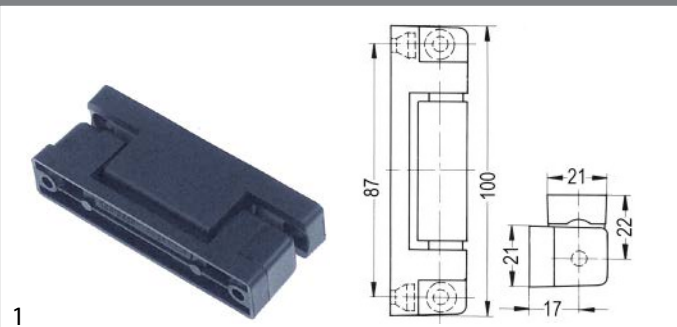

GEV No.	690276	Ref. No.	ectdiv4
description	edgemount hinge L 100mm W 21mm mounting distance 87mm hinging left/right with spring refrigeration units series 4513		

gaskets

refrigeration gaskets

plug-in gaskets

profile 9162

universal

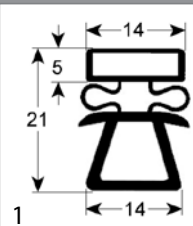

GEV No.	902269	Ref. No.	N/A
description	refrigeration gasket profile 9162 Wmm L 2500mm		

D

door catches	4
drawer latches	3

E

edgemount hinges	4
edgemount latches	3
electronic controllers	3

P

plug-in gaskets	4
-----------------	---

R

refrigeration gaskets	4
-----------------------	---