



GAS COMPONENTS



ELECTRIC COMPONENTS



WATER TECHNOLOGY



MECHANICAL COMPONENTS



TOOLS

Spare parts suitable for

GRIMAC

Find the complete and up-to-date range of products in our GEV Webshop



Manufacturer catalogue

The most important spare parts and accessories arranged clearly for every manufacturer

- ✓ Complete product range and all appliance data always up to date in the GEV Webshop
- ✓ Alphabetical Index at the end of the catalogue

GEV Webshop

www.gev-online.co.uk

www.gev-online.com











- 🔍 Add to Favourites
- 🔍 Sign In with email address and usual password
- 🔍 Easy-order – place several items in your basket at the same time
- 🔍 Quick Item search – no login needed







heating elements



heating elements for coffee machine



 <p>1</p>			
GEV No.	417026	Ref. No.	SM132
description	heating element 1000W 230V heating circuits 1 L 205mm W 50mm H 18mm L1 30mm L2 35mm L3 140mm mounting distance 28mm thread M10x1 connection M3 tube ø 8.5mm 2 hole fixing immersion heater windings 2		
accessories for	417026		
	GEV No.	510416	Ref. No. —
	flat gasket fibre ED ø 19mm ID ø 10.5mm thickness 1.5mm for thread M10 Qty 1 pcs		
	GEV No.	510893	Ref. No. —
	O-ring EPDM thickness 2.62mm ID ø 9.92mm Qty 1 pcs		
	GEV No.	520231	Ref. No. —
	nut thread M10x1 H 6mm WS 14 zinc-coated steel Qty 1 pcs		
	GEV No.	521129	Ref. No. —
	nut thread M10 H 6mm SS WS 17 Qty 1 pcs DIN/ISO DIN 439		
	GEV No.	527169	Ref. No. —
	hexagonal nut thread M3 H 2.8mm WS 5.5 brass Qty 1 pcs		
	GEV No.	560110	Ref. No. —
	plain washer ID ø 3.2mm ED ø 7mm thickness 0.5mm SS Qty 20 pcs DIN 125A for thread M3		
	GEV No.	560130	Ref. No. —
	hexagonal nut thread M3 H 2.4mm WS 5.5 SS DIN/ISO DIN 934 / ISO 4032/8673 Qty 20 pcs		

 <p>1</p>			
GEV No.	417027	Ref. No.	SM130
description	heating element 1250W 220V heating circuits 1 L 370mm H 70mm L1 32mm L2 58mm L3 280mm mounting distance 25mm thread M10x1 connection M3x0.6 2 hole fixing immersion heater		



 <p>1</p>			
GEV No.	417014	Ref. No.	C405
description	heating element 1300W 230V heating circuits 1 hole distance 59mm L 185mm W 40mm H 18mm hole ø 9mm tube ø 8.5mm connection male faston 6.3mm immersion heater 3 hole flange suitable for CIMBALI		
accessories for	417014		
	GEV No.	529484	Ref. No. —
	flat gasket fibre ED ø 58mm ID ø 50mm thickness 2mm Qty 1 pcs		









 <p>1</p>			
GEV No.	417006	Ref. No.	1240100216 W902
description	heating element 1300W 230V heating circuits 1 thread 1¼" L 110mm W 27mm H 30mm tube ø 6.4mm connection male faston 6.3mm immersion heater connection length 30mm flange with thread WS 37 with thread for safety thermostat		
accessories for	417006		
	GEV No.	510405	Ref. No. —
	flat gasket fibre ED ø 56mm ID ø 42mm thickness 2mm for thread 1¼" Qty 1 pcs		
	GEV No.	528021	Ref. No. 1110300016 A1200015 CA020T GRC610
	flat gasket PTFE ED ø 53mm ID ø 42.5mm thickness 3mm Qty 1 pcs equiv. no. 12001/02286 suitable for Astoria/Aurora/Brasilia/Wega		

 <p>1</p>			
GEV No.	417002	Ref. No.	F351
description	heating element 1500W 230V heating circuits 2 mounting ø 42mm hole distance 74mm L 140mm W 25mm H 58mm L1 16mm L2 54mm L3 70mm H1 26mm H2 32mm hole ø 11mm tube ø 8mm connection M6x1 immersion heater 2 hole flange suitable for FAEMA		
accessories for	417002		
	GEV No.	528002	Ref. No. —
	flat gasket PTFE ED ø 57mm ID ø 42mm thickness 3mm Qty 1 pcs equiv. no. 12001/W10470 suitable for		
	GEV No.	528488	Ref. No. —
	flat gasket fibre ED ø 57mm ID ø 42mm thickness 3mm Qty 1 pcs		

 <p>1</p>			
GEV No.	417057	Ref. No.	A080
description	heating element 1500W 230V heating circuits 2 thread 1¼" L 145mm W 23mm H 37mm tube ø 8mm connection M4 immersion heater flange with thread		
accessories for	417057		
	GEV No.	510405	Ref. No. —
	flat gasket fibre ED ø 56mm ID ø 42mm thickness 2mm for thread 1¼" Qty 1 pcs		
	GEV No.	528021	Ref. No. 1110300016 A1200015 CA020T GRC610
	flat gasket PTFE ED ø 53mm ID ø 42.5mm thickness 3mm Qty 1 pcs equiv. no. 12001/02286 suitable for Astoria/Aurora/Brasilia/Wega		



 <p>1</p>			
GEV No.	417021	Ref. No.	G346
description	heating element 1500W 230V heating circuits 3 mounting ø 40mm hole distance 52mm L 145mm W 34mm H 30mm hole ø 6.5mm connection male faston 6.3mm immersion heater 8 hole flange		

			
GEV No.	417011	Ref. No.	C181
description	heating element 1800W 230V heating circuits 3 hole distance 59mm L 170mm W 34mm H 35mm hole ø 9.7mm thermostat sleeves ø 7mm length thermostat sleeves 170mm number of thermostat sleeves 1 thermostat sleeve eccentric, non clinging tube ø 8.5mm connection male faston 6.3mm immersion heater 3 hole flange suitable for CIMBALI		
accessories for	417011		
	GEV No.	528002	Ref. No. —
	flat gasket PTFE ED ø 57mm ID ø 42mm thickness 3mm Qty 1 pcs equiv. no. 12001/W10470 suitable for		
	GEV No.	528488	Ref. No. —
	flat gasket fibre ED ø 57mm ID ø 42mm thickness 3mm Qty 1 pcs		

			
GEV No.	415006	Ref. No.	BF042
description	heating element 1880W 230V heating circuits 1 thread 1¼" L 147mm W 35mm H 26mm connection M4 immersion heater flange with thread copper		
spare parts for	415006		
	GEV No.	510405	Ref. No. —
	flat gasket fibre ED ø 56mm ID ø 42mm thickness 2mm for thread 1¼" Qty 1 pcs		
accessories for	415006		
	GEV No.	520232	Ref. No. —
	nut thread 1¼" H 5mm nickel-plated brass WS 47 Qty 1 pcs		
	GEV No.	521103	Ref. No. —
	nut thread M4 H 3mm WS 7 brass Qty 20 pcs		
	GEV No.	521104	Ref. No. —
	washer ID ø 4.3mm ED ø 8mm thickness 0.5mm brass Qty 20 pcs for thread M4		
	GEV No.	528021	Ref. No. 1110300016 A1200015 CA020T GRC610
	flat gasket PTFE ED ø 53mm ID ø 42.5mm thickness 3mm Qty 1 pcs equiv. no. 12001/02286 suitable for Astoria/Aurora/Brasilia/Wega		
	GEV No.	560111	Ref. No. —
	plain washer ID ø 4.3mm ED ø 9mm thickness 0.8mm SS Qty 20 pcs DIN 125A for thread M4		
	GEV No.	560131	Ref. No. —
	hexagonal nut thread M4 H 3.2mm WS 7 SS DIN/ISO DIN 934 / ISO 4032/8673 Qty 20 pcs		

			
GEV No.	417084	Ref. No.	A084
description	heating element 2000W 220V heating circuits 2 hole distance 55mm L 220mm W 35mm H 65mm L1 35mm L2 40mm L3 140mm H1 35mm H2 30mm hole ø 10mm connection M6 immersion heater 4 hole fixing		





			
GEV No.	417185	Ref. No.	SM488
description	heating element 2000W 230V heating circuits 1 mounting ø 40mm L 183mm W 28mm H 38mm hole distance 58mm hole ø 9mm length thermostat sleeves 145mm thermostat sleeves ø 5mm number of thermostat sleeves 1 thermostat sleeve lateral, not adjacent windings 3 tube ø 8mm connection 1/8" immersion heater 2 hole flange suitable for SAN MARCO		

			
GEV No.	417046	Ref. No.	CA064
description	heating element 2000W 230V heating circuits 1 thread 1¼" L 200mm W 32mm H 26mm tube ø 8.5mm thermostat sleeves ø 6.5mm length thermostat sleeves 152mm connection M4 immersion heater connection length 25mm flange with thread		
accessories for	417046		
	GEV No.	510405	Ref. No. —
	flat gasket fibre ED ø 56mm ID ø 42mm thickness 2mm for thread 1¼" Qty 1 pcs		
	GEV No.	528021	Ref. No. 1110300016 A1200015 CA020T GRC610
	flat gasket PTFE ED ø 53mm ID ø 42.5mm thickness 3mm Qty 1 pcs equiv. no. 12001/02286 suitable for Astoria/Aurora/Brasilia/Wega		

			
GEV No.	417349	Ref. No.	G185
description	heating element 2000W 230V heating circuits 3 mounting ø 40mm hole distance 43mm L 125mm W 33mm H 30mm immersion heater 4 hole flange		



			
GEV No.	417019	Ref. No.	G185
description	heating element 2000W 230V heating circuits 3 mounting ø 40mm hole distance 43mm L 139mm W 30mm H 30mm hole ø 10mm tube ø 8.5mm connection male faston 6.3mm immersion heater 4 hole flange		







			
1			
GEV No.	417004	Ref. No.	F382
description	heating element 2400W 230V heating circuits 2 mounting ø 42mm hole distance 74mm L 175mm W 27mm H 58mm L1 30mm L2 55mm L3 90mm H1 28mm H2 30mm hole ø 9.5mm tube ø 8.5mm connection M6 immersion heater 2 hole flange suitable for FAEMA		
accessories for	417004		
	GEV No.	525652	Ref. No. —
	grub screw thread M10 L 10mm brass DIN 914 intake hexagonal WS 5 Qty 1 pcs		
	GEV No.	528002	Ref. No. —
	flat gasket PTFE ED ø 57mm ID ø 42mm thickness 3mm Qty 1 pcs equiv. no. 12001/W10470 suitable for		
	GEV No.	528488	Ref. No. —
	flat gasket fibre ED ø 57mm ID ø 42mm thickness 3mm Qty 1 pcs		



			
1			
GEV No.	417107	Ref. No.	AS021
description	heating element 2600W 230V heating circuits 2 mounting ø 42mm hole distance 74mm L 295mm W 36mm H 41mm L1 22mm L2 38mm L3 235mm H1 30mm H2 11mm hole ø 10mm tube ø 8.5mm thermostat sleeves ø 6mm length thermostat sleeves 186mm thermostat sleeve not clinging number of thermostat sleeves 1 connection M6x1 immersion heater 2 hole flange		

			
1			
GEV No.	417025	Ref. No.	SM246
description	heating element 2600W 230V heating circuits 3 mounting ø 46mm hole distance 62mm L 380mm W 35mm H 58mm L1 30mm L2 60mm L3 290mm H1 32mm H2 28mm hole ø 11mm tube ø 8.5mm thermostat sleeves ø 7mm length thermostat sleeves 208mm thermostat sleeve not clinging number of thermostat sleeves 1 connection M3 immersion heater 3 hole flange suitable for SAN MARCO		
accessories for	417025		
	GEV No.	527169	Ref. No. —
	hexagonal nut thread M3 H 2.8mm WS 5.5 brass Qty 1 pcs		
	GEV No.	560110	Ref. No. —
	plain washer ID ø 3.2mm ED ø 7mm thickness 0.5mm SS Qty 20 pcs DIN 125A for thread M3		
	GEV No.	560130	Ref. No. —
	hexagonal nut thread M3 H 2.4mm WS 5.5 SS DIN/ISO DIN 934 / ISO 4032/8673 Qty 20 pcs		

			
1			
GEV No.	417015	Ref. No.	C182
description	heating element 2700W 230V heating circuits 1 mounting ø 54mm hole distance 55mm L 232mm W 35mm H 43mm hole ø 9mm thermostat sleeves ø 7mm length thermostat sleeves 230/240mm number of thermostat sleeves 2 thermostat sleeve not clinging tube ø 8.5mm connection M6x1 immersion heater 4 hole flange suitable for CIMBALI		
accessories for	417015		
	GEV No.	529496	Ref. No. —
	gasket fibre D1 ø 54mm D2 ø 98mm thickness 3mm hole ø 6.7mm hole distance 55mm for heating element suitable for CIMBALI M15		



			
1			
GEV No.	417354	Ref. No.	A2100146
description	heating element 2700W 230V heating circuits 3 mounting ø 42mm hole distance 74mm L 160mm W 34mm H 45mm L1 20mm L2 70mm L3 80mm H1 32mm H2 13mm hole ø 10mm tube ø 8.3mm thermostat sleeves ø 7mm length thermostat sleeves 140mm thermostat sleeve centre number of thermostat sleeves 1 connection male faston 6.3mm immersion heater 2 hole flange		

			
1			
GEV No.	417355	Ref. No.	A2100213
description	heating element 2700W 230V heating circuits 3 thread 1¼" L 160mm W 30mm H 45mm tube ø 8mm connection male faston 6.3mm immersion heater flange with thread WS 37		
accessories for	417355		
	GEV No.	528017	Ref. No. —
	flat gasket fibre ED ø 53mm ID ø 42mm thickness 2mm for thread 1¼" Qty 1 pcs		
	GEV No.	528022	Ref. No. —
	flat gasket PTFE ED ø 52mm ID ø 41mm thickness 2mm size 1¼" Qty 1 pcs suitable for CARIMALI, FAEMA, MARZOCCO, PAVONI		

			
1			
GEV No.	417062	Ref. No.	P073
description	heating element 3000W 230/400V heating circuits 3 thread 1¼" L 238mm W 32mm H 26mm tube ø 8mm connection male faston 6.3mm immersion heater flange with thread		
accessories for	417062		
	GEV No.	510405	Ref. No. —
	flat gasket fibre ED ø 56mm ID ø 42mm thickness 2mm for thread 1¼" Qty 1 pcs		
	GEV No.	528021	Ref. No. 1110300016 A1200015 CA020T GRC610
	flat gasket PTFE ED ø 53mm ID ø 42.5mm thickness 3mm Qty 1 pcs equiv. no. 12001/02286 suitable for Astoria/Aurora/Brasilia/Wega		





			
GEV No.	417029	Ref. No.	SM489
description	heating element 3000W 230V heating circuits 2 mounting ø 40mm L 325mm W 33mm H 28mm hole distance 58mm hole ø 9mm length thermostat sleeves 125mm thermostat sleeves ø 5mm number of thermostat sleeves 1 thermostat sleeve centre not clinging windings 2 tube ø 8mm connection M3 immersion heater 2 hole flange suitable for SAN MARCO		
accessories for	417029		
	GEV No.	527169	Ref. No. —
	hexagonal nut thread M3 H 2.8mm WS 5.5 brass Qty 1 pcs		
	GEV No.	560110	Ref. No. —
	plain washer ID ø 3.2mm ED ø 7mm thickness 0.5mm SS Qty 20 pcs DIN 125A for thread M3		
	GEV No.	560130	Ref. No. —
	hexagonal nut thread M3 H 2.4mm WS 5.5 SS DIN/ISO DIN 934 / ISO 4032/8673 Qty 20 pcs		



			
GEV No.	417356	Ref. No.	1240100121 GR705
description	heating element 3200W 230V heating circuits 2 mounting ø 42.5mm hole distance 75mm L 340mm W 33mm H 45mm L1 30mm L2 67mm L3 243mm H1 26mm H2 19mm hole ø 9.5mm tube ø 8.2mm connection M6 immersion heater 2 hole flange		
For models:	Zola-1, Zola-2		
accessories for	417356		
	GEV No.	526825	Ref. No. 1110300019 F043T GR709
	flat gasket PTFE ED ø 58mm ID ø 43mm thickness 3mm Qty 1 pcs		



			
GEV No.	417358	Ref. No.	1240100127 GRC102
description	heating element 3300W 230V heating circuits 2 thread 1¼" L 230mm W 38mm H 38mm tube ø 8mm connection male faston 6.3mm immersion heater connection length 55mm flange with thread coffee machine WS 37		
For models:	Eclisse, Ten, Twenty		

			
GEV No.	417353	Ref. No.	A2100031
description	heating element 3500W 230/400V heating circuits 3 mounting ø 43mm hole distance 74mm L 295mm W 34mm H 45mm L1 35mm L2 55mm L3 205mm H1 31mm H2 14mm hole ø 9.5mm tube ø 8.3mm thermostat sleeves ø 7mm length thermostat sleeves 210mm thermostat sleeve centre number of thermostat sleeves 1 connection male faston 6.3mm immersion heater 2 hole flange		
accessories for	417353		
	GEV No.	528021	Ref. No. 1110300016 A1200015 CA020T GRC610
	flat gasket PTFE ED ø 53mm ID ø 42.5mm thickness 3mm Qty 1 pcs equiv. no. 12001/02286 suitable for Astoria/Aurora/Brasilia/Wega		

			
GEV No.	417352	Ref. No.	A2100120
description	heating element 4000W 230/400V heating circuits 3 mounting ø 43mm hole distance 74mm L 545mm W 34mm H 45mm L1 35mm L2 55mm L3 455mm H1 31mm H2 14mm hole ø 9.5mm tube ø 8.3mm thermostat sleeves ø 7mm length thermostat sleeves 210mm thermostat sleeve centre number of thermostat sleeves 1 connection male faston 6.3mm immersion heater 2 hole flange		



			
GEV No.	417091	Ref. No.	GRIMAC
description	heating element 4000W 230V heating circuits 2 hole distance 53mm L 455mm W 39mm H 58mm L1 30mm L2 50mm L3 380mm H1 26mm H2 32mm hole ø 9mm tube ø 8mm connection M6 immersion heater 4 hole flange		

			
GEV No.	417446	Ref. No.	BF050
description	heating element 4000W 230V heating circuits 2 mounting ø 38.5mm hole distance 57mm L 342mm W 26mm H 51mm L1 35mm L2 50mm L3 257mm H1 25mm H2 26mm windings 2 hole ø 10mm tube ø 8mm connection M6 immersion heater 3 hole flange		
accessories for	417446		
	GEV No.	528740	Ref. No. —
	gasket ID ø 44mm PTFE thickness 3.5mm hole ø 9.5mm hole distance 58mm suitable for ITALCREM, VISACREM for heating element coffee machine parts		

			
GEV No.	417202	Ref. No.	V583/2
description	heating element 4000W 230V heating circuits 3 mounting ø 42mm hole distance 74mm L 295mm W 34mm H 63mm L1 30mm L2 70mm L3 190mm H1 31mm H2 32mm hole ø 9mm tube ø 8.5mm thermostat sleeves ø 6.5mm length thermostat sleeves 199mm thermostat sleeve not clinging number of thermostat sleeves 1 connection male faston 6.3mm immersion heater 2 hole flange		
accessories for	417202		
	GEV No.	528022	Ref. No. —
	flat gasket PTFE ED ø 52mm ID ø 41mm thickness 2mm size 1¼" Qty 1 pcs suitable for CARIMALI, FAEMA, MARZOCCO, PAVONI		
	GEV No.	528488	Ref. No. —
	flat gasket fibre ED ø 57mm ID ø 42mm thickness 3mm Qty 1 pcs		



			
GEV No.	417357	Ref. No.	1240100124 GR706
description	heating element 4500W 230V heating circuits 2 mounting ø 42.5mm hole distance 75mm L 480mm W 33mm H 50mm L1 23mm L2 52mm L3 405mm H1 26mm H2 24mm hole ø 9.5mm tube ø 8mm connection M6 immersion heater 2 hole flange		
For models:	Zola-1, Zola-2		





			
GEV No.	417359	Ref. No.	1240100129 GRT103
description	heating element 4500W 230V heating circuits 2 thread 1 1/4" L 345mm W 35mm H 35mm tube ø 8.2mm connection male faston 6.3mm immersion heater connection length 53mm flange with thread immersion heater WS 37		
For models:	Eclisse, Ten, Twenty		
spare parts for	417359		
	GEV No.	510405	Ref. No. —
description	flat gasket fibre ED ø 56mm ID ø 42mm thickness 2mm for thread 1 1/4" Qty 1 pcs		
	GEV No.	528021	Ref. No. 1110300016 A1200015 CA020T GRC610
description	flat gasket PTFE ED ø 53mm ID ø 42.5mm thickness 3mm Qty 1 pcs equiv. no. 12001/02286 suitable for Astoria/Aurora/Brasilia/Wega		

			
GEV No.	417112	Ref. No.	V583/3
description	heating element 4500W 230V heating circuits 3 mounting ø 42mm hole distance 74mm L 390mm W 35mm H 70mm L1 30mm L2 50mm L3 300mm H1 33mm H2 37mm hole ø 9mm tube ø 8mm thermostat sleeves ø 6.5mm length thermostat sleeves 200mm thermostat sleeve not clinging number of thermostat sleeves 1 connection male faston 6.3mm immersion heater 2 hole flange		



			
GEV No.	417141	Ref. No.	SM251
description	heating element 4500W 230V heating circuits 3 mounting ø 46mm hole distance 60mm L 553mm W 34mm H 62mm L1 30mm L2 70mm L3 453mm H1 31mm H2 31mm hole ø 11mm tube ø 8mm thermostat sleeves ø 7mm length thermostat sleeves 200mm thermostat sleeve centre not clinging connection M3 immersion heater 3 hole flange suitable for SAN MARCO		
accessories for	417141		
	GEV No.	527169	Ref. No. —
description	hexagonal nut thread M3 H 2.8mm WS 5.5 brass Qty 1 pcs		
	GEV No.	560110	Ref. No. —
description	plain washer ID ø 3.2mm ED ø 7mm thickness 0.5mm SS Qty 20 pcs DIN 125A for thread M3		
	GEV No.	560130	Ref. No. —
description	hexagonal nut thread M3 H 2.4mm WS 5.5 SS DIN/ISO DIN 934 / ISO 4032/8673 Qty 20 pcs		

			
GEV No.	417063	Ref. No.	CA058
description	heating element 4500W 230V heating circuits 3 thread 1 1/4" L 290mm W 30mm H 27mm tube ø 8mm connection male faston 6.3mm immersion heater connection length 35mm flange with thread coffee machine WS 38		
accessories for	417063		
	GEV No.	510405	Ref. No. —
description	flat gasket fibre ED ø 56mm ID ø 42mm thickness 2mm for thread 1 1/4" Qty 1 pcs		

accessories for	417063		
	GEV No.	528021	Ref. No. 1110300016 A1200015 CA020T GRC610
description	flat gasket PTFE ED ø 53mm ID ø 42.5mm thickness 3mm Qty 1 pcs equiv. no. 12001/02286 suitable for Astoria/Aurora/Brasilia/Wega		

			
GEV No.	417119	Ref. No.	G187
description	heating element 5000W 220V heating circuits 2 mounting ø 40mm hole distance 43mm L 398mm W 32mm H 33mm hole ø 9mm connection male faston 6.3mm immersion heater 4 hole flange		

radiation heaters

			
GEV No.	416656	Ref. No.	8184544 XO64
description	radiation heater rectangular 4000W 230V L 490mm W 245mm heating circuits 2 connections 2+2 IRCA		
spare parts for	416656		
	GEV No.	417727	Ref. No. —
description	terminal L 20m W 8.2mm		

accessories

sealing washers

PTFE gaskets

 			
GEV No.	528021	Ref. No.	1110300016 A1200015 CA020T GRC610
description	flat gasket PTFE ED ø 53mm ID ø 42.5mm thickness 3mm Qty 1 pcs equiv. no. 12001/02286 suitable for Astoria/Aurora/Brasilia/Wega		
For models:	Eclisse, Ten, Twenty		



O-rings

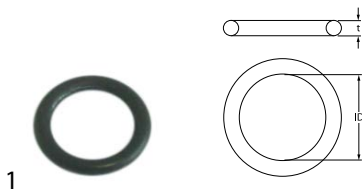

GEV No.	528231	Ref. No.	A1200028
description	O-ring Viton thickness 2.62mm ID ø 12.37mm Qty 1 pcs		

thermostats

bi-metal thermostats

bi-metal thermostats



GEV No.	390328	Ref. No.	A1400035
description	bi-metal thermostat hole distancemm switch-off temp. 152°C 1NC 1-pole 16A connection F6.3 M4		

switches and momentary switches

rocker/momentary rocker switches

30x22mm



GEV No.	301001	Ref. No.	MG74 MG74/2
description	rocker switch mounting measurements 30x22mm red 2NO 250V 16A illuminated 0-I connection male faston 6.3mm ambient temperature max. 125/55°C protection IP65		
For models:	Eclisse, Ten, Twenty, Zola-1, Zola-2		
accessories for	301001		



GEV No.	301036	Ref. No.	A2800052
description	protective cover internal size 30x22mm for rocker switch mounting measurementsmm		



GEV No.	301061	Ref. No.	A2100093
description	rocker switch mounting measurements 30x22mm orange 2NO 250V 16A illuminated connection male faston 6.3mm ambient temperature max. 125/55°C protection IP40		



GEV No.	301036	Ref. No.	A2800052
description	protective cover internal size 30x22mm for rocker switch mounting measurementsmm		



GEV No.	346474	Ref. No.	GRC803
description	dummy element external size 30x22mm suitable for rocker switch		
For models:	Eclisse, Ten, Twenty, Zola-1, Zola-2		



GEV No.	301078	Ref. No.	A2100038
description	momentary rocker switch mounting measurements 30x22mm black 2NO 250V 16A momentary 0-I connection male faston 6.3mm ambient temperature max. 85/125°C protection IP40		
accessories for	301078		



GEV No.	301036	Ref. No.	A2800052
description	protective cover internal size 30x22mm for rocker switch mounting measurementsmm		



GEV No.	346110	Ref. No.	1160200036 GR120
description	rocker switch mounting measurements 30x22mm red 2NO 250V 16A illuminated coffee connection male faston 6.3mm ambient temperature max. 125/55°C protection IP40		
For models:	Eclisse, Ten, Twenty, Zola-1, Zola-2		

blank



GEV No.	346144	Ref. No.	340226
description	push switch mounting measurements 30x22mm white 2CO 250V 16A illuminated connection male faston 6.3mm ambient temperature max. 100/55°C protection IP65		
accessories for	346144		



GEV No.	301036	Ref. No.	A2800052
description	protective cover internal size 30x22mm for rocker switch mounting measurementsmm		



push/momentary push switches

19x13mm



1

GEV No.	347292 ¹	Ref. No.	A2100043
description	push switch mounting measurements 19x13mm red 2NO 250V 16A illuminated connection male faston 6.3mm ambient temperature max. 105/55°C protection IP65 with cover cap		

¹illuminated

30x22mm



1

GEV No.	301036	Ref. No.	A2800052
description	protective cover internal size 30x22mm for rocker switch mounting measurementsmm		

ø25mm



1

GEV No.	347295	Ref. No.	A2100041
description	push button mounting ø 25mm black 2NO 250V 16A connection male faston 6.3mm ambient temperature max. 85°C protection IP40		



1

GEV No.	347294 ¹	Ref. No.	A2100045
description	push switch mounting ø 25mm red 2NO 250V 16A illuminated connection male faston 6.3mm ambient temperature max. 125/55°C protection IP40		

¹illuminated



1

GEV No.	347293	Ref. No.	A2100094
description	push switch mounting ø 25mm orange 2NO 250V 16A illuminated cup connection male faston 6.3mm ambient temperature max. 85°C protection IP40		

accessories

push buttons



1

GEV No.	347300	Ref. No.	116020056 MG543
description	push button external size 17x13mm shaft 3.5x3.5mm chrome oval		
For models:	Eclisse, Ten, Twenty, Zola-1, Zola-2		

microswitches

pin-plunger actuated



1

GEV No.	346145	Ref. No.	210031
description	microswitch with plunger 250V 10A 1CO connection male faston 4.8mm ambient temperature max. 125°C mounting distance 22mm black		



1

GEV No.	347757	Ref. No.	A2100297
description	microswitch with plunger 250V 16A 1CO connection male faston 4.8mm ambient temperature max. 125°C mounting distance 22mm actuating force: 120g black		

roller actuated

roller 0°



1

GEV No.	346370	Ref. No.	116030035 GR779 W612
description	microswitch with roller plunger 230V 16A 1CO connection screw L1 49mm ambient temperature max. 125°C thread L 14mm thread M10 mounting distance 25mm actuating force: 300g type MV15-2		
For models:	Eclisse, Ten, Twenty, Zola-1, Zola-2		

roller 90°



1

GEV No.	345104	Ref. No.	A2100042
description	microswitch with roller plunger 250V 16A 1CO connection male faston 6.3mm L 24mm ambient temperature max. 125°C thread L 12mm thread M10x0.75 mounting distance 22mm actuating force: 280g type EF83161.1		



system switches (ROLD)



GEV No.	345720	Ref. No.	1160200057 MG544
description	switch 2NO 250V 16A connection male faston 6.3mm		
For models:	Eclisse, Ten, Twenty, Zola-1, Zola-2		

rotary switches

BREMAS

accessories



GEV No.	527259	Ref. No.	1210100086 GR272
description	knob push-in ø 34/60mm shaft ø 5x5mm black H 21.4mm L 49mm		
For models:	Eclisse, Ten, Twenty, Zola-1, Zola-2		

TECNOMATIC



GEV No.	347297	Ref. No.	1160100006 GR273 GRC107
description	rotary switch 3 1-0-2 sets of contacts 6 type HD1607R012 600V 16A shaft ø 5x5mm shaft L 23mm shaft square with knob connection screw clamp		
For models:	Eclisse, Ten, Twenty, Zola-1, Zola-2		
accessories for	347297		
	GEV No.	111012	Ref. No. —
	knob switch zero mark t.max.°C° 34/60mm shaft ø 5x5mm shaft flat black H 22mm L 50mm		

miscellaneous



GEV No.	347296	Ref. No.	A2100316
description	rotary switch 25A shaft L 15mm with cable 6-pole shaft 5x5mm		

accessories

symbol labels



GEV No.	347342	Ref. No.	1080400014 GR265
description	symbol label CE 0-1-2 L 67mm W 50.5mm bore ø 9mm		
For models:	Eclisse, Ten, Twenty, Zola-1, Zola-2		

control equipment

MOELLER/EATON

LED signal elements



GEV No.	346487	Ref. No.	A2100319
description	indicator lamp white connection screw LED 85-264VAC		

lamps

indicator lights

indicator lights (complete)

ø 6mm



GEV No.	359568	Ref. No.	A2100024
description	indicator light ø 6mm 230V red connection male faston 2.8mm cable length 250mm		

ø10mm

with plug-in socket



GEV No.	359140	Ref. No.	A2100046
description	indicator light ø 10mm yellow 230V connection male faston 6.3mm Qty 1 pcs		

miscellaneous



GEV No.	359006	Ref. No.	359.006
description	indicator light white 230V		



contactors

ISKRA (FANAL)

power contactors

1



GEV No.	380413	Ref. No.	21003F
description	power contactor resistive load 20A 400VAC (AC3/400V) 8.5A/5.5kW main contacts 3NO auxiliary contacts 1NC connection screw connection type Fanal DSL7 01 type ISKRA K07M 01		

SIEMENS

power contactors

1



GEV No.	380526	Ref. No.	A2100154
description	power contactor resistive load 20A 230VAC (AC3/400V) 8.4A/4kW main contacts 4NO auxiliary contacts connection screw connection type 3TG10-10-0A2L2		

relays

power relays

with bracket mounting

1



GEV No.	380920	Ref. No.	A3200109
description	power relays FINDER 400VAC 10A 3CO connection male faston 4.8mm with mounting strap manuf. no. 60.63.8.400.0000 250V 3-pole		

level relays

GICAR

1



GEV No.	400524	Ref. No.	A1500005
description	level relay 230V voltage AC connection F6.3 type RL30 MICRO ST SAFETY PUMP		

DTI

1



GEV No.	402445	Ref. No.	A1500082
description	level controller 230V voltage AC 50/60Hz 8A connection F6.3 type DCLDD11000		

miscellaneous

1



GEV No.	402463	Ref. No.	104010006 F485 GR778 RLC302CF
description	level controller 230-240V 50-60Hz		
For models:	Eclisse, Ten, Twenty, Zola-1, Zola-2		



electronics

PCBs



1	GEV No.	402447	Ref. No.	A1500096
	description	keypad PCB L 125mm W 35mm with front panel buttons 6		



1	GEV No.	402497	Ref. No.	A1500098
	description	keypad PCB L 83mm W 48mm with display buttons 4		



1	GEV No.	402495	Ref. No.	A1500097
	description	PCB L 74mm W 64mm 230V		

central units



1	GEV No.	402462	Ref. No.	104020009 GRT104
	description	central unit 230V 50/60Hz type DOS 3GR+RL/F-C voltage AC		
	For models:	Eclisse, Ten, Twenty, Zola-1, Zola-2		



1	GEV No.	402460	Ref. No.	1040200015 GRW157
	description	central unit 230V 50/60Hz type DOS7 RL3 4GR+RL+THE voltage AC		
	For models:	Eclisse, Ten, Twenty, Zola-1, Zola-2		



1	GEV No.	402461	Ref. No.	1040200008 GRC103
	description	central unit 240V 50/60Hz type DOS 2GR+RL/F-C voltage AC		
	For models:	Eclisse, Ten, Twenty, Zola-1, Zola-2		



1	GEV No.	402470	Ref. No.	1040200012 GRW1130
	description	central unit 240V 50/60Hz type DOS RL0 1GR+RL+SIC/F voltage AC		
	For models:	Eclisse, Ten, Twenty, Zola-1, Zola-2		



1	GEV No.	402459	Ref. No.	1040200013 GRW156
	description	central unit 240V 50/60Hz type DOS7 RL3 2GR+RL+THE voltage AC		
	For models:	Eclisse, Ten, Twenty, Zola-1, Zola-2		



1

GEV No.	402456	Ref. No.	A1500095
----------------	--------	-----------------	----------

description	central unit 3-group 230V 50/60Hz type SDE3D FI3NBV6
--------------------	------------------------------------------------------



1

GEV No.	402454	Ref. No.	A1500070
----------------	--------	-----------------	----------

description	central unit 3-group 230V type SDE3D FI3NAV6
--------------------	----------------------------------------------



1

GEV No.	402171	Ref. No.	1040100002 MG307/1
----------------	--------	-----------------	-----------------------

description	control box for coffee machine 230V type MFC2SG
--------------------	-------------------------------------------------

For models:	Eclipse, Ten, Twenty, Zola-1, Zola-2
--------------------	--------------------------------------

dosing electronics

miscellaneous



1

GEV No.	402455	Ref. No.	A1500073
----------------	--------	-----------------	----------

description	dosing electronics 230V 50/60Hz type SDE11
--------------------	--------------------------------------------

keypads

front foils



1

GEV No.	402453	Ref. No.	A2400055
----------------	--------	-----------------	----------

description	front foil for keypad chrome-plated L 132mm W 42mm
--------------------	----------------------------------------------------



1

GEV No.	402452	Ref. No.	A1500093
----------------	--------	-----------------	----------

description	keypad foil coffee machine MIA L 79mm W 54mm buttons 6
--------------------	--------------------------------------------------------



1

GEV No.	402450	Ref. No.	A1500059
----------------	--------	-----------------	----------

description	keypad foil grey L 164mm W 34mm buttons 6
--------------------	-------------------------------------------



1

GEV No.	402451	Ref. No.	A1500094
----------------	--------	-----------------	----------

description	keypad foil L 79mm W 54mm buttons 2
--------------------	-------------------------------------



1

GEV No.	525111	Ref. No.	A2400054
----------------	--------	-----------------	----------

description	keypad foil L 90mm W 49mm buttons 4
--------------------	-------------------------------------

keypad units



1

GEV No.	402448	Ref. No.	A1500092
----------------	--------	-----------------	----------

description	keypad unit buttons 2 L 88mm W 60mm
--------------------	-------------------------------------



1

GEV No.	402562	Ref. No.	2040300001 GRW159
description	keypad unit buttons 5 black/silver with switch lighting LED L 155mm W 47mm switch		
For models:	Eclisse, Ten, Twenty, Zola-1, Zola-2		



2

GEV No.	402446	Ref. No.	A1500034
description	keypad unit buttons 6 grey L 164mm W 34mm		



1

GEV No.	402561	Ref. No.	1040300026 GRC104
description	keypad unit coffee machine EDISSE/TEN/TWENTY/ZOLA 1+2 buttons 5 black/white lighting LED L 115mm W 45mm		
For models:	Eclisse, Ten, Twenty, Zola-1, Zola-2		



1

GEV No.	402585	Ref. No.	1040200004 GR159
description	keypad unit coffee machine EDISSE/TEN/TWENTY/ZOLA 1+2 buttons 5 yellow/grey type TH SMT 1GR+RL lighting LED		
For models:	Eclisse, Ten, Twenty, Zola-1, Zola-2		



1

GEV No.	402449	Ref. No.	A1500091
description	keypad unit coffee machine FIORENZATO buttons 6 L 88mm W 60mm		

solenoid valves

solenoid valves (water)

metal

ODE

solenoid valves steam (water)

21A series



1

GEV No.	370573	Ref. No.	A1900002	
description	solenoid valve brass 2-ways 230VAC inlet 1/8" outlet 1/8" connection 1/8" L 40mm DN 2.5mm -10 up to 140°C type series 21A coil type ADA membranes FKM (water/steam) p max 14bar 50Hz			
accessories for	370573			
	GEV No.	371091	Ref. No.	—
	power socket plug type DIN 43650B cable lengthmm small			

31A1 series



1

GEV No.	370572	Ref. No.	A1900003
description	solenoid valve brass 3-ways 230VAC DN 1.5mm -10 up to 140°C coil type ADA membranes ruby p max 15bar p min 0bar flange 32x32mm		

4827K series



1

GEV No.	370571	Ref. No.	A1900068
description	solenoid valve brass 2-ways 230VAC DN 2mm -10 up to 140°C coil type ADA membranes FKM (water/steam) p max 22bar p min 0bar 50Hz flange 32x32mm		



solenoid valves (various)



1			
GEV No.	370119	Ref. No.	A1900029
description	solenoid valve 2-ways 230VAC flange 25x25mm		

pressure switches
for coffee machines

ø 38mm



1			
GEV No.	541725	Ref. No.	A2100051
description	pressure control ø 38mm pressure range 0.5-1.2bar 21A 250V connection 1/4" 1CO pressure connection 1/4"		



1			
GEV No.	541726	Ref. No.	A2100305
description	pressure control ø 38mm pressure range 0.5-1.5bar 16A 250V connection 1/4" pressure connection 1/4"		

electrodes



1			
GEV No.	400214	Ref. No.	GRC605
description	level electrode 1/4" total length 140mm probe L 112mm insulated probe length 26mm connection male faston 6.3mm stainless steel ø 2.5mm		
For models:	Eclisse, Ten, Twenty		



1			
GEV No.	402457	Ref. No.	A1400001
description	level electrode 1/4" total length 145mm probe L 124mm insulated probe length 20mm connection curved ø 2.5mm		



1			
GEV No.	401242	Ref. No.	2250400001 GR212
description	level electrode 1/4" total length 155mm probe L 128mm insulated probe length 26mm connection male faston 6.3mm stainless steel ø 2.5mm		
For models:	Zola-1, Zola-2		



1			
GEV No.	402458	Ref. No.	A1400003
description	level electrode 1/4" total length 75mm probe L 54mm insulated probe length 20mm connection curved ø 2.5mm		

motors

motors

for coffee grinders

components



1			
GEV No.	500239	Ref. No.	190067 270012
description	motor 230V 50Hz 1 phase ø 100mm ID ø 65mm H 195mm shaft ø 16mm type T48		



1			
GEV No.	500238	Ref. No.	190050 270003
description	motor 230V 50Hz 1 phase ø 110mm ID ø 65mm H 160mm shaft ø 14mm type T80		



pumps

booster pumps II

pump heads

FLUID-O-TECH



GEV No.	500065	Ref. No.	1220200004 V510
description	pump head PA204F FLUID-O-TECH L 82mm 200l/h connection 3/8" NPT with bypass brass 3 hole flange for coffee machine shaft ø 11/10mm		
accessories for	500065		
	GEV No.	500314	Ref. No. —
	coupling ø 40mm shaft diameter 10/11mm		
	GEV No.	520158	Ref. No. —
	elastic coupling ø 40mm rubber		





GEV No.	500064	Ref. No.	1220100007 V509/1
description	pump head PO204 FLUID-O-TECH L 82mm 200l/h connection 3/8" GAS with bypass brass clip connection for coffee machine shaft ø 4.8x11mm		
accessories for	500064		
	GEV No.	520126	Ref. No. —
	clamp for pump/motor		

vibration pumps



GEV No.	500217	Ref. No.	1220300001 MG044
description	vibration pump type 1106PAALB2N 230V 50Hz 70W inlet ø 1/8" IT outlet ø 1/8" IT outlet conical L 129mm with bypass FLUID-O-TECH		
spare parts for	500217		
	GEV No.	520250	Ref. No. —
	by-pass thread 1/8" IT T2: M12x1 IG		



GEV No.	500123	Ref. No.	1220300001 MG044
description	vibration pump type 1106PAALM1N 230V 50Hz 70W inlet ø 1/8" IT outlet ø 1/8" IT outlet conical L 129mm FLUID-O-TECH		
accessories for	500123		
	GEV No.	371090	Ref. No. —
	power socket plug type DIN 43650A screw		
	GEV No.	371120	Ref. No. —
	diode type IN5408		
	GEV No.	390698	Ref. No. —
	thermal fuse switch-off temp. 110°C suitable for ULKA pump		

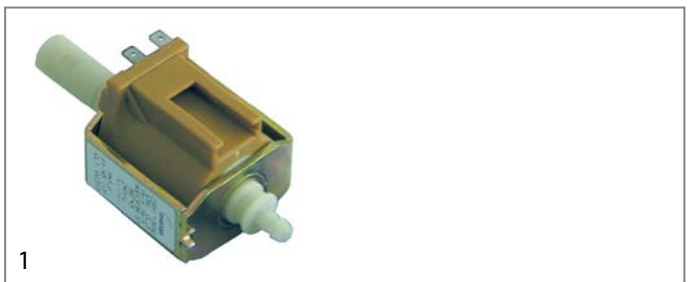

GEV No.	500219	Ref. No.	V080/1
description	vibration pump type CP.3A.958.1/ST 230V 65W 50Hz inlet ø 6 outlet ø 1/8" IT EATON (INVENSYS) L 123mm		

condensators & interference suppression filters

operating capacitors

plastic



GEV No.	365019	Ref. No.	A3200030
description	operating capacitor capacity 20µF 400V tolerance 5% 50/60Hz ambient temperature max. -25 to +85°C ø 39.5mm L 70mm M8 plastic connection male faston 6.3mm 16.10.25. protection		

equipment-specific units

for espresso machines

filter holders

filter holders standard

filter holders (complete)



1

GEV No.	525097	Ref. No.	A2200079
description	filter holder 2-way complete ID ø 61.8mm outlet distance 55mm mounting ø 82.4		



1

GEV No.	526832	Ref. No.	2200100028 GR767/1
description	filter holder single ID ø 61.5mm mounting ø 82.7		
For models:	Eclisse, Ten, Twenty, Zola-1, Zola-2		

filter holder without spout



1

GEV No.	525977	Ref. No.	N/A
description	filter holder suitable for CREM-EXPOBAR/WEGA/GRIMAC/SANRAMO without outlet mounting ø 83mm outlet 3/8" ID ø 61.5mm wedge height 10mm wedge position horizontal number of wedges 2 lever inclined		

filter holders short



1

GEV No.	526831	Ref. No.	1200100021 GR767 W561
description	filter holder mounting ø 82.7mm outlet 3/8" ID ø 61.5mm handle M12x1.75 wedge height 10.5mm wedge position horizontal number of wedges 2 lever straight chrome-plated brass		
For models:	Eclisse, Ten, Twenty, Zola-1, Zola-2		

handles

with external thread



1

GEV No.	529045	Ref. No.	GRC640
description	handle ø 35mm thread M12x1.75 thread L 15mm L 125mm black		

filters

for 1 cup



1

GEV No.	526261	Ref. No.	A2200221
description	coffee filter ø 70mm mounting ø 60.5mm H 20.5mm cups 1 amount of coffee 6.5g		



1

GEV No.	529011	Ref. No.	A2200028
description	coffee filter ø 70mm mounting ø 60mm H 24.5mm cups 1 amount of coffee 7g perforation ø 0.4mm		

for 2 cups



1

GEV No.	529197	Ref. No.	A2200029
description	coffee filter ø 70mm mounting ø 60mm H 24.5mm cups 2 amount of coffee 14g		

filter holder springs



1

GEV No.	526833	Ref. No.	1180100050 F094 GR766
description	filter holder spring L 76mm W 62mm wire gauge ø 1mm for espresso filter holder		
For models:	Eclisse, Ten, Twenty, Zola-1, Zola-2		

brewing units

shower screens

flat



1

GEV No.	529228	Ref. No.	A2200235
description	shower screen ø 51.6mm hole ø 6.2mm		

with upstand



1

GEV No.	528417	Ref. No.	107010007 A2200031 F277 GR761
description	shower screen ø 58mm H 19mm		
For models:	Eclisse, Ten, Twenty, Zola-1, Zola-2		

filter holder gaskets

flat

with internal notch



1

GEV No.	526269	Ref. No.	1110600020
description	filter holder gasket D1 ø 71mm D2 ø 56mm H 8.5mm with inside notch Qty 1 pcs		



1

GEV No.	525105	Ref. No.	A1200181
description	filter holder gasket with inside notch D1 ø 72mm D2 ø 56mm H 8mm with inside notch Qty 1 pcs		

standard



1

GEV No.	528031	Ref. No.	A1200006
description	filter holder gasket D1 ø 73mm D2 ø 57mm H 8.5mm rubber Qty 1 pcs		



1

GEV No.	525104	Ref. No.	A1200007
description	filter holder gasket D1 ø 73mm D2 ø 57mm H 8mm Qty 1 pcs		

with bevel 45x2



1

GEV No.	526834	Ref. No.	1110600035 GR763 W556
description	filter holder gasket with bevel 45x2 D1 ø 73mm D2 ø 57mm H 8.4mm		
For models:	Eclisse, Ten, Twenty, Zola-1, Zola-2		

shim gaskets



1

GEV No.	525103	Ref. No.	A1200033
description	shim gasket D1 ø 72mm D2 ø 58mm thickness 0.6mm paper Qty 1 pcs		



brewing units with solenoid valve

universal



GEV No.	525495	Ref. No.	1200500018 GR500C
description	brewing unit for solenoid valve model E61		
For models:	Eclisse, Ten, Twenty, Zola-1, Zola-2		
spare parts for	525495		
	GEV No.	529081	Ref. No. —
	water distributor ø 30mm hole ø 1.5mm H 15mm ET M10x1 grooves 6 2.5mm brass		
accessories for	525495		
	GEV No.	370057	Ref. No. —
	solenoid valve 3-ways 230VAC body outer cone DN 1.2mm slide-on receptacle DIN -20° up to 140°C PARKER type series VE-128 coil type ZB09 membranes ruby p max 10bar brass flange 32x32mm		
	GEV No.	525984	Ref. No. —
	filter holder suitable for AURORA/BRASILIA/FAEMA without outlet mounting ø 82.5mm outlet 3/8" ID ø 62mm wedge height 10.5mm wedge position horizontal number of wedges 2 lever straight		
	GEV No.	528030	Ref. No. —
	filter holder gasket D1 ø 72.7mm D2 ø 57.2mm H 8mm Qty 1 pcs		
	GEV No.	528165	Ref. No. —
	group gasket L 76mm W 72mm thickness 2.5mm aperture 26x64mm hole distance 55mm		
	GEV No.	528417	Ref. No. 1070100007 A2200031 F277 GR761
	shower screen ø 58mm H 19mm		

brewing units manual

components

drain units

drain valves



GEV No.	526002	Ref. No.	A2200208
description	valve support ø 16mm L 27mm brass shaft triangular D1 ø 10mm D2 ø 7mm		

gaskets

	1		
GEV No.	529795	Ref. No.	1110100039 A1200160 F001 GR795
description	gasket D1 ø 13mm D2 ø 4mm thickness 4mm coffee machine		
For models:	Eclisse, Ten, Twenty, Zola-1, Zola-2		

	1		
GEV No.	526488	Ref. No.	1110100042 F005 GR740 GR751
description	gasket D1 ø 13mm ID ø 4mm thickness 4mm EPDM		
For models:	Eclisse, Ten, Twenty, Zola-1, Zola-2		

springs

	1		
GEV No.	527935	Ref. No.	A2200209
description	compression spring ø 14.6mm L 33mm wire gauge ø 2mm		

	1		
GEV No.	526813	Ref. No.	1180100193 GR788 W549
description	compression spring ø 15mm L 28mm wire gauge ø 1.8mm		
For models:	Eclisse, Ten, Twenty, Zola-1, Zola-2		

camshafts



	1		
GEV No.	527940	Ref. No.	A2200188
description	camshaft shaft ø 8mm shaft intake ø 6.2mm L 86.5mm W 20mm H 17mm thread M6 brass		

	1		
GEV No.	526819	Ref. No.	1200700016 GR784
description	camshaft shaft ø 8mm shaft intake ø 7mm L 84.5mm W 21mm H 17mm thread 4.9 SS		
For models:	Eclisse, Ten, Twenty, Zola-1, Zola-2		

valves



1

GEV No.	526008	Ref. No.	A2200178
description	valve group outflow L 54.3mm ED ø 16mm shaft ø 4.5mm brass		
accessories for	526008		
	GEV No.	526003	Ref. No. —
	compression spring ø 13.8mm L 54.5mm wire gauge ø 1.5mm windings 10 drain valve		
	GEV No.	532550	Ref. No. —
	O-ring NBR 787/70 thickness 2.62mm ID ø 9.13mm Qty 10 pcs		



1

GEV No.	526007	Ref. No.	A2200180
description	valve group supply L 52.8mm ED ø 16mm shaft triangular		

components

nozzles

with thread



1

GEV No.	528486	Ref. No.	A2200174
description	nozzle bore ø 0.7mm thread M6x0.75 L 9mm WS 7		



1

GEV No.	526491	Ref. No.	1201600004 F212 GR715
description	nozzle bore ø 0.8mm thread M6x0.75 L 9mm		
For models:	Eclisse, Ten, Twenty, Zola-1, Zola-2		

springs



1

GEV No.	526561	Ref. No.	A2200192
description	compression spring ø 14.3mm L 21mm wire gauge ø 1.8mm		

water dispersions

water dispersions

group 3



1

GEV No.	527609	Ref. No.	AS101
description	water distributor ø 56.5-59mm conical H 10mm 8 holes hole ø 1.3mm mounting ø 5.6mm brass		

expansion valves

with hose connection



1

GEV No.	525096	Ref. No.	A1300028 A1300113
description	expansion valve T1: 1/8" ET hose ø 9mm total length 47mm		



1

GEV No.	525703	Ref. No.	A1300028 A1300113
description	expansion valve T1: 1/8" ET hose ø 9mm total length 47mm		

gasket supports



1

GEV No.	526017	Ref. No.	A2200203
description	gasket support D1 ø 16mm D2 ø 10mm ID ø 7mm L 25mm square brass		

compression springs



1

GEV No.	526812	Ref. No.	1180100053 F097 GR749
description	compression spring ø 13.3mm L 42.5mm wire gauge ø 1.5mm		
For models:	Eclisse, Ten, Twenty, Zola-1, Zola-2		

drain pans

drain pans



1

GEV No.	526821	Ref. No.	1210500016 GR126
description	drain pan L 102mm ø 79mm H 37mm connection 3/8" hose ø 15mm		
For models:	Eclisse, Ten, Twenty, Zola-1, Zola-2		



1

GEV No.	527946	Ref. No.	A1600002
description	drain pan L 69mm W 79mm H 54mm hose ø 14mm		



1

GEV No.	526564	Ref. No.	A1600134
description	drain pan ø 60mm H 46mm hole ø 20mm hose ø 10mm		

aerators and air bleeders



1

GEV No.	527981	Ref. No.	A1300007
description	aerator and air bleeder connection 1/4"		

steam/water taps

steam/water taps



1

GEV No.	526829	Ref. No.	2200400036 GR119
description	steam tap L 145mm T1: 1/4" T2: 3/8"		
For models:	Eclisse, Ten, Twenty, Zola-1, Zola-2		



1

GEV No.	525098	Ref. No.	A2200021
description	steam/water tap with gasket, spring and bush inlet 3/8" outlet 3/8" shaft 6.5x8 shaft L 30mm brass		

steam taps

steam taps (complete)



1

GEV No.	525239	Ref. No.	GR118
description	steam tap inlet 3/8" outlet 3/8"		
For models:	Eclisse, Ten, Twenty, Zola-1, Zola-2		



1

GEV No.	527954	Ref. No.	A2200066 F579
description	steam tap mounting pos. external inlet 3/8" outlet 3/8" chrome-plated brass		



1

GEV No.	525094	Ref. No.	A2200048
description	steam tap with lever inlet 3/8" outlet 3/8" chrome-plated brass		

			
1			
GEV No.	526492	Ref. No.	1200400045 GR329
description	steam tap with pipe inlet 3/8" outlet 3/8" chrome-plated brass pipe length 265mm tube ø 8mm		
For models:	Zola-2		

			
1			
GEV No.	526830	Ref. No.	1200400038 GR111
description	steam tap with steam pipe inlet 3/8" outlet 3/8" pipe length 190mm tube ø 8mm		
For models:	Eclisse, Ten, Twenty, Zola-1, Zola-2		

miscellaneous

			
1			
GEV No.	526017	Ref. No.	A2200203
description	gasket support D1 ø 16mm D2 ø 10mm ID ø 7mm L 25mm square brass		

components

gaskets

			
1			
GEV No.	527970	Ref. No.	1110300034 GR361
description	flat gasket PTFE ED ø 24mm ID ø 18mm thickness 2mm Qty 1 pcs		
For models:	Zola-2		

			
1			
GEV No.	529795	Ref. No.	1110100039 A1200160 F001 GR795
description	gasket D1 ø 13mm D2 ø 4mm thickness 4mm coffee machine		
For models:	Eclisse, Ten, Twenty, Zola-1, Zola-2		

			
1			
GEV No.	526488	Ref. No.	1110100042 F005 GR740 GR751
description	gasket D1 ø 13mm ID ø 4mm thickness 4mm EPDM		
For models:	Eclisse, Ten, Twenty, Zola-1, Zola-2		

			
1			
GEV No.	526487	Ref. No.	GR353
description	gasket D1 ø 15.5mm D2 ø 7.5mm thickness 4mm EPDM		
For models:	Zola-2		

gasket supports

			
1			
GEV No.	525175	Ref. No.	GR741
description	valve ø hexagon 16mm L 14mm brass		
For models:	Eclisse, Ten, Twenty, Zola-1, Zola-2		

springs

			
1			
GEV No.	525093	Ref. No.	1180100097 A2200002 GR362
description	compression spring ø 10.6mm L 29.5mm wire gauge ø 1.4mm		
For models:	Zola-2		

			
1			
GEV No.	527968	Ref. No.	1180100076 F777 GR742
description	compression spring ø 12.5mm L 31mm wire gauge ø 1.8mm		
For models:	Eclisse, Ten, Twenty, Zola-1, Zola-2		

			
1			
GEV No.	527969	Ref. No.	GR359
description	compression spring \varnothing 8mm L 21mm wire gauge \varnothing 0.4mm		
For models:	Zola-2		

valve bodies			
			
1			
GEV No.	526818	Ref. No.	1201500068 C411M GRT110
description	valve body for steam-/water-tap		
For models:	Eclisse, Ten, Twenty, Zola-1, Zola-2		

screw connections			
			
1			
GEV No.	526851	Ref. No.	GR040 GR40
description	screw connection for steam-/water-tap T1: 3/8" T2: M20x1.5 ID \varnothing 8mm WS 30 nickel-plated brass		
For models:	Eclisse, Ten, Twenty, Zola-1, Zola-2		

steam/water pipes			
steam pipes			
			
1			
GEV No.	525102	Ref. No.	A2000090
description	steam pipe H 150mm W 70mm tube \varnothing 8mm chrome-plated brass		

			
1			
GEV No.	526493	Ref. No.	1260200034 GR348
description	steam pipe H 268mm tube \varnothing 8mm IT 3/8"		
For models:	Zola-2		

			
1			
GEV No.	525100	Ref. No.	A2200014
description	steam pipe mounting pos. left thread 3/8" H 200mm tube \varnothing 8mm chrome-plated brass		

			
1			
GEV No.	525101	Ref. No.	A2200015
description	steam pipe mounting pos. right thread 3/8" H 200mm tube \varnothing 8mm chrome-plated brass		

			
1			
GEV No.	526494	Ref. No.	1260200031 GR211
description	steam pipe thread 3/8" H 195mm L 220mm \varnothing 14.5mm tube \varnothing 8mm suitable for GRIMAC		
For models:	Eclisse, Ten, Twenty, Zola-1, Zola-2		

nozzles for steam pipes			
			
1			
GEV No.	525099	Ref. No.	A2200044
description	steam nozzle thread M10x1 \varnothing 12mm L 14mm thread L 6mm 4 holes bore \varnothing 1.5mm chrome-plated brass		

nozzles for water pipes

nozzles for water pipes



1

GEV No.	525095	Ref. No.	A2200012
description	nozzle D1 ø 24mm H 30mm thread M10x1 int. ø 1 9mm		

accessories

bushes



1

GEV No.	526485	Ref. No.	1110300003 GR269
description	bush D1 ø 14.5mm D2 ø 11.5mm H 8mm PTFE ID ø 9mm		
For models:	Eclisse, Ten, Twenty, Zola-1, Zola-2		



1

GEV No.	526490	Ref. No.	1300900111 GR776 W604
description	bush D1 ø 14.5mm D2 ø 8.35mm H 3.6mm brass ID ø 7mm		
For models:	Eclisse, Ten, Twenty, Zola-1, Zola-2		

gaskets



1

GEV No.	528402	Ref. No.	A1200030
description	O-ring Viton thickness 2.62mm ID ø 10.78mm Qty 1 pcs		



1

GEV No.	528231	Ref. No.	A1200028
description	O-ring Viton thickness 2.62mm ID ø 12.37mm Qty 1 pcs		

springs



1

GEV No.	526815	Ref. No.	1180100012 AS035 GR775
description	compression spring ø 11.5mm L 16.5mm wire gauge ø 1.5mm		
For models:	Eclisse, Ten, Twenty, Zola-1, Zola-2		

tube handles



1

GEV No.	528625	Ref. No.	1110100148 GR130
description	tube handle L 35mm rubber ID ø 8mm		
For models:	Eclisse, Ten, Twenty, Zola-1, Zola-2		

union nuts



1

GEV No.	528826	Ref. No.	A2200036
description	union nut thread 3/8" L 21mm hole ø 12.5mm chrome-plated brass		

gaskets

flat gaskets

rubber gaskets



1

GEV No.	525107	Ref. No.	A1200155
description	flat gasket rubber ED ø 16mm ID ø 8mm thickness 4mm Qty 1 pcs		

fine filters

fine filters



1

GEV No.	529979	Ref. No.	A2200175
description	fine filter ø 8.8mm H 22mm		



1

GEV No.	528946	Ref. No.	1090500003 GR714 W527
description	fine filter pipe ø 8.5mm H 22mm		
For models:	Eclisse, Ten, Twenty, Zola-1, Zola-2		

intake valves

intake valves





1

GEV No.	526820	Ref. No.	2200600006 GR001C
description	intake valve complete		





accessories			
springs			
			
1			
GEV No.	526560	Ref. No.	A2200177
description	compression spring ø 14.3mm L 46mm wire gauge ø 1.5mm		

miscellaneous			
			
1			
GEV No.	528422	Ref. No.	GR360 GR747
description	ball ø 8mm SS		
For models:	Eclisse, Ten, Twenty, Zola-1, Zola-2		

level glasses			
level glasses			
gaskets			
			
1			
GEV No.	529408	Ref. No.	GR734 GR850
description	gasket D1 ø 16mm D2 ø 10mm H 8mm water level glass		
For models:	Eclisse, Ten, Twenty, Zola-1, Zola-2		

level glass pipes			
			
1			
GEV No.	527990	Ref. No.	1250300034 GR270
description	water level tube ø 11mm H 140mm ID ø 8mm marking Min/Max red		
For models:	Eclisse, Ten, Twenty, Zola-1, Zola-2		

			
1			
GEV No.	531177	Ref. No.	A1400008
description	water level tube ø 11mm H 170mm ID ø 8mm		

non-return valves			
gaskets			
			
1			
GEV No.	526489	Ref. No.	GR758
description	gasket D1 ø 14.9mm D2 ø 6mm total length 10mm L1 5mm L2 5mm		
For models:	Eclisse, Ten, Twenty, Zola-1, Zola-2		

compression springs			
			
1			
GEV No.	526811	Ref. No.	1180100081 FS214 GR748
description	compression spring ø 7.8mm L 35mm wire gauge ø 0.5mm		
For models:	Eclisse, Ten, Twenty, Zola-1, Zola-2		

pistons			
			
1			
GEV No.	526009	Ref. No.	A2200215
description	piston for non-return valve with O-ring ø 12mm L 20mm		

complete			
			
1			
GEV No.	529335	Ref. No.	A1300056
description	non-return valve inlet 1/8" outlet 1/8" L 30mm		

			
1			
GEV No.	527978	Ref. No.	A1300109
description	non-return valve inlet 3/8" outlet 3/8" L 38mm		

screw connections			
washers			
			
1			
GEV No.	526483	Ref. No.	1110400017 GR727
description	throttle disc D1 ø 18.3mm D2 ø 4mm thickness 1.6mm copper		
For models:	Eclisse, Ten, Twenty, Zola-1, Zola-2		

for coffee grinders

grinding burrs

grinding burrs straight

standard

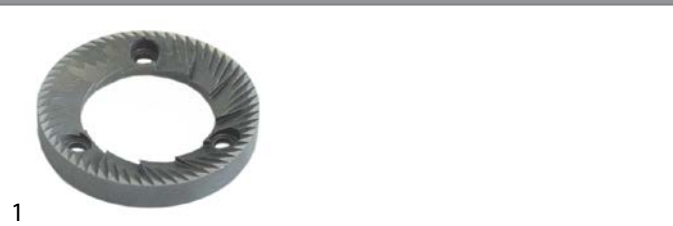

GEV No.	527227	Ref. No.	260001 260003 A3200063
description	grinding burrs pair turn direction right D1 ø 63mm ID ø 38mm H 9.5mm tooth spacing 3mm hole ø 5.5mm bore ø 8.5mm mounting ø 48 straight suitable for FIORENZATO		



GEV No.	527228	Ref. No.	260001 260003 A3200083
description	grinding burrs pair turn direction right D1 ø 83mm ID ø 45mm H 10mm tooth spacing 4mm hole ø 5.4mm bore ø 10mm mounting ø 64.5 straight suitable for FIORENZATO		

grinding burrs conical



GEV No.	527248	Ref. No.	MAC076
description	grinding burrs pair turn direction right D1 ø 40mm D2 ø 32mm H 20mm shaft ø 10mm with flute suitable for SAECO		

grinding burrs holders



GEV No.	527260	Ref. No.	170090 340182
description	grinding burr holder D1 ø 63mm D2 ø 80mm H 31mm type T80 suitable for FIORENZATO		

GEV No.	527261	Ref. No.	340183
description	grinding burr holder D1 ø 83mm D2 ø 90mm H 34mm type T45 suitable for FIORENZATO		

miscellaneous



GEV No.	802047	Ref. No.	160097
description	equipment foot rubber ømm H 22mm mounting measurements 31x18mm T80 Qty 1 pcs		

dosing containers

dosing containers (complete)



GEV No.	527508	Ref. No.	340123 RMT480006 RMUNI0007
description	dosing unit ø 120mm suitable for T80		

dosing container lids





GEV No.	527320	Ref. No.	160064
description	lid for dosing container mounting ø 114mm ø 122mm H 22mm suitable for M80		

			
1			
GEV No.	525166	Ref. No.	A320008
description	lid for dosing container mounting ø 116mm ø 130mm H 25mm		

			
1			
GEV No.	527323	Ref. No.	160078
description	lid for dosing container mounting ø 130mm ø 135mm H 24mm		

adjusting screws			
			
1			
GEV No.	527500	Ref. No.	340120
description	adjusting screw for dosing container thread M8 L 40mm plastic		

springs			
group 1			
			
1			
GEV No.	525110	Ref. No.	A3200049
description	tension spring ø 7.5mm total length 42mm wire gauge ø 0.8mm L1 29mm		

glass cylinders			
			
1			
GEV No.	525167	Ref. No.	A320009
description	glass cylinder for dosing container ø 125mm H 53mm plexiglas		

			
1			
GEV No.	527322	Ref. No.	160083 340231
description	glass cylinder ø 122mm H 10mm plexiglas		

			
1			
GEV No.	527326	Ref. No.	160079
description	glass cylinder ø 132mm H 75mm plexiglas		

levers			
levers			
			
1			
GEV No.	527507	Ref. No.	340159
description	lever complete L 110mm shaft ø 8mm plastic		

coffee presses			
components			
holders			
			
1			
GEV No.	525113	Ref. No.	A3200002
description	bracket H 22mm L 65mm plastic		

pressers			
			
1			
GEV No.	525112	Ref. No.	A3200001
description	coffee press ø 55mm H 34mm plastic		

coffee presses			
			
1			
GEV No.	527506	Ref. No.	160061
description	coffee press ø 57mm L 83mm H 41mm plastic		

automatic grinding

automatic grinding



GEV No. 525114 **Ref. No.** A3200084

description housing for microswitch \varnothing 116mm H 45mm plastic

sector plates



1

GEV No. 527502 **Ref. No.** 160073

description sector plates plastic

stars

central



1

GEV No. 527503 **Ref. No.** 340196

description star mounting pos. centre/bottom

upper



1

GEV No. 527501 **Ref. No.** 160072

description star mounting pos. upper \varnothing 107mm hole \varnothing 8mm H 39mm

bottom



1

GEV No. 527503 **Ref. No.** 340196

description star mounting pos. centre/bottom

adjustment mechanism

setting rings



1

GEV No. 527412 **Ref. No.** 340181

description setting ring mounting \varnothing 95mm \varnothing 111mm ID \varnothing 68mm H 41mm suitable for FIORENZATO for T45 equiv. no. 340181



1

GEV No. 527410 **Ref. No.** 340147

description setting ring \varnothing 106mm ID \varnothing 68mm H 30mm suitable for FIORENZATO for T80

coffee beans containers

container lids



1

GEV No. 527313 **Ref. No.** 160149

description lid for coffee beans container mounting \varnothing 174mm \varnothing 178mm



1

GEV No. 527315 **Ref. No.** 160081
A3200028

description lid for coffee beans container mounting \varnothing 200mm \varnothing 204mm

coffee beans containers



1

GEV No.	527312	Ref. No.	340066
description	coffee beans container 3-piece seat ø 68mm		







1

GEV No.	527311	Ref. No.	340068 RMT800012
description	coffee beans container complete ø 175mm H 220mm seat ø 68mm container capacity 1.2kg T80		





1

GEV No.	527314	Ref. No.	160080	
description	coffee beans container ø 172mm H 222mm seat ø 67mm M80			
accessories for	527314			
	GEV No.	527313	Ref. No.	160149
	lid for coffee beans container mounting ø 174mm ø 178mm			
	GEV No.	527318	Ref. No.	160063 A3200031
	catch L 86mm W 48mm thickness 2mm plastic			
	GEV No.	527319	Ref. No.	160067
	protection cap ø 60mm suitable for FIORENZATO plexiglas			



1

GEV No.	527316	Ref. No.	160076 A3200027	
description	coffee beans container ø 200mm H 255mm seat ø 67mm M1-T48			
spare parts for	527316			
	GEV No.	527315	Ref. No.	160081 A3200028
	lid for coffee beans container mounting ø 200mm ø 204mm			
	GEV No.	527318	Ref. No.	160063 A3200031
	catch L 86mm W 48mm thickness 2mm plastic			
	GEV No.	527319	Ref. No.	160067
	protection cap ø 60mm suitable for FIORENZATO plexiglas			

protection caps



1

GEV No. 527319 **Ref. No.** 160067

description protection cap ø 60mm suitable for FIORENZATO plexiglas



1

GEV No. 527411 **Ref. No.** 160091

description protection cap ø 68mm plastic

locks



1

GEV No. 527318 **Ref. No.** 160063
A3200031

description catch L 86mm W 48mm thickness 2mm plastic

support for filter holder



1

GEV No. 527518 **Ref. No.** 170033
170044

description bracket for filter holder L 105mm W 57mm H 15mm aluminium

counters

counters



1

GEV No. 527505 **Ref. No.** 210033

description counter ø 20mm lever length 35mm for dosing unit

for dishwashers

rotation plates

rotation plate bearings



1

GEV No. 519426 **Ref. No.** LAV817

description spindle for rotation plate

EQUIPMENT-SPECIFIC UNITS/KNOBS GRIMAC



1

GEV No. 519427 **Ref. No.** LAV837

description spindle for rotation plate

door mechanics

locks



1

GEV No. 512369 **Ref. No.** LAV256

description counterpart door catch



1

GEV No. 512160 **Ref. No.** LAV255

description door catch

accessories for 512160

GEV No. 512369 **Ref. No.** LAV256

description counterpart door catch

knobs

steam/water taps

steam/water taps



1

GEV No. 111348 **Ref. No.** 221020009
GR290

description knob steam ø 53mm shaft ø 8.5mm black



1

GEV No. 526828 **Ref. No.** 221020009
GR290

description knob steam ø 53mm shaft ø 8.5mm black

For models: Eclisse, Ten, Twenty, Zola-1, Zola-2



			
1			
GEV No.	111347	Ref. No.	2210200011 GR295
description	knob steam ø 53mm shaft ø 8.5mm black/chrome		
For models:	Eclisse, Ten, Twenty, Zola-1, Zola-2		

			
1			
GEV No.	111331	Ref. No.	2210200008 GR289
description	knob water ø 53mm shaft ø 8.5mm black		
For models:	Eclisse, Ten, Twenty, Zola-1, Zola-2		

			
1			
GEV No.	111332	Ref. No.	2210200010 GR294
description	knob water ø 53mm shaft ø 8.5mm black/chrome		
For models:	Eclisse, Ten, Twenty, Zola-1, Zola-2		

			
1			
GEV No.	111328	Ref. No.	A1600012
description	turning handle ø 44mm shaft ø 6x8mm black		

knob dial plates

			
1			
GEV No.	111330	Ref. No.	GR842
description	knob dial plate steam ø 20mm L 7mm black		
For models:	Eclisse, Ten, Twenty, Zola-1, Zola-2		

			
1			
GEV No.	111349	Ref. No.	GR843
description	knob dial plate water ø 20mm L 7mm black		
For models:	Eclisse, Ten, Twenty, Zola-1, Zola-2		

accessories

			
1			
GEV No.	111028	Ref. No.	2210200003 F309 GR855
description	star handle shaft 7x7mm ø 64mm L 24mm black		
For models:	Zola-2		

			
1			
GEV No.	111329	Ref. No.	GR819
description	star handle thread M8x1.25 ø 40mm L 27mm black		
For models:	Eclisse, Ten, Twenty, Zola-1, Zola-2		

miscellaneous

			
1			
GEV No.	527259	Ref. No.	1210100086 GR272
description	knob push-in ø 34/60mm shaft ø 5x5mm black H 21.4mm L 49mm		
For models:	Eclisse, Ten, Twenty, Zola-1, Zola-2		

handles and hand wheels

cone handles

			
1			
GEV No.	111327	Ref. No.	A1600172
description	cone handle thread M8 ø 30mm L 66mm thermoplastic black		

ball handles

			
1			
GEV No.	111346	Ref. No.	GRT030
description	ball handle thread M8 ø 25mm black matt		

star handles

			
1			
GEV No.	111333	Ref. No.	A1600004
description	star handle shaft 7x7mm ø 60mm L 24mm black thermoplastic		



1

GEV No.	111329	Ref. No.	GR819
description	star handle thread M8x1.25 ø 40mm L 27mm black		
For models:	Eclisse, Ten, Twenty, Zola-1, Zola-2		

equipment feet and end caps

equipment feet with stem



1

GEV No.	802047	Ref. No.	160097
description	equipment foot rubber ømm H 22mm mounting measurements 31x18mm T80 Qty 1 pcs		

gaskets

O-rings

EPDM

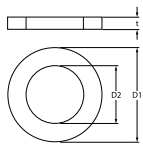
1

GEV No.	510177	Ref. No.	A1200039
description	O-ring EPDM thickness 1.78mm ID ø 7.66mm Qty 1 pcs		

1

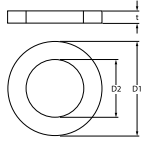
GEV No.	526824	Ref. No.	GR754
description	O-ring EPDM thickness 1.9mm ID ø 5.7mm Qty 1 pcs		
For models:	Eclisse, Ten, Twenty, Zola-1, Zola-2		

1

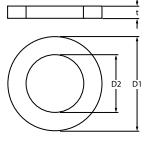
GEV No.	525255	Ref. No.	GR364
description	O-ring EPDM thickness 1.9mm ID ø 7.2mm Qty 1 pcs		
For models:	Zola-2		

1

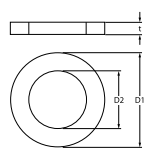
GEV No.	529412	Ref. No.	A1200040
description	O-ring EPDM thickness 2.62mm ID ø 10.78mm Qty 1 pcs		

silicone

1

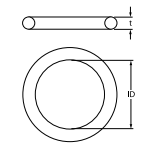
GEV No.	525388	Ref. No.	1110100004 MG264
description	O-ring silicone thickness 1.78mm ID ø 9.25mm Qty 1 pcs		

Viton

1

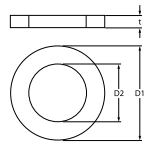
GEV No.	526369	Ref. No.	1110800025 C293 GR847
description	O-ring Viton thickness 1.78mm ID ø 10.82mm Qty 1 pcs		
For models:	Eclisse, Ten, Twenty, Zola-1, Zola-2		

1

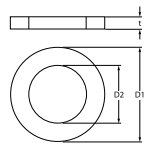
GEV No.	526822	Ref. No.	1110800040 F067 GR756
description	O-ring Viton thickness 1.9mm ID ø 8mm Qty 1 pcs		
For models:	Eclisse, Ten, Twenty, Zola-1, Zola-2		



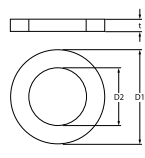

1

GEV No.	528402	Ref. No.	A1200030
description	O-ring Viton thickness 2.62mm ID ø 10.78mm Qty 1 pcs		

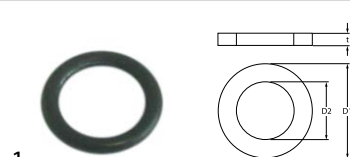

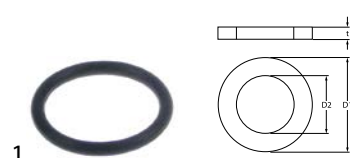
			
GEV No.	528231	Ref. No.	A1200028
description	O-ring Viton thickness 2.62mm ID ø 12.37mm Qty 1 pcs		

			
GEV No.	532560	Ref. No.	A1200151
description	O-ring Viton thickness 2.62mm ID ø 20.63mm Qty 1 pcs		

			
GEV No.	528525	Ref. No.	GR718
description	O-ring Viton thickness 3.53mm ID ø 18.64mm Qty 1 pcs		
For models:	Eclisse, Ten, Twenty, Zola-1, Zola-2		

sealing washers

fibre gaskets

			
GEV No.	526484	Ref. No.	GR806 GRC606
description	flat gasket fibre ED ø 17mm ID ø 13.2mm thickness 2mm Qty 1 pcs		

rubber gaskets

			
GEV No.	525107	Ref. No.	A1200155
description	flat gasket rubber ED ø 16mm ID ø 8mm thickness 4mm Qty 1 pcs		

PTFE gaskets

			
GEV No.	527638	Ref. No.	A1200044
description	flat gasket PTFE ED ø 12mm ID ø 10mm thickness 1mm Qty 1 pcs		

			
GEV No.	526661	Ref. No.	GR806 GRC606
description	flat gasket PTFE ED ø 17mm ID ø 13mm thickness 2mm Qty 1 pcs		
For models:	Eclisse, Ten, Twenty, Zola-1, Zola-2		

			
GEV No.	526481	Ref. No.	GR716 GR755
description	flat gasket PTFE ED ø 21.5mm ID ø 17mm thickness 2mm Qty 1 pcs		
For models:	Eclisse, Ten, Twenty, Zola-1, Zola-2		

			
GEV No.	527154	Ref. No.	A1200153
description	flat gasket PTFE ED ø 22mm ID ø 16.8mm thickness 2mm Qty 1 pcs		

			
GEV No.	526013	Ref. No.	1110300046 A1200011 GR846 R204
description	flat gasket PTFE ED ø 22mm ID ø 17mm thickness 2mm Qty 1 pcs		
For models:	Eclisse, Ten, Twenty, Zola-1, Zola-2		

			
GEV No.	527970	Ref. No.	1110300034 GR361
description	flat gasket PTFE ED ø 24mm ID ø 18mm thickness 2mm Qty 1 pcs		
For models:	Zola-2		

			
GEV No.	526265	Ref. No.	A1200009
description	flat gasket PTFE ED ø 24mm ID ø 19mm thickness 2mm Qty 1 pcs		

			
GEV No.	526482	Ref. No.	GR743 GR746
description	flat gasket PTFE ED ø 26.5mm ID ø 22mm thickness 2mm Qty 1 pcs		
For models:	Eclisse, Ten, Twenty, Zola-1, Zola-2		

			
1			
GEV No.	525106	Ref. No.	A1200158
description	flat gasket PTFE ED ø 26mm ID ø 19mm thickness 2mm Qty 1 pcs		

			
1			
GEV No.	526014	Ref. No.	A1200152
description	flat gasket PTFE ED ø 35mm ID ø 30mm thickness 2mm Qty 1 pcs		

			
1			
GEV No.	526827	Ref. No.	1110300021 F055T GR719
description	flat gasket PTFE ED ø 36mm ID ø 30mm thickness 2.5mm Qty 1 pcs		
For models:	Eclisse, Ten, Twenty, Zola-1, Zola-2		

			
1			
GEV No.	526826	Ref. No.	1110300016 CA020T GRC610
description	flat gasket PTFE ED ø 53mm ID ø 42.5mm thickness 3mm Qty 1 pcs		

			
1			
GEV No.	528021	Ref. No.	1110300016 A1200015 CA020T GRC610
description	flat gasket PTFE ED ø 53mm ID ø 42.5mm thickness 3mm Qty 1 pcs equiv. no. 12001/02286 suitable for Astoria/Aurora/Brasilia/Wega		
For models:	Eclisse, Ten, Twenty		

			
1			
GEV No.	526825	Ref. No.	1110300019 F043T GR709
description	flat gasket PTFE ED ø 58mm ID ø 43mm thickness 3mm Qty 1 pcs		
For models:	Zola-1, Zola-2		

Viton gaskets

			
1			
GEV No.	526486	Ref. No.	1110100044 F008 GR737
description	gasket Viton ED ø 16mm ID ø 8mm thickness 4mm Qty 1 pcs		
For models:	Eclisse, Ten, Twenty, Zola-1, Zola-2		

special gaskets

group gaskets

			
1			
GEV No.	526480	Ref. No.	1110500119 A1200162 GR721 W539A
description	group gasket L 75mm W 72mm thickness 3mm aperture 27x66mm hole distance 56.5mm		
For models:	Eclisse, Ten, Twenty, Zola-1, Zola-2		

springs

compression springs

			
1			
GEV No.	527504	Ref. No.	230023
description	compression spring ø 10.3mm L 60mm wire gauge ø 1.3mm		

			
1			
GEV No.	525093	Ref. No.	1180100097 A2200002 GR362
description	compression spring ø 10.6mm L 29.5mm wire gauge ø 1.4mm		
For models:	Zola-2		

			
1			
GEV No.	526815	Ref. No.	1180100012 AS035 GR775
description	compression spring ø 11.5mm L 16.5mm wire gauge ø 1.5mm		
For models:	Eclisse, Ten, Twenty, Zola-1, Zola-2		





			
1			
GEV No.	527968	Ref. No.	1180100076 F777 GR742
description	compression spring ø 12.5mm L 31mm wire gauge ø 1.8mm		
For models:	Eclisse, Ten, Twenty, Zola-1, Zola-2		

			
1			
GEV No.	527935	Ref. No.	A2200209
description	compression spring ø 14.6mm L 33mm wire gauge ø 2mm		

			
1			
GEV No.	525092	Ref. No.	A2200001
description	compression spring ø 12mm L 15mm wire gauge ø 1.5mm		

			
1			
GEV No.	526817	Ref. No.	GR799
description	compression spring ø 14.8mm L 18mm wire gauge ø 1.8mm		
For models:	Eclisse, Ten, Twenty, Zola-1, Zola-2		

			
1			
GEV No.	526812	Ref. No.	1180100053 F097 GR749
description	compression spring ø 13.3mm L 42.5mm wire gauge ø 1.5mm		
For models:	Eclisse, Ten, Twenty, Zola-1, Zola-2		

			
1			
GEV No.	526813	Ref. No.	1180100193 GR788 W549
description	compression spring ø 15mm L 28mm wire gauge ø 1.8mm		
For models:	Eclisse, Ten, Twenty, Zola-1, Zola-2		

			
1			
GEV No.	526814	Ref. No.	1180100052 F096 GR780
description	compression spring ø 13mm L 32.5mm wire gauge ø 1.3mm		
For models:	Eclisse, Ten, Twenty, Zola-1, Zola-2		

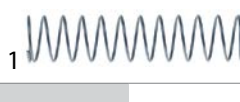
			
1			
GEV No.	526811	Ref. No.	1180100081 FS214 GR748
description	compression spring ø 7.8mm L 35mm wire gauge ø 0.5mm		
For models:	Eclisse, Ten, Twenty, Zola-1, Zola-2		

			
1			
GEV No.	526561	Ref. No.	A2200192
description	compression spring ø 14.3mm L 21mm wire gauge ø 1.8mm		

			
1			
GEV No.	527969	Ref. No.	GR359
description	compression spring ø 8mm L 21mm wire gauge ø 0.4mm		
For models:	Zola-2		

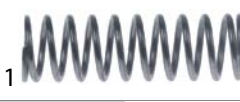
			
1			
GEV No.	526560	Ref. No.	A2200177
description	compression spring ø 14.3mm L 46mm wire gauge ø 1.5mm		

tension springs

			
1			
GEV No.	526816	Ref. No.	1180100054 F098 GR760
description	compression spring ø 14.5mm L 33.4mm wire gauge ø 2mm		
For models:	Eclisse, Ten, Twenty, Zola-1, Zola-2		

			
1			
GEV No.	525110	Ref. No.	A3200049
description	tension spring ø 7.5mm total length 42mm wire gauge ø 0.8mm L1 29mm		

manometers

 <p>1</p>			
GEV No.	541233	Ref. No.	S060
description	manometer double scale ø 60mm pressure range 0-2.5 / 0-15bar connection on the backside thread 1/8"		

 <p>1</p>			
GEV No.	541287	Ref. No.	S060
description	manometer double scale ø 60mm pressure range 0-2.5 / 0-15bar connection on the backside thread 1/8"		

 <p>1</p>			
GEV No.	541410	Ref. No.	A031 P052 W019
description	manometer double scale ø 60mm pressure range 0-2.5 / 0-15bar connection on the backside thread 1/8"		

 <p>1</p>			
GEV No.	541222	Ref. No.	VBM042
description	manometer double scale ø 60mm pressure range 0-2.5 / 0-16bar connection on the backside thread 1/8"		

 <p>1</p>			
GEV No.	541226	Ref. No.	AS057 SP030
description	manometer double scale ø 60mm pressure range 0-2.5 / 0-16bar connection on the backside thread 1/8"		

 <p>1</p>			
GEV No.	541227	Ref. No.	A031 P052 W019
description	manometer double scale ø 60mm pressure range 0-2.5 / 0-16bar connection on the backside thread 1/8"		

 <p>1</p>			
GEV No.	541708	Ref. No.	1250200034 GRC106
description	manometer double scale ø 60mm pressure range 0-2.5 / 0-16bar connection on the backside thread 1/8"		
For models:	Eclisse, Ten, Twenty, Zola-1, Zola-2		

 <p>1</p>			
GEV No.	541203	Ref. No.	F295
description	manometer double scale ø 63mm pressure range 0-2.5 / 0-15bar connection on the backside thread 1/8"		

 <p>1</p>			
GEV No.	541211	Ref. No.	C145
description	manometer double scale ø 63mm pressure range 0-2.5 / 0-15bar connection on the backside thread 1/8"		

 <p>1</p>			
GEV No.	541732	Ref. No.	1250200033 GR0345
description	manometer double scale ø 63mm pressure range 0-2.5 / 0-15bar connection on the backside thread 1/8" for GRIMAC		

			
1			
GEV No.	541266	Ref. No.	1250200031 GR034
description	manometer double scale ø 63mm pressure range 0-2.5 / 0-16bar connection on the backside thread 1/8"		

			
1			
GEV No.	541728	Ref. No.	A1400020
description	manometer double scale ø 63mm pressure range 0-3 / 0-18bar connection on the backside thread 1/8"		

			
1			
GEV No.	541279	Ref. No.	BF080
description	manometer double scale ø 63mm pressure range 0-2.5 / 0-25bar connection on the backside thread 1/8"		

			
1			
GEV No.	541209	Ref. No.	R067
description	manometer double scale ø 70mm pressure range 0-2.5 / 0-16bar connection thread 1/8"		

			
1			
GEV No.	541202	Ref. No.	F299 M149
description	manometer double scale ø 63mm pressure range 0-3 / 0-15bar connection on the backside thread 1/8"		

			
1			
GEV No.	541206	Ref. No.	F951
description	manometer ø 42mm pressure range 0 up to 16bar thread 1/8" marking 12 connection on the backside		

			
1			
GEV No.	541220	Ref. No.	SM098
description	manometer double scale ø 63mm pressure range 0-3 / 0-15bar connection on the backside thread 1/8"		

			
1			
GEV No.	541205	Ref. No.	F1069 F950
description	manometer ø 42mm pressure range 0 up to 2.5bar thread 1/8" marking 2 connection on the backside		

			
1			
GEV No.	541727	Ref. No.	A1400019
description	manometer double scale ø 63mm pressure range 0-3 / 0-18bar connection on the backside thread 1/8"		

			
1			
GEV No.	541217	Ref. No.	G119
description	manometer ø 49.3mm pressure range 0 up to 3bar thread 1/8" marking 2 connection on the backside		

			
1			
GEV No.	541221	Ref. No.	SM099
description	manometer ø 50mm pressure range 0 up to 3bar thread 1/4" marking 1-1.25 connection on the backside		



1

GEV No.	541225	Ref. No.	AS058
description	manometer ø 51mm pressure range 0 up to 3bar thread 1/4" marking 2 connection on the backside		



1

GEV No.	541232	Ref. No.	BE076
description	manometer ø 52mm pressure range 0 up to 3bar thread 1/4" marking 2 connection on the backside		



1

GEV No.	541284	Ref. No.	G118
description	manometer ø 52mm pressure range 0 up to 15bar connection on the backside marking 6/7 thread 1/4"		



1

GEV No.	541214	Ref. No.	G113
description	manometer ø 52mm pressure range 0 up to 3bar thread 1/8" connection on the backside		



1

GEV No.	541200	Ref. No.	A1400042 F298
description	manometer ø 52mm pressure range 0 up to 3bar connection on the backside marking 0.7-1 thread 1/8"		



1

GEV No.	541201	Ref. No.	A1400043 F297
description	manometer ø 53.5mm pressure range 0 up to 16bar connection on the backside thread 1/8"		



1

GEV No.	541283	Ref. No.	G117
description	manometer ø 52mm pressure range 0 up to 3bar connection on the backside marking 1-1.5 thread 1/4"		



1

GEV No.	541215	Ref. No.	G114
description	manometer ø 53mm pressure range 0 up to 16bar thread 1/8" marking 8-10 connection on the backside		



1

GEV No.	541248	Ref. No.	F296
description	manometer ø 52mm pressure range 0 up to 3bar marking 1.6 thread 1/8"		



1

GEV No.	541216	Ref. No.	G120
description	manometer ø 53mm pressure range 0 up to 16bar thread 1/8" marking 8-10 connection on the backside		

1

GEV No.	541213	Ref. No.	C149
description	manometer ø 57mm pressure range 0 up to 15bar thread 1/8" marking 8-10 connection on the backside		



1

GEV No.	541212	Ref. No.	C150
description	manometer ø 57mm pressure range 0 up to 2.5bar thread 1/8" connection on the backside		



1

GEV No.	541275	Ref. No.	C142
description	manometer ø 57mm pressure range 0 up to 2.5bar thread 1/8" marking 1.6 connection on the backside		



1

GEV No.	541286	Ref. No.	P051
description	manometer ø 60mm pressure range 0 up to 3bar thread 1/8" marking 1.5 connection on the backside		

valves and tank inlets

ball valves

universal

mini ball valves



1

GEV No.	520722	Ref. No.	GR198 GRC618
description	ball valve connection 1/4" IT - 1/4" ET DN8 total length 39mm chrome-plated brass		
For models:	Eclipse, Ten, Twenty, Zola-1, Zola-2		

water softeners

measuring devices



1

GEV No.	541754	Ref. No.	V550
description	control strip type water hardness (German)		

ancillary products

measuring devices



1

GEV No.	541754	Ref. No.	V550
description	control strip type water hardness (German)		

fastening material

screws

countersunk screws



1

GEV No.	560215	Ref. No.	A1100187
description	countersunk screw thread M5 L 14mm SS DIN 963/ISO 2009 Qty 20 pcs intake slotted head ø 9.2mm		

B			
ball valves	39		
bi-metal thermostats	8, 8		
booster pumps II	16		
C			
condensators & interference suppression filters	16		
contactors	11		
control equipment	10		
countersunk screws	39		
E			
electrodes	15		
F			
fastening material	39		
H			
heating elements	3		
heating elements for coffee machine	3		
I			
indicator lights	10		
indicator lights (complete)	10		
L			
lamps	10		
M			
measuring devices	39, 39		
microswitches	9		
motors	15		
O			
operating capacitors	16		
O-rings	32		
P			
pressure switches	15		
pumps	16		
push/momentary push switches	9		
R			
radiation heaters	7		
relays	11		
rocker/momentary rocker switches	8		
rotary switches	10		
S			
screws	39		
sealing washers	33		
solenoid valves	14		
		switches and momentary switches	8
		system switches (ROLD)	10
		T	
		thermostats	8
		V	
		valves and tank inlets	39
		vibration pumps	16
		W	
		water softeners	39