



GAS COMPONENTS



ELECTRIC COMPONENTS



WATER TECHNOLOGY



MECHANICAL COMPONENTS



TOOLS

Spare parts suitable for

GRAM

Find the complete and up-to-date range of products in our GEV Webshop



Manufacturer catalogue

The most important spare parts and accessories arranged clearly for every manufacturer

- ✓ Complete product range and all appliance data always up to date in the GEV Webshop
- ✓ Alphabetical Index at the end of the catalogue

GEV Webshop

www.gev-online.co.uk

www.gev-online.com



- 🔍 Add to Favourites
- 🔍 Sign In with email address and usual password
- 🔍 Easy-order – place several items in your basket at the same time
- 🔍 Quick Item search – no login needed



switches and momentary switches

microswitches

with push button

switches with snap-fit



1

GEV No.	347587	Ref. No.	76-507-0895
description	microswitch with lever 250V 1A 1CO connection male faston 2.8mm L 25x12.5mm ambient temperature max. 85°C actuating force: 50g for door lever length 26mm		

relays

plug-in/print relays

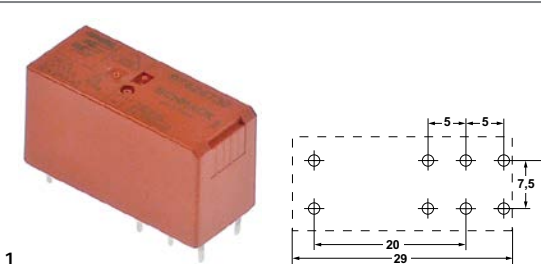

1

GEV No.	381168	Ref. No.	450200082
description	print relay 230VAC 2CO 2-pole at 250V 8A connection pins raster size 5mm SCHRACK manuf. no. RT424730 95.65/95.75		
For models:	F600-CSG-McDonalds		

electronic controllers

CAREL

refrigeration controllers

with panel



1

GEV No.	403317	Ref. No.	761222822
description	control panel grey with energy regulator model K 200/400 GRAM		



1

GEV No.	403318	Ref. No.	761222823
description	control panel white with energy regulator model K 200/400 GRAM		

probes

producer-specific probes

probes



1

GEV No.	379758	Ref. No.	76-507-2503
description	temperature probe NTC 4.8kOhm cable PVC probe -40 up to +110°C cable -10 up to 100°C connection male faston 2.8mm thread probe ø8x30mm cable length 0.6m		

electronics

PCBs



1

GEV No.	403017	Ref. No.	76-122-0028 761221374
description	control PCB for fridge L 90mm W 36mm suitable for GRAM type ETCD2D		

keypads

front foils



1

GEV No.	403939	Ref. No.	765040641
description	keypad foil black suitable for GRAM for Plus/Twin L 285mm W 40mm		
For models:	F600-CSG-McDonalds		



fans

axial fans

import



1

GEV No.	601748	Ref. No.	731221106 76-507-2542
description	axial fan L 80mm W 80mm H 25mm 230VAC 50/60Hz 4.6W connection plug cable length 580mm 2-pieces with probe suitable for GRAM fan wheel ø 75mm		
spare parts for	601748		
	GEV No.	379758	Ref. No. 76-507-2503
	temperature probe NTC 4.8kOhm cable PVC probe -40 up to +110°C cable -10 up to 100°C connection male faston 2.8mm thread probe ø8x30mm cable length 0.6m		

refrigeration fans

refrigeration motors universal

ELCO

N series - standard



1

GEV No.	601843	Ref. No.	61-290-0001 760071617
description	fan motor ELCO 10W 230V 50/60Hz bearing slide bearing L1 49mm L2 65mm L3 87mm W 82mm connection cable 1000mm cable length 1000mm 1300/1550rpm 3 mounting options N10-20/158		
For models:	F600-CSG-McDonalds		
spare parts for	601843		
	GEV No.	601413	Ref. No. —
	fixing plate suitable for fanwheel ED ø 32mm shaft ø 7 mounting distance 26mm		

accessories

fan wheels

aluminium

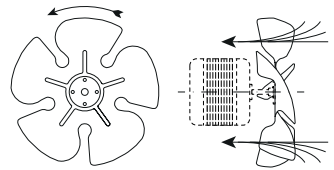
1

GEV No.	601282	Ref. No.	612900201
description	fan wheel sucking ø 200mm fan wheel mounting 25.4mm blade angle 34° W 44mm aluminium		
For models:	F600-CSG-McDonalds		

cold air circulating fans (other)



1

GEV No.	601375	Ref. No.	612900002
description	fan motor 230V 50/60Hz 10W W 84mm H 87mm D 95mm shaft L 25mm shaft ø 8mm PLASET type 20182 cable length 1000mm 1350rpm		
For models:	F600-CSG-McDonalds		
accessories for	601375		
	GEV No.	601282	Ref. No. 612900201
	fan wheel sucking ø 200mm fan wheel mounting 25.4mm blade angle 34° W 44mm aluminium		
	GEV No.	601570	Ref. No. —
	fan wheel blowing ø 200mm fan wheel mounting 25.4mm blade angle 28° W 37mm aluminium		

shelves and shelf rails

grates

universal

without upstand



1

GEV No.	970703	Ref. No.	76-508-0366
description	grate W 650mm D 530mm 2/1 H 11mm plastic-coated steel wire gauge frame 9mm lengthwise wires gauge 3mm grey		



gaskets

refrigeration gaskets

plug-in gaskets

profile 9048

We offer custom-made gaskets for this profile

1

GEV No.	902472	Ref. No.	761114263
description	refrigeration gasket profile 9048 W 180mm L 415mm plug size		

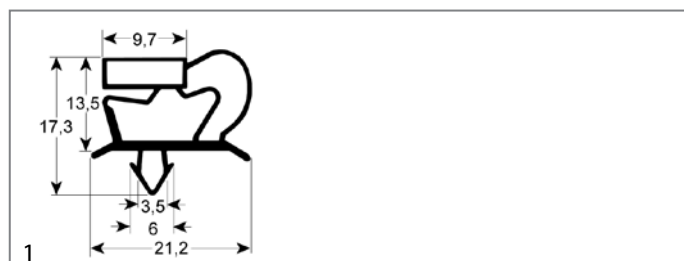

GEV No.	901898	Ref. No.	761114256
description	refrigeration gasket profile 9048 W 396mm L 570mm plug size		

profile 9051

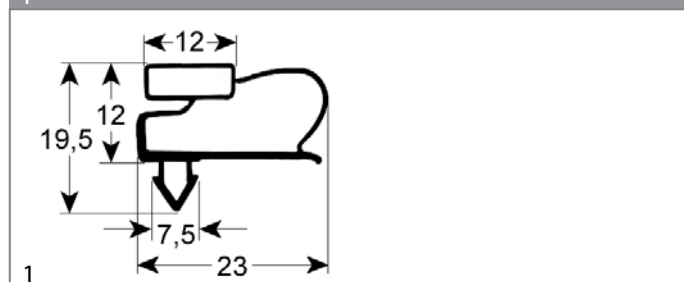

GEV No.	901418	Ref. No.	76-122-0036
description	refrigeration gasket profile 9051 W 570mm L 1580mm plug size F/ K400		

profile 9195

We offer custom-made gaskets for this profile

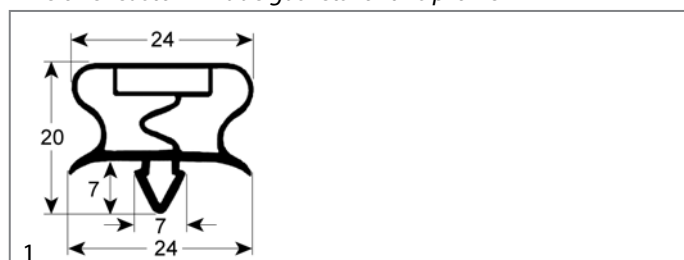

GEV No.	901647	Ref. No.	761258538 761259245
description	refrigeration gasket profile 9195 W 530mm L 1530mm plug size		

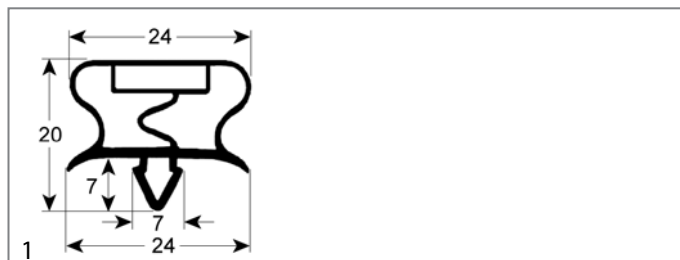

GEV No.	901897	Ref. No.	76-125-9244
description	refrigeration gasket profile 9195 W 620mm L 1520mm plug size		

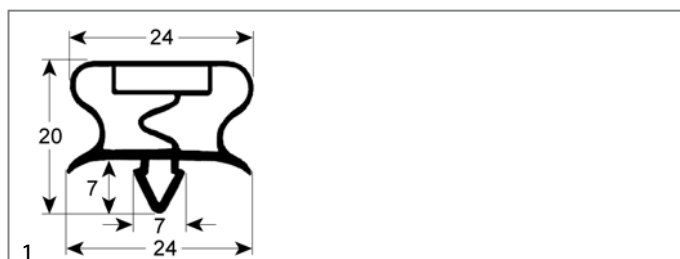

GEV No.	901643	Ref. No.	76-125-9243
description	refrigeration gasket profile 9195 W 625mm L 1380mm plug size		
For models:	F600-CSG-McDonalds		

profile 9950

We offer custom-made gaskets for this profile

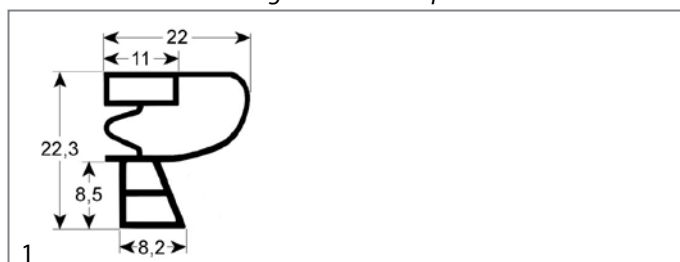

GEV No.	901895	Ref. No.	76-024-3225
description	refrigeration gasket profile 9950 W 490mm L 1410mm plug size		

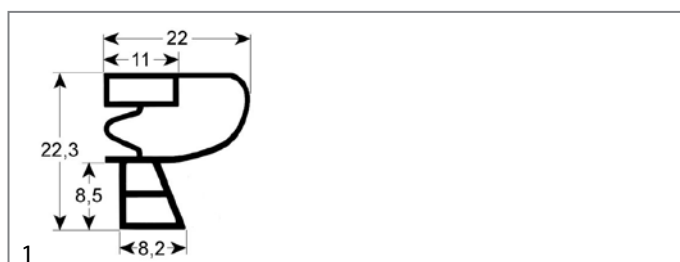

GEV No.	901644	Ref. No.	76-125-4573
description	refrigeration gasket profile 9950 W 670mm L 1490mm plug size		

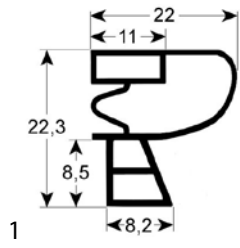

GEV No.	901896	Ref. No.	76-024-3227
description	refrigeration gasket profile 9950 W 705mm L 1415mm plug size		

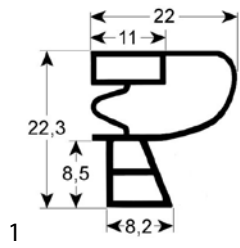

GEV No.	902311	Ref. No.	N/A
description	refrigeration gasket profile 9950 Wmm L 2500mm		

fastening material

washers

washers

DIN 125A



1

GEV No.	560312	Ref. No.	421708020
description	plain washer ID \varnothing 10.5mm ED \varnothing 20mm thickness 2mm SS Qty 1 pcs DIN 125A for thread M10		
For models:	F600-CSG-McDonalds		

A

axial fans 4

E

electronic controllers 3

F

fans 4

fastening material 6

G

grates 4

M

microswitches 3

P

plug-in gaskets 5

probes 3

R

refrigeration fans 4

refrigeration gaskets 5

refrigeration motors universal 4

relays 3

S

shelves and shelf rails 4

switches and momentary switches 3

W

washers 6