



GAS COMPONENTS



ELECTRIC COMPONENTS



WATER TECHNOLOGY



MECHANICAL COMPONENTS



TOOLS

Spare parts suitable for

GIORIK

Find the complete and up-to-date range of products in our GEV Webshop



Manufacturer catalogue

The most important spare parts and accessories arranged clearly for every manufacturer

- ✓ Complete product range and all appliance data always up to date in the GEV Webshop
- ✓ Alphabetical Index at the end of the catalogue

GEV Webshop

www.gev-online.co.uk

www.gev-online.com



- 🔍 Add to Favourites
- 🔍 Sign In with email address and usual password
- 🔍 Easy-order – place several items in your basket at the same time
- 🔍 Quick Item search – no login needed









heating elements

heating elements for bain maries

			
GEV No.	416067	Ref. No.	6001024
description	heating element 1380W 230V heating circuits 1 L 346mm W 190mm connection M5 tube ø 8.5mm 2 hole fixing thread 1/4" immersion heater W1 70mm W2 105mm H 27mm mounting distance 67mm		
For models:	BME46, BME66, SPE46		
spare parts for	416067		
	GEV No.	510417	Ref. No. —
	flat gasket fibre ED ø 20mm ID ø 14mm thickness 2mm Qty 1 pcs		
accessories for	416067		
	GEV No.	361182	Ref. No. —
	nut thread 1/4" H 5mm nickel-plated brass WS 17 Qty 1 pcs		
	GEV No.	520228	Ref. No. —
	tooth lock washer ID ø 15.3mm ED ø 24mm steel Qty 1 pcs for thread M14		
	GEV No.	550262	Ref. No. —
	flat gasket copper ED ø 20mm ID ø 14mm thickness 2mm		
	GEV No.	560112	Ref. No. —
	plain washer ID ø 5.3mm ED ø 10mm thickness 1mm SS Qty 20 pcs DIN 125A for thread M5		
	GEV No.	560132	Ref. No. —
	hexagonal nut thread M5 H 4mm WS 8 SS DIN/ISO DIN 934 / ISO 4032/8673 Qty 20 pcs		

heating elements for chip scuttles





			
GEV No.	416067	Ref. No.	6001024
description	heating element 1380W 230V heating circuits 1 L 346mm W 190mm connection M5 tube ø 8.5mm 2 hole fixing thread 1/4" immersion heater W1 70mm W2 105mm H 27mm mounting distance 67mm		
For models:	BME46, BME66, SPE46		
spare parts for	416067		
	GEV No.	510417	Ref. No. —
	flat gasket fibre ED ø 20mm ID ø 14mm thickness 2mm Qty 1 pcs		
accessories for	416067		
	GEV No.	361182	Ref. No. —
	nut thread 1/4" H 5mm nickel-plated brass WS 17 Qty 1 pcs		
	GEV No.	520228	Ref. No. —
	tooth lock washer ID ø 15.3mm ED ø 24mm steel Qty 1 pcs for thread M14		
	GEV No.	550262	Ref. No. —
	flat gasket copper ED ø 20mm ID ø 14mm thickness 2mm		
	GEV No.	560112	Ref. No. —
	plain washer ID ø 5.3mm ED ø 10mm thickness 1mm SS Qty 20 pcs DIN 125A for thread M5		

accessories for	416067		
	GEV No.	560132	Ref. No. —
	hexagonal nut thread M5 H 4mm WS 8 SS DIN/ISO DIN 934 / ISO 4032/8673 Qty 20 pcs		

heating elements for fryers

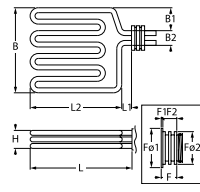
off-center connection

with thread

 			
GEV No.	416070	Ref. No.	6002137 6002137 + 6090144 + 6090145
description	heating element 10200W 230/400V heating circuits 3 L 300mm W 180mm H 33mm flange length 19.5mm flange length 1 9.5mm flange length 2 9.8mm flange ø1 62mm flange ø2 57mm thermostat sleeves ø 6.5mm sensor screw connection 2x M10x1 thermostat sleeve upper/lower L1 18mm L2 282mm W1 30mm W2 35mm thread M54x1.5 windings 5 tube ø 8.5mm cable length 450mm rotation flange immersion heater fryer connection length 130mm 2		
spare parts for	416070		
	GEV No.	510243	Ref. No. —
	O-ring Viton thickness 3.53mm ID ø 55.56mm Qty 1 pcs		
	GEV No.	550496	Ref. No. 6090144
	O-ring Viton thickness 3.53mm ID ø 50.39mm Qty 1 pcs		
accessories for	416070		
	GEV No.	510243	Ref. No. —
	O-ring Viton thickness 3.53mm ID ø 55.56mm Qty 1 pcs		
	GEV No.	550662	Ref. No. —
	ring nut thread M54x1.5 H 7mm		

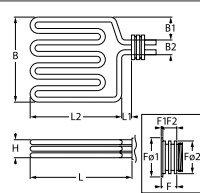
 			
GEV No.	416822	Ref. No.	6002137
description	heating element 10200W 230V heating circuits 3		
For models:	F15CL, F15L, F215CL, F215L		



GEV No.	416825	Ref. No.	6002151 6002151+6090144+6090145
description	heating element 12000W 230/400V heating circuits 3 mounting pos. right L 326mm W 180mm H 31mm flange length 19.5mm flange length 1 9.5mm flange length 2 9.8mm flange ø1 62mm flange ø2 57mm thermostat sleeves ø 7.5mm sensor screw connection 2x M10x1 thermostat sleeve upper/lower L1 19mm L2 307mm W1 33mm W2 33mm thread M54x1.5 windings 5 tube ø 8.5mm cable length 490mm rotation flange immersion heater fryer connection length 60mm		
For models:	15FE, 15FEC, 215FE, 215FEC		
spare parts for	416825		
	GEV No.	510243	Ref. No. —
	O-ring Viton thickness 3.53mm ID ø 55.56mm Qty 1 pcs		
accessories for	416825		
	GEV No.	550662	Ref. No. —
	ring nut thread M54x1.5 H 7mm		

GEV No.	416823	Ref. No.	6002138
description	heating element 15000W 230V heating circuits 3 windings 8		

GEV No.	416826	Ref. No.	6002152 6002152+6090144+6090145
description	heating element 16500W 230/400V heating circuits 3 mounting pos. right L 325mm W 255mm H 32mm flange length 19.5mm flange length 1 9.5mm flange length 2 10mm flange ø1 62mm flange ø2 57mm thermostat sleeves ø 9mm sensor screw connection 2x M10x1 thermostat sleeve upper/lower L1 18mm L2 307mm W1 31mm W2 34mm thread M54x1.5 windings 7 tube ø 8.5mm cable length 480mm connection cable rotation flange immersion heater fryer connection length 60mm		
For models:	20FE, 20FEC, 220FE, 220FEC, 920FE, 940FE, 940FEC		
spare parts for	416826		
	GEV No.	510243	Ref. No. —
	O-ring Viton thickness 3.53mm ID ø 55.56mm Qty 1 pcs		
	GEV No.	550496	Ref. No. 6090144
	O-ring Viton thickness 3.53mm ID ø 50.39mm Qty 1 pcs		
accessories for	416826		
	GEV No.	550662	Ref. No. —
	ring nut thread M54x1.5 H 7mm		

GEV No.	418835	Ref. No.	6002143 6002143+6090144+6090145
description	heating element 6800W 230/400V heating circuits 3 mounting pos. left L 370mm W 450mm H 33mm flange length 19mm flange length 1 9.5mm flange length 2 9.5mm flange ø1 62mm flange ø2 57mm sensor screw connection 2x M10x1 L1 18mm L2 352mm W1 30mm W2 34mm thread M54x1.5 tube ø 8.5mm cable length 500mm rotation flange fryer 2		
For models:	FP18S		
accessories for	418835		
	GEV No.	510243	Ref. No. —
	O-ring Viton thickness 3.53mm ID ø 55.56mm Qty 1 pcs		
	GEV No.	510245	Ref. No. —
	O-ring Viton thickness 3.53mm ID ø 50.8mm Qty 1 pcs		
	GEV No.	550662	Ref. No. —
	ring nut thread M54x1.5 H 7mm		

center connection

GEV No.	415297	Ref. No.	6002136 6002136+6090144+6090145
description	heating element 6800W 230/400V heating circuits 3 L 299mm W 107mm H 35mm flange length 19.5mm flange length 1 9.5mm flange length 2 9.8mm flange ø1 62mm flange ø2 57mm thermostat sleeves ø 8.5mm sensor screw connection 2x M10x1 thermostat sleeve upper/lower L1 16mm L2 283mm W1 30mm W2 77mm thread M54x1.5 tube ø 8.5mm cable length 450mm rotation flange immersion heater		
For models:	F10CL, F10L, FRE46, FRE66		
accessories for	415297		
	GEV No.	510243	Ref. No. —
	O-ring Viton thickness 3.53mm ID ø 55.56mm Qty 1 pcs		
	GEV No.	510245	Ref. No. —
	O-ring Viton thickness 3.53mm ID ø 50.8mm Qty 1 pcs		
	GEV No.	550447	Ref. No. —
	ring nut thread M54x1.5		



GEV No.	416824	Ref. No.	6002150 6002150+6090144+6090145
description	heating element 7000W 230/400V heating circuits 3 L 325mm W 110mm H 33mm flange length 19.5mm flange length 1 9.5mm flange length 2 9.8mm flange ø1 62mm flange ø2 57mm thermostat sleeves ø 8mm sensor screw connection 2x M10x1 thermostat sleeve upper/lower L1 18mm L2 307mm W1 40mm W2 35mm thread M54x1.5 tube ø 8.5mm cable length 520mm rotation flange immersion heater fryer connection length 50mm 2		
For models:	210FE, 210FEC, 922FE, 922FEC		
spare parts for	416824		
	GEV No.	510243	Ref. No. —
	O-ring Viton thickness 3.53mm ID ø 55.56mm Qty 1 pcs		
	GEV No.	550496	Ref. No. 6090144
	O-ring Viton thickness 3.53mm ID ø 50.39mm Qty 1 pcs		
accessories for	416824		
	GEV No.	550447	Ref. No. —
	ring nut thread M54x1.5		

GEV No.	418818	Ref. No.	6002054
description	heating element 3280W 230V L 320mm W 190mm H 170mm L1 39mm L2 281mm W1 79mm W2 32mm flange length 70mm flange width 22mm hole distance 56mm windings 5 hole ø 6mm		
For models:	FT5		

GEV No.	418817	Ref. No.	6001129
description	heating element 2000W 230V L 285mm W 137mm H 172mm L1 22mm L2 33mm L3 230mm W1 50mm W2 37mm hole distance 28mm windings 3 hole ø 6mm flange length 90mm flange width 56mm cable length 180mm tube ø 8.5mm		
For models:	FT3N		

<h3>2 hole fixing</h3>			
GEV No.	416065	Ref. No.	6001139
description	heating element 1333W 230V heating circuits 1 L 283mm W 20mm H 40mm thread M12x1 tube ø 8.5mm connection M4 connection length 52mm mounting distance 31mm windings 2 immersion heater 2 hole fixing		
For models:	FRE46T, FRE66T, FTR26T, FTR6T		
spare parts for	416065		
	GEV No.	507313	Ref. No. —
	O-ring EPDM thickness 2.62mm ID ø 13.95mm Qty 1 pcs		
accessories for	416065		
	GEV No.	361182	Ref. No. —
	nut thread 1/4" H 5mm nickel-plated brass WS 17 Qty 1 pcs		
	GEV No.	510417	Ref. No. —
	flat gasket fibre ED ø 20mm ID ø 14mm thickness 2mm Qty 1 pcs		
	GEV No.	520228	Ref. No. —
	tooth lock washer ID ø 15.3mm ED ø 24mm steel Qty 1 pcs for thread M14		
	GEV No.	521103	Ref. No. —
	nut thread M4 H 3mm WS 7 brass Qty 20 pcs		
	GEV No.	521104	Ref. No. —
	washer ID ø 4.3mm ED ø 8mm thickness 0.5mm brass Qty 20 pcs for thread M4		
	GEV No.	550262	Ref. No. —
	flat gasket copper ED ø 20mm ID ø 14mm thickness 2mm		
	GEV No.	560111	Ref. No. —
	plain washer ID ø 4.3mm ED ø 9mm thickness 0.8mm SS Qty 20 pcs DIN 125A for thread M4		
	GEV No.	560131	Ref. No. —
	hexagonal nut thread M4 H 3.2mm WS 7 SS DIN/ISO DIN 934 / ISO 4032/8673 Qty 20 pcs		





GEV No.	416064	Ref. No.	6001144
description	heating element 3300W 230V heating circuits 1 L 285mm W 74mm H 42mm thread M12x1 tube ø 8.5mm connection M4 connection length 37mm windings 5 fryer heaters 2 hole fixing		
For models:	FRE46F, FRE66F, FTR26F, FTR6F		
accessories for	416064		
	GEV No.	520229	Ref. No. —
	nut thread M12x1 H 4mm WS 16 zinc-coated steel Qty 1 pcs		



Table continues overleaf

accessories for		416064		
	GEV No.	521103	Ref. No.	—
nut thread M4 H 3mm WS 7 brass Qty 20 pcs				
	GEV No.	521104	Ref. No.	—
washer ID ø 4.3mm ED ø 8mm thickness 0.5mm brass Qty 20 pcs for thread M4				
	GEV No.	521110	Ref. No.	—
flat gasket fibre ED ø 20mm ID ø 13mm thickness 2mm Qty 1 pcs				
	GEV No.	521131	Ref. No.	—
nut thread M12x1 H 3.5mm WS 17 SS Qty 1 pcs				
	GEV No.	528110	Ref. No.	—
O-ring EPDM thickness 2.62mm ID ø 12.37mm Qty 1 pcs				
	GEV No.	560111	Ref. No.	—
plain washer ID ø 4.3mm ED ø 9mm thickness 0.8mm SS Qty 20 pcs DIN 125A for thread M4				
	GEV No.	560131	Ref. No.	—
hexagonal nut thread M4 H 3.2mm WS 7 SS DIN/ISO DIN 934 / ISO 4032/8673 Qty 20 pcs				

accessories for		416077		
	GEV No.	520228	Ref. No.	—
tooth lock washer ID ø 15.3mm ED ø 24mm steel Qty 1 pcs for thread M14				
	GEV No.	521103	Ref. No.	—
nut thread M4 H 3mm WS 7 brass Qty 20 pcs				
	GEV No.	521104	Ref. No.	—
washer ID ø 4.3mm ED ø 8mm thickness 0.5mm brass Qty 20 pcs for thread M4				
	GEV No.	550262	Ref. No.	—
flat gasket copper ED ø 20mm ID ø 14mm thickness 2mm				
	GEV No.	560111	Ref. No.	—
plain washer ID ø 4.3mm ED ø 9mm thickness 0.8mm SS Qty 20 pcs DIN 125A for thread M4				
	GEV No.	560131	Ref. No.	—
hexagonal nut thread M4 H 3.2mm WS 7 SS DIN/ISO DIN 934 / ISO 4032/8673 Qty 20 pcs				

heating elements for pasta cookers

				
GEV No.	418032	Ref. No.	6002063	
description	heating element 2000W 240V heating circuits 1 L 280mm W 75mm Hmm 2 hole fixing connection M4 thread 1/4" tube ø 8.5mm mounting distance 67mm pasta cooker			
For models:	22CP, 2CP, CPE66			
accessories for		418032		
	GEV No.	361182	Ref. No.	—
nut thread 1/4" H 5mm nickel-plated brass WS 17 Qty 1 pcs				
	GEV No.	510417	Ref. No.	—
flat gasket fibre ED ø 20mm ID ø 14mm thickness 2mm Qty 1 pcs				
	GEV No.	520228	Ref. No.	—
tooth lock washer ID ø 15.3mm ED ø 24mm steel Qty 1 pcs for thread M14				
	GEV No.	550262	Ref. No.	—
flat gasket copper ED ø 20mm ID ø 14mm thickness 2mm				

				
GEV No.	416077	Ref. No.	6002064	
description	heating element 2520/3000W 220/240V heating circuits 1 L 445mm W 66mm Hmm 2 hole fixing connection M4 thread 1/4" tube ø 8.5mm mounting distance 58mm connection length 34mm pasta cooker immersion heater			
For models:	23CP, 3CP, CP1, CP1BM			
accessories for		416077		
	GEV No.	361182	Ref. No.	—
nut thread 1/4" H 5mm nickel-plated brass WS 17 Qty 1 pcs				
	GEV No.	510417	Ref. No.	—
flat gasket fibre ED ø 20mm ID ø 14mm thickness 2mm Qty 1 pcs				

heating elements for salamanders/toast-

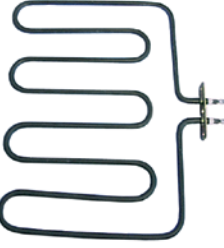
				
GEV No.	415659	Ref. No.	6001067 (old version)	
description	heating element 2000W 230V heating circuits 1 L 230mm W 303mm L1 35mm L2 195mm W1 135mm W2 33mm flange length 70mm flange width 22mm hole distance 56mm tube ø 8.5mm dry heating element connection M5 rectangular flange hole ø 5mm H 8.5mm			

				
GEV No.	419230	Ref. No.	6001067	
description	heating element 2185W 230V heating circuits 1 L 230mm W 303mm L1 35mm L2 195mm W1 135mm W2 33mm flange length 70mm flange width 22mm hole distance 56mm tube ø 8.5mm dry heating element connection M5 rectangular flange hole ø 5mm for salamander grill			
For models:	S505			

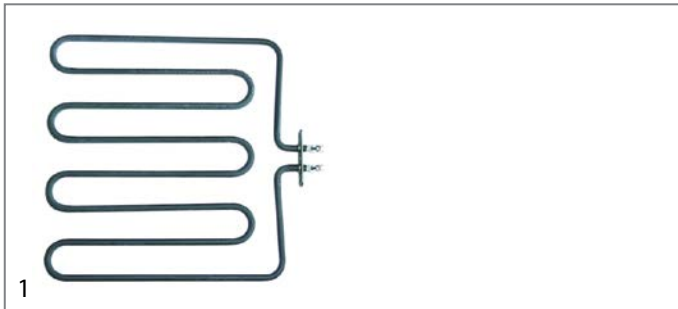

GEV No.	415215	Ref. No.	6002021
description	heating element 2570W 230V heating circuits 1 L 305mm W 297mm L1 19mm L2 286mm W1 132mm W2 22mm flange length 70mm flange width 22mm hole distance 56mm tube ø 8.5mm dry heating element connection M5 rectangular flange hole ø 5mm H 8.5mm		
For models:	S510		

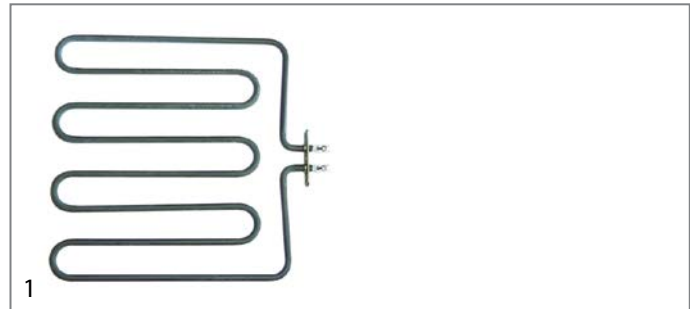

GEV No.	415217	Ref. No.	6003022
description	heating element 3100W 400V heating circuits 1 L 309mm W 295mm L1 24mm L2 285mm W1 130mm W2 33mm flange length 70mm flange width 22mm hole distance 28mm tube ø 8.5mm dry heating element connection M4 rectangular flange hole ø 5mm H 8.5mm		
accessories for	415217		

	GEV No.	521103	Ref. No.	—
		nut thread M4 H 3mm WS 7 brass Qty 20 pcs		
	GEV No.	521104	Ref. No.	—
		washer ID ø 4.3mm ED ø 8mm thickness 0.5mm brass Qty 20 pcs for thread M4		
	GEV No.	560111	Ref. No.	—
		plain washer ID ø 4.3mm ED ø 9mm thickness 0.8mm SS Qty 20 pcs DIN 125A for thread M4		
	GEV No.	560131	Ref. No.	—
		hexagonal nut thread M4 H 3.2mm WS 7 SS DIN/ISO DIN 934 / ISO 4032/8673 Qty 20 pcs		

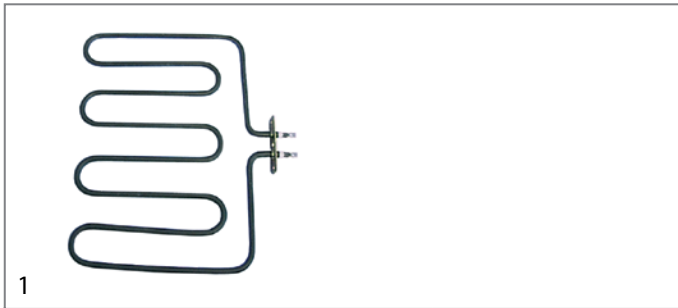

GEV No.	415660	Ref. No.	6001068 724-5085533
description	heating element 2800W 230V heating circuits 1 L 230mm W 298mm L1 20mm L2 210mm W1 133mm W2 32mm flange length 70mm flange width 22mm hole distance 56mm tube ø 8.5mm dry heating element connection M5 rectangular flange hole ø 5mm H 8.5mm		
For models:	S505R		

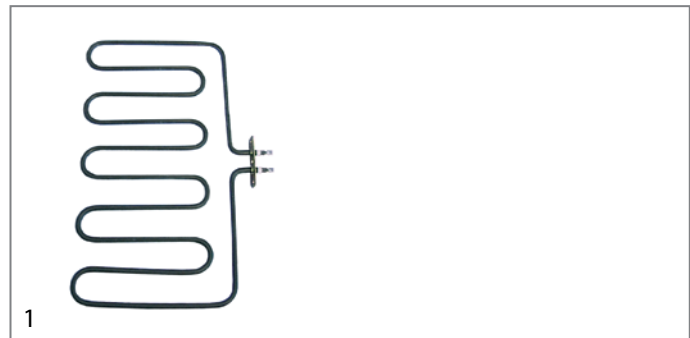

GEV No.	415213	Ref. No.	6001133
description	heating element 3300W 230V heating circuits 1 L 240mm W 380mm L1 24mm L2 220mm W1 174mm W2 33mm flange length 70mm flange width 22mm hole distance 56mm tube ø 8.5mm connection length 28mm dry heating element connection M5 rectangular flange hole ø 4mm		
For models:	SE520		

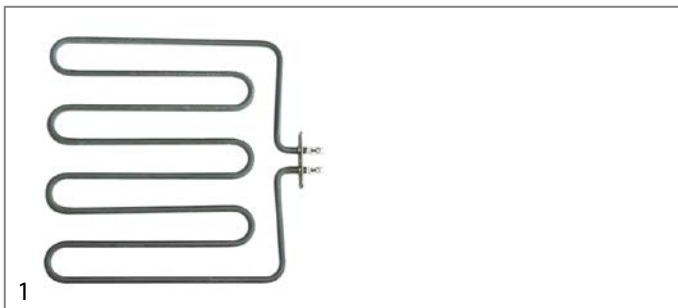

GEV No.	415623	Ref. No.	6003022
description	heating element 3100W 230V heating circuits 1 L 305mm W 295mm L1 25mm L2 280mm W1 131mm W2 33mm flange length 70mm flange width 22mm hole distance 56mm tube ø 8.5mm dry heating element connection M4 rectangular flange hole ø 5mm H 8.5mm		
For models:	S510S		

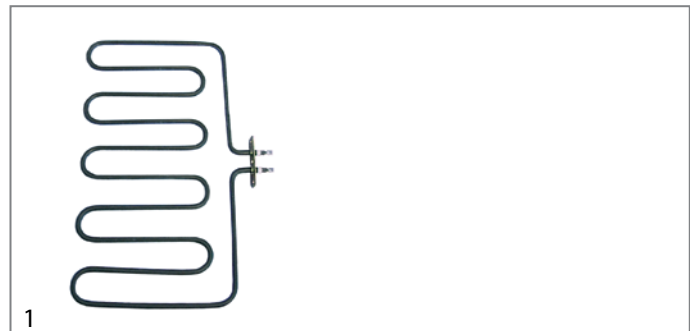





GEV No.	415214	Ref. No.	6003133
description	heating element 3300W 400V heating circuits 1 L 235mm W 380mm L1 20mm L2 216mm W1 174mm W2 33mm flange length 70mm flange width 22mm hole distance 56mm tube ø 8.5mm connection length 22mm dry heating element connection M5 rectangular flange hole ø 5mm		

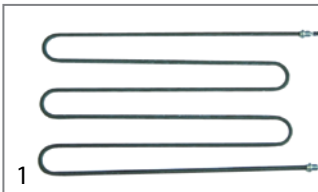

GEV No.	415220	Ref. No.	6002066
description	heating element 2730W 230V L 490mm W 270mm 2 hole fixing thread 1/4" mounting distance 261mm dry heating element tube ø 8.5mm heating circuits 1 H 8.5mm		
For models:	S511		



GEV No.	415209	Ref. No.	6003052
description	heating element 3000W 400V L 489mm W 270mm 2 hole fixing thread 1/4" mounting distance 265mm connection M5 dry heating element tube ø 8.5mm heating circuits 1 connection length 18mm		
For models:	S511S		

spare parts for	415209
	GEV No. 510417 Ref. No. — flat gasket fibre ED ø 20mm ID ø 14mm thickness 2mm Qty 1 pcs
accessories for	415209
	GEV No. 361182 Ref. No. — nut thread 1/4" H 5mm nickel-plated brass WS 17 Qty 1 pcs
	GEV No. 520228 Ref. No. — tooth lock washer ID ø 15.3mm ED ø 24mm steel Qty 1 pcs for thread M14
	GEV No. 550262 Ref. No. — flat gasket copper ED ø 20mm ID ø 14mm thickness 2mm



GEV No.	415450	Ref. No.	6002058
description	heating element 650W 230V L 265mm W 55mm thread M15x1 mounting distance 45mm connection length 38mm tube ø 10mm heating circuits 1 dry heating element 2 hole fixing H 10mm		
For models:	SR512, SR512R		



GEV No.	416820	Ref. No.	6001071
description	heating element 930W 230V L 260mm W 55mm thread M15x1 mounting distance 45mm connection length 26mm connection M4 tube ø 10mm heating circuits 1 dry heating element 2 hole fixing H 10mm		





GEV No.	416001	Ref. No.	6001066 6001070
description	radiation heater rectangular 1500W 230/240V L 265mm W 165mm H 32mm heating circuits 1 connections 2 connection type cable cable length 700mm EGO salamander grill		
For models:	SH505R, SH510P, SH510R, SH520G, SH520GM, SH560P		
accessories for	416001		
	GEV No. 390880 Ref. No. 6010039	safety rod thermostat switch-off temp. 780°C temperature range°C 2-pole 1NC/1NOA probe ø 4mm probe L 170mm capillary pipemm capillary pipe isolatedmm gland nut shaft ømm	
	GEV No. 403523 Ref. No. —	solid state relay ANLY 1 phase 40A 24-280V 4-32VDC L 47.5mm W 43mm screw type ASR-40DA	

immersion heating elements

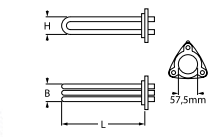
3 hole flange ø57.5mm

GEV No.	418085	Ref. No.	6003295
description	heating element 10000W 230V mounting ø 57.5mm heating circuits 3 L 393mm W 38mm H 52mm number of thermostat sleeves 1 thermostat sleeves ø 7mm length thermostat sleeves 350mm thermostat sleeve not clinging tube ø 8.5mm hole distance 73mm hole ø 8mm connection length 33mm connection M4 3 hole flange immersion heater		
For models:	VE20EC, VE20MX		
spare parts for	418085		
	GEV No. 510409 Ref. No. —	O-ring EPDM thickness 5.34mm ID ø 56.52mm Qty 1 pcs	

GEV No.	418084	Ref. No.	6003290
description	heating element 7599W 230V mounting ø 57.5mm heating circuits 3 L 340mm W 36mm H 42mm number of thermostat sleeves 1 thermostat sleeves ø 7mm length thermostat sleeves 270mm thermostat sleeve clinging tube ø 8.5mm hole distance 72mm hole ø 8mm connection M4 3 hole flange immersion heater		
For models:	EN10VE-EC-ESN1033, VE06EC, VE06MX, VE102EC, VE102MX, VE10EC, VE10MX		

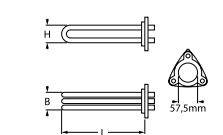

heating elements for convection





1

GEV No.	418087	Ref. No.	6002125
description	heating element 15000W 230/400V heating circuits 3 ID \varnothing 398mm ED \varnothing 415mm L 452mm H 121mm L1 32mm W1 105mm H1 80mm H2 25mm flange length 142mm flange width 25mm hole distance 126mm connection M4 tube \varnothing 8.5mm convection heating element hole \varnothing 6mm rectangular flange		
For models:	CE10MX, CE20MX, DE10EC, DE10ES, DE10MX, EF10GM, EF8PM, VE10EC, VE10MX, VE20EC, VE20MX		
accessories for	418087		
	GEV No.	550548	Ref. No. 2005173
	gasket L 144mm W 25.5mm thickness 2.2mm for heating element suitable for GIORIK equiv. no. 2005173		



1

GEV No.	418088	Ref. No.	6002121
description	heating element 25000W 400V heating circuits 3 ID \varnothing 388mm ED \varnothing 406mm L 452mm H 150mm L1 35mm W1 105mm H1 21mm H2 130mm flange length 142mm flange width 25mm hole distance 126mm connection M4 connection length 72mm tube \varnothing 8.5mm convection heating element hole \varnothing 6mm rectangular flange		
For models:	CE102MX, DE102EC, DE102MX, VE102EC, VE102MX		
accessories for	418088		
	GEV No.	550548	Ref. No. 2005173
	gasket L 144mm W 25.5mm thickness 2.2mm for heating element suitable for GIORIK equiv. no. 2005173		



1

GEV No.	418858	Ref. No.	6002100
description	heating element 7350W 230V heating circuits 3 ID \varnothing 215mm ED \varnothing 230mm L 267mm H 85mm L1 38mm W1 102mm H1 5mm H2 80mm flange length 142mm flange width 25mm hole distance 63mm cable length 1000mm convection heating element hole \varnothing 6mm		
For models:	EF4PM, EF5GM		



1

GEV No.	418086	Ref. No.	6002001
description	heating element 8400W 230V heating circuits 3 ID \varnothing 218mm ED \varnothing 235mm L 275mm H 112mm L1 40mm W1 105mm H1 32mm H2 80mm flange length 142mm flange width 25mm hole distance 64mm connection M4 tube \varnothing 8.5mm convection heating element hole \varnothing 6mm rectangular flange		
For models:	CE06MX, DE06EC, DE06ES, DE06MX, VE06EC, VE06MX		
accessories for	418086		
	GEV No.	550548	Ref. No. 2005173
	gasket L 144mm W 25.5mm thickness 2.2mm for heating element suitable for GIORIK equiv. no. 2005173		

radiation heaters



1

GEV No.	416001	Ref. No.	6001066 6001070
description	radiation heater rectangular 1500W 230/240V L 265mm W 165mm H 32mm heating circuits 1 connections 2 connection type cable cable length 700mm EGO salamander grill		
For models:	SH505R, SH510P, SH510R, SH520G, SH520GM, SH560P		
accessories for	416001		
	GEV No.	390880	Ref. No. 6010039
	safety rod thermostat switch-off temp. 780°C temperature range°C 2-pole 1NC/1NOA probe \varnothing 4mm probe L 170mm capillary pipemm capillary pipe isolatedmm gland nut shaft \varnothing mm		
	GEV No.	403523	Ref. No. —
	solid state relay ANLY 1 phase 40A 24-280V 4-32VDC L 47.5mm W 43mm screw type ASR-40DA		

accessories

sealing washers

O-rings

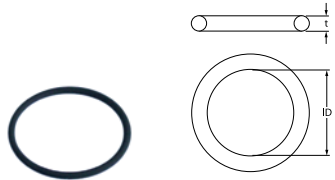



1

GEV No.	550496	Ref. No.	6090144
description	O-ring Viton thickness 3.53mm ID \varnothing 50.39mm Qty 1 pcs		
For models:	15FE, 15FEC, 20FE, 20FEC, 210FE, 210FEC, 215FE, 215FEC, 220FE, 220FEC, 920FE, 920FEC, 922FE, 922FEC, 940FE, 940FEC, F10CL, F10L, F15CL, F15L, F215CL, F215L, FP18NS, FP18S, FP27S, FRE46, FRE66		



flange gaskets

			
1			
GEV No.	550548	Ref. No.	2005173
description	gasket L 144mm W 25.5mm thickness 2.2mm for heating element suitable for GIORIK equiv. no. 2005173		
For models:	CE06MX, CE102MX, CE10MX, CE20MX, DE06EC, DE06ES, DE06MX, DE102EC, DE102MX, DE10EC, DE10ES, DE10MX, EF10GM, EF4PM, EF5GM, EF8PM, VE06EC, VE06MX, VE102EC, VE102MX, VE10EC, VE10MX, VE20EC, VE20MX		

			
1			
GEV No.	510368	Ref. No.	2005174
description	gasket L 70mm W 23.5mm hole ø 5mm hole distance 56mm FIBER thickness 2mm for heating element		
For models:	EF4, EF6PM, EF7GM, EN10VE-EC-ESN1033		

hot plates

square & rectangular

with radiused edge

			
1			
GEV No.	490074 ¹	Ref. No.	6001061
description	hot plate dimensions 300x300mm 4000W 400V with spill ring connection 4 screw clamps protector yes square		

¹incl. protector

round

with radiused edge

for domestic and commercial kitchens

			
1			
GEV No.	490020	Ref. No.	5910021
description	hot plate ø 220mm 2600W 230V connection 4 screw clamps with 8mm spill ring		
accessories for	490020		
	GEV No.	550796	Ref. No. —
fixing plate for hot plate ø220mm			

energy regulators

EGO

1-circuit

			
1			
GEV No.	380015	Ref. No.	6031023
description	energy regulator 230V 13A single-circuit turn direction right shaft ø 6x4.6mm shaft L 23mm mounting thread M4 power release 6-100% no. 50.57021.010		
For models:	DE06ES, DE06MX, DE102MX, DE10ES, DE10MX, DG06ES, DG06MX, DG102MX, DG10ES, DG10MX, EF10GM, EF4PM, EF5GM, EF6PM, EF7GM, EF8PM, GF10GM, GF4PM, GF5GM, GF6PM, GF7GM, GF8PM, S505, S505R, S510, S510S, S511, S511S, SR512R, VE06MX, VE102MX, VE10MX, VE20MX, VG06MX, VG102MX, VG10MX, VG20MX		

thermostats

control and safety thermostats

EGO



control thermostats

55.10/19_ series

			
1			
GEV No.	375548	Ref. No.	6010024
description	thermostat t.max. 142°C temperature range fixed 142°C 1-pole 1CO 16A probe ø 4mm probe L 157mm capillary pipe 870mm capillary pipe isolated 870mm gland nut shaft ø 6x4.6mm shaft Lmm shaft position		

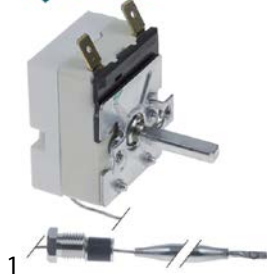
55.13_ series



GEV No.	375007	Ref. No.	6010015
description	thermostat t.max. 110°C temperature range 30-110°C 1-pole 1NO 16A probe ø 6mm probe L 113mm capillary pipe 870mm capillary pipe isolated gland nut M9x1 shaft L 25mm shaft position upper rotation 270°		
For models:	BME46, BME66, CP1BM, CPG1BM, SPE46		
accessories for	375007		
	GEV No.	110119	Ref. No. —
	knob thermostat t.max. 110°C ø 50mm shaft ø 6x4.6mm shaft flat upper black temperature range 30-110°C rotation 270°		
	GEV No.	110241	Ref. No. —
	knob thermostat t.max. 110°C ø 50mm shaft ø 6x4.6mm shaft flat upper black temperature range 30-110°C		



GEV No.	375492	Ref. No.	6010005
description	thermostat t.max. 190°C temperature range 94-190°C 1-pole 1NO 16A probe ø 6mm probe L 94mm capillary pipe 1090mm capillary pipe isolated 960mm gland nut M10x1 shaft ø 6x4.6mm shaft L 23mm shaft position upper rotation 310° probe material SS		
For models:	13FG, 15FE, 17FG, 207FG, 20FE, 210FE, 213FG, 215FE, 217FG, 220FE, 917FG, 920FE, 922FE, 927FG, 934FG, 940FE, F10L, F15L, F215L, FP-18NS, FP18S, FP27S, FRE46, FRE46F, FRE46R, FRE66, FRE66F, FRE66R, FT3N, FT5, FTR26F, FTR6F		

55.34_ series



GEV No.	375602	Ref. No.	6010016
description	thermostat t.max. 120°C temperature range 45-120°C 3-pole 3CO 16A probe ø 6mm probe L 140mm capillary pipe 900mm capillary pipe isolated 870mm gland nut shaft ø 6x4.6mm shaft L 23mm shaft position upper rotation 270°		
For models:	22CP, 23CP, 2CP, 3CP, CP1, CP1BM, CPE66		



GEV No.	375435	Ref. No.	6010004
description	thermostat t.max. 190°C temperature range 56-190°C 3-pole 3NO 16A probe ø 6mm probe L 130mm capillary pipe 900mm capillary pipe isolated 670mm gland nut M10x1 shaft ø 6x4.6mm shaft L 23mm shaft position upper rotation 318° probe material SS		
For models:	FRE46T, FRE66T, FTR10, FTR26T, FTR6T		

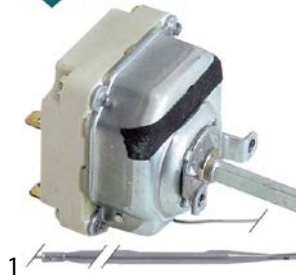

GEV No.	375362	Ref. No.	5910028 6010091
description	thermostat t.max. 320°C temperature range 55-320°C 3-pole 3NO 10A probe ø 4mm probe L 128mm capillary pipe 900mm capillary pipe isolated gland nut shaft ø 6x4.6mm shaft L 23mm shaft position upper rotation 270°		

safety thermostats

55.10/19_ series



GEV No.	375376	Ref. No.	2001046 2011140
description	safety thermostat capillary pipe 870mm probe ø 6mm 1-pole probe L 133mm 0.5A capillary pipe isolated gland nut M10x1 switch-off temp. 224°C probe		
For models:	13FG, 17FG, 207FG, 213FG, 917FG, 917FGC, 927FG, 927FGC, 934FG, 934FGC, FG07L, FG13L, FG213L		



GEV No.	375339	Ref. No.	6010020
description	safety thermostat switch-off temp. 225°C 1-pole 0.5A probe ø 6mm probe L 133mm capillary pipe 870mm capillary pipe isolatedmm gland nut M10x1 probe		
accessories for	375339		
	GEV No.	551083	Ref. No. —
	cap for safety thermostat thread M8x1		

55.32_ series



GEV No.	375277	Ref. No.	6010002
description	safety thermostat switch-off temp. 150°C 3-pole 3NC 20A probe ø 6mm probe L 79mm capillary pipe 900mm capillary pipe isolated 700mm gland nut probe		
For models:	22CP, 23CP, 2CP, 3CP, CP1, CP1BM, CPE66, EN10VE-EC-ESN1033, VE06EC, VE06MX, VE10EC, VE10MX, VG06EC, VG06MX, VG102EC, VG102MX, VG10EC, VG10MX, VG20EC, VG20MX		



GEV No.	375968	Ref. No.	6010026
description	safety thermostat switch-off temp. 360°C 1-pole 1NC 16A probe ø 6mm probe L 77mm capillary pipe 870mm capillary pipe isolated 660mm gland nut M10x1 probe probe material SS M8x1		
For models:	CG102MX, CG10MX, DG06EC, DG06ES, DG06MX, DG102EC, DG102MX, DG10EC, DG10ES, DG10MX, EF4, GF10GM, GF4PM, GF5GM, GF6PM, GF7GM, GF8PM, VG06EC, VG06MX, VG102EC, VG102MX, VG10EC, VG10MX		



GEV No.	375375	Ref. No.	6010036
description	safety thermostat switch-off temp. 230°C 3-pole 20A probe ø 6mm probe L 94mm capillary pipe 900mm capillary pipe isolated 670mm gland nut M10x1 probe SS		
For models:	210FE, 210FEC, 922FE, 922FEC, F10CL, F10L, F15CL, F15L, F215CL, F215L, FP18NS, FP18S, FP27S, FRE46, FRE46R, FRE46T, FRE66, FRE66R, FRE66T, FTR10, FTR26T, FTR6T		

55.14_ series

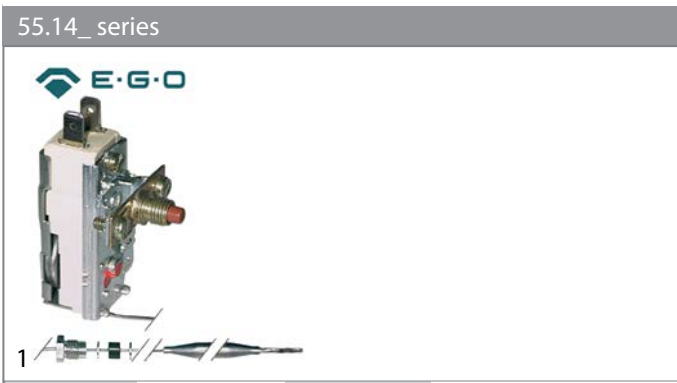

GEV No.	375260	Ref. No.	6010006
description	safety thermostat switch-off temp. 240°C 1-pole 16A probe ø 6mm probe L 77mm capillary pipe 1280mm capillary pipe isolated 1050mm gland nut M10x1 probe SS		
For models:	FRE46F, FRE66F, FT3N, FT5, FTR26F, FTR6F		



GEV No.	375258	Ref. No.	6010037
description	safety thermostat switch-off temp. 232°C 3-pole 20A probe ø 6mm probe L 94mm capillary pipe 900mm capillary pipe isolated 670mm gland nut M10x1 probe SS		
For models:	15FE, 15FEC, 20FE, 20FEC, 215FE, 215FEC, 220FE, 220FEC, 920FE, 920FEC, 940FE, 940FEC		



GEV No.	375628	Ref. No.	6010008
description	safety thermostat switch-off temp. 350°C 3-pole 20A probe ø 4mm probe L 120mm capillary pipe 900mm capillary pipe isolated 670mm gland nut M10x1 probe SS		
For models:	CE06MX, CE102MX, CE10MX, CE20MX, CG06MX, CG20MX, DE06EC, DE06ES, DE06MX, DE102EC, DE102MX, DE10EC, DE10ES, DE10MX, EF10GM, EF4PM, EF5GM, EF6PM, EF7GM, EF8PM, EN10VE-EC-ESN1033, VE06EC, VE06MX, VE102EC, VE102MX, VE10EC, VE10MX, VE20EC, VE20MX, VG20EC, VG20MX		

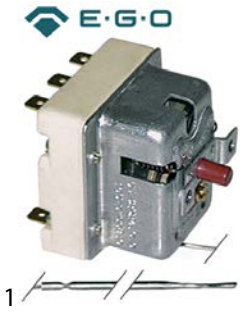

GEV No.	390142	Ref. No.	5910029
description	safety thermostat switch-off temp. 360°C 3-pole 20A probe ø 3.1mm probe L 188mm capillary pipe 1490mm capillary pipe isolated 800mm gland nut probe SS		

rod thermostats

safety rod thermostats



GEV No.	390880	Ref. No.	6010039
description	safety rod thermostat switch-off temp. 780°C temperature range°C 2-pole 1NC/1NOA probe ø 4mm probe L 170mm capillary pipemm capillary pipe isolatedmm gland nut shaft ømm		
For models:	SH520G, SH520GM, SH560P		

accessories

gland nut accessories

ducts



GEV No.	100820	Ref. No.	7050025
description	gland duct ET M14x1.5 IT M10x0.75 probe ø max. 6.5mm WS 22		

bolts with slot



GEV No.	520244	Ref. No.	6030024
description	bolt with slot thread M10x1 Qty 10 pcs nickel-plated brass		
For models:	FTR10		

connecting bows



GEV No.	550060	Ref. No.	6030016
description	connecting bow long for thermostat Qty 1 pcs		
For models:	FRE46F, FRE46R, FRE66F, FRE66R, FT3N, FT5, FTE100, FTE107, FTE46, FTE46B, FTE46R, FTE47L, FTE66L, FTE66LB, FTE66LM, FTE66LMB, FTE66R, FTE66RM, FTR26F, FTR6F, SPE46		



switches and momentary switches

push/momentary push switches

ø16mm



GEV No.	346345	Ref. No.	6032020
description	momentary push switch mounting ø 16mm black 1NO 250V 3A connection male faston 2.8mm ambient temperature max. 85°C protection IP40		
For models:	CE06MX, CE102MX, CE10MX, CE20MX, CG06MX, CG102MX, CG10MX, CG20MX, DE06MX, DE102MX, DE10MX, DG06MX, DG102MX, DG10MX, VE06MX, VE102MX, VE10MX, VE20MX, VG06MX, VG102MX, VG10MX, VG20MX		



accessories for	346345			
	GEV No.	346343	Ref. No.	6032021
	protective cover			
	GEV No.	346344	Ref. No.	6032022
	ring for protecting cover			





			
1			
GEV No.	346346	Ref. No.	6032038
description	momentary push switch mounting ø 16mm red 1NO/indicator light 250V 3A connection male faston 2.8mm ambient temperature max. 125/55°C protection IP40		
For models:	CG20MX, DG06EC, DG06ES, DG06MX, DG102EC, DG102MX, DG10EC, DG10ES, DG10MX, GF10GM, GF4PM, GF5GM, GF6PM, GF7GM, GF8PM, VG06EC, VG06MX, VG102EC, VG102MX, VG10EC, VG10MX, VG20EC, VG20MX		

accessories

protective covers

			
1			
GEV No.	346343	Ref. No.	6032021
description	protective cover		
For models:	CE06MX, CE102MX, CE10MX, CE20MX, CG06MX, CG102MX, CG10MX, CG20MX, DE06MX, DE102MX, DE10MX, DG06EC, DG06MX, DG102EC, DG102MX, DG10EC, DG10MX, VE06MX, VE102MX, VE10MX, VE20MX, VG06EC, VG06MX, VG102EC, VG102MX, VG10EC, VG10MX, VG20EC, VG20MX		
accessories for	346343		
		GEV No.	346344
		Ref. No.	6032022
	ring for protecting cover		

			
1			
GEV No.	346344	Ref. No.	6032022
description	ring for protecting cover		
For models:	CE06MX, CE102MX, CE10MX, CE20MX, CG06MX, CG102MX, CG10MX, CG20MX, DE06MX, DE102MX, DE10MX, DG06EC, DG06MX, DG102EC, DG102MX, DG10EC, DG10MX, VE06MX, VE102MX, VE10MX, VE20MX, VG06EC, VG06MX, VG102EC, VG102MX, VG10EC, VG10MX, VG20EC, VG20MX		
accessories for	346344		
		GEV No.	346343
		Ref. No.	6032021
	protective cover		

microswitches

lever actuated

			
1			
GEV No.	345773	Ref. No.	6043085
description	microswitch with lever 250V 16A 1CO connection male faston 6.3mm L 60mm ambient temperature max. 125°C mounting distance 22mm actuating force: 65g lever length 51mm		
For models:	15FE, 15FEC, 20FE, 20FEC, 210FE, 210FEC, 215FE, 215FEC, 220FE, 220FEC, 920FE, 920FEC, 922FE, 922FEC, 940FE, 940FEC, F10CL, F10L, F15CL, F15L, F215CL, F215L, FP18NS, FP18S, FP27S, FRE46, FRE46R, FRE66, FRE66R, SH510P, SH560P		

pin-plunger actuated

			
1			
GEV No.	345060	Ref. No.	6043086
description	microswitch with plunger 250V 16A 1NO connection male faston 6.3mm ambient temperature max. 85°C mounting distance 22mm type BS1010 actuating force: 350g red stroke 9mm		
For models:	FT3N, FT5, FTR10		

M10

			
1			
GEV No.	346347	Ref. No.	6043088
description	microswitch with plunger thread M10x0.75 thread L 14mm 250V 6A 2NO connection male faston 6.3mm stroke 4mm mounting distance 22mm ambient temperature max. 85°C actuating force: 100g		
For models:	CE06MX, CE102MX, CE10MX, CE20MX, CG06MX, CG102MX, CG10MX, CG20MX, DE06EC, DE06ES, DE06MX, DE102EC, DE102MX, DE10EC, DE10ES, DE10MX, DG06EC, DG06ES, DG06MX, DG102EC, DG102MX, DG10EC, DG10ES, DG10MX, VE06EC, VE06MX, VE102EC, VE102MX, VE10EC, VE10MX, VE20EC, VE20MX, VG06EC, VG06MX, VG102MX, VG10EC, VG10MX, VG20EC, VG20MX		



cam switches

on/off

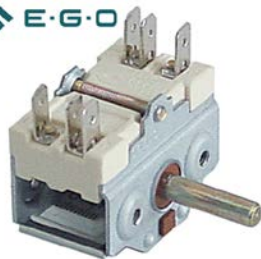

1

GEV No.	300129	Ref. No.	6030007
description	cam switch 2 operating positions 2NO sequence 0-1 16A shaft ø 6x4.6mm shaft L 23mm connection male faston 6.3mm ceramic		
For models:	13FGC, 17FGC, 207FGC, 213FGC, 217FGC, 917FGC, 927FGC, 934FGC, BM711, BM721, BM911, BM921, BME46, BME66, CE06MX, CE102MX, CE10MX, CE20MX, CG06MX, CG102MX, CG10MX, CG20MX, EF10GM, EF4PM, EF5GM, EF6PM, EF7GM, EF8PM, EN10VE-EC-ESN1033, FG07CL, FG213CL, GF10GM, GF4PM, GF5GM, GF6PM, GF7GM, GF8PM		



2

GEV No.	300139	Ref. No.	6030012
description	cam switch ON-OFF connection male faston		
For models:	210FEC, 922FEC, EF4, F10CL, F15CL, F215CL, FP18NS, FP18S, FP27S, FTR10, SH505R, SH510P, SH510R, SH520G, SH520GM, SH560P		

7-position



1

GEV No.	300004	Ref. No.	6030014
description	cam switch 7 operating positions 1NO/2CO sequence 0-1-2-3-4-5-6 16A shaft ø 6x4.6mm shaft L 23mm connection male faston 6.3mm 7-position ceramic		
For models:	PCE46, PCE66M, PCE66T		



1

GEV No.	300106	Ref. No.	6030001
description	cam switch 7 operating positions 1NO/2CO sequence 0-1-2-3-4-5-6 32A shaft ø 6x4.6mm shaft L 23mm connection screw 7-position shaft flat upper		

4 operating positions



1

GEV No.	300081	Ref. No.	6030036
description	cam switch 4 operating positions 3NO/2CO sequence 0-1-2-3 16A shaft ø 6x4.6mm shaft L 23mm connection screw		



1

GEV No.	300239	Ref. No.	6030040
description	operation switch 4 operating positions 4NO sequence 0-1-2-3 16A shaft ø 6x4.6mm shaft L 23mm connection male faston 6.3mm plastic		

operation switches



1

GEV No.	300002	Ref. No.	6030019
description	cam switch 2 operating positions 4NO 16A sequence 0-1 shaft ø 6x4.6mm shaft L 23mm connection male faston 6.3mm ceramic		



1

GEV No.	300166	Ref. No.	6030019
description	cam switch 2 operating positions 4NO 16A sequence 0-1 shaft \varnothing 6x4.6mm shaft L 23mm connection male faston 6.3mm ceramic 4-pole ambient temperature max. 318°C		
For models:	210FE, 22CP, 23CP, 2CP, 3CP, 922FE, CP1, CP1BM, CPE66, F10L, F15L, F215L, FRE46, FRE46R, FRE46T, FRE66, FRE66R, FRE66T, FTE66L, FTE66LB, FTE66R, FTE67L, FTE67LM, FTR26T, FTR6T		



1

GEV No.	300115	Ref. No.	5910023
description	cam switch 2 operating positions operation switch sequence 0-1 shaft \varnothing 6x4.6mm connection screw clamp 5-pole ambient temperature max. 318°C		



1

GEV No.	300200	Ref. No.	6030015
description	operation switch 2 operating positions 2NO 16A sequence 0-1 shaft \varnothing 6x4.6mm shaft L 23mm connection male faston 6.3mm operation switch ceramic		
For models:	13FG, 17FG, 207FG, 213FG, 217FG, 917FG, 927FG, 934FG, CP1BM, CPG1BM, FRE46F, FRE66F, FT3N, FT5, FTE100, FTE107, FTE46, FTE46B, FTE46R, FTE47L, FTE66LM, FTE66LMB, FTE66RM, FTR26F, FTR6F, SPE46		

rotary switches

BREMAS

A1600 series



1

GEV No.	346342	Ref. No.	6030031
description	rotary switch 7 1-2-3-4-5-6-7 sets of contacts 9 type CS0169137 400V 16A shaft \varnothing 4x5mm shaft L 20mm shaft square connection screw		
For models:	VE06MX, VE102MX, VE10MX, VE20MX, VG06MX, VG102MX, VG10MX, VG20MX		



1

GEV No.	346341	Ref. No.	6030030
description	rotary switch 8 1-2-3-4-5-6-7-8 sets of contacts 10 type CS0169134 400V 16A shaft \varnothing 4x5mm shaft L 20mm shaft square connection screw		
For models:	DE06EC, DE06ES, DE06MX, DE102EC, DE10EC, DE10ES, DE10MX, DG06EC, DG06ES, DG06MX, DG102EC, DG102MX, DG10EC, DG10ES, DG10MX, VE06EC, VE102EC, VE10EC, VE20EC, VG06EC, VG102EC, VG10EC, VG20EC		

GIOVENZANA
rotary switches



1

GEV No.	348053	Ref. No.	6030003
description	rotary switch 2 0-1 sets of contacts 4 type CX32 600V 32A shaft \varnothing 5x5mm shaft L 26mm shaft square connection screw		
For models:	15FE, 15FEC, 20FE, 20FEC, 215FE, 215FEC, 220FE, 220FEC, 920FE, 920FEC, 940FE, 940FEC		

encoders and potentiometers



1

GEV No.	401169	Ref. No.	6010102
description	encoder cable length 125mm		
For models:	DE06EC, DE102EC, DE10EC, DG06EC, DG102EC, DG10EC, SH505R, SH510P, SH510R, SH520G, SH520GM, SH560P, VE06EC, VE102EC, VE10EC, VE20EC, VG06EC, VG102EC, VG10EC, VG20EC		



1

GEV No.	300146	Ref. No.	6010076
description	potentiometer		



1

GEV No.	300187	Ref. No.	6010097
description	potentiometer 4.7KOhm rotation 310° shaft \varnothing 0.6x4.5mm shaft L 20mm cable length 650mm		
For models:	CE06MX, CE102MX, CE10MX, CE20MX, CG06MX, CG102MX, CG10MX, CG20MX, DE06ES, DE06MX, DE102MX, DE10ES, DE10MX, DG06ES, DG06MX, DG102MX, DG10ES, DG10MX, EF10GM, EF4PM, EF5GM, EF6PM, EF7GM, EF8PM, GF10GM, GF4PM, GF5GM, GF6PM, GF7GM, GF8PM, VE06MX, VE102MX, VE10MX, VE20MX, VG06MX, VG102MX, VG10MX, VG20MX		

lamps

indicator lights

indicator lights 2-piece (lens and indicator lamp)

indicator light lenses



ø13mm (type SF-3)

 <p>1</p>			
GEV No.	357046	Ref. No.	6061070
description	indicator light housings mounting measurements ø13mm green Qty 10 pcs with adapter round		
For models:	EF4, FP18NS, FP18S, FP27S, FT3N, FT5, FTR10, FTR26F, FTR26T, FTR6F, FTR6T, SR512, SR512R		

ø13mm (type SFK-3)

 <p>1</p>			
GEV No.	359225	Ref. No.	6061069
description	indicator light housings mounting measurements ø13mm clear Qty 1 pcs		
For models:	EF4, FP18NS, FP18S, FP27S, FT3N, FT5, FTR10, FTR26F, FTR26T, FTR6F, FTR6T, S505, S505R, S510, S510S, S511, S511S		

indicator lamps for socket type SRZ / SDK / SDY / SFK

 <p>1</p>							
GEV No.	359430	Ref. No.	6061067				
description	indicator lamp 230V clear connection cable 400mm						
For models:	EF4, FP18NS, FP18S, FP27S, FT3N, FT5, FTR10, FTR26F, FTR26T, FTR6F, FTR6T, S505, S505R, S510, S510S, S511, S511S						
accessories for	359430						
	 <p>1</p>	<table border="1"> <tr> <td>GEV No.</td> <td>359260</td> <td>Ref. No.</td> <td>—</td> </tr> </table>	GEV No.	359260	Ref. No.	—	
GEV No.	359260	Ref. No.	—				
description	indicator light housings mounting measurements ø12mm yellow round Qty 1 pcs						

 <p>1</p>			
GEV No.	359431	Ref. No.	6061068
description	indicator lamp 230V green connection cable 400mm cable material silicone		
For models:	EF4, FP18NS, FP18S, FP27S, FT3N, FT5, FTR10, FTR26F, FTR26T, FTR6F, FTR6T, SR512, SR512R		

indicator lights (complete)

ø12mm

with screw socket

 <p>1</p>			
GEV No.	359048	Ref. No.	6061051
description	indicator light ø 12mm 230V yellow connection male faston 6.3mm		

30x22mm

 <p>1</p>			
GEV No.	346965	Ref. No.	5910033
description	indicator light mounting measurements 30x22mm 230V yellow		

miscellaneous

 <p>1</p>			
GEV No.	359272	Ref. No.	6061073
description	indicator light green 230V		
For models:	15FE, 20FE, 210FE, 215FE, 220FE, 22CP, 23CP, 2CP, 920FE, 922FE, 940FE, BM711, BM721, BM911, BM921, BME46, BME66, CP1, CP1BM, CPE66, CPG1BM, F10L, F15L, F215L, FRE46, FRE46F, FRE46R, FRE46T, FRE66, FRE66F, FRE66R, FRE66T, FTE100, FTE107, FTE46, FTE46B, FTE46R, FTE47L, FTE66L, FTE66LB, FTE66LM, FTE66LMB, FTE66R, FTE66RM, FTE67L, FTE67LM, SPE46, SPR46		

 <p>1</p>			
GEV No.	359273	Ref. No.	6061072
description	indicator light yellow 230V		
For models:	15FE, 20FE, 210FE, 215FE, 220FE, 22CP, 23CP, 2CP, 3CP, 920FE, 922FE, 940FE, BM711, BM721, BM911, BM921, BME46, BME66, CP1, CP1BM, CPE66, CPG1BM, F10L, F15L, F215L, FRE46, FRE46F, FRE46R, FRE46T, FRE66, FRE66F, FRE66R, FRE66T, FTE100, FTE107, FTE46, FTE46B, FTE46R, FTE47L, FTE66L, FTE66LB, FTE66LM, FTE66LMB, FTE66R, FTE66RM, FTE67L, FTE67LM, PCE46, PCE66M, PCE66T...(Other models you can see in the webshop)		

screw-on/push-on fit

light bulbs

for ovens

 <p>1</p>			
GEV No.	359612	Ref. No.	6061053
description	light bulb t.max. 300°C socket E14 25W 230V ø 25mm L 56mm lens L 30mm for oven lamp type Philips		
For models:	EN10VE-EC-ESN1033		



halogen lamp
for socket G4 / G6.35 / G9





GEV No.	359599	Ref. No.	6061054
description	halogen lamp socket G4 12V 20W temp.-resist. 500°C		
For models:	CE06MX, CE102MX, CE10MX, CE20MX, CG06MX, CG102MX, CG10MX, CG20MX, DE06EC, DE06ES, DE06MX, DE102EC, DE102MX, DE10EC, DE10ES, DE10MX, DG06EC, DG06ES, DG06MX, DG102EC, DG102MX, DG10EC, DG10ES, DG10MX, VE06EC, VE06MX, VE102EC, VE102MX, VE10EC, VE10MX, VE20EC, VE20MX, VG06EC, VG06MX, VG102EC, VG102MX, VG10EC, VG10MX, VG20EC, VG20MX		



GEV No.	532649	Ref. No.	6090141
description	O-ring Viton ID ø 63.17mm thickness 2.62mm Qty 1 pcs		
For models:	EF10GM, EF4PM, EF5GM, EF6PM, EF7GM, EF8PM, GF10GM, GF4PM, GF5GM, GF6PM, GF7GM, GF8PM		

oven lamps
universal oven lamps
mounting diameter 47.8mm



GEV No.	359499	Ref. No.	6060055
description	lamp socket socket E14 mounting ø 47.8mm connection male faston 6.3mm		
For models:	EF10GM, EF4PM, EF5GM, EF6PM, EF7GM, EF8PM, GF10GM, GF4PM, GF5GM, GF6PM, GF7GM, GF8PM		
accessories for	359499		
	GEV No.	359725	Ref. No. —
	oven lamp glass thread ø 44mm H 43mm ø 54mm hard glas temp.-resist. 350°C		

30x70mm



GEV No.	359338	Ref. No.	6063077
description	lamp glass		
For models:	CE06MX, CE102MX, CE10MX, CE20MX, CG06MX, CG102MX, CG10MX, CG20MX, DE06EC, DE06ES, DE06MX, DE102EC, DE102MX, DE10EC, DE10ES, DE10MX, DG06EC, DG06ES, DG06MX, DG102EC, DG102MX, DG10EC, DG10ES, DG10MX, VE06EC, VE06MX, VE102EC, VE102MX, VE10EC, VE10MX, VE20EC, VE20MX, VG06EC, VG06MX, VG102EC, VG102MX, VG10EC, VG10MX, VG20EC, VG20MX		

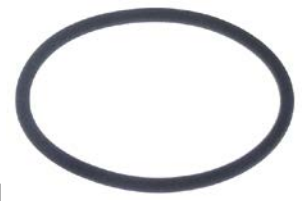

GEV No.	525313	Ref. No.	6090140
description	O-ring Viton ID ø 60.33mm thickness 3.53mm Qty 1 pcs		
For models:	EF10GM, EF4PM, EF5GM, EF6PM, EF7GM, EF8PM, GF10GM, GF4PM, GF5GM, GF6PM, GF7GM, GF8PM		



GEV No.	359337	Ref. No.	6063075
description	oven lamp socket G4 cable length 800mm connection Faston 6.3mm L 70mm W 29mm		
For models:	CE06MX, CE102MX, CE10MX, CE20MX, CG06MX, CG102MX, CG10MX, CG20MX, DE06EC, DE06ES, DE06MX, DE102EC, DE102MX, DE10EC, DE10ES, DE10MX, DG06EC, DG06ES, DG06MX, DG102EC, DG102MX, DG10EC, DG10ES, DG10MX, VE06EC, VE06MX, VE102EC, VE102MX, VE10EC, VE10MX, VE20EC, VE20MX, VG06EC, VG06MX, VG102EC, VG102MX, VG10EC, VG10MX, VG20EC, VG20MX		
accessories for	359337		
	GEV No.	359599	Ref. No. 6061054
	halogen lamp socket G4 12V 20W temp.-resist. 500°C		



55x70mm



1

GEV No.	359368	Ref. No.	6063074
description	lamp glass		

lamps

light bulbs



1

GEV No.	359612	Ref. No.	6061053
description	light bulb t.max. 300°C socket E14 25W 230V ø 25mm L 56mm lens L 30mm for oven lamp type Philips		
For models:	EN10VE-EC-ESN1033		

halogen lamps

for socket G4 / G6.35 / G9



1 500°C

GEV No.	359599	Ref. No.	6061054
description	halogen lamp socket G4 12V 20W temp.-resist. 500°C		
For models:	CE06MX, CE102MX, CE10MX, CE20MX, CG06MX, CG102MX, CG10MX, CG20MX, DE06EC, DE06ES, DE06MX, DE102EC, DE102MX, DE10EC, DE10ES, DE10MX, DG06EC, DG06ES, DG06MX, DG102EC, DG102MX, DG10EC, DG10ES, DG10MX, VE06EC, VE06MX, VE102EC, VE102MX, VE10EC, VE10MX, VE20EC, VE20MX, VG06EC, VG06MX, VG102EC, VG102MX, VG10EC, VG10MX, VG20EC, VG20MX		

timers

electric timers



1

GEV No.	350135	Ref. No.	6032059
description	timer MS65 operation time 120min time spreadmin 1CO/2NO at 250V 16A permanent position yes time range 0-120min impulse electric shaft ø 6x4.6mm shaft L 21mm mounting distance 28mm connection male faston 6.3mm screw mounting 250V voltage AC 50Hz		

with time spread



1

GEV No.	350074	Ref. No.	6032047
description	timer MS65 operation time 120min time spread 30min 1CO/2NO/1NC at 250V 16A permanent position yes impulse electric shaft ø 6x4.6mm shaft L 22mm mounting distance 28mm connection lateral Invensys 4-pole shaft position lower°		
For models:	CE06MX, CE102MX, CE10MX, CE20MX, CG06MX, CG102MX, CG10MX, CG20MX, DE06ES, DE06MX, DE102MX, DE10ES, DE10MX, DG06ES, DG06MX, DG102MX, DG10ES, DG10MX, EF10GM, EF4, EF4PM, EF5GM, EF6PM, EF7GM, EF8PM, GF10GM, GF4PM, GF5GM, GF6PM, GF7GM, GF8PM, VE06MX, VE102MX, VE10MX, VE20MX, VG06MX, VG102MX, VG10MX, VG20MX		

mechanical timers



1

GEV No.	350003	Ref. No.	6032040
description	timer M2 with bell 2-pole operation time 120min impulse mechanical 2NO at 250V 16A permanent position no shaft ø 6x4.6mm shaft 6x4.6mm shaft L 23mm mounting distance 28mm connection lateral		
accessories for	350003		
	GEV No.	Ref. No.	—
	110366		
	knob switch zero mark t.max.°C°C ø 44mm shaft ø 6x4.6mm shaft flat upper black		
	GEV No.	Ref. No.	—
	111199		
	dial plate graduation 120min permanent position no rotation 0-330° ø 60mm timers knob ø 45mm		

alarm devices

buzzer boards



1

GEV No.	401062	Ref. No.	6010090
description	buzzer board 230VAC L 48mm W 45mm connection Faston 6.3mm		
For models:	CE06MX, CE102MX, CE10MX, CE20MX, CG06MX, CG102MX, CG10MX, CG20MX, DE06MX, DE102MX, DE10MX, DG06MX, DG102MX, DG10MX, EF10GM, EF4PM, EF5GM, EF6PM, EF7GM, EF8PM, GF10GM, GF4PM, GF5GM, GF6PM, GF7GM, GF8PM		



contactors

GENERAL ELECTRIC (AEG)

power contactors



1

GEV No.	380244	Ref. No.	6046043
description	power contactor resistive load 25A 230VAC (AC3/400V) 9A/4kW main contacts 3NO auxiliary contacts 1NO connection screw connection type AEG LS4K 10A type GE CL00A 310		
For models:	F10CL, F10L, F15CL, F15L, F215CL, F215L, FP18NS, FP18S, FP27S, FRE46, FRE66		

ISKRA (FANAL)

power contactors



1

GEV No.	380204	Ref. No.	6046033 6046038
description	power contactor resistive load 25A 230VAC (AC3/400V) 9A/4kW main contacts 3NO auxiliary contacts 1NO connection screw connection type Fanal DSL9 10 type ISKRA KNL9 10		
For models:	15FE, 15FEC, 20FEC, 210FE, 210FEC, 215FE, 215FEC, 220FEC, 920FEC, 922FE, 922FEC, 940FEC, CE06MX, CE102MX, CE10MX, CE20MX, CG06MX, CG102MX, CG10MX, CG20MX, DE06EC, DE06ES, DE06MX, DE102EC, DE102MX, DE10EC, DE10ES, DE10MX, DG06ES, DG06MX, DG102MX, DG10ES, DG10MX, EF10GM, EF4, EF4PM, EF5GM, EF6PM, EF7GM, EF8PM, EN10VE-EC-ESN1033, GF10GM, GF4PM, GF5GM, GF6PM, GF7GM, GF8PM, VE06EC, VE06MX, VE102EC...(Other models you can see in the webshop)		



1

GEV No.	380424	Ref. No.	6046041
description	power contactor resistive load 35A 230VAC (AC3/400V) 32A/15kW main contacts 3NO connection screw connection type Fanal DSL30 type ISKRA KNL30		
accessories for	380424		
	GEV No.	381378	Ref. No. —
	overload switch connection screw setting range 24,5-30A for contactors KNL30 type BR30 24.5-30A		

LOVATO

power contactors



1

GEV No.	380788	Ref. No.	6046046
description	power contactor resistive load 32A 230VAC (AC3/400V) 18A/7.5kW main contacts 4NO connection screw connection type BF18T4A230		

relays

power relays

with DIN rail mounting

lateral



1

GEV No.	380379	Ref. No.	6041013
description	power relays SCHRACK 230VAC 25A 2CO connection male faston 6.3mm DIN rail manuf. no. RM809730		
For models:	SH505R, SH510R		

relay sockets



1

GEV No.	380487	Ref. No.	6040015
description	relay socket		
For models:	EN10VE-EC-ESN1033, VE06EC, VE06MX, VE102EC, VE102MX, VE10EC, VE10MX, VE20EC, VE20MX, VG06EC, VG06MX, VG102EC, VG102MX, VG10EC, VG10MX, VG20EC, VG20MX		



level relays

GICAR



1

GEV No.	401173	Ref. No.	6041043
description	level relay 230V connection F6.3 type RL30/3ES/F		
For models:	EN10VE-EC-ESN1033, VE06EC, VE06MX, VE102EC, VE102MX, VE10EC, VE10MX, VE20EC, VE20MX, VG06EC, VG06MX, VG102EC, VG102MX, VG10EC, VG10MX, VG20EC, VG20MX		

time relays

time relays



1

GEV No.	381119	Ref. No.	6042049
description	time relay LOVATO TM D time range 0.06-180s		
For models:	VE06EC, VE06MX, VE102EC, VE102MX, VE10EC, VE10MX, VE20EC, VE20MX, VG06EC, VG06MX, VG102EC, VG102MX, VG10EC, VG10MX, VG20EC, VG20MX		



1

GEV No.	380607	Ref. No.	6042054
description	time relay LOVATO TM M1 time range 0s-10 days 12-24V AC/DC 8A 1CO connection grip connection		
For models:	VE06MX, VE102MX, VE10MX, VE20MX, VG06MX, VG102MX, VG10MX, VG20MX		



1

GEV No.	380606	Ref. No.	6042056
description	time relay LOVATO TM PL time range 2x 0.1s-100 days 12-240V AC/DC 8A 1CO connection grip connection		
For models:	DE06ES, DE06MX, DE102MX, DE10ES, DE10MX, DG06ES, DG06MX, DG102MX, DG10ES, DG10MX		

transformers

encapsulated transformers

PMA



1

GEV No.	379054	Ref. No.	6010086
description	transformer primary 230VAC secondary 12VAC 3VA secondary 0.25A H 40mm L 45mm W 50mm connection screw 50/60Hz type 153/M		
For models:	SH505R, SH510R, SH520G, SH520GM		



1

GEV No.	401174	Ref. No.	6010079
description	transformer primary 230VAC secondary 12VAC 6VA secondary 0.5A connection screw 50Hz		
For models:	DE06EC, DE102EC, DE10EC, DG06EC, DG102EC, DG10EC, EN10VE-EC-ESN1033, SH510P, SH560P, VE06EC, VE102EC, VE10EC, VE20EC, VG06EC, VG102EC, VG10EC, VG20EC		

for lighting



1

GEV No.	401175	Ref. No.	6041065
description	transformer primary 230V secondary 11.5V 90VA		
For models:	CE06MX, CE102MX, CE10MX, CE20MX, CG06MX, CG102MX, CG10MX, CG20MX, DE06EC, DE06ES, DE06MX, DE102EC, DE102MX, DE10EC, DE10ES, DE10MX, DG06EC, DG06ES, DG06MX, DG102EC, DG102MX, DG10EC, DG10ES, DG10MX, VE06EC, VE06MX, VE102EC, VE102MX, VE10EC, VE10MX, VE20EC, VE20MX, VG06EC, VG06MX, VG102EC, VG102MX, VG10EC, VG10MX, VG20EC, VG20MX		



electronic controllers

EVCO - EVERY CONTROL

producer-specific devices



GEV No.	379459	Ref. No.	6011142
description	electronic controller EVCO mounting measurements 90x110mm 230V voltage AC TC/J 0-700°C display 3 digits temperature controller DIN rail		
For models:	13FGC, 15FEC, 17FGC, 207FGC, 20FEC, 210FEC, 213FGC, 215FEC, 217FGC, 220FEC, 917FGC, 920FEC, 922FEC, 927FGC, 934FGC, 940FEC, F10CL, F15CL, F215CL, FG07CL, FG213CL		
accessories for	379459		
	GEV No.	379462	Ref. No. 6000106
	temperature probe thermocouple J (Fe-CuNi) cable Vetrotex probe -50 up to +750°C cable -50 up to +350°C connection plug thread probe ø6x200mm cable length 0.7m		
	GEV No.	693124	Ref. No. 2007069
	keypad foil for fryer		

universal controllers

built-in version



GEV No.	378169	Ref. No.	6011125 6011130
description	electronic controller EVERY CONTROL EV7401 mounting measurements 66.5x66.5mm built-in depth 90mm 24/230V voltage AC NTC/PTC/Pt100/TC(J,K)/mA relay outputs 1 CO-8A(3) NTC/PTC/Pt100/TC(-J,K)/mA yes protection IP54 dependend on probe°C display 4 digits		
accessories for	378169		
	GEV No.	379053	Ref. No. —
	temperature probe PTC 1kOhm cable PVC probe -50 up to +150°C cable -10 up to 100°C probe ø6x30mm cable length 3m without screw connection 2-wire		
	GEV No.	379062	Ref. No. —
	temperature probe thermocouple J (Fe-CuNi) cable Vetrotex probe -50 up to +750°C cable -50 up to +350°C probe ø6x50mm cable length 3m without screw connection 2-wire		

accessories for	378169		
	GEV No.	379064	Ref. No. —
	temperature probe PTC 1kOhm cable silicone probe -50 up to +150°C cable -50 up to +180°C probe ø6x40mm cable length 3m without screw connection 2-wire		
	GEV No.	379131	Ref. No. —
	temperature probe Pt100 cable Vetrotex probe -200 up to +600°C cable -50 up to +350°C probe ø6x85mm cable length 3m without screw connection 3-wire resistance at 0°C 100Ohm		
	GEV No.	379161	Ref. No. —
	temperature probe NTC 10kOhm cable thermoplastic probe -40 up to +110°C cable -40 up to +110°C probe ø6x14mm cable length 3m without screw connection 2-wire		

SHANGFANG

accessories

	GEV No.	379054	Ref. No. 6010086
	transformer primary 230VAC secondary 12VAC 3VA secondary 0.25A H 40mm L 45mm W 50mm connection screw 50/60Hz type 153/M		
For models:	SH505R, SH510R, SH520G, SH520GM		

probes

universal probes

temperature probes

	GEV No.	379860	Ref. No. 6000100
	temperature probe NTC 10kOhm cable PVC probe -20 up to +80°C cable -10 up to 100°C probe ø6x40mm cable length 1.5m without screw connection 2-wire		

	GEV No.	379222 ¹	Ref. No. 6000083
	temperature probe Pt100 cable Vetrotex probe -200 up to +600°C cable -50 up to +350°C probe ø4x110mm cable length 1.4m 3-wire		
For models:	CE06MX, CE102MX, CE10MX, CE20MX, CG06MX, CG102MX, CG10MX, CG20MX, DE06ES, DE06MX, DE102MX, DE10ES, DE10MX, DG06ES, DG06MX, DG102MX, DG10ES, DG10MX, VE06MX, VE102EC, VE102MX, VE10MX, VE20MX, VG06MX, VG102MX, VG10MX, VG20MX		

	GEV No.	379050 ¹	Ref. No. 6000085
	temperature probe Pt100 cable Vetrotex probe -200 up to +600°C cable -50 up to +350°C probe ø6x100mm cable length 2.7m without screw connection 3-wire		
For models:	EF10GM, EF4PM, EF5GM, EF6PM, EF7GM, EF8PM, EN10VE-EC-ESN1033, GF10GM, GF4PM, GF5GM, GF6PM, GF7GM, GF8PM		



producer-specific probes

probes



1

GEV No.	379462	Ref. No.	6000106
description	temperature probe thermocouple J (Fe-CuNi) cable Vetrotex probe -50 up to +750°C cable -50 up to +350°C connection plug thread probe ø6x200mm cable length 0.7m		
For models:	207FGC, FG07CL, FG213CL		



1

GEV No.	403251	Ref. No.	6010110
description	keypad PCB salamander grill SRH1060 L 163mm W 70mm with display buttons 5		
For models:	SH510P, SH560P		

electronics

frequency converters



1

GEV No.	403841	Ref. No.	6010130 6010131
description	frequency converter with heat sink for combi-steamer L 135mm W 135mm 800W ECS P0010205-0		

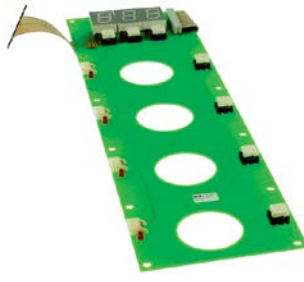

1

GEV No.	401168	Ref. No.	6010100
description	PCB		
For models:	DE06EC, DE102EC, DE10EC, DG06EC, DG102EC, DG10EC, VE06EC, VE102EC, VE10EC, VE20EC, VG06EC, VG102EC, VG10EC, VG20EC		

PCBs

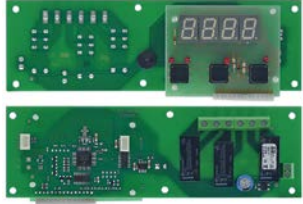

1

GEV No.	400736	Ref. No.	6010083
description	control PCB salamander grill SH50SR		
For models:	SH505R, SH510R, SH520G, SH520GM		



1

GEV No.	401170	Ref. No.	6010101
description	PCB		
For models:	DE06EC, DE102EC, DE10EC, DG06EC, DG102EC, DG10EC, VE06EC, VE102EC, VE10EC, VE20EC, VG06EC, VG102EC, VG10EC		

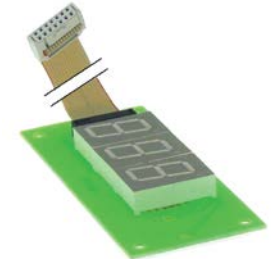

1

GEV No.	401166	Ref. No.	6010095
description	display		
For models:	CE06MX, CE102MX, CE20MX, CG06MX, CG102MX, CG10MX, CG20MX, DE06ES, DE06MX, DE102MX, DE10ES, DE10MX, DG06ES, DG06MX, DG102MX, DG10ES, DG10MX, EF10GM, EF4PM, EF5GM, EF6PM, EF7GM, EF8PM, GF10GM, GF4PM, GF5GM, GF6PM, GF7GM, GF8PM, VE06MX, VE102MX, VE10MX, VE20MX, VG06MX, VG102MX, VG10MX, VG20MX		



1

GEV No.	401171	Ref. No.	6010084
description	PCB combi-steamer		
For models:	CE06MX, CE102MX, CE10MX, CE20MX, CG06MX, CG102MX, CG10MX, CG20MX, DE06EC, DE06ES, DE06MX, DE102EC, DE102MX, DE10EC, DE10ES, DE10MX, DG06EC, DG06ES, DG06MX, DG102EC, DG102MX, DG10EC, DG10ES, DG10MX, EF4, EF4PM, EF6PM, EF8PM, GF4PM, GF6PM, GF8PM, VE06EC, VE06MX, VE102EC, VE102MX, VE10EC, VE10MX, VE20EC, VE20MX, VG06EC, VG06MX, VG102EC, VG102MX, VG10EC, VG10MX, VG20EC, VG20MX		



electric components





1

GEV No.	401172	Ref. No.	6010093
description	PCB combi-steamer VE 06/10		
For models:	VE06EC, VE06MX, VE102EC, VE102MX, VE10EC, VE10MX, VE20EC, VE20MX, VG06EC, VG06MX, VG102EC, VG102MX, VG10EC, VG10MX, VG20EC, VG20MX		



1

GEV No.	401167	Ref. No.	6010096
description	PCB combi-steamer VE 06/10 230V 50/60Hz		
For models:	CE06MX, CE102MX, CE10MX, CE20MX, CG06MX, CG102MX, CG10MX, CG20MX, DE06ES, DE06MX, DE102MX, DE10ES, DE10MX, DG06ES, DG06MX, DG102MX, DG10ES, DG10MX, EF10GM, EF4PM, EF5GM, EF6PM, EF7GM, EF8PM, GF10GM, GF4PM, GF5GM, GF6PM, GF7GM, GF8PM, VE06MX, VE102MX, VE10MX, VE20MX, VG06MX, VG102MX, VG10MX, VG20EC, VG20MX		
accessories for	401167		
	GEV No.	401062	Ref. No. 6010090
	buzzer board 230VAC L 48mm W 45mm connection Faston 6.3mm		



1

GEV No.	693124	Ref. No.	2007069
description	keypad foil for fryer		
For models:	13FGC, 15FEC, 17FGC, 207FGC, 20FEC, 210FEC, 213FGC, 215FEC, 217FGC, 220FEC, 917FGC, 920FEC, 922FEC, 927FGC, 934FGC, 940FEC, F10CL, F15CL, F215CL, FG07CL, FG213CL		



1

GEV No.	403791	Ref. No.	2012427 2016790
description	keypad foil for salamander grill model suitable for BARTSCHER ømm for mounting pos. suitable for for model L 547mm W 67mm		



1

GEV No.	403792	Ref. No.	2012890
description	keypad foil for salamander grill SH560P model suitable for GIORIK ømm for mounting pos. suitable for for model L 547mm W 67mm		
For models:	SH560P		



1

GEV No.	400739	Ref. No.	2012425
description	keypad foil salamander grill SH520 L 545mm W 67mm		
For models:	SH520G, SH520GM		

keypads

front foils



1

GEV No.	400737	Ref. No.	2012426
description	keypad foil		
For models:	SH505R		



1

GEV No.	400738	Ref. No.	2012423
description	keypad foil blue/grey/black suitable for SH510 L 715mm W 67mm		
For models:	SH510P, SH510R		

solenoid valves

solenoid valves (water)

RPE



1

GEV No.	374021	Ref. No.	6042071
description	solenoid valve double straight 230VAC inlet 3/4" outlet 10mm DN10 RPE		
For models:	CE20MX, CG20MX, VE06EC, VE06MX, VE102EC, VE102MX, VE10EC, VE10MX, VE20EC, VE20MX, VG06EC, VG06MX, VG102EC, VG102MX, VG10EC, VG10MX, VG20EC, VG20MX		

			
1			
GEV No.	374017	Ref. No.	6042070
description	solenoid valve single straight 230VAC inlet 3/4" outlet 10mm input 6l/min DN10 RPE polyamide flow regulating valve inlet white membranes NBR pressure range 0.2-10bar		
For models:	CE06MX, CE102MX, CE10MX, CG06MX, CG102MX, CG10MX, DE06EC, DE06ES, DE06MX, DE102EC, DE102MX, DE10EC, DE10ES, DE10MX, DG06EC, DG06ES, DG06MX, DG102EC, DG102MX, DG10EC, DG10ES, DG10MX, EF10GM, EF4, EF4PM, EF5GM, EF6PM, EF7GM, EF8PM, GF10GM, GF4PM, GF5GM, GF6PM, GF7GM, GF8PM		

reducers

outlet side

			
1			
GEV No.	371269	Ref. No.	6042091
description	reducer flow rate 0.07-0.14l/min brown		

			
1			
GEV No.	371265	Ref. No.	6042097
description	reducer flow rate 3l/min black		
For models:	VE06EC, VE06MX, VE102EC, VE102MX, VE10EC, VE10MX, VE20EC, VE20MX, VG06EC, VG06MX, VG102EC, VG102MX, VG10EC, VG10MX, VG20EC, VG20MX		

metal

CEME

solenoid valves

			
1			
GEV No.	370352	Ref. No.	6042075
description	solenoid valve 2-ways 230VAC inlet 1/2" IT outlet 1/2" IT L 55mm p max 0.5bar brass		
For models:	VE06EC, VE06MX, VE102EC, VE102MX, VE10EC, VE10MX, VE20EC, VE20MX, VG06EC, VG06MX, VG102EC, VG102MX, VG10EC, VG10MX, VG20EC, VG20MX		

fans

axial fans

ebm-papst

				
1				
GEV No.	601030 ¹	Ref. No.	6033175	
description	axial fan L 119mm W 119mm H 38mm 230VAC 50Hz 18W bearing ball bearing manuf. no. 4656Z metal connection male faston 2.8mm ebm-papst fan wheel ø 110mm temp.-resist. 75°C			
accessories for	601030			
	GEV No.	550898	Ref. No.	—
	connecting cable cable length 2000mm connection F 2.8 connection distance 7.9mm for axial flow fan			
	GEV No.	692497	Ref. No.	—
	guard ø 105mm mounting distance 150mm for axial fan ebm-papst-mm			

¹with ball bearings

import

				
1				
GEV No.	601080 ¹	Ref. No.	6033175	
description	axial fan L 119mm W 119mm H 38mm 230VAC 50/60Hz 23/20W bearing ball bearing connection male faston 2.8mm metal ADDA fan wheel ø 110mm temp.-resist. 70°C			
For models:	CE06MX, CE102MX, CE10MX, CE20MX, CG06MX, CG102MX, CG10MX, CG20MX, DE06EC, DE06MX, DE102EC, DE102MX, DE10EC, DE10MX, DG06EC, DG06MX, DG102EC, DG102MX, DG10EC, DG10MX, VE06EC, VE06MX, VE102EC, VE102MX, VE10EC, VE10MX, VE20EC, VE20MX, VG06EC, VG06MX, VG102EC, VG102MX, VG10EC, VG10MX, VG20EC, VG20MX			
accessories for	601080			
	GEV No.	550898	Ref. No.	—
	connecting cable cable length 2000mm connection F 2.8 connection distance 7.9mm for axial flow fan			
	GEV No.	692519	Ref. No.	—
	guard L 120mm W 120mm plastic			

¹with ball bearings



hot air motors

electric components

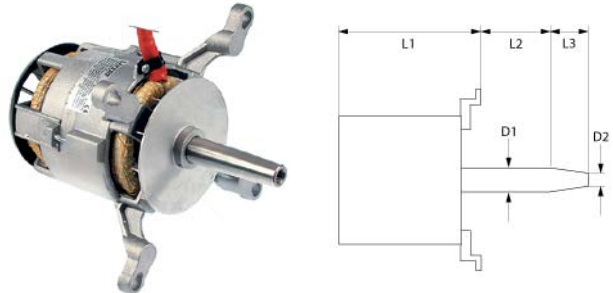

1

GEV No.	601046	Ref. No.	6033155
description	fan motor 220/380V 3 phase 50/60Hz 0.75kW 1350/1650rpm speeds 1 L1 185mm L2 42mm L3 47mm D1 ø 24mm D2 ø 20mm M12L IT 1.9/3.3A Cos(fi) 0.83 at 50Hz 200-240/346-415V at 60Hz 200-277/346-480V at 50Hz 1350rpm at 60Hz 1650rpm type ST80/4 no. 661512		
For models:	CE102MX, CE10MX, CE20MX, CG102MX, CG10MX, CG20MX, DE102MX, DE10MX, DG102MX, DG10MX, EF10GM, EF7GM, EN10VE-EC-ESN1033, VE102EC, VE102MX, VE10MX, VE20MX, VG102MX, VG10MX, VG20MX		

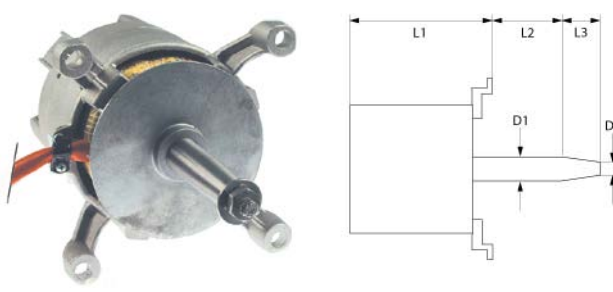

1

GEV No.	500641	Ref. No.	6033155
description	fan motor 220/380V 3 phase 50Hz 0.75kW 1420rpm speeds 1 L1 166mm L2 47mm L3 65mm D1 ø 24mm D2 ø 20mm M6R IT 1.4/2.4A Cos(fi) 0.83 at 50Hz 220/380V at 60Hz 240/415V type ST80/4 no. 643515 mounting distance 150mm		



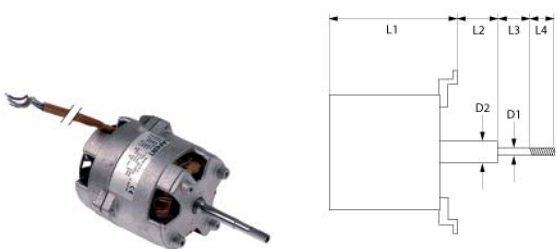

1

GEV No.	500640	Ref. No.	6032122
description	fan motor 220-240V 1 phase 50Hz 0.05/0.25HP 1400/2700rpm speeds 2 L1 145mm L2 65mm L3 35mm D1 ø 15mm D2 ø 12mm M10L ET 1.1/0.55A suitable capacitor 12.5µF/450V at 50Hz 1400/2700rpm type 2758D2253 no. 6032122		
For models:	CE06MX, CG06MX, DE06EC, DE06ES, DE06MX, DG06EC, DG06ES, DG06MX, VE06EC, VE06MX, VG06EC, VG06MX		
spare parts for	500640		
	GEV No.	560280	Ref. No. —
	nut thread M10L H 8mm WS 17 SS DIN/ISO DIN 934 / ISO 4032/8673 Qty 1 pcs		



1

GEV No.	601354	Ref. No.	6032128
description	fan motor 220-240V 1 phase 50Hz 0.11kW 2760rpm speeds 1 L1 130mm L2 32mm L3 30mm L4 18mm D1 ø 7/8mm D2 ø 9mm M4R IT 0.9A at 50Hz 230V at 50Hz 2760rpm suitable capacitor 4µF type LM63 shaft flat length 17mm		
accessories for	601354		
	GEV No.	365031	Ref. No. —
	operating capacitor capacity 4µF 450V tolerance 5% 50/60Hz ambient temperature max. -25 to +85°C ø 31mm L 58mm M8 plastic connection male faston 6.3mm protection		
	GEV No.	601061	Ref. No. —
	fan wheel D1 ø 160mm H1 60mm blades 15 D2 ø 18mm D3 ø 18mm H2 35mm		

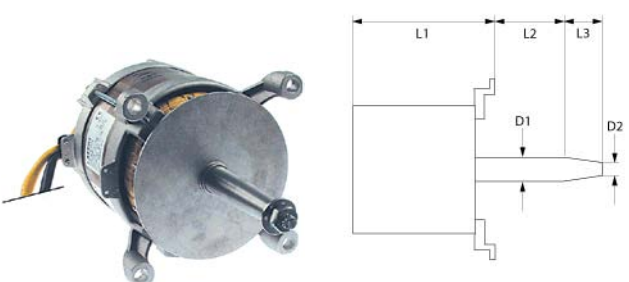

1

GEV No.	500643	Ref. No.	6034348
description	fan motor 230V 1 phase 50Hz 0.25/0.75kW 670/1370rpm speeds 2 L1 195mm L2 47mm L3 70mm D1 ø 24mm D2 ø 20mm M6R IT 1.5/4.7A suitable capacitor 50/20µF Cos(fi) 0.53/0.7 at 50Hz 670/1370rpm 4P/8P type FB100L no. 677325		
For models:	CE102MX, CE20MX, CG102MX, CG20MX, DE102EC, DE102MX, DG102EC, DG102MX, VE102EC, VE102MX, VE20EC, VE20MX, VG102EC, VG102MX, VG20EC, VG20MX		

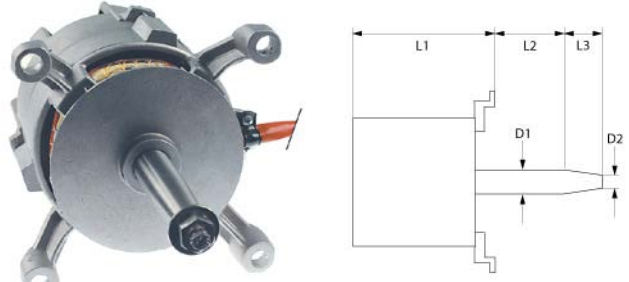

1

GEV No.	500642	Ref. No.	6033145
description	fan motor 380-415V 3 phase 50Hz 0.22/0.75kW 700/1400rpm speeds 2 L1 166mm L2 45mm L3 67mm D1 ø 24mm D2 ø 20mm M6R ITA at 50Hz 380-415V at 50Hz 700/1400rpm type FB80 4/8 no. 629764		
For models:	DE102EC, DE10EC, DG102EC, EF6PM, EF8PM, VE10EC, VE20EC, VG20EC		



			
1			
GEV No.	602135	Ref. No.	5901101
description	fan wheel blades 12 D1 ø 180mm D2 ø 8mm D3 ø 6x9mm H1 100mm H2 27mm H3mm		

			
1			
GEV No.	601202	Ref. No.	5901006
description	fan wheel D1 ø 180mm H1 100mm blades 16 D2 ø 11.5mm D3 ø 16mm H2 30mm		
For models:	CE06MX, CG06MX, DE06EC, DE06ES, DE06MX, DG06EC, DG06ES, DG06MX, VE06EC, VE06MX, VG06EC, VG06MX		

			
1			
GEV No.	601203	Ref. No.	5901010
description	fan wheel D1 ø 310mm H1 100mm blades 30 D2 ø 19.5mm D3 ø 23mm H2 46mm		
For models:	CE10MX, CG10MX, DE10EC, DE10ES, DE10MX, DG10EC, DG10ES, DG10MX, VE10EC, VE10MX, VG10EC, VG10MX		

			
1			
GEV No.	601204	Ref. No.	5901022
description	fan wheel D1 ø 350mm H1 135mm blades 30 D2 ø 19.5mm D3 ø 23mm H2 46mm		
For models:	CE102MX, DE102EC, VE102EC, VE102MX		

condensators & interference suppression filters

filters

interference suppression filters

			
1			
GEV No.	365045	Ref. No.	6090050
description	interference suppression filter type FC701Y2F 250V 50-60Hz conductor 2 with E connection cable 200mm L 40mm ø 30mm Hmm Wmm plastic Qty 1 pcs		
For models:	13FG, 13FGC, 15FE, 15FEC, 17FG, 17FGC, 207FG, 207FGC, 20FE, 20FEC, 210FE, 210FEC, 213FG, 213FGC, 215FE, 215FEC, 217FG, 217FGC, 220FE, 220FEC, 917FG, 917FGC, 920FE, 920FEC, 922FE, 922FEC, 927FG, 927FGC, 934FG, 934FGC, 940FE, 940FEC, CE06MX, CE102MX, CE10MX, CG06MX, CG102MX, CG10MX, DE06EC, DE06ES, DE06MX, DE102EC, DE102MX, DE10EC, DE10ES, DE10MX, DG06EC, DG06ES, DG06MX, DG102EC...(Other models you can see in the webshop)		

			
1			
GEV No.	365044	Ref. No.	6090050
description	interference suppression filter type FC701Y2F 250V 50-60Hz conductor 2 with E connection cable 200mm L 42mm ø 23mm Hmm Wmm plastic Qty 1 pcs		

electric accessories

terminals

porcelain clamps

			
1			
GEV No.	550116	Ref. No.	6050641
description	porcelain terminal block 3-pole 10mm ² hole distance 16mm max. 30A max 450V L 52mm W 30mm H 23mm mounting distance 16mm Qty 1 pcs		



gas taps

PEL

20S series



1

GEV No.	101094	Ref. No.	7060013
description	gas tap PEL type 20S gas inlet M16x1.5 (tube ø 10mm) bypass nozzle ø 0.35mm gas outlet M16x1.5 (tube ø 10/8mm) thermocouple connection M8x1 pilot connection shaft ø 8x6.5mm shaft L 22/15mm shaft flat lower		
spare parts for	101094		
	GEV No.	100408	Ref. No. —
	bypass nozzle type PEL20/21 bore ø 0.35mm thread M5x0.5		
	GEV No.	101060	Ref. No. —
	magnet unit standard L 39mm D1 ø 15.4mm D2 ø 11mm suitable for PEL20-21/JUNKERS/EGA		
	GEV No.	101205	Ref. No. —
	gas tap front part shaft ø 8x6.5mm shaft L 22/15mm shaft flat upper/lower suitable for PEL20		
	GEV No.	101230	Ref. No. —
	thermocouple nut T1: M8x1 T2: M18x1 aluminium		
accessories for	101094		
	GEV No.	101278	Ref. No. —
	olive for pipe ø 10mm Qty 1 pcs		
	GEV No.	101300	Ref. No. —
	union nut thread M16x1.5 tube ø 10mm		
	GEV No.	101450	Ref. No. —
	olive for pipe ø 8mm L 12.7mm Qty 1 pcs ED ø 10mm		
	GEV No.	101451	Ref. No. —
	union nut thread M16x1.5 tube ø 8mm		
	GEV No.	110081	Ref. No. —
	knob ø 70mm shaft ø 8x6.5mm shaft flat universal		
	GEV No.	110083	Ref. No. —
	knob dial plate gas tap without ignition flame silver		

21S series



1

GEV No.	107765	Ref. No.	7060016
description	gas tap PEL type 21S gas inlet pipe flange ø21mm bypass nozzle ø 0mm gas outlet M16x1.5 (tube ø 10/8mm) thermocouple connection M9x1 pilot connection M10x1 shaft ø 8x6.5mm shaft L 22/15mm shaft flat upper		

22S/O series



1











GEV No.	101086	Ref. No.	7060012
description	gas tap PEL type 22S/O gas inlet M20x1.5 (tube ø 12mm) bypass nozzle ø 0.35mm gas outlet M20x1.5 (tube ø 12/10mm) thermocouple connection M9x1 pilot connection M10x1 shaft ø 10x8mm shaft L 25/17mm shaft flat lower		
For models:	22CPG, 23CPG, 2CPG, 3CPG, CG740, CG780, CPG1, CPG1BM, CPG66, GG66, GG940, GG980, SG520, SG608		
spare parts for	101086		
	GEV No.	100259	Ref. No. —
	bypass nozzle type PEL22 bore ø 0.35mm thread M6x0.5		
	GEV No.	101058	Ref. No. —
	magnet unit L 39mm D1 ø 15.4mm D2 ø 13.5mm suitable for PEL22/EGA24197 standard		
	GEV No.	101201	Ref. No. —
	gas tap front part shaft ø 10x8mm shaft L 25/17mm shaft flat upper/lower suitable for PEL22		
	GEV No.	101231	Ref. No. —
	thermocouple nut T1: M9x1 T2: M18x1		
	GEV No.	101240	Ref. No. —
	gas connection thread M20x1.5 tube ø 12/10mm for PEL gas taps with gasket and screws horizontal		
	GEV No.	101460	Ref. No. —
	O-ring ø 12.37mm D1 ø 2.62mm suitable for PEL22		
	GEV No.	101461	Ref. No. —
	screw kit suitable for PEL22 Qty 4 pcs		
accessories for	101086		
	GEV No.	100908	Ref. No. —
	union screw thread M10x1 for pipe ø 4mm Qty 1 pcs		
	GEV No.	100909	Ref. No. 7050029
	union screw thread M10x1 for pipe ø 6mm Qty 1 pcs		
	GEV No.	101241	Ref. No. —
	gas connection thread M20x1.5 tube ø 12/10mm for PEL gas taps vertical		

Table continues overleaf





accessories for		101086		
	GEV No.	101246	Ref. No.	—
olive for pipe ø 4mm Qty 1 pcs				
	GEV No.	101248	Ref. No.	—
olive for pipe ø 12mm Qty 1 pcs suitable for PEL				
	GEV No.	101249	Ref. No.	—
olive for pipe ø 10mm Qty 1 pcs				
	GEV No.	101250	Ref. No.	—
union nut thread M20x1.5 for pipe ø 10mm				
	GEV No.	101251	Ref. No.	—
union nut thread M20x1.5 for pipe ø 12mm				
	GEV No.	101286	Ref. No.	—
olive ID ø 6mm Qty 1 pcs				
	GEV No.	110080	Ref. No.	—
knob ø 70mm shaft ø 10x8mm shaft flat universal				
	GEV No.	112206	Ref. No.	—
knob dial plate silver gas tap PEL21/22/23 t.max.°C ED ø 63mm ID ø 45.5mm				

gas thermostats

SIT

630 Eurosit series

				
1				
GEV No.	107688	Ref. No.	7020232	
description	gas thermostat 100-340°C gas inlet 3/8" gas outlet 3/8" thermocouple connection M9x1 pilot connection M10x1 probe ø 4mm probe L 72mm capillary pipe 1050mm			

				
1				
GEV No.	101409	Ref. No.	7020211	
description	gas thermostat type 630 Eurosit series t.max. 280°C 40-280°C gas inlet 3/8" gas outlet 3/8" thermocouple connection M9x1 pilot connection M10x1 probe ø 4mm probe L 72mm capillary pipe 1050mm SIT			
For models:	FTG100, FTG46, FTG46B, FTG46R, FTG66L, FTG66LG, FTG66R			
accessories for	101409			
	GEV No.	100904	Ref. No.	—
locking screw M10x1 for pipe ø 4mm Qty 1 pcs				
	GEV No.	100905	Ref. No.	—
locking screw M10x1 for pipe ø 6mm Qty 1 pcs				
	GEV No.	101273	Ref. No.	—
olive for pipe ø 12mm L 9.5mm brass Qty 1 pcs suitable for universal				
	GEV No.	101276	Ref. No.	—
union screw thread 3/8" tube ø 12mm Qty 1 pcs				

				
1				
GEV No.	101700	Ref. No.	7020218	
description	gas thermostat type 630 Eurosit series t.max. 340°C 100-340°C gas inlet 3/8" gas outlet 3/8" thermocouple connection M9x1 pilot connection M10x1 probe ø 4mm probe L 72mm capillary pipe 1050mm SIT			
accessories for	101700			
	GEV No.	100904	Ref. No.	—
locking screw M10x1 for pipe ø 4mm Qty 1 pcs				
	GEV No.	100905	Ref. No.	—
locking screw M10x1 for pipe ø 6mm Qty 1 pcs				
	GEV No.	101273	Ref. No.	—
olive for pipe ø 12mm L 9.5mm brass Qty 1 pcs suitable for universal				
	GEV No.	101276	Ref. No.	—
union screw thread 3/8" tube ø 12mm Qty 1 pcs				
	GEV No.	101333	Ref. No.	—
plug thread 3/8" with O-ring				

710 Minisit series

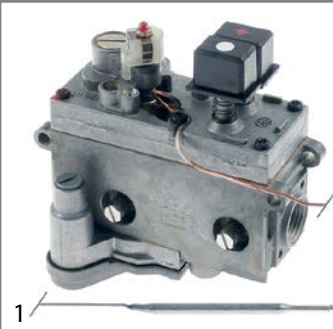

GEV No.	101437	Ref. No.	7020210
description	gas thermostat SIT type MINISIT 710 t.max. 190°C 110-190°C gas inlet 1/2" gas outlet 3/8" thermocouple connection M9x1 pilot connection M10x1 probe ø 6mm probe L 102mm capillary pipe 1050mm probe type type A3 pressure controller yes pressure regulator 3-18mbar gland nut		
spare parts for	101437		
	GEV No.	101053	Ref. No. —
	magnet unit T1: M9x1 T2: M24x1 L 45mm ø 17mm suitable for Minisit		
	GEV No.	102118	Ref. No. —
	probe 110-190°C probe ø 6mm probe L 102mm capillary pipe 1050mm t.max. 190°C fryer probe type type A3 suitable for MINISIT 710		
accessories for	101437		
	GEV No.	100809	Ref. No. 0925034
	O-ring EPDM thickness 2mm ID ø 21mm Qty 1 pcs		
	GEV No.	100820	Ref. No. 7050025
	gland duct ET M14x1.5 IT M10x0.75 probe ø max. 6.5mm WS 22		
	GEV No.	100904	Ref. No. —
	locking screw M10x1 for pipe ø 4mm Qty 1 pcs		
	GEV No.	100905	Ref. No. —
	locking screw M10x1 for pipe ø 6mm Qty 1 pcs		
	GEV No.	101054	Ref. No. —
	magnet unit T1: M10x1 T2: M24x1 L 45mm ø 17mm suitable for Minisit		
	GEV No.	101136	Ref. No. 7020230
	piezoelectric igniter suitable for Minisit with cover cap ømm connection F6.3x0.8		
	GEV No.	101137	Ref. No. —
	cover cap without piezoelectric igniter		
	GEV No.	101267	Ref. No. —
	reducer IT 3/8" ET 1/2" L 21mm		
	GEV No.	101268	Ref. No. —
	gas connection thread 3/8" angled with O-ring MINISIT 710		
	GEV No.	101269	Ref. No. —
	gas connection thread 1/2" angled with O-ring MINISIT 710		
	GEV No.	101270	Ref. No. —
	screw connection IT 3/8" ET 3/8" L 28mm		
	GEV No.	101272	Ref. No. —
	screw connection IT 1/2" ET 3/8" L 57mm		

accessories for	101437		
	GEV No.	101273	Ref. No. —
	olive for pipe ø 12mm L 9.5mm brass Qty 1 pcs suitable for universal		
	GEV No.	101274	Ref. No. 7070036
	olive for pipe ø 16mm Qty 1 pcs		
	GEV No.	101275	Ref. No. —
	union screw thread 1/2" for pipe ø 16mm Qty 1 pcs		
	GEV No.	101276	Ref. No. —
	union screw thread 3/8" tube ø 12mm Qty 1 pcs		
	GEV No.	110068	Ref. No. 5900200
	knob suitable for Minisit ø 37mm		

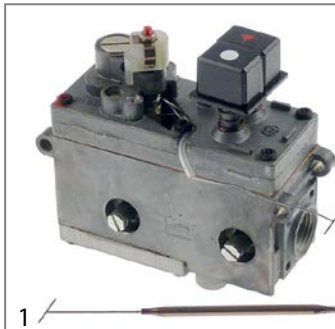

GEV No.	101435	Ref. No.	5910040
description	gas thermostat SIT type MINISIT 710 t.max. 340°C 100-340°C gas inlet 1/2" gas outlet 3/8" thermocouple connection M9x1 pilot connection M10x1 probe ø 4mm probe L 72mm capillary pipe 1050mm probe type type C1 pressure controller no pressure regulator mbar gland nut		
spare parts for	101435		
	GEV No.	101053	Ref. No. —
	magnet unit T1: M9x1 T2: M24x1 L 45mm ø 17mm suitable for Minisit		
	GEV No.	102107	Ref. No. —
	probe 100-340°C probe ø 4mm probe L 72mm capillary pipe 1050mm t.max. 340°C oven/grill probe type type C1 suitable for MINISIT 710		
accessories for	101435		
	GEV No.	100809	Ref. No. 0925034
	O-ring EPDM thickness 2mm ID ø 21mm Qty 1 pcs		
	GEV No.	100904	Ref. No. —
	locking screw M10x1 for pipe ø 4mm Qty 1 pcs		
	GEV No.	100905	Ref. No. —
	locking screw M10x1 for pipe ø 6mm Qty 1 pcs		
	GEV No.	101054	Ref. No. —
	magnet unit T1: M10x1 T2: M24x1 L 45mm ø 17mm suitable for Minisit		
	GEV No.	101136	Ref. No. 7020230
	piezoelectric igniter suitable for Minisit with cover cap ømm connection F6.3x0.8		
	GEV No.	101137	Ref. No. —
	cover cap without piezoelectric igniter		
	GEV No.	101267	Ref. No. —
	reducer IT 3/8" ET 1/2" L 21mm		



Table continues overleaf



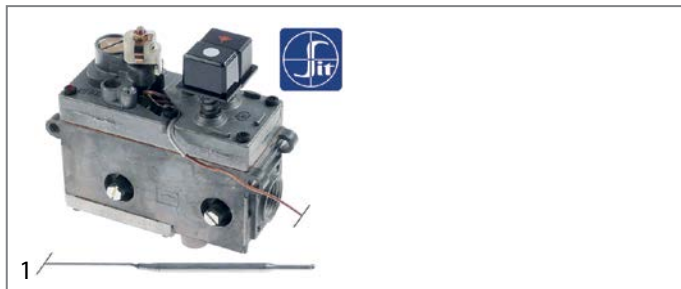

accessories for		101435		
	GEV No.	101268	Ref. No.	—
gas connection thread 3/8" angled with O-ring MINISIT 710				
	GEV No.	101269	Ref. No.	—
gas connection thread 1/2" angled with O-ring MINISIT 710				
	GEV No.	101270	Ref. No.	—
screw connection IT 3/8" ET 3/8" L 28mm				
	GEV No.	101272	Ref. No.	—
screw connection IT 1/2" ET 3/8" L 57mm				
	GEV No.	101273	Ref. No.	—
olive for pipe ø 12mm L 9.5mm brass Qty 1 pcs suitable for universal				
	GEV No.	101274	Ref. No.	7070036
olive for pipe ø 16mm Qty 1 pcs				
	GEV No.	101275	Ref. No.	—
union screw thread 1/2" for pipe ø 16mm Qty 1 pcs				
	GEV No.	101276	Ref. No.	—
union screw thread 3/8" tube ø 12mm Qty 1 pcs				
	GEV No.	110068	Ref. No.	5900200
knob suitable for Minisit ø 37mm				



GEV No.	101131	Ref. No.	7020200
description	gas thermostat without cap, button and angle SIT type MINISIT 710 t.max. 190°C 50-190°C gas inlet 1/2" gas outlet 3/8" thermocouple connection M9x1 pilot connection M10x1 probe ø 5mm probe L 98mm capillary pipe 1200mm probe type type A2 pressure controller no pressure regulator gland nut		
For models:	FG07L, FG13L, FG213L, FPG18		

spare parts for		101131		
	GEV No.	101053	Ref. No.	—
magnet unit T1: M9x1 T2: M24x1 L 45mm ø 17mm suitable for Minisit				
	GEV No.	102103	Ref. No.	—
probe 60-200°C probe ø 5mm probe L 98mm capillary pipe 1050mm t.max. 200°C fryer probe type type A2 suitable for MINISIT 710				

accessories for		101131		
	GEV No.	100809	Ref. No.	0925034
O-ring EPDM thickness 2mm ID ø 21mm Qty 1 pcs				
	GEV No.	100820	Ref. No.	7050025
gland duct ET M14x1.5 IT M10x0.75 probe ø max. 6.5mm WS 22				
	GEV No.	100904	Ref. No.	—
locking screw M10x1 for pipe ø 4mm Qty 1 pcs				

accessories for		101131		
	GEV No.	100905	Ref. No.	—
locking screw M10x1 for pipe ø 6mm Qty 1 pcs				
	GEV No.	101054	Ref. No.	—
magnet unit T1: M10x1 T2: M24x1 L 45mm ø 17mm suitable for Minisit				
	GEV No.	101136	Ref. No.	7020230
piezoelectric igniter suitable for Minisit with cover cap ømm connection F6.3x0.8				
	GEV No.	101137	Ref. No.	—
cover cap without piezoelectric igniter				
	GEV No.	101267	Ref. No.	—
reducer IT 3/8" ET 1/2" L 21mm				
	GEV No.	101268	Ref. No.	—
gas connection thread 3/8" angled with O-ring MINISIT 710				
	GEV No.	101269	Ref. No.	—
gas connection thread 1/2" angled with O-ring MINISIT 710				
	GEV No.	101270	Ref. No.	—
screw connection IT 3/8" ET 3/8" L 28mm				
	GEV No.	101272	Ref. No.	—
screw connection IT 1/2" ET 3/8" L 57mm				
	GEV No.	101273	Ref. No.	—
olive for pipe ø 12mm L 9.5mm brass Qty 1 pcs suitable for universal				
	GEV No.	101274	Ref. No.	7070036
olive for pipe ø 16mm Qty 1 pcs				
	GEV No.	101275	Ref. No.	—
union screw thread 1/2" for pipe ø 16mm Qty 1 pcs				
	GEV No.	101276	Ref. No.	—
union screw thread 3/8" tube ø 12mm Qty 1 pcs				
	GEV No.	110068	Ref. No.	5900200
knob suitable for Minisit ø 37mm				



gas valves and ignition boxes











gas control valves

SIT

NOVASIT



1

GEV No.	101956	Ref. No.	7020070
description	gas valve SIT series Novasit 820 230V 50Hz gas inlet 1/2" gas outlet 1/2" thermocouple connection M9x1 pilot connection M10x1 ignition pressure range 5-50mbar pressure regulator connection blind equiv. no. 0.820.031		
For models:	13FG, 13FGC, 17FG, 17FGC, 207FG, 207FGC, 213FG, 213FGC, 217FG, 217FGC, 917FG, 917FGC, 927FG, 927FGC, 934FG, 934FGC, FG07CL, FG213CL		
spare parts for	101956		
	GEV No.	101065	Ref. No. —
magnet unit with cable L 44mm D1 ø 30mm D2 ø 20mm suitable for NOVASIT			
	GEV No.	101313	Ref. No. —
solenoid coil 230V 50Hz			
accessories for	101956		
	GEV No.	100006	Ref. No. —
piezoelectric igniter suitable for ELETTROSIT body plastic blowing connection ø2.4mm ø 14mm			
	GEV No.	101305	Ref. No. —
gas connection straight 1/2" flange 45x45mm ELETTROSIT/V4400/4600/4605 suitable for SIT/HONEYWELL hole distance 36x36mm			
	GEV No.	101306	Ref. No. 7020011
gas connection angled flange 45x45mm hole distance 36x36mm 1/2" ELETTROSIT/V4400/4600/4605 screw with O-ring suitable for SIT/HONEYWELL			
	GEV No.	101307	Ref. No. —
gas connection straight flange 45x45mm hole distance 36x36mm 3/4" ELETTROSIT/V4400/4600/4605 screw with O-ring suitable for SIT/HONEYWELL			
	GEV No.	101308	Ref. No. —
gas connection angled flange 45x45mm hole distance 36x36mm 3/4" ELETTROSIT/V4400/4600/4605 screw with O-ring suitable for SIT/HONEYWELL			
	GEV No.	101312	Ref. No. —
microswitch			
	GEV No.	101314	Ref. No. —
solenoid coil 24V 50Hz			
	GEV No.	101317	Ref. No. —
plug with cable L 1000mm suitable for NOVASIT			
	GEV No.	101318	Ref. No. —
cover cap for solenoid coil suitable for NOVASIT			

accessories









1

GEV No.	101306	Ref. No.	7020011
description	gas connection angled flange 45x45mm hole distance 36x36mm 1/2" ELETTROSIT/V4400/4600/4605 screw with O-ring suitable for SIT/HONEYWELL		
spare parts for	101306		
	GEV No.	517104	Ref. No. —
O-ring EPDM thickness 2.62mm ID ø 31.42mm Qty 1 pcs			

TANDEM



1

GEV No.	101881	Ref. No.	7020080
description	gas valve 230V 50Hz gas inlet 1/2" gas outlet 1/2" pilot connection level slow ignition ignition times pressure range 3-50mbar power supply for modulator equiv. no. 0.830.041 suitable for Tandem		
For models:	CG06MX, CG102MX, CG10MX, CG20MX, DG06EC, DG06ES, DG06MX, DG102EC, DG102MX, DG10EC, DG10ES, DG10MX, GF10GM, GF4PM, GF5GM, GF6PM, GF7GM, GF8PM, VG06EC, VG06MX, VG102EC, VG102MX, VG10EC, VG10MX, VG20EC, VG20MX		
spare parts for	101881		
	GEV No.	101379	Ref. No. —
solenoid coil 230V 50Hz suitable for Tandem			
accessories for	101881		
	GEV No.	101274	Ref. No. 7070036
olive for pipe ø 16mm Qty 1 pcs			
	GEV No.	101275	Ref. No. —
union screw thread 1/2" for pipe ø 16mm Qty 1 pcs			
	GEV No.	101925	Ref. No. —
plug with O-ring thread M10x1 for pilot burner suitable for NOVASIT			
	GEV No.	102845	Ref. No. —
gas connection angled 1/2" flange 32x32mm hole distance 24x24mm Tandem			
	GEV No.	102846	Ref. No. —
gas connection straight 1/2" flange 32x32mm hole distance 24x24mm suitable for Tandem			
	GEV No.	102847	Ref. No. —
O-ring			



ignition boxes

SIT



1	GEV No.	101685	Ref. No.	7020085
description	ignition box SIT type 503EFD electrodes 2 waiting time 1.5s safety time 10s 220/240V 10VA 50-60Hz protection IP40			
For models:	CG06MX, CG102MX, CG10MX, CG20MX, DG06EC, DG06ES, DG06MX, DG102EC, DG102MX, DG10EC, DG10ES, DG10MX, GF10GM, GF4PM, GF5GM, GF6PM, GF7GM, GF8PM, VG06EC, VG06MX, VG102EC, VG-102MX, VG10EC, VG10MX, VG20EC, VG20MX			



1	GEV No.	107837	Ref. No.	7020206
description	ignition box SIT type 579DBC for combi-steamer suitable for GIORIK equiv. no. 0.579.418 electrodes 2 waiting time 1.5s safety time 5s 220/240V 12VA 50/60Hz			



ignition parts











pilot burners

SIT

100 series



1	GEV No.	106906	Ref. No.	7090022
description	pilot burner SIT type 100 series 3 flames nozzle \varnothing 0.2mm gas connection 6mm			
For models:	FG07CL, FG07L, FG13L, FG213CL, FG213L, SG608			
spare parts for	106906			
	GEV No.	100245	Ref. No.	7042005
	pilot burner nozzle LPG code 20 bore \varnothing 0.2mm Qty 1 pcs thread M8x0.75			
	GEV No.	100855	Ref. No.	—
	pilot burner bracket triple			
	GEV No.	100885	Ref. No.	—
	air mixing sleeve for pilot burner Qty 1 pcs			

spare parts for	106906			
	GEV No.	100916	Ref. No.	—
	compression spring for pilot burner Qty 1 pcs			
	GEV No.	100917	Ref. No.	—
	gasket for pilot burner Qty 1 pcs aluminium			
	GEV No.	100918	Ref. No.	—
	screw for pilot burner			
	GEV No.	107162	Ref. No.	7090002
	pilot burner cap SIT 3 flames Hmm Lmm Qty 1 pcs			
	GEV No.	107701	Ref. No.	—
	pilot burner bottom part SIT 100 series nozzle \varnothing 0.2mm			
accessories for	106906			
	GEV No.	100245	Ref. No.	7042005
	pilot burner nozzle LPG code 20 bore \varnothing 0.2mm Qty 1 pcs thread M8x0.75			
	GEV No.	100246	Ref. No.	—
	pilot burner nozzle natural gas bore \varnothing 0.35mm Qty 1 pcs thread M8x0.75			
	GEV No.	100904	Ref. No.	—
	locking screw M10x1 for pipe \varnothing 4mm Qty 1 pcs			
	GEV No.	100905	Ref. No.	—
	locking screw M10x1 for pipe \varnothing 6mm Qty 1 pcs			
	GEV No.	102110	Ref. No.	—
	pilot tube copper pipe \varnothing 4mm thickness 1mm L 3000mm			
	GEV No.	102111	Ref. No.	—
	pilot tube copper pipe \varnothing 6mm thickness 1mm L 3000mm			
	GEV No.	107171	Ref. No.	—
	pilot burner nozzle SIT natural/liquid gas bore \varnothing 0.25mm Qty 1 pcs			
	GEV No.	107700	Ref. No.	—
	pilot burner bottom part SIT 100 series nozzle \varnothing 0.25mm			
	GEV No.	107702	Ref. No.	—
	pilot burner bottom part SIT 100 series nozzle \varnothing 0.35mm			





















1	GEV No.	106907	Ref. No.	7090023
description	pilot burner SIT type 100 series 3 flames nozzle \varnothing 0.35mm gas connection 6mm			
For models:	13FG, 13FGC, 17FG, 17FGC, 207FG, 207FGC, 213FG, 213FGC, 217FG, 217FGC, 917FG, 917FGC, 927FG, 927FGC, 934FG, 934FGC			
spare parts for	106907			
	GEV No.	100246	Ref. No.	—
	pilot burner nozzle natural gas bore \varnothing 0.35mm Qty 1 pcs thread M8x0.75			

Table continues overleaf



spare parts for		106907		
	GEV No.	100855	Ref. No.	—
pilot burner bracket triple				
	GEV No.	100885	Ref. No.	—
air mixing sleeve for pilot burner Qty 1 pcs				
	GEV No.	100916	Ref. No.	—
compression spring for pilot burner Qty 1 pcs				
	GEV No.	100917	Ref. No.	—
gasket for pilot burner Qty 1 pcs aluminium				
	GEV No.	100918	Ref. No.	—
screw for pilot burner				
	GEV No.	107162	Ref. No.	7090002
pilot burner cap SIT 3 flames Hmm Lmm Qty 1 pcs				
	GEV No.	107702	Ref. No.	—
pilot burner bottom part SIT 100 series nozzle ø 0.35mm				
accessories for		106907		
	GEV No.	100245	Ref. No.	7042005
pilot burner nozzle LPG code 20 bore ø 0.2mm Qty 1 pcs thread M8x0.75				
	GEV No.	100904	Ref. No.	—
locking screw M10x1 for pipe ø 4mm Qty 1 pcs				
	GEV No.	100905	Ref. No.	—
locking screw M10x1 for pipe ø 6mm Qty 1 pcs				
	GEV No.	102110	Ref. No.	—
pilot tube copper pipe ø 4mm thickness 1mm L 3000mm				
	GEV No.	102111	Ref. No.	—
pilot tube copper pipe ø 6mm thickness 1mm L 3000mm				
	GEV No.	107171	Ref. No.	—
pilot burner nozzle SIT natural/liquid gas bore ø 0.25mm Qty 1 pcs				
	GEV No.	107700	Ref. No.	—
pilot burner bottom part SIT 100 series nozzle ø 0.25mm				
	GEV No.	107701	Ref. No.	—
pilot burner bottom part SIT 100 series nozzle ø 0.2mm				

accessories			
pilot burner caps			
	1		
GEV No.	107162	Ref. No.	7090002
description	pilot burner cap SIT 3 flames Hmm Lmm Qty 1 pcs		



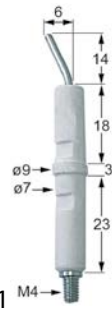









pilot burner nozzles			
	1		
GEV No.	100245	Ref. No.	7042005
description	pilot burner nozzle LPG code 20 bore ø 0.2mm Qty 1 pcs thread M8x0.75		

ignition electrodes			
	1		
GEV No.	100706	Ref. No.	6010046
description	ignition electrode connection M4 Qty 1 pcs		
For models:	13FG, 13FGC, 17FG, 17FGC, 207FG, 207FGC, 213FG, 213FGC, 217FG, 217FGC, 917FG, 917FGC, 927FG, 927FGC, 934FG, 934FGC, FG07CL, FG07L, FG13L, FG213CL, FG213L, SG608		





140 - 145 -150 series				
	1			
GEV No.	107114 ¹	Ref. No.	7090028	
description	pilot burner SIT type 140 series 2 flames nozzle ømm gas connectionmm			
For models:	CG740, CG780, GG940, GG980			
spare parts for	107114			
	GEV No.	100907	Ref. No.	—
screw connection thread M10x1 Qty 1 pcs type SEF 1 ømm for thermocouple				
accessories for	107114			
	GEV No.	100204	Ref. No.	—
pilot burner nozzle SIT LPG code 14 bore ø 0.18/0.20mm Qty 1 pcs suitable for 140 series				
	GEV No.	100205	Ref. No.	—
pilot burner nozzle SIT LPG code 19 bore ø 0.23/0.26mm Qty 1 pcs suitable for SIT 150 series				

¹incl. thermocouple fitting
Table continues overleaf

















accessories for		107114		
	GEV No.	100206	Ref. No.	—
	pilot burner nozzle SIT natural gas code 36 bore ø 0.60/0.55mm Qty 1 pcs suitable for SIT 150 series			
	GEV No.	100207	Ref. No.	7042013
	pilot burner nozzle SIT natural gas code 27 bore ø 0.40/0.38mm suitable for SIT 140 series			
	GEV No.	100216	Ref. No.	—
	pilot burner nozzle SIT natural gas code 38 bore ø 0.45mm Qty 1 pcs suitable for SIT 150 series			
	GEV No.	100701	Ref. No.	6010062
	ignition electrode connection M4 Qty 1 pcs			
	GEV No.	100801	Ref. No.	—
	gasket for pilot burner Qty 1 pcs			
	GEV No.	100897	Ref. No.	—
	olive for pipe ø 4mm Qty 1 pcs for pilot burner			
	GEV No.	100898	Ref. No.	—
	olive for pipe ø 6mm Qty 1 pcs for pilot burner			
	GEV No.	100906	Ref. No.	5900317 7050028
	screw connection thread M10x1 for ignition electrode brass Qty 1 pcs WS 10			
	GEV No.	100908	Ref. No.	—
	union screw thread M10x1 for pipe ø 4mm Qty 1 pcs			
	GEV No.	100909	Ref. No.	7050029
	union screw thread M10x1 for pipe ø 6mm Qty 1 pcs			
	GEV No.	102110	Ref. No.	—
	pilot tube copper pipe ø 4mm thickness 1mm L 3000mm			
	GEV No.	102111	Ref. No.	—
	pilot tube copper pipe ø 6mm thickness 1mm L 3000mm			

accessories for		100051		
	GEV No.	100209	Ref. No.	—
	pilot burner nozzle POLIDORO natural gas code 40 bore ø 0.4mm Qty 1 pcs			
	GEV No.	100701	Ref. No.	6010062
	ignition electrode connection M4 Qty 1 pcs			
	GEV No.	100906	Ref. No.	5900317 7050028
	screw connection thread M10x1 for ignition electrode brass Qty 1 pcs WS 10			
	GEV No.	100907	Ref. No.	—
	screw connection thread M10x1 Qty 1 pcs type SEF 1 ømm for thermocouple			
	GEV No.	100908	Ref. No.	—
	union screw thread M10x1 for pipe ø 4mm Qty 1 pcs			
	GEV No.	100909	Ref. No.	7050029
	union screw thread M10x1 for pipe ø 6mm Qty 1 pcs			
	GEV No.	102110	Ref. No.	—
	pilot tube copper pipe ø 4mm thickness 1mm L 3000mm			
	GEV No.	102111	Ref. No.	—
	pilot tube copper pipe ø 6mm thickness 1mm L 3000mm			
	GEV No.	102508	Ref. No.	—
	union screw thread M10x1 for pipe ø 4mm Qty 5 pcs			
	GEV No.	102509	Ref. No.	—
	union screw thread M10x1 for pipe ø 6mm Qty 5 pcs			
	GEV No.	102699	Ref. No.	—
	pilot burner nozzle POLIDORO natural gas code 25.2 bore ø 2x0.25mm Qty 1 pcs 2 bores			
	GEV No.	102795	Ref. No.	—
	olive for pipe ø 4mm Qty 1 pcs			
	GEV No.	102797	Ref. No.	—
	olive for pipe ø 6mm Qty 1 pcs			
	GEV No.	106703	Ref. No.	7042008
	pilot burner nozzle POLIDORO natural gas code 27.2 bore ø 2x0.27mm Qty 1 pcs			
	GEV No.	106704	Ref. No.	—
	pilot burner nozzle POLIDORO LPG code 16.2 bore ø 2x0.16mm Qty 1 pcs			
	GEV No.	106763	Ref. No.	—
	pilot burner nozzle POLIDORO natural gas code 27.2A bore ø 2x 0.27mm Qty 1 pcs			
	GEV No.	106859	Ref. No.	—
	pilot burner nozzle POLIDORO LPG code 24 bore ø 0.24mm Qty 1 pcs			

POLIDORO				
pilot burners				
	1			
GEV No.	100051			
Ref. No.	7090026			
description	pilot burner POLIDORO 3 flames code gas connectionmm			
For models:	22CPG, 23CPG, 2CPG, 3CPG, CPG1, CPG1BM, CPG66, FTG100, FTG46, FTG46B, FTG46R, FTG66L, FTG66LG, FTG66R, GG66			
spare parts for	100051			
	GEV No.	100907	Ref. No.	—
	screw connection thread M10x1 Qty 1 pcs type SEF 1 ømm for thermocouple			
accessories for	100051			
	GEV No.	100000	Ref. No.	—
	pilot burner nozzle POLIDORO LPG code 22 bore ø 0.22mm Qty 1 pcs			
	GEV No.	100208	Ref. No.	—
	pilot burner nozzle POLIDORO LPG code 20 bore ø 0.2mm Qty 1 pcs			



			
GEV No.	100867	Ref. No.	7090027
description	pilot burner POLIDORO 3 flames gas pressurebar code gas connection 6mm		
For models:	SG520		
accessories for	100867		
	GEV No.	100000	Ref. No. —
	pilot burner nozzle POLIDORO LPG code 22 bore ø 0.22mm Qty 1 pcs		
	GEV No.	100208	Ref. No. —
	pilot burner nozzle POLIDORO LPG code 20 bore ø 0.2mm Qty 1 pcs		
	GEV No.	100209	Ref. No. —
	pilot burner nozzle POLIDORO natural gas code 40 bore ø 0.4mm Qty 1 pcs		
	GEV No.	100907	Ref. No. —
	screw connection thread M10x1 Qty 1 pcs type SEF 1 ømm for thermocouple		
	GEV No.	100908	Ref. No. —
	union screw thread M10x1 for pipe ø 4mm Qty 1 pcs		
	GEV No.	100909	Ref. No. 7050029
	union screw thread M10x1 for pipe ø 6mm Qty 1 pcs		
	GEV No.	102110	Ref. No. —
	pilot tube copper pipe ø 4mm thickness 1mm L 3000mm		
	GEV No.	102111	Ref. No. —
	pilot tube copper pipe ø 6mm thickness 1mm L 3000mm		
	GEV No.	102699	Ref. No. —
	pilot burner nozzle POLIDORO natural gas code 25.2 bore ø 2x0.25mm Qty 1 pcs 2 bores		
	GEV No.	102795	Ref. No. —
	olive for pipe ø 4mm Qty 1 pcs		
	GEV No.	102797	Ref. No. —
	olive for pipe ø 6mm Qty 1 pcs		
	GEV No.	106703	Ref. No. 7042008
	pilot burner nozzle POLIDORO natural gas code 27.2 bore ø 2x0.27mm Qty 1 pcs		
	GEV No.	106704	Ref. No. —
	pilot burner nozzle POLIDORO LPG code 16.2 bore ø 2x0.16mm Qty 1 pcs		
	GEV No.	106763	Ref. No. —
	pilot burner nozzle POLIDORO natural gas code 27.2A bore ø 2x 0.27mm Qty 1 pcs		
	GEV No.	106859	Ref. No. —
	pilot burner nozzle POLIDORO LPG code 24 bore ø 0.24mm Qty 1 pcs		





















			
GEV No.	100076	Ref. No.	7090024
description	pilot burner POLIDORO 3 flames natural gas code 29.2 gas connection 6mm		
spare parts for	100076		
	GEV No.	100907	Ref. No. —
	screw connection thread M10x1 Qty 1 pcs type SEF 1 ømm for thermocouple		
accessories for	100076		
	GEV No.	100000	Ref. No. —
	pilot burner nozzle POLIDORO LPG code 22 bore ø 0.22mm Qty 1 pcs		
	GEV No.	100208	Ref. No. —
	pilot burner nozzle POLIDORO LPG code 20 bore ø 0.2mm Qty 1 pcs		
	GEV No.	100209	Ref. No. —
	pilot burner nozzle POLIDORO natural gas code 40 bore ø 0.4mm Qty 1 pcs		
	GEV No.	100701	Ref. No. 6010062
	ignition electrode connection M4 Qty 1 pcs		
	GEV No.	100906	Ref. No. 5900317 7050028
	screw connection thread M10x1 for ignition electrode brass Qty 1 pcs WS 10		
	GEV No.	100907	Ref. No. —
	screw connection thread M10x1 Qty 1 pcs type SEF 1 ømm for thermocouple		
	GEV No.	100908	Ref. No. —
	union screw thread M10x1 for pipe ø 4mm Qty 1 pcs		
	GEV No.	100909	Ref. No. 7050029
	union screw thread M10x1 for pipe ø 6mm Qty 1 pcs		
	GEV No.	102110	Ref. No. —
	pilot tube copper pipe ø 4mm thickness 1mm L 3000mm		
	GEV No.	102111	Ref. No. —
	pilot tube copper pipe ø 6mm thickness 1mm L 3000mm		
	GEV No.	102508	Ref. No. —
	union screw thread M10x1 for pipe ø 4mm Qty 5 pcs		
	GEV No.	102509	Ref. No. —
	union screw thread M10x1 for pipe ø 6mm Qty 5 pcs		
	GEV No.	102699	Ref. No. —
	pilot burner nozzle POLIDORO natural gas code 25.2 bore ø 2x0.25mm Qty 1 pcs 2 bores		
	GEV No.	102795	Ref. No. —
	olive for pipe ø 4mm Qty 1 pcs		
	GEV No.	102797	Ref. No. —
	olive for pipe ø 6mm Qty 1 pcs		

Table continues overleaf



accessories for		100076		
GEV No.		106703	Ref. No.	7042008
	pilot burner nozzle POLIDORO natural gas code 27.2 bore \varnothing 2x0.27mm Qty 1 pcs			
GEV No.		106704	Ref. No.	—
	pilot burner nozzle POLIDORO LPG code 16.2 bore \varnothing 2x0.16mm Qty 1 pcs			
GEV No.		106763	Ref. No.	—
	pilot burner nozzle POLIDORO natural gas code 27.2A bore \varnothing 2x0.27mm Qty 1 pcs			
GEV No.		106859	Ref. No.	—
	pilot burner nozzle POLIDORO LPG code 24 bore \varnothing 0.24mm Qty 1 pcs			



producer-specific pilot burners

GIORIK

				
1				
GEV No.	107764	Ref. No.	7090219	
description	pilot burner L 93mm \varnothing 8mm			

				
1				
GEV No.	107763	Ref. No.	7090218	
description	pilot burner L 95mm \varnothing 8mm			

electrodes

				
1				
GEV No.	100701	Ref. No.	6010062	
description	ignition electrode connection M4 Qty 1 pcs			
For models:	SG520			
accessories for	100701			
				
GEV No.	100906	Ref. No.	5900317 7050028	
description	screw connection thread M10x1 for ignition electrode brass Qty 1 pcs WS 10			

				
1				
GEV No.	100706	Ref. No.	6010046	
description	ignition electrode connection M4 Qty 1 pcs			
For models:	13FG, 13FGC, 17FG, 17FGC, 207FG, 207FGC, 213FG, 213FGC, 217FG, 217FGC, 917FG, 917FGC, 927FG, 927FGC, 934FG, 934FGC, FG07CL, FG07L, FG13L, FG213CL, FG213L, SG608			

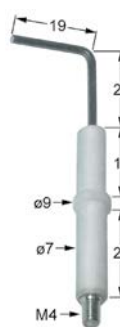
				
1				
GEV No.	102333	Ref. No.	2012111	
description	ignition electrode D1 \varnothing 7mm D2 \varnothing 9mm connection M4 L1 23mm L2 19mm BL1 18mm BL2 3mm BL3 23mm to clip			
For models:	CG06MX, CG102MX, CG10MX, CG20MX, DG06EC, DG06ES, DG06MX, DG102EC, DG102MX, DG10EC, DG10ES, DG10MX, VG06EC, VG06MX, VG102EC, VG102MX, VG10EC, VG10MX, VG20EC, VG20MX			

GEV No.	102314	Ref. No.	6010061
description	ignition electrode D1 ø 7mm D2 ø 9mm connection M4 L1 2mm BL1 28mm BL2 3mm BL3 23mm to clip		
For models:	22CPG, 23CPG, 2CPG, 3CPG, CPG1, CPG1BM, CPG66, FRG46, FRG66, FTG100, FTG46, FTG46B, FTG46R, FTG66L, FTG66LG, FTG66R, GG66		

GEV No.	102334	Ref. No.	2012110
description	ignition electrode D1 ø 7mm D2 ø 9mm connection M4 L1 9mm L2 12mm L3 62mm BL1 18mm BL2 3mm BL3 23mm to clip		
For models:	CG06MX, CG102MX, CG10MX, CG20MX, DG06EC, DG06ES, DG06MX, DG102EC, DG102MX, DG10EC, DG10ES, DG10MX, VG06EC, VG06MX, VG102EC, VG102MX, VG10EC, VG10MX, VG20EC, VG20MX		

GEV No.	102331	Ref. No.	2012109
description	ignition electrode D1 ø 7mm D2 ø 9mm connection M4 L1 34mm L2 40mm L3 14mm BL1 18mm BL2 3mm BL3 23mm to clip		
For models:	VG06EC, VG06MX, VG102EC, VG10EC, VG10MX		

GEV No.	100906	Ref. No.	5900317 7050028
description	screw connection thread M10x1 for ignition electrode brass Qty 1 pcs WS 10		

GEV No.	102332	Ref. No.	2012108
description	ignition electrode D1 ø 7mm D2 ø 9mm connection M4 L1 40mm L2 46mm BL1 18mm BL2 3mm BL3 23mm to clip		
For models:	VG06EC, VG06MX, VG102EC, VG102MX, VG10EC, VG10MX, VG20EC, VG20MX		

ignition cables

pre-assembled cables

GEV No.	100176	Ref. No.	6050610
description	ignition cable cable length 1000mm connection ø2.4mm / ø4mm permanent temperature 200°C		
For models:	CG740, CG780, CPG1, CPG1BM, FPG18, FTG100, FTG46, FTG46B, FTG46R, FTG66L, FTG66LG, FTG66R, GG66, GG940, GG980, SG520		

GEV No.	100140	Ref. No.	6050051
description	ignition cable cable length 400mm connection ø2.4mm / ø4mm		
For models:	13FG, 13FGC, 17FG, 17FGC, 207FG, 213FG, 213FGC, 217FG, 217FGC, 22CPG, 23CPG, 2CPG, 3CPG, 917FG, 917FGC, 927FG, 927FGC, 934FG, 934FGC, CPG66, FG07CL, FG213CL, FRG46, FRG66, SG608		



GEV No.	100025	Ref. No.	6050065
description	ignition cable cable length 600mm connection ø4mm / F6.3mm		
For models:	FG07L, FG13L, FG213L		





			
GEV No.	100019	Ref. No.	6050610
description	ignition cable cable length 900mm connection ø2.4mm / ø4mm		



piezoelectric igniters

mounting diameter 22mm

			
GEV No.	100039	Ref. No.	6010048
description	piezoelectric igniter body plastic blowing mounting ø 22mm connection F6.3x0.8 cable lengthmm		
accessories for	100039		
	GEV No.	100115	Ref. No. —
union nut ID ø M22x1mm			

			
GEV No.	100013	Ref. No.	6010047
description	piezoelectric igniter body plastic blowing mounting ø 22mm connection ø2.4mm cable lengthmm		
For models:	22CPG, 23CPG, 2CPG, 3CPG, CG740, CG780, CPG1, CPG1BM, CPG66, FPG18, FRG46, FRG66, FTG100, FTG46, FTG46B, FTG46R, FTG66L, FTG66LG, FTG66R, GG66, GG940, GG980, PCG46, PCG66, SG520, SG608		
accessories for	100013		
	GEV No.	100023	Ref. No. —
female bullet size 2.3mm 0.5-1.5mm ² CuZn t.max. 125°C Qty 20 pcs			

miscellaneous

			
GEV No.	nla ¹	Ref. No.	7020230
description	piezoelectric igniter suitable for Minisit with cover cap ømm connection F6.3x0.8		
For models:	FG07L, FG13L, FG213L		
spare parts for	101136		
	GEV No.	100001	Ref. No. —
piezoelectric igniter suitable for Minisit connection F6.3x0.8 ømm			

¹no longer available

ignition units

			
GEV No.	101002	Ref. No.	6041059
description	ignition unit outputs 2 230VAC dimensions 88x23x34mm mounting distance 73mm inlet F6.3x0.8 outlet F2.8x0.8 0.6VA 50/60Hz		
For models:	13FG, 13FGC, 17FG, 17FGC, 207FG, 207FGC, 213FG, 213FGC, 217FG, 217FGC, 917FG, 917FGC, 927FG, 927FGC, 934FG, 934FGC, FG07CL, FG213CL		

thermocouples

plug-in thermocouples

plug-in thermocouples standard

with barrel socket ø6(6.5)mm

thermocouples SIT

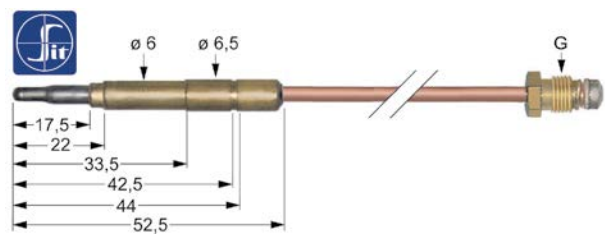
			
GEV No.	107609	Ref. No.	6010055
description	thermocouple SIT M9x1 L 600mm plug connection ø6.0(6.5)mm		
For models:	13FG, 17FG, 207FG, 213FG, 917FG, 917FGC, 927FG, 927FGC, 934FG, 934FGC, CG740, CG780, FG07L, FG13L, FG213L, FTG100, FTG46, FTG46B, FTG46R, FTG66L, FTG66LG, FTG66R, GG66, GG940, GG980, SG520, SG608		

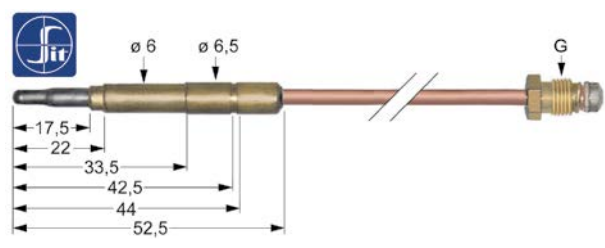
			
GEV No.	107611	Ref. No.	6010057
description	thermocouple SIT M9x1 L 850mm plug connection ø6.0(6.5)mm		
For models:	22CPG, 23CPG, 2CPG, 3CPG, CPG66		



plug-in thermocouples with interruption

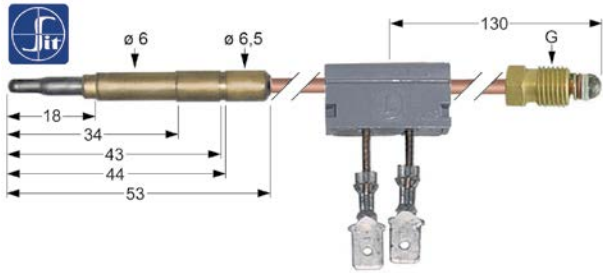



1	GEV No.	107177	Ref. No.	6010065
	description	thermocouple SIT with interrupter M9x1 L 600mm plug connection ø6.0mm F 6.3mm		

threaded thermocouples

threaded thermocouples standard

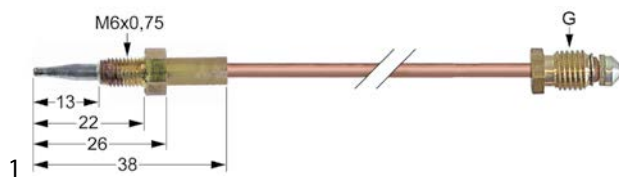
threaded thermocouples (miscellaneous)



1	GEV No.	107185	Ref. No.	6010171
	description	thermocouple M9x1 L 600mm M6x0.75		
	accessories for	107185		
	GEV No.	103173	Ref. No.	—
	nut thread M6x0.75 H 4mm WS 10 brass Qty 1 pcs			

producer-specific hob burners

GIORIK

CG740G



1	GEV No.	104674	Ref. No.	7090212
	description	burner cap ø 65mm 4kW		



1	GEV No.	104676	Ref. No.	7090213
	description	burner cap ø 95mm 8kW		



1	GEV No.	104673	Ref. No.	7090216
	description	burner head ø 160mm for burner cap ø 65mm 4kW		



1	GEV No.	104675	Ref. No.	7090217
	description	burner head ø 160mm for burner cap ø 95mm 8kW		



1	GEV No.	104677	Ref. No.	7090214
	description	burner lower part for burner cap ø 65mm 4kW		

gas burners

hob burners

universal hob burners

GEV





1	GEV No.	103066	Ref. No.	7090044
	description	burner cap ø 80mm		

accessories for 103066

	GEV No.	103065	Ref. No.	—
	burner ring for burner cap ø 80mm			

	GEV No.	104100	Ref. No.	—
	burner head for burner cap ø 80mm			

	GEV No.	104101	Ref. No.	—
	burner holder for burner cap ø 80mm with nozzle holder with mixing sleeve			

1

GEV No.	104678	Ref. No.	7090215
description	burner lower part for burner cap ø 95mm 8kW		

screw connections



1

GEV No.	104679	Ref. No.	7090221
description	pilot burner centre part ø 8mm L 30.4mm WS 15 ball port ø 3.8mm		

pan supports



1

GEV No.	210026	Ref. No.	7090046
description	pan support W 345mm L 398mm H 48mm		

accessories

pan supports



1

GEV No.	210026	Ref. No.	7090046
description	pan support W 345mm L 398mm H 48mm		

bar burners

bar burners



1

GEV No.	105687	Ref. No.	2010923
description	bar burner 2 row L 370mm W 220mm ømm H 50mm chargrill		
For models:	CG740, CG780		



1

GEV No.	105475	Ref. No.	2010924
description	bar burner 2 row L 575mm W 225mm ømm H 45mm 11kW chargrill		
For models:	GG940, GG980		



1

GEV No.	105776	Ref. No.	7090100
description	bar burner ø 50mm Wmm Hmm L 305mm with bolt M5x12 flange width 52mm convection oven flange ø 75mm		
For models:	CG06MX, DG06EC, DG06ES, DG06MX, VG06EC, VG06MX		



1

GEV No.	105775	Ref. No.	7090101
description	bar burner ø 50mm Wmm Hmm L 425mm with bolt M5x12 flange width 52mm convection oven flange ø 75mm		
For models:	CG102MX, CG10MX, CG20MX, DG102EC, DG102MX, DG10EC, DG10ES, DG10MX, VG102EC, VG102MX, VG10EC, VG10MX, VG20EC, VG20MX		



			
1			
GEV No.	105774	Ref. No.	7090102
description	bar burner ø 60mm Wmm Hmm L 245mm with bolt M5x12 flange width 67mm flange length 67mm convection oven		
For models:	VG06EC, VG06MX, VG102EC, VG102MX, VG10EC, VG10MX, VG20EC, VG20MX		

			
2			
GEV No.	105310	Ref. No.	7090079
description	bar burner ø 60mm Wmm Hmm L 260mm flange width 67mm flange length 67mm pasta cooker		
For models:	22CPG, 2CPG, CPG66		

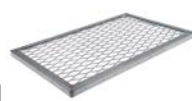
			
1			
GEV No.	104439	Ref. No.	2010949
description	lava rock grid L 540mm W 340mm H 20mm		

			
1			
GEV No.	105525	Ref. No.	2103520
description	surface burner ømm W 190mm H 43mm L 575mm salamander grill		
For models:	SG520		

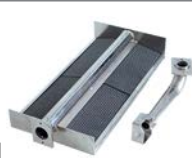
			
1			
GEV No.	105524	Ref. No.	2001246
description	surface burner ømm W 255mm H 80mm L 580mm with cast plates salamander grill		
For models:	SG608		

lava rock grids

			
1			
GEV No.	104439	Ref. No.	2010949
description	lava rock grid L 540mm W 340mm H 20mm		

tube burners

			
1			
GEV No.	105529	Ref. No.	2112970
description	tubular burner L 295mm W 55mm H 70mm for fryer oval		
For models:	207FG, 207FGC, 927FG, 927FGC		

			
1			
GEV No.	105532	Ref. No.	2112969
description	tubular burner L 295mm W 55mm H 70mm mounting pos. centre for fryer oval		
For models:	217FGC, 934FGC		

			
1			
GEV No.	105528	Ref. No.	2001231
description	tubular burner L 295mm W 55mm H 70mm mounting pos. centre/right for fryer oval		
For models:	FG13L, FG213CL, FG213L		

			
1			
GEV No.	105527	Ref. No.	2001230
description	tubular burner L 295mm W 55mm H 70mm mounting pos. left for fryer oval		
For models:	FG07CL, FG07L, FG13L, FG213CL, FG213L		



			
1			
GEV No.	105530	Ref. No.	2112968
description	tubular burner L 295mm W 55mm H 70mm mounting pos. left for fryer oval		
For models:	13FG, 13FGC, 17FG, 17FGC, 213FG, 213FGC, 217FG, 217FGC, 917FG, 917FGC, 934FG, 934FGC		

			
1			
GEV No.	105531	Ref. No.	2112967
description	tubular burner L 295mm W 55mm H 70mm mounting pos. right for fryer oval		
For models:	13FG, 13FGC, 17FG, 17FGC, 213FG, 213FGC, 217FG, 217FGC, 917FG, 917FGC, 934FG, 934FGC		

ceramic burners

accessories

ceramic plates

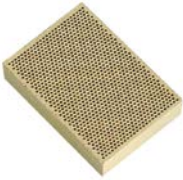
			
1			
GEV No.	105526	Ref. No.	7090073
description	ceramic plate L 69mm W 49mm H 13mm for salamander grill		
For models:	SG520		

gas nozzles

main nozzles

gas nozzles M7x1

			
1			
GEV No.	100518	Ref. No.	7042726
description	gas injector thread M7x1 WS 10 bore ø 0.85mm		

pilot burner nozzles

pilot burner nozzles POLIDORO

			
1			
GEV No.	106703	Ref. No.	7042008
description	pilot burner nozzle POLIDORO natural gas code 27.2 bore ø 2x0.27mm Qty 1 pcs		

pilot burner nozzles SIT

100 series

			
1			
GEV No.	100245	Ref. No.	7042005
description	pilot burner nozzle LPG code 20 bore ø 0.2mm Qty 1 pcs thread M8x0.75		

140/150 series



			
1			
GEV No.	100207	Ref. No.	7042013
description	pilot burner nozzle SIT natural gas code 27 bore ø 0.40/0.38mm suitable for SIT 140 series		

auxiliary gas parts

screw connections





olives

 <p>Image not available</p>			
1			
GEV No.	106426	Ref. No.	7070025
description	olive		

			
1			
GEV No.	101274	Ref. No.	7070036
description	olive for pipe ø 16mm Qty 1 pcs		
accessories for	101274		
	GEV No.	101275	Ref. No.
			—
	 union screw thread 1/2" for pipe ø 16mm Qty 1 pcs		

union screws

			
1			
GEV No.	100906	Ref. No.	5900317 7050028
description	screw connection thread M10x1 for ignition electrode brass Qty 1 pcs WS 10		

			
1			
GEV No.	100909	Ref. No.	7050029
description	union screw thread M10x1 for pipe ø 6mm Qty 1 pcs		
accessories for	100909		
	GEV No.	100898	Ref. No. —
olive for pipe ø 6mm Qty 1 pcs for pilot burner			
	GEV No.	101286	Ref. No. —
olive ID ø 6mm Qty 1 pcs			
	GEV No.	101287	Ref. No. —
olive for pipe ø 6mm Qty 1 pcs			
	GEV No.	101288	Ref. No. —
olive for pipe ø 6mm L 6mm aluminium Qty 1 pcs ED ø 8.5mm			

miscellaneous

			
1			
GEV No.	550449	Ref. No.	2010311
description	special wrench for ring nut		

for convection ovens/combi-steamers

doors

			
1			
GEV No.	690585	Ref. No.	2011212
description	bush for door mechanism L 35mm ED ø 36mm int. ø 1 31mm int. ø 2 13mm mounting distance 28mm brass		
For models:	CE06MX, CE102MX, CE10MX, CE20MX, CG06MX, CG102MX, CG10MX, CG20MX, DE06EC, DE06ES, DE06MX, DE102EC, DE102MX, DE10EC, DE10ES, DE10MX, DG06EC, DG06ES, DG06MX, DG102EC, DG102MX, DG10EC, DG10ES, DG10MX, VE06EC, VE06MX, VE102EC, VE102MX, VE10EC, VE10MX, VE20EC, VE20MX, VG06EC, VG06MX, VG102EC, VG102MX, VG10EC, VG10MX, VG20EC, VG20MX		

door mechanics

miscellaneous

			
1			
GEV No.	690585	Ref. No.	2011212
description	bush for door mechanism L 35mm ED ø 36mm int. ø 1 31mm int. ø 2 13mm mounting distance 28mm brass		
For models:	CE06MX, CE102MX, CE10MX, CE20MX, CG06MX, CG102MX, CG10MX, CG20MX, DE06EC, DE06ES, DE06MX, DE102EC, DE102MX, DE10EC, DE10ES, DE10MX, DG06EC, DG06ES, DG06MX, DG102EC, DG102MX, DG10EC, DG10ES, DG10MX, VE06EC, VE06MX, VE102EC, VE102MX, VE10EC, VE10MX, VE20EC, VE20MX, VG06EC, VG06MX, VG102EC, VG102MX, VG10EC, VG10MX, VG20EC, VG20MX		

for salamander grills

			
1			
GEV No.	692729	Ref. No.	2013882
description	belt for salamander grill L 385mm W 13mm Hmm ED ømm ID ømm		
For models:	SH505R, SH510P, SH510R, SH520G, SH520GM, SH560P		

equipment-specific units

for deep fryers

door magnets

			
1			
GEV No.	690524	Ref. No.	5900352
description	door magnet L 87mm W 18mm H 15mm mounting distance 73mm for folding door hinge		
For models:	13FG, 13FGC, 15FE, 15FEC, 17FG, 17FGC, 207FG, 207FGC, 20FE, 20FEC, 210FE, 210FEC, 213FG, 213FGC, 215FE, 215FEC, 217FG, 217FGC, 220FE, 220FEC, 22CP, 23CP, 2CP, 3CP, 917FG, 917FGC, 920FE, 920FEC, 922FE, 922FEC, 927FG, 927FGC, 934FG, 934FGC, 940FE, 940FEC, CG740, CG780, CPE66, CPG66, GG940, GG980		





			
1			
GEV No.	692728	Ref. No.	2013873
description	spindle for salamander grill L 493mm Wmm Hmm ED ø 5mm ID ømm		
For models:	SH505R, SH510P, SH510R, SH520G, SH520GM, SH560P		

knobs

producer-specific knobs

GIORIK

			
1			
GEV No.	111506	Ref. No.	2002915
description	knob energy regulator ø 50mm shaft ø 6x4.6mm shaft flat lower black		
For models:	S505, S505R, S510, S510S, S511, S511S, SR512R		

			
1			
GEV No.	112789	Ref. No.	2012984
description	knob gas tap with ignition flame t.max.°C ø 75mm shaft ø 8x6.5mm shaft flat lower black		

			
1			
GEV No.	112265	Ref. No.	2008671
description	knob gas tap with ignition flame t.max.°C ø 76mm shaft ø 10x8mm shaft flat upper black		
For models:	22CPG, 23CPG, 2CPG, 3CPG, CG740, CG780, CPG1, CPG1BM, CPG66, GG66, GG940, GG980		

			
1			
GEV No.	111511	Ref. No.	2008673
description	knob switch 0-1 t.max.°C ø 76mm shaft ø 6x4.6mm shaft flat upper black		
For models:	15FE, 20FE, 215FE, 220FE, 920FE, 940FE, BM711, BM721, BM911, BM921, BME46, BME66		

			
1			
GEV No.	112274	Ref. No.	2008674
description	knob thermostat 1-8 t.max.°C ø 67mm shaft ø 6x4.6mm shaft flat upper black		
For models:	BME46, BME66, CP1BM, CPG1BM, FTE100, FTE107, FTE46, FTE46B, FTE46R, FTE47L, FTE66L, FTE66LB, FTE66LM, FTE66LMB, FTE66R, FTE66RM, FTE67L, FTE67LM, SPE46		

			
1			
GEV No.	112273	Ref. No.	2008675
description	knob thermostat t.max. 110°C ø 76mm shaft ø 6x4.6mm shaft flat upper black temperature range 30-110°C rotation 270°		
For models:	22CP, 23CP, 2CP, 3CP, CP1, CP1BM, CPE66		

			
1			
GEV No.	111509	Ref. No.	2008672
description	knob thermostat t.max. 185°C ø 76mm shaft ø 6x4.6mm shaft flat upper black temperature range 140-185°C		
For models:	13FG, 15FE, 17FG, 207FG, 20FE, 210FE, 213FG, 215FE, 217FG, 220FE, 917FG, 920FE, 922FE, 927FG, 934FG, 940FE, F10L, F15L, F215L, FRE46, FRE46F, FRE46R, FRE46T, FRE66, FRE66F, FRE66R, FRE66T		



			
1			
GEV No.	111738	Ref. No.	2012261
description	knob switch zero mark ø 50mm shaft ø 6x4.6mm shaft flat left black		
For models:	CE06MX, CE102MX, CE10MX, CE20MX, CG06MX, CG102MX, CG10MX, CG20MX, DE06EC, DE06ES, DE06MX, DE102EC, DE102MX, DE10EC, DE10ES, DE10MX, DG06EC, DG06ES, DG06MX, DG102EC, DG102MX, DG10EC, DG10ES, DG10MX, SH510P, SH560P, VE06EC, VE06MX, VE102EC, VE102MX, VE10EC, VE10MX, VE20EC, VE20MX, VG06EC, VG06MX, VG102EC, VG102MX, VG10EC, VG10MX, VG20EC, VG20MX		

			
1			
GEV No.	111508	Ref. No.	2006823
description	knob switch zero mark ø 50mm shaft ø 6x4.6mm shaft flat left white		
For models:	13FGC, 15FEC, 17FGC, 207FGC, 20FEC, 210FEC, 213FGC, 215FEC, 217FGC, 220FEC, 917FGC, 920FEC, 922FEC, 927FGC, 934FGC, 940FEC, EF10GM, EF5GM, EF7GM, EN10VE-EC-ESN1033, F10CL, F15CL, F215CL, FG07CL, FG213CL, GF10GM, GF5GM, GF7GM, SH505R, SH510R, SH520G, SH520GM		
spare parts for	111508		
	GEV No.	551317	Ref. No. 5900253
knob spring			

			
1			
GEV No.	111739	Ref. No.	2012260
description	knob universal ø 50mm shaft ø 6x4.6mm shaft flat vertical universal		
For models:	DE06EC, DE102EC, DE10EC, DG06EC, DG102EC, DG10EC, SH510P, VE06EC, VE102EC, VE10EC, VE20EC, VG06EC, VG102EC, VG10EC, VG20EC		

accessories

button springs

			
1			
GEV No.	551317	Ref. No.	5900253
description	knob spring		
accessories for	551317		
	GEV No.	111508	Ref. No. 2006823
knob switch zero mark ø 50mm shaft ø 6x4.6mm shaft flat left white			

			
1			
GEV No.	550965	Ref. No.	5900242
description	knob spring ø 6x4.6mm Qty 1 pcs		
For models:	BME46, BME66, CPE66, FRE46, FRE46F, FRE46R, FRE46T, FRE66, FRE66F, FRE66R, FRE66T, FTE100, FTE107, FTE46, FTE46B, FTE46R, FTE47L, FTE66L, FTE66LB, FTE66LM, FTE66LMB, FTE66R, FTE66RM, FTE67L, FTE67LM, PCE46, PCE66M, PCE66T, PCG46, PCG66, SPE46		

handles and hand wheels

cylindrical handles

fixed

			
1			
GEV No.	540713	Ref. No.	5900235
description	cylindrical handle thread M8 ø 17mm L 38mm		
For models:	BME46, BME66, FP18NS, FP18S, FP27S, FPG18, FRE46, FRE46F, FRE46T, FRE66, FRE66F, FRE66T, FRG46, FRG66		

			
1			
GEV No.	691314	Ref. No.	2001110
description	cylindrical handle thread M8 ø 28mm L 86mm		
For models:	15FE, 15FEC, 20FE, 20FEC, 210FE, 210FEC, 215FE, 215FEC, 220FE, 220FEC, 920FE, 920FEC, 922FE, 922FEC, 940FE, 940FEC, F10CL, F10L, F15CL, F15L, F215CL, F215L		

levers

without handle

			
1			
GEV No.	540712	Ref. No.	2108943
description	lever		
For models:	BME46, BME66, FP18S, FP27S, FPG18, FRE46, FRE46F, FRE46T, FRE66, FRE66F, FRE66T, FRG46, FRG66		

locks

handle latches





universal

outside fixing

locks



1

GEV No.	694065	Ref. No.	5900125
description	door handle for headed units L 145mm W 40mm H 62mm spring length 33mm outer black		
spare parts for	694065		
	GEV No.	514390	Ref. No. —
	spring for door handle ø 6mm L 54mm W 27.5mm		
	GEV No.	694734	Ref. No. —
	door handle L 165mm W 40mm H 25mm black		
	GEV No.	694735	Ref. No. —
	cap ø 32mm black		
accessories for	694065		
	GEV No.	694066	Ref. No. —
	door catch with spigot 2-stage L 28mm W 14mm H 15mm H1 16mm total length 51mm thread M8 thread L 23mm stainless steel		
	GEV No.	694067	Ref. No. 5900124
	door catch with spigot 1-stage L 26mm total length 51mm thread M8		

snap locks

universal



1

GEV No.	690596	Ref. No.	2000160
description	snap lock L 60mm W 15mm H 36mm mounting distance 48/28mm spring thickness 1.5mm complete with door catch zamak		

espagnolette locks

universal



1

GEV No.	690040	Ref. No.	5900122
description	door catch with roller H 42mm L 40mm W 40mm zinc die cast mounting distance 26mm type 0751 series		
For models:	CE06MX, CE102MX, CE10MX, CE20MX, CG06MX, CG102MX, CG10MX, CG20MX, DE06EC, DE06ES, DE06MX, DE102EC, DE102MX, DE10EC, DE10ES, DE10MX, DG06EC, DG06ES, DG06MX, DG102EC, DG102MX, DG10EC, DG10ES, DG10MX, VE06EC, VE06MX, VE102EC, VE102MX, VE10EC, VE10MX, VE20EC, VE20MX, VG06EC, VG06MX, VG102EC, VG102MX, VG10EC, VG10MX, VG20EC, VG20MX		



1

GEV No.	700771	Ref. No.	5900123
description	latch gear opening to the left shaft intake ø 8x8mm L 170mm W 40mm H 40mm		

producer-specific

GIORIK



1

GEV No.	690585	Ref. No.	2011212
description	bush for door mechanism L 35mm ED ø 36mm int. ø 1 31mm int. ø 2 13mm mounting distance 28mm brass		
For models:	CE06MX, CE102MX, CE10MX, CE20MX, CG06MX, CG102MX, CG10MX, CG20MX, DE06EC, DE06ES, DE06MX, DE102EC, DE102MX, DE10EC, DE10ES, DE10MX, DG06EC, DG06ES, DG06MX, DG102EC, DG102MX, DG10EC, DG10ES, DG10MX, VE06EC, VE06MX, VE102EC, VE102MX, VE10EC, VE10MX, VE20EC, VE20MX, VG06EC, VG06MX, VG102EC, VG102MX, VG10EC, VG10MX, VG20EC, VG20MX		



1

GEV No.	690040	Ref. No.	5900122
description	door catch with roller H 42mm L 40mm W 40mm zinc die cast mounting distance 26mm type 0751 series		
For models:	CE06MX, CE102MX, CE10MX, CE20MX, CG06MX, CG102MX, CG10MX, CG20MX, DE06EC, DE06ES, DE06MX, DE102EC, DE102MX, DE10EC, DE10ES, DE10MX, DG06EC, DG06ES, DG06MX, DG102EC, DG102MX, DG10EC, DG10ES, DG10MX, VE06EC, VE06MX, VE102EC, VE102MX, VE10EC, VE10MX, VE20EC, VE20MX, VG06EC, VG06MX, VG102EC, VG102MX, VG10EC, VG10MX, VG20EC, VG20MX		



1

GEV No.	690584	Ref. No.	2013218
description	door handle L 190mm W 41.5mm metal mounting distance 55mm flange 45x72mm shaft 8x8mm shaft L 47mm		

miscellaneous



1

GEV No.	511482	Ref. No.	2006619
description	pressure pin L 52mm thread M10x1.5		
For models:	EF10GM, EF4PM, EF5GM, EF6PM, EF7GM, EF8PM, EN10VE-EC-ESN1033, GF10GM, GF4PM, GF5GM, GF6PM, GF7GM, GF8PM		

fittings for catering equipment

outlet taps

universal



1

GEV No.	541540	Ref. No.	7060031
description	outlet tap stainless steel W 38mm H 40mm thread 3/4" IT		
For models:	FTR10, FTR26F, FTR26T, FTR6F, FTR6T		
spare parts for	541540		
	GEV No.	697834	Ref. No. —
	cone handle thread M6x1 ø 13mm plastic L 53mm black thread L 6mm		

producer-specific

GIORIK



1

GEV No.	540700	Ref. No.	7060018
description	ball valve straight thread 1/2" IT - 1/2" IT connection 1/2" mounting pos. total length 64mm shaft intake ø 9x7.5mm 1/2" rosette thread G2 3/8" total length 64mm		
For models:	22CP, 22CPG, 23CP, 23CPG, 2CP, 2CPG, 3CP, 3CPG, BM711, BM721, BM911, BM921, CP1, CP1BM, CPE66, CPG1, CPG1BM, CPG66		
spare parts for	540700		
	GEV No.	540701	Ref. No. 2001250
	lever handle plastic L 65mm H 40mm thread connection 9x7.5		



1

GEV No.	514006	Ref. No.	7060060
description	drain pipe L 200mm thread ø 22mm		
For models:	BME46, BME66, FP18NS, FP18S, FP27S, FPG18, FRE46, FRE46F, FRE46R, FRE46T, FRE66, FRE66F, FRE66R, FRE66T, FRG46, FRG66		



1

GEV No.	540701	Ref. No.	2001250
description	lever handle plastic L 65mm H 40mm thread connection 9x7.5		
For models:	22CP, 22CPG, 23CP, 23CPG, 2CP, 2CPG, 3CP, 3CPG, CP1, CP1BM, CPE66, CPG1, CPG1BM, CPG66		



1

GEV No.	540776	Ref. No.	7060030
description	outlet tap L 83mm without handle thread 3/4" IT shaft L 9mm shaft ø 10x7.3mm handle M6		
For models:	BME46, BME66, FP18NS, FP18S, FP27S, FPG18, FRE46, FRE46F, FRE46R, FRE46T, FRE66, FRE66F, FRE66R, FRE66T, FRG46, FRG66		
spare parts for	540776		
	GEV No.	532453	Ref. No. —
	O-ring EPDM thickness 2.62mm ID ø 21.89mm Qty 1 pcs		

Table continues overleaf



accessories for		540776		
	GEV No.	110734	Ref. No.	—
	lever for outlet tap			
	GEV No.	514006	Ref. No.	7060060
	drain pipe L 200mm thread ø 22mm			
	GEV No.	514217	Ref. No.	—
	handle for outlet tap			
	GEV No.	540651	Ref. No.	—
	drain pipe total length 210mm shaft ø 22mm			
	GEV No.	540734	Ref. No.	—
	drain pipe thread			
	GEV No.	693082	Ref. No.	—
	lever handle thread			

baskets

fryer baskets

GIORIK

	1			
GEV No.	970583	Ref. No.	2003018	
description	fryer basket L1 260mm W1 220mm H1 100mm chrome-plated steel			
For models:	FT5			

	1			
GEV No.	970577	Ref. No.	2004579	
description	fryer basket L1 270mm W1 185mm H1 120mm chrome-plated steel			
For models:	FRE46F, FRE46T, FRE66F, FRE66T, FTR26F, FTR26T, FTR6F, FTR6T			

	1			
GEV No.	970138	Ref. No.	2003001	
description	fryer basket L1 290mm W1 135mm H1 120mm L2 490mm H2 175mm H3 220mm chrome-plated steel			
For models:	F10CL, F10L, FG07CL, FG07L			

	1			
GEV No.	970357	Ref. No.	2003008	
description	fryer basket L1 290mm W1 165mm H1 120mm chrome-plated steel			

	1			
GEV No.	970356	Ref. No.	2003003	
description	fryer basket L1 290mm W1 230mm H1 120mm chrome-plated steel			
For models:	F15CL, F15L, F215CL, F215L, FG13L, FG213CL, FG213L, FRE46, FRE66, FRG46, FRG66			

	1			
GEV No.	970642	Ref. No.	2010899	
description	fryer basket L1 290mm W1 230mm H1 120mm L2 240mm H2 200mm H3 200mm			
For models:	FTR10			

	1			
GEV No.	970358	Ref. No.	2003009	
description	fryer basket L1 290mm W1 330mm H1 120mm L2 507mm H2 175mm H3 220mm chrome-plated steel			





1

GEV No.	970360	Ref. No.	2012892
description	fryer basket L1 310mm W1 110mm H1 120mm chrome-plated steel		
For models:	213FG, 213FGC, 215FE, 215FEC		



1

GEV No.	970359	Ref. No.	2012898
description	fryer basket L1 310mm W1 130mm H1 120mm chrome-plated steel		
For models:	207FG, 207FGC, 210FE, 210FEC, 922FE, 922FEC, 927FG, 927FGC		
accessories for	970359		
	GEV No.	970632	Ref. No. 2012897
	crumb screen L 338mm W 134mm H 100mm		



1

GEV No.	970362	Ref. No.	2012895
description	fryer basket L1 310mm W1 145mm H1 120mm chrome-plated steel		
For models:	217FG, 217FGC, 220FE, 220FEC, 934FG, 934FGC, 940FE, 940FEC		



1

GEV No.	970361	Ref. No.	2012893
description	fryer basket L1 310mm W1 230mm H1 120mm chrome-plated steel		
For models:	13FG, 13FGC, 15FE, 15FEC, 213FG, 213FGC, 215FE, 215FEC		



1

GEV No.	970363	Ref. No.	2012896
description	fryer basket L1 310mm W1 300mm H1 120mm chrome-plated steel		
For models:	17FG, 17FGC, 20FE, 20FEC, 217FG, 217FGC, 220FE, 220FEC, 917FG, 917FGC, 920FE, 920FEC, 934FG, 934FGC, 940FE, 940FEC		



1

GEV No.	970727	Ref. No.	2003019
description	fryer basket L1 315mm W1 190mm H1 120mm FT7		

pasta baskets

GIORIK



1

GEV No.	970776	Ref. No.	2003080
description	pasta basket H1 210mm ø 145mm H2 320mm H3 370mm stainless steel		



1

GEV No.	970770	Ref. No.	2003046
description	pasta basket H1 215mm W1 290mm L1 160mm H2 410mm		

1

GEV No.	970675	Ref. No.	2101603 3101603
description	pasta basket H1 215mm W1 290mm L1 490mm size GN 1/1		



1

GEV No.	970587	Ref. No.	2003080 old
description	pasta basket ø 145mm H 230mm stainless steel handle length 180mm		



1

GEV No.	970672	Ref. No.	2003047
description	pasta basket H1 230mm W1 143mm L1 160mm size GN 1/6 left		



1

GEV No.	691314	Ref. No.	2001110
description	cylindrical handle thread M8 ø 28mm L 86mm		
For models:	15FE, 15FEC, 20FE, 20FEC, 210FE, 210FEC, 215FE, 215FEC, 220FE, 220FEC, 920FE, 920FEC, 922FE, 922FEC, 940FE, 940FEC, F10CL, F10L, F15CL, F15L, F215CL, F215L		

crumb screens



1

GEV No.	970671	Ref. No.	2003045
description	pasta basket H1 230mm W1 143mm L1 163mm size GN 1/6 right		

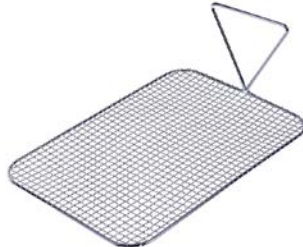

1

GEV No.	970628	Ref. No.	2104581
description	crumb screen L 285mm W 192mm H 100mm		
For models:	FRE46F, FRE46T, FRE66F, FRE66T, FTR26F, FTR26T, FTR6F, FTR6T		



1

GEV No.	970674	Ref. No.	2003075
description	pasta basket H1 230mm W1 300mm L1 330mm size GN 2/3		



1

GEV No.	970629	Ref. No.	2101364
description	crumb screen L 315mm W 235mm		
For models:	F15CL, F15L, F215CL, F215L, FG13L, FG213CL, FG213L, FRE46, FRE66, FRG46, FRG66		

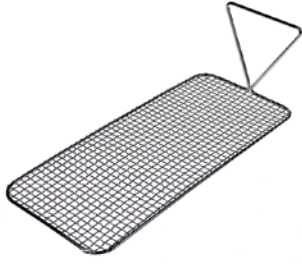

GEV No.	970632	Ref. No.	2012897
description	crumb screen L 338mm W 134mm H 100mm		
For models:	207FG, 207FGC, 210FE, 210FEC, 922FE, 922FEC, 927FG, 927FGC		

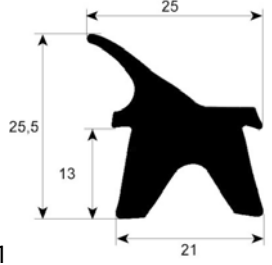

GEV No.	901351	Ref. No.	7070173
description	door seal profile 2402 W 490mm L 635mm external size		

gaskets

gaskets for heated units

window seals

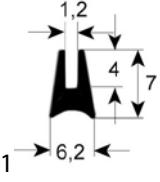

GEV No.	900440	Ref. No.	7070167
description	window gasket profile 1520 Qty supplied by meter		
For models:	CE06MX, CE102MX, CE10MX, CE20MX, CG06MX, CG102MX, CG10MX, CG20MX, DE06EC, DE06MX, DE102EC, DE102MX, DE10EC, DE10MX, DG06EC, DG06MX, DG102EC, DG102MX, DG10EC, DG10MX, VE06EC, VE06MX, VE102EC, VE102MX, VE10EC, VE10MX, VE20EC, VE20MX, VG06EC, VG06MX, VG102EC, VG102MX, VG10EC, VG10MX, VG20EC, VG20MX		

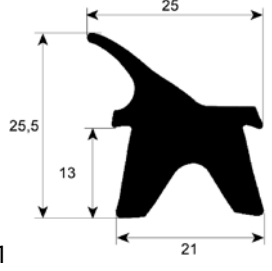

GEV No.	901158	Ref. No.	7070174
description	door seal profile 2402 W 640mm L 740mm		
For models:	EN10VE-EC-ESN1033		

door seals

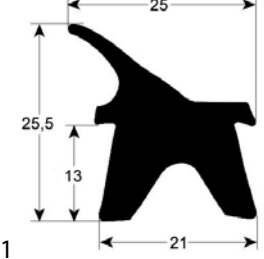

GEV No.	900348	Ref. No.	7070162 7070170 7070172 7070185
description	door seal profile 2402 Qty supplied by meter		
For models:	EF10GM, EF4, EF4PM, EF5GM, EF8PM, GF10GM, GF4PM, GF5GM, GF8PM		

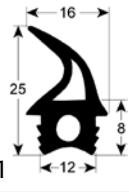

GEV No.	902409	Ref. No.	7070100
description	door seal profile 2714 Qty supplied by meter suitable for GIORIK		

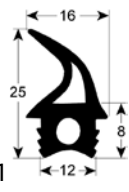

GEV No.	902410	Ref. No.	7070194
description	door seal profile 2714 W 438mm L 778mm suitable for GIORIK		

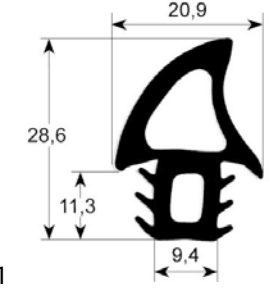

GEV No.	900439	Ref. No.	7070166
description	door seal profile 2750 Qty supplied by meter		
For models:	CE06MX, CE102MX, CE10MX, CE20MX, CG06MX, CG102MX, CG10MX, CG20MX, DE06EC, DE06ES, DE06MX, DE102EC, DE102MX, DE10EC, DE10ES, DE10MX, DG06EC, DG06ES, DG06MX, DG102EC, DG102MX, DG10EC, DG10ES, DG10MX, VE06EC, VE06MX, VE102EC, VE102MX, VE10EC, VE10MX, VE20EC, VE20MX, VG06EC, VG06MX, VG102EC, VG102MX, VG10EC, VG10MX, VG20EC, VG20MX		



O-rings

EPDM

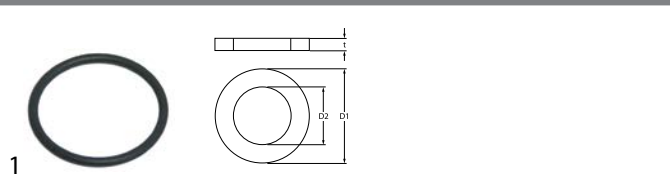

GEV No.	100809	Ref. No.	0925034
description	O-ring EPDM thickness 2mm ID ø 21mm Qty 1 pcs		

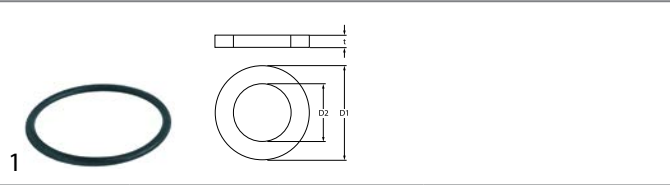

GEV No.	532118	Ref. No.	6090145
description	O-ring EPDM thickness 3.53mm ID ø 55.56mm Qty 10 pcs		
For models:	15FE, 15FEC, 20FE, 20FEC, 210FE, 210FEC, 215FE, 215FEC, 220FE, 220FEC, 920FE, 920FEC, 922FE, 922FEC, 940FE, 940FEC, F10CL, F10L, F15CL, F15L, F215CL, F215L, FP18NS, FP18S, FP27S, FRE46, FRE66		

Viton

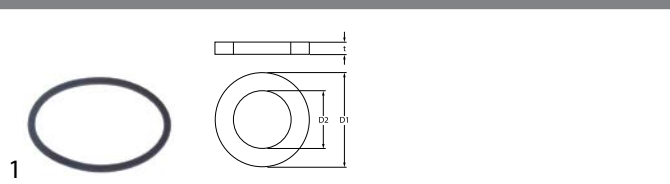

GEV No.	525313	Ref. No.	6090140
description	O-ring Viton ID ø 60.33mm thickness 3.53mm Qty 1 pcs		
For models:	EF10GM, EF4PM, EF5GM, EF6PM, EF7GM, EF8PM, GF10GM, GF4PM, GF5GM, GF6PM, GF7GM, GF8PM		

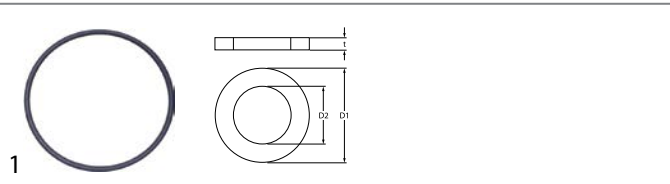

GEV No.	532649	Ref. No.	6090141
description	O-ring Viton ID ø 63.17mm thickness 2.62mm Qty 1 pcs		
For models:	EF10GM, EF4PM, EF5GM, EF6PM, EF7GM, EF8PM, GF10GM, GF4PM, GF5GM, GF6PM, GF7GM, GF8PM		

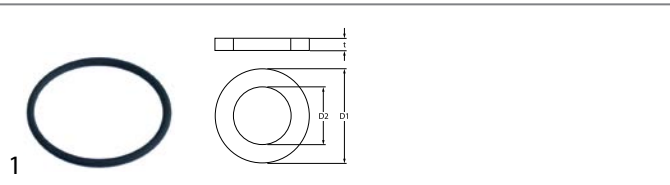

GEV No.	550496	Ref. No.	6090144
description	O-ring Viton thickness 3.53mm ID ø 50.39mm Qty 1 pcs		
For models:	15FE, 15FEC, 20FE, 20FEC, 210FE, 210FEC, 215FE, 215FEC, 220FE, 220FEC, 920FE, 920FEC, 922FE, 922FEC, 940FE, 940FEC, F10CL, F10L, F15CL, F15L, F215CL, F215L, FP18NS, FP18S, FP27S, FRE46, FRE66		

shaft gaskets

shaft gaskets



GEV No.	550549	Ref. No.	7070150
description	shaft sealing for fan motor		
For models:	CE06MX, CG06MX, DE06EC, DE06ES, DE06MX, DG06EC, DG06ES, DG06MX, VE06EC, VE06MX, VG06EC, VG06MX		

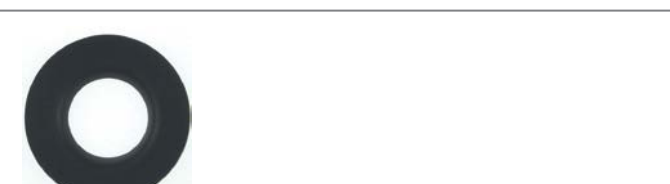

GEV No.	550550	Ref. No.	7070151
description	shaft sealing for fan motor		
For models:	CE102MX, CE10MX, CE20MX, CG102MX, CG10MX, CG20MX, DE102EC, DE102MX, DE10EC, DE10ES, DE10MX, DG102EC, DG102MX, DG10EC, DG10ES, DG10MX, VE102EC, VE102MX, VE10EC, VE10MX, VE20EC, VE20MX, VG102EC, VG102MX, VG10EC, VG10MX, VG20EC, VG20MX		

hoses

industrial hoses

PE hoses

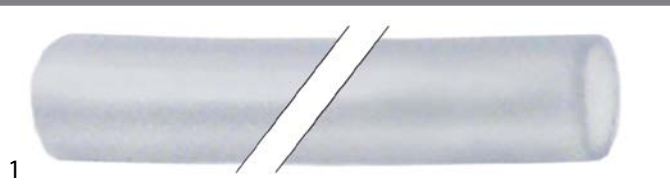

GEV No.	520549 ¹	Ref. No.	7090128
description	hose Lm operating p. 6bar burst p. 10bar t.max. 65°C LLDPE transparent ID ø 6mm ED ø 8mm John Guest supplied by meter		

¹by the meter

fittings, hose and pipe connectors

fittings

angle pieces

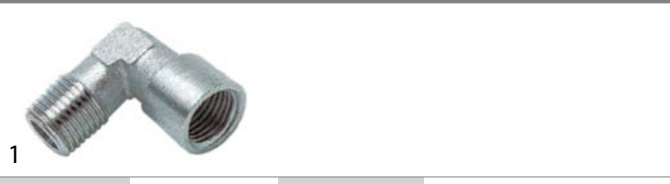

GEV No.	520824	Ref. No.	7050374
description	angle piece thread 1/8" ET - 1/8" IT nickel-plated brass		

tools

hand tools

wrenches

miscellaneous



1

GEV No.	550449	Ref. No.	2010311
description	special wrench for ring nut		

A		I	
alarm devices	19	ignition boxes	33
axial fans	25	ignition cables	38
B		ignition units	39
bar burners	41	immersion heating elements	8
C		indicator lights	17
cam switches	15	indicator lights (complete)	17
ceramic burners	43	industrial hoses	53
condensators & interference suppression filters	27	L	
contactors	20	lamps	17
control thermostats	10	light bulbs	17
D		M	
door seals	52	mechanical timers	19
E		microswitches	14
electric accessories	27	O	
electric timers	19	O-rings	53
electronic controllers	22	oven lamps	18
energy regulators	10	P	
espagnolette locks	47	PE hoses	53
F		piezoelectric igniters	39
fans	25	pilot burners	33
filters	27	probes	22
fittings	53	push/momentary push switches	13
G		R	
gas burners	40	radiation heaters	9
gas control valves	32	relays	20
gas nozzles	43	rod thermostats	13
gas taps	28	rotary switches	16
gas thermostats	29	S	
gaskets for heated units	52	safety rod thermostats	13
H		safety thermostats	11
halogen lamp	18	shaft gaskets	53
hand tools	54	snap locks	47
heating elements	3	solenoid valves	24
heating elements for bain maries	3	switches and momentary switches	13
heating elements for chip scuttles	3	T	
heating elements for convection	9	temperature probes	22
heating elements for fryers	3	terminals	27
heating elements for pasta cookers	6	thermocouples	39
heating elements for salamanders/toasters	6	thermostats	10
hob burners	40	time relays	21
hoses	53	timers	19
hot air motors	26	tools	54
hot plates	10	transformers	21
		tube burners	42

U

universal probes 22

W

window seals 52

wrenches 54