



**GAS COMPONENTS**



**ELECTRIC COMPONENTS**



**WATER TECHNOLOGY**



**MECHANICAL COMPONENTS**



**TOOLS**

Spare parts suitable for

**GIERRE**

Find the complete and up-to-date range of products in our GEV Webshop



# Manufacturer catalogue

The most important spare parts and accessories arranged clearly for every manufacturer

- ✓ Complete product range and all appliance data always up to date in the GEV Webshop
- ✓ Alphabetical Index at the end of the catalogue

## GEV Webshop

[www.gev-online.co.uk](http://www.gev-online.co.uk)

[www.gev-online.com](http://www.gev-online.com)



- 🔍 Add to Favourites
- 🔍 Sign In with email address and usual password
- 🔍 Easy-order – place several items in your basket at the same time
- 🔍 Quick Item search – no login needed

## heating elements

### heating elements for ovens

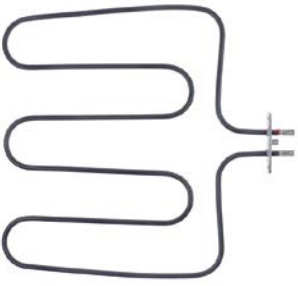

1

<b>GEV No.</b>	418792	<b>Ref. No.</b>	RES155
<b>description</b>	heating element 1400W 230V heating circuits 1 L 315mm W 320mm L1 55mm L2 260mm W1 150mm W2 30mm flange length 70mm flange width 22mm hole distance 56mm hole ø 4.2mm tube ø 6.3mm connection male faston 6.3mm rectangular flange		

### heating cables

connection on both sides

with wire end ferrules



1

<b>GEV No.</b>	419147	<b>Ref. No.</b>	R016781
<b>description</b>	heating cable 7W 230V L 3250mm L1 (unheated) 1150mm L2 (heated) 1050mm silicone ø 3mm		

### immersion heating elements



1

<b>GEV No.</b>	416149	<b>Ref. No.</b>	PRO065/5
<b>description</b>	heating element 7500W 220V heating circuits 6 L 310mm W 145mm H 130mm thermostat sleeves ø 6mm length thermostat sleeves 125mm number of thermostat sleeves 1 connection male faston 6.3mm special fixing		



1

<b>GEV No.</b>	418111	<b>Ref. No.</b>	PRO065/5
<b>description</b>	heating element 7500W 220V heating circuits 6 L 310mm W 145mm H 130mm thermostat sleeves ø 6x4mm length thermostat sleeves 137/125mm number of thermostat sleeves 2 thermostat sleeve clinging / not clinging connection male faston 6.3mm immersion heater special fixing		
<b>accessories for</b>	418111		
	<b>GEV No.</b>	<b>Ref. No.</b>	—
			 gasket silicone thickness 7mm ID ø 193.7mm Qty 1 pcs for heating element suitable for BARON equiv. no. A037485

### heating elements for convection



1

<b>GEV No.</b>	418998	<b>Ref. No.</b>	KITRES230
<b>description</b>	heating element 3000W 230V heating circuits 1 ID ø 182mm ED ø 195mm L 245mm H 52mm L1 45mm W1 30mm H1 25mm H2 27mm flange length 70mm flange width 22mm hole distance 56mm connection male faston 6.3mm connection length 44mm tube ø 6.2mm convection heating element hole ø 5mm		



1

<b>GEV No.</b>	418503	<b>Ref. No.</b>	RES101
<b>description</b>	heating element 7500W 230V heating circuits 3 ID ø 299mm ED ø 316mm L 350mm H 106mm L1 27mm W1 105mm H1 16mm H2 90mm flange length 142mm flange width 25mm hole distance 63mm connection M4 connection length 72mm tube ø 8.5mm convection heating element hole ø 6.3mm rectangular flange		



## energy regulators

EGO

1-circuit



<b>GEV No.</b>	380015	<b>Ref. No.</b>	SIM123
<b>description</b>	energy regulator 230V 13A single-circuit turn direction right shaft ø 6x4.6mm shaft L 23mm mounting thread M4 power release 6-100% no. 50.57021.010		

## thermostats

bi-metal thermostats

bi-metal thermostats



<b>GEV No.</b>	390148	<b>Ref. No.</b>	PRO065/8
<b>description</b>	bi-metal thermostat hole distance 23.5mm switch-off temp. 90°C 1NC 1-pole 16A connection F6.3 with flange		

control and safety thermostats

EGO

control thermostats

55.10/19\_ series



<b>GEV No.</b>	375983	<b>Ref. No.</b>	TER110
<b>description</b>	thermostat t.max. 262°C temperature range 50-255°C 1-pole 1NO 16A probe ø 3mm probe L 230mm capillary pipe 900mm capillary pipe isolated 350mm gland nut M10x1 shaft ø 6x4.6mm shaft L 23mm shaft position upper rotation 270° probe material SS		

E·G·O

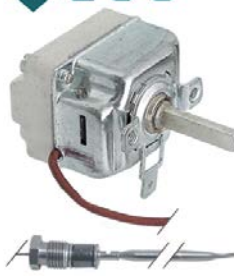

<b>GEV No.</b>	375652	<b>Ref. No.</b>	TER114
<b>description</b>	thermostat t.max. 266°C temperature range 50-255°C 1-pole 1NO 16A probe ø 3mm probe L 219mm capillary pipe 900mm capillary pipe isolated 350mm gland nut M10x1 shaft ø 6x4.6mm shaft L 23mm shaft position upper rotation 270°		

E·G·O

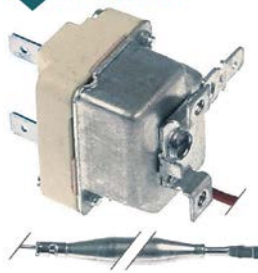

<b>GEV No.</b>	375806	<b>Ref. No.</b>	TER145
<b>description</b>	thermostat t.max. 85°C temperature range fixed 85°C 1-pole 1CO 16A probe ø 6mm probe L 75mm capillary pipe 900mm capillary pipe isolated 700mm gland nut		

safety thermostats

55.10/19\_ series

E·G·O



<b>GEV No.</b>	375807	<b>Ref. No.</b>	TER116
<b>description</b>	safety thermostat switch-off temp. 320°C 1-pole 16A probe ø 6mm probe L 77mm capillary pipe 870mm capillary pipe isolated 660mm gland nut M10x1 probe		



CAEM

safety thermostats



<b>GEV No.</b>	375000	<b>Ref. No.</b>	PRO065/4
<b>description</b>	safety thermostat switch-off temp. 135°C 1-pole 16A/250VA probe ø 6mm probe L 80mm capillary pipe 540mm capillary pipe isolatedmm gland nut copper		

PRODIGY / FIRT

control thermostats with operation switch

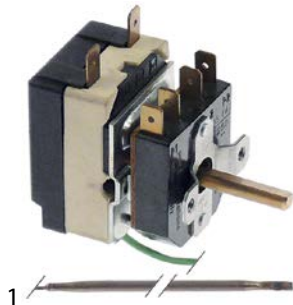

<b>GEV No.</b>	420445	<b>Ref. No.</b>	TER123
<b>description</b>	thermostat t.max. 300°C temperature range 50-300°C 1-pole 1NO 16A probe ø 3mm probe L 190mm capillary pipe 1015mm capillary pipe isolated 795mm gland nut shaft ø 6x4.6mm shaft L 24mm shaft position° shaft position upper rotation 270° outer switch 2NO		

switches and momentary switches

microswitches

lever actuated



<b>GEV No.</b>	345044	<b>Ref. No.</b>	MIC500
<b>description</b>	microswitch with lever 250V 16A 1CO connection male faston 6.3mm ambient temperature max. 85°C mounting distance 25mm type C99ZP3 actuating force: 25g lever length 71mm		

cam switches

on/off



<b>GEV No.</b>	300129	<b>Ref. No.</b>	COM123
<b>description</b>	cam switch 2 operating positions 2NO sequence 0-1 16A shaft ø 6x4.6mm shaft L 23mm connection male faston 6.3mm ceramic		

3 operating positions

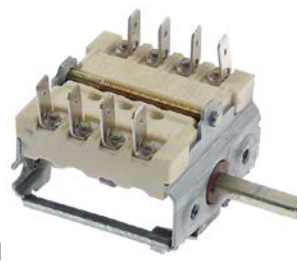

<b>GEV No.</b>	301315	<b>Ref. No.</b>	COM140
<b>description</b>	cam switch 3 operating positions 4NO sequence 1-0-2 16A shaft ø 6x4.6mm shaft L 23mm connection male faston 6.3mm 49.44915.712 ceramic		

rotary switches

BREMAS

A1200 series



<b>GEV No.</b>	346600	<b>Ref. No.</b>	COM160
<b>description</b>	rotary switch sets of contacts 8 4 0-1-2-3 type CS012461B 400V 12A shaft ø 4x5mm shaft L 25mm shaft square connection male faston 6.3mm		





## control equipment

## SIEMENS

## 3SB series ø22mm new



1

<b>GEV No.</b>	346602	<b>Ref. No.</b>	SEL560/2
<b>description</b>	contact block SIEMENS 3SB3400-0D 2NO max 400V 10A black		



1

<b>GEV No.</b>	346603	<b>Ref. No.</b>	SEL560/3
<b>description</b>	contact block SIEMENS 3SB3400-0E 2NC max 400V 10A black		

## rotary switches

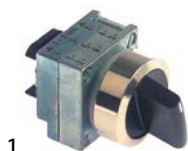

1

<b>GEV No.</b>	346601	<b>Ref. No.</b>	SEL560
<b>description</b>	rotary selector mounting measurements ø22mm black latching sequence 0-1		

## accessories for 346601



<b>GEV No.</b>	346602	<b>Ref. No.</b>	SEL560/2
<b>description</b>	contact block SIEMENS 3SB3400-0D 2NO max 400V 10A black		



<b>GEV No.</b>	346603	<b>Ref. No.</b>	SEL560/3
<b>description</b>	contact block SIEMENS 3SB3400-0E 2NC max 400V 10A black		



<b>GEV No.</b>	346630	<b>Ref. No.</b>	—
<b>description</b>	contact block SIEMENS 3SB3400-0B 1NO max 400V 10A black		



<b>GEV No.</b>	346631	<b>Ref. No.</b>	—
<b>description</b>	contact block SIEMENS 3SB3400-0C 1NC max 400V 10A black		



<b>GEV No.</b>	346632	<b>Ref. No.</b>	—
<b>description</b>	contact block SIEMENS 3SB3400-0D 1NC/1NO max 400V 10A black		

## lamps

## indicator lights

## indicator lights (complete)

ø10mm

with plug-in socket



1

<b>GEV No.</b>	359019	<b>Ref. No.</b>	SEG311
<b>description</b>	indicator light ø 10mm green 400V connection male faston 6.3mm Qty 1 pcs		



1

<b>GEV No.</b>	359034	<b>Ref. No.</b>	SEG312
<b>description</b>	indicator light ø 10mm yellow 400V connection male faston 6.3mm Qty 1 pcs		

## screw-on/push-on fit

## halogen lamp

for socket G4 / G6.35 / G9



1

<b>GEV No.</b>	359599	<b>Ref. No.</b>	LAM125
<b>description</b>	halogen lamp socket G4 12V 20W temp.-resist. 500°C		

## oven lamps

## lamps

## halogen lamps

for socket G4 / G6.35 / G9



1

<b>GEV No.</b>	359599	<b>Ref. No.</b>	LAM125
<b>description</b>	halogen lamp socket G4 12V 20W temp.-resist. 500°C		

## sockets

G4 / G5,3 / G6,35



1

<b>GEV No.</b>	359369	<b>Ref. No.</b>	POR150/3
<b>description</b>	lamp socket socket G4/G5.3/G6.35 24V ø 17mm H 10mm connection cable 120mm mounting distance 11.5mm for halogen lamp cable length 730mm		



## timers

### programme timers

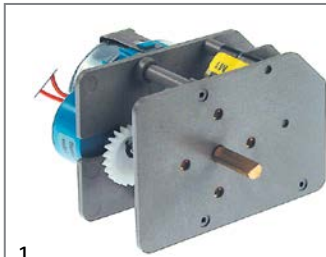

1

<b>GEV No.</b>	360334	<b>Ref. No.</b>	TEM105
<b>description</b>	timer FIBER P04 engines 1 chambers 2 operation time 120min 230V shaft $\varnothing$ 6x4.6mm shaft L 20mm manuf. no. P045J02W401 motor type M51BJ0R6400 impulse electric		
<b>spare parts for</b>	360334		
	<b>GEV No.</b>	360673	<b>Ref. No.</b> —
	motor kit pinion $\varnothing$ 6.8mm teeth 15 230V voltage AC 50/60Hz turn direction clockwise motor $\varnothing$ 48mm H 18.5mm motor type UDS-40NE1RNZ165 cable length 150mm with holder		

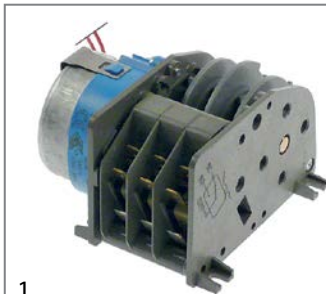

1

<b>GEV No.</b>	360627	<b>Ref. No.</b>	TEM115
<b>description</b>	timer FIBER P255J03H9U3c engines 1 chambers 3 operation time 6min 230V 50/60Hz shaft $\varnothing$ mm shaft Lmm motor type M51BJ0R00AA		

## alarm devices

### buzzer boards



1

<b>GEV No.</b>	401062	<b>Ref. No.</b>	TEM105/1
<b>description</b>	buzzer board 230VAC L 48mm W 45mm connection Faston 6.3mm		

## contactors

### LOVATO

#### power contactors



1

<b>GEV No.</b>	380083	<b>Ref. No.</b>	TEL144
<b>description</b>	power contactor resistive load 25A 230VAC (AC3/400V) 9A/4.2kW main contacts 3NO auxiliary contacts 1NC connection screw connection type BF0901A230		



1

<b>GEV No.</b>	380714	<b>Ref. No.</b>	TEL145
<b>description</b>	power contactor resistive load 25A 230VAC (AC3/400V) 9A/4.2kW main contacts 3NO auxiliary contacts 1NO connection screw connection type BF0910A230		

#### overload switches



1

<b>GEV No.</b>	380752	<b>Ref. No.</b>	TER213
<b>description</b>	overload switch setting range 1.6-2.5A for contactors BF (09-38) series connection screw		

## relays

### level relays

#### GICAR



1

<b>GEV No.</b>	401224	<b>Ref. No.</b>	PRO065/1
<b>description</b>	level relay 230V connection F6.3 type RL30/3ES/F/G		

## transformers

### for lighting



1

<b>GEV No.</b>	401570	<b>Ref. No.</b>	POR150/5
<b>description</b>	transformer primary 230V secondary 12V 105W		

## electronic controllers

### DIXELL

#### universal controllers



1

<b>GEV No.</b>	378008	<b>Ref. No.</b>	TER130
<b>description</b>	electronic controller DIXELL type XT110C-0C0KU- mounting measurements 71x29mm 12V voltage AC/DC NTC/PTC/Pt100/TC(J,K) relay outputs 1 CO-8A(3) NTC/PTC/Pt100/Pt1000/TC(J,K) DI defr. funct. dependent on probe°C display 3½ digits		



1

<b>GEV No.</b>	378007	<b>Ref. No.</b>	TER129
<b>description</b>	electronic controller DIXELL type XT111C-0C0TU mounting measurements 71x29mm 12V voltage AC/DC NTC/PTC/Pt100/TC(J,K) relay outputs 2 CO-8A(3) NO-5A(3) NTC/PTC/Pt100/TC(J,K) DI yes defr. funct. no dependent on probe°C display 3½ digits		

## probes

### producer-specific probes

#### probes



1

<b>GEV No.</b>	378009	<b>Ref. No.</b>	TER137
<b>description</b>	temperature probe thermocouple K (NiCr-Ni) cable silicone probe -50 up to 1150°C cable -50 up to +180°C connection 2-wire thread 1/8" probe ø3x200mm cable length 1m		

## solenoid valves

### solenoid valves (water)

#### RPE



1

<b>GEV No.</b>	370379	<b>Ref. No.</b>	VAL110
<b>description</b>	solenoid valve double straight 230VAC inlet 3/4" outlet 1/4" DN10 RPE plastic inlet 3/4"mm		

## ball valves electric



1

<b>GEV No.</b>	400460	<b>Ref. No.</b>	VAL555
<b>description</b>	ball valve inlet 3/4" IT outlet 3/4" IT 230V L 68mm 50/60Hz mode of operation electric		

## electrodes



1

<b>GEV No.</b>	400377	<b>Ref. No.</b>	PRO065/3
<b>description</b>	level electrode 1/4" total length 183mm probe L 158mm insulated probe length 114mm PTFE insulated connection male faston 6.3mm stainless steel ø 2.5mm		





1





<b>GEV No.</b>	400260	<b>Ref. No.</b>	PRO065/2
<b>description</b>	level electrode 1/4" total length 220mm probe L 195mm insulated probe length 185mm PTFE insulated connection male faston 6.3mm stainless steel ø 2.5mm		
<b>accessories for</b>	400260		
	<b>GEV No.</b>	521003	<b>Ref. No.</b> —
	nut thread 1/4" H 6.3mm chrome-plated brass WS 20 Qty 1 pcs		

**fans**

hot air motors

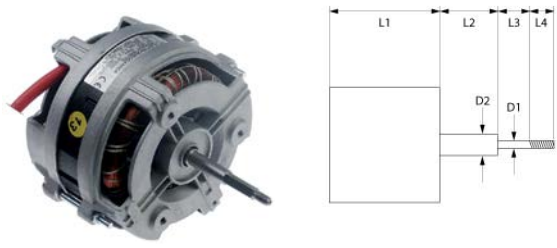
1



<b>GEV No.</b>	601648	<b>Ref. No.</b>	MOT300
<b>description</b>	fan motor 220-240V 1 phase 50/60Hz 0.12kW 2800/3400rpm speeds 1 L1 95mm L2 32mm L3 23mm L4 12mm D1 ø 6x8mm D2 ø 10mm M6R ET 0.9A power input 0.12W at 50Hz 2800rpm at 60Hz 3400rpm suitable capacitor 6.3µF/450V		
<b>accessories for</b>	601648		
	<b>GEV No.</b>	365012	<b>Ref. No.</b> —
	operating capacitor capacity 6.3µF 450V tolerance 5% 50Hz ambient temperature max. -25 to +85°C ø 30mm L 61 mm M8 plastic connection male faston 6.3mm protection		

1

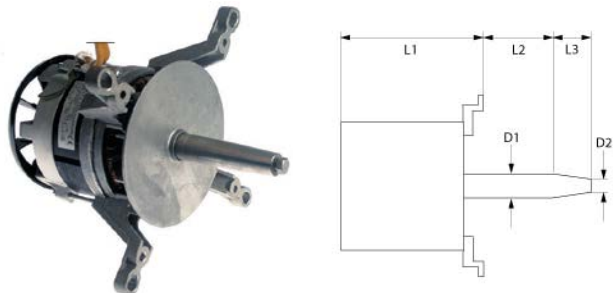

<b>GEV No.</b>	601356	<b>Ref. No.</b>	MOT103
<b>description</b>	fan motor 220-240V 1 phase 50Hz 0.37kW 1400rpm speeds 1 L1 168mm L2 45mm L3 47mm D1 ø 24mm D2 ø 20mm M8L IT 2A suitable capacitor 12.5µF/400V at 50Hz 1400rpm type 1021S2250		

1

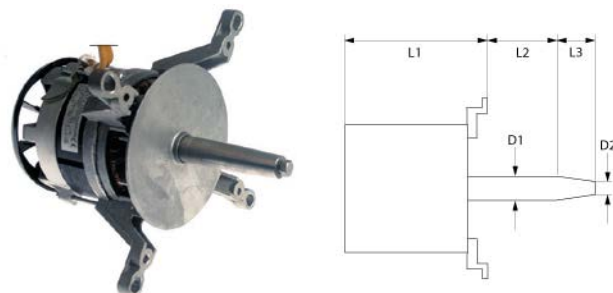

<b>GEV No.</b>	601544	<b>Ref. No.</b>	MOT101
<b>description</b>	fan motor 230/400V 3 phase 50Hz 0.5HP 1350rpm speeds 1 L1 168mm L2 45mm L3 27mm D1 ø 24mm D2 ø 20mm M8L IT 1.8/1A at 50Hz 1350rpm type FIR 1021		

1



<b>GEV No.</b>	601355	<b>Ref. No.</b>	VEN127
<b>description</b>	fan wheel D1 ø 270mm H1 100mm blades 12 D2 ø 19.5mm D3 ø 23mm H2 45mm		

1



<b>GEV No.</b>	602023	<b>Ref. No.</b>	VEL100
<b>description</b>	fan wheel D1 ø 270mm H1 120mm blades 12 D2 ø 19.5mm D3 ø 23mm H2 46mm		



hot air fans

miscellaneous



1

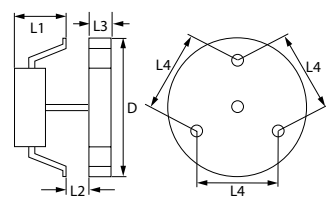

<b>GEV No.</b>	601509	<b>Ref. No.</b>	KITMOT204.01001 ZMOT214
<b>description</b>	hot air fan 220-240V 40W 50-60Hz L1 70mm L2 12mm L3 30mm L4 87mm fan wheel ø 155mm PLASET 57981		

accessories

miscellaneous



1

<b>GEV No.</b>	550879	<b>Ref. No.</b>	ZMOT214/1
<b>description</b>	insulation ø 130mm thickness 3mm hole ø 20mm for hot air fan		

gas valves and ignition boxes

ignition boxes

SIT



1

<b>GEV No.</b>	102303	<b>Ref. No.</b>	ELE300/1
<b>description</b>	ignition box SIT type 501EFD electrodes 2 waiting time 1.5s safety time 5s 250V 10VA 50-60Hz		

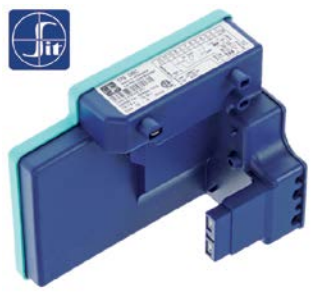

1

<b>GEV No.</b>	107850	<b>Ref. No.</b>	ELE500/1
<b>description</b>	ignition box SIT type 579DBC electrodes 2 waiting time 1.5s safety time 6s 220/240V 12VA 50/60Hz		

knobs

producer-specific knobs

GIERRE



1

<b>GEV No.</b>	110000	<b>Ref. No.</b>	MAN122 MAN125
<b>description</b>	knob switch zero mark ø 50mm shaft ø 6x4.6mm shaft flat upper black		

locks

handle latches

universal

inside fixing

locks







1

<b>GEV No.</b>	694054	<b>Ref. No.</b>	MAN710	
<b>description</b>	door handle for headed units L 145mm W 40mm H 62mm spring length 33mm inner black			
<b>spare parts for</b>	694054			
	<b>GEV No.</b>	514390	<b>Ref. No.</b>	—
	spring for door handle ø 6mm L 54mm W 27.5mm			
	<b>GEV No.</b>	694675	<b>Ref. No.</b>	—
	door catch L 88mm W 40mm H 37mm spring length 33mm mounting distance 60mm			
	<b>GEV No.</b>	694734	<b>Ref. No.</b>	—
	door handle L 165mm W 40mm H 25mm black			

Table continues overleaf



<b>spare parts for</b>	694054		
	GEV No.	694735	Ref. No. —
	cap ø 32mm black		
<b>accessories for</b>	694054		
	GEV No.	691123	Ref. No. —
	duct for door opener		
	GEV No.	694055	Ref. No. —
	door catch L 25mm W 14mm total length 54mm thread M8 thread L 29mm		
	GEV No.	694066	Ref. No. —
	door catch with spigot 2-stage L 28mm W 14mm H 15mm H1 16mm total length 51mm thread M8 thread L 23mm stainless steel		
	GEV No.	694067	Ref. No. MAN710/1
	door catch with spigot 1-stage L 26mm total length 51mm thread M8		

<b>accessories for</b>	694054		
	GEV No.	691123	Ref. No. —
	duct for door opener		
	GEV No.	694055	Ref. No. —
	door catch L 25mm W 14mm total length 54mm thread M8 thread L 29mm		
	GEV No.	694066	Ref. No. —
	door catch with spigot 2-stage L 28mm W 14mm H 15mm H1 16mm total length 51mm thread M8 thread L 23mm stainless steel		
	GEV No.	694067	Ref. No. MAN710/1
	door catch with spigot 1-stage L 26mm total length 51mm thread M8		

## producer-specific

### GIERRE

	1		
<b>GEV No.</b>	693840	<b>Ref. No.</b>	PIA530
<b>description</b>	base plate L 75mm W 35mm H 4mm for door handle mounting distance 60mm		

	1		
<b>GEV No.</b>	694067	<b>Ref. No.</b>	MAN710/1
<b>description</b>	door catch with spigot 1-stage L 26mm total length 51mm thread M8		

	1		
<b>GEV No.</b>	694054	<b>Ref. No.</b>	MAN710
<b>description</b>	door handle for headed units L 145mm W 40mm H 62mm spring length 33mm inner black		
<b>spare parts for</b>	694054		
	GEV No.	514390	Ref. No. —
	spring for door handle ø 6mm L 54mm W 27.5mm		
	GEV No.	694675	Ref. No. —
	door catch L 88mm W 40mm H 37mm spring length 33mm mounting distance 60mm		
	GEV No.	694734	Ref. No. —
	door handle L 165mm W 40mm H 25mm black		
	GEV No.	694735	Ref. No. —
	cap ø 32mm black		

## hinges

### oven hinges

	1		
<b>GEV No.</b>	694354	<b>Ref. No.</b>	CER145
<b>description</b>	oven hinge mounting distance 118mm lug mounting 13mm lever length 119mm groove distance 12mm spring thickness 4mm mounting ear position left spring length 53mm L 154mm W 22mm		

	1		
<b>GEV No.</b>	694353	<b>Ref. No.</b>	CER146
<b>description</b>	oven hinge mounting distance 118mm lug mounting 13mm lever length 119mm groove distance 12mm spring thickness 4mm mounting ear position right spring length 53mm L 154mm W 22mm Qty 1 pcs		

# gaskets

## gaskets for heated units

### window seals

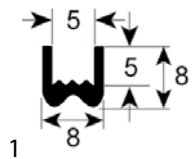

<b>GEV No.</b>	900868	<b>Ref. No.</b>	GUA540
<b>description</b>	window gasket profile 1575 L 2020mm Qty 1		

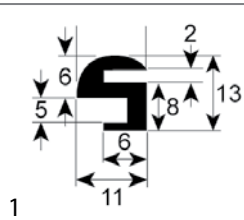

<b>GEV No.</b>	900869	<b>Ref. No.</b>	GUA520
<b>description</b>	window gasket profile 1873 L 1850mm Qty 1		

### door seals

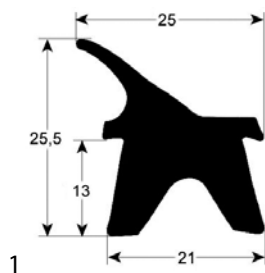

<b>GEV No.</b>	901690	<b>Ref. No.</b>	GUA065 GUA124
<b>description</b>	door seal profile 2402 W 640mm L 890mm external size 4-piece		

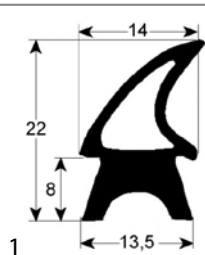

<b>GEV No.</b>	901688	<b>Ref. No.</b>	GUA400
<b>description</b>	door seal profile 2455 W 465mm L 745mm external size		

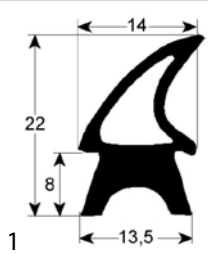

<b>GEV No.</b>	900770	<b>Ref. No.</b>	GUA500
<b>description</b>	door seal profile 2455 W 475mm L 650mm external size Qty 1		

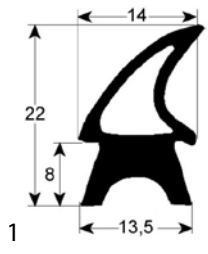

<b>GEV No.</b>	901689	<b>Ref. No.</b>	GUA090 GUA600
<b>description</b>	door seal profile 2455 W 635mm L 1700mm external size		

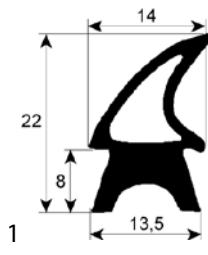

<b>GEV No.</b>	900771	<b>Ref. No.</b>	GUA510
<b>description</b>	door seal profile 2455 W 650mm L 870mm external size Qty 1		

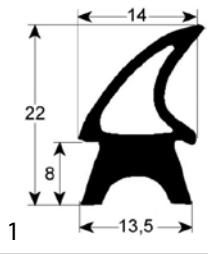

<b>GEV No.</b>	901687	<b>Ref. No.</b>	GUA410
<b>description</b>	door seal profile 2455 W 745mm L 865mm external size		

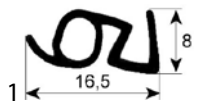

<b>GEV No.</b>	900772	<b>Ref. No.</b>	GUA320
<b>description</b>	door seal profile 2926 L 1500mm Qty 1		



door seals with fixing hook



1

<b>GEV No.</b>	900774	<b>Ref. No.</b>	GUA315
<b>description</b>	oven gasket L 660mm W 350mm with 6 mounting clips external size		

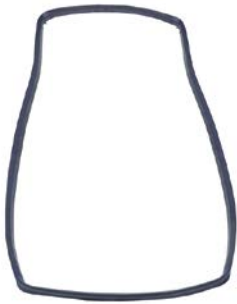

1

<b>GEV No.</b>	900773	<b>Ref. No.</b>	GUA312
<b>description</b>	oven gasket L 670mm W 280mm with 6 mounting clips external size		

O-rings

silicone



1

<b>GEV No.</b>	532488	<b>Ref. No.</b>	PRO065/7
<b>description</b>	O-ring silicone thickness 6.99mm ID ø 196.22mm Qty 1 pcs		

foam rubber gaskets



1

<b>GEV No.</b>	900867	<b>Ref. No.</b>	GUA310
<b>description</b>	foam rubber gasket W 10mm thickness 3mm self-adhesive Qty supplied by meter		

valves and tank inlets

ball valves

ball valves electric



1

<b>GEV No.</b>	400460	<b>Ref. No.</b>	VAL555
<b>description</b>	ball valve inlet 3/4" IT outlet 3/4" IT 230V L 68mm 50/60Hz mode of operation electric		

water cycle components

pressure reduction valves

pressure reduction valves

producer-specific



1

<b>GEV No.</b>	541185	<b>Ref. No.</b>	MIC510
<b>description</b>	pressure controller Metal Work series Bit MRA connection 1/4" default setting bar setting range 0-8bar p max 13bar t.max. 50°C plastic thread 1/4"		

accessories

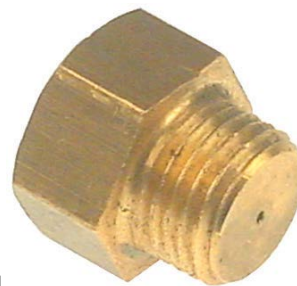

1

<b>GEV No.</b>	693841	<b>Ref. No.</b>	UGE655
<b>description</b>	nozzle for safety valve		





# fastening material

## fasteners

### roll pins



1

<b>GEV No.</b>	691637	<b>Ref. No.</b>	SPI102
<b>description</b>	roll pin ø 3mm L 20mm		

<b>A</b>		
alarm devices	7	
<b>B</b>		
ball valves	13	
ball valves electric	8, 13	
bi-metal thermostats	4, 4	
<b>C</b>		
cam switches	5	
contactors	7	
control equipment	6	
control thermostats	4	
<b>D</b>		
door seals	12	
door seals with fixing hook	13	
<b>E</b>		
electrodes	8	
electronic controllers	8	
energy regulators	4	
<b>F</b>		
fans	9	
fasteners	14	
fastening material	14	
foam rubber gaskets	13	
<b>G</b>		
gaskets for heated units	12	
<b>H</b>		
halogen lamp	6	
heating cables	3	
heating elements	3	
heating elements for convection	3	
heating elements for ovens	3	
hot air fans	10	
hot air motors	9	
<b>I</b>		
ignition boxes	10	
immersion heating elements	3	
indicator lights	6	
indicator lights (complete)	6	
<b>L</b>		
lamps	6	
<b>M</b>		
microswitches	5	
<b>O</b>		
O-rings	13	
oven hinges	11	
oven lamps	6	
<b>P</b>		
pressure reduction valves	13, 13	
probes	8	
programme timers	7	
<b>R</b>		
relays	8	
roll pins	14	
rotary switches	5	
<b>S</b>		
safety thermostats	4	
solenoid valves	8	
switches and momentary switches	5	
<b>T</b>		
thermostats	4	
timers	7	
transformers	8	
<b>V</b>		
valves and tank inlets	13	
<b>W</b>		
water cycle components	13	
window seals	12	