



**GAS COMPONENTS**



**ELECTRIC COMPONENTS**



**WATER TECHNOLOGY**



**MECHANICAL COMPONENTS**



**TOOLS**

Spare parts suitable for

**GASTROFRIT**

Find the complete and up-to-date range of products in our GEV Webshop



# Manufacturer catalogue

The most important spare parts and accessories arranged clearly for every manufacturer

- ✓ Complete product range and all appliance data always up to date in the GEV Webshop
- ✓ Alphabetical Index at the end of the catalogue

## GEV Webshop

[www.gev-online.co.uk](http://www.gev-online.co.uk)

[www.gev-online.com](http://www.gev-online.com)



- 🔍 Add to Favourites
- 🔍 Sign In with email address and usual password
- 🔍 Easy-order – place several items in your basket at the same time
- 🔍 Quick Item search – no login needed



# heating elements

## heating elements for fryers

**1**

<b>GEV No.</b>	418532	<b>Ref. No.</b>	306010.024
<b>description</b>	heating element 6900W 230/400V heating circuits 3 L 350mm W 215mm H 242mm L1 18mm L2 332mm H1 210mm H2 32mm flange length 250mm flange width 30mm hole distance 85mm hole ø 6mm connection cable cable length 320mm rectangular flange fryer		

**1**

<b>GEV No.</b>	418549	<b>Ref. No.</b>	306010.014
<b>description</b>	heating element 10000W 400V heating circuits 3 L 345mm W 200mm H 275mm windings 15 H1 235mm H2 40mm fryer heaters connection cable		

**1**

<b>GEV No.</b>	418552	<b>Ref. No.</b>	306010.013
<b>description</b>	heating element 10000W 400V heating circuits 3 L 345mm W 206mm H 265mm windings 15 H1 204mm H2 40mm fryer heaters cable length 1000mm tube ø 8.5mm connection length 430mm		

**1**

<b>GEV No.</b>	418550	<b>Ref. No.</b>	306010.017
<b>description</b>	heating element 14000W 400V heating circuits 3 L 349mm W 342mm H 275mm windings 18 H1 242mm H2 33mm fryer heaters tube ø 8.5mm special fixing connection special		

**1**

<b>GEV No.</b>	418551	<b>Ref. No.</b>	306010.010
<b>description</b>	heating element 7200W 400V heating circuits 3 L 285mm W 145mm H 268mm windings 12 H1 238mm H2 30mm fryer heaters cable length 1200mm		

**1**

<b>GEV No.</b>	418572	<b>Ref. No.</b>	306010.041
<b>description</b>	heating element 10000W 400V heating circuits 3 L 335mm W 204mm H 30mm windings 12 fryer heaters tube ø 8mm		

**1**

<b>GEV No.</b>	418573	<b>Ref. No.</b>	306010.042
<b>description</b>	heating element 13500W 400V heating circuits 3 L 343mm W 335mm H 33mm windings 18 fryer heaters tube ø 8mm connection length 13mm		

**1**

<b>GEV No.</b>	418553	<b>Ref. No.</b>	306010.040
<b>description</b>	heating element 7200W 400V heating circuits 3 L 260mm W 155mm H 33mm windings 12 special fixing connection special fryer heaters tube ø 8mm		



## accessories

## miscellaneous



1

<b>GEV No.</b>	418533	<b>Ref. No.</b>	306035.032
<b>description</b>	connecting block for heating element		



1

<b>GEV No.</b>	551106	<b>Ref. No.</b>	306015.006
<b>description</b>	connecting block for heating element		



1

<b>GEV No.</b>	551091	<b>Ref. No.</b>	505000.000
<b>description</b>	plug-in connection 5-pole with cable for heating element		

## thermostats

## control and safety thermostats

## EGO

## control thermostats

## 55.34\_ series



1

<b>GEV No.</b>	375143	<b>Ref. No.</b>	306025.007
<b>description</b>	thermostat t.max. 110°C temperature range 32-110°C 3-pole 3NO 16A probe ø 6mm probe L 138mm capillary pipe 1480mm capillary pipe isolated 1100mm gland nut M9x1 shaft ø 6x4.6mm shaft L 23mm shaft position upper rotation 270°		



1

<b>GEV No.</b>	375821	<b>Ref. No.</b>	306025.001 306025.006
<b>description</b>	thermostat t.max. 190°C temperature range 100-190°C 3-pole 3NO 16A probe ø 6mm probe L 133mm capillary pipe 530mm capillary pipe isolated 500mm gland nut shaft ø 6x4.6mm shaft L 23mm shaft position upper rotation 270° special fixing		

## safety thermostats

## 55.32\_ series



1

<b>GEV No.</b>	375393	<b>Ref. No.</b>	306025.010
<b>description</b>	safety thermostat switch-off temp. 235°C 3-pole 1CO/2NC 20A probe ø 6mm probe L 87mm capillary pipe 1790mm capillary pipe isolated 1710mm gland nut M9x1 probe SS		

## 55.33\_ series



1

<b>GEV No.</b>	375746	<b>Ref. No.</b>	306025.005
<b>description</b>	safety thermostat switch-off temp. 230°C 3-pole 20A probe ø 6mm probe L 117mm capillary pipe 1470mm capillary pipe isolated 1100mm gland nut M9x1 probe SS		





1

<b>GEV No.</b>	375995	<b>Ref. No.</b>	306050.010
<b>description</b>	safety thermostat switch-off temp. 230°C 3-pole 3NC 20A probe ø 6mm probe L 103mm capillary pipe 1170mm capillary pipe isolated 1060mm gland nut starting temperature 216°C probe		

## switches and momentary switches

### microswitches

#### lever actuated



1

<b>GEV No.</b>	347622	<b>Ref. No.</b>	306040.045
<b>description</b>	microswitch with lever 250V 12A 1CO connection male faston 6.3mm L 51mm ambient temperature max. 85°C mounting distance 22.2mm type XGK2-88-J26Z1 actuating force: 40g		



1

<b>GEV No.</b>	345791	<b>Ref. No.</b>	306040.045
<b>description</b>	microswitch with lever 250V 12A 1CO connection male faston L 51mm ambient temperature max. 85°C		

### cam switches

#### operation switches



1

<b>GEV No.</b>	301214	<b>Ref. No.</b>	306040.030
<b>description</b>	cam switch 2 operating positions operation switch 16A sequence 0-1 shaft ø 6x4.6mm shaft L 33mm connection male faston 6.3mm plastic ambient temperature max. 150°C		

### miscellaneous



1

<b>GEV No.</b>	346853	<b>Ref. No.</b>	306040.040
<b>description</b>	safety switch heating element with cable		

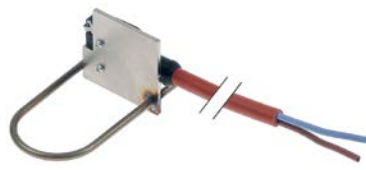

1

<b>GEV No.</b>	347626	<b>Ref. No.</b>	505000.106
<b>description</b>	safety switch heating element with cable 1160mm		

## control equipment

### GEV special

#### ø22mm

#### switches (complete)





1



<b>GEV No.</b>	347602	<b>Ref. No.</b>	306040.009
<b>description</b>	momentary push switch mounting measurements ø22mm 2NO/2NC 660V max. 16(4)A 0-1 momentary green illuminated connection screw		









1

<b>GEV No.</b>	346858	<b>Ref. No.</b>	306040.016	
<b>description</b>	push switch mounting measurements ø22mm 1NO 660V max. 16(4) A 0-1 latching ON-OFF green illuminated connection screw			
<b>spare parts for</b>	346858			
	<b>GEV No.</b>	345261	<b>Ref. No.</b>	—
	contact block 2NO 660V max. 16(4)A connection screw			
	<b>GEV No.</b>	359252	<b>Ref. No.</b>	—
	light bulb socket Ba9s 230V			



			
1			
<b>GEV No.</b>	346857	<b>Ref. No.</b>	306040.013 306040.014
<b>description</b>	push switch mounting measurements ø22mm 1NO 660V max. 16(4) A 0-1 latching red illuminated connection screw		
<b>spare parts for</b>	346857		
	GEV No.	345261	Ref. No. —
contact block 2NO 660V max. 16(4)A connection screw			
	GEV No.	359606	Ref. No. —
neon light bulb socket Ba9s 220V 2W clear ø 10mm L 28mm			

			
1			
<b>GEV No.</b>	346856	<b>Ref. No.</b>	306040.008
<b>description</b>	push switch mounting measurements ø22mm 1NO 660V max. 16(4) A 0-1 latching water blue illuminated connection screw		
<b>spare parts for</b>	346856		
	GEV No.	345261	Ref. No. —
contact block 2NO 660V max. 16(4)A connection screw			
	GEV No.	359252	Ref. No. —
light bulb socket Ba9s 230V			

			
1			
<b>GEV No.</b>	346855	<b>Ref. No.</b>	306040.014 306040.015
<b>description</b>	push switch mounting measurements ø22mm 3NO/1NC 660V max. 16(4)A 0-1 latching oil pump yellow illuminated connection screw/F6.3		
<b>spare parts for</b>	346855		
	GEV No.	345261	Ref. No. —
contact block 2NO 660V max. 16(4)A connection screw			
	GEV No.	345272	Ref. No. —
contact block 1NC/1NO 660V max. 16(4)A connection screw			
	GEV No.	359606	Ref. No. —
neon light bulb socket Ba9s 220V 2W clear ø 10mm L 28mm			

			
1			
<b>GEV No.</b>	347625	<b>Ref. No.</b>	306040.011
<b>description</b>	push switch mounting measurements ø22mm 3NO/1NC 660V max. 16(4)A 0-1 latching yellow illuminated connection screw		

## lamps

### indicator lights

#### indicator lights (complete)

ø10mm

with plug-in socket

			
1			
<b>GEV No.</b>	359439	<b>Ref. No.</b>	306045.010
<b>description</b>	indicator light ø 10mm 230V green cable length 220mm		

			
1			
<b>GEV No.</b>	359438	<b>Ref. No.</b>	306045.011
<b>description</b>	indicator light ø 10mm 230V red cable length 220mm		

## contactors

### TELEMECANIQUE (Schneider Electric)

#### power contactors

			
1			
<b>GEV No.</b>	380698	<b>Ref. No.</b>	306020.004
<b>description</b>	power contactor resistive load 20A 230VAC (AC3/400V) 12A/5.5kW main contacts 3NO auxiliary contacts 1NO/1NC connection spring terminal type LCD123P7		

1

<b>GEV No.</b>	380700	<b>Ref. No.</b>	306020.003
<b>description</b>	power contactor resistive load 38A 230VAC (AC3/400V) 18.5kW main contacts 1NO auxiliary contacts 1NC type LC1D38P7		



1

<b>GEV No.</b>	403878	<b>Ref. No.</b>	505000.205
<b>description</b>	solid state relay CRYDOM 3 phase 50A 530V 4-32 L 125mm W 95mm with heat sink		

ALLEN BRADLEY

power contactors



1

<b>GEV No.</b>	380459	<b>Ref. No.</b>	306020.002 306020.003
<b>description</b>	power contactor resistive load 65A 230VAC (AC3/400V) 30A/15kW main contacts 3NO connection screw connection type 100-C30KF00 50/60Hz		

miscellaneous



1

<b>GEV No.</b>	402564	<b>Ref. No.</b>	505000.094
<b>description</b>	solid state relay AIKS 3 phase 40A 48-480V 3-32 L 105mm W 75mm screw type ASS02-440DA		

solid state relays

CRYDOM



1

<b>GEV No.</b>	403038	<b>Ref. No.</b>	505000.150
<b>description</b>	solid state relay CRYDOM 1 phase 50A 480V 4-32VDC L 57mm W 45mm screw type CWD4850P		



probes

producer-specific probes

probes



1

<b>GEV No.</b>	400773	<b>Ref. No.</b>	306025.030
<b>description</b>	temperature probe Pt100 cable PTFE probe -100 up to 450°C cable -40 up to +250°C connection 2-wire thread M10x1.5 probe ø4x20mm cable length 0.5m		
<b>accessories for</b>	400773		
	<b>GEV No.</b>	532590	<b>Ref. No.</b> —
	O-ring silicone thickness 2.62mm ID ø 13.95mm Qty 1 pcs		
	<b>GEV No.</b>	560197	<b>Ref. No.</b> —
	nut thread M10 H 8mm WS 17 SS DIN/ISO DIN 934 / ISO 4032/8673 Qty 1 pcs		



1

<b>GEV No.</b>	403037	<b>Ref. No.</b>	306025.033
<b>description</b>	temperature probe Pt1000 cable PTFE probe -100 up to 450°C cable -40 up to +250°C connection 2-wire thread M10 probe ø4x30mm cable length 1m		



## electronics

## PCBs



1

<b>GEV No.</b>	403044	<b>Ref. No.</b>	502000.019
----------------	--------	-----------------	------------

<b>description</b>	conversion kit Gastro 6/7 into Gastro 8
--------------------	---



1

<b>GEV No.</b>	400770	<b>Ref. No.</b>	306200.020
----------------	--------	-----------------	------------

<b>description</b>	display PCB
--------------------	-------------

## Triacs

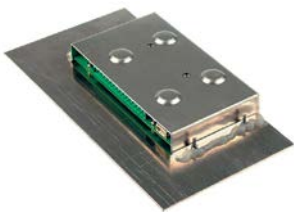

1

<b>GEV No.</b>	400771	<b>Ref. No.</b>	306200.007
----------------	--------	-----------------	------------

<b>description</b>	Triac
--------------------	-------

## keypads

## membrane keypads



1

<b>GEV No.</b>	403036	<b>Ref. No.</b>	306200.013
----------------	--------	-----------------	------------

<b>description</b>	membrane keypad buttons 7 L 150mm W 80mm
--------------------	--



1

<b>GEV No.</b>	400766	<b>Ref. No.</b>	306200.015
----------------	--------	-----------------	------------

<b>description</b>	membrane keypad for fryer
--------------------	---------------------------



1

<b>GEV No.</b>	400767	<b>Ref. No.</b>	306200.016
----------------	--------	-----------------	------------

<b>description</b>	membrane keypad for fryer
--------------------	---------------------------



1

<b>GEV No.</b>	400768	<b>Ref. No.</b>	306200.014
----------------	--------	-----------------	------------

<b>description</b>	membrane keypad for fryer
--------------------	---------------------------



1

<b>GEV No.</b>	400765	<b>Ref. No.</b>	306200.018
----------------	--------	-----------------	------------

<b>description</b>	membrane keypad for pasta cooker
--------------------	----------------------------------



1

<b>GEV No.</b>	400764	<b>Ref. No.</b>	306200.017
----------------	--------	-----------------	------------

<b>description</b>	membrane keypad pasta cooker TW-300
--------------------	-------------------------------------

## solenoid valves

## solenoid valves (water)

## various



1

<b>GEV No.</b>	372215	<b>Ref. No.</b>	309030.001 501000.002 (old version)
----------------	--------	-----------------	--

<b>description</b>	solenoid valve assembly
--------------------	-------------------------





metal

ODE

2-way



1

<b>GEV No.</b>	372004	<b>Ref. No.</b>	501000.002
<b>description</b>	solenoid valve assembly brass 2-ways supply 220/230VAC inlet 3/8" ET outlet 3/8" ET L 145mm DN 12mm ODE p max 0.1bar p min 20bar 50/60Hz		

pumps

oil pumps



1

<b>GEV No.</b>	500673	<b>Ref. No.</b>	306099.200
<b>description</b>	oil pump BRINKMANN type TB16/170-GZX+581 70W 230V 50Hz L 300mm 960l/h capacitor 5µF		

electric accessories

plugs - couplings - power sockets

protective contact power sockets

producer-specific power sockets

miscellaneous



1

<b>GEV No.</b>	551104	<b>Ref. No.</b>	306035.033
<b>description</b>	power socket SEV1011 type 13 built-in version 3-pole contacts P+N+E max. 10A max 250V countries CH		

cables

ribbon cables

group 1



1

<b>GEV No.</b>	400772	<b>Ref. No.</b>	306200.006
<b>description</b>	ribbon cable 34-pole L 135mm plug type FC-34P raster size 2.54mm		

terminals

PCB terminal blocks



1

<b>GEV No.</b>	403039	<b>Ref. No.</b>	306035.038
<b>description</b>	PCB terminal block 13-pole raster size 5mm		

equipment-specific units

for deep fryers

miscellaneous



1

<b>GEV No.</b>	692220	<b>Ref. No.</b>	302050.025
<b>description</b>	lifting device for basket mounting pos. left		



1			
<b>GEV No.</b>	692221	<b>Ref. No.</b>	302025.024 302050.024
<b>description</b>	lifting device for basket mounting pos. right		



1			
<b>GEV No.</b>	693942	<b>Ref. No.</b>	306099.015
<b>description</b>	lifting device without limit switch for fryer basket mounting pos. right		

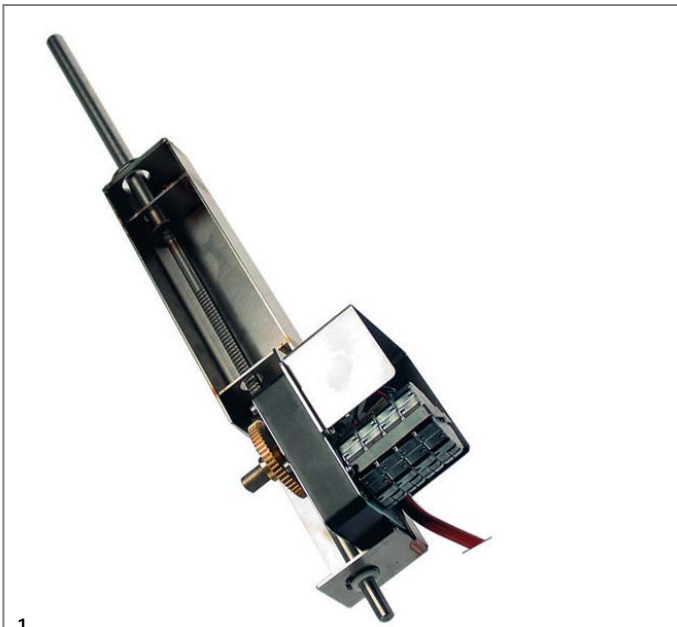

1			
<b>GEV No.</b>	693941	<b>Ref. No.</b>	306099.010
<b>description</b>	lifting device without limit switch for fryer basket mounting pos. left		



1			
<b>GEV No.</b>	692222	<b>Ref. No.</b>	303090.010
<b>description</b>	pump hose with pipe		

## knobs

### universal knobs

1			
<b>GEV No.</b>	110119	<b>Ref. No.</b>	306025.004
<b>description</b>	knob thermostat t.max. 110°C ø 50mm shaft ø 6x4.6mm shaft flat upper black temperature range 30-110°C rotation 270°		
<b>accessories for</b>	110119		
	<b>GEV No.</b>	110135	<b>Ref. No.</b> —
	rosette knob up to ø 52mm		



1

<b>GEV No.</b>	110434	<b>Ref. No.</b>	306025.002
<b>description</b>	knob thermostat t.max. 190°C ø 50mm shaft ø 6x4.6mm shaft flat upper silver temperature range 100-190°C rotation 270°		
<b>accessories for</b>	110434		
	<b>GEV No.</b>	110135	<b>Ref. No.</b> —
	rosette knob up to ø 52mm		

producer-specific knobs

GASTROFRIT



1

<b>GEV No.</b>	110119	<b>Ref. No.</b>	306025.004
<b>description</b>	knob thermostat t.max. 110°C ø 50mm shaft ø 6x4.6mm shaft flat upper black temperature range 30-110°C rotation 270°		
<b>accessories for</b>	110119		
	<b>GEV No.</b>	110135	<b>Ref. No.</b> —
	rosette knob up to ø 52mm		



1

<b>GEV No.</b>	110434	<b>Ref. No.</b>	306025.002
<b>description</b>	knob thermostat t.max. 190°C ø 50mm shaft ø 6x4.6mm shaft flat upper silver temperature range 100-190°C rotation 270°		
<b>accessories for</b>	110434		
	<b>GEV No.</b>	110135	<b>Ref. No.</b> —
	rosette knob up to ø 52mm		

filters

deep fryer filters



1

<b>GEV No.</b>	970544	<b>Ref. No.</b>	305099.002
<b>description</b>	oil filter W 200mm L 260mm Qty 1 pcs for fryer Hmm without handle		



1

<b>GEV No.</b>	970543	<b>Ref. No.</b>	305099.003
<b>description</b>	oil filter W 230mm L 475mm Qty 1 pcs for fryer H 30mm metall frame		
<b>accessories for</b>	970543		
	<b>GEV No.</b>	970544	<b>Ref. No.</b> 305099.002
	oil filter W 200mm L 260mm Qty 1 pcs for fryer Hmm without handle		

baskets

fryer baskets

GASTROFRIT



1

<b>GEV No.</b>	970881	<b>Ref. No.</b>	503000.366
<b>description</b>	bezel for fryer basket		



1

<b>GEV No.</b>	970882	<b>Ref. No.</b>	503000.365
<b>description</b>	bezel for fryer basket		



1

<b>GEV No.</b>	970752	<b>Ref. No.</b>	303010.001
<b>description</b>	fryer basket W1 150mm L1 250mm H1 160mm H2 250mm		
<b>accessories for</b>	970752		
	<b>GEV No.</b>	970882	<b>Ref. No.</b> 503000.365
	bezel for fryer basket		



1

<b>GEV No.</b>	970755	<b>Ref. No.</b>	303010.004
<b>description</b>	fryer basket W1 350mm L1 310mm H1 160mm H2 230mm		



1

<b>GEV No.</b>	970751	<b>Ref. No.</b>	303010.002
<b>description</b>	fryer basket W1 215mm L1 300mm H1 160mm H2 250mm		
<b>accessories for</b>	970751		
	<b>GEV No.</b>	970881	<b>Ref. No.</b> 503000.366
	bezel for fryer basket		



1

<b>GEV No.</b>	970538	<b>Ref. No.</b>	303010.004
<b>description</b>	fryer basket W1 350mm L1 310mm H1 160mm H2 250mm		

pasta baskets

GASTROFRIT



1

<b>GEV No.</b>	970759	<b>Ref. No.</b>	303010.052
<b>description</b>	fryer basket W1 350mm L1 295mm H1 160mm stainless steel		



1

<b>GEV No.</b>	970756	<b>Ref. No.</b>	301080.073
<b>description</b>	pasta basket H1 155mm W1 105mm L1 155mm size 1/6 left		



1

<b>GEV No.</b>	970769	<b>Ref. No.</b>	303010.052
<b>description</b>	fryer basket W1 350mm L1 300mm H1 195mm stainless steel with bezel		



1

<b>GEV No.</b>	970757	<b>Ref. No.</b>	301080.076
<b>description</b>	pasta basket H1 155mm W1 105mm L1 155mm size 1/6 right		



1

<b>GEV No.</b>	970806	<b>Ref. No.</b>	301080.070
<b>description</b>	pasta basket H1 185mm W1 95mm L1 135mm size 1/6 H2 250mm		



1

<b>GEV No.</b>	970754	<b>Ref. No.</b>	303010.053
<b>description</b>	pasta basket H1 195mm W1 200mm L1 300mm L2 530mm H2 250mm with holder		



1

<b>GEV No.</b>	970540	<b>Ref. No.</b>	303010.056
<b>description</b>	pasta basket L1 300mm W1 150mm H1 200mm H3 245mm stainless steel		
<b>accessories for</b>	970540		
	<b>GEV No.</b>	<b>Ref. No.</b>	503000.365
	bezel for fryer basket		



1

<b>GEV No.</b>	970541	<b>Ref. No.</b>	303010.055
<b>description</b>	pasta basket L1 300mm W1 200mm H1 155mm H3 250mm stainless steel		



1

<b>GEV No.</b>	970542	<b>Ref. No.</b>	303010.057
<b>description</b>	pasta basket L1 300mm W1 345mm H1 200mm H3 245mm stainless steel		
<b>accessories for</b>	970542		
	<b>GEV No.</b>	<b>Ref. No.</b>	503000.366
	bezel for fryer basket		



1

<b>GEV No.</b>	970760	<b>Ref. No.</b>	303010.058
<b>description</b>	pasta basket W1 150mm L1 300mm H1 195mm stainless steel		



1

<b>GEV No.</b>	970758	<b>Ref. No.</b>	301080.069
<b>description</b>	pasta basket W1 90mm L1 135mm H1 185mm size 1/6		

## gaskets

### O-rings

Viton



<b>GEV No.</b>	532622	<b>Ref. No.</b>	503000.030
<b>description</b>	O-ring EPDM thickness 5.7mm ID ø 34mm Qty 1 pcs		

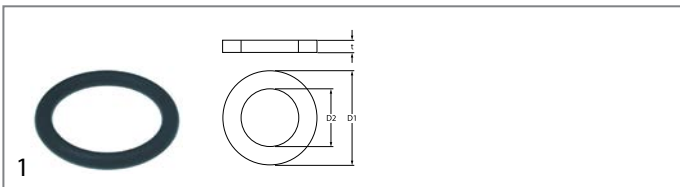

<b>GEV No.</b>	510625	<b>Ref. No.</b>	305010.073
<b>description</b>	O-ring Viton thickness 2.5mm ID ø 13mm Qty 2 pcs		



<b>GEV No.</b>	514360	<b>Ref. No.</b>	303030.002 new version
<b>description</b>	ball valve connection 1/2" IT - 1/2" IT DN15 total length 49mm		

## valves and tank inlets

### ball valves

universal

ball valves with lever handle



<b>GEV No.</b>	520282	<b>Ref. No.</b>	303030.011
<b>description</b>	ball valve connection 1" IT - 1" IT DN25 total length 67mm with lever handle		

producer-specific

GASTROFRIT

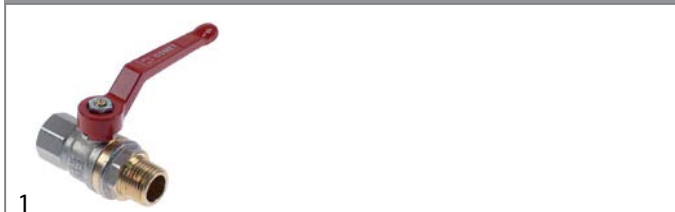

<b>GEV No.</b>	520735	<b>Ref. No.</b>	303030.002 old version
<b>description</b>	ball valve connection 1/2" IT - coupling DN13 total length 67mm with lever handle handle length 94mm		

**B**

ball valves 14

**C**

cables 9

cam switches 5

contactors 6

control equipment 5

control thermostats 4

**E**

electric accessories 9

**H**

heating elements 3

heating elements for fryers 3

**I**

indicator lights 6

indicator lights (complete) 6

**L**

lamps 6

**M**

microswitches 5

**O**

oil pumps 9

O-rings 13

**P**

plugs - couplings - power sockets 9

probes 7

protective contact power sockets 9

pumps 9

**R**

ribbon cables 9

**S**

safety thermostats 4

solenoid valves 8

solid state relays 7

switches and momentary switches 5

**T**

terminals 9

thermostats 4

**V**

valves and tank inlets 14