



GAS COMPONENTS



ELECTRIC COMPONENTS



WATER TECHNOLOGY



MECHANICAL COMPONENTS



TOOLS

Spare parts suitable for

GARLAND

Find the complete and up-to-date range of products in our GEV Webshop



Manufacturer catalogue

The most important spare parts and accessories arranged clearly for every manufacturer

- ✓ Complete product range and all appliance data always up to date in the GEV Webshop
- ✓ Alphabetical Index at the end of the catalogue

GEV Webshop

www.gev-online.co.uk

www.gev-online.com



- 🔍 Add to Favourites
- 🔍 Sign In with email address and usual password
- 🔍 Easy-order – place several items in your basket at the same time
- 🔍 Quick Item search – no login needed



hot plates

round

ring shaped



1

GEV No.	490203	Ref. No.	2195001
description	heating element ϕ 190mmW 240V connection screw with central hole inserts H 60mm open		

energy regulators

ROBERTSHAW

INF series



1

GEV No.	380041	Ref. No.	G031185-2
description	energy regulator 240V 15A turn direction left shaft ϕ 6x4.6mm shaft L 23mm mounting thread 8"-32UNC no. INF2401165		

thermostats

control and safety thermostats

INVENSYS / ROBERTSHAW

control thermostats



1

GEV No.	376038	Ref. No.	G0893-01
description	thermostat t.max. 232°C temperature range 12-232°C 1-pole 1NO 25A probe ϕ 6.5mm probe L 173mm capillary pipe 870mm capillary pipe isolatedmm gland nut shaft ϕ 6x4.6mm shaft L 20mm shaft position right 100-450°F		

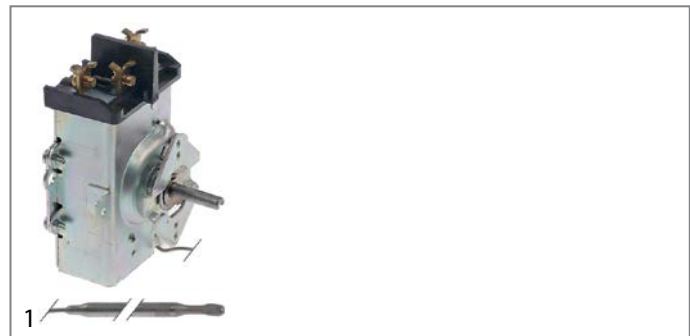

1

GEV No.	376044	Ref. No.	1102703
description	thermostat t.max. 232°C temperature range 37-232°C 2-pole 2NO 30A probe ϕ 6.5mm probe L 172mm capillary pipe 1045mm shaft ϕ 6.4x4.8mm shaft L 24mm 100-450°F		



1

GEV No.	376032	Ref. No.	1032499
description	thermostat t.max. 260°C temperature range 60-260°C 1-pole 1NO probe ϕ 5mm probe L 286mm capillary pipe 900mm capillary pipe isolatedmm gland nut shaft ϕ 6x4.6mm shaft L 20mm shaft position upper 140-500°F		



1

GEV No.	376033	Ref. No.	G02902-01
description	thermostat t.max. 260°C temperature range 64-260°C 1-pole 1NO probe ϕ 5mm probe L 285mm capillary pipe 1045mm capillary pipe isolatedmm gland nut shaft ϕ 6x4.6mm shaft L 20mm shaft position right 148-500°F		



1

GEV No.	376030	Ref. No.	1010300
description	thermostat t.max. 288°C temperature range 38-288°C 2-pole 2NO 30A probe ϕ 5mm probe L 295mm capillary pipe 1540mm capillary pipe isolatedmm gland nut shaft ϕ 6x4.6mm shaft L 20mm shaft position upper 100-550°F		



1

GEV No.	376037	Ref. No.	1032400 G0894-01
description	thermostat t.max. 288°C temperature range 65-288°C 1-pole 1NO probe ø 5mm probe L 286mm capillary pipe 1010mm capillary pipe isolated 255mm gland nut shaft ø 6x4.6mm shaft L 20mm shaft position right rotation 320° 150-550°F		



1

GEV No.	376036	Ref. No.	1611900
description	thermostat t.max. 314°C temperature range 38-314°C 1-pole 1NO probe ø 5mm probe L 285mm capillary pipe 1750mm capillary pipe isolatedmm gland nut shaft ø 6x4.6mm shaft L 20mm shaft position upper 100-598°F		



1

GEV No.	376031	Ref. No.	1010304
description	thermostat t.max. 371°C temperature range 148-371°C 2-pole 2NO 30A probe ø 5mm probe L 285mm capillary pipe 1540mm capillary pipe isolatedmm gland nut shaft ø 6x4.6mm shaft L 20mm shaft position upper probe material zinc-plated 300-700°F		

RANCO

thermostats



1

GEV No.	376040	Ref. No.	G2674-1
description	thermostat t.max. 204°C temperature range 65-204°C 1-pole 1NOA probe ø 6mm probe L 165mm capillary pipe 930mm capillary pipe isolatedmm gland nut shaft ø 6x4.6mm shaft L 24mm shaft position upper° rotation 320°		



1

GEV No.	376041	Ref. No.	2613100
description	thermostat t.max. 232°C temperature range 65-232°C 1-pole 1NOA probe ø 5mm probe L 324mm capillary pipe 1540mm capillary pipe isolatedmm gland nut shaft ø 6x4.6mm shaft L 24mm shaft position upper operating temperature range 150-450°F		



1

GEV No.	376039	Ref. No.	2613101
description	thermostat t.max. 260°C temperature range 65-260°C 1-pole 1NOA probe ø 4.8mm probe L 320mm capillary pipe 925mm capillary pipe isolatedmm gland nut shaft ø 6x4.6mm shaft L 24mm shaft position upper operating temperature range 150-500°F		



switches and momentary switches

rocker/momentary rocker switches

28x13.5mm



1

GEV No.	348099	Ref. No.	1358900
description	rocker switch mounting measurements 27.4x12.4mm black 1CO 250V 10A with neutral position connection male faston 6.3mm ambient temperature max. 85°C protection IP40		

37x21mm



1

GEV No.	348094	Ref. No.	1019205
description	momentary rocker switch mounting measurements 37x21mm black 2NO 250V 10A momentary connection male faston 6.3mm ambient temperature max. 125°C protection IP40		



1

GEV No.	348097 ¹	Ref. No.	1019204 G03055-1
description	rocker switch mounting measurements 37x21mm black 1CO 250V 10A with neutral position connection male faston 6.3mm ambient temperature max. 125/55°C protection IP55		

¹with neutral position



1

GEV No.	348095	Ref. No.	1019203 228006-2 G03054-2
description	rocker switch mounting measurements 37x21mm black 1NO 250V 20A connection male faston 6.3mm ambient temperature max. 125°C protection IP40		



1

GEV No.	348093	Ref. No.	1019209 1955402 G03054-1
description	rocker switch mounting measurements 37x21mm black 2CO 250V 10A connection male faston 6.3mm ambient temperature max. 125/55°C protection IP55		



1

GEV No.	348092 ¹	Ref. No.	1872404
description	rocker switch mounting measurements 37x21mm black 2CO 250V 10A illuminated connection male faston 6.3mm ambient temperature max. 125°C protection IP40		

¹illuminated



1

GEV No.	348096 ¹	Ref. No.	1729100 228264-1 2140 4527835
description	rocker switch mounting measurements 37x21mm black 2CO 250V 10A with neutral position connection male faston 6.3mm ambient temperature max. 125/55°C protection IP55		

¹with neutral position



1

GEV No.	348098 ¹	Ref. No.	1955401
description	rocker switch mounting measurements 37x21mm black 2CO 250V 10A with neutral position connection male faston 6.3mm ambient temperature max. 125/55°C protection IP55		

¹with neutral position

microswitches

pin-plunger actuated

M12



1

GEV No.	345138	Ref. No.	1019600
description	microswitch with plunger mounting distance 25mm thread M12x1 thread L 12mm 250V 20A 1CO connection screw stroke 7mm L1 13mm ambient temperature max. 85°C type Z15G1307 actuating force: 250g		



cam switches

4 operating positions



1

GEV No.	301313	Ref. No.	2667-1 4523164 CK114 02667-1 1010705 1010706 G02667-1
description	cam switch 4 operating positions 2CO/1NO sequence 0-1-2-3 16A shaft \varnothing 6.9x4.3mm shaft L 21.5mm connection screw ceramic		

7 operating positions



1

GEV No.	301312	Ref. No.	2146900 4523166
description	cam switch 7 operating positions 2CO/1NO sequence 0-1-2-3-4-5-6 16A shaft \varnothing 6x4.6mm shaft L 23mm connection male faston 6.3mm ceramic		

lamps

indicator lights

indicator lights (complete)

 \varnothing 13mm

with screw socket



1

GEV No.	360656	Ref. No.	G01296-2
description	indicator light \varnothing 12.5mm orange 250V connection cable 280mm Qty 1 pcs		

20x13mm



1

GEV No.	360657	Ref. No.	2138500
description	indicator light mounting measurements 20x13mm orange 250V connection cable 200mm rectangular snap-on connection		

screw-on/push-on fit

light bulbs

miscellaneous



1

GEV No.	360658	Ref. No.	1623900
description	light bulb socket E27 115V 40W \varnothing 48mm L 84mm		

contactors

HARTLAND

power contactors



1

GEV No.	580012	Ref. No.	1026101
description	contactor resistive load 50A 240VAC 40A/10HP (AC3/240V) 40A/7.46kW main contacts 4NO connection screw clamp/male faston 6.3mm type HCCY4XU04CG		



motors

gear motors

miscellaneous



1

GEV No.	602068	Ref. No.	7000240
description	gear motor MERKLE type B3715UP-095 3.45W 230V 50Hz 10rpm shaft ø 8mm L 125mm W 70mm H 75mm		

gas taps

PEL

21S series



1

GEV No.	106138	Ref. No.	2200199
description	gas tap PEL type 21S gas inlet M16x1.5 (tube ø 10mm) bypass nozzle ø 0.35mm gas outlet M10x1 IT (tube ø 6mm) thermocouple connection M8x1 pilot connection M10x1 shaft ø 8x6.5mm shaft L 37/15mm shaft flat upper		
spare parts for	106138		
	GEV No.	101060	Ref. No. —
	magnet unit standard L 39mm D1 ø 15.4mm D2 ø 11mm suitable for PEL20-21/JUNKERS/EGA		
	GEV No.	101231	Ref. No. —
	thermocouple nut T1: M9x1 T2: M18x1		
	GEV No.	106147	Ref. No. —
	gas tap front part shaft ø 8x6.5mm shaft L 37/15mm shaft flat upper/lower type PEL21		
	GEV No.	106202	Ref. No. —
	bypass nozzle type PEL20/21 bore ø 0mm thread M5x0.5		
accessories for	106138		
	GEV No.	100909	Ref. No. —
	union screw thread M10x1 for pipe ø 6mm Qty 1 pcs		
	GEV No.	101278	Ref. No. —
	olive for pipe ø 10mm Qty 1 pcs		
	GEV No.	101286	Ref. No. —
	olive ID ø 6mm Qty 1 pcs		
	GEV No.	101300	Ref. No. —
	union nut thread M16x1.5 tube ø 10mm		



1

GEV No.	107365 ¹	Ref. No.	CK2200196
description	gas tap PEL type 21S gas inlet M16x1.5 (tube ø 10mm) bypass nozzle ø 0mm gas outlet 2x ED 11mm G24 (tube ø 6mm) thermocouple connection M9x1 pilot connection M10x1 shaft ø 8x6.5mm shaft L 37/15mm shaft flat upper pipe outlet ø 6.5mm		

¹incl. union nuts and olives

22S/O series



1

GEV No.	107364	Ref. No.	2187099
description	gas tap PEL type 22S/O gas inlet M20x1.5 (tube ø 7/16") bypass nozzle ø 0mm gas outlet M20x1.5 (tube ø 7/16") thermocouple connection M9x1 pilot connection M10x1 shaft ø 10x8mm shaft L 25/17mm shaft flat upper pipe outlet ø 11.3mm		



1

GEV No.	107690	Ref. No.	CK179
description	gas tap PEL type 22S/O gas inlet M20x1.5 (tube ø 7/16") bypass nozzle ømm gas outlet M20x1.5 (tube ø 12/10mm) thermocouple connection M9x1 pilot connection M10x1 shaft ø 8x10mm shaft L 25/17mm shaft flat upper incl. accessories shaft length knob 17mm pipe outlet ø 11.3mm		



1

GEV No.	107363 ¹	Ref. No.	2513399 4601583
description	gas tap PEL type 22S/O gas inlet M20x1.5 (tube ø 7/16") bypass nozzle ømm gas outlet M20x1.5 (tube ø 12/10mm) thermocouple connection M9x1 pilot connection M10x1 shaft ø 8x10mm shaft L 25/17mm shaft flat upper shaft length knob 17mm pipe outlet ø 11.3mm		

¹incl. union nuts and olives

miscellaneous







			
1			
GEV No.	103258	Ref. No.	4530966
description	gas tap GARLAND type MV3514 gas inlet 1/4" bypass nozzle ømm gas outlet 1/4" pilot connection thermocouple connection shaft ø 4CR-1-650mm shaft L 45mm brass		

			
1			
GEV No.	101430	Ref. No.	1587700
description	gas valve gas inlet 3/4" gas outlet 3/4" thermocouple connection 11/32" pilot connection 1/4" pipe US type 7000BGOR-S7B pressure controller natural gas 3.5" W.C. suitable for ROBERTSHAW		

gas thermostats

ROBERTSHAW

			
1			
GEV No.	580180	Ref. No.	10170193 G01920-01
description	gas thermostat type FDO-1-04-48 65-287°C 150-550°F gas inlet 1/2" NPT gas outlet 1/2" NPT capillary pipe 48" - 1220mm probe ø 3/16" - 4.7mm probe L 14 3/4" - 375mmmm gland nut shaft ø 11.2x 7.5mm shaft L 21/21mm shaft flat lower ROBERTSHAW		

GEV No.	101430	Ref. No.	1587700
description	gas valve gas inlet 3/4" gas outlet 3/4" thermocouple connection 11/32" pilot connection 1/4" pipe US type 7000BGOR-S7B pressure controller natural gas 3.5" W.C. suitable for ROBERTSHAW		
spare parts for	101430		
	GEV No.	101047	Ref. No. —
	magnet unit T1: ASA 11/32 T2: M24x1 L 59mm ø 4mm suitable for ROBERTSHAW		
	GEV No.	101389	Ref. No. —
	pressure controller natural gas suitable for ROBERTSHAW		
	GEV No.	101481	Ref. No. —
	olive for pipe ø 1/4" CCT Qty 1 pcs		
	GEV No.	106109	Ref. No. —
	locking screw thread 7/16"-24 UNS for pipe ø 1/4" L 16mm brass Qty 1 pcs WS 7/16" (11.113mm) hole ø 6.4mm		
	GEV No.	580033	Ref. No. 1292703 2516-1 F810-0109 G02518-1 UK22
	knob suitable for ROBERTSHAW		
accessories for	101430		
	GEV No.	102122	Ref. No. —
	thermocouple ROBERTSHAW ASA 11/32 L 18" - 455mm 7/16"		
	GEV No.	102277	Ref. No. 812284
	thermocouple ROBERTSHAW ASA 11/32 L 36" - 915mm 7/16"		

gas valves and ignition boxes

gas control valves

ROBERTSHAW

gas controlled valves

			
1			
GEV No.	106923	Ref. No.	1467000 1467001
description	gas valve 60Hz type 7000BDER-S7A supply 24VAC		











			
1			
GEV No.	580043	Ref. No.	1092700
description	gas valve supply Operator gas inlet 1/4" CCT outlet 1/4" CCT gas inlet 3/4" NPT gas outlet 3/4" NPT thermocouple connection 3/8" NEF pilot connection 1/4" CCT type 7000BMSGOR pressure controller natural gas 3.5" W.C. suitable for ROBERTSHAW		
spare parts for	580043		
	GEV No.	101042	Ref. No. —
	magnet unit T1: 3/8" NEF suitable for ROBERTSHAW for gas operator		

Table continues overleaf



spare parts for 580043				
	GEV No.	101481	Ref. No.	—
olive for pipe ø 1/4" CCT Qty 1 pcs				
	GEV No.	106109	Ref. No.	—
locking screw thread 7/16"-24 UNS for pipe ø 1/4" L 16mm brass Qty 1 pcs WS 7/16" (11.113mm) hole ø 6.4mm				
	GEV No.	580033	Ref. No.	1292703 2516-1 F810-0109 G02518-1 UK22
knob suitable for ROBERTSHAW				
accessories for 580043				
	GEV No.	580035	Ref. No.	1093418 1577001 F810-0162
thermopile L 36" - 915mm probe ø 9mm probe L 38mm 250-750mV screw connection 7/16" connection 3/8" NEF				

millivolt controlled valves

				
1				
GEV No.	580031	Ref. No.	1292799 2511 F807-2427	
description	gas valve supply Operator millivolt gas inlet 3/4" NPT gas outlet 3/4" NPT thermocouple connection pilot connection 1/4" CCT type 7000BMVR pressure controller natural gas 3.5" W.C. suitable for ROBERTSHAW			
spare parts for 580031				
	GEV No.	101422	Ref. No.	—
operator natural gas supply Operator millivolt				
	GEV No.	106109	Ref. No.	—
locking screw thread 7/16"-24 UNS for pipe ø 1/4" L 16mm brass Qty 1 pcs WS 7/16" (11.113mm) hole ø 6.4mm				
	GEV No.	106121	Ref. No.	—
pressure controller natural gas 3.5" W.C.				
	GEV No.	580033	Ref. No.	1292703 2516-1 F810-0109 G02518-1 UK22
knob suitable for ROBERTSHAW				

ignition parts





pilot burners

SIT			
140 - 145 -150 series			
			
1			
GEV No.	107215	Ref. No.	2200701
description	pilot burner SIT type 145 series 2 flames nozzle ømm gas connectionmm without nozzles burner bearing left		

ROBERTSHAW

pilot burners

universal series - type 2			
			
1			
GEV No.	107367	Ref. No.	G0526-1
description	pilot burner ROBERTSHAW type 2C-2 1 flame natural gas code 18 for pipe ø 1/4" CCT		

				
1				
GEV No.	106078	Ref. No.	1415300 G0635-1	
description	pilot burner ROBERTSHAW type 2C-2 1 flame natural gas code 18 for pipe ø 3/16" - 1/4" CCT			
spare parts for 106078				
	GEV No.	100276	Ref. No.	1028202 1293000 F810-0126
pilot burner nozzle natural gas code 18 suitable for ROBERTSHAW				
	GEV No.	101481	Ref. No.	—
olive for pipe ø 1/4" CCT Qty 1 pcs				
	GEV No.	101483	Ref. No.	—
union nut thread 1/4" CCT short				





1

GEV No.	107403	Ref. No.	1091899
description	pilot burner ROBERTSHAW type 2C-2 1 flame natural gas code 18 for pipe ø 3/16" CCT		



1

GEV No.	107405	Ref. No.	1028200
description	pilot burner ROBERTSHAW type 2CH-6 1 flame natural/liquid gas code 18/10 for pipe ø 1/4" CCT 1/4"		
spare parts for	107405		
	GEV No.	100275	Ref. No.
			1028203 1028207 1293001
	pilot burner nozzle LPG code 10 bore ø 0.1mm suitable for ROBERTSHAW		
	GEV No.	100276	Ref. No.
			1028202 1293000 F810-0126
	pilot burner nozzle natural gas code 18 suitable for ROBERTSHAW		





1

GEV No.	107407	Ref. No.	1028298 1028299
description	pilot burner ROBERTSHAW type 2CH-10 1 flame natural gas code 21 for pipe ø 3/16" CCT 3/16"		

universal series - type 3



1

GEV No.	107399	Ref. No.	1028288 1028289
description	pilot burner ROBERTSHAW type 3CH-4 2 flames natural/liquid gas code 18/10 for pipe ø 1/4" CCT		
spare parts for	107399		
	GEV No.	100275	Ref. No.
			1028203 1028207 1293001
	pilot burner nozzle LPG code 10 bore ø 0.1mm suitable for ROBERTSHAW		
	GEV No.	100276	Ref. No.
			1028202 1293000 F810-0126
	pilot burner nozzle natural gas code 18 suitable for ROBERTSHAW		



1

GEV No.	580034	Ref. No.	8100154
description	pilot burner ROBERTSHAW type 3CH-6 2 flames natural gas code 18 for pipe ø 1/4" CCT		

universal series - type 6

Width of caps:
 6CH10 = 1" (25,4mm)
 6CH14 = 1½" (38,1mm)
 6CH24 = 2½" (63,5mm)
 6CH30 = 3" (76,2mm)





1

GEV No.	106117	Ref. No.	2706400
description	pilot burner ROBERTSHAW type 6CH24-1 3 flames natural gas code 26 for pipe ø 1/4" CCT gas connection 1/4" CCTmm nozzle ømm		





Mini Pilot series			
			
1			
GEV No.	107414	Ref. No.	1191300
description	pilot burner ROBERTSHAW type 2 2 flames natural/liquid gas code for pipe ø 3/16" - 1/4" CCT with thermocouple		

HONEYWELL			
pilot burners			
			
1			
GEV No.	107410	Ref. No.	1814901 1935802 CK1935802
description	pilot burner HONEYWELL type Q3451B1301 1315 1 flame natural gas nozzle BCR20 1/4"		

BASO			
pilot burners			
			
1			
GEV No.	107368	Ref. No.	G01267-5
description	pilot burner type J990MDA-2 2 flames natural/liquid gas		

accessories universal			
pilot burner brackets			
			
1			
GEV No.	692611	Ref. No.	2554500
description	pilot burner bracket zinc-plated suitable for GARLAND		

ignition electrode holders			
			
1			
GEV No.	107753	Ref. No.	2525800
description	spacer zinc-plated for piezoelectric igniter suitable for GARLAND		

electrodes			
			
1			
GEV No.	109198	Ref. No.	1466100
description	monitoring electrode connection ø male faston 6.3mm D1 ø 8mm D2 ø 5mm L1 20mm BL1 32mm BL2 13mm		

			
1			
GEV No.	100906	Ref. No.	2200704
description	screw connection thread M10x1 for ignition electrode brass Qty 1 pcs WS 10		

piezoelectric igniters				
mounting diameter 18mm				
				
1				
GEV No.	100009	Ref. No.	1309201	
description	piezoelectric igniter body plastic blowing mounting ø 18mm connection ø2.4mm front measurements 26mm M18x1.5			
accessories for	100009			
	GEV No.	101339	Ref. No.	—
cover cap for piezoelectric igniter				
	GEV No.	106869	Ref. No.	—
cover cap for piezoelectric igniter ID ø 22mm ED ø 35mm H 25mm				
	GEV No.	107931	Ref. No.	—
cover cap for piezoelectric igniter ID ø 21mm ED ø 36mm				

ignition units



GEV No.	103257	Ref. No.	4515818
description	ignition unit outputs 4 230VAC dimensions 111x28x34mm mounting distance 98mm inlet F6.3x0.8 outlet F2.8x0.8 type FZ4 set 6-piece 0.3VA 50-60Hz		
accessories for	103257		
GEV No.	101023	Ref. No.	—
description	ignition unit outputs 4 230VAC dimensions 111x28x34mm mounting distance 98mm inlet F6.3x0.8 outlet F2.8x0.8 type ZAG4 0.3VA 50-60Hz		

thermocouples

thermocouple sets universal



GEV No.	102280	Ref. No.	1019418 1029410 1415000 227183 G01575-1
description	thermocouple set ROBERTSHAW 5-piece L 18" - 455mm		



GEV No.	102283	Ref. No.	1920401
description	thermocouple set ROBERTSHAW 5-piece L 72" - 1825mm		

plug-in thermocouples

plug-in thermocouples standard

ROBERTSHAW

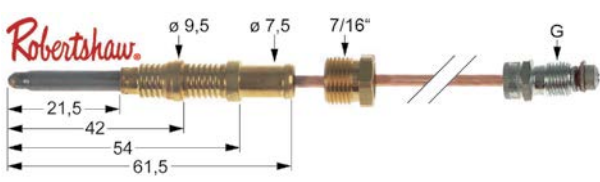

GEV No.	102277	Ref. No.	812284
description	thermocouple ROBERTSHAW ASA 11/32 L 36" - 915mm 7/16"		

with barrel socket ø6mm

SIT

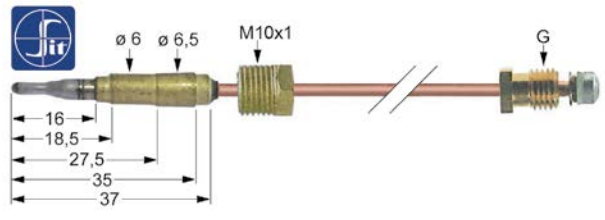

GEV No.	102944	Ref. No.	2200601 4523506
description	thermocouple M9x1 L 1500mm M10x1		

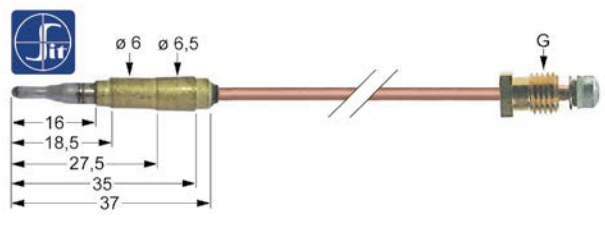

GEV No.	102246	Ref. No.	2200600 2200602
description	thermocouple M9x1 L 600mm plug connection ø6.0mm		

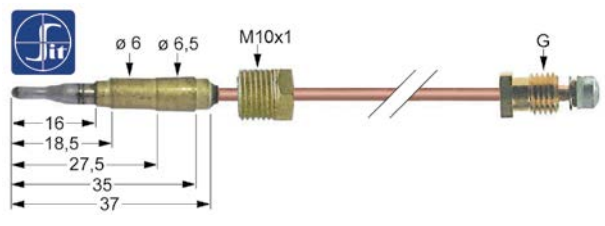

GEV No.	113041	Ref. No.	2321902
description	thermocouple SIT ASA 11/32 L 600mm plug connection ø6.0mm		

threaded thermocouples

threaded thermocouples standard

with socket with thread M8x1

SIT

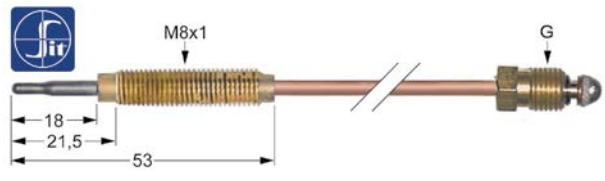

GEV No.	107644	Ref. No.	2155201
description	thermocouple SIT M10x1 L 750mm M8x1		
accessories for	107644		
GEV No.	102067	Ref. No.	—
description	nut thread M8x1 H 3mm brass Qty 1 pcs type SEF 1		



thermopiles

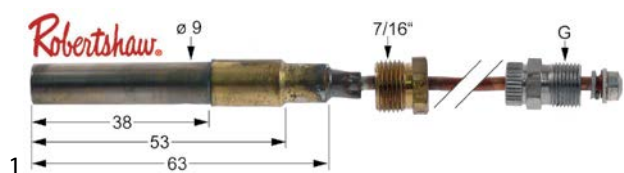

GEV No.	580035	Ref. No.	1093418 1577001 F810-0162
description	thermopile L 36" - 915mm probe \varnothing 9mm probe L 38mm 250-750mV screw connection 7/16" connection 3/8" NEF		

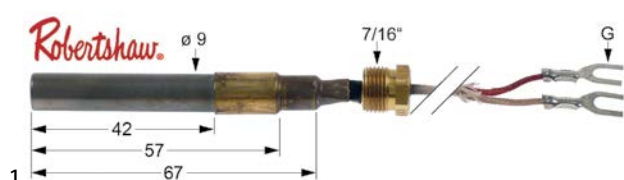

GEV No.	102116	Ref. No.	UK33
description	thermopile ROBERTSHAW L 900mm probe \varnothing 9mm probe L 57mm 250-750mV screw connection 7/16"		



GEV No.	103362	Ref. No.	810-06171 8101873
description	thermopile WHITE RODGERS L 900mm probe \varnothing 11.5mm probe L 46mm screw connection connection male faston 6.3mm		

accessories

interrupters



GEV No.	580046	Ref. No.	1092702
description	extension for interruptor L 18" - 455mm		

gas burners

hob burners

producer-specific hob burners

GARLAND



GEV No.	104667	Ref. No.	2217300
description	burner range \varnothing 180mmkW nozzle mounting 11.8 H 78mm star-shaped suitable for GARLAND mounting pos. front		

accessories

pan supports



GEV No.	210055	Ref. No.	G6214
description	pan support W 275mm L 275mm H 35mm mounting pos. burner suitable for GARLAND		



GEV No.	210056	Ref. No.	G0594-1
description	pan support W 275mm L 275mm H 35mm mounting pos. burner suitable for GARLAND		



GEV No.	210054	Ref. No.	1769101
description	pan support W 300mm L 325mm H 75mm mounting pos. range suitable for GARLAND		

bar burners

bar burners



GEV No.	104668	Ref. No.	1090500 1090599
description	burner cast iron W 58mm H 80mm L 533mm mounting pos. OVEN		

accessories

air slides



GEV No.	104666	Ref. No.	1028002
description	air slide ø 58mm thickness 0.8mm hole ø 11.8mm plate		



GEV No.	104665	Ref. No.	2519200
description	air slide ø 60mm thickness 0.8mm hole ø 11.5mm plate		

gas nozzles

main nozzles

gas nozzles (other)



GEV No.	107371	Ref. No.	G02486-52F
description	gas injector code 52 bore ø 1.6mm natural/liquid gas for grill		



GEV No.	107747	Ref. No.	2104563
description	gas injector thread 3/8" code 63 WS 13 bore ø 0.53mm L 35mm natural/liquid gas		



GEV No.	107743	Ref. No.	G02486-46
description	gas injector thread 7/16" code 46 WS 1/2" bore ø 1.5mm L 44mm natural/liquid gas		



GEV No.	107745	Ref. No.	G02486-51F
description	gas injector thread code 51 WS 13 bore ø 1.28mm L 45mm natural/liquid gas		



GEV No.	107744	Ref. No.	M8-50
description	gas injector thread M8 code 50 WS 13 bore ø 1.6mm L 18mm natural/liquid gas		



GEV No.	107746	Ref. No.	M8-55
description	gas injector thread M8 code 55 WS 13 bore ø 1.24mm L 18.5mm natural/liquid gas		

pilot burner nozzles

pilot burner nozzles ROBERTSHAW



GEV No.	100275	Ref. No.	1028203 1028207 1293001
description	pilot burner nozzle LPG code 10 bore ø 0.1mm suitable for ROBERTSHAW		



GEV No.	100276	Ref. No.	1028202 1293000 F810-0126
description	pilot burner nozzle natural gas code 18 suitable for ROBERTSHAW		

pilot burner nozzles (other)

GARLAND



GEV No.	107369	Ref. No.	G01267-3
description	pilot burner nozzle LPG code 012 Qty 1 pcs		



1			
GEV No.	107751	Ref. No.	2520802
description	pilot burner nozzle LPG code 30 gas pressurebar bore ø 0.5mm thread mounting distance 10mm Qty 1 pcs metal		

1			
GEV No.	107370	Ref. No.	G01267-2
description	pilot burner nozzle natural gas code 020 Qty 1 pcs		

1			
GEV No.	107749	Ref. No.	2200702
description	pilot burner nozzle natural gas code 32 gas pressurebar bore ø 0.2mm thread mounting distance 10mm Qty 1 pcs metal		

1			
GEV No.	107750	Ref. No.	2520801
description	pilot burner nozzle natural/liquid gas code 51 gas pressurebar bore ø 1mm thread mounting distance 10mm Qty 1 pcs metal		

1			
GEV No.	107748	Ref. No.	2200703 220703
description	pilot burner nozzle natural/liquid gas code gas pressurebar bore ø 1.3mm thread mounting distance 10mm Qty 1 pcs metal		

chokes

1			
GEV No.	107801	Ref. No.	1086597
description	restrictor AB type AP5-1 gas inlet 1/8"x27 NPT (tube ø 5mm) gas outlet 3/8"x24 UNF (tube ø 3/16" CC)		

auxiliary gas parts

screw connections

olives

1			
GEV No.	107752	Ref. No.	2520804
description	olive for pipe ø 3/16" L 10mm brass Qty 1 pcs suitable for SIT		

union nuts

1			
GEV No.	103254	Ref. No.	M245
description	union nut thread 3/8" tube ø 3/16"mm gas WS 11 L 10mm brass Qty 1 pcs		

union screws

1			
GEV No.	100906	Ref. No.	2200704
description	screw connection thread M10x1 for ignition electrode brass Qty 1 pcs WS 10		

1			
GEV No.	100907	Ref. No.	2200706
description	screw connection thread M10x1 Qty 1 pcs type SEF 1 ømm for thermocouple		

gas lines

pilot tubes

producer-specific

1			
GEV No.	107741	Ref. No.	CK2324001
description	pilot tube tube ø 4.6mm L 273mm W 4.6mm H 55mm metal connection screw		

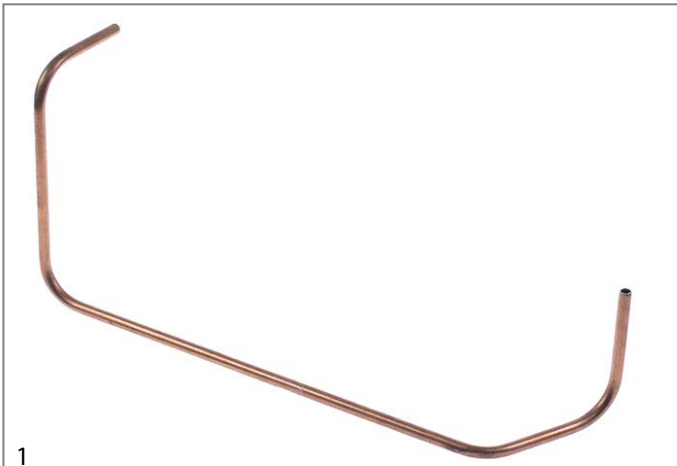

1	GEV No.	107740	Ref. No.	2229000
description pilot tube tube ø 4.6mm L 4300mm W 50mm H 100mm metal connection screw				

universal



1	GEV No.	106357	Ref. No.	GM308
description pilot tube aluminium pipe ø 1/4" CCT L 300mm				

miscellaneous



1	GEV No.	694825	Ref. No.	G01275-1 GARG01275-1
description support for solid top high temperature resistant L 75mm W 75mm H 65mm ceramic fibre				

equipment-specific units

for grills

housing and bezels

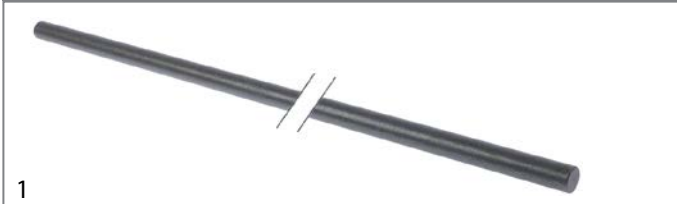

1	GEV No.	696680	Ref. No.	03866-1-5
description bar metal for grill L 535mm ø 16mm suitable for GARLAND				

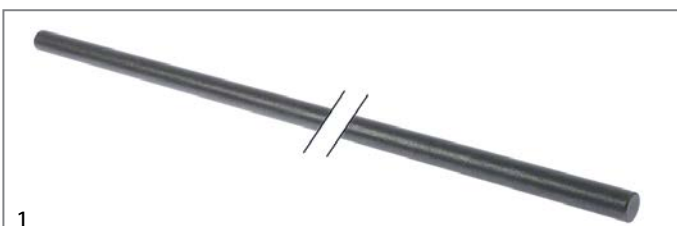

1	GEV No.	696681	Ref. No.	03866-2-5
description bar metal for grill L 795mm ø 16mm suitable for GARLAND				

for ovens

miscellaneous

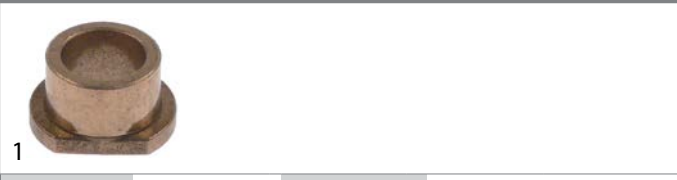

1	GEV No.	696672	Ref. No.	1011203
description bush brass for door bolt L 29mm W 29mm H 16mm				

accessories for 696672

	GEV No.	696671	Ref. No.	1082700
ring chrome-plated spacer L 35mm W 35mm H 4.5mm				

	GEV No.	696673	Ref. No.	1082199
lever joint metal for oven L 100mm W 70mm H 30mm mounting pos. right				

	GEV No.	696674	Ref. No.	1082198
lever joint metal for oven L 100mm W 70mm H 30mm mounting pos. left				

	GEV No.	696675	Ref. No.	1082802
connector metal for oven L 110mm W 18.5mm H 18.5mm mounting pos. right				









	GEV No.	696676	Ref. No.	1082803
connector metal for oven L 110mm W 18.5mm H 18.5mm mounting pos. left				









	GEV No.	696677	Ref. No.	1005800
door spring metal for oven L 165mm W 26.5mm H 26.5mm				

	GEV No.	696678	Ref. No.	1083001
holding plate metal for oven L 98mm W 32mm H 6mm				









	GEV No.	696679	Ref. No.	9004701
hook metal for door spring L 79mm W 22mm H 5.4mm				



			
GEV No.	696676	Ref. No.	1082803
description	connector metal for oven L 110mm W 18.5mm H 18.5mm mounting pos. left		
accessories for	696676		
	GEV No.	696671	Ref. No. 1082700
	ring chrome-plated spacer L 35mm W 35mm H 4.5mm		
	GEV No.	696672	Ref. No. 1011203
	bush brass for door bolt L 29mm W 29mm H 16mm		
	GEV No.	696673	Ref. No. 1082199
	lever joint metal for oven L 100mm W 70mm H 30mm mounting pos. right		
	GEV No.	696674	Ref. No. 1082198
	lever joint metal for oven L 100mm W 70mm H 30mm mounting pos. left		
	GEV No.	696675	Ref. No. 1082802
	connector metal for oven L 110mm W 18.5mm H 18.5mm mounting pos. right		
	GEV No.	696677	Ref. No. 1005800
	door spring metal for oven L 165mm W 26.5mm H 26.5mm		
	GEV No.	696678	Ref. No. 1083001
	holding plate metal for oven L 98mm W 32mm H 6mm		
	GEV No.	696679	Ref. No. 9004701
	hook metal for door spring L 79mm W 22mm H 5.4mm		



			
GEV No.	696675	Ref. No.	1082802
description	connector metal for oven L 110mm W 18.5mm H 18.5mm mounting pos. right		
accessories for	696675		
	GEV No.	696671	Ref. No. 1082700
	ring chrome-plated spacer L 35mm W 35mm H 4.5mm		
	GEV No.	696672	Ref. No. 1011203
	bush brass for door bolt L 29mm W 29mm H 16mm		
	GEV No.	696673	Ref. No. 1082199
	lever joint metal for oven L 100mm W 70mm H 30mm mounting pos. right		
	GEV No.	696674	Ref. No. 1082198
	lever joint metal for oven L 100mm W 70mm H 30mm mounting pos. left		
	GEV No.	696676	Ref. No. 1082803
	connector metal for oven L 110mm W 18.5mm H 18.5mm mounting pos. left		
	GEV No.	696677	Ref. No. 1005800
	door spring metal for oven L 165mm W 26.5mm H 26.5mm		
	GEV No.	696678	Ref. No. 1083001
	holding plate metal for oven L 98mm W 32mm H 6mm		









accessories for	696675		
	GEV No.	696679	Ref. No. 9004701
	hook metal for door spring L 79mm W 22mm H 5.4mm		

			
GEV No.	696677	Ref. No.	1005800
description	door spring metal for oven L 165mm W 26.5mm H 26.5mm		
accessories for	696677		
	GEV No.	696671	Ref. No. 1082700
	ring chrome-plated spacer L 35mm W 35mm H 4.5mm		
	GEV No.	696672	Ref. No. 1011203
	bush brass for door bolt L 29mm W 29mm H 16mm		
	GEV No.	696673	Ref. No. 1082199
	lever joint metal for oven L 100mm W 70mm H 30mm mounting pos. right		
	GEV No.	696674	Ref. No. 1082198
	lever joint metal for oven L 100mm W 70mm H 30mm mounting pos. left		
	GEV No.	696675	Ref. No. 1082802
	connector metal for oven L 110mm W 18.5mm H 18.5mm mounting pos. right		
	GEV No.	696676	Ref. No. 1082803
	connector metal for oven L 110mm W 18.5mm H 18.5mm mounting pos. left		
	GEV No.	696678	Ref. No. 1083001
	holding plate metal for oven L 98mm W 32mm H 6mm		
	GEV No.	696679	Ref. No. 9004701
	hook metal for door spring L 79mm W 22mm H 5.4mm		





			
GEV No.	696678	Ref. No.	1083001
description	holding plate metal for oven L 98mm W 32mm H 6mm		
accessories for	696678		
	GEV No.	696671	Ref. No. 1082700
	ring chrome-plated spacer L 35mm W 35mm H 4.5mm		
	GEV No.	696672	Ref. No. 1011203
	bush brass for door bolt L 29mm W 29mm H 16mm		
	GEV No.	696673	Ref. No. 1082199
	lever joint metal for oven L 100mm W 70mm H 30mm mounting pos. right		
	GEV No.	696674	Ref. No. 1082198
	lever joint metal for oven L 100mm W 70mm H 30mm mounting pos. left		
	GEV No.	696675	Ref. No. 1082802
	connector metal for oven L 110mm W 18.5mm H 18.5mm mounting pos. right		









Table continues overleaf

accessories for		696678		
	GEV No.	696676	Ref. No.	1082803
	connector metal for oven L 110mm W 18.5mm H 18.5mm mounting pos. left			
	GEV No.	696677	Ref. No.	1005800
	door spring metal for oven L 165mm W 26.5mm H 26.5mm			
	GEV No.	696679	Ref. No.	9004701
	hook metal for door spring L 79mm W 22mm H 5.4mm			

accessories for		696679		
	GEV No.	696679	Ref. No.	9004701
	hook metal for door spring L 79mm W 22mm H 5.4mm			
accessories for		696679		
	GEV No.	696671	Ref. No.	1082700
	ring chrome-plated spacer L 35mm W 35mm H 4.5mm			
	GEV No.	696672	Ref. No.	1011203
	bush brass for door bolt L 29mm W 29mm H 16mm			
	GEV No.	696673	Ref. No.	1082199
	lever joint metal for oven L 100mm W 70mm H 30mm mounting pos. right			
	GEV No.	696674	Ref. No.	1082198
	lever joint metal for oven L 100mm W 70mm H 30mm mounting pos. left			
	GEV No.	696675	Ref. No.	1082802
	connector metal for oven L 110mm W 18.5mm H 18.5mm mounting pos. right			
	GEV No.	696676	Ref. No.	1082803
	connector metal for oven L 110mm W 18.5mm H 18.5mm mounting pos. left			
	GEV No.	696677	Ref. No.	1005800
	door spring metal for oven L 165mm W 26.5mm H 26.5mm			
	GEV No.	696678	Ref. No.	1083001
	holding plate metal for oven L 98mm W 32mm H 6mm			

accessories for		696674		
	GEV No.	696674	Ref. No.	1082198
	lever joint metal for oven L 100mm W 70mm H 30mm mounting pos. left			
accessories for		696674		
	GEV No.	696671	Ref. No.	1082700
	ring chrome-plated spacer L 35mm W 35mm H 4.5mm			
	GEV No.	696672	Ref. No.	1011203
	bush brass for door bolt L 29mm W 29mm H 16mm			
	GEV No.	696673	Ref. No.	1082199
	lever joint metal for oven L 100mm W 70mm H 30mm mounting pos. right			

accessories for		696674		
	GEV No.	696675	Ref. No.	1082802
	connector metal for oven L 110mm W 18.5mm H 18.5mm mounting pos. right			
	GEV No.	696676	Ref. No.	1082803
	connector metal for oven L 110mm W 18.5mm H 18.5mm mounting pos. left			
	GEV No.	696677	Ref. No.	1005800
	door spring metal for oven L 165mm W 26.5mm H 26.5mm			
	GEV No.	696678	Ref. No.	1083001
	holding plate metal for oven L 98mm W 32mm H 6mm			
	GEV No.	696679	Ref. No.	9004701
	hook metal for door spring L 79mm W 22mm H 5.4mm			

accessories for		696673		
	GEV No.	696673	Ref. No.	1082199
	lever joint metal for oven L 100mm W 70mm H 30mm mounting pos. right			
accessories for		696673		
	GEV No.	696671	Ref. No.	1082700
	ring chrome-plated spacer L 35mm W 35mm H 4.5mm			
	GEV No.	696672	Ref. No.	1011203
	bush brass for door bolt L 29mm W 29mm H 16mm			
	GEV No.	696674	Ref. No.	1082198
	lever joint metal for oven L 100mm W 70mm H 30mm mounting pos. left			
	GEV No.	696675	Ref. No.	1082802
	connector metal for oven L 110mm W 18.5mm H 18.5mm mounting pos. right			
	GEV No.	696676	Ref. No.	1082803
	connector metal for oven L 110mm W 18.5mm H 18.5mm mounting pos. left			
	GEV No.	696677	Ref. No.	1005800
	door spring metal for oven L 165mm W 26.5mm H 26.5mm			
	GEV No.	696678	Ref. No.	1083001
	holding plate metal for oven L 98mm W 32mm H 6mm			
	GEV No.	696679	Ref. No.	9004701
	hook metal for door spring L 79mm W 22mm H 5.4mm			



accessories for		696671		
	GEV No.	696671	Ref. No.	1082700
	ring chrome-plated spacer L 35mm W 35mm H 4.5mm			
accessories for		696671		
	GEV No.	696672	Ref. No.	1011203
	bush brass for door bolt L 29mm W 29mm H 16mm			

Table continues overleaf



accessories for 696671				
	GEV No.	696673	Ref. No.	1082199
	lever joint metal for oven L 100mm W 70mm H 30mm mounting pos. right			
	GEV No.	696674	Ref. No.	1082198
	lever joint metal for oven L 100mm W 70mm H 30mm mounting pos. left			
	GEV No.	696675	Ref. No.	1082802
	connector metal for oven L 110mm W 18.5mm H 18.5mm mounting pos. right			
	GEV No.	696676	Ref. No.	1082803
	connector metal for oven L 110mm W 18.5mm H 18.5mm mounting pos. left			
	GEV No.	696677	Ref. No.	1005800
	door spring metal for oven L 165mm W 26.5mm H 26.5mm			
	GEV No.	696678	Ref. No.	1083001
	holding plate metal for oven L 98mm W 32mm H 6mm			
	GEV No.	696679	Ref. No.	9004701
	hook metal for door spring L 79mm W 22mm H 5.4mm			

for pizza ovens

firebricks



1	GEV No.	850124	Ref. No.	4523903
	description ceramic briquetts L 54.5mm W 42.5mm H 27mm Qty 126 pcs			

knobs

producer-specific knobs

GARLAND



1	GEV No.	112759	Ref. No.	4512139
	description knob gas tap with ignition flame T.max. temp. ø 54x24mm shaft ø 8.9x6.4mm shaft flat horizontal/vertical black range			



1	GEV No.	112749	Ref. No.	4512140
	description knob gas tap with ignition flame T.max. temp. ø 62mm shaft ø 8.9x6.4mm shaft flat horizontal/vertical black/silver for stove top			

1	GEV No.	112753	Ref. No.	4512120
	description knob gas tap with ignition flame T.max. temp. ø 62mm shaft ø 8.9x6.4mm shaft flat horizontal/vertical black/silver for stove top			

1	GEV No.	112750	Ref. No.	4512150
	description knob gas valve with ignition flame T.max. temp. ø 62mm shaft ø 10 8.9x6.4mm shaft flat horizontal/vertical black/silver for oven			



1	GEV No.	112757	Ref. No.	1089101
	description knob OVEN T.max. temp. ø 54x24mm shaft ø 8.7x6.2mm shaft flat lower black gas oven			
accessories for 112757				
	GEV No.	112749	Ref. No.	4512140
	knob gas tap with ignition flame T.max. temp. ø 62mm shaft ø 8.9x6.4mm shaft flat horizontal/vertical black/silver for stove top			
	GEV No.	112750	Ref. No.	4512150
	knob gas valve with ignition flame T.max. temp. ø 62mm shaft ø 10 8.9x6.4mm shaft flat horizontal/vertical black/silver for oven			
	GEV No.	112751	Ref. No.	4512141
	knob thermostat T.max. 500°F temp. 150-500°F ø 62mm shaft ø 10 8.9x6.4mm shaft flat horizontal/vertical black/silver for oven			
	GEV No.	112752	Ref. No.	G02716-1
	knob T.max. temp. ø 63mm shaft ø 6.4x4.8mm shaft flat horizontal/vertical black			
	GEV No.	112753	Ref. No.	4512120
	knob gas tap with ignition flame T.max. temp. ø 62mm shaft ø 8.9x6.4mm shaft flat horizontal/vertical black/silver for stove top			
	GEV No.	112754	Ref. No.	4512142
	knob thermostat T.max. 260°C temp. 70-260°C ø 62mm shaft ø 10mm shaft flat upper black/silver for oven			



Table continues overleaf

accessories for	112757		
	GEV No.	112755	Ref. No. G02716-3
	knob T.max. temp. ø 63mm shaft ø 11x7.9mm shaft flat horizontal/vertical black		
	GEV No.	112758	Ref. No. G02725-16
	knob dial plate thermostat T.max. 500°F temp. 150-500°F ø 59mm shaft ømm shaft flat silver oven		

	1		
GEV No.	112742	Ref. No.	4527470 CK4527470
description	knob range kit ignition/large/small ø 66mm shaft ø 8x6.5mm black/silver shaft 8 H 40mm Qty 1 pcs		



	1		
GEV No.	112756	Ref. No.	1089100
description	knob T.max. temp. ø 54x24mm shaft ø 8.5mm shaft flat upper black gas oven		

	1		
GEV No.	112755	Ref. No.	G02716-3
description	knob T.max. temp. ø 63mm shaft ø 11x7.9mm shaft flat horizontal/vertical black		
accessories for	112755		
	GEV No.	112758	Ref. No. G02725-16
	knob dial plate thermostat T.max. 500°F temp. 150-500°F ø 59mm shaft ømm shaft flat silver oven		

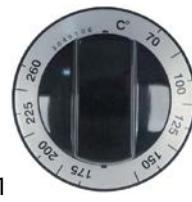
	1		
GEV No.	112752	Ref. No.	G02716-1
description	knob T.max. temp. ø 63mm shaft ø 6.4x4.8mm shaft flat horizontal/vertical black		
accessories for	112752		
	GEV No.	112758	Ref. No. G02725-16
	knob dial plate thermostat T.max. 500°F temp. 150-500°F ø 59mm shaft ømm shaft flat silver oven		

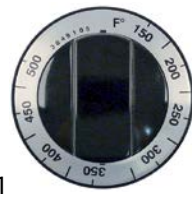
	1		
GEV No.	112754	Ref. No.	4512142
description	knob thermostat T.max. 260°C temp. 70-260°C ø 62mm shaft ø 10mm shaft flat upper black/silver for oven		

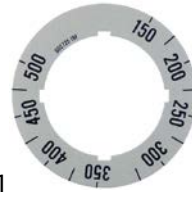
	1		
GEV No.	112751	Ref. No.	4512141
description	knob thermostat T.max. 500°F temp. 150-500°F ø 62mm shaft ø 10 8.9x6.4mm shaft flat horizontal/vertical black/silver for oven		

	1		
GEV No.	112758	Ref. No.	G02725-16
description	knob dial plate thermostat T.max. 500°F temp. 150-500°F ø 59mm shaft ømm shaft flat silver oven		
accessories for	112758		
	GEV No.	112752	Ref. No. G02716-1
	knob T.max. temp. ø 63mm shaft ø 6.4x4.8mm shaft flat horizontal/vertical black		
	GEV No.	112755	Ref. No. G02716-3
	knob T.max. temp. ø 63mm shaft ø 11x7.9mm shaft flat horizontal/vertical black		

baskets

fryer baskets

US producers

	1		
GEV No.	970184	Ref. No.	1035303
description	fryer basket L1 330mm W1 315mm H1 135mm		

B

bar burners 14

C

cam switches 6

contactors 6

E

energy regulators 3

G

gas burners 13

gas control valves 8

gas lines 15

gas nozzles 14

gas taps 7

gas thermostats 8

H

hob burners 13

hot plates 3

I

ignition units 12

indicator lights 6

indicator lights (complete) 6

L

lamps 6

light bulbs 6

M

microswitches 5

motors 7

P

piezoelectric igniters 11

pilot burners 9

R

rocker/momentary rocker switches 5

S

switches and momentary switches 5

T

thermocouples 12

thermostats 3