



GAS COMPONENTS



ELECTRIC COMPONENTS



WATER TECHNOLOGY



MECHANICAL COMPONENTS



TOOLS

Spare parts suitable for

GARBIN

Find the complete and up-to-date range of products in our GEV Webshop



Manufacturer catalogue

The most important spare parts and accessories arranged clearly for every manufacturer

- ✓ Complete product range and all appliance data always up to date in the GEV Webshop
- ✓ Alphabetical Index at the end of the catalogue

GEV Webshop

www.gev-online.co.uk

www.gev-online.com



- 🔍 Add to Favourites
- 🔍 Sign In with email address and usual password
- 🔍 Easy-order – place several items in your basket at the same time
- 🔍 Quick Item search – no login needed



heating elements

heating elements for ovens

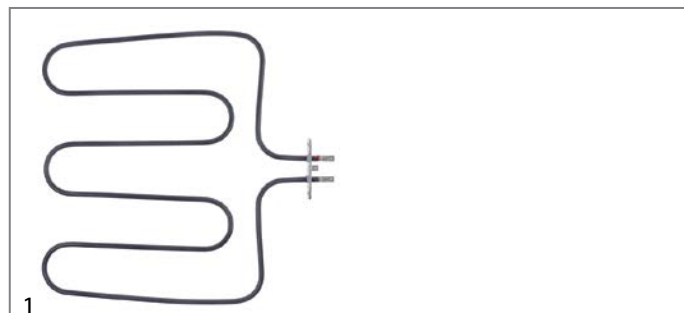

GEV No.	418792	Ref. No.	RES155
description	heating element 1400W 230V heating circuits 1 L 315mm W 320mm L1 55mm L2 260mm W1 150mm W2 30mm flange length 70mm flange width 22mm hole distance 56mm hole ø 4.2mm tube ø 6.3mm connection male faston 6.3mm rectangular flange		

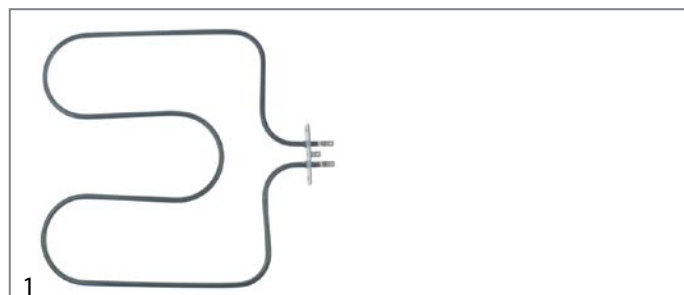

GEV No.	420276	Ref. No.	RES009 RES041 RES043 RESINF RESINF838443MX23
description	heating element 1500W 230V heating circuits 1 L 313mm W 300mm L1 48mm L2 305mm W1 135mm W2 30mm flange length 70mm flange width 22mm hole distance 56mm hole ø 5mm tube ø 6.5mm connection male faston 6.3mm windings 2 oven heating element		

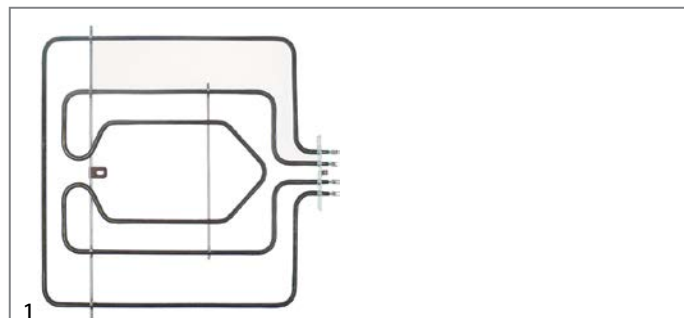

GEV No.	420275	Ref. No.	RES008 RES039 RES054 RESSUP2343MX
description	heating element 2400W 230V heating circuits 2 L 335mm W 350mm L1 30mm L2 305mm W1 145mm W2 60mm flange length 100mm flange width 22mm hole distance 86mm hole ø 5mm tube ø 6.5mm connection male faston 6.3mm oven heating element		

heating elements for convection



GEV No.	420534	Ref. No.	RES015
description	heating element 2000W 240V heating circuits 2 ID ø 220mm ED ø 233mm L 270mm H 44mm L1 16mm W1 58mm H1 14mm H2 30mm flange length 100mm flange width 22mm connection F6.3 tube ø 6.5mm threaded		



GEV No.	415966	Ref. No.	RES006 RES036
description	heating element 2500W 230V heating circuits 1 ID ø 176mm ED ø 188mm L 210mm H 28mm L1 22mm W1 30mm H1 3mm H2 25mm flange length 70mm flange width 22mm hole distance 56mm connection male faston 6.3mm tube ø 6.3mm convection heating element hole ø 5mm rectangular flange		



spare parts for	415966	GEV No.	510368	Ref. No.	—
accessories for	415966	GEV No.	510368	Ref. No.	—





GEV No.	420535	Ref. No.	RES029 RES029-UL
description	heating element 2500W 240V heating circuits 1 ID ø 185mm ED ø 293mm L 245mm H 30mm L1 32mm W1 30mm H1 8mm H2 22mm flange length 70mm flange width 22mm hole distance 57mm connection F6.3 tube ø 6.5mm hole ø 5mm threaded		

1 electric components



			
1			
GEV No.	417607	Ref. No.	RES000 RES36 RES4000
description	heating element 2x2000W 230V heating circuits 2 ID ϕ 185mm ED ϕ 200mm L 240mm H 50mm L1 40mm W1 63mm H1 15mm H2 35mm flange length 100mm flange width 22mm hole distance 85mm connection male faston 6.3mm tube ϕ 6.4mm hot air hole ϕ 4.9mm		
accessories for	417607		
	GEV No.	550986	Ref. No. —
	gasket L 100mm W 22mm 7 holes graphite thickness 1mm for heating element		

			
1			
GEV No.	420536	Ref. No.	RES017
description	heating element 3300W 230V heating circuits 1 ID ϕ 225mm ED ϕ 238mm L 270mm H 34mm L1 20mm W1 30mm H1 10mm H2 24mm flange length 70mm flange width 22mm hole distance 56mm connection F6.3 tube ϕ 6.25mm hole ϕ 5mm threaded		

			
1			
GEV No.	420295	Ref. No.	RES013 RES013-UL
description	heating element 3300W 240V heating circuits 1 ID ϕ 186mm ED ϕ 202mm L 250mm H 38mm L1 36mm W1 32mm H1 8mm H2 32mm flange length 70mm flange width 22mm hole distance 56mm connection male faston 6.3mm tube ϕ 8.5mm convection heating element hole ϕ 5mm flange for combi-steamer		

			
1			
GEV No.	417606	Ref. No.	RES026
description	heating element 4500W 230V heating circuits 3 ID ϕ 220mm ED ϕ 240mm L 280mm H 50mm L1mm W1 96mm H1 15mm H2 35mm flange length 140mm flange width 25mm hole distance 63mm connection male faston 6.3mm connection length 41.5mm tube ϕ 8.4mm hot air hole ϕ 7mm		

energy regulators

EGO

1-circuit

			
1			
GEV No.	380019	Ref. No.	REG001 REG100
description	energy regulator 240V 13A single-circuit turn direction right shaft ϕ 6x4.6mm shaft L 23mm mounting thread M4 power release 6-100% no. 50.57071.010		

thermostats

control and safety thermostats

EGO

control thermostats

55.17_ series

			
1			
GEV No.	390853	Ref. No.	TER005 TER034
description	thermostat t.max. 287°C temperature range 57-287°C 1-pole 1NO 16A probe ϕ 3.1mm probe L 122mm capillary pipe 1100mm capillary pipe isolated 1050mm gland nut shaft ϕ 6x4.6mm shaft L 23.5mm shaft position right rotation 270°		

CAEM

control thermostats

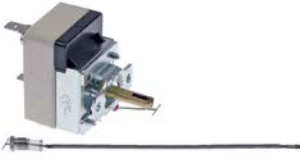
			
1			
GEV No.	375999	Ref. No.	TER001 TER007 TER290
description	thermostat t.max. 280°C temperature range 50-280°C 1-pole 1NO 16A probe ϕ 3mm probe L 180mm capillary pipe 1450mm capillary pipe isolated 20mm gland nut M10x1 shaft ϕ 6x4.6mm shaft L 18mm shaft position upper rotation 270° probe material SS		



safety thermostats



GEV No.	376029	Ref. No.	TER008
description	safety thermostat switch-off temp. 320°C temperature range°C 1-pole 1NC 20A probe ø 3mm probe L 165mm capillary pipe 1280mm capillary pipe isolated 1080mm gland nut shaft ømm probe SS 250V		



GEV No.	375990	Ref. No.	TER002 TER008 old TER325
description	safety thermostat switch-off temp. 335°C 1-pole 16A probe ø 3mm probe L 180mm capillary pipe 1400mm capillary pipe isolatedmm gland nut M10x1 probe SS		

TECASA

control thermostats

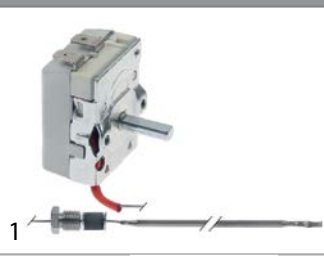

GEV No.	376028	Ref. No.	TER020
description	thermostat t.max. 280°C temperature range 50-280°C 1-pole 1NO 16A probe ø 3mm probe L 175mm capillary pipe 1450mm capillary pipe isolatedmm gland nut M10x1 shaft ø 6x4.6mm shaft L 18mm shaft position upper rotation 270° probe material SS		

safety thermostats



GEV No.	390964	Ref. No.	TER021
description	safety thermostat switch-off temp. 335°C temperature range°C 1-pole 1CO 16A probe ø 3mm probe L 120mm capillary pipe 1500mm capillary pipe isolatedmm gland nut M9x1 probe SS		

CAMPINI

control thermostats



GEV No.	391009	Ref. No.	TER031
description	thermostat switch-off temp. 318°C temperature range°C 1-pole 1NO 16A probe ø 3mm probe L 137mm capillary pipe 1440mm capillary pipe isolatedmm gland nut M9x1 probe SS		

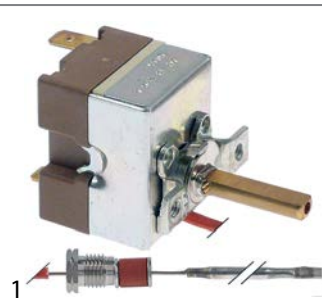

GEV No.	376064	Ref. No.	TER030
description	thermostat t.max. 280°C temperature range 50-280°C 1-pole 1NO 16A probe ø 3mm probe L 175mm capillary pipe 1450mm capillary pipe isolatedmm gland nut M10x1 shaft ø 6x4.6mm shaft L 18mm shaft position upper rotation 270° probe material SS		

switches and momentary switches

push/momentary push switches

ø25mm



GEV No.	347771	Ref. No.	PUL002 PUL245
description	momentary push switch mounting ø 25mm white 1NO/indicator light 250V 16A steam connection male faston 6.3mm ambient temperature max. 85°C protection IP40		

microswitches

pin-plunger actuated

M10



GEV No.	348199	Ref. No.	MIC001 MIC002 MIC253
description	microswitch thread L 17mm 250V 16A 1CO connection F6.3 stroke 7mm actuating force: 500g		



cam switches

10 operating positions



GEV No.	347770	Ref. No.	COM000 COM002 COM037
description	cam switch 10 operating positions 8NO sequence 0-1-2-3-4-5-6-7-8-9 18A shaft ø 6x4.6mm shaft L 23mm connection male faston 6.3mm plastic		

lamps

indicator lights

indicator lights (complete)

ø10mm

with plug-in socket



GEV No.	359138	Ref. No.	SEG000 SP036 SP037
description	indicator light ø 10mm red 230V connection male faston 6.3mm Qty 1 pcs		

screw-on/push-on fit

light bulbs

for ovens



GEV No.	359740	Ref. No.	LAM002
description	light bulb t.max. 300°C socket E14 15W 230V ø 22mm L 48mm lens L 20mm for oven lamp IMPORT		



GEV No.	357153	Ref. No.	LAM001
description	light bulb t.max. 300°C socket E14 25W 230V ø 25mm L 55mm lens L 30mm for oven type		

halogen lamp

for socket G4 / G6.35 / G9



GEV No.	359945	Ref. No.	LAM008
description	halogen lamp socket G9 230V 25W temp.-resist. 300°C		





GEV No.	359946	Ref. No.	LAM003
description	halogen lamp socket G9 230V 40W temp.-resist. 300°C		

oven lamps

universal oven lamps

mounting diameter 35.5mm





GEV No.	359718	Ref. No.	LAM006 Portlam 290	
description	oven lamp mounting ø 35.5mm 230V 15W socket E14 temp.-resist. 300°C connection male faston 6.3mm hard glas			
spare parts for	359718			
	GEV No.	359701	Ref. No.	POR021
	lamp socket socket E14 220-230V mounting ø 35.5mm connection male faston 6.3mm 15W			
	GEV No.	359740	Ref. No.	LAM002
	light bulb t.max. 300°C socket E14 15W 230V ø 22mm L 48mm lens L 20mm for oven lamp IMPORT			





GEV No.	359701	Ref. No.	POR021	
description	lamp socket socket E14 220-230V mounting ø 35.5mm connection male faston 6.3mm 15W			
accessories for	359701			
	GEV No.	359705	Ref. No.	—
	oven lamp glass thr.ø 33.5mm ø 52mm hard glas temp.-resist. 350°C			
	GEV No.	359709	Ref. No.	VET001 VET002
	oven lamp glass thr.ø 33.5mm ø 42mm hard glas temp.-resist. 350°C			
	GEV No.	359721	Ref. No.	—
	gasket silicone ED ø 48mm ID ø 39.5mm thickness 5mm Qty 1 pcs			
	GEV No.	359942	Ref. No.	—
	oven lamp glass thr.ø 33.5mm ø 41mm hard glas temp.-resist. 350°C			

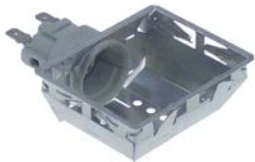

			
1			
GEV No.	359709	Ref. No.	VET001 VET002
description	oven lamp glass thr.ø 33.5mm ø 42mm hard glas temp.-resist. 350°C		

			
1			
GEV No.	358128	Ref. No.	GUA001 GUA019
description	gasket for oven lamp silicone ID ø 30mm ED ø 38mm thickness 2mm		

55x70mm			
			
1			
GEV No.	357159	Ref. No.	POR020
description	lamp socket socket E14 mounting measurements 55x70mm connection male faston 6.3mm Qty 1 pcs		

			
1			
GEV No.	359297	Ref. No.	COR000
description	frame L 95mm W 81mm mounting distance 68/83mm thickness 6mm		
accessories for	359297		
	GEV No.	359299	Ref. No. GHI000
	 gasket L 91mm W 77mm hole ø 3mm for oven lamp		

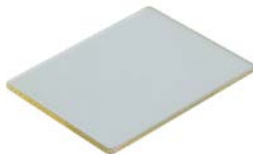

			
1			
GEV No.	359299	Ref. No.	GHI000
description	gasket L 91mm W 77mm hole ø 3mm for oven lamp		

			
1			
GEV No.	359296	Ref. No.	VET000
description	lamp glass L 74mm W 58mm thickness 3mm		

			
1			
GEV No.	357159	Ref. No.	POR020
description	lamp socket socket E14 mounting measurements 55x70mm connection male faston 6.3mm Qty 1 pcs		

lamps			
light bulbs			
			
1			
GEV No.	359740	Ref. No.	LAM002
description	light bulb t.max. 300°C socket E14 15W 230V ø 22mm L 48mm lens L 20mm for oven lamp IMPORT		

			
1			
GEV No.	357153	Ref. No.	LAM001
description	light bulb t.max. 300°C socket E14 25W 230V ø 25mm L 55mm lens L 30mm for oven type		

halogen lamps			
for socket G4 / G6.35 / G9			
			
1			
GEV No.	359945	Ref. No.	LAM008
description	halogen lamp socket G9 230V 25W temp.-resist. 300°C		
			
1			
GEV No.	359946	Ref. No.	LAM003
description	halogen lamp socket G9 230V 40W temp.-resist. 300°C		



sockets

G4 / G5,3 / G6,35



1

GEV No.	359304	Ref. No.	POR076
description	lamp socket socket G4 24V ø 17mm H 9mm connection cable 120mm mounting distance 12mm with 2 hole fixing mounting thread M3 cable length 120mm Qty 1 pcs		

timers

programme timers

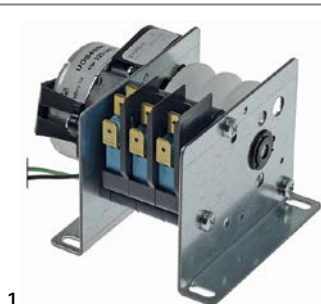

1

GEV No.	360726	Ref. No.	INV013 INV030 INVER230 INVERV
description	programme timer Guaitani R3/3 engines 1 chambers 3 operation time 6min 220/240V 50/60Hz shaft ø 6x6mm shaft L 44mm manuf. no. R3/3 motor type UDS40NE1RNZ165		
spare parts for	360726		
	GEV No.	360673	Ref. No. —
	motor kit pinion ø 6.8mm teeth 15 230V voltage AC 50/60Hz turn direction clockwise motor ø 48mm H 18.5mm mounting thread M4 connection male faston 6.3mm Invensys 230V voltage AC 2-pole		

electric timers



1

GEV No.	350194	Ref. No.	TIM000 TIM060
description	timer M565 with bell operation time 60min time spreadmin 2NO at 250V 16A permanent position yes impulse electric shaft ø 6x4.6mm shaft L 23mm mounting distance 29mm mounting thread M4 connection male faston 6.3mm Invensys 230V voltage AC 2-pole		

mechanical timers



1

GEV No.	350187	Ref. No.	TIM001
description	timer M2 2-pole operation time 60min impulse mechanical 2CO at 250V 16A permanent position yes shaft ø 6x4.6mm shaft 6x4.6mm shaft L 23mm mounting distance 28mm		

alarm devices

buzzer boards



1

GEV No.	401062	Ref. No.	BUZ000
description	buzzer board 230VAC L 48mm W 45mm connection Faston 6.3mm		



contactors

miscellaneous

power contactors



1

GEV No.	381172	Ref. No.	CON000 CON030
description	power contactor resistive load 20A 230VAC (AC3/400V) 9A/4.2kW main contacts 3NO auxiliary contacts 1NC connection screw connection type NC1-0901		
spare parts for	381172		
	GEV No.	110235	Ref. No. —
	knob energy regulator 1-3 t.max.°C ø 50mm shaft ø 6x4.6mm shaft flat upper black		
	GEV No.	380013	Ref. No. —
	energy regulator 400V 7A single-circuit turn direction right shaft ø 6x4.6mm mounting thread M4 no. 50.57031.010		



probes

producer-specific probes

probes

			
GEV No.	379887	Ref. No.	SON001 SON006 SON011
description	temperature probe Pt100 cable high temperatur film probe -50 up to +200°C cable -50 up to +200°C connection 2-wire thread M10x1.5 probe ø5x42mm cable length 1.9m		

core probes

			
GEV No.	379886	Ref. No.	SON000 SON102
description	core temperature probe Pt100 cable PTFE probe -40 up to +250°C cable -40 up to +250°C connection 2-wire probe ø4x100mm thread M10x1.5 cable length 3m handle ø 15mm handle length 90mm		

electronics

PCBs

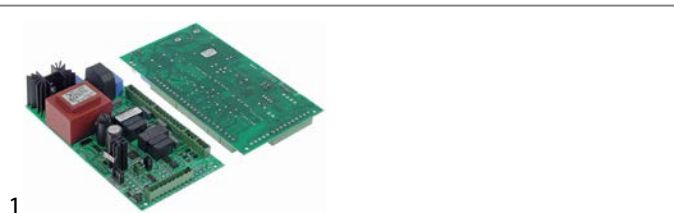
			
GEV No.	361951	Ref. No.	SCH094
description	PCB L 183mm W 103mm		

solenoïd valves

solenoïd valves (water)

ROBERTSHAW/INVENSYS

medium temperature: 90°C 90°C 60°C
ambient temperature: 60°C 25°C 60°C
duty cycle: 40% 100% 100%

solenoïd valves with reducers

3-fold

			
GEV No.	374104	Ref. No.	ELE002 ELE012
description	solenoid valve triple straight 230VAC inlet 3/4" outlet 11.5mm input/min output 2.5l/min output A 2.5l/min output B 2.5l/min output C 2.5l/min flow regulating valve outlet A brown flow regulating valve outlet B brown flow regulating valve outlet C brown		

RPE

solenoïd valves with reducers

single

			
GEV No.	374012	Ref. No.	ELE000 ELE1V
description	solenoid valve single straight 220-240VAC inlet 3/4" outlet JG 8 input 10-12l/min t.max. 60°C duty cycle 100% RPE plastic flow regulating valve outlet brown flow regulating valve inlet white output A 0.07-0.14l/min 2-ways medium temp max. 25°C male faston 6.3mm		

2-fold

			
GEV No.	374103	Ref. No.	ELE001 VAL236
description	solenoid valve double straight 220-240VAC inlet 3/4" outlet JG 8 input 4-4.5l/min output 0.07-0.14l/min flow regulating valve inlet yellow output A brownl/min output B brownl/min		

TP

solenoïd valves with reducers

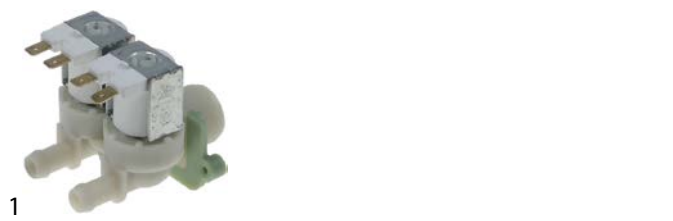
			
GEV No.	370628	Ref. No.	ELE2V
description	solenoid valve double straight 230VAC inlet 3/4" input 16l/min DN10 TP plastic outlet 11.5mm		



fans

cross flow fans

COPREL

with standard coil





GEV No.	601453	Ref. No.	MOT43SE
description	cross flow fan TFR 180 roller ø 60mm roller length 180mm laminated core thickness 16mm motor position right 230V/50-60Hz 17W universal bearing silicone connection male faston 6.3mm airflow 100m ³ /h -30 up to +100°C 230V 50Hz		
accessories for	601453		
	GEV No.	Ref. No.	—
	415114		
description	heater battery mounting distance 185mm W 40mm H 35mm 2000W 230V temperature restriction 105°C heating circuits 2 connection cable cable length 150mm L 192mm for cross flow fan		

hot air motors

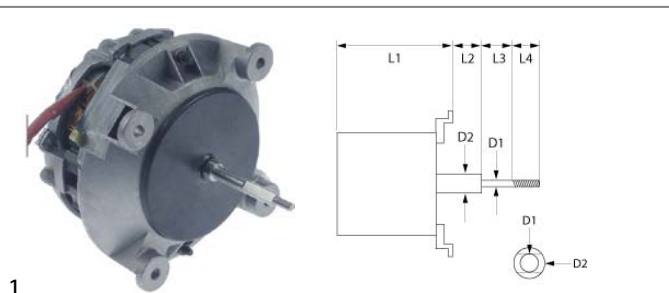

GEV No.	601854	Ref. No.	MOT002 MOT013+CON025
description	fan motor 230V 1 phase 50/60Hz 0.26/0.40kW 2800/3200rpm speeds 1 L1 96mm L2 68mm D1 ø 6/8mm M5x0.8 1.1/1.7A suitable capacitor 5µF/450V Cos(fi) 3217 type MFC80		



GEV No.	601856	Ref. No.	MOT200 MOTCOND44
description	fan motor 230V 1 phase 50Hz 0.075kW 2650rpm speeds 1 L1 85mm L2 30mm L3 23mm L4 12mm D1 ø 8x6mm D2 ø 8mm 0.6A suitable capacitor 5µF/400V		
accessories for	601856		
	GEV No.	Ref. No.	CON003
	365017		
description	operating capacitor capacity 5µF 450V tolerance 5% 50/60Hz ambient temperature max. -25 to +85°C ø 28mm L 54mm M8 plastic connection male faston 6.3mm 16.10.08 protection		



GEV No.	601993	Ref. No.	MOT001 MOT013 MOT017 MOT017+CON003 MOT201
description	fan motor 230V 1 phase 50Hz 0.18/0.12kW 2800rpm speeds 1 L1 85mm L2 65mm L3 23mm D1 ø 8mm D2 ø 6mm M5x0.8 0.8A suitable capacitor 5µF/450V		
accessories for	601993		
	GEV No.	Ref. No.	CON003
	365017		
description	operating capacitor capacity 5µF 450V tolerance 5% 50/60Hz ambient temperature max. -25 to +85°C ø 28mm L 54mm M8 plastic connection male faston 6.3mm 16.10.08 protection		

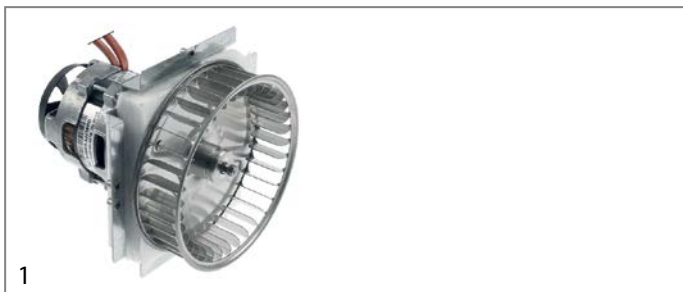

GEV No.	602012	Ref. No.	KIT030
description	fan motor 230V 50Hz 0.11/0.05kW 2800rpm L1 130mm L2 50mm D1 ø 8mm M5x0.8 suitable capacitor 4µF/450V type MFT63 H25		



GEV No.	601801	Ref. No.	VEN001
description	fan wheel D1 ø 160mm H1 43mm blades 36 D2 ø 8mm D3 ø 8mm H2 24mm		

hot air fans

miscellaneous



1

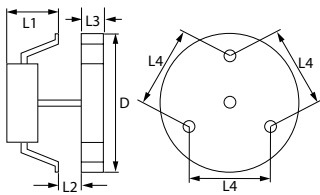

GEV No.	500902	Ref. No.	MOT019
description	fan motor 220V 55W 50/60Hz L1 68mm FIME type L25R without fan wheel		
accessories for	500902		
	GEV No.	Ref. No.	—
	550879		
	insulation ø 130mm thickness 3mm hole ø 20mm for hot air fan		



1

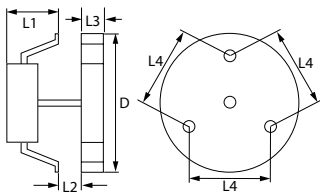

GEV No.	601825	Ref. No.	MOT+VEN046 MOT+VEN43 MOT005 MOT019+GUA061+VEN020
description	hot air fan 230-240V 55W 50/60Hz L1 65mm L2 8mm L3 29mm L4 87mm fan wheel ø 155mm PLASET type 9637.62683		

accessories

fan wheels for hot air fans



1

GEV No.	601979	Ref. No.	VEN010
description	fan wheel ø 159mm W 29mm shaft intake ø 6x5mm SS blades 12 Qty 1 pcs		

motors

gear motors

for ovens



1

GEV No.	500811	Ref. No.	MOT018
description	gear motor AUTOM type ASR/30/FR 230V 50Hz shaft ø 8mm L 150mm W 65mm H 90mm		

pumps

booster pumps II

accessories



1

GEV No.	365017	Ref. No.	CON003
description	operating capacitor capacity 5µF 450V tolerance 5% 50/60Hz ambient temperature max. -25 to +85°C ø 28mm L 54mm M8 plastic connection male faston 6.3mm 16.10.08 protection		



electric components

condensators & interference suppression filters

operating capacitors

plastic



1

GEV No.	365017	Ref. No.	CON003
description	operating capacitor capacity 5µF 450V tolerance 5% 50/60Hz ambient temperature max. -25 to +85°C ø 28mm L 54mm M8 plastic connection male faston 6.3mm 16.10.08 protection		

electric accessories

terminals

connection terminals with screw/faston connections



1

GEV No.	550534 ¹	Ref. No.	MOR000 MOR057
description	power terminal block 3-pole max. 40A max 450V connection ø6mm ² / F6.3 temp.-resist. 150°C cross section 6mm ² mounting distance 67mm with ground lug		

¹with ground lug

gas valves and ignition boxes

gas control valves

HONEYWELL



1

GEV No.	101186	Ref. No.	VAL000
description	gas valve type VK4105C 220-240V 50/60Hz gas inlet flange 32x32mm gas outlet flange 32x32mm thermocouple connection pilot connection pressure range 15-60mbar max 60mbar operator type pressure controller type V5360E 1226 1 HONEYWELL flange 32x32mm		
accessories for	101186		
	GEV No.	102845	Ref. No. —
	gas connection angled 1/2" flange 32x32mm hole distance 24x24mm Tandem		

accessories for	101186		
	GEV No.	102846	Ref. No. —
	gas connection straight 1/2" flange 32x32mm hole distance 24x24mm suitable for Tandem		

ignition boxes

HONEYWELL



1

GEV No.	102367	Ref. No.	CEN000
description	ignition box HONEYWELL type S4565A 2092 1 electrodes 3 waiting times safety time 10s 220-240V 4VA 50/60Hz		

gas nozzles

main nozzles

gas nozzles M13x1



1

GEV No.	103200	Ref. No.	UGE003
description	gas injector thread M13x1 bore ø 3.3mm WS 13		

equipment-specific units

for convection ovens/combi-steamers



1

GEV No.	699272	Ref. No.	BOC004
description	bush ID ø 9mm ED ø 21mm L 5mm		



knobs

producer-specific knobs

GARBIN

			
1			
GEV No.	112697	Ref. No.	MAN000
description	knob zero mark ø 43mm shaft ø 6x4.6mm shaft flat upper silver		

			
1			
GEV No.	112796	Ref. No.	MAN014 MAN038 MAN100
description	knob zero mark ø 49mm shaft ø 6x4.6mm shaft flat upper silver		

			
1			
GEV No.	112698	Ref. No.	MAN041
description	knob zero mark ø 50mm shaft ø 6x4.6mm shaft flat upper grey		

accessories

fascias

			
1			
GEV No.	112699	Ref. No.	DIS006 DIS65
description	bezel thermostat 0-270°C ø 65mm		

gaskets

			
1			
GEV No.	112700	Ref. No.	DIS003 DIS09
description	gasket for knob shaft ø 9mm ED ø 65mm Qty 1 pcs nylon		









locks

handle latches

universal

inside fixing









locks



				
1				
GEV No.	694054	Ref. No.	MAN011	
description	door handle for headed units L 145mm W 40mm H 62mm spring length 33mm inner black			
spare parts for	694054			
	GEV No.	514390	Ref. No.	—
	spring for door handle ø 6mm L 54mm W 27.5mm			
	GEV No.	694675	Ref. No.	—
	door catch L 88mm W 40mm H 37mm spring length 33mm mounting distance 60mm			
	GEV No.	694734	Ref. No.	—
	door handle L 165mm W 40mm H 25mm black			
	GEV No.	694735	Ref. No.	—
	cap ø 32mm black			
accessories for	694054			
	GEV No.	691123	Ref. No.	—
	duct for door opener			
	GEV No.	694055	Ref. No.	—
	door catch L 25mm W 14mm total length 54mm thread M8 thread L 29mm			
	GEV No.	694066	Ref. No.	—
	door catch with spigot 2-stage L 28mm W 14mm H 15mm H1 16mm total length 51mm thread M8 thread L 23mm stainless steel			
	GEV No.	694067	Ref. No.	NAS000
	door catch with spigot 1-stage L 26mm total length 51mm thread M8			



producer-specific

GARBIN

			
1			
GEV No.	694067	Ref. No.	NAS000
description	door catch with spigot 1-stage L 26mm total length 51mm thread M8		

			
GEV No.	694054	Ref. No.	MAN011
description	door handle for headed units L 145mm W 40mm H 62mm spring length 33mm inner black		
spare parts for	694054		
	GEV No.	514390	Ref. No. —
spring for door handle ø 6mm L 54mm W 27.5mm			
	GEV No.	694675	Ref. No. —
door catch L 88mm W 40mm H 37mm spring length 33mm mounting distance 60mm			
	GEV No.	694734	Ref. No. —
door handle L 165mm W 40mm H 25mm black			
	GEV No.	694735	Ref. No. —
cap ø 32mm black			
accessories for	694054		
	GEV No.	691123	Ref. No. —
duct for door opener			
	GEV No.	694055	Ref. No. —
door catch L 25mm W 14mm total length 54mm thread M8 thread L 29mm			
	GEV No.	694066	Ref. No. —
door catch with spigot 2-stage L 28mm W 14mm H 15mm H1 16mm total length 51mm thread M8 thread L 23mm stainless steel			
	GEV No.	694067	Ref. No. NAS000
door catch with spigot 1-stage L 26mm total length 51mm thread M8			

			
GEV No.	692563	Ref. No.	CER004 CERDX43
description	oven hinge mounting distance 123mm lug mounting 11mm lever length 124mm groove distance 11mm spring thickness 3.5mm mounting ear position left spring length 56mm L 148mm mounting pos. right W 20mm		
accessories for	692563		
	GEV No.	692564	Ref. No. CER003 CERSX43
oven hinge mounting distance 123mm lug mounting 11mm lever length 124mm groove distance 11mm spring thickness 3.5mm mounting ear position right spring length 56mm L 148mm mounting pos. left W 20mm			

			
GEV No.	692564	Ref. No.	CER003 CERSX43
description	oven hinge mounting distance 123mm lug mounting 11mm lever length 124mm groove distance 11mm spring thickness 3.5mm mounting ear position right spring length 56mm L 148mm mounting pos. left W 20mm		
accessories for	692564		
	GEV No.	692563	Ref. No. CER004 CERDX43
oven hinge mounting distance 123mm lug mounting 11mm lever length 124mm groove distance 11mm spring thickness 3.5mm mounting ear position left spring length 56mm L 148mm mounting pos. right W 20mm			

hinges

oven hinges

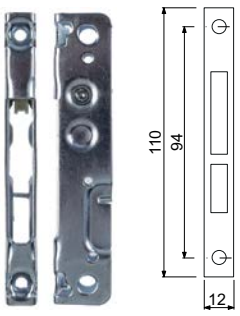
			
GEV No.	693045	Ref. No.	POR025
description	opposite support L 110mm W 12mm mounting distance 94mm		



			
1			
GEV No.	701217	Ref. No.	CER001 CER036 CER36 CER3623
description	oven hinge mounting distance 142mm lever length 118mm groove distance 10mm spring thickness 3.5mm spring length 57mm L 155mm mounting pos. left/right W 21mm		

			
2			
GEV No.	701184	Ref. No.	CER002 CER44
description	oven hinge mounting distance 142mm mounting distance 2mm lug mountingmm lever length 118mm groove distance 12mm spring thickness 4.5mm mounting ear position spring length 57mm mounting pos. left/right W 23mm C 10mm		

			
1			
GEV No.	901604	Ref. No.	GUA006 GUA222 GUA44
description	door seal W 660mm with 8 mounting clips H 360mm		

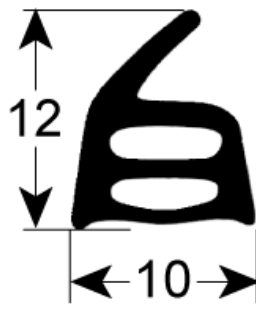
			
1			
GEV No.	902326	Ref. No.	GUA003 GUA029 GUA43
description	oven gasket external size L 460mm W 370mm with 6 mounting clips		

			
1			
GEV No.	902404	Ref. No.	GUA007
description	oven gasket L 680mm W 280mm 4-sided with 8 mounting clips		

gaskets

gaskets for heated units

door seals with fixing hook

			
1			
GEV No.	901605	Ref. No.	GUA010 GUA023
description	door seal W 320mm with 4 mounting clips H 350mm		

sealing washers

rubber gaskets

			
1			
GEV No.	506367	Ref. No.	GUA078 GUACIRC
description	flat gasket rubber ED ø 40mm ID ø 28mm thickness 1.8mm Qty 1 pcs		



fittings, hose and pipe connectors

push-in fittings

JOHN GUEST



1

GEV No.	440607	Ref. No.	RID000
description	push-in fitting John Guest straight pipe connection $\varnothing 6\text{mm}$ - $\varnothing 6\text{mm}$		

A			
alarm devices	8		
B			
booster pumps II	11		
C			
cam switches	6		
condensators & interference suppression filters	12		
contactors	8		
control thermostats	4		
cross flow fans	10		
D			
door seals with fixing hook	15		
E			
electric accessories	12		
electric timers	8		
energy regulators	4		
F			
fans	10		
G			
gas control valves	12		
gas nozzles	12		
gaskets for heated units	15		
H			
halogen lamp	6		
heating elements	3		
heating elements for convection	3		
heating elements for ovens	3		
hot air fans	11		
hot air motors	10		
I			
ignition boxes	12		
indicator lights	6		
indicator lights (complete)	6		
L			
lamps	6		
light bulbs	6		
M			
mechanical timers	8		
microswitches	5		
motors	11		
O			
operating capacitors	12		
oven hinges	14		
oven lamps	6		
P			
probes	9		
programme timers	8		
pumps	11		
push/momentary push switches	5		
push-in fittings	16		
S			
sealing washers	15		
solenoid valves	9		
switches and momentary switches	5		
T			
terminals	12		
thermostats	4		
timers	8		