



GAS COMPONENTS



ELECTRIC COMPONENTS



WATER TECHNOLOGY



MECHANICAL COMPONENTS



TOOLS

Spare parts suitable for

GIGA

Find the complete and up-to-date range of products in our GEV Webshop



Manufacturer catalogue

The most important spare parts and accessories arranged clearly for every manufacturer

- ✓ Complete product range and all appliance data always up to date in the GEV Webshop
- ✓ Alphabetical Index at the end of the catalogue

GEV Webshop

www.gev-online.co.uk

www.gev-online.com



- 🔍 Add to Favourites
- 🔍 Sign In with email address and usual password
- 🔍 Easy-order – place several items in your basket at the same time
- 🔍 Quick Item search – no login needed



heating elements

heating elements for ovens

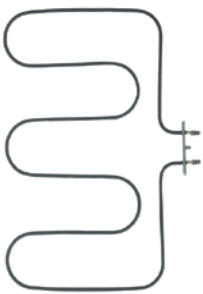

GEV No.	416042	Ref. No.	X68203
description	heating element 1500W 230V heating circuits 1 L 365mm W 500mm L1 45mm L2 315mm W1 240mm W2 30mm flange length 100mm flange width 22mm hole distance 86mm hole ø 5mm tube ø 6.3mm connection male faston 6.3mm mounting pos. lower rectangular flange dry heating element oven		
For models:	C4FFCEP, C4FFLE, C4FFLEP, C4FZCE, C4FZCEP, C4FZSFCEP, C4PFCE, C4PFLE, C4PQFCE, C4VFCE, C4VFLE, C6FFCEP, C6FFLE, C6FFLEP, C6FFLEPV, C6FFLEV, C6FZCE, C6FZCEP, C6FZSFCEP, C6FZSFCEV, C6PFCE, C6PFCEV, C6PFLE, C6PFLEV, C6PQFCE, C6PQFCEV, CC120E, CC81E, CCG120CE, CCG120E, CCG81CE, CCG81E, CCQ120E, CCQ81E, CCV81E, K2FTPFCE, K4FSFCE, K4FZCE, K4FZSFCE, K4PFCE, K4VFCE, K6FZCE, K6PFCE, K8FZCE, KTFPCE, SK4FZCEP, SK4PFCE, SK4PQFCE, SK4VFCE, SK6FZCEP... (Other models you can see in the webshop)		

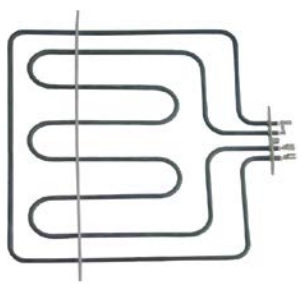



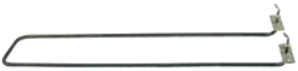

GEV No.	416041	Ref. No.	X68202
description	heating element 2600W 230V heating circuits 2 L 350mm W 355mm L1 36mm L2 314mm W1 147mm W2 60mm flange length 100mm flange width 22mm hole distance 80mm bridge length 480mm hole ø 5mm tube ø 6.3mm connection male faston 6.3mm mounting pos. upper rectangular flange dry heating element oven		
For models:	C4FFCEP, C4FFLE, C4FFLEP, C4FZCE, C4FZCEP, C4FZSFCEP, C4PFCE, C4PFLE, C4PQFCE, C4VFCE, C4VFLE, C6FFCEP, C6FFLE, C6FFLEP, C6FFLEPV, C6FFLEV, C6FZCE, C6FZCEP, C6FZSFCEP, C6FZSFCEV, C6PFCE, C6PFCEV, C6PFLE, C6PFLEV, C6PQFCE, C6PQFCEV, CC120E, CC81E, CCG120CE, CCG120E, CCG81CE, CCG81E, CCQ120E, CCQ81E, CCV81E, K2FTPFCE, K4FSFCE, K4FZCE, K4FZSFCE, K4PFCE, K4VFCE, K6FZCE, K6PFCE, K8FZCE, KTFPCE, SK4FZCEP, SK4PFCE, SK4PQFCE, SK4VFCE, SK6FZCEP... (Other models you can see in the webshop)		









GEV No.	416043	Ref. No.	0000X47000
description	heating element 990W 230V L 475mm W 106mm H 24mm lug length 55mm lug width 18mm hole distance 138mm hole ø 5mm tube ø 6.3mm connection M4 heating circuits 1 bracket mounting oven		
For models:	C2FTPFCE, C2FTPFCEP, C4FFE, C4FFEP, C4FZFE, C4FZFEP, C4FZSFEP, C4PFCE, C4PFE, C4PQFCE, C4PQFE, C4VFE, C6FFE, C6FFEP, C6FZFE, C6FZFEP, C6PFCE, C6PFCEV, C6PFE, C6PQFCE, C6PQFCEV, C6PQFE, CCTPFE8, CN10FE, K2FTPFCE, K4FFE, K4FS, K4FSFE, K4FZFE, K4FZSFE, K4PFE, K4VFE, K6FFE, K6FZFE, K6PFE, K8FFE, K8FZFE, KTFPCE, M74FMPFE, M74FPFE, M76FMPFE, M76FPFE		

heating elements for bain maries



GEV No.	416244	Ref. No.	Y19700
description	heating element 1000W 230V heating circuits 1 L 258mm W 34mm connection male faston 6.3mm tube ø 6.3mm 2 hole fixing thread 1/8" immersion heater H 35mm mounting distance 26mm		
For models:	M6B4E, M7B4E		
accessories for	416244		
	GEV No.	361181	Ref. No. —
	nut thread 1/8" H 4.5mm nickel-plated brass WS 14 Qty 1 pcs		
	GEV No.	525780	Ref. No. —
	flat gasket copper ED ø 13mm ID ø 10.2mm thickness 1.5mm for thread 1/8" Qty 1 pcs		
	GEV No.	560192	Ref. No. —
	tooth lock washer ID ø 10.4mm ED ø 18mm SS DIN/ISO DIN 6798A Qty 1 pcs for thread M10		



GEV No.	415130	Ref. No.	X45800
description	heating element 1500W 230V heating circuits 1 L 412mm W 50mm connection M3 tube ø 8.5mm 2 hole fixing thread 3/8" immersion heater mounting distance 42mm		
For models:	CBE4, CBE8, SKB40E, SKB80E, TB40E, TB60E, TB80E		
accessories for	415130		
	GEV No.	361183	Ref. No. —
	nut thread 3/8" H 6mm nickel-plated brass WS 20 Qty 1 pcs		
	GEV No.	521137	Ref. No. —
	flat gasket fibre ED ø 20mm ID ø 18mm thickness 1.5mm for thread 3/8" Qty 1 pcs		
	GEV No.	527169	Ref. No. —
	hexagonal nut thread M3 H 2.8mm WS 5.5 brass Qty 1 pcs		
	GEV No.	560110	Ref. No. —
	plain washer ID ø 3.2mm ED ø 7mm thickness 0.5mm SS Qty 20 pcs DIN 125A for thread M3		
	GEV No.	560130	Ref. No. —
	hexagonal nut thread M3 H 2.4mm WS 5.5 SS DIN/ISO DIN 934 / ISO 4032/8673 Qty 20 pcs		









GEV No.	416047	Ref. No.	Y10600
description	heating element 1780W 230V L 650mm W 170mm connection length 24mm connection M4 tube ø 9mm 2 hole fixing thread M14x1 immersion heater L1 25mm L2 35mm L3 590mm H 19mm mounting distance 161mm		
For models:	KB4, KB8		
accessories for	416047		
	GEV No.	510417	Ref. No. N/A
	flat gasket fibre ED ø 20mm ID ø 14mm thickness 2mm Qty 1 pcs		

Table continues overleaf



accessories for 416047			
	GEV No.	520228	Ref. No. —
tooth lock washer ID ø 15.3mm ED ø 24mm steel Qty 1 pcs for thread M14			
	GEV No.	521133	Ref. No. —
nut thread M14x1.5 H 6mm WS 19 zinc-coated steel Qty 1 pcs			
	GEV No.	550261	Ref. No. N/A
nut thread M14x1 H 4mm WS 19 SS Qty 1 pcs			
	GEV No.	550262	Ref. No. —
flat gasket copper ED ø 20mm ID ø 14mm thickness 2mm			

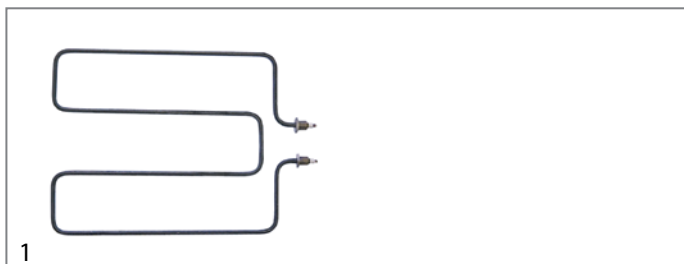

GEV No.	415844	Ref. No.	X45900
description	heating element 2600W 230V heating circuits 1 L 410mm W 300mm connection length 10mm connection M4 tube ø 8.5mm 2 hole fixing thread 3/8" immersion heater L1 27mm L2 383mm W1 120mm W2 60mm mounting distance 50mm		
For models:	CBE6, SKB60E, TB40E, TB60E, TB80E		
spare parts for	415844		
	GEV No.	521137	Ref. No. —
flat gasket fibre ED ø 20mm ID ø 18mm thickness 1.5mm for thread 3/8" Qty 1 pcs			
accessories for	415844		
	GEV No.	361183	Ref. No. —
nut thread 3/8" H 6mm nickel-plated brass WS 20 Qty 1 pcs			

heating elements for chip scuttles





GEV No.	416082	Ref. No.	X48400
description	heating element 350W 230V heating circuits 8.5 L 172mm W 74mm flange length 110mm flange width 22mm hole distance 94mm connection length 20mm connection male faston 6.3mm tube ø 8.5mm rectangular flange hole ø 6mm dry heating element		
For models:	CSP40E, M6SP4E, MC, SKP40E, TSP40E		

heating elements for fryers





off-center connection

with retaining rings

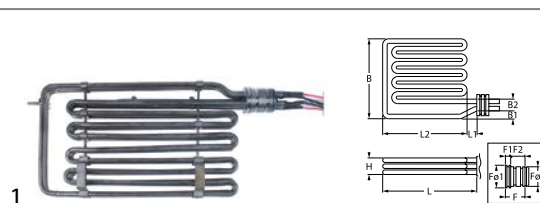

GEV No.	416408	Ref. No.	0000Y17000
description	heating element 12000W 230/400V heating circuits 3 mounting pos. left L 280mm W 225mm H 32mm flange length 45mm flange length 1 9.6mm flange length 2 35.4mm flange ø1 44.5mm flange ø2 39.5mm thermostat sleeves ø 7mm length thermostat sleeves 280mm number of thermostat sleeves 1 thermostat sleeve eccentric, non clinging windings 5 L1 10mm L2 270mm W1 13mm W2 31mm tube ø 8.5mm cable length 600mm rotation flange fryer connection length 50mm		
For models:	CFE15, CFE159, CFE15D, CFE15D9, KFE15, KFE159, KFE15D, KFE15D9, OPFE15, OPFE15D		
accessories for	416408		
	GEV No.	510899	Ref. No. X05400
	GEV No.	528155	Ref. No. X05300
	GEV No.	532545	Ref. No. X05000
	GEV No.	691621	Ref. No. M29600



GEV No.	416407	Ref. No.	Y14400
description	heating element 15000W 230/400V heating circuits 3 mounting pos. left L 355mm W 190mm H 32mm flange length 45mm flange length 1 9.6mm flange length 2 35.4mm flange ø1 44.5mm flange ø2 39.5mm thermostat sleeves ø 7mm length thermostat sleeves 280mm number of thermostat sleeves 1 thermostat sleeve eccentric, clinging windings 4 L1 15mm L2 340mm W1 13mm W2 32mm tube ø 8.5mm cable length 570mm rotation flange connection length 60mm		
For models:	KFE20, KFE20D, OPFE20, OPFE20D		
accessories for	416407		
	GEV No.	510899	Ref. No. X05400
	GEV No.	528155	Ref. No. X05300
	GEV No.	532545	Ref. No. X05000
	GEV No.	691621	Ref. No. M29600

1		
	GEV No.	Ref. No.
description	heating element 11000W 230V heating circuits 3 L 310mm W 125mm H 320mm rectangular flange connection M4 W2 93mm H1 280mm H2 45mm hole distance 95mm hole ø 5mm flange length 105mm flange width 35mm tube ø 8.5mm connection length 37mm	

1		
	GEV No.	Ref. No.
description	heating element 6000W 230/400V heating circuits 3 L 300mm W 182mm H 252mm L1 65mm L2 235mm W1 59mm W2 134mm W3 250mm H1 220mm H2 32mm windings 12 flange ø 40mm rotation flange cable length 380mm fryer heaters mounting ø 25mm	

1		
	GEV No.	Ref. No.
description	heating element 7500W 230/400V heating circuits 3 L 315mm W 170mm H 190mm L1 60mm L2 258mm W1 58mm W2 135mm W3 250mm H1 165mm H2 25mm windings 15 flange ø 30mm rotation flange cable length 980mm mounting ø 30mm tube ø 6.2mm connection length 21mm	
For models:	CF1E4, CF2E6, CF4E, CF6E, IF1E4, IF2E6, KFE1, KFE2, OPFE1, OPFE2, SKF1E, SKF2E, TF1E, TF2E, TF4E, TF6E	







1		
	GEV No.	Ref. No.
description	heating element 3200W 230V	
For models:	CF2E4, SKF2E4, TF2E4	

2 hole fixing			
1			
	GEV No.	Ref. No.	Ref. No.
description	heating element 1700W 230V heating circuits 1 L 290mm W 130mm W1 27mm W2 76mm connection M4 2 hole fixing immersion heater thread 1/4" tube ø 8.5mm mounting distance 64mm		
For models:	M6F4E, M6F6E, M7F4E, M7F6E		
accessories for	418652		
	GEV No.	Ref. No.	—
	nut thread 1/4" H 5mm nickel-plated brass WS 17 Qty 1 pcs		
	GEV No.	Ref. No.	N/A
	flat gasket fibre ED ø 20mm ID ø 14mm thickness 2mm Qty 1 pcs		
	GEV No.	Ref. No.	—
	tooth lock washer ID ø 15.3mm ED ø 24mm steel Qty 1 pcs for thread M14		
	GEV No.	Ref. No.	—
	nut thread M4 H 3mm WS 7 brass Qty 20 pcs		
	GEV No.	Ref. No.	—
	washer ID ø 4.3mm ED ø 8mm thickness 0.5mm brass Qty 20 pcs for thread M4		
	GEV No.	Ref. No.	—
	flat gasket copper ED ø 20mm ID ø 14mm thickness 2mm		
	GEV No.	Ref. No.	—
	plain washer ID ø 4.3mm ED ø 9mm thickness 0.8mm SS Qty 20 pcs DIN 125A for thread M4		
	GEV No.	Ref. No.	—
	hexagonal nut thread M4 H 3.2mm WS 7 SS DIN/ISO DIN 934 / ISO 4032/8673 Qty 20 pcs		

1			
	GEV No.	Ref. No.	Ref. No.
description	heating element 2500W 230V heating circuits 1 L 290mm W 55mm H 165mm H1 135mm H2 35mm thread 1/4" tube ø 8.5mm mounting distance 30mm 2 hole fixing connection M4		
For models:	CF1E4, CF2E6, CF4E, CF6E, IF4E, IF6E, SKF4E, SKF6E, TF1E, TF2E, TF4E, TF6E		
accessories for	416411		
	GEV No.	Ref. No.	—
	nut thread 1/4" H 5mm nickel-plated brass WS 17 Qty 1 pcs		
	GEV No.	Ref. No.	N/A
	flat gasket fibre ED ø 20mm ID ø 14mm thickness 2mm Qty 1 pcs		

Table continues overleaf





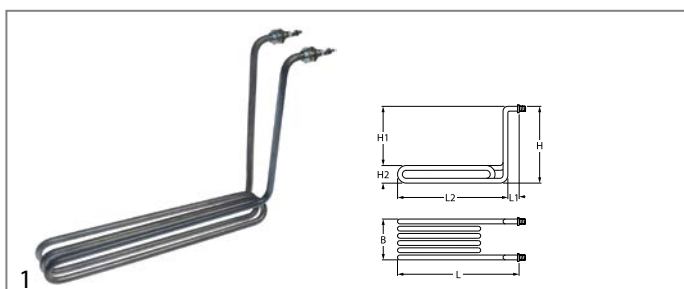

accessories for		416411	
	GEV No.	520228	Ref. No. —
tooth lock washer ID \varnothing 15.3mm ED \varnothing 24mm steel Qty 1 pcs for thread M14			
	GEV No.	521103	Ref. No. —
nut thread M4 H 3mm WS 7 brass Qty 20 pcs			
	GEV No.	521104	Ref. No. —
washer ID \varnothing 4.3mm ED \varnothing 8mm thickness 0.5mm brass Qty 20 pcs for thread M4			
	GEV No.	550262	Ref. No. —
flat gasket copper ED \varnothing 20mm ID \varnothing 14mm thickness 2mm			
	GEV No.	560111	Ref. No. —
plain washer ID \varnothing 4.3mm ED \varnothing 9mm thickness 0.8mm SS Qty 20 pcs DIN 125A for thread M4			
	GEV No.	560131	Ref. No. —
hexagonal nut thread M4 H 3.2mm WS 7 SS DIN/ISO DIN 934 / ISO 4032/8673 Qty 20 pcs			

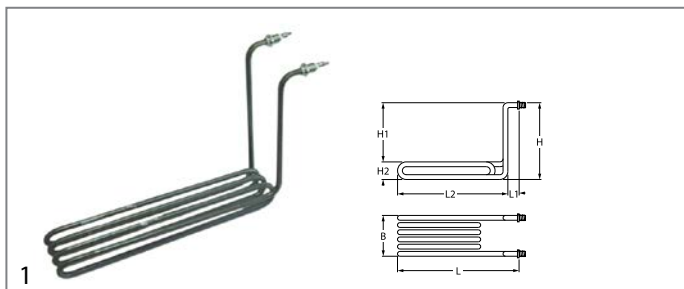





GEV No.	419020	Ref. No.	Y17100
description	heating element 2500W 230V heating circuits 1 L 315mm W 45mm H 230mm L1 25mm L2 290mm H1 193mm H2 37mm thread 1/4" mounting distance 37mm tube \varnothing 8.4mm connection M4 windings 3 for fryer		
For models:	SK10DSE, SK10SE		









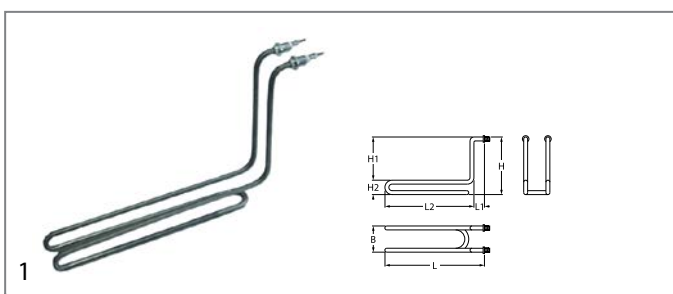

GEV No.	416055	Ref. No.	X46500
description	heating element 3000W 230V heating circuits 1 L 335mm W 65mm H 223mm L1 20mm L2 315mm H1 180mm H2 40mm thread 1/4" mounting distance 57mm tube \varnothing 8.5mm 2 hole fixing connection M4 connection length 26mm immersion heater windings 4		
For models:	15DPE, 15PE, SK10DSE9, SK10SE9		

accessories for		416055	
	GEV No.	361182	Ref. No. —
nut thread 1/4" H 5mm nickel-plated brass WS 17 Qty 1 pcs			
	GEV No.	510417	Ref. No. N/A
flat gasket fibre ED \varnothing 20mm ID \varnothing 14mm thickness 2mm Qty 1 pcs			
	GEV No.	520228	Ref. No. —
tooth lock washer ID \varnothing 15.3mm ED \varnothing 24mm steel Qty 1 pcs for thread M14			
	GEV No.	521103	Ref. No. —
nut thread M4 H 3mm WS 7 brass Qty 20 pcs			

accessories for		416055	
	GEV No.	521104	Ref. No. —
washer ID \varnothing 4.3mm ED \varnothing 8mm thickness 0.5mm brass Qty 20 pcs for thread M4			
	GEV No.	550262	Ref. No. —
flat gasket copper ED \varnothing 20mm ID \varnothing 14mm thickness 2mm			
	GEV No.	560111	Ref. No. —
plain washer ID \varnothing 4.3mm ED \varnothing 9mm thickness 0.8mm SS Qty 20 pcs DIN 125A for thread M4			
	GEV No.	560131	Ref. No. —
hexagonal nut thread M4 H 3.2mm WS 7 SS DIN/ISO DIN 934 / ISO 4032/8673 Qty 20 pcs			



GEV No.	416053	Ref. No.	X46100
description	heating element 1335-1450W 230-240V heating circuits 1 L 317mm W 42mm H 190mm L1 27mm L2 290mm H1 160mm H2 31mm thread 1/4" mounting distance 33mm tube \varnothing 8.5mm 2 hole fixing connection M4 connection length 25mm immersion heater windings 2		
For models:	7DSET, 7SET		

accessories for		416053	
	GEV No.	361182	Ref. No. —
nut thread 1/4" H 5mm nickel-plated brass WS 17 Qty 1 pcs			
	GEV No.	510417	Ref. No. N/A
flat gasket fibre ED \varnothing 20mm ID \varnothing 14mm thickness 2mm Qty 1 pcs			
	GEV No.	520228	Ref. No. —
tooth lock washer ID \varnothing 15.3mm ED \varnothing 24mm steel Qty 1 pcs for thread M14			
	GEV No.	521103	Ref. No. —
nut thread M4 H 3mm WS 7 brass Qty 20 pcs			
	GEV No.	521104	Ref. No. —
washer ID \varnothing 4.3mm ED \varnothing 8mm thickness 0.5mm brass Qty 20 pcs for thread M4			
	GEV No.	550262	Ref. No. —
flat gasket copper ED \varnothing 20mm ID \varnothing 14mm thickness 2mm			
	GEV No.	560111	Ref. No. —
plain washer ID \varnothing 4.3mm ED \varnothing 9mm thickness 0.8mm SS Qty 20 pcs DIN 125A for thread M4			
	GEV No.	560131	Ref. No. —
hexagonal nut thread M4 H 3.2mm WS 7 SS DIN/ISO DIN 934 / ISO 4032/8673 Qty 20 pcs			



GEV No.	416054	Ref. No.	X46600
description	heating element 1700W 230V heating circuits 1 L 320mm W 70mm H 215mm L1 25mm L2 295mm H1 177mm H2 38mm thread 1/4" mounting distance 62mm tube ø 8.5mm 2 hole fixing connection M4 immersion heater windings 3		
For models:	SK10DSE, SK10SE		
accessories for	416054		
	GEV No.	361182	Ref. No. —
	nut thread 1/4" H 5mm nickel-plated brass WS 17 Qty 1 pcs		
	GEV No.	510417	Ref. No. N/A
	flat gasket fibre ED ø 20mm ID ø 14mm thickness 2mm Qty 1 pcs		
	GEV No.	520228	Ref. No. —
	tooth lock washer ID ø 15.3mm ED ø 24mm steel Qty 1 pcs for thread M14		
	GEV No.	521103	Ref. No. —
	nut thread M4 H 3mm WS 7 brass Qty 20 pcs		
	GEV No.	521104	Ref. No. —
	washer ID ø 4.3mm ED ø 8mm thickness 0.5mm brass Qty 20 pcs for thread M4		
	GEV No.	550262	Ref. No. —
	flat gasket copper ED ø 20mm ID ø 14mm thickness 2mm		
	GEV No.	560111	Ref. No. —
	plain washer ID ø 4.3mm ED ø 9mm thickness 0.8mm SS Qty 20 pcs DIN 125A for thread M4		
	GEV No.	560131	Ref. No. —
	hexagonal nut thread M4 H 3.2mm WS 7 SS DIN/ISO DIN 934 / ISO 4032/8673 Qty 20 pcs		

heating elements for griddles

GEV No.	418650	Ref. No.	DER001ZR10
description	heating element 1200W 230V heating circuits 1 L 402mm W 75mm H 70mm tube ø 6.5mm L1 35mm connection male faston 6.3mm connection distance 68mm dry heating element		
For models:	M6FT4EL, M6FT4ER, M6FT6EL, M6FT6ELR, M7FT4EL, M7FT4ER, M7FT6EL, M7FT6ELR		

GEV No.	415651	Ref. No.	X45700
description	heating element 1500W 230V heating circuits 1 L 425mm W 72mm H 53mm tube ø 8.5mm L1 22mm connection male faston 6.3mm connection distance 52mm dry heating element		
For models:	CFTE1, CFTE1C, CFTE1R, CFTE2, CFTE22, CFTE2C, CFTE2C2, CFTE2LR, CFTE2R, CFTE3, CFTE3C, CFTE3LR, CFTE4, CFTE4C, CFTE4R, CFTE6, CFTE62, CFTE6C, CFTE6C2, CFTE6LR, CFTE6R, CFTE8, CFTE8C, CFTE8LR, SKT1E, SKT1EC, SKT1ER, SKT2E, SKT2E2, SKT2EC, SKT2EC2, SKT2ELR, SKT2ER, SKT2ER2, SKT3E, SKT3EC, SKT3ELR, SKT40E, SKT40EC, SKT40ER, SKT60E, SKT60E2, SKT60EC, SKT60EC2, SKT60ELR, SKT60ER, SKT60ER2, SKT80E, SKT80EC, SKT80ER...(Other models you can see in the webshop)		

GEV No.	420537	Ref. No.	Y15800
description	heating element 1750W 230V heating circuits 1 L 430mm W 60mm H 87mm tube ø 8.5mm		
For models:	CFTE1, CFTE1C, CFTE1R, CFTE2, CFTE22, CFTE2C, CFTE2C2, CFTE2LR, CFTE2R, CFTE2R2, CFTE3, CFTE3C, CFTE3LR, CFTE3R, CFTE4, CFTE4C, CFTE4R, CFTE6, CFTE62, CFTE6C, CFTE6C2, CFTE6LR, CFTE6R, CFTE6R2, CFTE8, CFTE8C, CFTE8LR, CFTE8R, CMP4, IFTE1, IFTE1C, IFTE1R, IFTE2, IFTE22, IFTE2C, IFTE2C2, IFTE2LR, IFTE2R, IFTE2R2, IFTE3, IFTE3C, IFTE3LR, IMP4, SKMP4, SKT1E, SKT1EC, SKT1ER, SKT2E, SKT2E2, SKT2EC...(Other models you can see in the webshop)		

GEV No.	416046	Ref. No.	0000Y10400
description	heating element 2350/2560W 220/240V heating circuits 1 L 590mm W 77mm H 80mm tube ø 8.5mm dry heating element		
For models:	KBRE, KBRE12, KBRE12IN, KBREIN, KBREM, KBREM12, KBREM12IN, KBREMIN, KFT4E, KFT4EC, KFT4ER, KFT8E, KFT8E23C, KFT8EC, KFT8ELR, KFT8ER, KFTE1, KFTE1C, KFTE1R, KFTE3, KFTE3C, KFTE3LR, KFTE4, KFTE4C, KFTE4R, KFTE8, KFTE8C, KFTE8LR, OPFT4E, OPFT4EC, OPFT4ER, OPFT8E, OPFT8E23C, OPFT8EC, OPFT8ELR, OPFT8ER		

heating elements for tilting bratt pan





GEV No.	415077	Ref. No.	Y00100
description	heating element stock pot 1300W 230V L 280mm W 150mm H 40mm connection male faston 6.3mm tilting bratt pan heating circuits 1 tube ø 8.5mm bracket mounting hole distance 142mm hole ø 5mm lug length 25mm lug width 15mm		
For models:	SKBR40E		

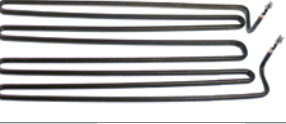













			
GEV No.	416045	Ref. No.	X48100
description	heating element tilting bratt pan 3400W 230V L 313mm W 195mm H 82mm connection M5 dry heating element heating circuits 1 tube ø 10mm W1 67mm W2 61mm		
For models:	CBRE, CBRE8, CBREIN		

			
GEV No.	417344	Ref. No.	0000Y10500
description	heating element tilting bratt pan 4700W 230V L 540mm W 210mm H 60mm heating circuits 1 tube ø 8.5mm W1 70mm W2 70mm		
For models:	KBRE, KBRE12, KBRE12IN, KBREIN, KBREM, KBREM12, KBREM12IN, KBREMIN, OPBRE, OPBRE12, OPBRE12IN, OPBRE12MIN, OPBREIN, OPBREM, OPBREM12, OPBREM12IN, OPBREM12IN		

heating elements for pasta cookers





			
GEV No.	416408	Ref. No.	0000Y17000
description	heating element 12000W 230/400V heating circuits 3 mounting pos. left L 280mm W 225mm H 32mm flange length 45mm flange length 1 9.6mm flange length 2 35.4mm flange ø1 44.5mm flange ø2 39.5mm thermostat sleeves ø 7mm length thermostat sleeves 280mm number of thermostat sleeves 1 thermostat sleeve eccentric, non clinging windings 5 L1 10mm L2 270mm W1 13mm W2 31mm tube ø 8.5mm cable length 600mm rotation flange fryer connection length 50mm		
For models:	CFE15, CFE159, CFE15D, CFE15D9, KFE15, KFE159, KFE15D, KFE15D9, OPFE15, OPFE15D		
accessories for	416408		
	GEV No.	510899	Ref. No. X05400
	O-ring EPDM thickness 3.53mm ID ø 37.69mm Qty 1 pcs		
	GEV No.	528155	Ref. No. X05300
	O-ring Viton thickness 3.53mm ID ø 32.93mm Qty 1 pcs		
	GEV No.	532545	Ref. No. X05000
	O-ring Viton thickness 3.53mm ID ø 49.21mm Qty 1 pcs		
	GEV No.	691621	Ref. No. M29600
	retaining ring shaft ø 40mm thickness 1.8mm steel DIN 471		

			
GEV No.	416407	Ref. No.	Y14400
description	heating element 15000W 230/400V heating circuits 3 mounting pos. left L 355mm W 190mm H 32mm flange length 45mm flange length 1 9.6mm flange length 2 35.4mm flange ø1 44.5mm flange ø2 39.5mm thermostat sleeves ø 7mm length thermostat sleeves 280mm number of thermostat sleeves 1 thermostat sleeve eccentric, clinging windings 4 L1 15mm L2 340mm W1 13mm W2 32mm tube ø 8.5mm cable length 570mm rotation flange connection length 60mm		
For models:	KFE20, KFE20D, OPFE20, OPFE20D		
accessories for	416407		
	GEV No.	510899	Ref. No. X05400
	O-ring EPDM thickness 3.53mm ID ø 37.69mm Qty 1 pcs		
	GEV No.	528155	Ref. No. X05300
	O-ring Viton thickness 3.53mm ID ø 32.93mm Qty 1 pcs		
	GEV No.	532545	Ref. No. X05000
	O-ring Viton thickness 3.53mm ID ø 49.21mm Qty 1 pcs		
	GEV No.	691621	Ref. No. M29600
	retaining ring shaft ø 40mm thickness 1.8mm steel DIN 471		

			
GEV No.	418651	Ref. No.	0000Y19800
description	heating element 1500W 230V heating circuits 1 L 300mm W 51mm 2 hole fixing connection male faston 6.3mm thread M14x1 tube ø 8.5mm mounting distance 43mm pasta cooker immersion heater		
For models:	CCPE4, CCPE6, ICPE4, M6CP4E, M7CP4E, SKCP40E, TCP40E, TCP60E		
spare parts for	418651		
	GEV No.	507313	Ref. No. —
	O-ring EPDM thickness 2.62mm ID ø 13.95mm Qty 1 pcs		
accessories for	418651		
	GEV No.	510417	Ref. No. N/A
	flat gasket fibre ED ø 20mm ID ø 14mm thickness 2mm Qty 1 pcs		
	GEV No.	520228	Ref. No. —
	tooth lock washer ID ø 15.3mm ED ø 24mm steel Qty 1 pcs for thread M14		
	GEV No.	521133	Ref. No. —
	nut thread M14x1.5 H 6mm WS 19 zinc-coated steel Qty 1 pcs		
	GEV No.	550261	Ref. No. N/A
	nut thread M14x1 H 4mm WS 19 SS Qty 1 pcs		
	GEV No.	550262	Ref. No. —
	flat gasket copper ED ø 20mm ID ø 14mm thickness 2mm		







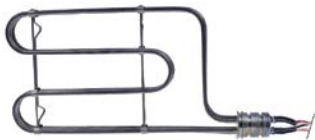

1

GEV No.	415902	Ref. No.	X47100 Y19900
description	heating element 2510W 230V L 295mm W 115mm Hmm 2 hole fixing connection male faston 6.3mm thread M14x1 tube ø 8.5mm		
For models:	CCPE6, ICPE6, SKCP60E, TCP60E		
accessories for	415902		
	GEV No.	510417	Ref. No. N/A
	flat gasket fibre ED ø 20mm ID ø 14mm thickness 2mm Qty 1 pcs		
	GEV No.	520228	Ref. No. —
	tooth lock washer ID ø 15.3mm ED ø 24mm steel Qty 1 pcs for thread M14		
	GEV No.	521133	Ref. No. —
	nut thread M14x1.5 H 6mm WS 19 zinc-coated steel Qty 1 pcs		
	GEV No.	550261	Ref. No. N/A
	nut thread M14x1 H 4mm WS 19 SS Qty 1 pcs		
	GEV No.	550262	Ref. No. —
	flat gasket copper ED ø 20mm ID ø 14mm thickness 2mm		







1

GEV No.	416989	Ref. No.	Y00900
description	heating element 4500W 230/400V heating circuits 3 L 357mm W 200mm H 25mm rotation flange tube ø 6.3mm L1 45mm L2 312mm W1 30mm W2 170mm cable length 570mm connection length 40mm flange length 1 9.6mm flange length 2 35.5mm flange length 45mm flange ø1 44.5mm flange ø2 39.5mm mounting pos. left fryer		
For models:	CCPE4, SKCP40E, TCP40E		
accessories for	416989		
	GEV No.	510899	Ref. No. X05400
	O-ring EPDM thickness 3.53mm ID ø 37.69mm Qty 1 pcs		
	GEV No.	528155	Ref. No. X05300
	O-ring Viton thickness 3.53mm ID ø 32.93mm Qty 1 pcs		
	GEV No.	532545	Ref. No. X05000
	O-ring Viton thickness 3.53mm ID ø 49.21mm Qty 1 pcs		
	GEV No.	691621	Ref. No. M29600
	retaining ring shaft ø 40mm thickness 1.8mm steel DIN 471		







1

GEV No.	418907	Ref. No.	Y18400
description	heating element 7500W 230V heating circuits 3 L 422mm W 186mm H 25mm tube ø 6.3mm L1 32mm L2 390mm W1 170mm W2 28mm cable length 550mm flange length 1 9.6mm flange length 2 35.4mm flange length 45mm flange ø1 44.5mm flange ø2 40mm mounting pos. left		
For models:	KCP4E, KCP82E, OPCP4E, OPCP82E		
accessories for	418907		
	GEV No.	510899	Ref. No. X05400
	O-ring EPDM thickness 3.53mm ID ø 37.69mm Qty 1 pcs		
	GEV No.	528155	Ref. No. X05300
	O-ring Viton thickness 3.53mm ID ø 32.93mm Qty 1 pcs		
	GEV No.	532545	Ref. No. X05000
	O-ring Viton thickness 3.53mm ID ø 49.21mm Qty 1 pcs		
	GEV No.	691621	Ref. No. M29600
	retaining ring shaft ø 40mm thickness 1.8mm steel DIN 471		

heating elements for chargrills



1

GEV No.	416000	Ref. No.	Y00200
description	heating element 1500W 230V L 438mm W 80mm H 62mm thread 1/4" mounting distance 19mm tube ø 8.5mm connection male faston 6.3mm windings 2 heating circuits 1 connection length 23mm 2 hole fixing dry heating element		
For models:	CRE4, CRE6, IRE4, IRE6, SKR40E, SKR60E, TR40E, TR60E		
spare parts for	416000		
	GEV No.	510417	Ref. No. N/A
	flat gasket fibre ED ø 20mm ID ø 14mm thickness 2mm Qty 1 pcs		
accessories for	416000		
	GEV No.	361182	Ref. No. —
	nut thread 1/4" H 5mm nickel-plated brass WS 17 Qty 1 pcs		
	GEV No.	520228	Ref. No. —
	tooth lock washer ID ø 15.3mm ED ø 24mm steel Qty 1 pcs for thread M14		
	GEV No.	550262	Ref. No. —
	flat gasket copper ED ø 20mm ID ø 14mm thickness 2mm		

heating elements for salamanders/toast-



GEV No.	416050	Ref. No.	0000X47800
description	heating element 1600W 220V heating circuits 1 L 304mm W 208mm H 50mm W1 94mm W2 30mm flange length 70mm flange width 22mm hole distance 56mm cable length 1480mm connection cable tube ø 6.3mm connection length 29mm hole ø 6mm rectangular flange dry heating element		
For models:	S600E, S680E		

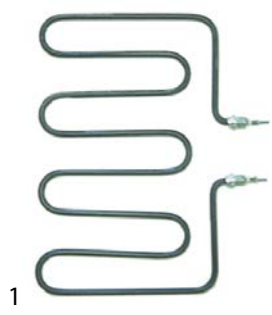

GEV No.	416049	Ref. No.	X48900
description	heating element 2500W 230V L 223mm W 310mm L1 18mm L2 205mm W1 120mm W2 70mm thread 1/4" mounting distance 61mm tube ø 8.5mm connection M4 connection length 39mm dry heating element 2 hole fixing salamander grill		

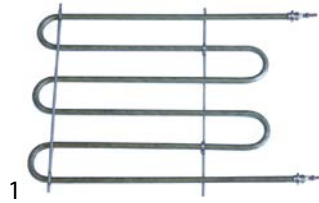

GEV No.	416154	Ref. No.	071018
description	heating element 2500W 230V L 368mm W 255mm thread 1/4" mounting distance 246mm connection M5 dry heating element tube ø 8.5mm heating circuits 1 connection length 36mm H 8.5mm connection distance 247mm		
For models:	S110E		

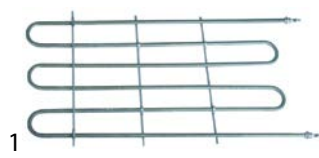

GEV No.	416156	Ref. No.	071036
description	heating element 3000W 230V L 600mm W 265mm flange with thread thread 1/4" mounting distance 260mm connection M5 dry heating element tube ø 8.5mm connection length 34mm		
For models:	S300E		



GEV No.	416759	Ref. No.	080328
description	heating element 650W 115V L 614mm thread M14x1.5 connection length 25mm tube ø 8.5mm connection M4 heating circuits 1 dry heating element		

ceramic heaters

245x60mm



GEV No.	415103	Ref. No.	X48000
description	ceramic emitter 650W 230V cable beaded cord L 245mm W 60mm H 35mm		
For models:	CSP40E, ISP4, SKP40E, TSP40E		
spare parts for	415103		
		GEV No.	415109
		Ref. No.	—
accessories for	415103		
		GEV No.	415110
		Ref. No.	—
	reflector L 245mm W 95mm H 31mm thickness 0.75mm hole ø 15x40mm		

quartz heating elements





GEV No.	415301	Ref. No.	FZ23050001
description	quartz heating element 190W 230V L 450mm ø 10mm connection plug-in connection		

immersion heating elements

3 hole flange ø38.5mm



GEV No.	416263	Ref. No.	905493
description	heating element 2600W 230V mounting ø 38.5mm heating circuits 1 L 293mm W 26mm H 26mm number of thermostat sleeves 1 thermostat sleeves ø 7mm length thermostat sleeves 260mm thermostat sleeve not clinging tube ø 6.3mm hole distance 57mm hole ø 10mm 3 hole flange connection male faston 6.3mm immersion heater		
For models:	GLB615		
spare parts for	416263		
		GEV No.	521120
		Ref. No.	907981 SD907981
	O-ring EPDM thickness 5.34mm ID ø 37.47mm Qty 1 pcs		
accessories for	416263		
		GEV No.	532577
		Ref. No.	—
	O-ring EPDM thickness 5.34mm ID ø 40.65mm Qty 1 pcs		

GEV No.	416264	Ref. No.	905521
description	heating element 3000W 230V hole distance 57mm		
For models:	GLB785, GLB795		
accessories for	416264		
	GEV No.	532577	Ref. No. —
	O-ring EPDM thickness 5.34mm ID ø 40.65mm Qty 1 pcs		

GEV No.	416267	Ref. No.	905560
description	heating element 4500W 230V mounting ø 38.5mm heating circuits 3 L 358mm W 32mm H 58mm L1 36mm L2 72mm L3 250mm H1 28mm H2 30mm hole distance 57mm hole ø 10mm tube ø 6.3mm connection male faston 6.3mm immersion heater 3 hole flange		
For models:	GLS805, GLS845, GLS905, GLS925		
spare parts for	416267		
	GEV No.	521120	Ref. No. 907981 SD907981
	O-ring EPDM thickness 5.34mm ID ø 37.47mm Qty 1 pcs		
accessories for	416267		
	GEV No.	532577	Ref. No. —
	O-ring EPDM thickness 5.34mm ID ø 40.65mm Qty 1 pcs		



GEV No.	416268	Ref. No.	905570
description	heating element 6000W 230V mounting ø 38.5mm heating circuits 3 L 360mm W 34mm H 55mm L1 35mm L2 70mm L3 255mm H1 27mm H2 28mm hole distance 57mm hole ø 10mm tube ø 6.3mm connection male faston 6.3mm immersion heater 3 hole flange		
For models:	GLS935, GLS945, GLS945S		
spare parts for	416268		
	GEV No.	532577	Ref. No. —
	O-ring EPDM thickness 5.34mm ID ø 40.65mm Qty 1 pcs		

3 hole flange ø47.5mm



GEV No.	418136	Ref. No.	080328DHE
description	heating element 4360W 240V mounting ø 47.5mm heating circuits 3 L 310mm W 31mm H 35mm number of thermostat sleeves 1 thermostat sleeves ø 7mm length thermostat sleeves 200mm thermostat sleeve clinging tube ø 6.3mm hole distance 62mm hole ø 8mm connection M4 3 hole flange immersion heater		
spare parts for	418136		
	GEV No.	510408	Ref. No. E11700
	O-ring EPDM thickness 5.34mm ID ø 47mm Qty 1 pcs		
accessories for	418136		
	GEV No.	510408	Ref. No. E11700
	O-ring EPDM thickness 5.34mm ID ø 47mm Qty 1 pcs		
	GEV No.	510562	Ref. No. —
	O-ring silicone thickness 5.34mm ID ø 47mm Qty 1 pcs		

GEV No.	415001	Ref. No.	N/A
description	heating element 4500W 230V mounting ø 47.5mm heating circuits 3 L 316mm W 35mm H 34mm number of thermostat sleeves 1 thermostat sleeves ø 7mm length thermostat sleeves 180mm thermostat sleeve eccentric, non clinging tube ø 6.3mm hole distance 62mm hole ø 8mm connection M4 3 hole flange immersion heater		
spare parts for	415001		
	GEV No.	510408	Ref. No. E11700
	O-ring EPDM thickness 5.34mm ID ø 47mm Qty 1 pcs		
accessories for	415001		
	GEV No.	510562	Ref. No. —
	O-ring silicone thickness 5.34mm ID ø 47mm Qty 1 pcs		
	GEV No.	521103	Ref. No. —
	nut thread M4 H 3mm WS 7 brass Qty 20 pcs		
	GEV No.	521104	Ref. No. —
	washer ID ø 4.3mm ED ø 8mm thickness 0.5mm brass Qty 20 pcs for thread M4		
	GEV No.	560111	Ref. No. —
	plain washer ID ø 4.3mm ED ø 9mm thickness 0.8mm SS Qty 20 pcs DIN 125A for thread M4		
	GEV No.	560131	Ref. No. —
	hexagonal nut thread M4 H 3.2mm WS 7 SS DIN/ISO DIN 934 / ISO 4032/8673 Qty 20 pcs		





GEV No.	416048	Ref. No.	Y15300
description	heating element 6000W 230V mounting \varnothing 47.5mm 3 hole flange immersion heater		
accessories for	416048		
	GEV No.	510408	Ref. No. E11700
	O-ring EPDM thickness 5.34mm ID \varnothing 47mm Qty 1 pcs		
	GEV No.	510562	Ref. No. —
	O-ring silicone thickness 5.34mm ID \varnothing 47mm Qty 1 pcs		





GEV No.	418439	Ref. No.	E11500
description	heating element 8000W 230V mounting \varnothing 47.5mm heating circuits 3 L 315mm W 37mm H 35mm number of thermostat sleeves 1 thermostat sleeves \varnothing 8.5mm length thermostat sleeves 215mm thermostat sleeve clinging tube \varnothing 8.5mm hole distance 62mm hole \varnothing 8mm connection M4 3 hole flange immersion heater		
For models:	KPI10E, KPI10EA, KPI20E, KPI20EA, OPPI10E, OPPI10EA		
accessories for	418439		
	GEV No.	510408	Ref. No. E11700
	O-ring EPDM thickness 5.34mm ID \varnothing 47mm Qty 1 pcs		
	GEV No.	510562	Ref. No. —
	O-ring silicone thickness 5.34mm ID \varnothing 47mm Qty 1 pcs		





GEV No.	416410	Ref. No.	E11600
description	heating element 9000W 230V mounting \varnothing 47.5mm heating circuits 3 L 395mm W 33mm H 35mm number of thermostat sleeves 1 thermostat sleeves \varnothing 7mm length thermostat sleeves 210mm thermostat sleeve eccentric, clinging tube \varnothing 8.5mm hole distance 63mm hole \varnothing 8mm connection M4		
For models:	CPEI, KPI15E, KPI15EA, KPI30E, KPI30EA, KPI50E, KPI50EA, OPPI15E, OPPI15EA		
accessories for	416410		
	GEV No.	510408	Ref. No. E11700
	O-ring EPDM thickness 5.34mm ID \varnothing 47mm Qty 1 pcs		
	GEV No.	510562	Ref. No. —
	O-ring silicone thickness 5.34mm ID \varnothing 47mm Qty 1 pcs		



GEV No.	416835	Ref. No.	40400042
description	heating element 9000W 230V mounting \varnothing 47.5mm heating circuits 3 L 415mm W 30mm H 46mm number of thermostat sleeves 1 thermostat sleeves \varnothing 7.5mm length thermostat sleeves 255mm thermostat sleeve eccentric, clinging hole distance 62mm hole \varnothing 8mm connection M4 3 hole flange immersion heater		
For models:	KPI15ET, KPI15ETA, KPI30ET, KPI30ETA, KPI50ET, KPI50ETA		
accessories for	416835		
	GEV No.	510408	Ref. No. E11700
	O-ring EPDM thickness 5.34mm ID \varnothing 47mm Qty 1 pcs		
	GEV No.	510562	Ref. No. —
	O-ring silicone thickness 5.34mm ID \varnothing 47mm Qty 1 pcs		

group 7



GEV No.	418505	Ref. No.	40400048
description	heating element 8000W 230V heating circuits 3 flange \varnothing 47.5mm L 497mm W 35mm H 56mm tube \varnothing 8.5mm thermostat sleeves \varnothing 7.5mm length thermostat sleeves 266mm number of thermostat sleeves 1 thermostat sleeve not clinging connection M4 immersion heater 3 hole flange hole distance 58mm mounting \varnothing 47.5mm hole \varnothing 8mm		
For models:	KPI10ET, KPI10ETA, KPI20ETA		
accessories for	418505		
	GEV No.	510408	Ref. No. E11700
	O-ring EPDM thickness 5.34mm ID \varnothing 47mm Qty 1 pcs		
	GEV No.	510562	Ref. No. —
	O-ring silicone thickness 5.34mm ID \varnothing 47mm Qty 1 pcs		

with compression flange 50 x 26mm





GEV No.	416209	Ref. No.	904957 905858
description	heating element 2000W 230V heating circuits 1 compression flange flange 50x26mm L 180mm W 90mm H 24mm L1 55mm L2 125mm W1 28mm W2 35mm connection male faston 6.3mm tube \varnothing 8.5mm connection length 28mm immersion heater		
For models:	GLS905, GLS925		
accessories for	416209		
	GEV No.	510387	Ref. No. —
	gasket L 46mm W 22mm \varnothing mm EPDM for heating element for flange 50x26mm		

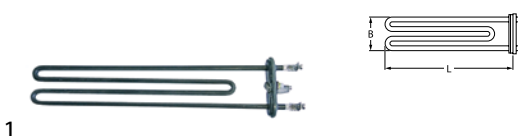

with compression flange 70 x 26mm







1

GEV No.	415000	Ref. No.	N/A
description	heating element 2900W 230V heating circuits 1 flange 70x26mm L 272mm W 51mm H mm tube ø 6.3mm connection M4 immersion heater compression flange		
spare parts for	415000		
	GEV No.	521128	Ref. No. N/A
	gasket L 66mm W 21mm ømm for heating element suitable for ELETTOBAR, WOLK		
accessories for	415000		
	GEV No.	521128	Ref. No. N/A
	gasket L 66mm W 21mm ømm for heating element suitable for ELETTOBAR, WOLK		





1

GEV No.	416244	Ref. No.	Y19700
description	heating element 1000W 230V heating circuits 1 L 258mm W 34mm connection male faston 6.3mm tube ø 6.3mm 2 hole fixing thread 1/8" immersion heater H 35mm mounting distance 26mm		
For models:	M6B4E, M7B4E		
accessories for	416244		
	GEV No.	361181	Ref. No. —
	nut thread 1/8" H 4.5mm nickel-plated brass WS 14 Qty 1 pcs		
	GEV No.	525780	Ref. No. —
	flat gasket copper ED ø 13mm ID ø 10.2mm thickness 1.5mm for thread 1/8" Qty 1 pcs		
	GEV No.	560192	Ref. No. —
	tooth lock washer ID ø 10.4mm ED ø 18mm SS DIN/ISO DIN 6798A Qty 1 pcs for thread M10		



1



GEV No.	416259	Ref. No.	905771
description	heating element 1600W 230V heating circuits 1 L 275mm W 38mm H 28mm thread M10x1 mounting distance 27mm tube ø 7.1mm connection male faston 6.3mm 2 hole fixing connection length 26mm immersion heater		
For models:	GLB615, GLB785, GLB795		
accessories for	416259		
	GEV No.	510416	Ref. No. —
	flat gasket fibre ED ø 19mm ID ø 10.5mm thickness 1.5mm for thread M10 Qty 1 pcs		
	GEV No.	510893	Ref. No. 904391
	O-ring EPDM thickness 2.62mm ID ø 9.92mm Qty 1 pcs		
	GEV No.	520231	Ref. No. —
	nut thread M10x1 H 6mm WS 14 zinc-coated steel Qty 1 pcs		

accessories for 416259

	GEV No.	521129	Ref. No.	—
	nut thread M10 H 6mm SS WS 17 Qty 1 pcs DIN/ISO DIN 439			



1

GEV No.	415010	Ref. No.	D230017
description	heating element 2000W 230V heating circuits 1 L 260mm W 125mm H 20mm L1 110mm L2 150mm W1 42mm W2 83mm thread M10x1 mounting distance 70mm tube ø 6.5mm connection M4 immersion heater 2 hole fixing		
spare parts for	415010		
	GEV No.	510416	Ref. No. —
	flat gasket fibre ED ø 19mm ID ø 10.5mm thickness 1.5mm for thread M10 Qty 1 pcs		
accessories for	415010		
	GEV No.	504306	Ref. No. —
	gasket fibre ED ø 16mm ID ø 10mm thickness 2mm Qty 1 pcs		
	GEV No.	510893	Ref. No. 904391
	O-ring EPDM thickness 2.62mm ID ø 9.92mm Qty 1 pcs		
	GEV No.	520231	Ref. No. —
	nut thread M10x1 H 6mm WS 14 zinc-coated steel Qty 1 pcs		
	GEV No.	521103	Ref. No. —
	nut thread M4 H 3mm WS 7 brass Qty 20 pcs		
	GEV No.	521104	Ref. No. —
	washer ID ø 4.3mm ED ø 8mm thickness 0.5mm brass Qty 20 pcs for thread M4		
	GEV No.	521129	Ref. No. —
	nut thread M10 H 6mm SS WS 17 Qty 1 pcs DIN/ISO DIN 439		
	GEV No.	560111	Ref. No. —
	plain washer ID ø 4.3mm ED ø 9mm thickness 0.8mm SS Qty 20 pcs DIN 125A for thread M4		
	GEV No.	560131	Ref. No. —
	hexagonal nut thread M4 H 3.2mm WS 7 SS DIN/ISO DIN 934 / ISO 4032/8673 Qty 20 pcs		



1







GEV No.	415665	Ref. No.	N/A
description	heating element 2750/3250W 220/240V heating circuits 1 L 380mm W 110mm H 30mm thread M10x1 mounting distance 75mm tube ø 6.5mm connection M4 immersion heater 2 hole fixing		
spare parts for	415665		
	GEV No.	510893	Ref. No. 904391
	O-ring EPDM thickness 2.62mm ID ø 9.92mm Qty 1 pcs		
accessories for	415665		
	GEV No.	510416	Ref. No. —
	flat gasket fibre ED ø 19mm ID ø 10.5mm thickness 1.5mm for thread M10 Qty 1 pcs		

Table continues overleaf





accessories for	415665		
	GEV No.	520231	Ref. No. —
	nut thread M10x1 H 6mm WS 14 zinc-coated steel Qty 1 pcs		
	GEV No.	520876	Ref. No. —
	protection cap for heating element ø 11.5mm H 32mm W 25mm plastic		
	GEV No.	521103	Ref. No. —
	nut thread M4 H 3mm WS 7 brass Qty 20 pcs		
	GEV No.	521104	Ref. No. —
	washer ID ø 4.3mm ED ø 8mm thickness 0.5mm brass Qty 20 pcs for thread M4		
	GEV No.	521129	Ref. No. —
	nut thread M10 H 6mm SS WS 17 Qty 1 pcs DIN/ISO DIN 439		
	GEV No.	560111	Ref. No. —
	plain washer ID ø 4.3mm ED ø 9mm thickness 0.8mm SS Qty 20 pcs DIN 125A for thread M4		
	GEV No.	560131	Ref. No. —
	hexagonal nut thread M4 H 3.2mm WS 7 SS DIN/ISO DIN 934 / ISO 4032/8673 Qty 20 pcs		

	1		
GEV No.	416261	Ref. No.	905748
description	heating element 3000W 230V heating circuits 1 L 358mm W 32mm H 34mm H2 37mm thread M10x1 mounting distance 26mm tube ø 6.5mm connection male faston 6.3mm 2 hole fixing immersion heater		
For models:	GLS805, GLS845, GLS935, GLS945, GLS945S		
accessories for	416261		
	GEV No.	510416	Ref. No. —
	flat gasket fibre ED ø 19mm ID ø 10.5mm thickness 1.5mm for thread M10 Qty 1 pcs		
	GEV No.	510893	Ref. No. 904391
	O-ring EPDM thickness 2.62mm ID ø 9.92mm Qty 1 pcs		
	GEV No.	520231	Ref. No. —
	nut thread M10x1 H 6mm WS 14 zinc-coated steel Qty 1 pcs		
	GEV No.	521129	Ref. No. —
	nut thread M10 H 6mm SS WS 17 Qty 1 pcs DIN/ISO DIN 439		

heating elements for convection

	1		
GEV No.	415251	Ref. No.	50039
description	heating element 2500W 230V heating circuits 1 ID ø 178mm ED ø 190mm L 242mm H 35mm L1 46mm W1 31mm H1 10mm H2 25mm flange length 70mm flange width 22mm hole distance 56mm connection male faston 6.3mm horizontal tube ø 6.3mm convection heating element hole ø 5mm rectangular flange		

	1		
GEV No.	416040	Ref. No.	X68002
description	heating element 2500W 230V heating circuits 1 ID ø 185mm ED ø 198mm L 212mm H 30mm L1 17mm W1 32mm H1 6mm H2 24mm flange length 70mm flange width 22mm hole distance 56mm connection male faston 6.3mm connection length 33mm tube ø 6.5mm dry heating element hole ø 5mm rectangular flange		
For models:	C4FFCEP, C4FFLE, C4FFLEP, C4FZFCE, C4FZFCEP, C4FZSFCEP, C4PFCE, C4PFLE, C4PQFCE, C4VFCE, C4VFLE, C6FFCEP, C6FFLE, C6FFLEP, C6FFLEPV, C6FFLEV, C6FZFCE, C6FZFCEP, C6FZFCEPV, C6FZFCEV, C6PFCE, C6PFCEV, C6PFLE, C6PFLEV, C6PQFCE, C6PQFCEV, CC120E, CC80E, CC81E, CCG120CE, CCG120E, CCG80E, CCG81CE, CCG81E, CCQ120E, CCQ80E, CCQ81E, CCV80E, CCV81E, K2FTPFCE, K4FSFCE, K4FZFCE, K4FZSFCE, K4PFCE, K4VFCE, K6FZFCE, K6PFCE, K8FZFCE, KTPFCE, M74FFXE...(Other models you can see in the webshop)		
accessories for	416040		
	GEV No.	510368	Ref. No. —
	gasket L 70mm W 23.5mm hole ø 5mm hole distance 56mm FIBER thickness 2mm for heating element		

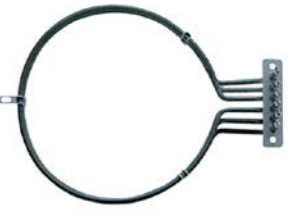
	1		
GEV No.	415850	Ref. No.	760978
description	heating element 5400W 230V heating circuits 3 ID ø 191mm ED ø 204mm L 268mm H 84mm L1 57mm W1 103mm H1 17mm H2 67mm flange length 140mm flange width 23mm hole distance 63/63mm connection M4 tube ø 6.5mm		

	1		
GEV No.	415871	Ref. No.	761344
description	heating element 6000W 230V heating circuits 3 ID ø 217mm ED ø 230mm L 267mm H 75mm L1 38mm W1 103mm H1 65mm H2 10mm flange length 140mm flange width 23mm hole distance 67mm connection M4 connection length 25mm tube ø 6.5mm convection heating element hole ø 5mm rectangular flange		



radiation heaters



1

GEV No.	490152	Ref. No.	Y17602
description	radiation heater octagonal 2500W 230V L 250mm W 250mm heating circuits 2 with heating coil energy regulation with temperature signalization connections 3+2 connection type cable AD		
For models:	C2V, C4V, C4VFCE, C4VFE, I2V, I4V, SK4VFCE, SKCV40E, SKCV80E, TCV40E, TCV80E		



1

GEV No.	490113	Ref. No.	Y12207
description	radiation heater ø 200mm 1800W 230V heating circuits 1 energy regulation with temperature signalization with ribbon heater connections 2+2 connection type male faston 6.3mm CERAMASPEED		
For models:	CCV80E, CCV81E, SKCV40E, SKCV80E		

1-circuit



1

GEV No.	490169	Ref. No.	AER009ZR10
description	radiation heater ø 165mm 1200W 230V heating circuits 1 H 32mm 7-position control without temperature signalization round connections 4 connection type male faston 6.3mm EGO		
For models:	M62V, M64V, M74V, M74VFXE		



1

GEV No.	490042	Ref. No.	Y17702
description	radiation heater ø 200mm 1800W 230V heating circuits 1 energy regulation with temperature signalization with ribbon heater connections 2+2 connection type male faston 6.3mm EGO		
For models:	C4V, C4VFCE, C4VFE, I4V, SK4VFCE, SKCV40E, SKCV80E, TCV80E		



1

GEV No.	490116	Ref. No.	Y12208
description	radiation heater ø 165mm 1200W 230V heating circuits 1 H 33mm 7-position control with temperature signalization with ribbon heater connections 2+2 connection type male faston 6.3mm CERAMASPEED		
For models:	CCV80E, CCV81E, SKCV40E, SKCV80E		



1

GEV No.	490171	Ref. No.	AER011ZR10
description	radiation heater ø 230mm 2100W 230V heating circuits 1 H 32mm 7-position control round		
For models:	M62V, M64V, M74V, M74VFXE		



1

GEV No.	490170	Ref. No.	AER010ZR10
description	radiation heater ø 200mm 1700W 230V heating circuits 1 7-position control without temperature signalization connections 4 connection type male faston 6.3mm EGO		
For models:	M64V, M74V, M74VFXE		



1

GEV No.	490050	Ref. No.	Y12408
description	radiation heater ø 250mm 2500W 230V heating circuits 1 with ribbon heater		
For models:	C2V, C4V, C4VFE, C4VFLE, TCV40E, TCV80E		

2-circuit



GEV No.	490114	Ref. No.	Y12409
description	radiation heater ø 230mm 2200W 230V heating circuits 2 energy regulation with temperature signalization partial power 750W with ribbon heater connections 2+2 connection type male faston 6.3mm CERAMASPEED		
For models:	C2V, C4V, C4VFE, C4VFLE, TCV40E, TCV80E		



GEV No.	490118	Ref. No.	Y17802
description	radiation heater ø 250mm 2500W heating circuits 2 partial power 1000W		
For models:	K2V, K4V, K4VFCE, K4VFE, OP2V, OP4V		

foil heating elements

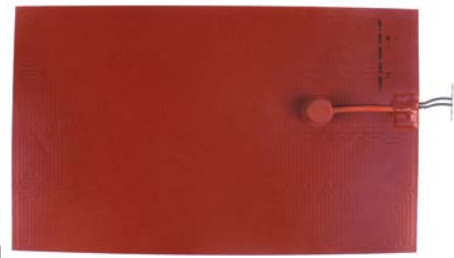

GEV No.	416406	Ref. No.	Y15900
description	foil heating element L 400mm W 240mm 1000W 230V t.max. 150°C with temperature limiter silicone cable length 2000mm thickness 1mm		
For models:	CBE4, CBE8, IBE4, IBE8, KB4, KB8, OPB4, OPB8, SKB40E, SKB80E, TB40E, TB80E		

accessories

hexagonal nuts



GEV No.	550261	Ref. No.	N/A
description	nut thread M14x1 H 4mm WS 19 SS Qty 1 pcs		

retaining rings



GEV No.	691621	Ref. No.	M29600
description	retaining ring shaft ø 40mm thickness 1.8mm steel DIN 471		
For models:	CCPE4, CFE15, CFE159, CFE15D, CFE15D9, KCP4E, KCP82E, KFE15, KFE159, KFE15D, KFE15D9, KFE20, KFE20D, OPCP4E, OPCP82E, OPFE15, OPFE15D, OPFE20, OPFE20D, SKCP40E, TCP40E		

sealing washers

fibre gaskets

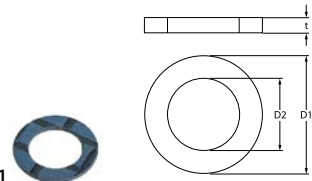

GEV No.	510417	Ref. No.	N/A
description	flat gasket fibre ED ø 20mm ID ø 14mm thickness 2mm Qty 1 pcs		

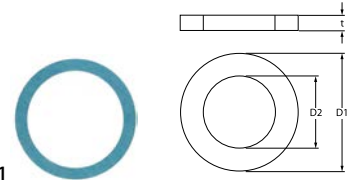

GEV No.	510406	Ref. No.	E50300
description	flat gasket fibre ED ø 60mm ID ø 48mm thickness 3mm for thread 1½" Qty 1 pcs		
For models:	KP10G, KP10GA, KP10GT, KP10GTA, KP15G, KP15GA, KP15GT, KP15GTA, KP20G, KP20GA, KP30G, KP30GA, KP50G, KP50GA, KPI10E, KPI10E9, KPI10EA, KPI10EA9, KPI10G, KPI10GA, KPI10GT, KPI10GTA, KPI15E, KPI15E9, KPI15EA, KPI15EA9, KPI15G, KPI15GA, KPI15GT, KPI15GTA, KPI20E, KPI20EA, KPI20G, KPI20GA, KPI30E, KPI30EA, KPI30G, KPI30GA, KPI50E, KPI50EA, KPI50G, KPI50GA, OPP10G, OPP10GA, OPP15G, OPP15GA, OPPI10E, OPPI10EA, OPPI10G, OPPI10GA... (Other models you can see in the webshop)		

O-rings

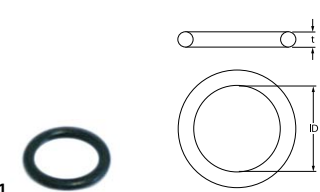

GEV No.	510893	Ref. No.	904391
description	O-ring EPDM thickness 2.62mm ID ø 9.92mm Qty 1 pcs		
For models:	GLB785, GLB795		

GEV No.	510072	Ref. No.	904350 N/A
description	O-ring EPDM thickness 3.53mm ID ø 32.93mm Qty 1 pcs		
For models:	GLB615, GLB785, GLB795		

GEV No.	510899	Ref. No.	X05400
description	O-ring EPDM thickness 3.53mm ID ø 37.69mm Qty 1 pcs		
For models:	CCPE4, CFE15, CFE159, CFE15D, CFE15D9, CMP4, KCP4E, KCP82E, KFE15, KFE159, KFE15D, KFE15D9, KFE20, KFE20D, OPCP4E, OPCP82E, OPFE15, OPFE15D, OPFE20, OPFE20D, SKCP40E, TCP40E, TMP4		

GEV No.	521120	Ref. No.	907981 SD907981
description	O-ring EPDM thickness 5.34mm ID ø 37.47mm Qty 1 pcs		
For models:	GLB785, GLB795, GLS905, GLS925, GLS935		

GEV No.	510408	Ref. No.	E11700
description	O-ring EPDM thickness 5.34mm ID ø 47mm Qty 1 pcs		
For models:	CPEI, CPEI9, KPI10E, KPI10E9, KPI10EA, KPI10EA9, KPI15E, KPI15E9, KPI15EA, KPI15EA9, KPI20E, KPI20EA, KPI30E, KPI30EA, KPI50E, KPI50EA, OPPI10E, OPPI10EA, OPPI15E, OPPI15EA		

GEV No.	532545	Ref. No.	X05000
description	O-ring Viton thickness 3.53mm ID ø 49.21mm Qty 1 pcs		
For models:	CCPE4, CFE15, CFE159, CFE15D, CFE15D9, KCP4E, KCP82E, KFE15, KFE159, KFE15D, KFE15D9, KFE20, KFE20D, OPCP4E, OPCP82E, OPFE15, OPFE15D, OPFE20, OPFE20D, SKCP40E, TCP40E		

flange gaskets

GEV No.	521128	Ref. No.	N/A
description	gasket L 66mm W 21mm ømm for heating element suitable for ELETTOBAR, WOLK		

capillary tube clips

GEV No.	551105	Ref. No.	M86800
description	capillary tube clip for pipe ø 6mm Qty 1 pcs		
For models:	CF1E4, CF2E6, CF4E, CF6E, GSP01, IF1E4, IF2E6, IF4E, IF6E, KFE1, KFE2, OPFE1, OPFE2, SKF1E, SKF2E, SKF4E, SKF6E, TF1E, TF2E, TF4E, TF6E		

GEV No.	550980	Ref. No.	M86900
description	capillary tube clip for pipe ø 8.5mm Qty 1 pcs		
For models:	15DPE, 15PE, 15PSE, 4DME, 4ME, 6+4LE, 6+4ME, 6DLE, 6DME, 6LE, 6ME, 7DSE, 7DSET, 7SE, 7SET, CF2E4, SK10DSE, SK10DSE9, SK10SE, SK10SE9, SKF2E4, TF2E4		

spring clips

GEV No.	550258	Ref. No.	M86500
description	probe clip for pipe ø 8mm for probe ø 6mm		
For models:	15DPE, 15PE, 15PSE, 4DME, 4ME, 6+4LE, 6+4ME, 6DLE, 6DME, 6LE, 6ME, 7DSE, 7SE, CF1E4, CF2E4, CF2E6, CF4E, CF6E, IF1E4, IF2E6, IF4E, IF6E, KFE1, KFE2, KFE4, KFE8, M6F4E, M6F6E, M7F4E, M7F6E, OPFE1, OPFE2, SK10DSE9, SK10SE9, SKF1E, SKF2E, SKF2E4, SKF4E, SKF6E, TF1E, TF2E, TF2E4, TF4E, TF6E		

protection caps

GEV No.	510093	Ref. No.	N/A
description	protection cap		

GEV No.	514202	Ref. No.	0900B42300
description	bracket for heating element mounting pos. right		



			
1			
GEV No.	514203	Ref. No.	1901B42300
description	bracket heating element mounting pos. left		

hot plates

square & rectangular

with radiused edge

			
1			
GEV No.	490066 ¹	Ref. No.	X45500
description	hot plate dimensions 220x220mm 2600W 230V with spill ring connection 4 screw clamps protector yes square		
For models:	C2PQ, C4PQ, C4PQFCE, C4PQFE, C6PQ, C6PQFCE, C6PQFCEV, C6PQFE, CCQ120E, CCQ80E, CCQ81E, I2PQ, I4PQ, M74PQ, M74PQFXE, SK4PQFCE, SK6PQFCE, SKCQ40E, SKCQ80E, TCQ120E, TCQ40E, TCQ80E		

¹incl. protector

			
1			
GEV No.	490056 ¹	Ref. No.	Y12000
description	hot plate dimensions 300x300mm 3000W 230V with spill ring connection 4 screw clamps protector yes square		
For models:	K2P, K4P, K4PFE, K6P, K6PFE		

¹incl. protector

			
1			
GEV No.	490071 ¹	Ref. No.	0000Y12100
description	hot plate dimensions 300x300mm 4000W 230V with spill ring connection 4 screw clamps protector yes square		
For models:	K2P, K4P, K4PFE, K4PFE, K6P, K6PFE, K6PFE, OP2P, OP4P, OP6P		

¹incl. protector

round



with radiused edge

for domestic and commercial kitchens

			
1			
GEV No.	490014	Ref. No.	AER003ZR10
description	hot plate ø 180mm 1500W 230V connection 4 screw clamps with 8mm spill ring		
For models:	M62P, M64P		

			
1			
GEV No.	490016	Ref. No.	AER002ZR10
description	hot plate ø 180mm 2000W 230V connection 4 screw clamps with 8mm spill ring		
For models:	M62P, M64P, M74P, M74PFXE, M76P, M76PFXE		

			
1			
GEV No.	490018	Ref. No.	X45400
description	hot plate ø 220mm 2000W 230V connection 4 screw clamps with 8mm spill ring		
For models:	C2P, C4P, C4PFCE, C4PFE, C6P, C6PFCE, C6PFCEV, C6PFE, CC80E, I2P, I4P, SK4PFCE, SK6PFCE, SKC40E, SKC80E, TC120E, TC40E, TC80E		

			
1			
GEV No.	490020	Ref. No.	0000X45300
description	hot plate ø 220mm 2600W 230V connection 4 screw clamps with 8mm spill ring		
For models:	C2P, C4P, C4PFCE, C4PFE, C4PFLE, C6P, C6PFCE, C6PFCEV, C6PFE, C6PFLE, C6PFLEV, CC120E, CC80E, CC81E, I2P, I4P, SK4PFCE, SK6PFCE, SKC40E, SKC80E, TC120E, TC40E, TC80E		
accessories for	490020		
	GEV No.	550796	Ref. No.
	 fixing plate for hot plate ø220mm		



accessories

miscellaneous

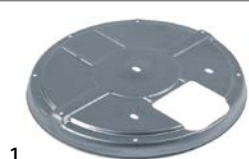

1			
GEV No.	490111	Ref. No.	X44900
description	cover for hot plate ø 237mm		
For models:	C2P, C4P, C4PFCE, C4PFCE9, C4PFE, C4PFE9, C4PFLE, C6P, C6PFCE, C6PFCEV, C6PFE, C6PFLE, C6PFLEV, CC120E, CC80E, CC81E, I2P, I4P, SK4PFCE, SK6PFCE, SKC40E, SKC80E, TC120E, TC40E, TC80E		

energy regulators

EGO

1-circuit



1			
GEV No.	380021	Ref. No.	Y12406
description	energy regulator		
For models:	C2V, C4V, C4VFE, C4VFLE, TCV40E, TCV80E		



Image not available

1			
GEV No.	380022	Ref. No.	Y12407
description	energy regulator		



1			
GEV No.	380015	Ref. No.	073010 X44400 Y12206 Y12406 Y44400
description	energy regulator 230V 13A single-circuit turn direction right shaft ø 6x4.6mm shaft L 23mm mounting thread M4 power release 6-100% no. 50.57021.010		
For models:	C4V, C4VFCE, C4VFE, CBE4, CBE8, CCV80E, CCV81E, CRE4, CRE6, IRE4, IRE6, K2V, K4V, K4VFCE, K4VFE, OP2V, OP4V, S110E, S300E, S600E, S680E, SK4VFCE, SKB40E, SKB80E, SKCV40E, SKCV80E, SKR40E, SKR60E, TB40E, TB80E, TCV80E, TR40E, TR60E		

2-circuit



1			
GEV No.	381304	Ref. No.	Y17604
description	energy regulator EGO 230V 13A dual circuit turn direction right shaft ø 6x4.6mm shaft L 22mm mounting thread M4 no. 50.55071.100		
For models:	C2V, C4V, C4VFCE, C4VFE, I2V, I4V, K2V, K4V, K4VFCE, K4VFE, OP2V, OP4V, SK4VFCE, SKCV40E, SKCV80E, TCV40E, TCV80E		



1			
GEV No.	380027	Ref. No.	Y12407
description	energy regulator EGO 230V 13A dual circuit turn direction right shaft ø 6x4.6mm shaft L 23mm mounting thread M4 power release 6-70% no. 50.55021.100		
For models:	C2V, C4V, C4VFE, C4VFLE, TCV40E, TCV80E		

thermostats

bi-metal thermostats

safety bi-metal thermostats



1			
GEV No.	390233	Ref. No.	N/A
description	bi-metal safety thermostat hole distance 24mm switch-off temp. 110°C 1NC 1-pole 16A connection F6.3 2 hole fixing without holder		
accessories for	390233		
		GEV No.	504736 Ref. No. —
		GEV No.	550388 Ref. No. —

control and safety thermostats

EGO

control thermostats

55.10/19_ series



GEV No.	375055	Ref. No.	X43100
description	thermostat t.max. 110°C temperature range 30-110°C 1-pole 1CO 16A probe ø 6mm probe L 130mm capillary pipe 1500mm capillary pipe isolatedmm gland nut shaft L 23mm shaft position upper rotation 318° 250V		
For models:	CBE4, CBE6, CBE8, SKB40E, SKB60E, SKB80E, TB40E, TB60E, TB80E		





GEV No.	375054	Ref. No.	X43100
description	thermostat t.max. 110°C temperature range 30-110°C 1-pole capillary pipe isolatedmm gland nut		



GEV No.	375363	Ref. No.	40100050 E10600
description	thermostat t.max. 161°C temperature range 73-161°C 1-pole 1NO 16A probe ø 3mm probe L 144mm capillary pipe 1600mm capillary pipe isolated 1600mm gland nut shaft ø 6x4.6mm shaft L 23mm shaft position upper rotation 270°		
For models:	CPEI, CPEI9, KPI10E, KPI10E9, KPI10EA, KPI10EA9, KPI10ET, KPI10ETA, KPI15E, KPI15E9, KPI15EA, KPI15EA9, KPI15ET, KPI15ETA, KPI20E, KPI20EA, KPI20ET, KPI20ETA, KPI30E, KPI30EA, KPI30ET, KPI30ETA, KPI50E, KPI50EA, KPI50ET, KPI50ETA, OPPI10E, OPPI10EA, OPPI15E, OPPI15EA		



GEV No.	375063	Ref. No.	0000X43300
description	thermostat t.max. 170°C temperature range 70-170°C 1-pole 1NO 16A probe ø 11mm probe L 28mm capillary pipe 900mm capillary pipe isolated 900mm gland nut shaft L 23mm shaft position upper rotation 270° screw-in probe probe thread M14x1		
accessories for	375063		
	GEV No.	510417	Ref. No. N/A
	flat gasket fibre ED ø 20mm ID ø 14mm thickness 2mm Qty 1 pcs		
	GEV No.	510420	Ref. No. —
	gasket copper ED ø 19.9mm ID ø 14.3mm thickness 2mm Qty 1 pcs		
	GEV No.	521133	Ref. No. —
	nut thread M14x1.5 H 6mm WS 19 zinc-coated steel Qty 1 pcs		

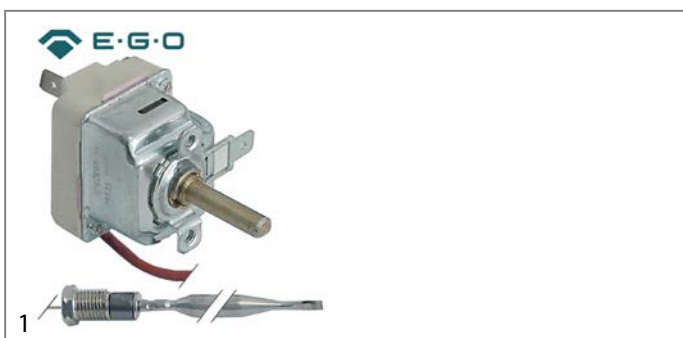

GEV No.	375237	Ref. No.	0000Y16000 X56800
description	thermostat t.max. 190°C temperature range 100-190°C 1-pole 1NO 16A probe ø 6mm probe L 130mm capillary pipe 1800mm capillary pipe isolated 1200mm gland nut M9x1 shaft L 23mm shaft position upper rotation 270°		
For models:	4DME, 4ME, 6+4LE, 6+4ME, CF15DG8, CF15G4, CF2E4, CFE15, CFE159, CFE15D, CFE15D9, KFE15, KFE159, KFE15D, KFE15D9, KFE20, KFE20D, KFE4, KFE8, KFG4, KFG8, OPFE15, OPFE15D, OPFE20, OPFE20D, SKF2E4, TF2E4		



GEV No.	390068	Ref. No.	0000X43600
description	thermostat t.max. 269°C temperature range 55-269°C 1-pole 1CO 16A probe ø 3.1mm probe L 219mm capillary pipe 1280mm capillary pipe isolated 1270mm gland nut shaft ø 6x4.6mm shaft L 23mm shaft position upper° rotation 318°		
For models:	CMP4, IMP4, KBRE, KBRE12, KBRE12IN, KBREIN, KBREM, KBREM12, KBREM12IN, KBREMIN, KBRG, KBRG12, KBRG12IN, KBRGIN, KBRGM, KBRGM12, KBRGM12IN, KBRGMIN, OPBRE, OPBRE12, OPBRE12IN, OPBREIN, OPBREM, OPBREM12, OPBREM12IN, OPBREMIN, OPBRG, OPBRG12, OPBRG12IN, OPBRGIN, OPBRGM, OPBRGM12, OPBRG-12IN, OPBRGMIN, SKMP4, TMP4		



GEV No.	375797	Ref. No.	Y19200
description	thermostat t.max. 300°C temperature range 50-300°C 1-pole 1NO 16A probe ø 6mm probe L 74mm capillary pipe 900mm capillary pipe isolatedmm gland nut shaft L 23mm shaft position upper rotation 270°		
For models:	CBRE, CBRE9, CBREIN, CBREIN9, CMP4, KBRE, KBRE12, KBRE12IN, KBRE9, KBREIN, KBREIN9, KBREM, KBREM12, KBREM12IN, KBREMIN, KBRG, KBRG12, KBRG12IN, KBRGIN, KBRGM, KBRGM12, KBRGM12IN, KBRGMIN, OPBRE, OPBRE12, OPBRE12IN, OPBRE12MIN, OPBREIN, OPBREM, OPBREM12, OPBREMIN, OPBRG, OPBRG12, OPBRG12IN, OPBRG12MIN, OPBRGIN, OPBRGM, OPBRGM12, OPBRGMIN, TMP4		



GEV No.	375216	Ref. No.	X49600
description	thermostat t.max. 280°C temperature range 50-280°C 1-pole 1NO 16A probe ø 3mm probe L 228mm capillary pipe 1300mm capillary pipe isolated 1150mm gland nut shaft L 23mm shaft position upper rotation 318°		
For models:	CC80E, CCG80E, CCQ80E, CCV80E		



GEV No.	375002	Ref. No.	X68205
description	thermostat t.max. 320°C temperature range 55-320°C 1-pole 1NO 16A probe ø 3.1mm probe L 226mm capillary pipe 870mm capillary pipe isolated 850mm gland nut shaft L 23mm shaft position upper rotation 270°		
For models:	C4FFCEP, C4FFLE, C4FFLEP, C4FZFCE, C4FZFCEP, C4FZSFCEP, C4PFCE, C4PFLE, C4PQFCE, C4VFCE, C4VFLE, C6FFCEP, C6FFLE, C6FFLEP, C6FFLEPV, C6FFLEV, C6FZFCE, C6FZFCEP, C6FZFCEPV, C6FZFCEV, C6PFCE, C6PFCEV, C6PFLE, C6PFLEV, C6PQFCE, C6PQFCEV, CC120E, CC80E, CC81E, CCG120CE, CCG120E, CCG80E, CCG81CE, CCG81E, CCQ120E, CCQ81E, CCV81E, K2FTPFCE, K4FSFCE, K4FZFCE, K4FZSFCE, K4PFCE, K4VFCE, K6FZFCE, K6PFCE, K8FZFCE, KTFPCE, M74FFXE, M74FMPFXE, M74FPFXE...(Other models you can see in the webshop)		



GEV No.	375270	Ref. No.	X49800
description	thermostat t.max. 295°C temperature range 45-295°C 1-pole 1NO 16A probe ø 4mm probe L 100mm capillary pipe 900mm capillary pipe isolated 350mm gland nut shaft L 23mm shaft position upper rotation 270°		
For models:	CBRE, CBRE8, CBREIN		

55.13_series



GEV No.	375677	Ref. No.	FZ400541
description	thermostat t.max. 195°C temperature range 103-195°C 1-pole 1NO 16A probe ø 4mm probe L 157mm capillary pipe 2250mm capillary pipe isolated 2020mm gland nut shaft L 18mm shaft position upper rotation 270°		



GEV No.	375006	Ref. No.	N/A
description	thermostat t.max. 85°C temperature range 30-85°C 1-pole 1CO 16A probe ø 6mm probe L 92mm capillary pipe 3150mm capillary pipe isolated 300mm gland nut shaft L 23mm shaft position upper rotation 270° probe material SS		



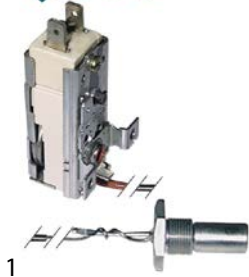

GEV No.	375426	Ref. No.	X57900
description	thermostat t.max. 93°C temperature range 30-93°C 1-pole 1CO 16A probe ø 6mm probe L 85mm capillary pipe 1230mm capillary pipe isolatedmm gland nut shaft position left rotation 270° probe material SS		
For models:	CBE4, CBE8, IBE4, IBE8, M6B4E, M7B4E, SKB40E, SKB80E, TB40E, TB80E		

55.14_series



GEV No.	390001	Ref. No.	D236023
description	thermostat t.max. 58°C temperature range fixed 58°C 1-pole 1NC 16A probe ø 11mm probe L 35mm capillary pipe 580mm capillary pipe isolated 580mm gland nut shaft Lmm shaft position° shaft position screw-in probe probe thread M14x1		

accessories for	390001			
	GEV No.	510417	Ref. No.	N/A
	flat gasket fibre ED ø 20mm ID ø 14mm thickness 2mm Qty 1 pcs			
	GEV No.	550261	Ref. No.	N/A
	nut thread M14x1 H 4mm WS 19 SS Qty 1 pcs			

55.34_series



GEV No.	375022	Ref. No.	AEC002ZR10
description	thermostat t.max. 180°C temperature range 95-180°C 3-pole 3NO 16A probe ø 6mm probe L 133mm capillary pipe 1780mm capillary pipe isolated 1400mm gland nut M9x1 shaft ø ø6x4.6mm shaft L 23mm rotation 270°		
For models:	M6F4E, M6F6E, M7F4E, M7F6E		



GEV No.	375097	Ref. No.	0000X43800
description	thermostat t.max. 195°C temperature range 95-195°C 3-pole 3NO 16A probe ø 6mm probe L 117mm capillary pipe 1780mm capillary pipe isolated 1400mm gland nut M9x1 shaft ø ø6x4.6mm shaft L 23mm shaft position upper rotation 270°		
For models:	15DPE, 15PE, 15PSE, 6+4ME, 6DME, 6ME, 7DSET, 7SET, CF1E4, CF2E6, CF4E, CF6E, CRE4, CRE6, IF1E4, IF2E6, IF4E, IF6E, IRE4, IRE6, KFE1, KFE2, OPFE1, OPFE2, SK10DSE, SK10DSE9, SK10SE, SK10SE9, SKF1E, SKF2E, SKF4E, SKF6E, SKR40E, SKR60E, TF1E, TF2E, TF4E, TF6E, TR40E, TR60E		



GEV No.	375453	Ref. No.	0000X43200 0000X43900 Y16400
description	thermostat t.max. 308°C temperature range 100-300°C 3-pole 3NO 16A probe ø 6mm probe L 75mm capillary pipe 1150mm capillary pipe isolatedmm gland nut shaft ø 6x4.6mm shaft L 23mm rotation 270° probe material SS		
For models:	C2FTPFE, C2FTPFEF, C4FFE, C4FFPE, C4FZFE, C4FZFEP, C4FZSFEP, C4PFCE, C4PFE, C4PFE9, C4PQFCE, C4PQFCE, C4VFE, C6FFE, C6FFPE, C6FZFE, C6FZFEP, C6PFCE, C6PFCEV, C6PFE, C6PQFCE, C6PQFCEV, C6PQFE, CCTPFE8, CFTE1, CFTE1C, CFTE1R, CFTE2, CFTE22, CFTE2C, CFTE2C2, CFTE2LR, CFTE2R, CFTE2R2, CFTE3, CFTE3C, CFTE3LR, CFTE3R, CFTE4, CFTE49, CFTE4C, CFTE4C9, CFTE4R, CFTE4R9, CFTE6, CFTE62, CFTE6C, CFTE6C2, CFTE6LR, CFTE6R...(Other models you can see in the webshop)		

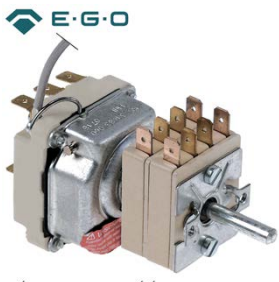



GEV No.	375917	Ref. No.	776-008-00
description	thermostat t.max. 550°C temperature range 85-500/85-550°C 3-pole 2NO/1NO 16A probe ø 3.9mm probe L 228mm capillary pipe 1110mm capillary pipe isolated 600mm gland nut shaft ø 6x4.6mm shaft L 23mm rotation 318° outer switch 2NO/2NO		

safety thermostats
55.10/19_series





GEV No.	375178	Ref. No.	0000X56700
description	safety thermostat switch-off temp. 230°C 1-pole 0.5A probe ø 4mm probe L 116mm capillary pipe 1500mm capillary pipe isolatedmm gland nut probe SS		
For models:	CFG15, CFG15D, KFG15, KFG15D, KFG20, KFG20D, OPFG15, OPFG15D, OPFG20, OPFG20D		



GEV No.	375282	Ref. No.	0000X43400
description	safety thermostat switch-off temp. 230°C 1-pole 16A probe ø 11mm probe L 28mm capillary pipe 850mm capillary pipe isolated 830mm gland nut probe screw-in probe probe thread M14x1		
For models:	CF10DG8M, CF10G4M, KFG1, KFG2, M7F4G, M7F8G, OPFG1, OPFG2, SKF10GM, SKF20GM, TF10GM, TF20GM		
accessories for	375282		
	GEV No.	507313	Ref. No. —
	O-ring EPDM thickness 2.62mm ID ø 13.95mm Qty 1 pcs		
	GEV No.	510420	Ref. No. —
	gasket copper ED ø 19.9mm ID ø 14.3mm thickness 2mm Qty 1 pcs		
	GEV No.	521133	Ref. No. —
	nut thread M14x1.5 H 6mm WS 19 zinc-coated steel Qty 1 pcs		



GEV No.	390062	Ref. No.	0000X49500 0000Y16300
description	safety thermostat switch-off temp. 235°C 1-pole 0.5A probe ø 6mm probe L 130mm capillary pipe 1800mm capillary pipe isolated 1500mm gland nut M9x1 probe SS		
For models:	15DPE, 15PE, 15PSE, 4DME, 4ME, 6+4LE, 6+4ME, 6DLE, 6DME, 6LE, 6ME, 7DSE, 7DSET, 7SE, 7SET, CF15DG8, CF15G4, CF1E4, CF2E4, CF2E6, CF4E, CF6E, CFE15, CFE15D, IF1E4, IF2E6, IF4E, IF6E, KFE1, KFE15, KFE15D, KFE2, KFE20, KFE20D, KFE4, KFE8, KFG4, KFG8, OPFE1, OPFE15, OPFE15D, OPFE2, OPFE20, OPFE20D, SK10DSE, SK10DSE9, SK10SE, SK10SE9, SKF1E, SKF2E...(Other models you can see in the webshop)		
accessories for	390062		
	GEV No.	551083	Ref. No. —
	cap for safety thermostat thread M8x1		



GEV No.	375352	Ref. No.	0000X49500 Y16300
description	safety thermostat switch-off temp. 245°C 1-pole 1NC 16A probe ø 6mm probe L 130mm capillary pipe 1200mm capillary pipe isolated 1200mm gland nut probe		



GEV No.	375353	Ref. No.	0000Y16500
description	safety thermostat switch-off temp. 355°C 1-pole 0.5A probe ø 4mm probe L 120mm capillary pipe 870mm capillary pipe isolated 870mm gland nut probe SS		
For models:	CBRE, CBRE9, CBREIN, CBREIN9, KBRE, KBRE12, KBRE12IN, KBRE9, KBREIN, KBREIN9, KBREM, KBREM12, KBREM12IN, KBREMIN, KBRG, KBRG12, KBRG12IN, KBRGIN, KBRGM, KBRGM12, KBRGM12IN, KBRG- MIN, KFT4G, KFT4GC, KFT4GR, KFT8G, KFT8G23C, KFT8GC, KFT8GLR, KFT8GR, KFTG1, KFTG1C, KFTG1R, KFTG3, KFTG3C, KFTG3LR, KFTG4, KFTG4C, KFTG4R, KFTG8, KFTG8C, KFTG8LR, KPI20GA, KPI30GA, KPI50GA, KTF4G, KTF4GC, KTF8GLR, OPBRE, OPBRE12...(Other models you can see in the webshop)		

55.32_series

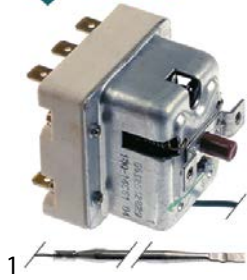

GEV No.	375364	Ref. No.	40100041 E10500
description	safety thermostat switch-off temp. 190°C 3-pole 20A probe ø 4mm probe L 120mm capillary pipe 3000mm capillary pipe isolated 3000mm gland nut probe		
For models:	CPEI, CPEI9, CPG, CPGI, KP10G, KP10GA, KP15G, KP15GA, KP110E, KP110E9, KP110EA, KP110EA9, KP110ET, KP110ETA, KP110G, KP110GA, KP110GT, KP110GTA, KP115E, KP115E9, KP115EA, KP115EA9, KP115ET, KP115ETA, KP115G, KP115GA, KP115GT, KP115GTA, KP120ET, KP120ETA, KP130ET, KP130ETA, KP150ET, KP150ETA, OPPI10E, OPPI10EA, OPPI10G, OPPI10GA, OPPI15E, OPPI15EA, OPPI15G, OPPI15GA		



GEV No.	375551	Ref. No.	AEC001ZR10
description	safety thermostat switch-off temp. 235°C 3-pole 20A probe ø 4mm probe L 120mm capillary pipe 1800mm capillary pipe isolated 1600mm gland nut probe SS		
For models:	M6F4E, M6F6E, M7F4E, M7F6E		



GEV No.	375252	Ref. No.	0000X44800
description	safety thermostat switch-off temp. 350°C 3-pole 20A probe ø 6mm probe L 89mm capillary pipe 3000mm capillary pipe isolated 960mm gland nut probe		
For models:	C4FFEP, C4ZFEP, C4ZFEP, C4FZSFEP, C4PFCE, C4PFE, C4PFE9, C4PQFCE, C4PQFE, C4VFE, C6FFEP, C6ZFEP, C6FZSFEP, C6PFCE, C6PFCEV, C6PFE, C6PQFCE, C6PQFCEV, C6PQFE, CFTE1, CFTE1C, CFTE1R, CFTE2, CFTE22, CFTE2C, CFTE2C2, CFTE2LR, CFTE2R, CFTE2R2, CFTE3, CFTE3C, CFTE3LR, CFTE3R, CFTE4, CFTE49, CFTE4C, CFTE4C9, CFTE4R, CFTE4R9, CFTE6, CFTE62, CFTE6C, CFTE6C2, CFTE6LR, CFTE6R, CFTE6R2, CFTE8, CFTE89, CFTE8C, CFTE8C9...(Other models you can see in the webshop)		

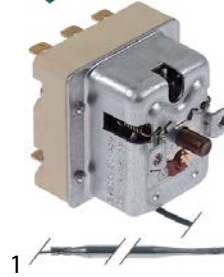

GEV No.	375392	Ref. No.	Y72100
description	safety thermostat switch-off temp. 360°C 3-pole 1CO/2NC 20A probe ø 4mm probe L 120mm capillary pipe 1490mm capillary pipe isolated 1450mm gland nut probe SS		

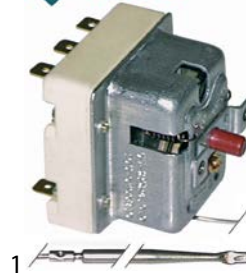

GEV No.	375350	Ref. No.	X49900 Y16600
description	safety thermostat switch-off temp. 360°C 3-pole 20A probe ø 4mm probe L 120mm capillary pipe 1800mm capillary pipe isolated 1800mm gland nut probe SS		

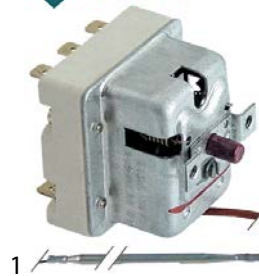

GEV No.	390227	Ref. No.	40100062 X49900
description	safety thermostat switch-off temp. 360°C 3-pole 20A probe ø 4mm probe L 120mm capillary pipe 1800mm capillary pipe isolated 1800mm gland nut probe SS		
For models:	CBRE, CBRE8, CBREIN, KPI20E, KPI20EA, KPI30E, KPI30EA, KPI50E, KPI50EA		

control thermostats with operation switch

55.10/19_ series





GEV No.	390039	Ref. No.	X57800 X5780011
description	thermostat t.max. 90°C temperature range 30-90°C 1-pole 1CO 16A probe ø 6mm probe L 173mm capillary pipe 980mm capillary pipe isolated 980mm gland nut shaft ø 6x4.6mm shaft L 23mm shaft position upper rotation 270° outer switch 2NO		
For models:	KB4, KB8, OPB4, OPB8		
accessories for	390039		
	GEV No.	111934	Ref. No. —
	knob thermostat t.max. 90°C ø 50mm shaft ø 6x4.6mm shaft flat upper black temperature range 30-90°C rotation 270°		

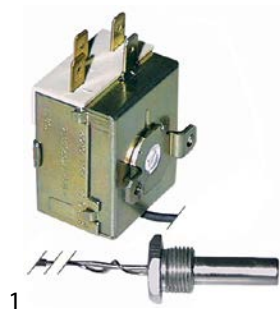

IMIT / TEMPOMATIC / ARTHERMO

control thermostats



GEV No.	390310	Ref. No.	907124
description	thermostat t.max. 85°C temperature range fixed 55°C 1-pole 1CO 16A probe ø 9.5mm probe L 37mm capillary pipe 600mm capillary pipe isolated 540mm gland nut shaft ømm shaft Lmm shaft position rotation° screw-in probe probe thread 3/8" probe material SS		
For models:	GLB615, GLB785, GLB795, GLS805, GLS845, GLS905, GLS925		
accessories for	390310		
	GEV No.	506024	Ref. No. 902104
	nut thread 3/8" H 6mm SS WS 22 Qty 1 pcs		
	GEV No.	529349	Ref. No. —
	flat gasket FIBER ED ø 22mm ID ø 16.5mm thickness 2mm for thread 3/8" Qty 1 pcs		



GEV No.	390006	Ref. No.	907100 907110 SD907110
description	thermostat t.max. 86°C temperature range 0-86°C 1-pole 1CO 16A probe ø 6.5mm probe L 95mm capillary pipe 1500mm capillary pipe isolatedmm gland nut shaft ø 6x4.6mm shaft L 19mm rotation 270°		
For models:	GLB785, GLB795, GLS935, GLS945, GLS945S		
accessories for	390006		
	GEV No.	110100	Ref. No. 903982
	knob thermostat t.max. 90°C 0-90°C ø 42mm shaft ø 6x4.6mm shaft flat -135° black		
	GEV No.	110105	Ref. No. —
	rosette knob ø 42mm ø 56mm zero mark		

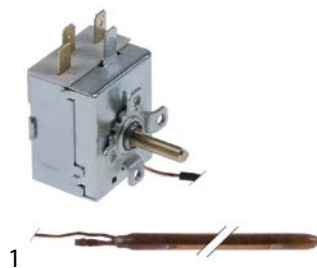

GEV No.	390683	Ref. No.	TR0440
description	thermostat t.max. 86°C temperature range 0-86°C 1-pole 1CO 16A probe ø 6.5mm probe L 98mm capillary pipe 1000mm capillary pipe isolated 960mm gland nut shaft ø 6x4.6mm shaft L 20mm shaft position +135° rotation 270° probe material copper		
For models:	GLB615, GLS805, GLS845, GLS905, GLS925		
accessories for	390683		
	GEV No.	110100	Ref. No. 903982
	knob thermostat t.max. 90°C 0-90°C ø 42mm shaft ø 6x4.6mm shaft flat -135° black		

safety thermostats

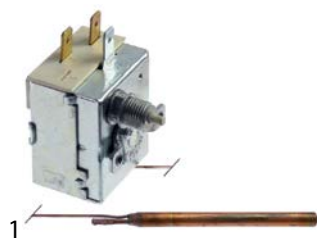

GEV No.	390023	Ref. No.	907125 SD907125
description	safety thermostat switch-off temp. 90-110°C 1-pole 16A probe ø 6.5mm probe L 90mm capillary pipe 1000mm capillary pipe isolatedmm gland nut probe		
For models:	GLB615, GLB785, GLB795, GLS805, GLS845, GLS905, GLS925, GLS935, GLS945, GLS945S		

various

control thermostats

 <p>Image not available</p>			
1			
GEV No.	390225	Ref. No.	X49400
description	thermostat		
For models:	4DME, 4ME, 6+4LE, 6+4ME, 6DLE, 6LE, 7DSE, 7SE		

 <p>Image not available</p>			
1			
GEV No.	375221	Ref. No.	X49800
description	thermostat gland nut		

safety thermostats

			
1			
GEV No.	390676	Ref. No.	907120
description	safety thermostat switch-off temp. 60°C 1-pole 1CO 16A probe ø 7mm probe L 100mm capillary pipe 1500mm		
For models:	GLS935, GLS945, GLS945S		

refrigeration thermostats

RANCO

K22 series

			
1			
GEV No.	390207	Ref. No.	I62026414
description	thermostat RANCO type K22L2030 probe ø 2mm probe Lmm capillary pipe 2000mm temperature range -13 up to -4°C		

			
1			
GEV No.	390209	Ref. No.	I62020100
description	thermostat RANCO type K22L1020 probe ø 9mm probe L 40mm capillary pipe 2000mm temperature range -20.5 up to -1.5°C		

			
1			
GEV No.	390277	Ref. No.	I63003800
description	thermostat RANCO type K22L3020 probe ø 9mm probe L 40mm capillary pipe 1600mm temperature range -26.5 up to -19.5°C		

			
1			
GEV No.	390280	Ref. No.	I62012500
description	thermostat RANCO type K22L3021 probe ø 9mm probe L 35mm capillary pipe 1600mm temperature range -14 up to -9°C		

			
1			
GEV No.	390279	Ref. No.	I62012900
description	thermostat RANCO type K22L3022 probe ø 9mm probe L 35mm capillary pipe 1600mm		

K50 series

			
1			
GEV No.	390208	Ref. No.	I620209100
description	thermostat RANCO type K50L3006 probe ømm probe Lmm capillary pipe 2000mm temperature range +1.5 up to +4°C		

K55 series

RANCO



GEV No.	390210	Ref. No.	I62026302
description	thermostat RANCO type K55L1042 capillary pipe 1100mm temperature range +1.7 up to +9.5°C probe ø10x110mm		

K61 series

RANCO



GEV No.	390206	Ref. No.	I62026400
description	thermostat RANCO type K61L1501 probe ømm probe Lmm capillary pipe 1800mm		

accessories

probe clips

spring clips

for thermostat



GEV No.	550258	Ref. No.	M86500
description	probe clip for pipe ø 8mm for probe ø 6mm		
For models:	15DPE, 15PE, 15PSE, 4DME, 4ME, 6+4LE, 6+4ME, 6DLE, 6DME, 6LE, 6ME, 7DSE, 7SE, CF1E4, CF2E4, CF2E6, CF4E, CF6E, IF1E4, IF2E6, IF4E, IF6E, KFE1, KFE2, KFE4, KFE8, M6F4E, M6F6E, M7F4E, M7F6E, OPFE1, OPFE2, SK10DSE9, SK10SE9, SKF1E, SKF2E, SKF2E4, SKF4E, SKF6E, TF1E, TF2E, TF2E4, TF4E, TF6E		

capillary tube clips



GEV No.	551105	Ref. No.	M86800
description	capillary tube clip for pipe ø 6mm Qty 1 pcs		
For models:	CF1E4, CF2E6, CF4E, CF6E, GSP01, IF1E4, IF2E6, IF4E, IF6E, KFE1, KFE2, OPFE1, OPFE2, SKF1E, SKF2E, SKF4E, SKF6E, TF1E, TF2E, TF4E, TF6E		



GEV No.	550980	Ref. No.	M86900
description	capillary tube clip for pipe ø 8.5mm Qty 1 pcs		
For models:	15DPE, 15PE, 15PSE, 4DME, 4ME, 6+4LE, 6+4ME, 6DLE, 6DME, 6LE, 6ME, 7DSE, 7DSET, 7SE, 7SET, CF2E4, SK10DSE, SK10DSE9, SK10SE, SK10SE9, SKF2E4, TF2E4		



plunger sockets



GEV No.	519211	Ref. No.	905191
description	thermowell thread 1/2" L 120mm single ø 6.5mm		
For models:	GLS935		



GEV No.	510986	Ref. No.	TR0298
description	thermowell thread 1/2" L 120mm SS double ø 6.5mm		
For models:	GLS945, GLS945S		

accessories for	510986		
	GEV No.	361184	Ref. No.
			—
			nut thread 1/2" H 6mm nickel-plated brass WS 24 Qty 1 pcs
	GEV No.	521122	Ref. No.
			—
			flat gasket fibre ED ø 31mm ID ø 21.5mm thickness 2mm for thread 1/2" Qty 1 pcs

connecting bows



GEV No.	550060	Ref. No.	X44600 X457
description	connecting bow long for thermostat Qty 1 pcs		
For models:	C2FTPF, C2FTPFEP, C4FFE, C4FFEP, C4ZF, C4ZFEP, C4ZSFEP, C4PFCE, C4PFE, C4PFE9, C4PQFCE, C4PQFE, C4VFE, C6FFE, C6FFEP, C6ZF, C6ZFEP, C6PFCE, C6PFCEV, C6PFE, C6PQFCE, C6PQFCEV, C6PQFE, CBRE, CBRE8, CBREIN, CC80E, CCG80E, CCQ80E, CCTPFEP, CCV80E, CF1E4, CF2E4, CF2E6, CF4E, CF6E, CFE15, CFE159, CFE15D, CFE15D9, CFTE1, CFTE1C, CFTE1R, CFTE2, CFTE22, CFTE2C, CFTE2C2, CFTE2LR, CFTE2R, CFTE2R2...(Other models you can see in the webshop)		



switches and momentary switches

rocker/momentary rocker switches

30x22mm

labelled



GEV No.	300125	Ref. No.	0000X50800
----------------	--------	-----------------	------------

description rocker switch mounting measurements 30x22mm green 2NO 230V 16A 0-I connection male faston 6.3mm ambient temperature max. 125/55°C protection IP65 with cover cap

For models: CBE4, CBE6, CBE8, CC80G, CF15DG8, CF15G4, CRE4, CRE6, CSP40E, IBE4, IBE8, IRE4, IRE6, ISP4, M6B4E, M6SP4E, M7B4E, MC, SK10DSE, SK10SE, SKB40E, SKB60E, SKB80E, SKP40E, SKR40E, SKR60E, TB40E, TB60E, TB80E, TR40E, TR60E, TSP40E

accessories for 300125



GEV No.	301036	Ref. No.	—
----------------	--------	-----------------	---

protective cover internal size 30x22mm for rocker switch mounting measurementsmm

push/momentary push switches

28.5x28.5mm



GEV No.	346866	Ref. No.	905324
----------------	--------	-----------------	--------

description momentary push switch mounting measurements 28.5x28.5mm yellow 2CO 250V 16A connection male faston 6.3mm ambient temperature max. 150/75°C protection IP40

For models: GLB785, GLB795



GEV No.	345588	Ref. No.	905326
----------------	--------	-----------------	--------

description push switch mounting measurements 28.5x28.5mm yellow 1CO 250V 16A connection male faston 6.3mm ambient temperature max. 85/125°C protection IP40

For models: GLB785, GLB795, GLS935

28.5x77.5mm



GEV No.	345590	Ref. No.	905327
----------------	--------	-----------------	--------

description switch combination latching mounting measurements 28.5x77.5mm orange/green/yellow 1NO/indicator light/indicator light 250V 16A connection male faston 6.3mm ambient temperature max. 85°C protection IP40

For models: GLS935

ø22mm



GEV No.	347425	Ref. No.	X56200 X69100
----------------	--------	-----------------	------------------

description momentary push switch mounting measurements ø22mm black 1NC/1NO 250V 5A connection screw ambient temperature max. 85°C protection IP40

For models: KBREM, KBREM12, KBREM12IN, KBREMIN, KBRGM, KBRGM12, KBRGM12IN, KBRGMIN, OPBRE12MIN, OPBREM, OPBREM12, OPBREM12IN, OPBREMIN, OPBRG12MIN, OPBRGM, OPBRGM12, OPBRGM12IN, OPBRGMIN



GEV No.	347426 ¹	Ref. No.	X56300 X69000
----------------	---------------------	-----------------	------------------

description momentary push switch mounting measurements ø22mm red 1NC/1NO 250V 5A connection screw ambient temperature max. 85°C protection IP40

For models: KBREM, KBREM12, KBREM12IN, KBREMIN, KBRGM, KBRGM12, KBRGM12IN, KBRGMIN, OPBRE12MIN, OPBREM, OPBREM12, OPBREM12IN, OPBREMIN, OPBRG12MIN, OPBRGM, OPBRGM12, OPBRGM12IN, OPBRGMIN

¹incl. knob

ø25mm



GEV No.	345001	Ref. No.	D999070
----------------	--------	-----------------	---------

description momentary push switch mounting ø 25mm yellow 1NO/indicator light 250V 16A cover connection male faston 6.3mm ambient temperature max. 85°C protection IP65

accessories for 345001



GEV No.	345039	Ref. No.	—
----------------	--------	-----------------	---

protective cover round ED ø 33mm external size 23mm internal size 21mm H 12mm clear mounting ø 25mm

microswitches

lever actuated



GEV No.	345773	Ref. No.	X52800
----------------	--------	-----------------	--------

description microswitch with lever 250V 16A 1CO connection male faston 6.3mm L 60mm ambient temperature max. 125°C mounting distance 22mm actuating force: 65g lever length 51mm

For models: 15DPE, 15PE, CF1E4, CF2E4, CF2E6, CF4E, CF6E, CFE15, CFE159, CFE15D, CFE15D9, IF1E4, IF2E6, IF4E, IF6E, KFE1, KFE15, KFE159, KFE15D, KFE15D9, KFE2, KFE20, KFE20D, OPFE1, OPFE15, OPFE15D, OPFE2, OPFE20, OPFE20D, SK10DSE, SK10SE, SKF1E, SKF2E, SKF4E, SKF6E, TF1E, TF2E, TF2E4, TF4E, TF6E





1

GEV No.	345044	Ref. No.	620033
description	microswitch with lever 250V 16A 1CO connection male faston 6.3mm ambient temperature max. 85°C mounting distance 25mm type C99ZP3 actuating force: 25g lever length 71mm		

pin-plunger actuated

M12



1

GEV No.	345350	Ref. No.	R31600
description	microswitch with plunger mounting distance 22mm thread M12x0.75 thread L 16mm 250V 16A 1CO connection male faston 6.3mm stroke 4mm ambient temperature max. 125°C type EF83161.3 actuating force: 66g		
For models:	15DPE, 15PE, 15PSE, 4DME, 4ME, 6+4LE, 6+4ME, 6DLE, 6DME, 6LE, 6ME, 7DSE, 7SE, CRE4, CRE6, IRE4, IRE6, KFE4, KFE8, SK10DSE, SK10DSE9, SK10SE, SK10SE9, SKR40E, SKR60E, TR40E, TR60E		
accessories for	345350		
	GEV No.	Ref. No.	
	345351	R3160D	
	nut thread M12x0.75 H 1.6mm WS 14 chrome-plated brass Qty 1 pcs		



1

GEV No.	346176	Ref. No.	X54900
description	microswitch with plunger mounting distance 25mm thread M12x0.75 250V 1CO ambient temperature max. 125°C type MK V11D10		
For models:	CBRE, CBRE9, CBREIN, CBREIN9, KBRE, KBRE12, KBRE12IN, KBRE9, KBREIN, KBREIN9, KBREM, KBREM12, KBREM12IN, KBREMIN, KBRG, KBRG12, KBRG12IN, KBRGIN, KBRGM, KBRGM12, KBRGM12IN, KBRGMIN, OPBRE, OPBRE12, OPBRE12IN, OPBRE12MIN, OPBREIN, OPBREM, OPBREM12, OPBREM12IN, OPBREM12MIN, OPBREM12IN, OPBRG, OPBRG12, OPBRG12IN, OPBRG12MIN, OPBRGIN, OPBRGM, OPBRGM12, OPBRGM12IN, OPBRGMIN		

accessories



1

GEV No.	518000	Ref. No.	N/A
description	adjusting screw for pressure pin		



1

GEV No.	518041	Ref. No.	N/A
description	pressure pin for microswitch L 25.4mm ø 4.7mm		

system switches (ROLD)



1

GEV No.	346498	Ref. No.	905307
description	element holder mounting measurements 28.5x28.5mm black single element holder		
For models:	GLB615, GLS805, GLS845, GLS905, GLS925		



1

GEV No.	345604	Ref. No.	905309
description	element holder single mounting measurements 28.5x28.5mm black for push buttons 23x23mm		
For models:	GLS945, GLS945S		



1

GEV No.	301104	Ref. No.	905312
description	momentary switch unit 1NO 250V 16A connection male faston 6.3mm		
For models:	GLB615, GLS805, GLS845, GLS905, GLS925		



1

GEV No.	345606	Ref. No.	D226071
description	momentary switch unit 2CO 250V 16A connection male faston 6.3mm		



1	GEV No.	345650	Ref. No.	905313
	description	momentary switch unit 2CO 250V 16A connection male faston 6.3mm		
	For models:	GLS945		



1	GEV No.	346816	Ref. No.	N/A
	description	push button ø 23mm black		



1	GEV No.	347439	Ref. No.	905305
	description	push button ø 23mm shaft 3.7x3.7mm yellow		
	For models:	GLB615, GLS805, GLS845, GLS905, GLS925		



1	GEV No.	347100	Ref. No.	905317
	description	switch 1CO 250V 16A connection male faston 6.3mm		
	For models:	GLS945		



1	GEV No.	345651	Ref. No.	905314 905318
	description	switch 2CO 250V 16A connection male faston 6.3mm		
	For models:	GLB615, GLS805, GLS845, GLS905, GLS925, GLS945S		

SWITCHES AND MOMENTARY SWITCHES GIGA

float switches

floats



1	GEV No.	695036	Ref. No.	I78312700
	description	float for ice maker ø 75mm L 115mm H 40mm plastic		

cam switches

on/off

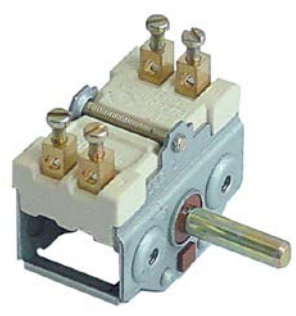

1	GEV No.	300151	Ref. No.	0000X51300
	description	cam switch 2 operating positions 2NO sequence 0-1 16A shaft ø 6x4.6mm shaft L 23mm connection screw ceramic		
	For models:	15DPE, 15PE, 15PSE, 6+4LE, 6+4ME, 6DLE, 6DME, 6LE, 6ME, 7DSET, 7SET, CMP4, IMP4, KBRE, KBRE12, KBRE12IN, KBRE9, KBREIN, KBREIN9, KBREM, KBREM12, KBREM12IN, KBREMIN, KBRG, KBRG12, KBRG12IN, KBRGIN, KBRGM, KBRGM12, KBRGM12IN, KBRGMIN, OPBRE, OPBRE12, OPBRE12IN, OPBRE12MIN, OPBREIN, OPBREM, OPBREM12, OPBREM12IN, OPBREM12MIN, OPBREIN, OPBREM, OPBREM12, OPBREM12IN, OPBREM12MIN, OPBRG, OPBRG12, OPBRG12IN, OPBRG12MIN, OPBRGIN, OPBRGM, OPBRGM12, OPBRGM12IN, OPBRGMIN, SK10DSE... (Other models you can see in the webshop)		

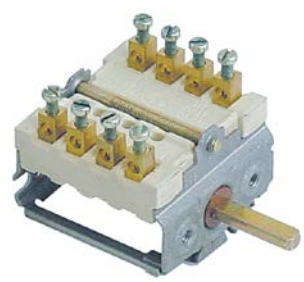

1	GEV No.	345665	Ref. No.	X40700
	description	cam switch 2 operating positions 4NO sequence 0-1 16A shaft ø 6x4.6mm shaft L 23mm connection screw		
	For models:	CRE4, KFTE1, KFTE1C, KFTE1R, KFTE3, KFTE3C, KFTE3LR, KFTE4, KFTE4C, KFTE4R, KFTE8, KFTE8C, KFTE8LR, SKR40E, TR40E		

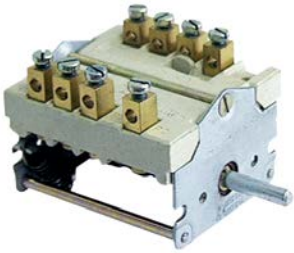
1

GEV No.	300095	Ref. No.	X40600
description	cam switch ON-OFF connection screw clamp		
For models:	CRE6, SKR60E, TR60E		

3 operating positions



1

GEV No.	300167	Ref. No.	0000E11000 40100004
description	cam switch 3 operating positions 2NO/1CO sequence 0-1-2 16A shaft \varnothing 6x4.6mm shaft L 23mm connection screw		
For models:	CPEI, CPEI9, KPI10E, KPI10E9, KPI10EA, KPI10EA9, KPI10ET, KPI10ETA, KPI15E, KPI15E9, KPI15EA, KPI15EA9, KPI15ET, KPI15ETA, KPI20E, KPI20EA, KPI20ET, KPI20ETA, KPI30E, KPI30EA, KPI30ET, KPI30ETA, KPI50E, KPI50EA, KPI50ET, KPI50ETA, M6CP4E, M7CP4E, OPPI10E, OPPI10EA, OPPI15E, OPPI15EA		

4-position



1

GEV No.	300104	Ref. No.	0000X44000
description	cam switch 4 operating positions 3NO/1CO sequence 0-1-2-3 32A shaft \varnothing 6x4.6mm shaft L 23mm connection screw ceramic		
For models:	CCPE4, CCPE6, ICPE4, ICPE6, KCP4E, KCP82E, OPCP4E, OPCP82E, SKCP40E, SKCP60E, TCP40E, TCP60E		

4 operating positions

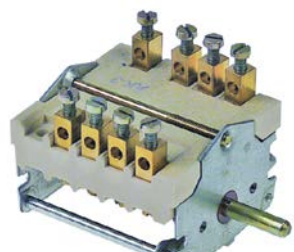

1

GEV No.	300076	Ref. No.	X40600
description	cam switch 4 operating positions 3NO/1CO sequence 0-1-2-3 32A shaft \varnothing 6x4.6mm shaft L 23mm connection screw 4-position ceramic		

7-position

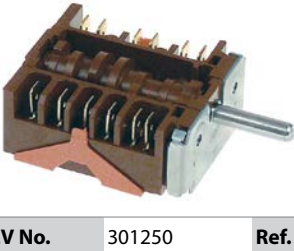

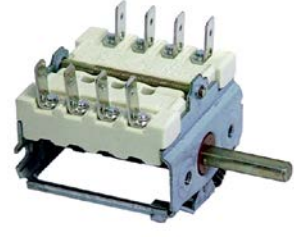

1

GEV No.	301250	Ref. No.	AEC004ZR10
description	cam switch 7 operating positions 1NO/2CO sequence 0-1-2-3-4-5-6 10A shaft \varnothing 6x4.6mm shaft L 23mm connection male faston 6.3mm 7-position		
For models:	M62P, M62V, M64P, M64V, M74P, M74PFXE, M74PQ, M74PQFXE, M74V, M74VFXE, M76P, M76PFXE		



1

GEV No.	300184	Ref. No.	0000X44100
description	cam switch 4 operating positions sequence 0-3-2-1 shaft \varnothing 6x4.6mm connection male faston 4-pole		
For models:	C2FTPF, C2FTPFEP, C4FFE, C4FFEP, C4FZFE, C4FZFEP, C4FZSFEP, C4PFCE, C4PFE, C4PFE9, C4PQFCE, C4PQFE, C4VFE, C6FFE, C6FFEP, C6FZFE, C6FZFEP, C6PFCE, C6PFCEV, C6PFE, C6PQFCE, C6PQFCEV, C6PQFE, CCTPFE8, CN10FE, K2FTPF, K4FFE, K4FS, K4FSFE, K4FZFE, K4FZSFE, K4PFE, K4PFE9, K4VFE, K6FFE, K6FZFE, K6PFE, K6PFE9, K8FFE, K8FZFE, KTPFE, M74FMPFE, M74FPFE, M76FMPFE, M76FPFE		

1

GEV No.	300004	Ref. No.	0000X54100
description	cam switch 7 operating positions 1NO/2CO sequence 0-1-2-3-4-5-6 16A shaft \varnothing 6x4.6mm shaft L 23mm connection male faston 6.3mm 7-position ceramic		
For models:	C2P, C2PQ, C4P, C4PFCE, C4PFCE9, C4PFE, C4PFE9, C4PFLE, C4PQ, C4PQFCE, C4PQFE, C6P, C6PFCE, C6PFCEV, C6PFE, C6PFLE, C6PFLEV, C6PQ, C6PQFCE, C6PQFCEV, C6PQFE, CC120E, CC80E, CC81E, CCQ120E, CCQ80E, CCQ81E, I2P, I2PQ, I4P, I4PQ, K2P, K4P, K4PFCE, K4PFCE9, K4PFE, K4PFE9, K6P, K6PFCE, K6PFE, K6PFE9, OP2P, OP4P, OP6P, SK4PFCE, SK4PQFCE, SK6PFCE, SK6PQFCE, SKC40E, SKC80E... (Other models you can see in the webshop)		

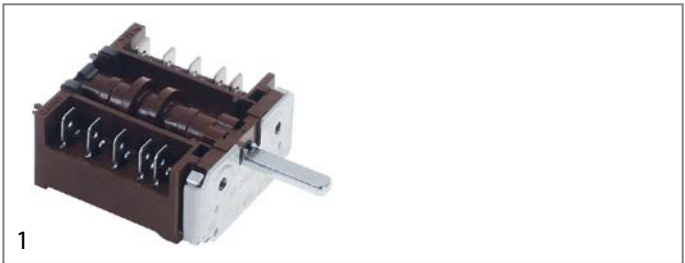

GEV No.	300239	Ref. No.	776-024-00
description	operation switch 4 operating positions 4NO sequence 0-1-2-3 16A shaft ø 6x4.6mm shaft L 23mm connection male faston 6.3mm plastic		

10 operating positions

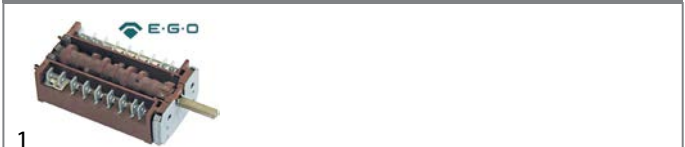

GEV No.	345666	Ref. No.	X68204
description	cam switch 10 operating positions 6NO/1CO sequence 0-1-2-3-4-5-6-7-8-9 8A shaft ø 6x4.6mm shaft L 23mm connection male faston 6.3mm plastic		
For models:	C4FFCEP, C4FFLE, C4FFLEP, C4FZFCE, C4FZFCEP, C4FZSFCEP, C4PFCE, C4PFLE, C4PQFCE, C4VFCE, C4VFLE, C6FFCEP, C6FFLE, C6FFLEP, C6FFLEPV, C6FFLEV, C6FZFCE, C6FZFCEP, C6FZFCEPV, C6FZFCEV, C6PFCE, C6PFCEV, C6PFLE, C6PFLEP, C6PQFCE, C6PQFCEV, CC120E, CC81E, CCG120CE, CCG120E, CCG81CE, CCG81E, CCQ120E, CCQ81E, CCV81E, K2FTPFCE, K4FSFCE, K4FZFCE, K4FZSFCE, K4PFCE, K4VFCE, K6FZFCE, K6PFCE, K8FZFCE, KTFPCE, SK4FZFCEP, SK4PFCE, SK4PQFCE, SK4VFCE, SK6FZFCEP...(Other models you can see in the webshop)		

operation switches



GEV No.	300166	Ref. No.	X40900
description	cam switch 2 operating positions 4NO 16A sequence 0-1 shaft ø 6x4.6mm shaft L 23mm connection male faston 6.3mm ceramic 4-pole ambient temperature max. 318°C		
For models:	CBRE, CBRE8, CBREIN, CC80E, CCG80E, CFTE1, CFTE1C, CFTE1R, CFTE2, CFTE22, CFTE2C, CFTE2C2, CFTE2LR, CFTE2R, CFTE3, CFTE3C, CFTE3LR, CFTE4, CFTE4C, CFTE4R, CFTE6, CFTE62, CFTE6C, CFTE6C2, CFTE6LR, CFTE6R, CFTE8, CFTE8C, CFTE8LR, SKBR40E, SKT1E, SKT1EC, SKT1ER, SKT2E, SKT2E2, SKT2EC, SKT2EC2, SKT2ELR, SKT2ER, SKT2ER2, SKT3E, SKT3EC, SKT3ELR, SKT40E, SKT40EC, SKT40ER, SKT60E, SKT60E2, SKT60EC, SKT60EC2...(Other models you can see in the webshop)		



GEV No.	300080	Ref. No.	0000X49700
description	cam switch 2 operating positions 4NO 16A sequence 0-1 shaft ø 6x4.6mm shaft L 23mm connection screw operation switch ceramic ambient temperature max. 150°C		

accessories for	300080			
	GEV No.	551456	Ref. No.	—
	gasket for switch ED ø 14mm ID ø 2.5mm thickness 3.5mm white			

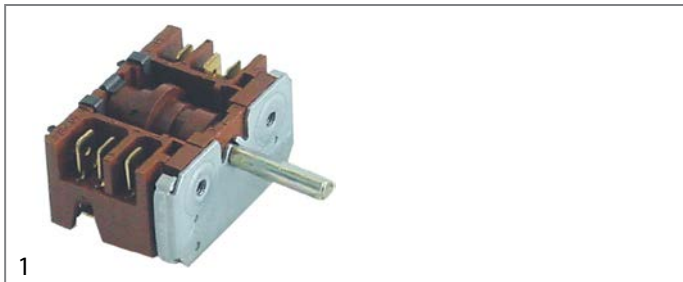

GEV No.	300127	Ref. No.	X56900
description	cam switch operation switch 16A connection male faston 2-pole		



GEV No.	345668	Ref. No.	X49700
description	operation switch		
For models:	C2FTPFCE, C2FTPFCEP, C4FFE, C4FFCEP, C4FZFE, C4FZFCEP, C4FZSFCEP, C4PFCE, C4PFCE, C4PFE9, C4PQFCE, C4PQFCE, C4VFE, C6FFE, C6FFCEP, C6FZFCE, C6FZFCEP, C6PFCE, C6PFCEV, C6PFE, C6PQFCE, C6PQFCEV, C6PQFE, C2TPFE8, CFE159, CFE15D9, CFTE1, CFTE1C, CFTE1R, CFTE2, CFTE22, CFTE2C, CFTE2C2, CFTE2LR, CFTE2R, CFTE2R2, CFTE3, CFTE3C, CFTE3LR, CFTE3R, CFTE4, CFTE49, CFTE4C, CFTE4C9, CFTE4R, CFTE4R9, CFTE6, CFTE62, CFTE6C, CFTE6C2...(Other models you can see in the webshop)		



GEV No.	345995	Ref. No.	X56900
description	operation switch 2-pole		
For models:	4DME, 4ME, 6+4LE, 6+4ME		





1

GEV No.	300091	Ref. No.	0000Y16200
description	operation switch EGO 2 operating positions 2NO 16A sequence 0-1 shaft ϕ 6x4.6mm shaft L 23mm connection screw ceramic		
For models:	CBRE, CBRE9, CBREIN, CBREIN9, CF1E4, CF2E4, CF2E6, CF4E, CF6E, CFE15, CFE159, CFE15D, CFE15D9, IF1E4, IF2E6, IF4E, IF6E, KFE1, KFE15, KFE159, KFE15D, KFE15D9, KFE2, KFE20, KFE20D, KFE4, KFE8, KFG4, KFG8, M74FFXE, M74FMPFXE, M74FPFXE, M74PFXE, M74PQFXE, M74VFXE, M76FFXE, M76FMPFXE, M76FPFXE, M76PFXE, OPFE1, OPFE15, OPFE15D, OPFE2, OPFE20, OPFE20D, SKF1E, SKF2E, SKF2E4, SKF4E, SKF6E...(Other models you can see in the webshop)		

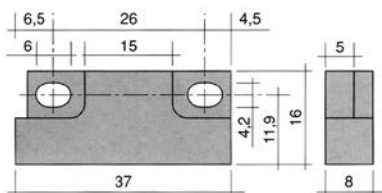
37x16mm

1

GEV No.	345600	Ref. No.	TR0666
description	magnetic switch L 37mm W 16mm 1NO 250V 0.2A P max. 50W connection cable cable length 960mm		
For models:	GLS935, GLS945, GLS945S		
accessories for	345600		
	GEV No.	519049	Ref. No.
			903651 908706 TR0220
	magnet ϕ mm L 63mm H 10.7mm W 18.8mm hole distance 52mm M2 hole ϕ 2mm		

touch sensitive light switches



1

GEV No.	402009	Ref. No.	I78316701
description	light barrier L 310mm W 35mm H 47mm		

magnetic switches

36x13mm

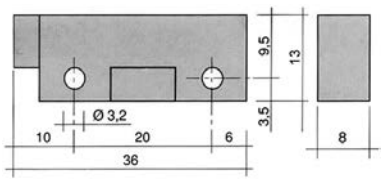



1

GEV No.	345118 ¹	Ref. No.	D211002
description	magnetic switch L 36mm W 13mm 1NO 250V 1A P max. 50W connection cable cable length 980mm		
accessories for	345118		
	GEV No.	345399	Ref. No.
			—
	magnet ϕ 3.3mm L 40mm H 8mm W 13mm hole distance 30mm M3		

¹with coded connector

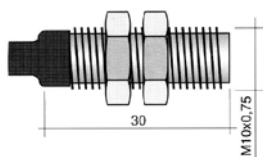
M10x0.75

1

GEV No.	345632	Ref. No.	TR0309
description	magnetic switch thread M10x0.75 1NO 250V 0.5A P max. 50W connection cable cable length 2000mm type 102		
For models:	GLB615, GLB785, GLB795, GLS805, GLS845, GLS905, GLS925		
accessories for	345632		
	GEV No.	100779	Ref. No.
			—
	nut thread M10x0.75 H 3mm WS 14 SS Qty 2 pcs		



accessories

magnets

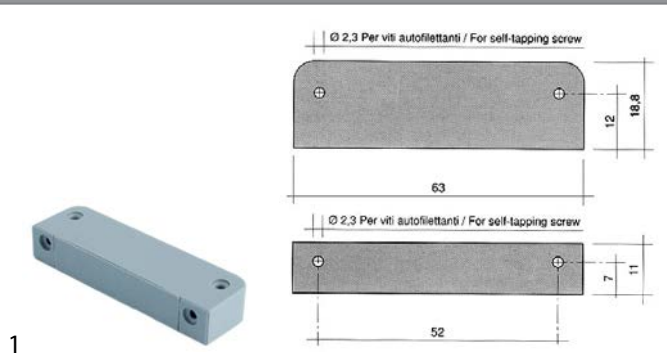

GEV No.	519049	Ref. No.	903651 908706 TR0220
description	magnet ømm L 63mm H 10.7mm W 18.8mm hole distance 52mm M2 hole ø 2mm		
For models:	GLB615, GLB785, GLB795, GLS805, GLS845, GLS905, GLS925, GLS935, GLS945, GLS945S		
accessories for	519049		
	GEV No.	560095	Ref. No. —
	sheet metal screws ø 2.9mm L 9.5mm SS Qty 20 pcs DIN 7981/ISO 7049 head ø 5.6mm oval head		

control equipment

ABB

ø22mm

switches (complete)



GEV No.	347425	Ref. No.	X56200 X69100
description	momentary push switch mounting measurements ø22mm black 1NC/1NO 250V 5A connection screw ambient temperature max. 85°C protection IP40		
For models:	KBREM, KBREM12, KBREM12IN, KBREMIN, KBRGM, KBRGM12, KBRGM12IN, KBRGMIN, OPBRE12MIN, OPBREM, OPBREM12, OPBREM12IN, OPBREMIN, OPBRG12MIN, OPBRGM, OPBRGM12, OPBRGM12IN, OPBRGMIN		



GEV No.	347426 ¹	Ref. No.	X56300 X69000
description	momentary push switch mounting measurements ø22mm red 1NC/1NO 250V 5A connection screw ambient temperature max. 85°C protection IP40		
For models:	KBREM, KBREM12, KBREM12IN, KBREMIN, KBRGM, KBRGM12, KBRGM12IN, KBRGMIN, OPBRE12MIN, OPBREM, OPBREM12, OPBREM12IN, OPBREMIN, OPBRG12MIN, OPBRGM, OPBRGM12, OPBRGM12IN, OPBRGMIN		

¹incl. knob

ERSCE



GEV No.	345989	Ref. No.	X56500
description	contact block ERSCE C01B 1NC max 230V 10(4)A red		
For models:	KBREM, KBREM12, KBREM12IN, KBREMIN, KBRGM, KBRGM12, KBRGM12IN, KBRGMIN, OPBRE12MIN, OPBREM, OPBREM12, OPBREM12IN, OPBREMIN, OPBRG12MIN, OPBRGM, OPBRGM12, OPBRGM12IN, OPBRGMIN		

TELEMECANIQUE (EFA)

XA2 series

switches (complete)



GEV No.	345593	Ref. No.	TR0850
description	rotary selector mounting measurements ø22mm 2NO complete		
For models:	GLS945S		

lamps

indicator lights

indicator lights 2-piece (lens and indicator lamp)

indicator lamps for socket type SRZ / SDK / SDY / SFK



GEV No.	359130	Ref. No.	903645
description	indicator lamp 230V clear connection male faston 6.3mm ø 8mm		
For models:	GLS905, GLS925		





GEV No.	359133	Ref. No.	40200154
description	indicator lamp 400V green connection male faston 6.3mm		
For models:	KPI10ET, KPI10ETA, KPI15ET, KPI15ETA, KPI20E, KPI20EA, KPI20ET, KPI20ETA, KPI30E, KPI30EA, KPI30ET, KPI30ETA, KPI50E, KPI50EA, KPI50ET, KPI50ETA		



GEV No.	359132	Ref. No.	903633
description	indicator lamp green 250V connection male faston 6.3mm protection IP54 ambient temperature max. 85°C		
For models:	GLS905, GLS925		

indicator lights (complete)			
ø 9mm			
			
GEV No.	345597	Ref. No.	903632 903643
description	indicator light ø 9mm 400V green connection male faston 6.3mm temp.-resist. 85°C		
For models:	GLB615, GLB785, GLB795, GLS805, GLS845, GLS945, GLS945S		

			
GEV No.	345598	Ref. No.	903629 903642
description	indicator light ø 9mm 400V yellow connection male faston 6.3mm temp.-resist. 85°C		
For models:	GLB615, GLB785, GLB795, GLS805, GLS845, GLS935, GLS945, GLS945S		

ø12mm			
with screw socket			
			
GEV No.	359048	Ref. No.	076006
description	indicator light ø 12mm 230V yellow connection male faston 6.3mm		
For models:	S110E, S300E		

			
GEV No.	359023	Ref. No.	X50600
description	indicator light ø 12mm 24V green connection male faston 6.3mm		

			
GEV No.	359291	Ref. No.	40200152
description	indicator light ø 12mm 400V green connection male faston 6.3mm		
For models:	KPI10ET, KPI10ETA, KPI15ET, KPI15ETA, KPI20E, KPI20EA, KPI20ET, KPI20ETA, KPI30E, KPI30EA, KPI30ET, KPI30ETA, KPI50E, KPI50EA, KPI50ET, KPI50ETA		

			
GEV No.	359292	Ref. No.	40200148
description	indicator light ø 12mm 400V red connection male faston 6.3mm		
For models:	KPI10ET, KPI10ETA, KPI15ET, KPI15ETA, KPI20ET, KPI20ETA, KPI30ET, KPI30ETA, KPI50ET, KPI50ETA		

			
GEV No.	359290	Ref. No.	40200150
description	indicator light ø 12mm 400V yellow connection male faston 6.3mm		
For models:	KPI10ET, KPI10ETA, KPI15ET, KPI15ETA, KPI20E, KPI20EA, KPI20ET, KPI20ETA, KPI30E, KPI30EA, KPI30ET, KPI30ETA, KPI50E, KPI50EA, KPI50ET, KPI50ETA		

with plug-in socket			
			
GEV No.	359041	Ref. No.	0000X50900
description	indicator light ø 12mm green 230V connection male faston 6.3mm temp.-resist. 120°C Qty 1 pcs		
For models:	15DPE, 15PE, 15PSE, 4DME, 4ME, 6+4LE, 6+4ME, 6DLE, 6DME, 6LE, 6ME, 7DSE, 7DSET, 7SE, 7SET, C2FTPFE, C2FTPFEP, C2P, C2PQ, C2V, C4FFCEP, C4FFCGP, C4FFE, C4FFEP, C4FFLE, C4FFLEP, C4FZFCE, C4FZFCEP, C4FZFCG, C4FZFCGP, C4FZFE, C4FZFEP, C4FZSFCEP, C4FZSFCEP, C4FZSFCEP, C4P, C4PFCE, C4PFCE9, C4PFE, C4PFE9, C4PFLE, C4PQ, C4PQFCE, C4PQFE, C4V, C4VFCE, C4VFE, C4VFLE, C6FFCEP, C6FFCGP... (Other models you can see in the webshop)		

			
GEV No.	359042	Ref. No.	0000X41200
description	indicator light ø 12mm yellow 230V connection male faston 6.3mm temp.-resist. 120°C Qty 1 pcs		
For models:	15DPE, 15PE, 15PSE, 4DME, 4ME, 6+4LE, 6+4ME, 6DLE, 6DME, 6LE, 6ME, 7DSE, 7DSET, 7SE, 7SET, C2FTPFE, C2FTPFEP, C4FFCEP, C4FFE, C4FFEP, C4FFLE, C4FFLEP, C4FZFCE, C4FZFCEP, C4FZFE, C4FZFEP, C4FZSFCEP, C4FZSFCEP, C4PFCE, C4PFE, C4PFE9, C4PFLE, C4PQFCE, C4PQFE, C4VFCE, C4VFE, C4VFLE, C6FFCEP, C6FFE, C6FFEP, C6FFLE, C6FFLEP, C6FFLEP, C6FFLEV, C6FZFCE, C6FZFCEP, C6FZFCEP, C6FZFCEP, C6FZFCE, C6FZFEP... (Other models you can see in the webshop)		

screw-on/push-on fit

light bulbs

for ovens

			
GEV No.	359610	Ref. No.	X68005
description	light bulb t.max. 300°C socket E14 15W 230V ø 22mm L 47mm lens L 20mm for oven lamp type Philips		
For models:	CC80E, CC80G, CCG80E, CCQ80E, CCV80E, GSP01		

oven lamps

universal oven lamps

mounting diameter 35.5mm



				
GEV No.	359718	Ref. No.	X68004	
description	oven lamp mounting ø 35.5mm 230V 15W socket E14 temp.-resist. 300°C connection male faston 6.3mm hard glas			
For models:	CC80E, CC80G, CCG80E, CCQ80E, CCV80E, GSP01, SKC40G, SKC80G			
spare parts for	359718			
	GEV No.	359701	Ref. No.	—
	 lamp socket socket E14 220-230V mounting ø 35.5mm connection male faston 6.3mm 15W			



Table continues overleaf



spare parts for	359718		
	GEV No.	359740	Ref. No.
			—
	light bulb t.max. 300°C socket E14 15W 230V ø 22mm L 48mm lens L 20mm for oven lamp IMPORT		

lamps

light bulbs

			
			
1			
GEV No.	359610	Ref. No.	X68005
description	light bulb t.max. 300°C socket E14 15W 230V ø 22mm L 47mm lens L 20mm for oven lamp type Philips		
For models:	CC80E, CC80G, CCG80E, CCQ80E, CCV80E, GSP01		

residual heat indicators



			
1			
GEV No.	359326	Ref. No.	Y12506
description	residual heat indicator 4-fold		
For models:	C4V, C4VFE, C4VFLE, TCV80E		



			
1			
GEV No.	359096	Ref. No.	Y12209 Y12410
description	residual heat indicator single		
For models:	C2V, CCV80E, CCV81E, SKCV40E, SKCV80E, TCV40E		



timers

programme timers

			
1			
GEV No.	360655	Ref. No.	907182
description	timer CDC 4904DV engines 2 chambers 4 operation time 6s/180s 230V		
For models:	GLS805, GLS845, GLS905, GLS925, GLS935, GLS945		

			
1			
GEV No.	360231	Ref. No.	907172
description	timer CDC 7803 engines 1 chambers 3 operation time 120s 230V shaft ømm shaft Lmm manuf. no. 7803F1 / 360231 motor type M37RN		
For models:	GLB615, GLB785, GLB795		
spare parts for	360231		
	GEV No.	360119	Ref. No.
			—
	motor CDC pinion ø 5.4mm teeth 12 230V turn direction right motor ø 37mm motor type M37RN for timer		

			
1			
GEV No.	360133	Ref. No.	D238066
description	timer CDC 7804DV engines 2 chambers 4 operation time 60s / 20min 230V shaft ømm shaft Lmm manuf. no. 7804DV / 360133 motor type M37RN/M37LN		
spare parts for	360133		
	GEV No.	360119	Ref. No.
			—
	motor CDC pinion ø 5.4mm teeth 12 230V turn direction right motor ø 37mm motor type M37RN for timer		
	GEV No.	360131	Ref. No.
			—
	motor CDC pinion ø 5.4mm teeth 12 230V turn direction left motor ø 37mm motor type M37LN for timer		

			
1			
GEV No.	360215	Ref. No.	907183
description	timer CDC 7805DV engines 2 chambers 5 operation time 6s / 3min 230V shaft ømm shaft Lmm motor type M37RN/M37LN		
For models:	GLS945S		
spare parts for	360215		
	GEV No.	360119	Ref. No.
			—
	motor CDC pinion ø 5.4mm teeth 12 230V turn direction right motor ø 37mm motor type M37RN for timer		
	GEV No.	360131	Ref. No.
			—
	motor CDC pinion ø 5.4mm teeth 12 230V turn direction left motor ø 37mm motor type M37LN for timer		

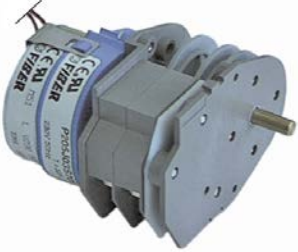



1

GEV No.	360160	Ref. No.	I62032801
description	timer FIBER P20 engines 1 chambers 2 operation time 32h 230V shaft ø 6x6x6mm shaft L 18mm manif. no. P205J03S705 motor type M51BJ0L6400		
spare parts for	360160		
	GEV No.	360674	Ref. No. —
	motor kit pinion ø 6.8mm teeth 15 230V voltage AC 50/60Hz turn direction counterclockwise motor ø 48mm H 18.5mm motor type UDS40NE1RNZ165 cable length 150mm with holder		





1

GEV No.	360052	Ref. No.	I62024404
description	timer FIBER P23 engines 1 chambers 2 operation time 15min 230V manif. no. P235JR1J707 motor type M51BJ0R6400		
spare parts for	360052		
	GEV No.	360673	Ref. No. —
	motor kit pinion ø 6.8mm teeth 15 230V voltage AC 50/60Hz turn direction clockwise motor ø 48mm H 18.5mm motor type UDS40NE1RNZ165 cable length 150mm with holder		





1

GEV No.	360163	Ref. No.	I62024402
description	timer FIBER P23 engines 1 chambers 1 operation time 15min 230V shaft L 30mm manif. no. P235JR1J706 motor type M51BJ0R6400		
spare parts for	360163		
	GEV No.	360673	Ref. No. —
	motor kit pinion ø 6.8mm teeth 15 230V voltage AC 50/60Hz turn direction clockwise motor ø 48mm H 18.5mm motor type UDS40NE1RNZ165 cable length 150mm with holder		



1

GEV No.	360233	Ref. No.	SD907183
description	timer FIBER P25 engines 2 chambers 5 operation time 6s / 3min 230V shaft ømm shaft Lmm manif. no. P255J05JBA9 motor type M51BJ0R6400 / M51BJ0L6400		
spare parts for	360233		
	GEV No.	360673	Ref. No. —
	motor kit pinion ø 6.8mm teeth 15 230V voltage AC 50/60Hz turn direction clockwise motor ø 48mm H 18.5mm motor type UDS40NE1RNZ165 cable length 150mm with holder		
	GEV No.	360674	Ref. No. —
	motor kit pinion ø 6.8mm teeth 15 230V voltage AC 50/60Hz turn direction counterclockwise motor ø 48mm H 18.5mm motor type UDS40NE1RNZ165 cable length 150mm with holder		



1

GEV No.	360162	Ref. No.	62024409
description	timer FIBER P23 engines 1 chambers 2 operation time 12min 230V manif. no. P235JR2J501 motor type M51BJ0R6400		
spare parts for	360162		
	GEV No.	360673	Ref. No. —
	motor kit pinion ø 6.8mm teeth 15 230V voltage AC 50/60Hz turn direction clockwise motor ø 48mm H 18.5mm motor type UDS40NE1RNZ165 cable length 150mm with holder		

mechanical timers



1

GEV No.	350003	Ref. No.	R31700
description	timer M2 with bell 2-pole operation time 120min impulse mechanical 2NO at 250V 16A permanent position no shaft ø 6x4.6mm shaft 6x4.6mm shaft L 23mm mounting distance 28mm connection lateral		
accessories for	350003		
	GEV No.	110366	Ref. No. —
	knob switch zero mark t.max.°C ø 44mm shaft ø 6x4.6mm shaft flat upper black		
	GEV No.	111199	Ref. No. —
	dial plate graduation 120min permanent position no rotation 0-330° ø 60mm timers knob ø 45mm		

contactors

GENERAL ELECTRIC (AEG)

power contactors



1			
GEV No.	380239	Ref. No.	D229019
description	power contactor resistive load 20A 230VAC (AC3/400V) 8.4A/4kW main contacts 3NO auxiliary contacts 1NC connection screw connection type LS05 01A type AEG LS05 01A type GE MC1A 301A		



1			
GEV No.	380244	Ref. No.	0000Y10000
description	power contactor resistive load 25A 230VAC (AC3/400V) 9A/4kW main contacts 3NO auxiliary contacts 1NO connection screw connection type AEG LS4K 10A type GE CL00A 310		
For models:	15DPE, 15PE, CBRE, CBREIN, CF1E4, CF2E6, CF4E, CF6E, CFE15, CFE15D, IF1E4, IF2E6, IF4E, IF6E, KBRE, KBRE12, KBRE12IN, KBREIN, KBREM, KBREM12, KBREM12IN, KBREMIN, KFE15, KFE15D, KFE20, KFE20D, KFE4, KFE8, OPBRE, OPBRE12, OPBRE12IN, OPBREIN, OPBREM, OPBREM12, OPBREM12IN, OPBREM12MIN, OPBREIN, OPBREM12MIN, OPBREMIN, OPFE15, OPFE15D, OPFE20, OPFE20D, SK10DSE, SK10SE, SKF1E, SKF2E, SKF4E, SKF6E, TF1E, TF2E, TF4E, TF6E		



1			
GEV No.	380262	Ref. No.	0000Y11100
description	power contactor resistive load 32A 230VAC (AC3/400V) 17A/7.5kW main contacts 3NO auxiliary contacts 1NC connection screw connection type AEG LS7K01A type GE CL02A 301 H 85mm		
For models:	CFE15, CFE15D, CPEI, KBRE, KBRE12, KBRE12IN, KBREIN, KBREM, KBREM12, KBREM12IN, KBREMIN, KFE15, KFE15D, KFE20, KFE20D, KFE4, KFE8, OPBRE, OPBRE12, OPBRE12IN, OPBRE12MIN, OPBREIN, OPBREM, OPBREM12, OPBREM12IN, OPBREM12MIN, OPBREIN, OPBREM12MIN, OPBREMIN, OPFE15, OPFE15D, OPFE20, OPFE20D		



1			
GEV No.	380261	Ref. No.	X55300
description	power contactor resistive load 32A 230VAC (AC3/400V) 17A/7.5kW main contacts 3NO auxiliary contacts 1NO connection screw connection type AEG LS7K 10A type GE CL02A 310		
For models:	CBRE, CBRE8, CBREIN		

SIEMENS

power contactors



1			
GEV No.	380389	Ref. No.	907095
description	power contactor resistive load 22A 230VAC (AC3/400V) 9A/4kW main contacts 3NO auxiliary contacts 1NO connection screw connection type 3RT10-16-1AP01		
For models:	GLS805, GLS845, GLS905, GLS925, GLS945, GLS945S		

TELEMECANIQUE (Schneider Electric)

power contactors



1			
GEV No.	380965	Ref. No.	y10100
description	power contactor resistive load 20A 230VAC (AC3/400V) 6A/2.2kW main contacts 3NO auxiliary contacts 1NO connection screw connection type LC1K0610P7+		
For models:	15DPE, 15PE, 15PSE, 6+4ME, 6DME, 6ME, 7DSET, 7SET, CF1E4, CF2E4, CF2E6, CMP4, CRE4, CRE6, IMP4, IRE4, IRE6, KFE1, KFE2, OPFE1, OPFE2, SK10DSE, SK10DSE9, SK10SE, SK10SE9, SKF1E, SKF2E, SKF2E4, SKMP4, SKR40E, SKR60E, TF1E, TF2E, TF2E4, TMP4, TR40E, TR60E		



			
1			
GEV No.	380617	Ref. No.	907043
description	power contactor resistive load 25A 24VAC (AC3/400V) 9A/4kW main contacts 3NO auxiliary contacts 1NO/1NC connection screw connection type LC1D09B7		
For models:	GLS935		

			
1			
GEV No.	380687	Ref. No.	905486
description	power relays FINDER 230VAC 30A 2NO connection F6.3 bracket mounting manuf. no. 66.82.8.230.0300		
For models:	GLS905, GLS925		

relays

power relays

with bracket mounting

			
1			
GEV No.	380312	Ref. No.	N/A
description	power relays FINDER 230VAC 10A 3CO connection male faston 4.8mm bracket mounting dimensions 52x32.2x36.5mm manuf. no. 60.63.8.230.0000		

			
1			
GEV No.	380139	Ref. No.	905476
description	power relays FINDER 230VAC 16A 2CO connection F6.3 bracket mounting dimensions 68x38.2x35.8mm manuf. no. 62.82.8.230.0000		
For models:	GLS805, GLS845, GLS935, GLS945, GLS945S		

			
1			
GEV No.	380403	Ref. No.	905474 905475
description	power relays FINDER 230VAC 16A 3CO connection F6.3 bracket mounting manuf. no. 62.83.8.230.0500		
For models:	GLB615, GLB785, GLB795, GLS935, GLS945, GLS945S		





			
1			
GEV No.	380311	Ref. No.	N/A
description	power relays Italiana Relè 230VAC 20A 1NC/1NO connection F6.3 bracket mounting manuf. no. A1B-230AC-FA		

electronic controllers

ELIWELL

refrigeration controllers

built-in version

			
1			
GEV No.	379577	Ref. No.	F00800
description	electronic controller ELIWELL type ID974 mounting measurements 71x29mm 230V voltage AC NTC/PTC relay outputs 3 relays -50 up to +150°C display 3½ digits RoomTempIN yes DEF Probe yes DEF Relay 8A fan relay 5A compressor relay 8A		
accessories for	379577		
	GEV No.	379053	Ref. No. —
	temperature probe PTC 1kOhm cable PVC probe -50 up to +150°C cable -10 up to 100°C probe ø6x30mm cable length 3m without screw connection 2-wire		
	GEV No.	379064	Ref. No. —
	temperature probe PTC 1kOhm cable silicone probe -50 up to +150°C cable -50 up to +180°C probe ø6x40mm cable length 3m without screw connection 2-wire		
	GEV No.	379161	Ref. No. —
	temperature probe NTC 10kOhm cable thermoplastic probe -40 up to +110°C cable -40 up to +110°C probe ø6x14mm cable length 3m without screw connection 2-wire		
	GEV No.	379782	Ref. No. —
	temperature probe PTC 1kOhm cable thermoplastic probe -50 up to +150°C cable -40 up to +110°C probe ø6x14mm cable length 3m 2-wire resistor 1kOhm		



EVCO - EVERY CONTROL

universal controllers

built-in version



1

GEV No.	378293	Ref. No.	W106560253
description	electronic controller EVCO mounting measurements 71x29mm 230V voltage AC NTC relay outputs 1-99 up to +150°C display 4 digits 16A default setting +50 up to +70°C type EVK401N7VHXXX01		
accessories for	378293		
	GEV No.	Ref. No.	—
	378261		
	temperature probe NTC 10kOhm cable thermoplastic probe -40 up to +110°C cable -40 up to +110°C probe ø6x35mm cable length 3m without screw connection 2-wire		
	GEV No.	Ref. No.	—
	379057		
	temperature probe NTC 10kOhm cable PVC probe -20 up to +80°C cable -10 up to 100°C probe ø6x25mm cable length 3m 2-wire		
	GEV No.	Ref. No.	—
	379160		
	temperature probe NTC 10kOhm cable thermoplastic probe -40 up to +110°C cable -40 up to +110°C probe ø6x14mm cable length 1.5m without screw connection 2-wire		
	GEV No.	Ref. No.	—
	379161		
	temperature probe NTC 10kOhm cable thermoplastic probe -40 up to +110°C cable -40 up to +110°C probe ø6x14mm cable length 3m without screw connection 2-wire		
	GEV No.	Ref. No.	—
	379342		
	temperature probe NTC 10kOhm cable PVC probe -20 up to +80°C cable -10 up to 100°C probe ø6x25mm cable length 1.5m 2-wire protection IP67		
	GEV No.	Ref. No.	—
	379343		
	temperature probe NTC 10kOhm cable silicone probe -40 up to +110°C cable -50 up to +180°C probe ø6x40mm cable length 3m 2-wire		
	GEV No.	Ref. No.	—
	379458		
	temperature probe NTC 10kOhm cable silicone probe -40 up to +110°C cable -50 up to +180°C probe ø6x40mm cable length 1.5m without screw connection 2-wire		
	GEV No.	Ref. No.	—
	379784		
	temperature probe NTC 2kOhm cable thermoplastic probe -40 up to +110°C cable -40 up to +110°C probe ø6x35mm cable length 2m without screw connection 2-wire resistor 2kOhm		
	GEV No.	Ref. No.	—
	379860		
	temperature probe NTC 10kOhm cable PVC probe -20 up to +80°C cable -10 up to 100°C probe ø6x40mm cable length 1.5m without screw connection 2-wire		

probes

universal probes

temperature probes



1

GEV No.	378067	Ref. No.	RX70401
description	temperature probe PTC 1kOhm cable silicone probe -50 up to +150°C cable -50 up to +180°C probe ø6x40mm cable length 2m without screw connection 2-wire		

producer-specific probes

probes



1

GEV No.	378332	Ref. No.	SD909025
description	temperature probe NTC 10kOhm cable silicone probe -40 up to +110°C cable -50 up to +180°C connection 2-wire thread probe ø6x50mm cable length 2.5m		



1

GEV No.	402006	Ref. No.	I62040406
description	temperature probe PTC 2kOhm cable PVC probe -50 up to +150°C cable -10 up to 100°C connection plug thread probe ø5x60mm cable length 1.5m		



1

GEV No.	402008	Ref. No.	I62040402
description	temperature probe PTC 2kOhm cable PVC probe -50 up to +150°C cable -10 up to 100°C connection plug thread probe ø6x50mm cable length 1.2m		



1

GEV No.	402191	Ref. No.	I62040401
description	temperature probe PTC 2kOhm cable TPE probe -50 up to +150°C cable -40 up to +110°C connection plug thread probe ø5x20mm cable length 1.8m		



1

GEV No.	378132	Ref. No.	RX70401
description	temperature probe PTC cable silicone probe -50 up to +150°C cable -50 up to +180°C connection 2-wire thread probe ø6x40mm cable length 2m		



electronics

PCBs

1



GEV No.	361366	Ref. No.	N/A
description	PCB dishwasher 11F suitable for DB2 type DB2/EV1/EKP-M		

1



GEV No.	403326	Ref. No.	SD909012
description	PCB dishwasher Tronic L 145mm W 116mm		

keypads

front foils

1



GEV No.	519441	Ref. No.	907064
description	front foil L 180mm W 98mm		
For models:	GLS9455		

solenoïd valves

solenoïd valves (water)

ELBI

1



GEV No.	370246	Ref. No.	N/A
description	solenoïd valve double straight 230VAC inlet 3/4" outlet 11.5mm t.max. 90°C ELBI plastic output B 0.5l/min flow regulating valve outlet B red		

TP

1





















GEV No.	370021	Ref. No.	N/A	
description	solenoïd valve double straight 230VAC inlet 3/4" outlet 11.5mm DN10 TP flow regulating valve inlet white			
spare parts for	370021			
	GEV No.	371013	Ref. No.	—
accessories for	370021			
	GEV No.	371220	Ref. No.	—
description	reducer TP flow rate 3l/min red tolerance ±15%			
	GEV No.	371221	Ref. No.	—
description	reducer TP flow rate 5.5l/min yellow tolerance ±15%			
	GEV No.	371222	Ref. No.	—
description	reducer TP flow rate 6l/min grey tolerance ±15%			
	GEV No.	371223	Ref. No.	—
description	reducer TP flow rate 10l/min white tolerance ±15%			
	GEV No.	371224	Ref. No.	—
description	reducer TP flow rate 12l/min bronze tolerance ±15%			
	GEV No.	371225	Ref. No.	—
description	reducer TP flow rate 16l/min light brown tolerance ±15%			
	GEV No.	371226	Ref. No.	—
description	reducer TP flow rate 20l/min red tolerance ±15%			
	GEV No.	371230	Ref. No.	—
description	reducer TP flow rate 0.25l/min red tolerance ±25%			
	GEV No.	371231	Ref. No.	—
description	reducer TP flow rate 0.35l/min violet tolerance ±25%			
	GEV No.	371232	Ref. No.	—
description	reducer TP flow rate 0.5l/min orange tolerance ±25%			
	GEV No.	371233	Ref. No.	—
description	reducer TP flow rate 0.8l/min white tolerance ±25%			
	GEV No.	371234	Ref. No.	—
description	reducer TP flow rate 1l/min light blue tolerance ±25%			
	GEV No.	371235	Ref. No.	—
description	reducer TP flow rate 1.2l/min brown tolerance ±25%			
	GEV No.	371236	Ref. No.	—
description	reducer TP flow rate 1.5l/min light brown tolerance ±25%			

Table continues overleaf

1 electric components









accessories for		370021		
GEV No.	Ref. No.	Ref. No.	Ref. No.	Ref. No.
	371237	—	—	—
reducer TP flow rate 2.5l/min yellow tolerance ±25%				
	371238	—	—	—
reducer TP flow rate 3.4l/min dark green tolerance ±25%				
	371239	—	—	—
reducer TP flow rate 5l/min black tolerance ±25%				
	371240	—	—	—
reducer TP flow rate 8l/min blue tolerance ±20%				



GEV No.	370017	Ref. No.	902390 D240011
description	solenoid valve single straight 230VAC inlet 3/4" outlet 11.5mm DN10 TP p max 10bar		
For models:	GLB615, GLB785, GLB795, GLS805, GLS845, GLS905, GLS925, GLS935, GLS945, GLS945S		

spare parts for		370017		
GEV No.	Ref. No.	Ref. No.	Ref. No.	Ref. No.
	371013	—	—	—
solenoid coil TP 230VAC 50/60Hz				

accessories for		370017		
GEV No.	Ref. No.	Ref. No.	Ref. No.	Ref. No.
	371220	—	—	—
reducer TP flow rate 3l/min red tolerance ±15%				
	371221	—	—	—
reducer TP flow rate 5.5l/min yellow tolerance ±15%				
	371222	—	—	—
reducer TP flow rate 6l/min grey tolerance ±15%				
	371223	—	—	—
reducer TP flow rate 10l/min white tolerance ±15%				
	371224	—	—	—
reducer TP flow rate 12l/min bronze tolerance ±15%				
	371225	—	—	—
reducer TP flow rate 16l/min light brown tolerance ±15%				
	371226	—	—	—
reducer TP flow rate 20l/min red tolerance ±15%				
	371230	—	—	—
reducer TP flow rate 0.25l/min red tolerance ±25%				
	371231	—	—	—
reducer TP flow rate 0.35l/min violet tolerance ±25%				
	371232	—	—	—
reducer TP flow rate 0.5l/min orange tolerance ±25%				

accessories for		370017		
GEV No.	Ref. No.	Ref. No.	Ref. No.	Ref. No.
	371233	—	—	—
reducer TP flow rate 0.8l/min white tolerance ±25%				
	371234	—	—	—
reducer TP flow rate 1l/min light blue tolerance ±25%				
	371235	—	—	—
reducer TP flow rate 1.2l/min brown tolerance ±25%				
	371236	—	—	—
reducer TP flow rate 1.5l/min light brown tolerance ±25%				
	371237	—	—	—
reducer TP flow rate 2.5l/min yellow tolerance ±25%				
	371238	—	—	—
reducer TP flow rate 3.4l/min dark green tolerance ±25%				
	371239	—	—	—
reducer TP flow rate 5l/min black tolerance ±25%				
	371240	—	—	—
reducer TP flow rate 8l/min blue tolerance ±20%				

solenoid valves with reducers



GEV No.	370527	Ref. No.	65010572 I65010564
description	solenoid valve single straight 220-240VAC inlet 3/4" outlet 11.5mm output 0.8l/min TP plastic flow regulating valve outlet white 8VA		

pressure switches

for warewashing

ø 58mm with male faston 6.3mm

with connection horizontal





GEV No.	541847	Ref. No.	776-009-00
description	pressure control pressure range 112/70mbar connection 6mm ø 58mm		





 <p>1</p>			
GEV No.	541781	Ref. No.	905288
description	pressure control pressure range 118/50mbar connection male faston 6.3mm ø 58mm pressure connection horizontal pressure connection ø 6mm		
For models:	GLS945		

 <p>1</p>			
GEV No.	541017	Ref. No.	905270
description	pressure control with mounting strap pressure range 40/20mbar connection 6mm ø 58mm pressure connection horizontal warewashing		
For models:	GLB615, GLB785, GLB795, GLS805, GLS845		

 <p>1</p>			
GEV No.	541169	Ref. No.	905282
description	pressure control pressure range 160/30mbar connection 6mm ø 58mm pressure connection horizontal warewashing		
For models:	GLS945S		

 <p>1</p>			
GEV No.	541003	Ref. No.	N/A
description	pressure control pressure range 55/35mbar connection 6mm ø 58mm pressure connection horizontal warewashing pressure connection ø 6mm		

 <p>1</p>			
GEV No.	541168	Ref. No.	905275
description	pressure control pressure range 90/35mbar connection 6mm ø 58mm pressure connection horizontal warewashing pressure connection ø 6mm		
For models:	GLS905, GLS925, GLS935		

 <p>1</p>			
GEV No.	541106	Ref. No.	N/A
description	pressure control pressure range 90/56mbar connection 6mm ø 58mm pressure connection horizontal warewashing pressure connection ø 6mm		

<p>accessories</p>			
 <p>1</p>			
GEV No.	541109	Ref. No.	N/A
description	Y-piece plastic hose ø 8-6-8mm for pressure switch		

<p>for refrigeration</p>			
<p>DANFOSS</p>			
 <p>1</p>			
GEV No.	541824	Ref. No.	I62045100
description	pressure control pressure connection 6mm soldering connection type ACB-2UA426W 250V cable length 2000mm 6A -30 up to +85°C contacts 1NO		

<p>SAGI NO MIYA</p>			
 <p>1</p>			
GEV No.	541115	Ref. No.	I62024800
description	pressure control reset manual refrigeration connection 7/16" UNF (1/4" SAE)		

<p>JOHNSON CONTROLS</p>			
 <p>1</p>			
GEV No.	541116	Ref. No.	I62007500
description	pressure control HD switch pressure 10bar reset automatic switching diff. 1.1 bar pressure range 7-29bar p max 38bar refrigeration type P20EA-9950C connection soldering connection 6.35mm CO JOHNSON CONTROLS pressure connection soldering connection 6.35mm		



hot air fans

ebm-papst



1

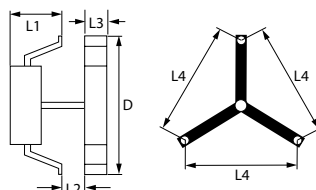

GEV No.	601741	Ref. No.	V02900
description	hot air fan 230V 32W 0.27A 3 hole fixing L1 60mm L2 21mm L3 20mm L4 88mm fan wheel ø 150mm type R2K150-AC01-14 ebm-papst		



1

GEV No.	541117	Ref. No.	I62023101
description	pressure control HD switch pressure 24bar reset manual switching diff. 4.7bar pressure range 7-29bar p max 38bar refrigeration type P20GA-9950T connection male faston 6.3mm CO JOHNSON CONTROLS pressure connection soldering connection 6.35mm		

electrodes



1

GEV No.	400130	Ref. No.	50001910
description	level electrode M14x1.25 total length 220mm probe L 194mm insulated probe length 26mm connection male faston 6.3mm ø 2.5mm		

fans

refrigeration fans

refrigeration motors universal

ELCO

RE series



1

GEV No.	601608	Ref. No.	FQ320590
description	fan motor 18W 230/240V 50/60Hz W 90mm cable length 1000mm 2600rpm ELCO R18-25/010 3 mounting options bearing slide bearing H 110mm L 90mm		
spare parts for	601608		
	GEV No.	601413	Ref. No. —
	fixing plate suitable for fanwheel ED ø 32mm shaft ø 7 mounting distance 26mm		

hot air motors



1

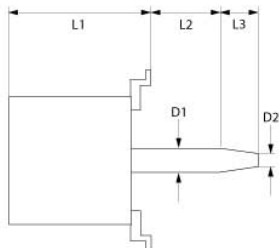

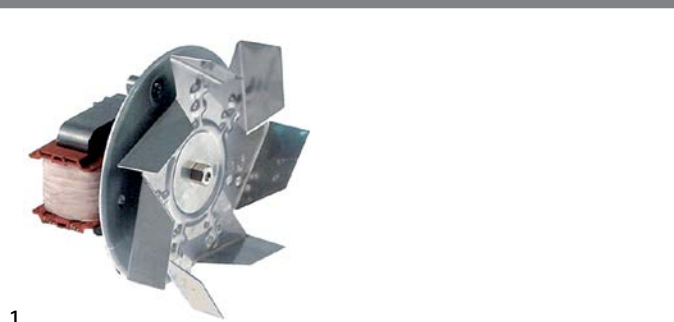

GEV No.	500671	Ref. No.	LAR65040071
description	fan motor 200-240V 1 phase 50/60Hz 0.11kW 2760/3320rpm speeds 1 L1 130mm L2 55mm L3 30mm D1 ø 15mm D2 ø 12mm M10L ET at 50Hz 2760rpm at 60Hz 3320rpm		

miscellaneous

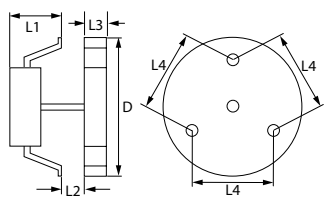

1



GEV No.	601054	Ref. No.	X68003
description	hot air fan 220-240V 32W 50/60Hz L1 60mm L2 10mm L3 25mm L4 87mm fan wheel ø 150mm FIME type C20X0E01/46		
For models:	C4FFLE, C4FFLEP, C4PFLE, C4VFLE, C6FFLE, C6FFLEP, C6FFLEPV, C6FFLEV, C6PFLE, C6PFLEV, CC120E, CC80E, CC81E, CCG120E, CCG80E, CCG81E, CCQ120E, CCQ80E, CCQ81E, CCV80E, CCV81E		
spare parts for	601054		
	GEV No.	601441	Ref. No. —
	fan wheel ø 150mm W 25mm shaft intake ø 6x5mm stainless steel blades 7		
accessories for	601054		
	GEV No.	550879	Ref. No. V05400
	insulation ø 130mm thickness 3mm hole ø 20mm for hot air fan		



1

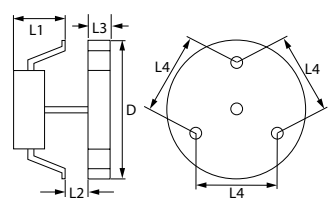

GEV No.	601448	Ref. No.	V03000
description	hot air fan 220-240V 32W 50/60Hz L1 60mm L2 11mm L3 25mm L4 87mm fan wheel ø 155mm FIME type C20X0E01/11		
For models:	C4FFCEP, C4FFCGP, C4FZFCE, C4ZFCEP, C4ZFCEG, C4ZFCEGP, C4FZSFCEP, C4FZSFCGP, C4PFCE, C4PQFCE, C4VFCE, C6FFCEP, C6FFCGP, C6FZFCE, C6FZFCEP, C6FZFCEPV, C6FZFCEV, C6FZFCEG, C6FZFCEGP, C6FZFCEGPV, C6FZFCEGV, C6PFCE, C6PFCEV, C6PQFCE, C6PQFCEV, CC120CG, CC80E, CC81CG, CCG120CE, CCG80E, CCG81CE, K2FTPFCE, K2FTPFCEG, K4FSFCE, K4FSFCEG, K4FZFCE, K4FZFCEG, K4FZSFCE, K4FZSFCEG, K4PFCE, K4VFCE, K6FZFCE, K6FZFCEG, K6PFCE, K8FZFCE, K8FZFCEG, KTPFCE, KTPFCEG, M74FFXE, M74FMPFXE...(Other models you can see in the webshop)		
accessories for	601448		
	GEV No.	550879	Ref. No. V05400
	insulation ø 130mm thickness 3mm hole ø 20mm for hot air fan		



1

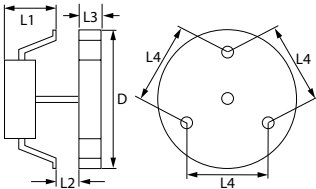

GEV No.	601125	Ref. No.	G6EX
description	hot air fan 220-240V 45W 50/60Hz L1 70mm L2 11mm L3 25mm L4 87mm fan wheel ø 150mm FIME type C30R0479CLF		
accessories for	601125		
	GEV No.	550879	Ref. No. V05400
insulation ø 130mm thickness 3mm hole ø 20mm for hot air fan			

accessories

miscellaneous



1

GEV No.	550879	Ref. No.	V05400
description	insulation ø 130mm thickness 3mm hole ø 20mm for hot air fan		
For models:	C4FFCEP, C4FFCGP, C4FZFCE, C4ZFCEP, C4ZFZFCG, C4FZFZFCGP, C4FZSFCEP, C4FZSFZFCGP, C4PFCE, C4PQFCE, C4VFCE, C6FFCEP, C6FFZFCGP, C6FZFCE, C6FZFCEP, C6FZFZFCGP, C6FZFCEV, C6FZFZFCGP, C6FZFZFCGPV, C6FZFZFCGPV, C6PFCE, C6PFCEV, C6PQFCE, C6PQFCEV, CC120CG, CC80E, CC81CG, CCG120CE, CCG80E, CCG81CE, K2FTPFCE, K2FTPFZFCGP, K4FSFCE, K4FSFZFCGP, K4FZFCE, K4FZFZFCGP, K4FZSFCE, K4FZSFZFCGP, K4PFCE, K4VFCE, K6FZFCE, K6FZFZFCGP, K6PFCE, K8FZFCE, K8FZFZFCGP, KTPFCE, KTPFZFCGP, M74FFXE, M74FMPFXE... (Other models you can see in the webshop)		

pumps



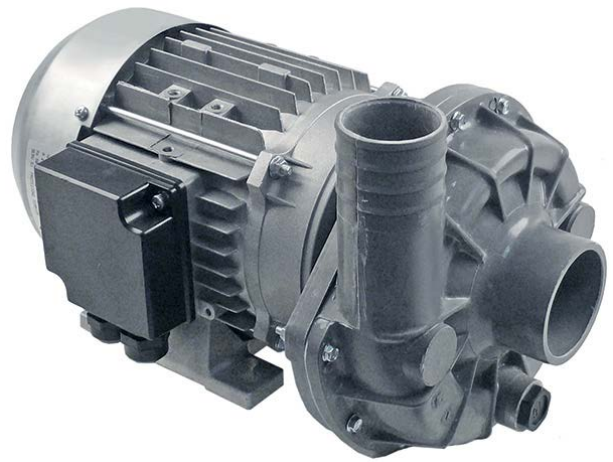

wash and rinse pumps

FIR

pumps



1

GEV No.	500023	Ref. No.	D130025
description	pump inlet ø 63mm outlet ø 47mm type 1225.2725 230/400V 50Hz 3 phase 1.1kW 1.5HP L 335mm rotation direction right FIR		
spare parts for	500023		
	GEV No.	510602	Ref. No. D124002
impellor ø 110mm H 34mm rotation direction right thread M8L shaft ø 28mm seat ø 12.2mm blades 6			
	GEV No.	510693	Ref. No. D141002
mechanical shaft seal for shaft ø 12mm slide ring ext. ø 24mm slide ring H 15.5mm slide ring int. ø 11mm counter ring mounting ø 24mm height counter ring 8mm counter ring int. ø 13.5mm			
	GEV No.	521513	Ref. No. —
pump cover FIR inlet ø 63mm outlet ø 47mm turn direction right ID ø 150mm inner height 32mm			
	GEV No.	524416	Ref. No. —
pump cover gasket thickness 4x4mm Qty 1 pcs			

LGB



1

GEV No.	500542	Ref. No.	D130097
description	pump inlet ø 28mm outlet ø 26mm type ZF130DX 230V 50Hz 1 phase 0.3kW 0.41HP L 190mm rotation direction left capacitor 6.3µF LGB		
spare parts for	500542		
	GEV No.	365012	Ref. No. —
	operating capacitor capacity 6.3µF 450V tolerance 5% 50Hz ambient temperature max. -25 to +85°C ø 30mm L 61mm M8 plastic connection male faston 6.3mm protection		
	GEV No.	510703	Ref. No. N/A
	mechanical shaft seal for shaft ø 13mm slide ring H 13mm height counter ring 5.5mm ED ø 26mm		
	GEV No.	521107	Ref. No. —
	pump cover LGB inlet ø 28mm outlet ø 26mm auxiliary pressure connection 12mm ID ø 77mm		
	GEV No.	521228	Ref. No. —
	impellor ø 72mm H 17mm rotation direction left thread M7R shaft ø 13mm shaft length 12mm blades 3		
	GEV No.	528800	Ref. No. —
	O-ring EPDM thickness 2.62mm ID ø 75.87mm Qty 1 pcs		



1

GEV No.	500094	Ref. No.	902231
description	pump inlet ø 28mm outlet ø 26mm type ZF131SX 230V 50Hz 1 phase 0.2kW 0.15HP L 195mm rotation direction left capacitor 6.3µF LGB		
For models:	GLB785, GLB795		
spare parts for	500094		
	GEV No.	365012	Ref. No. —
	operating capacitor capacity 6.3µF 450V tolerance 5% 50Hz ambient temperature max. -25 to +85°C ø 30mm L 61mm M8 plastic connection male faston 6.3mm protection		

spare parts for	500094		
	GEV No.	502266	Ref. No. —
	pump cover inlet ø 28mm outlet ø 26mm		
	GEV No.	510703	Ref. No. N/A
	mechanical shaft seal for shaft ø 13mm slide ring H 13mm height counter ring 5.5mm ED ø 26mm		
	GEV No.	521085	Ref. No. —
	impellor ø 72mm H 17mm thread M7L shaft ø 13mm shaft length 12mm blades 3		
	GEV No.	528800	Ref. No. —
	O-ring EPDM thickness 2.62mm ID ø 75.87mm Qty 1 pcs		

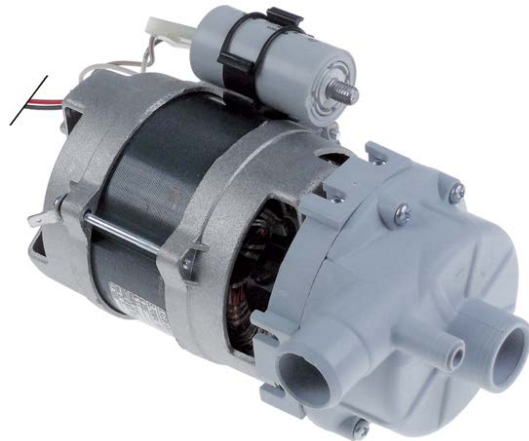





1

GEV No.	500567	Ref. No.	902238
description	pump inlet ø 28mm outlet ø 28mm type ZF121DX 230V 50Hz 1 phase 0.25kW L 195mm rotation direction left capacitor 6.3µF LGB		
For models:	GLB615		
spare parts for	500567		
	GEV No.	365012	Ref. No. —
	operating capacitor capacity 6.3µF 450V tolerance 5% 50Hz ambient temperature max. -25 to +85°C ø 30mm L 61mm M8 plastic connection male faston 6.3mm protection		
	GEV No.	510703	Ref. No. N/A
	mechanical shaft seal for shaft ø 13mm slide ring H 13mm height counter ring 5.5mm ED ø 26mm		
	GEV No.	521098	Ref. No. —
	pump cover LGB inlet ø 28mm outlet ø 26mm auxiliary pressure connection 12mm ID ø 77mm		
	GEV No.	521099	Ref. No. —
	impellor ø 72mm H 17mm thread M7R shaft ø 13mm shaft length 12mm		
	GEV No.	528800	Ref. No. —
	O-ring EPDM thickness 2.62mm ID ø 75.87mm Qty 1 pcs		







1

GEV No.	500508	Ref. No.	902293
description	pump inlet \varnothing 45mm outlet \varnothing 38mm type ZF320VSX 230V 50Hz 1 phase 0.75kW 1HP L 230mm rotation direction right capacitor 12.5 μ F LGB		
For models:	GLS945		
spare parts for	500508		
	GEV No.	365014	Ref. No. —
	operating capacitor capacity 12.5 μ F 450V tolerance 5%Hz ambient temperature max. -25 to +85°C \varnothing 35mm L 70mm M8 plastic connection male faston 6.3mm 45S.C3DS.12.5 protection		
	GEV No.	510702	Ref. No. —
	mechanical shaft seal height counter ring 5.5mm ID \varnothing 12mm		
	GEV No.	521247	Ref. No. —
	impellor \varnothing 90mm H 27mm rotation direction right thread M8L blades 6		
	GEV No.	521542	Ref. No. —
	pump cover LGB inlet \varnothing 45mm outlet \varnothing 40mm auxiliary pressure connection 13mm supporting pressure open \varnothing 150mm ID \varnothing 120mm inner height 25mm		
	GEV No.	521714	Ref. No. —
	pump cover gasket thickness 4x4mm Qty 1 pcs		



1

GEV No.	500470	Ref. No.	902304
description	pump inlet \varnothing 45mm outlet \varnothing 40mm type ZF270VDX 230V 50Hz 1 phase 0.6kW 0.8HP L 225mm rotation direction left capacitor 12.5 μ F LGB		
For models:	GLS905, GLS925		
spare parts for	500470		
	GEV No.	365014	Ref. No. —
	operating capacitor capacity 12.5 μ F 450V tolerance 5%Hz ambient temperature max. -25 to +85°C \varnothing 35mm L 70mm M8 plastic connection male faston 6.3mm 45S.C3DS.12.5 protection		
	GEV No.	510702	Ref. No. —
	mechanical shaft seal height counter ring 5.5mm ID \varnothing 12mm		
	GEV No.	521109	Ref. No. —
	pump cover LGB inlet \varnothing 45mm outlet \varnothing 40mm supporting pressure 12		
	GEV No.	521111	Ref. No. —
	impellor \varnothing 105mm H 29mm thread M8R shaft \varnothing 20mm shaft length 5mm		
	GEV No.	521714	Ref. No. —
	pump cover gasket thickness 4x4mm Qty 1 pcs		









1

GEV No.	500156	Ref. No.	D130109
description	pump inlet ø 50mm outlet ø 50mm type ZF400SX 230V 50Hz 1 phase 0.6kW 0.8HP L 210mm rotation direction right capacitor 16µF LGB		
spare parts for	500156		
	GEV No.	509020	Ref. No. —
	impellor ø 104mm H 25mm M8L		
	GEV No.	510703	Ref. No. N/A
	mechanical shaft seal for shaft ø 13mm slide ring H 13mm height counter ring 5.5mm ED ø 26mm		
	GEV No.	513713	Ref. No. —
	pump cover bottom part		
	GEV No.	521548	Ref. No. N/A
	pump cover LGB inlet ø 50mm outlet ø 50mm		
	GEV No.	521562	Ref. No. N/A
	pump cover		
	GEV No.	521734	Ref. No. —
	pump cover bottom part		
	GEV No.	523509	Ref. No. —
	deep-groove ball bearing type 6201-2RS shaft ø 12mm ED ø 32mm W 10mm with sealing discs deep-groove ball bearing DIN 625-1		
	GEV No.	532623	Ref. No. —
	O-ring EPDM thickness 2.62mm ID ø 120.32mm Qty 1 pcs		
accessories for	500156		
	GEV No.	365021	Ref. No. —
	operating capacitor capacity 16µF 425V tolerance 5% 50/60Hz ambient temperature max. -25 to +85°C ø 35mm L 73mm single M8 plastic connection male faston 6.3mm 416.10.99 protection		



1





GEV No.	500543	Ref. No.	N/A
description	pump inlet ø 50mm outlet ø 50mm type ZF400VSX 230V 50Hz 1 phase 0.85kW 1.2HP L 245mm rotation direction right capacitor 16µF LGB		
spare parts for	500543		
	GEV No.	365021	Ref. No. —
	operating capacitor capacity 16µF 425V tolerance 5% 50/60Hz ambient temperature max. -25 to +85°C ø 35mm L 73mm single M8 plastic connection male faston 6.3mm 416.10.99 protection		
	GEV No.	509020	Ref. No. —
	impellor ø 104mm H 25mm M8L		
	GEV No.	510703	Ref. No. N/A
	mechanical shaft seal for shaft ø 13mm slide ring H 13mm height counter ring 5.5mm ED ø 26mm		
	GEV No.	521548	Ref. No. N/A
	pump cover LGB inlet ø 50mm outlet ø 50mm		
	GEV No.	521734	Ref. No. —
	pump cover bottom part		
	GEV No.	532623	Ref. No. —
	O-ring EPDM thickness 2.62mm ID ø 120.32mm Qty 1 pcs		



1			
GEV No.	500002	Ref. No.	D130068
description	pump inlet ø 60mm outlet ø 50mm type ZA400SX 230V 50Hz 1 phase 0.9kW 1.2HP L 300mm rotation direction right capacitor 20µF LGB		
spare parts for	500002		
	GEV No.	365019	Ref. No. —
	operating capacitor capacity 20µF 400V tolerance 5% 50/60Hz ambient temperature max. -25 to +85°C ø 39.5mm L 70mm M8 plastic connection male faston 6.3mm 16.10.25. protection		
	GEV No.	509020	Ref. No. —
	impellor ø 104mm H 25mm M8L		
	GEV No.	510703	Ref. No. N/A
	mechanical shaft seal for shaft ø 13mm slide ring H 13mm height counter ring 5.5mm ED ø 26mm		
	GEV No.	521547	Ref. No. —
	pump cover LGB inlet ø 60mm outlet ø 50mm supporting pressure M8 turn direction right ø 160mm ID ø 127mm inner height 36mm		
	GEV No.	532623	Ref. No. —
	O-ring EPDM thickness 2.62mm ID ø 120.32mm Qty 1 pcs		



1			
GEV No.	500469	Ref. No.	902322
description	pump inlet ø 63mm outlet ø 48mm type ZF650SX 230/400V 50Hz 3 phase 1.35kW 1.83HP L 335mm rotation direction right LGB		
For models:	GLS945S		
spare parts for	500469		
	GEV No.	510551	Ref. No. D456023
	pump cover gasket ID ø 158.3mm pump type 1214/1293/1225/2243/1226/1204/3473/1241 thickness 3.53mm EPDM Qty 1 pcs		

spare parts for	500469		
	GEV No.	510694	Ref. No. —
	mechanical shaft seal for shaft ø 13mm height counter ring 8mm ID ø 11.5mm H 16mm mounting ø 24/26mm int. ø 1 14mm		
	GEV No.	521069	Ref. No. —
	fanwheel cover		
	GEV No.	521240	Ref. No. —
	impellor ø 110mm H 32mm rotation direction left thread M8L shaft ø 20mm shaft length 10mm seat ø 8.2mm blades 6		
	GEV No.	521536	Ref. No. —
	pump cover ALBA / LGB inlet ø 62mm outlet ø 50mm auxiliary pressure connection 12mm supporting pressure closed turn direction right ø 180mm ID ø 150mm inner height 38mm		

booster pumps II

accessories

1			
	GEV No.	365015	Ref. No. 901730
	operating capacitor capacity 10µF 400V tolerance 5%Hz ambient temperature max. -25 to +85°C ø 35.5mm L 59mm M8 plastic connection male faston 6.3mm protection		
For models:	GLS805, GLS845, GLS905, GLS925		

pumps for ice machines

1			
	GEV No.	500047	Ref. No. I6204330
	pump REBO type MH30F1 30W 230V 50Hz outlet ø 12.7mm L 135mm rotation direction left		

1			
	GEV No.	500204	Ref. No. I67000206
	pump REBO type MH50F 60W 230V 50Hz inlet ø 19mm outlet ø 19mm L 125mm rotation direction right for ice-cube maker		





1

GEV No.	500048	Ref. No.	I79311303
description	pump REBO type MH50F 60W 230V 50Hz outlet ø 18mm L 137mm rotation direction right for ice maker		



1

GEV No.	500203	Ref. No.	I67000212
description	pump REBO type MH50F 60W 230V 50Hz outlet ø 21mm L 110mm rotation direction right for ice maker		



1

GEV No.	500046	Ref. No.	I67003606
description	pump REBO type NR40 40W 230V 50Hz inlet ø 12mm outlet ø 12mm L 75mm rotation direction right for ice-cube maker		

condensators & interference suppression filters

operating capacitors

plastic



1

GEV No.	365015	Ref. No.	901730
description	operating capacitor capacity 10µF 400V tolerance 5%Hz ambient temperature max. -25 to +85°C ø 35.5mm L 59mm M8 plastic connection male faston 6.3mm protection		
For models:	GLS805, GLS845, GLS905, GLS925		

filters

interference suppression filters



1

GEV No.	365130	Ref. No.	902105
description	interference suppression filter capacity 0.47µF(X2)+2x0.01µF(Y2) 1M0hm		
For models:	GLS805, GLS845, GLS935, GLS945S		



1

GEV No.	365168	Ref. No.	902107
description	interference suppression filter type FCP045000 250V 50/60Hz conductor 4 with E connection male faston 6.3mm L 56mm ø 38mm Hmm Wmm M8 plastic Qty 1 pcs		
For models:	GLS905, GLS925, GLS945		



1

GEV No.	365048	Ref. No.	N/A
description	interference suppression filter type KPB7028 275V 50/60Hz conductor 2 with E connection male faston 6.3mm L 50mm ø 38mm Hmm Wmm M8 aluminium Qty 1 pcs		

fuses

fine fuses



1

GEV No.	358605	Ref. No.	40200084
description	fine fuse size ø5x20mm 3.15A slow-acting rated 250V Qty 10 pcs		
For models:	KPI10ET, KPI10ETA, KPI15ET, KPI15ETA		



electric accessories

cables

accessories

cable glands

threaded cable glands

screw connections



1

GEV No.	530431	Ref. No.	902687
description	cable gland thread PG13.5 cable \varnothing 12mm mounting \varnothing 21mm Qty 1 pcs plastic WS 24		
For models:	GLB615, GLB785, GLB795		

terminals

connection terminals with screw/faston connections



1

GEV No.	550278	Ref. No.	904140
description	power terminal block 3-pole max. 40A max 400V connection \varnothing 6mm ² / F6.3 temp.-resist. 150°C cross section 6mm ²		
For models:	GLB615, GLB785, GLB795		



1

GEV No.	550411	Ref. No.	904150 X59000
description	power terminal block 6-pole max. 40A max 450V connection \varnothing 6mm ² / F6.3 temp.-resist. 150°C cross section 6mm ²		
For models:	C1W, C2I, C2P, C2PQ, C2V, C4FFEP, C4ZFCE, C4ZFCEP, C4ZSFEP, C4I, C4P, C4PQ, C4V, C4VFCE, C4VFE, C6FFEP, C6FZFE, C6FZFEP, C6P, C6PQ, CBRE, CBRE9, CBREIN, CBREIN9, CC80E, CCPE4, CCPE6, CF1E4, CF2E4, CF2E6, CF4E, CF6E, CFTE1, CFTE1C, CFTE1R, CFTE2, CFTE22, CFTE2C, CFTE2C2, CFTE2LR, CFTE2R, CFTE2R2, CFTE3, CFTE3C, CFTE3LR, CFTE3R, CFTE4, CFTE49, CFTE4C, CFTE4C9...(Other models you can see in the webshop)		

connection terminals with screw connection



1

GEV No.	550470	Ref. No.	X59200
description	power terminal block 3-pole max. 40A max 400V connection M6/M6 temp.-resist. 150°C cross section 6mm ²		
For models:	C4FFCEP, C4FFCGP, C4ZFCE, C4ZFCEP, C4ZFCEG, C4ZFCEGP, C4ZSFCEP, C4ZSFCEGP, C4PFCE, C4PQCE, C4VFCE, C6FFCEP, C6FFCEGP, C6FZFCE, C6FZFCEP, C6FZFCEPV, C6FZFCEV, C6FZFCEG, C6FZFCEGP, C6FZFCEGPV, C6FZFCEGV, C6PFCE, C6PFCEV, C6PQCE, C6PQCEV, CBE4, CBE8, CC120CG, CC80G, CC81CG, CCG120CE, CCG80E, CCG81CE, CSP40E, GSP01, IBE4, IBE8, ISP4, K2FTPFCE, K2FTPFE, K4FFE, K4FSFCE, K4FSFE, K4ZFCE, K4ZFCE, K4ZSFCE, K4ZSFE, K4PFE, K4VFE, K6FFE...(Other models you can see in the webshop)		



1

GEV No.	550507	Ref. No.	X59100
description	power terminal block 4-pole max. 40A max 400V connection M6/M6 temp.-resist. 150°C		
For models:	CF1E4, CF2E6, CF4E, CF6E, CFE15, CFE159, CFE15D, CFE15D9, CMP4, IF1E4, IF2E6, IMP4, KFE1, KFE15, KFE159, KFE15D, KFE15D9, KFE2, KFE20, KFE20D, OPFE1, OPFE15, OPFE15D, OPFE2, OPFE20, OPFE20D, SKF1E, SKF2E, SKF4E, SKF6E, SKMP4, TF1E, TF2E, TF4E, TF6E, TMP4		

connection terminals with faston connections

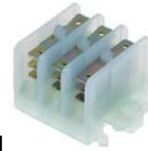

1

GEV No.	519304	Ref. No.	955068
description	distribution terminal block 3-pole max. 15A max 450V connection male faston 6.3mm temp.-resist. 110°C Qty 1 pcs		
For models:	GLS935, GLS945		

plug-in terminal blocks



1

GEV No.	519360	Ref. No.	904170
description	plug-in terminal block 16-pole max. 32A max 450V connection screw connection temp.-resist. 150°C cross section 4mm ² female		
For models:	GLS805, GLS845, GLS905, GLS925		



			
1			
GEV No.	519361	Ref. No.	904200
description	plug-in terminal block 16-pole max. 32A max 450V connection screw connection temp.-resist. 150°C cross section 4mm ² male		
For models:	GLS805, GLS845, GLS905, GLS925		

rail-mounted terminals

rail-mounted terminal blocks

			
1			
GEV No.	550407	Ref. No.	0000X53900 X53400+X53700+X53800+X53900
description	rail-mounted terminal block 5-pole cross section 16mm ² max 600V		
For models:	C2V, C4PFCE, C4PFE, C4PFE9, C4PQFCE, C4PQFE, C4V, C4VFCE, C4VFE, C6PFCE, C6PFCEV, C6PFE, C6PQFCE, C6PQFCEV, C6PQFE, CF1E4, CF2E6, CF4E, CF6E, CFE15, CFE159, CFE15D, CFE15D9, IF1E4, IF2E6, IF4E, K2V, K4PFE, K4PFE9, K4V, K4VFCE, K4VFE, K6PFE, K6PFE9, KBRE, KBRE12, KBRE12IN, KBRE9, KBREIN, KBREIN9, KBREM, KBREM12, KBREM12IN, KBREMIN, KFE1, KFE15, KFE159, KFE15D, KFE15D9, KFE2... (Other models you can see in the webshop)		

WIELAND

rail-mounted terminals type 9700A

			
1			
GEV No.	550375	Ref. No.	904169
description	rail-mounted terminal WIELAND type 9700A/10 SL2 S35 1.5-16mm ² top-hat rail 35mm yellow/green W 10mm L 53mm		
For models:	GLS935		





various

 <p>Image not available</p>			
1			
GEV No.	550408	Ref. No.	X52500
description	power terminal block		
For models:	CF1E4, CF2E6, CFE15, CFE15D, KFE1, KFE15, KFE15D, KFE2, KFE20, KFE20D, KFE4, KFE8, SKF1E, SKF2E, TF1E, TF2E		











gas taps

PEL

20S series

				
1				
GEV No.	101094	Ref. No.	0000X10100	
description	gas tap PEL type 20S gas inlet M16x1.5 (tube ø 10mm) bypass nozzle ø 0.35mm gas outlet M16x1.5 (tube ø 10/8mm) thermocouple connection M8x1 pilot connection shaft ø 8x6.5mm shaft L 22/15mm shaft flat lower			
spare parts for	101094			
	GEV No.	100408	Ref. No.	—
	bypass nozzle type PEL20/21 bore ø 0.35mm thread M5x0.5			
	GEV No.	101060	Ref. No.	—
	magnet unit standard L 39mm D1 ø 15.4mm D2 ø 11mm suitable for PEL20-21/JUNKERS/EGA			
	GEV No.	101205	Ref. No.	—
	gas tap front part shaft ø 8x6.5mm shaft L 22/15mm shaft flat upper/lower suitable for PEL20			
	GEV No.	101230	Ref. No.	—
	thermocouple nut T1: M8x1 T2: M18x1 aluminium			
accessories for	101094			
	GEV No.	101278	Ref. No.	—
	olive for pipe ø 10mm Qty 1 pcs			
	GEV No.	101300	Ref. No.	—
	union nut thread M16x1.5 tube ø 10mm			
	GEV No.	101450	Ref. No.	—
	olive for pipe ø 8mm L 12.7mm Qty 1 pcs ED ø 10mm			
	GEV No.	101451	Ref. No.	—
	union nut thread M16x1.5 tube ø 8mm			
	GEV No.	110081	Ref. No.	—
	knob ø 70mm shaft ø 8x6.5mm shaft flat universal			
	GEV No.	110083	Ref. No.	—
	knob dial plate gas tap without ignition flame silver			



			
1			
GEV No.	101491	Ref. No.	0000X10100 0000X10400 1000X10100 2000X10100 2000X10400 3000X10100 X08000
description	gas tap PEL type 20S gas inlet M16x1.5 (tube ø 10mm) bypass nozzle ø 0.35mm gas outlet M16x1.5 (tube ø 10/8mm) thermocouple connection M9x1 pilot connection shaft ø 8x6.5mm shaft L 22/15mm shaft flat lower		
For models:	B4F, B6F, B8F, C2F, C2FTPF, C2FTPF, C2FZ, C2TP2FGP, C4F, C4FFE, C4FFG, C4FFLE, C4FFLG, C4FZ, C4FZFC, C4FZFCG, C4FZFE, C4FZFG, C6F, C6FFE, C6FFG, C6FFGA, C6FFLE, C6FFLEV, C6FFLG, C6FFLV, C6FZ, C6FZFC, C6FZFCV, C6FZFCG, C6FZFCV, C6FZFE, C6FZFG, C6FZFGA, CC120G, CC80G, CC81G, CCG120E, CCG80E, CCG81E, K2F, K2FTPF, K4F, K4FFE, K4FFG, K6F, K6FFE, K6FFG, K8F, K8FFG...(Other models you can see in the webshop)		
spare parts for	101491		
	GEV No.	100408	Ref. No. —
	bypass nozzle type PEL20/21 bore ø 0.35mm thread M5x0.5		
	GEV No.	101060	Ref. No. —
	magnet unit standard L 39mm D1 ø 15.4mm D2 ø 11mm suitable for PEL20-21/JUNKERS/EGA		
	GEV No.	101205	Ref. No. —
	gas tap front part shaft ø 8x6.5mm shaft L 22/15mm shaft flat upper/lower suitable for PEL20		
accessories for	101491		
	GEV No.	101287	Ref. No. —
	olive for pipe ø 6mm Qty 1 pcs		
	GEV No.	101300	Ref. No. —
	union nut thread M16x1.5 tube ø 10mm		
	GEV No.	101450	Ref. No. —
	olive for pipe ø 8mm L 12.7mm Qty 1 pcs ED ø 10mm		
	GEV No.	101451	Ref. No. —
	union nut thread M16x1.5 tube ø 8mm		
	GEV No.	110081	Ref. No. —
	knob ø 70mm shaft ø 8x6.5mm shaft flat universal		
	GEV No.	110083	Ref. No. —
	knob dial plate gas tap without ignition flame silver		

21S series















			
1			
GEV No.	101397	Ref. No.	0000X08100 0000X10500 0000X10800 1000X10500 2000X10500 3000X10500
description	gas tap PEL type 21S gas inlet M16x1.5 (tube ø 10mm) bypass nozzle ø 0.35mm gas outlet M16x1.5 (tube ø 10/8mm) thermocouple connection M9x1 pilot connection M10x1 shaft ø 8x6.5mm shaft L 22/15mm shaft flat lower		
For models:	2FZP, B4F, B4FZ, B6F, B6FZ, B8F, B8FZ, C2FP, C2FTPF, C2FTPF, C2FZP, C2TP2FGP, C4FFCEP, C4FFCGP, C4FFEP, C4FFGP, C4FFLEP, C4FFLGP, C4FP, C4FZFC, C4FZFCG, C4FZFE, C4FZFGP, C4FZP, C4FZSFC, C4FZSFCGP, C4FZSFE, C4FZSFGP, C4FZSP, C6FFCEP, C6FFCGP, C6FFEP, C6FFGAP, C6FFGP, C6FFLEP, C6FFLEPV, C6FFLGP, C6FFLGPV, C6FP, C6FZFC, C6FZFC, C6FZFCGP, C6FZFCGPV, C6FZFE, C6FZFGAP, C6FZFGP, C6FZP, CCTP8, CCTPFG8, CFTG1...(Other models you can see in the webshop)		
spare parts for	101397		
	GEV No.	100408	Ref. No. —
	bypass nozzle type PEL20/21 bore ø 0.35mm thread M5x0.5		
	GEV No.	101060	Ref. No. —
	magnet unit standard L 39mm D1 ø 15.4mm D2 ø 11mm suitable for PEL20-21/JUNKERS/EGA		
	GEV No.	101206	Ref. No. —
	gas tap front part shaft ø 8x6.5mm shaft L 22/15mm shaft flat upper/lower suitable for PEL21		
	GEV No.	101231	Ref. No. —
	thermocouple nut T1: M9x1 T2: M18x1		
accessories for	101397		
	GEV No.	100908	Ref. No. X13200
	union screw thread M10x1 for pipe ø 4mm Qty 1 pcs		
	GEV No.	100909	Ref. No. —
	union screw thread M10x1 for pipe ø 6mm Qty 1 pcs		
	GEV No.	101246	Ref. No. —
	olive for pipe ø 4mm Qty 1 pcs		
	GEV No.	101278	Ref. No. —
	olive for pipe ø 10mm Qty 1 pcs		
	GEV No.	101286	Ref. No. —
	olive ID ø 6mm Qty 1 pcs		
	GEV No.	101300	Ref. No. —
	union nut thread M16x1.5 tube ø 10mm		
	GEV No.	101450	Ref. No. —
	olive for pipe ø 8mm L 12.7mm Qty 1 pcs ED ø 10mm		
	GEV No.	101451	Ref. No. —
	union nut thread M16x1.5 tube ø 8mm		

Table continues overleaf



accessories for 101397				
	GEV No.	110081	Ref. No.	—
knob ø 70mm shaft ø 8x6.5mm shaft flat universal				
	GEV No.	112206	Ref. No.	—
knob dial plate silver gas tap PEL21/22/23 t.max.°C ED ø 63mm ID ø 45.5mm				

22S/O series

 <p>1</p>				
GEV No.	101086	Ref. No.	0000Y21400 0000Y21500 0000Y21600 0000Y21700	
description	gas tap PEL type 22S/O gas inlet M20x1.5 (tube ø 12mm) bypass nozzle ø 0.35mm gas outlet M20x1.5 (tube ø 12/10mm) thermocouple connection M9x1 pilot connection M10x1 shaft ø 10x8mm shaft L 25/17mm shaft flat lower			
For models:	B4F, B6F, B8F, C2FTPFE, C2FTPFEF, C2FTPFG, C2FTPFGP, CCPG4, CCPG82, CCTP8, CCTPFG8, CPG, CPGI, K2F, K2FTPFG, K4F, K4FFE, K4FFG, K6F, K6FFE, K6FFG, K8F, K8FFE, K8FFG, KCP4, KCP82, KTP, KTPFG, OPCP4, OPCP82			
spare parts for 101086				
	GEV No.	100259	Ref. No.	—
bypass nozzle type PEL22 bore ø 0.35mm thread M6x0.5				
	GEV No.	101058	Ref. No.	—
magnet unit L 39mm D1 ø 15.4mm D2 ø 13.5mm suitable for PEL22/EGA24197 standard				
	GEV No.	101201	Ref. No.	—
gas tap front part shaft ø 10x8mm shaft L 25/17mm shaft flat upper/lower suitable for PEL22				
	GEV No.	101231	Ref. No.	—
thermocouple nut T1: M9x1 T2: M18x1				
	GEV No.	101240	Ref. No.	—
gas connection thread M20x1.5 tube ø 12/10mm for PEL gas taps with gasket and screws horizontal				
	GEV No.	101460	Ref. No.	—
O-ring ø 12.37mm D1 ø 2.62mm suitable for PEL22				
	GEV No.	101461	Ref. No.	—
screw kit suitable for PEL22 Qty 4 pcs				
accessories for 101086				
	GEV No.	100908	Ref. No.	X13200
union screw thread M10x1 for pipe ø 4mm Qty 1 pcs				
	GEV No.	100909	Ref. No.	—
union screw thread M10x1 for pipe ø 6mm Qty 1 pcs				
	GEV No.	101241	Ref. No.	—
gas connection thread M20x1.5 tube ø 12/10mm for PEL gas taps vertical				
	GEV No.	101246	Ref. No.	—
olive for pipe ø 4mm Qty 1 pcs				

accessories for 101086				
	GEV No.	101248	Ref. No.	—
olive for pipe ø 12mm Qty 1 pcs suitable for PEL				
	GEV No.	101249	Ref. No.	—
olive for pipe ø 10mm Qty 1 pcs				
	GEV No.	101250	Ref. No.	—
union nut thread M20x1.5 for pipe ø 10mm				
	GEV No.	101251	Ref. No.	—
union nut thread M20x1.5 for pipe ø 12mm				
	GEV No.	101286	Ref. No.	—
olive ID ø 6mm Qty 1 pcs				
	GEV No.	110080	Ref. No.	—
knob ø 70mm shaft ø 10x8mm shaft flat universal				
	GEV No.	112206	Ref. No.	—
knob dial plate silver gas tap PEL21/22/23 t.max.°C ED ø 63mm ID ø 45.5mm				

22S/V series







 <p>1</p>				
GEV No.	101087	Ref. No.	0000Y21700 000Y21600	
description	gas tap PEL type 22S/V gas inlet M20x1.5 (tube ø 12mm) bypass nozzle ø 0.35mm gas outlet M20x1.5 (tube ø 12/10mm) thermocouple connection M9x1 pilot connection M10x1 shaft ø 10x8mm shaft L 25/17mm shaft flat upper			
For models:	B4F, B6F, B8F, CCPG8, K4F, K4FFE, K4FFG, K6F, K6FFE, K6FFG, K8F, K8FFE, K8FFG, KCP4, KCP8, KCP82, OPCP4, OPCP82			
spare parts for 101087				
	GEV No.	100259	Ref. No.	—
bypass nozzle type PEL22 bore ø 0.35mm thread M6x0.5				
	GEV No.	101058	Ref. No.	—
magnet unit L 39mm D1 ø 15.4mm D2 ø 13.5mm suitable for PEL22/EGA24197 standard				
	GEV No.	101201	Ref. No.	—
gas tap front part shaft ø 10x8mm shaft L 25/17mm shaft flat upper/lower suitable for PEL22				
	GEV No.	101231	Ref. No.	—
thermocouple nut T1: M9x1 T2: M18x1				
	GEV No.	101241	Ref. No.	—
gas connection thread M20x1.5 tube ø 12/10mm for PEL gas taps vertical				
	GEV No.	101460	Ref. No.	—
O-ring ø 12.37mm D1 ø 2.62mm suitable for PEL22				
	GEV No.	101461	Ref. No.	—
screw kit suitable for PEL22 Qty 4 pcs				

Table continues overleaf



















accessories for		101087		
	GEV No.	100908	Ref. No.	X13200
	union screw thread M10x1 for pipe ø 4mm Qty 1 pcs			
	GEV No.	100909	Ref. No.	—
	union screw thread M10x1 for pipe ø 6mm Qty 1 pcs			
	GEV No.	101240	Ref. No.	—
	gas connection thread M20x1.5 tube ø 12/10mm for PEL gas taps with gasket and screws horizontal			
	GEV No.	101246	Ref. No.	—
	olive for pipe ø 4mm Qty 1 pcs			
	GEV No.	101248	Ref. No.	—
	olive for pipe ø 12mm Qty 1 pcs suitable for PEL			
	GEV No.	101249	Ref. No.	—
	olive for pipe ø 10mm Qty 1 pcs			
	GEV No.	101250	Ref. No.	—
	union nut thread M20x1.5 for pipe ø 10mm			
	GEV No.	101251	Ref. No.	—
	union nut thread M20x1.5 for pipe ø 12mm			
	GEV No.	101286	Ref. No.	—
	olive ID ø 6mm Qty 1 pcs			
	GEV No.	110080	Ref. No.	—
	knob ø 70mm shaft ø 10x8mm shaft flat universal			
	GEV No.	112206	Ref. No.	—
	knob dial plate silver gas tap PEL21/22/23 t.max.°C ED ø 63mm ID ø 45.5mm			

23S/O series



1

GEV No.	101893	Ref. No.	30100003	
description	gas tap PEL type 23S/O gas inlet M28x1.5 (tube ø 20mm) bypass nozzle ø 0.35mm gas outlet M24x1.5 (tube ø 16mm) thermocouple connection M9x1 pilot connection M10x1 shaft ø 10x8mm shaft L 25/17mm shaft flat lower			
For models:	KP20G, KP20GA, KP20GT, KP20GTA, KP30G, KP30GA, KP30GT, KP30GTA, KP50G, KP50GA, KP50GT, KP50GTA, KPGN18G, KPGN27G, KPGN37G, KPI20G, KPI20GA, KPI20GT, KPI20GTA, KPI30G, KPI30GA, KPI30GT, KPI30GTA, KPI50G, KPI50GA, KPI50GT, KPI50GTA, KPIGN18G, KPIGN27G, KPIGN37G			
spare parts for	101893			
	GEV No.	101045	Ref. No.	—
	magnet unit T1: M9x1 T2: M22x1 L 46mm ø 18mm suitable for PEL23S M9x1			
	GEV No.	101204	Ref. No.	—
	gas tap front part shaft ø 10x8mm shaft L 25/17mm shaft flat upper/lower suitable for PEL23S			





spare parts for		101893		
	GEV No.	101244	Ref. No.	—
	gas connection thread M24x1.5 tube ø 12/16mm horizontal for PEL gas taps			
	GEV No.	101463	Ref. No.	—
	screw suitable for PEL23S Qty 4 pcs			
	GEV No.	528455	Ref. No.	—
	O-ring Viton thickness 2.62mm ID ø 18.72mm Qty 1 pcs			
accessories for	101893			
	GEV No.	100908	Ref. No.	X13200
	union screw thread M10x1 for pipe ø 4mm Qty 1 pcs			
	GEV No.	100909	Ref. No.	—
	union screw thread M10x1 for pipe ø 6mm Qty 1 pcs			
	GEV No.	101246	Ref. No.	—
	olive for pipe ø 4mm Qty 1 pcs			
	GEV No.	101252	Ref. No.	—
	union nut thread M24x1.5 for pipe ø 12mm			
	GEV No.	101253	Ref. No.	—
	union nut thread M24x1.5 PEL for pipe ø 16mm			
	GEV No.	101254	Ref. No.	—
	union nut thread M28x1.5 tube ø 20mm			
	GEV No.	101255	Ref. No.	—
	olive for pipe ø 12mm Qty 1 pcs			
	GEV No.	101256	Ref. No.	—
	olive for pipe ø 16mm Qty 1 pcs			
	GEV No.	101257	Ref. No.	—
	olive for pipe ø 20mm Qty 1 pcs			
	GEV No.	101286	Ref. No.	—
	olive ID ø 6mm Qty 1 pcs			
	GEV No.	110080	Ref. No.	—
	knob ø 70mm shaft ø 10x8mm shaft flat universal			
	GEV No.	112206	Ref. No.	—
	knob dial plate silver gas tap PEL21/22/23 t.max.°C ED ø 63mm ID ø 45.5mm			



23S/V series





GEV No.	101093	Ref. No.	0000Y21300
description	gas tap PEL type 23S/V gas inlet M28x1.5 (tube ø 20mm) bypass nozzle ø 0.35mm thermocouple connection M10x1 pilot connection M10x1 shaft ø 10x8mm shaft L 25/17mm shaft flat lower		
For models:	CPG, CPGI, KP10G, KP10GA, KP10GT, KP10GTA, KP15G, KP15GA, KP15GT, KP15GTA, KP20G, KP20GA, KP30G, KP30GA, KP50G, KP50GA, KPI10G, KPI10GA, KPI10GT, KPI10GTA, KPI15G, KPI15GA, KPI15GT, KPI15GTA, OPP10G, OPP10GA, OPP15G, OPP15GA, OPPI10G, OPPI10GA, OPPI15G, OPPI15GA		
spare parts for	101093		
	GEV No.	100455	Ref. No. —
	bypass nozzle type PEL23/24 bore ø 0.35mm thread M8x0.5		
	GEV No.	101059	Ref. No. —
	magnet unit T1: M10x1 T2: M22x1 L 46mm ø 18mm suitable for PEL23S M10x1		
	GEV No.	101204	Ref. No. —
	gas tap front part shaft ø 10x8mm shaft L 25/17mm shaft flat upper/lower suitable for PEL23S		
	GEV No.	101245	Ref. No. —
	gas connection thread M24x1.5 tube ø 12/16mm vertical for PEL gas taps		
	GEV No.	101463	Ref. No. —
	screw suitable for PEL23S Qty 4 pcs		
	GEV No.	528455	Ref. No. —
	O-ring Viton thickness 2.62mm ID ø 18.72mm Qty 1 pcs		
accessories for	101093		
	GEV No.	100908	Ref. No. X13200
	union screw thread M10x1 for pipe ø 4mm Qty 1 pcs		
	GEV No.	100909	Ref. No. —
	union screw thread M10x1 for pipe ø 6mm Qty 1 pcs		
	GEV No.	101246	Ref. No. —
	olive for pipe ø 4mm Qty 1 pcs		
	GEV No.	101252	Ref. No. —
	union nut thread M24x1.5 for pipe ø 12mm		
	GEV No.	101253	Ref. No. —
	union nut thread M24x1.5 PEL for pipe ø 16mm		
	GEV No.	101254	Ref. No. —
	union nut thread M28x1.5 tube ø 20mm		
	GEV No.	101255	Ref. No. —
	olive for pipe ø 12mm Qty 1 pcs		
	GEV No.	101256	Ref. No. —
	olive for pipe ø 16mm Qty 1 pcs		

accessories for	101093		
	GEV No.	101257	Ref. No. —
	olive for pipe ø 20mm Qty 1 pcs		
	GEV No.	101286	Ref. No. —
	olive ID ø 6mm Qty 1 pcs		
	GEV No.	110080	Ref. No. —
	knob ø 70mm shaft ø 10x8mm shaft flat universal		
	GEV No.	112206	Ref. No. —
	knob dial plate silver gas tap PEL21/22/23 t.max. °C ED ø 63mm ID ø 45.5mm		

miscellaneous

			
1			
GEV No.	106574	Ref. No.	AGC003ZR10
description	bracket		
For models:	CC120CG, CC80G, CC81CG, CCG120CE, CCG80E, CCG81CE, M62F, M64F, M74F, M74FFXE, M74FFXG, M76F, M76FFXE, M76FFXG, M7FT-4GL, M7FT4GR, M7FT6GL, M7FT6GLR, SKC40G, SKC80G		

			
1			
GEV No.	106573	Ref. No.	AGC005ZR10
description	gas tap gas inlet pipe flange ø16mm bypass nozzle ø 0.39mm gas outlet M13x1 IT pilot connection thermocouple connection plug-in connection shaft ø 6x4.6mm shaft L 32.5/20.5mm shaft flat upper		
For models:	CC120CG, CC80G, CC81CG, CCG120CE, CCG80E, CCG81CE, M62F, M64F, M74F, M74FFXE, M74FFXG, M76F, M76FFXE, M76FFXG, M7FT-4GL, M7FT4GR, M7FT6GL, M7FT6GLR, SKC40G, SKC80G		
accessories for	106573		
	GEV No.	106574	Ref. No. AGC003ZR10
	bracket		

gas thermostats

SIT

630 Eurosit series

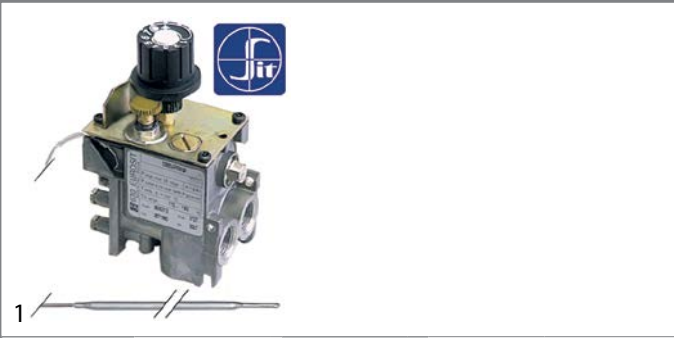

GEV No.	101413	Ref. No.	X16700
description	gas thermostat type 630 Eurosit series t.max. 100°C 30-100°C gas inlet 3/8" gas outlet 3/8" thermocouple connection M9x1 pilot connection M10x1 probe ø 5mm probe L 122mm capillary pipe 1050mm SIT		
For models:	CBG4, CBG6, CBG8, KB4G, KB8G, OPB4G, SKB40G, SKB60G, SKB80G, TB40G, TB60G, TB80G, TP40G		
accessories for	101413		
	GEV No.	100904	Ref. No. —
	locking screw M10x1 for pipe ø 4mm Qty 1 pcs		
	GEV No.	100905	Ref. No. —
	locking screw M10x1 for pipe ø 6mm Qty 1 pcs		
	GEV No.	101273	Ref. No. —
	olive for pipe ø 12mm L 9.5mm brass Qty 1 pcs suitable for universal		
	GEV No.	101276	Ref. No. —
	union screw thread 3/8" tube ø 12mm Qty 1 pcs		
	GEV No.	101333	Ref. No. —
	plug thread 3/8" with O-ring		

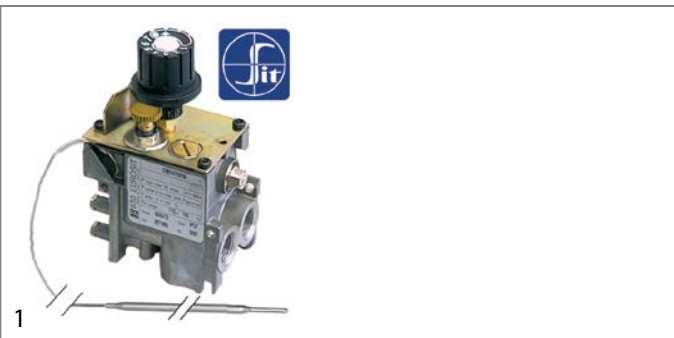

GEV No.	101188	Ref. No.	0000X12900
description	gas thermostat type 630 Eurosit series t.max. 190°C 110-190°C gas inlet 3/8" gas outlet 3/8" thermocouple connection M9x1 pilot connection M10x1 probe ø 4mm probe L 202mm capillary pipe 1050mm SIT		
For models:	CF10DG8M, CF10G4M, KFG1, KFG2, M7F4G, M7F8G, OPFG1, OPFG2, SKF10GM, SKF20GM, TF10GM, TF20GM		
accessories for	101188		
	GEV No.	100904	Ref. No. —
	locking screw M10x1 for pipe ø 4mm Qty 1 pcs		
	GEV No.	100905	Ref. No. —
	locking screw M10x1 for pipe ø 6mm Qty 1 pcs		



accessories for	101188		
	GEV No.	101273	Ref. No. —
	olive for pipe ø 12mm L 9.5mm brass Qty 1 pcs suitable for universal		
	GEV No.	101276	Ref. No. —
	union screw thread 3/8" tube ø 12mm Qty 1 pcs		
	GEV No.	101333	Ref. No. —
	plug thread 3/8" with O-ring		



GEV No.	101915	Ref. No.	0000X13400
description	gas thermostat type 630 Eurosit series t.max. 320°C 80-320°C gas inlet 3/8" gas outlet 3/8" thermocouple connection M9x1 pilot connection M10x1 probe ø 4mm probe L 72mm capillary pipe 1050mm SIT		
For models:	C2FTPFGP, C2TP2FGP, C4FFGP, C4FZFG, C4FZFGP, C4FZSFGP, C6FFGA, C6FFGAP, C6FFGP, C6FZFG, C6FZFGA, C6FZFGAP, C6FZFGP, CBRG, CBRGIN, CCTPFG8, CFTG1C, CFTG2C, CFTG2C2, CFTG3C, CFTG4C, CFTG6C, CFTG6C2, CFTG8C, CN14FGA, K2FTPFG, K4FFG, K4FSFG, K4FZFG, K4FZSFG, K6FFG, K6FFGA, K6FZFG, K6FZFGA, K8FFG, K8FZFG, KFT4G, KFT4GC, KFT4GR, KFT8G, KFT8G23C, KFT8GC, KFT8GLR, KFT8GR, KFTG1, KFTG1C, KFTG1R, KFTG3, KFTG3C, KFTG3LR...(Other models you can see in the webshop)		
accessories for	101915		
	GEV No.	100825	Ref. No. —
	gas tap spindle shaft ø 8x6.5mm shaft L 22/14mm suitable for EUROSIT		
	GEV No.	100904	Ref. No. —
	locking screw M10x1 for pipe ø 4mm Qty 1 pcs		
	GEV No.	100905	Ref. No. —
	locking screw M10x1 for pipe ø 6mm Qty 1 pcs		
	GEV No.	100949	Ref. No. —
	gasket suitable for 630 Eurosit series		
	GEV No.	101273	Ref. No. —
	olive for pipe ø 12mm L 9.5mm brass Qty 1 pcs suitable for universal		
	GEV No.	101276	Ref. No. —
	union screw thread 3/8" tube ø 12mm Qty 1 pcs		
	GEV No.	101333	Ref. No. —
	plug thread 3/8" with O-ring		
	GEV No.	101390	Ref. No. —
	gas tap spindle shaft ø 6x4.6mm shaft L 32/15mm gas tap with ignition flame suitable for ZANUSSI, MARENO for gas thermostat EUROSIT		
	GEV No.	101392	Ref. No. —
	adapter suitable for 630 Eurosit series		

Table continues overleaf



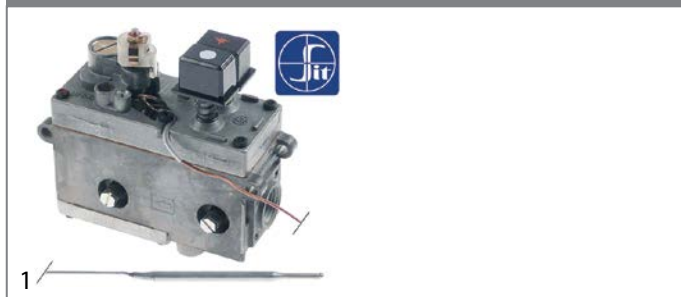

accessories for 101915	
	GEV No. 110357 Ref. No. — gas tap spindle shaft ø 8x6.5mm shaft L 36/12mm suitable for 630 Eurosit series
	GEV No. 110358 Ref. No. — adapter shaft ø 10x8mm shaft L 29/18mm suitable for 630 Eurosit series

710 Minisit series



GEV No.	101135	Ref. No.	Y23000
description	gas thermostat SIT type MINISIT 710 t.max. 190°C 110-190°C gas inlet 1/2" gas outlet 3/8" thermocouple connection M9x1 pilot connection M10x1 probe ø 6mm probe L 102mm capillary pipe 1050mm probe type type A3 pressure controller no pressure regulator mbar gland nut		
For models:	CFG15, CFG15D, KFG15, KFG15D, KFG20, KFG20D, OPFG15, OPFG15D, OPFG20, OPFG20D		



spare parts for 101135	
	GEV No. 101053 Ref. No. — magnet unit T1: M9x1 T2: M24x1 L 45mm ø 17mm suitable for Minisit
	GEV No. 102118 Ref. No. — probe 110-190°C probe ø 6mm probe L 102mm capillary pipe 1050mm t.max. 190°C fryer probe type type A3 suitable for MINISIT 710

accessories for 101135	
	GEV No. 100809 Ref. No. — O-ring EPDM thickness 2mm ID ø 21mm Qty 1 pcs
	GEV No. 100820 Ref. No. — gland duct ET M14x1.5 IT M10x0.75 probe ø max. 6.5mm WS 22
	GEV No. 100904 Ref. No. — locking screw M10x1 for pipe ø 4mm Qty 1 pcs
	GEV No. 100905 Ref. No. — locking screw M10x1 for pipe ø 6mm Qty 1 pcs
	GEV No. 101054 Ref. No. — magnet unit T1: M10x1 T2: M24x1 L 45mm ø 17mm suitable for Minisit
	GEV No. 101136 Ref. No. Y17400 piezoelectric igniter suitable for Minisit with cover cap ømm connection F6.3x0.8
	GEV No. 101137 Ref. No. — cover cap without piezoelectric igniter
	GEV No. 101267 Ref. No. — reducer IT 3/8" ET 1/2" L 21mm
	GEV No. 101268 Ref. No. — gas connection thread 3/8" angled with O-ring MINISIT 710

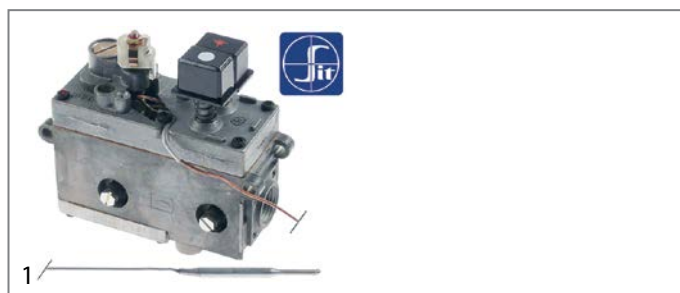
accessories for 101135	
	GEV No. 101269 Ref. No. — gas connection thread 1/2" angled with O-ring MINISIT 710
	GEV No. 101270 Ref. No. — screw connection IT 3/8" ET 3/8" L 28mm
	GEV No. 101272 Ref. No. — screw connection IT 1/2" ET 3/8" L 57mm
	GEV No. 101273 Ref. No. — olive for pipe ø 12mm L 9.5mm brass Qty 1 pcs suitable for universal
	GEV No. 101274 Ref. No. — olive for pipe ø 16mm Qty 1 pcs
	GEV No. 101275 Ref. No. — union screw thread 1/2" for pipe ø 16mm Qty 1 pcs
	GEV No. 101276 Ref. No. — union screw thread 3/8" tube ø 12mm Qty 1 pcs
	GEV No. 110068 Ref. No. Y17400 Y23100 knob suitable for Minisit ø 37mm



GEV No.	101132	Ref. No.	Y17400
description	gas thermostat SIT type MINISIT 710 t.max. 340°C 100-340°C gas inlet 1/2" gas outlet 3/8" thermocouple connection M9x1 pilot connection M10x1 probe ø 5mm probe L 68mm capillary pipe 1050mm probe type type B1 pressure controller no pressure regulator mbar gland nut ignition gas no		

spare parts for 101132	
	GEV No. 101053 Ref. No. — magnet unit T1: M9x1 T2: M24x1 L 45mm ø 17mm suitable for Minisit
	GEV No. 102102 Ref. No. — probe 100-340°C probe ø 5mm probe L 68mm capillary pipe 1750mm t.max. 340°C oven/grill probe type type B1 suitable for MINISIT 710

















accessories for 101132	
	GEV No. 100809 Ref. No. — O-ring EPDM thickness 2mm ID ø 21mm Qty 1 pcs
	GEV No. 100904 Ref. No. — locking screw M10x1 for pipe ø 4mm Qty 1 pcs
	GEV No. 100905 Ref. No. — locking screw M10x1 for pipe ø 6mm Qty 1 pcs
	GEV No. 101054 Ref. No. — magnet unit T1: M10x1 T2: M24x1 L 45mm ø 17mm suitable for Minisit



Table continues overleaf

accessories for		101132		
	GEV No.	101136	Ref. No.	Y17400
	piezoelectric igniter suitable for Minisit with cover cap omm connection F6.3x0.8			
	GEV No.	101137	Ref. No.	—
	cover cap without piezoelectric igniter			
	GEV No.	101267	Ref. No.	—
	reducer IT 3/8" ET 1/2" L 21mm			
	GEV No.	101268	Ref. No.	—
	gas connection thread 3/8" angled with O-ring MINISIT 710			
	GEV No.	101269	Ref. No.	—
	gas connection thread 1/2" angled with O-ring MINISIT 710			
	GEV No.	101270	Ref. No.	—
	screw connection IT 3/8" ET 3/8" L 28mm			
	GEV No.	101272	Ref. No.	—
	screw connection IT 1/2" ET 3/8" L 57mm			
	GEV No.	101273	Ref. No.	—
	olive for pipe ø 12mm L 9.5mm brass Qty 1 pcs suitable for universal			
	GEV No.	101274	Ref. No.	—
	olive for pipe ø 16mm Qty 1 pcs			
	GEV No.	101275	Ref. No.	—
	union screw thread 1/2" for pipe ø 16mm Qty 1 pcs			
	GEV No.	101276	Ref. No.	—
	union screw thread 3/8" tube ø 12mm Qty 1 pcs			
	GEV No.	110068	Ref. No.	Y17400 Y23100
	knob suitable for Minisit ø 37mm			

spare parts for		101076		
	GEV No.	101058	Ref. No.	—
	magnet unit L 39mm D1 ø 15.4mm D2 ø 13.5mm suitable for PEL22/EGA24197 standard			
	GEV No.	106200	Ref. No.	—
	nut thread M9x1 suitable for PEL 24/25S			
accessories for		101076		
	GEV No.	100908	Ref. No.	X13200
	union screw thread M10x1 for pipe ø 4mm Qty 1 pcs			
	GEV No.	100909	Ref. No.	—
	union screw thread M10x1 for pipe ø 6mm Qty 1 pcs			
	GEV No.	101246	Ref. No.	—
	olive for pipe ø 4mm Qty 1 pcs			
	GEV No.	101248	Ref. No.	—
	olive for pipe ø 12mm Qty 1 pcs suitable for PEL			
	GEV No.	101249	Ref. No.	—
	olive for pipe ø 10mm Qty 1 pcs			
	GEV No.	101250	Ref. No.	—
	union nut thread M20x1.5 for pipe ø 10mm			
	GEV No.	101251	Ref. No.	—
	union nut thread M20x1.5 for pipe ø 12mm			
	GEV No.	101286	Ref. No.	—
	olive ID ø 6mm Qty 1 pcs			
	GEV No.	110079	Ref. No.	—
	knob dial plate gas thermostat 1-8 silver			
	GEV No.	110080	Ref. No.	—
	knob ø 70mm shaft ø 10x8mm shaft flat universal			

PEL

24ST series

				
GEV No.	101076	Ref. No.	0000X11200	
description	gas thermostat PEL type 24ST 120-320°C gas inlet M20x1.5 (tube ø 12mm) bypass nozzle ø 0.35mm gas outlet M20x1.5 (tube ø 12/10mm) thermocouple connection M9x1 pilot connection M10x1 capillary pipe 1200mm probe ø 6mm probe L 100mm shaft ø 10x8mm shaft L 27/17mm shaft flat upper			
For models:	C2FTPFPG, C2FTPFPGP, C4FFG, C4FFGP, C6FFG, C6FFGP, CCTPFPG8, CFTG4C, CFTG6C, CFTG8C, K2FTPFPG, K4FFG, K6FFG, K8FFG, KFTG4, KFTG4C, KFTG4R, KFTG8, KFTG8C, KFTG8LR, KTPFG, SKT40GC, SKT60GC, SKT80GC, TT40GC, TT60GC, TT80GC			
spare parts for	101076			
	GEV No.	100455	Ref. No.	—
	bypass nozzle type PEL23/24 bore ø 0.35mm thread M8x0.5			



SABAF

GEV No.	101181	Ref. No.	AGC006ZR10 X68053
description	gas thermostat SABAF t.max. 300°C gas inlet pipe flange ø16mm bypass nozzle ø 0.46mm gas outlet M13x1 IT (tube ø 8mm) gas outlet 2 thermocouple connection M8x1 pilot connection capillary pipe 850mm probe ø 4mm probe L 150mm shaft ø 6x4.6mm shaft L 45/27mm shaft flat upper		
For models:	C4FFFCGP, C4FFLGP, C4FFLGV, C4FZFCG, C4FZFCGP, C4FZSFCGP, C6FF- CGP, C6FFLG, C6FFLGP, C6FFLGPV, C6FFLGV, C6FZFCG, C6FZFCGP, C6FZFCGPV, C6FZFCGV, CC120CG, CC120G, CC80G, CC81CG, CC81G, K2FTPCG, K4FSFCG, K4FZFCG, K4FZSFCG, K6FZFCG, K8FZFCG, KTPFCG, M74FFXG, M74FMPFXG, M74FPFXG, M76FFXG, M76FMPFXG, M76FPFXG, SK4FZFCGP, SK6FZFCGP		
spare parts for	101181		
	GEV No.	101060	Ref. No. —
	magnet unit standard L 39mm D1 ø 15.4mm D2 ø 11mm suitable for PEL20-21/JUNKERS/EGA		
accessories for	101181		
	GEV No.	101277	Ref. No. —
	olive ID ø 8mm Qty 1 pcs		
	GEV No.	101376	Ref. No. X68050
	gasket ID ø 8mm ED ø 12mm H 3/5mm		
	GEV No.	101477	Ref. No. —
	union screw thread M13x1 tube ø 8mm Qty 1 pcs		
	GEV No.	101751	Ref. No. X07400 X68052
	bracket		
	GEV No.	110360	Ref. No. —
	knob without symbol ø 65mm shaft ø 6x4.6mm shaft flat upper black		
	GEV No.	110603	Ref. No. —
	knob dial plate gas thermostat t.max. 300°C 90-300°C		

gas valves and ignition boxes

gas control valves

SIT

NOVASIT



GEV No.	101162	Ref. No.	0000X11400
description	gas valve SIT series Novasit 820 230V 50Hz gas inlet 1/2" gas outlet 1/2" thermocouple connection M9x1 pilot connection M10x1 ignition pressure 3-5mbar pressure range 3-30mbar pressure regulator con- nection blind equiv. no. 0.820.010		
For models:	CF15DG8, CF15G4, KBRG, KBRG12, KBRG12IN, KBRGIN, KBRGM, KBRGM12, KBRGM12IN, KBRGMIN, KFG4, KFG8, OPBRG, OPBRG12, OPBRG12IN, OPBRG12MIN, OPBRGIN, OPBRGM, OPBRGM12, OPBRG- M12IN, OPBRGMIN		
spare parts for	101162		
	GEV No.	101065	Ref. No. —
	magnet unit with cable L 44mm D1 ø 30mm D2 ø 20mm suitable for NOVASIT		
	GEV No.	101313	Ref. No. X50400
	solenoid coil 230V 50Hz		
accessories for	101162		
	GEV No.	100006	Ref. No. —
	piezoelectric igniter suitable for ELETTROSIT body plastic blowing connection ø2.4mm ø 14mm		
	GEV No.	101305	Ref. No. —
	gas connection straight 1/2" flange 45x45mm ELETTROSIT/ V4400/4600/4605 suitable for SIT/HONEYWELL hole distance 36x36mm		
	GEV No.	101306	Ref. No. —
	gas connection angled flange 45x45mm hole distance 36x36mm 1/2" ELETTROSIT/V4400/4600/4605 screw with O-ring suitable for SIT/ HONEYWELL		
	GEV No.	101307	Ref. No. —
	gas connection straight flange 45x45mm hole distance 36x36mm 3/4" ELETTROSIT/V4400/4600/4605 screw with O-ring suitable for SIT/ HONEYWELL		
	GEV No.	101308	Ref. No. —
	gas connection angled flange 45x45mm hole distance 36x36mm 3/4" ELETTROSIT/V4400/4600/4605 screw with O-ring suitable for SIT/ HONEYWELL		
	GEV No.	101312	Ref. No. 0000X49000 X49000
	microswitch		
	GEV No.	101314	Ref. No. X50300
	solenoid coil 24V 50Hz		
	GEV No.	101317	Ref. No. —
	plug with cable L 1000mm suitable for NOVASIT		

Table continues overleaf





accessories for	101162		
	GEV No.	101318	Ref. No. —
	cover cap for solenoid coil suitable for NOVASIT		



accessories			
			
1			
GEV No.	101312	Ref. No.	0000X49000
description	microswitch		
For models:	CF15DG8, CF15G4, KBRG, KBRG12, KBRG12IN, KBRGIN, KBRGM, KBRGM12, KBRGM12IN, KBRGMIN, KFG4, KFG8, OPBRG, OPBRG12, OPBRG12IN, OPBRG12MIN, OPBRGIN, OPBRGM, OPBRGM12, OPBRGM12IN, OPBRGMIN		

			
1			
GEV No.	101313	Ref. No.	X50400
description	solenoid coil 230V 50Hz		
For models:	CF15DG8, CF15G4, KFG4, KFG8		
accessories for	101313		
	GEV No.	550896	Ref. No. —
	gasket with screw gas valves NOVASIT		

			
1			
GEV No.	101314	Ref. No.	X50300
description	solenoid coil 24V 50Hz		

safety valves

SIT			
400 series			
			
1			
GEV No.	101470	Ref. No.	0000Y21800
description	safety valve front fixing M12x1 pressure range 50mbar gas inlet 1/8" IT gas outlet 1/8" - M6x0.75 thermocouple connection M8x1 equiv. no. 0.400.088 suitable for SIT		
For models:	KBRG12, KBRG12IN, KBRGM12, KBRGM12IN, OPBRG12, OPBRG12IN, OPBRG12MIN, OPBRGM12, OPBRGM12IN		
spare parts for	101470		
	GEV No.	101052	Ref. No. —
	magnet unit L 43.5mm D1 ø 15.3mm D2 ø 10.5mm suitable for SIT M1		

accessories for	101470		
	GEV No.	101299	Ref. No. —
	nut thread M12x1		
	GEV No.	101499	Ref. No. —
	protection cap for safety valve thread M12x0.75 ID ø 18mm L 24mm aluminium		

ignition parts

pilot burners

























SIT			
100 series			
			
1			
GEV No.	106904	Ref. No.	0000X19900
description	pilot burner SIT type 100 series 1 flame nozzle ø 0.2mm gas connection 6mm		
For models:	B4F, B6F, B8F, C2FP, C2FTPFG, C2FTPFGP, C2TP2FGP, C4FFCEP, C4FFCGP, C4FFEP, C4FFG, C4FFGP, C4FP, C4FZFG, C4FZFGP, C4FZSFGP, C6FFCEP, C6FFCGP, C6FFEP, C6FFG, C6FFGP, C6FP, C6FZFG, C6FZFGP, CCTPFG8, K2F, K2FTPFCE, K2FTPFCG, K2FTPFE, K2FTPFG, K4F, K4FFE, K4FFG, K4FS, K4FSFCE, K4FSFCG, K4FSFE, K4FSFG, K4FZFG, K4FZSFG, K6F, K6FFE, K6FFG, K6FZFG, K8F, K8FFE, K8FFG, K8FZFG, KTPFG, M72FTPFG...(Other models you can see in the webshop)		
spare parts for	106904		
	GEV No.	100245	Ref. No. X19906
	pilot burner nozzle LPG code 20 bore ø 0.2mm Qty 1 pcs thread M8x0.75		
	GEV No.	100855	Ref. No. —
	pilot burner bracket triple		
	GEV No.	100885	Ref. No. X19901
	air mixing sleeve for pilot burner Qty 1 pcs		
	GEV No.	100916	Ref. No. —
	compression spring for pilot burner Qty 1 pcs		
	GEV No.	100917	Ref. No. —
	gasket for pilot burner Qty 1 pcs aluminium		
	GEV No.	100918	Ref. No. —
	screw for pilot burner		
	GEV No.	107160	Ref. No. —
	pilot burner cap SIT 1 flame Hmm Lmm Qty 1 pcs		
	GEV No.	107166	Ref. No. —
	pilot burner head SIT 1 flame Hmm Lmm Qty 1 pcs		
	GEV No.	107701	Ref. No. X19900
	pilot burner bottom part SIT 100 series nozzle ø 0.2mm		

Table continues overleaf



accessories for		106904	
	GEV No.	100246	Ref. No. 0000X19907 X19907
	pilot burner nozzle natural gas bore ø 0.35mm Qty 1 pcs thread M8x0.75		
	GEV No.	100904	Ref. No. —
	locking screw M10x1 for pipe ø 4mm Qty 1 pcs		
	GEV No.	100905	Ref. No. —
	locking screw M10x1 for pipe ø 6mm Qty 1 pcs		
	GEV No.	102110	Ref. No. —
	pilot tube copper pipe ø 4mm thickness 1mm L 3000mm		
	GEV No.	102111	Ref. No. —
	pilot tube copper pipe ø 6mm thickness 1mm L 3000mm		
	GEV No.	107171	Ref. No. —
	pilot burner nozzle SIT natural/liquid gas bore ø 0.25mm Qty 1 pcs		
	GEV No.	107700	Ref. No. —
	pilot burner bottom part SIT 100 series nozzle ø 0.25mm		
	GEV No.	107702	Ref. No. —
	pilot burner bottom part SIT 100 series nozzle ø 0.35mm		

 <p>1</p>			
GEV No.	106906	Ref. No.	0000X13500 30100005
description	pilot burner SIT type 100 series 3 flames nozzle ø 0.2mm gas connection 6mm		
For models:	C2FTPFE, C2FTPFEP, C2FTPFG, C2FTPFGP, C6FFGA, C6FFGAP, CBG4, CBG6, CBG8, CBRG, CBRGIN, CCPG4, CCPG8, CCPG82, CCTP8, CCTPFG8, CFTG22, CFTG2C2, CFTG2LR, CFTG2R2, CFTG62, CFTG6C2, CFTG6LR, CFTG6R2, CPG, CPGI, CPLG1, CPLG2, CPLG4, CPLG8, K2FTPFCE, K2FTPFCG, K2FTPFE, K2FTPFG, KB4G, KB8G, KCP4, KCP8, KCP82, KP10G, KP10GA, KP10GT, KP10GTA, KP15G, KP15GA, KP15GT, KP15GTA, KP20G, KP20GA, KP20GT...(Other models you can see in the webshop)		
spare parts for		106906	
	GEV No.	100245	Ref. No. X19906
	pilot burner nozzle LPG code 20 bore ø 0.2mm Qty 1 pcs thread M8x0.75		
	GEV No.	100855	Ref. No. —
	pilot burner bracket triple		
	GEV No.	100885	Ref. No. X19901
	air mixing sleeve for pilot burner Qty 1 pcs		
	GEV No.	100916	Ref. No. —
	compression spring for pilot burner Qty 1 pcs		
	GEV No.	100917	Ref. No. —
	gasket for pilot burner Qty 1 pcs aluminium		
	GEV No.	100918	Ref. No. —
	screw for pilot burner		

spare parts for		106906	
	GEV No.	107162	Ref. No. —
	pilot burner cap SIT 3 flames Hmm Lmm Qty 1 pcs		
	GEV No.	107701	Ref. No. X19900
	pilot burner bottom part SIT 100 series nozzle ø 0.2mm		
accessories for		106906	
	GEV No.	100245	Ref. No. X19906
	pilot burner nozzle LPG code 20 bore ø 0.2mm Qty 1 pcs thread M8x0.75		
	GEV No.	100246	Ref. No. 0000X19907 X19907
	pilot burner nozzle natural gas bore ø 0.35mm Qty 1 pcs thread M8x0.75		
	GEV No.	100904	Ref. No. —
	locking screw M10x1 for pipe ø 4mm Qty 1 pcs		
	GEV No.	100905	Ref. No. —
	locking screw M10x1 for pipe ø 6mm Qty 1 pcs		
	GEV No.	102110	Ref. No. —
	pilot tube copper pipe ø 4mm thickness 1mm L 3000mm		
	GEV No.	102111	Ref. No. —
	pilot tube copper pipe ø 6mm thickness 1mm L 3000mm		
	GEV No.	107171	Ref. No. —
	pilot burner nozzle SIT natural/liquid gas bore ø 0.25mm Qty 1 pcs		
	GEV No.	107700	Ref. No. —
	pilot burner bottom part SIT 100 series nozzle ø 0.25mm		
	GEV No.	107702	Ref. No. —
	pilot burner bottom part SIT 100 series nozzle ø 0.35mm		





accessories			
pilot burner bottom parts			
 <p>1</p>			
GEV No.	107701	Ref. No.	X19900
description	pilot burner bottom part SIT 100 series nozzle ø 0.2mm		
For models:	B4F, B6F, B8, B8F, C2FP, C2FTPFEP, C2FTPFGP, C2TP2FGP, C4FFCEP, C4FFCGP, C4FFEP, C4FFGP, C4FFLEP, C4FFLGP, C4FP, C6FFCEP, C6FFCGP, C6FFEP, C6FFGAP, C6FFGP, C6FFLEP, C6FFLGP, C6FFLGPV, C6FP, FCE, FCG, FE, K2F, K2FTPFCE, K2FTPFCG, K2FTPFE, K2FTPFG, K4F, K4FFE, K4FFG, K4FS, K4FSFG, K6F, K6FFE, K6FFG, K6FG, K8F, K8FFE, K8FFG, OP2F, OP4F, OP4FS, OP6F, OP8F...(Other models you can see in the webshop)		
spare parts for		107701	
	GEV No.	100245	Ref. No. X19906
	pilot burner nozzle LPG code 20 bore ø 0.2mm Qty 1 pcs thread M8x0.75		
	GEV No.	100916	Ref. No. —
	compression spring for pilot burner Qty 1 pcs		

Table continues overleaf



spare parts for		107701		
	GEV No.	100917	Ref. No.	—
gasket for pilot burner Qty 1 pcs aluminium				
	GEV No.	100918	Ref. No.	—
screw for pilot burner				
accessories for		107701		
	GEV No.	100246	Ref. No.	0000X19907 X19907
pilot burner nozzle natural gas bore ϕ 0.35mm Qty 1 pcs thread M8x0.75				
	GEV No.	100904	Ref. No.	—
locking screw M10x1 for pipe ϕ 4mm Qty 1 pcs				
	GEV No.	100905	Ref. No.	—
locking screw M10x1 for pipe ϕ 6mm Qty 1 pcs				
	GEV No.	102110	Ref. No.	—
pilot tube copper pipe ϕ 4mm thickness 1mm L 3000mm				
	GEV No.	102111	Ref. No.	—
pilot tube copper pipe ϕ 6mm thickness 1mm L 3000mm				
	GEV No.	102742	Ref. No.	—
pilot burner nozzle LPG code 25 bore ϕ 0.25mm Qty 1 pcs				

pilot burner nozzles

	1		
GEV No.	100245	Ref. No.	X19906
description pilot burner nozzle LPG code 20 bore ϕ 0.2mm Qty 1 pcs thread M8x0.75			
For models: B4F, B6F, B8, B8F, C2FP, C2FTPFGP, C2TP2FGP, C4FFCEP, C4FFCGP, C4FFEP, C4FFGP, C4FP, C4FZFG, C4FZFGP, C4FZSFGP, C6FFCEP, C6FFCGP, C6FFEP, C6FFGP, C6FP, C6FZFG, C6FZFGP, CBG4, CBRG, CBRGIN, CCPG4, CCPG82, CCTP8, CCTPFG8, CF10DG8M, CF10G4M, CFTG22, CFTG2C2, CFTG2LR, CFTG2R2, CFTG62, CFTG6C2, CFTG6LR, CFTG6R2, CPG, CPGI, CPLG1, CPLG2, FCE, FCG, FE, K2F, K2FTPFC, K2FTPFCG, K2FTPFE...(Other models you can see in the webshop)			

	1		
GEV No.	100246	Ref. No.	0000X19907
description pilot burner nozzle natural gas bore ϕ 0.35mm Qty 1 pcs thread M8x0.75			
For models: B4F, B6F, B8, B8F, C2FP, C2FTPFGP, C2TP2FGP, C4FFCEP, C4FFCGP, C4FFEP, C4FFGP, C4FP, C4FZFG, C4FZFGP, C4FZSFGP, C6FFCEP, C6FFCGP, C6FFEP, C6FFGP, C6FP, C6FZFG, C6FZFGP, CBG4, CBRG, CBRGIN, CCPG4, CCPG82, CCTP8, CCTPFG8, CF10DG8M, CF10G4M, CFTG22, CFTG2C2, CFTG2LR, CFTG2R2, CFTG62, CFTG6C2, CFTG6LR, CFTG6R2, CPG, CPGI, CPLG1, CPLG2, FCE, FCG, FE, K2F, K2FTPFC, K2FTPFCG, K2FTPFE...(Other models you can see in the webshop)			

	1		
GEV No.	102972	Ref. No.	30500003
description pilot burner nozzle natural gas code 40 bore ϕ 0.4mm Qty 1 pcs			
For models: KP20G, KP20GA, KP20GT, KP20GTA, KP30G, KP30GA, KP30GT, KP30GTA, KP50G, KP50GA, KP50GT, KP50GTA, KPGN18G, KPGN27G, KPGN37G, KPI20G, KPI20GA, KPI20GT, KPI20GTA, KPI30G, KPI30GA, KPI30GT, KPI30GTA, KPI50G, KPI50GA, KPI50GT, KPI50GTA, KPIGN18G, KPIGN27G, KPIGN37G			

ignition electrodes

	1		
GEV No.	100706	Ref. No.	0000X14600 30100054 719-020-00
description ignition electrode connection M4 Qty 1 pcs			
For models: C2FTPFE, C2FTPFEF, C2FTPFG, C2FTPFGP, C2TP2FGP, C4FFCGP, C4FFG, C4FFGP, C4FZFCG, C4FZFCGP, C4FZSFCGP, C6FFCGP, C6FFG, C6FFGA, C6FFGAP, C6FFGP, C6FZFCG, C6FZFCGP, C6FZFCGPV, C6FZFCGV, CBG4, CBG6, CBG8, CBRG, CBRGIN, CC120CG, CC81CG, CCPG4, CCPG8, CCPG82, CCTP8, CCTPFG8, CFG15, CFG15D, CFTG22, CFTG2C2, CFTG2LR, CFTG2R2, CFTG62, CFTG6C2, CFTG6LR, CFTG6R2, CPG, CPGI, CPLG1, CPLG2, CPLG4, CPLG8, K2FTPFC, K2FTPFCG...(Other models you can see in the webshop)			

miscellaneous











	1		
GEV No.	100885	Ref. No.	X19901
description air mixing sleeve for pilot burner Qty 1 pcs			
For models: B4F, B6F, B8, B8F, C2FP, C2FTPFEF, C2FTPFGP, C2TP2FGP, C4FFCEP, C4FFCGP, C4FFEP, C4FFGP, C4FFLEP, C4FFLGP, C4FP, C6FFCEP, C6FFCGP, C6FFEP, C6FFGP, C6FFGAP, C6FFGP, C6FFLEP, C6FFLEPV, C6FFLGP, C6FFLGPV, C6FP, FCE, FCG, FE, K2F, K2FTPFC, K2FTPFCG, K2FTPFE, K2FTPFG, K4F, K4FFE, K4FFG, K4FS, K4FSFCE, K4FSFCG, K4FSFE, K4FSFG, K6F, K6FFE, K6FFG, K6FG, K8F, K8FFE, K8FFG, M72FPTFG, M74FMPFG...(Other models you can see in the webshop)			

140 - 145 -150 series











	1			
GEV No.	102450	Ref. No.	X14400	
description pilot burner SIT type 150 series 1 flame nozzle ϕ mm gas connection 6mm				
For models: 2FZP, B4FZ, B6FZ, B8FZ, C2FZP, C2TP2FGP, C4FZFCPE, C4FZFCGP, C4FZFEP, C4FZFGP, C4FZP, C4FZSFCEP, C4FZSFCGP, C4FZSFE, C4FZSFGP, C4FZSP, C6FFGAP, C6FZFCPE, C6FZFCPEPV, C6FZFCGP, C6FZFCGPV, C6FZFEP, C6FZFGA, C6FZFGAP, C6FZFGP, C6FZP, CN14FGA, I2FZP, I4FZP, I6FZP, K2FZ, K4FZ, K4FZFCE, K4FZFCEG, K4FZFE, K4FZFG, K4FZFGA, K4FZS, K4FZSFCE, K4FZSFCEG, K4FZSFE, K4FZSFG, K6FFGA, K6FZ, K6FZFCE, K6FZFCG, K6FZFE, K6FZFG, K6FZFGA, K8FZ...(Other models you can see in the webshop)				
spare parts for		102450		
	GEV No.	100204	Ref. No.	—
pilot burner nozzle SIT LPG code 14 bore ϕ 0.18/0.20mm Qty 1 pcs suitable for 140 series				
	GEV No.	100205	Ref. No.	0000X30000 X30000
pilot burner nozzle SIT LPG code 19 bore ϕ 0.23/0.26mm Qty 1 pcs suitable for SIT 150 series				

Table continues overleaf



spare parts for		102450	
	GEV No.	100206	Ref. No. 0000X30100 X30100
pilot burner nozzle SIT natural gas code 36 bore ø 0.60/0.55mm Qty 1 pcs suitable for SIT 150 series			
	GEV No.	100207	Ref. No. X30300
pilot burner nozzle SIT natural gas code 27 bore ø 0.40/0.38mm suitable for SIT 140 series			
	GEV No.	100216	Ref. No. —
pilot burner nozzle SIT natural gas code 38 bore ø 0.45mm Qty 1 pcs suitable for SIT 150 series			
	GEV No.	100765	Ref. No. —
pilot burner nozzle SIT LPG code 20 bore ø 0.35mm Qty 1 pcs suitable for 150 series			
	GEV No.	100897	Ref. No. —
olive for pipe ø 4mm Qty 1 pcs for pilot burner			
	GEV No.	100898	Ref. No. —
olive for pipe ø 6mm Qty 1 pcs for pilot burner			
	GEV No.	100906	Ref. No. X13002
screw connection thread M10x1 for ignition electrode brass Qty 1 pcs WS 10			
	GEV No.	100907	Ref. No. —
screw connection thread M10x1 Qty 1 pcs type SEF 1 ømm for thermocouple			
	GEV No.	100908	Ref. No. X13200
union screw thread M10x1 for pipe ø 4mm Qty 1 pcs			
	GEV No.	100909	Ref. No. —
union screw thread M10x1 for pipe ø 6mm Qty 1 pcs			
	GEV No.	101246	Ref. No. —
olive for pipe ø 4mm Qty 1 pcs			

			
1			
GEV No.	100170	Ref. No.	0000X13000
description pilot burner SIT type 150 series 1 flame nozzle ømm gas connectionmm			
For models: C2FTPFPG, CCTP8, CCTPFG8, CFTG1, CFTG1C, CFTG1R, CFTG2, CFTG2C, CFTG2R, CFTG3, CFTG3C, CFTG3LR, CFTG3R, CFTG4, CFTG4C, CFTG4R, CFTG6, CFTG6C, CFTG6R, CFTG8, CFTG8C, CFTG8LR, CFTG8R, K2FTPFCE, K2FTPFCEG, K2FTPFE, K2FTPFG, KBRG, KBRG12, KBRG12IN, KBRGIN, KBRGM, KBRGM12, KBRGM12IN, KBRGMIN, KFT4G, KFT4GC, KFT4GR, KFT8G, KFT8G23C, KFT8GC, KFT8GLR, KFT8GR, KFTG1, KFTG1C, KFTG1R, KFTG3, KFTG3C, KFTG3LR, KFTG4...(Other models you can see in the webshop)			
spare parts for 100170			
	GEV No.	100907	Ref. No. —
screw connection thread M10x1 Qty 1 pcs type SEF 1 ømm for thermocouple			
accessories for 100170			
	GEV No.	100204	Ref. No. —
pilot burner nozzle SIT LPG code 14 bore ø 0.18/0.20mm Qty 1 pcs suitable for 140 series			
	GEV No.	100205	Ref. No. 0000X30000 X30000
pilot burner nozzle SIT LPG code 19 bore ø 0.23/0.26mm Qty 1 pcs suitable for SIT 150 series			

accessories for		100170	
	GEV No.	100206	Ref. No. 0000X30100 X30100
pilot burner nozzle SIT natural gas code 36 bore ø 0.60/0.55mm Qty 1 pcs suitable for SIT 150 series			
	GEV No.	100207	Ref. No. X30300
pilot burner nozzle SIT natural gas code 27 bore ø 0.40/0.38mm suitable for SIT 140 series			
	GEV No.	100216	Ref. No. —
pilot burner nozzle SIT natural gas code 38 bore ø 0.45mm Qty 1 pcs suitable for SIT 150 series			
	GEV No.	100701	Ref. No. 0000X13001 X13001 X16900
ignition electrode connection M4 Qty 1 pcs			
	GEV No.	100801	Ref. No. —
gasket for pilot burner Qty 1 pcs			
	GEV No.	100897	Ref. No. —
olive for pipe ø 4mm Qty 1 pcs for pilot burner			
	GEV No.	100898	Ref. No. —
olive for pipe ø 6mm Qty 1 pcs for pilot burner			
	GEV No.	100906	Ref. No. X13002
screw connection thread M10x1 for ignition electrode brass Qty 1 pcs WS 10			
	GEV No.	100908	Ref. No. X13200
union screw thread M10x1 for pipe ø 4mm Qty 1 pcs			
	GEV No.	100909	Ref. No. —
union screw thread M10x1 for pipe ø 6mm Qty 1 pcs			

160 series

			
1			
GEV No.	100056	Ref. No.	X17000
description pilot burner SIT type 160 series 3 flames nozzle ømm gas connectionmm			
For models: CBRG, CBRG8, CBRGIN			
spare parts for 100056			
	GEV No.	100907	Ref. No. —
screw connection thread M10x1 Qty 1 pcs type SEF 1 ømm for thermocouple			
accessories for 100056			
	GEV No.	100202	Ref. No. —
pilot burner nozzle natural gas code 41 Qty 1 pcs nozzle ø 0.41mm			
	GEV No.	100203	Ref. No. —
pilot burner nozzle LPG code 25 Qty 1 pcs nozzle ø 0.25mm			
	GEV No.	100701	Ref. No. 0000X13001 X13001 X16900
ignition electrode connection M4 Qty 1 pcs			

Table continues overleaf



accessories for 100056				
GEV No.	100801	Ref. No.	—	
			gasket for pilot burner Qty 1 pcs	
GEV No.	100869	Ref. No.	—	
			pilot burner nozzle natural gas code 51 Qty 1 pcs suitable for 160 series nozzle ø 0.51mm	
GEV No.	100870	Ref. No.	—	
			olive for pipe ø 4mm Qty 1 pcs suitable for 160 series for pilot burner	
GEV No.	100906	Ref. No.	X13002	
			screw connection thread M10x1 for ignition electrode brass Qty 1 pcs WS 10	
GEV No.	100908	Ref. No.	X13200	
			union screw thread M10x1 for pipe ø 4mm Qty 1 pcs	
GEV No.	100909	Ref. No.	—	
			union screw thread M10x1 for pipe ø 6mm Qty 1 pcs	
GEV No.	101287	Ref. No.	—	
			olive for pipe ø 6mm Qty 1 pcs	
GEV No.	102110	Ref. No.	—	
			pilot tube copper pipe ø 4mm thickness 1mm L 3000mm	
GEV No.	102111	Ref. No.	—	
			pilot tube copper pipe ø 6mm thickness 1mm L 3000mm	
GEV No.	107650	Ref. No.	—	
			pilot burner nozzle SIT LPG code 30 Qty 1 pcs	

producer-specific pilot burners

GIGA

Counter 700 / Top 700 / Kappa 900 / Snack 600 series

1				
GEV No.	100145	Ref. No.	0000X19000	
description	pilot burner SIT type 100 series 3 flames nozzle ø 0.2mm gas connectionmm			
For models:	CF10DG8M, CF10G4M, CFG15, CFG15D, KFG1, KFG15, KFG15D, KFG2, KFG20, KFG20D, M7F4G, M7F8G, OPFG1, OPFG2, SKF10GM, SKF20GM, TF10GM, TF20GM			
spare parts for 100145				
GEV No.	100245	Ref. No.	X19906	
			pilot burner nozzle LPG code 20 bore ø 0.2mm Qty 1 pcs thread M8x0.75	
GEV No.	100837	Ref. No.	—	
			pilot burner cap 3 flames H 24mm L 48mm Qty 1 pcs	
GEV No.	100855	Ref. No.	—	
			pilot burner bracket triple	





spare parts for 100145				
GEV No.	100881	Ref. No.	—	
			pilot burner bottom part PRO-GAS 100 series nozzle ø 0.2mm	
GEV No.	100885	Ref. No.	X19901	
			air mixing sleeve for pilot burner Qty 1 pcs	
GEV No.	100916	Ref. No.	—	
			compression spring for pilot burner Qty 1 pcs	
GEV No.	100917	Ref. No.	—	
			gasket for pilot burner Qty 1 pcs aluminium	
GEV No.	100918	Ref. No.	—	
			screw for pilot burner	





accessories for 100145				
GEV No.	100246	Ref. No.	0000X19907 X19907	
			pilot burner nozzle natural gas bore ø 0.35mm Qty 1 pcs thread M8x0.75	
GEV No.	100882	Ref. No.	—	
			pilot burner bottom part PRO-GAS 100 series nozzle ø 0.25mm	
GEV No.	100883	Ref. No.	—	
			pilot burner bottom part PRO-GAS 100 series nozzle ø 0.35mm	
GEV No.	100904	Ref. No.	—	
			locking screw M10x1 for pipe ø 4mm Qty 1 pcs	
GEV No.	100905	Ref. No.	—	
			locking screw M10x1 for pipe ø 6mm Qty 1 pcs	
GEV No.	102110	Ref. No.	—	
			pilot tube copper pipe ø 4mm thickness 1mm L 3000mm	
GEV No.	102111	Ref. No.	—	
			pilot tube copper pipe ø 6mm thickness 1mm L 3000mm	
GEV No.	102742	Ref. No.	—	
			pilot burner nozzle LPG code 25 bore ø 0.25mm Qty 1 pcs	



1				
GEV No.	107701	Ref. No.	X19900	
description	pilot burner bottom part SIT 100 series nozzle ø 0.2mm			
For models:	B4F, B6F, B8, B8F, C2FP, C2FTPFEP, C2FTPFPG, C2TP2FGP, C4FFCEP, C4FFCGP, C4FFEP, C4FFGP, C4FFLEP, C4FFLGP, C4FP, C6FFCEP, C6FFCGP, C6FFEP, C6FFGAP, C6FFGP, C6FFLEP, C6FFLEPV, C6FFLGP, C6FFLGPV, C6FP, FCE, FCG, FE, K2F, K2FTPFCE, K2FTPFPG, K2FTPFE, K2FTPFG, K4F, K4FFE, K4FFG, K4FS, K4FSFG, K6F, K6FFE, K6FFG, K6FG, K8F, K8FFE, K8FFG, OP2F, OP4F, OP4FS, OP6F, OP8F...(Other models you can see in the webshop)			
spare parts for 107701				
GEV No.	100245	Ref. No.	X19906	
			pilot burner nozzle LPG code 20 bore ø 0.2mm Qty 1 pcs thread M8x0.75	

Table continues overleaf



spare parts for		107701		
	GEV No.	100916	Ref. No.	—
compression spring for pilot burner Qty 1 pcs				
	GEV No.	100917	Ref. No.	—
gasket for pilot burner Qty 1 pcs aluminium				
	GEV No.	100918	Ref. No.	—
screw for pilot burner				
accessories for		107701		
	GEV No.	100246	Ref. No.	0000X19907 X19907
pilot burner nozzle natural gas bore ø 0.35mm Qty 1 pcs thread M8x0.75				
	GEV No.	100904	Ref. No.	—
locking screw M10x1 for pipe ø 4mm Qty 1 pcs				
	GEV No.	100905	Ref. No.	—
locking screw M10x1 for pipe ø 6mm Qty 1 pcs				
	GEV No.	102110	Ref. No.	—
pilot tube copper pipe ø 4mm thickness 1mm L 3000mm				
	GEV No.	102111	Ref. No.	—
pilot tube copper pipe ø 6mm thickness 1mm L 3000mm				
	GEV No.	102742	Ref. No.	—
pilot burner nozzle LPG code 25 bore ø 0.25mm Qty 1 pcs				

	1			
GEV No.	100099	Ref. No.	Y20300	
description	pilot burner cap 1 flame suitable for 100 series			
For models:	B4F, B6F, B8, B8F, C2FP, C2FTPFEP, C2FTPFPG, C2TP2FGP, C4FFCEP, C4FFCGP, C4FFEP, C4FFGP, C4FFLEP, C4FFLGP, C4FP, C6FFCEP, C6FFCGP, C6FFEP, C6FFGAP, C6FFGP, C6FFLEP, C6FFLEPV, C6FFLGP, C6FFLGPV, C6FFLGPV, C6FP, FCE, FCG, FE, K2F, K2FTPFCE, K2FTPFCEG, K2FTPFE, K2FTPFG, K4F, K4FFE, K4FFG, K4FS, K4FSFCE, K4FSFCG, K4FSFE, K4FSFG, K6F, K6FFE, K6FFG, K6FG, K8F, K8FFE, K8FFG, OP2F, OP4F...(Other models you can see in the webshop)			
accessories for		100099		
	GEV No.	100245	Ref. No.	X19906
pilot burner nozzle LPG code 20 bore ø 0.2mm Qty 1 pcs thread M8x0.75				
	GEV No.	100246	Ref. No.	0000X19907 X19907
pilot burner nozzle natural gas bore ø 0.35mm Qty 1 pcs thread M8x0.75				
	GEV No.	100881	Ref. No.	—
pilot burner bottom part PRO-GAS 100 series nozzle ø 0.2mm				
	GEV No.	100882	Ref. No.	—
pilot burner bottom part PRO-GAS 100 series nozzle ø 0.25mm				

accessories for		100099		
	GEV No.	100883	Ref. No.	—
pilot burner bottom part PRO-GAS 100 series nozzle ø 0.35mm				
	GEV No.	100885	Ref. No.	X19901
air mixing sleeve for pilot burner Qty 1 pcs				
	GEV No.	102742	Ref. No.	—
pilot burner nozzle LPG code 25 bore ø 0.25mm Qty 1 pcs				

accessories universal

covers



1

GEV No.	106572	Ref. No.	0000X23200
description	cover for pilot burner		
For models:	CF10DG8M, CF10G4M, KFG1, KFG2, KFG20, KFG20D, M7F4G, M7F8G, OPFG1, OPFG2, OPFG20, OPFG20D, SKF10GM, SKF20GM, TF10GM, TF20GM		

electrodes



1

GEV No.	102439	Ref. No.	AGB013ZR10
description	ignition electrode		
For models:	M7FT4GL, M7FT4GR, M7FT6GL, M7FT6GLR		



1

GEV No.	102440	Ref. No.	AGB011ZR10
description	ignition electrode		
For models:	CC120CG, CC80G, CC81CG, CCG120CE, CCG80E, CCG81CE, M62F, M64F, M74F, M74FFXE, M74FFXG, M76F, M76FFXE, M76FFXG, M7FT-4GL, M7FT4GR, M7FT6GL, M7FT6GLR, SKC40G, SKC80G		

GEV No.	100701	Ref. No.	0000X13001 X16900
description	ignition electrode connection M4 Qty 1 pcs		
For models:	C2TP2FGP, C6FFGAP, C6FZFGA, C6FZFGAP, CFTG1, CFTG1C, CFTG1R, CFTG2, CFTG2C, CFTG2R, CFTG3, CFTG3C, CFTG3LR, CFTG3R, CFTG4, CFTG4C, CFTG4R, CFTG6, CFTG6C, CFTG6R, CFTG8, CFTG8C, CFTG8LR, CFTG8R, CN14FGA, K2FTPFCE, K2FTPFCEG, K2FTPFE, K2FTPFG, K6FFGA, K6FZFGA, KBRG, KBRG12, KBRG12IN, KBRGIN, KBRGM, KBRGM12, KBRGM12IN, KBRGMIN, KFT4G, KFT4GC, KFT4GR, KFT8G, KFT8G23C, KFT8GC, KFT8GLR, KFT8GR, KFTG1, KFTG1C, KFTG1R...(Other models you can see in the webshop)		
accessories for	100701		
		GEV No.	100906
		Ref. No.	X13002
	screw connection thread M10x1 for ignition electrode brass Qty 1 pcs WS 10		

GEV No.	100706	Ref. No.	0000X14600 30100054 719-020-00
description	ignition electrode connection M4 Qty 1 pcs		
For models:	C2FTPFE, C2FTPFEP, C2FTPFG, C2FTPFGP, C2TP2FGP, C4FFCGP, C4FFG, C4FFGP, C4FZFCG, C4FZFCGP, C4FZSFCGP, C6FFCGP, C6FFG, C6FFGA, C6FFGAP, C6FFGP, C6FZFCG, C6FZFCGP, C6FZFCGPV, C6FZFCGV, CBG4, CBG6, CBG8, CBRG, CBRGIN, CC120CG, CC81CG, CCPG4, CCPG8, CCPG82, CCTP8, CCTPFG8, CFG15, CFG15D, CFTG22, CFTG2C2, CFTG2LR, CFTG2R2, CFTG62, CFTG6C2, CFTG6LR, CFTG6R2, CPG, CPGI, CPLG1, CPLG2, CPLG4, CPLG8, K2FTPFCE, K2FTPFCEG...(Other models you can see in the webshop)		

GEV No.	102467	Ref. No.	AGB019ZR10
description	ignition electrode D1 ø 5.5mm D2 ø 7mm connection ø2.4mm cable length 600mm L1 1mm BL1 16mm BL2 6mm BL3 3mm BL4 8mm D3 ø 10mm D4 ø 5mm connection ø 3mm		
For models:	CC120CG, CC80G, CC81CG, CCG120CE, CCG80E, CCG81CE, M62F, M64F, M74F, M74FFXE, M74FFXG, M76F, M76FFXE, M76FFXG, SKC40G, SKC80G		

GEV No.	100733	Ref. No.	X14500
description	ignition electrode D1 ø 7mm D2 ø 8.5mm cable length 600mm BL1 28mm BL2 3mm BL3 23mm to clip connection ø 2.4mm		
For models:	C2F, C2FTPFE, C2FTPFG, C2FZ, C2TP2FGP, C4F, C4FFE, C4FFG, C4FFLE, C4FFLG, C4FZ, C4FZFCG, C4FZFCG, C4FZFE, C4FZFG, C6F, C6FFE, C6FFG, C6FFGA, C6FFLE, C6FFLEV, C6FFLG, C6FFLGV, C6FZ, C6FZFCG, C6FZFCG, C6FZFCGV, C6FZFE, C6FZFG, C6FZFGA, I2FZ, I4FZ, T2F, T2FZ, T4F, T4FZ, T6F, T6FZ		

GEV No.	100822	Ref. No.	0000X16800
description	ignition electrode D1 ø 7mm D2 ø 9mm connection M4 L1 16mm L2 25mm L3 8mm BL1 18mm BL2 3mm BL3 23mm to clip		
For models:	C2FTPFGP, C2TP2FGP, C4FFGP, C4FZFG, C4FZFGP, C4FZSFGP, C6FFGP, C6FZFG, C6FZFGP, CCTPFG8, CF10DG8M, CF10G4M, K2FTPFG, K4FFG, K4FFSFG, K4FZFG, K4FZSFG, K6FFG, K6FZFG, K8FFG, K8FZFG, KFG1, KFG2, KTPFG, M72FPTFG, M74FMPFG, M74FPFG, M76FMPFG, M76FPFG, M7F4G, M7F8G, OPFG1, OPFG2, SKF10GM, SKF20GM, TF10GM, TF20GM		

GEV No.	100818	Ref. No.	X68041
description	ignition electrode flange length 23mm flange width 15mm D1 ø 7mm L1 18mm BL1 12mm BL2 41mm connection F 2.8x0.8mm fixing dimensions ø5x4mm with flange		
For models:	C4FFLG, C4FFLGP, C6FFLG, C6FFLGP, C6FFLGPV, C6FFLGV, CC120G, CC80G, CC81G, M74FFXG, M74FMPFXG, M74FPFXG, M76FFXG, M76FMPFXG, M76FPFXG		

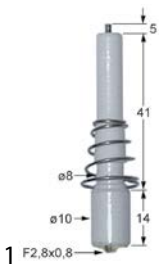
GEV No.	100729	Ref. No.	X15000
description	ignition electrode L1 5mm D1 ø8mm D2 ø10mm BL1 41mm BL2 14mm connection F 2.8x0.8mm to clip with spring		
For models:	CC120CG, CC120G, CC80G, CC81CG, CC81G, CCG120CE, CCG120E, CCG80E, CCG81CE, CCG81E, SKC40G, SKC80G		



GEV No.	100906	Ref. No.	X13002
description	screw connection thread M10x1 for ignition electrode brass Qty 1 pcs WS 10		



GEV No.	100175	Ref. No.	0000X40300
description	ignition cable cable length 1750mm connection ø2.4mm / ø4mm		
For models:	C2FTPFPG, C2FTPFPGP, C2TP2FPG, C4FFG, C4FFGPG, C4FZFG, C4FZFGP, C4FZSFGP, C6FFG, C6FFGA, C6FFGAP, C6FFGP, C6FZFG, C6FZFGA, C6FZFGAP, C6FZFGP, CCTPF8, CN14FGA, K2FTPFCE, K2FTPFCC, K2FTPFE, K2FTPFG, K4FFG, K4FSFCG, K4FSFG, K4FZFCG, K4FZFG, K4FZSFCG, K4FZSFG, K6FFG, K6FFGA, K6FZFCG, K6FZFG, K6FZFGA, K8FFG, K8FZFCG, K8FZFG, KTP, KTPFCE, KTPFCG, KTPFE, KTPFG, M72FPTFG, M74FMPFG, M74FPFG, M76FMPFG, M76FPFG, OPTP		



GEV No.	100177	Ref. No.	X40500
description	ignition cable cable length 600mm		



GEV No.	100197	Ref. No.	000X40500
description	ignition cable cable length 600mm connection F2.8mm / ø2.4mm		
For models:	CC120CG, CC120G, CC80G, CC81CG, CC81G, CCG120CE, CCG120E, CCG80E, CCG81CE, CCG81E, CCPG4, CCPG8, CCPG82, CF15DG8, CF15G4, KBRG, KBRG12, KBRG12IN, KBRGIN, KBRGM, KBRGM12, KBRGM12IN, KBRGMIN, KCP4, KCP82, KFG4, KFG8, M7FT4GL, M7FT4GR, M7FT6GL, M7FT6GLR, OPBRG, OPBRG12, OPBRG12IN, OPBRG12MIN, OPBRGIN, OPBRGM, OPBRGM12, OPBRGM12IN, OPBRGMIN, OPCP4, OPCP82, SKC40G, SKC80G		

ignition cables

pre-assembled cables



GEV No.	100176	Ref. No.	0000X41000 E10000
description	ignition cable cable length 1000mm connection ø2.4mm / ø4mm permanent temperature 200°C		
For models:	C2FTPFE, C2FTPFEP, C2FTPFG, C2FTPFPG, C2TP2FPG, CCPG4, CCPG82, CCTP8, CCTPF8, CFG15, CFG15D, CPG, CPGL, CPLG4, CPLG8, K2FTPFCE, K2FTPFCC, K2FTPFE, K2FTPFG, KCP4, KCP8, KCP82, KFG1, KFG15, KFG15D, KFG2, KFG20, KFG20D, KP10G, KP10GA, KP10GT, KP10GTA, KP15G, KP15GA, KP15GT, KP15GTA, KP10G, KP10GA, KP10GT, KP10GTA, KP15G, KP15GA, KP15GT, KP15GTA, KTP, KTPFCE, KTPFCG, KTPFE, KTPFG, M7CP4G...(Other models you can see in the webshop)		



GEV No.	100015	Ref. No.	X40100
description	ignition cable cable length 600mm connection ø2.4mm / ø2.4mm		



GEV No.	100178	Ref. No.	0000X40500
description	ignition cable cable length 900mm connection F2.8mm / ø2.4mm		

piezoelectric igniters

mounting diameter 18mm



GEV No.	100026	Ref. No.	X40100
description	ignition cable cable length 1000mm connection ø4mm / F6.3mm		
For models:	C2TP2FPG, CBG4, CBG6, CBG8, CBRG, CBRG8, CBRGIN, CF10DG8M, CF10G4M, CFG15, CFG15D, CFTG1, CFTG1C, CFTG1R, CFTG2, CFTG22, CFTG2C, CFTG2C2, CFTG2LR, CFTG2R, CFTG2R2, CFTG3, CFTG3C, CFTG3LR, CFTG3R, CFTG4, CFTG4C, CFTG4R, CFTG6, CFTG62, CFTG6C, CFTG6C2, CFTG6LR, CFTG6R, CFTG6R2, CFTG8, CFTG8C, CFTG8LR, CFTG8R, CPLG1, CPLG2, K2FTPFCE, K2FTPFCC, K2FTPFE, K2FTPFG, KB4G, KB8G, KFG1, KFG15, KFG15D...(Other models you can see in the webshop)		



GEV No.	100003	Ref. No.	0000M00500
description	piezoelectric igniter body metal blowing mounting ø 18mm connection F2.8x0.8		
For models:	C2F, C2FTPFE, C2FTPFEP, C2FTPFG, C2FTPFPG, C4F, C4FFE, C4FFG, C4FFGP, C4FFLE, C4FFLG, C6F, C6FFE, C6FFG, C6FFGA, C6FFGAP, C6FFGP, C6FFLE, C6FFLEV, C6FFLG, C6FFLGV, CBG4, CBG6, CBG8, CC120G, CC80G, CC81G, CCG120E, CCG80E, CCG81E, CCPG4, CCPG8, CCPG82, CCTP8, CCTPFE8, CCTPF8, CF10DG8M, CF10G4M, CFG15, CFG15D, CFTG1, CFTG1C, CFTG1R, CFTG2, CFTG22, CFTG2C, CFTG2C2, CFTG2LR, CFTG2R, CFTG2R2...(Other models you can see in the webshop)		





GEV No.	100174	Ref. No.	X68040
description	ignition cable cable length 1500mm connection F2.8mm / F2.8mm		
For models:	C4FFLG, C4FFLGP, C6FFLG, C6FFLGP, C6FFLGPV, C6FFLGV, CC80G, M74FFXG, M74FMPFXG, M74FPFXG, M76FFXG, M76FMPFXG, M76FPFXG		



			
1			
GEV No.	100004	Ref. No.	0000M02100
description	piezoelectric igniter body plastic blowing mounting ø 18mm connection ø2.4mm		
For models:	C2FTPFPG, C2FZ, C2TP2FGP, C4FFFCGP, C4FFGP, C4FZ, C4FZFCE, C4FZFCG, C4FZFCGP, C4FZFE, C4FZFG, C4FZFGP, C4FZSFCGP, C4FZSFGP, C6FFFCGP, C6FFGAP, C6FFGP, C6FZ, C6FZFCE, C6FZFCEV, C6FZFCG, C6FZFCGP, C6FZFCGPV, C6FZFCGV, C6FZFE, C6FZFG, C6FZFGA, C6FZFGAP, C6FZFGP, CBG4, CBRG, CBRGIN, CC120CG, CC80G, CC81CG, CCG120CE, CCG80E, CCG81CE, CCPG4, CCPG82, CCTP8, CCTPFG8, CF10DG8M, CF10G4M, CFG15, CFG15D, CFTG1, CFTG1C, CFTG1R, CFTG2...(Other models you can see in the webshop)		



mounting diameter 22mm			
			
1			
GEV No.	100013	Ref. No.	40100130
description	piezoelectric igniter body plastic blowing mounting ø 22mm connection ø2.4mm cable lengthmm		
For models:	KP20G, KP20GA, KP20GT, KP20GTA, KP30G, KP30GA, KP30GT, KP30GTA, KP50G, KP50GA, KP50GT, KP50GTA, KPGN18G, KPGN27G, KPGN37G, KPI20G, KPI20GA, KPI20GT, KPI20GTA, KPI30G, KPI30GA, KPI30GT, KPI30GTA, KPI50G, KPI50GA, KPI50GT, KPI50GTA, KPIGN18G, KPIGN27G, KPIGN37G		
accessories for	100013		
	GEV No.	100023	Ref. No. —
	female bullet size 2.3mm 0.5-1.5mm ² CuZn t.max. 125°C Qty 20 pcs		

miscellaneous			
			
1			
GEV No.	nla ¹	Ref. No.	Y17400
description	piezoelectric igniter suitable for Minisit with cover cap ømm connection F6.3x0.8		
spare parts for	101136		
	GEV No.	100001	Ref. No. —
	piezoelectric igniter suitable for Minisit connection F6.3x0.8 ømm		

¹no longer available

ignition units

			
Image not available			
1			
GEV No.	101011	Ref. No.	X50200
description	ignition unit outputs 1 24V		

			
1			
GEV No.	101009	Ref. No.	068160
description	ignition unit outputs 2 1.5 V/DC dimensions 88x23x34mm mounting distance 73mm inlet F6.3x0.8 outlet F2.8x0.8 mounting ø 73mm		
For models:	S350G		
accessories for	101009		
	GEV No.	301195	Ref. No. 068163
	ignition switch for battery type AA 1.5V mounting ø 22mm built-in depth 42mm connection male faston 2.8mm/6.3mm red ignitionA protection IP40 ambient temperature max. 125/55°C		

			
1			
GEV No.	102485	Ref. No.	0000X50000
description	ignition unit outputs 2 220-240VAC 0.6VA 50-60Hz		
For models:	CF15DG8, CF15G4, KBRG, KBRG12, KBRG12IN, KBRGIN, KBRGM, KBRGM12, KBRGM12IN, KBRGMIN, KFG4, KFG8, OPBRG, OPBRG12, OPBRG12IN, OPBRG12MIN, OPBRGIN, OPBRGM, OPBRGM12, OPBRGM12IN, OPBRGMIN		

ignition switches

			
1			
GEV No.	301195	Ref. No.	068163
description	ignition switch for battery type AA 1.5V mounting ø 22mm built-in depth 42mm connection male faston 2.8mm/6.3mm red ignitionA protection IP40 ambient temperature max. 125/55°C		
For models:	S350G		
accessories for	301195		
	GEV No.	101009	Ref. No. 068160
	ignition unit outputs 2 1.5 V/DC dimensions 88x23x34mm mounting distance 73mm inlet F6.3x0.8 outlet F2.8x0.8 mounting ø 73mm		
	GEV No.	101031	Ref. No. —
	ignition unit outputs 4 1.5 V/DC dimensions 111x23x34mm mounting distance 100mm inlet F6.3x0.8 outlet F2.8x0.8 mounting ø 100mm		

Table continues overleaf

plug-in thermocouples with cable link



GEV No.	102466	Ref. No.	AGB017ZR10
description	thermocouple with coupling L 600mm bullet receptacle ø2mm plug-in connection		
For models:	CC120CG, CC80G, CC81CG, CCG120CE, CCG80E, CCG81CE, M62F, M64F, M74F, M74FFXE, M74FFXG, M76F, M76FFXE, M76FFXG, M7FT-4GL, M7FT4GR, M7FT6GL, M7FT6GLR, SKC40G, SKC80G		

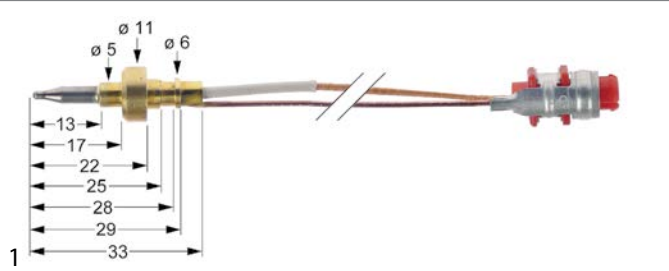
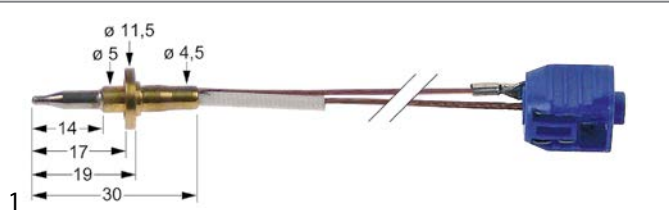

GEV No.	102441	Ref. No.	AGB009ZR10
description	thermocouple with two-conductors L 500mm plug-in connection bullet receptacle ø2mm plug-in connection		
For models:	CC120CG, CC80G, CC81CG, CCG120CE, CCG80E, CCG81CE, M62F, M64F, M74F, M74FFXE, M74FFXG, M76F, M76FFXE, M76FFXG, M7FT-4GL, M7FT4GR, M7FT6GL, M7FT6GLR, SKC40G, SKC80G		

plug-in thermocouples with interruption

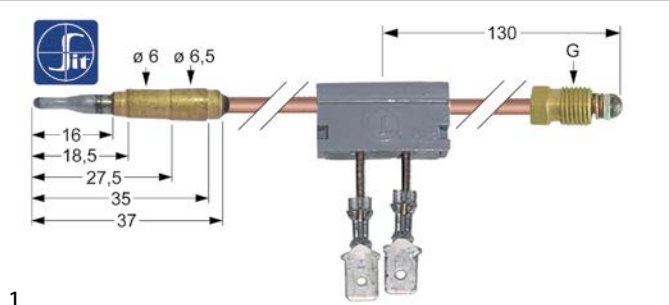

GEV No.	100172	Ref. No.	0000X14300
description	thermocouple SIT with interrupter ASA 11/32 L 400mm plug connection ø6.0mm F 6.3mm		
For models:	KBRG, KBRG12, KBRG12IN, KBRGIN, KBRGM, KBRGM12, KBRGM12IN, KBRGMIN, KFT4G, KFT4GC, KFT4GR, KFT8G, KFT8G23C, KFT8GC, KFT8GLR, KFT8GR, KFTG1, KFTG1C, KFTG1R, KFTG3, KFTG3C, KFTG3LR, KFTG4, KFTG4C, KFTG4R, KFTG8, KFTG8C, KFTG8LR, KTF4G, KTF4GC, KTF8GLR, OPBRG, OPBRG12, OPBRG12IN, OPBRG12MIN, OPBRGIN, OPBRGM, OPBRGM12, OPBRGM12IN, OPBRGMIN, OPFT4G, OPFT4GC, OPFT4GR, OPFT8G, OPFT8G23C, OPFT8GC, OPFT8GLR, OPFT8GR, OPFT4G, OPFT4GC...(Other models you can see in the webshop)		

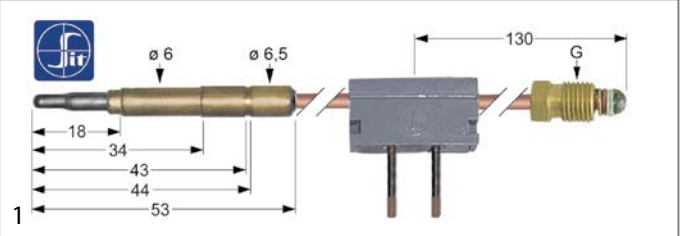

GEV No.	107164	Ref. No.	0000X14000
description	thermocouple SIT with interrupter M9x1 L 1000mm plug connection ø6.0(6.5)mm soldering connection		
For models:	CPG, CPGI, KP10G, KP10GA, KP15G, KP15GA, KPI10G, KPI10GA, KPI15G, KPI15GA, OPP10G, OPP10GA, OPP15G, OPP15GA, OPPI10G, OPPI10GA, OPPI15G, OPPI15GA		

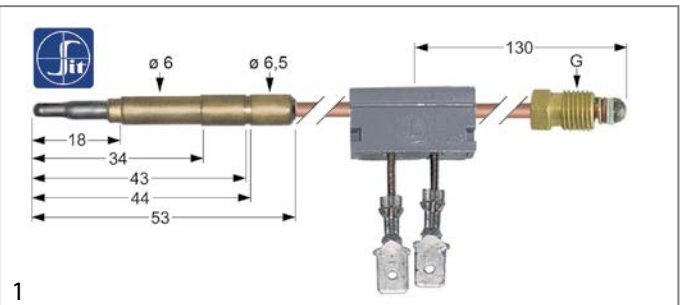

GEV No.	107177	Ref. No.	0000X19100
description	thermocouple SIT with interrupter M9x1 L 600mm plug connection ø6.0mm F 6.3mm		
For models:	CF10DG8M, CF10G4M, CF15DG8, CF15G4, CFG15, CFG15D, KFG1, KFG15, KFG15D, KFG2, KFG20, KFG20D, KFG4, KFG8, M7CP4G, M7F4G, M7F8G, OPFG1, OPFG15, OPFG15D, OPFG2, OPFG20, OPFG20D, SKF10GM, SKF20GM, TF10GM, TF20GM		

threaded thermocouples

threaded thermocouples standard

with socket with thread M8x1

SIT

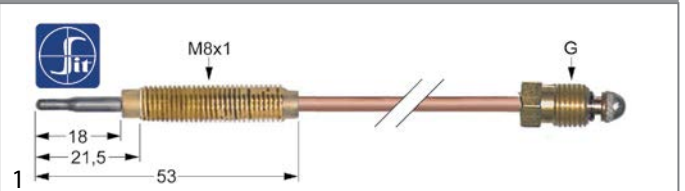

GEV No.	107634	Ref. No.	X68045
description	thermocouple SIT M8x1 L 1500mm M8x1		
For models:	C4FFLG, C4FFLGP, C6FFLG, C6FFLGP, C6FFLGPV, C6FFLGV, CC120G, CC80G, CC81G, M74FFXG, M74FMPFXG, M74FPFXG, M76FFXG, M76FMPFXG, M76FPFXG		

accessories for	107634		
	GEV No.	102067	Ref. No.
			X15900
	nut thread M8x1 H 3mm brass Qty 1 pcs type SEF 1		



GEV No.	107636	Ref. No.	X15700
description	thermocouple SIT M9x1 L 600mm M8x1		
For models:	C2TP2FGP, CC120CG, CC120G, CC80G, CC81CG, CC81G, CCG120CE, CCG120E, CCG80E, CCG81CE, CCG81E, SKC40G, SKC80G		
accessories for	107636		
		GEV No.	102067
		Ref. No.	X15900
	nut thread M8x1 H 3mm brass Qty 1 pcs type SEF 1		

extensions

GEV No.	102852	Ref. No.	0000X19400
description	thermocouple extension thread M9x1 L 1500mm		
For models:	C2FTPFPG, C2TP2FGP, C4FFCGP, C4FFGP, C4FZFCG, C4FZFCGP, C4FZFG, C4FZFGP, C4FZSFCGP, C4FZSFGP, C6FFCGP, C6FFGAP, C6FFGP, C6FZFCG, C6FZFCGP, C6FZFCGPV, C6FZFCGV, C6FZFG, C6FZFGA, C6FZFGAP, C6FZFGP, CC120CG, CC81CG, CCTPFG8, CN14FGA, K2FTPFPG, K2FTPFG, K4FFG, K4FSFCG, K4FSFG, K4FZFCG, K4FZFG, K4FZSFCG, K4FZSFG, K6FFG, K6FFGA, K6FZFCG, K6FZFG, K6FZFGA, K8FFG, K8FZFCG, K8FZFG, KTFPG, KTFPG, SK4FZFCGP, SK6FZFCGP		
accessories for	102852		
		GEV No.	101261
		Ref. No.	—
	thermocouple fitting thread M9x1 Qty 1 pcs		

accessories

nuts

GEV No.	102067	Ref. No.	X15900
description	nut thread M8x1 H 3mm brass Qty 1 pcs type SEF 1		
For models:	CC120CG, CC120G, CC80G, CC81CG, CC81G, CCG120CE, CCG120E, CCG80E, CCG81CE, CCG81E, SKC40G, SKC80G		

screws

GEV No.	102464	Ref. No.	X16500
description	thermocouple fitting thread M10x1 brass Qty 1 pcs		
For models:	B4F, B6F, B8, B8F, C2FP, C2FTPFPG, C2TP2FGP, C4FFCEP, C4FFCGP, C4FFGP, C4FFGP, C4FP, C6FFCEP, C6FFCGP, C6FFGP, C6FFGP, C6FP, FCE, FCG, FE, K2F, K2FTPFCE, K2FTPFPG, K2FTPFE, K2FTPFG, K4F, K4FFE, K4FFG, K4FS, K4FSFCE, K4FSFCG, K4FSFE, K4FSFG, K6F, K6FFE, K6FFG, K6FG, K8F, K8FFE, K8FFG, OP2F, OP4F, OP4FS, OP6F, OP8F, T2FP, T4FP, T6FP		

gas burners

hob burners

universal hob burners

GEV





GEV No.	103068	Ref. No.	M00400
description	burner cap ø 100mm		
For models:	CC120CG, CC120G, CC80G, CC81CG, CC81G, CCG120CE, CCG120E, CCG80E, CCG81CE, CCG81E, SKC40G, SKC80G		
accessories for	103068		
		GEV No.	103067
		Ref. No.	M01100
	burner ring for burner cap ø 100mm		
		GEV No.	104102
		Ref. No.	M00900
	burner head for burner cap ø 100mm ext. ø 130		
		GEV No.	104103
		Ref. No.	M00700
	burner holder suitable for burner ø100mm with nozzle holder		





GEV No.	103066	Ref. No.	M00300
description	burner cap ø 80mm		
For models:	CC120CG, CC120G, CC80G, CC81CG, CC81G, CCG120CE, CCG120E, CCG80E, CCG81CE, CCG81E, SKC40G, SKC80G		
accessories for	103066		
		GEV No.	103065
		Ref. No.	M01000
	burner ring for burner cap ø 80mm		
		GEV No.	104100
		Ref. No.	M00800
	burner head for burner cap ø 80mm		
		GEV No.	104101
		Ref. No.	M00600
	burner holder for burner cap ø 80mm with nozzle holder with mixing sleeve		





GEV No.	104102	Ref. No.	M00900
description	burner head for burner cap ø 100mm ext. ø 130		
For models:	CC120CG, CC120G, CC80G, CC81CG, CC81G, CCG120CE, CCG120E, CCG80E, CCG81CE, CCG81E, SKC40G, SKC80G		







			
1			
GEV No.	104100	Ref. No.	M00800
description	burner head for burner cap ø 80mm		
For models:	CC120CG, CC120G, CC80G, CC81CG, CC81G, CCG120CE, CCG120E, CCG80E, CCG81CE, CCG81E, SKC40G, SKC80G		
accessories for	104100		
	GEV No.	103065	Ref. No. M01000
burner ring for burner cap ø 80mm			
	GEV No.	103066	Ref. No. M00300
burner cap ø 80mm			
	GEV No.	104103	Ref. No. M00700
burner holder suitable for burner ø100mm with nozzle holder			

			
1			
GEV No.	104101	Ref. No.	M00600
description	burner holder for burner cap ø 80mm with nozzle holder with mixing sleeve		
For models:	CC120CG, CC120G, CC80G, CC81CG, CC81G, CCG120CE, CCG120E, CCG80E, CCG81CE, CCG81E, SKC40G, SKC80G		
accessories for	104101		
	GEV No.	103065	Ref. No. M01000
burner ring for burner cap ø 80mm			
	GEV No.	103066	Ref. No. M00300
burner cap ø 80mm			
	GEV No.	104100	Ref. No. M00800
burner head for burner cap ø 80mm			

			
1			
GEV No.	104103	Ref. No.	M00700
description	burner holder suitable for burner ø100mm with nozzle holder		
For models:	CC120CG, CC120G, CC80G, CC81CG, CC81G, CCG120CE, CCG120E, CCG80E, CCG81CE, CCG81E, SKC40G, SKC80G		
accessories for	104103		
	GEV No.	103067	Ref. No. M01100
burner ring for burner cap ø 100mm			
	GEV No.	103068	Ref. No. M00400
burner cap ø 100mm			
	GEV No.	104102	Ref. No. M00900
burner head for burner cap ø 100mm ext. ø 130			





			
1			
GEV No.	103067	Ref. No.	M01100
description	burner ring for burner cap ø 100mm		
For models:	CC120CG, CC120G, CC80G, CC81CG, CC81G, CCG120CE, CCG120E, CCG80E, CCG81CE, CCG81E, SKC40G, SKC80G		
accessories for	103067		
	GEV No.	103068	Ref. No. M00400
burner cap ø 100mm			
	GEV No.	104102	Ref. No. M00900
burner head for burner cap ø 100mm ext. ø 130			
	GEV No.	104103	Ref. No. M00700
burner holder suitable for burner ø100mm with nozzle holder			

			
1			
GEV No.	103065	Ref. No.	M01000
description	burner ring for burner cap ø 80mm		
For models:	CC120CG, CC120G, CC80G, CC81CG, CC81G, CCG120CE, CCG120E, CCG80E, CCG81CE, CCG81E, SKC40G, SKC80G		
accessories for	103065		
	GEV No.	103066	Ref. No. M00300
burner cap ø 80mm			
	GEV No.	104100	Ref. No. M00800
burner head for burner cap ø 80mm			
	GEV No.	104101	Ref. No. M00600
burner holder for burner cap ø 80mm with nozzle holder with mixing sleeve			

producer-specific hob burners

GIGA

Snack 600 series



			
1			
GEV No.	103068	Ref. No.	M00400
description	burner cap ø 100mm		
For models:	CC120CG, CC120G, CC80G, CC81CG, CC81G, CCG120CE, CCG120E, CCG80E, CCG81CE, CCG81E, SKC40G, SKC80G		
accessories for	103068		
	GEV No.	103067	Ref. No. M01100
burner ring for burner cap ø 100mm			
	GEV No.	104102	Ref. No. M00900
burner head for burner cap ø 100mm ext. ø 130			
	GEV No.	104103	Ref. No. M00700
burner holder suitable for burner ø100mm with nozzle holder			







 <p>1</p>			
GEV No.	103066	Ref. No.	M00300
description	burner cap ø 80mm		
For models:	CC120CG, CC120G, CC80G, CC81CG, CC81G, CCG120CE, CCG120E, CCG80E, CCG81CE, CCG81E, SKC40G, SKC80G		
accessories for	103066		
	GEV No.	103065	Ref. No. M01000
burner ring for burner cap ø 80mm			
	GEV No.	104100	Ref. No. M00800
burner head for burner cap ø 80mm			
	GEV No.	104101	Ref. No. M00600
burner holder for burner cap ø 80mm with nozzle holder with mixing sleeve			

 <p>1</p>			
GEV No.	104102	Ref. No.	M00900
description	burner head for burner cap ø 100mm ext. ø 130		
For models:	CC120CG, CC120G, CC80G, CC81CG, CC81G, CCG120CE, CCG120E, CCG80E, CCG81CE, CCG81E, SKC40G, SKC80G		





 <p>1</p>			
GEV No.	104100	Ref. No.	M00800
description	burner head for burner cap ø 80mm		
For models:	CC120CG, CC120G, CC80G, CC81CG, CC81G, CCG120CE, CCG120E, CCG80E, CCG81CE, CCG81E, SKC40G, SKC80G		
accessories for	104100		
	GEV No.	103065	Ref. No. M01000
burner ring for burner cap ø 80mm			
	GEV No.	103066	Ref. No. M00300
burner cap ø 80mm			
	GEV No.	104103	Ref. No. M00700
burner holder suitable for burner ø100mm with nozzle holder			

 <p>1</p>			
GEV No.	104101	Ref. No.	M00600
description	burner holder for burner cap ø 80mm with nozzle holder with mixing sleeve		
For models:	CC120CG, CC120G, CC80G, CC81CG, CC81G, CCG120CE, CCG120E, CCG80E, CCG81CE, CCG81E, SKC40G, SKC80G		
accessories for	104101		
	GEV No.	103065	Ref. No. M01000
burner ring for burner cap ø 80mm			
	GEV No.	103066	Ref. No. M00300
burner cap ø 80mm			

accessories for	104101		
	GEV No.	104100	Ref. No. M00800
burner head for burner cap ø 80mm			

 <p>1</p>			
GEV No.	104103	Ref. No.	M00700
description	burner holder suitable for burner ø100mm with nozzle holder		
For models:	CC120CG, CC120G, CC80G, CC81CG, CC81G, CCG120CE, CCG120E, CCG80E, CCG81CE, CCG81E, SKC40G, SKC80G		
accessories for	104103		
	GEV No.	103067	Ref. No. M01100
burner ring for burner cap ø 100mm			
	GEV No.	103068	Ref. No. M00400
burner cap ø 100mm			
	GEV No.	104102	Ref. No. M00900
burner head for burner cap ø 100mm ext. ø 130			

 <p>1</p>			
GEV No.	103067	Ref. No.	M01100
description	burner ring for burner cap ø 100mm		
For models:	CC120CG, CC120G, CC80G, CC81CG, CC81G, CCG120CE, CCG120E, CCG80E, CCG81CE, CCG81E, SKC40G, SKC80G		
accessories for	103067		
	GEV No.	103068	Ref. No. M00400
burner cap ø 100mm			
	GEV No.	104102	Ref. No. M00900
burner head for burner cap ø 100mm ext. ø 130			
	GEV No.	104103	Ref. No. M00700
burner holder suitable for burner ø100mm with nozzle holder			

 <p>1</p>			
GEV No.	103065	Ref. No.	M01000
description	burner ring for burner cap ø 80mm		
For models:	CC120CG, CC120G, CC80G, CC81CG, CC81G, CCG120CE, CCG120E, CCG80E, CCG81CE, CCG81E, SKC40G, SKC80G		
accessories for	103065		
	GEV No.	103066	Ref. No. M00300
burner cap ø 80mm			
	GEV No.	104100	Ref. No. M00800
burner head for burner cap ø 80mm			
	GEV No.	104101	Ref. No. M00600
burner holder for burner cap ø 80mm with nozzle holder with mixing sleeve			



Top 700, Sistema 800, Opera 900 series



GEV No.	108144	Ref. No.	V00400
description	burner cap ø 117mm 6/7.8kW		
For models:	2FZP, B4FZ, B6FZ, B8FZ, C2FZ, C2FZP, C2TP2FGP, C4FZ, C4FZFCE, C4FZFCEP, C4FZFCEG, C4FZFCEP, C4FZFE, C4FZFEP, C4FZFG, C4FZFGP, C4FZP, C4FZSFCEP, C4FZSFCEG, C4FZSFCEP, C4FZSFGP, C4FZSP, C6FZ, C6FZFCE, C6FZFCEP, C6FZFCEPV, C6FZFCEV, C6FZFCEG, C6FZFCEG, C6FZFCEGP, C6FZFCEGPV, C6FZFCEGV, C6FZFE, C6FZFEP, C6FZFG, C6FZFGA, C6FZFGAP, C6FZFGP, C6FZP, I2FZ, I2FZP, I4FZ, I4FZP, I6FZP, K2FZ, K4FZ, K4FZFCE, K4FZFCEG, K4FZFEP, K4FZFEG, K4FZFEGA...(Other models you can see in the webshop)		
accessories for	108144		
	GEV No.	106422	Ref. No. 0000V01900 V01900
	burner lower part for burner cap ø 117/125mm 6/7.8/9.5kW		
	GEV No.	108143	Ref. No. V00200
	burner head for burner cap ø 117mm 6/7.8kW		



GEV No.	103018	Ref. No.	V02600
description	burner cap ø 125mm		
For models:	B4FZ, B6FZ, B8FZ, K2FZ, K4FZ, K4FZFCE, K4FZFCEG, K4FZFEP, K4FZFEG, K4FZFEGA, K4FZS, K4FZSFCE, K4FZSFCEG, K4FZSFE, K4FZSFG, K6FZ, K6FZFCE, K6FZFCEG, K6FZFEP, K6FZFEG, K6FZFEGA, K8FZ, K8FZFCE, K8FZFCEG, K8FZFE, K8FZFEG, OP2FZ, OP4FZ, OP6FZ, OP8FZ, OPFZ		



GEV No.	103026	Ref. No.	V00300
description	burner cap ø 87mm 4kW		
For models:	2FZP, B4FZ, B6FZ, B8FZ, C2FZ, C2FZP, C4FZ, C4FZFCE, C4FZFCEP, C4FZFCEG, C4FZFCEGP, C4FZFE, C4FZFEP, C4FZFG, C4FZFGP, C4FZP, C6FZ, C6FZFCE, C6FZFCEP, C6FZFCEPV, C6FZFCEV, C6FZFCEG, C6FZFCEG, C6FZFCEGP, C6FZFCEGPV, C6FZFCEGV, C6FZFE, C6FZFEP, C6FZFG, C6FZFGA, C6FZFGAP, C6FZFGP, C6FZP, I2FZ, I2FZP, I4FZ, I4FZP, I6FZP, K2FZ, K4FZ, K4FZFCE, K4FZFCEG, K4FZFEP, K4FZFEG, K4FZFEGA, K4FZSFG, K6FZ, K6FZFCE, K6FZFCEG, K6FZFEP, K6FZFEG...(Other models you can see in the webshop)		
accessories for	103026		
	GEV No.	103000	Ref. No. V01800
	burner lower part for burner cap ø 87mm 4kW		
	GEV No.	103025	Ref. No. V00100
	burner head for burner cap ø 87mm 4kW		



GEV No.	108143	Ref. No.	V00200
description	burner head for burner cap ø 117mm 6/7.8kW		
For models:	2FZP, B4FZ, B6FZ, B8FZ, C2FZ, C2FZP, C2TP2FGP, C4FZ, C4FZFCE, C4FZFCEP, C4FZFCEG, C4FZFCEP, C4FZFE, C4FZFEP, C4FZFG, C4FZFGP, C4FZP, C4FZSFCEP, C4FZSFCEG, C4FZSFCEP, C4FZSFGP, C4FZSP, C6FZ, C6FZFCE, C6FZFCEP, C6FZFCEPV, C6FZFCEV, C6FZFCEG, C6FZFCEG, C6FZFCEGP, C6FZFCEGPV, C6FZFCEGV, C6FZFE, C6FZFEP, C6FZFG, C6FZFGA, C6FZFGAP, C6FZFGP, C6FZP, I2FZ, I2FZP, I4FZ, I4FZP, I6FZP, K2FZ, K4FZ, K4FZFCE, K4FZFCEG, K4FZFEP, K4FZFEG, K4FZFEGA...(Other models you can see in the webshop)		
accessories for	108143		
	GEV No.	106422	Ref. No. 0000V01900 V01900
	burner lower part for burner cap ø 117/125mm 6/7.8/9.5kW		
	GEV No.	108144	Ref. No. V00400
	burner cap ø 117mm 6/7.8kW		



GEV No.	103017	Ref. No.	V02500
description	burner head for burner cap ø 125mm 9.5kW		
For models:	B4FZ, B6FZ, B8FZ, K2FZ, K4FZ, K4FZFCE, K4FZFCEG, K4FZFEP, K4FZFEG, K4FZFEGA, K4FZS, K4FZSFCE, K4FZSFCEG, K4FZSFE, K4FZSFG, K6FZ, K6FZFCE, K6FZFCEG, K6FZFEP, K6FZFEG, K6FZFEGA, K8FZ, K8FZFCE, K8FZFCEG, K8FZFE, K8FZFEG, OP2FZ, OP4FZ, OP6FZ, OP8FZ, OPFZ		





GEV No.	103025	Ref. No.	V00100
description	burner head for burner cap ø 87mm 4kW		
For models:	2FZP, B4FZ, B6FZ, B8FZ, C2FZ, C2FZP, C4FZ, C4FZFCE, C4FZFCEP, C4FZFCEG, C4FZFCEGP, C4FZFE, C4FZFEP, C4FZFG, C4FZFGP, C4FZP, C6FZ, C6FZFCE, C6FZFCEP, C6FZFCEPV, C6FZFCEV, C6FZFCEG, C6FZFCEG, C6FZFCEGP, C6FZFCEGPV, C6FZFCEGV, C6FZFE, C6FZFEP, C6FZFG, C6FZFGA, C6FZFGAP, C6FZFGP, C6FZP, I2FZ, I2FZP, I4FZ, I4FZP, I6FZP, K2FZ, K4FZ, K4FZFCE, K4FZFCEG, K4FZFEP, K4FZFEG, K4FZFEGA, K4FZSFG, K6FZ, K6FZFCE, K6FZFCEG, K6FZFEP, K6FZFEG...(Other models you can see in the webshop)		
accessories for	103025		
	GEV No.	103000	Ref. No. V01800
	burner lower part for burner cap ø 87mm 4kW		
	GEV No.	103026	Ref. No. V00300
	burner cap ø 87mm 4kW		















							
1							
GEV No.	106422	Ref. No.	0000V01900				
description	burner lower part for burner cap ø 117/125mm 6/7.8/9.5kW						
For models:	2FZP, B4FZ, B6FZ, B8FZ, C2FZP, C2TP2FGP, C4FZFCEP, C4FZFCGP, C4FZFEP, C4FZFPG, C4FZFP, C4FZSFCEP, C4FZSFCGP, C4FZSFEP, C4FZSFGP, C4FZSP, C6FZFCEP, C6FZFCEPV, C6FZFCGP, C6FZFCGPV, C6FZFEP, C6FZFGAP, C6FZFGP, C6FZP, I2FZP, I4FZP, I6FZP, K2FZ, K4FZ, K4FZFCE, K4FZFCG, K4FZFE, K4FZFG, K4FZFGA, K4FZS, K4FZSFCE, K4FZSFCG, K4FZSFE, K4FZSFG, K6FZ, K6FZFCE, K6FZFCG, K6FZFE, K6FZFG, K6FZFGA, K8FZ, K8FZFCE, K8FZFCG, K8FZFE, K8FZFG...(Other models you can see in the webshop)						
accessories for	106422						
	<table border="1"> <tr> <td>GEV No.</td> <td>108143</td> <td>Ref. No.</td> <td>V00200</td> </tr> </table> 	GEV No.	108143	Ref. No.	V00200	burner head for burner cap ø 117mm 6/7.8kW	
GEV No.	108143	Ref. No.	V00200				
	<table border="1"> <tr> <td>GEV No.</td> <td>108144</td> <td>Ref. No.</td> <td>V00400</td> </tr> </table> 	GEV No.	108144	Ref. No.	V00400	burner cap ø 117mm 6/7.8kW	
GEV No.	108144	Ref. No.	V00400				









							
1							
GEV No.	103000	Ref. No.	V01800				
description	burner lower part for burner cap ø 87mm 4kW						
For models:	2FZP, B4FZ, B6FZ, B8FZ, C2FZP, C4FZFCEP, C4FZFCGP, C4FZFEP, C4FZFPG, C4FZFP, C6FZFCEP, C6FZFCEPV, C6FZFCGP, C6FZFCGPV, C6FZFEP, C6FZFGAP, C6FZFGP, C6FZP, I2FZP, I4FZP, I6FZP, K2FZ, K4FZ, K4FZFCE, K4FZFCG, K4FZFE, K4FZFG, K4FZFGA, K4FZSFG, K6FZ, K6FZFCE, K6FZFCG, K6FZFE, K6FZFG, K8FZ, K8FZFCE, K8FZFCG, K8FZFE, K8FZFG, M74FMP, M74FMPFE, M74FMPFG, M74FMPFXE, M74FMPFXG, M76FMP, M76FMPFE, M76FMPFG, M76FMPFXE, M76FMPFXG, OP2FZ...(Other models you can see in the webshop)						
accessories for	103000						
	<table border="1"> <tr> <td>GEV No.</td> <td>103025</td> <td>Ref. No.</td> <td>V00100</td> </tr> </table> 	GEV No.	103025	Ref. No.	V00100	burner head for burner cap ø 87mm 4kW	
GEV No.	103025	Ref. No.	V00100				
	<table border="1"> <tr> <td>GEV No.</td> <td>103026</td> <td>Ref. No.</td> <td>V00300</td> </tr> </table> 	GEV No.	103026	Ref. No.	V00300	burner cap ø 87mm 4kW	
GEV No.	103026	Ref. No.	V00300				

Counter 700, Kappa 900 series

							
1							
GEV No.	105300	Ref. No.	X21800				
description	burner cap ø 120mm 7kW with central hole ID ø 64mm						
For models:	B4F, B6F, B8F, FCE, FCG, FE, K4F, K4FFE, K4FFG, K4FS, K4FSFCE, K4FSFCG, K4FSFE, K4FSFG, K6F, K6FFE, K6FFG, K6FG, K8F, K8FFE, K8FFG, OP4F, OP4FS, OP6F, OP8F						
accessories for	105300						
	<table border="1"> <tr> <td>GEV No.</td> <td>100907</td> <td>Ref. No.</td> <td>—</td> </tr> </table> 	GEV No.	100907	Ref. No.	—	screw connection thread M10x1 Qty 1 pcs type SEF 1 ømm for thermocouple	
GEV No.	100907	Ref. No.	—				
	<table border="1"> <tr> <td>GEV No.</td> <td>101452</td> <td>Ref. No.</td> <td>B83900</td> </tr> </table> 	GEV No.	101452	Ref. No.	B83900	ignition electrode support for burner type C/D suitable for 900 series	
GEV No.	101452	Ref. No.	B83900				

accessories for	105300						
	<table border="1"> <tr> <td>GEV No.</td> <td>101453</td> <td>Ref. No.</td> <td>B83800</td> </tr> </table> 	GEV No.	101453	Ref. No.	B83800	bracket for thermocouple gas range for burner type C/D suitable for 900 series	
GEV No.	101453	Ref. No.	B83800				
	<table border="1"> <tr> <td>GEV No.</td> <td>101454</td> <td>Ref. No.</td> <td>—</td> </tr> </table> 	GEV No.	101454	Ref. No.	—	union screw for igniter thread M10x1 ID ø 7mm L 15mm	
GEV No.	101454	Ref. No.	—				
	<table border="1"> <tr> <td>GEV No.</td> <td>104108</td> <td>Ref. No.</td> <td>0000X16100</td> </tr> </table> 	GEV No.	104108	Ref. No.	0000X16100	nozzle holder nozzle mounting M10x1 tube ø 10mm gas inlet M16x1.5 gas outlet M14x1	
GEV No.	104108	Ref. No.	0000X16100				
	<table border="1"> <tr> <td>GEV No.</td> <td>104294</td> <td>Ref. No.</td> <td>—</td> </tr> </table> 	GEV No.	104294	Ref. No.	—	burner head E for burner cap ø 120mm 8.3kW	
GEV No.	104294	Ref. No.	—				
	<table border="1"> <tr> <td>GEV No.</td> <td>105301</td> <td>Ref. No.</td> <td>—</td> </tr> </table> 	GEV No.	105301	Ref. No.	—	venturi for burner cap ø 120mm 7kW	
GEV No.	105301	Ref. No.	—				









							
1							
GEV No.	103069	Ref. No.	X21600				
description	burner cap ø 80mm 4.3kW with central hole						
For models:	B4F, B6F, B8F, C2F, C2FP, C2FTPE, C2FTPEP, C2FTPEG, C2FTPEGP, C2TP2FGP, C4F, C4FFCEP, C4FFCGP, C4FFE, C4FFEP, C4FFG, C4FFGP, C4FFLE, C4FFLEP, C4FFLG, C4FFLGP, C4FP, C6F, C6FFCEP, C6FFCGP, C6FFE, C6FFEP, C6FFG, C6FFGA, C6FFGAP, C6FFGP, C6FFLE, C6FFLEP, C6FFLEPV, C6FFLEV, C6FFLG, C6FFLGP, C6FFLGPV, C6FFLGV, C6FP, FE, K2F, K2FTPECE, K2FTPECG, K2FTPEE, K2FTPEG, K4F, K4FFE, K4FFG, K6F...(Other models you can see in the webshop)						
accessories for	103069						
	<table border="1"> <tr> <td>GEV No.</td> <td>100907</td> <td>Ref. No.</td> <td>—</td> </tr> </table> 	GEV No.	100907	Ref. No.	—	screw connection thread M10x1 Qty 1 pcs type SEF 1 ømm for thermocouple	
GEV No.	100907	Ref. No.	—				
	<table border="1"> <tr> <td>GEV No.</td> <td>101452</td> <td>Ref. No.</td> <td>B83900</td> </tr> </table> 	GEV No.	101452	Ref. No.	B83900	ignition electrode support for burner type C/D suitable for 900 series	
GEV No.	101452	Ref. No.	B83900				
	<table border="1"> <tr> <td>GEV No.</td> <td>101453</td> <td>Ref. No.</td> <td>B83800</td> </tr> </table> 	GEV No.	101453	Ref. No.	B83800	bracket for thermocouple gas range for burner type C/D suitable for 900 series	
GEV No.	101453	Ref. No.	B83800				
	<table border="1"> <tr> <td>GEV No.</td> <td>101454</td> <td>Ref. No.</td> <td>—</td> </tr> </table> 	GEV No.	101454	Ref. No.	—	union screw for igniter thread M10x1 ID ø 7mm L 15mm	
GEV No.	101454	Ref. No.	—				
	<table border="1"> <tr> <td>GEV No.</td> <td>104104</td> <td>Ref. No.</td> <td>—</td> </tr> </table> 	GEV No.	104104	Ref. No.	—	burner head for burner cap ø 80mm 3.5kW code 100212	
GEV No.	104104	Ref. No.	—				
	<table border="1"> <tr> <td>GEV No.</td> <td>104105</td> <td>Ref. No.</td> <td>0900X21300</td> </tr> </table> 	GEV No.	104105	Ref. No.	0900X21300	burner lower part for burner cap ø 80mm 3.5kW	
GEV No.	104105	Ref. No.	0900X21300				
	<table border="1"> <tr> <td>GEV No.</td> <td>104108</td> <td>Ref. No.</td> <td>0000X16100</td> </tr> </table> 	GEV No.	104108	Ref. No.	0000X16100	nozzle holder nozzle mounting M10x1 tube ø 10mm gas inlet M16x1.5 gas outlet M14x1	
GEV No.	104108	Ref. No.	0000X16100				
	<table border="1"> <tr> <td>GEV No.</td> <td>105297</td> <td>Ref. No.</td> <td>0750X22200 0900X22200 721-030-00</td> </tr> </table> 	GEV No.	105297	Ref. No.	0750X22200 0900X22200 721-030-00	burner head for burner cap ø 80mm 4.3kW for pilot burner	
GEV No.	105297	Ref. No.	0750X22200 0900X22200 721-030-00				

			
1			
GEV No.	103070	Ref. No.	X21700
description	burner cap ø 95mm 6.4kW with central hole		
For models:	B4F, B6F, B8F, C2F, C2FP, C2FTPFE, C2FTPFE, C2FTPFG, C2FTPFGP, C2TP2FGP, C4F, C4FFCEP, C4FFCGP, C4FFE, C4FFEP, C4FFG, C4FFGP, C4FFLE, C4FFLEP, C4FFLG, C4FFLGP, C4FP, C6F, C6FFCEP, C6FFCGP, C6FFE, C6FFEP, C6FFG, C6FFGA, C6FFGAP, C6FFGP, C6FFLE, C6FFLEP, C6FFLEPV, C6FFLEV, C6FFLG, C6FFLGP, C6FFLGPV, C6FFLGV, C6FP, K2F, K2FTPFE, K2FTPFCG, K2FTPFE, K2FTPFG, K4F, K4FFE, K4FFG, K6F, K6FFE...(Other models you can see in the webshop)		
accessories for	103070		
	GEV No.	100907	Ref. No. —
	screw connection thread M10x1 Qty 1 pcs type SEF 1 ømm for thermocouple		
	GEV No.	101452	Ref. No. B83900
	ignition electrode support for burner type C/D suitable for 900 series		
	GEV No.	101453	Ref. No. B83800
	bracket for thermocouple gas range for burner type C/D suitable for 900 series		
	GEV No.	101454	Ref. No. —
	union screw for igniter thread M10x1 ID ø 7mm L 15mm		
	GEV No.	104106	Ref. No. —
	burner head for burner cap ø 100mm 5.5kW for igniter		
	GEV No.	104107	Ref. No. —
	burner lower part for burner cap ø 100mm 6.4kW		
	GEV No.	104108	Ref. No. 0000X16100
	nozzle holder nozzle mounting M10x1 tube ø 10mm gas inlet M16x1.5 gas outlet M14x1		









			
1			
GEV No.	104478	Ref. No.	0750X21100 0900X21100
description	burner head for burner cap ø 100mm for igniter		
For models:	C2F, C2FTPFE, C2FTPFG, C2TP2FGP, C4F, C4FFE, C4FFG, C4FFLE, C4FFLG, C6F, C6FFE, C6FFG, C6FFGA, C6FFLE, C6FFLEV, C6FFLG, C6FFLGP, T2F, T4F, T6F		

			
1			
GEV No.	105348	Ref. No.	0750X21200 0900X21200 721-026-00
description	burner head for burner cap ø 120mm 7kW with ignition flame		
For models:	B4F, B6F, B8F, FCE, FCG, FE, K4F, K4FFE, K4FFG, K4FS, K4FSFCE, K4FSFCG, K4FSFE, K4FSFG, K6F, K6FFE, K6FFG, K6FG, K8F, K8FFE, K8FFG, OP4F, OP4FS, OP6F, OP8F		

			
1			
GEV No.	104480	Ref. No.	0750X21000 0900X21000
description	burner head for burner cap ø 80mm 3.5kW		
For models:	C2F, C2FTPFE, C2FTPFG, C4F, C4FFE, C4FFG, C4FFLE, C4FFLG, C6F, C6FFE, C6FFG, C6FFGA, C6FFLE, C6FFLEV, C6FFLG, C6FFLGP, T2F, T4F, T6F		



			
1			
GEV No.	105297	Ref. No.	0750X22200 0900X22200 721-030-00
description	burner head for burner cap ø 80mm 4.3kW for pilot burner		
For models:	B4F, B6F, B8F, C2FP, C2FTPFE, C2FTPFG, C2TP2FGP, C4FFCEP, C4FFCGP, C4FFEP, C4FFGP, C4FFLE, C4FFLGP, C4FP, C6FFCEP, C6FFCGP, C6FFEP, C6FFGAP, C6FFGP, C6FFLE, C6FFLEPV, C6FFLG, C6FFLGPV, C6FP, FE, K2F, K2FTPFE, K2FTPFCG, K2FTPFE, K2FTPFG, K4F, K4FFE, K4FFG, K6F, K6FFE, K6FFG, K6FG, K8F, K8FFE, K8FFG, OP2F, OP4F, OP6F, OP8F, T2FP, T4FP, T6FP		
accessories for	105297		
	GEV No.	100907	Ref. No. —
	screw connection thread M10x1 Qty 1 pcs type SEF 1 ømm for thermocouple		
	GEV No.	101452	Ref. No. B83900
	ignition electrode support for burner type C/D suitable for 900 series		
	GEV No.	101453	Ref. No. B83800
	bracket for thermocouple gas range for burner type C/D suitable for 900 series		
	GEV No.	101454	Ref. No. —
	union screw for igniter thread M10x1 ID ø 7mm L 15mm		
	GEV No.	103069	Ref. No. X21600
	burner cap ø 80mm 4.3kW with central hole		
	GEV No.	104105	Ref. No. 0900X21300
	burner lower part for burner cap ø 80mm 3.5kW		
	GEV No.	104108	Ref. No. 0000X16100
	nozzle holder nozzle mounting M10x1 tube ø 10mm gas inlet M16x1.5 gas outlet M14x1		



			
GEV No.	105298	Ref. No.	0750X22100 0900X22100 721-028-00
description	burner head for burner cap ø 95mm 6.4kW for pilot burner		
For models:	B4F, B6F, B8F, C2F, C2FTPFE, C2FTPFGP, C2TP2FGP, C4FFCEP, C4FFCGP, C4FFEP, C4FFGP, C4FFLEP, C4FFLGP, C4FP, C6FFCEP, C6FFCGP, C6FFEP, C6FFGAP, C6FFGP, C6FFLEP, C6FFLEPV, C6FFLGP, C6FFLGPV, C6FP, K2F, K2FTPCE, K2FTPFCG, K2FTPFE, K2FTPFG, K4F, K4FFE, K4FFG, K6F, K6FFE, K6FFG, K8F, K8FFE, K8FFG, OP2F, OP4F, OP6F, OP8F, T2FP, T4FP, T6FP		
accessories for	105298		
	GEV No.	100907	Ref. No. —
	screw connection thread M10x1 Qty 1 pcs type SEF 1 ømm for thermocouple		
	GEV No.	101452	Ref. No. B83900
	ignition electrode support for burner type C/D suitable for 900 series		
	GEV No.	101453	Ref. No. B83800
	bracket for thermocouple gas range for burner type C/D suitable for 900 series		
	GEV No.	101454	Ref. No. —
	union screw for igniter thread M10x1 ID ø 7mm L 15mm		
	GEV No.	103070	Ref. No. X21700
	burner cap ø 95mm 6.4kW with central hole		
	GEV No.	104107	Ref. No. —
	burner lower part for burner cap ø 100mm 6.4kW		
	GEV No.	104108	Ref. No. 0000X16100
	nozzle holder nozzle mounting M10x1 tube ø 10mm gas inlet M16x1.5 gas outlet M14x1		



			
GEV No.	104482	Ref. No.	0750X21300 0900X21300 721-029-00
description	burner lower part 3.5/4.3kW		
For models:	B4F, B6F, B8F, C2F, C2FP, C2FTPFE, C2FTPFGP, C2FTPFG, C2FTPFGP, C2TP2FGP, C4F, C4FFCEP, C4FFCGP, C4FFE, C4FFEP, C4FFG, C4FFGP, C4FFLE, C4FFLEP, C4FFLG, C4FFLGP, C4FP, C6F, C6FFCEP, C6FFCGP, C6FFE, C6FFEP, C6FFG, C6FFGA, C6FFGAP, C6FFGP, C6FFLE, C6FFLEP, C6FFLEPV, C6FFLEV, C6FFLG, C6FFLGP, C6FFLGPV, C6FFLGV, C6FP, K2F, K2FTPCE, K2FTPFCG, K2FTPFE, K2FTPFG, K4F, K4FFE, K4FFG, K6F, K6FFE...(Other models you can see in the webshop)		





			
GEV No.	104476	Ref. No.	0750X21400 0900X21400
description	burner lower part 5.5/6.4kW		
For models:	B4F, B6F, B8F, C2F, C2FP, C2FTPFE, C2FTPFGP, C2FTPFG, C2FTPFGP, C2TP2FGP, C4F, C4FFCEP, C4FFCGP, C4FFE, C4FFEP, C4FFG, C4FFGP, C4FFLE, C4FFLEP, C4FFLG, C4FFLGP, C4FP, C6F, C6FFCEP, C6FFCGP, C6FFE, C6FFEP, C6FFG, C6FFGA, C6FFGAP, C6FFGP, C6FFLE, C6FFLEP, C6FFLEPV, C6FFLEV, C6FFLG, C6FFLGP, C6FFLGPV, C6FFLGV, C6FP, K2F, K2FTPCE, K2FTPFCG, K2FTPFE, K2FTPFG, K4F, K4FFE, K4FFG, K6F, K6FFE...(Other models you can see in the webshop)		

			
GEV No.	104477	Ref. No.	0750X21500 0900X21500 721-025-00
description	burner lower part 7/8.3kW		
For models:	B4F, B6F, B8F, FCE, FCG, FE, K4F, K4FFE, K4FFG, K4FS, K4FSFCE, K4FSFCG, K4FSFE, K4FSFG, K6F, K6FFE, K6FFG, K6FG, K8F, K8FFE, K8FFG, OP4F, OP4FS, OP6F, OP8F		
accessories for	104477		
	GEV No.	104108	Ref. No. 0000X16100
	nozzle holder nozzle mounting M10x1 tube ø 10mm gas inlet M16x1.5 gas outlet M14x1		

			
GEV No.	104105	Ref. No.	0900X21300
description	burner lower part for burner cap ø 80mm 3.5kW		
accessories for	104105		
	GEV No.	100907	Ref. No. —
	screw connection thread M10x1 Qty 1 pcs type SEF 1 ømm for thermocouple		
	GEV No.	101452	Ref. No. B83900
	ignition electrode support for burner type C/D suitable for 900 series		
	GEV No.	101453	Ref. No. B83800
	bracket for thermocouple gas range for burner type C/D suitable for 900 series		
	GEV No.	101454	Ref. No. —
	union screw for igniter thread M10x1 ID ø 7mm L 15mm		
	GEV No.	103069	Ref. No. X21600
	burner cap ø 80mm 4.3kW with central hole		
	GEV No.	104104	Ref. No. —
	burner head for burner cap ø 80mm 3.5kW code 100212		



Table continues overleaf



accessories for 104105			
	GEV No.	104108	Ref. No. 0000X16100
nozzle holder nozzle mounting M10x1 tube ø 10mm gas inlet M16x1.5 gas outlet M14x1			
	GEV No.	105297	Ref. No. 0750X22200 0900X22200 721-030-00
burner head for burner cap ø 80mm 4.3kW for pilot burner			





1 			
GEV No.	104108	Ref. No.	0000X16100
description	nozzle holder nozzle mounting M10x1 tube ø 10mm gas inlet M16x1.5 gas outlet M14x1		
For models:	B4F, B6F, B8, B8F, C2F, C2FP, C2FTPFE, C2FTPFEF, C2FTPFG, C2FTPFGP, C2TP2FGP, C4F, C4FFCEP, C4FFCGP, C4FFE, C4FFEP, C4FFG, C4FFGP, C4FFLE, C4FFLEP, C4FFLG, C4FFLGP, C4FP, C4FZFG, C4FZFGP, C4FZS-FGP, C6F, C6FFCEP, C6FFCGP, C6FFE, C6FFEP, C6FFG, C6FFGA, C6FF-GAP, C6FFGP, C6FFLE, C6FFLEP, C6FFLEPV, C6FFLEV, C6FFLG, C6FFLGP, C6FFLGPV, C6FFLGV, C6FP, C6FZFG, C6FZFGP, CCTP8, CCTPFE8, CCTPFG8, CF10DG8M...(Other models you can see in the webshop)		
accessories for 104108			
	GEV No.	102382	Ref. No. —
nut thread M14x1 H 3.5mm WS 18 brass Qty 1 pcs			
	GEV No.	104105	Ref. No. 0900X21300
burner lower part for burner cap ø 80mm 3.5kW			
	GEV No.	104107	Ref. No. —
burner lower part for burner cap ø 100mm 6.4kW			

solid tops			
			
1			
GEV No.	107586	Ref. No.	X22800
description	round burner ø 120mm		
For models:	C2FTPFGP, CCTP8, CCTPFG8, K2FTPFE, K2FTPFCG, K2FTPFE, K2FTPFG, KTP, KTPFCE, KTPFCG, KTPFE, KTPFG, OPTP, TTP8		

			
1			
GEV No.	105104	Ref. No.	0903X20900
description	round burner ø 180mm		
For models:	C2FTPFE, C2FTPFEF, C2FTPFG, C2FTPFGP, CCTP8, CCTPFG8		

miscellaneous			
			
1			
GEV No.	108145	Ref. No.	AGB004ZR10
description	burner cap ø 100mm		
For models:	CC120CG, CC80G, CC81CG, CCG120CE, CCG80E, CCG81CE, M62F, M64F, M74F, M74FFXE, M74FFXG, M76F, M76FFXE, M76FFXG, SKC40G, SKC80G		
accessories for 108145			
	GEV No.	108146	Ref. No. AGB003ZR10
burner head for burner cap ø 100mm			

			
1			
GEV No.	108146	Ref. No.	AGB003ZR10
description	burner head for burner cap ø 100mm		
For models:	CC120CG, CC80G, CC81CG, CCG120CE, CCG80E, CCG81CE, M62F, M64F, M74F, M74FFXE, M74FFXG, M76F, M76FFXE, M76FFXG, SKC40G, SKC80G		
accessories for 108146			
	GEV No.	108145	Ref. No. AGB004ZR10
burner cap ø 100mm			
	GEV No.	108147	Ref. No. AGB012ZR10
burner lower part for burner cap ø 100mm			

			
1			
GEV No.	108147	Ref. No.	AGB012ZR10
description	burner lower part for burner cap ø 100mm		
For models:	CC120CG, CC80G, CC81CG, CCG120CE, CCG80E, CCG81CE, M62F, M64F, M74F, M74FFXE, M74FFXG, M76F, M76FFXE, M76FFXG, SKC40G, SKC80G		
accessories for 108147			
	GEV No.	102440	Ref. No. AGB011ZR10
ignition electrode			
	GEV No.	108145	Ref. No. AGB004ZR10
burner cap ø 100mm			
	GEV No.	108146	Ref. No. AGB003ZR10
burner head for burner cap ø 100mm			

pan supports



GEV No.	210163	Ref. No.	0550M48200
description	pan support		
For models:	CC120G, CC80G, CC81G, CCG120E, CCG80E, CCG81E, SKC40G, SKC80G		



GEV No.	210162	Ref. No.	KG1
description	pan support W 392mm L 385mm H 50mm mounting pos. lateral		
For models:	B4F, B6F, B8F, K2F, K2FTPF, K4F, K4FFE, K4FFG, K6F, K6FFE, K6FFG, K8F, K8FFE, K8FFG		



GEV No.	210255	Ref. No.	DFG001ZV10
description	pan support W 294mm L 538mm		
For models:	M62F, M64F, M72FPTFG, M74F, M74FFXE, M74FFXG, M74FMP, M74FMPFE, M74FMPFG, M74FMPFXE, M74FMPFXG, M74FP, M74FPFE, M74FPFG, M74FPFXE, M74FPFXG, M76F, M76FFXE, M76FFXG, M76FMP, M76FMPFE, M76FMPFG, M76FMPFXE, M76FMPFXG, M76FP, M76FPFE, M76FPFG, M76FPFXE, M76FPFXG		

accessories

reducers for pan supports

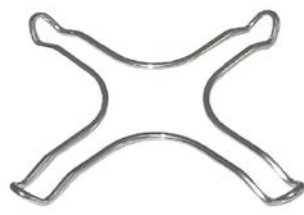

GEV No.	210050	Ref. No.	GR
description	reducer for pan support L 260mm W 260mm chrome-plated steel suitable for universal		



GEV No.	210245	Ref. No.	1550Y63000
description	pan support W 370mm L 580mm		
For models:	2FZP, C2FZ, C2FZP, C4FZ, C4FZFCE, C4FZFCEP, C4FZFCG, C4FZFCGP, C4FZFE, C4FZFEP, C4FZFG, C4FZFGP, C4FZP, C4FZSFCEP, C4FZSFCGP, C4FZSFE, C4FZSFGP, C4FZSP, C6FZ, C6FZFCE, C6FZFCEP, C6FZFCEPV, C6FZFCEV, C6FZFCG, C6FZFCGP, C6FZFCGPV, C6FZFCGV, C6FZFE, C6FZFEP, C6FZFG, C6FZFGA, C6FZFGAP, C6FZFGP, C6FZP, CC120CG, CC80G, CC81CG, CCG120CE, CCG80E, CCG81CE, I2FZ, I2FZP, I4FZ, I4FZP, I6FZP, SK2FP, SK4FP, SK4FZFCEP, SK4FZFCGP, SK6FZFCEP...(Other models you can see in the webshop)		



GEV No.	210163	Ref. No.	0550M48200
description	pan support		
For models:	CC120G, CC80G, CC81G, CCG120E, CCG80E, CCG81E, SKC40G, SKC80G		



GEV No.	210141	Ref. No.	1550X25000
description	pan support W 385mm L 580mm		



GEV No.	210255	Ref. No.	DFG001ZV10
description	pan support W 294mm L 538mm		
For models:	M62F, M64F, M72FPTFG, M74F, M74FFXE, M74FFXG, M74FMP, M74FMPFE, M74FMPFG, M74FMPFXE, M74FMPFXG, M74FP, M74FPFE, M74FPFG, M74FPFXE, M74FPFXG, M76F, M76FFXE, M76FFXG, M76FMP, M76FMPFE, M76FMPFG, M76FMPFXE, M76FMPFXG, M76FP, M76FPFE, M76FPFG, M76FPFXE, M76FPFXG		



bar burners

bar burners



GEV No.	105102	Ref. No.	X68046
----------------	--------	-----------------	--------

description	bar burner 1-row ø 27mm Wmm Hmm L 418mm oven
For models:	CBG4, CBG6, CBG8, CC80G, KB4G, KB8G, M74FFXG, M74FMPFXG, M74FPFXG, M76FFXG, M76FMPFXG, M76FPFXG, OPB4G, SKB40G, SKB60G, SKB80G, TB40G, TB60G, TB80G, TP40G

spare parts for	105102
------------------------	--------

	GEV No.	104651	Ref. No.	X68047
	mounting flange for igniter and thermocouple			



GEV No.	105115	Ref. No.	Y22200
----------------	--------	-----------------	--------

description	bar burner 1-row ø 40mm Wmm Hmm L 500mm flange width 43mm flange length 43mm tilting bratt pan
For models:	KBRG, KBRG12, KBRG12IN, KBRGIN, KBRGM, KBRGM12, KBRGM12IN, KBRGMIN, OPBRG, OPBRG12, OPBRG12IN, OPBRG12MIN, OPBRGIN, OPBRGM, OPBRGM12, OPBRGM12IN, OPBRGMIN



GEV No.	104217	Ref. No.	717-144-00 X23900
----------------	--------	-----------------	----------------------

description	bar burner 1-row ø 60mm Wmm Hmm L 505mm flange width 67mm flange length 67mm fryer
For models:	KCP4, KCP82, OPCP4, OPCP82



GEV No.	105260	Ref. No.	X20100
----------------	--------	-----------------	--------

description	bar burner 2 row L 450mm W 300mm ømm H 50mm 8.5kW griddle
For models:	CFTG2, CFTG2C, CFTG2R, CFTG6, CFTG6C, CFTG6R, SKT2G, SKT2GC, SKT2GR, SKT60G, SKT60GC, SKT60GR, TT2G, TT2GC, TT2GR, TT60G, TT60GC, TT60GR



GEV No.	105302	Ref. No.	Y22000
----------------	--------	-----------------	--------

description	bar burner 3 row L 445mm W 280mm ømm H 40mm solid top
For models:	K2FTPFC, K2FTPFCG, K2FTPFE, K2FTPFG, KTP, KTPFCE, KTPFCG, KTPFE, KTPFG, OPTP



GEV No.	105340	Ref. No.	X24100
----------------	--------	-----------------	--------

description	bar burner 3 row L 480mm W 305mm ømm H 60mm mounting distance 280mm chargrill
For models:	CPLG1, CPLG2, CPLG4, CPLG8, KPLG1, KPLG2, M7PL1G, M7PL2G, OPPLG1, OPPLG2, SKPL1G, SKPL2G, SKPL4G, SKPL8G, TPLG1, TPLG2



GEV No.	105303	Ref. No.	0000Y20100
----------------	--------	-----------------	------------

description	bar burner 3 row L 630mm W 265mm ømm H 60mm griddle
For models:	KFT4G, KFT4GC, KFT4GR, KFT8G, KFT8G23C, KFT8GC, KFT8GLR, KFT8GR, KFTG1, KFTG1C, KFTG1R, KFTG3, KFTG3C, KFTG3LR, KFTG4, KFTG4C, KFTG4R, KFTG8, KFTG8C, KFTG8LR, KTF4G, KTF4GC, KTF8GLR, OPFT4G, OPFT4GC, OPFT4GR, OPFT8G, OPFT8G23C, OPFT8GC, OPFT8GLR, OPFT8GR, OPTF4G, OPTF4GC, OPTF8GLR



GEV No.	109056	Ref. No.	DGB002ZR10
----------------	--------	-----------------	------------

description	bar burner angled L 460mm W 183mm ømm Hmm oven
For models:	M7FT4GL, M7FT4GR, M7FT6GL, M7FT6GLR



GEV No.	105105	Ref. No.	X20400
----------------	--------	-----------------	--------

description	bar burner angled L 600mm W 305mm ømm Hmm oven
For models:	C2FTPFG, C2FTPFGP, C2TP2FGP, C4FFG, C4FFGP, C4FZFG, C4FZFGP, C4FZSFGP, C6FFG, C6FFGP, C6FZFG, C6FZFGP, CCTPFG8, K2FTPFG, K4FFG, K4FSFG, K4FZFG, K4FZSFG, K6FFG, K6FZFG, K8FFG, K8FZFG, KTPFG



1

GEV No.	105114	Ref. No.	Y22100
description	bar burner for kettle		





1

GEV No.	109055	Ref. No.	DGB001ZR10
description	bar burner ø 26mm Wmm Hmm L 580mm oven		
For models:	M72FPTFG, M74FMPFG, M74FPFG, M76FMPFG, M76FPFG		



1

GEV No.	105103	Ref. No.	X68401	
description	bar burner ø 27mm Wmm Hmm L 638mm oven			
For models:	C4FFLG, C4FFLGP, C6FFLG, C6FFLGP, C6FFLGPV, C6FFLGV, CC120G, CC81G			
spare parts for	105103			
	GEV No.	104651	Ref. No.	X68047
	mounting flange for igniter and thermocouple			
accessories for	105103			
	GEV No.	104651	Ref. No.	X68047
	mounting flange for igniter and thermocouple			



1

GEV No.	105110	Ref. No.	X20600
description	bar burner ø 40mm Wmm Hmm L 323mm tilting bratt pan flange ø 61mm		
For models:	CBRG, CBRG8, CBRGIN, CPG, CPGI		



1

GEV No.	105718	Ref. No.	E30100
description	bar burner ø 40mm Wmm Hmm L 395mm flange ø 61mm tilting bratt pan		
For models:	CPG, CPGI, KP10G, KP10GA, KP10GT, KP10GTA, KP15G, KP15GA, KP15GT, KP15GTA, KPI10G, KPI10GA, KPI10GT, KPI10GTA, KPI15G, KPI15GA, KPI15GT, KPI15GTA, OPP10G, OPP10GA, OPP15G, OPP15GA, OPPI10G, OPPI10GA, OPPI15G, OPPI15GA		



1

GEV No.	105257	Ref. No.	Y22100
description	bar burner ø 40mm Wmm Hmm L 397mm kettle flange ø 61mm mounting distance 45mm		



1

GEV No.	105108	Ref. No.	X23800
description	bar burner ø 50mm Wmm Hmm L 350mm pasta cooker		
For models:	CCPG4, CCPG82		



1

GEV No.	109057	Ref. No.	Y23500
description	bar burner ø 60mm Wmm Hmm L 335mm pasta cooker		
For models:	CCPG4, CCPG82, M7CP4G		





1

GEV No.	105255	Ref. No.	0000X20000
description	bar burner ømm W 41mm H 34mm L 490mm flange width 70mm 5.5kW griddle		



			
1			
GEV No.	105256	Ref. No.	0000X20100
description	bar burner tilting bratt pan		

			
1			
GEV No.	105341	Ref. No.	B49900
description	lava rock grid L 450mm W 330mm		
For models:	CPLG4, CPLG8		

 Image not available			
1			
GEV No.	104651	Ref. No.	X68047
description	mounting flange for igniter and thermocouple		
spare parts for	104651		
	GEV No.	Ref. No.	X68401
	105103		
	bar burner ø 27mm Wmm Hmm L 638mm oven		
accessories for	104651		
	GEV No.	Ref. No.	X68401
	105103		
	bar burner ø 27mm Wmm Hmm L 638mm oven		

lava rock grids			
			
1			
GEV No.	105341	Ref. No.	B49900
description	lava rock grid L 450mm W 330mm		
For models:	CPLG4, CPLG8		

 Image not available			
1			
GEV No.	104651	Ref. No.	X68047
description	mounting flange for igniter and thermocouple		
spare parts for	104651		
	GEV No.	Ref. No.	X68401
	105103		
	bar burner ø 27mm Wmm Hmm L 638mm oven		
accessories for	104651		
	GEV No.	Ref. No.	X68401
	105103		
	bar burner ø 27mm Wmm Hmm L 638mm oven		

tube burners



			
1			
GEV No.	105107	Ref. No.	X23000
description	tubular burner L 255mm W 49mm H 65mm for fryer oval		
For models:	CF15DG8, CF15G4, KFG4, KFG8		

			
1			
GEV No.	105261	Ref. No.	0900X23100
description	tubular burner ø 74mm L 180mm W 75mm H 60mm for fryer round		
For models:	CF10DG8M, CF10G4M, KFG1, KFG2, M7F4G, M7F8G, OPFG1, OPFG2, SKF10GM, SKF20GM, TF10GM, TF20GM		

accessories

nozzle holders			
			
1			
GEV No.	106283	Ref. No.	X68042
description	nozzle holder nozzle M6 M10x1 screw pipe fitting 1/4" tube ø 6mm		
For models:	CBG4, CBG6, CBG8, KB4G, KB8G, OPB4G, SKB40G, SKB60G, SKB80G, TB40G, TB60G, TB80G, TP40G		

			
1			
GEV No.	104108	Ref. No.	0000X16100
description	nozzle holder nozzle mounting M10x1 tube ø 10mm gas inlet M16x1.5 gas outlet M14x1		
For models:	B4F, B6F, B8, B8F, C2F, C2FP, C2FTPFE, C2FTPFEF, C2FTPFG, C2FTPFGP, C2TP2FGP, C4F, C4FFCEP, C4FFCGP, C4FFE, C4FFEP, C4FFG, C4FFGP, C4FFLE, C4FFLEP, C4FFLG, C4FFLGP, C4FP, C4FZFG, C4FZFGP, C4FZS-FGP, C6F, C6FFCEP, C6FFCGP, C6FFE, C6FFEP, C6FFG, C6FFGA, C6FF-GAP, C6FFGP, C6FFLE, C6FFLEP, C6FFLEPV, C6FFLEV, C6FFLG, C6FFLGP, C6FFLGPV, C6FFLV, C6FP, C6FZFG, C6FZFGP, CCTP8, CCTPFE8, CCTPFG8, CF10DG8M...(Other models you can see in the webshop)		
accessories for	104108		
	GEV No.	102382	Ref. No. —
	nut thread M14x1 H 3.5mm WS 18 brass Qty 1 pcs		
	GEV No.	104105	Ref. No. 0900X21300
	burner lower part for burner cap ø 80mm 3.5kW		
	GEV No.	104107	Ref. No. —
	burner lower part for burner cap ø 100mm 6.4kW		

			
1			
GEV No.	106520	Ref. No.	0600V01100
description	nozzle holder thread 3/8" L 53mm IT M10x1 nozzle mounting M10x1		
For models:	2FZP, B4FZ, B6FZ, B8FZ, C2FZ, C2FZP, C2TP2FGP, C4FZ, C4FZFCE, C4FZFCEP, C4FZFCEG, C4FZFCEP, C4FZFEP, C4FZFG, C4FZFGP, C4FZP, C4FZSFCEP, C4FZSFCEG, C4FZSFEP, C4FZSFGP, C4FZSP, C6FZ, C6FZFCE, C6FZFCEP, C6FZFCEPV, C6FZFCEV, C6FZFCEG, C6FZFCEG, C6FZFCEGP, C6FZFCEGPV, C6FZFCEGV, C6FZFCE, C6FZFEP, C6FZFG, C6FZFGA, C6FZFGAP, C6FZFGP, C6FZP, K2FZ, K4FZ, K4FZFCE, K4FZFCEG, K4FZFCE, K4FZFG, K4FZFGA, K4FZS, K4FZSFCE, K4FZSFCEG, K4FZSFE, K4FZSFG...(Other models you can see in the webshop)		
accessories for	106520		
	GEV No.	106521	Ref. No. 0600V01500 V01500
	air mixing sleeve L 30mm thread 3/8" IT		

miscellaneous			
			
1			
GEV No.	104481	Ref. No.	872-091-00
description	reducer for burner H 7mm D1 ø 24mm D2 ø 26mm hole ø 14mm		
For models:	B4F, B6F, B8F, C2FP, C2TP2FGP, C4FFCEP, C4FFCGP, C4FFEP, C4FFGP, C4FP, C6FFCEP, C6FFCGP, C6FFEP, C6FFGP, C6FP, K2F, K2FTPCE, K2FTPCEG, K2FTPFE, K2FTPFG, K4F, K4FFE, K4FFG, K4FS, K4FSCE, K4FSCEG, K4FSFE, K4FSFG, K6F, K6FFE, K6FFG, K8F, K8FFE, K8FFG, OP2F, OP4F, OP4FS, OP6F, OP8F, T2FP, T4FP, T6FP		

gas nozzles

main nozzles

gas nozzles M6x0.75

			
1			
GEV No.	106481	Ref. No.	DGI095N09E
description	gas injector thread M6x0.75 WS 7 bore ø 0.95mm		
For models:	CC120CG, CC80G, CC81CG, CCG120CE, CCG80E, CCG81CE, M62F, M64F, M74F, M74FFXE, M74FFXG, M74FMPFXG, M74FPFXG, M76F, M76FFXE, M76FFXG, M76FMPFXG, M76FPFXG, M77T6GL, M77T6GLR, SKC40G, SKC80G		

			
1			
GEV No.	106591	Ref. No.	X25800
description	gas injector thread M6x0.75 WS 7 bore ø 1.15mm		
For models:	CBG4, CBG6, CBG8, CC80G, KB4G, KB8G, OPB4G, SKB40G, SKB60G, SKB80G, TB40G, TB60G, TB80G, TP40G		

			
1			
GEV No.	106482	Ref. No.	DGI110N09E
description	gas injector thread M6x0.75 WS 7 bore ø 1.1mm		
For models:	M77T4GL, M77T4GR		

			
1			
GEV No.	106483	Ref. No.	DGI135N09E
description	gas injector thread M6x0.75 WS 7 bore ø 1.35mm		
For models:	M72FPTFG, M74FMPFG, M74FPFG, M76FMPFG, M76FPFG		

			
1			
GEV No.	106484	Ref. No.	DGI145N09E
description	gas injector thread M6x0.75 WS 7 bore ø 1.45mm		
For models:	M62F, M64F, M74F, M74FFXE, M74FFXG, M74FMPFXG, M74FPFXG, M76F, M76FFXE, M76FFXG, M76FMPFXG, M76FPFXG, M77T6GL, M77T6GLR		





			
1			
GEV No.	106485	Ref. No.	DGI160N09E
description	gas injector thread M6x0.75 WS 7 bore ø 1.6mm		
For models:	M7FT4GL, M7FT4GR		

			
1			
GEV No.	106486	Ref. No.	DGI198N09E
description	gas injector thread M6x0.75 WS 7 bore ø 1.98mm		
For models:	M72FPTFG, M74FMPFG, M74FPFG, M76FMPFG, M76FPFG		

gas nozzles M7x1

			
1			
GEV No.	100976	Ref. No.	X37800
description	gas injector thread M7x1 WS 10 bore ø 0.7mm		

			
1			
GEV No.	100518	Ref. No.	X38100
description	gas injector thread M7x1 WS 10 bore ø 0.85mm		

			
1			
GEV No.	100517	Ref. No.	X38000
description	gas injector thread M7x1 WS 10 bore ø 0.8mm		
For models:	CC120CG, CC120G, CC80G, CC81CG, CC81G, CCG120CE, CCG120E, CCG80E, CCG81CE, CCG81E, SKC40G, SKC80G		

			
1			
GEV No.	100519	Ref. No.	X38300
description	gas injector thread M7x1 WS 10 bore ø 0.95mm		
For models:	CC120CG, CC120G, CC80G, CC81CG, CC81G, CCG120CE, CCG120E, CCG80E, CCG81CE, CCG81E, SKC40G, SKC80G		

			
1			
GEV No.	100523	Ref. No.	X38800
description	gas injector thread M7x1 WS 10 bore ø 1.4mm		
For models:	CC120CG, CC120G, CC80G, CC81CG, CC81G, CCG120CE, CCG120E, CCG80E, CCG81CE, CCG81E, SKC40G, SKC80G		

			
1			
GEV No.	100524	Ref. No.	X39300
description	gas injector thread M7x1 WS 10 bore ø 1.55mm		
For models:	CC120CG, CC120G, CC80G, CC81CG, CC81G, CCG120CE, CCG120E, CCG80E, CCG81CE, CCG81E, SKC40G, SKC80G		

gas nozzles M10x1

			
1			
GEV No.	100639	Ref. No.	Y30500
description	gas injector thread M10x1 WS 11 bore ø 1.25mm inner peaked		
For models:	CPLG4, CPLG8, SKPL1G, SKPL2G		

			
1			
GEV No.	100641	Ref. No.	Y08600
description	gas injector thread M10x1 WS 11 bore ø 1.35mm inner peaked		
For models:	CBRG, CBRGIN, KP10G, KP10GA, KP10GT, KP10GTA, KP15G, KP15GA, KP15GT, KP15GTA, KP110G, KP110GA, KP110GT, KP110GTA, KP115G, KP115GA, KP115GT, KP115GTA, OPP10G, OPP10GA, OPP15G, OPP15GA, OPPI10G, OPPI10GA, OPPI15G, OPPI15GA		

			
1			
GEV No.	106306	Ref. No.	X29600
description	gas injector thread M10x1 WS 11 bore ø 1.45mm code 145		
For models:	CPLG1, CPLG2, KPLG1, KPLG2, M7PL1G, M7PL2G, OPPLG1, OPPLG2, SKPL1G, SKPL2G, TPLG1, TPLG2		

			
1			
GEV No.	106286	Ref. No.	Y30700
description	gas injector thread M10x1 WS 11 bore ø 1.55mm inner peaked		
For models:	C4FFCGP, C4FZFCG, C4FZFCGP, C4FZSFCGP, C6FFCGP, C6FZFCG, C6FZFCGP, C6FZFCGPV, C6FZFCGV, CC120CG, CC81CG, CFTG22, CFTG2C2, CFTG2LR, CFTG2R2, CFTG62, CFTG6C2, CFTG6LR, CFTG6R2, K2FTPFCG, K4FSFCG, K4FZFCG, K4FZSFCG, K6FZFCG, K8FZFCG, KBRG, KBRGIN, KBRGM, KBRGMIN, KTFPCG, OPBRG, OPBRGIN, OPBRGM, OPBRGMIN, SK4FZFCGP, SK6FZFCGP, SKT2G2, SKT2GC2, SKT2GLR, SKT2GR2, SKT60G2, SKT60GC2, SKT60GLR, SKT60GR2, TT2G2, TT2G2LR, TT2GC2, TT2GLR, TT2GR2, TT60G2...(Other models you can see in the webshop)		

			
GEV No.	100643	Ref. No.	Y08700
description	gas injector thread M10x1 WS 11 bore ø 1.5mm inner peaked		
For models:	CCPG4, CCPG82, M7CP4G		

			
GEV No.	102867	Ref. No.	0000Y09100
description	gas injector thread M10x1 WS 11 bore ø 1.65mm		
For models:	KFT4G, KFT4GC, KFT4GR, KFT8G, KFT8G23C, KFT8GC, KFT8GLR, KFT8GR, KFTG1, KFTG1C, KFTG1R, KFTG3, KFTG3C, KFTG3LR, KFTG4, KFTG4C, KFTG4R, KFTG8, KFTG8C, KFTG8LR, KTF4G, KTF4GC, KTF8GLR, OPFT4G, OPFT4GC, OPFT4GR, OPFT8G, OPFT8G23C, OPFT8GC, OPFT8GLR, OPFT8GR, OPTF4G, OPTF4GC, OPTF8GLR		

			
GEV No.	100644	Ref. No.	Y30800
description	gas injector thread M10x1 WS 11 bore ø 1.6mm inner peaked		
For models:	KBRG, KBRG12, KBRG12IN, KBRGIN, KBRGM, KBRGM12, KBRGM12IN, KBRGMIN, KCP4, KCP82, OPBRG, OPBRGIN, OPBRGM, OPBRGM12, OPBRGM12IN, OPBRGMIN, OPCP4, OPCP82, SKCP60G, TCP60G		

			
GEV No.	103328	Ref. No.	Y30000
description	gas injector thread M10x1 WS 11 bore ø 1mm		
For models:	C4FFCGP, C4FZFCG, C4FZFCGP, C4FZSFCGP, C6FFCGP, C6FZFCG, C6FZFCGP, C6FZFCGPV, C6FZFCGV, CC120CG, CC81CG, K2FTPFCC, K4FSFCG, K4FZFCG, K4FZSFCG, K6FZFCG, K8FZFCG, KTFPCG, SK4FZFCGP, SK6FZFCGP		

			
GEV No.	106288	Ref. No.	Y31300
description	gas injector thread M10x1 WS 11 bore ø 2.05mm inner peaked		
For models:	KP10G, KP10GA, KP10GT, KP10GTA, KP15G, KP15GA, KP15GT, KP15GTA, KP110G, KP110GA, KP110GT, KP110GTA, KP115G, KP115GA, KP115GT, KP115GTA, OPP10G, OPP10GA, OPP15G, OPP15GA, OPPI10G, OPPI10GA, OPPI15G, OPPI15GA		

			
GEV No.	106287	Ref. No.	Y31200
description	gas injector thread M10x1 WS 11 bore ø 2.2mm inner peaked		
For models:	C6FFGA, C6FFGAP, CPLG1, CPLG2, KPLG1, KPLG2, M7PL1G, M7PL2G, OPPLG1, OPPLG2, SKPL1G, SKPL2G, TPLG1, TPLG2		

			
GEV No.	106500	Ref. No.	Y08800
description	gas injector thread M10x1 WS 11 bore ø 2.3mm inner peaked		
For models:	CCPG4, CCPG82, KP10G, KP10GA, KP15G, KP15GA, KP110G, KP110GA, KP115G, KP115GA, M7CP4G, OPP10G, OPP10GA, OPP15G, OPP15GA, OPPI10G, OPPI10GA, OPPI15G, OPPI15GA		

			
GEV No.	106289	Ref. No.	Y31500
description	gas injector thread M10x1 WS 11 bore ø 2.45mm inner peaked		
For models:	KCP4, KCP82, OPCP4, OPCP82		

			
GEV No.	100154	Ref. No.	Y30100
description	gas injector thread M10x1 bore ø 1.05mm L 30mm WS 12		
For models:	KBRG12, KBRG12IN, KBRGM12, KBRGM12IN, OPBRG12, OPBRG12IN, OPBRG12MIN, OPBRGM12, OPBRGM12IN		

			
GEV No.	106466	Ref. No.	X34000
description	gas injector thread M10x1 WS 12 bore ø 1.15mm		
For models:	B4F, B6F, B8F, C2F, C2FP, C2FTPFE, C2FTPFEP, C2FTPFG, C2FTPFGP, C4F, C4FFE, C4FFEP, C4FFG, C4FFGP, C4FFLE, C4FFLEP, C4FFLG, C4FFLGP, C4FP, C6F, C6FFE, C6FFEP, C6FFG, C6FFGA, C6FFGAP, C6FFGP, C6FFLE, C6FFLEP, C6FFLEPV, C6FFLEV, C6FFLG, C6FFLGP, C6FFLGPV, C6FFLGV, C6FP, CFTG1, CFTG1C, CFTG1R, CFTG3, CFTG3C, CFTG3LR, CFTG3R, CFTG4, CFTG4C, CFTG4R, CFTG8, CFTG8C, CFTG8LR, CFTG8R, I2FZ... (Other models you can see in the webshop)		

			
GEV No.	102705	Ref. No.	X33300
description	gas injector thread M10x1 WS 11 bore ø 0.8mm		

			
GEV No.	100420	Ref. No.	X33600
description	gas injector thread M10x1 WS 11 bore ø 0.95mm		
For models:	B4F, B4FZ, B6F, B6FZ, B8F, B8FZ, C2F, C2FP, C2FTPFE, C2FTPFEP, C2FTPFG, C2FTPFGP, C4F, C4FFE, C4FFEP, C4FFG, C4FFGP, C4FFLE, C4FFLEP, C4FFLG, C4FFLGP, C4FP, C6F, C6FFE, C6FFEP, C6FFG, C6FFGA, C6FFGAP, C6FFGP, C6FFLE, C6FFLEP, C6FFLEPV, C6FFLEV, C6FFLG, C6FFLGP, C6FFLGPV, C6FFLGV, C6FP, CF10DG8M, CF10G4M, K2F, K2FTPFG, K2FZ, K4F, K4FFE, K4FFG, K4FZ, K4FZFCG, K4FZFE... (Other models you can see in the webshop)		





			
GEV No.	106285	Ref. No.	X34000
description	gas injector thread M10x1 WS 11 bore ø 1.15mm		

			
GEV No.	106490	Ref. No.	X34200
description	gas injector thread M10x1 WS 11 bore ø 1.25mm		
For models:	B4FZ, B6FZ, B8FZ, C2FTPFGP, C2FZ, C2FZP, C2TP2FGP, C4FZ, C4FZFCPEP, C4FZFCGP, C4FZFEP, C4FZFGP, C4FZP, C4FZSP, C6FZ, C6FZFCEP, C6FZFCEPV, C6FZFCGP, C6FZFCGPV, C6FZFEP, C6FZFGAP, C6FZFGP, C6FZP, CCTP8, CCTPFG8, CFTG1, CFTG1C, CFTG1R, CFTG3, CFTG3C, CFTG3LR, CFTG4, CFTG4C, CFTG4R, CFTG8, CFTG8C, CFTG8LR, K2FZ, K4FZ, K4FZCE, K4FZFCG, K4FZFE, K4FZFG, K4FZFGA, K4FZSFG, K6FZ, K6FZCE, K6FZFCG, K6FZFE, K6FZFG...(Other models you can see in the webshop)		

			
GEV No.	102774	Ref. No.	X34600
description	gas injector thread M10x1 WS 11 bore ø 1.45mm		
For models:	2FZP, B4FZ, B6FZ, B8FZ, C2FTPFG, C2FTPFGP, C2FZ, C2FZP, C4FFG, C4FFGP, C4FZ, C4FZCE, C4FZCEP, C4FZFCG, C4FZFCGP, C4FZFE, C4FZFEP, C4FZFG, C4FZFGP, C4FZP, C6FFG, C6FFGP, C6FZ, C6FZCE, C6FZFCEP, C6FZFCEPV, C6FZFCEV, C6FZFCG, C6FZFCGP, C6FZFCGPV, C6FZFCGV, C6FZFE, C6FZFEP, C6FZFG, C6FZFGA, C6FZFGAP, C6FZFGP, C6FZP, CCTPFG8, CF10DG8M, CF10G4M, I2FZ, I2FZP, I4FZ, I4FZP, I6FZP, K2FTPFG, K2FZ, K4FFG, K4FSFG...(Other models you can see in the webshop)		

			
GEV No.	101997	Ref. No.	X34500
description	gas injector thread M10x1 WS 11 bore ø 1.4mm		
For models:	B4F, B6F, B8F, C2FTPFGP, C2TP2FGP, C4FFGP, C4FZFG, C4FZFGP, C4FZSFGP, C6FFGP, C6FZFG, C6FZFGP, CCTPFG8, FCE, FCG, FE, K2FTPFG, K4F, K4FFE, K4FFG, K4FS, K4FSCE, K4FSFCG, K4FSFE, K4FSFG, K4FZFG, K4FZSFG, K6F, K6FFE, K6FFG, K6FG, K6FZFG, K8F, K8FFE, K8FFG, K8FZFG, KTPFG, OP4F, OP4FS, OP6F, OP8F		

			
GEV No.	100793	Ref. No.	X34700
description	gas injector thread M10x1 WS 11 bore ø 1.5mm		
For models:	B4F, B4FZ, B6F, B6FZ, B8F, B8FZ, C2F, C2FP, C2FTPFE, C2FTPFGP, C2FTPFG, C2FTPFGP, C2TP2FGP, C4F, C4FFCEP, C4FFCGP, C4FFE, C4FFEP, C4FFG, C4FFGP, C4FFLE, C4FFLEP, C4FFLG, C4FFLGP, C4FP, C6F, C6FFCEP, C6FFCGP, C6FFE, C6FFEP, C6FFG, C6FFGA, C6FFGAP, C6FFGP, C6FFLE, C6FFLEP, C6FFLEPV, C6FFLEV, C6FFLG, C6FFLGP, C6FFLGPV, C6FFLGV, C6FP, CCTP8, CCTPFG8, CFTG2, CFTG2C, CFTG2R, CFTG6, CFTG6C...(Other models you can see in the webshop)		

			
GEV No.	106440	Ref. No.	X35400
description	gas injector thread M10x1 WS 11 bore ø 1.85mm		
For models:	B4F, B6F, B8F, C2F, C2FP, C2FTPFE, C2FTPFG, C2FTPFGP, C2FTPFGP, C2FZ, C2FZP, C2TP2FGP, C4F, C4FFE, C4FFEP, C4FFG, C4FFGP, C4FFLE, C4FFLEP, C4FFLG, C4FFLGP, C4FP, C4FZ, C4FZFCEP, C4FZFCGP, C4FZFEP, C4FZFGP, C4FZP, C4FZSP, C6F, C6FFE, C6FFEP, C6FFG, C6FFGA, C6FFGAP, C6FFGP, C6FFLE, C6FFLEP, C6FFLEPV, C6FFLEV, C6FFLG, C6FFLGP, C6FFLGPV, C6FFLGV, C6FP, C6FZ, C6FZFCEP, C6FZFCEPV, C6FZFCGP, C6FZFCGPV...(Other models you can see in the webshop)		

			
GEV No.	102984	Ref. No.	X35300
description	gas injector thread M10x1 WS 11 bore ø 1.8mm		
For models:	B4F, B6F, B8F, C2FP, C2FTPFG, C2TP2FGP, C4FFCEP, C4FFCGP, C4FFEP, C4FFGP, C4FP, C6FFCEP, C6FFCGP, C6FFEP, C6FFGP, C6FP, K2F, K2FTPCE, K2FTPFCG, K2FTPFE, K2FTPFG, K4F, K4FFE, K4FFG, K6F, K6FFE, K6FFG, K8F, K8FFE, K8FFG, OP2F, OP4F, OP6F, OP8F, T2FP, T4FP, T6FP		

			
GEV No.	109116	Ref. No.	X33700
description	gas injector thread M10x1 WS 11 bore ø 1mm code 100		
For models:	2FZP, B4F, B4FZ, B6F, B6FZ, B8F, B8FZ, C2FP, C2FTPFGP, C2FZ, C2FZP, C2TP2FGP, C4FFCEP, C4FFCGP, C4FFEP, C4FFGP, C4FP, C4FZ, C4FZCE, C4FZFCEP, C4FZFCG, C4FZFCGP, C4FZFE, C4FZFEP, C4FZFG, C4FZFGP, C4FZP, C6FFCEP, C6FFCGP, C6FFEP, C6FFGP, C6FP, C6FZ, C6FZCE, C6FZFCEP, C6FZFCEPV, C6FZFCEV, C6FZFCG, C6FZFCGP, C6FZFCGPV, C6FZFCGV, C6FZFE, C6FZFEP, C6FZFG, C6FZFGA, C6FZFGAP, C6FZFGP, C6FZP, I2FZ, I2FZP...(Other models you can see in the webshop)		

			
GEV No.	106284	Ref. No.	X32700
description	gas injector thread M10x1 WS 11 bore ø 2.15mm		
For models:	C2FTPFGP, C2TP2FGP, C4FFGP, C4FZFG, C4FZFGP, C4FZSFGP, C6FFGP, C6FZFG, C6FZFGP, CCTPFG8, K2FTPFG, K4FFG, K4FSFG, K4FZFG, K4FZSFG, K6FFG, K6FZFG, K8FFG, K8FZFG, KTPFG		

			
GEV No.	106491	Ref. No.	X35800
description	gas injector thread M10x1 WS 11 bore ø 2.1mm		
For models:	B4F, B6F, B8F, K4F, K4FFE, K4FFG, K6F, K6FFE, K6FFG, K8F, K8FFE, K8FFG		



GEV No.	106495	Ref. No.	X36000
description	gas injector thread M10x1 WS 11 bore ø 2.25mm		
For models:	B4FZ, B6FZ, B8FZ, CFTG2, CFTG2C, CFTG2R, CFTG6, CFTG6C, CFTG6R, K2FZ, K4FZ, K4FZFCE, K4FZFCG, K4FZFE, K4FZFG, K4FZFGA, K4FZS, K4FZSFCE, K4FZSFCG, K4FZSFE, K4FZSFG, K6FZ, K6FZFCE, K6FZFCG, K6FZFE, K6FZFG, K6FZFGA, K8FZ, K8FZFCE, K8FZFCG, K8FZFE, K8FZFG, OP2FZ, OP4FZ, OP6FZ, OP8FZ, OPFZ, SKT2G, SKT2GC, SKT2GR, SKT60G, SKT60GC, SKT60GR, TT2G, TT2GC, TT2GR, TT60G, TT60GC, TT60GR		



GEV No.	100067	Ref. No.	Y35000
description	gas injector thread M10x1 WS 12 bore ø 1.1mm G30 gas pressure 30mbar		
For models:	CFG15, CFG15D, KFG15, KFG15D, OPFG15, OPFG15D		



GEV No.	107343	Ref. No.	Y35200
description	gas injector thread M10x1 WS 12 bore ø 1.2mm LPG gas pressure 30mbar		
For models:	KFG20, KFG20D, OPFG20, OPFG20D		



GEV No.	106290	Ref. No.	Y35900
description	gas injector thread M10x1 WS 12 bore ø 1.85mm inner peaked		
For models:	KFG20, KFG20D, OPFG20, OPFG20D		



GEV No.	106318	Ref. No.	X34100
description	gas injector thread M10x1 WS 12 bore ø 1.2mm		
For models:	B4F, B6F, B8F, C2FP, C2FTPFGP, C2TP2FGP, C4FFCEP, C4FFCGP, C4FFEP, C4FFGP, C4FP, C6FFCEP, C6FFCGP, C6FFEP, C6FFGP, C6FP, K2F, K2FTPFC, K2FTPFCG, K2FTPFE, K2FTPFG, K4F, K4FFE, K4FFG, K6F, K6FFE, K6FFG, K8F, K8FFE, K8FFG, OP2F, OP4F, OP6F, OP8F, T2FP, T4FP, T6FP		



GEV No.	100404	Ref. No.	X34400
description	gas injector thread M10x1 WS 12 bore ø 1.35mm		
For models:	2FZP, B4FZ, B8FZ, C2FZ, C2FZP, C4FZ, C4FZFCE, C4FZFCEP, C4FZFCG, C4FZFCGP, C4FZFE, C4FZFEP, C4FZFG, C4FZFGP, C4FZP, C4FZSFCEP, C4FZSFCGP, C4FZSFE, C4FZSFG, C4FZSP, C6FZ, C6FZFCE, C6FZFCEP, C6FZFCEPV, C6FZFCEV, C6FZFCG, C6FZFCGP, C6FZFCGPV, C6FZFCGV, C6FZFE, C6FZFEP, C6FZFG, C6FZFGA, C6FZFGAP, C6FZFGP, C6FZP, I2FZP, I4FZP, I6FZP, K4FZ, K4FZFCE, K4FZFCG, K4FZFE, K4FZFG, K4FZS, K4FZSFCE, K4FZSFCG, K4FZSFE, K4FZSFG, K6FZ...(Other models you can see in the webshop)		



GEV No.	100401	Ref. No.	X34300
description	gas injector thread M10x1 WS 12 bore ø 1.3mm		
For models:	B4F, B6F, B8F, K4F, K4FFE, K4FFG, K6F, K6FFE, K6FFG, K8F, K8FFE, K8FFG		



GEV No.	100629	Ref. No.	X35700
description	gas injector thread M10x1 WS 12 bore ø 2mm		
For models:	2FZP, B4F, B4FZ, B6F, B8F, B8FZ, C2FZ, C2FZP, C4FZ, C4FZFCE, C4FZFCEP, C4FZFCG, C4FZFCGP, C4FZFE, C4FZFEP, C4FZFG, C4FZFGP, C4FZP, C4FZSFCEP, C4FZSFCGP, C4FZSFE, C4FZSFG, C4FZSP, C6FZ, C6FZFCE, C6FZFCEP, C6FZFCEPV, C6FZFCEV, C6FZFCG, C6FZFCGP, C6FZFCGPV, C6FZFCEV, C6FZFE, C6FZFEP, C6FZFG, C6FZFGA, C6FZFGAP, C6FZFGP, C6FZP, FCE, FCG, FE, I2FZ, I2FZP, I4FZ, I4FZP, I6FZP, K2FZ, K4F, K4FFE...(Other models you can see in the webshop)		

pilot burner nozzles

pilot burner nozzles SIT

100 series



GEV No.	100245	Ref. No.	X19906
description	pilot burner nozzle LPG code 20 bore ø 0.2mm Qty 1 pcs thread M8x0.75		
For models:	B4F, B6F, B8, B8F, C2FP, C2FTPFGP, C2TP2FGP, C4FFCEP, C4FFCGP, C4FFEP, C4FFGP, C4FP, C4FZFG, C4FZFGP, C4FZSFGP, C6FFCEP, C6FFCGP, C6FFEP, C6FFGP, C6FP, C6FZFG, C6FZFGP, CBG4, CBRG, CBRGIN, CCPG4, CCPG82, CCTP8, CCTPFG8, CF10DG8M, CF10G4M, CFTG22, CFTG2C2, CFTG2LR, CFTG2R2, CFTG62, CFTG6C2, CFTG6LR, CFTG6R2, CPG, CPGI, CPLG1, CPLG2, FCE, FCG, FE, K2F, K2FTPFC, K2FTPFCG, K2FTPFE...(Other models you can see in the webshop)		





			
GEV No.	100246	Ref. No.	0000X19907
description	pilot burner nozzle natural gas bore ø 0.35mm Qty 1 pcs thread M8x0.75		
For models:	B4F, B6F, B8, B8F, C2FP, C2FTPFPG, C2TP2FGP, C4FFCEP, C4FFCGP, C4FFEP, C4FFGP, C4FP, C4FZFG, C4FZFGP, C4FZSFGP, C6FFCEP, C6FFCGP, C6FFEP, C6FFGP, C6FP, C6FZFG, C6FZFGP, CBG4, CBRG, CBRGIN, CCPG4, CCPG82, CCTP8, CCTPF8, CF10DG8M, CF10G4M, CFTG22, CFTG2C2, CFTG2LR, CFTG2R2, CFTG62, CFTG6C2, CFTG6LR, CFTG6R2, CPG, CPGL, CPLG1, CPLG2, FCE, FCG, FE, K2F, K2FTPFCE, K2FTPFCE, K2FTPFCE...(Other models you can see in the webshop)		

			
GEV No.	102973	Ref. No.	X19909
description	pilot burner nozzle natural gas bore ø 0.45mm Qty 1 pcs		
For models:	CFG15, CFG15D, KFG15, KFG15D, KFG20, KFG20D, OPFG15, OPFG15D, OPFG20, OPFG20D		

			
GEV No.	102972	Ref. No.	30500003
description	pilot burner nozzle natural gas code 40 bore ø 0.4mm Qty 1 pcs		
For models:	KP20G, KP20GA, KP20GT, KP20GTA, KP30G, KP30GA, KP30GT, KP30GTA, KP50G, KP50GA, KP50GT, KP50GTA, KPGN18G, KPGN27G, KPGN37G, KPI20G, KPI20GA, KPI20GT, KPI20GTA, KPI30G, KPI30GA, KPI30GT, KPI30GTA, KPI50G, KPI50GA, KPI50GT, KPI50GTA, KPIGN18G, KPIGN27G, KPIGN37G		

140/150 series

			
GEV No.	100205	Ref. No.	0000X30000
description	pilot burner nozzle SIT LPG code 19 bore ø 0.23/0.26mm Qty 1 pcs suitable for SIT 150 series		
For models:	2FZP, B4FZ, B6FZ, B8FZ, C2FZP, C2TP2FGP, C4FZFCPEP, C4FZFCGP, C4FZFEP, C4FZFGP, C4FZP, C4FZSFCEP, C4FZSFCEP, C4FZSFCEP, C4FZSFCEP, C4FZSFCEP, C6FFGAP, C6FZFCEP, C6FZFCEPV, C6FZFCGP, C6FZFCGPV, C6FZFEP, C6FZFGA, C6FZFGAP, C6FZFGP, C6FZP, CFTG1, CFTG1C, CFTG1R, CFTG2, CFTG2C, CFTG2R, CFTG3, CFTG3C, CFTG3LR, CFTG3R, CFTG4, CFTG4C, CFTG4R, CFTG6, CFTG6C, CFTG6R, CFTG8, CFTG8C, CFTG8LR, CFTG8R, CN14FGA, I2FZP, I4FZP, I6FZP...(Other models you can see in the webshop)		

			
GEV No.	100207	Ref. No.	X30300
description	pilot burner nozzle SIT natural gas code 27 bore ø 0.40/0.38mm suitable for SIT 140 series		
For models:	2FZP, B4FZ, B6FZ, B8FZ, C2FZP, C2TP2FGP, C4FZFCPEP, C4FZFCGP, C4FZFEP, C4FZFGP, C4FZP, C4FZSFCEP, C4FZSFCEP, C4FZSFCEP, C4FZSFCEP, C4FZSFCEP, C4FZSFCEP, C6FZFCEP, C6FZFCEPV, C6FZFCGP, C6FZFCGPV, C6FZFEP, C6FZFGAP, C6FZFGP, C6FZP, I2FZP, I4FZP, I6FZP, K2FZ, K4FZ, K4FZFCE, K4FZFCG, K4FZFE, K4FZFG, K4FZFGA, K4FZS, K4FZSFCE, K4FZSFCE, K4FZSFE, K4FZSFG, K6FZ, K6ZFCE, K6ZFCEG, K6ZFCE, K6ZFCE, K6ZFCE, K6FZ, K8FZ, K8ZFCE, K8ZFCEG, K8ZFCE, K8ZFCE...(Other models you can see in the webshop)		

			
GEV No.	100206	Ref. No.	0000X30100
description	pilot burner nozzle SIT natural gas code 36 bore ø 0.60/0.55mm Qty 1 pcs suitable for SIT 150 series		
For models:	C6FFGAP, C6FZFGA, C6FZFGAP, CFTG1, CFTG1C, CFTG1R, CFTG2, CFTG2C, CFTG2R, CFTG3, CFTG3C, CFTG3LR, CFTG3R, CFTG4, CFTG4C, CFTG4R, CFTG6, CFTG6C, CFTG6R, CFTG8, CFTG8C, CFTG8LR, CFTG8R, CN14FGA, K2FTPFCE, K2FTPFCEG, K2FTPFCE, K2FTPFCE, K2FTPFCE, K2FTPFCE, K6FFGA, K6FZFGA, KBRG, KBRG12, KBRG12IN, KBRGIN, KBRGM, KBRGM12, KBRGM12IN, KBRGMIN, KFT4G, KFT4GC, KFT4GR, KFT8G, KFT8G23C, KFT8GC, KFT8GLR, KFT8GR, KFTG1, KFTG1C, KFTG1R, KFTG3...(Other models you can see in the webshop)		

bypass nozzles

bypass nozzles PEL20/21

			
GEV No.	100554	Ref. No.	X11000
description	bypass nozzle type PEL20/21 bore ø 0.45mm thread M5x0.5		
For models:	2FZP, B4F, B4FZ, B6F, B6FZ, B8F, B8FZ, C2FP, C2FTPFPG, C2FZ, C2FZP, C2TP2FGP, C4FFCEP, C4FFCGP, C4FFEP, C4FFGP, C4FP, C4FZ, C4FZFCE, C4FZFCEP, C4FZFCG, C4FZFCGP, C4FZFE, C4FZFEP, C4FZFG, C4FZFGP, C4FZP, C6FFCEP, C6FFCGP, C6FFEP, C6FFGP, C6FP, C6FZ, C6FZFCE, C6FZFCEP, C6FZFCEPV, C6FZFCG, C6FZFCGP, C6FZFCGPV, C6FZFCGP, C6FZFE, C6FZFEP, C6FZFG, C6FZFGA, C6FZFGAP, C6FZFGP, C6FZP, I2FZ, I2FZP...(Other models you can see in the webshop)		

			
GEV No.	100550	Ref. No.	X11100
description	bypass nozzle type PEL20/21 bore ø 0.55mm thread M5x0.5		
For models:	C2FTPFPG, C2TP2FGP, CFTG22, CFTG2LR, CFTG2R2, CFTG62, CFTG6LR, CFTG6R2, I2FZ, I4FZ, SKT2G2, SKT2GLR, SKT2GR2, SKT60G2, SKT60GLR, SKT60GR2, TT2G2, TT2G2LR, TT2GR2, TT60G2, TT60GLR, TT60GR2		

			
GEV No.	100278	Ref. No.	X04800
description	bypass nozzle type PEL20/21 bore ø 0.75mm thread M5x0.5		
For models:	2FZP, B4F, B4FZ, B6F, B6FZ, B8, B8F, B8FZ, C2FP, C2FTPFPG, C2FZ, C2FZP, C2TP2FGP, C4FFCEP, C4FFCGP, C4FFEP, C4FFGP, C4FP, C4FZ, C4FZFCE, C4FZFCEP, C4FZFCG, C4FZFCGP, C4FZFE, C4FZFEP, C4FZFG, C4FZFGP, C4FZP, C4FZSFCEP, C4FZSFCEP, C4FZSFCEP, C4FZSFCEP, C4FZSFCEP, C4FZSFCEP, C6FFGAP, C6FZFCEP, C6FZFCEPV, C6FZFCGP, C6FZFCGPV, C6FZFEP, C6FZFGAP, C6FZFGP, C6FZP, I2FZP, I4FZP, I6FZP, K2FZ, K4FZ, K4FZFCE, K4FZFCG, K4FZFE, K4FZFG, K4FZFGA, K4FZS, K4FZSFCE, K4FZSFCE, K4FZSFE, K4FZSFG, K6FZ, K6ZFCE, K6ZFCEG, K6ZFCE, K6ZFCE, K6ZFCE, K6FZ, K8FZ, K8ZFCE, K8ZFCEG, K8ZFCE, K8ZFCE...(Other models you can see in the webshop)		

			
GEV No.	100552	Ref. No.	X09700
description	bypass nozzle type PEL20/21 bore ø 0.7mm thread M5x0.5		
For models:	CFTG1, CFTG1R, CFTG22, CFTG2LR, CFTG2R2, CFTG3, CFTG3LR, CFTG3R, CFTG4, CFTG4R, CFTG62, CFTG6LR, CFTG6R2, CFTG8, CFTG8LR, CFTG8R, SKT2G, SKT2G2, SKT2GLR, SKT2GR, SKT2GR2, SKT60G, SKT60G2, SKT60GLR, SKT60GR, SKT60GR2, TT1G, TT1GR, TT2G2, TT2GLR, TT2GR2, TT3G, TT3GLR, TT40G, TT40GR, TT60G2, TT60GLR, TT60GR2, TT80G, TT80GLR		

			
1			
GEV No.	100555	Ref. No.	X09800
description	bypass nozzle type PEL20/21 bore ø 0.8mm thread M5x0.5		





			
1			
GEV No.	100528	Ref. No.	X10600
description	bypass nozzle type PEL20/21 bore ø 0.9mm thread M5x0.5		
For models:	CFTG1, CFTG1R, CFTG2, CFTG2R, CFTG3, CFTG3LR, CFTG3R, CFTG4, CFTG4R, CFTG6, CFTG6R, CFTG8, CFTG8LR, CFTG8R, SKT1G, SKT1GR, SKT3G, SKT3GLR, SKT40G, SKT40GR, SKT80G, SKT80GLR, TT1G, TT1GR, TT2G, TT2GR, TT3G, TT3GLR, TT40G, TT40GR, TT60G, TT60GR, TT80G, TT80GLR		

auxiliary gas parts

screw connections

union screws

			
1			
GEV No.	100906	Ref. No.	X13002
description	screw connection thread M10x1 for ignition electrode brass Qty 1 pcs WS 10		

			
1			
GEV No.	100908	Ref. No.	X13200
description	union screw thread M10x1 for pipe ø 4mm Qty 1 pcs		
For models:	2FZP, B4FZ, B6FZ, B8FZ, C2FZP, C4FZFCE, C4FZFCEP, C4FZFCCG, C4FZFCCGP, C4FZFE, C4FZFEP, C4FZFG, C4FZFGP, C4FZP, C4FZSFCEP, C4FZSFCCGP, C4FZSFEP, C4FZSFGP, C4FZSP, C6FFGAP, C6FZFCE, C6FZFCEP, C6FZFCEPV, C6FZFCEV, C6FZFCCG, C6FZFCCGP, C6FZFCCGPV, C6FZFCCGPV, C6FZFCE, C6FZFEP, C6FZFG, C6FZFGA, C6FZFGAP, C6FZFGP, C6FZP, CN14FGA, I2FZP, I4FZP, I6FZP, K2FZ, K4FZ, K4FZFCE, K4FZFCCG, K4FZFE, K4FZFG, K4FZFGA, K4FZS, K4FZSFCE, K4FZSFCCG, K4FZSFE... (Other models you can see in the webshop)		
accessories for	100908		
	GEV No.	100897	Ref. No. —
	olive for pipe ø 4mm Qty 1 pcs for pilot burner		
	GEV No.	101246	Ref. No. —
	olive for pipe ø 4mm Qty 1 pcs		
	GEV No.	101280	Ref. No. —
	olive for pipe ø 4mm Qty 1 pcs		
	GEV No.	101282	Ref. No. —
	olive for pipe ø 4mm L 7.4mm Qty 1 pcs		

angle pieces

			
1			
GEV No.	106283	Ref. No.	X68042
description	nozzle holder nozzle M6 M10x1 screw pipe fitting 1/4" tube ø 6mm		
For models:	CBG4, CBG6, CBG8, KB4G, KB8G, OPB4G, SKB40G, SKB60G, SKB80G, TB40G, TB60G, TB80G, TP40G		

gas ball valves

miscellaneous

			
1			
GEV No.	514215	Ref. No.	M75300
description	outlet tap angled wing handle inlet 1/2" IT outlet 3/4" IT L 53.5mm approval EN 331		
For models:	15PSE, 7DSE, 7DSET, 7SE, 7SET		

consumables

lava rocks / ceramic briquetts

			
1			
GEV No.	105342	Ref. No.	M30500
description	lava rocks content 9kg		
For models:	CPLG1, CPLG2, CPLG4, CPLG8, KPLG1, KPLG2, M7PL1G, M7PL2G, OPPLG1, OPPLG2, SKPL1G, SKPL2G, SKPL4G, SKPL8G, TPLG1, TPLG2		

equipment-specific units

for meat mincers

augers

complete

			
1			
GEV No.	698037	Ref. No.	W12477
description	auger model 12 ø 53mm L 135mm stainless steel with spindle ENTERPRISE		



1

GEV No.	698036	Ref. No.	W012410085
description	auger model 12 ø 53mm L 150mm cast iron with spindle ENTERPRISE		

for potato peelers

abrasive side elements

grinding discs



1

GEV No.	696377	Ref. No.	PL400
description	grating disc ø 350mm for potato peeler device		

for dough mixers

flange bearings



1

GEV No.	693112	Ref. No.	X61500
description	flange bearing type UCF204 shaft ø 20mm 4 hole flange hole distance 64mm H 33mm flange length 86mm flange width 86mm hole ø 12mm flange F204 ball bearing UC204G2 FH 25.5mm		

for ice-cube maker

drain systems

overflow pipes



1

GEV No.	695047	Ref. No.	I66021901
description	overflow pipe L 78mm straight		

curtains

without holder



1

GEV No.	695076	Ref. No.	I78416909
description	curtain for ice maker W 284mm H 83mm		



1

GEV No.	695075	Ref. No.	I78416901
description	curtain for ice maker W 305mm H 115mm shaft length 323mm shaft ø 6mm		



1

GEV No.	695077	Ref. No.	I78425003
description	curtain for ice maker W 570mm H 115mm shaft length 610mm shaft ø 6mm		

accessories

holders



1

GEV No.	695078	Ref. No.	I66046900
description	curtain holder for ice maker		



1

GEV No.	695080	Ref. No.	I66038800
description	curtain holder for ice maker W 15mm H 80mm left		



1

GEV No.	695079	Ref. No.	I66038801
description	curtain holder for ice maker W 15mm H 80mm right		

lamellas



1

GEV No.	695081	Ref. No.	I66062900
description	lamella for ice maker W 28mm H 71mm ø 6mm		

hoses

hose connectors

with thread



1

GEV No.	695045	Ref. No.	I66022400
description	hose connector 3-way ID ø 15mm ED ø 21mm L 91mm		

floats

container lids



1

GEV No.	695038	Ref. No.	I66036300
description	lid L 150mm W 102mm for float container		

float containers



1

GEV No.	695037	Ref. No.	I79312601
description	float container for ice maker plastic		

for espresso machines

steam/water taps

steam/water pipes

accessories

gaskets



1

GEV No.	510893	Ref. No.	904391
description	O-ring EPDM thickness 2.62mm ID ø 9.92mm Qty 1 pcs		
For models:	GLB785, GLB795		

for deep fryers

lids



1

GEV No.	970369	Ref. No.	B65300
description	lid for fryer		
For models:	CF1E4, CF2E6, CF4E, CF6E, IF1E4, IF2E6, KFE1, KFE2, OPFE1, OPFE2, SKF1E, SKF2E, TF1E, TF2E, TF4E, TF6E		

glass panels



1

GEV No.	691623	Ref. No.	K98111
description	glass panel L 28mm W 28mm thickness 3mm		
For models:	CFG15, CFG15D, KFG15, KFG15D, KFG20, KFG20D, OPFG15, OPFG15D, OPFG20, OPFG20D		

miscellaneous



1

GEV No.	514204	Ref. No.	A75500
description	cam		



for convection ovens/combi-steamers

spare parts and accessories



1			
GEV No.	550734	Ref. No.	X53400
description	bracket		

for tilting bratt pans

spindles



1			
GEV No.	690546	Ref. No.	K49100
description	thread block thread Tr24x5 right-hand thread W 38mm bolt ø 20mm D 40mm H 40mm		
For models:	KBRE, KBRE12, KBRE12IN, KBRE9, KBREIN, KBREIN9, KBREM, KBREM12, KBREM12IN, KBREMIN, KBRG, KBRG12, KBRG12IN, KBRGIN, KBRGM, KBRGM12, KBRGM12IN, KBRGMIN, OPBRE, OPBRE12, OPBRE12IN, OPBRE12MIN, OPBREIN, OPBREM, OPBREM12, OPBREM12IN, OPBREM12MIN, OPBRG, OPBRG12, OPBRG12IN, OPBRG12MIN, OPBRGIN, OPBRGM, OPBRGM12, OPBRGM12IN, OPBRGMIN		



1			
GEV No.	690543	Ref. No.	X65400 X65402
description	threaded rod		
For models:	CBRE, CBRE8, CBRE9, CBREIN, CBREIN9, CBRG, CBRG8, CBRGIN		



1			
GEV No.	690547	Ref. No.	K49200
description	threaded rod		

miscellaneous



1			
GEV No.	690545	Ref. No.	Y42100
description	ball bearing		
For models:	KBREM, KBREM12, KBREM12IN, KBREMIN, KBRGM, KBRGM12, KBRGM12IN, KBRGMIN, OPBRE12MIN, OPBREM, OPBREM12, OPBREM12IN, OPBREM12MIN, OPBRG12MIN, OPBRGM, OPBRGM12, OPBRGM12IN, OPBRGMIN		



1			
GEV No.	690967	Ref. No.	X65403
description	spindle L 400mm ø 20mm for hand wheel		
For models:	CBRE, CBRE9, CBREIN, CBREIN9, CBRG, CBRGIN		



1			
GEV No.	690542	Ref. No.	X65500
description	threaded bush		
For models:	CBRE, CBRE8, CBRE9, CBREIN, CBREIN9, CBRG, CBRG8, CBRGIN		

for boiling pans

filters



1			
GEV No.	514503	Ref. No.	30700122
description	drain filter for kettle size 76x145mm		
For models:	KPI10ET, KPI10ETA, KPI10VT, KPI10VTA, KPI15ET, KPI15ETA, KPI15VT, KPI15VTA		

miscellaneous



1			
GEV No.	540639	Ref. No.	10400058
description	extension		
For models:	KPI10VT, KPI10VTA, KPI15VT, KPI15VTA, KPI20VT, KPI20VTA, KPI30VT, KPI30VTA, KPI50VT, KPI50VTA		

for ovens

glass panels



1

GEV No.	694363	Ref. No.	Y61800
description	glass panel L 516mm W 380mm thickness 4mm for door		

for dishwashers

containers

container lids



1

GEV No.	510109	Ref. No.	N/A
description	lid for salt tank		



1

GEV No.	510110	Ref. No.	N/A
description	lid for salt tank		

salt tanks



1

GEV No.	524177	Ref. No.	N/A	
description	lid ø 69mm H 20mm for salt tank ID ø 50mm			
accessories for	524177			
	GEV No.	524148	Ref. No.	—
	O-ring EPDM thickness 3.53mm ID ø 40.86mm Qty 1 pcs			







1

GEV No.	510018	Ref. No.	N/A
description	nut ø 92mm H 10.5mm for salt tank ID ø 64mm		



1

GEV No.	510032	Ref. No.	N/A	
description	salt tank without gasket new model			
spare parts for	510032			
	GEV No.	506015	Ref. No.	—
	O-ring EPDM thickness 3.53mm ID ø 39.69mm Qty 1 pcs			
	GEV No.	510018	Ref. No.	N/A
	nut ø 92mm H 10.5mm for salt tank ID ø 64mm			
	GEV No.	510071	Ref. No.	N/A
	flat gasket rubber ED ø 81mm ID ø 68mm thickness 3mm for salt tank Qty 1 pcs			
	GEV No.	524177	Ref. No.	N/A
	lid ø 69mm H 20mm for salt tank ID ø 50mm			



accessories



1

GEV No.	510071	Ref. No.	N/A
description	flat gasket rubber ED ø 81mm ID ø 68mm thickness 3mm for salt tank Qty 1 pcs		

boilers

boilers for dishwashers



1

GEV No.	518378	Ref. No.	N/A
description	boiler		



1

GEV No.	519028	Ref. No.	900486
description	boiler		
For models:	GLS905, GLS925		



1

GEV No.	519021	Ref. No.	900351
description	boiler ø 100mm L 340mm		
For models:	GLB615		





Image not available

1

GEV No.	519023	Ref. No.	900355	
description	boiler ø 125mm L 330mm			
For models:	GLB785, GLB795			
accessories for	519023			
	GEV No.	415167	Ref. No.	—
	heating element 3000W 230V mounting ø 38.5mm heating circuits 2 L 300mm W 21mm H 35mm number of thermostat sleeves 1 thermostat sleeves ø 6.5mm length thermostat sleeves 53mm thermostat sleeve not clinging tube ø 6.3mm hole distance 57mm hole ø 10mm 3 hole flange connection male faston 6.3mm immersion heater			
	GEV No.	532577	Ref. No.	—
	O-ring EPDM thickness 5.34mm ID ø 40.65mm Qty 1 pcs			



1

GEV No.	518377	Ref. No.	N/A
description	boiler ø 150mm L 360mm		



1

GEV No.	519022	Ref. No.	900353 SD900353
description	boiler ø 150mm L 400mm		
For models:	GLS805, GLS845		



1

GEV No.	519487	Ref. No.	900485	
description	boiler with heating element 6000W 230V ø 155mm L 400mm			
For models:	GLS935, GLS945, GLS945S			
spare parts for	519487			
	GEV No.	416268	Ref. No.	905570
	heating element 6000W 230V mounting ø 38.5mm heating circuits 3 L 360mm W 34mm H 55mm L1 35mm L2 70mm L3 255mm H1 27mm H2 28mm hole distance 57mm hole ø 10mm tube ø 6.3mm connection male faston 6.3mm immersion heater 3 hole flange			
	GEV No.	532577	Ref. No.	—
	O-ring EPDM thickness 5.34mm ID ø 40.65mm Qty 1 pcs			

accessories



1

GEV No.	518348	Ref. No.	N/A
description	hose connector		

housing and bezels

miscellaneous



1

GEV No.	697926	Ref. No.	901657
description	sticker for handle rail L 460mm		
For models:	GLS805, GLS845		

hood mechanics for dishwashers

bolts



1

GEV No.	519202	Ref. No.	904771
description	screw bolt hood mechanics		
For models:	GLS935		

bushes



1

GEV No.	519031	Ref. No.	900514
description	bush for hood rod		
For models:	GLS935		



1

GEV No.	519205	Ref. No.	904796
description	bush hood mechanics		
For models:	GLS935, GLS945, GLS945S		

spring holders



1

GEV No.	519243	Ref. No.	906066
description	bush for spring holder hood mechanics		
For models:	GLS935, GLS945, GLS945S		

hood handles



1

GEV No.	519447	Ref. No.	908728
description	hood handle		
For models:	GLS945, GLS945S		



1

GEV No.	519206	Ref. No.	904930
description	lever joint hood mechanics		
For models:	GLS935		

screws for spring compressor



1

GEV No.	519260	Ref. No.	907222
description	screw for spring compressor hood mechanics		
For models:	GLS935		



1

GEV No.	519274	Ref. No.	902377
description	screw thread M10 L 187mm for spring compressor hood mechanics		
For models:	GLS945, GLS945S		

basket guides

basket holders

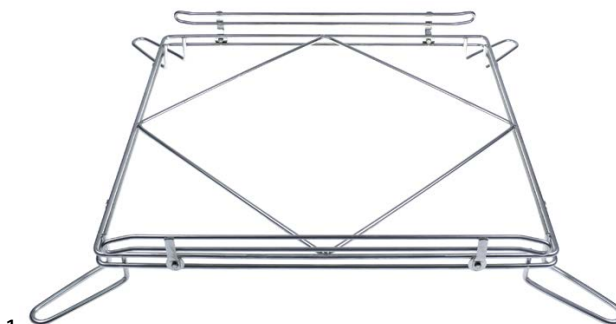

1

GEV No.	971057	Ref. No.	908708
description	basket support		
For models:	GLS945, GLS945S		

air traps

air traps

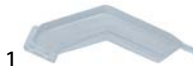

1

GEV No.	511450	Ref. No.	SD907254
description	air trap		
accessories for	511450		







GEV No.	511197	Ref. No.	903261
----------------	--------	-----------------	--------



gasket L 46mm W 33mm for air trap











 <p>1</p>			
GEV No.	518488	Ref. No.	N/A
description	air trap		
accessories for	518488		
	GEV No.	504618	Ref. No. —
O-ring EPDM thickness 2.62mm ID ø 15.54mm Qty 1 pcs			
	GEV No.	510075	Ref. No. N/A
flat gasket rubber ED ø 22mm ID ø 13mm thickness 1.5mm Qty 1 pcs			
	GEV No.	510106	Ref. No. N/A
hose connector for air trap			

 <p>1</p>			
GEV No.	519250	Ref. No.	907254
description	air trap		
For models:	GLS905, GLS925, GLS945, GLS945S		

 <p>1</p>			
GEV No.	519263	Ref. No.	907252
description	air trap		
For models:	GLB785, GLB795, GLS805, GLS845		
accessories for	519263		
	GEV No.	519057	Ref. No. —
nut thread 3/8" WS 25 H 6mm brass			
	GEV No.	519114	Ref. No. 903260 SD903260
flat gasket rubber ED ø 25mm ID ø 16.5mm thickness 2mm Qty 1 pcs			

 <p>1</p>			
GEV No.	519319	Ref. No.	TR0268
description	air trap		
For models:	GLS935		
accessories for	519319		
	GEV No.	519057	Ref. No. —
nut thread 3/8" WS 25 H 6mm brass			
	GEV No.	519114	Ref. No. 903260 SD903260
flat gasket rubber ED ø 25mm ID ø 16.5mm thickness 2mm Qty 1 pcs			

 <p>1</p>			
GEV No.	519212	Ref. No.	905273
description	air trap L 54mm W 41mm H 45mm hose ø 6mm		
For models:	GLB615		
accessories for	519212		
	GEV No.	519057	Ref. No. —
nut thread 3/8" WS 25 H 6mm brass			
	GEV No.	519114	Ref. No. 903260 SD903260
flat gasket rubber ED ø 25mm ID ø 16.5mm thickness 2mm Qty 1 pcs			

 <p>1</p>			
GEV No.	510103	Ref. No.	N/A
description	air trap L 85mm W 20mm H 80mm hose ø 6mm plastic		
spare parts for	510103		
	GEV No.	505045	Ref. No. —
O-ring EPDM thickness 1.78mm ID ø 5.28mm Qty 1 pcs			
	GEV No.	505094	Ref. No. —
air trap			
	GEV No.	510016	Ref. No. N/A
eye bolt for rinse aid container connection			
	GEV No.	510105	Ref. No. N/A
hose connector for air trap			

 <p>1</p>			
GEV No.	518200	Ref. No.	N/A
description	air trap ø 34mm H 78mm hose ø 6mm plastic		
spare parts for	518200		
	GEV No.	504618	Ref. No. —
O-ring EPDM thickness 2.62mm ID ø 15.54mm Qty 1 pcs			
	GEV No.	510075	Ref. No. N/A
flat gasket rubber ED ø 22mm ID ø 13mm thickness 1.5mm Qty 1 pcs			
	GEV No.	510106	Ref. No. N/A
hose connector for air trap			

air trap accessories



1	GEV No.	511385	Ref. No.	907926
	description	flange L 46mm W 32mm for air trap		
	For models:	GLS905, GLS925, GLS945, GLS945S		



1	GEV No.	510075	Ref. No.	N/A
	description	flat gasket rubber ED ø 22mm ID ø 13mm thickness 1.5mm Qty 1 pcs		



1	GEV No.	511197	Ref. No.	903261
	description	gasket L 46mm W 33mm for air trap		
	For models:	GLS905, GLS925, GLS945, GLS945S		



1	GEV No.	510105	Ref. No.	N/A	
	description	hose connector for air trap			
	spare parts for	510105			
		GEV No.	510017	Ref. No.	N/A
		union screw			



1	GEV No.	510106	Ref. No.	N/A
	description	hose connector for air trap		

backflow preventers

backflow preventers



1	GEV No.	518237	Ref. No.	N/A
	description	backflow preventer		



1	GEV No.	518297	Ref. No.	N/A
	description	backflow preventer		



1	GEV No.	516101	Ref. No.	TR2433	
	description	backflow preventer dishwasher hose ø 12mm			
	For models:	GLB785, GLB795, GLS805, GLS845, GLS905, GLS925, GLS935, GLS945, GLS945S			
	spare parts for	516101			
		GEV No.	506367	Ref. No.	—
		flat gasket rubber ED ø 40mm ID ø 28mm thickness 1.8mm Qty 1 pcs			

miscellaneous



1	GEV No.	519237	Ref. No.	906001
	description	plain washer		
	For models:	GLS945S		

door mechanics

linkage



1	GEV No.	518355	Ref. No.	N/A
	description	door pin stop rod		



1	GEV No.	519261	Ref. No.	907240
	description	door pin tie bar		
	For models:	GLB785, GLS805, GLS845		



threaded shafts

			
1			
GEV No.	519228	Ref. No.	905424
description	threaded part end stop		
For models:	GLB785, GLS805, GLS845		

sliding plates

			
1			
GEV No.	518356	Ref. No.	N/A
description	sliding plate sliding plate		

			
1			
GEV No.	519208	Ref. No.	904952
description	sliding plate sliding plate		
For models:	GLB785, GLS805, GLS845		

hinges

			
1			
GEV No.	519035	Ref. No.	901245
description	door hinge bores 3 hinge		
For models:	GLB615, GLB785, GLB795, GLS805, GLS845		

			
1			
GEV No.	518547	Ref. No.	N/A
description	door hinge hinge mounting pos. left		

			
1			
GEV No.	518253	Ref. No.	N/A
description	door hinge hinge mounting pos. right		

			
1			
GEV No.	518301	Ref. No.	N/A
description	door hinge mounting pos. left/right		

			
1			
GEV No.	502263	Ref. No.	901249
description	hinge mounting pos. left L 94mm N45/N50		
For models:	GLS905, GLS925		

			
1			
GEV No.	502262	Ref. No.	901248
description	hinge mounting pos. right L 94mm N45/N50		
For models:	GLS905, GLS925		

hinge camps



1

GEV No.	518257	Ref. No.	N/A
description	hinge camp mounting pos. left		

hinge pins



1

GEV No.	518267	Ref. No.	N/A
description	hinge pin hinge pin		



1

GEV No.	519204	Ref. No.	904795
description	hinge pin hinge pin		
For models:	GLB615, GLB785, GLB795, GLS805, GLS845		

door bumpers



1

GEV No.	518066	Ref. No.	N/A
description	door bumper end stop		

locks



1

GEV No.	519247	Ref. No.	906121 SD906121
description	door catch door locking catch		
For models:	GLB615, GLB785, GLB795, GLS805, GLS845, GLS905, GLS925		

accessories for 519247



1

GEV No.	519050	Ref. No.	902023
description	nut thread M12x1.75 H 4mm WS 16 SS Qty 1 pcs for snap lock		



1

GEV No.	513138	Ref. No.	N/A
description	door catch with nut door locking catch		



1

GEV No.	518245	Ref. No.	N/A
description	spigot door catch		

miscellaneous



1

GEV No.	504435	Ref. No.	908146
description	flat gasket plastic ED ø 18mm ID ø 9.5mm thickness 2.5mm for door hinge Qty 1 pcs		
For models:	GLS905, GLS925		

screw connections



1

GEV No.	519054	Ref. No.	902070
description	locknut thread 1"		
For models:	GLB615, GLB785, GLB795		



1

GEV No.	519053	Ref. No.	902061
description	locknut thread 1/2"		
For models:	GLS935, GLS945, GLS945S		



1

GEV No.	519055	Ref. No.	902080
description	locknut thread 1 1/4"		
For models:	GLB615, GLB785, GLB795, GLS805, GLS845, GLS935, GLS945, GLS945S		





1

GEV No.	519056	Ref. No.	902090
description	locknut thread 1 3/4"		
For models:	GLS805, GLS845		



 <p>1</p>			
GEV No.	519008	Ref. No.	900050
description	locknut thread 2¼" Qty 1 pcs		
For models:	GLS945S		

 <p>1</p>			
GEV No.	501351	Ref. No.	908124
description	flange mounting pos. upper ø 91mm H 11mm ID ø 45mm hole ø 5.5mm		
For models:	GLS905, GLS925		

 <p>1</p>			
GEV No.	519076	Ref. No.	902679
description	screw with nut thread M10x1.5 H 17mm WS 22		
For models:	GLB785, GLB795		

 <p>1</p>			
GEV No.	519122	Ref. No.	903351
description	flat gasket for rinse arm		
For models:	GLB615, GLB785, GLB795, GLS935, GLS945, GLS945S		

washing and rinsing systems

 <p>1</p>			
GEV No.	519088	Ref. No.	902891
description	bush for wash arm		
For models:	GLS945S		

 <p>1</p>			
GEV No.	519006	Ref. No.	900035
description	locknut		
For models:	GLB785, GLB795, GLS935		

 <p>1</p>			
GEV No.	519062	Ref. No.	902351
description	cap		
For models:	GLB615, GLB785, GLB795		



 <p>1</p>			
GEV No.	519087	Ref. No.	902890
description	locknut for wash arm		
For models:	GLS945S		

 <p>1</p>			
GEV No.	518238	Ref. No.	N/A
description	manifold ø 12mm L 98mm		

 <p>1</p>			
GEV No.	510016	Ref. No.	N/A
description	eye bolt for rinse aid container connection		

 <p>1</p>			
GEV No.	519007	Ref. No.	900049
description	opposite support mounting pos. lower for wash arm support		
For models:	GLS945S		

 <p>1</p>			
GEV No.	518461	Ref. No.	N/A
description	flange for wash arm support		

			
1			
GEV No.	519444	Ref. No.	905449
description	opposite support mounting pos. upper/lower for wash arm support suitable for Silanos		
For models:	GLS805, GLS845, GLS905, GLS925, GLS945		
accessories for	519444		
	GEV No.	519445	Ref. No. 908141
	gasket D1 ø 80mm D2 ø 50mm thickness 3mm with 4 screw holes		

			
1			
GEV No.	519238	Ref. No.	906002
description	plain washer ID ø 15mm ED ø 33mm thickness 0.8mm SS Qty 1 pcs		
For models:	GLB785, GLB795		

			
1			
GEV No.	501349	Ref. No.	908456
description	reducer for rinse arm shaft		
For models:	GLS945		

			
1			
GEV No.	519201	Ref. No.	904765
description	rinse pipe		
For models:	GLB615, GLB785, GLB795, GLS935		

			
1			
GEV No.	519198	Ref. No.	904753
description	rinse pipe mounting pos. lower ø 16mm L 13.5mm		
For models:	GLS945S		

			
1			
GEV No.	518003	Ref. No.	N/A
description	screw cap		

			
1			
GEV No.	510011	Ref. No.	N/A
description	screw connection plastic		

			
1			
GEV No.	501348	Ref. No.	906004
description	shim for rinse arm shaft		
For models:	GLS945		

			
1			
GEV No.	519437	Ref. No.	902183
description	spacer piece		
For models:	GLS905, GLS925		

			
1			
GEV No.	517355	Ref. No.	908702
description	spacer piece for wash arm support ID ø 44mm ED ø 80mm thickness 18mm L 55mm plastic		
For models:	GLS805, GLS845		

			
1			
GEV No.	518337	Ref. No.	N/A
description	throttle disc		

			
1			
GEV No.	519085	Ref. No.	902880
description	Thumb screw ø 34mm thread M6		
For models:	GLB615, GLB785, GLB795, GLS805, GLS845, GLS905, GLS925, GLS935, GLS945, GLS945S		

1

GEV No.	510112	Ref. No.	N/A
description	Thumb screw thread M10 thread L 10mm ø 22mm H 4.5mm SS		



1

GEV No.	518484	Ref. No.	N/A
description	wash arm support for stationary arms mounting pos. upper		



1

GEV No.	519019	Ref. No.	900164
description	wash pipe mounting pos. upper		
For models:	GLS935		



1

GEV No.	519459	Ref. No.	908729
description	wash pipe mounting pos. upper edition until 11/2005		
For models:	GLS945, GLS945S		



1

GEV No.	519438	Ref. No.	903743
description	wash pipe ø 37mm L 700mm plastic suitable for Silanos		
For models:	GLS905, GLS925		



1

GEV No.	519537	Ref. No.	908701
description	wash pipe ø 37mm L 720mm plastic suitable for Silanos		
For models:	GLS805, GLS845		

washing and rinsing systems (sorted by producer)

GIGA

rinse arms

rotary

complete







GEV No.	510118	Ref. No.	N/A	
description	wash arm L 245mm nozzles 4 mounting ø 12mm mounting pos. upper			
spare parts for	510118			
	GEV No.	510011	Ref. No.	N/A
	screw connection plastic			
	GEV No.	510012	Ref. No.	N/A
	flat gasket PTFE ED ø 16.5mm ID ø 12.5mm thickness 1.5mm Qty 1 pcs equiv. no. 437008			
	GEV No.	510013	Ref. No.	N/A
	rinse arm shaft			
	GEV No.	510130	Ref. No.	N/A
	union nut for rinse jet			
	GEV No.	510139	Ref. No.	N/A
	rinse jet			
	GEV No.	518326	Ref. No.	N/A
	rinse arm boss			
	GEV No.	518328	Ref. No.	N/A
	rinse arm mounting pos. right L 110mm mounting ø 13mm nozzles 2			
	GEV No.	518329	Ref. No.	—
	rinse arm mounting pos. left L 110mm mounting ø 13mm nozzles 2			



wash and rinse arms combined

rotary





complete

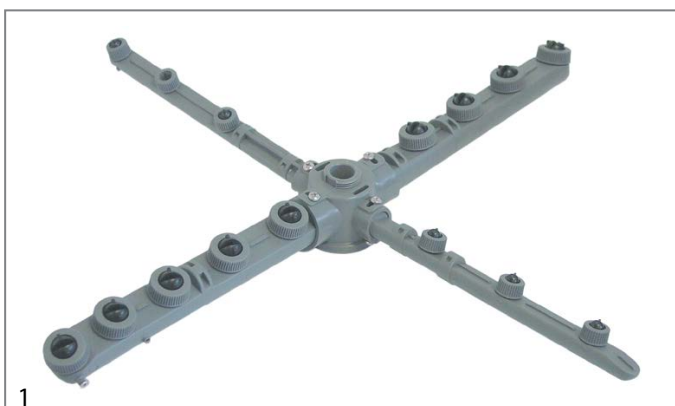

GEV No.	510119	Ref. No.	N/A
description	wash and rinse arm wash arm L 410mm rinse arm L 410mm w. jets 7 r. jets 5 mounting ø 16.5mm mounting pos. lower		
spare parts for	510119		
	GEV No.	510010	Ref. No. N/A
	wash arm boss L1 64mm L2 60mm mounting ø 16.5mm		
	GEV No.	510130	Ref. No. N/A
	union nut for rinse jet		
	GEV No.	510131	Ref. No. N/A
	union nut for wash jet		
	GEV No.	510138	Ref. No. —
	wash jet fine groove		
	GEV No.	510139	Ref. No. N/A
	rinse jet		
	GEV No.	518004	Ref. No. N/A
	wash jet		
	GEV No.	518382	Ref. No. N/A
	wash arm mounting pos. right L 175mm mounting ø 24mm nozzles 4		
	GEV No.	518383	Ref. No. —
	rinse arm mounting pos. left L 175mm mounting ø 13mm nozzles 2		
	GEV No.	518384	Ref. No. —
	rinse arm mounting pos. right L 175mm mounting ø 13mm nozzles 3		
	GEV No.	518631	Ref. No. —
	wash arm mounting pos. left L 170mm nozzles mounting ø 24mm		
accessories for	510119		
	GEV No.	510108	Ref. No. N/A
	rinse arm shaft		
	GEV No.	510112	Ref. No. N/A
	Thumb screw thread M10 thread L 10mm ø 22mm H 4.5mm SS		
	GEV No.	518003	Ref. No. N/A
	screw cap		

accessories for	510119		
	GEV No.	518008	Ref. No. —
	gasket D1 ø 43mm D2 ø 78mm thickness 2mm with 6 holes wash arm support		
	GEV No.	518036	Ref. No. N/A
	formed hose angled warewashing		



GEV No.	518411	Ref. No.	N/A
description	wash and rinse arm wash arm L 410mm rinse arm L 415mm w. jets 7 r. jets 5 mounting ø 17/52mm mounting pos. upper		
spare parts for	518411		
	GEV No.	510138	Ref. No. —
	wash jet fine groove		
	GEV No.	510139	Ref. No. N/A
	rinse jet		
	GEV No.	518053	Ref. No. N/A
	union nut for rinse jet		
	GEV No.	518272	Ref. No. N/A
	union nut for wash jet		
accessories for	518411		
	GEV No.	510112	Ref. No. N/A
	Thumb screw thread M10 thread L 10mm ø 22mm H 4.5mm SS		
	GEV No.	518003	Ref. No. N/A
	screw cap		

knobs

producer-specific knobs

GIGA

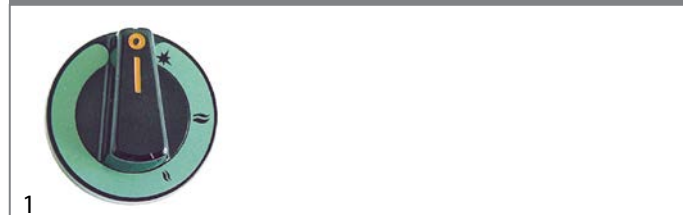

GEV No.	110771	Ref. No.	0000X00800
description	knob gas tap with ignition flame ø 60mm shaft ø 8x6.5mm shaft flat upper black		
For models:	C2FP, C2FTPFP, C2FTPFGP, C4FFE, C4FFGP, C4FFLE, C4FFLGP, C4FP, C6FFE, C6FFGAP, C6FFGP, C6FFLE, C6FFLEPV, C6FFLGP, C6FFLGPV, C6FP, CFTG1, CFTG1R, CFTG2, CFTG22, CFTG2LR, CFTG2R, CFTG2R2, CFTG3, CFTG3LR, CFTG4, CFTG4R, CFTG6, CFTG62, CFTG6LR, CFTG6R, CFTG6R2, CFTG8, CFTG8LR, CPG, CPGI, CPLG4, CPLG8, SKPL1G, SKPL2G, SKT1G, SKT1GR, SKT2G, SKT2G2, SKT2GLR, SKT2GR, SKT2GR2, SKT3G, SKT3GLR, SKT40G...(Other models you can see in the webshop)		



GEV No.	110049	Ref. No.	0000X00100
description	knob gas tap without ignition flame ø 60mm shaft ø 8x6.5mm shaft flat upper		
For models:	C2F, C2FTPFE, C2FTPFG, C4F, C4FFE, C4FFG, C4FFLE, C4FFLG, C6F, C6FFE, C6FFG, C6FFGA, C6FFLE, C6FFLEV, C6FFLG, C6FFLGV, CC120G, CC80G, CC81G, CCG120E, CCG80E, CCG81E, SKC40G, SKC80G, T2F, T4F, T6F		



GEV No.	110352	Ref. No.	0000X00900
description	knob gas thermostat 1-8 ø 60mm shaft ø 8x6.5mm shaft flat upper black		
For models:	C4FFLG, C4FFLGP, C6FFLG, C6FFLGP, C6FFLGPV, C6FFLGV, CC120G, CC80G, CC81G		



GEV No.	110774	Ref. No.	0000X03800 old version
description	knob oven ø 60mm shaft ø 6x4.6mm shaft flat lower black		



GEV No.	110775	Ref. No.	0000X01200
description	knob oven TH/BH/TH+BH ø 60mm shaft ø 6x4.6mm shaft flat upper black		
For models:	C2FTPFE, C2FTPFP, C4FFE, C4FFGP, C4PFE, C4PQFE, C4VFE, C6FFE, C6FFGP, C6PFE, C6PQFE, CCTPFE8		

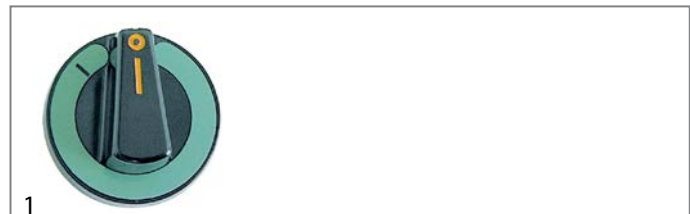

GEV No.	110773	Ref. No.	0000X00600
description	knob switch 0-1 ø 60mm shaft ø 6x4.6mm shaft flat upper black		
For models:	15DPE, 15PE, 15PSE, 6+4LE, 6+4ME, 6DLE, 6DME, 6LE, 6ME, 7DSET, 7SET, CRE4, CRE6, SK10DSE, SK10DSE9, SK10SE, SK10SE9, SKR40E, SKR60E, TR40E, TR60E		



GEV No.	110770	Ref. No.	0000X01000
description	knob switch 4-position ø 60mm shaft ø 6x4.6mm shaft flat upper		
For models:	CCPE4, CCPE6, SKCP40E, SKCP60E, TCP40E, TCP60E		



GEV No.	110451	Ref. No.	0000X00500
description	knob switch 7-position ø 60mm shaft ø 6x4.6mm shaft flat upper black		
For models:	C2P, C2PQ, C4P, C4PFE, C4PFLE, C4PQ, C4PQFE, C6P, C6PFE, C6PFLE, C6PFLEV, C6PQ, C6PQFE, CC120E, CC80E, CC81E, CCQ120E, CCQ80E, CCQ81E, SKC40E, SKC80E, SKCQ40E, SKCQ80E, TC120E, TC40E, TC80E, TCQ120E, TCQ40E, TCQ80E		



GEV No.	110453	Ref. No.	0000X00400
description	knob thermostat t.max. 110°C 30-110°C ø 60mm shaft ø 6x4.6mm shaft flat upper black temperature range 30-110°C		
For models:	CBE4, CBE6, CBE8, SKB40E, SKB60E, SKB80E, TB40E, TB60E, TB80E		



1

GEV No.	110455	Ref. No.	0000X00700
description	knob thermostat t.max. 195°C ø 60mm shaft ø 6x4.6mm shaft flat upper temperature range 100-195°C		
For models:	15DPE, 15PE, 15PSE, 4DME, 4ME, 6+4LE, 6+4ME, 6DLE, 6DME, 6LE, 6ME, 7DSE, 7DSET, 7SE, 7SET, CF15DG8, CF15G4, CF1E4, CF2E4, CF2E6, SK10DSE, SK10DSE9, SK10SE, SK10SE9, SKF1E, SKF2E, SKF2E4, TF1E, TF2E		



1

GEV No.	110454	Ref. No.	0000X00300
description	knob thermostat t.max. 300°C 50-300°C ø 60mm shaft ø 6x4.6mm shaft flat upper		
For models:	C4FFLE, C4FFLEP, C4PFLE, C4VFLE, C6FFLE, C6FFLEP, C6FFLEPV, C6FFLEV, C6PFLE, C6PFLEP, CBRE8, CC120E, CC81E, CCG120E, CCG81E, CCQ120E, CCQ81E, CCV81E, CFTE1, CFTE1C, CFTE1R, CFTE2, CFTE22, CFTE2C, CFTE2C2, CFTE2LR, CFTE2R, CFTE3, CFTE3C, CFTE3LR, CFTE4, CFTE4C, CFTE4R, CFTE6, CFTE62, CFTE6C, CFTE6C2, CFTE6LR, CFTE6R, CFTE8, CFTE8C, CFTE8LR, SKBR40E, SKT1E, SKT1EC, SKT1ER, SKT2E, SKT2E2, SKT2EC, SKT2EC2...(Other models you can see in the webshop)		



1

GEV No.	110776	Ref. No.	0000X03700
description	knob thermostat t.max. 300°C 50-300°C ø 60mm shaft ø 6x4.6mm shaft flat upper black		
For models:	C2FTPFE, C2FTPFEF, C4FFE, C4FFEP, C4PFE, C4PQFE, C4VFE, C6FFE, C6FFEP, C6PFE, C6PQFE, CCTPFE8		



1

GEV No.	110452	Ref. No.	0000X01400
description	knob thermostat t.max. 300°C ø 60mm shaft ø 6x4.6mm shaft flat upper temperature range 50-300°C		
For models:	CC80E, CCG80E, CCQ80E, CCV80E		



1

GEV No.	110779	Ref. No.	0000Y03800
description	knob gas thermostat 1-8 ø 75mm shaft ø 10x8mm shaft flat upper black		
For models:	K2FTPFPG, K4FFG, K6FFG, K8FFG, KFTG4, KFTG4C, KFTG4R, KFTG8, KFTG8C, KFTG8LR, KTPFG		



1

GEV No.	110781	Ref. No.	0000Y04700
description	knob oven TH/BH/TH+BH ø 75mm shaft ø 6x4.6mm shaft flat upper black		
For models:	K4FFE, K4PFE, K6FFE, K6PFE, K8FFE		



1

GEV No.	110786	Ref. No.	0000Y04400
description	knob switch 0-1 ø 75mm shaft ø 6x4.6mm shaft flat upper black		
For models:	KBRE, KBRE12, KBRE12IN, KBREIN, KBREM, KBREM12, KBREM12IN, KBREMIN, KBRG, KBRG12, KBRG12IN, KBRGIN, KBRGM, KBRGM12, KBRGM12IN, KBRGMIN, KFTE1, KFTE1C, KFTE1R, KFTE3, KFTE3C, KFTE3LR, KFTE4, KFTE4C, KFTE4R, KFTE8, KFTE8C, KFTE8LR		



1

GEV No.	110780	Ref. No.	0000Y04600
description	knob t.max. 300°C temperature range 50-300°C ø 75mm shaft ø 6x4.6mm shaft flat upper black		
For models:	K4FFE, K4PFE, K6FFE, K6PFE, K8FFE		



1

GEV No.	111470	Ref. No.	0000Y65007
description	knob oven t.max. °C ø 71mm shaft ø 6x4.6mm shaft flat upper black		
For models:	C4FFEP, C4ZFZE, C4ZFZEP, C4FZSFEP, C4PFCE, C4PFE, C4PFE9, C4PQFCE, C4PQFE, C4VFE, C6FFEP, C6FZFE, C6FZFEP, C6PFCE, C6PFCEV, C6PFE, C6PQFCE, C6PQFCEV, C6PQFE, CN10FE, K2FTPF, K4FFE, K4FS, K4FSFE, K4ZFZE, K4FZSFE, K4PFE, K4PFE9, K4VFE, K6FFE, K6FZFE, K6PFE, K6PFE9, K8FFE, K8FZFE, KTPFE		



1

GEV No.	111493	Ref. No.	0000X03800 0000Y65008
description	knob oven t.max. °C ø 71mm shaft ø 6x4.6mm shaft flat upper black		
For models:	C4FFCEP, C4FFLE, C4FFLEP, C4FZFCE, C4FZFCEP, C4FZSFCEP, C4PFCE, C4PFLE, C4PQFCE, C4VFCE, C4VFLE, C6FFCEP, C6FFLE, C6FFLEP, C6FFLEPV, C6FFLEV, C6FZCE, C6FZFCEP, C6FZFCEPV, C6FZFCEV, C6PFCE, C6PFCEV, C6PFLE, C6PFLEV, C6PQFCE, C6PQFCEV, CC120E, CC81E, CCG120CE, CCG120E, CCG81CE, CCG81E, CCQ120E, CCQ81E, CCV81E, K2FTPFCE, K4FSFCE, K4FZFCE, K4FZSFCE, K4PFCE, K4VFCE, K6FZFCE, K6PFCE, K8FZFCE, KTPFCE, SK4FZFCEP, SK4PFCE, SK4PQFCE, SK4VFCE, SK6FZFCEP...(Other models you can see in the webshop)		



1

GEV No.	112136	Ref. No.	0000Y65011
description	knob switch 4-position t.max. °C ø 71mm shaft ø 6x4.6mm shaft flat upper black		
For models:	CCPE4, CCPE6, CPEI, CPEI9, ICPE4, ICPE6, K4PFE, K6PFE, KCP4E, KC-P82E, KP110E, KP110E9, KP110EA, KP110EA9, KP115E, KP115E9, KP115EA, KP115EA9, KP120E, KP120EA, KP130E, KP130EA, KP150E, KP150EA, OPC-P4E, OPCP82E, SKCP40E, SKCP60E, TCP40E, TCP60E		



1

GEV No.	112137	Ref. No.	0000Y65002
description	knob thermostat t.max. 195°C ø 71mm shaft ø 6x4.6mm shaft flat upper black temperature range 100-195°C		
For models:	15DPE, 15PE, CF1E4, CF2E4, CF2E6, CF4E, CF6E, CFE15, CFE159, CFE15D, CFE15D9, IF1E4, IF2E6, IF4E, IF6E, KFE1, KFE15, KFE159, KFE15D, KFE15D9, KFE2, KFE20, KFE20D, OPFE1, OPFE15, OPFE15D, OPFE2, OPFE20, OPFE20D, SK10DSE, SK10SE, SKF1E, SKF2E, SKF2E4, SKF4E, SKF6E, TF1E, TF2E, TF2E4, TF4E, TF6E		



1

GEV No.	112135	Ref. No.	0000Y65004
description	knob thermostat t.max. 300°C ø 71mm shaft ø 6x4.6mm shaft flat upper black temperature range 50-300°C rotation 270°		
For models:	C4FFCEP, C4FFEP, C4FZFCE, C4FZFCEP, C4ZFZE, C4FZFEP, C4FZSFCEP, C4FZSFEP, C4PFCE, C4PFE, C4PFE9, C4PQFCE, C4PQFE, C4VFCE, C4VFE, C6FFCEP, C6FFEP, C6FZCE, C6FZFCEP, C6FZFCEPV, C6FZFCEV, C6FZFE, C6FZFEP, C6PFCE, C6PFCEV, C6PFE, C6PQFCE, C6PQFCEV, C6PQFE, CBRE, CBRE9, CBREIN, CBREIN9, CCG120CE, CCG81CE, CFTE1, CFTE1C, CFTE1R, CFTE2, CFTE22, CFTE2C, CFTE2C2, CFTE2LR, CFTE2R, CFTE2R2, CFTE3, CFTE3C, CFTE3LR, CFTE3R, CFTE4...(Other models you can see in the webshop)		



1

GEV No.	110456	Ref. No.	Y65000
description	knob universal ø 71mm shaft ø 6x4.6mm shaft flat upper black		



1

GEV No.	110457	Ref. No.	Y65100
description	knob universal ø 71mm shaft ø 8x6.5mm shaft flat upper black		



1

GEV No.	110458	Ref. No.	Y65003
description	knob dial plate gas tap with ignition flame ED ø 66mm ID ø 50mm silver		



1

GEV No.	110465	Ref. No.	Y65007
description	knob dial plate oven BH/TH/BH+TH ED ø 66mm ID ø 50mm silver		

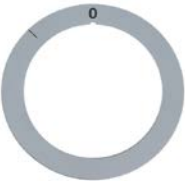

1

GEV No.	110479	Ref. No.	Y65010
description	knob dial plate switch 0-1 ED ø 66mm ID ø 50mm silver		

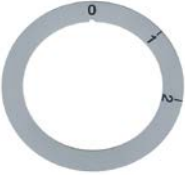

1

GEV No.	110690	Ref. No.	0000Y65012
description	knob dial plate switch 0-1-2 ED ø 66mm ID ø 50mm silver		
For models:	CPEI, CPEI9, KPI10E, KPI10E9, KPI10EA, KPI10EA9, KPI15E, KPI15E9, KPI15EA, KPI15EA9, KPI20E, KPI20EA, KPI30E, KPI30EA, KPI50E, KPI50EA, OPPI10E, OPPI10EA, OPPI15E, OPPI15EA		

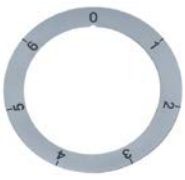

1

GEV No.	110464	Ref. No.	Y65005
description	knob dial plate switch 7-position ED ø 66mm ID ø 50mm silver		

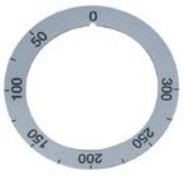

1

GEV No.	110462	Ref. No.	Y65004
description	knob dial plate thermostat t.max. 300°C 50-300°C rotation 270° ED ø 66mm ID ø 50mm silver		



1

GEV No.	110778	Ref. No.	Y65014
description	knob dial plate thermostat t.max. 90°C 30-90°C rotation 270° ED ø 66mm ID ø 50mm silver		



1

GEV No.	111226	Ref. No.	DFP032A60A DFP032A80A
description	knob gas tap with ignition flame t.max.°C ø 70mm shaft ø 8x6.5mm shaft flat upper		
For models:	M72FPTFG, M74FMP, M74FMPFE, M74FMPFG, M74FMPFXE, M74FMPFXG, M74FP, M74FPFE, M74FPFG, M74FPFXE, M74FPFXG, M76FMP, M76FMPFE, M76FMPFG, M76FMPFXE, M76FMPFXG, M76FP, M76FPFE, M76FPFG, M76FPFXE, M76FPFXG, M7CP4G, M7PL1G, M7PL2G		



1

GEV No.	111228	Ref. No.	DFP012A60A
description	knob gas tap without ignition flame t.max.°C ø 70mm shaft ø 6x4.6mm shaft flat upper		
For models:	M62F, M64F, M74F, M74FFXE, M74FFXG, M76F, M76FFXE, M76FFXG, M7FT4GL, M7FT4GR, M7FT6GL, M7FT6GLR		



1

GEV No.	111231	Ref. No.	DFP092A60A
description	knob gas thermostat 1-8 ø 70mm shaft ø 6x4.6mm shaft flat upper black		
For models:	M74FFXG, M74FMPFXG, M74FPFXG, M76FFXG, M76FMPFXG, M76FPFXG		



1

GEV No.	111229	Ref. No.	DFP072A60A
description	knob oven TH/BH/TH+BH ø 70mm shaft ø 6x4.6mm shaft flat upper		
For models:	M74FMPFE, M74FPFE, M76FMPFE, M76FPFE		



1

GEV No.	111227	Ref. No.	DFP122A60A
description	knob switch 0-1-2 ø 70mm shaft ø 6x4.6mm shaft flat upper		
For models:	M6CP4E, M7CP4E		



1

GEV No.	111224	Ref. No.	DFP052A60A
description	knob switch 7-position ø 70mm shaft ø 6x4.6mm shaft flat upper		
For models:	M62P, M62V, M64P, M64V, M74P, M74PFXE, M74PQ, M74PQFXE, M74V, M74VFXE, M76P, M76PFXE		



1

GEV No.	111225	Ref. No.	DFP022A60A
description	knob thermostat t.max. 195°C ø 70mm shaft ø 6x4.6mm shaft flat upper temperature range 100-195°C		
For models:	M6F4E, M6F6E, M7F4E, M7F6E		



1

GEV No.	111230	Ref. No.	DFP042A60A
description	knob thermostat t.max. 300°C ø 70mm shaft ø 6x4.6mm shaft flat upper black temperature range 50-300°C rotation 270°		
For models:	M6FT4EL, M6FT4ER, M6FT6EL, M6FT6ELR, M74FFXE, M74FMPFE, M74FMPFXE, M74FPFE, M74FPFXE, M74PFXE, M74PQFXE, M74VFXE, M76FFXE, M76FMPFE, M76FMPFXE, M76FPFE, M76FPFXE, M76PFXE, M7FT4EL, M7FT4ER, M7FT6EL, M7FT6ELR		



1

GEV No.	111232	Ref. No.	DFP142A60A
description	knob thermostat t.max. 90°C ø 70mm shaft ø 6x4.6mm shaft flat upper black temperature range 30-90°C rotation 270°		
For models:	M6B4E, M7B4E		



1

GEV No.	110824	Ref. No.	Y65300
description	knob switch zero mark ø 40mm shaft ø 6x4.6mm shaft flat upper black		
For models:	S600E		



1

GEV No.	699300	Ref. No.	761-005-00
description	knob zero mark ø 67mm shaft ø 6x4.6mm shaft flat upper black		



1

GEV No.	699301	Ref. No.	761-006-00
description	knob zero mark ø 67mm shaft ø 8x6mm shaft flat upper black		

accessories

button springs



1

GEV No.	550132	Ref. No.	063009
description	knob spring ø 6x4.6mm Qty 10 pcs		
For models:	S110E, S300E, S350G		

handles and hand wheels

hand wheels

hand wheels



1

GEV No.	690540	Ref. No.	X18500
description	hand wheel ø 150mm		
For models:	CBRE, CBRE8, CBREIN, CBRG, CBRG8, CBRGIN		



1

GEV No.	690544	Ref. No.	0900X18500
description	hand wheel ø 150mm		



1

GEV No.	693113	Ref. No.	0900X18500
description	hand wheel ø 150mm D1 ø 38mm bore ø 14mm thread groove width 5mm L1 38mm L2 40mm handle length 65mm with folding handle		
For models:	CBRE, CBRE9, CBREIN, CBREIN9, CBRG, CBRGIN		
spare parts for	693113		
	GEV No.	Ref. No.	—
	514255		
	folding handle ø 26mm total length 85mm seat ø 20mm shaft ømm thread M6 with pin L 85mm		
accessories for	693113		
	GEV No.	Ref. No.	E10300028
	690968		
	roll pin ø 5mm L 20mm		



1

GEV No.	692430	Ref. No.	0900Y41900
description	hand wheel ø 200mm D1 ø 50mm bore ø 20mm thread groove width 6mm groove depth 13mm mounting distance 30mm L1 47mm L2 50mm handle length 90mm with folding handle		



1

GEV No.	692431	Ref. No.	0900Y41900
description	hand wheel ø 200mm D1 ø 50mm bore ø 20mm thread groove width 8mm groove depth 12mm mounting distance 32mm L1 40mm L2 43mm handle length 65mm with folding handle		
For models:	KBRE, KBRE12, KBRE12IN, KBRE9, KBREIN, KBREIN9, KBRG, KBRG12, KBRG12IN, KBRGIN, OPBRE, OPBRE12, OPBRE12IN, OPBREIN, OPBRG, OPBRG12, OPBRG12IN, OPBRGIN		

cone handles



1

GEV No.	693121	Ref. No.	065007
description	cone handle thread M8 ø 33mm L 82mm plastic black		
For models:	S110E, S300E, S350G		



1

GEV No.	695615	Ref. No.	761-081-00 AVA017ZR10
description	cone handle thread M5x0.8 fryer cover		
For models:	CBE4, CBE8, CBG4, CF4E, CF6E, CRE4, CRE6, M6CP4E, M6F4E, M6F6E, M7CP4E, M7CP4G, M7F4E, M7F4G, M7F6E, M7F8G, SKB40E, SKB40G, SKB80E, SKF10GM, SKF1E, SKF20GM, SKF2E, SKF4E, SKF6E, SKR40E, SKR60E, TB40E, TB40G, TB80E, TF10GM, TF1E, TF20GM, TF2E, TF4E, TF6E, TR40E, TR60E		

ball handles



1

GEV No.	540323	Ref. No.	20200013
description	ball handle thread M10 ø 40mm with metal bush black		
For models:	KPI10ET, KPI10ETA, KPI15ET, KPI15ETA, KPI20ET, KPI20ETA, KPI20VT, KPI20VTA, KPI30ET, KPI30ETA, KPI30VT, KPI30VTA, KPI50ET, KPI50ETA, KPI50VT, KPI50VTA		

handle rails

handle rails



GEV No. 524271 **Ref. No.** 903933

description handle rail L 512mm W 28mm H 40mm dark blue Qty 1 pcs

For models: GLS805, GLS845

accessories for 524271

GEV No. 697926 **Ref. No.** 901657

sticker for handle rail L 460mm



GEV No. 511195 **Ref. No.** 903934

description handle rail L 562mm W 40mm suitable for Silanos blue hole distance 257/393/493mm

For models: GLS905, GLS925

end caps



GEV No. 518530 **Ref. No.** N/A

description end cap mounting pos. left



GEV No. 518529 **Ref. No.** N/A

description end cap mounting pos. right

bracket handles



GEV No. 695616 **Ref. No.** AVA013ZR10

description handle L 185mm bracket handle

For models: M7CP4G, M7F4G, M7F8G



GEV No. 390732 **Ref. No.** Y65700

description handle rod L 590mm H 60mm tube ø 30mm stainless steel

For models: B4F, B4FZ, B6F, B6FZ, B8FZ, C1W, C2FTPFPG, C2TP2FGP, C4FFCEP, C4FFCGP, C4FFEP, C4FFGP, C4FZFCE, C4FZFCEP, C4FZFCEG, C4FZFCGP, C4FZFCE, C4FZFEP, C4FZFG, C4FZFGP, C4FZSFCEP, C4FZSFCGP, C4FZSFEP, C4FZSFGP, C4I, C4PFCE, C4PFE, C4PFE9, C4PQFCE, C4PQFE, C4V, C4VFCE, C4VFE, C6FFCEP, C6FFCGP, C6FFEP, C6FFGAP, C6FFGP, C6FZFCE, C6FZFCEP, C6FZFCEPV, C6FZFCEV, C6FZFCEG, C6FZFCEGP, C6FZFCEGPV, C6FZFCEGV, C6FZFE, C6FZFEP, C6FZFG, C6FZFGA...(Other models you can see in the webshop)



GEV No. 691338 **Ref. No.** AVA011ZR10
AVA037ZR10

description pull handle L 485mm H 52mm mounting distance 470mm

For models: M72FPTFG, M74FFXE, M74FFXG, M74FMPFE, M74FMPFG, M74FMPFXE, M74FMPFXG, M74FPFE, M74FPFG, M74FPFXE, M74FPFXG, M74PFXE, M74PQFXE, M74VFXE, M76FFXE, M76FFXG, M76FMPFE, M76FMPFG, M76FMPFXE, M76FMPFXG, M76FPFE, M76FPFG, M76FPFXE, M76FPFXG, M76PFXE

accessories

miscellaneous



GEV No. 693119 **Ref. No.** 055807

description hand protection for griddle

For models: S110E, S300E, S350G



locks

edgemount latches

handle latches

CAFF/FERMOD

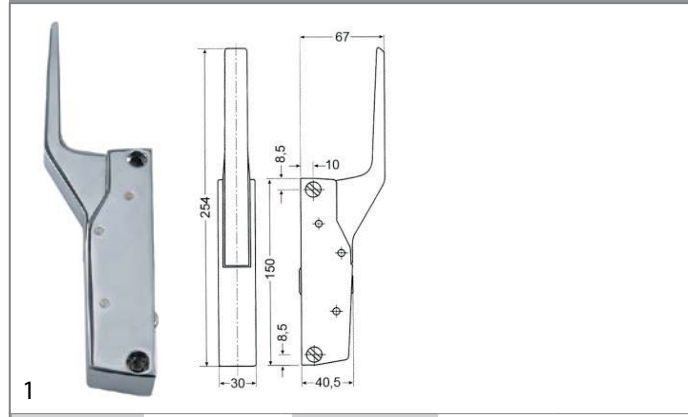

GEV No.	700060	Ref. No.	RX1496
description	handle latch L 150mm mounting distance 133mm non lockable heated units G 791		
accessories for	700060		
	GEV No.	700061	Ref. No. —
	door catch L 58mm W 20mm H 35mm mounting distance 42mm chrome-plated brass for headed units		
	GEV No.	700062	Ref. No. —
	handle protection heated units		

RAHRBACH

6188 ERGO series

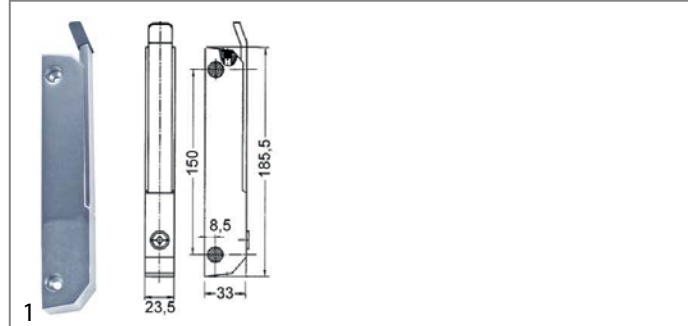

GEV No.	690808	Ref. No.	M19700
description	handle latch L 185mm mounting distance 150mm chrome-plated non lockable for headed units 6188 type ERGO		
For models:	GSP01		
accessories for	690808		
	GEV No.	690110	Ref. No. —
	base plate H 1mm L 38mm W 11mm mounting distance 26mm plastic		
	GEV No.	690111	Ref. No. —
	base plate H 2mm L 38mm W 11mm mounting distance 26mm plastic		
	GEV No.	690114	Ref. No. —
	base plate H 3.5mm L 185mm W 30mm mounting distance 150mm with inclination thread M5		
	GEV No.	700082	Ref. No. —
	door catch L 38mm W 18mm mounting distance 26mm		

snap locks

universal



1

GEV No.	690596	Ref. No.	R31200
description	snap lock L 60mm W 15mm H 36mm mounting distance 48/28mm spring thickness 1.5mm complete with door catch zamak		

hinges

spring assisted hinges

producer-specific

DESMON



1

GEV No.	701011	Ref. No.	FP280847
description	spring assisted hinge with hinge camp L 74mm W 24mm shaft length 18mm mounting distance 25mm mounting measurements 22x22x100mm		

GIGA



1

GEV No.	701011	Ref. No.	FP280847
description	spring assisted hinge with hinge camp L 74mm W 24mm shaft length 18mm mounting distance 25mm mounting measurements 22x22x100mm		

oven hinges

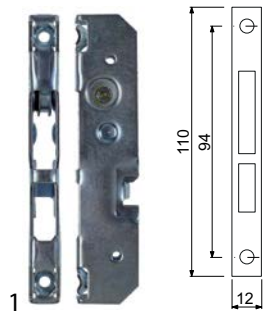

GEV No.	700003	Ref. No.	X68006
description	opposite support L 110mm W 12mm mounting distance 94mm		
For models:	C4FFLE, C4FFLEP, C4FFLG, C4FFLGP, C4PFLE, C4VFLE, C6FFLE, C6FFLEP, C6FFLEPV, C6FFLEV, C6FFLG, C6FFLGP, C6FFLGPV, C6FFLGV, C6PFLE, C6PFLEV, CC120E, CC120G, CC80E, CC80G, CC81E, CC81G, CCG120E, CCG80E, CCG81E, CCQ120E, CCQ80E, CCQ81E, CCV80E, CCV81E		

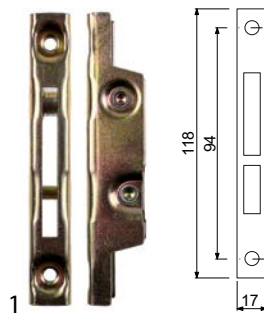

GEV No.	700001	Ref. No.	N/A
description	opposite support L 118mm W 17mm mounting distance 94mm		

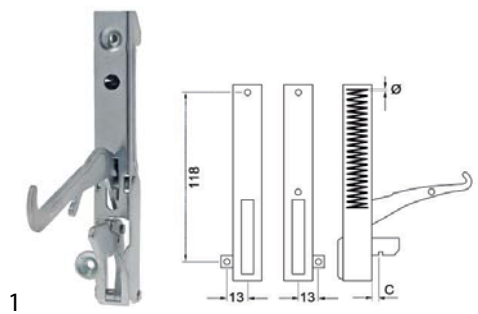

GEV No.	700013	Ref. No.	X68021
description	oven hinge mounting distance 118mm lug mounting 13mm lever length 119mm groove distance 13mm spring thickness 3.5mm mounting ear position left spring length 60mm L 154mm		
For models:	C4FFLE, C4FFLEP, C4FFLG, C4FFLGP, C4PFLE, C4VFLE, C6FFLE, C6FFLEP, C6FFLEPV, C6FFLEV, C6FFLG, C6FFLGP, C6FFLGPV, C6FFLGV, C6PFLE, C6PFLEV, CC120E, CC120G, CC80E, CC80G, CC81E, CC81G, CCG120E, CCG80E, CCG81E, CCQ120E, CCQ80E, CCQ81E, CCV80E, CCV81E		
accessories for	700013		
	GEV No.	700003	Ref. No. X68006
	opposite support L 110mm W 12mm mounting distance 94mm		

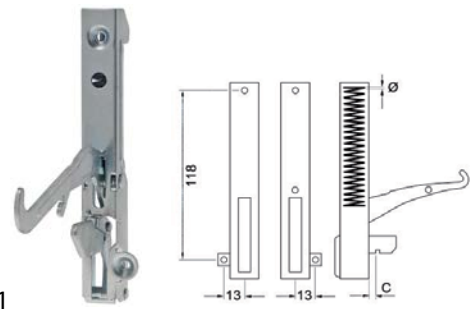

GEV No.	700014	Ref. No.	X68020
description	oven hinge mounting distance 118mm mounting distance 2mm lug mounting 13mm lever length 119mm groove distance 13mm spring thickness 3.5mm mounting ear position right spring length 60mm L 154mm		
For models:	C4FFLE, C4FFLEP, C4FFLG, C4FFLGP, C4PFLE, C4VFLE, C6FFLE, C6FFLEP, C6FFLEPV, C6FFLEV, C6FFLG, C6FFLGP, C6FFLGPV, C6FFLGV, C6PFLE, C6PFLEV, CC120E, CC120G, CC80E, CC80G, CC81E, CC81G, CCG120E, CCG80E, CCG81E, CCQ120E, CCQ80E, CCQ81E, CCV80E, CCV81E		
accessories for	700014		
	GEV No.	700003	Ref. No. X68006
	opposite support L 110mm W 12mm mounting distance 94mm		



GEV No.	700006	Ref. No.	0000X66000
description	oven hinge mounting distance 173mm mounting distance 2 105mm lug mounting 14mm lever length 120mm groove distance 11mm spring thickness 3.5mm mounting ear position left spring length 112mm W 25mm		
For models:	C2FTPF, C2FTPFEP, C2FTPFG, C2FTPFGP, C2TP2FGP, C4FFCEP, C4FFCGP, C4FFE, C4FFEP, C4FFG, C4FFGP, C4ZFCE, C4ZFCEP, C4ZFZFCG, C4ZFZFCGP, C4ZFZE, C4ZFZEP, C4ZFZFG, C4ZFZFGP, C4FZSFCEP, C4FZSFCEP, C4FZSFEP, C4FZSFGP, C4PFCE, C4PFE, C4PFE9, C4PQFCE, C4PQFE, C4VFCE, C4VFE, C6FFCEP, C6FFCGP, C6FFE, C6FFEP, C6FFG, C6FFGA, C6FFGAP, C6FFGP, C6FZFCE, C6FZFCEP, C6FZFCEPV, C6FZFCEV, C6FZFZFCG, C6FZFZFCGP, C6FZFZFCGPV, C6FZFZFCGV, C6FZFZE, C6FZFZEP, C6FZFZFG, C6FZFZGA...(Other models you can see in the webshop)		
accessories for	700006		
	GEV No.	700001	Ref. No. N/A
	opposite support L 118mm W 17mm mounting distance 94mm		
	GEV No.	700007	Ref. No. 0000X66100 X66100
	oven hinge mounting distance 173mm mounting distance 2 105mm lug mounting 14mm lever length 120mm groove distance 11mm spring thickness 3.5mm mounting ear position right spring length 112mm W 25mm		



GEV No.	700007	Ref. No.	0000X66100
description	oven hinge mounting distance 173mm mounting distance 2 105mm lug mounting 14mm lever length 120mm groove distance 11mm spring thickness 3.5mm mounting ear position right spring length 112mm W 25mm		
For models:	C2FTPFE, C2FTPFEP, C2FTPFG, C2FTPFGP, C2TP2FGP, C4FFCEP, C4FFCGP, C4FFE, C4FFEP, C4FFG, C4FFGP, C4FZCE, C4FZCEP, C4FZFCG, C4FZFCGP, C4FZFE, C4FZFEP, C4FZFG, C4FZFGP, C4FZSFCEP, C4FZSFCGP, C4FZSFEP, C4FZSFGP, C4PFCE, C4PFE, C4PFE9, C4PQFCE, C4PQFE, C4VFCE, C4VFE, C6FFCEP, C6FFCGP, C6FFE, C6FFEP, C6FFG, C6FFGA, C6FFGAP, C6FFGP, C6FZFCE, C6FZFCEP, C6FZFCEPV, C6FZCEV, C6FZFCG, C6FZFCGP, C6FZFCGPV, C6FZFCGV, C6FZFE, C6FZFEF, C6FZFG, C6FZFGA...(Other models you can see in the webshop)		
accessories for	700007		
GEV No.	700001	Ref. No.	N/A
description	opposite support L 118mm W 17mm mounting distance 94mm		
GEV No.	700006	Ref. No.	0000X66000 X66000
description	oven hinge mounting distance 173mm mounting distance 2 105mm lug mounting 14mm lever length 120mm groove distance 11mm spring thickness 3.5mm mounting ear position left spring length 112mm W 25mm		

door bearing

GEV No.	700721	Ref. No.	DVA012ZR10
description	bolt L 15mm ø 6mm		
For models:	M7CP4G, M7F4G, M7F8G		
GEV No.	700720	Ref. No.	SLM563ZR10
description	door hinge for fryer		
For models:	M7CP4G, M7F4G, M7F8G		
accessories for	700720		
GEV No.	700721	Ref. No.	DVA012ZR10
description	bolt L 15mm ø 6mm		

pullouts

rollers

GEV No.	692465	Ref. No.	908704
description	roller rollerø 33mm B1 8mm A 33mm B 8mm C 14.5mm D M8mm E 11.5mm plastic tread plastic bearing ball bearing thread M8x1.25 thread L 20mm Qty 1 pcs		
For models:	GLS945, GLS945S		

fittings for catering equipment

outlet taps

producer-specific

GIGA

GEV No.	514325	Ref. No.	M75400
description	ball valve connection 1" IT - 1" IT DN25 total length 83mm with lever handle		
For models:	15DPE, 15PE, CCPE4, CCPE6, CCPG4, CCPG8, CCPG82, CF10DG8M, CF10G4M, CF15DG8, CF15G4, CFE15, CFE15D, CFG15, CFG15D, KCP4, KCP4E, KCP8, KCP82, KCP82E, KFE15, KFE15D, KFE20, KFE20D, KFE4, KFE8, KFG1, KFG15, KFG15D, KFG2, KFG20, KFG20D, KFG4, KFG8, OPCP4, OPCP4E, OPCP82, OPCP82E, OPFE15, OPFE15D, OPFE20, OPFE20D, OPFG1, OPFG15, OPFG15D, OPFG2, OPFG20, OPFG20D, TCP40E, TCP60E		
GEV No.	540730	Ref. No.	M75500
description	ball valve connection 3/4" IT - 3/4" IT DN20 total length 70mm with lever handle handle length 95mm		
For models:	CCPE4, CCPE6, KB4, KB4G, KB8, OPB4, OPB4G, OPB8, SKCP40E, SKCP60E, TCP40E, TCP60E		
GEV No.	514411	Ref. No.	M22200
description	handle		
For models:	CBE4, CBE8, CBG4, CF10DG8M, CF10G4M, CF1E4, CF2E4, CF2E6, CF4E, CF6E, CRE4, CRE6, SK10DSE, SK10SE, SKB40E, SKB40G, SKB80E, SKCP40E, SKCP60E, SKCP60G, SKF10GM, SKF1E, SKF20GM, SKF2E, SKF2E4, SKF4E, SKF6E, SKR40E, SKR60E, TB40E, TB40G, TB80E, TCP60G, TF10GM, TF1E, TF20GM, TF2E, TF2E4, TF4E, TF6E, TP40G, TR40E, TR60E		

			
GEV No.	514446	Ref. No.	M75700
description	handle for outlet tap		
For models:	15DPE, 15PE, CCPG4, CCPG8, CCPG82, KCP4, KCP4E, KCP82, KCP82E, KFG1, KFG2, OPCP4, OPCP4E, OPCP82, OPCP82E, OPFG1, OPFG2, TF10GM, TF20GM		

			
GEV No.	514410	Ref. No.	T30200
description	lever		
For models:	CBE4, CBE8, CBG4, CF10DG8M, CF10G4M, CF1E4, CF2E4, CF2E6, CF4E, CF6E, CRE4, CRE6, SK10DSE, SK10SE, SKB40E, SKB40G, SKB80E, SKCP60G, SKF10GM, SKF1E, SKF20GM, SKF2E, SKF2E4, SKF4E, SKF6E, SKR40E, SKR60E, TB40E, TB40G, TB80E, TCP60G, TF10GM, TF1E, TF20GM, TF2E, TF2E4, TF4E, TF6E, TP40G, TR40E, TR60E		

			
GEV No.	514215	Ref. No.	M75300
description	outlet tap angled wing handle inlet 1/2" IT outlet 3/4" IT L 53.5mm approval EN 331		
For models:	15PSE, 7DSE, 7DSET, 7SE, 7SET		

			
GEV No.	514233	Ref. No.	0000X15200
description	outlet tap DN25 connection 3/4" total length 85mm		
For models:	CBE4, CBE8, CBG4, CF10DG8M, CF10G4M, CF1E4, CF2E4, CF2E6, CF4E, CF6E, CRE4, CRE6, SKB40E, SKB40G, SKB80E, SKF10GM, SKF1E, SKF20GM, SKF2E, SKF4E, SKF6E, SKR40E, SKR60E, TB40E, TB40G, TB80E, TCP60G, TF10GM, TF1E, TF20GM, TF2E, TF2E4, TF4E, TF6E, TP40G, TR40E, TR60E		
accessories for	514233		
	GEV No.	514410	Ref. No. T30200
	GEV No.	514411	Ref. No. M22200

aerators and air bleeders



			
GEV No.	540827	Ref. No.	Y70200
description	aerator and air bleeder thread 3/4" ET chrome-plated L 45mm ø 36mm		
For models:	KPI20E, KPI20EA, KPI20G, KPI20GA, KPI30E, KPI30EA, KPI30G, KPI30GA, KPI50E, KPI50EA, KPI50G, KPI50GA		

lid hinges

type RUBINETTERIE DEL FRIULI

for circular lids

lid hinges

			
GEV No.	540839	Ref. No.	0000E50000 0000Y45200
description	lid hinge L 270mm mounting distance 139mm flange radius 470mm opening angle 80° spring thickness 5mm bore ø M16mm for circular lids		
For models:	CPEI, CPG, CPGI, KP10G, KP10GA, KP10GT, KP10GTA, KP15G, KP15GA, KP15GT, KP15GTA, KPI10E, KPI10EA, KPI10G, KPI10GA, KPI10GT, KPI10GTA, KPI15E, KPI15EA, KPI15G, KPI15GA, KPI15GT, KPI15GTA, OPP10G, OPP10GA, OPP15G, OPP15GA, OPP10E, OPP10EA, OPP10G, OPP10GA, OPP15E, OPP15EA, OPP15G, OPP15GA		
spare parts for	540839		
	GEV No.	514137	Ref. No. —
	spring guide for lid hinge ID ø 28mm ED ø 32mm L 225mm zinc-coated steel		
	GEV No.	514140	Ref. No. —
	lid hinge body lid radius 470mm		
	GEV No.	514144	Ref. No. —
	bracket for lid hinge		
	GEV No.	514145	Ref. No. —
	adjusting bush L 108mm ø 80/60mm		
	GEV No.	540854	Ref. No. —
	torsion spring ø 50.8mm wire gauge ø 5.1mm L1 34mm L2 104mm L3 29mm mounting pos. right		
	GEV No.	540855	Ref. No. —
	torsion spring ø 50.8mm wire gauge ø 5.1mm L1 34mm L2 104mm L3 29mm mounting pos. left		

lid hinges



1

GEV No.	540720	Ref. No.	Y45200
description	lid hinge for circular lids		
spare parts for	540720		
	GEV No.	514143	Ref. No. —
	lid hinge body lid radius 320mm		
	GEV No.	514146	Ref. No. —
	bracket for lid hinge		
	GEV No.	514147	Ref. No. —
	adjusting bush		
	GEV No.	540846	Ref. No. —
	torsion spring ø 42.5mm wire gauge ø 4.1mm L1 93mm L2 26mm L3 26mm mounting pos. left		
	GEV No.	540847	Ref. No. —
	torsion spring ø 42.5mm wire gauge ø 4.1mm L1 93mm L2 26mm L3 26mm mounting pos. right		

FIREX

lid hinges



1

GEV No.	514412	Ref. No.	20300096
description	lid hinge L 230mm mounting distance 1 150mm flange radius 320mm spring thickness 4mm for circular lids		
For models:	KPI10ET, KPI10ETA, KPI10VT, KPI10VTA, KPI15ET, KPI15ETA, KPI15VT, KPI15VTA		
spare parts for	514412		
	GEV No.	540846	Ref. No. —
	torsion spring ø 42.5mm wire gauge ø 4.1mm L1 93mm L2 26mm L3 26mm mounting pos. left		
	GEV No.	540847	Ref. No. —
	torsion spring ø 42.5mm wire gauge ø 4.1mm L1 93mm L2 26mm L3 26mm mounting pos. right		



1

GEV No.	514413	Ref. No.	20300086
description	lid hinge L 270mm mounting distance 1 139mm flange radius 395mm spring thickness 5mm bore ø M15mm for circular lids		
For models:	KP20G, KP20GA, KP20GT, KP20GTA, KP30G, KP30GA, KP30GT, KP30GTA, KP50G, KP50GA, KP50GT, KP50GTA, KPI20E, KPI20EA, KPI20ET, KPI20G, KPI20GA, KPI20GT, KPI20GTA, KPI20VT, KPI20VTA, KPI30E, KPI30EA, KPI30G, KPI30GA, KPI30GT, KPI30GTA, KPI50E, KPI50EA, KPI50G, KPI50GA, KPI50GT, KPI50GTA		
spare parts for	514413		
	GEV No.	540854	Ref. No. —
	torsion spring ø 50.8mm wire gauge ø 5.1mm L1 34mm L2 104mm L3 29mm mounting pos. right		
	GEV No.	540855	Ref. No. —
	torsion spring ø 50.8mm wire gauge ø 5.1mm L1 34mm L2 104mm L3 29mm mounting pos. left		



1

GEV No.	514414	Ref. No.	20300108
description	lid hinge L 270mm mounting distance 1 139mm flange radius 470mm spring thickness 6mm bore ø M15mm for circular lids		
For models:	KPI30ET, KPI30VT, KPI30VTA, KPI50ET, KPI50VT, KPI50VTA		
spare parts for	514414		
	GEV No.	540856	Ref. No. —
	torsion spring ø 52mm wire gauge ø 6.2mm L1 30mm L2 95mm L3 30mm mounting pos. right		
	GEV No.	540857	Ref. No. —
	torsion spring ø 52mm wire gauge ø 6.2mm L1 30mm L2 95mm L3 30mm mounting pos. left		

lid catches

1

GEV No.	540850	Ref. No.	Y70900
description	lid lock handle ø 70mm L 134mm ET M12		

1

GEV No.	514127	Ref. No.	20300093
description	lid lock handle ø 70mm L 143mm		
For models:	KP20GA, KP20GTA, KP30GA, KP30GTA, KP50GA, KP50GTA, KPI10ETA, KPI10VTA, KPI15ETA, KPI15VTA, KPI20EA, KPI20ETA, KPI20GA, KPI20GTA, KPI20VT, KPI20VTA, KPI30EA, KPI30ETA, KPI30GA, KPI30GTA, KPI30VT, KPI30VTA, KPI50EA, KPI50ETA, KPI50GA, KPI50GTA, KPI50VT, KPI50VTA		

inlet taps

1

GEV No.	514210	Ref. No.	X18000
description	shut-off valve		

drain taps

brass

drain taps

1



GEV No.	540132	Ref. No.	39.302.02523 Y71100
description	drain tap 1 1/2" IT conical seal kettle A 90mm B 137mm B1 70mm chrome-plated brass		
For models:	KP20G, KP20GA, KP30G, KP30GA, KP50G, KP50GA, KPI20E, KPI20EA, KPI20G, KPI20GA, KPI30E, KPI30EA, KPI30G, KPI30GA, KPI50E, KPI50EA, KPI50G, KPI50GA		
spare parts for	540132		
	GEV No.	540213	Ref. No. —
	handle ID ø 5mm L 117mm		
	GEV No.	540461	Ref. No. —
	shim for drain tap		
	GEV No.	540464	Ref. No. —
	nut for drain tap thread 1 1/2"		
accessories for	540132		
	GEV No.	510404	Ref. No. —
	flat gasket fibre ED ø 44mm ID ø 34mm thickness 2mm Qty 1 pcs		

1

GEV No.	540275	Ref. No.	30200198
description	drain tap 2" IT with union nut A 90mm B 151mm B1 80mm chrome-plated brass		
For models:	KP20G, KP20GA, KP20GT, KP20GTA, KP30G, KP30GA, KP30GT, KP30GTA, KP50G, KP50GA, KP50GT, KP50GTA, KPGN18G, KPGN27G, KPGN37G, KPI10ET, KPI10ETA, KPI10VT, KPI10VTA, KPI15ET, KPI15ETA, KPI15VT, KPI15VTA, KPI20E, KPI20EA, KPI20ET, KPI20ETA, KPI20G, KPI20GA, KPI20GT, KPI20GTA, KPI20VT, KPI20VTA, KPI30E, KPI30EA, KPI30ET, KPI30ETA, KPI30G, KPI30GA, KPI30GT, KPI30GTA, KPI30VT, KPI30VTA, KPI50E, KPI50EA, KPI50ET, KPI50ETA, KPI50G, KPI50GA, KPI50GT...(Other models you can see in the webshop)		
spare parts for	540275		
	GEV No.	540214	Ref. No. —
	handle ID ø 6mm L 145mm		

Table continues overleaf



accessories for 540275	
	GEV No. 529484 Ref. No. —
flat gasket fibre ED ø 58mm ID ø 50mm thickness 2mm Qty 1 pcs	
	GEV No. 542448 Ref. No. —
gasket silicone 60x49x2 for drain tap 2"	

	
1	
GEV No.	540267 Ref. No. E50200
description	drain tap connection with union nut thread 2"
For models:	KP10G, KP10GA, KP10GT, KP10GTA, KP15G, KP15GA, KP15GT, KP15GTA, KP110E, KP110E9, KP110EA, KP110EA9, KP110G, KP110GA, KP110GT, KP110GTA, KP115E, KP115E9, KP115EA, KP115EA9, KP115G, KP115GA, KP115GT, KP115GTA, OPP10G, OPP10GA, OPP15G, OPP15GA, OPP110E, OPP110EA, OPP110G, OPP110GA, OPP115E, OPP115EA, OPP115G, OPP115GA
spare parts for	540267
	GEV No. 505517 Ref. No. —
O-ring EPDM thickness 5.34mm ID ø 53.34mm Qty 1 pcs	
	GEV No. 540214 Ref. No. —
handle ID ø 6mm L 145mm	

accessories	
	
1	
GEV No.	540959 Ref. No. 10500060
description	gasket for drain tap hose ext. ø 60mm ID ø 50mm H 2mm
For models:	KP20G, KP20GA, KP20GT, KP20GTA, KP30G, KP30GA, KP30GT, KP30GTA, KP50G, KP50GA, KP50GT, KP50GTA, KPGN18G, KPGN27G, KPGN37G, KPI10ET, KPI10ETA, KPI10VT, KPI10VTA, KPI15ET, KPI15ETA, KPI15VT, KPI15VTA, KPI20E, KPI20EA, KPI20ET, KPI20ETA, KPI20G, KPI20GA, KPI20GT, KPI20GTA, KPI20VT, KPI20VTA, KPI30E, KPI30EA, KPI30ET, KPI30ETA, KPI30G, KPI30GA, KPI30GT, KPI30GTA, KPI30VT, KPI30VTA, KPI50E, KPI50EA, KPI50ET, KPI50ETA, KPI50G, KPI50GA, KPI50GT...(Other models you can see in the webshop)

	
1	
GEV No.	540958 Ref. No. 10200002
description	rosette for drain tap hose ext. ø 120mm ID ø 60mm H 13mm
For models:	KP20G, KP20GA, KP20GT, KP20GTA, KP30G, KP30GA, KP30GT, KP30GTA, KP50G, KP50GA, KP50GT, KP50GTA, KPGN18G, KPGN27G, KPGN37G, KPI10ET, KPI10ETA, KPI10VT, KPI10VTA, KPI15ET, KPI15ETA, KPI15VT, KPI15VTA, KPI20E, KPI20EA, KPI20ET, KPI20ETA, KPI20G, KPI20GA, KPI20GT, KPI20GTA, KPI20VT, KPI20VTA, KPI30E, KPI30EA, KPI30ET, KPI30ETA, KPI30G, KPI30GA, KPI30GT, KPI30GTA, KPI30VT, KPI30VTA, KPI50E, KPI50EA, KPI50ET, KPI50ETA, KPI50G, KPI50GA, KPI50GT...(Other models you can see in the webshop)

	
1	
GEV No.	540957 Ref. No. 10400006
description	screw-in socket for drain tap thread 2" L 120mm
For models:	KPI10VT, KPI10VTA, KPI15VT, KPI15VTA

test taps

test taps

	
1	
GEV No.	540818 Ref. No. E50400 Y71300
description	test tap thread 1/2" ETW 88mm W1 38mm
For models:	CPEI, CPEI9, CPG, CPGI, KPI10E, KPI10E9, KPI10EA, KPI10EA9, KPI10G, KPI10GA, KPI10GT, KPI10GTA, KPI15E, KPI15E9, KPI15EA, KPI15EA9, KPI15G, KPI15GA, KPI15GT, KPI15GTA, KPI20E, KPI20EA, KPI20G, KPI20GA, KPI30E, KPI30EA, KPI30G, KPI30GA, KPI50E, KPI50EA, KPI50G, KPI50GA, OPP110E, OPP110EA, OPP110G, OPP110GA, OPP115E, OPP115EA, OPP115G, OPP115GA

safety fittings

accessories



GEV No.	540835	Ref. No.	10400061
description	screw cap thread 3/4"		
For models:	KP20GT, KP20GTA, KP30GT, KP30GTA, KP50GT, KP50GTA, KPI10ET, KPI10ETA, KPI15ET, KPI15ETA, KPI20E, KPI20EA, KPI20ET, KPI20ETA, KPI20G, KPI20GA, KPI20GT, KPI20GTA, KPI30E, KPI30EA, KPI30ET, KPI30ETA, KPI30G, KPI30GA, KPI30GT, KPI30GTA, KPI50E, KPI50EA, KPI50ET, KPI50ETA, KPI50G, KPI50GA, KPI50GT, KPI50GTA, KPIGN37G		
spare parts for	540835		
	GEV No.	513016	Ref. No.
	O-ring EPDM thickness 3.53mm ID ø 26.58mm Qty 1 pcs		
accessories for	540835		
	GEV No.	513016	Ref. No.
	O-ring EPDM thickness 3.53mm ID ø 26.58mm Qty 1 pcs		

safety valves



GEV No.	514415	Ref. No.	30300018 30300024
description	safety valve for kettle thread M33		
For models:	KP20GA, KP20GTA, KP30GA, KP30GTA, KP50GA, KP50GTA, KPI10VTA, KPI15VTA, KPI20EA, KPI20GA, KPI20GTA, KPI20VT, KPI20VTA, KPI30EA, KPI30GA, KPI30GTA, KPI30VT, KPI30VTA, KPI50EA, KPI50GA, KPI50GTA, KPI50VT, KPI50VTA		



GEV No.	540721	Ref. No.	Y70300
description	safety valve triggering pressure 0.5bar M88 thread 1 1/4"		
accessories for	540721		
	GEV No.	541501	Ref. No.
	reducer for safety fitting IT 1 1/4" ET 3/4"		



GEV No.	540722	Ref. No.	30300026 Y70800
description	safety valve with outlet for lid		
For models:	KPI10ETA, KPI15ETA, KPI20ETA, KPI30ETA, KPI50ETA		

equipment feet and end caps

equipment feet

with screw mounting



GEV No.	701092	Ref. No.	713-007-00 713-028-00 AVA010ZR10
description	equipment foot tube ø 50mm thread M10 thread L 23mm H 113/160mm SS Qty 1 pcs		
For models:	M72FPTFG, M74F, M74FFXE, M74FFXG, M74FMP, M74FMPFE, M74FMPFG, M74FMPFXE, M74FMPFXG, M74FP, M74FPFE, M74FPFG, M74FPFXE, M74FPFXG, M74P, M74PFXE, M74PQ, M74PQFXE, M74V, M74VFXE, M76F, M76FFXE, M76FFXG, M76FMP, M76FMPFE, M76FMPFG, M76FMPFXE, M76FMPFXG, M76FP, M76FPFE, M76FPFG, M76FPFXE, M76FPFXG, M76P, M76PFXE, M7B4E, M7CP4E, M7CP4G, M7F4E, M7F4G, M7F6E, M7F8G, M7FT4EL, M7FT4ER, M7FT4GL, M7FT4GR, M7FT6EL, M7FT6ELR, M7FT6GL, M7FT6GLR...(Other models you can see in the webshop)		



GEV No.	701304	Ref. No.	905016
description	equipment foot tube ø 52mm thread M10 thread L 18mm H 130-190mm SS size 2" Qty 1 pcs WS 44		
For models:	GLS925		



screw-in feet

 <p>1</p>			
GEV No.	695614	Ref. No.	765-049-00 M06400
description	equipment foot thread M10 ø 26mm H 30mm		
For models:	15PSE, 2FZP, C1W, C2FZ, C2FZP, C2I, C2P, C2PQ, C2V, C4FZ, C4FZP, C4FZSP, C4I, C4P, C4PQ, C4V, C4VFCE, C4VFE, C6FZ, C6FZP, C6P, C6PQ, CBE4, CBE8, CBG4, CCPE4, CCPE6, CCTP8, CF10DG8M, CF10G4M, CF1E4, CF2E4, CF2E6, CF4E, CF6E, CFTE1, CFTE1C, CFTE1R, CFTE2, CFTE22, CFTE2C, CFTE2C2, CFTE2LR, CFTE2R, CFTE2R2, CFTE3, CFTE3C, CFTE3LR, CFTE3R, CFTE4...(Other models you can see in the webshop)		

bolting feet

 <p>1</p>			
GEV No.	693442	Ref. No.	064001
description	equipment foot ø 29mm H 15mm rubber bore ø 6mm Qty 1 pcs		
For models:	S300E		

baskets
fryer baskets

 <p>1</p>			
GEV No.	970609	Ref. No.	Y46900
description	fryer basket L1 275mm W1 130mm H1 120mm H2 240mm		
For models:	15DPE, 15PE, CF10DG8M, CF10G4M, CFE15, CFE159, CFE15D, CFE15D9, CFG15, CFG15D, KFE15, KFE159, KFE15D, KFE15D9, KFG1, KFG15, KFG15D, KFG2, M7F4G, M7F8G, OPFE15, OPFE15D, OPFG1, OPFG15, OPFG15D, OPFG2, SKF10GM, SKF20GM, TF10GM, TF20GM		

 <p>1</p>			
GEV No.	970603	Ref. No.	Y46800
description	fryer basket L1 275mm W1 270mm H1 120mm L2 470mm H2 150mm H3 230mm chrome-plated steel		
For models:	15DPE, 15PE, CF10DG8M, CF10G4M, CFE15, CFE159, CFE15D, CFE15D9, KFE15, KFE159, KFE15D, KFE15D9, KFG1, KFG2, M7F4G, M7F8G, OPFE15, OPFE15D, OPFG1, OPFG2, SKF10GM, SKF20GM, TF10GM, TF20GM		

 <p>1</p>			
GEV No.	970451	Ref. No.	Y48100
description	fryer basket L1 280mm W1 100mm H1 100mm chrome-plated steel		
For models:	CF1E4, CF2E6, CF4E, CF6E, IF1E4, IF2E6, IF4E, IF6E, KFE1, KFE2, M6F4E, M6F6E, M7F4E, M7F6E, OPFE1, OPFE2, SKF1E, SKF2E, SKF4E, SKF6E, TF1E, TF2E, TF4E, TF6E		

 <p>1</p>			
GEV No.	970215	Ref. No.	Y47700 Y48000
description	fryer basket L1 280mm W1 200mm H1 100mm chrome-plated steel		
For models:	CF1E4, CF2E6, CF4E, CF6E, IF1E4, IF2E6, IF4E, IF6E, KFE1, KFE2, M6F4E, M6F6E, M7F4E, M7F6E, OPFE1, OPFE2, SK10DSE, SK10SE, SKF1E, SKF2E, SKF4E, SKF6E, TF1E, TF2E, TF4E, TF6E		

 <p>1</p>			
GEV No.	970610	Ref. No.	X55600
description	fryer basket L1 290mm W1 215mm H1 120mm L2 230mm H2 230mm H3 230mm chrome-plated steel		
For models:	CFE15, CFE15D, CFG15, CFG15D, KFE15, KFE15D, KFG15, KFG15D, OPFE15, OPFE15D, OPFG15, OPFG15D		



1

GEV No.	970214	Ref. No.	Y47900
description	fryer basket L1 295mm W1 100mm H1 105mm		
For models:	CF1E4, CF2E6, CF4E, CF6E, IF1E4, IF2E6, IF4E, IF6E, KFE1, KFE2, OPFE1, OPFE2, SK10DSE, SK10SE, SKF1E, SKF2E, SKF4E, SKF6E, TF1E, TF2E, TF4E, TF6E		



1

GEV No.	970449	Ref. No.	X63100
description	fryer basket L1 300mm W1 110mm H1 110mm chrome-plated steel		
For models:	15DPE, 15PE, CF10DG8M, CF10G4M, CF2E4, KFG1, KFG2, OPFG1, OPFG2, SK10DSE, SK10DSE9, SK10SE, SK10SE9, SKF10GM, SKF20GM, SKF2E4, TF10GM, TF20GM, TF2E4		



1

GEV No.	970217	Ref. No.	X62000
description	fryer basket L1 300mm W1 230mm H1 105mm		
For models:	15DPE, 15PE, CF10DG8M, CF10G4M, KFG1, KFG2, OPFG1, OPFG2, SK10DSE, SK10DSE9, SK10SE, SK10SE9, SKF10GM, SKF20GM, TF10GM, TF20GM		



1

GEV No.	970262	Ref. No.	X63200
description	fryer basket L1 315mm W1 123mm H1 130mm		
For models:	CF15DG8, CF15G4		



1

GEV No.	970265	Ref. No.	Y45900
description	fryer basket L1 330mm W1 140mm H1 135mm L2 700mm H2 160mm H3 250mm chrome-plated steel		
For models:	KFE4, KFE8, KFG4, KFG8		



1

GEV No.	970266	Ref. No.	Y46000
description	fryer basket L1 330mm W1 280mm H1 140mm		
For models:	KFE4, KFE8, KFG4, KFG8		

pasta baskets

GIGA



1

GEV No.	970771	Ref. No.	X59600
description	pasta basket H1 160mm W1 135mm L1 275mm L2 470mm H2 185mm H3 270mm stainless steel		
For models:	CCPE4, CCPE6, ICPE4, ICPE6, SKCP40E, SKCP60E, SKCP60G, TCP40E, TCP60E, TCP60G		



1

GEV No.	970608	Ref. No.	DVC002ZR10
description	pasta basket L1 120mm W1 90mm H1 148mm H2 235mm stainless steel		
For models:	M6CP4E, M7CP4E		



1

GEV No.	970607	Ref. No.	712-049-00 X62900
description	pasta basket L1 140mm W1 140mm H1 205mm H2 300mm stainless steel		
For models:	M7CP4G		



1

GEV No.	970223	Ref. No.	X60600
description	pasta basket L1 160mm W1 290mm H1 200mm H3 340mm stainless steel		
For models:	CCPG4, CCPG82, KCP4, KCP4E, KCP82, KCP82E, OPCP4, OPCP4E, OPCP82, OPCP82E		



1

GEV No.	970550	Ref. No.	712-064-00 X59700
description	pasta basket L1 295mm W1 135mm H1 200mm L2 390mm H2 220mm H3 305mm stainless steel		
For models:	CCPG4, CCPG82, M7CP4G		



1

GEV No.	970206	Ref. No.	X62600
description	pasta basket L1 280mm W1 145mm H1 160mm H3 298mm stainless steel		



1

GEV No.	970606	Ref. No.	DVC001ZR10
description	pasta basket L1 295mm W1 95mm H1 125mm H2 240mm stainless steel		
For models:	M6CP4E, M7CP4E		



1

GEV No.	970224	Ref. No.	X62800
description	pasta basket L1 290mm W1 160mm H1 200mm H2 280mm stainless steel		
For models:	CCPG8, KCP8		

crumb screens

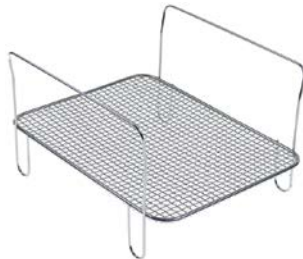

1

GEV No.	970280	Ref. No.	X62300
description	crumb screen L 280mm W 210mm H 150mm suitable for fryer		
For models:	7DSE, 7DSET, 7SE, 7SET		



1

GEV No.	970216	Ref. No.	X62600
description	pasta basket L1 295mm W1 135mm H1 160mm H3 290mm stainless steel		
For models:	CCPE4, CCPE6, SKCP40E, SKCP60E, TCP40E, TCP60E		



1

GEV No.	970271	Ref. No.	X62300
description	crumb screen L 280mm W 210mm suitable for fryer		



1

GEV No.	970222	Ref. No.	Y47800
description	crumb screen L 303mm W 212mm suitable for fryer		
For models:	CF1E4, CF2E6, CF4E, CF6E, IF1E4, IF2E6, IF4E, IF6E, KFE1, KFE2, OPFE1, OPFE2, SK10DSE, SK10SE, SKF1E, SKF2E, SKF4E, SKF6E, TF1E, TF2E, TF4E, TF6E		

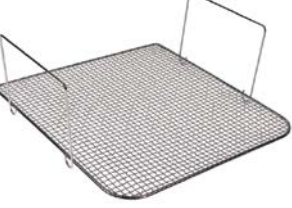

1

GEV No.	970605	Ref. No.	0000Y47000
description	crumb screen L 310mm W 295mm suitable for fryer		
For models:	15DPE, 15PE, CF10DG8M, CF10G4M, CFE15, CFE159, CFE15D, CFE15D9, KFE15, KFE159, KFE15D, KFE15D9, KFG1, KFG2, M7F4G, M7F8G, OPFE15, OPFE15D, OPFG1, OPFG2, SKF10GM, SKF20GM, TF10GM, TF20GM		



1

GEV No.	970219	Ref. No.	X62200
description	crumb screen L 337mm W 237mm fryer		
For models:	CF10DG8M, CF10G4M, KFG1, KFG2, OPFG1, OPFG2, SKF10GM, SKF20GM, TF10GM, TF20GM		

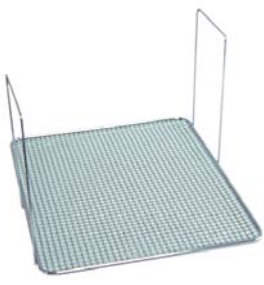

1

GEV No.	970261	Ref. No.	X64600
description	crumb screen L 340mm W 290mm suitable for fryer		
For models:	CF15DG8, CF15G4		

shelves and shelf rails

grates

producer-specific



1

GEV No.	693443	Ref. No.	055809
description	chargrill grid W 400mm D 345mm SS wire gauge frame 8mm lengthwise wires gauge 3mm crossing wires 1		
For models:	S110E		

gaskets

refrigeration gaskets

plug-in gaskets

profile 9010

We offer custom-made gaskets for this profile

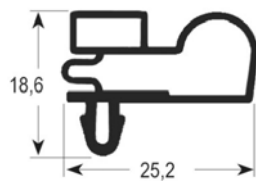

1

GEV No.	900600	Ref. No.	FH250051
description	refrigeration gasket profile 9010 W 660mm L 1585mm plug size		

gaskets for heated units

door seals

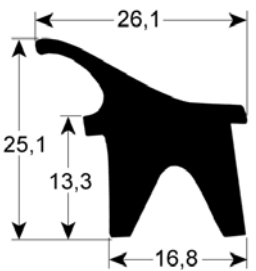

1

GEV No.	900683	Ref. No.	RX3351
description	door seal profile 2400 W 475mm L 645mm Qty 1		

GEV No.	900544	Ref. No.	0000X05600
description	door seal profile 2740 L 1350mm Qty 1		
For models:	C2FTPF, C2FTPFEP, C2FTPFG, C2FTPFGP, C2TP2FGP, C4FFE, C4FFEP, C4FFG, C4FFGP, C4FZFE, C4FZFEP, C4FZFG, C4FZFGP, C4FZSFEP, C4FZSFGP, C4PFCE, C4PFE, C4PFE9, C4PQFCE, C4PQFE, C4VFE, C6FFE, C6FFEP, C6FFG, C6FFGA, C6FFGAP, C6FFGP, C6FZFE, C6FZFEP, C6FZFG, C6FZFGP, C6PFCE, C6PFCEV, C6PFE, C6PQFCE, C6PQFCEV, C6PQFE, CCTPF8, CCTPFG8, CN10FE, K2FTPF, K2FTPFG, K4FFE, K4FFG, K4FS, K4FSFE, K4FSFG, K4FZFE, K4FZFG, K4FZSFE...(Other models you can see in the webshop)		

GEV No.	900230	Ref. No.	X68009
description	door seal profile 2920 L 1400mm Qty 1		
For models:	CC80E, CC80G, CCG80E, CCQ80E, CCV80E		

GEV No.	900229	Ref. No.	0000X05600
description	door seal profile 2930 L 1350mm Qty 1		

door seals with fixing hook

GEV No.	900231 ¹	Ref. No.	X68201
description	door seal L 590mm W 300mm 3-sided long side open with mounting clip		
For models:	C4FFLE, C4FFLEP, C4FFLG, C4FFLGP, C4PFLE, C4VFLE, C6FFLE, C6FFLEP, C6FFLEPV, C6FFLEV, C6FFLG, C6FFLGP, C6FFLGPV, C6FFLGV, C6PFLE, C6PFLEV, CC120E, CC120G, CC81E, CC81G, CCG120E, CCG81E, CCQ120E, CCQ81E, CCV81E		

¹3-sided, long side open

boiling pan gaskets

GEV No.	900819	Ref. No.	10600300
description	boiling pan gasket profile 3010 L 1000mm		
For models:	KP20GA, KP20GTA, KP30GA, KP30GTA, KP50GA, KP50GTA, KPI10ETA, KPI10VTA, KPI15ETA, KPI15VTA, KPI20EA, KPI20GA, KPI20GTA, KPI30EA, KPI30GA, KPI30GTA, KPI50EA, KPI50GA, KPI50GTA		

GEV No.	900821	Ref. No.	10600300/1
description	boiling pan gasket profile 3010 L 2000mm		
For models:	KPI10ETA, KPI10VTA, KPI15ETA, KPI15VTA		

GEV No.	900822	Ref. No.	10600300/2
description	boiling pan gasket profile 3010 L 2400mm		
For models:	KPI20ETA, KPI20VTA		

GEV No.	900823	Ref. No.	10600300/3
description	boiling pan gasket profile 3010 L 3000mm		
For models:	KPI30ETA, KPI30VTA, KPI50ETA, KPI50VTA		

O-rings

EPDM

GEV No.	529545	Ref. No.	904324
description	O-ring EPDM thickness 1.78mm ID ϕ 10.82mm Qty 1 pcs		
For models:	GLB615, GLS805, GLS845, GLS945		



GEV No.	511500	Ref. No.	N/A
description	O-ring EPDM thickness 1.78mm ID \varnothing 2.9mm Qty 10 pcs		



GEV No.	528815	Ref. No.	X05200
description	O-ring EPDM thickness 1.78mm ID \varnothing 3.69mm Qty 1 pcs		
For models:	CF10DG8M, CF10G4M, KFG1, KFG2, M7F4G, M7F8G, OPFG1, OPFG2, SKF10GM, SKF20GM, TF10GM, TF20GM		



GEV No.	510303	Ref. No.	904321
description	O-ring EPDM thickness 1.78mm ID \varnothing 6.75mm Qty 1 pcs		
For models:	GLB615, GLB785, GLB795, GLS805, GLS845, GLS905, GLS925, GLS935, GLS945, GLS945S		



GEV No.	510177	Ref. No.	N/A
description	O-ring EPDM thickness 1.78mm ID \varnothing 7.66mm Qty 1 pcs		



GEV No.	519181	Ref. No.	904388
description	O-ring EPDM thickness 1mm ID \varnothing 5mm Qty 1 pcs		
For models:	GLB615, GLB785, GLB795, GLS805, GLS845, GLS905, GLS925, GLS935, GLS945, GLS945S		



GEV No.	518227	Ref. No.	N/A
description	O-ring EPDM thickness 2.62mm ID \varnothing 12.37mm Qty 1 pcs		



GEV No.	528333	Ref. No.	904390
description	O-ring EPDM thickness 2.62mm ID \varnothing 13.1mm Qty 1 pcs		
For models:	GLS935		



GEV No.	510893	Ref. No.	904391
description	O-ring EPDM thickness 2.62mm ID \varnothing 9.92mm Qty 1 pcs		
For models:	GLB785, GLB795		



GEV No.	510554	Ref. No.	N/A
description	O-ring EPDM thickness 2mm ID \varnothing 120mm Qty 1 pcs		

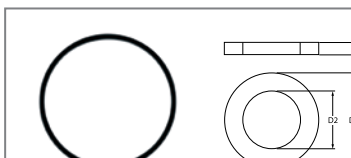

GEV No.	510009	Ref. No.	N/A
description	O-ring EPDM thickness 3.53mm ID \varnothing 101.2mm Qty 1 pcs		



GEV No.	511322	Ref. No.	904430
description	O-ring EPDM thickness 3.53mm ID \varnothing 20.22mm Qty 1 pcs		
For models:	GLB615, GLB785, GLB795, GLS805, GLS845, GLS905, GLS925, GLS945, GLS945S		



GEV No.	501352	Ref. No.	904404
description	O-ring EPDM thickness 3.53mm ID \varnothing 21.82mm Qty 1 pcs		
For models:	GLS805, GLS845, GLS905, GLS925		

GEV No.	511937	Ref. No.	10500110
description	O-ring EPDM thickness 3.53mm ID ø 28.17mm Qty 1 pcs		
For models:	KP20GT, KP20GTA, KP30GT, KP30GTA, KP50GT, KP50GTA, KPI10ET, KPI10ETA, KPI15ET, KPI15ETA, KPI20E, KPI20EA, KPI20ET, KPI20ETA, KPI20G, KPI20GA, KPI20GT, KPI20GTA, KPI30E, KPI30EA, KPI30ET, KPI30ETA, KPI30G, KPI30GA, KPI30GT, KPI30GTA, KPI50E, KPI50EA, KPI50ET, KPI50ETA, KPI50G, KPI50GA, KPI50GT, KPI50GTA, KPIGN37G		

GEV No.	521120	Ref. No.	907981 SD907981
description	O-ring EPDM thickness 5.34mm ID ø 37.47mm Qty 1 pcs		
For models:	GLB785, GLB795, GLS905, GLS925, GLS935		

GEV No.	510072	Ref. No.	904350 N/A
description	O-ring EPDM thickness 3.53mm ID ø 32.93mm Qty 1 pcs		
For models:	GLB615, GLB785, GLB795		

GEV No.	510408	Ref. No.	E11700
description	O-ring EPDM thickness 5.34mm ID ø 47mm Qty 1 pcs		
For models:	CPEI, CPEI9, KPI10E, KPI10E9, KPI10EA, KPI10EA9, KPI15E, KPI15E9, KPI15EA, KPI15EA9, KPI20E, KPI20EA, KPI30E, KPI30EA, KPI50E, KPI50EA, OPPI10E, OPPI10EA, OPPI15E, OPPI15EA		

GEV No.	510899	Ref. No.	X05400
description	O-ring EPDM thickness 3.53mm ID ø 37.69mm Qty 1 pcs		
For models:	CCPE4, CFE15, CFE159, CFE15D, CFE15D9, CMP4, KCP4E, KCP82E, KFE15, KFE159, KFE15D, KFE15D9, KFE20, KFE20D, OPCP4E, OPCP82E, OPFE15, OPFE15D, OPFE20, OPFE20D, SKCP40E, TCP40E, TMP4		

GEV No.	532545	Ref. No.	X05000
description	O-ring Viton thickness 3.53mm ID ø 49.21mm Qty 1 pcs		
For models:	CCPE4, CFE15, CFE159, CFE15D, CFE15D9, KCP4E, KCP82E, KFE15, KFE159, KFE15D, KFE15D9, KFE20, KFE20D, OPCP4E, OPCP82E, OPFE15, OPFE15D, OPFE20, OPFE20D, SKCP40E, TCP40E		

GEV No.	519179	Ref. No.	904380
description	O-ring EPDM thickness 3.53mm ID ø 41.28mm Qty 1 pcs		
For models:	GLB615, GLB785, GLB795, GLS805, GLS845, GLS935, GLS945, GLS945S		

GEV No.	510551	Ref. No.	D456023
description	pump cover gasket ID ø 158.3mm pump type 1214/1293/1225/2243/1226/1204/3473/1241 thickness 3.53mm EPDM Qty 1 pcs		

GEV No.	511331	Ref. No.	904395
description	O-ring EPDM thickness 3.53mm ID ø 53.57mm Qty 1 pcs		
For models:	GLS935, GLS945, GLS945S		

silicone			
GEV No.	695064	Ref. No.	I64004120
description	O-ring silicone thickness 2mm ID ø 66.4mm Qty 1 pcs		

Viton

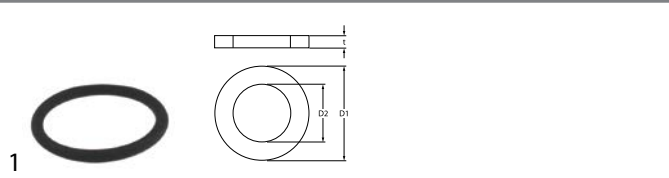

GEV No.	528155	Ref. No.	X05300
description	O-ring Viton thickness 3.53mm ID ø 32.93mm Qty 1 pcs		
For models:	CCPE4, CFE15, CFE159, CFE15D, CFE15D9, KCP4E, KCP82E, KFE15, KFE159, KFE15D, KFE15D9, KFE20, KFE20D, OPCP4E, OPCP82E, OPFE15, OPFE15D, OPFE20, OPFE20D, SKCP40E, TCP40E		

sealing washers

fibre gaskets



GEV No.	518541	Ref. No.	N/A
description	flat gasket FIBER ED ø 12mm ID ø 8mm thickness 1.5mm Qty 1 pcs		



GEV No.	518393	Ref. No.	N/A
description	flat gasket FIBER ED ø 24mm ID ø 17mm thickness 2mm Qty 1 pcs		



GEV No.	510417	Ref. No.	N/A
description	flat gasket fibre ED ø 20mm ID ø 14mm thickness 2mm Qty 1 pcs		



GEV No.	510406	Ref. No.	E50300
description	flat gasket fibre ED ø 60mm ID ø 48mm thickness 3mm for thread 1½" Qty 1 pcs		
For models:	KP10G, KP10GA, KP10GT, KP10GTA, KP15G, KP15GA, KP15GT, KP15GTA, KP20G, KP20GA, KP30G, KP30GA, KP50G, KP50GA, KPI10E, KPI10E9, KPI10EA, KPI10EA9, KPI10G, KPI10GA, KPI10GT, KPI10GTA, KPI15E, KPI15E9, KPI15EA, KPI15EA9, KPI15G, KPI15GA, KPI15GT, KPI15GTA, KPI20E, KPI20EA, KPI20G, KPI20GA, KPI30E, KPI30EA, KPI30G, KPI30GA, KPI50E, KPI50EA, KPI50G, KPI50GA, OPP10G, OPP10GA, OPP15G, OPP15GA, OPPI10E, OPPI10EA, OPPI10G, OPPI10GA... (Other models you can see in the webshop)		

rubber gaskets



GEV No.	510075	Ref. No.	N/A
description	flat gasket rubber ED ø 22mm ID ø 13mm thickness 1.5mm Qty 1 pcs		



GEV No.	511936	Ref. No.	904991
description	flat gasket rubber ED ø 25mm ID ø 16.5mm thickness 1.8mm Qty 1 pcs warewashing		
For models:	GLB615, GLS805, GLS845, GLS905, GLS925		



GEV No.	519114	Ref. No.	903260 SD903260
description	flat gasket rubber ED ø 25mm ID ø 16.5mm thickness 2mm Qty 1 pcs		
For models:	GLB615, GLB785, GLB795, GLS805, GLS845		

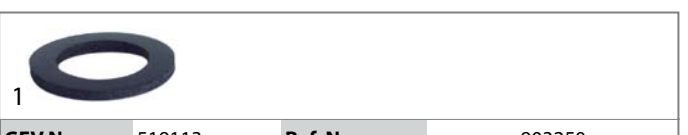

GEV No.	519113	Ref. No.	903250
description	flat gasket rubber ED ø 28mm ID ø 19mm thickness 3mm Qty 1 pcs		
For models:	GLS935, GLS945, GLS945S		



GEV No.	513059	Ref. No.	N/A
description	flat gasket rubber ED ø 52mm ID ø 40mm thickness 3mm Qty 1 pcs		



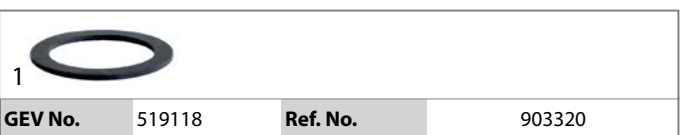

GEV No.	519117	Ref. No.	903301
description	flat gasket rubber ED ø 60mm ID ø 47mm thickness 3mm Qty 1 pcs		
For models:	GLB615, GLB785, GLB795		





GEV No.	519118	Ref. No.	903320
description	flat gasket rubber ED ø 70mm ID ø 52mm thickness 3mm Qty 1 pcs		
For models:	GLS805, GLS845		





 <p>1</p>			
GEV No.	519347	Ref. No.	TR2448
description	flat gasket rubber ED ø 80mm ID ø 60mm thickness 3mm Qty 1 pcs equiv. no. TR2448 suitable for Silanos		
For models:	GLS9455		

 <p>1</p>			
GEV No.	510071	Ref. No.	N/A
description	flat gasket rubber ED ø 81mm ID ø 68mm thickness 3mm for salt tank Qty 1 pcs		

 <p>1</p>			
GEV No.	518060	Ref. No.	D456040
description	gasket rubber ED ø 132mm ID ø 122mm thickness 5mm		

<p>plastic gaskets</p>  <p>1</p>			
GEV No.	504435	Ref. No.	908146
description	flat gasket plastic ED ø 18mm ID ø 9.5mm thickness 2.5mm for door hinge Qty 1 pcs		
For models:	GLS905, GLS925		

<p>copper gaskets</p> <p>DIN-7603-C</p>  <p>1</p>			
GEV No.	691624	Ref. No.	K98800
description	gasket copper ED ø 17mm ID ø 12.5mm thickness 2.5mm		
For models:	CFG15, CFG15D, KFG15, KFG15D, KFG20, KFG20D, OPFG15, OPFG15D, OPFG20, OPFG20D		

<p>paper gasket</p>  <p>1</p>			
GEV No.	511650	Ref. No.	903403
description	flat gasket paper ED ø 24mm ID ø 10.5mm thickness 1mm Qty 1 pcs warewashing		
For models:	GLB615, GLS805, GLS845		

<p>PTFE gaskets</p>  <p>1</p>			
GEV No.	510012	Ref. No.	N/A
description	flat gasket PTFE ED ø 16.5mm ID ø 12.5mm thickness 1.5mm Qty 1 pcs equiv. no. 437008		

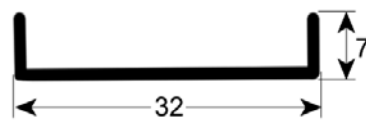
<p>special gaskets</p> <p>door seals for dishwashers</p>  <p>1</p>			
GEV No.	518536	Ref. No.	N/A
description	door seal L 590mm W 32mm dishwasher suitable for ELETTRORBAR, WOLK equiv. no. 437052		

<p>miscellaneous</p>  <p>1</p>			
GEV No.	510066	Ref. No.	N/A
description	gasket for filter		

 <p>1</p>			
GEV No.	510014	Ref. No.	N/A
description	gasket suitable for HOBART equiv. no. 139321-155 L 84mm W 40mm thickness 2.5mm		

<p>gaskets for wash arm support</p>  <p>1</p>			
GEV No.	506223	Ref. No.	905257
description	gasket D1 ø 110mm D2 ø 82mm thickness 3mm with 4 screw holes flange		
For models:	GLS905, GLS925		



1

GEV No.	518025	Ref. No.	N/A
description	gasket D1 ø 50mm D2 ø 82mm thickness 2mm with 6 holes wash arm support equiv. no. 437014 suitable for COLGED		



1

GEV No.	519445	Ref. No.	908141
description	gasket D1 ø 80mm D2 ø 50mm thickness 3mm with 4 screw holes		
For models:	GLS805, GLS845, GLS905, GLS925, GLS945		



1

GEV No.	518339	Ref. No.	N/A
description	gasket D2 ø 50mm thickness 2mm with 3 screw holes wash arm support equiv. no. 437064 suitable for COLGED hole ø 50mm hole distance 67mm		

refrigeration cycle components

cooling water regulators

JOHNSON CONTROLS



1

GEV No.	541483	Ref. No.	I62011100
description	cooling water regulator 3/8" type V46AA-9950 connection 6mm soldering connection pressure range 5-18bar water pressure max. 10bar water temperature max. 90°C capillary pipe 750mm L 160mm 0.9kg		

transmission technology and ball bearings

ball bearings

flange bearings



1

GEV No.	693112	Ref. No.	X61500
description	flange bearing type UCF204 shaft ø 20mm 4 hole flange hole distance 64mm H 33mm flange length 86mm flange width 86mm hole ø 12mm flange F204 ball bearing UC204G2 FH 25.5mm		

springs

torsion springs



1

GEV No.	690548	Ref. No.	Y71500
description	torsion spring ø 39mm wire gauge ø 7mm L1 281mm L2 31mm L3 24mm mounting pos. left		
For models:	KBRE, KBRE12, KBRE12IN, KBRE9, KBREIN, KBREIN9, KBREM, KBREM12, KBREM12IN, KBREMIN, KBRG, KBRG12, KBRG12IN, KBRGIN, KBRGM, KBRGM12, KBRGM12IN, KBRGMIN, OPBRE, OPBRE12, OPBRE12IN, OPBRE12MIN, OPBREIN, OPBREM, OPBREM12, OPBREM12IN, OPBREM12MIN, OPBRG, OPBRG12, OPBRG12IN, OPBRG12MIN, OPBRGIN, OPBRGM, OPBRGM12, OPBRGM12IN, OPBRGMIN		



1

GEV No.	690549	Ref. No.	Y71800
description	torsion spring ø 39mm wire gauge ø 7mm L1 31mm L2 281mm L3 24mm mounting pos. left		
For models:	KBRE12, KBRE12IN, KBREM, KBREM12, KBREM12IN, KBREMIN, KBRG12, KBRG12IN, KBRGM12, KBRGM12IN, OPBRE12, OPBRE12IN, OPBRE12MIN, OPBREM, OPBREM12, OPBREM12IN, OPBREM12MIN, OPBRG12, OPBRG12IN, OPBRG12MIN, OPBRGM12, OPBRGM12IN		



compression springs

			
1			
GEV No.	691622	Ref. No.	X15800
description	compression spring ø 13.4/8.3mm L 15mm wire gauge ø 0.75mm conical		
For models:	CC120CG, CC120G, CC80G, CC81CG, CC81G, CCG120CE, CCG120E, CCG80E, CCG81CE, CCG81E, IFTE1, IFTE1C, IFTE1R, IFTE2, IFTE22, IFTE2C, IFTE2C2, IFTE2LR, IFTE2R, IFTE2R2, IFTE3, IFTE3C, IFTE3LR, SKC40G, SKC80G, SKT1E, SKT1EC, SKT1ER, SKT2E, SKT2E2, SKT2EC, SKT2EC2, SKT2ELR, SKT2ER, SKT2ER2, SKT3E, SKT3EC, SKT3ELR, SKT40E, SKT40EC, SKT40ER, SKT60E, SKT60E2, SKT60EC, SKT60EC2, SKT60ELR, SKT60ER, SKT60ER2, SKT80E, SKT80EC...(Other models you can see in the webshop)		

tension springs

			
1			
GEV No.	519443	Ref. No.	908041
description	tension spring ø 11.5mm total length 220mm wire gauge ø 2mm		
For models:	GLS905, GLS925		

			
1			
GEV No.	519163	Ref. No.	904133 904137
description	tension spring ø 38.5mm total length 394mm wire gauge ø 6.5mm for hood		
For models:	GLS935, GLS945, GLS945S		

manometers



			
1			
GEV No.	541579	Ref. No.	E51000
description	manometer ø 52mm pressure range 0 up to 1bar connection marking 0.5 thread 1/4"		
For models:	CPEI, CPEI9, CPG, CPGI, KP10G, KP10GA, KP15G, KP15GA, KP10E, KP10E9, KP10EA, KP10EA9, KP110G, KP110GA, KP110GT, KP110GTA, KP115E, KP115E9, KP115EA, KP115EA9, KP115G, KP115GA, KP115GT, KP115GTA, OPPI10E, OPPI10EA, OPPI10G, OPPI10GA, OPPI15E, OPPI15EA, OPPI15G, OPPI15GA		

			
1			
GEV No.	541062	Ref. No.	30300022 Y70700
description	manometer ø 63mm pressure range 0 up to 1bar connection marking adjustable kettle thread 1/4"		
For models:	KP20GT, KP20GTA, KP30GT, KP30GTA, KP50GT, KP50GTA, KPI10ET, KPI10ETA, KPI10VT, KPI10VTA, KPI15ET, KPI15ETA, KPI15VT, KPI15VTA, KPI20E, KPI20EA, KPI20ET, KPI20ETA, KPI20G, KPI20GA, KPI20GT, KPI20GTA, KPI20VT, KPI20VTA, KPI30E, KPI30EA, KPI30ET, KPI30ETA, KPI30G, KPI30GA, KPI30GT, KPI30GTA, KPI30VT, KPI30VTA, KPI50E, KPI50EA, KPI50ET, KPI50ETA, KPI50G, KPI50GA, KPI50GT, KPI50GTA, KPI50VT, KPI50VTA, KPIGN37G		

dosing pumps

piston pumps

with solenoid coil

			
1			
GEV No.	361026	Ref. No.	D987017
description	dosing pump inlet 5mm outlet 5mm 230V detergent duty cycle 30% type EV1		
spare parts for	361026		
		GEV No.	361365
		Ref. No.	D201020
	solenoid coil 230VAC for type EV1		
		GEV No.	510298
		Ref. No.	—
	lip valve dosing pump suitable for DB2/DS5		

spare parts

			
1			
GEV No.	361113	Ref. No.	D201002
description	solenoid coil 230VAC for type DB2		

			
1			
GEV No.	361365	Ref. No.	D201020
description	solenoid coil 230VAC for type EV1		



1

GEV No.	361366	Ref. No.	N/A
description	PCB dishwasher 11F suitable for DB2 type DB2/EV1/EKP-M		









membrane dosing pumps

self-priming

LANG



1

GEV No.	361575	Ref. No.	902199
description	dosing pump type N6 rinse aid pressure connection \varnothing straight, 4x6mm suction connection \varnothing angled, 6mm LANG		
For models:	GLB785, GLB795, GLS935		
spare parts for	361575		
	GEV No.	361079	Ref. No. —
	spring for type N5/N6 for ball		
	GEV No.	361080	Ref. No. —
	O-ring EPDM thickness 2mm ID \varnothing 16mm Qty 1 pcs		
	GEV No.	361085	Ref. No. —
	O-ring EPDM thickness 2mm ID \varnothing 8mm Qty 1 pcs		
	GEV No.	361309	Ref. No. —
	ball for type N5/N6		
	GEV No.	361310	Ref. No. —
	bracket for type N6 ball guide		
	GEV No.	361311	Ref. No. —
	O-ring EPDM thickness 2mm ID \varnothing 6mm Qty 1 pcs for type N6		
	GEV No.	361314	Ref. No. —
	valve ring for type N6 holder for O-ring		
	GEV No.	361317	Ref. No. —
	sealing disc for type N6		
	GEV No.	361886	Ref. No. —
	non-return valve inletmm outletmm outlet \varnothing 12.4mm L 12.7mm		

self-priming with supporting pressure

GERMAC

type 2001



1

GEV No.	361545	Ref. No.	902018
description	dosing pump type 2001 rinse aid inlet 4x6mm outlet M10x1 suction connection \varnothing 4x6mm supporting pressure 11mm rebound ball PTFE 1mm GERMAC CODE VNR/U3		
For models:	GLB615, GLS805, GLS845, GLS905, GLS925, GLS945, GLS945S		
spare parts for	361545		
	GEV No.	361551	Ref. No. —
	compression spring wire gauge \varnothing 1mm		
	GEV No.	361700	Ref. No. —
	hose connector rotary hose \varnothing 4x6mm plastic connection M10x1		
	GEV No.	361702	Ref. No. —
	hose connector brass hose \varnothing 4x6mm		
	GEV No.	361705	Ref. No. —
	gasket for hose connector M12x1		
	GEV No.	510298	Ref. No. —
	lip valve dosing pump suitable for DB2/DS5		
accessories for	361545		
	GEV No.	361142	Ref. No. —
	mounting set detergent hose type 4x6mm hose length 2m PVC 2x hose/container filter/tank intake transparent		
	GEV No.	361550	Ref. No. —
	hose connector hose \varnothing 4x6mm		
	GEV No.	361553	Ref. No. —
	membrane EPDM		
	GEV No.	361701	Ref. No. —
	hose connector thread M10x1 grommet \varnothing 7.5mm		
	GEV No.	361703	Ref. No. —
	hose connector thread M10x1 brass pipe connection \varnothing 4x6mmmm		
	GEV No.	361704	Ref. No. —
	hose connector brass straight thread M12x1 hose \varnothing 11mm Qty 1 pcs		
	GEV No.	510296	Ref. No. —
	membrane silicone		
	GEV No.	520090	Ref. No. —
	PVC hose ID \varnothing 4mm ED \varnothing 6mm L 2m thickness 1mm t.max. 60°C transparent		
	GEV No.	520091	Ref. No. —
	nylon hose ID \varnothing 4mm ED \varnothing 6mm L 2m thickness 1mm operating p. 10bar burst p. 50bar t.max. 100°C transparent		



accessories

container filters



1

GEV No.	361062	Ref. No.	902568
description	container filter hose ø 4mm		
For models:	GLS935, GLS945S		



1

GEV No.	513043	Ref. No.	N/A
description	container filter hose ø 4mm		

T-pieces

without non-return valve



1

GEV No.	512093	Ref. No.	905408
description	T-piece connection 1: 12mm connection 2: 4mm		
For models:	GLB615, GLS805, GLS845, GLS905, GLS925, GLS945, GLS945S		
accessories for	512093		
	GEV No.	Ref. No.	—
	361083		
	union nut T1: M10x1 for hose 6mm		



1

GEV No.	519217	Ref. No.	905381
description	T-piece plastic hose ø 12-9-12mm 3-way hose ø 12-9-12mmmm		
For models:	GLS935		

tank inlets



1

GEV No.	361270	Ref. No.	D468151 D999104
description	tank inlet SS M12 hose ø 4mm		



hoses

supply hoses

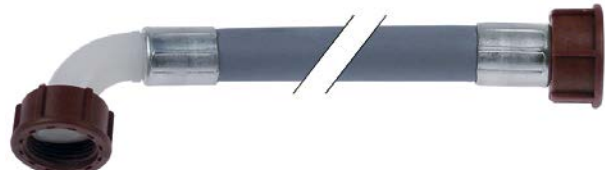
PVC supply hoses



1

GEV No.	520010	Ref. No.	907344
description	supply hose PVC straight-curved DN13 connections 3/4" L 1500mm operating p. 10bar burst p. 32bar t.max. 90°C blue approval VDE flat seal		
For models:	GLB615, GLB785, GLB795, GLS805, GLS845, GLS905, GLS925		
accessories for	520010		
	GEV No.	Ref. No.	—
	520053		
	screen connection 3/4" D1 ø 26mm D2 ø 15mm Qty 10 pcs rubber thickness 8mm		
	GEV No.	Ref. No.	—
	520054		
	flat gasket rubber ED ø 23.5mm ID ø 14mm thickness 2.3mm Qty 10 pcs		



1

GEV No.	520011	Ref. No.	907345
description	supply hose PVC straight-curved DN13 connections 3/4" L 2000mm operating p. 10bar burst p. 32bar t.max. 90°C approval VDE flat seal		
For models:	GLS935, GLS945, GLS945S		

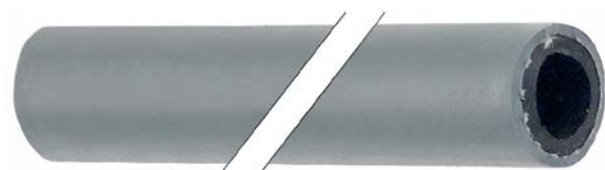

1

GEV No.	520015	Ref. No.	N/A
description	supply hose ID ø 10mm ED ø 17mm L 5m operating p. 20bar burst p. 60bar t.max. 95°C grey Qty 5m		
accessories for	520015		
	GEV No.	Ref. No.	—
	504377		
	hose connector grommet ø 23mm grommet length 25mm total length 55mm for water filling		



drain hoses



1

GEV No.	513718	Ref. No.	D143120
description	drain hose DN19 L 1500mm straight ϕ inside 24mm straight ext. ϕ 28mm outer hose ϕ 23mm		



1

GEV No.	518068	Ref. No.	D143136
description	drain hose DN34 L 2000mm elbow ϕ inside 50mm elbow ext. ϕ 59mm inner hose ϕ 35mm outer hose ϕ 42mm PVC		



1

GEV No.	518518	Ref. No.	N/A
description	drain hose DN19 L 1500mm A int. ϕ 21mm A ext. ϕ 27mm B int. ϕ 29mm B ext. ϕ 35mm outer hose ϕ 25mm		



1

GEV No.	518219	Ref. No.	N/A
description	drain hose DN19 L 630mm A int. ϕ 20mm A ext. ϕ 27mm B int. ϕ 21mm B ext. ϕ 28mm outer hose ϕ 24mm		

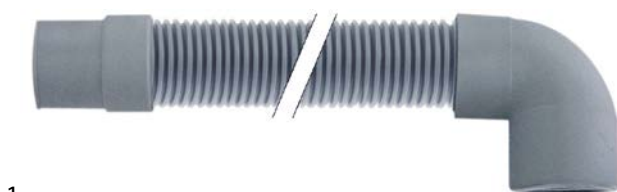

1

GEV No.	530571	Ref. No.	907440
description	drain hose DN24 L 1500mm straight ϕ inside 24mm straight ext. ϕ 29mm elbow ϕ inside 29mm elbow ext. ϕ 35mm outer hose ϕ 28mm		
For models:	GLB615, GLB785, GLB795		

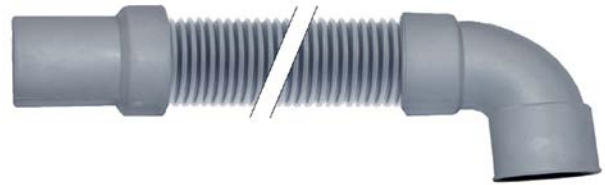

1

GEV No.	519272	Ref. No.	907450 907451
description	drain hose DN24 L 1500mm straight ϕ inside 32mm straight ext. ϕ 35mm elbow ϕ inside 40mm elbow ext. ϕ 46mm outer hose ϕ 38mm		
For models:	GLS805, GLS845, GLS935, GLS945, GLS945S		

industrial hoses

nylon hoses



1

GEV No.	520032	Ref. No.	907260
description	nylon hose ID ϕ 4mm ED ϕ 6mm L 5m thickness 1mm operating p. 10bar burst p. 50bar t.max. 100°C blue		
For models:	GLS805, GLS845		

pressure control hoses



1

GEV No.	530560	Ref. No.	N/A
description	pressure control hose ID ϕ 5mm ED ϕ 9mm L 5m operating p. 30bar burst p. 90bar temp.-resist. 60°C		

PVC hoses

PVC hoses without fabric



1

GEV No.	520027	Ref. No.	907270
description	PVC hose ID ϕ 4mm ED ϕ 7mm L 10m thickness 1.5mm t.max. 60°C transparent		
For models:	GLB615, GLB785, GLB795, GLS805, GLS845, GLS935		

silicone hoses
without fabric



1

GEV No.	530410	Ref. No.	907272 907279
description	silicone hose ID ø 4mm ED ø 7mm L 2m thickness 1.5mm t.max. 200°C transparent		
For models:	GLB615, GLB785, GLB795, GLS805, GLS845, GLS905, GLS925, GLS935, GLS945, GLS945S		



1

GEV No.	519392	Ref. No.	903756
description	formed hose L 61mm dishwasher straight hose ext. ø 50mm hose int. ø 38mm		
For models:	GLS805, GLS845, GLS905, GLS925, GLS945		

formed hoses

straight



1

GEV No.	518070	Ref. No.	N/A
description	formed hose dishwasher straight mounting pos. upper equiv. no. 127026		



1

GEV No.	518381	Ref. No.	N/A
description	formed hose dishwasher straight mounting pos. upper equiv. no. 127035		



1

GEV No.	518380	Ref. No.	N/A
description	formed hose ext. ø 53 ID ø 43mm L 65mm dishwasher straight mounting pos. upper equiv. no. 127036		

form L



1

GEV No.	519137	Ref. No.	903701
description	formed hose D1 ø 75mm D2 ø 59mm L 220mm curved		
For models:	GLS935		



1

GEV No.	519563	Ref. No.	908136
description	formed hose end piece A ext. ø 56mm end piece A int. ø 45mm AD2 ø 56mm ø end piece B 44mm L 160mm Qty 1 L-shape		
For models:	GLS905, GLS925		



1

GEV No.	519160	Ref. No.	903876
description	formed hose L 150mm warewashing L-shape equiv. no. 903876 W 110mm hose int. ø 40mm		
For models:	GLS805, GLS845		



1

GEV No.	518216	Ref. No.	N/A
description	formed hose warewashing L-shape equiv. no. 127001 mounting pos. upper		



1

GEV No.	518520	Ref. No.	N/A
description	formed hose warewashing L-shape equiv. no. 127005		



1

GEV No.	518225	Ref. No.	N/A
description	formed hose warewashing L-shape equiv. no. 127041		



1

GEV No.	519128	Ref. No.	903665
description	formed hose warewashing L-shape equiv. no. 903665		
For models:	GLB785, GLB795		



1

GEV No.	519132	Ref. No.	903674
description	formed hose warewashing L-shape equiv. no. 903674		
For models:	GLB615, GLB785, GLB795		



1

GEV No.	519151	Ref. No.	908713
description	formed hose warewashing L-shape equiv. no. 903761		
For models:	GLS9455		



1

GEV No.	519159	Ref. No.	903875
description	formed hose warewashing L-shape equiv. no. 903875		
For models:	GLS805, GLS845		

form S



1

GEV No.	519131	Ref. No.	903668
description	formed hose S-shape warewashing equiv. no. 903668		
For models:	GLB615		

form U



1

GEV No.	518517	Ref. No.	N/A
description	formed hose for drain pump D1 ø 28mm D2 ø 21mm warewashing U-shape		



miscellaneous



1

GEV No.	518036	Ref. No.	N/A
description	formed hose angled warewashing		



1

GEV No.	519216	Ref. No.	905382
description	T-piece plastic hose ø 12-12-12mm 3-way		
For models:	GLB615, GLB785, GLB795, GLS805, GLS845, GLS905, GLS925, GLS935, GLS945S		

for dishwashers

miscellaneous



1

GEV No.	519448	Ref. No.	907295
description	hose D1 ø 12mm D2 ø 19.5mm		
For models:	GLB615, GLB785, GLB795, GLS805, GLS845, GLS905, GLS925, GLS935, GLS945, GLS945S		



1

GEV No.	519217	Ref. No.	905381
description	T-piece plastic hose ø 12-9-12mm 3-way hose ø 12-9-12mmmm		
For models:	GLS935		



1

GEV No.	530590	Ref. No.	907359
description	hose ED ø 15mm ID ø 8mm equiv. no. 200117 Qty supplied by meter		
For models:	GLS935		

fittings

angle pieces



1

GEV No.	520821	Ref. No.	908120
description	angle piece thread 1/4" IT - 1/4" IT nickel-plated brass		
For models:	GLB785, GLB795, GLS935, GLS945, GLS945S		



1

GEV No.	530432	Ref. No.	907360
description	pressure hose ED ø 17mm ID ø 10mm L 1000mm operating p. 10bar burst p. 25bar temp.-resist. 110°C		
For models:	GLB615, GLB785, GLB795		

fittings, hose and pipe connectors

hose connectors

without screw connection



1

GEV No.	541109	Ref. No.	N/A
description	Y-piece plastic hose ø 8-6-8mm for pressure switch		

hose connectors

brass



1

GEV No.	513253	Ref. No.	N/A
description	hose connector brass angled thread 1/4" hose ø 12mm Qty 1 pcs		

nickel-plated brass



1

GEV No.	519239	Ref. No.	905452 905453
description	hose connector nickel-plated brass thread 1/4" hose ø 11mm Qty 1 pcs		
For models:	GLB615, GLS945, GLS945S		

producer-specific



1			
GEV No.	519290	Ref. No.	908121
description	hose connector		
For models:	GLS935, GLS945, GLS945S		



1			
GEV No.	519291	Ref. No.	906003
description	hose connector		
For models:	GLB785, GLB795, GLS805, GLS845		



1			
GEV No.	512093	Ref. No.	905408
description	T-piece connection 1: 12mm connection 2: 4mm		
For models:	GLB615, GLS805, GLS845, GLS905, GLS925, GLS945, GLS945S		
accessories for	512093		



GEV No.	361083	Ref. No.	—
union nut T1: M10x1 for hose 6mm			



1			
GEV No.	514325	Ref. No.	M75400
description	ball valve connection 1" IT - 1" IT DN25 total length 83mm with lever handle		
For models:	15DPE, 15PE, CCPE4, CCPE6, CCPG4, CCPG8, CCPG82, CF10DG8M, CF10G4M, CF15DG8, CF15G4, CFE15, CFE15D, CFG15, CFG15D, KCP4, KCP4E, KCP8, KCP82, KCP82E, KFE15, KFE15D, KFE20, KFE20D, KFE4, KFE8, KFG1, KFG15, KFG15D, KFG2, KFG20, KFG20D, KFG4, KFG8, OPCP4, OPCP4E, OPCP82, OPCP82E, OPFE15, OPFE15D, OPFE20, OPFE20D, OPFG1, OPFG15, OPFG15D, OPFG2, OPFG20, OPFG20D, TCP40E, TCP60E		



1			
GEV No.	540730	Ref. No.	M75500
description	ball valve connection 3/4" IT - 3/4" IT DN20 total length 70mm with lever handle handle length 95mm		
For models:	CCPE4, CCPE6, KB4, KB4G, KB8, OPB4, OPB4G, OPB8, SKCP40E, SKCP60E, TCP40E, TCP60E		

producer-specific

GIGA



1			
GEV No.	514212	Ref. No.	0000X15300
description	ball valve total length 93mm handle length 95mm L 93mm inlet 3/4" ET lever handle grommet ø 22mm outlet ø22mm		
For models:	15DPE, 15PE, CF10DG8M, CF10G4M, CF1E4, CF2E6, CF4E, CF6E, CFE15, CFE159, CFE15D, CFE15D9, IBE4, IBE8, ICPE4, ICPE6, IF1E4, IF2E6, IF4E, IF6E, IRE4, IRE6, KFE1, KFE15, KFE159, KFE15D, KFE15D9, KFE2, KFE20, KFE20D, KFG1, KFG2, OPFE1, OPFE15, OPFE15D, OPFE2, OPFE20, OPFE20D, OPFG1, OPFG2, TF1E, TF2E, TF4E, TF6E		

accessories



1			
GEV No.	514217	Ref. No.	M75700 old
description	handle for outlet tap		

valves and tank inlets

ball valves

universal

ball valves with lever handle



1			
GEV No.	520282	Ref. No.	AVA015ZR10
description	ball valve connection 1" IT - 1" IT DN25 total length 67mm with lever handle		
For models:	15DPE, 15PE, CCPG4, CCPG82, CF10DG8M, CF10G4M, CFG15, CFG15D, KCP4, KCP4E, KCP82, KCP82E, KFG1, KFG15, KFG15D, KFG2, KFG20, KFG20D, M7CP4G, M7F4G, M7F8G, OPCP4, OPCP4E, OPCP82, OPCP82E, OPFG1, OPFG15, OPFG15D, OPFG2, OPFG20, OPFG20D		







shut-off valves

universal



1

GEV No.	514370	Ref. No.	0000X18000
description	shut-off valve connection 1/2" 1/2" hot total length 54mm shaft ø M5x0.8mm		
For models:	CBRE, CBRE9, CBREIN, CBREIN9, CBRG, CBRGIN, CCPE4, CCPE6, CCPG4, CCPG8, CCPG82, ICPE4, ICPE6, KB4, KB4G, KB8, KBRE, KBRE12, KBRE12IN, KBRE9, KBREIN, KBREIN9, KBREM, KBREM12, KBREM12IN, KBREMIN, KBRG, KBRG12, KBRG12IN, KBRGIN, KBRGM, KBRGM12, KBRGM12IN, KBRGMIN, KCP4, KCP4E, KCP82, KCP82E, M7CP4G, OPB4, OPB4G, OPB8, OPBRE, OPBRE12, OPBRE12IN, OPBRE12MIN, OPBREIN, OPBREM, OPBREM12, OPBREM12IN...(Other models you can see in the webshop)		
spare parts for	514370		
	GEV No. 514085	Ref. No.	—
	rosette connection 26x19G chrome-plated total lengthmm mounting pos.		
	GEV No. 514086	Ref. No.	—
	hexagonal nut connection 26x19G brass total lengthmm mounting pos. H 6mm WS 34 Qty 1 pcs		
	GEV No. 540414	Ref. No.	—
	star handle connection hot total lengthmm mounting pos. shaft diameter 7x7mm ø 55mm 35 built-in depth 22mm		
	GEV No. 540415	Ref. No.	—
	star handle connection cold total lengthmm mounting pos. shaft diameter 7x7mm ø 55mm 35 built-in depth 22mm		
	GEV No. 540672	Ref. No.	—
	gasket suitable for tap head		





1

GEV No.	514208	Ref. No.	M75600
description	shut-off valve connection 1/2" 1/2" straight total length 64mm shaft ø 8x10mm		
For models:	KB4, KB8, KBRE, KBRE12, KBRE12IN, KBREIN, KBREM, KBREM12, KBREM12IN, KBREMIN, KBRG, KBRG12, KBRG12IN, KBRGIN, KBRGM, KBRGM12, KBRGM12IN, KBRGMIN, KCP8, OPBRG, OPBRG12, OPBRG12IN, OPBRGIN		

inlet taps



1

GEV No.	514214	Ref. No.	Y71000
description	inlet spout tube ø 20mm projection 90mm overall height 175mm spout height 135mm rotation 360° thread 1/2" ET		
accessories for	514214		
	GEV No. 511470	Ref. No.	—
	nut thread 1/2" ø 40mm H 8mm WS 25 brass Qty 1 pcs		
	GEV No. 511474	Ref. No.	—
	flat washer for thread 1/2"		
	GEV No. 511477	Ref. No.	—
	flat gasket rubber ED ø 42mm ID ø 21mm thickness 2mm Qty 1 pcs		

ancillary products

clamps

hose clamps

DIN 3017 - W2



1

GEV No.	520115	Ref. No.	902460
description	hose clamp ø 25-40mm width 9mm Qty 10 pcs DIN 3017		
For models:	GLB615, GLB785, GLB795, GLS905, GLS925, GLS935		



1

GEV No.	520116	Ref. No.	902441
description	hose clamp ø 32-50mm width 9mm Qty 5 pcs DIN 3017		
For models:	GLB615, GLB785, GLB795, GLS805, GLS845, GLS905, GLS925, GLS945, GLS945S		



1

GEV No.	520117	Ref. No.	902480
description	hose clamp stainless steel ø 40-60mm width 9mm Qty 5 pcs DIN 3017		
For models:	GLS805, GLS845, GLS945, GLS945S		



DIN 3017 - W4



GEV No.	520120	Ref. No.	902440
description	hose clamp SS W4 ø 12-20mm width 9mm Qty 1 pcs DIN 3017		
For models:	GLB615, GLB785, GLB795, GLS805, GLS845, GLS905, GLS925, GLS935, GLS945, GLS945S		

oval head screws



GEV No.	560569	Ref. No.	907785
description	oval head screw thread M6 internal thread L 13mm head ø 16mm stainless steel Qty 1 pcs ø 9x13mm		
For models:	GLS935		

measuring equipment

thermometers

built-in thermometers



GEV No.	541086	Ref. No.	907090
description	thermometer mounting measurements 58x25.5mm 0 up to +120°C capillary pipe 2000mm probe ø 6mm probe L 23mm		
For models:	GLS935, GLS945, GLS945S		

hexagonal screws



GEV No.	560309	Ref. No.	907846
description	hexagonal screw thread M10 thread L 16mm SS WS 17 Qty 1 pcs DIN 933 / ISO 4017		
For models:	GLB615		

fastening material

screws

countersunk screws



GEV No.	560266	Ref. No.	907651
description	countersunk screw thread M4 L 8mm SS DIN 965/ISO 7046 Qty 1 pcs head ø 7.5mm		
For models:	GLB615, GLB785, GLB795, GLS805, GLS845, GLS905, GLS925, GLS935, GLS945, GLS945S		



GEV No.	560086	Ref. No.	907780
description	hexagonal screw thread M6 thread L 10mm SS WS 10 Qty 20 pcs DIN 933 / ISO 4017		
For models:	GLS945		



GEV No.	560464	Ref. No.	907820
description	hexagonal screw thread M8 thread L 12mm SS WS 13 Qty 1 pcs head thickness 5mm DIN 933 / ISO 4017		
For models:	GLB615, GLB785, GLB795, GLS805, GLS845, GLS905, GLS925, GLS935, GLS945, GLS945S		

knurled screws



GEV No.	560267	Ref. No.	907871
description	countersunk screw thread M5 L 25mm SS DIN 965/ISO 7046 Qty 1 pcs intake Phillips		
For models:	GLS805, GLS845		

GEV No.	510112	Ref. No.	N/A
description	Thumb screw thread M10 thread L 10mm ø 22mm H 4.5mm SS		



nuts

hexagonal nuts

DIN 934 / ISO 4032/8673



GEV No.	560197	Ref. No.	902022 902025
description	nut thread M10 H 8mm WS 17 SS DIN/ISO DIN 934 / ISO 4032/8673 Qty 1 pcs		
For models:	GLB615, GLS805, GLS845, GLS935		

DIN 985

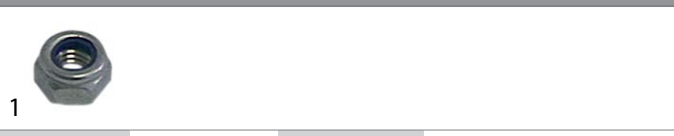

GEV No.	560142	Ref. No.	902040
description	hexagonal nut thread M6 H 6mm SS WS 10 Qty 20 pcs DIN/ISO DIN 985 self-locking		
For models:	GLB785, GLS805, GLS845		

hexagonal nuts metric (without norm)



GEV No.	521134	Ref. No.	N/A
description	hexagonal nut thread M14x1 SS		



GEV No.	519059	Ref. No.	902130
description	locknut thread 1"		
For models:	GLS935		



GEV No.	519056	Ref. No.	902090
description	locknut thread 1 3/4"		
For models:	GLS805, GLS845		



GEV No.	345351	Ref. No.	R3160D
description	nut thread M12x0.75 H 1.6mm WS 14 chrome-plated brass Qty 1 pcs		



GEV No.	519050	Ref. No.	902023
description	nut thread M12x1.75 H 4mm WS 16 SS Qty 1 pcs for snap lock		
For models:	GLB615, GLB785, GLB795, GLS805, GLS845, GLS905, GLS925		



GEV No.	550261	Ref. No.	N/A
description	nut thread M14x1 H 4mm WS 19 SS Qty 1 pcs		



GEV No.	102067	Ref. No.	X15900
description	nut thread M8x1 H 3mm brass Qty 1 pcs type SEF 1		
For models:	CC120CG, CC120G, CC80G, CC81CG, CC81G, CCG120CE, CCG120E, CCG80E, CCG81CE, CCG81E, SKC40G, SKC80G		

hexagonal nuts inch thread



GEV No.	503042	Ref. No.	902100
description	nut thread 3/8" H 6mm brass WS 22 Qty 1 pcs		
For models:	GLB615, GLB785, GLB795, GLS805, GLS845		



GEV No.	506024	Ref. No.	902104
description	nut thread 3/8" H 6mm SS WS 22 Qty 1 pcs		
For models:	GLB615, GLS805, GLS845, GLS905, GLS925		

washers

spring rings



GEV No.	519235	Ref. No.	905941
description	lock washer		
For models:	GLS935, GLS945, GLS945S		



1

GEV No.	560124	Ref. No.	905940
description	lock washer ID \varnothing 8.3mm ED \varnothing 15mm SS DIN127 Qty 20 pcs for thread M8		
For models:	GLS935		

washers

DIN 125A



1

GEV No.	560312	Ref. No.	906055
description	plain washer ID \varnothing 10.5mm ED \varnothing 20mm thickness 2mm SS Qty 1 pcs DIN 125A for thread M10		
For models:	GLB615, GLS805, GLS845, GLS935, GLS945, GLS945S		

miscellaneous



1

GEV No.	519241	Ref. No.	906050
description	plain washer for roller spring		
For models:	GLS935		



1

GEV No.	519238	Ref. No.	906002
description	plain washer ID \varnothing 15mm ED \varnothing 33mm thickness 0.8mm SS Qty 1 pcs		
For models:	GLB785, GLB795		

fasteners

clamps

hose clamps

DIN 3017 - W2



1

GEV No.	520115	Ref. No.	902460
description	hose clamp \varnothing 25-40mm width 9mm Qty 10 pcs DIN 3017		
For models:	GLB615, GLB785, GLB795, GLS905, GLS925, GLS935		



1

GEV No.	520116	Ref. No.	902441
description	hose clamp \varnothing 32-50mm width 9mm Qty 5 pcs DIN 3017		
For models:	GLB615, GLB785, GLB795, GLS805, GLS845, GLS905, GLS925, GLS945, GLS945S		



1

GEV No.	520117	Ref. No.	902480
description	hose clamp stainless steel \varnothing 40-60mm width 9mm Qty 5 pcs DIN 3017		
For models:	GLS805, GLS845, GLS945, GLS945S		

DIN 3017 - W4



1

GEV No.	520120	Ref. No.	902440
description	hose clamp SS W4 \varnothing 12-20mm width 9mm Qty 1 pcs DIN 3017		
For models:	GLB615, GLB785, GLB795, GLS805, GLS845, GLS905, GLS925, GLS935, GLS945, GLS945S		

retaining rings

DIN 471



1

GEV No.	691621	Ref. No.	M29600
description	retaining ring shaft \varnothing 40mm thickness 1.8mm steel DIN 471		
For models:	CCPE4, CFE15, CFE159, CFE15D, CFE15D9, KCP4E, KCP82E, KFE15, KFE159, KFE15D, KFE15D9, KFE20, KFE20D, OPCP4E, OPCP82E, OPFE15, OPFE15D, OPFE20, OPFE20D, SKCP40E, TCP40E		

DIN 7993



1

GEV No.	518308	Ref. No.	N/A
description	retaining ring DIN 7993 for drain assembly thickness 3mm ED \varnothing 57mm		



roll pins



1

GEV No.	690968	Ref. No.	E10300028
description	roll pin ø 5mm L 20mm		

consumables

lava rocks / ceramic briquetts



1

GEV No.	105342	Ref. No.	M30500
description	lava rocks content 9kg		
For models:	CPLG1, CPLG2, CPLG4, CPLG8, KPLG1, KPLG2, M7PL1G, M7PL2G, OPPLG1, OPPLG2, SKPL1G, SKPL2G, SKPL4G, SKPL8G, TPLG1, TPLG2		

fuses

fine fuses



1

GEV No.	358605	Ref. No.	40200084
description	fine fuse size ø5x20mm 3.15A slow-acting rated 250V Qty 10 pcs		
For models:	KPI10ET, KPI10ETA, KPI15ET, KPI15ETA		

B

ball valves	140
bar burners	83
bi-metal thermostats	19
boiling pan gaskets	127
booster pumps II	50

C

cable glands	52
cables	52
cam switches	30
capillary tube clips	27
ceramic heaters	10
clamps	141, 144
condensators & interference suppression filters	51
consumables	145
contactors	38
container filters	135
control equipment	34
control thermostats	20, 25
cooling water regulators	132
countersunk screws	142

D

door seals	126
door seals for dishwashers	131
door seals with fixing hook	127
dosing pumps	133
drain hoses	136

E

edgemount latches	115
electric accessories	52
electrodes	44
electronic controllers	39
energy regulators	19

F

fans	44
fasteners	144
fastening material	142
filters	51
fine fuses	145
fittings	139
float switches	30
foil heating elements	16
formed hoses	137
fuses	51, 145

G

gas ball valves	92
gas burners	73

gas control valves	61
gas nozzles	86
gas taps	53
gas thermostats	58
gaskets for heated units	126
gaskets for wash arm support	131
grates	126

H

handle latches	115
heating elements	3
heating elements for bain maries	3
heating elements for chargrills	9
heating elements for chip scuttles	4
heating elements for convection	14
heating elements for fryers	4
heating elements for griddles	7
heating elements for ovens	3
heating elements for pasta cookers	8
heating elements for salamanders/toasters	10
heating elements for tilting bratt pan	7
hexagonal nuts	143
hexagonal screws	142
hob burners	73
hose clamps	141, 144
hose connectors	139, 139
hoses	135
hot air fans	44
hot air motors	44
hot plates	18

I

ignition cables	69
ignition switches	70
ignition units	70
immersion heating elements	10
indicator lights	34
indicator lights (complete)	35
industrial hoses	136
inlet spouts	141
inlet taps	141

K

knurled screws	142
----------------	-----

L

lamps	34
lava rocks / ceramic briquetts	92, 145
light bulbs	35

M

magnetic switches	33
measuring equipment	142

mechanical timers	37	shut-off valves	141
microswitches	28	silicone hoses	137
N		snap locks	115
nuts	143	solenoid valves	41
nylon hoses	136	spring assisted hinges	115
O		spring clips	27
operating capacitors	51	spring rings	143
O-rings	127	supply hoses	135
oval head screws	142	switches and momentary switches	28
oven hinges	116	system switches (ROLD)	29
oven lamps	35	T	
P		tank inlets	135
piezoelectric igniters	69	temperature probes	40
pilot burners	62	terminals	52
plug-in gaskets	126	thermocouples	71
plunger sockets	27	thermostats	19
pressure control hoses	136	threaded cable glands	52
pressure switches	42	timers	36
probe clips	27	touch sensitive light switches	33
probes	40	tube burners	85
programme timers	36	U	
pumps	46	universal probes	40
pumps for ice machines	50	V	
push/momentary push switches	28	valves and tank inlets	140
PVC hoses	136	W	
PVC supply hoses	135	wash and rinse pumps	46
Q		washers	144
quartz heating elements	10		
R			
radiation heaters	15		
refrigeration cycle components	132		
refrigeration fans	44		
refrigeration gaskets	126		
refrigeration motors universal	44		
refrigeration thermostats	26		
relays	39		
residual heat indicators	36		
retaining rings	144		
rocker/momentary rocker switches	28		
roll pins	145		
S			
safety bi-metal thermostats	19		
safety thermostats	23, 25		
safety valves	62		
screws	142		
sealing washers	130		
shelves and shelf rails	126		