



GAS COMPONENTS



ELECTRIC COMPONENTS



WATER TECHNOLOGY



MECHANICAL COMPONENTS



TOOLS

Spare parts suitable for

GGF

Find the complete and up-to-date range of products in our GEV Webshop



Manufacturer catalogue

The most important spare parts and accessories arranged clearly for every manufacturer

- ✓ Complete product range and all appliance data always up to date in the GEV Webshop
- ✓ Alphabetical Index at the end of the catalogue

GEV Webshop

www.gev-online.co.uk

www.gev-online.com







- 🔍 Add to Favourites
- 🔍 Sign In with email address and usual password
- 🔍 Easy-order – place several items in your basket at the same time
- 🔍 Quick Item search – no login needed





heating elements

heating elements for pizza ovens

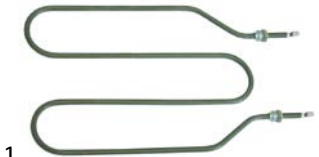





GEV No.	416836	Ref. No.	RESIS008
description	heating element 1000W 230V L 700mm W 142mm thread 1/4" mounting distance 133mm connection length 93mm connection male faston 6.3mm tube ø 8.5mm heating circuits 1 dry heating element 2 hole fixing		
For models:	FM44		
accessories for	416836		
	GEV No.	361182	Ref. No. —
	nut thread 1/4" H 5mm nickel-plated brass WS 17 Qty 1 pcs		
	GEV No.	510417	Ref. No. —
	flat gasket fibre ED ø 20mm ID ø 14mm thickness 2mm Qty 1 pcs		
	GEV No.	520228	Ref. No. —
	tooth lock washer ID ø 15.3mm ED ø 24mm steel Qty 1 pcs for thread M14		
	GEV No.	550262	Ref. No. —
	flat gasket copper ED ø 20mm ID ø 14mm thickness 2mm		







GEV No.	416841	Ref. No.	RESIS002
description	heating element 1100W 230V L 375mm W 255mm L1 20mm L2 80mm L3 275mm W1 50mm W2 155mm thread 1/4" mounting distance 147mm connection length 67mm connection male faston 6.3mm windings 2 tube ø 8.5mm heating circuits 1 dry heating element 2 hole fixing		
accessories for	416841		
	GEV No.	361182	Ref. No. —
	nut thread 1/4" H 5mm nickel-plated brass WS 17 Qty 1 pcs		
	GEV No.	510417	Ref. No. —
	flat gasket fibre ED ø 20mm ID ø 14mm thickness 2mm Qty 1 pcs		
	GEV No.	520228	Ref. No. —
	tooth lock washer ID ø 15.3mm ED ø 24mm steel Qty 1 pcs for thread M14		
	GEV No.	550262	Ref. No. —
	flat gasket copper ED ø 20mm ID ø 14mm thickness 2mm		







GEV No.	416839	Ref. No.	RESIS010
description	heating element 1500W 230V L 1062mm W 141mm thread 1/4" mounting distance 132mm connection length 95mm connection M5 tube ø 8.5mm heating circuits 1 dry heating element 2 hole fixing		
accessories for	416839		
	GEV No.	361182	Ref. No. —
	nut thread 1/4" H 5mm nickel-plated brass WS 17 Qty 1 pcs		

accessories for	416839		
	GEV No.	510417	Ref. No. —
	flat gasket fibre ED ø 20mm ID ø 14mm thickness 2mm Qty 1 pcs		
	GEV No.	520228	Ref. No. —
	tooth lock washer ID ø 15.3mm ED ø 24mm steel Qty 1 pcs for thread M14		
	GEV No.	550262	Ref. No. —
	flat gasket copper ED ø 20mm ID ø 14mm thickness 2mm		







GEV No.	416837	Ref. No.	RESIS009
description	heating element 1500W 230V L 700mm W 270mm L1 30mm L2 70mm L3 600mm W1 174mm W2 148mm thread 1/4" mounting distance 40mm connection length 108mm connection M5 windings 2 tube ø 8.5mm heating circuits 1 dry heating element 2 hole fixing		
spare parts for	416837		
	GEV No.	510417	Ref. No. —
	flat gasket fibre ED ø 20mm ID ø 14mm thickness 2mm Qty 1 pcs		
accessories for	416837		
	GEV No.	361182	Ref. No. —
	nut thread 1/4" H 5mm nickel-plated brass WS 17 Qty 1 pcs		
	GEV No.	520228	Ref. No. —
	tooth lock washer ID ø 15.3mm ED ø 24mm steel Qty 1 pcs for thread M14		
	GEV No.	550262	Ref. No. —
	flat gasket copper ED ø 20mm ID ø 14mm thickness 2mm		

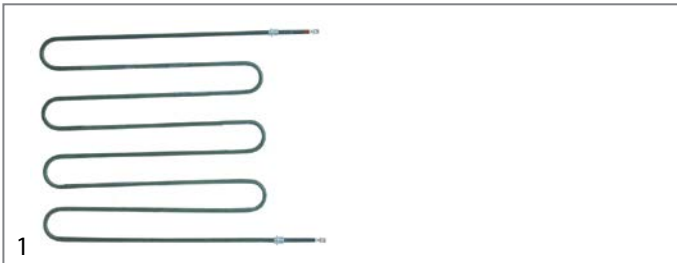

GEV No.	416640	Ref. No.	RESIS006
description	heating element 1600W 230V L 890mm W 220mm connection length 93mm L1 30mm L3 815mm W1 28mm W2 150mm tube ø 8.5mm heating circuits 1 2 hole fixing dry heating element pizza oven thread 1/4" mounting distance 150mm		
accessories for	416640		
	GEV No.	361182	Ref. No. —
	nut thread 1/4" H 5mm nickel-plated brass WS 17 Qty 1 pcs		
	GEV No.	510417	Ref. No. —
	flat gasket fibre ED ø 20mm ID ø 14mm thickness 2mm Qty 1 pcs		
	GEV No.	520228	Ref. No. —
	tooth lock washer ID ø 15.3mm ED ø 24mm steel Qty 1 pcs for thread M14		
	GEV No.	550262	Ref. No. —
	flat gasket copper ED ø 20mm ID ø 14mm thickness 2mm		







GEV No.	416637	Ref. No.	RESIS001
description	heating element 2000W 230V L 470mm W 420mm thread 1/4" mounting distance 412mm connection length 100mm connection M5 tube ø 8.5mm heating circuits 1 dry heating element 2 hole fixing pizza oven		
accessories for	416637		
	GEV No.	361182	Ref. No. —
	nut thread 1/4" H 5mm nickel-plated brass WS 17 Qty 1 pcs		
	GEV No.	510417	Ref. No. —
	flat gasket fibre ED ø 20mm ID ø 14mm thickness 2mm Qty 1 pcs		
	GEV No.	520228	Ref. No. —
	tooth lock washer ID ø 15.3mm ED ø 24mm steel Qty 1 pcs for thread M14		
	GEV No.	550262	Ref. No. —
	flat gasket copper ED ø 20mm ID ø 14mm thickness 2mm		



GEV No.	416638	Ref. No.	RESIS003
description	heating element 2100W 230V L 580mm W 460mm thread 1/4" mounting distance 425mm connection length 102mm connection M5 tube ø 8.5mm heating circuits 1 dry heating element 2 hole fixing		
accessories for	416638		
	GEV No.	361182	Ref. No. —
	nut thread 1/4" H 5mm nickel-plated brass WS 17 Qty 1 pcs		
	GEV No.	510417	Ref. No. —
	flat gasket fibre ED ø 20mm ID ø 14mm thickness 2mm Qty 1 pcs		
	GEV No.	520228	Ref. No. —
	tooth lock washer ID ø 15.3mm ED ø 24mm steel Qty 1 pcs for thread M14		
	GEV No.	550262	Ref. No. —
	flat gasket copper ED ø 20mm ID ø 14mm thickness 2mm		



GEV No.	416840	Ref. No.	RESIS011
description	heating element 2200W 230V L 1060mm W 260mm L1 35mm L2 85mm L3 940mm W1 50mm W2 160mm thread 1/4" mounting distance 152mm connection length 94mm connection M5 windings 2 tube ø 8.5mm heating circuits 1 dry heating element 2 hole fixing		
accessories for	416840		
	GEV No.	361182	Ref. No. —
	nut thread 1/4" H 5mm nickel-plated brass WS 17 Qty 1 pcs		
	GEV No.	510417	Ref. No. —
	flat gasket fibre ED ø 20mm ID ø 14mm thickness 2mm Qty 1 pcs		
	GEV No.	520228	Ref. No. —
	tooth lock washer ID ø 15.3mm ED ø 24mm steel Qty 1 pcs for thread M14		
	GEV No.	550262	Ref. No. —
	flat gasket copper ED ø 20mm ID ø 14mm thickness 2mm		

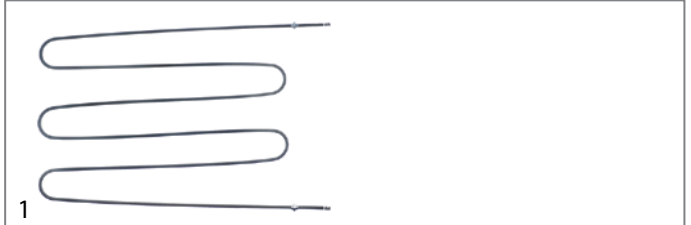

GEV No.	420041	Ref. No.	RESIS013
description	heating element 3000W 230V L 690mm W 460mm thread 1/4" mounting distance 452mm connection M5 tube ø 8.5mm heating circuits 1 for pizza oven mounting pos. upper/lower		
For models:	X4-36, X44-36		

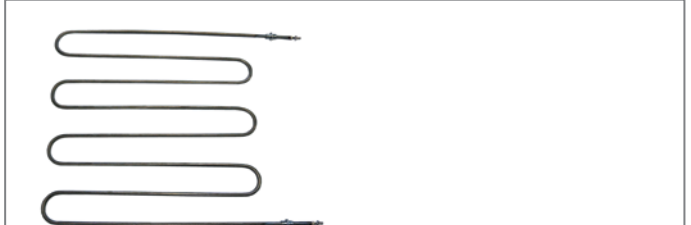

GEV No.	416639	Ref. No.	RESIS004
description	heating element 3600W 230V L 585mm W 800mm thread 1/4" mounting distance 792mm connection length 100mm connection M5 tube ø 8.5mm heating circuits 1 dry heating element 2 hole fixing pizza oven		



GEV No.	419051	Ref. No.	RESIS012
description	heating element 800W 230V L 880mm W 80mm thread 1/4" mounting distance 75mm connection length 120mm connection screw tube ø 8.5mm heating circuits 1 dry heating element 2 hole fixing		

thermostats

control and safety thermostats

EGO

control thermostats

55.10/19_series

E-G-O

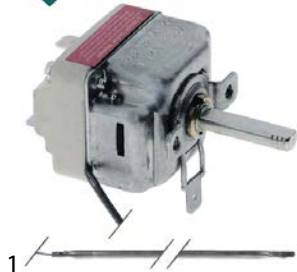

GEV No.	375247	Ref. No.	TERMO001
description	thermostat t.max. 500°C temperature range 75-500°C 1-pole 1NO 16A probe ø 4mm probe L 228mm capillary pipe 900mm capillary pipe isolatedmm gland nut shaft ø 6x4.6mm shaft L 23mm shaft position upper rotation 270°		
For models:	X4-36, X44-36		

55.34_series

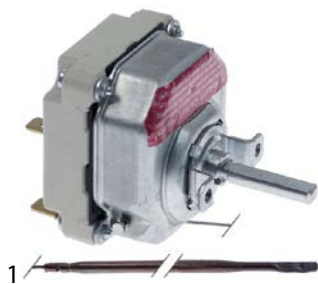

GEV No.	375132	Ref. No.	thermo003 old version2
description	thermostat t.max. 500°C temperature range 50-500°C 3-pole 3NO 16A probe ø 4mm probe L 228mm capillary pipe 1200mm capillary pipe isolatedmm gland nut shaft ø 6x4.6mm shaft L 23mm shaft position upper rotation 270°		

E-G-O

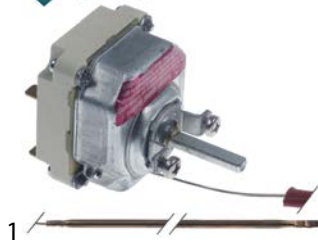

GEV No.	375498	Ref. No.	TERMO002 TERMO002+MANOP003 TERMO003
description	thermostat t.max. 512°C temperature range 60-512°C 3-pole 3NO 16A probe ø 3.8mm probe L 225mm capillary pipe 1150mm capillary pipe isolated 1110mm gland nut shaft ø 6x4.6mm shaft L 32mm shaft position upper rotation 270°		

JUMO

control thermostats

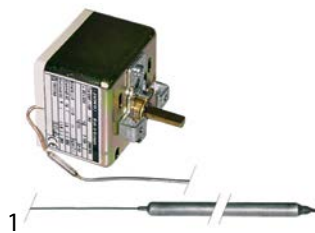

GEV No.	375103	Ref. No.	thermo003 old Version1
description	thermostat t.max. 500°C temperature range 20-500°C 3-pole 3CO 16A probe ø 8mm probe L 155mm capillary pipe 1000mm capillary pipe isolatedmm gland nut shaft ø 6x4.6mm shaft L 17mm rotation 270°		

switches and momentary switches

rocker/momentary rocker switches

30x11mm



GEV No.	345382	Ref. No.	INTER001
description	rocker switch mounting measurements 30x11mm green 1NO/ indicator light 250V 16A 0-1 connection male faston 6.3mm ambient temperature max. 85°C protection IP40		
For models:	X4-36, X44-36		

rotary switches

BREMAS

A1200 series



GEV No.	345775	Ref. No.	unbekannt
description	rotary switch 12A 2 operating positions 1-pole		



GEV No.	345547	Ref. No.	unbekannt
description	rotary switch sets of contacts 1 2 0-1 type CA0120001 380V 12A shaft ø 5x5mm shaft L 23mm shaft square connection screw		



lamps

indicator lights

indicator lights 2-piece (lens and indicator lamp)

indicator lamps for socket type SA / SC / SD / SF / SR



1

GEV No.	359520	Ref. No.	LAMPA002
description	indicator lamp 400V green connection cable 400mm cable material silicone Qty 1 pcs		
For models:	X4-36, X44-36		

indicator lights (complete)

ø10mm

with screw socket



1

GEV No.	359274	Ref. No.	Lampa spia verde
description	indicator light ø 10mm 400V green		

screw-on/push-on fit

light bulbs

for ovens



1

GEV No.	359448	Ref. No.	LAMPA006
description	light bulb t.max. 500°C socket E14 25W 240V ø 24mm L 54mm lens L 21mm for pizza oven not shock-resistant type		

halogen lamp

for socket GU5.3 / GU10 / GZ5.3



1

GEV No.	357054	Ref. No.	LAMPA003
description	halogen lamp socket GU5.3 12V 20W ø 50mm H 38mm temp.-resist. 300°C AC/DC		

oven lamps

universal oven lamps

mounting diameter 35.5mm



1

GEV No.	359660	Ref. No.	LAMPA010
description	oven lamp mounting ø 35.5mm 230V 25W socket E14 temp.-resist. 300°C connection male faston 6.3mm hard glas		
For models:	X4-36, X44-36		



1

GEV No.	359661	Ref. No.	VETRO002	
description	oven lamp glass thread 32.1 ø 58mm hard glas temp.-resist. 350°C			
For models:	X4-36, X44-36			
accessories for	359661			
	GEV No.	359700	Ref. No.	—
	gasket for pizza oven fibre glass ID ø 32.5mm ED ø 55mm thickness 5mm			

lamps

light bulbs



1

GEV No.	359448	Ref. No.	LAMPA006
description	light bulb t.max. 500°C socket E14 25W 240V ø 24mm L 54mm lens L 21mm for pizza oven not shock-resistant type		

halogen lamps

for socket GU5,3 / GU10



1

GEV No.	357054	Ref. No.	LAMPA003
description	halogen lamp socket GU5.3 12V 20W ø 50mm H 38mm temp.-resist. 300°C AC/DC		

transformers

open transformers

with plug connection



1

GEV No.	400956	Ref. No.	TRASF001
description	transformer primary 230VAC secondary 12VAC 20VA connection male faston 6.3mm 50/60Hz type T602012/E temperature restriction 150°C ambient temperature max. 80°C		

ignition parts

pilot burners

POLIDORO

pilot burners



1

GEV No.	106899	Ref. No.	PILGA001
description	pilot burner POLIDORO 2 flames natural gas		

electrodes



1

GEV No.	100868	Ref. No.	Candele A.O.10
description	ignition electrode flange length 23mm flange width 15mm D1 ø 7mm L1 9mm BL1 21mm BL2 14mm connection M4 fixing dimensions 4x5mm with flange		

piezoelectric igniters

mounting diameter 22mm



1

GEV No.	100008	Ref. No.	ERTA 070602
description	piezoelectric igniter body plastic blowing mounting ø 22mm connection ø2mm cable lengthmm		

ignition bridges



1

GEV No.	105557	Ref. No.	bruc.int.accensi. G9
description	ignition bridge for pizza oven		



1

GEV No.	105556	Ref. No.	bruc.int.accen.G4/G6 BRUGA004
description	pilot burner L 580mm ø 12mm for pizza oven		

gas burners

bar burners

bar burners



1

GEV No.	105554	Ref. No.	bruciatori 0-51 G4 BRUGA001
description	bar burner ø 50mm Wmm Hmm L 520mm flange width 52mm flange ø 75mm pizza oven		



1

GEV No.	105555	Ref. No.	BRUGA002
description	bar burner ø 50mm Wmm Hmm L 800mm flange width 52mm flange ø 75mm 5.2kW pizza oven		



			
1			
GEV No.	105862	Ref. No.	Bruc. later. G6-G9 BRUGA003
description	bar burner ø 50mm Wmm Hmm L 800mm flange width 52mm flange ø 75mm mounting pos. lateral pizza oven		

equipment-specific units

for vegetable slicers

miscellaneous

			
1			
GEV No.	110703	Ref. No.	IMPUG001
description	cylindrical handle thread M10 ø 28mm L 87mm		
For models:	X4-36, X44-36		

for cheese graters

miscellaneous

			
1			
GEV No.	110703	Ref. No.	IMPUG001
description	cylindrical handle thread M10 ø 28mm L 87mm		
For models:	X4-36, X44-36		

for convection ovens/combi-steamers



glass panels

			
1			
GEV No.	693100	Ref. No.	VETRO001
description	glass panel L 250mm W 100mm thickness 5mm rectangular		

for pizza ovens

glass panels

			
1			
GEV No.	693131	Ref. No.	vetro 350x100x5 VETRO004
description	glass panel L 350mm W 100mm thickness 4mm rectangular		

				
1				
GEV No.	700962	Ref. No.	VETRO005	
description	glass panel L 415mm W 108mm thickness 5mm rectangular for door			
For models:	X4-36, X44-36			
accessories for	700962			
	GEV No.	901400	Ref. No.	GUARN003
	window gasket suitable for GGF L 416mm external weith 113mm Qty 1m thickness 2.5mm			

firebricks

			
1			
GEV No.	850051	Ref. No.	Piastra refretaria Baby TAVEL007
description	firebrick L 500mm W 500mm H 17mm delivery freight forwarding company only		

			
1			
GEV No.	850100	Ref. No.	TAVEL015
description	firebrick L 610mm W 305mm H 17mm delivery freight forwarding company only		

 <p>Image not available</p>			
1			
GEV No.	850052	Ref. No.	Piastra refretaria P4
description	firebrick L 610mm W 610mm H 16mm delivery freight forwarding company only		

			
1			
GEV No.	850109	Ref. No.	TAVEL011
description	firebrick L 718mm W 359mm H 17mm delivery freight forwarding company only		
For models:	X4-36, X44-36		

			
1			
GEV No.	850053	Ref. No.	Piastra refretaria P6 TAVEL006
description	firebrick L 915mm W 610mm H 18mm delivery freight forwarding company only		

knobs

producer-specific knobs

GGF

			
1			
GEV No.	111468	Ref. No.	MANOP004
description	knob zero mark ø 42mm shaft ø 6x4.6mm shaft flat upper black/red		

handles and hand wheels

cylindrical handles

fixed

			
1			
GEV No.	110703	Ref. No.	IMPUG001
description	cylindrical handle thread M10 ø 28mm L 87mm		
For models:	X4-36, X44-36		

door handles

door handles

			
1			
GEV No.	694308	Ref. No.	MANIG004
description	door handle for pizza oven L 140mm W 78mm handle ø 27.5mm with flange black		

gaskets

gaskets for heated units

window seals

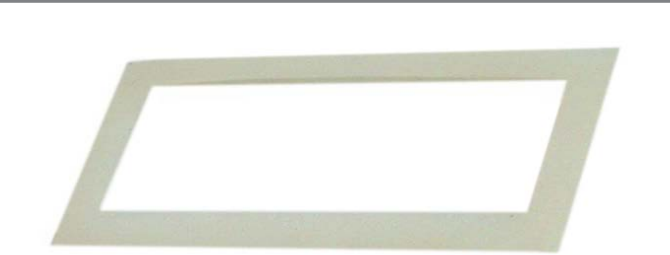

1

GEV No.	693101	Ref. No.	GUARN001
description	window gasket L 250mm W 100mm thickness 5mm		



1

GEV No.	696519	Ref. No.	GUARN004
description	window gasket L 355mm W 105mm thickness 3mm		

special gaskets

miscellaneous



1

GEV No.	901400	Ref. No.	GUARN003
description	window gasket suitable for GGF L 416mm external weith 113mm Qty 1m thickness 2.5mm		
For models:	X4-36, X44-36		

B

bar burners 7

C

control thermostats 5,5

G

gas burners 7

gaskets for heated units 10

H

halogen lamp 6

heating elements 3

heating elements for pizza ovens 3

I

ignition bridges 7

indicator lights 6

indicator lights (complete) 6

L

lamps 6

light bulbs 6

O

oven lamps 6

P

piezoelectric igniters 7

pilot burners 7

R

rocker/momentary rocker switches 5

rotary switches 5

S

switches and momentary switches 5

T

thermostats 5

transformers 7

W

window seals 10