



**GAS COMPONENTS**



**ELECTRIC COMPONENTS**



**WATER TECHNOLOGY**



**MECHANICAL COMPONENTS**



**TOOLS**

Spare parts suitable for

**FRYMASTER**

Find the complete and up-to-date range of products in our GEV Webshop



# Manufacturer catalogue

The most important spare parts and accessories arranged clearly for every manufacturer

- ✓ Complete product range and all appliance data always up to date in the GEV Webshop
- ✓ Alphabetical Index at the end of the catalogue

## GEV Webshop

[www.gev-online.co.uk](http://www.gev-online.co.uk)

[www.gev-online.com](http://www.gev-online.com)



- 🔍 Add to Favourites
- 🔍 Sign In with email address and usual password
- 🔍 Easy-order – place several items in your basket at the same time
- 🔍 Quick Item search – no login needed



## heating elements

### heating elements for fryers

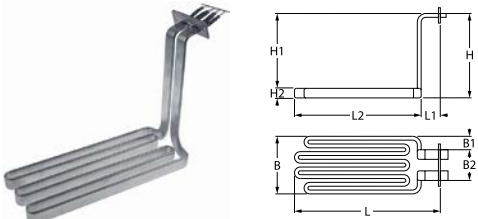

<b>GEV No.</b>	417623	<b>Ref. No.</b>	44-8262155 807-2645 826-2155
<b>description</b>	heating element 8500W 240V L 400mm W 145mm H 300mm flange connection plug heating circuits 3 fryer heaters L1 352mm L2 30mm H1 255mm H2 25mm hole distance 85mm hole ø 6mm flange length 101mm flange width 35mm cable length 1000mm		



<b>GEV No.</b>	390636	<b>Ref. No.</b>	807-3515
<b>description</b>	thermostat t.max. 204°C temperature range 93-204°C 1-pole 1NO 0.67A probe ø 9.5mm probe L 123mm capillary pipe 915mm capillary pipe isolatedmm gland nut 1/4" NPT shaft ø 6x4.6mm shaft L 21mm shaft position lower rotation 315° probe material nickel-plated probe thread 1/4" US		

### heating elements for heated cabinets



<b>GEV No.</b>	419006	<b>Ref. No.</b>	8070748
<b>description</b>	heating element 825W 208/240V heating circuits 1 L 517mm connection snap-on connection tube ø 11mm for chafing dish		

## thermostats

### control and safety thermostats

#### INVENSYS / ROBERTSHAW

##### control thermostats



<b>GEV No.</b>	376042	<b>Ref. No.</b>	8262014
<b>description</b>	thermostat t.max. 191°C 1-pole 1NOA probe ø 8mm probe L 124mm capillary pipe 590mm capillary pipe isolatedmm gland nut shaft ø 6.3x4.7mm shaft L 24mm shaft position upper operating temperature range 375°F		

##### various

##### control thermostats

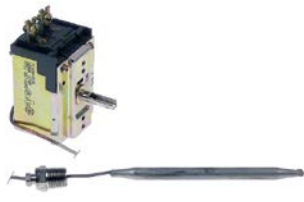

<b>GEV No.</b>	580023	<b>Ref. No.</b>	807-1147 807-1692 8262013
<b>description</b>	thermostat temperature range 94-190°C 1-pole probe ø 8mm probe L 120mm capillary pipe 600mm gland nut 1/4" shaft ø 6x4.6mm shaft L 16mm		

##### safety thermostats

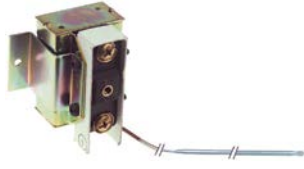

<b>GEV No.</b>	580022	<b>Ref. No.</b>	807-0063 8071070 8261001
<b>description</b>	safety thermostat		

### accessories

#### axis extensions



<b>GEV No.</b>	580030	<b>Ref. No.</b>	810-0202
<b>description</b>	shaft extension		



			
1			
<b>GEV No.</b>	580028	<b>Ref. No.</b>	810-0199 810-0345
<b>description</b>	shaft extension flexible for thermostat		

## fitting parts

 Image not available			
1			
<b>GEV No.</b>	580025	<b>Ref. No.</b>	806-0066 806-0066SP
<b>description</b>	mounting plate for thermostat		

## miscellaneous

			
1			
<b>GEV No.</b>	580026	<b>Ref. No.</b>	806-0087 806-0087SP 820-0015
<b>description</b>	bezel for thermostat		

## switches and momentary switches

## rocker/momentary rocker switches

## 37x21mm

			
1			
<b>GEV No.</b>	348095	<b>Ref. No.</b>	2026 8073580
<b>description</b>	rocker switch mounting measurements 37x21mm black 1NO 250V 20A connection male faston 6.3mm ambient temperature max. 125°C protection IP40		

			
1			
<b>GEV No.</b>	347969	<b>Ref. No.</b>	8074036
<b>description</b>	rocker switch mounting measurements 37x21mm black 2NO 250V 10A 0-1 connection male faston 6.3mm ambient temperature max. 85°C protection IP44		

## contactors

## HARTLAND

## power contactors

			
1			
<b>GEV No.</b>	381283	<b>Ref. No.</b>	810-1202
<b>description</b>	power contactor resistive load 40A 24VAC 30A/10HP (AC3/240V) 30A/7.46kW main contacts 3NO auxiliary contacts connection screw clamp/male faston 6.3mm type HCCY3XQ02CY		

			
1			
<b>GEV No.</b>	381277	<b>Ref. No.</b>	807-2284 8263417
<b>description</b>	power contactor resistive load 50A 24VAC 40A/10HP (AC3/240V) 40A/7.46kW main contacts 3NO auxiliary contacts connection screw clamp/male faston 6.3mm type HCCY3XQ04CG		

## transformers

## open transformers

## with plug connection

 Image not available			
1			
<b>GEV No.</b>	403944	<b>Ref. No.</b>	807-1999 807-5129
<b>description</b>	transformer primary 208/220/230/240VAC secondary 12/24VAC H 65mm L 65mm W 130mm connection male faston 4.8mm 50/60Hz		



## probes

### producer-specific probes

#### probes

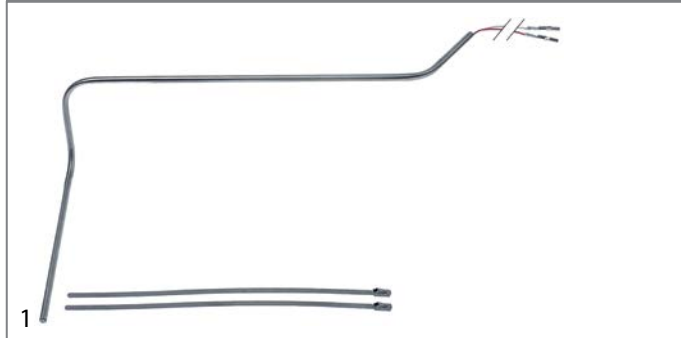

<b>GEV No.</b>	379819	<b>Ref. No.</b>	807-2478 8261526
<b>description</b>	probe PTC 1kOhm cable PVC probe -50 up to +150°C cable -10 up to 100°C connection 2-wire thread probe ø5x280mm cable length 0.6m		

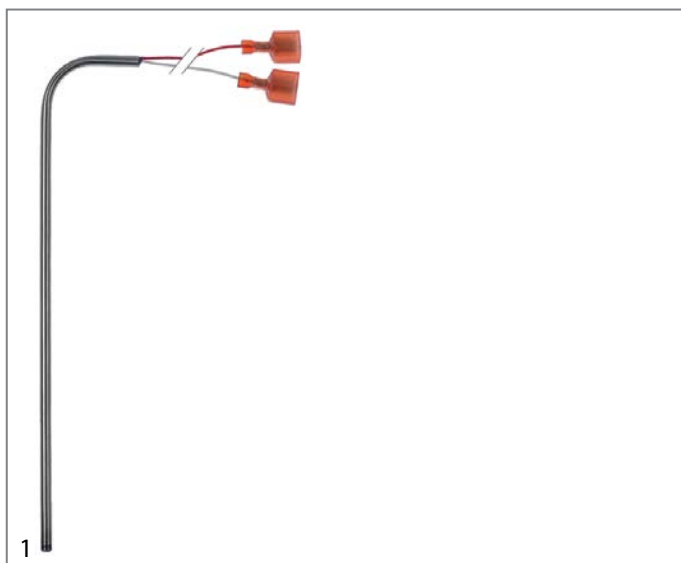

<b>GEV No.</b>	403771	<b>Ref. No.</b>	8064764
<b>description</b>	temperature probe Pt1000 cable PTFE probe -40 up to +250°C connection F6.3 thread probe 5x205mm cable length 0.14m		

## electronics

### PCBs

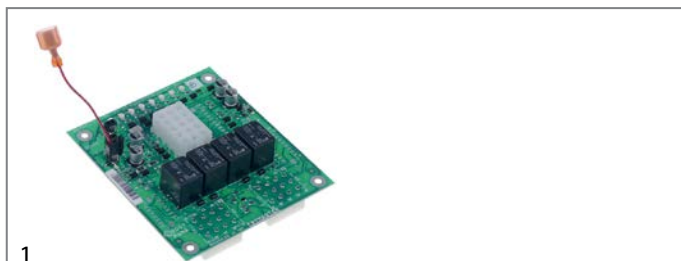

<b>GEV No.</b>	402936	<b>Ref. No.</b>	8262256
<b>description</b>	PCB for fryer H14/H17/H22 L 125mm W 110mm		

## gas valves and ignition boxes

### gas control valves

#### HONEYWELL

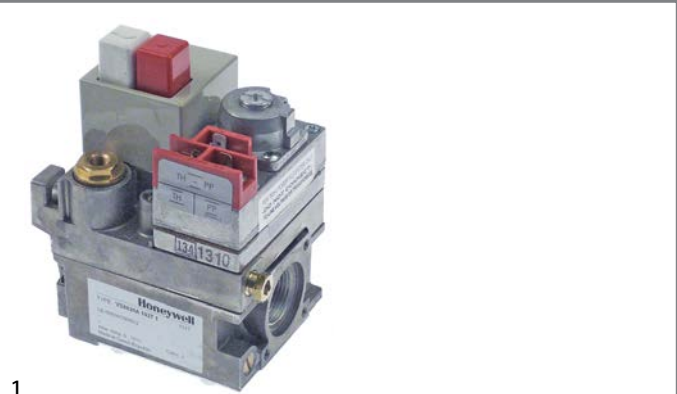





<b>GEV No.</b>	107362	<b>Ref. No.</b>	8072122
<b>description</b>	gas valve type VS8820A natural gas 0.75VHz gas inlet 3/4" NPT gas outlet 3/4" NPT thermocouple connection ASA 11/32 pilot connection 1/4" CCT pressure range 2.5-20mbar operator type VS824A HONEYWELL		

#### ROBERTSHAW

#### electric controlled valves



<b>GEV No.</b>	101429	<b>Ref. No.</b>	806-1452 806-1452SP 807-0308
<b>description</b>	gas valve 120V 50/60Hz gas inlet 3/4" gas outlet 3/4" thermo-couple connection 3/8" NEF pilot connection 1/4" pipe US type 7000BMSER-120 pressure controller natural gas 3.5" W.C. suitable for ROBERTSHAW		

<b>spare parts for</b>	101429			
	<b>GEV No.</b>	101047	<b>Ref. No.</b>	—
	magnet unit T1: ASA 11/32 T2: M24x1 L 59mm ø 4mm suitable for ROBERTSHAW			
	<b>GEV No.</b>	101389	<b>Ref. No.</b>	—
	pressure controller natural gas suitable for ROBERTSHAW			
	<b>GEV No.</b>	580033	<b>Ref. No.</b>	810-0109 810-0433
	knob suitable for ROBERTSHAW			
<b>accessories for</b>	101429			
	<b>GEV No.</b>	580035	<b>Ref. No.</b>	810-0162
	thermopile L 36" - 915mm probe ø 9mm probe L 38mm 250-750mV screw connection 7/16" connection 3/8" NEF			



gas controlled valves

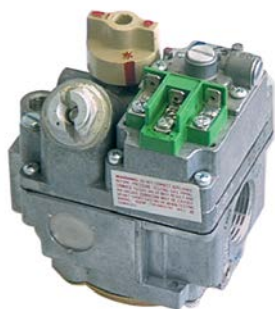

1			
<b>GEV No.</b>	580032	<b>Ref. No.</b>	807-0428
<b>description</b>	gas valve 50/60Hz gas inlet 1/2" gas outlet 1/2" thermocouple connection 3/8" NEF pilot connection 1/4" pipe US type 7000BMSE pressure controller natural gas 3.5" W.C. suitable for ROBERTSHAW supply 24VAC supply 12VDC		
<b>spare parts for</b>	580032		
	<b>GEV No.</b>	101047	<b>Ref. No.</b> —
	magnet unit T1: ASA 11/32 T2: M24x1 L 59mm ø 4mm suitable for ROBERTSHAW		
	<b>GEV No.</b>	101389	<b>Ref. No.</b> —
	pressure controller natural gas suitable for ROBERTSHAW		
	<b>GEV No.</b>	101403	<b>Ref. No.</b> —
	operator 24V voltage AC natural gas suitable for ROBERTSHAW		
	<b>GEV No.</b>	580033	<b>Ref. No.</b> 810-0109 810-0433
	knob suitable for ROBERTSHAW		
<b>accessories for</b>	580032		
	<b>GEV No.</b>	580035	<b>Ref. No.</b> 810-0162
	thermopile L 36" - 915mm probe ø 9mm probe L 38mm 250-750mV screw connection 7/16" connection 3/8" NEF		

millivolt controlled valves



1			
<b>GEV No.</b>	106122	<b>Ref. No.</b>	8070115 8072427
<b>description</b>	gas valve supply Operator millivolt gas inlet 1/2" NPT gas outlet 1/2" NPT thermocouple connection pilot connection 1/4" CCT type 7000BMVR pressure controller natural gas 4.0" W.C.		
<b>spare parts for</b>	106122		
	<b>GEV No.</b>	101422	<b>Ref. No.</b> —
	operator natural gas supply Operator millivolt		
	<b>GEV No.</b>	106109	<b>Ref. No.</b> —
	locking screw thread 7/16"-24 UNS for pipe ø 1/4" L 16mm brass Qty 1 pcs WS 7/16" (11.113mm) hole ø 6.4mm		

<b>spare parts for</b>	106122		
	<b>GEV No.</b>	580033	<b>Ref. No.</b> 810-0109 810-0433
	knob suitable for ROBERTSHAW		



1			
<b>GEV No.</b>	580031	<b>Ref. No.</b>	807-0115 807-0306 807-2427 807-2428 810-0014
<b>description</b>	gas valve supply Operator millivolt gas inlet 3/4" NPT gas outlet 3/4" NPT thermocouple connection pilot connection 1/4" CCT type 7000BMVR pressure controller natural gas 3.5" W.C. suitable for ROBERTSHAW		
<b>spare parts for</b>	580031		
	<b>GEV No.</b>	101422	<b>Ref. No.</b> —
	operator natural gas supply Operator millivolt		
	<b>GEV No.</b>	106109	<b>Ref. No.</b> —
	locking screw thread 7/16"-24 UNS for pipe ø 1/4" L 16mm brass Qty 1 pcs WS 7/16" (11.113mm) hole ø 6.4mm		
	<b>GEV No.</b>	106121	<b>Ref. No.</b> —
	pressure controller natural gas 3.5" W.C.		
	<b>GEV No.</b>	580033	<b>Ref. No.</b> 810-0109 810-0433
	knob suitable for ROBERTSHAW		



## ignition parts

### pilot burners

#### ROBERTSHAW

##### pilot burners

##### universal series - type 6



Width of caps:

6CH10 = 1" (25,4mm)

6CH14 = 1½" (38,1mm)

6CH24 = 2½" (63,5mm)

6CH30 = 3" (76,2mm)

			
1			
<b>GEV No.</b>	107394	<b>Ref. No.</b>	8102032
<b>description</b>	pilot burner ROBERTSHAW type 6CH14-2 3 flames natural gas code 26 for pipe ø 1/4" CCT		
<b>spare parts for</b>	107394		
	<b>GEV No.</b>	100277	<b>Ref. No.</b> —
	 pilot burner nozzle natural gas code 26 suitable for ROBERTSHAW		

#### HONEYWELL

##### pilot burners

			
1			
<b>GEV No.</b>	107397	<b>Ref. No.</b>	8071707
<b>description</b>	pilot burner type Q348AC1 1144 3 flames natural gas nozzle NE22 1/4"		

#### WHITE ROGERS

			
1			
<b>GEV No.</b>	107419	<b>Ref. No.</b>	8100156 8100157
<b>description</b>	pilot burner type 262A38 0407 2 flames natural gas 1/4" nozzle TL020		

			
1			
<b>GEV No.</b>	107393	<b>Ref. No.</b>	8100426
<b>description</b>	pilot burner type 262A38 1112 2 flames natural gas 1/4"		

			
1			
<b>GEV No.</b>	107392	<b>Ref. No.</b>	8100427
<b>description</b>	pilot burner type 262A38 1310 2 flames LPG 1/4"		

			
1			
<b>GEV No.</b>	107366	<b>Ref. No.</b>	8121286
<b>description</b>	pilot burner type 262A38 2 flames natural gas 1/4"		

### piezoelectric igniters

#### mounting diameter 18mm

			
1			
<b>GEV No.</b>	100009	<b>Ref. No.</b>	810-1001
<b>description</b>	piezoelectric igniter body plastic blowing mounting ø 18mm connection ø2.4mm front measurements 26mm M18x1.5		
<b>accessories for</b>	100009		
	<b>GEV No.</b>	101339	<b>Ref. No.</b> —
	 cover cap for piezoelectric igniter		
	<b>GEV No.</b>	106869	<b>Ref. No.</b> —
	 cover cap for piezoelectric igniter ID ø 22mm ED ø 35mm H 25mm		
	<b>GEV No.</b>	107931	<b>Ref. No.</b> —
	 cover cap for piezoelectric igniter ID ø 21mm ED ø 36mm		



### thermocouples

#### plug-in thermocouples

#### plug-in thermocouples with interruption

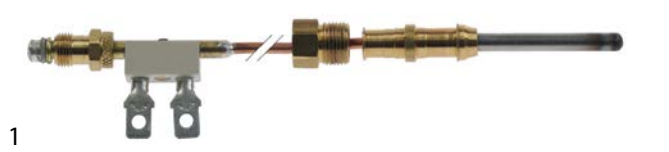

<b>GEV No.</b>	103349	<b>Ref. No.</b>	8103442
<b>description</b>	thermocouple WHITE RODGERS with interrupter L 750mm male faston 6.3mm 7/16" gas connection 11/32"		

#### thermopiles

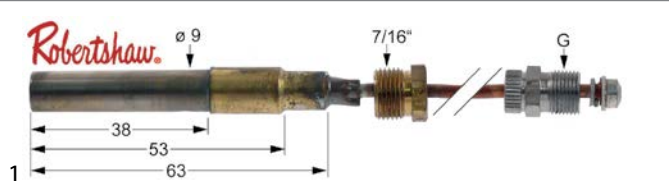

<b>GEV No.</b>	580035	<b>Ref. No.</b>	810-0162
<b>description</b>	thermopile L 36" - 915mm probe $\varnothing$ 9mm probe L 38mm 250-750mV screw connection 7/16" connection 3/8" NEF		

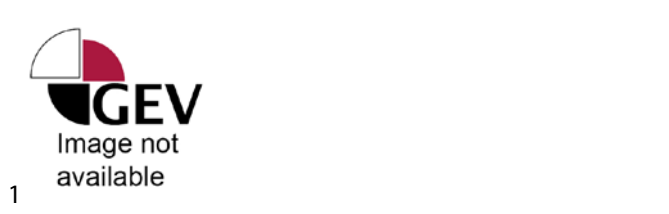

<b>GEV No.</b>	103362	<b>Ref. No.</b>	810-06171 810-1873
<b>description</b>	thermopile WHITE RODGERS L 900mm probe $\varnothing$ 11.5mm probe L 46mm screw connection connection male faston 6.3mm		

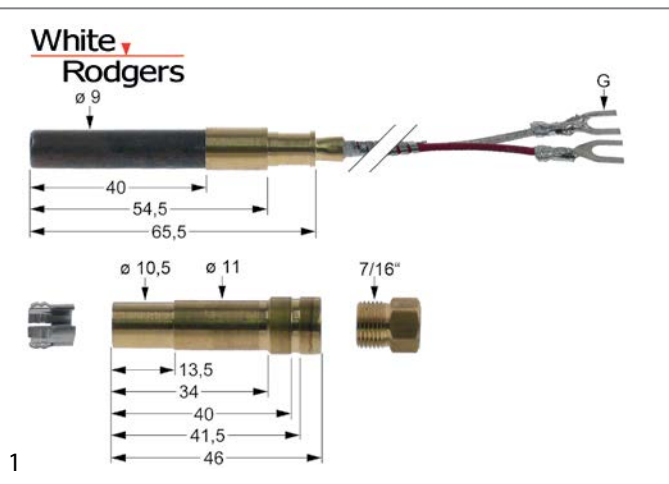

<b>GEV No.</b>	103243	<b>Ref. No.</b>	6717038 807-3485
<b>description</b>	thermopile with PG9 adapter WHITE RODGERS L 36" - 915mm probe $\varnothing$ 9mm probe L 40mm 250-750mV screw connection 7/16" connection spate terminals		

### accessories

#### interrupters



<b>GEV No.</b>	580046	<b>Ref. No.</b>	807-0280
<b>description</b>	extension for interruptor L 18" - 455mm		

### gas nozzles

#### main nozzles

#### gas nozzles 1/8" NPT



<b>GEV No.</b>	102559	<b>Ref. No.</b>	610-0140 810-0140 826-1352
<b>description</b>	gas injector thread 1/8" NPT WS 13 code 67		



<b>GEV No.</b>	103256	<b>Ref. No.</b>	8100129 826-1353
<b>description</b>	gas injector thread 1/8" WS 13 bore $\varnothing$ 1.7mm brass code 1.7		

#### gas nozzles (other)



<b>GEV No.</b>	103134	<b>Ref. No.</b>	812-1028
<b>description</b>	gas injector T1: 9/16" UNEF T2: 1/8" NPT WS 16 bore $\varnothing$ 2.2mm L 51mm		

### pilot burner nozzles

#### pilot burner nozzles ROBERTSHAW

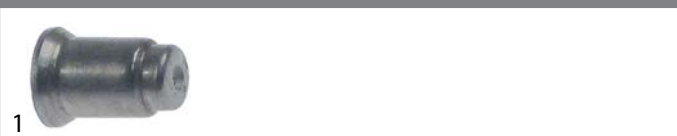

<b>GEV No.</b>	100275	<b>Ref. No.</b>	810-0125
<b>description</b>	pilot burner nozzle LPG code 10 bore $\varnothing$ 0.1mm suitable for ROBERTSHAW		





			
1			
<b>GEV No.</b>	100276	<b>Ref. No.</b>	810-0126
<b>description</b>	pilot burner nozzle natural gas code 18 suitable for ROBERTSHAW		

equipment-specific units

for deep fryers

miscellaneous

			
1			
<b>GEV No.</b>	580026	<b>Ref. No.</b>	806-0087 806-0087SP 820-0015
<b>description</b>	bezel for thermostat		

 <p>Image not available</p>			
1			
<b>GEV No.</b>	580025	<b>Ref. No.</b>	806-0066 806-0066SP
<b>description</b>	mounting plate for thermostat		

			
1			
<b>GEV No.</b>	580030	<b>Ref. No.</b>	810-0202
<b>description</b>	shaft extension		

			
1			
<b>GEV No.</b>	580028	<b>Ref. No.</b>	810-0199 810-0345
<b>description</b>	shaft extension flexible for thermostat		

knobs

producer-specific knobs

<p>FRYMASTER</p>  <p>Image not available</p>			
1			
<b>GEV No.</b>	580024	<b>Ref. No.</b>	806-0047 810-0110 810-1720 K249
<b>description</b>	knob		

filters

deep fryer filters

			
1			
<b>GEV No.</b>	970749	<b>Ref. No.</b>	6716985 803-0170
<b>description</b>	oil filter W 500mm L 706mm for fryer paper 100pcs		

baskets

fryer baskets

US producers

			
1			
<b>GEV No.</b>	970134	<b>Ref. No.</b>	803-0019
<b>description</b>	fryer basket L1 280mm W1 140mm H1 105mm		

			
1			
<b>GEV No.</b>	970183	<b>Ref. No.</b>	803-0022 803-0271 803-0307
<b>description</b>	fryer basket L1 308mm W1 160mm H1 135mm		



1

<b>GEV No.</b>	970911	<b>Ref. No.</b>	803-0099
<b>description</b>	fryer basket W1 312mm L1 325mm H1 130mm		

**C**

contactors 4

**G**

gas control valves 5

gas nozzles 8

**H**

heating elements 3

heating elements for fryers 3

heating elements for heated cabinets 3

**P**

piezoelectric igniters 7

pilot burners 7

probes 5

**R**

rocker/momentary rocker switches 4

**S**

switches and momentary switches 4

**T**

thermocouples 8

thermostats 3

transformers 4