



GAS COMPONENTS



ELECTRIC COMPONENTS



WATER TECHNOLOGY



MECHANICAL COMPONENTS



TOOLS

Spare parts suitable for

FRIULINOX

Find the complete and up-to-date range of products in our GEV Webshop



Manufacturer catalogue

The most important spare parts and accessories arranged clearly for every manufacturer

- ✓ Complete product range and all appliance data always up to date in the GEV Webshop
- ✓ Alphabetical Index at the end of the catalogue

GEV Webshop

www.gev-online.co.uk

www.gev-online.com



- 🔍 Add to Favourites
- 🔍 Sign In with email address and usual password
- 🔍 Easy-order – place several items in your basket at the same time
- 🔍 Quick Item search – no login needed



heating elements

heating elements for refrigeration

heating elements for defrosting

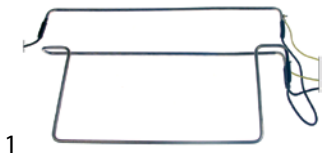

1

GEV No.	418567	Ref. No.	995594 FR6620631 FR995594
description	heating element 140W 230V L 490mm W 190mm cable length 3500mm tube ø 6.3mm connection length 45mm immersion heater H 35mm		



1

GEV No.	418577	Ref. No.	6620303 995379 FR6620303 FR995379
description	heating element 350W 230V L 293mm W 445mm L1 43mm L2 250mm W1 355mm W2 90mm cable length 1450mm defrosting connection cable		

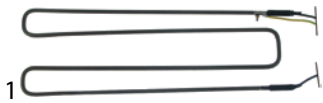

1

GEV No.	418580	Ref. No.	935475 BN1666354 FR935475
description	heating element 350W 230V L 420mm W 135mm cable length 3600mm tube ø 6.3mm defrosting		



1

GEV No.	418581	Ref. No.	990337 FR6621071 FR990337
description	heating element 350W 230V L 525mm W 90mm L1 15mm L2 510mm W1 60mm W2 30mm cable length 1800mm tube ø 6.5mm defrosting		

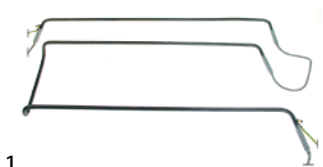

1

GEV No.	418568	Ref. No.	995748 FR995748
description	heating element 430W 230V L 445/523mm W 180mm connection cable cable length 3500mm tube ø 6.3mm immersion heater H 45mm		

GEV No.	418576	Ref. No.	6621081 935614 FR6621081 FR935614
description	heating element 500W 230V L 100mm W 520mm L1 30mm L2 70mm W1 35mm W2 495mm cable length 1700mm defrosting		

GEV No.	418578	Ref. No.	995584 FR995584
description	heating element 660W 230V L 290mm W 460mm connection cable L1 40mm L2 250mm cable length 1400mm tube ø 6.3mm defrosting		

GEV No.	418579	Ref. No.	6620371 995381 FR6620371 FR995381
description	heating element 700W 230V L 290mm W 610mm L1 40mm L2 250mm tube ø 6.3mm defrosting		

GEV No.	418796	Ref. No.	965105 FR6620950 FR965105
description	heating element 700W 230V L 440mm W 670mm L1 60mm L2 380mm W1 30mm W2 640mm cable length 2500mm tube ø 6.5mm defrosting		

GEV No.	418566	Ref. No.	995581 995641 FR6620502 FR995581
description	heating element 75W 220V L 500mm W 35mm H 45mm cable length 5700mm tube ø 6.3mm dry heating element		

heating elements for condensate evaporation



GEV No.	418582	Ref. No.	1666101 935616 BN1666101 FR935616
description	heating element 100W 230V L 140mm W 225mm H 80mm W1 62mm W2 62mm cable length 1500mm connection cable tube ø 9mm thermostat sleeves ø 7.5mm length thermostat sleeves 111mm thermostat sleeve lateral, adjacent condensate evaporation number of thermostat sleeves 1		

heating cables

drain heating cables



GEV No.	418570	Ref. No.	995162 FR6620031 FR995162
description	drain heating cable 12W 230V ø 4mm L 3190mm L1 (unheated) 1650mm L2 (heated) 1540mm defrost drain metal connection male faston		



GEV No.	418569	Ref. No.	995878 FR6621090 FR995878
description	drain heating cable 6W 230V ø 5mm L 2690mm L1 (unheated) 1930mm L2 (heated) 760mm defrost drain metal connection male faston		

connection on both sides

with wire end ferrules



GEV No.	420389	Ref. No.	FR965042
description	heating cable 40.9W 230V L 4250mm for blast chiller		



GEV No.	420391	Ref. No.	FR6620731 FR965103
description	heating cable 68.6W 230V L 5800mm for blast chiller		

with male fastons



GEV No.	420229	Ref. No.	925378 FR925378
description	heating cable 39.2W 230V L 6600mm door frame heating ø 4.2mm connection male faston 6.3mm		



GEV No.	417576	Ref. No.	996456 FR6621641 FR965043 FR996456
description	heating cable 45.3W 230V L 5000mm		

connection on both sides (metal braided)



GEV No.	418590	Ref. No.	935355 FR935355
description	heating cable 26W 230V L1 (unheated) 460mm L2 (heated) 3500mm door frame heating ø 4mm L 4420mm connection cable		





GEV No.	418554	Ref. No.	925293 FR925293
description	heating cable 28W 230V L1 (unheated) 900mm L2 (heated) 3440mm door frame heating ø 4mm L 5240mm connection cable		





GEV No.	418555	Ref. No.	925374 FR925374
description	heating cable 31W 230V L1 (unheated) 900mm L2 (heated) 3950mm ø 3mm L 5750mm connection cable		





			
GEV No.	418557	Ref. No.	925376 FR925376
description	heating cable 36W 230V L1 (unheated) 900mm L2 (heated) 4540mm door frame heating ø 4mm L 6340mm connection cable		

			
GEV No.	418559	Ref. No.	925375 FR925375
description	heating cable 50W 230V L1 (unheated) 900mm L2 (heated) 6260mm ø 3mm L 8060mm		

			
GEV No.	418561	Ref. No.	925384 FR925384
description	heating cable 51W L1 (unheated) 900mm L2 (heated) 6410mm ø 4mm L 8210mm connection cable		

			
GEV No.	418560	Ref. No.	925377 FR6620920 FR925377
description	heating cable 54W 230V L1 (unheated) 900mm L2 (heated) 6720mm door frame heating ø 4mm L 8520mm connection cable		

			
GEV No.	418592	Ref. No.	935353 FR935353
description	heating cable 58W L1 (unheated) 2000mm L2 (heated) 4400mm ø 3mm L 8400mm connection cable		

			
GEV No.	418562	Ref. No.	925295 FR925295
description	heating cable 60W 230V L1 (unheated) 900mm L2 (heated) 7540mm door frame heating ø 4mm L 9340mm connection cable		

			
GEV No.	418556	Ref. No.	925297 925298 FR925297 FR925298
description	heating cable 63W 230V L1 (unheated) 910mm L2 (heated) 7915mm door frame heating ø 4mm L 9725mm connection cable		

			
GEV No.	418564	Ref. No.	925296 FR6620800 FR925296
description	heating cable 75W 230V L1 (unheated) 900mm L2 (heated) 9410mm door frame heating ø 4mm L 11210mm connection cable		

			
GEV No.	418563	Ref. No.	925385 FR6620860 FR925385
description	heating cable 75W L1 (unheated) 930mm L2 (heated) 8520mm door frame heating ø 4mm L 10260mm connection cable		

			
GEV No.	418565	Ref. No.	925299 FR925299
description	heating cable 83W L1 (unheated) 900mm L2 (heated) 10100mm ø 4mm L 11900mm connection cable		

miscellaneous

			
GEV No.	418558	Ref. No.	925294 FR6620780 FR925294
description	heating cable on both sides 44W L 7230mm ø 4mm door frame heating L1 (unheated) 5430mm L2 (heated) 900mm metal		

			
GEV No.	418591	Ref. No.	935354 FR935354
description	heating cable on both sides 72W 230V L 9600mm ø 4mm L1 (unheated) 2000mm L2 (heated) 5600mm metal connection cable		

thermostats

control and safety thermostats

PRODIGY / FIRT

control thermostats

			
GEV No.	390595	Ref. No.	995574 FR6631660 FR995574
description	thermostat type PRODIGY temperature range 30-90°C probe ø 6.5mm probe L 63mm capillary pipe 1500mm		



refrigeration thermostats

universal with housing



GEV No.	390536	Ref. No.	995921 FR995921
description	thermostat temperature range -35 up to +35°C probe ø6x110mm capillary pipe 1500mm PRODIGY at 400V 16A 1CO type TR/711-N		

RANCO

K22 series

RANCO



GEV No.	390261	Ref. No.	2475912 995352 FR6639240 FR995352 MA2475912
description	thermostat RANCO type K22L2557 probe ømm probe Lmm capillary pipe 2550mm temperature range -5 up to +13°C		

K55 series

RANCO



GEV No.	390259	Ref. No.	995395 FR995395
description	thermostat RANCO type K55L5026 probe ømm probe Lmm capillary pipe 2000mm temperature range +0.5 up to +8.0°C		

RANCO



GEV No.	390275	Ref. No.	995385 FR995385
description	thermostat RANCO type K55L5047 probe ømm probe Lmm capillary pipe 2000mm temperature range -24 up to -19°C		

RANCO



GEV No.	390445	Ref. No.	995386 FR995386	
description	thermostat RANCO type K55-L5061			
accessories for	390445			
	GEV No.	111209	Ref. No.	995440 FR995440
knob switch zero mark ø 25mm shaft ø 6x4.6mm black				

switches and momentary switches

rocker/momentary rocker switches

25.5x25mm



GEV No.	346869 ¹	Ref. No.	925643 FR925643
description	rocker switch mounting measurements 25.5x25mm green 2NO 250V 16A illuminated main switch connection male faston 6.3mm ambient temperature max. 85°C protection IP40		

¹illuminated

GEV No.	301245 ¹	Ref. No.	996032 FR6641020 FR996032
description	rocker switch mounting measurements 25.5x25mm white 2NO 250V 16A 0-I connection male faston 6.3mm protection IP40		

¹illuminated

30x11 mm







GEV No.	301010	Ref. No.	995938 FR995938
description	rocker switch mounting measurements 30x11mm red 1NO/indicator light 250V 16A 0-I connection male faston 6.3mm ambient temperature max. 85/125°C protection IP40		

accessories for 301010

GEV No.	301035	Ref. No.	—
protective cover mounting measurements 30x11mm			



30x22mm							
 <p>1</p>							
GEV No.	301003	Ref. No.	995257 FR995257				
description	rocker switch mounting measurements 30x22mm green 2NO 250V 16A illuminated 0-I connection male faston 6.3mm ambient temperature max. 125/55°C protection IP65						
accessories for	301003						
 <table border="1"> <tr> <td>GEV No.</td> <td>301036</td> <td>Ref. No.</td> <td>—</td> </tr> </table> <p>protective cover internal size 30x22mm for rocker switch mounting measurementsmm</p>				GEV No.	301036	Ref. No.	—
GEV No.	301036	Ref. No.	—				

 <p>1</p>							
GEV No.	301002	Ref. No.	995258 FR995258				
description	rocker switch mounting measurements 30x22mm orange 2NO 250V 16A illuminated 0-I connection male faston 6.3mm ambient temperature max. 85/125°C protection IP65						
accessories for	301002						
 <table border="1"> <tr> <td>GEV No.</td> <td>301036</td> <td>Ref. No.</td> <td>—</td> </tr> </table> <p>protective cover internal size 30x22mm for rocker switch mounting measurementsmm</p>				GEV No.	301036	Ref. No.	—
GEV No.	301036	Ref. No.	—				

 <p>1</p>			
GEV No.	301029	Ref. No.	996209 FR996209
description	rocker switch mounting measurements 30x22mm green 1NO/NO 250V 16A illuminated connection male faston 6.3mm ambient temperature max. 85°C protection IP40		

 <p>1</p>			
GEV No.	301102	Ref. No.	6640421 995516 FR6640421 FR995516
description	rocker switch mounting measurements 30x22mm orange/green 1CO/indicator light 250V 16A illuminated connection male faston 6.3mm ambient temperature max. 85°C protection IP40		



 <p>1</p>			
GEV No.	301103	Ref. No.	995410 FR995410
description	rocker switch mounting measurements 30x22mm orange/green 1NO/indicator light 250V 16A illuminated 0-I connection male faston ambient temperature max. 85°C protection IP40		

microswitches

lever actuated			
 <p>1</p>			
GEV No.	345257	Ref. No.	995264 FR995264
description	microswitch with lever 250V 16A 1CO connection male faston 6.3mm L 29mm L1 33mm ambient temperature max. 120°C mounting distance 22mm actuating force: 130g lever length 31.5mm		

pin-plunger actuated			
M12			
 <p>1</p>			
GEV No.	345138	Ref. No.	995265 FR995265
description	microswitch with plunger mounting distance 25mm thread M12x1 thread L 12mm 250V 20A 1CO connection screw stroke 7mm L1 13mm ambient temperature max. 85°C type Z15G1307 actuating force: 250g		

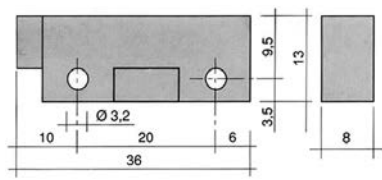
magnetic switches

36x13mm							
 <p>1</p>							
							
GEV No.	345335	Ref. No.	995405 FR995405				
description	magnetic switch L 36mm W 13mm 1NO 250V 0.04A P max. 10W connection cable cable length 960mm						
accessories for	345335						
 <table border="1"> <tr> <td>GEV No.</td> <td>519049</td> <td>Ref. No.</td> <td>—</td> </tr> </table> <p>magnet ømm L 63mm H 10.7mm W 18.8mm hole distance 52mm M2 hole ø 2mm</p>				GEV No.	519049	Ref. No.	—
GEV No.	519049	Ref. No.	—				



encoders and potentiometers

			
1			
GEV No.	401762	Ref. No.	996248 FR996248
description	encoder shaft L 14mm cable length 300mm shaft 4.5x6mm		

lamps

indicator lights

indicator lights (complete)

30x22mm

			
1			
GEV No.	359156	Ref. No.	995402 FR995402
description	indicator light mounting measurements 30x22mm 230V yellow connection male faston 6.3mm temp.-resist. 125/55°C type RL2		

			
1			
GEV No.	301138	Ref. No.	FR995406
description	indicator light mounting measurements 30x22mm 230V red/green connection male faston 6.3mm temp.-resist. 125/55°C type RL2		

fluorescent lamps



fluorescent lamps

G13

			
1			
GEV No.	359386	Ref. No.	995340 FR995340
description	fluorescent lamp socket G13 L 1198mm 36W 230V Qty 1 pcs		

accessories

sockets

			
1			
GEV No.	359441	Ref. No.	995341 995342 FR995341 FR995342
description	lamp socket cable length 2780mm for fluorescent lamps		
accessories for	359441		
			
	GEV No.	359442	Ref. No.
			995456 FR995456
	description bracket for bulb socket		

ballasts

			
1			
GEV No.	401633	Ref. No.	995338 FR995338
description	electrical ballast 36W for fluorescent lamps		

fridge lamps



			
1			
GEV No.	359595	Ref. No.	995412 FR995412
description	light bulb socket E14 15W 230-240V ø 25mm L 56mm lens L 30mm Qty 1 pcs		

producer-specific fridge lamps

FRIULINOX



			
1			
GEV No.	359442	Ref. No.	995456 FR995456
description	bracket for bulb socket		

 <p>1</p>			
GEV No.	359444	Ref. No.	935357 BN164201 FR935357
description	lamp glass		

 <p>1</p>			
GEV No.	359443	Ref. No.	995413 FR6690951 FR995413
description	lamp socket socket E14 cable length 2000mm		
accessories for	359443		
	GEV No.	359595	Ref. No. 995412 FR995412
	light bulb socket E14 15W 230-240V ø 25mm L 56mm lens L 30mm Qty 1 pcs		

timers

programme timers

 <p>1</p>			
GEV No.	360388	Ref. No.	995393 FR995393
description	timer FIBER P25 engines 1 chambers 2 operation time 7.2h 230V shaft ø 6x4.6mm shaft L 14mm manuf. no. P255J02R0V2 motor type M51BJ0L6400 for blast chiller operation time 7.2h		
spare parts for	360388		
	GEV No.	360674	Ref. No. —
	motor kit pinion ø 6.8mm teeth 15 230V voltage AC 50/60Hz turn direction counterclockwise motor ø 48mm H 18.5mm motor type UDS40NE1RNZ165 cable length 150mm with holder		

defrost timers

BIGATTI

 <p>1</p>			
GEV No.	360182	Ref. No.	995266 FR6640110 FR995266
description	defrost timer BIGATTI type SB1.72 defrosting interval 2x per 24h defrosting time 6-180min fan delaymin 230V		

 <p>1</p>			
GEV No.	360058	Ref. No.	995339
description	defrost timer type SB3.82 defrosting interval 1-12x in 24h defrosting time 2-54min fan delay 0-15min 230V defr. funct. 1-12x per 24h		

relays

power relays

with bracket mounting

 <p>1</p>			
GEV No.	380626	Ref. No.	995399 FR995399
description	power relays FINDER 230VAC 10A 2CO connection male faston 4.8mm bracket mounting manuf. no. 62.62.8.230.0000		



with special fixing



1

GEV No.	381417	Ref. No.	995345 FR6630900 FR995345
description	power relays OMRON 230VAC 30A 1NO connection F6.3 manuf. no. 15X5H1		

with male contacts

female contact 2.0mm



1

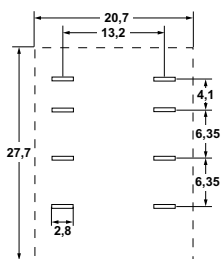

GEV No.	380377	Ref. No.	6638380 995570 FR6638380 FR995570 FR995940
description	power relays FINDER 220-240VAC 10A 2CO connection F2 plug-in connection manuf. no. 55.32.8.230.0000 94.92.3 250V		
accessories for	380377		
	GEV No.	Ref. No.	—
	380341		
	relay socket 4-pole contacts 12 300V voltage AC 6A Italiana Relè manuf. no. ZMD4		
	GEV No.	Ref. No.	—
	380378		
	relay socket 2-pole 55/85 dimensions 70.5x30x27mm 250V voltage AC 10A FINDER manuf. no. 94.72		
	GEV No.	Ref. No.	—
	380384		
	relay socket 2-pole contacts male faston 2.8mm 250V voltage AC 10A W 23mm for		
	GEV No.	Ref. No.	—
	380399		
	relay socket 4-pole dimensions 76.2x27x86.1mm 250V voltage AC 1A FINDER manuf. no. 94.94.3		

transformers

encapsulated transformers

PMA



1

GEV No.	379054	Ref. No.	995252
description	transformer primary 230VAC secondary 12VAC 3VA secondary 0.25A H 40mm L 45mm W 50mm connection screw 50/60Hz type 153/M		

electronic controllers

ELIWELL

universal controllers

built-in version



1

GEV No.	379559	Ref. No.	995237 FR995237
description	electronic controller ELIWELL type IC901 mounting measurements 71x29mm 12V voltage AC/DC NTC/PTC relay outputs 1 relay refrigeration front measurements 74x32mm built-in depth 60mm protection IP65 accuracy superior to 0.5% from final value% defr. funct. no -55 up to +150°C display 2½ digit Templn1 yes 15A		
accessories for	379559		
	GEV No.	Ref. No.	—
	379053		
	temperature probe PTC 1kOhm cable PVC probe -50 up to +150°C cable -10 up to 100°C probe ø6x30mm cable length 3m without screw connection 2-wire		
	GEV No.	Ref. No.	995500 995562 FR995500
	379064		
	temperature probe PTC 1kOhm cable silicone probe -50 up to +150°C cable -50 up to +180°C probe ø6x40mm cable length 3m without screw connection 2-wire		
	GEV No.	Ref. No.	926057 FR926057
	379161		
	temperature probe NTC 10kOhm cable thermoplastic probe -40 up to +110°C cable -40 up to +110°C probe ø6x14mm cable length 3m without screw connection 2-wire		
	GEV No.	Ref. No.	—
	379782		
	temperature probe PTC 1kOhm cable thermoplastic probe -50 up to +150°C cable -40 up to +110°C probe ø6x14mm cable length 3m 2-wire resistor 1kOhm		



refrigeration controllers

built-in version



Image not available

1

GEV No.	378080	Ref. No.	996027 FR996027
description	electronic controller ELIWELL type EWDB231 mounting measurements 58x25.5mm 12V NTC		



1

GEV No.	378038	Ref. No.	995474 FR6631211 FR995474
description	electronic controller ELIWELL type EWPC961/AR mounting measurements 71x29mm 12V PTC		



1

GEV No.	378083	Ref. No.	995707 FR995707
description	electronic controller ELIWELL type EWPC972 mounting measurements 71x29mm 230V voltage AC relay outputs 2 protection IP65 -55 up to +140°C		



1

GEV No.	378082	Ref. No.	995702 FR995702
description	electronic controller ELIWELL type EWPC974 mounting measurements 71x29mm 12V voltage AC/DC NTC/PTC relay outputs 3 front measurements 33x75mm protection IP65 -50 up to +150°C		



1

GEV No.	378085	Ref. No.	995704 FR995704
description	electronic controller ELIWELL type EWPC974 mounting measurements 71x29mm 12V voltage AC/DC PTC front measurements 33x75mm protection IP65 -50 up to +150°C		



1

GEV No.	378086	Ref. No.	995705 FR995705
description	electronic controller ELIWELL type EWPC974 mounting measurements 71x29mm 12V voltage AC/DC PTC relay outputs 1 -50 up to +150°C		



1

GEV No.	378087	Ref. No.	995709 FR995709
description	electronic controller ELIWELL type EWPC974 mounting measurements 71x29mm 12V voltage AC/DC PTC relay outputs 1 front measurements 33x75mm protection IP65 -50 up to +150°C		



1

GEV No.	378088	Ref. No.	995710 FR995710
description	electronic controller ELIWELL type EWPC974 mounting measurements 71x29mm 12V voltage AC/DC PTC relay outputs 1 front measurements 33x75mm protection IP65 -50 up to +150°C		



1

GEV No.	378089	Ref. No.	996194 FR6633920 FR996194
description	electronic controller ELIWELL type ID961 mounting measurements 71x29mm 230V voltage AC NTC/PTC relay outputs 1 front measurements 33x75mm protection IP65 -55 up to +99°C display 3½ digits		



1

GEV No.	378091	Ref. No.	996197 996199 996278 FR996197 FR996199 FR996278
description	electronic controller ELIWELL type ID974 mounting measurements 71x29mm 230V voltage AC NTC (PTC selectable via parameter) relay outputs 3 relays front measurements 74x32mm built-in depth 60mm mode of operation NTC protection IP65 -50 to +140°C display 3½ digits sensor 1 NTC/PTC		

accessories for 378091			
GEV No.	378194	Ref. No.	—
temperature probe NTC 10kOhm cable PVC probe -20 up to +80°C cable -10 up to 100°C probe ø7x24.5mm cable length 1.5m without screw connection 2-wire			
GEV No.	379052	Ref. No.	995452 995453 FR995452 FR995453
temperature probe PTC 1kOhm cable silicone probe -50 up to +150°C cable -50 up to +180°C probe ø6x40mm cable length 1.5m without screw connection 2-wire			
GEV No.	379053	Ref. No.	—
temperature probe PTC 1kOhm cable PVC probe -50 up to +150°C cable -10 up to 100°C probe ø6x30mm cable length 3m without screw connection 2-wire			
GEV No.	379057	Ref. No.	—
temperature probe NTC 10kOhm cable PVC probe -20 up to +80°C cable -10 up to 100°C probe ø6x25mm cable length 3m 2-wire			
GEV No.	379064	Ref. No.	995500 995562 FR995500
temperature probe PTC 1kOhm cable silicone probe -50 up to +150°C cable -50 up to +180°C probe ø6x40mm cable length 3m without screw connection 2-wire			
GEV No.	379160	Ref. No.	—
temperature probe NTC 10kOhm cable thermoplastic probe -40 up to +110°C cable -40 up to +110°C probe ø6x14mm cable length 1.5m without screw connection 2-wire			
GEV No.	379161	Ref. No.	926057 FR926057
temperature probe NTC 10kOhm cable thermoplastic probe -40 up to +110°C cable -40 up to +110°C probe ø6x14mm cable length 3m without screw connection 2-wire			

accessories for 378091			
GEV No.	379343	Ref. No.	—
temperature probe NTC 10kOhm cable silicone probe -40 up to +110°C cable -50 up to +180°C probe ø6x40mm cable length 3m 2-wire			
GEV No.	379458	Ref. No.	—
temperature probe NTC 10kOhm cable silicone probe -40 up to +110°C cable -50 up to +180°C probe ø6x40mm cable length 1.5m without screw connection 2-wire			





1

GEV No.	378094	Ref. No.	996201 FR996201
description	electronic controller ELIWELL type ID974 mounting measurements 71x29mm 230V voltage AC NTC/PTC -50 up to +150°C display 3½ digits		
accessories for 378094			
GEV No.	379052	Ref. No.	995452 995453 FR995452 FR995453
temperature probe PTC 1kOhm cable silicone probe -50 up to +150°C cable -50 up to +180°C probe ø6x40mm cable length 1.5m without screw connection 2-wire			
GEV No.	379053	Ref. No.	—
temperature probe PTC 1kOhm cable PVC probe -50 up to +150°C cable -10 up to 100°C probe ø6x30mm cable length 3m without screw connection 2-wire			
GEV No.	379057	Ref. No.	—
temperature probe NTC 10kOhm cable PVC probe -20 up to +80°C cable -10 up to 100°C probe ø6x25mm cable length 3m 2-wire			
GEV No.	379343	Ref. No.	—
temperature probe NTC 10kOhm cable silicone probe -40 up to +110°C cable -50 up to +180°C probe ø6x40mm cable length 3m 2-wire			
GEV No.	379458	Ref. No.	—
temperature probe NTC 10kOhm cable silicone probe -40 up to +110°C cable -50 up to +180°C probe ø6x40mm cable length 1.5m without screw connection 2-wire			
GEV No.	379781	Ref. No.	—
temperature probe PTC 1kOhm cable thermoplastic probe -50 up to +150°C cable -40 up to +110°C probe ø6x14mm cable length 1.5m without screw connection 2-wire			
GEV No.	550790	Ref. No.	—
PCB terminal block 2-pole raster size 3.81mm			
GEV No.	550805	Ref. No.	—
PCB terminal block 7-pole raster size 5mm			





			
1			
GEV No.	378033	Ref. No.	996196 FR996196
description	electronic controller ELIWELL type ID974 mounting measurements 71x29mm 230V voltage AC NTC/PTC relay outputs 2 front measurements 33x75mm protection IP65 -50 up to +150°C display 3½ digits		

			
1			
GEV No.	378048	Ref. No.	996200 FR996200
description	electronic controller ELIWELL type ID974 mounting measurements 71x29mm 230V voltage AC NTC/PTC relay outputs 2 front measurements 33x75mm protection IP65 -50 up to +150°C display 3½ digits sensor 1 NTC/PTC		

			
1			
GEV No.	378133	Ref. No.	996277 FR996277
description	electronic controller ELIWELL type ID974 mounting measurements 71x29mm 230V voltage AC NTC/PTC relay outputs 3 front measurements 33x75mm -50 up to +150°C display 3½ digits		
accessories for	378133		
	GEV No.	378194	Ref. No. —
	temperature probe NTC 10kOhm cable PVC probe -20 up to +80°C cable -10 up to 100°C probe ø7x24.5mm cable length 1.5m without screw connection 2-wire		
	GEV No.	379052	Ref. No. 995452 995453 FR995452 FR995453
	temperature probe PTC 1kOhm cable silicone probe -50 up to +150°C cable -50 up to +180°C probe ø6x40mm cable length 1.5m without screw connection 2-wire		
	GEV No.	379053	Ref. No. —
	temperature probe PTC 1kOhm cable PVC probe -50 up to +150°C cable -10 up to 100°C probe ø6x30mm cable length 3m without screw connection 2-wire		
	GEV No.	379057	Ref. No. —
	temperature probe NTC 10kOhm cable PVC probe -20 up to +80°C cable -10 up to 100°C probe ø6x25mm cable length 3m 2-wire		
	GEV No.	379064	Ref. No. 995500 995562 FR995500
	temperature probe PTC 1kOhm cable silicone probe -50 up to +150°C cable -50 up to +180°C probe ø6x40mm cable length 3m without screw connection 2-wire		

accessories for	378133		
	GEV No.	379142	Ref. No. —
	temperature probe PTC 1kOhm cable PVC probe -50 up to +150°C cable -10 up to 100°C probe ø6x30mm cable length 1.5m without screw connection 2-wire		
	GEV No.	379160	Ref. No. —
	temperature probe NTC 10kOhm cable thermoplastic probe -40 up to +110°C cable -40 up to +110°C probe ø6x14mm cable length 1.5m without screw connection 2-wire		
	GEV No.	379161	Ref. No. 926057 FR926057
	temperature probe NTC 10kOhm cable thermoplastic probe -40 up to +110°C cable -40 up to +110°C probe ø6x14mm cable length 3m without screw connection 2-wire		
	GEV No.	379343	Ref. No. —
	temperature probe NTC 10kOhm cable silicone probe -40 up to +110°C cable -50 up to +180°C probe ø6x40mm cable length 3m 2-wire		
	GEV No.	379458	Ref. No. —
	temperature probe NTC 10kOhm cable silicone probe -40 up to +110°C cable -50 up to +180°C probe ø6x40mm cable length 1.5m without screw connection 2-wire		
	GEV No.	379781	Ref. No. —
	temperature probe PTC 1kOhm cable thermoplastic probe -50 up to +150°C cable -40 up to +110°C probe ø6x14mm cable length 1.5m without screw connection 2-wire		
	GEV No.	379782	Ref. No. —
	temperature probe PTC 1kOhm cable thermoplastic probe -50 up to +150°C cable -40 up to +110°C probe ø6x14mm cable length 3m 2-wire resistor 1kOhm		

EVCO - EVERY CONTROL



refrigeration controllers

built-in version

			
1			
GEV No.	378506	Ref. No.	995703 996198 BN32140974 FR995703 FR996198
description	electronic controller EVCO type EVKB23N7PXXSX01 mounting measurements 71x29mm 230V PTC/NTC -40 up to +105°C pre-programmed		

			
1			
GEV No.	379850	Ref. No.	1681118 926156 936092 BN1681118 FR926156 FR936092
description	electronic controller EVERY CONTROL type EVC20S35N7ALX40 mounting measurements 165x45mm 230V voltage AC NTC relay outputs 4 NO-16A(5) NO-8A(4) CO-8A(4) NO-8A(4) NTC NTC DI DI for fridge front measurementsmm built-in depth 56mm protection IP00 yes yes yes -40 up to +99°C display 4 digits		

for blast chiller			
			
1			
GEV No.	378484	Ref. No.	FR6635860 FR995036
description	electronic controller EVCO type EVK802P7 mounting measurements 71x29mm 230V voltage AC NTC/PTC relay outputs 2 NO-8A(4) CO-8A(4) NTC/PTC DI for blast freezer built-in depth 59mm protection IP65 -40 up to +105°C display 3½ digits with additional input for core temperature probe		

			
2			
GEV No.	379738	Ref. No.	925644 996193 996275 FR925644 FR996193 FR996275
description	electronic controller EVERY CONTROL type EVKB21N7PCXSX01 mounting measurements 71x29mm 230V voltage AC NTC relay outputs 1 front measurementsmm built-in depth 59mm protection IP65 preprogrammed -40 up to +105°C display 3½ digits 2 RoomTempIN NTC DEF Probe TempIN3 DEF Relay fan relay DigiIN 1 compressor relay CO-16A(5)		
accessories for	379738		
	GEV No.	379053	Ref. No. —
	temperature probe PTC 1kOhm cable PVC probe -50 up to +150°C cable -10 up to 100°C probe ø6x30mm cable length 3m without screw connection 2-wire		
	GEV No.	379064	Ref. No. 995500 995562 FR995500
	temperature probe PTC 1kOhm cable silicone probe -50 up to +150°C cable -50 up to +180°C probe ø6x40mm cable length 3m without screw connection 2-wire		
	GEV No.	379161	Ref. No. 926057 FR926057
	temperature probe NTC 10kOhm cable thermoplastic probe -40 up to +110°C cable -40 up to +110°C probe ø6x14mm cable length 3m without screw connection 2-wire		
	GEV No.	379782	Ref. No. —
	temperature probe PTC 1kOhm cable thermoplastic probe -50 up to +150°C cable -40 up to +110°C probe ø6x14mm cable length 3m 2-wire resistor 1kOhm		
	GEV No.	550801	Ref. No. —
	PCB terminal block 3-pole raster size 5mm		
	GEV No.	550803	Ref. No. —
	PCB terminal block 5-pole raster size 5mm		

SHANGFANG			
accessories			
			
1			
GEV No.	379054	Ref. No.	995252
description	transformer primary 230VAC secondary 12VAC 3VA secondary 0.25A H 40mm L 45mm W 50mm connection screw 50/60Hz type 153/M		

miscellaneous			
refrigeration controllers			
			
1			
GEV No.	378411	Ref. No.	996595 FR996380 FR996595
description	power PCB EVCO type EVC80P16P7FRL01 mounting measurements 170x120mm		



probes

universal probes

temperature probes



GEV No.	378036	Ref. No.	6634600 935886 995790 995793 FR6634600 FR935886 FR995790 FR995793
description	temperature probe NTC 10kOhm cable thermoplastic probe -40 up to +110°C cable -40 up to +110°C probe ø6x14mm cable length 3m without screw connection 2-wire		



GEV No.	379161	Ref. No.	926057 FR926057
description	temperature probe NTC 10kOhm cable thermoplastic probe -40 up to +110°C cable -40 up to +110°C probe ø6x14mm cable length 3m without screw connection 2-wire		



GEV No.	379052	Ref. No.	995452 995453 FR995452 FR995453
description	temperature probe PTC 1kOhm cable silicone probe -50 up to +150°C cable -50 up to +180°C probe ø6x40mm cable length 1.5m without screw connection 2-wire		



GEV No.	379064	Ref. No.	995500 995562 FR995500
description	temperature probe PTC 1kOhm cable silicone probe -50 up to +150°C cable -50 up to +180°C probe ø6x40mm cable length 3m without screw connection 2-wire		

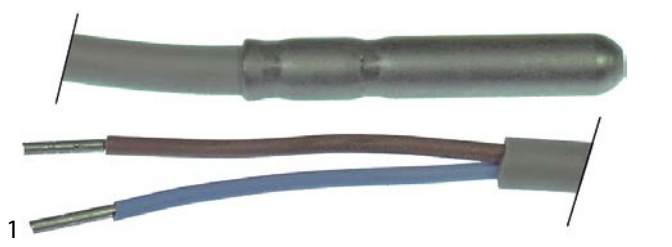

GEV No.	379282	Ref. No.	995547 995571 FR6631630 FR995547 FR995571 RA930009 RRA930009 SIRRA930009
description	temperature probe PTC cable silicone probe -50 up to +150°C cable -50 up to +180°C probe ø6x30mm cable length 5m without screw connection 2-wire		

core probes

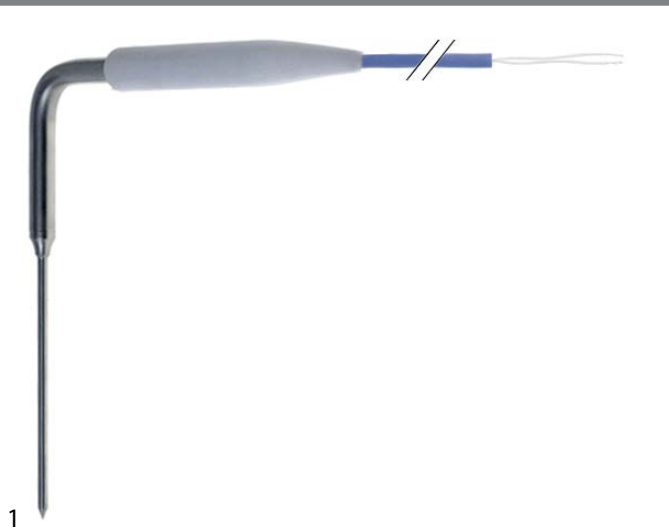

GEV No.	378392	Ref. No.	6638200 996424 996452 FR6638200 FR6638211 FR996424 FR996452
description	core temperature probe Pt1000 universal angled probe -40 up to +120°C cable -10 up to 100°C cable PVC probe ø4x100mm cable length 5m 2-wire resistance at 0°C 1000Ohm for blast chiller		

producer-specific probes

probes



GEV No.	378035	Ref. No.	995789 995792 FR995789 FR995792
description	temperature probe NTC 10kOhm cable TPE probe -40 up to +110°C cable -40 up to +110°C connection coded plug thread probe ø6x-14mm cable length 1.5m		



core probes

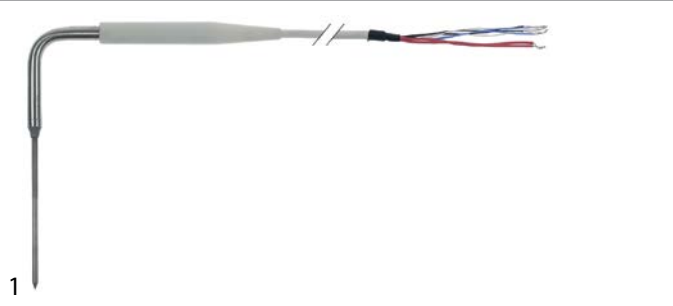

GEV No.	378679	Ref. No.	6638220 FR6638220
description	core temperature probe Pt1000 connection 8-wire probe ø4x100mm cable length 5m handle ø 16mm handle length 110mm		

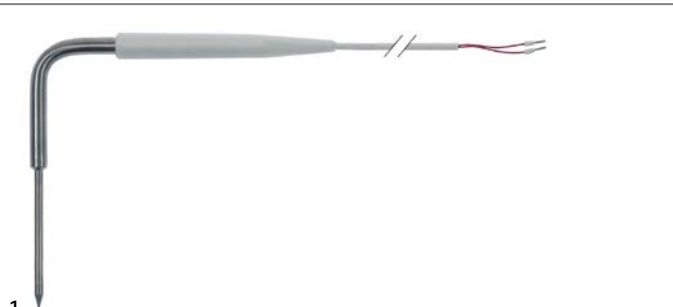

GEV No.	401756	Ref. No.	996070 FR996070
description	core temperature probe PTC 1kOhm cable silicone probe -40 up to +120°C cable -50 up to +180°C connection 2-wire probe ø4.5x100mm thread cable length 4.5m handle ø 10mm handle length 120mm L1 150mm L2 50mm		

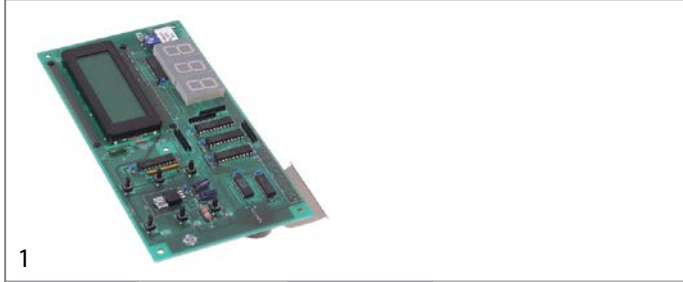

GEV No.	401761	Ref. No.	995858 995972 FR995858 FR995972
description	PCB cable length 850mm „Master“ board		



GEV No.	401757	Ref. No.	995857 FR6632510 FR995857
description	power PCB blast freezer ESP2000 suitable for FRIULINOX		

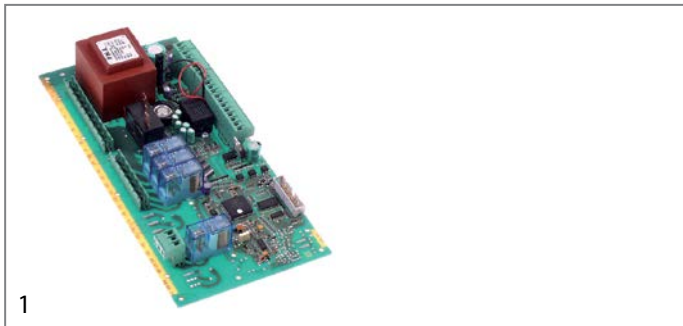

GEV No.	401758	Ref. No.	6632410 965101 FR6632410 FR965101
description	power PCB blast freezer ESP2000 suitable for FRIULINOX		



GEV No.	403199	Ref. No.	990229 FR990229
description	relay PCB refrigerator AL-EN1+AL-EN2 L 93mm W 67mm		

electronics

PCBs

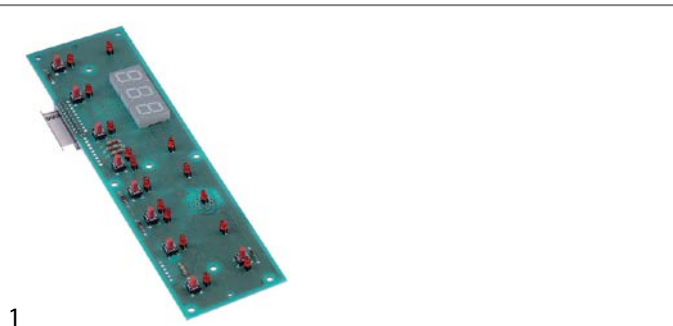

GEV No.	401763	Ref. No.	6632420 965102 FR6632420 FR965102
description	keypad PCB blast chiller FRIULINOX with cable		



keypads

front foils

1 

GEV No.	401760	Ref. No.	965009 FR965009
description	keypad foil blast chiller L 243mm W 74mm		

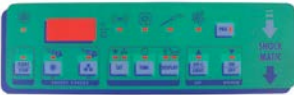
1 

GEV No.	401759	Ref. No.	965008 FR965008
description	keypad foil for blast freezer L 243mm W 750mm		

1 

GEV No.	401813	Ref. No.	965165 FR965165
description	keypad foil grey L 240mm W 80mm		

1 

GEV No.	401766	Ref. No.	965106 FR965106
description	keypad foil L 210mm W 70mm		

1 

GEV No.	401765	Ref. No.	995982 FR995982
description	keypad foil L 300mm W 125mm		

1 

GEV No.	401814	Ref. No.	965166
description	keypad foil yellow L 240mm W 80mm		

solenoid valves

solenoid valves (refrigeration)

CASTEL

valves

1 

GEV No.	370466	Ref. No.	995336 FR995336
description	solenoid valve NC CASTEL 230V p max 32bar connection 6mm soldering connection -35 up to +105°C refrigeration ø 1/4"mm		

SANHUA

valves

1 

GEV No.	370757	Ref. No.	995508 FR995508
description	solenoid valve type MDF-A03-6H001 230VAC p max 45bar pressure range 2 up to 31bar connection 10mm soldering connection -30 up to +105°C SANHUA refrigeration tube ø 10mm L 111mm		

valve bodies

1 

GEV No.	370823	Ref. No.	N/A	
description	solenoid valve body MDF3 type MDF-A03-3H005 p max 31bar connection 6mm ODF -30 up to +105°C L 102mm refrigeration SANHUA coolant R22/R134a/R404A/R407C/R410A/R507			
accessories for	370823			
	GEV No.	370825	Ref. No.	N/A
	solenoid coil 220/240VAC 12/10VA seat ø 25.4mm coil type MQ-A0322G-000001			



SANHUA



1

GEV No.	370824	Ref. No.	N/A
description	solenoid valve body MDF6 type MDF-A03-6H005 p max 31bar connection 8mm ODF -30 up to +105°C L 111mm refrigeration SANHUA coolant R22/R134a/R404A/R407C/R410A/R507		
accessories for	370824		
	GEV No.	370825	Ref. No. N/A
	solenoid coil 220/240VAC 12/10VA seat ø 25.4mm coil type MQ-A0322G-000001		

spare parts and accessories

SANHUA



1

GEV No.	370825	Ref. No.	N/A
description	solenoid coil 220/240VAC 12/10VA seat ø 25.4mm coil type MQ-A0322G-000001		
accessories for	370825		
	GEV No.	370824	Ref. No. N/A
	solenoid valve body MDF6 type MDF-A03-6H005 p max 31bar connection 8mm ODF -30 up to +105°C L 111mm refrigeration SANHUA coolant R22/R134a/R404A/R407C/R410A/R507		

pressure switches

for refrigeration

RANCO

O16 series



1

GEV No.	541123	Ref. No.	995240 FR995240
description	pressure control RANCO type O16-H6750 pressure connection vertical HD refrigeration reset automatic switching diff. 2.5-8bar pressure range 7-30bar connection 7/16" UNF (1/4" SAE)		

compressors

ACC/ZEL

R134A

LBP monophase

Lower evaporation temperature below -20°C

ACC



1

GEV No.	605062	Ref. No.	925645
description	compressor coolant R134a type GL80AA 220-240V 50Hz LBP fully hermetic 9kg 1/5HP cylinder capacity 7.39cm ³ RSIR H 175mm 102W 144W 196W 256W 326W test method ASHRAE ambient temperature max. 43°C		

HMBP monophase

High/Medium evaporation temperature above -20/-15 °C

ACC



1

GEV No.	605010	Ref. No.	995784 BN141565100050
description	compressor coolant R134a type GP12TB 220-240V 50Hz HMBP fully hermetic 11.2kg 3/8HP power input 661W cylinder capacity 12cm ³ CSIR H 203.6mmW 143W 194W 259W 339W 432W 539W 661W 796W test method ASHRAE ambient temperature max. 43°C		



CUBIGEL

R134A

LBP monophase

Lower evaporation temperature below -20°C



1

GEV No.	605197	Ref. No.	FR6682400
description	compressor coolant R134a type GL60AA 220-240V 50Hz LBP 9.1kg 1/6HP power input 126W cylinder capacity 5.99cm ³ RSIR H 175mm 98W 135W 178W 227W 283W test method ASHRAE ambient temperature max. 43°C		

R404a/R507

LBP monophase

Lower evaporation temperature below -20°C



1

GEV No.	605075	Ref. No.	BN141565100195 FR996883
description	compressor coolant R404a/R507a type MX21FB_A 220-240V 50Hz LBP 16.5kg 3/4HP cylinder capacity 20.72cm ³ CSR H 220mm 575W 655W 742W 836W 938W test method ASHRAE		

EMBRACO / ASPERA

R134A

LBP monophase

Lower evaporation temperature below -20°C



1

GEV No.	605061	Ref. No.	995490 BN141565100024 FR995490
description	compressor coolant R134a type EMT49HLP 220-240V 50Hz LBP 7.71kg 1/6HP power input 125W cylinder capacity 5.56cm ³ RSIR H 166mm 98W 131W 170W 217W 274W 342W test method ASHRAE		

HBP monophase

High evaporation temperature above -15°C



1

GEV No.	605135	Ref. No.	995742 FR995742
description	compressor coolant R134a type EMT6170Z 220-240V 50Hz HBP fully hermetic 8.1kg 1/6HP cylinder capacity 7.69cm ³ CSIR H 166mm WWW 281W 358W 448W 550W 663W 982W		



1

GEV No.	605175	Ref. No.	996135
description	compressor coolant R134a type NJ6226Z 220-240V 50Hz HBP 19.8kg 1 1/4HP cylinder capacity 34.37cm ³ CSR H 253mm WWW 1144W 1497W 1892W 2340W 2852W 3438W		



R22

HBP monophase

High evaporation temperature above -15°C

embraco



1

GEV No.	605066	Ref. No.	995503
description	compressor type L40TN coolant R22 220/240V 50/60Hz HBP 9.5kg 1/6HP cylinder capacity 4.04cm ³ CSIR H 191mmWW 113W 150W 195W 248W 309W 380W 458W 545WW		

R290A

LBP monophase

Lower evaporation temperature below -20°C

R290



1

GEV No.	605204	Ref. No.	BN14156511060
description	compressor coolant R290 type NEK2160U 220-240V 50Hz LBP 11.9kg 3/4HP cylinder capacity 16.8cm ³ CSR H 206mm 508W 646W 808W 995W 1206WWWWWW test method ASHRAE		

R290



1

GEV No.	605202	Ref. No.	BN14156511065
description	compressor coolant R290 type NT2170U 220-240V 50Hz LBP 17kg 3/4HP cylinder capacity 20.44cm ³ CSR H 220mm 544W 698W 883W 1097W 1340WWWWWW test method ASHRAE		

MBP monophase

Medium evaporation temperature above -20°C

R290



1

GEV No.	605200	Ref. No.	BN14156511070
description	compressor coolant R290 type EMT6144U 220-240V 50Hz MBP 7.8kg 1/6HP cylinder capacity 4.5cm ³ CSIR H 166mmWW 228W 280W 342W 416W 502W 598W 705W test method EN 12900		

R404a/R507

LBP monophase

Lower evaporation temperature below -20°C



1

GEV No.	605144	Ref. No.	995745 FR6683120 FR995745
description	compressor coolant R404a/R507 type NEK2168GK 220-240V 50Hz LBP 22.9kg 3/4HP cylinder capacity 14.28cm ³ CSR H 200mm 345W 454W 587W 742W 921W 1123WWWWWW		



1

GEV No.	605174	Ref. No.	995767 BN141565100200 FR6681010 FR995767
description	compressor coolant R404a/R507 type NJ2192GK 220-240V 50Hz LBP 20.4kg 1 1/4HP cylinder capacity 26.2cm ³ CSR H 265mm 685W 989W 1342W 1745W 2196W 2196WWWWWW		



1

GEV No.	605081	Ref. No.	995711 FR995711
description	compressor coolant R404a/R507 type NJ2212GK 220-240V 50Hz LBP fully hermetic 21.5kg 1 1/2HP power input 1150W cylinder capacity 34cm ³ CSR H 277mm 880W 1269W 1738W 2289W 2921W 2921WWWWWW test method ASHRAE		



1

GEV No.	605078	Ref. No.	995769 FR995769
description	compressor coolant R404a/R507 type NT2180GK 220-240V 50Hz LBP fully hermetic 17.3kg 1HP cylinder capacity 20.44cm ³ CSIR H 221mm 515W 598W 682W 769W 859W 956WWWWWW test method ASHRAE		

HMBP monophase

High/Medium evaporation temperature above -20/-15 °C



1

GEV No.	605030	Ref. No.	995925 FR995925
description	compressor coolant R404a/R507 type NJ9226GK 220-240V 50Hz HMBP fully hermetic 20.8kg 1HP cylinder capacity 21.7cm ³ CSR H 265mmW 1363W 1764W 2249W 2819W 3472W 4210W 5032W test method ASHRAE		

accessories



1

GEV No.	380074	Ref. No.	995139 FR6632040 FR995139
description	start relay 230V suitable for compressor		

L'UNITE HERMETIQUE / TECUMSEH

R134A

HMBP monophase

High/Medium evaporation temperature above -20/-15 °C



1

GEV No.	605137	Ref. No.	995783
description	compressor coolant R134a type AEZ4430Y 220-240V 50Hz HMBP fully hermetic 10.2kg 1/4HP power input 330W cylinder capacity 8.8cm ³ CSIR H 199mmWW 245W 328W 432W 558W 698WW		



SECOF DANFOSS

R134A

LBP monophase

Lower evaporation temperature below -20°C



1

GEV No.	605052	Ref. No.	995422 FR995422
description	compressor coolant R134a type TLSG 220-240V 50Hz LBP/HBP fully hermetic 7.5kg 1/6HP cylinder capacity 5.08cm ³ RSIR/CSIR H 173mm 69W 97W 132W 172W 220W 277W 345W 423W 461W test method ASHRAE		
spare parts for	605052		
	GEV No.	380076	Ref. No. 996016 FR996016
start relay DANFOSS 117U6000 HST			



1

GEV No.	605053	Ref. No.	995787 FR995787
description	compressor coolant R134a type TLS6F 220-240V 50Hz LBP fully hermetic 7.3kg power input 125W cylinder capacity 5.7cm ³ RSIR/CSIR H 173mm 95W 128W 172W 226W 290W test method ASHRAE 71W		

MBP monophase

Medium evaporation temperature above -20°C



1

GEV No.	605060	Ref. No.	14156511095 995743 BN14156511095 FR995743
description	compressor coolant R134a type NL10MF 220-240V 50/60Hz MBP fully hermetic 10.5kg 1/3HP cylinder capacity 10.1cm ³ RSIR/CSIR H 203mmWW 293W 382W 487W 611W 758W 930W 1129W test method ASHRAE (50Hz)		
spare parts for	605060		
	GEV No.	381530	Ref. No. —
start relay DANFOSS 117U6022 HST			



1

GEV No.	605059	Ref. No.	996352 FR996352
description	compressor coolant R134a type NL6.1MF 220-240V 50/60Hz MBP fully hermetic 10.5kg 1/6HP cylinder capacity 6.13cm ³ RSIR/CSIR H 190mmW 156W 209W 271W 345W 432W 533W 650W test method ASHRAE (50Hz) 784W		
spare parts for	605059		
	GEV No.	380484	Ref. No. —
start relay DANFOSS 117U6015/F394 HST			



SECO



1

GEV No.	605063	Ref. No.	995740 996353 BN141552210730 FR995740
description	compressor coolant R134a type NL7.3MF 220-240V 50/60Hz MBP fully hermetic 10.5kg 1/5HP power input 298W cylinder capacity 7.27cm ³ RSIR/CSIR H 197mmWW 198W 261W 336W 425W 530W 652W 794W test method ASHRAE (50Hz)		
spare parts for	605063		
	GEV No.	381528	Ref. No.
	start relay DANFOSS 117U6016 HST		

HMBP monophase

High/Medium evaporation temperature above -20/-15 °C



1

GEV No.	605089	Ref. No.	996354 FR996889
description	compressor coolant R134a type NL8.4MF 220-240V 50Hz HMBP fully hermetic 10.5kg 1/4HP cylinder capacity 8.35cm ³ RSIR/CSIR H 197mmW 235W 305W 390W 491W 610W 749W 912W test method ASHRAE		
spare parts for	605089		
	GEV No.	381528	Ref. No.
	start relay DANFOSS 117U6016 HST		

HBP monophase

High evaporation temperature above -15°C



1

GEV No.	605052	Ref. No.	995422 FR995422
description	compressor coolant R134a type TL5G 220-240V 50Hz LBP/HBP fully hermetic 7.5kg 1/6HP cylinder capacity 5.08cm ³ RSIR/CSIR H 173mm 69W 97W 132W 172W 220W 277W 345W 423W 461W test method ASHRAE		
spare parts for	605052		
	GEV No.	380076	Ref. No.
	start relay DANFOSS 117U6000 HST		



1

GEV No.	605077	Ref. No.	995983 FR6681520 FR995983
description	compressor coolant R134a type SC15G 220-240V 50Hz HMBP fully hermetic 13.1kg 3/8HP cylinder capacity 15.3cm ³ CSIR H 203mmW 203W 358W 523W 703W 901W 1124W 1377W 1665W test method ASHRAEW 1993W		
spare parts for	605077		
	GEV No.	365062	Ref. No.
	starting capacitor 80µF 220/300V 50/60Hz duty cycle 3min/1min ø 38mm L 98mm plastic connection cable 100mm		
	GEV No.	380078	Ref. No.
	start relay DANFOSS 117U6005 HST		



R404a/R507

LBP monophase

Lower evaporation temperature below -20°C



GEV No.	605080	Ref. No.	995875 FR995875
description	compressor coolant R404a/R507 type FR8,5CL HST 220-240V 50Hz LBP fully hermetic 10.6kg 1 1/2HP cylinder capacity 7.95cm ³ CSIR H 196mm 259W 338W 434W 546W 674WWWWWW test method ASHRAE 147W 195W 115W		
spare parts for	605080		
	GEV No.	380079	Ref. No. 996019 FR996019
start relay DANFOSS 117U6010 HST			



GEV No.	605057	Ref. No.	995485 FR6681271 FR995485
description	compressor coolant R404a/R507 type SC12CL 220-240V 50Hz LBP fully hermetic 12.5kg 3/8HP cylinder capacity 12.87cm ³ CSIR H 209mm 410W 568W 754W 971W 1220W 1505WWWWWW test method ASHRAE		
spare parts for	605057		
	GEV No.	380078	Ref. No. 996018 FR996018
start relay DANFOSS 117U6005 HST			



GEV No.	605056	Ref. No.	995746 FR995746
description	compressor coolant R404a/R507 type SC18CLX.2 220-240V 50Hz LBP fully hermetic 13.7kg 5/8HP cylinder capacity 17.69cm ³ CSR H 219mm 562W 691W 881W 1095W 1332W 1593WWWWWW test method ASHRAE		
spare parts for	605056		
	GEV No.	381548	Ref. No. —
start relay DANFOSS			





GEV No.	605082	Ref. No.	995770 FR6681440 FR995770
description	compressor coolant R404a/R507 type SC21CL 220-240V 50Hz LBP fully hermetic 14kg 7/8HP cylinder capacity 20.95cm ³ CSIR H 219mm 719W 947W 1215W 1524W 1876WWWWWW test method ASHRAE 378W 529W 263W		

accessories

	GEV No.	380076	Ref. No. 996016 FR996016
description	start relay DANFOSS 117U6000 HST		



 <p>1</p>			
GEV No.	380077	Ref. No.	996124 FR996124
description	start relay DANFOSS 117U6004/F097 HST		

 <p>1</p>			
GEV No.	380078	Ref. No.	996018 FR996018
description	start relay DANFOSS 117U6005 HST		

 <p>1</p>			
GEV No.	380079	Ref. No.	996019 FR996019
description	start relay DANFOSS 117U6010 HST		

 <p>1</p>			
GEV No.	380059	Ref. No.	996020 FR996020
description	start relay DANFOSS 117U6015/F418 HST		

 <p>1</p>			
GEV No.	380058	Ref. No.	996021 FR996021
description	start relay DANFOSS 117U6019/F278 HST		

 <p>1</p>			
GEV No.	380073	Ref. No.	996017 FR996017
description	start relay DANFOSS 117U6022		

miscellaneous			
 <p>1</p>			
GEV No.	401634	Ref. No.	996025 FR6633320 FR996025
description	switch box type DANFOSS 177-7012		

accessories			
miscellaneous			
 <p>1</p>			
GEV No.	401635	Ref. No.	995781 FR995781
description	terminal box 1262108 complete		

fans			
axial fans			
ebm-papst			
 <p>1</p>			
GEV No.	601082 ¹	Ref. No.	925649 FR925649
description	axial fan L 92mm W 92mm H 25mm 230VAC 50/60Hz 9/11W bearing ball bearing manuf. no. 3956 metal connection male faston 2.8mm ebm-papst fan wheel ø 85mm temp.-resist. 80°C		
accessories for	601082		
	GEV No.	691103	Ref. No. —
	guard ø 90mm mounting distance 83mm for axial fan 92mm		

¹with ball bearings

ebmpapst

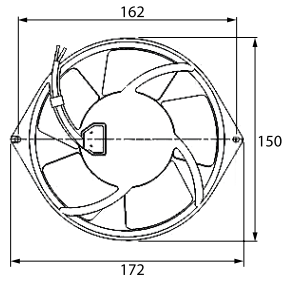

1

GEV No.	601088 ¹	Ref. No.	996073 FR6671590 FR996073
description	axial fan L 172mm W 150mm H 55mm 230VAC 50/60Hz 39/45W bearing ball bearing connection cable 350mm manuf. no. 7855ES metal ebm-papst fan wheel ø 140mm temp.-resist. 50°C		

¹with ball bearings

import

ADDA



1

GEV No.	601130 ¹	Ref. No.	915008 FR915008
description	axial fan L 80mm W 80mm H 25mm 230VAC 50/60Hz 13/14W bearing ball bearing connection male faston 2.8mm metal ADDA fan wheel ø 75mm temp.-resist. 70°C airflow 30.6m ³ /h		
accessories for	601130		
	GEV No.	550898	Ref. No. —
	connecting cable cable length 2000mm connection F 2.8 connection distance 7.9mm for axial flow fan		

¹with ball bearings



1

GEV No.	602074	Ref. No.	995910 FR995910
description	axial fan 230 50/60Hz 66/80W connection cable 2400mm blowing fan wheel ø 200mm 2490/2745rpm		
accessories for	602074		
	GEV No.	365198	Ref. No. —
	operating capacitor capacity 2µF 450V 50/60Hz ambient temperature max. -25 up to +70°C ø 40mm L 61mm M8 aluminium connection male faston 6.3mm		

refrigeration fans





refrigeration motors universal

ELCO

N series - multi fit



1

GEV No.	601427	Ref. No.	935630 FR6610010 FR935630
description	fan motor ELCO 10W 230V 50/60Hz bearing slide bearing L1 49mm L2 59mm L3 86.5mm W 83mm connection cable 500mm 1300/1550rpm 5 mounting options VNT10-20/028		
spare parts for	601427		
	GEV No.	560140	Ref. No. —
	hexagonal nut thread M4 H 4.8mm SS WS 7 Qty 20 pcs DIN/ISO DIN 985 self-locking		
	GEV No.	560332	Ref. No. —
	plain washer ID ø 4.3mm ED ø 9mm thickness 0.8mm SS Qty 1 pcs		
	GEV No.	560340	Ref. No. —
	hexagonal nut thread M4 H 3.2mm WS 7 SS DIN/ISO DIN 934 / ISO 4032/8673 Qty 1 pcs		
	GEV No.	601413	Ref. No. —
	fixing plate suitable for fanwheel ED ø 32mm shaft ø 7 mounting distance 26mm		



1





GEV No.	601430	Ref. No.	925647 FR925647
description	fan motor ELCO 5W 230V 50/60Hz bearing slide bearing L1 48mm L2 52mm L3 79.5mm W 83mm connection cable 500mm 1300/1550rpm 5 mounting options VNT5-13/027		
spare parts for	601430		
	GEV No.	560140	Ref. No. —
	hexagonal nut thread M4 H 4.8mm SS WS 7 Qty 20 pcs DIN/ISO DIN 985 self-locking		
	GEV No.	560332	Ref. No. —
	plain washer ID ø 4.3mm ED ø 9mm thickness 0.8mm SS Qty 1 pcs		
	GEV No.	560340	Ref. No. —
	hexagonal nut thread M4 H 3.2mm WS 7 SS DIN/ISO DIN 934 / ISO 4032/8673 Qty 1 pcs		

Table continues overleaf



spare parts for 601430			
	GEV No. 601413	Ref. No.	—
fixing plate suitable for fanwheel ED ø 32mm shaft ø 7 mounting distance 26mm			

IMPORT

multi fit fan motors

 			
1			
GEV No.	601023	Ref. No.	FR996919
description	fan motor 16W 230V 50-60Hz L1 45mm L2 61mm L3 92mm W 84mm cable length 500mm 1300rpm YZF16-25-18/26 5 mounting options bearing slide bearing		

accessories

fan wheels

aluminium

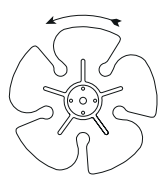
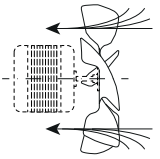
  			
1			
GEV No.	601070	Ref. No.	925648 FR925648
description	fan wheel sucking ø 200mm fan wheel mounting 25.4mm blade angle 28° W 38mm aluminium		

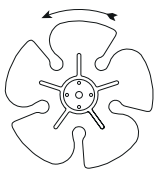
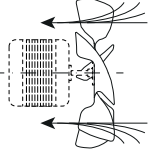
  			
1			
GEV No.	601172	Ref. No.	935640 FR935640
description	fan wheel sucking ø 230mm fan wheel mounting 25.4mm blade angle 34° W 50mm aluminium		

cooling motors (complete)

			
1			
GEV No.	601435	Ref. No.	935647 FR935647
description	fan 230V 10W 50/60Hz fan wheel ø 200mm shaft L 25mm L 67mm W 83mm H 83mm blade angle 27° connection cable 3000mm		

			
1			
GEV No.	601401	Ref. No.	995277 FR995277
description	fan 230V 10W 50/60Hz fan wheel ø 230mm shaft L 10mm feet depth 70mm L 67mm W 83mm H 83mm blade angle 23° connection cable 1600mm		

			
1			
GEV No.	601402	Ref. No.	995525 FR995525
description	fan 230V 10W 50/60Hz fan wheel ø 230mm shaft L 14mm L 67mm W 83mm H 83mm blade angle 23° connection cable 1000mm		
For models:	AF6-20		

			
1			
GEV No.	601436	Ref. No.	996158 FR996158
description	fan 230V 10W 50/60Hz fan wheel ø 230mm shaft L 6mm L 67mm W 83mm H 83mm blade angle 27° connection cable 1000mm		

			
1			
GEV No.	601403	Ref. No.	995526 FR995526
description	fan 230V 12W 50/60Hz fan wheel ø 254mm shaft L 9mm L 66mm W 83mm H 83mm blade angle 23° connection cable 1000mm		



			
1			
GEV No.	601400	Ref. No.	995280 FR6670060 FR995280
description	fan 230V 5W 50/60Hz fan wheel ø 172mm shaft L 20mm feet depth 40mm L 60mm W 83mm H 83mm blade angle 23° connection cable 1600mm		

			
1			
GEV No.	601404	Ref. No.	995414 FR6670131 FR995414
description	fan 230V 12W 50/60Hz fan wheel ø 230mm shaft L 10mm L 67mm W 85mm blade angle 31° connection cable 2000mm H 85mm		

cold air circulating fans (complete)

ebm-papst

A2E series

			
1			
GEV No.	601707	Ref. No.	965321 FR6678380
description	fan A2E300-AC47-02 fan wheel ø 300mm blades 5 230V 50/60Hz 140/190W ø 92mm H 100mm 2900rpm cable length 450mm blowing suitable capacitor 5µF		
accessories for	601707		
	GEV No.	365017	Ref. No. —
	operating capacitor capacity 5µF 450V tolerance 5% 50/60Hz ambient temperature max. -25 to +85°C ø 28mm L 54mm M8 plastic connection male faston 6.3mm 16.10.08 protection		
	GEV No.	601949	Ref. No. —
	guard ebm-papst for fan wheel ø 300mm ø 330mm hole distance 368mm H 65mm		



HIDRIA

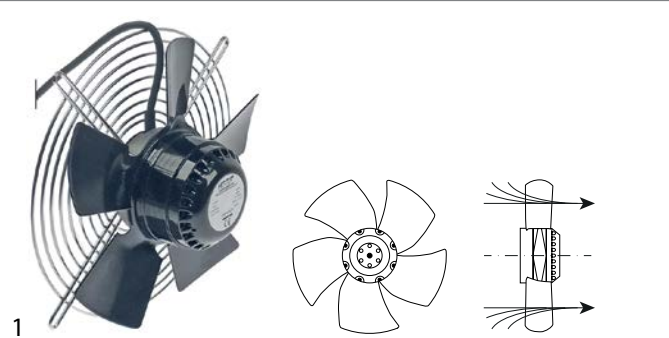

GEV No.	602073	Ref. No.	965313 FR6678570
description	fan type R09R-2525P-2M-3510 fan wheel ø 250mm 230V 50Hz 95W HIDRIA 2700rpm blowing cable length 2500mm mounting distance 300mm		

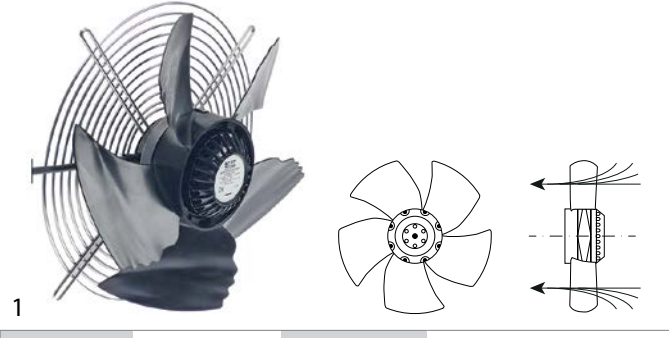

GEV No.	602029	Ref. No.	FR6678370
description	fan type R09R-30SPB-4M-3509 fan wheel ø 300mm 230V 50/60Hz 80W ø 105mm suitable capacitor 2.5µF HIDRIA suitable for blast chiller 1370rpm H 90mm cable length 1800mm mounting distance 255mm		



miscellaneous



GEV No.	601858	Ref. No.	996074 FR6671580 FR996074	
description	fan 52W REH190X62-1CN fan wheel ø 190mm blades 16 230V 50/60Hz input current 0.39/0.49A H 70mm 2600/2900rpm connection 4-wire cable length 450mm rotation direction right XFAN with capacitor suitable capacitor 2.5µF			
spare parts for	601858			
	GEV No.	365170	Ref. No.	996154
	capacitor capacity 2µF 425V tolerance 5% 50/60Hz ambient temperature max. -25 to +85°C ø 25mm L 49mm M8 plastic connection cable 250mm 416.17.74 protection			

cold air circulating fans (other)



GEV No.	601375	Ref. No.	996156 FR996156	
description	fan motor 230V 50/60Hz 10W W 84mm H 87mm D 95mm shaft L 25mm shaft ø 8mm PLASET type 20182 cable length 1000mm 1350rpm			
accessories for	601375			
	GEV No.	601282	Ref. No.	—
	fan wheel sucking ø 200mm fan wheel mounting 25.4mm blade angle 34° W 44mm aluminium			
	GEV No.	601570	Ref. No.	—
	fan wheel blowing ø 200mm fan wheel mounting 25.4mm blade angle 28° W 37mm aluminium			

cross flow fans

COPREL

with moulded coils



GEV No.	601434	Ref. No.	935581 FR6670311 FR935581
description	cross flow fan COPREL FFR roller ø 60mm roller length 300mm laminated core thickness 30mm motor position right 230V/50Hz 43W refrigeration bearing rubber connection cable 1800mm coil type moulded -10 up to +60°C		



GEV No.	601398	Ref. No.	995634 FR6670210 FR995634
description	cross flow fan COPREL TFL roller ø 60mm roller length 180mm laminated core thickness 20mm motor position left 230V/50Hz 25W refrigeration bearing rubber connection cable 2400mm coil type impregnated -10 up to +60°C		



1

GEV No.	601399	Ref. No.	6670250 995773 FR6670250 FR995773
description	cross flow fan COPREL TFL roller ø 60mm roller length 270mm laminated core thickness 35mm motor position left 230V/50Hz 49W refrigeration bearing rubber connection cable 2700mm coil type impregnated -10 up to +60°C		

condensators & interference suppression filters

starting capacitors

starting capacitors



1

GEV No.	365063	Ref. No.	996022 FR996022
description	starting capacitor 220/300V 50Hz DANFOSS duty cycle 1.7/0.10% capacity 60µF for PL/TL		



1

GEV No.	365061	Ref. No.	996023 FR996023
description	starting capacitor 220/300V 50Hz DANFOSS duty cycle 1.7/0.10% capacity 80µF for FR/NL		



1

GEV No.	365062	Ref. No.	996024 FR6633310 FR996024
description	starting capacitor 80µF 220/300V 50/60Hz duty cycle 3min/1min ø 38mm L 98mm plastic connection cable 100mm		

operating capacitors

plastic



1

GEV No.	365170	Ref. No.	996154
description	capacitor capacity 2µF 425V tolerance 5% 50/60Hz ambient temperature max. -25 to +85°C ø 25mm L 49mm M8 plastic connection cable 250mm 416.17.74 protection		



1

GEV No.	365009	Ref. No.	995750
description	operating capacitor capacity 2.5µF 400V tolerance 5% 50Hz ambient temperature max. -25 to +85°C ø 36.5mm L 55mm M8 plastic connection male faston 6.3mm 1.27.65C3 protection		

electronic components

printer



1

GEV No.	401755	Ref. No.	995799 FR995799
description	printer type ALFAP.2-3		

equipment-specific units

for blast chiller



1

GEV No.	699244	Ref. No.	4710700 965281 FR4710700 FR965281
description	outflow plug ø 19.5mm H 83.5mm		



for refrigerated counters

lid hinges



GEV No.	695568	Ref. No.	925453 FR1270681 FR925453
description	bearing for lid mounting pos. left		



GEV No.	695567	Ref. No.	925452 FR1270671 FR925452
description	bearing for lid mounting pos. right		

knobs

producer-specific knobs

FRIULINOX



GEV No.	111209	Ref. No.	995440 FR995440
description	knob switch zero mark ø 25mm shaft ø 6x4.6mm black		



GEV No.	111210	Ref. No.	995496 FR4750360 FR995496
description	knob timer ø 45mm shaft ø 6mm		

handles and hand wheels

bracket handles



GEV No.	690448	Ref. No.	935507 FR6440720 FR935507
description	pull handle L 402mm H 42mm mounting distance 375mm		

locks

locking devices

producer-specific

FRIULINOX



GEV No.	690825	Ref. No.	935400 FR935400
description	key cylinder with slide latch ø 23mm thread M19x1 mounting measurements 16.5x19mm hub 30-37mm shaft ø 11mm thread L 22mm		



GEV No.	690028	Ref. No.	930141 FR930141
description	locking device H 20/12mm L 50mm W 20mm overall height 40mm		

walk-in fridge catches

INTERKLIMAT

1800 series

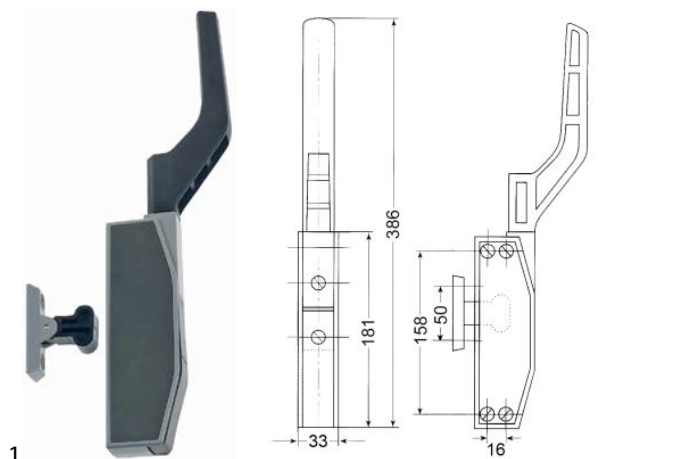

GEV No.	690457	Ref. No.	945028 FR945028
description	handle latch mounting distance 158mm L 181mm refrigeration units external lock type 1825 suitable for 1850		

7000 series

locks



GEV No.	694920	Ref. No.	965180 FR965180
description	walk-in fridge catch type 7325 door thickness 70-80mm L 243mm W 167mm H 60mm lockable		

various



GEV No.	691956	Ref. No.	945015 FR945015
description	walk-in fridge catch		

hinges

edgemount hinges

CAFF/FERMOD

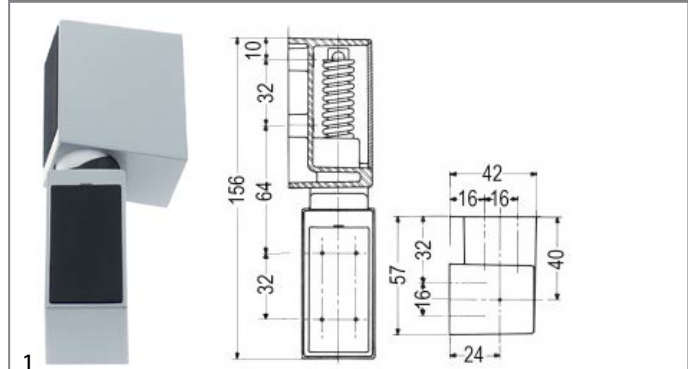

GEV No.	692447	Ref. No.	975002 FR975002
description	edgemount hinge L 156mm mounting distance 64/32mm hinging left with gradient and spring series G 466		

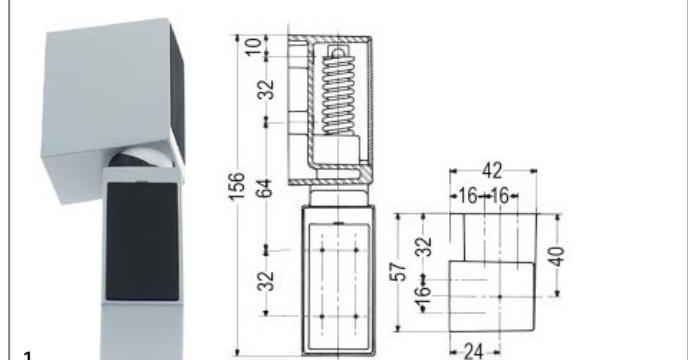

GEV No.	690642	Ref. No.	975001 FR975001
description	edgemount hinge L 156mm mounting distance 64/32mm hinging right with gradient and spring series G 466		

spring assisted hinges

producer-specific

FRIULINOX





GEV No.	695566	Ref. No.	925035 FR925035
description	bolt for hinge thread M6		





GEV No.	695563	Ref. No.	925274 FR925274
description	bush for hinge Qty 10 pcs		





 <p>1</p>			
GEV No.	690577	Ref. No.	935318 FR6410610 FR935318
description	hinge bearing with bolt suitable for FRIULINOX		

 <p>1</p>			
GEV No.	701436	Ref. No.	BN14850012 FR935179
description	door hinge L 60mm W 30mm mounting pos. upper bolt 14mm bolt ø 15mm suitable for refrigerator		

 <p>1</p>			
GEV No.	695564	Ref. No.	935084 FR935084
description	hinge camp L 44mm W 22mm H 108mm ø 18mm		

 <p>1</p>			
GEV No.	695549	Ref. No.	935317 FR935317
description	hinge L 150mm mounting pos. bottom left		

 <p>1</p>			
GEV No.	690552	Ref. No.	925273 FR925273
description	spring assisted hinge bottom left/right refrigerated counter suitable for FRIULINOX		
For models:	TR47S, TR75/3SIL		

 <p>1</p>			
GEV No.	695546	Ref. No.	935604 FR935604
description	hinge L 165mm mounting pos. bottom left		

 <p>1</p>			
GEV No.	701131	Ref. No.	925275 FR925275
description	spring assisted hinge L 99mm W 30mm mounting pos. right		

 <p>1</p>			
GEV No.	695547	Ref. No.	935603 FR935603
description	hinge L 165mm mounting pos. bottom right		

door bearing

 <p>1</p>			
GEV No.	701437	Ref. No.	996411 FR996411
description	door hinge L 45mm W 35mm mounting pos. upper bolt 14.5mm bolt ø 6mm refrigerator		

 <p>1</p>			
GEV No.	695553	Ref. No.	935218 FR6410271 FR935218
description	hinge mounting pos. bottom left		

			
1			
GEV No.	695565	Ref. No.	925523 FR925523
description	hinge mounting pos. bottom left		

			
1			
GEV No.	695552	Ref. No.	935217 FR6410261 FR935217
description	hinge mounting pos. bottom right		

			
1			
GEV No.	695559	Ref. No.	925277 FR925277
description	hinge mounting pos. bottom right		

			
1			
GEV No.	695557	Ref. No.	935313 FR6410482 FR935313
description	hinge mounting pos. centre/left		

			
1			
GEV No.	695556	Ref. No.	935312 FR935312
description	hinge mounting pos. centre/right		

			
1			
GEV No.	695551	Ref. No.	925630 FR925630
description	hinge mounting pos. left/right bottom		

			
1			
GEV No.	695569	Ref. No.	925631 FR925631
description	hinge mounting pos. left/right kit		

			
1			
GEV No.	695550	Ref. No.	925629 FR925629
description	hinge mounting pos. left/right upper		

			
1			
GEV No.	695554	Ref. No.	935216 FR935216
description	hinge mounting pos. upper left		

			
1			
GEV No.	695561	Ref. No.	6410541 935315 FR6410541 FR935315
description	hinge mounting pos. upper left		

			
1			
GEV No.	695555	Ref. No.	935051 FR6410211 FR935051
description	hinge mounting pos. upper right		



			
1			
GEV No.	695558	Ref. No.	6410900 925276 FR6410900 FR925276
description	hinge mounting pos. upper right		

			
1			
GEV No.	690576	Ref. No.	935309 FR6410461 FR935309
description	hinge bearing mounting pos. upper left with bolt refrigerator		

			
1			
GEV No.	695560	Ref. No.	935314 FR6410531 FR935314
description	hinge mounting pos. upper right		

			
1			
GEV No.	690575	Ref. No.	935308 FR6410451 FR935308
description	hinge bearing mounting pos. upper right with bolt		

			
1			
GEV No.	695562	Ref. No.	925272 FR6410880 FR925272
description	hinge mounting pos. upper suitable for FRIULINOX shaft ø 6x9mm		
For models:	TR47S		



pullouts

drawer slides

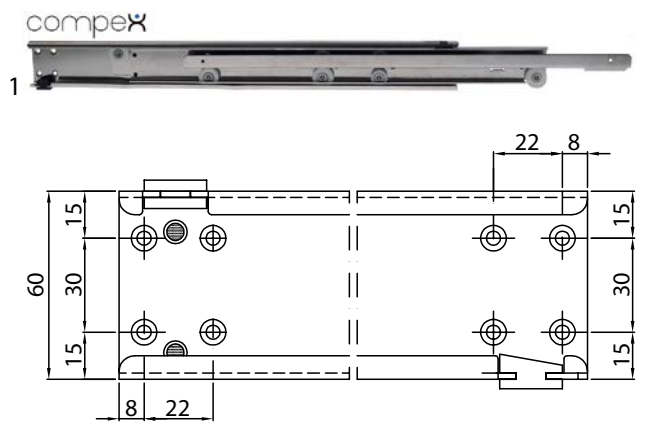
universal



			
1			
GEV No.	690581	Ref. No.	935311 FR935311
description	hinge bearing mounting pos. bottom left with bolt		

GEV No.	690753 ¹	Ref. No.	BN144906+1449081	
description	telescopic slide pair L 550mm pull-out length 610mm total length 1160mm Qty 1 pair capacity 50kg H 60mm SS telescopic			
spare parts for	690753			
	GEV No.	690750	Ref. No.	—
	GEV No.	696333	Ref. No.	—

			
1			
GEV No.	690580	Ref. No.	935310 935316 FR6411550 FR935310 FR935316
description	hinge bearing mounting pos. bottom right with bolt		

¹multiple slide (60mm more than nominal length)



producer-specific



GEV No.	690613	Ref. No.	990160 FR6450160 FR990160
----------------	--------	-----------------	---------------------------------

description drawer slide L 570mm pull-out lengthmm Qty 1 pair W 17mm H 60mm mounting pos. right/left SS with stopper

spare parts for 690613

	GEV No.	690750	Ref. No.	—
stop for telescopic rail L 20mm plastic H 12mm D 9mm				



GEV No.	690611	Ref. No.	990005 FR6450022 FR990005
----------------	--------	-----------------	---------------------------------

description drawer slide L 600mm pull-out lengthmm Qty 1 pair W 17mm H 60mm mounting pos. right/left with stopper

spare parts for 690611

	GEV No.	690750	Ref. No.	—
stop for telescopic rail L 20mm plastic H 12mm D 9mm				



GEV No.	690612	Ref. No.	990204 FR6450170 FR990204
----------------	--------	-----------------	---------------------------------

description drawer slide L 660mm pull-out lengthmm Qty 1 pair W 17mm H 60mm mounting pos. right/left SS

filters

device filters



GEV No.	692818	Ref. No.	935322 FR935322
----------------	--------	-----------------	--------------------

description filter L 245mm W 245mm H 8mm for fridge



GEV No.	692816	Ref. No.	140408 935320 BN140408 FR935320
----------------	--------	-----------------	--

description filter L 290mm W 290mm H 5mm for fridge

equipment feet and end caps

screw-in feet



GEV No.	695545	Ref. No.	925640 FR925640
----------------	--------	-----------------	--------------------

description equipment foot thread M10 thread L 32mm ø 40mm H 12mm Qty 1 pcs

shelves and shelf rails

grates

universal

without upstand



GEV No.	970122	Ref. No.	990039 FR6350610 FR990039
----------------	--------	-----------------	---------------------------------

description grate W 325mm D 530mm GN 1/1 H 8mm stainless steel wire gauge frame 7mm lengthwise wires gauge 4mm crossing wires 1

accessories for 970122





	GEV No.	690330	Ref. No.	—
rack L 1000mm W 22mm H 4mm aperture 3x8mm hole distance 12.5mm stainless steel				



	GEV No.	694700	Ref. No.	—
shelf support L 31/28mm W 22mm H 18mm SS Qty 12 pcs				





	GEV No.	694701	Ref. No.	—
shelf support L 31/28mm W 22mm H 17mm SS with hook Qty 12 pcs				



			
1			
GEV No.	970125	Ref. No.	990028 FR6351760 FR990028
description	grate W 325mm D 530mm GN 1/1 plastic-coated steel crossing wires 1 white suitable for refrigerator		
accessories for	970125		
	GEV No.	690330	Ref. No. —
	rack L 1000mm W 22mm H 4mm aperture 3x8mm hole distance 12.5mm stainless steel		
	GEV No.	694700	Ref. No. —
	shelf support L 31/28mm W 22mm H 18mm SS Qty 12 pcs		
	GEV No.	694701	Ref. No. —
	shelf support L 31/28mm W 22mm H 17mm SS with hook Qty 12 pcs		

			
1			
GEV No.	970132	Ref. No.	990026 BN1440040600 FR990026
description	grate W 400mm D 600mm plastic-coated steel crossing wires 1 white suitable for refrigerator		
accessories for	970132		
	GEV No.	690330	Ref. No. —
	rack L 1000mm W 22mm H 4mm aperture 3x8mm hole distance 12.5mm stainless steel		
	GEV No.	694700	Ref. No. —
	shelf support L 31/28mm W 22mm H 18mm SS Qty 12 pcs		
	GEV No.	694701	Ref. No. —
	shelf support L 31/28mm W 22mm H 17mm SS with hook Qty 12 pcs		

			
1			
GEV No.	970077	Ref. No.	990040 FR990040
description	grate W 400mm D 600mm SS crossing wires 1		
accessories for	970077		
	GEV No.	690330	Ref. No. —
	rack L 1000mm W 22mm H 4mm aperture 3x8mm hole distance 12.5mm stainless steel		
	GEV No.	694700	Ref. No. —
	shelf support L 31/28mm W 22mm H 18mm SS Qty 12 pcs		
	GEV No.	694701	Ref. No. —
	shelf support L 31/28mm W 22mm H 17mm SS with hook Qty 12 pcs		

			
1			
GEV No.	970126	Ref. No.	990230
description	grate W 530mm D 650mm GN 2/1 plastic-coated steel wire gauge frame 8mm lengthwise wires gauge 5mm crossing wires 2 white suitable for refrigerator		
accessories for	970126		
	GEV No.	690330	Ref. No. —
	rack L 1000mm W 22mm H 4mm aperture 3x8mm hole distance 12.5mm stainless steel		
	GEV No.	694700	Ref. No. —
	shelf support L 31/28mm W 22mm H 18mm SS Qty 12 pcs		
	GEV No.	694701	Ref. No. —
	shelf support L 31/28mm W 22mm H 17mm SS with hook Qty 12 pcs		

shelf rails and supports

producer-specific

			
1			
GEV No.	700700	Ref. No.	935672 FR935672
description	guide L-shape L 450mm W 41mm H 24mm mounting pos. left/right		



1

GEV No.	700701	Ref. No.	935669 FR935669
description	guide L-shape L 730mm W 41mm H 24mm mounting pos. left/right		



1

GEV No.	700699	Ref. No.	990333 FR990333
description	pair of setting bar L-shape L 730mm W 41mm H 24mm		



1

GEV No.	700698	Ref. No.	990332 FR990332
description	pair of setting bar L-shape L 450mm W 41mm H 26mm		



1

GEV No.	690617	Ref. No.	990165
description	pair of setting bar U-shape L 480mm W 13mm inner high 19mm		



1

GEV No.	700695	Ref. No.	990060
description	pair of setting bar L-shape L 558mm W 16mm H 24mm		



1

GEV No.	700702	Ref. No.	990085 FR990085
description	pair of setting bar U-shape L 505mm W 21mm inner high 20mm		



1

GEV No.	690616	Ref. No.	990127 990167 FR990127 FR990167
description	pair of setting bar L-shape L 623mm W 16mm H 22mm		



1

GEV No.	690619	Ref. No.	990058 990302 FR990058 FR990302
description	pair of setting bar U-shape L 560mm W 13mm inner high 19mm		



1

GEV No.	700694	Ref. No.	990059 FR990059
description	pair of setting bar L-shape L 650mm W 16mm H 24mm mounting distance 620mm		



1

GEV No.	690615	Ref. No.	990166 FR990166
description	pair of setting bar U-shape L 567mm W 13mm H 19mm mounting pos. left/right		



1



GEV No.	700696	Ref. No.	990330 FR990330
description	pair of setting bar U-shape L 585mm W 13mm inner height 20mm		

1



GEV No.	692090	Ref. No.	990029 FR990029
description	pair of setting bar U-shape L 633mm W 13mm inner height 20mm		

1



GEV No.	690618	Ref. No.	990057 FR990057
description	pair of setting bar U-shape L 650mm W 13mm inner height 19mm mounting distance 620mm		

1



GEV No.	691319	Ref. No.	990164 FR990164
description	pair of setting bar U-shape L 668mm W 13mm inner height 20mm		

1



GEV No.	700691	Ref. No.	935374 FR935374
description	rack L 1020mm mounting pos. at the back left hole distance 102mm aperture 14x14mm		

1



GEV No.	700690	Ref. No.	935373 FR935373
description	rack L 1020mm mounting pos. at the back right hole distance 102mm aperture 14x14mm		

1



GEV No.	700692	Ref. No.	935372 FR935372
description	rack L 1020mm mounting pos. front hole distance 102mm aperture 14x14mm		

1



GEV No.	700689	Ref. No.	935601 FR935601
description	rack L 1250mm hole distance 60mm aperture 14x23mm		

1



GEV No.	700688	Ref. No.	935365 FR935365
description	rack L 1300mm hole distance 45mm aperture 14x14mm		

1



GEV No.	700693	Ref. No.	935363 FR935363
description	rack L 1300mm mounting pos. front hole distance 45mm aperture 14x14mm		



1

GEV No.	700687	Ref. No.	935234 FR935234
description	rack L 1360mm hole distance 75mm aperture 14x14mm		



1

GEV No.	700686	Ref. No.	935236 FR6151420 FR935236
description	rack L 1360mm hole distance 75mm aperture 14x23mm		



1

GEV No.	700685	Ref. No.	935235 FR935235
description	rack L 580mm hole distance 60mm aperture 14x14mm		



1

GEV No.	700684	Ref. No.	935237 FR935237
description	rack L 580mm hole distance 60mm aperture 14x23mm		

gaskets

refrigeration gaskets

miscellaneous



1

GEV No.	900704	Ref. No.	935654 FR935654
description	bottom gasket L 690mm		

plug-in gaskets

profile 9048

We offer custom-made gaskets for this profile

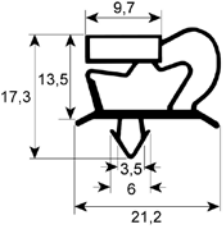

1

GEV No.	900687	Ref. No.	4500681 925283 FR4500681 FR925283
description	refrigeration gasket profile 9048 W 160mm L 390mm plug size		
For models:	TR 37 S		

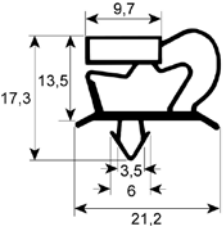

1

GEV No.	900289	Ref. No.	925316 FR4500721 FR925316
description	refrigeration gasket profile 9048 W 160mm L 460mm plug size		

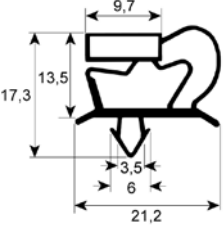

1

GEV No.	900281	Ref. No.	925438 FR925438
description	refrigeration gasket profile 9048 W 160mm L 600mm plug size		



GEV No.	900698	Ref. No.	4500501 925159 FR4500501 FR925159
description	refrigeration gasket profile 9048 W 170mm L 390mm plug size		

GEV No.	900284	Ref. No.	925433 FR925433
description	refrigeration gasket profile 9048 W 265mm L 655mm plug size		

GEV No.	900282	Ref. No.	925068 FR925068
description	refrigeration gasket profile 9048 W 180mm L 580mm plug size		

GEV No.	900696	Ref. No.	915017 FR304500051 FR915017
description	refrigeration gasket profile 9048 W 350mm L 415mm plug size		

GEV No.	900313	Ref. No.	925053 FR4500282 FR925053
description	refrigeration gasket profile 9048 W 185mm L 370mm plug size drawer size 1/3		

GEV No.	900694	Ref. No.	925284 FR925284
description	refrigeration gasket profile 9048 W 370mm L 390mm plug size		

GEV No.	900288	Ref. No.	925437 FR925437
description	refrigeration gasket profile 9048 W 265mm L 600mm plug size		

GEV No.	900689	Ref. No.	925317 FR925317
description	refrigeration gasket profile 9048 W 370mm L 460mm plug size		

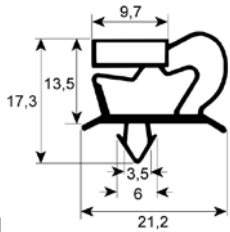

1

GEV No.	900842	Ref. No.	14413690499 925633 BN14413690499 FR925633
description	refrigeration gasket profile 9048 W 370mm L 500mm plug size		

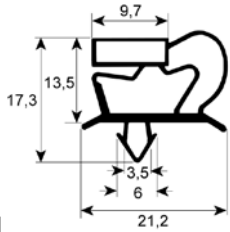

1

GEV No.	900685	Ref. No.	925519 FR4500931 FR925519
description	refrigeration gasket profile 9048 W 370mm L 560mm plug size		

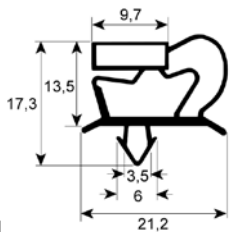

1

GEV No.	900312	Ref. No.	4500312 925052 FR4500312 FR925052
description	refrigeration gasket profile 9048 W 370mm L 615mm plug size door size 1/1		

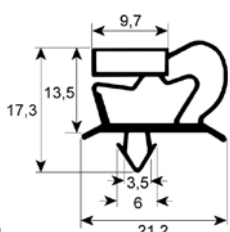

1

GEV No.	900695	Ref. No.	4500302 925055 FR4500302 FR925055
description	refrigeration gasket profile 9048 W 375mm L 400mm plug size		

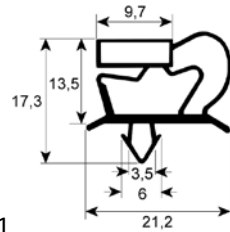

1

GEV No.	900699	Ref. No.	925157 FR4500521 FR925157
description	refrigeration gasket profile 9048 W 390mm L 390mm plug size		

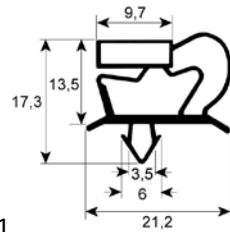

1

GEV No.	900287	Ref. No.	925156 FR4500531 FR925156
description	refrigeration gasket profile 9048 W 390mm L 610mm plug size		

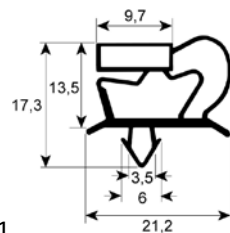

1

GEV No.	900719	Ref. No.	925070 FR4500342 FR925070
description	refrigeration gasket profile 9048 W 395mm L 580mm plug size		

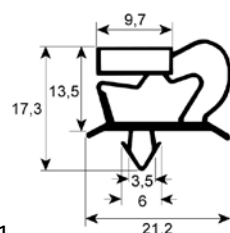

1

GEV No.	900731	Ref. No.	14414300620 926005 BN14414300620 FR926005
description	refrigeration gasket profile 9048 W 396mm L 566mm plug size		

GEV No.	901011	Ref. No.	925104 FR925104
description	refrigeration gasket profile 9048 W 412mm L 625mm plug size		

GEV No.	901012	Ref. No.	925067 FR4500352 FR925067
description	refrigeration gasket profile 9048 W 590mm L 635mm plug size		

GEV No.	901214	Ref. No.	995948old FR995948old
description	refrigeration gasket profile 9048 W 435mm L 695mm plug size		

GEV No.	900315	Ref. No.	935186 FR4500251 FR935186
description	refrigeration gasket profile 9048 W 660mm L 755mm plug size 1/2 door		

GEV No.	900283	Ref. No.	925436 FR4500831 FR925436
description	refrigeration gasket profile 9048 W 580mm L 600mm plug size		

GEV No.	900310	Ref. No.	4500451 935306 FR4500451 FR935306
description	refrigeration gasket profile 9048 W 677mm L 1512mm plug size door		

GEV No.	900286	Ref. No.	925432 FR4500791 FR925432
description	refrigeration gasket profile 9048 W 580mm L 667mm plug size		

GEV No.	901212	Ref. No.	995950old FR995950old
description	refrigeration gasket profile 9048 W 695mm L 1210mm plug size		

GEV No.	902258	Ref. No.	N/A
description	refrigeration gasket profile 9048 Wmm L 2500mm		

profile 9703
We offer custom-made gaskets for this profile

GEV No.	900702	Ref. No.	935610 FR935610
description	refrigeration gasket profile 9703 W 652mm L 1482mm plug size		

GEV No.	900701	Ref. No.	935691 FR4500180 FR935691
description	refrigeration gasket profile 9703 W 670mm L 1510mm plug size		

GEV No.	900703	Ref. No.	935432 FR935432
description	refrigeration gasket profile 9703 W 685mm L 1530mm plug size		

profile 9794

We offer custom-made gaskets for this profile

GEV No.	900691	Ref. No.	4500671 925282 FR4500671 FR925282
description	refrigeration gasket profile 9794 W 265mm L 390mm plug size		
For models:	TR 27 GOLD, TR 37 S, TR 47 GOLD		

GEV No.	900686	Ref. No.	4500711 925315 FR4500711 FR925315
description	refrigeration gasket profile 9794 W 270mm L 460mm plug size		

GEV No.	900688	Ref. No.	925158 FR4500511 FR925158
description	refrigeration gasket profile 9794 W 280mm L 390mm plug size		

GEV No.	900690	Ref. No.	925069 FR925069
description	refrigeration gasket profile 9794 W 290mm L 580mm plug size		



GEV No.	900856	Ref. No.	925556 FR4500951 FR925556
description	refrigeration gasket profile 9794 W 358mm L 910mm plug size		

GEV No.	900718	Ref. No.	4500441 935215 FR4500441 FR935215
description	refrigeration gasket profile 9794 W 535mm L 1185mm plug size		

GEV No.	900684	Ref. No.	077FR925281 4500661 FR4500661
description	refrigeration gasket profile 9794 W 390mm L 580mm plug size		
For models:	TR 47 GOLD		

GEV No.	901838	Ref. No.	1441571718 935204 BN1441571718 FR935204
description	refrigeration gasket profile 9794 W 571mm L 718mm		

GEV No.	902523	Ref. No.	14414580620 915259 BN14414580620 FR915259
description	refrigeration gasket profile 9794 W 450mm L 613mm plug size		

GEV No.	902111	Ref. No.	935813 FR4501211 FR935813
description	refrigeration gasket profile 9794 W 599mm L 1559mm plug size		

GEV No.	902207	Ref. No.	4500551 925198 FR4500551 FR925198
description	refrigeration gasket profile 9794 W 458mm L 608mm plug size		

GEV No.	901667	Ref. No.	935818 FR4501251 FR935818
description	refrigeration gasket profile 9794 W 615mm L 680mm plug size		

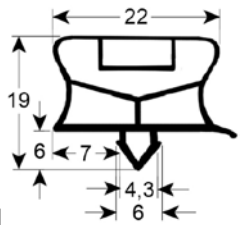

GEV No.	901153	Ref. No.	4501221 935819 FR4501221 FR935819
description	refrigeration gasket profile 9794 W 622mm L 1495mm plug size		

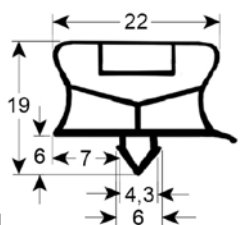

GEV No.	900700	Ref. No.	4501131 935602 FR4501131 FR935602
description	refrigeration gasket profile 9794 W 640mm L 1455mm plug size		

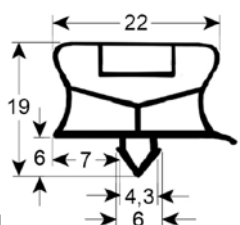

GEV No.	901597	Ref. No.	4500461 935307 FR4500461 FR935307
description	refrigeration gasket profile 9794 W 678mm L 730mm plug size with magnet		

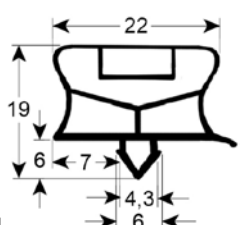

GEV No.	900693	Ref. No.	4501121 935638 FR4501121 FR935638
description	refrigeration gasket profile 9794 W 680mm L 1535mm plug size		

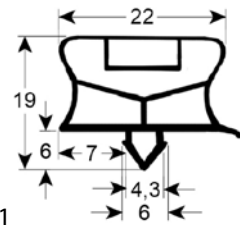

GEV No.	900697	Ref. No.	935639 FR4501111 FR935639
description	refrigeration gasket profile 9794 W 680mm L 740mm plug size		

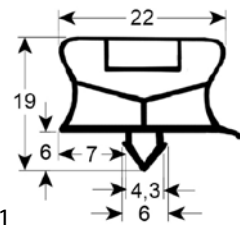

GEV No.	900612	Ref. No.	4500651 975004 FR4500651 FR975004
description	refrigeration gasket profile 9794 W 755mm L 1820mm plug size		

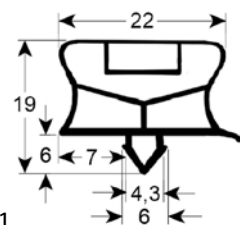

GEV No.	901918	Ref. No.	4501091 995965 FR4501091
description	refrigeration gasket profile 9794 W 945mm L 755mm external size L1 780mm W1 965mm plug size		

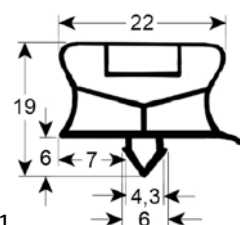

GEV No.	902308	Ref. No.	N/A
description	refrigeration gasket profile 9794 Wmm L 2500mm		



profile 9794Z (blast freezer)

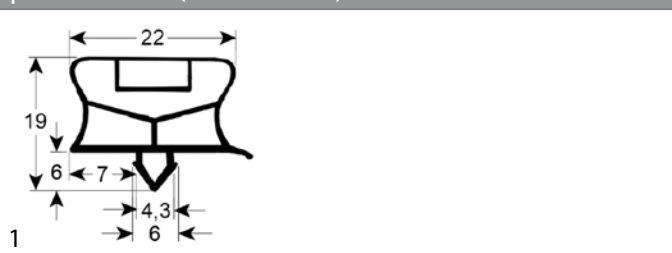

GEV No.	901837 ¹	Ref. No.	4500901 FR4500901 FR995950
description	blast freezer gasket profile 9794Z W 1210mm L 695mm for blast chiller suitable for FRIULINOX		

¹for blast freezer

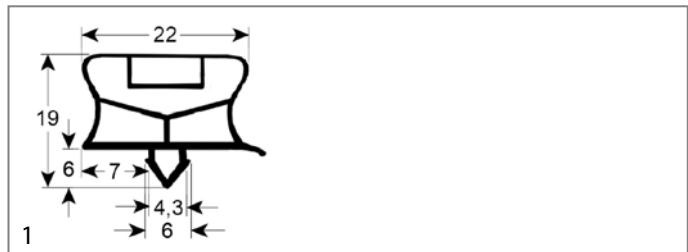

GEV No.	901819 ¹	Ref. No.	4501502 965298 FR4501502 FR965298
description	blast freezer gasket profile 9794Z W 685mm L 645mm suitable for FRIULINOX		

¹for blast freezer

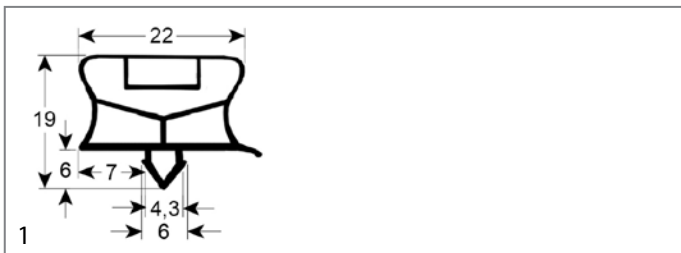

GEV No.	901820 ¹	Ref. No.	965128 FR4501151 FR965128
description	blast freezer gasket profile 9794Z W 336mm L 692mm suitable for FRIULINOX		

¹for blast freezer

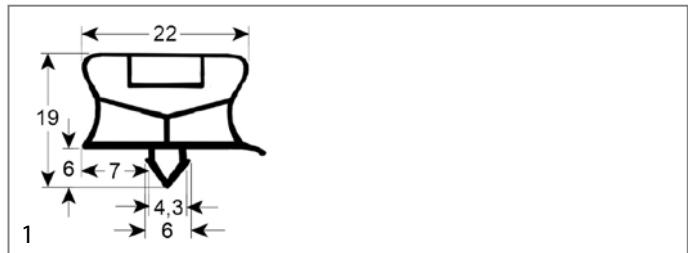

GEV No.	901814 ¹	Ref. No.	FR4501621 FR965385
description	blast freezer gasket profile 9794Z W 690mm L 363mm for blast chiller suitable for FRIULINOX		

¹for blast freezer

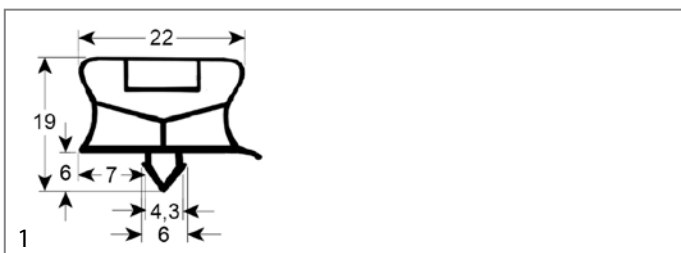

GEV No.	901812 ¹	Ref. No.	965122 FR4501142 FR965122
description	blast freezer gasket profile 9794Z W 440mm L 360mm plug size suitable for FRIULINOX		

¹for blast freezer

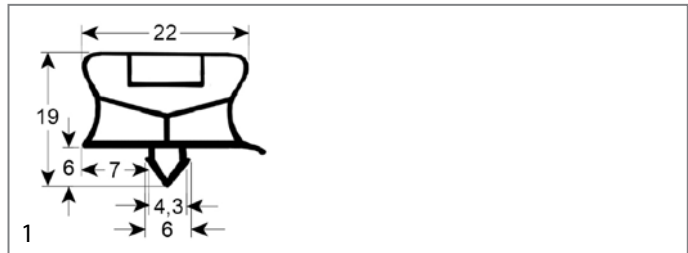

GEV No.	901835 ¹	Ref. No.	4500921 995948 FR4500921 FR995948
description	blast freezer gasket profile 9794Z W 695mm L 437mm for blast chiller suitable for FRIULINOX		

¹for blast freezer

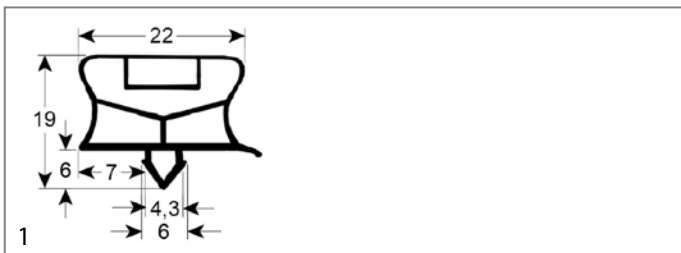

GEV No.	901813 ¹	Ref. No.	4500701 FR4500701 FR925314
description	blast freezer gasket profile 9794Z W 580mm L 461mm for blast chiller suitable for FRIULINOX		

¹for blast freezer

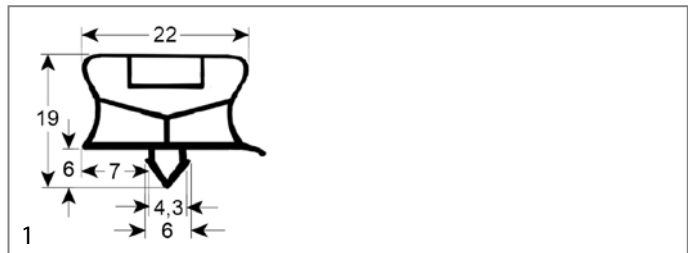

GEV No.	901836 ¹	Ref. No.	4500911 995949 FR4500911 FR995949
description	blast freezer gasket profile 9794Z W 817mm L 690mm for blast chiller suitable for FRIULINOX		

¹for blast freezer

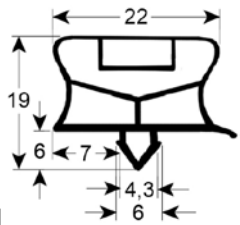

GEV No.	901800 ¹	Ref. No.	4501512 996457 FR4501512 FR996457
description	blast freezer gasket profile 9794Z W 847mm L 685mm for blast chiller suitable for FRIULINOX		

¹for blast freezer

profile 9195

We offer custom-made gaskets for this profile

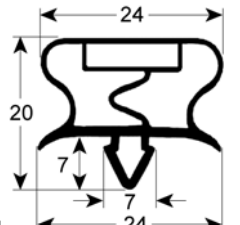

GEV No.	900855	Ref. No.	4500292 925054 FR4500292 FR925054
description	refrigeration gasket profile 9195 W 305mm L 390mm plug size		

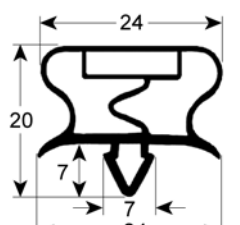

GEV No.	902435	Ref. No.	996453 FR996453
description	refrigeration gasket profile 9195 W 400mm L 690mm		

screw-in gaskets

profile 9663

We offer custom-made gaskets for this profile

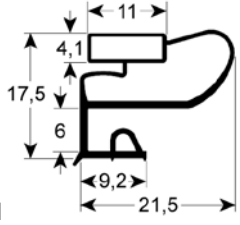

GEV No.	902295	Ref. No.	N/A
description	refrigeration gasket profile 9663 Wmm L 2500mm		

profile 9030

We offer custom-made gaskets for this profile

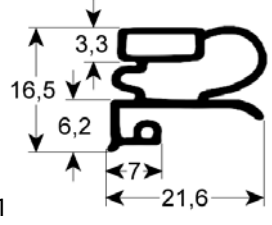

GEV No.	901805	Ref. No.	FR925019
description	refrigeration gasket profile 9030 W 198mm L 595mm		

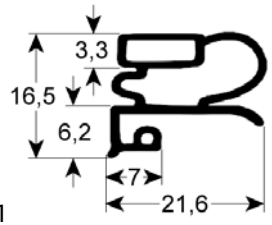

GEV No.	901806	Ref. No.	FR925020
description	refrigeration gasket profile 9030 W 306mm L 595mm		

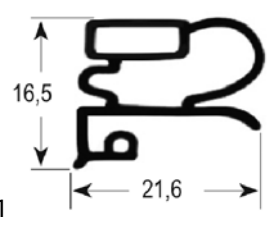

GEV No.	900002	Ref. No.	925017 FR925017
description	refrigeration gasket profile 9030 W 310mm L 390mm external size drawer for refrigerated counter refrigeration size 1/2		

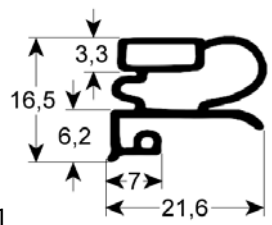

GEV No.	901804	Ref. No.	925018 FR925018
description	refrigeration gasket profile 9030 W 390mm L 490mm		

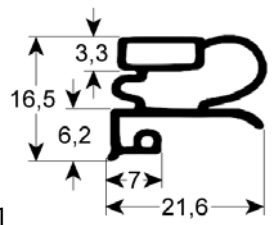

GEV No.	901808	Ref. No.	FR925013
description	refrigeration gasket profile 9030 W 390mm L 634mm		



GEV No.	901810	Ref. No.	FR4500071 FR925014
description	refrigeration gasket profile 9030 W 595mm L 634mm		

GEV No.	900005	Ref. No.	935046
description	refrigeration gasket profile 9030 W 675mm L 770mm external size 1/2 door refrigeration suitable for ELECTROLUX, ZANUSSI		

profile 9665			
GEV No.	901803	Ref. No.	FR925016
description	refrigeration gasket profile 9665 W 198mm L 390mm external size		

gaskets for walk-in fridges			
GEV No.	901185	Ref. No.	4500431 945018 FR4500431 FR945018
description	gasket for walk-in fridges profile 9780 W 680mm L 1930mm plug size grey		

GEV No.	901431	Ref. No.	4500270 945001 FR4500270 FR945001
description	gasket for walk-in fridges profile 9780 W 735mm L 1835mm plug size grey		

GEV No.	901247	Ref. No.	945002 FR4500260 FR945002
description	gasket for walk-in fridges profile 9780 W 830mm L 1920mm plug size grey		

refrigeration cycle components

cooling water regulators

JOHNSON CONTROLS

GEV No.	541150	Ref. No.	995492 FR6850520 FR995492
description	cooling water regulator 3/8" type V46AA-9609 connection 7/16" UNF (1/4" SAE) pressure range 5-23bar water pressure max. 10bar water temperature max. 90°C capillary pipe 750mm L 160mm 0.9kg		

valves

expansion valves

HONEYWELL

valves



1			
GEV No.	750018	Ref. No.	995678 FR6850730 FR995678
description	expansion valve HONEYWELL type TMV coolant R134a angled 90° thermostatically controlled inlet 5/8" UNF (3/8" SAE) outlet 3/4" UNF (1/2" SAE) p max 25bar -30 up to +15°C		



1			
GEV No.	750017	Ref. No.	995771 FR995771
description	expansion valve HONEYWELL type TMV coolant R404a/R507 angled 90° thermostatically controlled inlet 5/8" UNF (3/8" SAE) outlet 3/4" UNF (1/2" SAE) p max 25bar -50 up to -27°C		



1			
GEV No.	750019	Ref. No.	995681 FR6850760 FR995681
description	expansion valve HONEYWELL type TMVX coolant R404a/R507 angled 90° thermostatically controlled inlet 5/8" UNF (3/8" SAE) outlet 3/4" UNF (1/2" SAE) 7/16" UNF (1/4" SAE) p max 25bar -50 up to -27°C		

nozzle inserts



1			
GEV No.	750028	Ref. No.	995713 FR995713
description	nozzle insert nozzle ø 0.3mm type VD0.3 TMV/TMVX HONEYWELL		



1			
GEV No.	750027	Ref. No.	995714 FR995714
description	nozzle insert type VD0.5 nozzle ø 0.5mm TMV/TMVX HONEYWELL		



1			
GEV No.	750026	Ref. No.	995716 FR995716
description	nozzle insert type VD1.0 nozzle ø 1mm TMV/TMVX HONEYWELL		



1			
GEV No.	750025	Ref. No.	995717 FR995717
description	nozzle insert type VD1.5 nozzle ø 1.5mm TMV/TMVX HONEYWELL		

SANHUA

valves









1			
GEV No.	750674	Ref. No.	N/A
description	expansion valve SANHUA type RFKA03-3.4-03 coolant R404a/R507a inlet 3/8" outlet 12mm p max 35bar -40 up to +10°C capillary pipe 1500mm		

spare parts for 750674



	GEV No.	750678	Ref. No.	—
	nozzle insert size 0X type 140114 RFK SANHUA			
	GEV No.	750679	Ref. No.	—
	nozzle insert size 00 type 151214 RFK SANHUA			
	GEV No.	750680	Ref. No.	—
	nozzle insert size 01 type 160601 RFK SANHUA			
	GEV No.	750681	Ref. No.	—
	nozzle insert size 02 type 160517 RFK SANHUA			
	GEV No.	750682	Ref. No.	—
	nozzle insert size 03 type 160519 RFK SANHUA			
	GEV No.	750683	Ref. No.	—
	nozzle insert size 04 type 140721 RFK SANHUA			
	GEV No.	750684	Ref. No.	—
	nozzle insert size 05 type 140813 RFK SANHUA			





1







GEV No.	750676 ¹	Ref. No.	N/A
description	expansion valve SANHUA type RFKA03-3.4-04 coolant R404a/R507a inlet 3/8" outlet 12mm p max 35bar MOP -10°C capillary pipe 1500mm		
spare parts for	750676		
	GEV No.	750678	Ref. No. —
	nozzle insert size 0X type 140114 RFK SANHUA		
	GEV No.	750679	Ref. No. —
	nozzle insert size 00 type 151214 RFK SANHUA		
	GEV No.	750680	Ref. No. —
	nozzle insert size 01 type 160601 RFK SANHUA		
	GEV No.	750681	Ref. No. —
	nozzle insert size 02 type 160517 RFK SANHUA		
	GEV No.	750682	Ref. No. —
	nozzle insert size 03 type 160519 RFK SANHUA		
	GEV No.	750683	Ref. No. —
	nozzle insert size 04 type 140721 RFK SANHUA		
	GEV No.	750684	Ref. No. —
	nozzle insert size 05 type 140813 RFK SANHUA		

spare parts for 750677

	GEV No.	750682	Ref. No.	—
	nozzle insert size 03 type 160519 RFK SANHUA			
	GEV No.	750683	Ref. No.	—
	nozzle insert size 04 type 140721 RFK SANHUA			
	GEV No.	750684	Ref. No.	—
	nozzle insert size 05 type 140813 RFK SANHUA			







1

GEV No.	750675	Ref. No.	N/A
description	expansion valve SANHUA type RFKA03E-3.4-02 coolant R404a/R507a inlet 3/8" outlet 12mm 6mm p max 35bar -40 up to +10°C capillary pipe 1500mm		
spare parts for	750675		
	GEV No.	750678	Ref. No. —
	nozzle insert size 0X type 140114 RFK SANHUA		
	GEV No.	750679	Ref. No. —
	nozzle insert size 00 type 151214 RFK SANHUA		
	GEV No.	750680	Ref. No. —
	nozzle insert size 01 type 160601 RFK SANHUA		
	GEV No.	750681	Ref. No. —
	nozzle insert size 02 type 160517 RFK SANHUA		
	GEV No.	750682	Ref. No. —
	nozzle insert size 03 type 160519 RFK SANHUA		
	GEV No.	750683	Ref. No. —
	nozzle insert size 04 type 140721 RFK SANHUA		
	GEV No.	750684	Ref. No. —
	nozzle insert size 05 type 140813 RFK SANHUA		



1

GEV No.	750677 ¹	Ref. No.	N/A
description	expansion valve SANHUA type RFKA03E-3.4-01 coolant R404a/R507a inlet 3/8" outlet 12mm 6mm p max 35bar MOP -10°C capillary pipe 1500mm		
spare parts for	750677		
	GEV No.	750678	Ref. No. —
	nozzle insert size 0X type 140114 RFK SANHUA		
	GEV No.	750679	Ref. No. —
	nozzle insert size 00 type 151214 RFK SANHUA		
	GEV No.	750680	Ref. No. —
	nozzle insert size 01 type 160601 RFK SANHUA		
	GEV No.	750681	Ref. No. —
	nozzle insert size 02 type 160517 RFK SANHUA		

indicators

DANFOSS



GEV No.	750066	Ref. No.	995423 996271 FR996271
description	sight glass DANFOSS type SGN10 with indicator connection ODS/ODF 10mm -50 up to +80°C p max 35bar		

filter driers

DANFOSS



GEV No.	750031	Ref. No.	6525570 995136 995690 FR6525570 FR995690
description	dryer connection 7/16" UNF (1/4" SAE) 41cm ³ p max 46bar -40 up to +70°C 202g type DML 032S size 3 cubic inches		

miscellaneous



GEV No.	750244	Ref. No.	995376 FR6520182 FR995376
description	dryer size 15g ø 19mm L 117mm connection 3,2/6,2mm		



GEV No.	750245	Ref. No.	995377 FR6520192 FR995377
description	dryer size 25g ø 24mm L 125mm connection 3,2/6,2mm		



GEV No.	750231	Ref. No.	995482 FR995482
description	dryer size 40g ø 24mm L 164mm connection 3,2/6,2mm		



GEV No.	750232	Ref. No.	995483 FR995483
description	dryer size 40g ø 24mm L 168mm connection 6,2/6,2mm		

evaporators

for fridges

producer-specific



GEV No.	750243	Ref. No.	995373 FR995373
description	evaporator complete with fan		



GEV No.	750241	Ref. No.	6524310 935664 FR6524310 FR935664
description	evaporator L 240mm W 140mm H 505mm		



1

GEV No.	750242	Ref. No.	6521360 995375 FR6521360 FR995375
description	evaporator L 245mm W 140mm H 650mm complete with fan		



1

GEV No.	750237	Ref. No.	995601 FR995601
description	evaporator L 250mm W 150mm H 650mm		



1

GEV No.	750236	Ref. No.	935675 FR6521660 FR935675
description	evaporator L 245mm W 155mm H 650mm		
For models:	AR 14-2		



1

GEV No.	750235	Ref. No.	995600 FR6522080 FR995600
description	evaporator L 300mm W 140mm H 520mm complete with fan		



1

GEV No.	750234	Ref. No.	935674 FR6521640 FR935674
description	evaporator L 250mm W 140mm H 500mm		



1

GEV No.	750104	Ref. No.	14330570134 935868 935869 BN14330570134 FR935868 FR935869
description	evaporator L 410mm W 120mm H 490mm complete with fan		



1

GEV No.	750195	Ref. No.	915048 FR915048
description	evaporator L 425mm W 315mm H 60mm		



1

GEV No.	750197	Ref. No.	995481 FR6521732 FR995481
description	evaporator L 500mm W 60mm H 330mm		



1

GEV No.	750315	Ref. No.	6524510 935476 FR6524510 FR935476
description	evaporator L 430mm W 170mm H 50mm		



1

GEV No.	750233	Ref. No.	995618 FR6524230 FR995618
description	evaporator L 500mm W 85mm H 470mm		



1

GEV No.	750198	Ref. No.	6522092 995609 FR6522092 FR995609
description	evaporator L 495mm W 60mm H 460mm		
For models:	TR37 S		



1

GEV No.	750240	Ref. No.	935615 FR6525090 FR935615
description	evaporator L 510mm W 140mm H 205mm		



1

GEV No.	750196	Ref. No.	995604 FR6522240 FR995604
description	evaporator L 500mm W 60mm H 330mm		

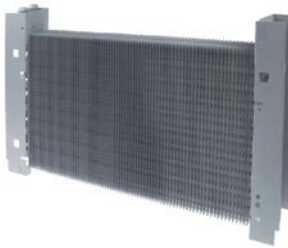

1

GEV No.	750363	Ref. No.	BN14330210292
description	evaporator L 520mm W 60mm H 300mm		

1

GEV No.	750238	Ref. No.	6524990 935611 FR6524990 FR935611
description	evaporator L 535mm W 80mm H 205mm		



1

GEV No.	750239	Ref. No.	6524980 935613 FR6524980 FR935613
description	evaporator L 535mm W 95mm H 210mm		

evaporation and condensing trays

evaporation trays



1

GEV No.	750225	Ref. No.	1405020090 995605 BN1405020090 FR995605
description	evaporation tray L 520mm W 68mm H 28mm		
For models:	TR 37 S		



1

GEV No.	750224	Ref. No.	925607 FR925607
description	evaporation tray left L 270mm W 70mm H 40mm		



1

GEV No.	750223	Ref. No.	925566 FR1180560 FR925566
description	evaporation tray right L 270mm W 70mm H 40mm		

unheated condensing trays



1

GEV No.	750287	Ref. No.	4740240 995932 FR4740240 FR995932
description	evaporation tray L 254mm W 108mm H 100mm		

springs

torsion springs



1

GEV No.	690272	Ref. No.	935058 936086 FR935058 FR935697
description	torsion spring \varnothing 15mm L2 80mm wire gauge \varnothing 2.5mm mounting pos. left L1 27mm L3 16mm		
accessories for	690272		

GEV No.	690271	Ref. No.	1412083 935057 935696 936085 BN1412083 FR935057 FR935696 FR936085
description	torsion spring \varnothing 15mm L2 80mm wire gauge \varnothing 2.5mm mounting pos. right L1 27mm L3 16mm		



1

GEV No.	690271	Ref. No.	1412083 935057 935696 936085 BN1412083 FR935057 FR935696 FR936085
description	torsion spring \varnothing 15mm L2 80mm wire gauge \varnothing 2.5mm mounting pos. right L1 27mm L3 16mm		
accessories for	690271		

GEV No.	690272	Ref. No.	935058 936086 FR935058 FR935697
description	torsion spring \varnothing 15mm L2 80mm wire gauge \varnothing 2.5mm mounting pos. left L1 27mm L3 16mm		

miscellaneous

			
1			
GEV No.	691221	Ref. No.	990077 FR990077
description	spring clip		

A			
axial fans		25	
B			
ballasts		8	
C			
cold air circulating fans (complete)		28	
compressors		18	
condensators & interference suppression filters		30	
cooling water regulators		49	
core probes		15	
cross flow fans		29	
D			
defrost timers		9	
E			
edgemount hinges		32	
electronic controllers		10	
evaporators		52	
expansion valves		50	
F			
fans		25	
filter driers		52	
fluorescent lamps		8, 8	
fridge lamps		8	
G			
grates		36	
H			
heating cables		4	
heating elements		3	
heating elements for condensate evaporation		4	
heating elements for defrosting		3	
heating elements for refrigeration		3	
I			
indicator lights		8	
indicator lights (complete)		8	
indicators		52	
L			
lamps		8	
M			
magnetic switches		7	
microswitches		7	
O			
operating capacitors		30	
P			
plug-in gaskets		40	
pressure switches		18	
probes		15	
programme timers		9	
R			
refrigeration cycle components		49	
refrigeration fans		26	
refrigeration gaskets		40	
refrigeration motors universal		26	
refrigeration thermostats		6	
relays		9	
rocker/momentary rocker switches		6	
S			
screw-in gaskets		48	
shelves and shelf rails		36	
solenoid valves		17	
spring assisted hinges		32	
starting capacitors		30	
switches and momentary switches		6	
T			
temperature probes		15	
thermostats		5	
timers		9	
transformers		10	
U			
universal probes		15	
W			
walk-in fridge catches		32	