



GAS COMPONENTS



ELECTRIC COMPONENTS



WATER TECHNOLOGY



MECHANICAL COMPONENTS



TOOLS

Spare parts suitable for

FRACINO

Find the complete and up-to-date range of products in our GEV Webshop



Manufacturer catalogue

The most important spare parts and accessories arranged clearly for every manufacturer

- ✓ Complete product range and all appliance data always up to date in the GEV Webshop
- ✓ Alphabetical Index at the end of the catalogue

GEV Webshop

www.gev-online.co.uk

www.gev-online.com



- 🔍 Add to Favourites
- 🔍 Sign In with email address and usual password
- 🔍 Easy-order – place several items in your basket at the same time
- 🔍 Quick Item search – no login needed



heating elements

heating elements for coffee machine



1

GEV No.	417247	Ref. No.	FC161
description	heating element 2700W 230V heating circuits 2 mounting \varnothing 42mm hole distance 75mm L 175mm W 32mm H 66mm L1 25mm L2 30mm L3 120mm H1 32mm H2 34mm hole \varnothing 10mm tube \varnothing 8.5mm thermostat sleeves \varnothing 7mm length thermostat sleeves 200mm thermostat sleeve eccentric, non clinging number of thermostat sleeves 1 connection male faston 6.3mm immersion heater 2 hole flange		



1

GEV No.	417246	Ref. No.	HEA161
description	heating element 2850W 230V heating circuits 1 thread 1 1/4" L 117mm \varnothing 37mm tube \varnothing 6.3mm connection male faston 6.3mm immersion heater connection length 11mm flange with thread WS 37		



1

GEV No.	417248	Ref. No.	FC162
description	heating element 4000W 230V heating circuits 2 mounting \varnothing 42mm hole distance 75mm L 395mm W 28mm H 53mm L1 36mm L2 32mm L3 327mm H1 32mm H2 21mm hole \varnothing 10mm tube \varnothing 8.5mm thermostat sleeves \varnothing 7mm length thermostat sleeves 193mm thermostat sleeve eccentric, non clinging number of thermostat sleeves 1 connection male faston 6.3mm immersion heater 2 hole flange		



1

GEV No.	417249	Ref. No.	FC163
description	heating element 7500W 230V heating circuits 3 mounting \varnothing 42mm hole distance 75mm L 555mm W 34mm H 60mm L1 30mm L2 50mm L3 475mm H1 31mm H2 29mm hole \varnothing 10mm tube \varnothing 8.5mm thermostat sleeves \varnothing 7mm length thermostat sleeves 342mm thermostat sleeve centre not clinging number of thermostat sleeves 1 connection male faston 6.3mm immersion heater 2 hole flange		

accessories

sealing washers

fibre gaskets

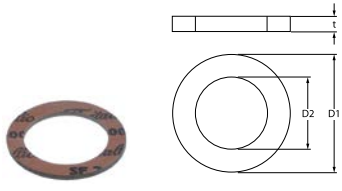

1

GEV No.	526060	Ref. No.	FC165F
description	flat gasket fibre D1 \varnothing 60mm D2 \varnothing 43mm thickness 3mm coffee machine Qty 1 pcs		

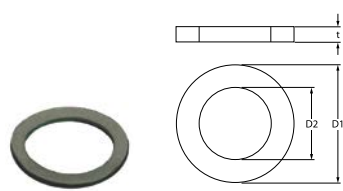

1

GEV No.	528017	Ref. No.	HEA165
description	flat gasket fibre ED \varnothing 53mm ID \varnothing 42mm thickness 2mm for thread 1 1/4" Qty 1 pcs		

PTFE gaskets

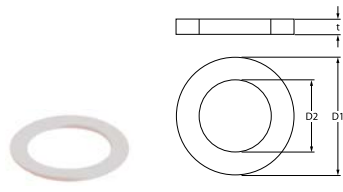

1

GEV No.	528925	Ref. No.	FC165T
description	flat gasket PTFE ED \varnothing 59.5mm ID \varnothing 42mm thickness 3mm Qty 1 pcs suitable for VFA Express		

Viton gaskets



1

GEV No.	526061	Ref. No.	FC165 FC165V
description	flat gasket Viton D1 \varnothing 60mm D2 \varnothing 43mm thickness 3mm		

thermostats

bi-metal thermostats

safety bi-metal thermostats



1

GEV No.	390689	Ref. No.	HEA166
description	bi-metal safety thermostat switch-off temp. 200°C 1-pole 16A connection F6.3 thread M4 with extension		



switches and momentary switches

rocker/momentary rocker switches

30x22mm



1

GEV No.	301247	Ref. No.	FC189
description	rocker switch mounting measurements 30x22mm red 2NO 250V 16A illuminated connection male faston 6.3mm ambient temperature max. 125/55°C protection IP40		
spare parts for	301247		
	GEV No.	301060	Ref. No.
			—
description	rocker switch mounting measurements 30x22mm red 2NO 250V 16A illuminated connection male faston 6.3mm ambient temperature max. 125/55°C protection IP40		

ø20mm



1



GEV No.	301246	Ref. No.	HEA189
description	rocker switch mounting ø 20mm black 2NO 250V 10A connection male faston 4.8mm ambient temperature max. 85°C protection IP40		

push/momentary push switches

ø16mm



1

GEV No.	301248	Ref. No.	FC189/C
description	push switch mounting measurements ø16mm silver 2CO 6A with connecting cable 250V connection male faston 6.3mm cup protection IP40 ambient temperature max. 125/55°C		
spare parts for	301248		
	GEV No.	347448	Ref. No.
			FC189/CA
description	push button mounting measurements ø16mm silver illuminated cup		
	GEV No.	347449	Ref. No.
			FC189/CS
description	contact block momentary 2CO 3-pole		

accessories

frame



1

GEV No.	347212	Ref. No.	FC189S/P
description	frame for rocker switch oval external size 40x46mm internal size 30x22mm 0-1 black plastic		

control equipment

miscellaneous



1

GEV No.	347449	Ref. No.	FC189/CS
description	contact block momentary 2CO 3-pole		





1

GEV No.	347448	Ref. No.	FC189/CA
description	push button mounting measurements ø16mm silver illuminated cup		



1

GEV No.	301248	Ref. No.	FC189/C
description	push switch mounting measurements ø16mm silver 2CO 6A with connecting cable 250V connection male faston 6.3mm cup protection IP40 ambient temperature max. 125/55°C		

spare parts for	301248		
	GEV No.	347448	Ref. No.
			FC189/CA
description	push button mounting measurements ø16mm silver illuminated cup		
	GEV No.	347449	Ref. No.
			FC189/CS
description	contact block momentary 2CO 3-pole		



1

GEV No.	347535	Ref. No.	FCC189
description	push switch mounting measurements ø16mm silver illuminated cup		

lamps

indicator lights

indicator lights (complete)

ø10mm

with plug-in socket



1

GEV No.	359139	Ref. No.	FC190/G
description	indicator light ø 10mm green 230V connection male faston 6.3mm Qty 1 pcs		





			
1			
GEV No.	359138	Ref. No.	FC190/R
description	indicator light ø 10mm red 230V connection male faston 6.3mm Qty 1 pcs		

			
1			
GEV No.	359140	Ref. No.	FC190
description	indicator light ø 10mm yellow 230V connection male faston 6.3mm Qty 1 pcs		

relays

level relays

<p>GICAR</p> 			
1			
GEV No.	402103	Ref. No.	FC172/A
description	level controller 230/240V voltage AC 50/60Hz connection F6.3 type NRL30/1E-2C/F		

			
1			
GEV No.	528636	Ref. No.	HEA172
description	level controller 230V voltage AC 50/60Hz 16/5A connection F6.3 type RL30 MICRO ST		

			
1			
GEV No.	400240	Ref. No.	FC172
description	level relay 230V voltage AC 50/60Hz 8-pole 5A connection plug-in connection round 8-pole type RL30/1E-2C/8		

electronics

central units

			
1			
GEV No.	402254	Ref. No.	FC91/2/NT
description	central unit 2 groups 230V 50/60Hz type ET30 F 2GRCZ voltage AC		

			
1			
GEV No.	402253	Ref. No.	FC91/3/ET40
description	central unit 3 groups		

dosing electronics

<p>GICAR</p> 			
1			
GEV No.	402255	Ref. No.	FC90/NT
description	dosing electronics 1 group 230V voltage AC 50/60Hz type RL30 MICRO Z		

keypads

membrane keypads

			
1			
GEV No.	402252	Ref. No.	FC94CD
description	membrane keypad FRACINO L 133mm W 40.5mm		



1

GEV No.	402567	Ref. No.	FC94C
description	membrane keypad L 134mm W 39mm		

control panel



1

GEV No.	527973	Ref. No.	FC94
description	control panel L 153.5mm W 44mm black plastic		

accessories



1

GEV No.	347213	Ref. No.	N/A
description	push button brass external size 25mm mounting ø 22mm ET M22x1 IT M12x1		

solenoid valves

solenoid valves (water)

metal

PARKER

2-way

VE-161 series



1

GEV No.	370552	Ref. No.	FC171COM/07
description	solenoid valve 2-ways 230VAC connection 1/4" ET L 44mm with fittings DN 2.2mm t.max. 80°C -10 up to 180°C type series 161.4 coil type KT09 membranes Viton p max 10bar p min 0bar 50Hz 230V voltage AC		



1

GEV No.	370553	Ref. No.	FC171
description	solenoid valve 2-ways 230VAC connection 1/8" L 32mm DN 2.2mm t.max. 80°C -10 up to 140°C type series VE-161.4 coil type KT09 membranes Viton p max 10bar p min 0bar 50Hz brass		

3-way

VE-128 series



1

GEV No.	370060	Ref. No.	FC125/1
description	solenoid valve 3-ways 230VAC body outer cone DN 1.2mm slide-on receptacle DIN -20° up to 140°C PARKER type series VE-128 coil type YB09 with cable membranes Viton p max 10bar brass flange 32x32mm		

spare parts for 370060



GEV No.	370062	Ref. No.	—
description	solenoid valve body PARKER 3-ways outer cone		



GEV No.	371033	Ref. No.	—
description	solenoid coil PARKER 230VAC 9VA coil type YB09 with cable seat ø 14mm		



GEV No.	371095	Ref. No.	—
description	O-ring Viton thickness 1.78mm ID ø 6.07mm Qty 1 pcs		

accessories for 370060



GEV No.	101527	Ref. No.	FC120
description	O-ring Viton thickness 1.78mm ID ø 6.75mm Qty 1 pcs		



GEV No.	532193	Ref. No.	—
description	O-ring silicone thickness 1.78mm ID ø 6.75mm Qty 10 pcs		

electrodes



1

GEV No.	401258	Ref. No.	FC191
description	level electrode 1/4" total length 120mm probe L 94mm insulated probe length 90mm PTFE insulated connection angled, male faston 6.3mm stainless steel ø 2.5mm		



equipment-specific units

for espresso machines

filter holders

filter holders standard

filter holder without spout



1

GEV No.	525988	Ref. No.	N/A
description	filter holder suitable for FRACINO without outlet mounting ø 80.2mm outlet 3/8" ID ø 62mm wedge height 11mm wedge position horizontal number of wedges 2 lever straight		

filter holders short



1

GEV No.	526066	Ref. No.	FC105/P
description	filter holder mounting ø 80.2mm outlet 3/8" ID ø 62mm handle M12x1.75 wedge height 11mm wedge position horizontal number of wedges 2 lever straight chrome-plated brass		



1

GEV No.	531160	Ref. No.	FC105/B
description	filter holder mounting ø 82mm outlet 3/8" ID ø 62mm handle M14x1.5 wedge height 10mm wedge position horizontal number of wedges 2 lever straight chrome-plated brass		

accessories for

531160



GEV No.	531159	Ref. No.	FC106/9/16
description	handle ø 34mm thread M14x1.5 thread L 15mm L 130mm black		

handles

with external thread



1

GEV No.	531159	Ref. No.	FC106/9/16
description	handle ø 34mm thread M14x1.5 thread L 15mm L 130mm black		

filters

for 1 cup



1

GEV No.	526069	Ref. No.	FC107
description	coffee filter ø 70mm mounting ø 60mm H 20.5mm cups 1 amount of coffee 7g perforation ø 0.4mm		



1

GEV No.	526132	Ref. No.	FC107/D
description	coffee filter ø 70mm mounting ø 60mm H 23.5mm cups 1 amount of coffee 10g perforation ø 0.4mm		

for 2 cups



1

GEV No.	526067	Ref. No.	FC108
description	coffee filter ø 70mm mounting ø 60mm H 20.5mm cups 2 amount of coffee 12g		



1

GEV No.	526068	Ref. No.	FC108/D
description	coffee filter ø 70mm mounting ø 60mm H 24.5mm cups 2 amount of coffee 14g		

for coffee pods



1

GEV No.	526070	Ref. No.	FC107/POD
description	coffee filter ø 70mm mounting ø 60mm H 17mm cups 1 für coffee pods		

1

for 2 cups



1

GEV No.	526899	Ref. No.	FC108/POD
description	coffee filter ø 70mm mounting ø 60.5mm H 19.3mm cups 2 für coffee pods perforation ø 0.4mm		

brewing units

shower screens

flat



1

GEV No.	529193	Ref. No.	FC103M
description	shower screen ø 52.1mm hole ø 6.3mm		
accessories for	529193		
	GEV No.	560300	Ref. No.
			FC103S
description	countersunk screw thread M5 L 16mm SS DIN 963/ISO 2009 Qty 1 pcs intake slotted head ø 9mm		

screws



1

GEV No.	560300	Ref. No.	FC103S
description	countersunk screw thread M5 L 16mm SS DIN 963/ISO 2009 Qty 1 pcs intake slotted head ø 9mm		

filter holder gaskets

flat

standard



1

GEV No.	526064	Ref. No.	FC104/8.5
description	filter holder gasket D1 ø 73.3mm D2 ø 57.3mm H 8.5mm Qty 1 pcs		



1

GEV No.	526063	Ref. No.	FC104
description	filter holder gasket D1 ø 73.3mm D2 ø 57.3mm H 8mm		



1

GEV No.	526065	Ref. No.	FC104/9
description	filter holder gasket D1 ø 73.3mm D2 ø 57.3mm H 9mm Qty 1 pcs		

shim gaskets



1

GEV No.	528599	Ref. No.	FC104/P
description	shim gasket D1 ø 72mm D2 ø 58mm thickness 0.4mm paper Qty 1 pcs		

safety valves

safety valves

3/8"



1

GEV No.	526047	Ref. No.	FC134
description	safety valve connection 3/8" triggering pressure 1.8bar approval CE 0036 sealed		

expansion valves

with hose connection



1

GEV No.	526049	Ref. No.	HEA178
description	expansion valve T1: 1/8" IT hose ø 6mm L 48mm		



compression springs



1

GEV No.	526053	Ref. No.	FC178/B
description	compression spring \varnothing 13.8mm L 19.6mm wire gauge \varnothing 2mm		

with non-return valve



1

GEV No.	526048	Ref. No.	HEA138C
description	expansion valve with non-return valve connection 1/8"		

drain pans

drain pans



1

GEV No.	526021	Ref. No.	FC140/A
description	drain pan L 81mm W 65mm H 48mm hole \varnothing 8mm hose \varnothing 20mm suitable for FRACINO		

aerators and air bleeders



1

GEV No.	529303	Ref. No.	FC135
description	aerator and air bleeder connection 1/4" only steam		

spare parts for 529303



GEV No.	528687	Ref. No.	HEA180A
description	O-ring Viton thickness 1.78mm ID \varnothing 3.69mm Qty 1 pcs		

steam/water taps

steam/water taps

steam taps

steam taps (complete)



1

GEV No.	526036	Ref. No.	HEA222AA
description	steam tap steam tap inlet 1/4"		



1

GEV No.	526031	Ref. No.	CHE222AA
description	steam tap with steam pipe and knob inlet 1/4"/1/2"		

spare parts for 526031



GEV No.	526032	Ref. No.	FC194/B
description	steam nozzle thread M10x1 4 holes chrome-plated brass		



GEV No.	526035	Ref. No.	HEA221
description	steam pipe thread 3/8" H 155mm L 190mm \varnothing 11.4mm tube \varnothing 9.5mm stainless steel suitable for FRACINO		

accessories for 526031



GEV No.	526039	Ref. No.	FC56
description	tube handle L 34mm plastic		

			
1			
GEV No.	526030	Ref. No.	BAM222AA
description	steam tap with steam pipe and knob steam inlet 1/4"		

			
1			
GEV No.	526034	Ref. No.	BAM222AA FC222AA
description	steam tap with steam pipe and knob steam inlet 1/4"		

			
1			
GEV No.	526033	Ref. No.	FC222AA/04
description	steam tap with steam pipe inlet 1/4"		

components

bushes

			
1			
GEV No.	526040	Ref. No.	FC222T
description	bush D1 ø 10.35mm D2 ø 8.85mm ID ø 6.1mm H 6.35mm brass		

<p>gaskets</p> 			
1			
GEV No.	527961	Ref. No.	FC77
description	flat gasket copper ED ø 21mm ID ø 17.2mm thickness 1.5mm		

			
1			
GEV No.	531194	Ref. No.	FC198A (D1b)
description	gasket D1 ø 12mm thickness 5.1mm green Viton steam/water tap		

<p>springs</p> 			
1			
GEV No.	527958	Ref. No.	FC222U
description	compression spring ø 10.5mm L 32mm wire gauge ø 1.3mm for steam-/water-tap		

			
1			
GEV No.	526055	Ref. No.	FC222U
description	compression spring ø 10.7mm L 32mm wire gauge ø 1.3mm		

<p>water taps</p>			
<p>water taps</p>			
			
1			
GEV No.	526026	Ref. No.	HEA222B
description	water tap with handle inlet 1/4"		



1

GEV No.	526027	Ref. No.	FC222AB/CON
description	water tap with water pipe and knob inlet 1/4"		



1

GEV No.	526029	Ref. No.	CHE222B
description	water tap with water pipe and knob inlet 1/4"/1/2"		



1

GEV No.	526028	Ref. No.	BAM222AB
description	water tap with water pipe and knob water inlet 1/4"		



1

GEV No.	526038	Ref. No.	FC222AB/04
description	water tap with water pipe inlet 1/4"		

steam/water pipes

steam pipes



1

GEV No.	526035	Ref. No.	HEA221	
description	steam pipe thread 3/8" H 155mm L 190mm ø 11.4mm tube ø 9.5mm stainless steel suitable for FRACINO			
spare parts for	526035			
	GEV No.	526032	Ref. No.	FC194/B
accessories for	526035			
	GEV No.	526039	Ref. No.	FC56
	tube handle L 34mm plastic			



1

GEV No.	526037	Ref. No.	BAM222X/SS FC222X
description	steam pipe thread 3/8" H 210mm ø 14.3mm tube ø 9.5mm BAMBI-NO, CLASSIC		

nozzles for steam pipes



1

GEV No.	526032	Ref. No.	FC194/B
description	steam nozzle thread M10x1 4 holes chrome-plated brass		

nozzles for water pipes

tap aerators



1

GEV No.	527974	Ref. No.	FC194E
----------------	--------	-----------------	--------

description	tap aerator H 17mm
--------------------	--------------------

accessories

bushes



1

GEV No.	526052	Ref. No.	FC222F/M
----------------	--------	-----------------	----------

description	bush D1 ø 15mm H 5mm brass inner cone steam/water tap ID ø 7.1mm
--------------------	--



1

GEV No.	531150	Ref. No.	UNI222FP
----------------	--------	-----------------	----------

description	bush D1 ø 15mm int. ø 11mm H 5.5mm PTFE inner cone
--------------------	--

gaskets



1

GEV No.	531149	Ref. No.	UNI222EM
----------------	--------	-----------------	----------

description	gasket PTFE ID ø 12.5mm H 3mm thickness 1.5mm inner cone D1 ø 15mm D2 ø 12mm
--------------------	--



1

GEV No.	528402	Ref. No.	FC182
----------------	--------	-----------------	-------

description	O-ring Viton thickness 2.62mm ID ø 10.78mm Qty 1 pcs
--------------------	--

springs



1

GEV No.	526054	Ref. No.	FC222C
----------------	--------	-----------------	--------

description	compression spring ø 10.8mm L 23.8mm wire gauge ø 1.6mm steam pipe
--------------------	--

tube handles



1

GEV No.	526039	Ref. No.	FC56
----------------	--------	-----------------	------

description	tube handle L 34mm plastic
--------------------	----------------------------

washers



1

GEV No.	560485	Ref. No.	UNI222F
----------------	--------	-----------------	---------

description	plain washer ID ø 6.4mm ED ø 14mm thickness 1.4mm stainless steel Qty 1 pcs
--------------------	---

fine filters

fine filters



1

GEV No.	526045	Ref. No.	FC130
----------------	--------	-----------------	-------

description	fine filter ø 9mm H 22mm
--------------------	--------------------------

intake valves

intake valves



1

GEV No.	526430	Ref. No.	FC138COM
----------------	--------	-----------------	----------

description	intake valve complete
--------------------	-----------------------

accessories

gaskets



1

GEV No.	526062	Ref. No.	FC198
----------------	--------	-----------------	-------

description	gasket D1 ø 12.1mm thickness 4mm white for non-return valve
--------------------	---

level glasses

level glasses

pressure rings



1

GEV No.	526051	Ref. No.	FC183
----------------	--------	-----------------	-------

description	press ring D1 ø 14.8mm D2 ø 11.5mm thickness 3.1mm brass water level glass
--------------------	--



level glasses (complete)



GEV No. 526043 **Ref. No.** FC181A

description water level tube set

spare parts for 526043

GEV No. 526042 **Ref. No.** FC181

description water level tube ø 11mm H 140mm ID ø 8mm red

level glass pipes



GEV No. 526042 **Ref. No.** FC181

description water level tube ø 11mm H 140mm ID ø 8mm red

pipes

pipes



GEV No. 526044 **Ref. No.** BAM2221ES
FC2221ES

description pipe ø 9.5mm L 64.5mm T1: M10x1 ET T2: M8x1 IT extension

non-return valves

compression springs



GEV No. 526056 **Ref. No.** HEA180C

description compression spring ø 7mm L 15mm wire gauge ø 0.3mm for non-return valve



GEV No. 526057 **Ref. No.** FC180DNT

description compression spring ø 9.7mm L 14mm wire gauge ø 0.4mm for non-return valve

complete



GEV No. 526050 **Ref. No.** HEA180

description non-return valve inlet 1/8" IT outlet 1/8" ET

miscellaneous



GEV No. 526041 **Ref. No.** HEA138COM

description pip kit T1: 1/8" T2: 1/8" T3: 1/4" with solenoid valve L 140mm for FRACINO

for coffee grinders

miscellaneous



GEV No. 111286 **Ref. No.** HEA307C

description knob spring L 20.3mm W 9.5mm H 12.5mm

knobs

steam/water taps

steam/water taps



GEV No. 111280 **Ref. No.** FC222H/R
FR222H
ROM222H

description knob ø 51mm thread Tr18x4 black

accessories for 111280



GEV No. 111287 **Ref. No.** FC222Q

description spacer ring for knob thread 1/2" ID ø 29mm ED ø 25mm H 22.5mm



GEV No. 111288 **Ref. No.** FC222N

description compression spring ø 33mm L 33mm wire gauge ø 1.6mm knob





GEV No. 111289 **Ref. No.** FC222P

description ring for spring ID ø 29.3mm ED ø 27mm H 3.3mm

			
1			
GEV No.	111285	Ref. No.	HEA307A
description	turning handle ø 44.3mm shaft ø 9.5mm black		

knob dial plates

			
1			
GEV No.	111283	Ref. No.	FC222L/RS
description	symbol steam ø 44mm black		

			
1			
GEV No.	111282	Ref. No.	FC222L/R ROM222L
description	symbol steam ø 44mm chrome		

			
1			
GEV No.	111284	Ref. No.	FC222L/RW
description	symbol water ø 44mm black		

			
1			
GEV No.	111281	Ref. No.	FC222L/HR ROM222M
description	symbol water ø 44mm chrome		

accessories

			
1			
GEV No.	111288	Ref. No.	FC222N
description	compression spring ø 33mm L 33mm wire gauge ø 1.6mm knob		

			
1			
GEV No.	111280	Ref. No.	FC222H/R FR222H ROM222H
description	knob ø 51mm thread Tr18x4 black		

accessories for 111280			
-------------------------------	--	--	--

	GEV No.	111287	Ref. No.	FC222Q
spacer ring for knob thread 1/2" ID ø 29mm ED ø 25mm H 22.5mm				

	GEV No.	111288	Ref. No.	FC222N
compression spring ø 33mm L 33mm wire gauge ø 1.6mm knob				

accessories for 111280				
	GEV No.	111289	Ref. No.	FC222P
ring for spring ID ø 29.3mm ED ø 27mm H 3.3mm				

			
1			
GEV No.	526046	Ref. No.	FC222K/D.91
description	retainer clip L 20mm wire gauge ø 1.5mm SS Qty 1 pcs		

			
1			
GEV No.	111289	Ref. No.	FC222P
description	ring for spring ID ø 29.3mm ED ø 27mm H 3.3mm		

accessories

button springs

			
1			
GEV No.	111286	Ref. No.	HEA307C
description	knob spring L 20.3mm W 9.5mm H 12.5mm		

miscellaneous

			
1			
GEV No.	111289	Ref. No.	FC222P
description	ring for spring ID ø 29.3mm ED ø 27mm H 3.3mm		

			
1			
GEV No.	111287	Ref. No.	FC222Q
description	spacer ring for knob thread 1/2" ID ø 29mm ED ø 25mm H 22.5mm		

gaskets

O-rings

silicone

			
1			
GEV No.	530311	Ref. No.	FC178/C
description	O-ring silicone thickness 1.78mm ID ø 17.17mm Qty 1 pcs		

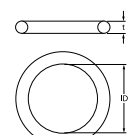



Viton

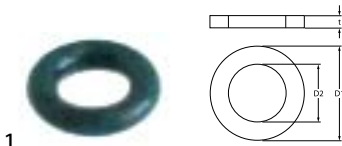

1

GEV No.	528687	Ref. No.	HEA180A
description	O-ring Viton thickness 1.78mm ID ø 3.69mm Qty 1 pcs		

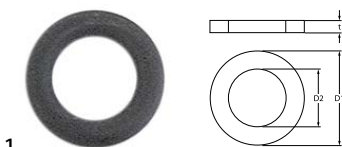

1

GEV No.	101527	Ref. No.	FC120
description	O-ring Viton thickness 1.78mm ID ø 6.75mm Qty 1 pcs		



1

GEV No.	528402	Ref. No.	FC182
description	O-ring Viton thickness 2.62mm ID ø 10.78mm Qty 1 pcs		

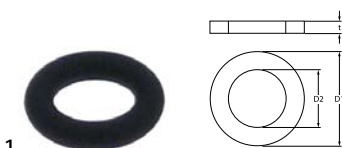

1

GEV No.	526071	Ref. No.	FC222SG
description	O-ring Viton thickness 2mm ID ø 5.6mm Qty 1 pcs		



1

GEV No.	526072	Ref. No.	FC222E/M
description	O-ring Viton thickness 3mm ID ø 9.8mm Qty 1 pcs		

sealing washers

aluminium gaskets



1

GEV No.	526059	Ref. No.	FC77A
description	gasket aluminium ED ø 22.4mm ID ø 16.6mm thickness 0.9mm for thread 3/8" Qty 1 pcs		

fibre gaskets



1

GEV No.	528017	Ref. No.	HEA165
description	flat gasket fibre ED ø 53mm ID ø 42mm thickness 2mm for thread 1 1/4" Qty 1 pcs		

copper gaskets

DIN-7603-A



1

GEV No.	527961	Ref. No.	FC77
description	flat gasket copper ED ø 21mm ID ø 17.2mm thickness 1.5mm		



1

GEV No.	528660	Ref. No.	FC222G
description	flat gasket copper ED ø 21mm ID ø 17mm thickness 1.5mm suitable for 3/8"		

PTFE gaskets



1

GEV No.	528925	Ref. No.	FC165T
description	flat gasket PTFE ED ø 59.5mm ID ø 42mm thickness 3mm Qty 1 pcs suitable for VFA Expres		

springs

compression springs



1

GEV No.	527958	Ref. No.	FC222U
description	compression spring ø 10.5mm L 32mm wire gauge ø 1.3mm for steam-/water-tap		



1

GEV No.	111288	Ref. No.	FC222N
description	compression spring ø 33mm L 33mm wire gauge ø 1.6mm knob		

manometers

 <p>1</p>			
GEV No.	541708	Ref. No.	FC179 FC179M
description	manometer double scale ø 60mm pressure range 0-2.5 / 0-16bar connection on the backside thread 1/8"		

 <p>1</p>			
GEV No.	541692	Ref. No.	HEA179
description	manometer ø 41mm pressure range 0-3bar FRACINO thread 1/8" connection on the backside		

water softeners

automatic softeners

spare parts

 <p>1</p>			
GEV No.	530311	Ref. No.	FC178/C
description	O-ring silicone thickness 1.78mm ID ø 17.17mm Qty 1 pcs		

fastening material

screws

countersunk screws

 <p>1</p>			
GEV No.	560300	Ref. No.	FC103S
description	countersunk screw thread M5 L 16mm SS DIN 963/ISO 2009 Qty 1 pcs intake slotted head ø 9mm		

washers

washers

miscellaneous

 <p>1</p>			
GEV No.	526058	Ref. No.	FC222J
description	washer ID ø 6.65mm ED ø 25mm thickness 1.5mm		

fasteners

retainer clips

 <p>1</p>			
GEV No.	526046	Ref. No.	FC222K/D.91
description	retainer clip L 20mm wire gauge ø 1.5mm SS Qty 1 pcs		

A

automatic softeners 16

B

bi-metal thermostats 3

C

control equipment 4

countersunk screws 16

E

electrodes 6

F

fasteners 16

fastening material 16

H

heating elements 3

heating elements for coffee machine 3

I

indicator lights 4

indicator lights (complete) 4

L

lamps 4

O

O-rings 14

P

push/momentary push switches 4

R

relays 5

retainer clips 16

rocker/momentary rocker switches 4

S

safety bi-metal thermostats 3

screws 16

sealing washers 15

solenoid valves 6

switches and momentary switches 4

T

thermostats 3

W

washers 16

water softeners 16