



GAS COMPONENTS



ELECTRIC COMPONENTS



WATER TECHNOLOGY



MECHANICAL COMPONENTS



TOOLS

Spare parts suitable for

FOSTER

Find the complete and up-to-date range of products in our GEV Webshop



Manufacturer catalogue

The most important spare parts and accessories arranged clearly for every manufacturer

- ✓ Complete product range and all appliance data always up to date in the GEV Webshop
- ✓ Alphabetical Index at the end of the catalogue

GEV Webshop

www.gev-online.co.uk

www.gev-online.com



- 🔍 Add to Favourites
- 🔍 Sign In with email address and usual password
- 🔍 Easy-order – place several items in your basket at the same time
- 🔍 Quick Item search – no login needed



heating elements

heating elements for refrigeration

heating elements for defrosting



GEV No.	417604	Ref. No.	15240023
description	heating element 140W 230V L 335mm W 135mm L1 30mm L2 305mm W1 105mm W2 30mm cable length 500mm tube ø 8.5mm		

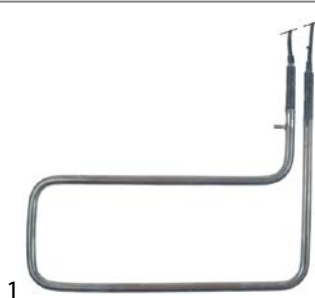

GEV No.	417603	Ref. No.	15240625
description	heating element 200W 230V L 250mm W 200mm L1 25mm L2 225mm W1 100mm W2 100mm cable length 500mm tube ø 8.5mm		

heating elements for condensate evaporation



GEV No.	420434	Ref. No.	15843061
description	heating element 975W 240V L 1020mm W 70mm Hmm cable length 500mm tube ø 8mm		

heating cables

drain heating cables



GEV No.	378455	Ref. No.	00-556114
description	drain heating cable 6W 240V L 1700mm L1 (unheated) 1050mm L2 (heated) 650mm cable length 1700mm PVC Qty 1 connection 2-wire		

thermostats

refrigeration thermostats

RANCO

K50 series

RANCO



GEV No.	390581	Ref. No.	15315803
description	thermostat RANCO type K50-S3595 probe ø 2mm probe Lmm capillary pipe 2000mm		

switches and momentary switches

rocker/momentary rocker switches

28x22mm



GEV No.	301305	Ref. No.	15243562
description	rocker switch mounting measurements 28.5x22mm black 2NO 240V 16A 0-1 connection male faston 6.3mm ambient temperature max. 85/125°C protection IP44		



GEV No.	301301 ¹	Ref. No.	15243564
description	rocker switch mounting measurements 28x22mm green 2NO 250V 20A illuminated connection male faston 6.3mm ambient temperature max. 85°C protection IP40		

¹illuminated

30x22mm



GEV No.	301003	Ref. No.	15243565
description	rocker switch mounting measurements 30x22mm green 2NO 250V 16A illuminated 0-1 connection male faston 6.3mm ambient temperature max. 125/55°C protection IP65		

accessories for 301003



GEV No.	301036	Ref. No.	—
description	protective cover internal size 30x22mm for rocker switch mounting measurementsmm		



magnetic switches

miscellaneous



1

GEV No.	347629	Ref. No.	16240122
description	magnetic switch 250V 1NO connection plug L 800mm		

encoders and potentiometers



1

GEV No.	403521	Ref. No.	00-555396
description	encoder shaft L 15mm		

alarm devices

loudspeakers



1

GEV No.	350226	Ref. No.	064501
description	loudspeaker ø 64mm built-in depth 20mm 500hm 0.3W connection male faston 2.8mm		

electronic controllers

ELIWELL

refrigeration controllers

built-in version



1

GEV No.	378495	Ref. No.	16250407
description	electronic controller ELIWELL type ID961LX mounting measurements 71x29mm 230V voltage AC NTC/PTC relay outputs 1 CO-8A(3) NTC/PTC DI built-in depth 59mm protection IP65 yes display 3 digits		

LAE

refrigeration controllers

built-in version



1

GEV No.	381376	Ref. No.	00556122
----------------	--------	-----------------	----------

description electronic controller LAE type 00-556122 mounting measurements 26x48mmV voltage relay outputs FOSTER front measurements 65x31.5mm built-in depth 50mm protection IP44 built-in version defr. funct.°C display



1

GEV No.	378489	Ref. No.	00-556223
----------------	--------	-----------------	-----------

description electronic controller LAE type AT1-5BS6E-1FS mounting measurements 71x29mm 230V voltage AC NTC/PTC relay outputs 2 NO-16A(8) NO-7A(2) NTC/PTC NTC/PTC DI front measurements 77x35mm built-in depth 70mm protection IP55 yes -50 to +120°C display 3 digits



1

GEV No.	379764	Ref. No.	00-555848 00-556224 16270000
----------------	--------	-----------------	------------------------------------

description electronic controller LAE type AT2-5BS4E-AG mounting measurements 71x29mm 230V voltage AC NTC/PTC relay outputs 3 NO-16A(5) NO-7A(2) NO-7A(2) NTC/PTC NTC/PTC DI front measurements 77x35mm built-in depth 70mm protection IP55 accuracy 1% built-in version yes -50 to +120°C display 3 digits





accessories for 379764

GEV No.	379780	Ref. No.	—
temperature probe NTC 10kOhm cable TPE probe -40 up to +110°C cable -40 up to +110°C probe ø6x35mm cable length 1.5m without screw connection			
GEV No.	379781	Ref. No.	—
temperature probe PTC 1kOhm cable thermoplastic probe -50 up to +150°C cable -40 up to +110°C probe ø6x14mm cable length 1.5m without screw connection 2-wire			





built-in version 2-piece





GEV No.	378450	Ref. No.	16240105
description	keypad unit LAE type LCD5-S mounting measurements 71x29mm built-in depth 20mm display 3 digits		
spare parts for	378450		
	GEV No.	403459	Ref. No. —
	connection cable LAE type FC06-20M01		
accessories for	378450		
	GEV No.	378253	Ref. No. —
	load module LAE type BD1-28C155W-B mounting measurements 107x95x47mm 230V voltage AC NTC relay outputs 5 NO-16A(12) NO-16A(4) NO-16A(4) NO-7A(2) NO-7A(2) NTC NTC DI DI built-in depth 47mm protection IP40 yes yes -50 to +120°C display		
	GEV No.	403458	Ref. No. —
	load module LAE type BIT25B153E-A mounting measurements 88x85mm 230V voltage AC NTC relay outputs 3 NO-20A(8) NO-16A(4) NO-7A(2) NTC NTC DI DI front measurementsmm built-in depth 40mm protection IP55 yes yes -50 up to +110°C display		
	GEV No.	403459	Ref. No. —
	connection cable LAE type FC06-20M01		



GEV No.	379771	Ref. No.	00-555992
description	keypad unit LAE type LCD5-S mounting measurements 71x29mmV voltage relay outputs front measurements 77x35x20mm built-in depth 20mm protection IP55°C display 3 digits		
accessories for	379771		
	GEV No.	378253	Ref. No. —
	load module LAE type BD1-28C155W-B mounting measurements 107x95x47mm 230V voltage AC NTC relay outputs 5 NO-16A(12) NO-16A(4) NO-16A(4) NO-7A(2) NO-7A(2) NTC NTC DI DI built-in depth 47mm protection IP40 yes yes -50 to +120°C display		
	GEV No.	403458	Ref. No. —
	load module LAE type BIT25B153E-A mounting measurements 88x85mm 230V voltage AC NTC relay outputs 3 NO-20A(8) NO-16A(4) NO-7A(2) NTC NTC DI DI front measurementsmm built-in depth 40mm protection IP55 yes yes -50 up to +110°C display		
	GEV No.	403459	Ref. No. —
	connection cable LAE type FC06-20M01		



GEV No.	403413	Ref. No.	00555739 00-555920 00-556225
description	power PCB LAE type LF28B253E-1FS mounting measurements 104x91mm 230V voltage AC NTC relay outputs 3 NO-20A(6) NO-12A(4) NO-7A(2) NTC NTC DI DI front measurements 105x63mm built-in depth 45mm protection IP2x -50 up to +80°C display		
accessories for	403413		
	GEV No.	379771	Ref. No. 00-555992
	keypad unit LAE type LCD5-S mounting measurements 71x29mmV voltage relay outputs front measurements 77x35x20mm built-in depth 20mm protection IP55°C display 3 digits		
	GEV No.	379784	Ref. No. —
	temperature probe NTC 2kOhm cable thermoplastic probe -40 up to +110°C cable -40 up to +110°C probe ø6x35mm cable length 2m without screw connection 2-wire resistor 2kOhm		
	GEV No.	403459	Ref. No. —
	connection cable LAE type FC06-20M01		



GEV No.	379498	Ref. No.	00-555206
description	electronic controller LAE type SMD12RU20 mounting measurements 71x29mm display 3 digits		

miscellaneous

refrigeration controllers



GEV No.	403414	Ref. No.	00-554478
description	electronic controller FOSTER mounting measurements 160x120x55mm		



probes

universal probes

temperature probes



GEV No.	378454	Ref. No.	00-556293
description	temperature probe NTC 2kOhm cable thermoplastic probe -40 up to +110°C cable -40 up to +110°C probe ø6x28mm cable length 2.5m 2-wire		



GEV No.	378453	Ref. No.	00-555124
description	temperature probe NTC 10kOhm cable thermoplastic probe -40 up to +110°C cable -40 up to +110°C probe ø6x14mm cable length 7m 2-wire		

producer-specific probes

probes



GEV No.	378451	Ref. No.	00-554473 00-554474
description	surface probe PTC 1kOhm cable PVC probe -50 up to +150°C cable -10 up to 100°C connection plug thread probe ø6x35mm cable length 1.5m		

core probes



GEV No.	378452	Ref. No.	00-554451
description	core temperature probe NTC 2kOhm cable PVC probe -40 up to +120°C cable -10 up to 100°C connection 2-wire probe ø6x155mm thread cable length 1.5m handle ømm handle length 50mm		

electronics

PCBs



GEV No.	403569	Ref. No.	01-275719-01
description	display L 140mm W 65mm type FD1-11/14		



GEV No.	360624	Ref. No.	00-555395
description	PCB blast freezer RBC20-60 L 185mm W 135mm suitable for FOSTER 115/230V		



GEV No.	361932	Ref. No.	00-556242
description	PCB refrigerators and re Fridgerator-freezers EPRO/EPREM L 100mm W 90mm suitable for FOSTER		

central units



GEV No.	403568	Ref. No.	16251036
description	control box L 195mm W 140mm type FD1-14		



keypads

keypad units



1

GEV No.	403519	Ref. No.	00-554477
description	keypad freezer FST-FCC-DE2 buttons 4 cable length 2x1000mm suitable for FOSTER L 118mm W 68mm		



1

GEV No.	403520	Ref. No.	15247078
description	keypad unit blast freezer blast freezer buttons 6 suitable for FOSTER L 445mm W 112mm		



1

GEV No.	403517	Ref. No.	00-556020
description	keypad unit freezer FST-FCC-DE2 buttons 1 W ø80mm		

solenoid valves

solenoid valves (refrigeration)

CASTEL

valve bodies





STANDARD series

suitable for refrigerants R22, R134a, R404A, R407C, R410A, R507



1

GEV No.	370382	Ref. No.	19863034	
description	solenoid valve body NC type 1028/M10S p max 45bar connection 10mm soldering connection DN 3mm -35 up to +105°C L 125mm refrigeration straight CASTEL			
accessories for	370382			
	GEV No.	371084	Ref. No.	—
	solenoid coil CASTEL 230VAC 8VA 50/60Hz connection cable 1000mm type CM2			

accessories for	370382			
	GEV No.	371090	Ref. No.	—
	power socket plug type DIN 43650A screw			
	GEV No.	371301	Ref. No.	—
	solenoid coil CASTEL 110VAC 8VA 50/60Hz seat ø 11.5mm connection DIN 43650A type HF2			
	GEV No.	371314	Ref. No.	—
	solenoid coil CASTEL 240VAC 8VA 50/60Hz seat ø 11.5mm			
	GEV No.	371321	Ref. No.	—
	solenoid coil CASTEL 12/24VAC 50/60Hz seat ø 11.5mm connection DIN 43650A type HF2			

compressors

ACC/ZEL

R134A

HMBP monophase

High/Medium evaporation temperature above -20/-15 °C



1

GEV No.	605008	Ref. No.	00-555464
description	compressor coolant R134a type GL80TB 220-240V 50Hz HMBP fully hermetic 9.5kg 1/5HP power input 554W cylinder capacity 7.6cm ³ CSIR H 175.5mm 165W 215W 290W 390W 500W 615W 727W 840W test method ASHRAE ambient temperature max. 43°C		



1

GEV No.	605009	Ref. No.	00-555665
description	compressor coolant R134a type GL90TB 220-240V 50Hz HMBP fully hermetic 10.8kg 1/4HP power input 293W cylinder capacity 8.8cm ³ CSIR H 175.5mmW 143W 194W 259W 339W 432W 539W 661W 796W test method ASHRAE		



R404a/R507

LBP monophase

Lower evaporation temperature below -20°C



1

GEV No.	605127	Ref. No.	00-555681
description	compressor coolant R404a/R507 type MX18FB 220-240V 50Hz LBP 17.3kg 5/8HP cylinder capacity 18.4cm ³ CSR H 230mm 575W 750W 985W 1219W 1498W test method ASHRAE ambient temperature max. 43°C		

CUBIGEL

R404a/R507

HMBP monophase

High/Medium evaporation temperature above -20/-15 °C



1

GEV No.	605013	Ref. No.	00-555671
description	compressor coolant R404a/R507 type ML60TB 220-240V 50Hz HMBP fully hermetic 10.1kg 1/4HP power input 647W cylinder capacity 5.68cm ³ CSIR H 175.5mmW 244W 319W 407W 511W 628W 760W 906W 1067W test method ASHRAE		

EMBRACO / ASPERA

R290A

LBP monophase

Lower evaporation temperature below -20°C



1

GEV No.	605214	Ref. No.	00-556305
description	compressor coolant R290 type NEK2150U 220/240V 50Hz LBP 11.6kg 1/2HP cylinder capacity 13.54cm ³ CSIR H 206mm 403W 515W 650W 804W 979W test method ASHRAE		



1

GEV No.	605243	Ref. No.	00-570193
description	compressor coolant R290 type NEU2155U 220-240V 50Hz LBP 11.2kg 3/4HP cylinder capacity 13.54cm ³ CSIR H 190mm 463W 744W 916W 1110W test method ASHRAE		

R404a/R507

LBP monophase

Lower evaporation temperature below -20°C



1

GEV No.	605144	Ref. No.	00-556388
description	compressor coolant R404a/R507 type NEK2168GK 220-240V 50Hz LBP 22.9kg 3/4HP cylinder capacity 14.28cm ³ CSR H 200mm 345W 454W 587W 742W 921W 1123W test method ASHRAE		





HMBP monophase

High/Medium evaporation temperature above -20/-15 °C



1

GEV No.	605132	Ref. No.	00-556380
description	compressor coolant R404a/R507 type NT6222GK 200-240V 50Hz HMBP fully hermetic 17kg 1HP cylinder capacity 17.39cm ³ CSR H 252mmW 810W 1032W 1040W 1174W 1307W 1583W 2247W test method ASHRAE		
accessories for	605132		
	GEV No.	365142	Ref. No. —
	operating capacitor capacity 15µF 450V with metal case tolerance 5% 50/60Hz ø 40mm L 110mm M8x1.25		
	GEV No.	365153	Ref. No. —
	starting capacitor 52µF 330V 50/60Hz duty cycle 3s 41280A133 2252347 ø 36mm L 83mm M8 plastic connection cable 350mm		
	GEV No.	390981	Ref. No. —
	klixon suitable for NT6222GK		

L'UNITE HERMETIQUE / TECUMSEH

R134A

HMBP monophase

High/Medium evaporation temperature above -20/-15 °C



1

GEV No.	605137	Ref. No.	15422024
description	compressor coolant R134a type AEZ4430Y 220-240V 50Hz HMBP fully hermetic 10.2kg 1/4HP power input 330W cylinder capacity 8.8cm ³ CSIR H 199mmWW 245W 328W 432W 558W 698WW		

R404A

LBP monophase

Lower evaporation temperature below -20°C



1

GEV No.	605157	Ref. No.	00-554691
description	compressor coolant R404A type CAJ2428Z 220-240V 50Hz LBP 21kg 5/8HP cylinder capacity 15.2cm ³ CSR H 271mm 434W 589W 773W 991W 1246WWWWWW		



1

GEV No.	605238	Ref. No.	00-554685
description	compressor coolant R404A type CAJ2432Z 220-240V 50Hz LBP 21.5kg 5/8HP cylinder capacity 18.3cm ³ CSR H 271mm 542W 738W 971W 1247W 1567WWWWWW test method EN 12900 ambient temperature max. 32°C		

HMBP monophase

High/Medium evaporation temperature above -20/-15 °C



1

GEV No.	605025	Ref. No.	00-599646
description	compressor coolant R404A type AE4430Z-FZ 220-240V 50Hz HMBP fully hermetic 10.2kg 1/4HP power input 427W cylinder capacity 5.7cm ³ CSIR H 186mmWW 258W 346W 441W 550W 682W 794W test method EN 12900 908W		
spare parts for	605025		
	GEV No.	380061	Ref. No. —
	start relay MTRP0027-31 120/240V voltage AC 8A 1NO		

fans

refrigeration fans

refrigeration motors universal

miscellaneous



GEV No.	601994	Ref. No.	15870041
description	fan motor 10W 240V 50Hz cable length 200mm FASCO AE1E5781K with capacitor bearing slide bearing		

accessories

fan wheels

aluminium

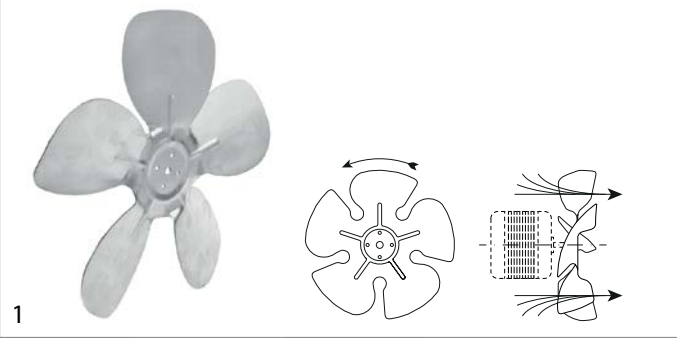

GEV No.	601998	Ref. No.	15871021
description	fan wheel blowing ø 250mm fan wheel mounting 25.4mm blade angle 22° W 35mm aluminium		

cooling motors (complete)



GEV No.	601997	Ref. No.	16250730
description	fan 230V 35W 50/60Hz fan wheel ø 220mm connection 3-wire cable length 1500mm 1300/1550rpm		



GEV No.	605021	Ref. No.	15422012
description	compressor coolant R404A type AEZ4425Z 220-240V 50Hz HMBP fully hermetic 9.8kg 1/5HP cylinder capacity 4.5cm ³ CSIR H 186mmWW 198W 263W 341W 432W 537W 629W test method EN 12900 723W		



GEV No.	605065	Ref. No.	00-554470
description	compressor coolant R404A type CAJ4519Z 220-240V 50Hz HMBP 24kg 1.5HP cylinder capacity 34.4cm ³ CSR H 282mmWWW 1769W 2353W 3009W 3756W 4360W 5200W		

SECOP DANFOSS

R134A

HMBP monophase

High/Medium evaporation temperature above -20/-15 °C



GEV No.	605077	Ref. No.	00-556062
description	compressor coolant R134a type SC15G 220-240V 50Hz HMBP fully hermetic 13.1kg 3/8HP cylinder capacity 15.3cm ³ CSIR H 203mmW 203W 358W 523W 703W 901W 1124W 1377W 1665W test method ASHRAEW 1993W		

spare parts for 605077

GEV No.	365062	Ref. No.	—
description	starting capacitor 80µF 220/300V 50/60Hz duty cycle 3min/1min ø 38mm L 98mm plastic connection cable 100mm		

GEV No.	380078	Ref. No.	—
description	start relay DANFOSS 117U6005 HST		



1

GEV No.	601996	Ref. No.	00-555495 00-570082 15470027
description	fan 230V 75W 50/60Hz fan wheel ø 250mm connection 3-wire cable length 1500mm 1300/1550rpm		



1

GEV No.	602007	Ref. No.	00-599687
description	fan fan wheel ø 200mm 230V 50/60Hz 10W ø 250mm 1300/1550rpm connection 3-wire cable length 2000mm ELCO sucking		

cold air circulating fans (complete)

ebm-papst

A4E series

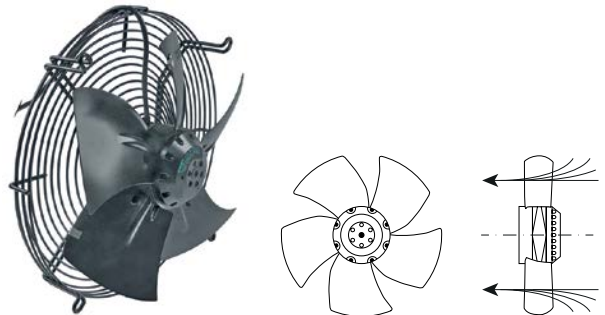

1

GEV No.	601995	Ref. No.	00-554366
description	fan A4E300-AR26-16 fan wheel ø 300mm blades 5 230V 50Hz 70/95W 1380/1570rpm cable length 1400mm ebm-papst sucking		



1

GEV No.	602008	Ref. No.	00-556010 00-570062 00-570202
description	fan fan wheel ø 200mm 230V 50/60Hz 10W ø 250mm 1400rpm connection 2-wire cable length 2000mm ELCO blowing		

hot air fans

ELCO



1

GEV No.	602006	Ref. No.	00-554617
description	fan fan wheel ø 200mm 230V 50/60Hz 10W ø 250mm 1300/1550rpm connection 3-wire cable length 2000mm ELCO blowing		

ebm-papst

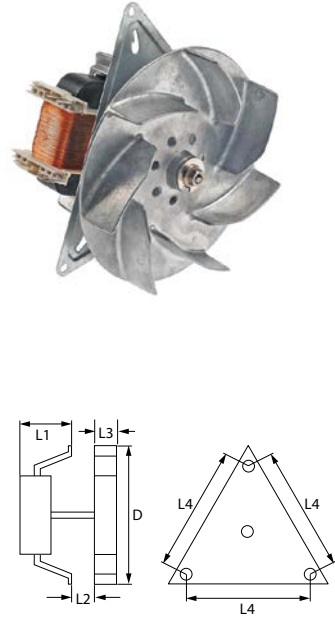

1

GEV No.	601999	Ref. No.	00-554022
description	hot air fan 240V 28W 0.1A L1 65mm L2 17mm L3 28mm L4 157mm fan wheel ø 150mm ebm-papst type R2K150-AA03-10		

accessories universal



1

GEV No.	521075	Ref. No.	15872071
description	fanwheel cover L 350mm W 350mm hole distance 265mm		

equipment-specific units

for fridges

housing and bezels

covers



1

GEV No.	692562	Ref. No.	15350021
description	cover for pull handle L 295mm W 25mm plate thickness max. 3mm plastic Qty 1 pcs		

handles and hand wheels

bracket handles



1

GEV No.	690448	Ref. No.	15230221
description	pull handle L 402mm H 42mm mounting distance 375mm		

recessed handles



1

GEV No.	698553	Ref. No.	01-230376-01
description	door handle L 115mm W 55mm H 18mm mounting distance 60mm SS		

locks

locking devices

producer-specific

FOSTER



1

GEV No.	692553	Ref. No.	16230046
description	key cylinder kit		



1

GEV No.	692211	Ref. No.	15230366
description	locking device mounting distance 38mm		

walk-in fridge catches

CAFF/FERMOD



520/521 series



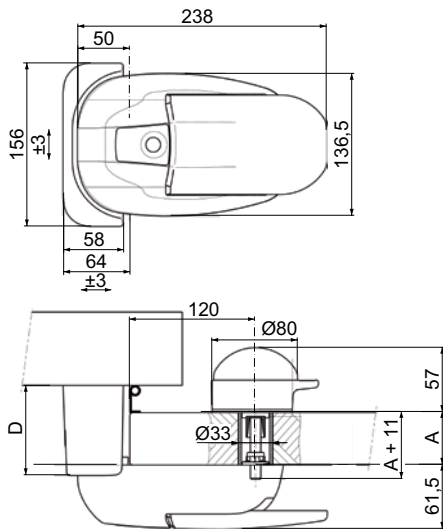



1





GEV No.	701438	Ref. No.	00-570079
description	walk-in fridge catch door thickness 27-213mm L 238mm W 136.5mm H 61.5mm lockable type 521		
spare parts for	701438		
	GEV No.	700618	Ref. No. 15230359
	door opener type 520/521/620/621/920/921 for door thickness 30-120mm		
accessories for	701438		
	GEV No.	701472	Ref. No. —
	door catch W 58mm L 156mm H 52mm for off-set 27/43mm type 520/521		
	GEV No.	701473	Ref. No. —
	door catch W 58mm L 156mm H 69mm for off-set 44/60mm type 520/521		
	GEV No.	701474	Ref. No. —
	door catch W 58mm L 156mm H 86mm for off-set 61/77mm type 520/521		
	GEV No.	701475	Ref. No. —
	door catch W 58mm L 156mm H 103mm for off-set 78/94mm type 520/521		

accessories for	701438		
	GEV No.	701476	Ref. No. —
	door catch W 58mm L 156mm H 120mm for off-set 95/111mm type 520/521		
	GEV No.	701477	Ref. No. —
	base plate W 58mm L 156mm H 17mm type 520/521		

			
1			
GEV No.	700618	Ref. No.	15230359
description	door opener type 520/521/620/621/920/921 for door thickness 30-120mm		
spare parts for	700618		
	GEV No.	701418	Ref. No. —
	lid ED ø 80mm green for door opener		

620/621 series			
			
1			
GEV No.	700618	Ref. No.	15230359
description	door opener type 520/521/620/621/920/921 for door thickness 30-120mm		
spare parts for	700618		
	GEV No.	701418	Ref. No. —
	lid ED ø 80mm green for door opener		

920/921 series			
			
1			
GEV No.	700618	Ref. No.	15230359
description	door opener type 520/521/620/621/920/921 for door thickness 30-120mm		
spare parts for	700618		
	GEV No.	701418	Ref. No. —
	lid ED ø 80mm green for door opener		

hinges

edgmount hinges

CHG

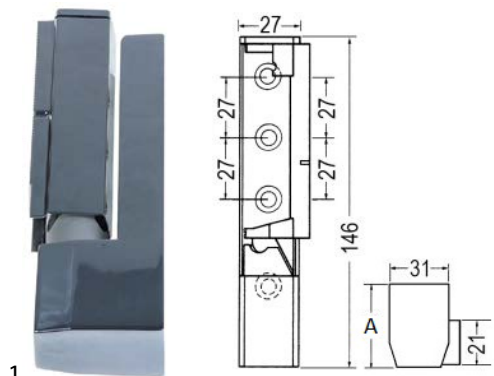

GEV No. 690296 **Ref. No.** 00-555851

description edgmount hinge L 146mm W 31mm mounting distance 27/27mm hinging left/right with gradient L1 45mm series R50

accessories for 690296



GEV No. 345323 **Ref. No.** —
microswitch with lever 250V 10A 1CO connection male faston ambient temperature max. 105°C

door bearing



1

GEV No. 692552 **Ref. No.** 15230498

description hinge bearing L 76mm W 24mm mounting distance 25.5mm shaft ø 7mm Qty 1 pcs



1

GEV No. 692555 **Ref. No.** 15230501

description spring assisted hinge L 75mm W 25mm H 110mm mounting pos. upper and bottom Qty 2 pcs

spring assisted hinges

producer-specific

FOSTER



1

GEV No. 701460 **Ref. No.** 15230508

description spring assisted hinge series FOSTER chrome-plated, polished L 136mm W 24mm door hinge left mounting distance 25mm metal

accessories for 701460



GEV No. 701459 **Ref. No.** 15230509
spring assisted hinge series FOSTER chrome-plated, polished L 136mm W 24mm door hinge right mounting distance 25mm metal



1

GEV No. 701459 **Ref. No.** 15230509

description spring assisted hinge series FOSTER chrome-plated, polished L 136mm W 24mm door hinge right mounting distance 25mm metal

accessories for 701459



GEV No. 701460 **Ref. No.** 15230508
spring assisted hinge series FOSTER chrome-plated, polished L 136mm W 24mm door hinge left mounting distance 25mm metal

pullouts

drawer slides



1

GEV No. 692561 **Ref. No.** 15230674

description telescopic slide pair Qty 1 pair pcs L 550mm pull-out length 400mm SS

shelves and shelf rails

grates

universal

without upstand





1

GEV No. 970712 **Ref. No.** 15271429

description grate W 325mm D 530mm GN 1/1 H 11mm plastic-coated steel wire gauge frame 9mm lengthwise wires gauge 4mm crossing wires 1 grey



			
1			
GEV No.	970871	Ref. No.	15271430
description	grate W 650mm D 530mm GN 2/1 plastic-coated steel wire gauge frame 9mm lengthwise wires gauge 3.7mm crossing wires 1 grey		

with upstand			
			
1			
GEV No.	970873	Ref. No.	15271425
description	grate W 650mm D 530mm GN 2/1 H 41mm plastic-coated steel wire gauge frame 9mm lengthwise wires gauge 3.7mm crossing wires 1 grey		

shelf rails and supports

universal			
			
1			
GEV No.	690332	Ref. No.	00-556005
description	shelf support L 31/28mm W 22mm H 17mm SS with hook Qty 1 pcs		
accessories for	690332		
	GEV No.	690330	Ref. No.
			—
	rack L 1000mm W 22mm H 4mm aperture 3x8mm hole distance 12.5mm stainless steel		

producer-specific

			
1			
GEV No.	692559	Ref. No.	00-745543-01
description	guide U-shape L 479mm W 25mm mounting pos. left/right inner height 12mm		

			
1			
GEV No.	692558	Ref. No.	00-745542-01
description	guide U-shape L 580mm W 24mm H 12mm mounting pos. left/right		

			
1			
GEV No.	692557	Ref. No.	01-233197-01
description	guide U-shape L 610mm W 25mm H 12mm mounting pos. left/right		

			
1			
GEV No.	692560	Ref. No.	01-272911-01
description	guide U-shape L 636mm W 25mm mounting pos. left/right inner height 12mm		

			
1			
GEV No.	692554	Ref. No.	01.255900-01
description	shelf support L 35/25mm W 19mm H 25mm SS Qty 1 pcs		

gaskets

refrigeration gaskets

plug-in gaskets

profile 9703

We offer custom-made gaskets for this profile

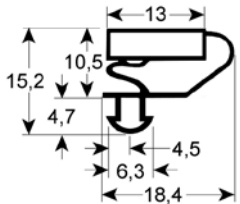
			
1			
GEV No.	901663	Ref. No.	01-257028-01 15212214
description	refrigeration gasket profile 9703 W 595mm L 1515mm plug size		

profile 9195

We offer custom-made gaskets for this profile

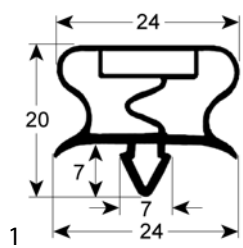

GEV No.	901880	Ref. No.	01-231715-01
description	refrigeration gasket profile 9195 W 156mm L 379mm plug size		

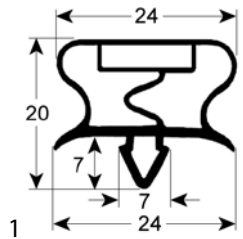

GEV No.	901747	Ref. No.	01-231711-01
description	refrigeration gasket profile 9195 W 375mm L 610mm plug size		

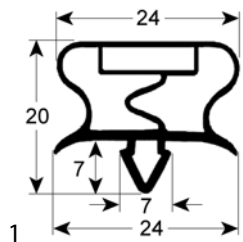

GEV No.	901886	Ref. No.	01-231720-01
description	refrigeration gasket profile 9195 W 520mm L 685mm plug size		

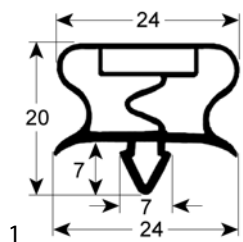

GEV No.	901887	Ref. No.	01-232852-01
description	refrigeration gasket profile 9195 W 573mm L 1117mm plug size		

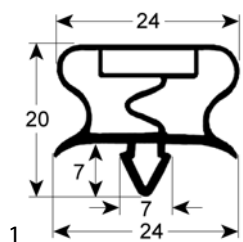

GEV No.	901884	Ref. No.	01-232996-01
description	refrigeration gasket profile 9195 W 573mm L 351mm plug size		

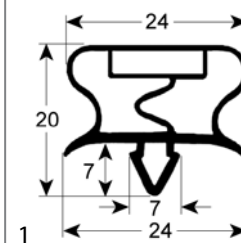

GEV No.	901336	Ref. No.	01-231709-01
description	refrigeration gasket profile 9195 W 595mm L 1525mm plug size		

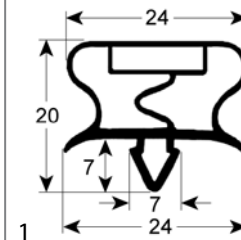

GEV No.	901363	Ref. No.	01-231704-01
description	refrigeration gasket profile 9195 W 595mm L 721mm plug size		

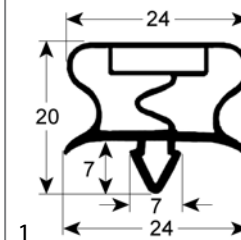

GEV No.	901882	Ref. No.	01-231707-01
description	refrigeration gasket profile 9195 W 598mm L 1216mm plug size		

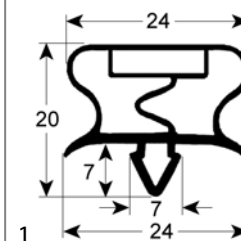

GEV No.	901888	Ref. No.	01-232251-01
description	refrigeration gasket profile 9195 W 600mm L 684mm plug size		

profile 9171

We offer custom-made gaskets for this profile

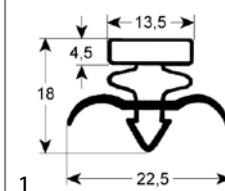

GEV No.	901770	Ref. No.	15210777
description	refrigeration gasket profile 9171 W 278mm L 406mm plug size for drawer		



GEV No.	901287	Ref. No.	15211775
description	refrigeration gasket profile 9171 W 390mm L 625mm plug size		

GEV No.	901883	Ref. No.	15210783
description	refrigeration gasket profile 9171 W 496mm L 526mm plug size		

GEV No.	901771	Ref. No.	15210778
description	refrigeration gasket profile 9171 W 406mm L 164mm plug size for drawer		

GEV No.	901889	Ref. No.	15211805
description	refrigeration gasket profile 9171 W 508mm L 712mm plug size		

GEV No.	901421	Ref. No.	15210775
description	refrigeration gasket profile 9171 W 410mm L 620mm plug size		

GEV No.	901890	Ref. No.	15210737
description	refrigeration gasket profile 9171 W 526mm L 1420mm plug size		

GEV No.	901665	Ref. No.	15211800
description	refrigeration gasket profile 9171 W 422mm L 593mm plug size		

GEV No.	901199	Ref. No.	15210764
description	refrigeration gasket profile 9171 W 550mm L 1344mm plug size		

GEV No.	901772	Ref. No.	15210779
description	refrigeration gasket profile 9171 W 474mm L 523mm plug size		

GEV No.	901395	Ref. No.	15211731
description	refrigeration gasket profile 9171 W 585mm L 1555mm plug size		

GEV No.	901633	Ref. No.	15210780
description	refrigeration gasket profile 9171 W 480mm L 730mm plug size		

GEV No.	901664	Ref. No.	15211734
description	refrigeration gasket profile 9171 W 585mm L 745mm plug size		

GEV No.	901184	Ref. No.	15211732
description	refrigeration gasket profile 9171 W 595mm L 1310mm plug size		

GEV No.	901422	Ref. No.	15211751
description	refrigeration gasket profile 9171 W 770mm L 1830mm plug size		

GEV No.	901420	Ref. No.	15210770
description	refrigeration gasket profile 9171 W 610mm L 620mm plug size		

GEV No.	902270	Ref. No.	N/A
description	refrigeration gasket profile 9171 Wmm L 2500mm		

GEV No.	901773	Ref. No.	15211794
description	refrigeration gasket profile 9171 W 615mm L 495mm plug size		

door seal rails

GEV No.	901892	Ref. No.	00-879086-01
description	gasket support L 40mm W 1490mm grey		

GEV No.	901885	Ref. No.	15211770
description	refrigeration gasket profile 9171 W 621mm L 587mm plug size		

GEV No.	901891	Ref. No.	00.879085-01
description	gasket support L 40mm W 570mm grey		

GEV No.	901748	Ref. No.	15211789
description	refrigeration gasket profile 9171 W 730mm L 1540mm plug size for fridge		

special gaskets

miscellaneous

GEV No.	512422	Ref. No.	01-231852-16
description	thermal break suitable for FOSTER L 580mm W 360mm size kit metal thickness 1mm		

GEV No.	901419	Ref. No.	15210767
description	refrigeration gasket profile 9171 W 730mm L 1790mm plug size		



refrigeration cycle components

valves

expansion valves

DANFOSS

valves

type TS2/TES2



GEV No.	750530	Ref. No.	81453620/0
description	expansion valve DANFOSS type TS2 coolant R404a/R507 angled nozzle 068-2006 inlet 3/8" SAE outlet 1/2" SAE p max 34bar -30 up to +10°C capillary pipe 1500mm		

filter driers

GMC

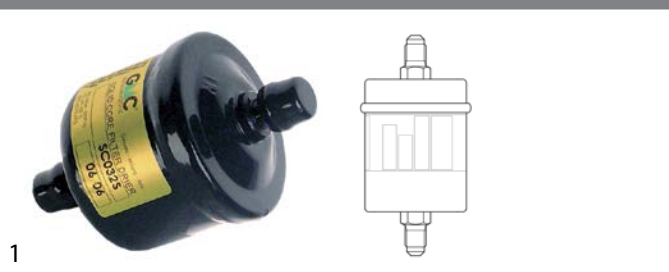

GEV No.	750086	Ref. No.	19300357/0
description	dryer type SC032S connection ODF 1/4"-ODM 3/8" 50cm ³ p max 45bar -40 up to +80°C 261g total length 95mm ø 57.5mm		

miscellaneous



GEV No.	750501	Ref. No.	15480908
description	dryer ø 17.5mm L 110mm connection 8,2/7,7mm Qty 1 pcs		

evaporators

for fridges

producer-specific



GEV No.	750503	Ref. No.	00-878253-02
description	evaporator L 550mm W 200mm H 70mm suitable for FOSTER		



GEV No.	750504	Ref. No.	15463031 F15463031
description	evaporator L 700mm W 250mm H 190mm suitable for FOSTER		

evaporation and condensing trays

unheated condensing trays



GEV No.	750502	Ref. No.	15271004
description	condensing tray L 258mm W 136mm H 60.5mm plastic		

A			
alarm devices	4		
C			
cold air circulating fans (complete)	11		
compressors	7		
D			
door seal rails	18		
E			
edgemount hinges	14		
electronic controllers	4		
evaporators	19		
expansion valves	19		
F			
fans	10		
filter driers	19		
G			
grates	14		
H			
heating cables	3		
heating elements	3		
heating elements for condensate evaporation	3		
heating elements for defrosting	3		
heating elements for refrigeration	3		
hot air fans	11		
M			
magnetic switches	4		
P			
plug-in gaskets	15		
probes	6		
R			
refrigeration cycle components	19		
refrigeration fans	10		
refrigeration gaskets	15		
refrigeration motors universal	10		
refrigeration thermostats	3		
rocker/momentary rocker switches	3		
S			
shelves and shelf rails	14		
solenoid valves	7		
spring assisted hinges	14		
switches and momentary switches	3		
T			
temperature probes	6		
thermostats	3		
U			
universal probes	6		
W			
walk-in fridge catches	13		