



GAS COMPONENTS



ELECTRIC COMPONENTS



WATER TECHNOLOGY



MECHANICAL COMPONENTS



TOOLS

Spare parts suitable for

FORNITALIA

Find the complete and up-to-date range of products in our GEV Webshop



Manufacturer catalogue

The most important spare parts and accessories arranged clearly for every manufacturer

- ✓ Complete product range and all appliance data always up to date in the GEV Webshop
- ✓ Alphabetical Index at the end of the catalogue

GEV Webshop

www.gev-online.co.uk

www.gev-online.com



- 🔍 Add to Favourites
- 🔍 Sign In with email address and usual password
- 🔍 Easy-order – place several items in your basket at the same time
- 🔍 Quick Item search – no login needed





heating elements



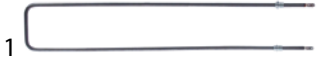

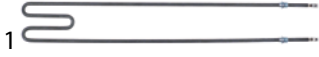
heating elements for pizza ovens

| | | | |
|---|---|-----------------|-------------------------|
|  | | | |
| GEV No. | 418094 | Ref. No. | 105/65Z15 K105/65 15 |
| description | heating element 1000W 230V L 600mm W 95mm thread 1/4" mounting distance 86mm connection length 84mm connection M4 tube ø 8.5mm heating circuits 1 dry heating element mounting pos. lower 2 hole fixing | | |





| | | | |
|---|--|-----------------|-----------|
|  | | | |
| GEV No. | 418987 | Ref. No. | K65/65 18 |
| description | heating element 1000W 230V L 604mm W 113mm thread 1/4" mounting distance 105mm connection length 85mm connection M4 tube ø 8.5mm heating circuits 1 dry heating element mounting pos. upper 2 hole fixing pizza oven | | |

| | | | |
|---|---|-----------------|------------------------|
|  | | | |
| GEV No. | 419145 | Ref. No. | K105/6518 K65/65 15 |
| description | heating element 1000W 230V L 610mm W 94mm thread 1/4" mounting distance 86mm connection length 87mm connection M4 tube ø 8.5mm heating circuits 1 dry heating element mounting pos. upper 2 hole fixing | | |

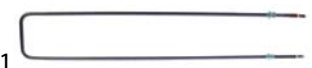
| | | | |
|---|---|-----------------|------------|
|  | | | |
| GEV No. | 419187 | Ref. No. | K65/105 15 |
| description | heating element 1600W 230V L 1000mm W 115mm thread 1/4" mounting distance 106.5mm connection length 85mm connection M4 tube ø 8.5mm heating circuits 1 dry heating element mounting pos. lower 2 hole fixing pizza oven | | |

| | | | |
|---|---|-----------------|-------------------|
|  | | | |
| GEV No. | 418089 | Ref. No. | 40/60Z6 |
| description | heating element 600W 230V L 480mm W 120mm thread 1/4" mounting distance 112mm connection length 42mm connection male faston 6.3mm tube ø 8.5mm heating circuits 1 dry heating element mounting pos. upper 2 hole fixing | | |
| accessories for | 418089 | | |
|  | GEV No. | 361182 | Ref. No. — |
| | nut thread 1/4" H 5mm nickel-plated brass WS 17 Qty 1 pcs | | |
|  | GEV No. | 510417 | Ref. No. — |
| | flat gasket fibre ED ø 20mm ID ø 14mm thickness 2mm Qty 1 pcs | | |
|  | GEV No. | 520228 | Ref. No. — |
| | tooth lock washer ID ø 15.3mm ED ø 24mm steel Qty 1 pcs for thread M14 | | |
|  | GEV No. | 550262 | Ref. No. — |
| | flat gasket copper ED ø 20mm ID ø 14mm thickness 2mm | | |

| | | | |
|--|--|-----------------|--|
|  | | | |
| GEV No. | 418092 | Ref. No. | 65/65Z15 K65/65 15 K65/65 15 old version |
| description | heating element 600W 230V L 595mm W 122mm thread 1/4" mounting distance 115mm connection length 84mm connection M4 tube ø 8.5mm heating circuits 1 dry heating element mounting pos. lower 2 hole fixing | | |

| | | | |
|---|---|-----------------|-------------------|
|  | | | |
| GEV No. | 418090 | Ref. No. | 40/60Z7 BJ07 |
| description | heating element 700W 230V L 480mm W 120mm thread 1/4" mounting distance 111mm connection length 55mm connection male faston 6.3mm tube ø 8.5mm heating circuits 1 dry heating element mounting pos. lower 2 hole fixing | | |
| accessories for | 418090 | | |
|  | GEV No. | 361182 | Ref. No. — |
| | nut thread 1/4" H 5mm nickel-plated brass WS 17 Qty 1 pcs | | |
|  | GEV No. | 510417 | Ref. No. — |
| | flat gasket fibre ED ø 20mm ID ø 14mm thickness 2mm Qty 1 pcs | | |
|  | GEV No. | 520228 | Ref. No. — |
| | tooth lock washer ID ø 15.3mm ED ø 24mm steel Qty 1 pcs for thread M14 | | |
|  | GEV No. | 550262 | Ref. No. — |
| | flat gasket copper ED ø 20mm ID ø 14mm thickness 2mm | | |

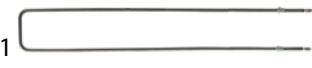
| | | | |
|--|---|-----------------|------------|
|  | | | |
| GEV No. | 418097 | Ref. No. | 105/105Z18 |
| description | heating element 900W 230V L 1000mm W 195mm thread M14x1.5 mounting distance 186mm connection length 85mm connection M4 tube ø 8.5mm dry heating element mounting pos. upper 2 hole fixing | | |



thermostats

control and safety thermostats

EGO

control thermostats

55.10/19_series



| | | | |
|--------------------|--|-----------------|----------|
| GEV No. | 375253 | Ref. No. | 40/60Z17 |
| description | thermostat t.max. 455°C temperature range 85-455°C 1-pole 1NO 16A probe ø 3.9mm probe L 228mm capillary pipe 870mm capillary pipe isolated 660mm gland nut shaft ø 6x4.6mm shaft L 23mm shaft position upper rotation 270° | | |

safety thermostats

55.10/19_series



| | | | |
|--------------------|--|-----------------|----------|
| GEV No. | 375191 | Ref. No. | 40/60Z19 |
| description | safety thermostat switch-off temp. 500°C 1-pole 16A probe ø 3.9mm probe L 230mm capillary pipe 870mm capillary pipe isolated 660mm gland nut probe | | |

switches and momentary switches

cam switches

on/off

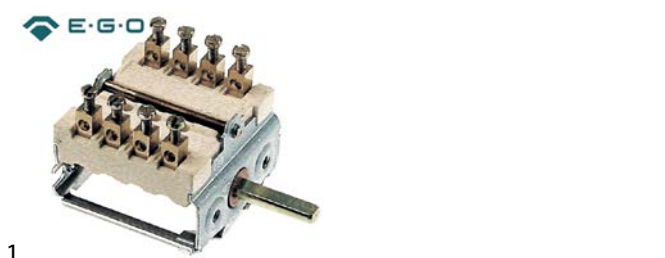

| | | | |
|--------------------|---|-----------------|----------|
| GEV No. | 300176 | Ref. No. | 40/60Z18 |
| description | cam switch 2 operating positions 4NO sequence 0-1 16A shaft ø 6x4.6mm shaft L 23mm connection screw | | |

lamps

indicator lights

indicator lights (complete)

ø 6mm

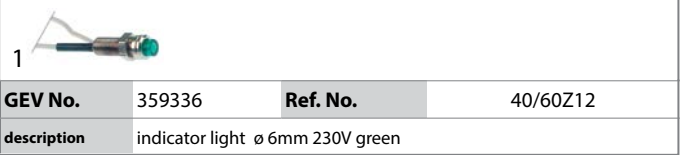

| | | | |
|--------------------|----------------------------------|-----------------|----------|
| GEV No. | 359336 | Ref. No. | 40/60Z12 |
| description | indicator light ø 6mm 230V green | | |

screw-on/push-on fit

halogen lamp

for socket GU5.3 / GU10 / GZ5.3



| | | | |
|--------------------|---|-----------------|--------------------|
| GEV No. | 359496 | Ref. No. | 65/65Z10 K65/65 |
| description | halogen lamp socket GU5.3 12V 50W temp.-resist. 300°C | | |

oven lamps

producer-specific oven lamps

FORNITALIA

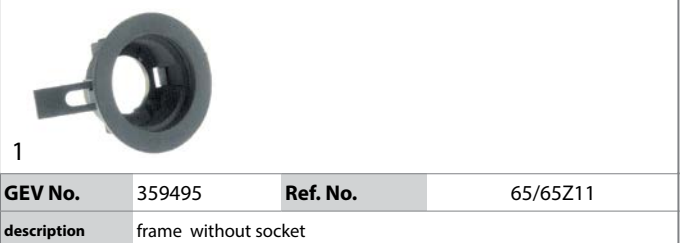

| | | | |
|--------------------|----------------------|-----------------|----------|
| GEV No. | 359495 | Ref. No. | 65/65Z11 |
| description | frame without socket | | |

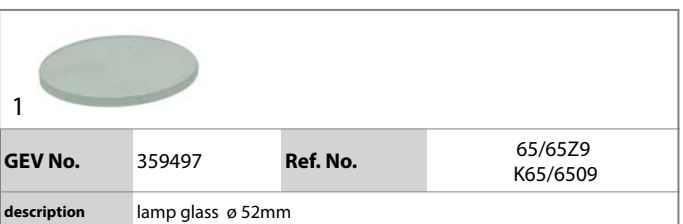

| | | | |
|--------------------|-------------------|-----------------|---------------------|
| GEV No. | 359497 | Ref. No. | 65/65Z9 K65/6509 |
| description | lamp glass ø 52mm | | |

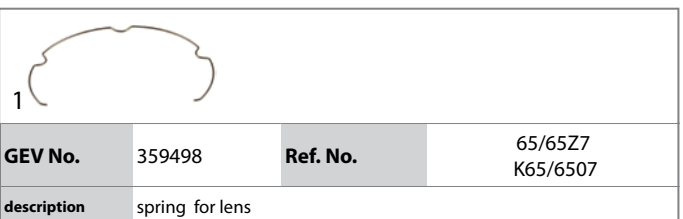

| | | | |
|--------------------|-----------------|-----------------|---------------------|
| GEV No. | 359498 | Ref. No. | 65/65Z7 K65/6507 |
| description | spring for lens | | |



| | | | |
|---|---|-----------------|--------------------|
|  | | | |
| 1 | | | |
| GEV No. | 359496 | Ref. No. | 65/65Z10 K65/65 |
| description | halogen lamp socket GU5.3 12V 50W temp.-resist. 300°C | | |

lamps
halogen lamps
for socket GU5,3 / GU10

| | | | |
|---|---|-----------------|--------------------|
|  | | | |
| 1 | | | |
| GEV No. | 359496 | Ref. No. | 65/65Z10 K65/65 |
| description | halogen lamp socket GU5.3 12V 50W temp.-resist. 300°C | | |

transformers

open transformers
with clamp terminal

| | | | |
|---|--|-----------------|----------|
|  | | | |
| 1 | | | |
| GEV No. | 401176 | Ref. No. | 65/65Z26 |
| description | transformer primary 230V secondary 10/24V 50VA | | |

for lighting

| | | | |
|---|--|-----------------|----------|
|  | | | |
| 1 | | | |
| GEV No. | 401177 | Ref. No. | 65/65Z24 |
| description | transformer primary 230V secondary 11.5V 50W | | |

probes

producer-specific probes

| | | | |
|--|---|-----------------|----------|
|  | | | |
| 1 | | | |
| GEV No. | 379930 | Ref. No. | 65/65Z25 |
| description | temperature probe thermocouple K (NiCr-Ni) cable Vetrotex probe -50 up to 1150°C cable -50 up to +350°C connection 2-wire thread probe ø3x100mm cable length 3.2m | | |

electronics

PCBs

| | | | |
|---|-------------|-----------------|------------------------------------|
|  | | | |
| 1 | | | |
| GEV No. | 401178 | Ref. No. | 105/105Z22 65/65 22 65/65Z22 |
| description | control PCB | | |

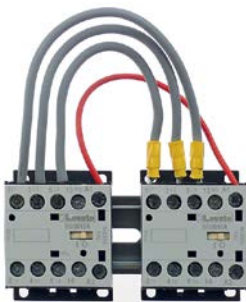
| | | | |
|--|---|-----------------|-------------------------|
|  | | | |
| 1 | | | |
| GEV No. | 403643 | Ref. No. | K65/65 23 (old version) |
| description | conversion kit pizza oven K65 suitable for FORNITALIA | | |

| | | | |
|--|--|-----------------|-----------------------------|
|  | | | |
| 1 | | | |
| GEV No. | 401179 | Ref. No. | 65/65Z23 K65/65 23 (old) |
| description | power PCB pizza oven K65 suitable for FORNITALIA | | |



| | | | |
|---|--|-----------------|-----------|
|  | | | |
| 1 | | | |
| GEV No. | 403072 | Ref. No. | K65/65 23 |
| description | power PCB pizza oven K65 suitable for FORNITALIA | | |

keypads

front foils

| | | | |
|---|------------|-----------------|----------|
|  | | | |
| 1 | | | |
| GEV No. | 693371 | Ref. No. | 40/60Z16 |
| description | front foil | | |

fans

axial fans

import

| | | | |
|---|--|-----------------|-----------------------|
|  | | | |
| 1 | | | |
| GEV No. | 601158 ¹ | Ref. No. | 65/65Z20 B65/65 20 |
| description | axial fan L 119mm W 119mm H 25mm 12VDC 5.4W bearing ball bearing connection cable 300mm plastic ADDA temp.-resist. -10 up to +70°C | | |

¹with ball bearings

accessories

fan guards

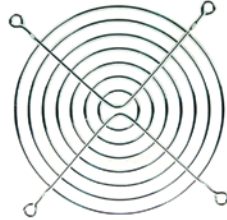
| | | | |
|--|---|-----------------|----------|
|  | | | |
| 1 | | | |
| GEV No. | 601206 | Ref. No. | 65/65Z19 |
| description | guard ø 115mm mounting distance 105mm for axial fan 119mm | | |

equipment-specific units

for pizza ovens

springs

| | | | |
|--|--|-----------------|----------------------|
|  | | | |
| 1 | | | |
| GEV No. | 693369 | Ref. No. | 65/65Z1 B65/65 01 |
| description | torsion spring ø 22mm L2 51mm wire gauge ø 3.7mm L1 38mm L3 15mm | | |

glass panels

| | | | |
|--|--|-----------------|---------|
|  | | | |
| 1 | | | |
| GEV No. | 693374 | Ref. No. | 40/60Z1 |
| description | glass panel L 258mm W 78mm thickness 4mm rectangular | | |



1

| | | | |
|--------------------|---|-----------------|------------------------------------|
| GEV No. | 693372 | Ref. No. | 16/K65/65 65/65Z16 K65/65 16 |
| description | glass panel L 418mm W 103mm thickness 4mm rectangular | | |

firebricks



1

| | | | |
|--------------------|--|-----------------|-------------|
| GEV No. | 850090 | Ref. No. | K105/105 14 |
| description | firebrick L 1025mm W 500mm H 15mm mounting pos. lower delivery freight forwarding company only | | |
| For models: | KCK105/105 | | |



1

| | | | |
|--------------------|--|-----------------|------------|
| GEV No. | 850092 | Ref. No. | K65/105 14 |
| description | firebrick L 1025mm W 605mm H 15mm mounting pos. lower delivery freight forwarding company only | | |



1

| | | | |
|--------------------|---|-----------------|---------------|
| GEV No. | 850081 | Ref. No. | KCK105/105 R5 |
| description | firebrick L 1030mm W 160mm H 15mm with lamp duct mounting pos. side part right delivery freight forwarding company only | | |
| For models: | KCK105/105 | | |



1

| | | | |
|--------------------|---|-----------------|---------------|
| GEV No. | 850082 | Ref. No. | KCK105/105 R2 |
| description | firebrick L 1030mm W 160mm H 15mm with probe duct mounting pos. side part left delivery freight forwarding company only | | |
| For models: | KCK105/105 | | |



1

| | | | |
|--------------------|--|-----------------|---------------|
| GEV No. | 850083 | Ref. No. | KCK105/105 R3 |
| description | firebrick L 1045mm W 160mm H 15mm mounting pos. side part at the back delivery freight forwarding company only | | |
| For models: | KCK105/105 | | |



1

| | | | |
|--------------------|--|-----------------|--------------|
| GEV No. | 850089 | Ref. No. | KCK105/65 R4 |
| description | firebrick L 1045mm W 325mm H 15mm mounting pos. upper delivery freight forwarding company only | | |
| For models: | KCK105/65 | | |

1



| | | | |
|--------------------|--|-----------------|---------------|
| GEV No. | 850091 | Ref. No. | KCK105/105 R4 |
| description | firebrick L 1045mm W 520mm H 15mm mounting pos. upper delivery freight forwarding company only | | |
| For models: | KCK105/105 | | |

1



| | | | |
|--------------------|---|-----------------|------------|
| GEV No. | 850118 | Ref. No. | K65/105 14 |
| description | firebrick L 342mm W 605mm H 14mm mounting pos. lower delivery freight forwarding company only | | |
| For models: | KCK65/105 | | |

1



| | | | |
|--------------------|---|-----------------|-----------|
| GEV No. | 850094 | Ref. No. | K65/65 14 |
| description | firebrick L 606mm W 313mm H 15mm mounting pos. lower Qty 2 pcs delivery freight forwarding company only | | |
| For models: | KCK65/65 | | |

1



| | | | |
|--------------------|---|-----------------|------------------|
| GEV No. | 850095 | Ref. No. | Bigou Z4 BJ04 |
| description | firebrick L 625mm W 425mm H 15mm delivery freight forwarding company only | | |
| For models: | BJ60/60 | | |

1



| | | | |
|--------------------|---|-----------------|------------|
| GEV No. | 850087 | Ref. No. | K105/65 14 |
| description | firebrick L 625mm W 500mm H 15mm mounting pos. lower delivery freight forwarding company only | | |
| For models: | KCK105/65 | | |

1



| | | | |
|--------------------|---|-----------------|-------------|
| GEV No. | 850085 | Ref. No. | KCK65/65 R2 |
| description | firebrick L 630mm W 160mm H 15mm with lamp duct mounting pos. side part left delivery freight forwarding company only | | |
| For models: | KCK65/65 | | |

1



| | | | |
|--------------------|--|-----------------|-------------|
| GEV No. | 850084 | Ref. No. | KCK65/65 R5 |
| description | firebrick L 630mm W 160mm H 15mm with lamp duct mounting pos. side part right delivery freight forwarding company only | | |
| For models: | KCK65/65 | | |

1



| | | | |
|--------------------|---|-----------------|-------------|
| GEV No. | 850086 | Ref. No. | KCK65/65 R3 |
| description | firebrick L 645mm W 160mm H 15mm mounting pos. side part at the back delivery freight forwarding company only | | |
| For models: | KCK65/65 | | |



1

| | | | |
|--------------------|---|-----------------|--------------|
| GEV No. | 850088 | Ref. No. | KCK65/105 R4 |
| description | firebrick L 645mm W 520mm H 15mm mounting pos. upper delivery freight forwarding company only | | |
| For models: | KCK65/105 | | |



1

| | | | |
|--------------------|---|-----------------|-------------|
| GEV No. | 850123 | Ref. No. | KCK65/65 R4 |
| description | firebrick L 645mm W 640mm H 15mm mounting pos. upper delivery freight forwarding company only | | |
| For models: | KCK65/65 | | |

doors



1

| | | | |
|--------------------|---------------|-----------------|----------------------|
| GEV No. | 693368 | Ref. No. | 65/65Z2 K65/65 02 |
| description | bush for door | | |

knobs

universal knobs



1

| | | | |
|--------------------|---|-----------------|----------|
| GEV No. | 110253 | Ref. No. | 40/60Z13 |
| description | knob switch zero mark t.max.°C° ø 50mm shaft ø 6x4.6mm shaft flat upper black | | |

producer-specific knobs

FORNITALIA



1

| | | | |
|--------------------|--|-----------------|----------|
| GEV No. | 111742 | Ref. No. | 65/65Z13 |
| description | knob potentiometer ø 78mm shaft ø 6x4.6mm shaft flat upper black | | |



1

| | | | |
|--------------------|---|-----------------|------------------|
| GEV No. | 111740 | Ref. No. | 40/60Z15 BJ15 |
| description | knob thermostat t.max. 450°C ø 49mm shaft ø 6x4.6mm shaft flat upper black temperature range 85-450°C rotation 270° | | |

handles and hand wheels

cone handles



1

| | | | |
|--------------------|--|-----------------|----------|
| GEV No. | 693370 | Ref. No. | 65/65Z17 |
| description | cone handle thread M12x1.5 thread L 12.5mm | | |

filters

device filters

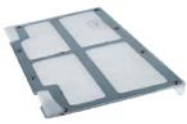

1

| | | | |
|--------------------|--------|-----------------|-----------------------|
| GEV No. | 693373 | Ref. No. | 65/65Z21 K65/65 21 |
| description | filter | | |

springs

torsion springs



1

| | | | |
|--------------------|--|-----------------|----------------------|
| GEV No. | 693369 | Ref. No. | 65/65Z1 B65/65 01 |
| description | torsion spring \varnothing 22mm L2 51mm wire gauge \varnothing 3.7mm L1 38mm L3 15mm | | |

A

axial fans 6

C

cam switches 4

control thermostats 4

F

fans 6

H

halogen lamp 4

heating elements 3

heating elements for pizza ovens 3

I

indicator lights 4

indicator lights (complete) 4

L

lamps 4

O

oven lamps 4

P

probes 5

S

safety thermostats 4

switches and momentary switches 4

T

thermostats 4

transformers 5