



**GAS COMPONENTS**



**ELECTRIC COMPONENTS**



**WATER TECHNOLOGY**



**MECHANICAL COMPONENTS**



**TOOLS**

Spare parts suitable for

**FOINOX**

Find the complete and up-to-date range of products in our GEV Webshop



# Manufacturer catalogue

The most important spare parts and accessories arranged clearly for every manufacturer

- ✓ Complete product range and all appliance data always up to date in the GEV Webshop
- ✓ Alphabetical Index at the end of the catalogue

## GEV Webshop

[www.gev-online.co.uk](http://www.gev-online.co.uk)

[www.gev-online.com](http://www.gev-online.com)



- 🔍 Add to Favourites
- 🔍 Sign In with email address and usual password
- 🔍 Easy-order – place several items in your basket at the same time
- 🔍 Quick Item search – no login needed



## heating elements

### heating elements for ovens



1

|                    |   |                 |       |
|--------------------|---|-----------------|-------|
| <b>GEV No.</b>     | 418759  | <b>Ref. No.</b> | 10645 |
| <b>description</b> | heating element 1800W 230V heating circuits 1 L 360mm W 390mm L1 95mm L2 265mm W1 165mm W2 60mm flange length 100mm flange width 23mm hole distance 86mm bridge length 485mm hole ø 3.3mm tube ø 6.3mm connection male faston 6.3mm connection length 10mm windings 4 rectangular flange dry heating element mounting thread M4 |                 |       |

### heating elements for heated cabinets



1



|                    |   |                 |       |
|--------------------|---|-----------------|-------|
| <b>GEV No.</b>     | 419065  | <b>Ref. No.</b> | 10602 |
| <b>description</b> | heating element 1400W 230V heating circuits 1 L 375mm W 140mm connection length 30mm connection male faston 6.3mm tube ø 6.3mm 2 hole fixing thread M10x1 dry heating element L1 45mm L2 75mm L3 255mm W1 45mm W2 50mm mounting distance 44mm |                 |       |

### immersion heating elements

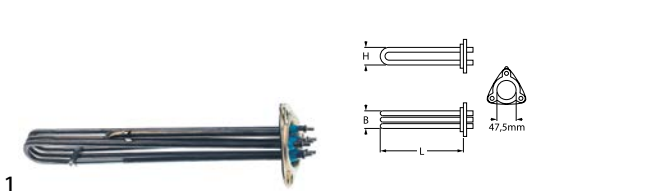
#### 3 hole flange ø47.5mm



1

|   |  |                 |                 |   |
|---|--|-----------------|-----------------|---|
| <b>GEV No.</b>  | 418136   | <b>Ref. No.</b> | 3434            |   |
| <b>description</b>  | heating element 4360W 240V mounting ø 47.5mm heating circuits 3 L 310mm W 31mm H 35mm number of thermostat sleeves 1 thermostat sleeves ø 7mm length thermostat sleeves 200mm thermostat sleeve clinging tube ø 6.3mm hole distance 62mm hole ø 8mm connection M4 3 hole flange immersion heater |                 |                 |   |
| <b>For models:</b>  | FM06EB, FM06EDG, FM10EB, FM10EDG, FM20EB, FM20EDG  |                 |                 |   |
| <b>spare parts for</b>  | 418136   |                 |                 |   |
|  | <b>GEV No.</b>   | 510408          | <b>Ref. No.</b> | — |
|   | O-ring EPDM thickness 5.34mm ID ø 47mm Qty 1 pcs   |                 |                 |   |
| <b>accessories for</b>  | 418136   |                 |                 |   |
|  | <b>GEV No.</b>   | 510408          | <b>Ref. No.</b> | — |
|   | O-ring EPDM thickness 5.34mm ID ø 47mm Qty 1 pcs   |                 |                 |   |
|  | <b>GEV No.</b>   | 510562          | <b>Ref. No.</b> | — |
|   | O-ring silicone thickness 5.34mm ID ø 47mm Qty 1 pcs   |                 |                 |   |

#### with expansion flange 70 x 18mm



1

|                    |  |                 |       |
|--------------------|--|-----------------|-------|
| <b>GEV No.</b>     | 418137   | <b>Ref. No.</b> | 10622 |
| <b>description</b> | heating element 3000W 230V heating circuits 1 flange 70x18mm L 220mm W 65mm Hmm connection male faston 6.3mm tube ø 8.5mm immersion heater expansion flange connection length 34mm |                 |       |
| <b>For models:</b> | FM200EA, FM200EAP, FM200EB, FM201EA, FM201EAP, FM201EB   |                 |       |



1

|                    |  |                 |       |
|--------------------|--|-----------------|-------|
| <b>GEV No.</b>     | 418138   | <b>Ref. No.</b> | 10620 |
| <b>description</b> | heating element 6000W 230V heating circuits 1 flange 70x18mm L 445mm W 68mm connection male faston 6.3mm tube ø 8.5mm immersion heater expansion flange connection length 34mm |                 |       |
| <b>For models:</b> | FM401EA, FM401EAP, FM401EB   |                 |       |

### heating elements for convection



1

|                    |  |                 |                   |
|--------------------|--|-----------------|-------------------|
| <b>GEV No.</b>     | 418129   | <b>Ref. No.</b> | 10638<br>40400038 |
| <b>description</b> | heating element 16000W 230V heating circuits 3 ID ø 337mm ED ø 358mm L 450mm H 100mm L1 84mm W1 108mm H1 15mm H2 85mm flange length 142mm flange width 25mm hole distance 64mm connection M4 tube ø 8.5mm convection heating element hole ø 6mm rectangular flange |                 |                   |
| <b>For models:</b> | FC201EA, FC201EAP, FC201EB, FM201EA, FM201EAP, FM201EB, MM201EA, MM201EAP, MM201EB   |                 |                   |



1

|                    |   |                 |       |
|--------------------|---|-----------------|-------|
| <b>GEV No.</b>     | 418127  | <b>Ref. No.</b> | 10641 |
| <b>description</b> | heating element 16000W 230V heating circuits 3 ID ø 390mm ED ø 410mm L 430mm H 99mm L1 15mm W1 100mm H1 15mm H2 84mm flange length 142mm flange width 25mm hole distance 63mm connection M4 tube ø 8.5mm convection heating element hole ø 6mm rectangular flange |                 |       |
| <b>For models:</b> | FC200EA, FC200EAP, FC200EB, FC401EA, FC401EAP, FC401EB, FM200EA, FM200EAP, FM200EB, FM401EA, FM401EAP, FM401EB, MM200EA, MM200EAP, MM200EB, MM401EA, MM401EAP   |                 |       |



1

|                    |  |                 |      |
|--------------------|--|-----------------|------|
| <b>GEV No.</b>     | 418133   | <b>Ref. No.</b> | 0022 |
| <b>description</b> | heating element 2000W 220V heating circuits 1 ID ø 187mm ED ø 200mm L 215mm H 25mm L1 15mm W1 60mm H1 5mm H2 20mm flange length 100mm flange width 22mm hole distance 86mm connection male faston 6.3mm connection length 37mm tube ø 6.5mm convection heating element hole ø 5mm rectangular flange |                 |      |
| <b>For models:</b> | FE1-2, FE2-3   |                 |      |



1

|                    |  |                 |      |
|--------------------|--|-----------------|------|
| <b>GEV No.</b>     | 416412   | <b>Ref. No.</b> | 0159 |
| <b>description</b> | heating element 2500W 230V heating circuits 1 ID ø 188mm ED ø 200mm L 215mm H 30mm L1 3mm W1 53mm H1 5mm H2 25mm flange length 100mm flange width 22mm hole distance 86mm connection male faston 6.3mm |                 |      |



1

|                    |  |                 |      |
|--------------------|--|-----------------|------|
| <b>GEV No.</b>     | 418134   | <b>Ref. No.</b> | 0508 |
| <b>description</b> | heating element 3300W 240V heating circuits 1 ID ø 185mm ED ø 200mm L 215mm H 30mm W1 60mm H1 5mm H2 25mm flange length 100mm flange width 22mm hole distance 85mm connection male faston 6.3mm connection length 22mm tube ø 6.5mm convection heating element hole ø 5mm rectangular flange |                 |      |
| <b>For models:</b> | FC06E, FC06EA, FC06EDG, FC12E, FC12EA, FC12EDG   |                 |      |



1

|                    |  |                 |       |
|--------------------|--|-----------------|-------|
| <b>GEV No.</b>     | 418130   | <b>Ref. No.</b> | 10601 |
| <b>description</b> | heating element 3900W 230V heating circuits 3 ID ø 175mm ED ø 245mm L 285mm H 32mm L1 60mm W1 62mm H1 10mm H2 26mm flange length 93mm flange width 22mm hole distance 77mm connection male faston 6.3mm connection length 61mm tube ø 6.5mm convection heating element hole ø 5mm rectangular flange |                 |       |
| <b>For models:</b> | MM2/3EA, MM2/3EB   |                 |       |

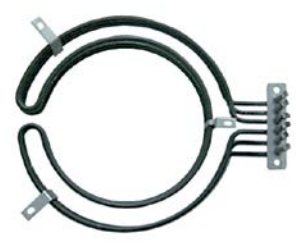

1

|                    |  |                 |       |
|--------------------|--|-----------------|-------|
| <b>GEV No.</b>     | 415855   | <b>Ref. No.</b> | 10601 |
| <b>description</b> | heating element 3900W 230V heating circuits 3 ID ø 176mm ED ø 244mm L 282mm H 43mm L1 38mm W1 61mm H1 13mm H2 30mm flange length 92mm flange width 22mm hole distance 78mm connection male faston 6.3mm connection length 60mm tube ø 6.3mm convection heating element hole ø 6.3mm rectangular flange |                 |       |



1

|                    |  |                 |      |
|--------------------|--|-----------------|------|
| <b>GEV No.</b>     | 418131   | <b>Ref. No.</b> | 1023 |
| <b>description</b> | heating element 6000W 230V heating circuits 3 ID ø 217mm ED ø 231mm L 271mm H 90mm L1 41mm W1 103mm H1 24mm H2 66mm flange length 140mm flange width 22mm hole distance 63mm tube ø 6.3mm convection heating element hole ø 5mm rectangular flange |                 |      |



1

|                    |  |                 |               |
|--------------------|--|-----------------|---------------|
| <b>GEV No.</b>     | 418132   | <b>Ref. No.</b> | 3016<br>3016A |
| <b>description</b> | heating element 7350W 230V heating circuits 3 ID ø 250mm ED ø 265mm L 277mm H 75mm L1 17mm W1 102mm H1 12mm H2 67mm flange length 143mm flange width 25mm hole distance 7mm connection M4 tube ø 6.5mm convection heating element hole ø 63mm rectangular flange |                 |               |
| <b>For models:</b> | FC06SE, FC06SEA, FC06SEGD, FM06EB, FM06EDG, FP05E, FP05EDG, MM06EA, MM06EAP, MM06EB  |                 |               |







1

|                    |  |                 |       |
|--------------------|--|-----------------|-------|
| <b>GEV No.</b>     | 418753   | <b>Ref. No.</b> | 10628 |
| <b>description</b> | heating element 8000W 230V heating circuits 3 ID ø 287mm ED ø 300mm L 345mm H 90mm L1 39mm H1 20mm H2 67mm flange length 142mm flange width 25mm hole distance 12.7mm connection M4 connection length 67mm tube ø 6.5mm convection heating element hole ø 7mm rectangular flange |                 |       |



|                    |  |                 |       |
|--------------------|--|-----------------|-------|
| <b>GEV No.</b>     | 418128   | <b>Ref. No.</b> | 10633 |
| <b>description</b> | heating element 9000W 230V heating circuits 3 ID ø 500mm ED ø 515mm L 535mm H 95mm L1 13mm W1 105mm H1 15mm H2 80mm flange length 142mm flange width 25mm hole distance 64mm connection M4 tube ø 8.5mm convection heating element hole ø 6mm rectangular flange |                 |       |
| <b>For models:</b> | FC200EA, FC200EAP, FC200EB, FC401EA, FC401EAP, FC401EB, FM200EA, FM200EAP, FM200EB, FM401EA, FM401EAP, FM401EB, MM200EA, MM200EAP, MM200EB, MM401EA, MM401EAP  |                 |       |



|   |   |                 |                   |
|---|---|-----------------|-------------------|
| <b>GEV No.</b>  | 418135  | <b>Ref. No.</b> | 1126              |
| <b>description</b>  | heating element 920W 230V heating circuits 1 ID ø 200mm ED ø 215mm L 255mm H 40mm thread 1/4" connection male faston 6.3mm 2 hole fixing mounting distance 24mm tube ø 8.5mm convection heating element |                 |                   |
| <b>For models:</b>  | FC06E, FC06EA, FC06EDG, FC12E, FC12EA, FC12EDG  |                 |                   |
| <b>accessories for</b>  | 418135  |                 |                   |
|  | <b>GEV No.</b>  | 361182          | <b>Ref. No.</b> — |
|   | nut thread 1/4" H 5mm nickel-plated brass WS 17 Qty 1 pcs   |                 |                   |
|  | <b>GEV No.</b>  | 510417          | <b>Ref. No.</b> — |
|   | flat gasket fibre ED ø 20mm ID ø 14mm thickness 2mm Qty 1 pcs   |                 |                   |
|  | <b>GEV No.</b>  | 520228          | <b>Ref. No.</b> — |
|   | tooth lock washer ID ø 15.3mm ED ø 24mm steel Qty 1 pcs for thread M14  |                 |                   |
|  | <b>GEV No.</b>  | 550262          | <b>Ref. No.</b> — |
|   | flat gasket copper ED ø 20mm ID ø 14mm thickness 2mm  |                 |                   |



|                    |   |                 |      |
|--------------------|---|-----------------|------|
| <b>GEV No.</b>     | 418139  | <b>Ref. No.</b> | 1466 |
| <b>description</b> | heating element 3500W 240V heating circuits 1 L 620mm W 120mm L1 33mm L2 587mm W2 90mm flange length 70mm flange width 22mm hole distance 56mm connection length 100mm connection M4 tube ø 8.5mm hole ø 6mm W1 30mm rectangular flange convection heating element windings 2 |                 |      |
| <b>For models:</b> | FC12SE, FC12SEA, FC12SEDG, FC20E, FC20EA, FC20EDG, FM10EB, FM10EDG, FM20EB, FM20EDG, FP10E, FP10EDG, MM10EA, MM10EAP, MM10EB, MM20EA, MM20EAP, MM20EB   |                 |      |

accessories

sealing washers

O-rings

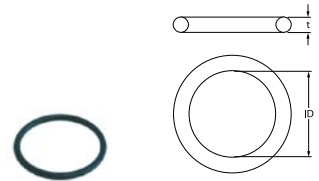

|                    |   |                 |   |
|--------------------|---|-----------------|---|
| <b>GEV No.</b>     | 521120  | <b>Ref. No.</b> | — |
| <b>description</b> | O-ring EPDM thickness 5.34mm ID ø 37.47mm Qty 1 pcs |                 |   |

energy regulators

EGO

1-circuit



|                    |  |                 |      |
|--------------------|--|-----------------|------|
| <b>GEV No.</b>     | 380015   | <b>Ref. No.</b> | 0280 |
| <b>description</b> | energy regulator 230V 13A single-circuit turn direction right shaft ø 6x4.6mm shaft L 23mm mounting thread M4 power release 6-100% no. 50.57021.010  |                 |      |
| <b>For models:</b> | FC05E, FC05EU, FC05G, FC05GU, FC06E, FC06EA, FC06EDG, FC06G, FC06GA, FC06GDG, FC06SE, FC06SEA, FC06SEDG, FC12E, FC12EA, FC12EDG, FC12G, FC12GA, FC12GDG, FC12SE, FC12SEA, FC12SEDG, FC200EB, FC200GB, FC201EB, FC20E, FC20EA, FC20EDG, FC20G, FC20GA, FC20GDG, FC401EB, FDE10, FDE155, FDE55, FDG10, FDG155, FDG55, FM06EB, FM06GB, FM10EB, FM10GB, FM20EB, FM20GB, FP05E, FP05EDG, FP05G, FP05GDG, FP10E, FP10EDG...(Other models you can see in the webshop) |                 |      |



# thermostats

## control and safety thermostats

EGO

control thermostats

55.10/19\_ series

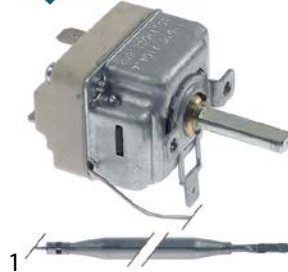

|                    |  |                 |       |
|--------------------|--|-----------------|-------|
| <b>GEV No.</b>     | 375647   | <b>Ref. No.</b> | 10005 |
| <b>description</b> | thermostat t.max. 110°C temperature range 31-110°C 1-pole 1NO 16A probe ø 6mm probe L 133mm capillary pipe 870mm capillary pipe isolatedmm gland nut shaft ø 6x4.6mm shaft L 23mm shaft position upper rotation 318° |                 |       |
| <b>For models:</b> | MM2/3EB  |                 |       |

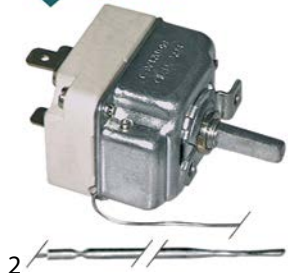

|                    |   |                 |                      |
|--------------------|---|-----------------|----------------------|
| <b>GEV No.</b>     | 390068  | <b>Ref. No.</b> | 0283<br>0596<br>3529 |
| <b>description</b> | thermostat t.max. 269°C temperature range 55-269°C 1-pole 1CO 16A probe ø 3.1mm probe L 219mm capillary pipe 1280mm capillary pipe isolated 1270mm gland nut shaft ø 6x4.6mm shaft L 23mm shaft position upper° rotation 318°   |                 |                      |
| <b>For models:</b> | FC05E, FC05EU, FC05G, FC05GU, FC06E, FC06EA, FC06EDG, FC06G, FC06GA, FC06GDG, FC06SE, FC06SEA, FC06SEDG, FC12E, FC12EA, FC12EDG, FC12G, FC12GA, FC12GDG, FC12SE, FC12SEA, FC12SEDG, FC200EB, FC200GB, FC201EB, FC201GB, FC20E, FC20EA, FC20EDG, FC20G, FC20GA, FC20GDG, FC401EB, FC401GB, FDE10, FDE155, FDE55, FDG10, FDG155, FDG55, FM200EB, FM200GB, FM201EB, FM201GB, FM401EB, FM401GB, FP05E, FP05EDG, FP05G, FP05GDG... (Other models you can see in the webshop) |                 |                      |



|                    |  |                 |      |
|--------------------|--|-----------------|------|
| <b>GEV No.</b>     | 375002   | <b>Ref. No.</b> | 0026 |
| <b>description</b> | thermostat t.max. 320°C temperature range 55-320°C 1-pole 1NO 16A probe ø 3.1mm probe L 226mm capillary pipe 870mm capillary pipe isolated 850mm gland nut shaft L 23mm shaft position upper rotation 270° |                 |      |
| <b>For models:</b> | FE1-2, FE2-3   |                 |      |

## safety thermostats

55.10/19\_ series

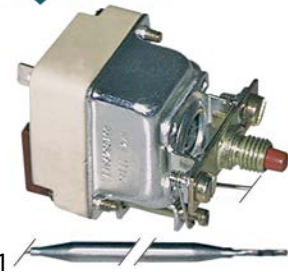

|                        |   |                 |              |
|------------------------|---|-----------------|--------------|
| <b>GEV No.</b>         | 375250  | <b>Ref. No.</b> | 0599<br>3528 |
| <b>description</b>     | safety thermostat capillary pipe 870mm probe ø 6mm 1-pole probe L 129mm 16A capillary pipe isolatedmm gland nut switch-off temp. 130°C probe SS |                 |              |
| <b>For models:</b>     | FM06EDG, FM06GB, FM10EDG, FM10GB, FM201EA, FM201EAP, FM201EB, FM201GB, FM20EDG, FM20GB, FM401EB, FM401GB  |                 |              |
| <b>spare parts for</b> | 375250  |                 |              |
|                        |    | <b>GEV No.</b>  | 551083       |
|                        |   | <b>Ref. No.</b> | —            |
|                        | cap for safety thermostat thread M8x1   |                 |              |



|                    |  |                 |      |
|--------------------|--|-----------------|------|
| <b>GEV No.</b>     | 376008   | <b>Ref. No.</b> | 0166 |
| <b>description</b> | safety thermostat switch-off temp. 352°C 1-pole 16A probe ø 3mm probe L 200mm capillary pipe 885mm capillary pipe isolated 780mm gland nut probe |                 |      |



55.32\_series

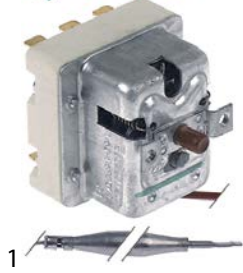

|                    |  |                 |              |
|--------------------|--|-----------------|--------------|
| <b>GEV No.</b>     | 375649   | <b>Ref. No.</b> | 3019<br>3023 |
| <b>description</b> | safety thermostat switch-off temp. 160°C 3-pole 20A probe ø 6mm probe L 87mm capillary pipe 890mm capillary pipe isolated 880mm gland nut probe SS |                 |              |
| <b>For models:</b> | FM06EB, FM06GDG, FM10EB, FM10GDG, FM20EB, FM20GDG  |                 |              |

CAEM

control thermostats

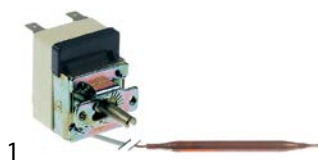

|                    |   |                 |       |
|--------------------|---|-----------------|-------|
| <b>GEV No.</b>     | 375645  | <b>Ref. No.</b> | 10008 |
| <b>description</b> | thermostat t.max. 120°C temperature range 30-120°C 1-pole 1CO 16A probe ø 6mm probe L 110mm capillary pipe 1600mm capillary pipe isolated 1550mm gland nut shaft ø 6x4.6mm shaft L 22mm shaft position upper rotation 270° probe material copper 250V |                 |       |

switches and momentary switches

push/momentary push switches

28.5x77.5mm



|                    |  |                 |       |
|--------------------|--|-----------------|-------|
| <b>GEV No.</b>     | 346365   | <b>Ref. No.</b> | 10044 |
| <b>description</b> | switch combination momentary/latching mounting measurements 28.5x77.5mm black 2CO/2CO 250V 16A with indicator connection male faston 6.3mm ambient temperature max. 85°C protection IP40 |                 |       |
| <b>For models:</b> | MM06EB, MM06GB, MM10EB, MM10GB, MM20EB, MM20GB   |                 |       |



|                    |   |                 |       |
|--------------------|---|-----------------|-------|
| <b>GEV No.</b>     | 346363  | <b>Ref. No.</b> | 10043 |
| <b>description</b> | switch combination with indicator mounting measurements 28.5x77.5mm black 2CO/2CO 250V 16A connection male faston 6.3mm ambient temperature max. 85°C protection IP40 |                 |       |
| <b>For models:</b> | FM06EB, FM06GB, FM10EB, FM10GB, FM20EB, FM20GB  |                 |       |

microswitches

pin-plunger actuated

M10



|                    |   |                 |      |
|--------------------|---|-----------------|------|
| <b>GEV No.</b>     | 345032  | <b>Ref. No.</b> | 1519 |
| <b>description</b> | microswitch with plunger thread M10x1 thread L 12mm 250V 16A 1CO connection male faston 6.3mm stroke 7mm mounting distance 22mm L 28mm ambient temperature max. 125°C type SP9603 actuating force: 180g |                 |      |

non-standard



Image not available

|                    |                        |                 |       |
|--------------------|------------------------|-----------------|-------|
| <b>GEV No.</b>     | 348019                 | <b>Ref. No.</b> | 70201 |
| <b>description</b> | microswitch with cable |                 |       |

system switches (ROLD)



|                    |                  |                 |      |
|--------------------|------------------|-----------------|------|
| <b>GEV No.</b>     | 345721           | <b>Ref. No.</b> | 3471 |
| <b>description</b> | blank cap holder |                 |      |



|                    |   |                 |       |
|--------------------|---|-----------------|-------|
| <b>GEV No.</b>     | 345537  | <b>Ref. No.</b> | 10313 |
| <b>description</b> | element holder mounting measurements 20.6x16.4mm grey arched for push buttons 13x17mm   |                 |       |
| <b>For models:</b> | FC05G, FC05GU, FC200EA, FC200EAP, FC200EB, FC200GA, FC200GAP, FC200GB, FC201EB, FC201GA, FC201GAP, FC201GB, FC401EB, FC401GA, FC401GAP, FC401GB, FDE10, FDE155, FDE155DG, FDE55, FDE55DG, FDG10, FDG155, FDG155DG, FDG55, FDG55DG, FM200EA, FM200EAP, FM200EB, FM200GA, FM200GAP, FM200GB, FM201EA, FM201EAP, FM201EB, FM201GA, FM201GAP, FM201GB, FM401EA, FM401EAP, FM401EB, FM401GA, FM401GAP, FM401GB, MM200EA, MM200EAP, MM200EB, MM200GA, MM200GAP, MM200GB...(Other models you can see in the webshop) |                 |       |



|  |                |        |                 |      |
|--|----------------|--------|-----------------|------|
| 1  | <b>GEV No.</b> | 345131 | <b>Ref. No.</b> | 3475 |
| <b>description</b> element holder mounting measurements 28.5x28.5mm grey single element holder |                |        |                 |      |



|  |                |        |                 |      |
|--|----------------|--------|-----------------|------|
| 1  | <b>GEV No.</b> | 346201 | <b>Ref. No.</b> | 3468 |
| <b>description</b> element holder mounting measurements 28.5x77.5mm grey three-fold element holder |                |        |                 |      |



|   |                |        |                 |      |
|---|----------------|--------|-----------------|------|
| 1   | <b>GEV No.</b> | 345606 | <b>Ref. No.</b> | 3474 |
| <b>description</b> momentary switch unit 2CO 250V 16A connection male faston 6.3mm  |                |        |                 |      |
| <b>For models:</b> FC05G, FC05GU, FC200EA, FC200EAP, FC200EB, FC200GA, FC200GAP, FC200GB, FC201EB, FC201GA, FC201GAP, FC201GB, FC401EB, FC401GA, FC401GAP, FC401GB, FDG10, FDG155, FDG55, FM10GB, FM200EA, FM200EAP, FM200EB, FM200GA, FM200GAP, FM200GB, FM201EA, FM201EAP, FM201EB, FM201GA, FM201GAP, FM201GB, FM401EA, FM401EAP, FM401EB, FM401GA, FM401GAP, FM401GB, MM06GB, MM10GB, MM2/3EB, MM200EA, MM200EAP, MM200EB, MM200GA, MM200GAP, MM200GB, MM201EA, MM201EAP, MM201EB...(Other models you can see in the webshop) |                |        |                 |      |



|   |                |        |                 |      |
|---|----------------|--------|-----------------|------|
| 1   | <b>GEV No.</b> | 345538 | <b>Ref. No.</b> | 3480 |
| <b>description</b> push button ø 11.9mm black |                |        |                 |      |



|  |                |        |                 |      |
|--|----------------|--------|-----------------|------|
| 1  | <b>GEV No.</b> | 345133 | <b>Ref. No.</b> | 3470 |
| <b>description</b> push button ø 23mm grey |                |        |                 |      |
| <b>For models:</b> MM2/3EB                 |                |        |                 |      |



|  |                |        |                 |      |
|--|----------------|--------|-----------------|------|
| 1  | <b>GEV No.</b> | 346211 | <b>Ref. No.</b> | 3469 |
| <b>description</b> push button ø 23mm grey with lens |                |        |                 |      |



|  |                |        |                 |       |
|--|----------------|--------|-----------------|-------|
| 1  | <b>GEV No.</b> | 345539 | <b>Ref. No.</b> | 10312 |
| <b>description</b> push button size 17x13mm grey   |                |        |                 |       |
| <b>For models:</b> FC05G, FC05GU, FC200EA, FC200EAP, FC200EB, FC200GA, FC200GAP, FC200GB, FC201EB, FC201GA, FC201GAP, FC201GB, FC401EB, FC401GA, FC401GAP, FC401GB, FDE10, FDE155, FDE155DG, FDE55, FDE55DG, FDG10, FDG155, FDG155DG, FDG55, FDG55DG, FM200EA, FM200EAP, FM200EB, FM200GA, FM200GAP, FM200GB, FM201EA, FM201EAP, FM201EB, FM201GA, FM201GAP, FM201GB, FM401EA, FM401EAP, FM401EB, FM401GA, FM401GAP, FM401GB, MM200EA, MM200EAP, MM200EB, MM200GA, MM200GAP, MM200GB...(Other models you can see in the webshop) |                |        |                 |       |



|  |                |        |                 |      |
|--|----------------|--------|-----------------|------|
| 1  | <b>GEV No.</b> | 346364 | <b>Ref. No.</b> | 3472 |
| <b>description</b> rotary disc red/white disc ø 20.6mm |                |        |                 |      |



|  |                |        |                 |      |
|--|----------------|--------|-----------------|------|
| 1  | <b>GEV No.</b> | 345605 | <b>Ref. No.</b> | 3473 |
| <b>description</b> switch 2CO 250V 16A connection male faston 6.3mm  |                |        |                 |      |
| <b>For models:</b> FC05G, FC05GU, FC06E, FC06EA, FC06EDG, FC06G, FC06GA, FC06GDG, FC06SE, FC06SEA, FC06SEDG, FC12E, FC12EA, FC12EDG, FC12G, FC12GA, FC12GDG, FC12SE, FC12SEA, FC12SEDG, FC200EA, FC200EAP, FC200EB, FC200GB, FC201EB, FC201GB, FC20E, FC20EA, FC20EDG, FC20G, FC20GA, FC20GDG, FC401EB, FC401GB, FDE10, FDE155, FDE155DG, FDE55, FDG10, FDG155, FDG155DG, FDG55, FDG55DG, FM06EB, FM06GB, FM10EB, FM10GB, FM200EA, FM200EAP, FM200EB...(Other models you can see in the webshop) |                |        |                 |      |





cam switches

4 operating positions



|                    |  |                 |      |
|--------------------|--|-----------------|------|
| 1                  |  |                 |      |
| <b>GEV No.</b>     | 300010   | <b>Ref. No.</b> | 0281 |
| <b>description</b> | cam switch 4 operating positions 2NO/2CO sequence 0-1-2-3 16A shaft ø 6x4.6mm shaft L 23mm connection male faston 6.3mm ceramic  |                 |      |
| <b>For models:</b> | FC05E, FC05EU, FC05G, FC05GU, FC06E, FC06EA, FC06EDG, FC06G, FC06GA, FC06GDG, FC06SE, FC06SEA, FC06SEDG, FC12E, FC12EA, FC12EDG, FC12G, FC12GA, FC12GDG, FC12SE, FC12SEA, FC12SEDG, FC200EB, FC200GB, FC201EB, FC201GB, FC20E, FC20EA, FC20EDG, FC20G, FC20GA, FC20GDG, FC401EB, FDE10, FDE155, FDE55, FDG10, FDG155, FDG55, FM200GB, FP05E, FP05EDG, FP05G, FP05GDG, FP10E, FP10EDG, FP10G, FP10GDG |                 |      |

5 operating positions

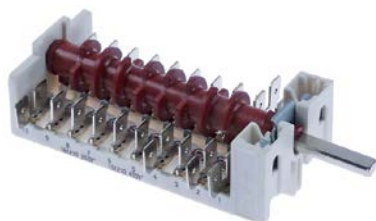

|                    |   |                 |      |
|--------------------|---|-----------------|------|
| 1                  |   |                 |      |
| <b>GEV No.</b>     | 347652  | <b>Ref. No.</b> | 3018 |
| <b>description</b> | cam switch 5 operating positions 5NO/2CO sequence 0-1-2-3-4 16A shaft ø 6x4.6mm shaft L 23mm connection male faston 6.3mm plastic   |                 |      |
| <b>For models:</b> | FM06EB, FM06GB, FM10EB, FM10GB, FM200EA, FM200EAP, FM200EB, FM200GA, FM200GAP, FM201EA, FM201EAP, FM201EB, FM201GA, FM201GAP, FM201GB, FM20EB, FM20GB, FM401EA, FM401EAP, FM401EB, FM401GA, FM401GAP, FM401GB, MM06EB, MM06GB, MM10EB, MM10GB, MM2/3EB, MM200EB, MM200GB, MM201EB, MM201GB, MM20EB, MM20GB, MM401GB |                 |      |

10 operating positions



|                    |  |                 |       |
|--------------------|--|-----------------|-------|
| 1                  |  |                 |       |
| <b>GEV No.</b>     | 301205   | <b>Ref. No.</b> | 10027 |
| <b>description</b> | cam switch 10 operating positions 5NO/1CO sequence 0-1-2-3-4-5-6-7-8-9 16A shaft ø 6x4.6mm shaft L 23mm connection male faston 6.3mm ceramic |                 |       |

operation switches



|                    |   |                 |      |
|--------------------|---|-----------------|------|
| 1                  |   |                 |      |
| <b>GEV No.</b>     | 300153  | <b>Ref. No.</b> | 0038 |
| <b>description</b> | cam switch 3 operating positions operation switch 16A sequence 0-1-2 shaft ø 6x4.6mm shaft L 23mm connection male faston 6.3mm plastic ambient temperature max. 240°C |                 |      |
| <b>For models:</b> | FE1-2, FE2-3  |                 |      |

magnetic switches

M10x0.75



|                    |  |                 |       |
|--------------------|--|-----------------|-------|
| 1                  |  |                 |       |
| <b>GEV No.</b>     | 348024   | <b>Ref. No.</b> | 10419 |
| <b>description</b> | magnetic switch 1NO 250V 1A P max. 10W connection Faston 6.3mm cable length 2000mm |                 |       |

accessories

magnets



|                    |   |                 |       |
|--------------------|---|-----------------|-------|
| 1                  |   |                 |       |
| <b>GEV No.</b>     | 348007  | <b>Ref. No.</b> | 10420 |
| <b>description</b> | magnet ø 23mm Lmm H 10mm Wmm ID ø 4.5mm ED ø 23mm M3 hole ø 4.5mm |                 |       |

encoders and potentiometers



|                    |                      |                 |                |
|--------------------|----------------------|-----------------|----------------|
| 1                  |                      |                 |                |
| <b>GEV No.</b>     | 401592               | <b>Ref. No.</b> | 10527<br>10566 |
| <b>description</b> | potentiometer 10KOhm |                 |                |



## lamps

## indicator lights

## indicator lights (complete)

ø10mm

## with plug-in socket



1

|                    |  |                 |      |
|--------------------|--|-----------------|------|
| <b>GEV No.</b>     | 359139   | <b>Ref. No.</b> | 0631 |
| <b>description</b> | indicator light ø 10mm green 230V connection male faston 6.3mm Qty 1 pcs   |                 |      |
| <b>For models:</b> | FC200EB, FC200GB, FC201EB, FC201GB, FC401EB, FC401GB, FDE10, FDE155, FDE55, FDG10, FDG155, FDG55, FM06EB, FM06GB, FM10EB, FM10GB, FM200GB, FM201EB, FM201GB, FM20EB, FM20GB, FM401EB, FM401GB, MM200EB, MM200GB, MM201EB, MM201GB, MM401GB |                 |      |



1

|                    |  |                 |      |
|--------------------|--|-----------------|------|
| <b>GEV No.</b>     | 359138   | <b>Ref. No.</b> | 0591 |
| <b>description</b> | indicator light ø 10mm red 230V connection male faston 6.3mm Qty 1 pcs   |                 |      |
| <b>For models:</b> | FC05E, FC05EU, FC05G, FC05GU, FC06E, FC06EA, FC06EDG, FC06G, FC06GA, FC06GDG, FC06SE, FC06SEA, FC06SEDG, FC12E, FC12EA, FC12EDG, FC12G, FC12GA, FC12GDG, FC12SE, FC12SEA, FC12SEDG, FC20E, FC20EA, FC20EDG, FC20G, FC20GA, FC20GDG, FE1-2, FE2-3, FM06EB, FM06GB, FM10EB, FM10GB, FM200EB, FM200GB, FM201EB, FM201GB, FM20EB, FM20GB, FM401EB, FM401GB, FP05E, FP05EDG, FP05G, FP05GDG, FP10E, FP10EDG, FP10G, FP10GDG |                 |      |



1

|                    |  |                 |      |
|--------------------|--|-----------------|------|
| <b>GEV No.</b>     | 359140   | <b>Ref. No.</b> | 0592 |
| <b>description</b> | indicator light ø 10mm yellow 230V connection male faston 6.3mm Qty 1 pcs  |                 |      |
| <b>For models:</b> | FC05E, FC05EU, FC05G, FC05GU, FC06E, FC06EA, FC06EDG, FC06G, FC06GA, FC06GDG, FC06SE, FC06SEA, FC06SEDG, FC12E, FC12EA, FC12EDG, FC12G, FC12GA, FC12GDG, FC12SE, FC12SEA, FC12SEDG, FC200EB, FC200GB, FC201EB, FC201GB, FC20E, FC20EA, FC20EDG, FC20G, FC20GA, FC20GDG, FC401EB, FC401GB, FDE10, FDE155, FDE155DG, FDE55, FDE55DG, FDG10, FDG155, FDG155DG, FDG55, FDG55DG, FE1-2, FE2-3, FM06EB, FM06GB, FM10EB, FM10GB...(Other models you can see in the webshop) |                 |      |

## screw-on/push-on fit

## light bulbs

## for ovens



1

|                    |  |                 |            |
|--------------------|--|-----------------|------------|
| <b>GEV No.</b>     | 359610   | <b>Ref. No.</b> | 35.0003.01 |
| <b>description</b> | light bulb t.max. 300°C socket E14 15W 230V ø 22mm L 47mm lens L 20mm for oven lamp type Philips   |                 |            |
| <b>For models:</b> | FC05E, FC05EU, FC05G, FC05GU, FC06E, FC06EA, FC06EDG, FC06G, FC06GA, FC06GDG, FC06SE, FC06SEA, FC06SEDG, FC12E, FC12EA, FC12EDG, FC12G, FC12GA, FC12GDG, FC12SE, FC12SEA, FC12SEDG, FC20E, FC20EA, FC20EDG, FC20G, FC20GA, FC20GDG, FE1-2, FE2-3, FP05E, FP05EDG, FP05G, FP05GDG, FP10E, FP10EDG, FP10G, FP10GDG |                 |            |



1

|                    |  |                 |      |
|--------------------|--|-----------------|------|
| <b>GEV No.</b>     | 359612   | <b>Ref. No.</b> | 3546 |
| <b>description</b> | light bulb t.max. 300°C socket E14 25W 230V ø 25mm L 56mm lens L 30mm for oven lamp type Philips   |                 |      |
| <b>For models:</b> | FM06EB, FM06EDG, FM06GB, FM06GDG, FM10EB, FM10EDG, FM10GB, FM10GDG, FM20EB, FM20EDG, FM20GB, FM20GDG, MM06EA, MM06EAP, MM06EB, MM06GA, MM06GAP, MM06GB, MM10EA, MM10EAP, MM10EB, MM10GA, MM10GAP, MM10GB, MM2/3EA, MM2/3EB, MM20EA, MM20EAP, MM20EB, MM20GA, MM20GAP, MM20GB |                 |      |

## halogen lamp

## for socket G4 / G6.35 / G9



1

|                    |   |                 |       |
|--------------------|---|-----------------|-------|
| <b>GEV No.</b>     | 359599  | <b>Ref. No.</b> | 10307 |
| <b>description</b> | halogen lamp socket G4 12V 20W temp.-resist. 500°C  |                 |       |
| <b>For models:</b> | FC200EA, FC200EAP, FC200EB, FC200GA, FC200GAP, FC200GB, FC201EA, FC201EAP, FC201EB, FC201GA, FC201GAP, FC201GB, FC401EA, FC401EAP, FC401EB, FC401GA, FC401GAP, FC401GB, FDE10, FDE155, FDE155DG, FDE55, FDE55DG, FDG10, FDG155, FDG155DG, FDG55, FDG55DG, FM200EA, FM200EAP, FM200EB, FM200GA, FM200GAP, FM200GB, FM201EA, FM201EAP, FM201EB, FM201GA, FM201GAP, FM201GB, FM401EA, FM401EAP, FM401EB, FM401GA, FM401GAP, FM401GB, MM200EA, MM200EAP, MM200EB, MM200GA...(Other models you can see in the webshop) |                 |       |

## oven lamps

## universal oven lamps



## mounting diameter 35.5mm



1



|                        |  |                 |                 |         |
|------------------------|--|-----------------|-----------------|---------|
| <b>GEV No.</b>         | 359701   | <b>Ref. No.</b> | 35.0002.01      |         |
| <b>description</b>     | lamp socket socket E14 220-230V mounting ø 35.5mm connection male faston 6.3mm 15W |                 |                 |         |
| <b>For models:</b>     | FC05E, FC05G, FC05GU, FE1-2  |                 |                 |         |
| <b>accessories for</b> | 359701   |                 |                 |         |
|                        | <b>GEV No.</b>   | 359705          | <b>Ref. No.</b> | —       |
|                        | oven lamp glass thr.ø 33.5mm ø 52mm hard glas temp.-resist. 350°C                  |                 |                 |         |
|                        | <b>GEV No.</b>   | 359709          | <b>Ref. No.</b> | —       |
|                        | oven lamp glass thr.ø 33.5mm ø 42mm hard glas temp.-resist. 350°C                  |                 |                 |         |
|                        | <b>GEV No.</b>   | 359721          | <b>Ref. No.</b> | 0812.01 |
|                        | gasket silicone ED ø 48mm ID ø 39.5mm thickness 5mm Qty 1 pcs                      |                 |                 |         |
|                        | <b>GEV No.</b>   | 359942          | <b>Ref. No.</b> | —       |
|                        | oven lamp glass thr.ø 33.5mm ø 41mm hard glas temp.-resist. 350°C                  |                 |                 |         |



|   |   |                 |                   |
|---|---|-----------------|-------------------|
|  |   |                 |                   |
| 1   |   |                 |                   |
| <b>GEV No.</b>  | 359661  | <b>Ref. No.</b> | 35000101          |
| <b>description</b>  | oven lamp glass thread 32.1 ø 58mm hard glas temp.-resist. 350°C      |                 |                   |
| <b>accessories for</b>  | 359661  |                 |                   |
|  | <b>GEV No.</b>  | 359700          | <b>Ref. No.</b> — |
|   | gasket for pizza oven fibre glass ID ø 32.5mm ED ø 55mm thickness 5mm |                 |                   |

|   |   |                 |         |
|---|---|-----------------|---------|
|  |   |                 |         |
| 1   |   |                 |         |
| <b>GEV No.</b>  | 359721  | <b>Ref. No.</b> | 0812.01 |
| <b>description</b>  | gasket silicone ED ø 48mm ID ø 39.5mm thickness 5mm Qty 1 pcs   |                 |         |
| <b>For models:</b>  | FC05E, FC05EU, FC05G, FC05GU, FC06E, FC06EA, FC06EDG, FC06G, FC06GA, FC06GDG, FC06SE, FC06SEA, FC06SEDG, FC12E, FC12EA, FC12EDG, FC12G, FC12GA, FC12GDG, FC12SE, FC12SEA, FC12SEDG, FC200EA, FC200EAP, FC200EB, FC200GA, FC200GAP, FC200GB, FC201EA, FC201EAP, FC201EB, FC201GA, FC201GAP, FC201GB, FC401EA, FC401EAP, FC401EB, FC401GA, FC401GAP, FC401GB, FE1-2, FE2-3, FM200EA, FM200EAP, FM200EB, FM200GA, FM200GAP, FM200GB, FM201EA, FM201EAP...(Other models you can see in the webshop) |                 |         |

|   |  |                 |                            |
|---|--|-----------------|----------------------------|
| mounting diameter 47.8mm  |  |                 |                            |
|  |  |                 |                            |
| 1   |  |                 |                            |
| <b>GEV No.</b>  | 359703   | <b>Ref. No.</b> | 10340                      |
| <b>description</b>  | oven lamp mounting ø 47.8mm 230V 15W socket E14 temp.-resist. 300°C connection male faston 6.3mm hard glas |                 |                            |
| <b>spare parts for</b>  | 359703   |                 |                            |
|  | <b>GEV No.</b>   | 359610          | <b>Ref. No.</b> 35.0003.01 |
|   | light bulb t.max. 300°C socket E14 15W 230V ø 22mm L 47mm lens L 20mm for oven lamp type Philips           |                 |                            |
|  | <b>GEV No.</b>   | 359725          | <b>Ref. No.</b> —          |
|   | oven lamp glass thread ø 44mm H 43mm ø 54mm hard glas temp.-resist. 350°C                                  |                 |                            |

|  |   |                 |                       |
|--|---|-----------------|-----------------------|
| 55x70mm  |   |                 |                       |
|  |   |                 |                       |
| 1  |   |                 |                       |
| <b>GEV No.</b>   | 359297  | <b>Ref. No.</b> | 10306                 |
| <b>description</b>   | frame L 95mm W 81mm mounting distance 68/83mm thickness 6mm |                 |                       |
| <b>For models:</b>   | FC05G, FC05GU   |                 |                       |
| <b>accessories for</b>   | 359297  |                 |                       |
|   | <b>GEV No.</b>  | 359299          | <b>Ref. No.</b> 10304 |
|  | gasket L 91mm W 77mm hole ø 3mm for oven lamp               |                 |                       |

|  |   |                 |       |
|--|---|-----------------|-------|
|  |   |                 |       |
| 1  |   |                 |       |
| <b>GEV No.</b>   | 359299  | <b>Ref. No.</b> | 10304 |
| <b>description</b>   | gasket L 91mm W 77mm hole ø 3mm for oven lamp |                 |       |
| <b>For models:</b>   | FC05G, FC05GU                                 |                 |       |

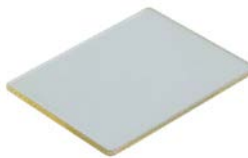
|   |  |                 |       |
|---|--|-----------------|-------|
|  |  |                 |       |
| 1   |  |                 |       |
| <b>GEV No.</b>  | 359296                                 | <b>Ref. No.</b> | 10305 |
| <b>description</b>  | lamp glass L 74mm W 58mm thickness 3mm |                 |       |
| <b>For models:</b>  | FC05G, FC05GU                          |                 |       |











|  |  |                 |                   |
|--|--|-----------------|-------------------|
| 55x100mm   |  |                 |                   |
|  |  |                 |                   |
| 1  |  |                 |                   |
| <b>GEV No.</b>   | 359698   | <b>Ref. No.</b> | 3542              |
| <b>description</b>   | lamp socket L 100mm W 55mm socket E14 connection male faston 6.3mm   |                 |                   |
| <b>For models:</b>   | FM06EB, FM06EDG, FM06GB, FM06GDG, FM10EB, FM10EDG, FM10GB, FM10GDG, FM20EB, FM20EDG, FM20GB, FM20GDG, MM06EA, MM06EAP, MM06EB, MM06GA, MM06GAP, MM06GB, MM10EA, MM10EAP, MM10EB, MM10GA, MM10GAP, MM10GB, MM2/3EA, MM2/3EB, MM20EA, MM20EAP, MM20EB, MM20GA, MM20GAP, MM20GB |                 |                   |
| <b>spare parts for</b>   | 359698   |                 |                   |
|   | <b>GEV No.</b>   | 358119          | <b>Ref. No.</b> — |
|  | frame L 118mm W 72mm mounting distance 143mm for bulb socket   |                 |                   |
|   | <b>GEV No.</b>   | 358122          | <b>Ref. No.</b> — |
|  | gasket L 112mm W 68mm silicone thickness 3mm for bulb socket   |                 |                   |
|   | <b>GEV No.</b>   | 358123          | <b>Ref. No.</b> — |
|  | lamp glass L 112mm W 68mm  |                 |                   |

Table continues overleaf

|  |                |        |                            |
|--|----------------|--------|----------------------------|
| <b>spare parts for</b> 359698  |                |        |                            |
|                 | <b>GEV No.</b> | 359612 | <b>Ref. No.</b> 3546       |
| light bulb t.max. 300°C socket E14 25W 230V ø 25mm L 56mm lens L 30mm for oven lamp type Philips |                |        |                            |
|                 | <b>GEV No.</b> | 359714 | <b>Ref. No.</b> 3543       |
| gasket for bulb socket   |                |        |                            |
|                 | <b>GEV No.</b> | 359715 | <b>Ref. No.</b> 3544       |
| lamp glass L 110mm W 65mm thickness 5mm  |                |        |                            |
|                 | <b>GEV No.</b> | 359716 | <b>Ref. No.</b> 1265A 3545 |
| frame for bulb socket  |                |        |                            |
| <b>accessories for</b> 359698  |                |        |                            |
|                 | <b>GEV No.</b> | 359612 | <b>Ref. No.</b> 3546       |
| light bulb t.max. 300°C socket E14 25W 230V ø 25mm L 56mm lens L 30mm for oven lamp type Philips |                |        |                            |
|                 | <b>GEV No.</b> | 359938 | <b>Ref. No.</b> —          |
| borosilicate glass L 115mm W 69mm  |                |        |                            |

|   |  |                 |            |
|---|--|-----------------|------------|
|  |  |                 |            |
| 1   |  |                 |            |
| <b>GEV No.</b>  | 359716   | <b>Ref. No.</b> | 1265A 3545 |
| <b>description</b>  | frame for bulb socket  |                 |            |
| <b>For models:</b>  | FC20E, FC20EA, FC20EDG, FC20G, FC20GA, FC20GDG, FM06EB, FM06EDG, FM06GB, FM06GDG, FM10EB, FM10EDG, FM10GB, FM10GDG, FM20EB, FM20EDG, FM20GB, FM20GDG, MM06EA, MM06EAP, MM06EB, MM06GA, MM06GAP, MM06GB, MM10EA, MM10EAP, MM10EB, MM10GA, MM10GAP, MM10GB, MM2/3EA, MM2/3EB, MM20EA, MM20EAP, MM20EB, MM20GA, MM20GAP, MM20GB |                 |            |

|   |  |                 |      |
|---|--|-----------------|------|
|  |  |                 |      |
| 1   |  |                 |      |
| <b>GEV No.</b>  | 359714   | <b>Ref. No.</b> | 3543 |
| <b>description</b>  | gasket for bulb socket   |                 |      |
| <b>For models:</b>  | FC20E, FC20EA, FC20EDG, FC20G, FC20GA, FC20GDG, FM06EB, FM06EDG, FM06GB, FM06GDG, FM10EB, FM10EDG, FM10GB, FM10GDG, FM20EB, FM20EDG, FM20GB, FM20GDG, MM06EA, MM06EAP, MM06EB, MM06GA, MM06GAP, MM06GB, MM10EA, MM10EAP, MM10EB, MM10GA, MM10GAP, MM10GB, MM2/3EA, MM2/3EB, MM20EA, MM20EAP, MM20EB, MM20GA, MM20GAP, MM20GB |                 |      |

|  |  |                 |      |
|--|--|-----------------|------|
|  |  |                 |      |
| 1  |  |                 |      |
| <b>GEV No.</b>   | 359715   | <b>Ref. No.</b> | 3544 |
| <b>description</b>   | lamp glass L 110mm W 65mm thickness 5mm  |                 |      |
| <b>For models:</b>   | FC20E, FC20EA, FC20EDG, FC20G, FC20GA, FC20GDG, FM06EB, FM06EDG, FM06GB, FM06GDG, FM10EB, FM10EDG, FM10GB, FM10GDG, FM20EB, FM20EDG, FM20GB, FM20GDG, MM06EA, MM06EAP, MM06EB, MM06GA, MM06GAP, MM06GB, MM10EA, MM10EAP, MM10EB, MM10GA, MM10GAP, MM10GB, MM2/3EB, MM20EA, MM20EAP, MM20EB, MM20GB |                 |      |



|  |  |                 |      |
|--|--|-----------------|------|
|  |  |                 |      |
| 1  |  |                 |      |
| <b>GEV No.</b>   | 359698   | <b>Ref. No.</b> | 3542 |
| <b>description</b>   | lamp socket L 100mm W 55mm socket E14 connection male faston 6.3mm   |                 |      |
| <b>For models:</b>   | FM06EB, FM06EDG, FM06GB, FM06GDG, FM10EB, FM10EDG, FM10GB, FM10GDG, FM20EB, FM20EDG, FM20GB, FM20GDG, MM06EA, MM06EAP, MM06EB, MM06GA, MM06GAP, MM06GB, MM10EA, MM10EAP, MM10EB, MM10GA, MM10GAP, MM10GB, MM2/3EA, MM2/3EB, MM20EA, MM20EAP, MM20EB, MM20GA, MM20GAP, MM20GB |                 |      |

|  |                |        |                            |
|--|----------------|--------|----------------------------|
| <b>spare parts for</b> 359698  |                |        |                            |
|               | <b>GEV No.</b> | 358119 | <b>Ref. No.</b> —          |
| frame L 118mm W 72mm mounting distance 143mm for bulb socket                                     |                |        |                            |
|               | <b>GEV No.</b> | 358122 | <b>Ref. No.</b> —          |
| gasket L 112mm W 68mm silicone thickness 3mm for bulb socket                                     |                |        |                            |
|               | <b>GEV No.</b> | 358123 | <b>Ref. No.</b> —          |
| lamp glass L 112mm W 68mm  |                |        |                            |
|               | <b>GEV No.</b> | 359612 | <b>Ref. No.</b> 3546       |
| light bulb t.max. 300°C socket E14 25W 230V ø 25mm L 56mm lens L 30mm for oven lamp type Philips |                |        |                            |
|               | <b>GEV No.</b> | 359714 | <b>Ref. No.</b> 3543       |
| gasket for bulb socket   |                |        |                            |
|               | <b>GEV No.</b> | 359715 | <b>Ref. No.</b> 3544       |
| lamp glass L 110mm W 65mm thickness 5mm  |                |        |                            |
|               | <b>GEV No.</b> | 359716 | <b>Ref. No.</b> 1265A 3545 |
| frame for bulb socket  |                |        |                            |
| <b>accessories for</b> 359698  |                |        |                            |
|               | <b>GEV No.</b> | 359612 | <b>Ref. No.</b> 3546       |
| light bulb t.max. 300°C socket E14 25W 230V ø 25mm L 56mm lens L 30mm for oven lamp type Philips |                |        |                            |
|               | <b>GEV No.</b> | 359938 | <b>Ref. No.</b> —          |
| borosilicate glass L 115mm W 69mm  |                |        |                            |

producer-specific oven lamps

FOINOX

|   |                     |                 |       |
|---|---------------------|-----------------|-------|
|  |                     |                 |       |
| 1   |                     |                 |       |
| <b>GEV No.</b>  | 359840              | <b>Ref. No.</b> | 40863 |
| <b>description</b>  | frame for oven lamp |                 |       |

|   |   |                 |       |
|---|---|-----------------|-------|
|  |   |                 |       |
| 1   |   |                 |       |
| <b>GEV No.</b>  | 359297  | <b>Ref. No.</b> | 10306 |
| <b>description</b>  | frame L 95mm W 81mm mounting distance 68/83mm thickness 6mm   |                 |       |
| <b>For models:</b>  | FC05G, FC05GU   |                 |       |
| <b>accessories for</b>  | 359297  |                 |       |
|   | <b>GEV No.</b>  | <b>Ref. No.</b> |       |
|   | 359299  | 10304           |       |
|   |  gasket L 91mm W 77mm hole ø 3mm for oven lamp |                 |       |

|   |   |                 |       |
|---|---|-----------------|-------|
|  |   |                 |       |
| 1   |   |                 |       |
| <b>GEV No.</b>  | 359299  | <b>Ref. No.</b> | 10304 |
| <b>description</b>  | gasket L 91mm W 77mm hole ø 3mm for oven lamp |                 |       |
| <b>For models:</b>  | FC05G, FC05GU                                 |                 |       |

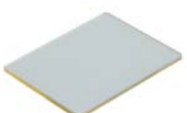
|   |  |                 |       |
|---|--|-----------------|-------|
|  |  |                 |       |
| 1   |  |                 |       |
| <b>GEV No.</b>  | 359296                                 | <b>Ref. No.</b> | 10305 |
| <b>description</b>  | lamp glass L 74mm W 58mm thickness 3mm |                 |       |
| <b>For models:</b>  | FC05G, FC05GU                          |                 |       |

|   |  |                 |       |
|---|--|-----------------|-------|
|  |  |                 |       |
| 1   |  |                 |       |
| <b>GEV No.</b>  | 359839                                 | <b>Ref. No.</b> | 10867 |
| <b>description</b>  | lamp socket socket G4 for halogen lamp |                 |       |

lamps

light bulbs

|   |  |                 |            |
|---|--|-----------------|------------|
|  |  |                 |            |
| 1   |  |                 |            |
| <b>GEV No.</b>  | 359610   | <b>Ref. No.</b> | 35.0003.01 |
| <b>description</b>  | light bulb t.max. 300°C socket E14 15W 230V ø 22mm L 47mm lens L 20mm for oven lamp type Philips   |                 |            |
| <b>For models:</b>  | FC05E, FC05EU, FC05G, FC05GU, FC06E, FC06EA, FC06EDG, FC06G, FC06GA, FC06GDG, FC06SE, FC06SEA, FC06SEDG, FC12E, FC12EA, FC12EDG, FC12G, FC12GA, FC12GDG, FC12SE, FC12SEA, FC12SEDG, FC20E, FC20EA, FC20EDG, FC20G, FC20GA, FC20GDG, FE1-2, FE2-3, FP05E, FP05EDG, FP05G, FP05GDG, FP10E, FP10EDG, FP10G, FP10GDG |                 |            |

|   |  |                 |      |
|---|--|-----------------|------|
|  |  |                 |      |
| 1   |  |                 |      |
| <b>GEV No.</b>  | 359612   | <b>Ref. No.</b> | 3546 |
| <b>description</b>  | light bulb t.max. 300°C socket E14 25W 230V ø 25mm L 56mm lens L 30mm for oven lamp type Philips   |                 |      |
| <b>For models:</b>  | FM06EB, FM06EDG, FM06GB, FM06GDG, FM10EB, FM10EDG, FM10GB, FM10GDG, FM20EB, FM20EDG, FM20GB, FM20GDG, MM06EA, MM06EAP, MM06EB, MM06GA, MM06GAP, MM06GB, MM10EA, MM10EAP, MM10EB, MM10GA, MM10GAP, MM10GB, MM2/3EA, MM2/3EB, MM20EA, MM20EAP, MM20EB, MM20GA, MM20GAP, MM20GB |                 |      |

halogen lamps

for socket G4 / G6.35 / G9

|   |  |                 |       |
|---|--|-----------------|-------|
|  |  |                 |       |
| 1   |  |                 |       |
| <b>GEV No.</b>  | 359599   | <b>Ref. No.</b> | 10307 |
| <b>description</b>  | halogen lamp socket G4 12V 20W temp.-resist. 500°C   |                 |       |
| <b>For models:</b>  | FC200EA, FC200EAP, FC200EB, FC200GA, FC200GAP, FC200GB, FC201EA, FC201EAP, FC201EB, FC201GA, FC201GAP, FC201GB, FC401EA, FC401EAP, FC401EB, FC401GA, FC401GAP, FC401GB, FDE10, FDE155, FDE155DG, FDE55, FDE55DG, FDG10, FDG155, FDG155DG, FDG55, FDG55DG, FM200EA, FM200EAP, FM200EB, FM200GA, FM200GAP, FM200GB, FM201EA, FM201EAP, FM201EB, FM201GA, FM201GAP, FM201GB, FM401EA, FM401EAP, FM401EB, FM401GA, FM401GAP, FM401GB, MM200EA, MM200EAP, MM200EB, MM200GA... (Other models you can see in the webshop) |                 |       |

sockets

G4 / G5,3 / G6,35

|   |  |                 |       |
|---|--|-----------------|-------|
|  |  |                 |       |
| 1   |  |                 |       |
| <b>GEV No.</b>  | 359646   | <b>Ref. No.</b> | 10308 |
| <b>description</b>  | lamp socket socket G4/G5.3/G6.35 24V ø 17mm H 15mm connection cable 130mm mounting distance 26mm for halogen lamp holder length 31mm cable length 130mm  |                 |       |
| <b>For models:</b>  | FC200EA, FC200EAP, FC200EB, FC200GA, FC200GAP, FC200GB, FC201EA, FC201EAP, FC201EB, FC201GA, FC201GAP, FC201GB, FC401EA, FC401EAP, FC401EB, FC401GA, FC401GAP, FC401GB, FDE10, FDE155, FDE155DG, FDE55, FDE55DG, FDG10, FDG155, FDG155DG, FDG55, FDG55DG, FM200EA, FM200EAP, FM200EB, FM200GA, FM200GAP, FM200GB, FM201EA, FM201EAP, FM201EB, FM201GA, FM201GAP, FM201GB, FM401EA, FM401EAP, FM401EB, FM401GA, FM401GAP, FM401GB, MM200EA, MM200EAP, MM200EB, MM200GA... (Other models you can see in the webshop) |                 |       |



## timers

## programme timers

|  |   |                 |                   |
|--|---|-----------------|-------------------|
|   |   |                 |                   |
| 1  |   |                 |                   |
| <b>GEV No.</b>   | 360339  | <b>Ref. No.</b> | 10039<br>10042    |
| <b>description</b>   | timer FIBER P25 engines 1 chambers 1 operation time 20s 230V shaft $\varnothing$ 6x4.6mm shaft L 20mm manuf. no. P255J01C1N4 motor type M51BJ0R6400   |                 |                   |
| <b>For models:</b>   | FC200EA, FC200EAP, FC200EB, FC200GA, FC200GAP, FC200GB, FC201EA, FC201EAP, FC201EB, FC201GA, FC201GAP, FC201GB, FC401EA, FC401EAP, FC401EB, FC401GA, FC401GAP, FC401GB, FM200EA, FM200EAP, FM200EB, FM200GA, FM200GAP, FM200GB, FM201EA, FM201EAP, FM201EB, FM201GA, FM201GAP, FM201GB, FM401EA, FM401EAP, FM401EB, FM401GA, FM401GAP, FM401GB, MM200EA, MM200EAP, MM200EB, MM200GA, MM200GAP, MM200GB, MM201EA, MM201EAP, MM201GA, MM201GAP, MM201GB, MM401EA, MM401EAP, MM401GA...(Other models you can see in the webshop) |                 |                   |
| <b>spare parts for</b>   | 360339  |                 |                   |
|  | <b>GEV No.</b>  | 360673          | <b>Ref. No.</b> — |
|  | motor kit pinion $\varnothing$ 6.8mm teeth 15 230V voltage AC 50/60Hz turn direction clockwise motor $\varnothing$ 48mm H 18.5mm motor type UDS-40NE1RNZ165 cable length 150mm with holder  |                 |                   |

## mechanical timers

|   |  |                 |                   |
|---|--|-----------------|-------------------|
|  |  |                 |                   |
| 1   |  |                 |                   |
| <b>GEV No.</b>  | 350003   | <b>Ref. No.</b> | 0039              |
| <b>description</b>  | timer M2 with bell 2-pole operation time 120min impulse mechanical 2NO at 250V 16A permanent position no shaft $\varnothing$ 6x4.6mm shaft 6x4.6mm shaft L 23mm mounting distance 28mm connection lateral  |                 |                   |
| <b>For models:</b>  | FC05E, FC05EU, FC05G, FC05GU, FC06E, FC06EA, FC06EDG, FC06G, FC06GA, FC06GDG, FC06SE, FC06SEA, FC06SEDG, FC12E, FC12EA, FC12EDG, FC12G, FC12GA, FC12GDG, FC12SE, FC12SEA, FC12SEDG, FC20E, FC20EA, FC20EDG, FC20G, FC20GA, FC20GDG, FDE10, FDE15S, FDE55, FDG10, FDG15S, FDG55, FP05E, FP05EDG, FP05G, FP05GDG, FP10E, FP10EDG, FP10G, FP10GDG |                 |                   |
| <b>accessories for</b>  | 350003   |                 |                   |
|  | <b>GEV No.</b>   | 110366          | <b>Ref. No.</b> — |
|   | knob switch zero mark t.max. $^{\circ}$ C $^{\circ}$ C $\varnothing$ 44mm shaft $\varnothing$ 6x4.6mm shaft flat upper black   |                 |                   |
|  | <b>GEV No.</b>   | 111199          | <b>Ref. No.</b> — |
|   | dial plate graduation 120min permanent position no rotation 0-330 $^{\circ}$ $\varnothing$ 60mm timers knob $\varnothing$ 45mm   |                 |                   |

|  |   |                 |                      |
|--|---|-----------------|----------------------|
|  |   |                 |                      |
| 1  |   |                 |                      |
| <b>GEV No.</b>   | 350008  | <b>Ref. No.</b> | 0050<br>3433<br>0050 |
| <b>description</b>   | timer M2 with bell 2-pole operation time 120min impulse mechanical 2NO at 250V 16A permanent position yes shaft $\varnothing$ 6x4.6mm shaft 6x4.6mm shaft L 24mm mounting distance 28mm connection lateral  |                 |                      |
| <b>For models:</b>   | FC05G, FC05GU, FC200EB, FC200GB, FC201EB, FC201GB, FC401EB, FC401GB, FE1-2, FE2-3, FM06EB, FM06GB, FM10EB, FM10GB, FM200EB, FM200GB, FM201EB, FM201GB, FM20EB, FM20GB, FM401EB, FM401GB, MM06EB, MM06GB, MM10EB, MM10GB, MM2/3EB, MM200EB, MM200GB, MM201EB, MM201GB, MM20EB, MM20GB, MM401GB |                 |                      |

## alarm devices

## alarm units

|  |  |                 |      |
|--|--|-----------------|------|
|  |  |                 |      |
| 1  |  |                 |      |
| <b>GEV No.</b>   | 350081   | <b>Ref. No.</b> | 0636 |
| <b>description</b>   | alarm device 9-15VDC H 14.5mm wall-mounted version 75dB protection IPx0  |                 |      |
| <b>For models:</b>   | FC06E, FC06EA, FC06EDG, FC06G, FC06GA, FC06GDG, FC06SE, FC06SEA, FC06SEDG, FC12E, FC12EA, FC12EDG, FC12G, FC12GA, FC12GDG, FC12SE, FC12SEA, FC12SEDG, FC20E, FC20EA, FC20EDG, FC20G, FC20GA, FC20GDG, FP05E, FP05EDG, FP05G, FP05GDG, FP10E, FP10EDG, FP10G, FP10GDG |                 |      |

## buzzers

|  |  |                 |      |
|--|--|-----------------|------|
|  |  |                 |      |
| 1  |  |                 |      |
| <b>GEV No.</b>   | 350050   | <b>Ref. No.</b> | 1553 |
| <b>description</b>   | buzzer 230VAC connection male faston 6.3mm screw mounting thread M4 60dB |                 |      |
| <b>For models:</b>   | FC05G, FC05GU  |                 |      |



## contactors

### SIEMENS

#### power contactors



1

**GEV No.** 380645      **Ref. No.** 10004

**description** power contactor 230VAC with auxiliary contacts



1

**GEV No.** 381387      **Ref. No.** 10001

**description** power contactor resistive load 22A 230VAC (AC3/400V) 4kW main contacts 3NO auxiliary contacts 1NO connection screw connection type 3RT2016-1AP01



1

**GEV No.** 380389      **Ref. No.** 10001

**description** power contactor resistive load 22A 230VAC (AC3/400V) 9A/4kW main contacts 3NO auxiliary contacts 1NO connection screw connection type 3RT10-16-1AP01

#### overload switches



1

**GEV No.** 381002      **Ref. No.** 10003

**description** overload switch setting range 1.8-2.5A

## relays

### power relays

#### with male contacts

#### female contact 2.0mm



1

**GEV No.** 380642      **Ref. No.** 10504

**description** power relays 230VAC connection 2.0 plug-in connection

**For models:** MM06EB, MM06GB, MM10EB, MM10GB, MM2/3EB, MM20EB, MM20GB

**accessories for** 380642



**GEV No.** 380378      **Ref. No.** 10509

**description** relay socket 2-pole 55/85 dimensions 70.5x30x27mm 250V voltage AC 10A FINDER manuf. no. 94.72



**GEV No.** 380384      **Ref. No.** —

**description** relay socket 2-pole contacts male faston 2.8mm 250V voltage AC 10A W 23mm for



**GEV No.** 380399      **Ref. No.** —

**description** relay socket 4-pole dimensions 76.2x27x86.1mm 250V voltage AC 1A FINDER manuf. no. 94.94.3

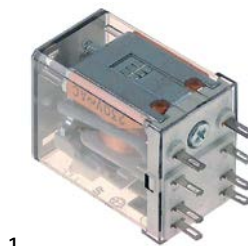

1

**GEV No.** 380377      **Ref. No.** 10507

**description** power relays FINDER 220-240VAC 10A 2CO connection F2 plug-in connection manuf. no. 55.32.8.230.0000 94.92.3 250V

**For models:** FM200EA, FM200EAP, FM200EB, FM200GA, FM200GAP, FM200GB, FM201EA, FM201EAP, FM201EB, FM201GA, FM201GAP, FM201GB, FM401EA, FM401EAP, FM401EB, FM401GA, FM401GAP, FM401GB, MM200EB, MM200GB, MM201EB, MM401GB

**accessories for** 380377



**GEV No.** 380341      **Ref. No.** —

**description** relay socket 4-pole contacts 12 300V voltage AC 6A Italiana Relè manuf. no. ZMD4



**GEV No.** 380378      **Ref. No.** 10509

**description** relay socket 2-pole 55/85 dimensions 70.5x30x27mm 250V voltage AC 10A FINDER manuf. no. 94.72



**GEV No.** 380384      **Ref. No.** —

**description** relay socket 2-pole contacts male faston 2.8mm 250V voltage AC 10A W 23mm for



**GEV No.** 380399      **Ref. No.** —

**description** relay socket 4-pole dimensions 76.2x27x86.1mm 250V voltage AC 1A FINDER manuf. no. 94.94.3

relay sockets



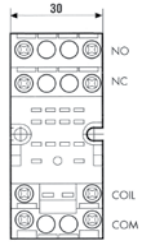

1

|                    |  |                 |       |
|--------------------|--|-----------------|-------|
| <b>GEV No.</b>     | 380641   | <b>Ref. No.</b> | 10505 |
| <b>description</b> | relay socket                                   |                 |       |
| <b>For models:</b> | MM06EB, MM06GB, MM10EB, MM10GB, MM20EB, MM20GB |                 |       |

1

|   |   |                 |                   |
|---|---|-----------------|-------------------|
| <b>GEV No.</b>  | 380378  | <b>Ref. No.</b> | 10509             |
| <b>description</b>  | relay socket 2-pole 55/85 dimensions 70.5x30x27mm 250V voltage AC 10A FINDER manuf. no. 94.72   |                 |                   |
| <b>For models:</b>  | FM200EA, FM200EAP, FM200EB, FM200GA, FM200GAP, FM200GB, FM201EA, FM201EAP, FM201EB, FM201GA, FM201GAP, FM201GB, FM401EA, FM401EAP, FM401EB, FM401GA, FM401GAP, FM401GB, MM200EB, MM200GB, MM201EB, MM201GB, MM401GB |                 |                   |
| <b>accessories for</b>  | 380378  |                 |                   |
|  | <b>GEV No.</b>  | 380804          | <b>Ref. No.</b> — |
|   | support bracket   |                 |                   |



1

|                    |  |                 |       |
|--------------------|--|-----------------|-------|
| <b>GEV No.</b>     | 380638   | <b>Ref. No.</b> | 10503 |
| <b>description</b> | relay socket 8-pole dimensions 51x41x23mm 250V 10A FINDER manuf. no. 90.26 |                 |       |
| <b>For models:</b> | MM06EB, MM06GB, MM10EB, MM10GB, MM2/3EB, MM20EB, MM20GB                    |                 |       |

level relays

GICAR



1



|                    |  |                 |       |
|--------------------|--|-----------------|-------|
| <b>GEV No.</b>     | 401224   | <b>Ref. No.</b> | 10532 |
| <b>description</b> | level relay 230V connection F6.3 type RL30/3ES/F/G |                 |       |
| <b>For models:</b> | FM200EB, FM200GB, FM201EB                          |                 |       |

time relays

time relays



1

|   |   |                 |                       |
|---|---|-----------------|-----------------------|
| <b>GEV No.</b>  | 380329  | <b>Ref. No.</b> | 10508                 |
| <b>description</b>  | time relay FIBER 85.02.8.240 time range 0.05s - 100h 230-240VAC 10A mounting measurements 20.6x27.7mm 2CO connection 2.0  |                 |                       |
| <b>For models:</b>  | FM200EA, FM200EAP, FM200EB, FM200GA, FM200GAP, FM200GB, FM201EA, FM201EAP, FM201EB, FM201GA, FM201GAP, FM201GB, FM401EA, FM401EAP, FM401EB, FM401GA, FM401GAP, FM401GB, MM200EB, MM200GB, MM201EB, MM201GB, MM401GB |                 |                       |
| <b>accessories for</b>  | 380329  |                 |                       |
|  | <b>GEV No.</b>  | 380378          | <b>Ref. No.</b> 10509 |
|   | relay socket 2-pole 55/85 dimensions 70.5x30x27mm 250V voltage AC 10A FINDER manuf. no. 94.72   |                 |                       |
|  | <b>GEV No.</b>  | 380803          | <b>Ref. No.</b> —     |
|   | relay socket 2-pole dimensions 76.2x27x86.1mm 250V voltage AC 10A FINDER manuf. no. 94.92.3   |                 |                       |



1

|   |   |                 |                       |
|---|---|-----------------|-----------------------|
| <b>GEV No.</b>  | 380639  | <b>Ref. No.</b> | 10501                 |
| <b>description</b>  | time relay TECNOLOGIC RTR12DS06S time range 6s 230VAC 5A mounting measurements 34x34mm 1CO connection plug-in connection round 8-pole |                 |                       |
| <b>For models:</b>  | MM06EB, MM06GB, MM10EB, MM10GB, MM2/3EB, MM20EB, MM20GB   |                 |                       |
| <b>accessories for</b>  | 380639  |                 |                       |
|  | <b>GEV No.</b>  | 380638          | <b>Ref. No.</b> 10503 |
|   | relay socket 8-pole dimensions 51x41x23mm 250V 10A FINDER manuf. no. 90.26  |                 |                       |



1

|   |  |                 |       |
|---|--|-----------------|-------|
| <b>GEV No.</b>  | 380640   | <b>Ref. No.</b> | 10502 |
| <b>description</b>  | time relay TECNOLOGIC RTR12DS60S time range 60s 230VAC 5A 1CO connection plug-in connection round 8-pole |                 |       |
| <b>For models:</b>  | MM06EB, MM06GB, MM10EB, MM10GB, MM2/3EB, MM20EB, MM20GB  |                 |       |
| <b>accessories for</b>  | 380640   |                 |       |
|   | <b>GEV No.</b>   | <b>Ref. No.</b> |       |
|  | 380638   | 10503           |       |
|   | relay socket 8-pole dimensions 51x41x23mm 250V 10A FINDER manuf. no. 90.26                               |                 |       |



1

|                    |  |                 |      |
|--------------------|--|-----------------|------|
| <b>GEV No.</b>     | 379054   | <b>Ref. No.</b> | 1551 |
| <b>description</b> | transformer primary 230VAC secondary 12VAC 3VA secondary 0.25A H 40mm L 45mm W 50mm connection screw 50/60Hz type 153/M  |                 |      |
| <b>For models:</b> | FC06E, FC06EA, FC06EDG, FC06G, FC06GA, FC06GDG, FC06SE, FC06SEA, FC06SEDG, FC12E, FC12EA, FC12EDG, FC12G, FC12GA, FC12GDG, FC12SE, FC12SEA, FC12SEDG, FC200EB, FC200GB, FC201EB, FC201GB, FC20E, FC20EA, FC20EDG, FC20G, FC20GA, FC20GDG, FC401EB, FC401GB, FM06EB, FM06GB, FM10EB, FM10GB, FM200EB, FM200GB, FM201EB, FM201GB, FM20EB, FM20GB, FM401EB, FM401GB, FP05E, FP05EDG, FP05G, FP05GDG, FP10E, FP10EDG, FP10G, FP10GDG...(Other models you can see in the webshop) |                 |      |

## transformers

### open transformers

#### with clamp terminal



1

|                    |  |                 |                |
|--------------------|--|-----------------|----------------|
| <b>GEV No.</b>     | 401229   | <b>Ref. No.</b> | 10323<br>10324 |
| <b>description</b> | transformer primary 230V secondary 12V 63VA  |                 |                |
| <b>For models:</b> | FC200EA, FC200EAP, FC200EB, FC200GA, FC200GAP, FC200GB, FDG55, FDG55DG, MM200EA, MM200EAP, MM200EB, MM200GA, MM200GAP, MM200GB |                 |                |

### encapsulated transformers

#### PMA



1

|                    |  |                 |      |
|--------------------|--|-----------------|------|
| <b>GEV No.</b>     | 379196   | <b>Ref. No.</b> | 0635 |
| <b>description</b> | transformer primary 230VAC secondary 12VAC 10VA secondary 0.8A connection screw 50Hz   |                 |      |
| <b>For models:</b> | FC06E, FC06EA, FC06EDG, FC06G, FC06GA, FC06GDG, FC06SE, FC06SEA, FC06SEDG, FC12E, FC12EA, FC12EDG, FC12G, FC12GA, FC12GDG, FC12SE, FC12SEA, FC12SEDG, FC20E, FC20EA, FC20EDG, FC20G, FC20GA, FC20GDG, FM200EA, FM200EAP, FM200GA, FM200GAP, FM201EA, FM201EAP, FM201GA, FM201GAP, FM401EA, FM401EAP, FM401GA, FM401GAP, FP05E, FP05EDG, FP05G, FP05GDG, FP10E, FP10EDG, FP10G, FP10GDG |                 |      |

## electronic controllers





### EVCO - EVERY CONTROL

#### universal controllers

##### built-in version



1

|   |  |                 |      |
|---|--|-----------------|------|
| <b>GEV No.</b>  | 378131   | <b>Ref. No.</b> | 1549 |
| <b>description</b>  | electronic controller EVERY CONTROL EVK411M mounting measurements 71x29mm 12V voltage AC/DC NTC/PTC/Pt100/Pt1000 relay outputs 1 CO-16A(8) NTC/PTC/Pt100/Pt1000/TC(J,K)/mV/mA yes protection IP65 dependent on probe°C display 3½ digits   |                 |      |
| <b>For models:</b>  | FC06E, FC06EA, FC06EDG, FC06G, FC06GA, FC06GDG, FC06SE, FC06SEA, FC06SEDG, FC12E, FC12EA, FC12EDG, FC12G, FC12GA, FC12GDG, FC12SE, FC12SEA, FC12SEDG, FC200EB, FC200GB, FC201EB, FC201GB, FC20E, FC20EA, FC20EDG, FC20G, FC20GA, FC20GDG, FC401EB, FC401GB, FM06EB, FM06GB, FM10EB, FM10GB, FM200EB, FM200GB, FM201EB, FM201GB, FM20EB, FM20GB, FM401EB, FM401GB, FP05E, FP05EDG, FP05G, FP05GDG, FP10E, FP10EDG, FP10G, FP10GDG...(Other models you can see in the webshop) |                 |      |
| <b>accessories for</b>  | 378131   |                 |      |
|   | <b>GEV No.</b>   | <b>Ref. No.</b> |      |
|  | 379050   | 0634            |      |
|   | temperature probe Pt100 cable Vetrotex probe -200 up to +600°C cable -50 up to +350°C probe ø6x100mm cable length 2.7m without screw connection 3-wire   |                 |      |
|   | <b>GEV No.</b>   | <b>Ref. No.</b> | —    |
|  | 379160   |                 |      |
|   | temperature probe NTC 10kOhm cable thermoplastic probe -40 up to +110°C cable -40 up to +110°C probe ø6x14mm cable length 1.5m without screw connection 2-wire   |                 |      |
|   | <b>GEV No.</b>   | <b>Ref. No.</b> | —    |
|  | 379781   |                 |      |
|   | temperature probe PTC 1kOhm cable thermoplastic probe -50 up to +150°C cable -40 up to +110°C probe ø6x14mm cable length 1.5m without screw connection 2-wire  |                 |      |
|   | <b>GEV No.</b>   | <b>Ref. No.</b> | —    |
|  | 379944   |                 |      |
|   | temperature probe Pt1000 cable Vetrotex probe -70 up to +500°C cable -50 up to +350°C connection 2-wire thread probe ø6x180mm cable length 1.7m  |                 |      |



# SHANGFANG

## accessories



|                    |  |                 |      |
|--------------------|--|-----------------|------|
| <b>GEV No.</b>     | 379054   | <b>Ref. No.</b> | 1551 |
| <b>description</b> | transformer primary 230VAC secondary 12VAC 3VA secondary 0.25A H 40mm L 45mm W 50mm connection screw 50/60Hz type 153/M  |                 |      |
| <b>For models:</b> | FC06E, FC06EA, FC06EDG, FC06G, FC06GA, FC06GDG, FC06SE, FC06SEA, FC06SEDG, FC12E, FC12EA, FC12EDG, FC12G, FC12GA, FC12GDG, FC12SE, FC12SEA, FC12SEDG, FC200EB, FC200GB, FC201EB, FC201GB, FC20E, FC20EA, FC20EDG, FC20G, FC20GA, FC20GDG, FC401EB, FC401GB, FM06EB, FM06GB, FM10EB, FM10GB, FM200EB, FM200GB, FM201EB, FM201GB, FM20EB, FM20GB, FM401EB, FM401GB, FP05E, FP05EDG, FP05G, FP05GDG, FP10E, FP10EDG, FP10G, FP10GDG...(Other models you can see in the webshop) |                 |      |

## core probes



|                    |   |                 |       |
|--------------------|---|-----------------|-------|
| <b>GEV No.</b>     | 379945  | <b>Ref. No.</b> | 10402 |
| <b>description</b> | core temperature probe Pt100 cable PTFE probe -40 up to +250°C cable -40 up to +250°C connection plug probe ø3.5x100mm thread cable length 0.5m handle ø 10mm handle length 80mm  |                 |       |
| <b>For models:</b> | FC06E, FC06EA, FC06EDG, FC12E, FC12EA, FC12EDG, FC12G, FC12GA, FC12GDG, FC12SE, FC12SEA, FC12SEDG, FC20E, FC20EA, FC20EDG, FC20G, FC20GA, FC20GDG, FM10EB, FM10GB, FM20EB, FM20GB, FP10E, FP10EDG, FP10G, FP10GDG, MM06EA, MM06EAP, MM06EB, MM06GA, MM06GAP, MM10EA, MM10EAP, MM10EB, MM10GA, MM10GAP, MM20EA, MM20EAP, MM20EB, MM20GA, MM20GAP, MM20GB |                 |       |

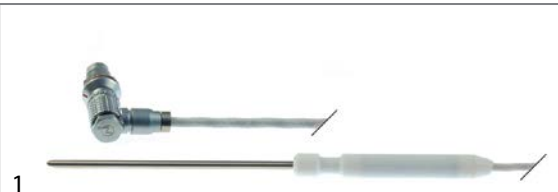

|                    |  |                 |       |
|--------------------|--|-----------------|-------|
| <b>GEV No.</b>     | 379946   | <b>Ref. No.</b> | 10401 |
| <b>description</b> | core temperature probe Pt100 cable PTFE probe -40 up to +250°C cable -40 up to +250°C connection plug probe ø3.5x100mm thread cable length 0.7m handle ø 10mm handle length 80mm |                 |       |
| <b>For models:</b> | FC06G, FC06GA, FC06GDG, FC06SE, FC06SEA, FC06SEDG, FM06EB, FM06GB, FP05E, FP05EDG, FP05G, FP05GDG, MM2/3EA   |                 |       |



|                    |   |                 |                |
|--------------------|---|-----------------|----------------|
| <b>GEV No.</b>     | 379947  | <b>Ref. No.</b> | 10405<br>10406 |
| <b>description</b> | core temperature probe Pt100 cable PTFE probe -40 up to +250°C cable -40 up to +250°C connection plug probe ø3.5x100mm thread cable length 1.2m handle ø 10mm handle length 80mm  |                 |                |
| <b>For models:</b> | FC200EA, FC200EAP, FC200EB, FC200GA, FC200GAP, FC200GB, FC201EA, FC201EAP, FC201EB, FC201GA, FC201GAP, FC201GB, FC401EA, FC401EAP, FC401EB, FC401GA, FC401GAP, FC401GB, FM200EA, FM200EAP, FM200EB, FM200GA, FM200GAP, FM200GB, FM201EA, FM201EAP, FM201EB, FM201GA, FM201GAP, FM201GB, FM401EA, FM401EAP, FM401EB, FM401GA, FM401GAP, FM401GB, MM200EA, MM200EAP, MM200EB, MM200GA, MM200GAP, MM200GB, MM201EA, MM201EAP, MM201EB, MM201GA, MM201GAP, MM201GB, MM401EA, MM401EAP...(Other models you can see in the webshop) |                 |                |

## probes

### universal probes

#### temperature probes



|                    |  |                 |      |
|--------------------|--|-----------------|------|
| <b>GEV No.</b>     | 379050 <sup>1</sup>  | <b>Ref. No.</b> | 0634 |
| <b>description</b> | temperature probe Pt100 cable Vetrotex probe -200 up to +600°C cable -50 up to +350°C probe ø6x100mm cable length 2.7m without screw connection 3-wire |                 |      |

<sup>1</sup>3-wire



|                    |  |                 |       |
|--------------------|--|-----------------|-------|
| <b>GEV No.</b>     | 378067   | <b>Ref. No.</b> | 70401 |
| <b>description</b> | temperature probe PTC 1kOhm cable silicone probe -50 up to +150°C cable -50 up to +180°C probe ø6x40mm cable length 2m without screw connection 2-wire |                 |       |

### producer-specific probes

#### probes



|                    |  |                 |       |
|--------------------|--|-----------------|-------|
| <b>GEV No.</b>     | 402154   | <b>Ref. No.</b> | 10411 |
| <b>description</b> | temperature probe Pt100 cable silicone probe -100 up to 450°C cable -50 up to +180°C connection 3-wire thread 1/8" probe ø6x35mm cable length 1.5m |                 |       |



|                    |   |                 |       |
|--------------------|---|-----------------|-------|
| 1                  |   |                 |       |
| <b>GEV No.</b>     | 379350 <sup>1</sup>   | <b>Ref. No.</b> | 70404 |
| <b>description</b> | core temperature probe PTC 1kOhm cable silicone probe -40 up to +120°C cable -50 up to +180°C connection plug probe ø4x100mm thread cable length 1.7m handle ø 8mm handle length 120/35mm L1 120mm L2 130mm |                 |       |

<sup>1</sup> multipoint probe



|                    |  |                 |        |
|--------------------|--|-----------------|--------|
| 1                  |  |                 |        |
| <b>GEV No.</b>     | 379662 <sup>1</sup>  | <b>Ref. No.</b> | 70402A |
| <b>description</b> | core temperature probe PTC 1kOhm cable silicone probe -40 up to +120°C cable -50 up to +180°C connection plug probe ø4x70mm thread cable length 1.3m handle ø 16mm handle length 120mm L1 120mm L2 130mm |                 |        |

<sup>1</sup> multipoint probe



|                    |   |                 |                 |
|--------------------|---|-----------------|-----------------|
| 1                  |   |                 |                 |
| <b>GEV No.</b>     | 379806 <sup>1</sup>   | <b>Ref. No.</b> | 70405<br>70405A |
| <b>description</b> | core temperature probe PTC 1kOhm cable silicone probe -40 up to +120°C cable -50 up to +180°C connection plug probe ø5x70mm thread cable length 1.2m handle ø 16mm handle length 125mm L1 170mm L2 65mm |                 |                 |

<sup>1</sup> multipoint probe

|                    |  |                 |      |
|--------------------|--|-----------------|------|
| 1                  |  |                 |      |
| <b>GEV No.</b>     | 379948   | <b>Ref. No.</b> | 3566 |
| <b>description</b> | core temperature probe thermocouple J (Fe-CuNi) cable SS corrugated hose probe -40 up to +250°C cable -40 up to +250°C connection 1/8" probe ø3.5x100mm thread 1/8" cable length 1.8m handle ø 10mm handle length 80mm |                 |      |
| <b>For models:</b> | FM06EDG, FM06GDG   |                 |      |

|                    |   |                 |      |
|--------------------|---|-----------------|------|
| 1                  |   |                 |      |
| <b>GEV No.</b>     | 379951  | <b>Ref. No.</b> | 3567 |
| <b>description</b> | temperature probe thermocouple J (Fe-CuNi) cable SS corrugated hose probe -40 up to +250°C cable -40 up to +250°C connection 2-wire probe ø3.5x100mm thread 1/8" cable length 2.1m handle ø 10mm handle length 80mm |                 |      |
| <b>For models:</b> | FM10EDG, FM10GDG, FM20EDG, FM20GDG  |                 |      |

## electronics

### EPROMS



|                    |                      |                 |       |
|--------------------|----------------------|-----------------|-------|
| 1                  |                      |                 |       |
| <b>GEV No.</b>     | 403201               | <b>Ref. No.</b> | 10547 |
| <b>description</b> | EPROM type FOCABO 59 |                 |       |

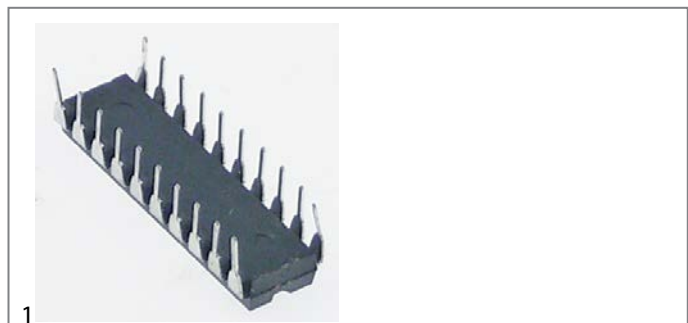

|                    |                      |                 |       |
|--------------------|----------------------|-----------------|-------|
| 1                  |                      |                 |       |
| <b>GEV No.</b>     | 403062               | <b>Ref. No.</b> | 10550 |
| <b>description</b> | EPROM type FOCABO P5 |                 |       |



PCBs

1



|                    |             |                 |       |
|--------------------|-------------|-----------------|-------|
| <b>GEV No.</b>     | 401042      | <b>Ref. No.</b> | 10029 |
| <b>description</b> | display PCB |                 |       |

1

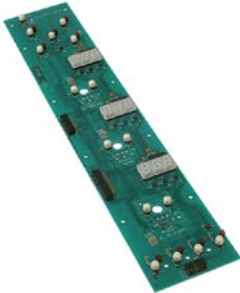

|                    |  |                 |       |
|--------------------|--|-----------------|-------|
| <b>GEV No.</b>     | 401245   | <b>Ref. No.</b> | 10536 |
| <b>description</b> | keypad PCB   |                 |       |
| <b>For models:</b> | FC12E, FC12EA, FC12EDG, FC12G, FC12GA, FC12GDG, FC12SE, FC12SEA, FC12SEDG, FC200EA, FC200EAP, FC200GA, FC200GAP, FC201EA, FC201EAP, FC20E, FC20EA, FC20EDG, FC20G, FC20GA, FC20GDG, FC401EA, FC401EAP, FC401GA, FC401GAP, FDE10, FDE155DG, FDE55DG, FDG10, FDG155DG, FDG55DG, FM200EA, FM200EAP, FM200GA, FM200GAP, FM201EA, FM201EAP, FM201GA, FM201GAP, FM401EA, FM401EAP, FM401GA, FM401GAP, MM06EA, MM06EAP, MM06GA, MM06GAP, MM10EA, MM10EAP, MM10GA... (Other models you can see in the webshop) |                 |       |

1



|                    |                    |                 |       |
|--------------------|--------------------|-----------------|-------|
| <b>GEV No.</b>     | 401569             | <b>Ref. No.</b> | 10563 |
| <b>description</b> | keypad PCB         |                 |       |
| <b>For models:</b> | MM201ED, MM201ESAC |                 |       |

1



|                    |            |                 |       |
|--------------------|------------|-----------------|-------|
| <b>GEV No.</b>     | 403061     | <b>Ref. No.</b> | 10513 |
| <b>description</b> | keypad PCB |                 |       |

1



|                    |  |                 |      |
|--------------------|--|-----------------|------|
| <b>GEV No.</b>     | 401219   | <b>Ref. No.</b> | 0614 |
| <b>description</b> | keypad PCB convection oven FC06/12/20  |                 |      |
| <b>For models:</b> | FC06E, FC06EA, FC06EDG, FC06G, FC06GA, FC06GDG, FC06SE, FC06SEA, FC06SEDG, FC12E, FC12EA, FC12EDG, FC12G, FC12GA, FC12GDG, FC12SE, FC12SEA, FC12SEDG, FC20E, FC20EA, FC20EDG, FC20G, FC20GA, FC20GDG, FP05E, FP05EDG, FP05G, FP05GDG, FP10E, FP10EDG, FP10G, FP10GDG |                 |      |

1



|                    |        |                 |       |
|--------------------|--------|-----------------|-------|
| <b>GEV No.</b>     | 402318 | <b>Ref. No.</b> | 10555 |
| <b>description</b> | PCB    |                 |       |

1





|                    |   |                 |       |
|--------------------|---|-----------------|-------|
| <b>GEV No.</b>     | 402930  | <b>Ref. No.</b> | 10565 |
| <b>description</b> | PCB combi-steamer LCM06/M100 L 110mm W 80mm Fan Reversal Card |                 |       |

1



|                    |   |                 |       |
|--------------------|---|-----------------|-------|
| <b>GEV No.</b>     | 403473  | <b>Ref. No.</b> | 10672 |
| <b>description</b> | PCB combi-steamer LCM06/M100 L 95mm W 79mm H 43mm Fan Reversal Card |                 |       |



|   |  |                 |                       |
|---|--|-----------------|-----------------------|
|  |  |                 |                       |
| 1   |  |                 |                       |
| <b>GEV No.</b>  | 401566                                   | <b>Ref. No.</b> | 10524                 |
| <b>description</b>  | power PCB without EPROM type CQB 324(02) |                 |                       |
| <b>accessories for</b>  | 401566                                   |                 |                       |
|  | <b>GEV No.</b>                           | 403062          | <b>Ref. No.</b> 10550 |
|   | EPROM type FOCABO P5                     |                 |                       |
|  | <b>GEV No.</b>                           | 403201          | <b>Ref. No.</b> 10547 |
|   | EPROM type FOCABO 59                     |                 |                       |

## solenoid valves

### solenoid valves (water)

|  |   |                 |      |
|--|---|-----------------|------|
| RPE  |   |                 |      |
|  |   |                 |      |
| 1  |   |                 |      |
| <b>GEV No.</b>   | 374021  | <b>Ref. No.</b> | 1363 |
| <b>description</b>   | solenoid valve double straight 230VAC inlet 3/4" outlet 10mm DN10 RPE   |                 |      |
| <b>For models:</b>   | FC201EA, FC201EAP, FC201EB, FC201GA, FC201GAP, FC201GB, FC20E, FC20EA, FC20EDG, FC20G, FC20GA, FC20GDG, FC401EA, FC401EAP, FC401EB, FC401GA, FC401GAP, FC401GB, FM06EB, FM06EDG, FM06GB, FM06GDG, FM10EB, FM10EDG, FM10GB, FM10GDG, FM20EB, FM20EDG, FM20GB, FM20GDG, MM201EA, MM201EAP, MM201EB, MM201GA, MM201GAP, MM201GB, MM401EA, MM401EAP, MM401GA, MM401GAP, MM401GB |                 |      |



|   |   |                 |      |
|---|---|-----------------|------|
|  |   |                 |      |
| 1   |   |                 |      |
| <b>GEV No.</b>  | 374017  | <b>Ref. No.</b> | 0282 |
| <b>description</b>  | solenoid valve single straight 230VAC inlet 3/4" outlet 10mm input 6l/min DN10 RPE polyamide flow regulating valve inlet white membranes NBR pressure range 0.2-10bar   |                 |      |
| <b>For models:</b>  | FC05E, FC05EU, FC05G, FC05GU, FC06E, FC06EA, FC06EDG, FC06G, FC06GA, FC06GDG, FC06SE, FC06SEADG, FC12E, FC12EA, FC12EDG, FC12G, FC12GA, FC12GDG, FC12SE, FC12SEA, FC12SEADG, FC200EA, FC200EAP, FC200EB, FC200GA, FC200GAP, FC200GB, FC201EA, FC201EAP, FC201EB, FC201GA, FC201GAP, FC201GB, FC401EA, FC401EAP, FC401EB, FC401GA, FC401GAP, FC401GB, FDE10, FDE155, FDE155DG, FDE55, FDE55DG, FDG10, FDG155, FDG155DG, FDG55, FDG55DG...(Other models you can see in the webshop) |                 |      |

|   |  |                 |       |
|---|--|-----------------|-------|
| reducers  |  |                 |       |
| outlet side   |  |                 |       |
|  |  |                 |       |
| 1   |  |                 |       |
| <b>GEV No.</b>  | 371269   | <b>Ref. No.</b> | 13001 |
| <b>description</b>  | reducer flow rate 0.07-0.14l/min brown   |                 |       |
| <b>For models:</b>  | MM06EA, MM06EAP, MM06GA, MM06GAP, MM06GB, MM10EA, MM10EAP, MM10GA, MM10GAP, MM10GB, MM20EA, MM20EAP, MM20EB, MM20GA, MM20GAP, MM20GB |                 |       |

|   |   |                 |      |
|---|---|-----------------|------|
|  |   |                 |      |
| 1   |   |                 |      |
| <b>GEV No.</b>  | 371266  | <b>Ref. No.</b> | 0289 |
| <b>description</b>  | reducer flow rate 0.2l/min red  |                 |      |
| <b>For models:</b>  | FC05G, FC05GU, FC200EA, FC200EAP, FC200EB, FC200GA, FC200GAP, FC200GB, FC201EA, FC201EAP, FC201EB, FC201GA, FC201GAP, FC201GB, FC20E, FC20EA, FC20EDG, FC20G, FC20GA, FC20GDG, FC401EA, FC401EAP, FC401EB, FC401GA, FC401GAP, FC401GB, FDE10, FDE155, FDE155DG, FDE55, FDE55DG, FDG10, FDG155, FDG155DG, FDG55, FDG55DG, FM06EB, FM06EDG, FM06GB, FM06GDG, FM10EB, FM10EDG, FM10GB, FM10GDG, FM200EA, FM200EAP, FM200EB, FM200GA, FM200GAP, FM200GB...(Other models you can see in the webshop) |                 |      |

|  |   |                 |              |
|--|---|-----------------|--------------|
|  |   |                 |              |
| 1  |   |                 |              |
| <b>GEV No.</b>   | 371268  | <b>Ref. No.</b> | 0290<br>0295 |
| <b>description</b>   | reducer flow rate 0.32-0.42l/min green                                      |                 |              |
| <b>For models:</b>   | FM06GB, FM06GDG, FM10EB, FM10EDG, FM10GDG, FM20EB, FM20EDG, FM20GB, FM20GDG |                 |              |

### solenoid valves with reducers

|   |  |                 |                   |
|---|--|-----------------|-------------------|
| 4-fold  |  |                 |                   |
|  |  |                 |                   |
| 1   |  |                 |                   |
| <b>GEV No.</b>  | 374026   | <b>Ref. No.</b> | 13003             |
| <b>description</b>  | solenoid valve 4-fold straight 230VAC inlet 3/4" outlet 11.5mm duty cycle 100% RPE plastic pressure range 0.2-10bar  |                 |                   |
| <b>For models:</b>  | FM200EA, FM200EAP, FM200EB, FM200GA, FM200GAP, FM200GB, FM201EA, FM201EAP, FM201EB, FM201GA, FM201GAP, FM201GB, FM401EA, FM401EAP, FM401EB, FM401GA, FM401GAP, FM401GB |                 |                   |
| <b>spare parts for</b>  | 374026   |                 |                   |
|  | <b>GEV No.</b>   | 371015          | <b>Ref. No.</b> — |
|   | solenoid coil RPE 230VAC 8.4VA 50/60Hz seat ø 9mm connection male faston 6.3mm   |                 |                   |



metal

CEME

solenoid valves

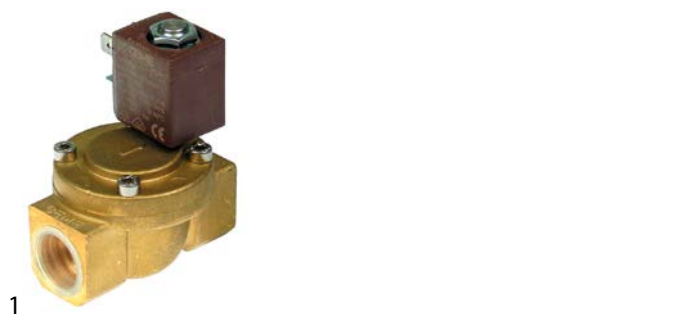

|                    |   |                 |       |
|--------------------|---|-----------------|-------|
| <b>GEV No.</b>     | 370348  | <b>Ref. No.</b> | 11022 |
| <b>description</b> | solenoid valve 2-ways 230VAC connection 1/2" L 60mm t.max. 90°C membranes NBR p max 10bar p min 0.25bar brass |                 |       |

|                    |   |                 |      |
|--------------------|---|-----------------|------|
| <b>GEV No.</b>     | 401228  | <b>Ref. No.</b> | 3572 |
| <b>description</b> | level electrode total length 175mm connection male faston 6.3mm ø 2.5mm   |                 |      |
| <b>For models:</b> | FM10GB, FM200EA, FM200EAP, FM200EB, FM200GA, FM200GAP, FM200GB, FM201EA, FM201EAP, FM201EB, FM201GA, FM201GAP, FM201GB, FM401EA, FM401EAP, FM401GA, FM401GAP, FM401GB |                 |      |

compressors

EMBRACO / ASPERA

R404a/R507

LBP monophase

Lower evaporation temperature below -20°C

|                    |  |                 |       |
|--------------------|--|-----------------|-------|
| <b>GEV No.</b>     | 605260   | <b>Ref. No.</b> | 71056 |
| <b>description</b> | compressor coolant R404A type NT2192GK 220/240V 50Hz LBP 17.5kg 1.1HP cylinder capacity 22.37cm³ CSCR 815W 1066W 1361W 1701W 2085W |                 |       |

|                    |  |                 |       |
|--------------------|--|-----------------|-------|
| <b>GEV No.</b>     | 605174   | <b>Ref. No.</b> | 71042 |
| <b>description</b> | compressor coolant R404a/R507 type NJ2192GK 220-240V 50Hz LBP 20.4kg 1 1/4HP cylinder capacity 26.2cm³ CSR H 265mm 685W 989W 1342W 1745W 2196W 2196W |                 |       |

ball valves electric

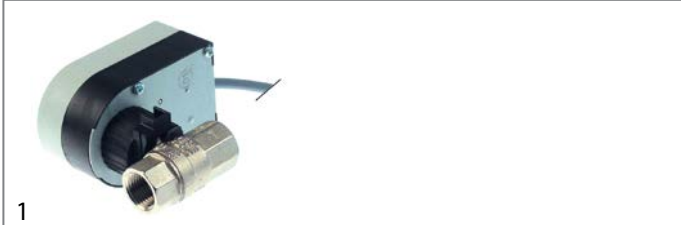

|                    |   |                 |       |
|--------------------|---|-----------------|-------|
| <b>GEV No.</b>     | 401233  | <b>Ref. No.</b> | 10036 |
| <b>description</b> | ball valve inlet 1/2" IT outlet 1/2" IT 230V 50/60Hz mode of operation electric W 60mm H 99mm cable 4-pole 2.5W 4-pole duty cycle 50% |                 |       |
| <b>For models:</b> | FM200EA, FM200EAP, FM200EB, FM200GA, FM200GAP, FM200GB, FM201EA, FM201EAP, FM201EB, FM201GB, FM401EA, FM401EAP, FM401EB, FM401GB      |                 |       |

electrodes

|                    |  |                 |      |
|--------------------|--|-----------------|------|
| <b>GEV No.</b>     | 401225   | <b>Ref. No.</b> | 3680 |
| <b>description</b> | level electrode M12 ET - 1/8" ET total length 124/127/139mm probe L 91/95/104mm insulated probe length 42mm set 3-piece connection male faston 6.3mm ø 2.5mm |                 |      |
| <b>For models:</b> | FM06EB, FM06EDG  |                 |      |

|                    |   |                 |      |
|--------------------|---|-----------------|------|
| <b>GEV No.</b>     | 401226  | <b>Ref. No.</b> | 3681 |
| <b>description</b> | level electrode M12x1 total length 150/160/171mm probe L 117/127/138mm insulated probe length 20mm set 3-piece connection male faston 6.3mm ø 2.5mm |                 |      |
| <b>For models:</b> | FM10EB, FM10EDG, FM20EB, FM20EDG  |                 |      |

|                    |   |                 |      |
|--------------------|---|-----------------|------|
| <b>GEV No.</b>     | 401227  | <b>Ref. No.</b> | 3683 |
| <b>description</b> | level electrode M12x1 total length 80/86/98mm probe L 48/53/65mm insulated probe length 20mm set 3-piece connection male faston 6.3mm ø 2.5mm |                 |      |
| <b>For models:</b> | FM06GB, FM06GDG, FM10GDG, FM20GB, FM20GDG   |                 |      |



fans

axial fans

import



1

|   |   |                 |                   |
|---|---|-----------------|-------------------|
| <b>GEV No.</b>  | 601080 <sup>1</sup>   | <b>Ref. No.</b> | 10724             |
| <b>description</b>  | axial fan L 119mm W 119mm H 38mm 230VAC 50/60Hz 23/20W bearing ball bearing connection male faston 2.8mm metal ADDA fan wheel ø 110mm temp.-resist. 70°C  |                 |                   |
| <b>For models:</b>  | FC200EA, FC200EAP, FC200EB, FC200GA, FC200GAP, FC200GB, FC201EA, FC201EAP, FC201EB, FC201GA, FC201GAP, FC201GB, FC401EA, FC401EAP, FC401EB, FC401GA, FC401GAP, FC401GB, FM200EA, FM200EAP, FM200EB, FM200GA, FM200GAP, FM200GB, FM201EA, FM201EAP, FM201EB, FM201GA, FM201GAP, FM201GB, FM401EA, FM401EAP, FM401EB, FM401GA, FM401GAP, FM401GB, MM200EA, MM200EAP, MM200EB, MM200GA, MM200GAP, MM200GB, MM201EA, MM201EAP, MM201EB, MM201GA, MM201GAP, MM201GB, MM401EA, MM401EAP...(Other models you can see in the webshop) |                 |                   |
| <b>accessories for</b>  | 601080  |                 |                   |
|  | <b>GEV No.</b>  | 550898          | <b>Ref. No.</b> — |
|   | connecting cable cable length 2000mm connection F 2.8 connection distance 7.9mm for axial flow fan  |                 |                   |
|  | <b>GEV No.</b>  | 692519          | <b>Ref. No.</b> — |
|   | guard L 120mm W 120mm plastic   |                 |                   |

<sup>1</sup>with ball bearings



1

|   |   |                 |                   |
|---|---|-----------------|-------------------|
| <b>GEV No.</b>  | 601130 <sup>1</sup>   | <b>Ref. No.</b> | 10721             |
| <b>description</b>  | axial fan L 80mm W 80mm H 25mm 230VAC 50/60Hz 13/14W bearing ball bearing connection male faston 2.8mm metal ADDA fan wheel ø 75mm temp.-resist. 70°C airflow 30.6m <sup>3</sup> /h |                 |                   |
| <b>accessories for</b>  | 601130  |                 |                   |
|  | <b>GEV No.</b>  | 550898          | <b>Ref. No.</b> — |
|   | connecting cable cable length 2000mm connection F 2.8 connection distance 7.9mm for axial flow fan  |                 |                   |

<sup>1</sup>with ball bearings



1

|   |   |                 |                   |
|---|---|-----------------|-------------------|
| <b>GEV No.</b>  | 601081 <sup>1</sup>   | <b>Ref. No.</b> | 10720             |
| <b>description</b>  | axial fan L 80mm W 80mm H 38mm 230VAC 50/60Hz 14/13.5W bearing ball bearing connection male faston 2.8mm metal ADDA fan wheel ø 75mm temp.-resist. 70°C   |                 |                   |
| <b>For models:</b>  | FC200EA, FC200EAP, FC200EB, FC200GA, FC200GAP, FC200GB, FC201EA, FC201EAP, FC201EB, FC201GA, FC201GAP, FC201GB, FC401EA, FC401EAP, FC401EB, FC401GA, FC401GAP, FC401GB, FDE10, FDE15S, FDE15SDG, FDE55, FDE55DG, FDG10, FDG15S, FDG15SDG, FDG55, FDG55DG, FM200EA, FM200EAP, FM200EB, FM200GA, FM200GAP, FM200GB, FM201EA, FM201EAP, FM201EB, FM201GA, FM201GAP, FM201GB, FM401EA, FM401EAP, FM401EB, FM401GA, FM401GAP, FM401GB, MM2/3EA, MM2/3EB, MM200EA, MM200EAP...(Other models you can see in the webshop) |                 |                   |
| <b>accessories for</b>  | 601081  |                 |                   |
|  | <b>GEV No.</b>  | 691102          | <b>Ref. No.</b> — |
|   | guard ø 75mm mounting distance 71mm for axial fan 80mm  |                 |                   |

<sup>1</sup>with ball bearings

refrigeration fans

cooling motors (complete)



1

|                    |  |                 |       |
|--------------------|--|-----------------|-------|
| <b>GEV No.</b>     | 694178   | <b>Ref. No.</b> | 70701 |
| <b>description</b> | fan 220-240V 16W 50-60Hz fan wheel ø 250mm connection with cable mounting distance 300mm |                 |       |



cold air circulating fans (complete)

ebm-papst

A4D series

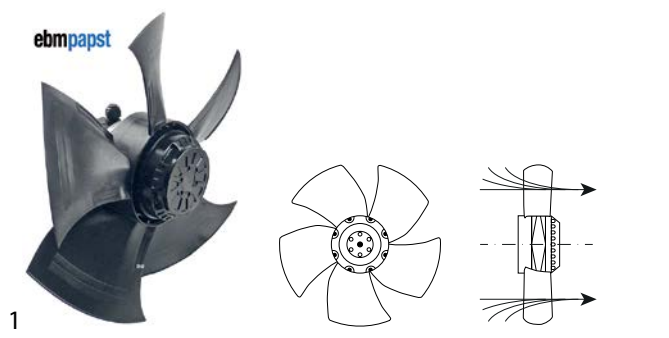

|                    |   |                 |       |
|--------------------|---|-----------------|-------|
| <b>GEV No.</b>     | 601628  | <b>Ref. No.</b> | 70705 |
| <b>description</b> | fan A4D500-AM03-01 fan wheel ø 500mm blades 5 400V 50Hz 720W 1390rpm cable length 450mm rotation direction left ebm-papst sucking |                 |       |

A4E series

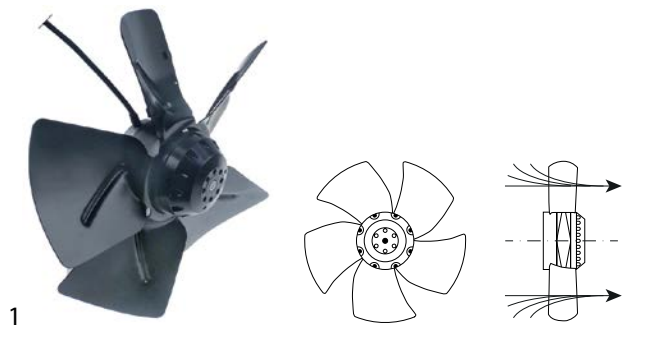

|                    |   |                 |       |
|--------------------|---|-----------------|-------|
| <b>GEV No.</b>     | 601684  | <b>Ref. No.</b> | 70702 |
| <b>description</b> | fan A4E350-AA06-54 fan wheel ø 350mm blades 5 230V 50/60Hz 145W 1380/1540rpm cable length 450mm ebm-papst blowing suitable capacitor 5µF/400VµF |                 |       |

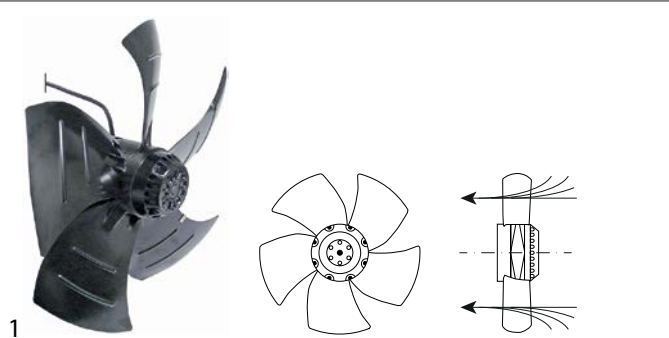

|                    |  |                 |       |
|--------------------|--|-----------------|-------|
| <b>GEV No.</b>     | 602045   | <b>Ref. No.</b> | 70704 |
| <b>description</b> | fan A4E450-AP01-01 fan wheel ø 450mm blades 5 230V 50/60Hz 245/355W mounting distance 65mm 1400/1600rpm connection 4-wire cable length 500mm rotation direction left ebm-papst sucking suitable capacitor MLR25PRLµF |                 |       |

ZIEHL-ABEGG

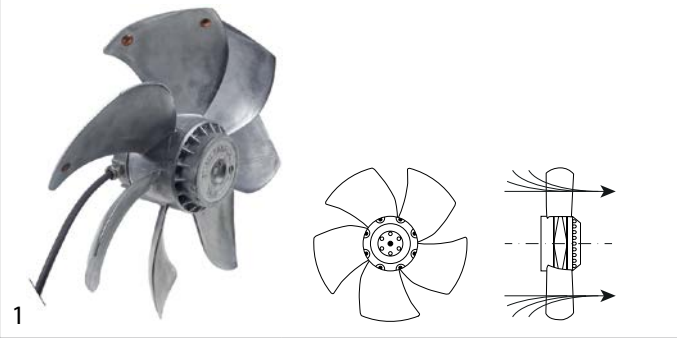

|                    |   |                 |       |
|--------------------|---|-----------------|-------|
| <b>GEV No.</b>     | 601726  | <b>Ref. No.</b> | 70706 |
| <b>description</b> | fan fan wheel ø 360mm 230V 50/60Hz 200/310W cable length 2600mm ZIEHL-ABEGG complete H 118mm type FE035-4EA.0F.A7 |                 |       |

hot air motors

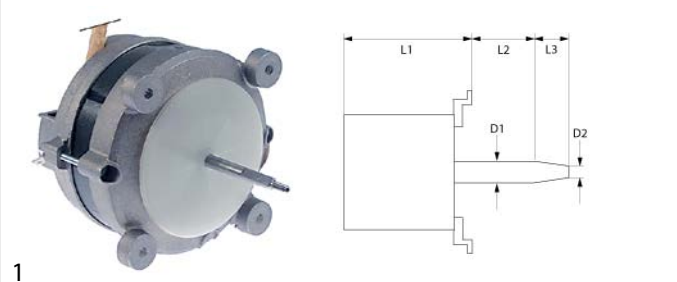

|                |        |                 |      |
|----------------|--------|-----------------|------|
| <b>GEV No.</b> | 601362 | <b>Ref. No.</b> | 1720 |
|----------------|--------|-----------------|------|

**description**

**accessories for** 601362

|  |                    |  |                 |   |
|--|--------------------|--|-----------------|---|
|  | <b>GEV No.</b>     | 365017   | <b>Ref. No.</b> | — |
|  | <b>description</b> | operating capacitor capacity 5µF 450V tolerance 5% 50/60Hz ambient temperature max. -25 to +85°C ø 28mm L 54mm M8 plastic connection male faston 6.3mm 16.10.08 protection |                 |   |

|  |                    |  |                 |   |
|--|--------------------|--|-----------------|---|
|  | <b>GEV No.</b>     | 694600   | <b>Ref. No.</b> | — |
|  | <b>description</b> | bush for hot air motors ø 25mm H 10mm seat ø 8.5mm |                 |   |

|  |                    |   |                 |   |
|--|--------------------|---|-----------------|---|
|  | <b>GEV No.</b>     | 694601  | <b>Ref. No.</b> | — |
|  | <b>description</b> | spring for hot air motors ø 22mm H 18mm ID ø 19mm |                 |   |

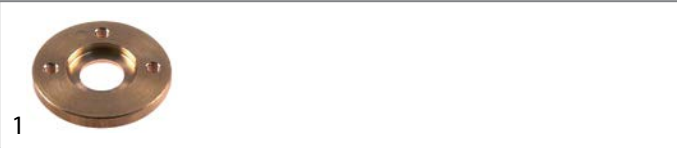





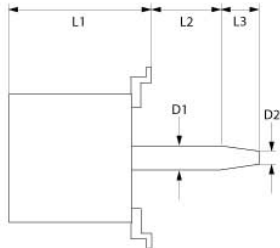

|                    |   |                 |      |
|--------------------|---|-----------------|------|
| <b>GEV No.</b>     | 550757  | <b>Ref. No.</b> | 0693 |
| <b>description</b> | counterflange for fan motor ED ø 48mm int. ø 1 24mm int. ø 2 15mm thickness 5mm brass |                 |      |

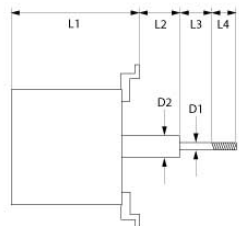

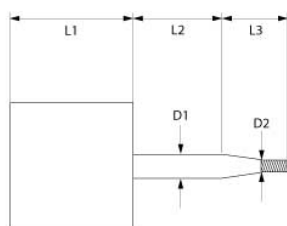

|  |  |                 |      |
|--|--|-----------------|------|
|  <p>1</p> |  |                 |      |
| <b>GEV No.</b>   | 550854   | <b>Ref. No.</b> | 0691 |
| <b>description</b>   | counterflange for fan motor ED $\phi$ 60mm int. $\phi$ 1 34.5mm int. $\phi$ 2 24.6mm thickness 5.1mm brass   |                 |      |
| <b>For models:</b>   | FC200EA, FC200EAP, FC200EB, FC200GA, FC200GAP, FC200GB, FC201EA, FC201EAP, FC201EB, FC201GA, FC201GAP, FC201GB, FC401EA, FC401EAP, FC401EB, FC401GA, FC401GAP, FC401GB, FDE10, FDE155, FDE155DG, FDE55, FDE55DG, FDG10, FDG155, FDG155DG, FDG55, FDG55DG, FM200EA, FM200EAP, FM200EB, FM200GA, FM200GAP, FM200GB, FM201EA, FM201EAP, FM201EB, FM201GA, FM201GAP, FM201GB, FM401EA, FM401EAP, FM401EB, FM401GA, FM401GAP, FM401GB, MM200EA, MM200EAP, MM200EB, MM200GA... (Other models you can see in the webshop) |                 |      |

|  |  |                 |               |
|--|--|-----------------|---------------|
|   <p>2</p> |  |                 |               |
| <b>GEV No.</b>   | 601046   | <b>Ref. No.</b> | 0840<br>0840B |
| <b>description</b>   | fan motor 220/380V 3 phase 50/60Hz 0.75kW 1350/1650rpm speeds 1 L1 185mm L2 42mm L3 47mm D1 $\phi$ 24mm D2 $\phi$ 20mm M12L IT 1.9/3.3A Cos(f) 0.83 at 50Hz 200-240/346-415V at 60Hz 200-277/346-480V at 50Hz 1350rpm at 60Hz 1650rpm type ST80/4 no. 661512 |                 |               |

|  |   |                 |       |
|--|---|-----------------|-------|
|   <p>1</p> |   |                 |       |
| <b>GEV No.</b>   | 601354  | <b>Ref. No.</b> | 1100C |
| <b>description</b>   | fan motor 220-240V 1 phase 50Hz 0.11kW 2760rpm speeds 1 L1 130mm L2 32mm L3 30mm L4 18mm D1 $\phi$ 7/8mm D2 $\phi$ 9mm M4R IT 0.9A at 50Hz 230V at 50Hz 2760rpm suitable capacitor 4 $\mu$ F type LM63 shaft flat length 17mm |                 |       |
| <b>accessories for</b>   | 601354  |                 |       |
|  | <b>GEV No.</b>  | <b>Ref. No.</b> | 1103  |
|   | operating capacitor capacity 4 $\mu$ F 450V tolerance 5% 50/60Hz ambient temperature max. -25 to +85°C $\phi$ 31mm L 58mm M8 plastic connection male faston 6.3mm protection  |                 |       |
|  | <b>GEV No.</b>  | <b>Ref. No.</b> | —     |
|   | fan wheel D1 $\phi$ 160mm H1 60mm blades 15 D2 $\phi$ 18mm D3 $\phi$ 18mm H2 35mm   |                 |       |

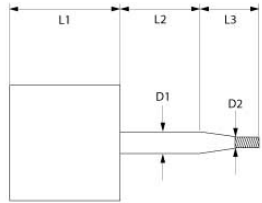
|   |  |                 |      |
|---|--|-----------------|------|
|   <p>1</p> |  |                 |      |
| <b>GEV No.</b>  | 601043   | <b>Ref. No.</b> | 0764 |
| <b>description</b>  | fan motor 220-240V 1 phase 50Hz 0.37/0.07kW 0.1/0.5HP 1400/2700rpm speeds 2 L1 123mm L2 107mm L3 15mm D1 $\phi$ 15mm D2 $\phi$ 12mm M10L ET 2/0.7A suitable capacitor 20 $\mu$ F/250V at 50Hz 1400/2700rpm type 1057 |                 |      |
| <b>For models:</b>  | FC06G, FC06GA, FC06GDG, FC06SE, FC06SEA, FC06SEDG, FM06EB, FM06EDG, FM06GB, FM06GDG, FP05E, FP05EDG, FP05G, FP05GDG, MM06EA, MM06EAP, MM06EB, MM06GA, MM06GAP, MM06GB  |                 |      |
| <b>accessories for</b>  | 601043   |                 |      |
|   | <b>GEV No.</b>   | <b>Ref. No.</b> | 0775 |
|    | operating capacitor capacity 20 $\mu$ F 400V tolerance 5% 50/60Hz ambient temperature max. -25 to +85°C $\phi$ 39.5mm L 70mm M8 plastic connection male faston 6.3mm 16.10.25. protection                            |                 |      |

|   |   |                 |       |
|---|---|-----------------|-------|
|   <p>1</p> |   |                 |       |
| <b>GEV No.</b>  | 601166  | <b>Ref. No.</b> | 10705 |
| <b>description</b>  | fan motor 220-240V 1 phase 50Hz 0.37kW 2700rpm speeds 1 L1 123mm L2 77mm L3 30mm D1 $\phi$ 15mm D2 $\phi$ 12mm M10L ET 2A suitable capacitor 12.5 $\mu$ F/450V at 50Hz 2700rpm type 1057.2157 |                 |       |
| <b>For models:</b>  | FC05G, FC05GU   |                 |       |
| <b>spare parts for</b>  | 601166  |                 |       |
|   | <b>GEV No.</b>  | <b>Ref. No.</b> | 0932  |
|    | operating capacitor capacity 12.5 $\mu$ F 450V tolerance 5%Hz ambient temperature max. -25 to +85°C $\phi$ 35mm L 70mm M8 plastic connection male faston 6.3mm 45S.C3DS.12.5 protection       |                 |       |
| <b>accessories for</b>  | 601166  |                 |       |
|   | <b>GEV No.</b>  | <b>Ref. No.</b> | 1118  |
|    | fan wheel D1 $\phi$ 160mm H1 60mm blades 15 D2 $\phi$ 16mm D3 $\phi$ 16mm H2 29mm   |                 |       |

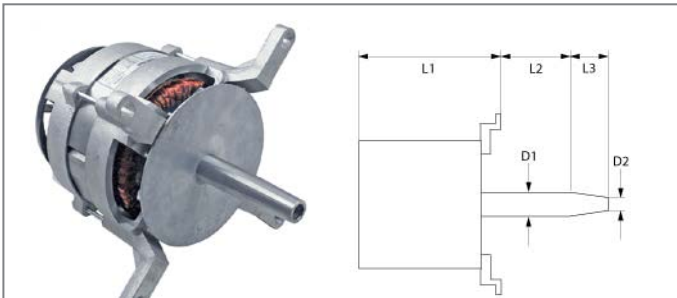

1

|                    |   |                 |       |
|--------------------|---|-----------------|-------|
| <b>GEV No.</b>     | 499185  | <b>Ref. No.</b> | 0841B |
| <b>description</b> | fan motor 380-415V 3 phase 50/60Hz 0.13/0.55kW 700/1350rpm speeds 2 L1 170mm L2 49mm L3 45mm D1 ø 24mm D2 ø 20mm M12x1.75 4P/8P type FB100L |                 |       |

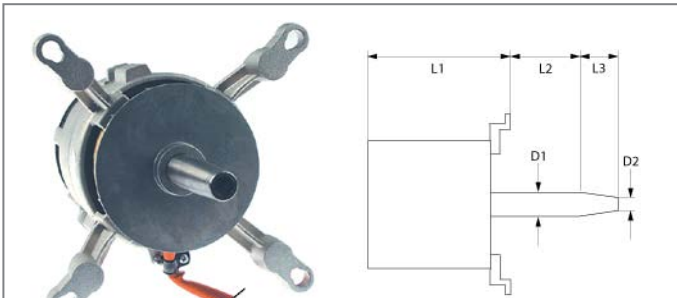

1

|                    |  |                 |      |
|--------------------|--|-----------------|------|
| <b>GEV No.</b>     | 500652   | <b>Ref. No.</b> | 0841 |
| <b>description</b> | fan motor 380-415V 3 phase 50Hz 0.13/0.55kW 700/1350rpm speeds 2 L1 188mm L2 44mm L3 48mm D1 ø 24mm D2 ø 20mm M12L ITA Cos(φ) 0.13/0.55 at 50Hz 700/1350rpm 4P/8P type FB80 4/8 no. 390133 |                 |      |
| <b>For models:</b> | FM10EDG, FM20EDG, FM20GDG  |                 |      |



1

|                    |  |                 |      |
|--------------------|--|-----------------|------|
| <b>GEV No.</b>     | 514507   | <b>Ref. No.</b> | 1104 |
| <b>description</b> | fan wheel blades 15 D1 ø 160mm D2 ø 11mm D3 ø 16mm H1 60mm H2 18mm |                 |      |



1

|                    |  |                 |       |
|--------------------|--|-----------------|-------|
| <b>GEV No.</b>     | 601067   | <b>Ref. No.</b> | 15007 |
| <b>description</b> | fan wheel D1 ø 150mm H1 38mm blades 36 D2 ø 6mm D3 ø 6mm H2 14mm |                 |       |
| <b>For models:</b> | MM2/3EA, MM2/3EB   |                 |       |



1

|                    |  |                 |      |
|--------------------|--|-----------------|------|
| <b>GEV No.</b>     | 601165   | <b>Ref. No.</b> | 1118 |
| <b>description</b> | fan wheel D1 ø 160mm H1 60mm blades 15 D2 ø 16mm D3 ø 16mm H2 29mm |                 |      |
| <b>For models:</b> | FC05G, FC05GU  |                 |      |



1

|                    |   |                 |      |
|--------------------|---|-----------------|------|
| <b>GEV No.</b>     | 601060  | <b>Ref. No.</b> | 0758 |
| <b>description</b> | fan wheel D1 ø 180mm H1 60mm blades 16 D2 ø 11mm D3 ø 16mm H2 30mm  |                 |      |
| <b>For models:</b> | FC06G, FC06GA, FC06GDG, FC06SE, FC06SEA, FC06SEDG, FM06EB, FM06EDG, FM06GB, FM06GDG, FP05E, FP05EDG, FP05G, FP05GDG, MM06EA, MM06EAP, MM06EB, MM06GA, MM06GAP, MM06GB |                 |      |



1

|                    |  |                 |       |
|--------------------|--|-----------------|-------|
| <b>GEV No.</b>     | 601064   | <b>Ref. No.</b> | 15016 |
| <b>description</b> | fan wheel D1 ø 220mm H1 78mm blades 20 D2 ø 11.5mm D3 ø 16.5mm H2 30mm |                 |       |



1

|                    |  |                 |      |
|--------------------|--|-----------------|------|
| <b>GEV No.</b>     | 601224   | <b>Ref. No.</b> | 3196 |
| <b>description</b> | fan wheel D1 ø 300mm H1 100mm blades 24 D2 ø 19.5mm D3 ø 23mm H2 46mm  |                 |      |
| <b>For models:</b> | FC201EA, FC201EAP, FC201EB, FC201GA, FC201GAP, FC201GB, FM10EB, FM10EDG, FM10GB, FM10GDG, FM201EA, FM201EAP, FM201EB, FM201GA, FM201GAP, FM201GB, MM10EA, MM10EAP, MM10EB, MM10GA, MM10GAP, MM10GB, MM201EA, MM201EAP, MM201EB, MM201GA, MM201GAP, MM201GB |                 |      |





1

|                    |   |                 |      |
|--------------------|---|-----------------|------|
| <b>GEV No.</b>     | 601063  | <b>Ref. No.</b> | 0759 |
| <b>description</b> | fan wheel D1 ø 350mm H1 100mm blades 24 D2 ø 19.5mm D3 ø 23mm H2 46mm   |                 |      |
| <b>For models:</b> | FC12G, FC12GA, FC12GDG, FC12SE, FC12SEA, FC12SEDG, FC200EA, FC200EAP, FC200EB, FC200GA, FC200GAP, FC200GB, FC20E, FC20EA, FC20EDG, FC20G, FC20GA, FC20GDG, FC401EA, FC401EAP, FC401EB, FC401GA, FC401GAP, FC401GB, FM200EA, FM200EAP, FM200EB, FM200GA, FM200GAP, FM200GB, FM20EB, FM20EDG, FM20GB, FM20GDG, FM401EA, FM401EAP, FM401EB, FM401GA, FM401GAP, FM401GB, FP10E, FP10EDG, FP10G, FP10GDG, MM200EA, MM200EAP, MM200EB, MM200GA, MM200GAP, MM200GB...(Other models you can see in the webshop) |                 |      |



1

|                    |  |                 |      |
|--------------------|--|-----------------|------|
| <b>GEV No.</b>     | 691810   | <b>Ref. No.</b> | 0692 |
| <b>description</b> | flange for fan motor ED ø 48mm int. ø 1 19.5mm int. ø 2 15mm thickness 3.5mm brass |                 |      |



1

|                    |   |                 |      |
|--------------------|---|-----------------|------|
| <b>GEV No.</b>     | 550852  | <b>Ref. No.</b> | 0690 |
| <b>description</b> | flange for fan motor ED ø 60mm int. ø 1 28.5mm int. ø 2 24.5mm thickness 3.5mm brass  |                 |      |
| <b>For models:</b> | FC200EA, FC200EAP, FC200EB, FC200GA, FC200GAP, FC200GB, FC201EA, FC201EAP, FC201EB, FC201GA, FC201GAP, FC201GB, FC401EA, FC401EAP, FC401EB, FC401GA, FC401GAP, FC401GB, FDE10, FDE155, FDE155DG, FDE55, FDE55DG, FDG10, FDG155, FDG155DG, FDG55, FDG55DG, FM200EA, FM200EAP, FM200EB, FM200GA, FM200GAP, FM200GB, FM201EA, FM201EAP, FM201EB, FM201GA, FM201GAP, FM201GB, FM401EA, FM401EAP, FM401EB, FM401GA, FM401GAP, FM401GB, MM200EA, MM200EAP, MM200EB, MM200GA...(Other models you can see in the webshop) |                 |      |



1

|                    |   |                 |      |
|--------------------|---|-----------------|------|
| <b>GEV No.</b>     | 550853  | <b>Ref. No.</b> | 0688 |
| <b>description</b> | gasket for fan motor ID ø 24mm ED ø 29mm thickness 3mm  |                 |      |
| <b>For models:</b> | FC200EA, FC200EAP, FC200EB, FC200GA, FC200GAP, FC200GB, FC201EA, FC201EAP, FC201EB, FC201GA, FC201GAP, FC201GB, FC401EA, FC401EAP, FC401EB, FC401GA, FC401GAP, FC401GB, FDE10, FDE155, FDE155DG, FDE55, FDE55DG, FDG10, FDG155, FDG155DG, FDG55, FDG55DG, FM200EA, FM200EAP, FM200EB, FM200GA, FM200GAP, FM200GB, FM201EA, FM201EAP, FM201EB, FM201GA, FM201GAP, FM201GB, FM401EA, FM401EAP, FM401EB, FM401GA, FM401GAP, FM401GB, MM200EA, MM200EAP, MM200EB, MM200GA...(Other models you can see in the webshop) |                 |      |

hot air fans

miscellaneous



1

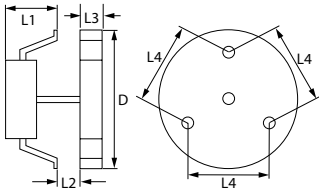

|   |  |                 |                        |
|---|--|-----------------|------------------------|
| <b>GEV No.</b>  | 601125   | <b>Ref. No.</b> | 0016<br>0016A<br>10731 |
| <b>description</b>  | hot air fan 220-240V 45W 50/60Hz L1 70mm L2 11mm L3 25mm L4 87mm fan wheel ø 150mm FIME type C30R0479CLF |                 |                        |
| <b>For models:</b>  | FC06E, FC06EA, FC06EDG, FC12E, FC12EA, FC12EDG, FE1-2, FE2-3   |                 |                        |
| <b>accessories for</b>  | 601125   |                 |                        |
|  | <b>GEV No.</b>   | 550879          | <b>Ref. No.</b> —      |
|   | insulation ø 130mm thickness 3mm hole ø 20mm for hot air fan   |                 |                        |

pumps  
drain pumps

ASKOLL



1

|                    |                |                 |      |
|--------------------|----------------|-----------------|------|
| <b>GEV No.</b>     | 500565         | <b>Ref. No.</b> | 3363 |
| <b>description</b> | drain pump 30W |                 |      |



## condensators & interference suppression filters

### operating capacitors

#### plastic



1

|                    |  |                 |      |
|--------------------|--|-----------------|------|
| <b>GEV No.</b>     | 365014   | <b>Ref. No.</b> | 0932 |
| <b>description</b> | operating capacitor capacity 12.5µF 450V tolerance 5%Hz ambient temperature max. -25 to +85°C ø 35mm L 70mm M8 plastic connection male faston 6.3mm 45S.C3DS.12.5 protection |                 |      |



1

|                    |  |                 |      |
|--------------------|--|-----------------|------|
| <b>GEV No.</b>     | 365019   | <b>Ref. No.</b> | 0775 |
| <b>description</b> | operating capacitor capacity 20µF 400V tolerance 5% 50/60Hz ambient temperature max. -25 to +85°C ø 39.5mm L 70mm M8 plastic connection male faston 6.3mm 16.10.25. protection |                 |      |



1

|                    |   |                 |      |
|--------------------|---|-----------------|------|
| <b>GEV No.</b>     | 365031  | <b>Ref. No.</b> | 1103 |
| <b>description</b> | operating capacitor capacity 4µF 450V tolerance 5% 50/60Hz ambient temperature max. -25 to +85°C ø 31mm L 58mm M8 plastic connection male faston 6.3mm protection |                 |      |

## electric accessories

### cables

#### ribbon cables

##### group 1



1

|                    |  |                 |       |
|--------------------|--|-----------------|-------|
| <b>GEV No.</b>     | 400228   | <b>Ref. No.</b> | 70528 |
| <b>description</b> | ribbon cable 16-pole L 600mm plug type FC-16P raster size 2.54mm |                 |       |



1

|                    |   |                 |      |
|--------------------|---|-----------------|------|
| <b>GEV No.</b>     | 402841  | <b>Ref. No.</b> | 3443 |
| <b>description</b> | ribbon cable 26-pole L 1000mm plug type FC-26P raster size 2.54mm with insulation |                 |      |

### cable harnesses



1

|                    |   |                 |       |
|--------------------|---|-----------------|-------|
| <b>GEV No.</b>     | 551191  | <b>Ref. No.</b> | 11029 |
| <b>description</b> | cable harness for thermal fuse 1.5mm <sup>2</sup> 2-pole L 100mm white plug type Faston 6.3mm |                 |       |

### terminals

#### porcelain clamps



1

|                    |   |                 |       |
|--------------------|---|-----------------|-------|
| <b>GEV No.</b>     | 550112  | <b>Ref. No.</b> | 10360 |
| <b>description</b> | porcelain terminal block 2-pole 2.5mm <sup>2</sup> max. 10A max 250V t.max. 200°C L 22mm W 17mm H 15mm mounting distance mm Qty 1 pcs |                 |       |

#### various



1

|                    |                          |                 |       |
|--------------------|--------------------------|-----------------|-------|
| <b>GEV No.</b>     | 693955                   | <b>Ref. No.</b> | 10220 |
| <b>description</b> | terminal grounding cable |                 |       |
| <b>For models:</b> | FC05G, FC05GU            |                 |       |

## gas valves and ignition boxes

### gas control valves

#### HONEYWELL







1

|                        |  |                 |                 |   |
|------------------------|--|-----------------|-----------------|---|
| <b>GEV No.</b>         | 106004   | <b>Ref. No.</b> | 11017           |   |
| <b>description</b>     | gas valve type VK4105C 220-240V 50/60Hz gas inlet flange 32x32mm gas outlet flange 32x32mm thermocouple connection pilot connection pressure range 15-60mbar max 60mbar operator type pressure controller type V5306E 1234 1 suitable for HONEYWELL flange 32x32mm |                 |                 |   |
| <b>For models:</b>     | FC05G, FC05GU  |                 |                 |   |
| <b>accessories for</b> | 106004   |                 |                 |   |
|                        | <b>GEV No.</b>   | 102845          | <b>Ref. No.</b> | — |
|                        | gas connection angled 1/2" flange 32x32mm hole distance 24x24mm Tandem   |                 |                 |   |
|                        | <b>GEV No.</b>   | 102846          | <b>Ref. No.</b> | — |
|                        | gas connection straight 1/2" flange 32x32mm hole distance 24x24mm suitable for Tandem  |                 |                 |   |

1

|   |   |                 |                   |
|---|---|-----------------|-------------------|
| <b>GEV No.</b>  | 101186  | <b>Ref. No.</b> | 11017             |
| <b>description</b>  | gas valve type VK4105C 220-240V 50/60Hz gas inlet flange 32x32mm gas outlet flange 32x32mm thermocouple connection pilot connection pressure range 15-60mbar max 60mbar operator type pressure controller type V5360E 1226 1 HONEYWELL flange 32x32mm |                 |                   |
| <b>accessories for</b>  | 101186  |                 |                   |
|  | <b>GEV No.</b>  | 102845          | <b>Ref. No.</b> — |
|   | gas connection angled 1/2" flange 32x32mm hole distance 24x24mm Tandem  |                 |                   |
|  | <b>GEV No.</b>  | 102846          | <b>Ref. No.</b> — |
|   | gas connection straight 1/2" flange 32x32mm hole distance 24x24mm suitable for Tandem   |                 |                   |





|   |  |        |                   |
|---|--|--------|-------------------|
| <b>accessories for</b>  | 101127   |        |                   |
|  | <b>GEV No.</b>   | 101301 | <b>Ref. No.</b> — |
|   | gas connection thread 1/2" straight ELETTRISIT screw with O-ring |        |                   |
|  | <b>GEV No.</b>   | 101303 | <b>Ref. No.</b> — |
|   | gas connection straight thread 3/4" ELETTRISIT                   |        |                   |
|  | <b>GEV No.</b>   | 101309 | <b>Ref. No.</b> — |
|   | extension  |        |                   |

**SIT**

**ELETTRISIT**



1

|   |  |                 |                      |
|---|--|-----------------|----------------------|
| <b>GEV No.</b>  | 101127   | <b>Ref. No.</b> | 0766                 |
| <b>description</b>  | gas valve SIT type ELETTRISIT 230V gas inlet 3/4" gas outlet 3/4" thermocouple connection M9x1 pilot connection M10x1 lateral equiv. no. 0.810.175 |                 |                      |
| <b>For models:</b>  | FC06G, FC06GA, FC06GDG, FC12G, FC12GA, FC12GDG, FC20G, FC20GA, FC20GDG, FP05G, FP05GDG, FP10G, FP10GDG   |                 |                      |
| <b>spare parts for</b>  | 101127   |                 |                      |
|  | <b>GEV No.</b>   | 101312          | <b>Ref. No.</b> 1119 |
|   | microswitch  |                 |                      |
|  | <b>GEV No.</b>   | 101352          | <b>Ref. No.</b> —    |
|   | solenoid coil 230V 50Hz suitable for ELETTRISIT  |                 |                      |
| <b>accessories for</b>  | 101127   |                 |                      |
|  | <b>GEV No.</b>   | 100006          | <b>Ref. No.</b> —    |
|   | piezoelectric igniter suitable for ELETTRISIT body plastic blowing connection ø2.4mm ø 14mm  |                 |                      |
|  | <b>GEV No.</b>   | 100904          | <b>Ref. No.</b> —    |
|   | locking screw M10x1 for pipe ø 4mm Qty 1 pcs   |                 |                      |
|  | <b>GEV No.</b>   | 100905          | <b>Ref. No.</b> 0830 |
|   | locking screw M10x1 for pipe ø 6mm Qty 1 pcs   |                 |                      |

**NOVASIT**

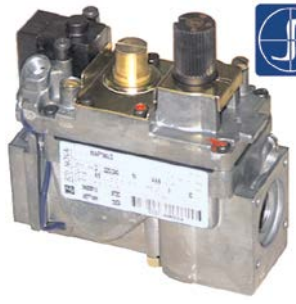

1













|   |  |                 |                      |
|---|--|-----------------|----------------------|
| <b>GEV No.</b>  | 101162   | <b>Ref. No.</b> | 3015                 |
| <b>description</b>  | gas valve SIT series Novasit 820 230V 50Hz gas inlet 1/2" gas outlet 1/2" thermocouple connection M9x1 pilot connection M10x1 ignition pressure 3-5mbar pressure range 3-30mbar pressure regulator connection blind equiv. no. 0.820.010 |                 |                      |
| <b>For models:</b>  | FM20GB, FM20GDG, MM20GA, MM20GAP, MM20GB   |                 |                      |
| <b>spare parts for</b>  | 101162   |                 |                      |
|  | <b>GEV No.</b>   | 101065          | <b>Ref. No.</b> —    |
|   | magnet unit with cable L 44mm D1 ø 30mm D2 ø 20mm suitable for NOVASIT   |                 |                      |
|  | <b>GEV No.</b>   | 101313          | <b>Ref. No.</b> —    |
|   | solenoid coil 230V 50Hz  |                 |                      |
| <b>accessories for</b>  | 101162   |                 |                      |
|  | <b>GEV No.</b>   | 100006          | <b>Ref. No.</b> —    |
|   | piezoelectric igniter suitable for ELETTRISIT body plastic blowing connection ø2.4mm ø 14mm  |                 |                      |
|  | <b>GEV No.</b>   | 101305          | <b>Ref. No.</b> —    |
|   | gas connection straight 1/2" flange 45x45mm ELETTRISIT/V4400/4600/4605 suitable for SIT/HONEYWELL hole distance 36x36mm  |                 |                      |
|  | <b>GEV No.</b>   | 101306          | <b>Ref. No.</b> —    |
|   | gas connection angled flange 45x45mm hole distance 36x36mm 1/2" ELETTRISIT/V4400/4600/4605 screw with O-ring suitable for SIT/HONEYWELL  |                 |                      |
|  | <b>GEV No.</b>   | 101307          | <b>Ref. No.</b> —    |
|   | gas connection straight flange 45x45mm hole distance 36x36mm 3/4" ELETTRISIT/V4400/4600/4605 screw with O-ring suitable for SIT/HONEYWELL  |                 |                      |
|  | <b>GEV No.</b>   | 101308          | <b>Ref. No.</b> —    |
|   | gas connection angled flange 45x45mm hole distance 36x36mm 3/4" ELETTRISIT/V4400/4600/4605 screw with O-ring suitable for SIT/HONEYWELL  |                 |                      |
|  | <b>GEV No.</b>   | 101312          | <b>Ref. No.</b> 1119 |
|   | microswitch  |                 |                      |
|  | <b>GEV No.</b>   | 101314          | <b>Ref. No.</b> —    |
|   | solenoid coil 24V 50Hz   |                 |                      |

Table continues overleaf







|   |  |        |                   |
|---|--|--------|-------------------|
| <b>accessories for</b>  | 101162   |        |                   |
|  | <b>GEV No.</b>                                   | 101317 | <b>Ref. No.</b> — |
|   | plug with cable L 1000mm suitable for NOVASIT    |        |                   |
|  | <b>GEV No.</b>                                   | 101318 | <b>Ref. No.</b> — |
|   | cover cap for solenoid coil suitable for NOVASIT |        |                   |



| accessories   |  |                 |      |
|---|--|-----------------|------|
|  | 1                                      |                 |      |
| <b>GEV No.</b>  | 101674                                 | <b>Ref. No.</b> | 3020 |
| <b>description</b>  | knob extension L 57mm NOVA 822/826/827 |                 |      |
| <b>For models:</b>  | FM06GB, FM20GB, FM20GDG                |                 |      |

|   |  |                 |      |
|---|--|-----------------|------|
|  | 1  |                 |      |
| <b>GEV No.</b>  | 101359                                     | <b>Ref. No.</b> | 3020 |
| <b>description</b>  | knob extension L 75mm suitable for NOVASIT |                 |      |

|  |  |                 |      |
|--|--|-----------------|------|
|  | 1  |                 |      |
| <b>GEV No.</b>   | 100905                                       | <b>Ref. No.</b> | 0830 |
| <b>description</b>   | locking screw M10x1 for pipe ø 6mm Qty 1 pcs |                 |      |

|   |             |                 |      |
|---|-------------|-----------------|------|
|  | 1           |                 |      |
| <b>GEV No.</b>  | 101312      | <b>Ref. No.</b> | 1119 |
| <b>description</b>  | microswitch |                 |      |

| SIGMA   |   |                 |                   |
|---|---|-----------------|-------------------|
|  | 1   |                 |                   |
| <b>GEV No.</b>  | 107499  | <b>Ref. No.</b> | 11140             |
| <b>description</b>  | gas valve 230V 50Hz gas inlet 3/4" gas outlet 3/4" SIT equiv. no. 0.848.049 |                 |                   |
| <b>spare parts for</b>  | 107499  |                 |                   |
|  | <b>GEV No.</b>  | 106214          | <b>Ref. No.</b> — |
|   | solenoid coil 230V 50Hz Sigma   |                 |                   |
| <b>accessories for</b>  | 107499  |                 |                   |
|  | <b>GEV No.</b>  | 107222          | <b>Ref. No.</b> — |
|   | plug for solenoid valve 3-pole cable length 1070mm                          |                 |                   |

|  |   |                 |                   |
|--|---|-----------------|-------------------|
|  | 1   |                 |                   |
| <b>GEV No.</b>   | 107498  | <b>Ref. No.</b> | 11009             |
| <b>description</b>   | gas valve type Sigma 230V 50Hz gas inlet 1/2" gas outlet 1/2" pressure range 2-50mbar |                 |                   |
| <b>spare parts for</b>   | 107498  |                 |                   |
|   | <b>GEV No.</b>  | 106214          | <b>Ref. No.</b> — |
|  | solenoid coil 230V 50Hz Sigma   |                 |                   |
| <b>accessories for</b>   | 107498  |                 |                   |
|   | <b>GEV No.</b>  | 107222          | <b>Ref. No.</b> — |
|  | plug for solenoid valve 3-pole cable length 1070mm                                    |                 |                   |

| TANDEM  |   |                 |                   |
|---|---|-----------------|-------------------|
|  | 1   |                 |                   |
| <b>GEV No.</b>  | 101984  | <b>Ref. No.</b> | 11002             |
| <b>description</b>  | gas valve 230V 50Hz gas inlet 1/2" gas outlet 1/2" pilot connection level slow ignition ignition times pressure range 2-50mbar power supply for modulator 230VAC rectified Tandem equiv. no. 0.836.010  |                 |                   |
| <b>For models:</b>  | FC200GA, FC200GAP, FC200GB, FC201GA, FC201GAP, FC201GB, FC401GA, FC401GAP, FC401GB, FDG10, FDG155, FDG155DG, FDG55, FDG55DG, FM06GB, FM06GDG, FM10GB, FM10GDG, FM200GA, FM200GAP, FM200GB, FM201GA, FM201GAP, FM201GB, FM401GA, FM401GAP, FM401GB, MM06GA, MM06GAP, MM06GB, MM10GA, MM10GAP, MM10GB, MM200GA, MM200GAP, MM200GB, MM201GA, MM201GAP, MM201GB, MM401GA, MM401GAP, MM401GB |                 |                   |
| <b>spare parts for</b>  | 101984  |                 |                   |
|  | <b>GEV No.</b>  | 101379          | <b>Ref. No.</b> — |
|   | solenoid coil 230V 50Hz suitable for Tandem   |                 |                   |
| <b>accessories for</b>  | 101984  |                 |                   |
|  | <b>GEV No.</b>  | 101274          | <b>Ref. No.</b> — |
|   | olive for pipe ø 16mm Qty 1 pcs   |                 |                   |
|  | <b>GEV No.</b>  | 101275          | <b>Ref. No.</b> — |
|   | union screw thread 1/2" for pipe ø 16mm Qty 1 pcs   |                 |                   |
|  | <b>GEV No.</b>  | 101925          | <b>Ref. No.</b> — |
|   | plug with O-ring thread M10x1 for pilot burner suitable for NOVASIT   |                 |                   |
|  | <b>GEV No.</b>  | 102845          | <b>Ref. No.</b> — |
|   | gas connection angled 1/2" flange 32x32mm hole distance 24x24mm Tandem  |                 |                   |

Table continues overleaf



|   |         |        |            |
|---|---------|--------|------------|
| accessories for   |         | 101984 |            |
|   | GEV No. | 102846 | Ref. No. — |
| gas connection straight 1/2" flange 32x32mm hole distance 24x24mm suitable for Tandem |         |        |            |
|   | GEV No. | 102847 | Ref. No. — |
| O-ring  |         |        |            |

ignition boxes

HONEYWELL



|  |  |          |                |
|--|--|----------|----------------|
| 1  |  |          |                |
| GEV No.  | 101165   | Ref. No. | 11003<br>11020 |
| description  | ignition box HONEYWELL type S4560A 1008 equiv. no. S4560A 1008 electrodes 1 waiting time 0s safety time 10s 220-240V 10VA 50Hz |          |                |
| spare parts for  | 101165   |          |                |
|  | GEV No.  | 358696   | Ref. No. —     |
| fine fuse size ø5x20mm 4A medium lag rated 250V Qty 10 pcs |  |          |                |



|             |   |          |       |
|-------------|---|----------|-------|
| 1           |   |          |       |
| GEV No.     | 102367  | Ref. No. | 11016 |
| description | ignition box HONEYWELL type S4565A 2092 1 electrodes 3 waiting times safety time 10s 220-240V 4VA 50/60Hz |          |       |
| For models: | FC05G, FC05GU   |          |       |

SIT



|   |  |          |            |
|---|--|----------|------------|
| 1   |  |          |            |
| GEV No.   | 103278   | Ref. No. | 11003      |
| description   | ignition box kit SIT type 571DBC electrodes 2 waiting time 1.5s safety time 5s 250V 10VA 50/60Hz   |          |            |
| For models:   | FC200GA, FC200GAP, FC200GB, FC201GA, FC201GAP, FC201GB, FC401GA, FC401GAP, FC401GB, FDG10, FDG155, FDG155DG, FDG55, FDG55DG, FM06GB, FM06GDG, FM10GB, FM10GDG, FM200GA, FM200GAP, FM200GB, FM201GA, FM201GAP, FM201GB, FM401GA, FM401GAP, FM401GB, MM06GA, MM06GAP, MM06GB, MM10GA, MM10GAP, MM10GB, MM200GA, MM200GAP, MM200GB, MM201GA, MM201GAP, MM201GB, MM20GA, MM20GAP, MM20GB, MM401GA, MM401GAP, MM401GB |          |            |
| spare parts for   | 103278   |          |            |
|   | GEV No.  | 107246   | Ref. No. — |
| ignition box SIT type 571DBC electrodes 2 waiting time 1s safety time 10s 230V 12VA 50/60Hz |  |          |            |



|             |   |          |       |
|-------------|---|----------|-------|
| 1           |   |          |       |
| GEV No.     | 102309  | Ref. No. | 11010 |
| description | ignition box SIT type 537ABC electrodes 3 waiting time 1.5s safety time 10s 230V 10VA 50-60Hz protection IP44 |          |       |



|             |  |          |       |
|-------------|--|----------|-------|
| 1           |  |          |       |
| GEV No.     | 107497   | Ref. No. | 11147 |
| description | ignition box SIT type 579DBC electrodes 1 waiting time 1s safety time 5s 220/240V 12VA 50/60Hz |          |       |















## ignition parts





## pilot burners

SIT

100 series



|   |  |                 |      |
|---|--|-----------------|------|
| <b>GEV No.</b>  | 106906   | <b>Ref. No.</b> | 0836 |
| <b>description</b>  | pilot burner SIT type 100 series 3 flames nozzle $\varnothing$ 0.2mm gas connection 6mm  |                 |      |
| <b>For models:</b>  | FC06G, FC06GA, FC06GDG, FC12G, FC12GA, FC12GDG, FC20G, FC20GA, FC20GDG, FM06GB, FM20GB, FP05G, FP05GDG, FP10G, FP10GDG, MM20GB |                 |      |
| <b>spare parts for</b>  | 106906   |                 |      |
|    | GEV No. 100245   | Ref. No.        | —    |
|   | pilot burner nozzle LPG code 20 bore $\varnothing$ 0.2mm Qty 1 pcs thread M8x0.75  |                 |      |
|    | GEV No. 100855   | Ref. No.        | —    |
|   | pilot burner bracket triple  |                 |      |
|    | GEV No. 100885   | Ref. No.        | —    |
|   | air mixing sleeve for pilot burner Qty 1 pcs   |                 |      |
|  | GEV No. 100916   | Ref. No.        | —    |
|   | compression spring for pilot burner Qty 1 pcs  |                 |      |
|  | GEV No. 100917   | Ref. No.        | —    |
|   | gasket for pilot burner Qty 1 pcs aluminium  |                 |      |
|  | GEV No. 100918   | Ref. No.        | —    |
|   | screw for pilot burner   |                 |      |
|  | GEV No. 107162   | Ref. No.        | —    |
|   | pilot burner cap SIT 3 flames Hmm Lmm Qty 1 pcs  |                 |      |
|  | GEV No. 107701   | Ref. No.        | —    |
|   | pilot burner bottom part SIT 100 series nozzle $\varnothing$ 0.2mm   |                 |      |
| <b>accessories for</b>  | 106906   |                 |      |
|  | GEV No. 100245   | Ref. No.        | —    |
|   | pilot burner nozzle LPG code 20 bore $\varnothing$ 0.2mm Qty 1 pcs thread M8x0.75  |                 |      |
|  | GEV No. 100246   | Ref. No.        | —    |
|   | pilot burner nozzle natural gas bore $\varnothing$ 0.35mm Qty 1 pcs thread M8x0.75   |                 |      |
|  | GEV No. 100904   | Ref. No.        | —    |
|   | locking screw M10x1 for pipe $\varnothing$ 4mm Qty 1 pcs   |                 |      |
|  | GEV No. 100905   | Ref. No.        | 0830 |
|   | locking screw M10x1 for pipe $\varnothing$ 6mm Qty 1 pcs   |                 |      |
|  | GEV No. 102110   | Ref. No.        | —    |
|   | pilot tube copper pipe $\varnothing$ 4mm thickness 1mm L 3000mm  |                 |      |

|   |  |          |   |
|---|--|----------|---|
| <b>accessories for</b>  | 106906   |          |   |
|  | GEV No. 102111   | Ref. No. | — |
|   | pilot tube copper pipe $\varnothing$ 6mm thickness 1mm L 3000mm                |          |   |
|  | GEV No. 107171   | Ref. No. | — |
|   | pilot burner nozzle SIT natural/liquid gas bore $\varnothing$ 0.25mm Qty 1 pcs |          |   |
|  | GEV No. 107700   | Ref. No. | — |
|   | pilot burner bottom part SIT 100 series nozzle $\varnothing$ 0.25mm            |          |   |
|  | GEV No. 107702   | Ref. No. | — |
|   | pilot burner bottom part SIT 100 series nozzle $\varnothing$ 0.35mm            |          |   |

## accessories

## ignition electrodes



|                    |   |                 |      |
|--------------------|---|-----------------|------|
| <b>GEV No.</b>     | 100706  | <b>Ref. No.</b> | 0832 |
| <b>description</b> | ignition electrode connection M4 Qty 1 pcs  |                 |      |
| <b>For models:</b> | FC06G, FC06GA, FC06GDG, FC12G, FC12GA, FC12GDG, FC20G, FC20GA, FC20GDG, FM06GB, FM20GB, FM20GDG, FP05G, FP05GDG, FP10G, FP10GDG, MM20GB |                 |      |

## electrodes

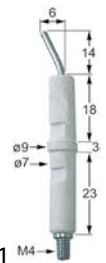

|                    |   |                 |      |
|--------------------|---|-----------------|------|
| <b>GEV No.</b>     | 100706  | <b>Ref. No.</b> | 0832 |
| <b>description</b> | ignition electrode connection M4 Qty 1 pcs  |                 |      |
| <b>For models:</b> | FC06G, FC06GA, FC06GDG, FC12G, FC12GA, FC12GDG, FC20G, FC20GA, FC20GDG, FM06GB, FM20GB, FM20GDG, FP05G, FP05GDG, FP10G, FP10GDG, MM20GB |                 |      |



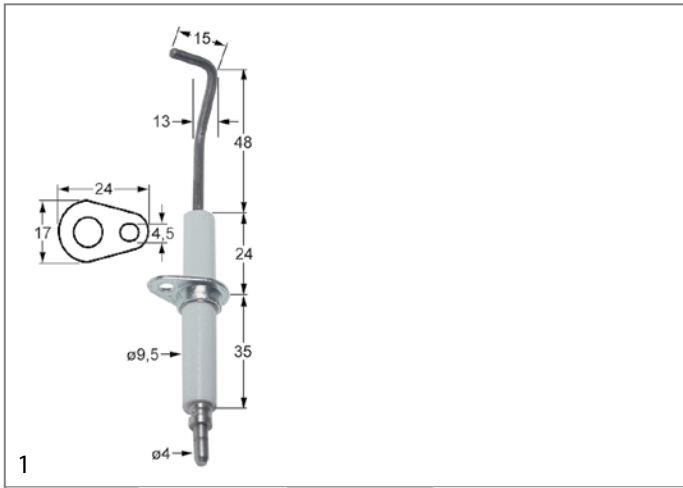

|                    |   |                 |                |
|--------------------|---|-----------------|----------------|
| <b>GEV No.</b>     | 102342  | <b>Ref. No.</b> | 11001<br>11007 |
| <b>description</b> | ignition electrode flange length 24mm flange width 17mm D1 ø 9.5mm L1 48mm L2 13mm L3 15mm BL1 24mm BL2 35mm fixing dimensions ø4.5mm with flange connection ø 4mm  |                 |                |
| <b>For models:</b> | FC05G, FC05GU, FC200GA, FC200GAP, FC200GB, FC201GA, FC-201GAP, FC201GB, FC401GA, FC401GAP, FC401GB, FDG10, FDG155, FDG155DG, FDG55, FDG55DG, FM06GDG, FM10GB, FM10GDG, FM200GA, FM200GAP, FM200GB, FM201GA, FM201GAP, FM201GB, FM401GA, FM401GAP, FM401GB, MM06GA, MM06GAP, MM06GB, MM10GA, MM10GAP, MM10GB, MM200GA, MM200GAP, MM200GB, MM201GA, MM201GAP, MM201GB, MM20GA, MM20GAP, MM401GB |                 |                |

ignition cables

pre-assembled cables

|                    |   |                 |      |
|--------------------|---|-----------------|------|
| <b>GEV No.</b>     | 100026  | <b>Ref. No.</b> | 3958 |
| <b>description</b> | ignition cable cable length 1000mm connection ø4mm / F6.3mm |                 |      |

|                    |   |                 |      |
|--------------------|---|-----------------|------|
| <b>GEV No.</b>     | 102190  | <b>Ref. No.</b> | 3974 |
| <b>description</b> | ignition cable cable length 1500mm connection ø4mm / F2.8mm |                 |      |

|                    |   |                 |      |
|--------------------|---|-----------------|------|
| <b>GEV No.</b>     | 102270  | <b>Ref. No.</b> | 3959 |
| <b>description</b> | ignition cable cable length 1500mm connection ø4mm / F6.3mm |                 |      |

|                    |   |                 |      |
|--------------------|---|-----------------|------|
| <b>GEV No.</b>     | 102155  | <b>Ref. No.</b> | 3973 |
| <b>description</b> | ignition cable cable length 900mm connection ø4mm / F2.8mm                |                 |      |
| <b>For models:</b> | FM10GB, MM06GA, MM06GAP, MM06GB, MM10GA, MM10GAP, MM10GB, MM20GA, MM20GAP |                 |      |

ignition units

|                    |   |                 |      |
|--------------------|---|-----------------|------|
| <b>GEV No.</b>     | 101002  | <b>Ref. No.</b> | 0825 |
| <b>description</b> | ignition unit outputs 2 230VAC dimensions 88x23x34mm mounting distance 73mm inlet F6.3x0.8 outlet F2.8x0.8 0.6VA 50/60Hz        |                 |      |
| <b>For models:</b> | FC06G, FC06GA, FC06GDG, FC12G, FC12GA, FC12GDG, FC20G, FC20GA, FC20GDG, FM06GB, FM20GB, FM20GDG, FP05G, FP05GDG, FP10G, FP10GDG |                 |      |

thermocouples

plug-in thermocouples

plug-in thermocouples standard

with barrel socket ø6(6.5)mm

thermocouples SIT

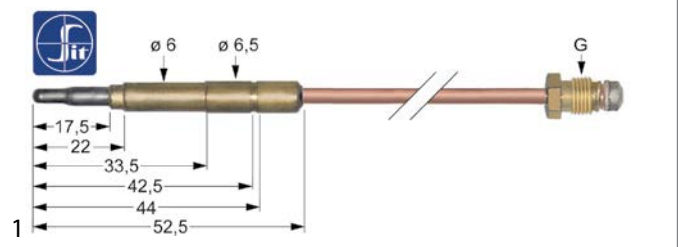

|                    |   |                 |      |
|--------------------|---|-----------------|------|
| <b>GEV No.</b>     | 107612  | <b>Ref. No.</b> | 1668 |
| <b>description</b> | thermocouple SIT M9x1 L 1000mm plug connection ø6.0(6.5)mm  |                 |      |
| <b>For models:</b> | FC06G, FC06GA, FC06GDG, FC12G, FC12GA, FC12GDG, FC20G, FC-20GA, FC20GDG, FM06GB, FP05G, FP05GDG, FP10G, FP10GDG |                 |      |

plug-in thermocouples with interruption

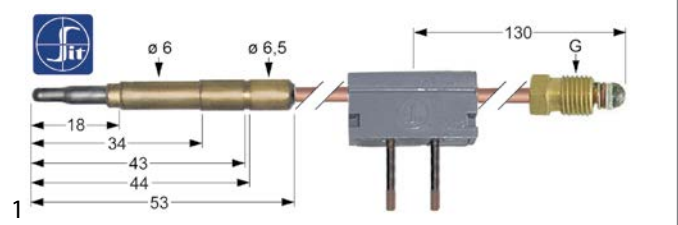

|                    |  |                 |      |
|--------------------|--|-----------------|------|
| <b>GEV No.</b>     | 107164   | <b>Ref. No.</b> | 0831 |
| <b>description</b> | thermocouple SIT with interrupter M9x1 L 1000mm plug connection ø6.0(6.5)mm soldering connection |                 |      |



## gas burners

### bar burners

#### bar burners



|                    |   |                 |       |
|--------------------|---|-----------------|-------|
| <b>GEV No.</b>     | 105788  | <b>Ref. No.</b> | 0767A |
| <b>description</b> | bar burner 1-row ø 50mm Wmm Hmm L 483mm flange width 71mm convection oven flange ø 75mm |                 |       |



|                    |  |                 |      |
|--------------------|--|-----------------|------|
| <b>GEV No.</b>     | 105787   | <b>Ref. No.</b> | 0768 |
| <b>description</b> | bar burner ø 40mm Wmm Hmm L 415mm flange width 43mm flange length 43mm convection oven |                 |      |
| <b>For models:</b> | FC06G, FC06GA, FC06GDG, FM06GB, FM06GDG, FP05G, FP05GDG, MM06GA, MM06GAP, MM06GB       |                 |      |



|                    |   |                 |      |
|--------------------|---|-----------------|------|
| <b>GEV No.</b>     | 105790  | <b>Ref. No.</b> | 3131 |
| <b>description</b> | bar burner ø 50mm Wmm Hmm L 325mm flange width 57mm flange length 57mm convection oven                    |                 |      |
| <b>For models:</b> | FM06GB, FM06GDG, FM10GB, FM10GDG, FM200GA, FM200GAP, FM200GB, FM201GA, FM201GAP, FM201GB, FM20GB, FM20GDG |                 |      |



|                    |  |                 |                |
|--------------------|--|-----------------|----------------|
| <b>GEV No.</b>     | 105791   | <b>Ref. No.</b> | 11031<br>11032 |
| <b>description</b> | bar burner ø 50mm Wmm Hmm L 375mm flange width 57mm flange length 57mm convection oven |                 |                |
| <b>For models:</b> | FM401GA, FM401GAP, FM401GB   |                 |                |



|                    |   |                 |               |
|--------------------|---|-----------------|---------------|
| <b>GEV No.</b>     | 105789  | <b>Ref. No.</b> | 11030<br>1361 |
| <b>description</b> | bar burner ø 50mm Wmm Hmm L 618mm flange width 71mm convection oven flange ø 75mm   |                 |               |
| <b>For models:</b> | FC200GA, FC200GAP, FC200GB, FC201GA, FC201GAP, FC201GB, FC20G, FC20GA, FC20GDG, FC401GA, FC401GAP, FC401GB, FM200GA, FM200GAP, FM200GB, FM201GA, FM201GAP, FM201GB, FM20GDG, FM401GA, FM401GAP, FM401GB, MM200GB, MM201GA, MM201GAP, MM201GB, MM20GA, MM20GAP, MM20GB, MM401GA, MM401GAP, MM401GB |                 |               |

## gas nozzles

### main nozzles

#### gas nozzles M10x1



|                    |   |                 |      |
|--------------------|---|-----------------|------|
| <b>GEV No.</b>     | 106287  | <b>Ref. No.</b> | 2142 |
| <b>description</b> | gas injector thread M10x1 WS 11 bore ø 2.2mm inner peaked |                 |      |

### pilot burner nozzles

#### pilot burner nozzles SIT

##### 100 series



|                    |   |                 |      |
|--------------------|---|-----------------|------|
| <b>GEV No.</b>     | 107170  | <b>Ref. No.</b> | 1667 |
| <b>description</b> | pilot burner nozzle SIT natural gas bore ø 0.35mm Qty 1 pcs |                 |      |

## auxiliary gas parts

### screw connections

#### olives



|                        |                                 |                 |      |
|------------------------|---------------------------------|-----------------|------|
| <b>GEV No.</b>         | 101256                          | <b>Ref. No.</b> | 0665 |
| <b>description</b>     | olive for pipe ø 16mm Qty 1 pcs |                 |      |
| <b>For models:</b>     | FC05G, FC05GU                   |                 |      |
| <b>accessories for</b> | 101256                          |                 |      |



|                    |  |                 |   |
|--------------------|--|-----------------|---|
| <b>GEV No.</b>     | 101253                                       | <b>Ref. No.</b> | — |
| <b>description</b> | union nut thread M24x1.5 PEL for pipe ø 16mm |                 |   |



union screws



|   |                |        |                 |      |
|---|----------------|--------|-----------------|------|
| 1   | <b>GEV No.</b> | 100905 | <b>Ref. No.</b> | 0830 |
| <b>description</b> locking screw M10x1 for pipe ø 6mm Qty 1 pcs |                |        |                 |      |



|   |                |        |                 |      |
|---|----------------|--------|-----------------|------|
| 1   | <b>GEV No.</b> | 101467 | <b>Ref. No.</b> | 1107 |
| <b>description</b> union screw thread M18x1.5 for pipe ø 12mm Qty 1 pcs |                |        |                 |      |

equipment-specific units

for convection ovens/combi-steamers

injection pipes



|   |                |        |                 |      |
|---|----------------|--------|-----------------|------|
| 1   | <b>GEV No.</b> | 692310 | <b>Ref. No.</b> | 3872 |
| <b>description</b> injection pipe for convection oven ED ø 8mm ID ø 6mm L 180mm |                |        |                 |      |

glass panels



|  |                |        |                 |       |
|--|----------------|--------|-----------------|-------|
| 1  | <b>GEV No.</b> | 693985 | <b>Ref. No.</b> | 15196 |
| <b>description</b> glass panel L 443mm W 543mm thickness 4mm |                |        |                 |       |



|  |                |        |                 |                |
|--|----------------|--------|-----------------|----------------|
| 1  | <b>GEV No.</b> | 691937 | <b>Ref. No.</b> | 15202<br>15205 |
| <b>description</b> glass panel L 543mm W 442mm thickness 4mm |                |        |                 |                |



|  |                |        |                 |       |
|--|----------------|--------|-----------------|-------|
| 1  | <b>GEV No.</b> | 694355 | <b>Ref. No.</b> | 15146 |
| <b>description</b> glass panel L 745mm W 355mm thickness 4mm |                |        |                 |       |

for ovens

glass panels



|  |                |        |                 |       |
|--|----------------|--------|-----------------|-------|
| 1  | <b>GEV No.</b> | 691812 | <b>Ref. No.</b> | 15190 |
| <b>description</b> glass panel L 432mm W 346mm thickness 4mm |                |        |                 |       |

knobs

producer-specific knobs

FOINOX



|  |                |        |                 |      |
|--|----------------|--------|-----------------|------|
| 1  | <b>GEV No.</b> | 111753 | <b>Ref. No.</b> | 0150 |
| <b>description</b> knob switch zero mark ø 37mm shaft ø 6x4.6mm shaft flat upper black |                |        |                 |      |
| <b>For models:</b> FE1-2, FE2-3  |                |        |                 |      |



|  |                |        |                 |       |
|--|----------------|--------|-----------------|-------|
| 1  | <b>GEV No.</b> | 111240 | <b>Ref. No.</b> | 15021 |
| <b>description</b> knob switch zero mark ø 40mm shaft ø 6x4.6mm shaft flat upper |                |        |                 |       |

|   |   |                 |               |
|---|---|-----------------|---------------|
|  |   |                 |               |
| 1   |   |                 |               |
| <b>GEV No.</b>  | 111751  | <b>Ref. No.</b> | 0898<br>15019 |
| <b>description</b>  | knob switch zero mark ø 50mm shaft ø 6x4.6mm shaft flat upper black   |                 |               |
| <b>For models:</b>  | FC05E, FC05EU, FC05G, FC05GU, FC06E, FC06EA, FC06EDG, FC06G, FC06GA, FC06GDG, FC06SE, FC06SEA, FC06SEDG, FC12E, FC12EA, FC12EDG, FC12G, FC12GA, FC12GDG, FC12SE, FC12SEA, FC12SEDG, FC20E, FC20EA, FC20EDG, FC20G, FC20GA, FC20GDG, FM10GB, FP05E, FP05EDG, FP05G, FP05GDG, FP10E, FP10EDG, FP10G, FP10GDG, MM06EA, MM06EAP, MM06EB, MM06GA, MM06GAP, MM06GB, MM10EA, MM10EAP, MM10EB, MM10GA, MM10GAP, MM10GB, MM2/3EA...(Other models you can see in the webshop) |                 |               |

|   |   |                 |       |
|---|---|-----------------|-------|
|  |   |                 |       |
| 1   |   |                 |       |
| <b>GEV No.</b>  | 111752  | <b>Ref. No.</b> | 15018 |
| <b>description</b>  | knob switch zero mark ø 50mm shaft ø 6x4.6mm shaft flat upper black   |                 |       |
| <b>For models:</b>  | FC05G, FC05GU, FC200EA, FC200EAP, FC200EB, FC200GA, FC200GAP, FC200GB, FC201EA, FC201EAP, FC201EB, FC201GA, FC201GAP, FC201GB, FC401EA, FC401EAP, FC401EB, FC401GA, FC401GAP, FC401GB, FDE10, FDE15, FDE55, FDG10, FDG15, FDG55, FM200EA, FM200EAP, FM200EB, FM200GA, FM200GAP, FM200GB, FM201EA, FM201EAP, FM201EB, FM201GA, FM201GAP, FM201GB, FM401EA, FM401EAP, FM401EB, FM401GA, FM401GAP, FM401GB, MM200EA, MM200EAP, MM200EB, MM200GA, MM200GAP, MM200GB...(Other models you can see in the webshop) |                 |       |

|   |  |                 |       |
|---|--|-----------------|-------|
|  |  |                 |       |
| 1   |  |                 |       |
| <b>GEV No.</b>  | 111410   | <b>Ref. No.</b> | 15075 |
| <b>description</b>  | knob zero mark ø 50mm shaft ø 6x4.6mm shaft flat upper black |                 |       |

## handles and hand wheels

### mushroom cap handles

|   |  |                 |      |
|---|--|-----------------|------|
|  |  |                 |      |
| 1   |  |                 |      |
| <b>GEV No.</b>  | 111411   | <b>Ref. No.</b> | 0382 |
| <b>description</b>  | mushroom cap handle thread M6 handle ø 26mm ø 17mm L 17mm plastic black matt |                 |      |
| <b>For models:</b>  | FC05G, FC05GU  |                 |      |







## locks

### handle latches

universal

outside fixing



locks

|   |   |                 |                       |
|---|---|-----------------|-----------------------|
|   |   |                 |                       |
| 1   |   |                 |                       |
| <b>GEV No.</b>  | 694065  | <b>Ref. No.</b> | 90199                 |
| <b>description</b>  | door handle for headed units L 145mm W 40mm H 62mm spring length 33mm outer black                                     |                 |                       |
| <b>spare parts for</b>  | 694065  |                 |                       |
|    | <b>GEV No.</b>  | 514390          | <b>Ref. No.</b> 15057 |
|   | spring for door handle ø 6mm L 54mm W 27.5mm  |                 |                       |
|    | <b>GEV No.</b>  | 694734          | <b>Ref. No.</b> —     |
|   | door handle L 165mm W 40mm H 25mm black   |                 |                       |
|  | <b>GEV No.</b>  | 694735          | <b>Ref. No.</b> —     |
|   | cap ø 32mm black  |                 |                       |
| <b>accessories for</b>  | 694065  |                 |                       |
|  | <b>GEV No.</b>  | 694066          | <b>Ref. No.</b> 3772  |
|   | door catch with spigot 2-stage L 28mm W 14mm H 15mm H1 16mm total length 51mm thread M8 thread L 23mm stainless steel |                 |                       |
|  | <b>GEV No.</b>  | 694067          | <b>Ref. No.</b> —     |
|   | door catch with spigot 1-stage L 26mm total length 51mm thread M8   |                 |                       |

### producer-specific

HIOS/FOINOX

|   |   |                 |      |
|---|---|-----------------|------|
|  |   |                 |      |
| 1   |   |                 |      |
| <b>GEV No.</b>  | 694066  | <b>Ref. No.</b> | 3772 |
| <b>description</b>  | door catch with spigot 2-stage L 28mm W 14mm H 15mm H1 16mm total length 51mm thread M8 thread L 23mm stainless steel |                 |      |



|  |   |                 |                       |
|--|---|-----------------|-----------------------|
|   |   |                 |                       |
| 1  |   |                 |                       |
| <b>GEV No.</b>   | 694065  | <b>Ref. No.</b> | 90199                 |
| <b>description</b>   | door handle for headed units L 145mm W 40mm H 62mm spring length 33mm outer black                                     |                 |                       |
| <b>spare parts for</b>   | 694065  |                 |                       |
|   | <b>GEV No.</b>  | 514390          | <b>Ref. No.</b> 15057 |
|  | spring for door handle $\varnothing$ 6mm L 54mm W 27.5mm  |                 |                       |
|   | <b>GEV No.</b>  | 694734          | <b>Ref. No.</b> —     |
|  | door handle L 165mm W 40mm H 25mm black   |                 |                       |
|   | <b>GEV No.</b>  | 694735          | <b>Ref. No.</b> —     |
|  | cap $\varnothing$ 32mm black  |                 |                       |
| <b>accessories for</b>   | 694065  |                 |                       |
|   | <b>GEV No.</b>  | 694066          | <b>Ref. No.</b> 3772  |
|  | door catch with spigot 2-stage L 28mm W 14mm H 15mm H1 16mm total length 51mm thread M8 thread L 23mm stainless steel |                 |                       |
|  | <b>GEV No.</b>  | 694067          | <b>Ref. No.</b> —     |
|  | door catch with spigot 1-stage L 26mm total length 51mm thread M8   |                 |                       |

|   |  |                 |       |
|---|--|-----------------|-------|
|  |  |                 |       |
| 1   |  |                 |       |
| <b>GEV No.</b>  | 514390   | <b>Ref. No.</b> | 15057 |
| <b>description</b>  | spring for door handle $\varnothing$ 6mm L 54mm W 27.5mm |                 |       |

## edgmount latches

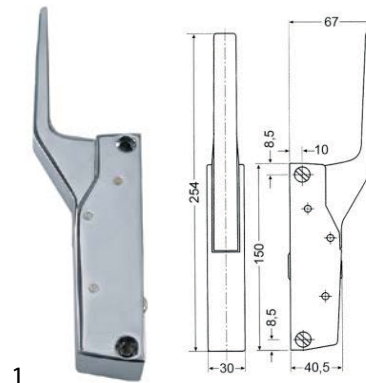

### handle latches

#### CAFF/FERMOD

|   |   |                 |                      |
|---|---|-----------------|----------------------|
|  |   |                 |                      |
| 1   |   |                 |                      |
| <b>GEV No.</b>  | 700060  | <b>Ref. No.</b> | 1496                 |
| <b>description</b>  | handle latch L 150mm mounting distance 133mm non lockable heated units G 791                |                 |                      |
| <b>accessories for</b>  | 700060  |                 |                      |
|  | <b>GEV No.</b>  | 700061          | <b>Ref. No.</b> 1500 |
|   | door catch L 58mm W 20mm H 35mm mounting distance 42mm chrome-plated brass for headed units |                 |                      |

|   |                                |        |                   |
|---|--------------------------------|--------|-------------------|
| <b>accessories for</b>  | 700060                         |        |                   |
|  | <b>GEV No.</b>                 | 700062 | <b>Ref. No.</b> — |
|   | handle protection heated units |        |                   |

## door catches

|   |  |                 |                   |
|---|--|-----------------|-------------------|
|  |  |                 |                   |
| 1   |  |                 |                   |
| <b>GEV No.</b>  | 700061   | <b>Ref. No.</b> | 1500              |
| <b>description</b>  | door catch L 58mm W 20mm H 35mm mounting distance 42mm chrome-plated brass for headed units  |                 |                   |
| <b>For models:</b>  | FC06E, FC06EA, FC06EDG, FC06G, FC06GA, FC06GDG, FC06SE, FC06SEA, FC06SEDG, FC12E, FC12EA, FC12EDG, FC12G, FC12GA, FC12GDG, FC12SE, FC12SEA, FC12SEDG, FC20E, FC20EA, FC20EDG, FC20G, FC20GA, FC20GDG, FM06EB, FM06EDG, FM06GB, FM06GDG, FM10EB, FM10EDG, FM10GDG, FM20EB, FM20EDG, FM20GB, FM20GDG, FP05E, FP05EDG, FP05G, FP05GDG, FP10E, FP10EDG, FP10G, FP10GDG |                 |                   |
| <b>accessories for</b>  | 700061   |                 |                   |
|  | <b>GEV No.</b>   | 690414          | <b>Ref. No.</b> — |
|   | handle latch L 150mm mounting distance 133mm non lockable refrigeration units G 791  |                 |                   |

## snap locks

### universal

|  |  |                 |      |
|--|--|-----------------|------|
|  |  |                 |      |
| 1  |  |                 |      |
| <b>GEV No.</b>   | 690864   | <b>Ref. No.</b> | 0285 |
| <b>description</b>   | door catch L 38mm W 13mm H 21mm mounting distance 28mm zamak with spigot |                 |      |
| <b>For models:</b>   | FC05E, FC05EU, FC05G, FC05GU   |                 |      |

|  |  |                 |       |
|--|--|-----------------|-------|
|  |  |                 |       |
| 1  |  |                 |       |
| <b>GEV No.</b>   | 690863   | <b>Ref. No.</b> | 0285B |
| <b>description</b>   | snap lock L 60mm W 16mm mounting distance 48mm spring thickness 1.5mm without door catch zamak |                 |       |

|   |  |                 |       |
|---|--|-----------------|-------|
|  |  |                 |       |
| 1   |  |                 |       |
| <b>GEV No.</b>  | 690903   | <b>Ref. No.</b> | 0117B |
| <b>description</b>  | snap lock L 69mm W 13mm H 20mm mounting distance 57mm complete with door catch nickel-plated brass |                 |       |
| <b>For models:</b>  | FE1-2, FE2-3   |                 |       |

|   |   |                 |       |
|---|---|-----------------|-------|
|  |   |                 |       |
| 1   |   |                 |       |
| <b>GEV No.</b>  | 692609  | <b>Ref. No.</b> | 0117B |
| <b>description</b>  | snap lock L 70mm W 13mm H 21mm mounting distance 60/30mm complete with door catch zamak |                 |       |

### espagnolette locks

#### producer-specific

#### HIOS/FOINOX

|  |                               |                 |        |
|--|-------------------------------|-----------------|--------|
|  |                               |                 |        |
| 1  |                               |                 |        |
| <b>GEV No.</b>   | 690829                        | <b>Ref. No.</b> | 3736.1 |
| <b>description</b>   | bush H 8mm ID ø 8mm ED ø 26mm |                 |        |

|   |                                       |                 |      |
|---|---------------------------------------|-----------------|------|
|  |                                       |                 |      |
| 1   |                                       |                 |      |
| <b>GEV No.</b>  | 690828                                | <b>Ref. No.</b> | 3734 |
| <b>description</b>  | bush L 20mm brass ID ø 10mm ED ø 15mm |                 |      |





|   |  |                 |      |
|---|--|-----------------|------|
|  |  |                 |      |
| 1   |  |                 |      |
| <b>GEV No.</b>  | 514317   | <b>Ref. No.</b> | 3754 |
| <b>description</b>  | disc ID ø 11mm ED ø 17mm H 3mm brass   |                 |      |
| <b>For models:</b>  | FC06E, FC06EA, FC06EDG, FC06G, FC06GA, FC06GDG, FC06SE, FC06SEA, FC06SEDG, FC12E, FC12EA, FC12EDG, FC12G, FC12GA, FC12GDG, FC12SE, FC12SEA, FC12SEDG, FC200EA, FC200EAP, FC200EB, FC200GA, FC200GAP, FC200GB, FC201EA, FC201EAP, FC201EB, FC201GA, FC201GAP, FC201GB, FC20E, FC20EA, FC20EDG, FC20G, FC20GA, FC20GDG, FC401EA, FC401EAP, FC401EB, FC401GA, FC401GAP, FC401GB, FDE10, FDE155, FDE155DG, FDE55, FDE55DG, FDG10, FDG155, FDG155DG...(Other models you can see in the webshop) |                 |      |

|   |                  |                 |       |
|---|------------------|-----------------|-------|
|  |                  |                 |       |
| 1   |                  |                 |       |
| <b>GEV No.</b>  | 514320           | <b>Ref. No.</b> | 3760A |
| <b>description</b>  | door catch       |                 |       |
| <b>For models:</b>  | MM2/3EA, MM2/3EB |                 |       |

|   |  |                 |        |
|---|--|-----------------|--------|
|  |  |                 |        |
| 1   |  |                 |        |
| <b>GEV No.</b>  | 514321   | <b>Ref. No.</b> | 3738.1 |
| <b>description</b>  | door catch with roller L 35mm W 26mm H 32mm mounting distance 20mm rollerø 10mm  |                 |        |
| <b>For models:</b>  | FC06E, FC06EA, FC06EDG, FC06G, FC06GA, FC06GDG, FC06SE, FC06SEA, FC06SEDG, FC12E, FC12EA, FC12EDG, FC12G, FC12GA, FC12GDG, FC12SE, FC12SEA, FC12SEDG, FC200EA, FC200EAP, FC200EB, FC200GA, FC200GAP, FC200GB, FC201EA, FC201EAP, FC201EB, FC201GA, FC201GAP, FC201GB, FC20E, FC20EA, FC20EDG, FC20G, FC20GA, FC20GDG, FC401EA, FC401EAP, FC401EB, FC401GA, FC401GAP, FC401GB, FDE10, FDE155, FDE155DG, FDE55, FDE55DG, FDG10, FDG155, FDG155DG...(Other models you can see in the webshop) |                 |        |

|  |             |                 |      |
|--|-------------|-----------------|------|
|  |             |                 |      |
| 1  |             |                 |      |
| <b>GEV No.</b>   | 514195      | <b>Ref. No.</b> | 1742 |
| <b>description</b>   | door handle |                 |      |

|   |  |                 |        |
|---|--|-----------------|--------|
|  |  |                 |        |
| 1   |  |                 |        |
| <b>GEV No.</b>  | 514316   | <b>Ref. No.</b> | 3700.2 |
| <b>description</b>  | door handle black  |                 |        |
| <b>For models:</b>  | FC06E, FC06EA, FC06EDG, FC06G, FC06GA, FC06GDG, FC06SE, FC06SEA, FC06SEDG, FC12E, FC12EA, FC12EDG, FC12G, FC12GA, FC12GDG, FC12SE, FC12SEA, FC12SEDG, FC200EA, FC200EAP, FC200EB, FC200GA, FC200GAP, FC200GB, FC201EA, FC201EAP, FC201EB, FC201GA, FC201GAP, FC201GB, FC20E, FC20EA, FC20EDG, FC20G, FC20GA, FC20GDG, FC401EA, FC401EAP, FC401EB, FC401GA, FC401GAP, FC401GB, FDE10, FDE155, FDE155DG, FDE55, FDE55DG, FDG10, FDG155, FDG155DG...(Other models you can see in the webshop) |                 |        |

|   |   |        |                        |
|---|---|--------|------------------------|
| <b>accessories for</b>  | 514316  |        |                        |
|  | <b>GEV No.</b>  | 514321 | <b>Ref. No.</b> 3738.1 |
|   | door catch with roller L 35mm W 26mm H 32mm mounting distance 20mm rollerø 10mm |        |                        |
|  | <b>GEV No.</b>  | 690826 | <b>Ref. No.</b> 3910   |
|   | striker bolt L1 60mm L2 64mm D1 ø 20mm D2 ø 10mm                                |        |                        |
|  | <b>GEV No.</b>  | 690862 | <b>Ref. No.</b> 3747   |
|   | latch gear opening to the right shaft intake ø 8x8mm L 170mm W 40mm H 29mm      |        |                        |
|  | <b>GEV No.</b>  | 691655 | <b>Ref. No.</b> 3909   |
|   | striker bolt L1 60mm L2 95mm D1 ø 20mm D2 ø 10mm                                |        |                        |











|   |  |                 |       |
|---|--|-----------------|-------|
|  |  |                 |       |
| 1   |  |                 |       |
| <b>GEV No.</b>  | 697936   | <b>Ref. No.</b> | 61869 |
| <b>description</b>  | door handle L 200mm W 65mm H 48mm handle ø 30mm shaft 8x8mm shaft L 64mm |                 |       |

|   |  |                 |      |
|---|--|-----------------|------|
|  |  |                 |      |
| 1   |  |                 |      |
| <b>GEV No.</b>  | 696513   | <b>Ref. No.</b> | 1745 |
| <b>description</b>  | door handle L 200mm W 65mm H 48mm handle ø 30mm shaft 8x8mm shaft L 72mm   |                 |      |
| <b>accessories for</b>  | 696513   |                 |      |
|   | <b>GEV No.</b>   | <b>Ref. No.</b> |      |
|  | 690862   | 3747            |      |
| <b>description</b>  | latch gear opening to the right shaft intake ø 8x8mm L 170mm W 40mm H 29mm |                 |      |

|   |   |                 |      |
|---|---|-----------------|------|
|  |   |                 |      |
| 1   |   |                 |      |
| <b>GEV No.</b>  | 690827  | <b>Ref. No.</b> | 3775 |
| <b>description</b>  | latch block L 40mm brass hole ø 20mm dimensions 30x30mm |                 |      |

|   |  |                 |      |
|---|--|-----------------|------|
|  |  |                 |      |
| 1   |  |                 |      |
| <b>GEV No.</b>  | 690862   | <b>Ref. No.</b> | 3747 |
| <b>description</b>  | latch gear opening to the right shaft intake ø 8x8mm L 170mm W 40mm H 29mm   |                 |      |
| <b>For models:</b>  | FC06E, FC06EA, FC06EDG, FC06G, FC06GA, FC06GDG, FC06SE, FC06SEA, FC06SEDG, FC12E, FC12EA, FC12EDG, FC12G, FC12GA, FC12GDG, FC12SE, FC12SEA, FC12SEDG, FC200EA, FC200EAP, FC200EB, FC200GA, FC200GAP, FC200GB, FC201EA, FC201EAP, FC201EB, FC201GA, FC201GAP, FC201GB, FC20E, FC20EA, FC20EDG, FC401EA, FC401EAP, FC401EB, FC401GA, FC401GAP, FC401GB, FDE10, FDE15S, FDE15SDG, FDE5S, FDE5SDG, FDG10, FDG15S, FDG15SDG, FDG5S, FDG5SDG, FM06EB...(Other models you can see in the webshop) |                 |      |
| <b>accessories for</b>  | 690862   |                 |      |
|   | <b>GEV No.</b>   | <b>Ref. No.</b> |      |
|  | 514317   | 3754            |      |
| <b>description</b>  | disc ID ø 11mm ED ø 17mm H 3mm brass   |                 |      |
|  | <b>GEV No.</b>   | <b>Ref. No.</b> |      |
|   | 514321   | 3738.1          |      |
| <b>description</b>  | door catch with roller L 35mm W 26mm H 32mm mounting distance 20mm roller ø 10mm   |                 |      |
|  | <b>GEV No.</b>   | <b>Ref. No.</b> |      |
|   | 690826   | 3910            |      |
| <b>description</b>  | striker bolt L1 60mm L2 64mm D1 ø 20mm D2 ø 10mm   |                 |      |
|  | <b>GEV No.</b>   | <b>Ref. No.</b> |      |
|   | 690827   | 3775            |      |
| <b>description</b>  | latch block L 40mm brass hole ø 20mm dimensions 30x30mm  |                 |      |
|  | <b>GEV No.</b>   | <b>Ref. No.</b> |      |
|   | 690828   | 3734            |      |
| <b>description</b>  | bush L 20mm brass ID ø 10mm ED ø 15mm  |                 |      |

|   |   |                 |  |
|---|---|-----------------|--|
| <b>accessories for</b>  | 690862  |                 |  |
|   | <b>GEV No.</b>                                    | <b>Ref. No.</b> |  |
|  | 690829  | 3736.1          |  |
| <b>description</b>  | bush H 8mm ID ø 8mm ED ø 26mm                     |                 |  |
|  | <b>GEV No.</b>                                    | <b>Ref. No.</b> |  |
|   | 691637  | 3780            |  |
| <b>description</b>  | roll pin ø 3mm L 20mm                             |                 |  |
|  | <b>GEV No.</b>                                    | <b>Ref. No.</b> |  |
|   | 691653  | 40328           |  |
| <b>description</b>  | striker bolt L1 60mm L2 240mm D1 ø 20mm D2 ø 10mm |                 |  |
|  | <b>GEV No.</b>                                    | <b>Ref. No.</b> |  |
|   | 691654  | 40332           |  |
| <b>description</b>  | striker bolt L1 60mm L2 113mm D1 ø 20mm D2 ø 10mm |                 |  |
|  | <b>GEV No.</b>                                    | <b>Ref. No.</b> |  |
|   | 691655  | 3909            |  |
| <b>description</b>  | striker bolt L1 60mm L2 95mm D1 ø 20mm D2 ø 10mm  |                 |  |
|  | <b>GEV No.</b>                                    | <b>Ref. No.</b> |  |
|   | 691656  | 3795            |  |
| <b>description</b>  | striker bolt L1 60mm L2 315mm D1 ø 20mm D2 ø 10mm |                 |  |
|  | <b>GEV No.</b>                                    | <b>Ref. No.</b> |  |
|   | 691657  | 3796            |  |
| <b>description</b>  | striker bolt L1 60mm L2 283mm D1 ø 20mm D2 ø 10mm |                 |  |
|  | <b>GEV No.</b>                                    | <b>Ref. No.</b> |  |
|   | 691658  | 40329           |  |
| <b>description</b>  | striker bolt L1 60mm L2 570mm D1 ø 20mm D2 ø 10mm |                 |  |

|  |                       |                 |      |
|--|-----------------------|-----------------|------|
|  |                       |                 |      |
| 1  |                       |                 |      |
| <b>GEV No.</b>   | 691637                | <b>Ref. No.</b> | 3780 |
| <b>description</b>   | roll pin ø 3mm L 20mm |                 |      |

|  |   |                 |       |
|--|---|-----------------|-------|
|  |   |                 |       |
| 1  |   |                 |       |
| <b>GEV No.</b>   | 691654  | <b>Ref. No.</b> | 40332 |
| <b>description</b>   | striker bolt L1 60mm L2 113mm D1 ø 20mm D2 ø 10mm |                 |       |

|  |   |                 |       |
|--|---|-----------------|-------|
|  |   |                 |       |
| 1  |   |                 |       |
| <b>GEV No.</b>   | 691653  | <b>Ref. No.</b> | 40328 |
| <b>description</b>   | striker bolt L1 60mm L2 240mm D1 ø 20mm D2 ø 10mm |                 |       |

|  |   |                 |      |
|--|---|-----------------|------|
|  |   |                 |      |
| 1  |   |                 |      |
| <b>GEV No.</b>   | 691657  | <b>Ref. No.</b> | 3796 |
| <b>description</b>   | striker bolt L1 60mm L2 283mm D1 ø 20mm D2 ø 10mm |                 |      |

|  |   |                 |      |
|--|---|-----------------|------|
|  |   |                 |      |
| 1  |   |                 |      |
| <b>GEV No.</b>   | 691656  | <b>Ref. No.</b> | 3795 |
| <b>description</b>   | striker bolt L1 60mm L2 315mm D1 ø 20mm D2 ø 10mm |                 |      |

|  |   |                 |       |
|--|---|-----------------|-------|
|  |   |                 |       |
| 1  |   |                 |       |
| <b>GEV No.</b>   | 691658  | <b>Ref. No.</b> | 40329 |
| <b>description</b>   | striker bolt L1 60mm L2 570mm D1 ø 20mm D2 ø 10mm |                 |       |

|   |  |                 |      |
|---|--|-----------------|------|
|  |  |                 |      |
| <b>GEV No.</b>  | 690826   | <b>Ref. No.</b> | 3910 |
| <b>description</b>  | striker bolt L1 60mm L2 64mm D1 ø 20mm D2 ø 10mm |                 |      |

|   |  |                 |      |
|---|--|-----------------|------|
|  |  |                 |      |
| <b>GEV No.</b>  | 691655   | <b>Ref. No.</b> | 3909 |
| <b>description</b>  | striker bolt L1 60mm L2 95mm D1 ø 20mm D2 ø 10mm |                 |      |



|                    |  |                 |         |
|--------------------|--|-----------------|---------|
| <b>GEV No.</b>     | 514310   | <b>Ref. No.</b> | 0321.05 |
| <b>description</b> | hinge bearing mounting pos. bottom left without bolt   |                 |         |
| <b>For models:</b> | FC06E, FC06EA, FC06EDG, FC06G, FC06GA, FC06GDG, FC06SE, FC06SEA, FC06SEDG, FC12E, FC12EA, FC12EDG, FC12G, FC12GA, FC12GDG, FC12SE, FC12SEA, FC12SEDG, FC20E, FC20EA, FC20EDG, FC20G, FC20GA, FC20GDG, FM06EB, FM06EDG, FM06GB, FM06GDG, FM10EB, FM10EDG, FM10GB, FM10GDG, FM20EB, FM20EDG, FM20GB, FM20GDG, FP05E, FP05EDG, FP05G, FP05GDG, FP10E, FP10EDG, FP10G, FP10GDG, MM06EA, MM06EAP, MM06EB, MM06GA, MM06GAP, MM06GB...(Other models you can see in the webshop) |                 |         |



|                    |   |                 |       |
|--------------------|---|-----------------|-------|
| <b>GEV No.</b>     | 514313  | <b>Ref. No.</b> | 12025 |
| <b>description</b> | hinge bearing mounting pos. lower without bolt  |                 |       |
| <b>For models:</b> | FC200EA, FC200EAP, FC200EB, FC200GA, FC200GAP, FC200GB, FC201EA, FC201EAP, FC201EB, FC201GA, FC201GAP, FC201GB, FC401EA, FC401EAP, FC401EB, FC401GA, FC401GAP, FC401GB, FDE10, FDE15, FDE15SDG, FDE5, FDE5SDG, FDG10, FDG15, FDG15SDG, FDG5, FDG5SDG, FM200EA, FM200EAP, FM200EB, FM200GA, FM200GAP, FM200GB, FM201EA, FM201EAP, FM201EB, FM201GA, FM201GAP, FM201GB, FM401EA, FM401EAP, FM401EB, FM401GA, FM401GAP, FM401GB, MM200EA, MM200EAP, MM200EB, MM200GA...(Other models you can see in the webshop) |                 |       |



|                    |  |                 |       |
|--------------------|--|-----------------|-------|
| <b>GEV No.</b>     | 514315   | <b>Ref. No.</b> | 30082 |
| <b>description</b> | hinge bearing mounting pos. lower without bolt |                 |       |
| <b>For models:</b> | MM2/3EA, MM2/3EB                               |                 |       |



|                    |   |                 |       |
|--------------------|---|-----------------|-------|
| <b>GEV No.</b>     | 514305  | <b>Ref. No.</b> | 0046B |
| <b>description</b> | hinge bearing mounting pos. upper left without bolt |                 |       |
| <b>For models:</b> | FE1-2, FE2-3  |                 |       |



|                    |   |                 |                |
|--------------------|---|-----------------|----------------|
| <b>GEV No.</b>     | 514307  | <b>Ref. No.</b> | 1003A<br>12178 |
| <b>description</b> | hinge bearing mounting pos. upper left without bolt |                 |                |
| <b>For models:</b> | FC05G, FC05GU                                       |                 |                |

## hinges oven hinges

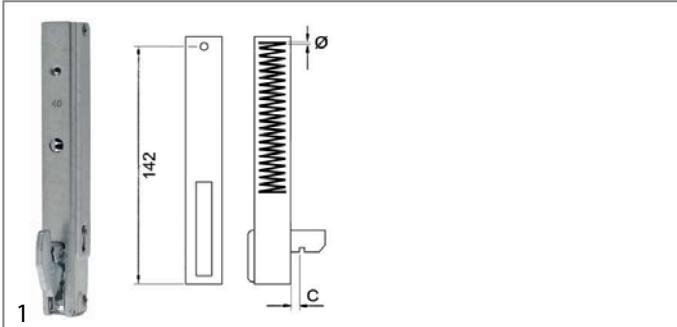

|                    |  |                 |       |
|--------------------|--|-----------------|-------|
| <b>GEV No.</b>     | 700390   | <b>Ref. No.</b> | 15062 |
| <b>description</b> | oven hinge mounting distance 142mm mounting distance 2mm lug mountingmm lever lengthmm groove distance 12mm spring thickness 3mm mounting ear position spring length 116mm L 170mm mounting pos. left/right W 22mm |                 |       |

## door bearing



|                    |  |                 |       |
|--------------------|--|-----------------|-------|
| <b>GEV No.</b>     | 514306   | <b>Ref. No.</b> | 0045D |
| <b>description</b> | hinge bearing mounting pos. bottom left without bolt |                 |       |
| <b>For models:</b> | FE1-2, FE2-3   |                 |       |



|                    |  |                 |       |
|--------------------|--|-----------------|-------|
| <b>GEV No.</b>     | 514308   | <b>Ref. No.</b> | 1004A |
| <b>description</b> | hinge bearing mounting pos. bottom left without bolt |                 |       |
| <b>For models:</b> | FC05E, FC05EU, FC05G, FC05GU                         |                 |       |





|   |   |                 |       |
|---|---|-----------------|-------|
|  |   |                 |       |
| 1   |   |                 |       |
| <b>GEV No.</b>  | 514309  | <b>Ref. No.</b> | 0322C |
| <b>description</b>  | hinge bearing mounting pos. upper left without bolt   |                 |       |
| <b>For models:</b>  | FC06E, FC06EA, FC06EDG, FC06G, FC06GA, FC06GDG, FC06SE, FC06SEA, FC06SEDG, FC12E, FC12EA, FC12EDG, FC12G, FC12GA, FC12GDG, FC12SE, FC12SEA, FC12SEDG, FM06EB, FM06EDG, FM06GB, FM06GDG, FM10EB, FM10EDG, FM10GB, FM10GDG, FP05G, FP05GDG, FP10E, FP10EDG, FP10G, FP10GDG, MM06EA, MM06EAP, MM06EB, MM06GA, MM06GAP, MM06GB, MM10EA, MM10EAP, MM10EB, MM10GA, MM10GAP, MM10GB, MM20EA, MM20EAP, MM20EB, MM20GB |                 |       |

|   |   |                 |            |
|---|---|-----------------|------------|
|  |   |                 |            |
| 1   |   |                 |            |
| <b>GEV No.</b>  | 514311  | <b>Ref. No.</b> | 15.0007.01 |
| <b>description</b>  | hinge bearing mounting pos. upper left without bolt   |                 |            |
| <b>For models:</b>  | FC20E, FC20EA, FC20EDG, FC20G, FC20GA, FC20GDG, FM20EB, FM20EDG, FM20GB, FM20GDG, MM20GA, MM20GAP |                 |            |

|  |   |                 |       |
|--|---|-----------------|-------|
|  |   |                 |       |
| 1  |   |                 |       |
| <b>GEV No.</b>   | 514312  | <b>Ref. No.</b> | 12024 |
| <b>description</b>   | hinge bearing mounting pos. upper left without bolt   |                 |       |
| <b>For models:</b>   | FC200EA, FC200EAP, FC200EB, FC200GA, FC200GAP, FC200GB, FC201EA, FC201EAP, FC201EB, FC201GA, FC201GAP, FC201GB, FC401EA, FC401EAP, FC401EB, FC401GA, FC401GAP, FC401GB, FDE10, FDE155, FDE55, FDE55DG, FDG10, FDG155, FDG155DG, FDG55, FDG55DG, FM200EA, FM200EAP, FM200EB, FM200GA, FM200GAP, FM200GB, FM201EA, FM201EAP, FM201EB, FM201GA, FM201GAP, FM201GB, FM401EA, FM401EAP, FM401EB, FM401GA, FM401GAP, FM401GB, MM200EA, MM200EAP, MM200EB, MM200GA, MM200GAP...(Other models you can see in the webshop) |                 |       |

|   |   |                 |       |
|---|---|-----------------|-------|
|  |   |                 |       |
| 1   |   |                 |       |
| <b>GEV No.</b>  | 514314  | <b>Ref. No.</b> | 30083 |
| <b>description</b>  | hinge bearing mounting pos. upper left without bolt |                 |       |
| <b>For models:</b>  | MM2/3EA, MM2/3EB                                    |                 |       |

## DERBY RUOTE

with fixing plate

chrome-plated steel

|  |   |                 |       |
|--|---|-----------------|-------|
|  |   |                 |       |
| 1  |   |                 |       |
| <b>GEV No.</b>   | 700210  | <b>Ref. No.</b> | 15034 |
| <b>description</b>   | swivel castor with swivel brake ø 125mm plate fixing housing chrome-plated sheet steel plate size 95x70mm hole distance 50x70mm capacity 100kg bearing ball bearing wheel body polypropylene tread TPE tyres H 162mm wheel width 30mm Qty 1 pcs |                 |       |

## gaskets

refrigeration gaskets

plug-in gaskets

profile 9048

We offer custom-made gaskets for this profile

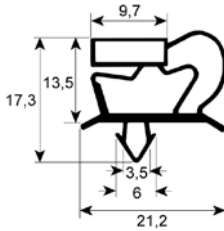
|   |   |                 |       |
|---|---|-----------------|-------|
|  |   |                 |       |
| 1   |   |                 |       |
| <b>GEV No.</b>  | 900345  | <b>Ref. No.</b> | 74001 |
| <b>description</b>  | refrigeration gasket profile 9048 W 410mm L 670mm plug size for blast chiller |                 |       |

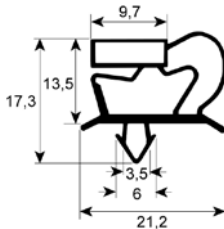
|  |   |                 |       |
|--|---|-----------------|-------|
|  |   |                 |       |
| 1  |   |                 |       |
| <b>GEV No.</b>   | 901211  | <b>Ref. No.</b> | 74002 |
| <b>description</b>   | refrigeration gasket profile 9048 W 555mm L 705mm plug size for blast chiller |                 |       |

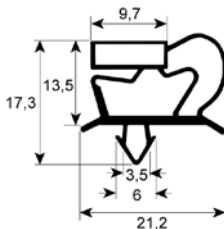
|  |   |                 |       |
|--|---|-----------------|-------|
|  |   |                 |       |
| 1  |   |                 |       |
| <b>GEV No.</b>   | 901209  | <b>Ref. No.</b> | 74003 |
| <b>description</b>   | refrigeration gasket profile 9048 W 710mm L 835mm plug size for blast chiller |                 |       |

gaskets for heated units

window seals

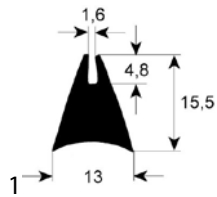

|                    |   |                 |       |
|--------------------|---|-----------------|-------|
| <b>GEV No.</b>     | 900463                                    | <b>Ref. No.</b> | 30093 |
| <b>description</b> | window gasket profile 1650 L 1110mm Qty 1 |                 |       |
| <b>For models:</b> | MM2/3EA, MM2/3EB                          |                 |       |

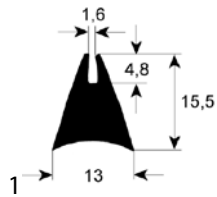

|                    |   |                 |                      |
|--------------------|---|-----------------|----------------------|
| <b>GEV No.</b>     | 900472  | <b>Ref. No.</b> | 0490<br>0498<br>1441 |
| <b>description</b> | window gasket profile 1650 L 1700mm Qty 1   |                 |                      |
| <b>For models:</b> | FC05E, FC05EU, FC05G, FC05GU, FC06E, FC06EA, FC06EDG, FC06G, FC06GA, FC06GDG, FC06SE, FC06SEA, FC06SEDG, FC12G, FC12GA, FC12GDG, FM06EB, FM06EDG, FM06GB, FM06GDG, FP05E, FP05EDG, FP05G, FP05GDG, FP10G, FP10GDG, MM06EA, MM06EAP, MM06EB, MM06GA, MM06GAP, MM06GB |                 |                      |

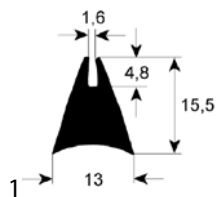

|                    |   |                 |              |
|--------------------|---|-----------------|--------------|
| <b>GEV No.</b>     | 900473  | <b>Ref. No.</b> | 0489<br>1444 |
| <b>description</b> | window gasket profile 1650 L 2250mm Qty 1   |                 |              |
| <b>For models:</b> | FC12E, FC12EA, FC12EDG, FC12SE, FC12SEA, FC12SEDG, FC20E, FC20EA, FC20EDG, FC20G, FC20GA, FC20GDG, FM10EB, FM10EDG, FM10GB, FM10GDG, FM20EB, FM20EDG, FM20GB, FM20GDG, FP10E, FP10EDG, MM10EA, MM10EAP, MM10EB, MM10GA, MM10GAP, MM10GB, MM20EA, MM20EAP, MM20EB, MM20GA, MM20GAP, MM20GB |                 |              |

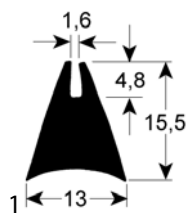

|                    |  |                 |     |
|--------------------|--|-----------------|-----|
| <b>GEV No.</b>     | 900881   | <b>Ref. No.</b> | N/A |
| <b>description</b> | window gasket profile 1650 Qty supplied by meter |                 |     |

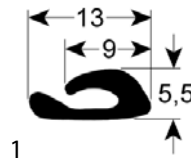

|                    |   |                 |       |
|--------------------|---|-----------------|-------|
| <b>GEV No.</b>     | 900469  | <b>Ref. No.</b> | 14017 |
| <b>description</b> | window gasket profile 1880 L 1385mm Qty 1   |                 |       |
| <b>For models:</b> | FC200EA, FC200EAP, FC200EB, FC200GA, FC200GAP, FC200GB, FC201EA, FC201EAP, FC201EB, FC201GA, FC201GAP, FC201GB, FC401EA, FC401EAP, FC401EB, FC401GA, FC401GAP, FC401GB, FM200EA, FM200EAP, FM200EB, FM200GA, FM200GAP, FM200GB, FM201EA, FM201EAP, FM201EB, FM201GA, FM201GAP, FM201GB, FM401EA, FM401EAP, FM401EB, FM401GA, FM401GAP, FM401GB, MM200EA, MM200EAP, MM200EB, MM200GA, MM200GAP, MM200GB, MM201EA, MM201EAP, MM201EB, MM201GA, MM201GAP, MM201GB, MM401EA, MM401EAP...(Other models you can see in the webshop) |                 |       |

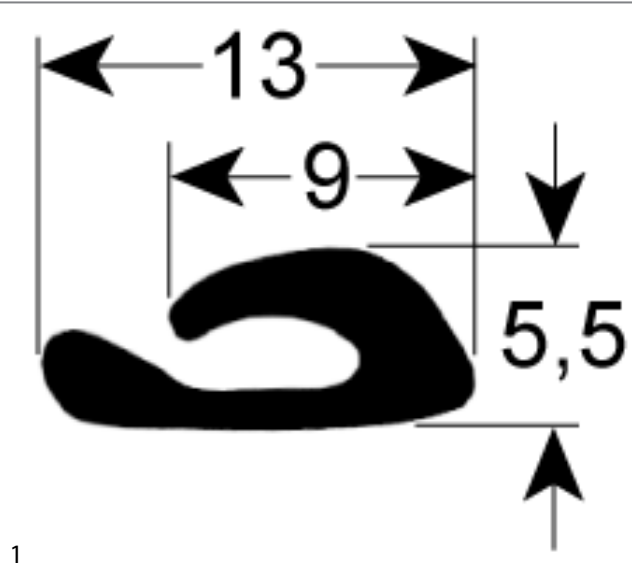

|                    |   |                 |      |
|--------------------|---|-----------------|------|
| <b>GEV No.</b>     | 902550                                    | <b>Ref. No.</b> | 0032 |
| <b>description</b> | window gasket profile 1880 L 5170mm Qty 1 |                 |      |

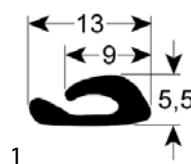

|                        |  |                 |                 |
|------------------------|--|-----------------|-----------------|
| <b>GEV No.</b>         | 900470   | <b>Ref. No.</b> | 14018           |
| <b>description</b>     | window gasket profile 1880 L 520mm Qty 1   |                 |                 |
| <b>For models:</b>     | FC200EA, FC200EAP, FC200EB, FC200GA, FC200GAP, FC200GB, FM200EA, FM200EAP, FM200EB, FM200GA, FM200GAP, FM200GB, MM200EA, MM200EAP, MM200EB, MM200GA, MM200GAP, MM200GB |                 |                 |
| <b>accessories for</b> | 900470   |                 |                 |
|                        | <b>GEV No.</b>   | 900471          | <b>Ref. No.</b> |
|                        |  |                 | 14019           |
|                        | window gasket profile 1880 L 680mm Qty 1   |                 |                 |



|                        |   |                 |       |
|------------------------|---|-----------------|-------|
|                        |   |                 |       |
| <b>GEV No.</b>         | 900471  | <b>Ref. No.</b> | 14019 |
| <b>description</b>     | window gasket profile 1880 L 680mm Qty 1  |                 |       |
| <b>For models:</b>     | FC201EA, FC201EAP, FC201EB, FC201GA, FC201GAP, FC201GB, FC401EA, FC401EAP, FC401EB, FC401GA, FC401GAP, FC401GB, FM201EA, FM201EAP, FM201EB, FM201GA, FM201GAP, FM201GB, FM401EA, FM401EAP, FM401EB, FM401GA, FM401GAP, FM401GB, MM201EA, MM201EAP, MM201EB, MM201GA, MM201GAP, MM201GB, MM401EA, MM401EAP, MM401GA, MM401GAP, MM401GB |                 |       |
| <b>accessories for</b> | 900471  |                 |       |
|                        |   |                 |       |
| <b>GEV No.</b>         | 900470  | <b>Ref. No.</b> | 14018 |
| <b>description</b>     | window gasket profile 1880 L 520mm Qty 1  |                 |       |

|                    |  |                 |       |
|--------------------|--|-----------------|-------|
|                    |  |                 |       |
| <b>GEV No.</b>     | 902549                                   | <b>Ref. No.</b> | 60327 |
| <b>description</b> | window gasket profile 1880 L 730mm Qty 1 |                 |       |

|                    |  |                 |       |
|--------------------|--|-----------------|-------|
|                    |  |                 |       |
| <b>GEV No.</b>     | 900882   | <b>Ref. No.</b> | 14002 |
| <b>description</b> | window gasket profile 1880 Qty supplied by meter |                 |       |

|                    |                                      |                 |       |
|--------------------|--------------------------------------|-----------------|-------|
| <b>door seals</b>  |                                      |                 |       |
|                    |                                      |                 |       |
| <b>GEV No.</b>     | 900461                               | <b>Ref. No.</b> | 30099 |
| <b>description</b> | door seal profile 2400 L 380mm Qty 1 |                 |       |
| <b>For models:</b> | MM2/3EA, MM2/3EB                     |                 |       |

|                    |  |                 |      |
|--------------------|--|-----------------|------|
|                    |  |                 |      |
| <b>GEV No.</b>     | 901325                                       | <b>Ref. No.</b> | 1443 |
| <b>description</b> | door seal profile 2400 L 410mm external size |                 |      |

|                    |                                      |                 |       |
|--------------------|--------------------------------------|-----------------|-------|
|                    |                                      |                 |       |
| <b>GEV No.</b>     | 900462                               | <b>Ref. No.</b> | 30098 |
| <b>description</b> | door seal profile 2400 L 410mm Qty 1 |                 |       |
| <b>For models:</b> | MM2/3EA, MM2/3EB                     |                 |       |

|                    |  |                 |      |
|--------------------|--|-----------------|------|
|                    |  |                 |      |
| <b>GEV No.</b>     | 901324                                       | <b>Ref. No.</b> | 1442 |
| <b>description</b> | door seal profile 2400 L 620mm external size |                 |      |

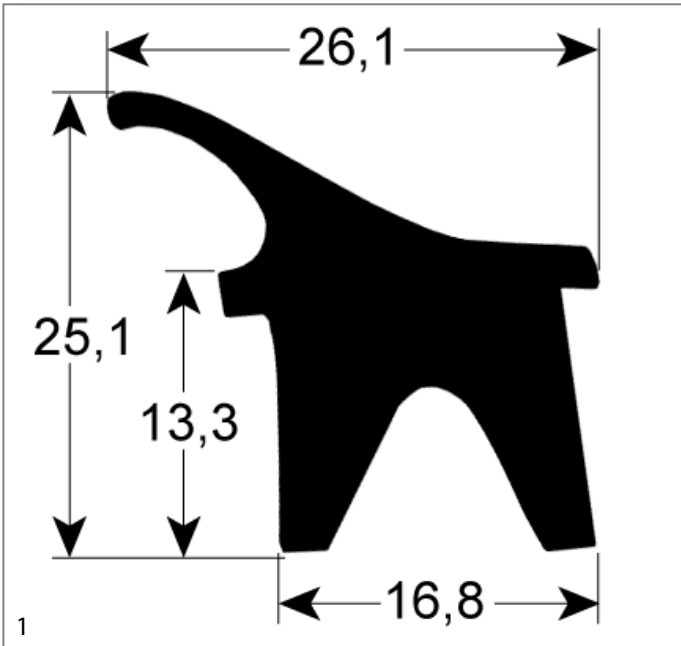

|                    |                                      |                 |      |
|--------------------|--------------------------------------|-----------------|------|
| <b>GEV No.</b>     | 902551                               | <b>Ref. No.</b> | 1446 |
| <b>description</b> | door seal profile 2400 L 695mm Qty 1 |                 |      |

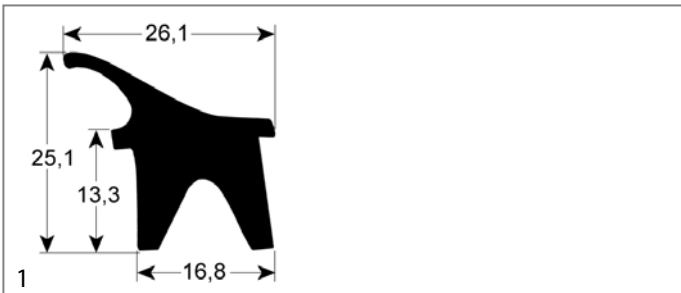

|                    |  |                 |     |
|--------------------|--|-----------------|-----|
| <b>GEV No.</b>     | 900883                                       | <b>Ref. No.</b> | N/A |
| <b>description</b> | door seal profile 2400 Qty supplied by meter |                 |     |

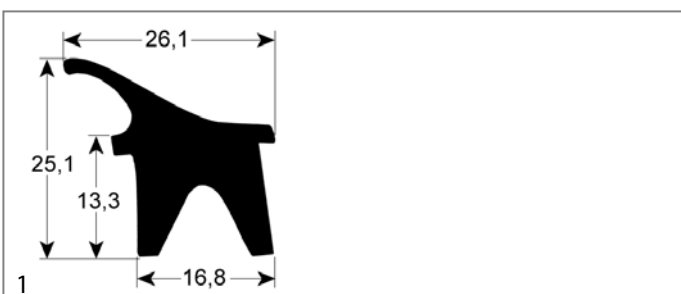

|                    |  |                 |       |
|--------------------|--|-----------------|-------|
| <b>GEV No.</b>     | 900934                                       | <b>Ref. No.</b> | 0271B |
| <b>description</b> | door seal profile 2400 Qty supplied by meter |                 |       |

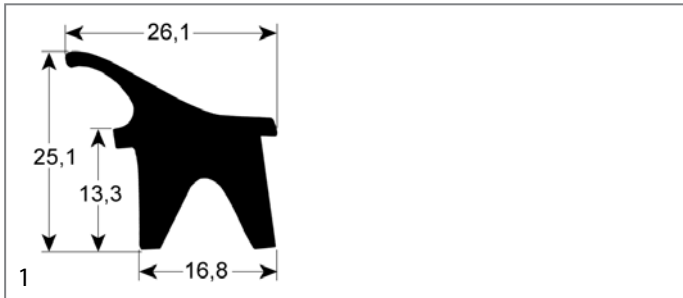

|                    |  |                 |     |
|--------------------|--|-----------------|-----|
| <b>GEV No.</b>     | 900480   | <b>Ref. No.</b> | N/A |
| <b>description</b> | door seal profile 2400 W 390mm L 400mm external size Qty 1 |                 |     |

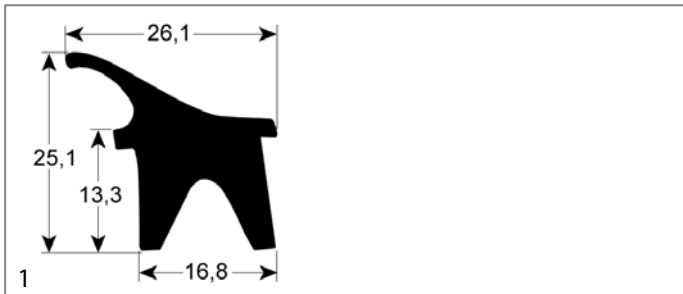

|                    |  |                 |      |
|--------------------|--|-----------------|------|
| <b>GEV No.</b>     | 900464   | <b>Ref. No.</b> | 1093 |
| <b>description</b> | door seal profile 2400 W 420mm L 645mm external size Qty 1 |                 |      |
| <b>For models:</b> | FC05E, FC05EU, FC05G, FC05GU                               |                 |      |

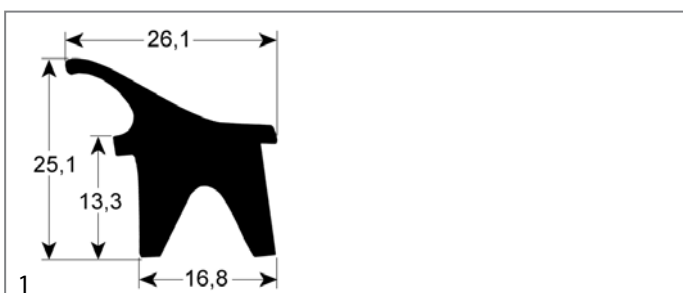

|                    |  |                 |      |
|--------------------|--|-----------------|------|
| <b>GEV No.</b>     | 900683   | <b>Ref. No.</b> | 3351 |
| <b>description</b> | door seal profile 2400 W 475mm L 645mm Qty 1                                       |                 |      |
| <b>For models:</b> | FM06EB, FM06EDG, FM06GB, FM06GDG, MM06EA, MM06EAP, MM06EB, MM06GA, MM06GAP, MM06GB |                 |      |

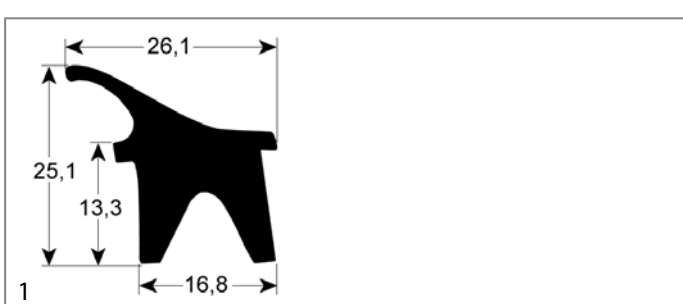

|                    |   |                 |      |
|--------------------|---|-----------------|------|
| <b>GEV No.</b>     | 900465  | <b>Ref. No.</b> | 0323 |
| <b>description</b> | door seal profile 2400 W 480mm L 700mm external size Qty 1  |                 |      |
| <b>For models:</b> | FC06E, FC06EA, FC06EDG, FC06G, FC06GA, FC06GDG, FC06SE, FC06SEA, FC06SEDG, FP05E, FP05EDG, FP05G, FP05GDG |                 |      |



|                    |   |                 |              |
|--------------------|---|-----------------|--------------|
| <b>GEV No.</b>     | 900468  | <b>Ref. No.</b> | 1217<br>3352 |
| <b>description</b> | door seal profile 2400 W 640mm L 800mm external size Qty 1  |                 |              |
| <b>For models:</b> | FC20E, FC20EA, FC20EDG, FC20G, FC20GA, FC20G DG, FM10EB, FM10EDG, FM10GB, FM10GDG, FM20EB, FM20EDG, FM20GB, FM20GDG, MM10EA, MM10EAP, MM10EB, MM10GA, MM10GAP, MM10GB, MM20EA, MM20EAP, MM20EB, MM20GA, MM20GAP, MM20GB |                 |              |

|                        |   |                 |                       |
|------------------------|---|-----------------|-----------------------|
| <b>GEV No.</b>         | 900478  | <b>Ref. No.</b> | 14020                 |
| <b>description</b>     | door seal profile 2415 L 1465mm mounting pos. left/right Qty 1  |                 |                       |
| <b>For models:</b>     | FC201EA, FC201EAP, FC201EB, FC201GA, FC201GAP, FC201GB, FC401EA, FC401EAP, FC401EB, FC401GA, FC401GAP, FC401GB, FM201EA, FM201EAP, FM201EB, FM201GA, FM201GAP, FM201GB, FM401EA, FM401EAP, FM401EB, FM401GA, FM401GAP, FM401GB, MM201EA, MM201EAP, MM201EB, MM201GA, MM201GAP, MM201GB, MM401EA, MM401EAP, MM401GA, MM401GAP, MM401GB |                 |                       |
| <b>accessories for</b> | 900478  |                 |                       |
|                        | <b>GEV No.</b>  | 900479          | <b>Ref. No.</b> 14021 |
|                        | door seal profile 2415 L 635mm mounting pos. upper/lower Qty 1  |                 |                       |

|                    |   |                 |       |
|--------------------|---|-----------------|-------|
| <b>GEV No.</b>     | 900475  | <b>Ref. No.</b> | 14013 |
| <b>description</b> | door seal profile 2400 W 685mm L 1465mm external size Qty 1 |                 |       |

|                        |  |                 |                       |
|------------------------|--|-----------------|-----------------------|
| <b>GEV No.</b>         | 901302   | <b>Ref. No.</b> | 14029                 |
| <b>description</b>     | door seal profile 2415 L 543mm mounting pos. left/right Qty 1  |                 |                       |
| <b>accessories for</b> | 901302   |                 |                       |
|                        | <b>GEV No.</b>   | 901300          | <b>Ref. No.</b> 14028 |
|                        | door seal profile 2415 L 675mm mounting pos. upper/lower Qty 1 |                 |                       |

|                    |  |                 |       |
|--------------------|--|-----------------|-------|
| <b>GEV No.</b>     | 900474   | <b>Ref. No.</b> | 14014 |
| <b>description</b> | door seal profile 2400 W 685mm L 805mm external size Qty 1 |                 |       |

|                        |   |                 |                       |
|------------------------|---|-----------------|-----------------------|
| <b>GEV No.</b>         | 900479  | <b>Ref. No.</b> | 14021                 |
| <b>description</b>     | door seal profile 2415 L 635mm mounting pos. upper/lower Qty 1  |                 |                       |
| <b>For models:</b>     | FC201EA, FC201EAP, FC201EB, FC201GA, FC201GAP, FC201GB, FC401EA, FC401EAP, FC401EB, FC401GA, FC401GAP, FC401GB, FM201EA, FM201EAP, FM201EB, FM201GA, FM201GAP, FM201GB, FM401EA, FM401EAP, FM401EB, FM401GA, FM401GAP, FM401GB, MM201EA, MM201EAP, MM201EB, MM201GA, MM201GAP, MM201GB, MM401EA, MM401EAP, MM401GA, MM401GAP, MM401GB |                 |                       |
| <b>accessories for</b> | 900479  |                 |                       |
|                        | <b>GEV No.</b>  | 900478          | <b>Ref. No.</b> 14020 |
|                        | door seal profile 2415 L 1465mm mounting pos. left/right Qty 1  |                 |                       |

|                    |   |                 |      |
|--------------------|---|-----------------|------|
| <b>GEV No.</b>     | 900466  | <b>Ref. No.</b> | 0324 |
| <b>description</b> | door seal profile 2400 W 700mm L 915mm external size Qty 1  |                 |      |
| <b>For models:</b> | FC12E, FC12EA, FC12EDG, FC12G, FC12GA, FC12GDG, FC12SE, FC12SEA, FC12SEDG, FP10E, FP10EDG, FP10G, FP10GDG |                 |      |

|                        |  |                 |                       |
|------------------------|--|-----------------|-----------------------|
| <b>GEV No.</b>         | 901300   | <b>Ref. No.</b> | 14028                 |
| <b>description</b>     | door seal profile 2415 L 675mm mounting pos. upper/lower Qty 1 |                 |                       |
| <b>accessories for</b> | 901300   |                 |                       |
|                        | <b>GEV No.</b>   | 901302          | <b>Ref. No.</b> 14029 |
|                        | door seal profile 2415 L 543mm mounting pos. left/right Qty 1  |                 |                       |

|                        |  |                 |  |
|------------------------|--|-----------------|--|
| <b>GEV No.</b>         | 900476   | <b>Ref. No.</b> | 14012  |
| <b>description</b>     | door seal profile 2415 L 695mm mounting pos. upper/lower Qty 1 |                 |  |
| <b>accessories for</b> | 900476   |                 |  |
|                        | <b>GEV No.</b>   | 900477          | <b>Ref. No.</b> 14011, 14012, 14013, 14014, 14021, 14028 |
|                        | door seal profile 2415 L 805mm mounting pos. left/right Qty 1  |                 |  |

|                        |  |                 |  |
|------------------------|--|-----------------|--|
| <b>GEV No.</b>         | 900477   | <b>Ref. No.</b> | 14011, 14012, 14013, 14014, 14021, 14028 |
| <b>description</b>     | door seal profile 2415 L 805mm mounting pos. left/right Qty 1  |                 |  |
| <b>For models:</b>     | FC200EA, FC200EAP, FC200EB, FC200GA, FC200GAP, FC200GB, FM200EA, FM200EAP, FM200EB, FM200GA, FM200GAP, FM200GB, MM200EA, MM200EAP, MM200EB, MM200GA, MM200GAP, MM200GB |                 |  |
| <b>accessories for</b> | 900477   |                 |  |
|                        | <b>GEV No.</b>   | 900476          | <b>Ref. No.</b> 14012                    |
|                        | door seal profile 2415 L 695mm mounting pos. upper/lower Qty 1   |                 |  |

|                    |   |                 |       |
|--------------------|---|-----------------|-------|
| <b>GEV No.</b>     | 902166  | <b>Ref. No.</b> | 14082 |
| <b>description</b> | door seal profile 2749 W 660mm L 1450mm external size suitable for FOINOX |                 |       |

|                    |                                       |                 |       |
|--------------------|---------------------------------------|-----------------|-------|
| <b>GEV No.</b>     | 902548                                | <b>Ref. No.</b> | 61558 |
| <b>description</b> | door seal profile 2768 L 1952mm Qty 1 |                 |       |

|                    |                                 |                 |       |
|--------------------|---------------------------------|-----------------|-------|
| <b>GEV No.</b>     | 900879                          | <b>Ref. No.</b> | 60320 |
| <b>description</b> | door seal profile 2768 L 2020mm |                 |       |

|                    |                                 |                 |       |
|--------------------|---------------------------------|-----------------|-------|
| <b>GEV No.</b>     | 901713                          | <b>Ref. No.</b> | 60321 |
| <b>description</b> | door seal profile 2768 L 2700mm |                 |       |

door seals with fixing hook



1

|                    |   |                 |      |
|--------------------|---|-----------------|------|
| <b>GEV No.</b>     | 900811                                  | <b>Ref. No.</b> | 0161 |
| <b>description</b> | door seal L 320mm W 240mm external size |                 |      |

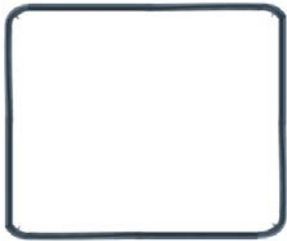

1

|                    |   |                 |      |
|--------------------|---|-----------------|------|
| <b>GEV No.</b>     | 900810  | <b>Ref. No.</b> | 0162 |
| <b>description</b> | door seal L 360mm W 290mm with 8 mounting clips external size |                 |      |



1

|                    |   |                 |       |
|--------------------|---|-----------------|-------|
| <b>GEV No.</b>     | 900307  | <b>Ref. No.</b> | 14070 |
| <b>description</b> | door seal L 480mm W 380mm type ECG Speedy external size |                 |       |



1

|                    |  |                 |       |
|--------------------|--|-----------------|-------|
| <b>GEV No.</b>     | 901299                                       | <b>Ref. No.</b> | 14076 |
| <b>description</b> | door seal W 620mm with mounting clip H 360mm |                 |       |



1

|                    |  |                 |       |
|--------------------|--|-----------------|-------|
| <b>GEV No.</b>     | 901342   | <b>Ref. No.</b> | 14073 |
| <b>description</b> | oven gasket L 620mm W 270mm with 10 mounting clips plug size |                 |       |

O-rings

EPDM

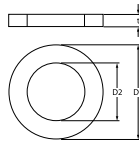



1

|                    |   |                 |   |
|--------------------|---|-----------------|---|
| <b>GEV No.</b>     | 521120  | <b>Ref. No.</b> | — |
| <b>description</b> | O-ring EPDM thickness 5.34mm ID ø 37.47mm Qty 1 pcs |                 |   |

sealing washers

silicone gaskets



1

|                    |   |                 |         |
|--------------------|---|-----------------|---------|
| <b>GEV No.</b>     | 359721  | <b>Ref. No.</b> | 0812.01 |
| <b>description</b> | gasket silicone ED ø 48mm ID ø 39.5mm thickness 5mm Qty 1 pcs   |                 |         |
| <b>For models:</b> | FC05E, FC05EU, FC05G, FC05GU, FC06E, FC06EA, FC06EDG, FC06G, FC06GA, FC06GDG, FC06SE, FC06SEA, FC06SEDG, FC12E, FC12EA, FC12EDG, FC12G, FC12GA, FC12GDG, FC12SE, FC12SEA, FC12SEDG, FC200EA, FC200EAP, FC200EB, FC200GA, FC200GAP, FC200GB, FC201EA, FC201EAP, FC201EB, FC201GA, FC201GAP, FC201GB, FC401EA, FC401EAP, FC401EB, FC401GA, FC401GAP, FC401GB, FE1-2, FE2-3, FM200EA, FM200EAP, FM200EB, FM200GA, FM200GAP, FM200GB, FM201EA, FM201EAP...(Other models you can see in the webshop) |                 |         |

shaft gaskets

shaft gaskets



1

|                    |                      |                 |      |
|--------------------|----------------------|-----------------|------|
| <b>GEV No.</b>     | 698247               | <b>Ref. No.</b> | 0689 |
| <b>description</b> | shaft seal ID ø 15mm |                 |      |

## evaporators

### for fridges

#### producer-specific



1

|                    |  |                 |       |
|--------------------|--|-----------------|-------|
| <b>GEV No.</b>     | 750301   | <b>Ref. No.</b> | 71041 |
| <b>description</b> | evaporator L 700mm W 440mm H 100mm suitable for FOINOX |                 |       |

## hose reels and spray guns

### spray guns



1

|   |  |                 |                   |
|---|--|-----------------|-------------------|
| <b>GEV No.</b>  | 691048   | <b>Ref. No.</b> | 1518.01           |
| <b>description</b>  | spray gun for appliances 1/2" ET L 225mm type STAR             |                 |                   |
| <b>spare parts for</b>  | 691048   |                 |                   |
|  | <b>GEV No.</b>   | 507309          | <b>Ref. No.</b> — |
|   | O-ring EPDM thickness 2.62mm ID ø 17.13mm Qty 1 pcs            |                 |                   |
|  | <b>GEV No.</b>   | 510322          | <b>Ref. No.</b> — |
|   | O-ring EPDM thickness 1.78mm ID ø 17.17mm Qty 1 pcs            |                 |                   |
|  | <b>GEV No.</b>   | 524055          | <b>Ref. No.</b> — |
|   | flat gasket rubber ED ø 18mm ID ø 12mm thickness 2mm Qty 1 pcs |                 |                   |
|  | <b>GEV No.</b>   | 528485          | <b>Ref. No.</b> — |
|   | O-ring EPDM thickness 1.78mm ID ø 6.07mm Qty 1 pcs             |                 |                   |
|  | <b>GEV No.</b>   | 528494          | <b>Ref. No.</b> — |
|   | gasket rubber ED ø 13mm ID ø 4mm thickness 4mm Qty 1 pcs       |                 |                   |

## valves and tank inlets

### ball valves

#### ball valves electric



1

|                    |   |                 |       |
|--------------------|---|-----------------|-------|
| <b>GEV No.</b>     | 401233  | <b>Ref. No.</b> | 10036 |
| <b>description</b> | ball valve inlet 1/2" IT outlet 1/2" IT 230V 50/60Hz mode of operation electric W 60mm H 99mm cable 4-pole 2.5W 4-pole duty cycle 50% |                 |       |
| <b>For models:</b> | FM200EA, FM200EAP, FM200EB, FM200GA, FM200GAP, FM200GB, FM201EA, FM201EAP, FM201EB, FM201GB, FM401EA, FM401EAP, FM401EB, FM401GB      |                 |       |

## measuring equipment

### thermometers

#### built-in thermometers

##### ø52mm



1

|                    |  |                 |              |
|--------------------|--|-----------------|--------------|
| <b>GEV No.</b>     | 541077   | <b>Ref. No.</b> | 0593<br>0594 |
| <b>description</b> | thermometer mounting ø 52mm t.max. 350°C +50 up to +350°C probe ø 6mm probe L 30mm capillary pipe 1000mm built-in depth 28mm |                 |              |
| <b>For models:</b> | FC05G, FC05GU  |                 |              |

## fastening material

### screws

#### hexagonal screws



1

|                    |   |                 |       |
|--------------------|---|-----------------|-------|
| <b>GEV No.</b>     | 560083  | <b>Ref. No.</b> | 17120 |
| <b>description</b> | hexagonal screw thread M5 thread L 10mm SS WS 8 Qty 20 pcs DIN 933 / ISO 4017 |                 |       |





fasteners

roll pins



1

|                    |                       |                 |      |
|--------------------|-----------------------|-----------------|------|
| <b>GEV No.</b>     | 691637                | <b>Ref. No.</b> | 3780 |
| <b>description</b> | roll pin ø 3mm L 20mm |                 |      |



1

|                    |                       |                 |       |
|--------------------|-----------------------|-----------------|-------|
| <b>GEV No.</b>     | 504003                | <b>Ref. No.</b> | 17022 |
| <b>description</b> | roll pin ø 3mm L 24mm |                 |       |



|   |        |                                 |    |
|---|--------|---------------------------------|----|
| <b>A</b>  |        |                                 |    |
| alarm devices                                   | 14     | hexagonal screws                | 48 |
| axial fans                                      | 23     | hot air fans                    | 27 |
|   |        | hot air motors                  | 24 |
| <b>B</b>  |        | <b>I</b>                        |    |
| ball valves                                     | 48     | ignition boxes                  | 31 |
| ball valves electric                            | 22, 48 | ignition cables                 | 33 |
| bar burners                                     | 34     | ignition units                  | 33 |
|   |        | immersion heating elements      | 3  |
| <b>C</b>  |        | indicator lights                | 10 |
| cables  | 28     | indicator lights (complete)     | 10 |
| cam switches                                    | 9      | <b>L</b>                        |    |
| castors and bumper angles                       | 41     | lamps                           | 10 |
| cold air circulating fans (complete)            | 24     | light bulbs                     | 10 |
| compressors                                     | 22     |                                 |    |
| condensators & interference suppression filters | 28     | <b>M</b>                        |    |
| contactors                                      | 15     | magnetic switches               | 9  |
| control thermostats                             | 6      | measuring equipment             | 48 |
|   |        | mechanical timers               | 14 |
| <b>D</b>  |        | microswitches                   | 7  |
| door catches                                    | 37     |                                 |    |
| door seals                                      | 43     | <b>O</b>                        |    |
| door seals with fixing hook                     | 47     | operating capacitors            | 28 |
| drain pumps                                     | 27     | O-rings                         | 47 |
|   |        | oven hinges                     | 40 |
| <b>E</b>  |        | oven lamps                      | 10 |
| edgemount latches                               | 37     |                                 |    |
| electric accessories                            | 28     | <b>P</b>                        |    |
| electrodes                                      | 22     | pilot burners                   | 32 |
| electronic controllers                          | 17     | plug-in gaskets                 | 41 |
| energy regulators                               | 5      | probes                          | 18 |
| espagnolette locks                              | 38     | programme timers                | 14 |
| evaporators                                     | 48     | pumps                           | 27 |
|   |        | push/momentary push switches    | 7  |
| <b>F</b>  |        |                                 |    |
| fans  | 23     | <b>R</b>                        |    |
| fasteners                                       | 49     | refrigeration fans              | 23 |
| fastening material                              | 48     | refrigeration gaskets           | 41 |
|   |        | relays                          | 15 |
| <b>G</b>  |        | ribbon cables                   | 28 |
| gas burners                                     | 34     | roll pins                       | 49 |
| gas control valves                              | 28     |                                 |    |
| gas nozzles                                     | 34     | <b>S</b>                        |    |
| gaskets for heated units                        | 42     | safety thermostats              | 6  |
|   |        | screws                          | 48 |
| <b>H</b>  |        | sealing washers                 | 47 |
| halogen lamp                                    | 10     | shaft gaskets                   | 47 |
| handle latches                                  | 37     | snap locks                      | 37 |
| heating elements                                | 3      | solenoid valves                 | 21 |
| heating elements for convection                 | 3      | spray guns                      | 48 |
| heating elements for heated cabinets            | 3      | spray guns with external thread | 48 |
| heating elements for ovens                      | 3      | switches and momentary switches | 7  |

system switches (ROLD) 7

## T

temperature probes 18

terminals 28

thermocouples 33

thermostats 6

time relays 16

timers 14

transformers 17

## U

universal probes 18

## V

valves and tank inlets 48

## W

window seals 42