



**GAS COMPONENTS**



**ELECTRIC COMPONENTS**



**WATER TECHNOLOGY**



**MECHANICAL COMPONENTS**



**TOOLS**

Spare parts suitable for

**FIREX**

Find the complete and up-to-date range of products in our GEV Webshop



# Manufacturer catalogue

The most important spare parts and accessories arranged clearly for every manufacturer

- ✓ Complete product range and all appliance data always up to date in the GEV Webshop
- ✓ Alphabetical Index at the end of the catalogue

## GEV Webshop

[www.gev-online.co.uk](http://www.gev-online.co.uk)

[www.gev-online.com](http://www.gev-online.com)



- 🔍 Add to Favourites
- 🔍 Sign In with email address and usual password
- 🔍 Easy-order – place several items in your basket at the same time
- 🔍 Quick Item search – no login needed



## heating elements

### heating elements for tilting bratt pan





|                    |  |                 |          |
|--------------------|--|-----------------|----------|
| <b>GEV No.</b>     | 416692   | <b>Ref. No.</b> | 40400082 |
| <b>description</b> | heating element tilting bratt pan 2900W 230V L 312mm W 200mm H 82mm connection M5 dry heating element heating circuits 1 tube ø 8.5mm W1 66mm W2 68mm connection distance 61mm |                 |          |



### immersion heating elements

#### 3 hole flange ø47.5mm



|   |   |                 |                 |   |
|---|---|-----------------|-----------------|---|
| <b>GEV No.</b>  | 416834  | <b>Ref. No.</b> | 40400040        |   |
| <b>description</b>  | heating element 8000W 230V mounting ø 47.5mm heating circuits 3 L 323mm W 35mm H 45mm number of thermostat sleeves 1 thermostat sleeves ø 7mm length thermostat sleeves 263mm thermostat sleeve eccentric, clinging tube ø 8.5mm hole distance 64mm hole ø 8mm connection M4 3 hole flange immersion heater |                 |                 |   |
| <b>accessories for</b>  | 416834  |                 |                 |   |
|  | <b>GEV No.</b>  | 510408          | <b>Ref. No.</b> | — |
|   | O-ring EPDM thickness 5.34mm ID ø 47mm Qty 1 pcs  |                 |                 |   |
|  | <b>GEV No.</b>  | 510562          | <b>Ref. No.</b> | — |
|   | O-ring silicone thickness 5.34mm ID ø 47mm Qty 1 pcs  |                 |                 |   |





|   |  |                 |                 |   |
|---|--|-----------------|-----------------|---|
| <b>GEV No.</b>  | 416835   | <b>Ref. No.</b> | 40400042        |   |
| <b>description</b>  | heating element 9000W 230V mounting ø 47.5mm heating circuits 3 L 415mm W 30mm H 46mm number of thermostat sleeves 1 thermostat sleeves ø 7.5mm length thermostat sleeves 255mm thermostat sleeve eccentric, clinging hole distance 62mm hole ø 8mm connection M4 3 hole flange immersion heater |                 |                 |   |
| <b>For models:</b>  | KPI15ETA-GIGA, KPI15ET-GIGA, KPI30ETA-GIGA, KPI30ET-GIGA, KPI50ETA-GIGA, KPI50ET-GIGA  |                 |                 |   |
| <b>accessories for</b>  | 416835   |                 |                 |   |
|  | <b>GEV No.</b>   | 510408          | <b>Ref. No.</b> | — |
|   | O-ring EPDM thickness 5.34mm ID ø 47mm Qty 1 pcs   |                 |                 |   |
|  | <b>GEV No.</b>   | 510562          | <b>Ref. No.</b> | — |
|   | O-ring silicone thickness 5.34mm ID ø 47mm Qty 1 pcs   |                 |                 |   |



|   |   |                 |                 |   |
|---|---|-----------------|-----------------|---|
| <b>GEV No.</b>  | 419113  | <b>Ref. No.</b> | 40400038        |   |
| <b>description</b>  | heating element 9000W 230V mounting ø 47.5mm heating circuits 3 L 550mm W 38mm H 45mm number of thermostat sleeves 1 thermostat sleeves ø 7.3mm length thermostat sleeves 260mm tube ø 8.5mm connection M4 3 hole flange immersion heater L1 55mm H1 33mm H2 34mm |                 |                 |   |
| <b>accessories for</b>  | 419113  |                 |                 |   |
|  | <b>GEV No.</b>  | 510408          | <b>Ref. No.</b> | — |
|   | O-ring EPDM thickness 5.34mm ID ø 47mm Qty 1 pcs  |                 |                 |   |

#### group 7



|   |  |                 |                 |   |
|---|--|-----------------|-----------------|---|
| <b>GEV No.</b>  | 418505   | <b>Ref. No.</b> | 40400048        |   |
| <b>description</b>  | heating element 8000W 230V heating circuits 3 flange ø 47.5mm L 497mm W 35mm H 56mm tube ø 8.5mm thermostat sleeves ø 7.5mm length thermostat sleeves 266mm number of thermostat sleeves 1 thermostat sleeve not clinging connection M4 immersion heater 3 hole flange hole distance 58mm mounting ø 47.5mm hole ø 8mm |                 |                 |   |
| <b>For models:</b>  | KPI10ETA-GIGA, KPI10ET-GIGA, KPI20ETA-GIGA   |                 |                 |   |
| <b>accessories for</b>  | 418505   |                 |                 |   |
|  | <b>GEV No.</b>   | 510408          | <b>Ref. No.</b> | — |
|   | O-ring EPDM thickness 5.34mm ID ø 47mm Qty 1 pcs   |                 |                 |   |
|  | <b>GEV No.</b>   | 510562          | <b>Ref. No.</b> | — |
|   | O-ring silicone thickness 5.34mm ID ø 47mm Qty 1 pcs   |                 |                 |   |



## thermostats

## control and safety thermostats

EGO

control thermostats

55.10/19\_ series

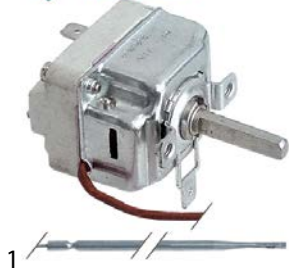

|                    |  |                 |          |
|--------------------|--|-----------------|----------|
| <b>GEV No.</b>     | 375363   | <b>Ref. No.</b> | 40100050 |
| <b>description</b> | thermostat t.max. 161°C temperature range 73-161°C 1-pole 1NO 16A probe ø 3mm probe L 144mm capillary pipe 1600mm capillary pipe isolated 1600mm gland nut shaft ø 6x4.6mm shaft L 23mm shaft position upper rotation 270°       |                 |          |
| <b>For models:</b> | KPI10ETA-GIGA, KPI10ET-GIGA, KPI15ETA-GIGA, KPI15ET-GIGA, KPI20EA-GIGA, KPI20E-GIGA, KPI20ETA-GIGA, KPI20ET-GIGA, KPI30EA-GIGA, KPI30E-GIGA, KPI30ETA-GIGA, KPI30ET-GIGA, KPI50EA-GIGA, KPI50E-GIGA, KPI50ETA-GIGA, KPI50ET-GIGA |                 |          |

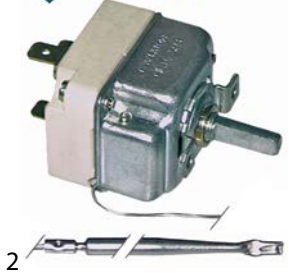

|                    |  |                 |          |
|--------------------|--|-----------------|----------|
| <b>GEV No.</b>     | 375270   | <b>Ref. No.</b> | 40100042 |
| <b>description</b> | thermostat t.max. 295°C temperature range 45-295°C 1-pole 1NO 16A probe ø 4mm probe L 100mm capillary pipe 900mm capillary pipe isolated 350mm gland nut shaft L 23mm shaft position upper rotation 270° |                 |          |

safety thermostats

55.32\_ series

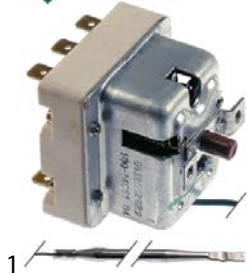

|                    |   |                 |          |
|--------------------|---|-----------------|----------|
| <b>GEV No.</b>     | 375364  | <b>Ref. No.</b> | 40100041 |
| <b>description</b> | safety thermostat switch-off temp. 190°C 3-pole 20A probe ø 4mm probe L 120mm capillary pipe 3000mm capillary pipe isolated 3000mm gland nut probe  |                 |          |
| <b>For models:</b> | KPI10ETA-GIGA, KPI10ET-GIGA, KPI15ETA-GIGA, KPI15ET-GIGA, KPI20ETA-GIGA, KPI20ET-GIGA, KPI30ETA-GIGA, KPI30ET-GIGA, KPI50ETA-GIGA, KPI50ET-GIGA, PM9.G170GN-FAGOR, PM9.G270GN-FAGOR, PM9.G370GN-FAGOR |                 |          |

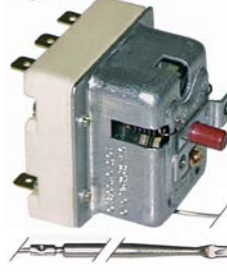

|                    |   |                 |          |
|--------------------|---|-----------------|----------|
| <b>GEV No.</b>     | 375350  | <b>Ref. No.</b> | 40100062 |
| <b>description</b> | safety thermostat switch-off temp. 360°C 3-pole 20A probe ø 4mm probe L 120mm capillary pipe 1800mm capillary pipe isolated 1800mm gland nut probe SS |                 |          |



|                    |   |                 |          |
|--------------------|---|-----------------|----------|
| <b>GEV No.</b>     | 390227  | <b>Ref. No.</b> | 40100062 |
| <b>description</b> | safety thermostat switch-off temp. 360°C 3-pole 20A probe ø 4mm probe L 120mm capillary pipe 1800mm capillary pipe isolated 1800mm gland nut probe SS |                 |          |
| <b>For models:</b> | KPI20EA-GIGA, KPI20E-GIGA, KPI30EA-GIGA, KPI30E-GIGA, KPI50EA-GIGA, KPI50E-GIGA   |                 |          |

## accessories

gland nut accessories

ducts



|                    |  |                 |          |
|--------------------|--|-----------------|----------|
| <b>GEV No.</b>     | 550148   | <b>Ref. No.</b> | 10400188 |
| <b>description</b> | gland duct ET M12x0.75 IT M9x1 probe ø max. 6.5mm WS 17 silicone |                 |          |

## switches and momentary switches



push/momentary push switches

ø25mm



|                    |   |                 |          |
|--------------------|---|-----------------|----------|
| <b>GEV No.</b>     | 345038  | <b>Ref. No.</b> | 40100034 |
| <b>description</b> | momentary push switch mounting ø 25mm black 2NO 250V 16A connection male faston 6.3mm ambient temperature max. 85°C protection IP40 |                 |          |
| <b>For models:</b> | PM9.G170GN-FAGOR, PM9.G270GN-FAGOR, PM9.G370GN-FAGOR  |                 |          |



|   |   |                 |          |
|---|---|-----------------|----------|
|  <p>1</p>  |   |                 |          |
| <b>GEV No.</b>  | 345039  | <b>Ref. No.</b> | 40100036 |
| <b>description</b>  | protective cover round ED ø 33mm external size 23mm internal size 21mm H 12mm clear mounting ø 25mm |                 |          |
| <b>For models:</b>  | PM9.G170GN-FAGOR, PM9.G270GN-FAGOR, PM9.G370GN-FAGOR  |                 |          |
| <b>accessories for</b>  | 345039  |                 |          |
|  <p>momentary push switch mounting ø 25mm yellow 1NO/indicator light 250V 16A cover connection male faston 6.3mm ambient temperature max. 85°C protection IP65</p> |   |                 |          |

**microswitches**

**lever actuated**

|  |  |                 |          |
|--|--|-----------------|----------|
|  <p>1</p> |  |                 |          |
| <b>GEV No.</b>   | 345044   | <b>Ref. No.</b> | 40100007 |
| <b>description</b>   | microswitch with lever 250V 16A 1CO connection male faston 6.3mm ambient temperature max. 85°C mounting distance 25mm type C99ZP3 actuating force: 25g lever length 71mm |                 |          |

**roller-lever actuated**

**microswitches**

|  |  |                 |          |
|--|--|-----------------|----------|
|  <p>1</p> |  |                 |          |
| <b>GEV No.</b>   | 347272   | <b>Ref. No.</b> | 40100122 |
| <b>description</b>   | microswitch with handle with a switch 250V 16A 1CO connection male faston ambient temperature max. 85°C mounting distance 22.2mm white lever length 20mm |                 |          |

**cam switches**

**3 operating positions**

|  |  |                 |  |
|--|--|-----------------|--|
|  <p>1</p> |  |                 |  |
| <b>GEV No.</b>   | 300167   | <b>Ref. No.</b> | 40100004<br>40100004+SMP0936-00+SMP0938-00 |
| <b>description</b>   | cam switch 3 operating positions 2NO/1CO sequence 0-1-2 16A shaft ø 6x4.6mm shaft L 23mm connection screw  |                 |  |
| <b>For models:</b>   | KPI10ETA-GIGA, KPI10ET-GIGA, KPI15ETA-GIGA, KPI15ET-GIGA, KPI20EA-GIGA, KPI20E-GIGA, KPI20ETA-GIGA, KPI20ET-GIGA, KPI30EA-GIGA, KPI30E-GIGA, KPI30ETA-GIGA, KPI30ET-GIGA, KPI50EA-GIGA, KPI50E-GIGA, KPI50ETA-GIGA, KPI50ET-GIGA |                 |  |

**lamps**

**indicator lights**

**indicator lights 2-piece (lens and indicator lamp)**

**indicator lamps for socket type SRZ / SDK / SDY / SFK**

|  |  |                 |          |
|--|--|-----------------|----------|
|  <p>1</p> |  |                 |          |
| <b>GEV No.</b>   | 359133   | <b>Ref. No.</b> | 40200154 |
| <b>description</b>   | indicator lamp 400V green connection male faston 6.3mm   |                 |          |
| <b>For models:</b>   | KPI10ETA-GIGA, KPI10ET-GIGA, KPI15ETA-GIGA, KPI15ET-GIGA, KPI20EA-GIGA, KPI20E-GIGA, KPI20ETA-GIGA, KPI20ET-GIGA, KPI30EA-GIGA, KPI30E-GIGA, KPI30ETA-GIGA, KPI30ET-GIGA, KPI50EA-GIGA, KPI50E-GIGA, KPI50ETA-GIGA, KPI50ET-GIGA |                 |          |

**indicator lights (complete)**

**ø12mm**

**with screw socket**

|  |  |                 |          |
|--|--|-----------------|----------|
|  <p>1</p> |  |                 |          |
| <b>GEV No.</b>   | 359291   | <b>Ref. No.</b> | 40200152 |
| <b>description</b>   | indicator light ø 12mm 400V green connection male faston 6.3mm   |                 |          |
| <b>For models:</b>   | KPI10ETA-GIGA, KPI10ET-GIGA, KPI15ETA-GIGA, KPI15ET-GIGA, KPI20EA-GIGA, KPI20E-GIGA, KPI20ETA-GIGA, KPI20ET-GIGA, KPI30EA-GIGA, KPI30E-GIGA, KPI30ETA-GIGA, KPI30ET-GIGA, KPI50EA-GIGA, KPI50E-GIGA, KPI50ETA-GIGA, KPI50ET-GIGA |                 |          |

|  |  |                 |          |
|--|--|-----------------|----------|
|  <p>1</p> |  |                 |          |
| <b>GEV No.</b>   | 359292   | <b>Ref. No.</b> | 40200148 |
| <b>description</b>   | indicator light ø 12mm 400V red connection male faston 6.3mm   |                 |          |
| <b>For models:</b>   | KPI10ETA-GIGA, KPI10ET-GIGA, KPI15ETA-GIGA, KPI15ET-GIGA, KPI20ETA-GIGA, KPI20E-GIGA, KPI20ETA-GIGA, KPI20ET-GIGA, KPI30ETA-GIGA, KPI30E-GIGA, KPI30ETA-GIGA, KPI30ET-GIGA, KPI50ETA-GIGA, KPI50E-GIGA |                 |          |

|  |  |                 |          |
|--|--|-----------------|----------|
|  <p>1</p> |  |                 |          |
| <b>GEV No.</b>   | 359290   | <b>Ref. No.</b> | 40200150 |
| <b>description</b>   | indicator light ø 12mm 400V yellow connection male faston 6.3mm  |                 |          |
| <b>For models:</b>   | KPI10ETA-GIGA, KPI10ET-GIGA, KPI15ETA-GIGA, KPI15ET-GIGA, KPI20EA-GIGA, KPI20E-GIGA, KPI20ETA-GIGA, KPI20ET-GIGA, KPI30EA-GIGA, KPI30E-GIGA, KPI30ETA-GIGA, KPI30ET-GIGA, KPI50EA-GIGA, KPI50E-GIGA, KPI50ETA-GIGA, KPI50ET-GIGA |                 |          |







## timers

## mechanical timers



1

|   |  |                 |                   |
|---|--|-----------------|-------------------|
| <b>GEV No.</b>  | 350176   | <b>Ref. No.</b> | 40100158          |
| <b>description</b>  | timer C20 2-pole operation time 5min 2NO at 250V 16A permanent position no shaft ø 6x4.6mm shaft 6x4.6mm shaft L 20mm mounting distance 28mm |                 |                   |
| <b>accessories for</b>  | 350176   |                 |                   |
|  | <b>GEV No.</b>   | 110366          | <b>Ref. No.</b> — |
|   | knob switch zero mark t.max.°C ø 44mm shaft ø 6x4.6mm shaft flat upper black   |                 |                   |
|  | <b>GEV No.</b>   | 112138          | <b>Ref. No.</b> — |
|   | dial plate graduation 5min permanent position no rotation 0-290° ø 60mm  |                 |                   |

## relays

## level relays

## GICAR



1

|                    |   |                 |          |
|--------------------|---|-----------------|----------|
| <b>GEV No.</b>     | 403748  | <b>Ref. No.</b> | 40800054 |
| <b>description</b> | level controller 230V voltage AC 50/60Hz connection male faston 6.3mm type RL30/2E-2C/F |                 |          |

## solenoid valves

## solenoid valves (water)

## metal

## SIRAI

## solenoid valves steam (water)

## 2-way

## L153-D series



1

|   |  |                 |                   |
|---|--|-----------------|-------------------|
| <b>GEV No.</b>  | 370326   | <b>Ref. No.</b> | 30100066          |
| <b>description</b>  | solenoid valve 2-ways 230VAC connection 1" L 105mm DN 22mm slide-on receptacle DIN -10 up to 140°C SIRAI type series L153-D coil type Z914A membranes EPDM (steam/water) p max 8bar p min 0.1bar |                 |                   |
| <b>spare parts for</b>  | 370326   |                 |                   |
|  | <b>GEV No.</b>   | 371161          | <b>Ref. No.</b> — |
|   | solenoid coil 230VAC 27VA SIRAI coil type Z923A seat ø 16mm 50Hz   |                 |                   |

## fuses

## fine fuses



1

|                    |  |                 |          |
|--------------------|--|-----------------|----------|
| <b>GEV No.</b>     | 358605   | <b>Ref. No.</b> | 40200084 |
| <b>description</b> | fine fuse size ø5x20mm 3.15A slow-acting rated 250V Qty 10 pcs |                 |          |
| <b>For models:</b> | KPI10ETA-GIGA, KPI10ET-GIGA, KPI15ETA-GIGA, KPI15ET-GIGA       |                 |          |

## gas taps

## PEL

## 22S/O series



1



|   |   |                 |                   |
|---|---|-----------------|-------------------|
| <b>GEV No.</b>  | 101892  | <b>Ref. No.</b> | 30100009          |
| <b>description</b>  | gas tap PEL type 22S/O gas inlet M20x1.5 (tube ø 12mm) bypass nozzle ø 0.35mm gas outlet M20x1.5 (tube ø 12/10mm) thermocouple connection M9x1 pilot connection M10x1 shaft ø 10x8mm shaft L 25/17mm shaft flat lower |                 |                   |
| <b>spare parts for</b>  | 101892  |                 |                   |
|  | <b>GEV No.</b>  | 101058          | <b>Ref. No.</b> — |
|   | magnet unit L 39mm D1 ø 15.4mm D2 ø 13.5mm suitable for PEL22/EGA24197 standard   |                 |                   |
|  | <b>GEV No.</b>  | 101201          | <b>Ref. No.</b> — |
|   | gas tap front part shaft ø 10x8mm shaft L 25/17mm shaft flat upper/lower suitable for PEL22   |                 |                   |

Table continues overleaf



| spare parts for   |   | 101892 |            |
|---|---|--------|------------|
|    | GEV No.   | 101231 | Ref. No. — |
|   | thermocouple nut T1: M9x1 T2: M18x1   |        |            |
|    | GEV No.   | 101240 | Ref. No. — |
|   | gas connection thread M20x1.5 tube ø 12/10mm for PEL gas taps with gasket and screws horizontal |        |            |
|    | GEV No.   | 101460 | Ref. No. — |
|   | O-ring ø 12.37mm D1 ø 2.62mm suitable for PEL22   |        |            |
|    | GEV No.   | 101461 | Ref. No. — |
|   | screw kit suitable for PEL22 Qty 4 pcs  |        |            |
| accessories for   |   | 101892 |            |
|    | GEV No.   | 100908 | Ref. No. — |
|   | union screw thread M10x1 for pipe ø 4mm Qty 1 pcs   |        |            |
|    | GEV No.   | 100909 | Ref. No. — |
|   | union screw thread M10x1 for pipe ø 6mm Qty 1 pcs   |        |            |
|    | GEV No.   | 101246 | Ref. No. — |
|   | olive for pipe ø 4mm Qty 1 pcs  |        |            |
|    | GEV No.   | 101248 | Ref. No. — |
|   | olive for pipe ø 12mm Qty 1 pcs suitable for PEL  |        |            |
|   | GEV No.   | 101249 | Ref. No. — |
|   | olive for pipe ø 10mm Qty 1 pcs   |        |            |
|  | GEV No.   | 101250 | Ref. No. — |
|   | union nut thread M20x1.5 for pipe ø 10mm  |        |            |
|  | GEV No.   | 101251 | Ref. No. — |
|   | union nut thread M20x1.5 for pipe ø 12mm  |        |            |
|  | GEV No.   | 101286 | Ref. No. — |
|   | olive ID ø 6mm Qty 1 pcs  |        |            |
|  | GEV No.   | 110080 | Ref. No. — |
|   | knob ø 70mm shaft ø 10x8mm shaft flat universal   |        |            |
|  | GEV No.   | 112206 | Ref. No. — |
|   | knob dial plate silver gas tap PEL21/22/23 t.max.°C ED ø 63mm ID ø 45.5mm                       |        |            |

















| 23S/O series  |   |          |            |
|---|---|----------|------------|
|   |   |          |            |
| 1   |   |          |            |
| GEV No.   | 101893  | Ref. No. | 30100003   |
| description   | gas tap PEL type 23S/O gas inlet M28x1.5 (tube ø 20mm) bypass nozzle ø 0.35mm gas outlet M24x1.5 (tube ø 16mm) thermocouple connection M9x1 pilot connection M10x1 shaft ø 10x8mm shaft L 25/17mm shaft flat lower  |          |            |
| For models:   | KP20GA-GIGA, KP20G-GIGA, KP20GTA-GIGA, KP20GT-GIGA, KP30GA-GIGA, KP30G-GIGA, KP30GTA-GIGA, KP30GT-GIGA, KP50GA-GIGA, KP50G-GIGA, KP50GTA-GIGA, KP50GT-GIGA, KPGN18G-GIGA, KPGN27G-GIGA, KPGN37G-GIGA, KPI20GA-GIGA, KPI20G-GIGA, KPI20GTA-GIGA, KPI20GT-GIGA, KPI30GA-GIGA, KPI30G-GIGA, KPI30GTA-GIGA, KPI30GT-GIGA, KPI50GA-GIGA, KPI50G-GIGA, KPI50GTA-GIGA, KPI50GT-GIGA, KPIGN18G-GIGA, KPIGN27G-GIGA, KPIGN37G-GIGA, PM9.G170GN-FAGOR, PM9.G270GN-FAGOR, PM9.G370GN-FAGOR |          |            |
| spare parts for   |   | 101893   |            |
|    | GEV No.   | 101045   | Ref. No. — |
|   | magnet unit T1: M9x1 T2: M22x1 L 46mm ø 18mm suitable for PEL23S M9x1   |          |            |
|    | GEV No.   | 101204   | Ref. No. — |
|   | gas tap front part shaft ø 10x8mm shaft L 25/17mm shaft flat upper/lower suitable for PEL23S  |          |            |
|   | GEV No.   | 101244   | Ref. No. — |
|   | gas connection thread M24x1.5 tube ø 12/16mm horizontal for PEL gas taps  |          |            |
|  | GEV No.   | 101463   | Ref. No. — |
|   | screw suitable for PEL23S Qty 4 pcs   |          |            |
| accessories for   |   | 101893   |            |
|  | GEV No.   | 100908   | Ref. No. — |
|   | union screw thread M10x1 for pipe ø 4mm Qty 1 pcs   |          |            |
|  | GEV No.   | 100909   | Ref. No. — |
|   | union screw thread M10x1 for pipe ø 6mm Qty 1 pcs   |          |            |
|  | GEV No.   | 101246   | Ref. No. — |
|   | olive for pipe ø 4mm Qty 1 pcs  |          |            |
|  | GEV No.   | 101252   | Ref. No. — |
|   | union nut thread M24x1.5 for pipe ø 12mm  |          |            |
|  | GEV No.   | 101253   | Ref. No. — |
|   | union nut thread M24x1.5 PEL for pipe ø 16mm  |          |            |
|  | GEV No.   | 101254   | Ref. No. — |
|   | union nut thread M28x1.5 tube ø 20mm  |          |            |
|  | GEV No.   | 101255   | Ref. No. — |
|   | olive for pipe ø 12mm Qty 1 pcs   |          |            |
|  | GEV No.   | 101256   | Ref. No. — |
|   | olive for pipe ø 16mm Qty 1 pcs   |          |            |
|  | GEV No.   | 101257   | Ref. No. — |
|   | olive for pipe ø 20mm Qty 1 pcs   |          |            |

Table continues overleaf

|   |   |        |          |   |
|---|---|--------|----------|---|
| <b>accessories for</b>  | 101893  |        |          |   |
|  | GEV No.   | 101286 | Ref. No. | — |
|   | olive ID ø 6mm Qty 1 pcs  |        |          |   |
|  | GEV No.   | 110080 | Ref. No. | — |
|   | knob ø 70mm shaft ø 10x8mm shaft flat universal                           |        |          |   |
|  | GEV No.   | 112206 | Ref. No. | — |
|   | knob dial plate silver gas tap PEL21/22/23 t.max.°C ED ø 63mm ID ø 45.5mm |        |          |   |

## gas thermostats

### SIT

#### 630 Eurosit series



|   |   |                 |            |
|---|---|-----------------|------------|
| <b>GEV No.</b>  | 101125  | <b>Ref. No.</b> | 30100080   |
| <b>description</b>  | gas thermostat type 630 Eurosit series t.max. 340°C 100-340°C gas inlet 3/8" gas outlet 3/8" thermocouple connection M9x1 pilot connection M10x1 probe ø 4mm probe L 72mm capillary pipe 1050mm SIT |                 |            |
| <b>accessories for</b>  | 101125  |                 |            |
|  | GEV No.   | 100825          | Ref. No. — |
|   | gas tap spindle shaft ø 8x6.5mm shaft L 22/14mm suitable for EUROSIT  |                 |            |
|  | GEV No.   | 100904          | Ref. No. — |
|   | locking screw M10x1 for pipe ø 4mm Qty 1 pcs  |                 |            |
|  | GEV No.   | 100905          | Ref. No. — |
|   | locking screw M10x1 for pipe ø 6mm Qty 1 pcs  |                 |            |
|  | GEV No.   | 100949          | Ref. No. — |
|   | gasket suitable for 630 Eurosit series  |                 |            |
|  | GEV No.   | 101273          | Ref. No. — |
|   | olive for pipe ø 12mm L 9.5mm brass Qty 1 pcs suitable for universal  |                 |            |
|  | GEV No.   | 101276          | Ref. No. — |
|   | union screw thread 3/8" tube ø 12mm Qty 1 pcs   |                 |            |
|  | GEV No.   | 101333          | Ref. No. — |
|   | plug thread 3/8" with O-ring  |                 |            |
|  | GEV No.   | 101390          | Ref. No. — |
|   | gas tap spindle shaft ø 6x4.6mm shaft L 32/15mm gas tap with ignition flame suitable for ZANUSSI, MARENO for gas thermostat EUROSIT   |                 |            |
|  | GEV No.   | 101392          | Ref. No. — |
|   | adapter suitable for 630 Eurosit series   |                 |            |
|  | GEV No.   | 110357          | Ref. No. — |
|   | gas tap spindle shaft ø 8x6.5mm shaft L 36/12mm suitable for 630 Eurosit series   |                 |            |

|   |  |        |            |
|---|--|--------|------------|
| <b>accessories for</b>  | 101125   |        |            |
|  | GEV No.  | 110358 | Ref. No. — |
|   | adapter shaft ø 10x8mm shaft L 29/18mm suitable for 630 Eurosit series |        |            |







## gas valves and ignition boxes

### gas control valves

#### SIT







#### NOVASIT







|   |   |                 |                   |
|---|---|-----------------|-------------------|
| <b>GEV No.</b>  | 101187  | <b>Ref. No.</b> | 30100014          |
| <b>description</b>  | gas valve SIT series Novasit 820 0.17VHz gas inlet 1/2" gas outlet 1/2" thermocouple connection M9x1 pilot connection M10x1 ignition pressurebar pressure range 5-50mbar pressure regulator connection blind equiv. no. 0.820.301 supply Operator millivolt |                 |                   |
| <b>spare parts for</b>  | 101187  |                 |                   |
|  | GEV No.   | 101065          | Ref. No. —        |
|   | magnet unit with cable L 44mm D1 ø 30mm D2 ø 20mm suitable for NOVASIT  |                 |                   |
| <b>accessories for</b>  | 101187  |                 |                   |
|  | GEV No.   | 100110          | Ref. No. 30100000 |
|   | pilot burner SIT type 190 series 3 flames nozzle ømm gas connectionmm   |                 |                   |
|  | GEV No.   | 101305          | Ref. No. —        |
|   | gas connection straight 1/2" flange 45x45mm ELETTROSIT/V4400/4600/4605 suitable for SIT/HONEYWELL hole distance 36x36mm   |                 |                   |
|  | GEV No.   | 101306          | Ref. No. —        |
|   | gas connection angled flange 45x45mm hole distance 36x36mm 1/2" ELETTROSIT/V4400/4600/4605 screw with O-ring suitable for SIT/HONEYWELL   |                 |                   |
|  | GEV No.   | 101307          | Ref. No. —        |
|   | gas connection straight flange 45x45mm hole distance 36x36mm 3/4" ELETTROSIT/V4400/4600/4605 screw with O-ring suitable for SIT/HONEYWELL   |                 |                   |
|  | GEV No.   | 101308          | Ref. No. —        |
|   | gas connection angled flange 45x45mm hole distance 36x36mm 3/4" ELETTROSIT/V4400/4600/4605 screw with O-ring suitable for SIT/HONEYWELL   |                 |                   |
|  | GEV No.   | 102116          | Ref. No. 40400130 |
|   | thermopile ROBERTSHAW L 900mm probe ø 9mm probe L 57mm 250-750mV screw connection 7/16"   |                 |                   |





|  |  |                 |          |
|--|--|-----------------|----------|
|                         |  |                 |          |
| 1  |  |                 |          |
| <b>GEV No.</b>   | 107833   | <b>Ref. No.</b> | 30100012 |
| <b>description</b>   | gas valve SIT series Novasit 826 230V 50Hz gas inlet 1/2" gas outlet 1/2" pilot connection closed pressure range 2-50mbar pressure regulator connection blind equiv. no. 0.826.010 |                 |          |
| <b>spare parts for</b>   | 107833   |                 |          |
|                         |  |                 |          |
| <b>GEV No.</b>   | 101542   | <b>Ref. No.</b> | —        |
| <b>description</b>   | solenoid coil 50Hz NOVA 822/826/827 suitable for NOVASIT 230V  |                 |          |
| <b>accessories for</b>   | 107833   |                 |          |
|              |  |                 |          |
| <b>GEV No.</b>   | 101305   | <b>Ref. No.</b> | —        |
| <b>description</b>   | gas connection straight 1/2" flange 45x45mm ELETTROSIT/V4400/4600/4605 suitable for SIT/HONEYWELL hole distance 36x36mm  |                 |          |
|                         |  |                 |          |
| <b>GEV No.</b>   | 101306   | <b>Ref. No.</b> | —        |
| <b>description</b>   | gas connection angled flange 45x45mm hole distance 36x36mm 1/2" ELETTROSIT/V4400/4600/4605 screw with O-ring suitable for SIT/HONEYWELL  |                 |          |
|  |  |                 |          |
| <b>GEV No.</b>   | 101307   | <b>Ref. No.</b> | —        |
| <b>description</b>   | gas connection straight flange 45x45mm hole distance 36x36mm 3/4" ELETTROSIT/V4400/4600/4605 screw with O-ring suitable for SIT/HONEYWELL  |                 |          |
|  |  |                 |          |
| <b>GEV No.</b>   | 101308   | <b>Ref. No.</b> | —        |
| <b>description</b>   | gas connection angled flange 45x45mm hole distance 36x36mm 3/4" ELETTROSIT/V4400/4600/4605 screw with O-ring suitable for SIT/HONEYWELL  |                 |          |
|                       |  |                 |          |
| <b>GEV No.</b>   | 101859   | <b>Ref. No.</b> | —        |
| <b>description</b>   | panel-mounted inlet with cable L 1000mm for rectifier suitable for NOVASIT   |                 |          |

| accessories   |  |                 |          |
|---|--|-----------------|----------|
|  |  |                 |          |
| 1   |  |                 |          |
| <b>GEV No.</b>  | 100110   | <b>Ref. No.</b> | 30100000 |
| <b>description</b>  | pilot burner SIT type 190 series 3 flames nozzle 0mm gas connectionmm      |                 |          |
| <b>accessories for</b>  | 100110   |                 |          |
|  |  |                 |          |
| <b>GEV No.</b>  | 100202   | <b>Ref. No.</b> | —        |
| <b>description</b>  | pilot burner nozzle natural gas code 41 Qty 1 pcs nozzle 0.41mm            |                 |          |
|  |  |                 |          |
| <b>GEV No.</b>  | 100203   | <b>Ref. No.</b> | —        |
| <b>description</b>  | pilot burner nozzle LPG code 25 Qty 1 pcs nozzle 0.25mm                    |                 |          |
|  |  |                 |          |
| <b>GEV No.</b>  | 100701   | <b>Ref. No.</b> | —        |
| <b>description</b>  | ignition electrode connection M4 Qty 1 pcs                                 |                 |          |
|  |  |                 |          |
| <b>GEV No.</b>  | 100906   | <b>Ref. No.</b> | —        |
| <b>description</b>  | screw connection thread M10x1 for ignition electrode brass Qty 1 pcs WS 10 |                 |          |

|   |   |                 |          |
|---|---|-----------------|----------|
| <b>accessories for</b>  | 100110  |                 |          |
|  |   |                 |          |
| <b>GEV No.</b>  | 100907  | <b>Ref. No.</b> | —        |
| <b>description</b>  | screw connection thread M10x1 Qty 1 pcs type SEF 1 0mm for thermocouple |                 |          |
|  |   |                 |          |
| <b>GEV No.</b>  | 100908  | <b>Ref. No.</b> | —        |
| <b>description</b>  | union screw thread M10x1 for pipe 04mm Qty 1 pcs                        |                 |          |
|  |   |                 |          |
| <b>GEV No.</b>  | 100909  | <b>Ref. No.</b> | —        |
| <b>description</b>  | union screw thread M10x1 for pipe 06mm Qty 1 pcs                        |                 |          |
|  |   |                 |          |
| <b>GEV No.</b>  | 101282  | <b>Ref. No.</b> | —        |
| <b>description</b>  | olive for pipe 04mm L 7.4mm Qty 1 pcs                                   |                 |          |
|  |   |                 |          |
| <b>GEV No.</b>  | 101287  | <b>Ref. No.</b> | —        |
| <b>description</b>  | olive for pipe 06mm Qty 1 pcs   |                 |          |
|  |   |                 |          |
| <b>GEV No.</b>  | 102110  | <b>Ref. No.</b> | —        |
| <b>description</b>  | pilot tube copper pipe 04mm thickness 1mm L 3000mm                      |                 |          |
|  |   |                 |          |
| <b>GEV No.</b>  | 102111  | <b>Ref. No.</b> | —        |
| <b>description</b>  | pilot tube copper pipe 06mm thickness 1mm L 3000mm                      |                 |          |
|  |   |                 |          |
| <b>GEV No.</b>  | 107650  | <b>Ref. No.</b> | 30500006 |
| <b>description</b>  | pilot burner nozzle SIT LPG code 30 Qty 1 pcs                           |                 |          |

## ignition parts

### pilot burners







| SIT  |   |                 |          |
|--|---|-----------------|----------|
| 100 series   |   |                 |          |
|  |   |                 |          |
| 1  |   |                 |          |
| <b>GEV No.</b>   | 106906  | <b>Ref. No.</b> | 30100005 |
| <b>description</b>   | pilot burner SIT type 100 series 3 flames nozzle 0.2mm gas connection 6mm   |                 |          |
| <b>For models:</b>   | KP20GA-GIGA, KP20G-GIGA, KP20GTA-GIGA, KP20GT-GIGA, KP30GA-GIGA, KP30G-GIGA, KP30GTA-GIGA, KP30GT-GIGA, KP50GA-GIGA, KP50G-GIGA, KP50GTA-GIGA, KP50GT-GIGA, KPGN18G-GIGA, KPGN27G-GIGA, KPGN37G-GIGA, KPI20GA-GIGA, KPI20G-GIGA, KPI20GTA-GIGA, KPI20GT-GIGA, KPI30GA-GIGA, KPI30G-GIGA, KPI30GTA-GIGA, KPI30GT-GIGA, KPI50GA-GIGA, KPI50G-GIGA, KPI50GTA-GIGA, KPI50GT-GIGA, KPIGN18G-GIGA, KPIGN27G-GIGA, KPIGN37G-GIGA, PM9.G170GN-FAGOR, PM9.G270GN-FAGOR, PM9.G370GN-FAGOR |                 |          |
| <b>spare parts for</b>   | 106906  |                 |          |
|   |   |                 |          |
| <b>GEV No.</b>   | 100245  | <b>Ref. No.</b> | 30500005 |
| <b>description</b>   | pilot burner nozzle LPG code 20 bore 0.2mm Qty 1 pcs thread M8x0.75   |                 |          |
|   |   |                 |          |
| <b>GEV No.</b>   | 100855  | <b>Ref. No.</b> | —        |
| <b>description</b>   | pilot burner bracket triple   |                 |          |
|   |   |                 |          |
| <b>GEV No.</b>   | 100885  | <b>Ref. No.</b> | —        |
| <b>description</b>   | air mixing sleeve for pilot burner Qty 1 pcs  |                 |          |
|   |   |                 |          |
| <b>GEV No.</b>   | 100916  | <b>Ref. No.</b> | —        |
| <b>description</b>   | compression spring for pilot burner Qty 1 pcs   |                 |          |

Table continues overleaf

| spare parts for   |         | 106906 |                   |
|---|---------|--------|-------------------|
|    | GEV No. | 100917 | Ref. No. —        |
| gasket for pilot burner Qty 1 pcs aluminium   |         |        |                   |
|    | GEV No. | 100918 | Ref. No. —        |
| screw for pilot burner  |         |        |                   |
|    | GEV No. | 107162 | Ref. No. —        |
| pilot burner cap SIT 3 flames Hmm Lmm Qty 1 pcs                                     |         |        |                   |
|    | GEV No. | 107701 | Ref. No. —        |
| pilot burner bottom part SIT 100 series nozzle ø 0.2mm                              |         |        |                   |
| accessories for   |         | 106906 |                   |
|    | GEV No. | 100245 | Ref. No. 30500005 |
| pilot burner nozzle LPG code 20 bore ø 0.2mm Qty 1 pcs thread M8x0.75               |         |        |                   |
|    | GEV No. | 100246 | Ref. No. —        |
| pilot burner nozzle natural gas bore ø 0.35mm Qty 1 pcs thread M8x0.75              |         |        |                   |
|    | GEV No. | 100904 | Ref. No. —        |
| locking screw M10x1 for pipe ø 4mm Qty 1 pcs  |         |        |                   |
|    | GEV No. | 100905 | Ref. No. —        |
| locking screw M10x1 for pipe ø 6mm Qty 1 pcs  |         |        |                   |
|   | GEV No. | 102110 | Ref. No. —        |
| pilot tube copper pipe ø 4mm thickness 1mm L 3000mm                                 |         |        |                   |
|  | GEV No. | 102111 | Ref. No. —        |
| pilot tube copper pipe ø 6mm thickness 1mm L 3000mm                                 |         |        |                   |
|  | GEV No. | 107171 | Ref. No. —        |
| pilot burner nozzle SIT natural/liquid gas bore ø 0.25mm Qty 1 pcs                  |         |        |                   |
|  | GEV No. | 107700 | Ref. No. —        |
| pilot burner bottom part SIT 100 series nozzle ø 0.25mm                             |         |        |                   |
|  | GEV No. | 107702 | Ref. No. —        |
| pilot burner bottom part SIT 100 series nozzle ø 0.35mm                             |         |        |                   |

accessories

pilot burner nozzles

|   |        |          |          |
|---|--------|----------|----------|
|  | 1      |          |          |
| GEV No.   | 100245 | Ref. No. | 30500005 |
| description pilot burner nozzle LPG code 20 bore ø 0.2mm Qty 1 pcs thread M8x0.75   |        |          |          |

|  |        |          |          |
|--|--------|----------|----------|
|   | 1      |          |          |
| GEV No.  | 102972 | Ref. No. | 30500003 |
| description pilot burner nozzle natural gas code 40 bore ø 0.4mm Qty 1 pcs   |        |          |          |
| For models: KP20GA-GIGA, KP20G-GIGA, KP20GTA-GIGA, KP20GT-GIGA, KP-30GA-GIGA, KP30G-GIGA, KP30GTA-GIGA, KP30GT-GIGA, KP50GA-GIGA, KP50G-GIGA, KP50GTA-GIGA, KP50GT-GIGA, KPGN18G-GIGA, KPGN27G-GIGA, KPGN37G-GIGA, KPI20GA-GIGA, KPI20G-GIGA, KPI20GTA-GIGA, KPI20GT-GIGA, KPI30GA-GIGA, KPI30G-GIGA, KPI30GTA-GIGA, KPI30GT-GIGA, KPI50GA-GIGA, KPI50G-GIGA, KPI50GTA-GIGA, KPI50GT-GIGA, KPIGN18G-GIGA, KPIGN27G-GIGA, KPIGN37G-GIGA, PM9.G170GN-FAGOR, PM9.G270GN-FAGOR, PM9.G370GN-FAGOR |        |          |          |

ignition electrodes

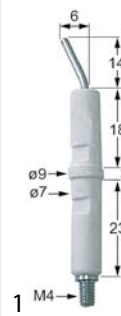

|  |        |          |          |
|--|--------|----------|----------|
| GEV No.  | 100706 | Ref. No. | 30100054 |
| description ignition electrode connection M4 Qty 1 pcs   |        |          |          |
| For models: KP20GA-GIGA, KP20G-GIGA, KP20GTA-GIGA, KP20GT-GIGA, KP-30GA-GIGA, KP30G-GIGA, KP30GTA-GIGA, KP30GT-GIGA, KP50GA-GIGA, KP50G-GIGA, KP50GTA-GIGA, KP50GT-GIGA, KPGN18G-GIGA, KPGN27G-GIGA, KPGN37G-GIGA, KPI20GA-GIGA, KPI20G-GIGA, KPI20GTA-GIGA, KPI20GT-GIGA, KPI30GA-GIGA, KPI30G-GIGA, KPI30GTA-GIGA, KPI30GT-GIGA, KPI50GA-GIGA, KPI50G-GIGA, KPI50GTA-GIGA, KPI50GT-GIGA, KPIGN18G-GIGA, KPIGN27G-GIGA, KPIGN37G-GIGA |        |          |          |

190 series















|   |         |          |            |
|---|---------|----------|------------|
| GEV No.   | 100110  | Ref. No. | 30100000   |
| description pilot burner SIT type 190 series 3 flames nozzle ømm gas connectionmm   |         |          |            |
| accessories for 100110  |         |          |            |
|  | GEV No. | 100202   | Ref. No. — |
| pilot burner nozzle natural gas code 41 Qty 1 pcs nozzle ø 0.41mm                   |         |          |            |
|  | GEV No. | 100203   | Ref. No. — |
| pilot burner nozzle LPG code 25 Qty 1 pcs nozzle ø 0.25mm                           |         |          |            |
|  | GEV No. | 100701   | Ref. No. — |
| ignition electrode connection M4 Qty 1 pcs  |         |          |            |
|  | GEV No. | 100906   | Ref. No. — |
| screw connection thread M10x1 for ignition electrode brass Qty 1 pcs WS 10          |         |          |            |
|  | GEV No. | 100907   | Ref. No. — |
| screw connection thread M10x1 Qty 1 pcs type SEF 1 ømm for thermocouple             |         |          |            |
|  | GEV No. | 100908   | Ref. No. — |
| union screw thread M10x1 for pipe ø 4mm Qty 1 pcs                                   |         |          |            |
|  | GEV No. | 100909   | Ref. No. — |
| union screw thread M10x1 for pipe ø 6mm Qty 1 pcs                                   |         |          |            |
|  | GEV No. | 101282   | Ref. No. — |
| olive for pipe ø 4mm L 7.4mm Qty 1 pcs  |         |          |            |
|  | GEV No. | 101287   | Ref. No. — |
| olive for pipe ø 6mm Qty 1 pcs  |         |          |            |

Table continues overleaf



|   |   |        |                          |
|---|---|--------|--------------------------|
| <b>accessories for</b>  | 100110  |        |                          |
|  | <b>GEV No.</b>  | 102110 | <b>Ref. No.</b> —        |
|   | pilot tube copper pipe $\varnothing$ 4mm thickness 1mm L 3000mm |        |                          |
|  | <b>GEV No.</b>  | 102111 | <b>Ref. No.</b> —        |
|   | pilot tube copper pipe $\varnothing$ 6mm thickness 1mm L 3000mm |        |                          |
|  | <b>GEV No.</b>  | 107650 | <b>Ref. No.</b> 30500006 |
|   | pilot burner nozzle SIT LPG code 30 Qty 1 pcs                   |        |                          |

**electrodes**

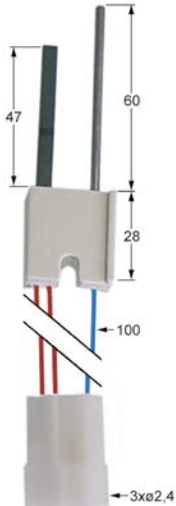

|                    |   |                 |            |
|--------------------|---|-----------------|------------|
| <b>GEV No.</b>     | 100730  | <b>Ref. No.</b> | 30100032/1 |
| <b>description</b> | glow plug cable length 100mm connection $\varnothing$ 2.4mm L1 47mm L2 60mm |                 |            |

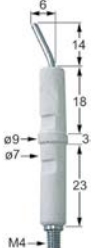

|                    |   |                 |          |
|--------------------|---|-----------------|----------|
| <b>GEV No.</b>     | 100706  | <b>Ref. No.</b> | 30100054 |
| <b>description</b> | ignition electrode connection M4 Qty 1 pcs  |                 |          |
| <b>For models:</b> | KP20GA-GIGA, KP20G-GIGA, KP20GTA-GIGA, KP20GT-GIGA, KP30GA-GIGA, KP30G-GIGA, KP30GTA-GIGA, KP30GT-GIGA, KP50GA-GIGA, KP50G-GIGA, KP50GTA-GIGA, KP50GT-GIGA, KPGN18G-GIGA, KPGN27G-GIGA, KPGN37G-GIGA, KPI20GA-GIGA, KPI20G-GIGA, KPI20GTA-GIGA, KPI20GT-GIGA, KPI30GA-GIGA, KPI30G-GIGA, KPI30GTA-GIGA, KPI30GT-GIGA, KPI50GA-GIGA, KPI50G-GIGA, KPI50GTA-GIGA, KPI50GT-GIGA, KPIGN18G-GIGA, KPIGN27G-GIGA, KPIGN37G-GIGA |                 |          |



|                    |  |                 |          |
|--------------------|--|-----------------|----------|
| <b>GEV No.</b>     | 100709   | <b>Ref. No.</b> | 30100050 |
| <b>description</b> | ignition electrode D1 $\varnothing$ 7mm D2 $\varnothing$ 9mm connection M4 L1 13mm L2 13mm L3 23mm BL1 18mm BL2 3mm BL3 23mm to clip |                 |          |
| <b>For models:</b> | PM9.G170GN-FAGOR, PM9.G270GN-FAGOR, PM9.G370GN-FAGOR   |                 |          |

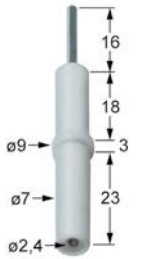

|                    |   |                 |          |
|--------------------|---|-----------------|----------|
| <b>GEV No.</b>     | 102330  | <b>Ref. No.</b> | 30100052 |
| <b>description</b> | ignition electrode D1 $\varnothing$ 7mm D2 $\varnothing$ 9mm L1 16mm BL1 18mm BL2 3mm BL3 23mm to clip connection $\varnothing$ 2.4mm |                 |          |

**piezoelectric igniters**

**mounting diameter 22mm**



|   |   |                 |                   |
|---|---|-----------------|-------------------|
| <b>GEV No.</b>  | 100013  | <b>Ref. No.</b> | 40100130          |
| <b>description</b>  | piezoelectric igniter body plastic blowing mounting $\varnothing$ 22mm connection $\varnothing$ 2.4mm cable lengthmm  |                 |                   |
| <b>For models:</b>  | KP20GA-GIGA, KP20G-GIGA, KP20GTA-GIGA, KP20GT-GIGA, KP30GA-GIGA, KP30G-GIGA, KP30GTA-GIGA, KP30GT-GIGA, KP50GA-GIGA, KP50G-GIGA, KP50GTA-GIGA, KP50GT-GIGA, KPGN18G-GIGA, KPGN27G-GIGA, KPGN37G-GIGA, KPI20GA-GIGA, KPI20G-GIGA, KPI20GTA-GIGA, KPI20GT-GIGA, KPI30GA-GIGA, KPI30G-GIGA, KPI30GTA-GIGA, KPI30GT-GIGA, KPI50GA-GIGA, KPI50G-GIGA, KPI50GTA-GIGA, KPI50GT-GIGA, KPIGN18G-GIGA, KPIGN27G-GIGA, KPIGN37G-GIGA |                 |                   |
| <b>accessories for</b>  | 100013  |                 |                   |
|  | <b>GEV No.</b>  | 100023          | <b>Ref. No.</b> — |
|   | female bullet size 2.3mm 0.5-1.5mm <sup>2</sup> CuZn t.max. 125°C Qty 20 pcs  |                 |                   |





## gas nozzles

### pilot burner nozzles

#### pilot burner nozzles SIT

##### 100 series



1

|                    |   |                 |          |
|--------------------|---|-----------------|----------|
| <b>GEV No.</b>     | 100245  | <b>Ref. No.</b> | 30500005 |
| <b>description</b> | pilot burner nozzle LPG code 20 bore $\varnothing$ 0.2mm Qty 1 pcs thread M8x0.75 |                 |          |



1

|                    |   |                 |          |
|--------------------|---|-----------------|----------|
| <b>GEV No.</b>     | 102972  | <b>Ref. No.</b> | 30500003 |
| <b>description</b> | pilot burner nozzle natural gas code 40 bore $\varnothing$ 0.4mm Qty 1 pcs  |                 |          |
| <b>For models:</b> | KP20GA-GIGA, KP20G-GIGA, KP20GTA-GIGA, KP20GT-GIGA, KP30GA-GIGA, KP30G-GIGA, KP30GTA-GIGA, KP30GT-GIGA, KP50GA-GIGA, KP50G-GIGA, KP50GTA-GIGA, KP50GT-GIGA, KPGN18G-GIGA, KPGN27G-GIGA, KPGN37G-GIGA, KPI20GA-GIGA, KPI20G-GIGA, KPI20GTA-GIGA, KPI20GT-GIGA, KPI30GA-GIGA, KPI30G-GIGA, KPI30GTA-GIGA, KPI30GT-GIGA, KPI50GA-GIGA, KPI50G-GIGA, KPI50GTA-GIGA, KPI50GT-GIGA, KPIGN18G-GIGA, KPIGN27G-GIGA, KPIGN37G-GIGA, PM9.G170GN-FAGOR, PM9.G270GN-FAGOR, PM9.G370GN-FAGOR |                 |          |

##### 160 series



1

|                    |   |                 |          |
|--------------------|---|-----------------|----------|
| <b>GEV No.</b>     | 107650  | <b>Ref. No.</b> | 30500006 |
| <b>description</b> | pilot burner nozzle SIT LPG code 30 Qty 1 pcs |                 |          |



1

|                    |   |                 |          |
|--------------------|---|-----------------|----------|
| <b>GEV No.</b>     | 107175  | <b>Ref. No.</b> | 30500007 |
| <b>description</b> | pilot burner nozzle SIT natural gas code 51 Qty 1 pcs suitable for 160 series |                 |          |

## equipment-specific units

### for dough mixers

#### flange bearings



1

|                    |   |                 |          |
|--------------------|---|-----------------|----------|
| <b>GEV No.</b>     | 693112  | <b>Ref. No.</b> | 20400012 |
| <b>description</b> | flange bearing type UCF204 shaft $\varnothing$ 20mm 4 hole flange hole distance 64mm H 33mm flange length 86mm flange width 86mm hole $\varnothing$ 12mm flange F204 ball bearing UC204G2 FH 25.5mm |                 |          |

### for tilting bratt pans

#### spindles



1

|                    |   |                 |                        |
|--------------------|---|-----------------|------------------------|
| <b>GEV No.</b>     | 693110                                  | <b>Ref. No.</b> | SMB012800<br>SMB129-00 |
| <b>description</b> | threaded rod L 363mm $\varnothing$ 20mm |                 |                        |

#### miscellaneous



1

|                    |         |                 |           |
|--------------------|---------|-----------------|-----------|
| <b>GEV No.</b>     | 693111  | <b>Ref. No.</b> | SMB013000 |
| <b>description</b> | spindle |                 |           |



1

|                    |         |                 |           |
|--------------------|---------|-----------------|-----------|
| <b>GEV No.</b>     | 693114  | <b>Ref. No.</b> | SMB063000 |
| <b>description</b> | spindle |                 |           |



1

|                    |   |                 |                             |
|--------------------|---|-----------------|-----------------------------|
| <b>GEV No.</b>     | 693109  | <b>Ref. No.</b> | SC02200<br>SC02200+10300042 |
| <b>description</b> | threaded bush for tilting bratt pan brass thread TR20x4 |                 |                             |



## for boiling pans

## filters



1

|                    |  |                 |                        |
|--------------------|--|-----------------|------------------------|
| <b>GEV No.</b>     | 514503   | <b>Ref. No.</b> | 30700122<br>FX30700122 |
| <b>description</b> | drain filter for kettle size 76x145mm  |                 |                        |
| <b>For models:</b> | KPI10ETA-GIGA, KPI10ET-GIGA, KPI10VTA-GIGA, KPI10VT-GIGA, KPI15ETA-GIGA, KPI15ET-GIGA, KPI15VTA-GIGA, KPI15VT-GIGA, PM9.G170GN-FAGOR, PM9.G270GN-FAGOR, PM9.G370GN-FAGOR |                 |                        |

## miscellaneous



1

|                    |   |                 |          |
|--------------------|---|-----------------|----------|
| <b>GEV No.</b>     | 540639  | <b>Ref. No.</b> | 10400058 |
| <b>description</b> | extension   |                 |          |
| <b>For models:</b> | KPI10VTA-GIGA, KPI10VT-GIGA, KPI15VTA-GIGA, KPI15VT-GIGA, KPI20VTA-GIGA, KPI20VT-GIGA, KPI30VTA-GIGA, KPI30VT-GIGA, KPI50VTA-GIGA, KPI50VT-GIGA |                 |          |

## knobs

## producer-specific knobs

## FIREX



1

|                    |   |                 |          |
|--------------------|---|-----------------|----------|
| <b>GEV No.</b>     | 112571  | <b>Ref. No.</b> | 20200001 |
| <b>description</b> | knob gas tap with ignition flame $\varnothing$ 65mm shaft $\varnothing$ 10x8mm shaft flat lower   |                 |          |
| <b>For models:</b> | KP20GA-GIGA, KP20G-GIGA, KP20GTA-GIGA, KP20GT-GIGA, KP30GA-GIGA, KP30G-GIGA, KP30GTA-GIGA, KP30GT-GIGA, KP50GA-GIGA, KP50G-GIGA, KP50GTA-GIGA, KP50GT-GIGA, KPGN18G-GIGA, KPGN27G-GIGA, KPGN37G-GIGA, KPI20GA-GIGA, KPI20G-GIGA, KPI20GTA-GIGA, KPI20GT-GIGA, KPI30GA-GIGA, KPI30G-GIGA, KPI30GTA-GIGA, KPI30GT-GIGA, KPI50GA-GIGA, KPI50G-GIGA, KPI50GTA-GIGA, KPI50GT-GIGA, KPIGN18G-GIGA, KPIGN27G-GIGA, KPIGN37G-GIGA, PM9.G170GN-FAGOR, PM9.G270GN-FAGOR, PM9.G370GN-FAGOR |                 |          |

## handles and hand wheels

## hand wheels

## hand wheels



1

|                    |  |                 |           |
|--------------------|--|-----------------|-----------|
| <b>GEV No.</b>     | 692443   | <b>Ref. No.</b> | SMB013600 |
| <b>description</b> | hand wheel $\varnothing$ 150mm D1 $\varnothing$ 38mm bore $\varnothing$ 14mm thread groove width 6mm groove depth 13mm mounting distance 18mm L1 40mm L2 43mm handle length 65mm with folding handle |                 |           |



1

|                    |  |                 |           |
|--------------------|--|-----------------|-----------|
| <b>GEV No.</b>     | 692430   | <b>Ref. No.</b> | SMB063600 |
| <b>description</b> | hand wheel $\varnothing$ 200mm D1 $\varnothing$ 50mm bore $\varnothing$ 20mm thread groove width 6mm groove depth 13mm mounting distance 30mm L1 47mm L2 50mm handle length 90mm with folding handle |                 |           |

## ball handles



1

|                    |  |                 |          |
|--------------------|--|-----------------|----------|
| <b>GEV No.</b>     | 540323   | <b>Ref. No.</b> | 20200013 |
| <b>description</b> | ball handle thread M10 $\varnothing$ 40mm with metal bush black  |                 |          |
| <b>For models:</b> | KPI10ETA-GIGA, KPI10ET-GIGA, KPI15ETA-GIGA, KPI15ET-GIGA, KPI20ETA-GIGA, KPI20ET-GIGA, KPI20VTA-GIGA, KPI20VT-GIGA, KPI30ETA-GIGA, KPI30ET-GIGA, KPI30VTA-GIGA, KPI30VT-GIGA, KPI50ETA-GIGA, KPI50ET-GIGA, KPI50VTA-GIGA, KPI50VT-GIGA |                 |          |



## fittings for catering equipment

### lid hinges

type RUBINETTERIE DEL FRIULI

for circular lids

spare parts



|                    |  |                 |          |
|--------------------|--|-----------------|----------|
| <b>GEV No.</b>     | 540855   | <b>Ref. No.</b> | 20500046 |
| <b>description</b> | torsion spring ø 50.8mm wire gauge ø 5.1mm L1 34mm L2 104mm L3 29mm mounting pos. left |                 |          |

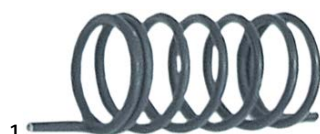

|                    |   |                 |          |
|--------------------|---|-----------------|----------|
| <b>GEV No.</b>     | 540854  | <b>Ref. No.</b> | 20500044 |
| <b>description</b> | torsion spring ø 50.8mm wire gauge ø 5.1mm L1 34mm L2 104mm L3 29mm mounting pos. right |                 |          |

### FIREX

lid hinges



|                    |  |                 |          |
|--------------------|--|-----------------|----------|
| <b>GEV No.</b>     | 514412   | <b>Ref. No.</b> | 20300096 |
| <b>description</b> | lid hinge L 230mm mounting distance 1 150mm flange radius 320mm spring thickness 4mm for circular lids             |                 |          |
| <b>For models:</b> | KPI10ETA-GIGA, KPI10ET-GIGA, KPI10VTA-GIGA, KPI10VT-GIGA, KPI15ETA-GIGA, KPI15ET-GIGA, KPI15VTA-GIGA, KPI15VT-GIGA |                 |          |

|                        |  |        |                 |   |
|------------------------|--|--------|-----------------|---|
| <b>spare parts for</b> | 514412   |        |                 |   |
|                        | <b>GEV No.</b>   | 540846 | <b>Ref. No.</b> | — |
|                        | torsion spring ø 42.5mm wire gauge ø 4.1mm L1 93mm L2 26mm L3 26mm mounting pos. left  |        |                 |   |
|                        | <b>GEV No.</b>   | 540847 | <b>Ref. No.</b> | — |
|                        | torsion spring ø 42.5mm wire gauge ø 4.1mm L1 93mm L2 26mm L3 26mm mounting pos. right |        |                 |   |



|                        |   |                 |                 |          |
|------------------------|---|-----------------|-----------------|----------|
| <b>GEV No.</b>         | 514413  | <b>Ref. No.</b> | 20300086        |          |
| <b>description</b>     | lid hinge L 270mm mounting distance 1 139mm flange radius 395mm spring thickness 5mm bore ø M15mm for circular lids   |                 |                 |          |
| <b>For models:</b>     | KP20GA-GIGA, KP20G-GIGA, KP20GTA-GIGA, KP20GT-GIGA, KP30GA-GIGA, KP30G-GIGA, KP30GTA-GIGA, KP30GT-GIGA, KP50GA-GIGA, KP50G-GIGA, KP50GTA-GIGA, KP50GT-GIGA, KPI20EA-GIGA, KPI20E-GIGA, KPI20ET-GIGA, KPI20GA-GIGA, KPI20G-GIGA, KPI20GTA-GIGA, KPI20GT-GIGA, KPI20VTA-GIGA, KPI20VT-GIGA, KPI30EA-GIGA, KPI30E-GIGA, KPI30GA-GIGA, KPI30G-GIGA, KPI30GT-GIGA, KPI30GT-GIGA, KPI50EA-GIGA, KPI50E-GIGA, KPI50GA-GIGA, KPI50G-GIGA, KPI50GTA-GIGA, KPI50GT-GIGA |                 |                 |          |
| <b>spare parts for</b> | 514413  |                 |                 |          |
|                        | <b>GEV No.</b>  | 540854          | <b>Ref. No.</b> | 20500044 |
|                        | torsion spring ø 50.8mm wire gauge ø 5.1mm L1 34mm L2 104mm L3 29mm mounting pos. right   |                 |                 |          |
|                        | <b>GEV No.</b>  | 540855          | <b>Ref. No.</b> | 20500046 |
|                        | torsion spring ø 50.8mm wire gauge ø 5.1mm L1 34mm L2 104mm L3 29mm mounting pos. left  |                 |                 |          |



|                        |   |                 |                 |   |
|------------------------|---|-----------------|-----------------|---|
| <b>GEV No.</b>         | 514414  | <b>Ref. No.</b> | 20300108        |   |
| <b>description</b>     | lid hinge L 270mm mounting distance 1 139mm flange radius 470mm spring thickness 6mm bore ø M15mm for circular lids |                 |                 |   |
| <b>For models:</b>     | KPI30ET-GIGA, KPI30VTA-GIGA, KPI30VT-GIGA, KPI50ET-GIGA, KPI50VTA-GIGA, KPI50VT-GIGA                                |                 |                 |   |
| <b>spare parts for</b> | 514414  |                 |                 |   |
|                        | <b>GEV No.</b>  | 540856          | <b>Ref. No.</b> | — |
|                        | torsion spring ø 52mm wire gauge ø 6.2mm L1 30mm L2 95mm L3 30mm mounting pos. right                                |                 |                 |   |
|                        | <b>GEV No.</b>  | 540857          | <b>Ref. No.</b> | — |
|                        | torsion spring ø 52mm wire gauge ø 6.2mm L1 30mm L2 95mm L3 30mm mounting pos. left                                 |                 |                 |   |

spare parts



|                    |  |                 |          |
|--------------------|--|-----------------|----------|
| <b>GEV No.</b>     | 540855   | <b>Ref. No.</b> | 20500046 |
| <b>description</b> | torsion spring ø 50.8mm wire gauge ø 5.1mm L1 34mm L2 104mm L3 29mm mounting pos. left |                 |          |



|                    |   |                 |          |
|--------------------|---|-----------------|----------|
| <b>GEV No.</b>     | 540854  | <b>Ref. No.</b> | 20500044 |
| <b>description</b> | torsion spring ø 50.8mm wire gauge ø 5.1mm L1 34mm L2 104mm L3 29mm mounting pos. right |                 |          |

**ICOS**



|                    |  |                 |          |
|--------------------|--|-----------------|----------|
| <b>GEV No.</b>     | 540855   | <b>Ref. No.</b> | 20500046 |
| <b>description</b> | torsion spring ø 50.8mm wire gauge ø 5.1mm L1 34mm L2 104mm L3 29mm mounting pos. left |                 |          |



|                    |   |                 |          |
|--------------------|---|-----------------|----------|
| <b>GEV No.</b>     | 540854  | <b>Ref. No.</b> | 20500044 |
| <b>description</b> | torsion spring ø 50.8mm wire gauge ø 5.1mm L1 34mm L2 104mm L3 29mm mounting pos. right |                 |          |

**lid catches**

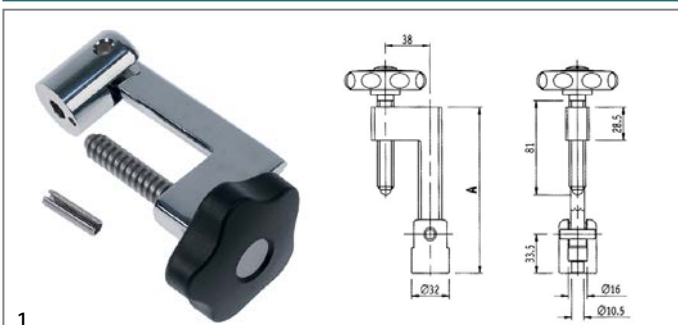

|                    |  |                 |          |
|--------------------|--|-----------------|----------|
| <b>GEV No.</b>     | 514127   | <b>Ref. No.</b> | 20300093 |
| <b>description</b> | lid lock handle ø 70mm L 143mm   |                 |          |
| <b>For models:</b> | KP20GA-GIGA, KP20GTA-GIGA, KP30GA-GIGA, KP30GTA-GIGA, KP50GA-GIGA, KP50GTA-GIGA, KPI10ETA-GIGA, KPI10VTA-GIGA, KPI15ETA-GIGA, KPI15VTA-GIGA, KPI20EA-GIGA, KPI20ETA-GIGA, KPI20GA-GIGA, KPI20GTA-GIGA, KPI20VTA-GIGA, KPI20VT-GIGA, KPI30EA-GIGA, KPI30ETA-GIGA, KPI30GA-GIGA, KPI30GTA-GIGA, KPI30VTA-GIGA, KPI30VT-GIGA, KPI50EA-GIGA, KPI50ETA-GIGA, KPI50GA-GIGA, KPI50GTA-GIGA, KPI50VTA-GIGA, KPI50VT-GIGA |                 |          |

**inlet taps**



|                    |                |                 |          |
|--------------------|----------------|-----------------|----------|
| <b>GEV No.</b>     | 693108         | <b>Ref. No.</b> | 30200005 |
| <b>description</b> | shut-off valve |                 |          |

**drain taps**

**brass drain taps**



|   |  |                 |                   |
|---|--|-----------------|-------------------|
| <b>GEV No.</b>  | 540275   | <b>Ref. No.</b> | 30200198          |
| <b>description</b>  | drain tap 2" IT with union nut A 90mm B 151mm B1 80mm chrome-plated brass  |                 |                   |
| <b>For models:</b>  | KP20GA-GIGA, KP20G-GIGA, KP20GTA-GIGA, KP20GT-GIGA, KP30GA-GIGA, KP30G-GIGA, KP30GTA-GIGA, KP30GT-GIGA, KP50GA-GIGA, KP50G-GIGA, KP50GTA-GIGA, KP50GT-GIGA, KPGN18G-GIGA, KPGN27G-GIGA, KPGN37G-GIGA, KPI10ETA-GIGA, KPI10ET-GIGA, KPI10VTA-GIGA, KPI10VT-GIGA, KPI15ETA-GIGA, KPI15ET-GIGA, KPI15VTA-GIGA, KPI15VT-GIGA, KPI20EA-GIGA, KPI20E-GIGA, KPI20ETA-GIGA, KPI20ET-GIGA, KPI20GA-GIGA, KPI20G-GIGA, KPI20GTA-GIGA, KPI20GT-GIGA, KPI20VTA-GIGA, KPI20VT-GIGA, KPI30EA-GIGA, KPI30E-GIGA, KPI30ETA-GIGA, KPI30ET-GIGA, KPI30GA-GIGA, KPI30G-GIGA, KPI30GTA-GIGA, KPI30GT-GIGA, KPI30VTA-GIGA, KPI30VT-GIGA, KPI50EA-GIGA, KPI50E-GIGA, KPI50ETA-GIGA, KPI50ET-GIGA, KPI50GA-GIGA, KPI50G-GIGA, KPI50GTA-GIGA...(Other models you can see in the webshop) |                 |                   |
| <b>spare parts for</b>  | 540275   |                 |                   |
|  | <b>GEV No.</b>   | 540214          | <b>Ref. No.</b> — |
|   | handle ID ø 6mm L 145mm  |                 |                   |
| <b>accessories for</b>  | 540275   |                 |                   |
|  | <b>GEV No.</b>   | 529484          | <b>Ref. No.</b> — |
|   | flat gasket fibre ED ø 58mm ID ø 50mm thickness 2mm Qty 1 pcs  |                 |                   |
|  | <b>GEV No.</b>   | 542448          | <b>Ref. No.</b> — |
|   | gasket silicone 60x49x2 for drain tap 2"   |                 |                   |





| accessories   |   |                 |          |
|---|---|-----------------|----------|
|  |   |                 |          |
| 1   |   |                 |          |
| <b>GEV No.</b>  | 540956  | <b>Ref. No.</b> | 10500062 |
| <b>description</b>  | gasket for drain tap hose ext. ø 46mm ID ø 38mm H 2mm |                 |          |

|   |  |                 |          |
|---|--|-----------------|----------|
|  |  |                 |          |
| 1   |  |                 |          |
| <b>GEV No.</b>  | 540959   | <b>Ref. No.</b> | 10500060 |
| <b>description</b>  | gasket for drain tap hose ext. ø 60mm ID ø 50mm H 2mm  |                 |          |
| <b>For models:</b>  | KP20GA-GIGA, KP20G-GIGA, KP20GTA-GIGA, KP20GT-GIGA, KP30GA-GIGA, KP30G-GIGA, KP30GTA-GIGA, KP30GT-GIGA, KP50GA-GIGA, KP50G-GIGA, KP50GTA-GIGA, KP50GT-GIGA, KPGN18G-GIGA, KPGN27G-GIGA, KPGN37G-GIGA, KPI10ETA-GIGA, KPI10ET-GIGA, KPI10VTA-GIGA, KPI10VT-GIGA, KPI15ETA-GIGA, KPI15ET-GIGA, KPI15VTA-GIGA, KPI15VT-GIGA, KPI20EA-GIGA, KPI20E-GIGA, KPI20ETA-GIGA, KPI20ET-GIGA, KPI20GA-GIGA, KPI20G-GIGA, KPI20GTA-GIGA, KPI20GT-GIGA, KPI20VTA-GIGA, KPI20VT-GIGA, KPI30EA-GIGA, KPI30E-GIGA, KPI30ETA-GIGA, KPI30ET-GIGA, KPI30GA-GIGA, KPI30G-GIGA, KPI30GTA-GIGA, KPI30GT-GIGA, KPI30VTA-GIGA, KPI30VT-GIGA, KPI50EA-GIGA, KPI50E-GIGA, KPI50ETA-GIGA, KPI50ET-GIGA, KPI50GA-GIGA, KPI50G-GIGA, KPI50GTA-GIGA...(Other models you can see in the webshop) |                 |          |

|   |  |                 |          |
|---|--|-----------------|----------|
|  |  |                 |          |
| 1   |  |                 |          |
| <b>GEV No.</b>  | 540958   | <b>Ref. No.</b> | 10200002 |
| <b>description</b>  | rosette for drain tap hose ext. ø 120mm ID ø 60mm H 13mm   |                 |          |
| <b>For models:</b>  | KP20GA-GIGA, KP20G-GIGA, KP20GTA-GIGA, KP20GT-GIGA, KP30GA-GIGA, KP30G-GIGA, KP30GTA-GIGA, KP30GT-GIGA, KP50GA-GIGA, KP50G-GIGA, KP50GTA-GIGA, KP50GT-GIGA, KPGN18G-GIGA, KPGN27G-GIGA, KPGN37G-GIGA, KPI10ETA-GIGA, KPI10ET-GIGA, KPI10VTA-GIGA, KPI10VT-GIGA, KPI15ETA-GIGA, KPI15ET-GIGA, KPI15VTA-GIGA, KPI15VT-GIGA, KPI20EA-GIGA, KPI20E-GIGA, KPI20ETA-GIGA, KPI20ET-GIGA, KPI20GA-GIGA, KPI20G-GIGA, KPI20GTA-GIGA, KPI20GT-GIGA, KPI20VTA-GIGA, KPI20VT-GIGA, KPI30EA-GIGA, KPI30E-GIGA, KPI30ETA-GIGA, KPI30ET-GIGA, KPI30GA-GIGA, KPI30G-GIGA, KPI30GTA-GIGA, KPI30GT-GIGA, KPI30VTA-GIGA, KPI30VT-GIGA, KPI50EA-GIGA, KPI50E-GIGA, KPI50ETA-GIGA, KPI50ET-GIGA, KPI50GA-GIGA, KPI50G-GIGA, KPI50GTA-GIGA...(Other models you can see in the webshop) |                 |          |

|   |                                     |                 |          |
|---|-------------------------------------|-----------------|----------|
|  |                                     |                 |          |
| 1   |                                     |                 |          |
| <b>GEV No.</b>  | 540955                              | <b>Ref. No.</b> | 10200004 |
| <b>description</b>  | rosette for drain tap thread 1 1/2" |                 |          |

|   |   |                 |          |
|---|---|-----------------|----------|
|  |   |                 |          |
| 1   |   |                 |          |
| <b>GEV No.</b>  | 540954                                      | <b>Ref. No.</b> | 10400009 |
| <b>description</b>  | screw-in socket for drain tap thread 1 1/2" |                 |          |

|  |  |                 |          |
|--|--|-----------------|----------|
|  |  |                 |          |
| 1  |  |                 |          |
| <b>GEV No.</b>   | 540957   | <b>Ref. No.</b> | 10400006 |
| <b>description</b>   | screw-in socket for drain tap thread 2" L 120mm          |                 |          |
| <b>For models:</b>   | KPI10VTA-GIGA, KPI10VT-GIGA, KPI15VTA-GIGA, KPI15VT-GIGA |                 |          |

**safety fittings**

| accessories  |  |                 |                 |
|--|--|-----------------|-----------------|
|  |  |                 |                 |
| 1  |  |                 |                 |
| <b>GEV No.</b>   | 540835   | <b>Ref. No.</b> | 10400061        |
| <b>description</b>   | screw cap thread 3/4"  |                 |                 |
| <b>For models:</b>   | KP20GTA-GIGA, KP20GT-GIGA, KP30GTA-GIGA, KP30GT-GIGA, KP50GTA-GIGA, KP50GT-GIGA, KPI10ETA-GIGA, KPI10ET-GIGA, KPI15ETA-GIGA, KPI15ET-GIGA, KPI20EA-GIGA, KPI20E-GIGA, KPI20ETA-GIGA, KPI20ET-GIGA, KPI20GA-GIGA, KPI20G-GIGA, KPI20GTA-GIGA, KPI20GT-GIGA, KPI30EA-GIGA, KPI30E-GIGA, KPI30ETA-GIGA, KPI30ET-GIGA, KPI30GA-GIGA, KPI30G-GIGA, KPI30GTA-GIGA, KPI30GT-GIGA, KPI50EA-GIGA, KPI50E-GIGA, KPI50ETA-GIGA, KPI50ET-GIGA, KPI50GA-GIGA, KPI50G-GIGA, KPI50GTA-GIGA, KPI50GT-GIGA, KPIGN37G-GIGA, PM9.G170GN-FAGOR, PM9.G270GN-FAGOR, PM9.G370GN-FAGOR |                 |                 |
| <b>spare parts for</b>   | 540835   |                 |                 |
|  | <b>GEV No.</b>   | 513016          | <b>Ref. No.</b> |
|  |   |                 | —               |
| <b>accessories for</b>   | 540835   |                 |                 |
|  | <b>GEV No.</b>   | 513016          | <b>Ref. No.</b> |
|  |   |                 | —               |

safety valves



|                    |   |                 |                                  |
|--------------------|---|-----------------|----------------------------------|
| <b>GEV No.</b>     | 514415  | <b>Ref. No.</b> | 30300018<br>30300024<br>30300026 |
| <b>description</b> | safety valve for kettle thread M33  |                 |                                  |
| <b>For models:</b> | KP20GA-GIGA, KP20GTA-GIGA, KP30GA-GIGA, KP30GTA-GIGA, KP50GA-GIGA, KP50GTA-GIGA, KPI10VTA-GIGA, KPI15VTA-GIGA, KPI20EA-GIGA, KPI20GA-GIGA, KPI20GTA-GIGA, KPI20VTA-GIGA, KPI20VT-GIGA, KPI30EA-GIGA, KPI30GA-GIGA, KPI30GTA-GIGA, KPI30VTA-GIGA, KPI30VT-GIGA, KPI50EA-GIGA, KPI50GA-GIGA, KPI50GTA-GIGA, KPI50VTA-GIGA, KPI50VT-GIGA |                 |                                  |



|                    |   |                 |          |
|--------------------|---|-----------------|----------|
| <b>GEV No.</b>     | 540722  | <b>Ref. No.</b> | 30300026 |
| <b>description</b> | safety valve with outlet for lid  |                 |          |
| <b>For models:</b> | KPI10ETA-GIGA, KPI15ETA-GIGA, KPI20ETA-GIGA, KPI30ETA-GIGA, KPI50ETA-GIGA |                 |          |

gaskets

gaskets for heated units

boiling pan gaskets

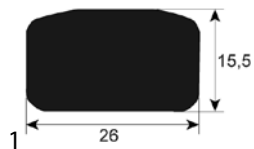

|                    |  |                 |          |
|--------------------|--|-----------------|----------|
| <b>GEV No.</b>     | 900819   | <b>Ref. No.</b> | 10600300 |
| <b>description</b> | boiling pan gasket profile 3010 L 1000mm   |                 |          |
| <b>For models:</b> | KP20GA-GIGA, KP20GTA-GIGA, KP30GA-GIGA, KP30GTA-GIGA, KP50GA-GIGA, KP50GTA-GIGA, KPI10ETA-GIGA, KPI10VTA-GIGA, KPI15ETA-GIGA, KPI15VTA-GIGA, KPI20EA-GIGA, KPI20GA-GIGA, KPI20GTA-GIGA, KPI20VTA-GIGA, KPI20VT-GIGA, KPI30EA-GIGA, KPI30GA-GIGA, KPI30GTA-GIGA, KPI30VTA-GIGA, KPI30VT-GIGA, KPI50EA-GIGA, KPI50GA-GIGA, KPI50GTA-GIGA |                 |          |

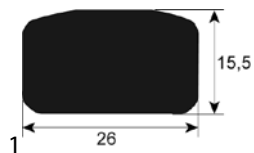

|                    |  |                 |            |
|--------------------|--|-----------------|------------|
| <b>GEV No.</b>     | 900821   | <b>Ref. No.</b> | 10600300/1 |
| <b>description</b> | boiling pan gasket profile 3010 L 2000mm                   |                 |            |
| <b>For models:</b> | KPI10ETA-GIGA, KPI10VTA-GIGA, KPI15ETA-GIGA, KPI15VTA-GIGA |                 |            |

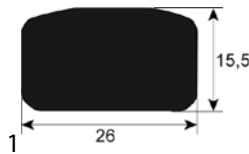

|                    |  |                 |            |
|--------------------|--|-----------------|------------|
| <b>GEV No.</b>     | 900822                                   | <b>Ref. No.</b> | 10600300/2 |
| <b>description</b> | boiling pan gasket profile 3010 L 2400mm |                 |            |
| <b>For models:</b> | KPI20ETA-GIGA, KPI20VTA-GIGA             |                 |            |

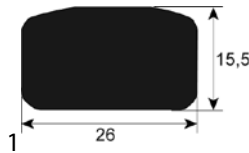

|                    |  |                 |            |
|--------------------|--|-----------------|------------|
| <b>GEV No.</b>     | 900823   | <b>Ref. No.</b> | 10600300/3 |
| <b>description</b> | boiling pan gasket profile 3010 L 3000mm                   |                 |            |
| <b>For models:</b> | KPI30ETA-GIGA, KPI30VTA-GIGA, KPI50ETA-GIGA, KPI50VTA-GIGA |                 |            |

O-rings

EPDM



|                    |   |                 |          |
|--------------------|---|-----------------|----------|
| <b>GEV No.</b>     | 511937  | <b>Ref. No.</b> | 10500110 |
| <b>description</b> | O-ring EPDM thickness 3.53mm ID ø 28.17mm Qty 1 pcs   |                 |          |
| <b>For models:</b> | KP20GTA-GIGA, KP20GT-GIGA, KP30GTA-GIGA, KP30GT-GIGA, KP50GTA-GIGA, KP50GT-GIGA, KPI10ETA-GIGA, KPI10ET-GIGA, KPI15ETA-GIGA, KPI15ET-GIGA, KPI20EA-GIGA, KPI20E-GIGA, KPI20ETA-GIGA, KPI20E-T-GIGA, KPI20ET-GIGA, KPI20GA-GIGA, KPI20G-GIGA, KPI20GTA-GIGA, KPI20GT-GIGA, KPI30EA-GIGA, KPI30E-GIGA, KPI30ETA-GIGA, KPI30ET-GIGA, KPI30GA-GIGA, KPI30G-GIGA, KPI30GTA-GIGA, KPI30GT-GIGA, KPI50EA-GIGA, KPI50E-GIGA, KPI50ETA-GIGA, KPI50ET-GIGA, KPI50GA-GIGA, KPI50G-GIGA, KPI50GTA-GIGA, KPI50GT-GIGA, KPIGN37G-GIGA, PM9.G170GN-FAGOR, PM9.G270GN-FAGOR, PM9.G370GN-FAGOR |                 |          |

transmission technology and ball bearings

ball bearings

flange bearings



|                    |   |                 |          |
|--------------------|---|-----------------|----------|
| <b>GEV No.</b>     | 693112  | <b>Ref. No.</b> | 20400012 |
| <b>description</b> | flange bearing type UCF204 shaft ø 20mm 4 hole flange hole distance 64mm H 33mm flange length 86mm flange width 86mm hole ø 12mm flange F204 ball bearing UC204G2 FH 25.5mm |                 |          |





## springs

### torsion springs

|   |  |          |          |
|---|--|----------|----------|
|  |  |          |          |
| GEV No.   | 540855   | Ref. No. | 20500046 |
| description   | torsion spring ø 50.8mm wire gauge ø 5.1mm L1 34mm L2 104mm L3 29mm mounting pos. left |          |          |

|   |   |          |          |
|---|---|----------|----------|
|  |   |          |          |
| GEV No.   | 540854  | Ref. No. | 20500044 |
| description   | torsion spring ø 50.8mm wire gauge ø 5.1mm L1 34mm L2 104mm L3 29mm mounting pos. right |          |          |

### gas tension springs

#### gas tension springs

|   |   |          |          |
|---|---|----------|----------|
|  |   |          |          |
| GEV No.   | 698322  | Ref. No. | 20300270 |
| description   | gas tension spring 882.5N hub 100mm D1 ø 22mm D2 ø 10mm hole distance 300mm hole ø 8/10mm L 315mm |          |          |









## manometers

|   |   |          |          |
|---|---|----------|----------|
|  |   |          |          |
| GEV No.   | 541062  | Ref. No. | 30300022 |
| description   | manometer ø 63mm pressure range 0 up to 1bar connection marking adjustable kettle thread 1/4"   |          |          |
| For models:   | KP20GTA-GIGA, KP20GT-GIGA, KP30GTA-GIGA, KP30GT-GIGA, KP50GTA-GIGA, KP50GT-GIGA, KPI10ETA-GIGA, KPI10ET-GIGA, KPI10VTA-GIGA, KPI10VT-GIGA, KPI15ETA-GIGA, KPI15ET-GIGA, KPI15VTA-GIGA, KPI15VT-GIGA, KPI20EA-GIGA, KPI20E-GIGA, KPI20ETA-GIGA, KPI20ET-GIGA, KPI20GA-GIGA, KPI20G-GIGA, KPI20GTA-GIGA, KPI20GT-GIGA, KPI20VTA-GIGA, KPI20VT-GIGA, KPI30EA-GIGA, KPI30E-GIGA, KPI30ETA-GIGA, KPI30ET-GIGA, KPI30GA-GIGA, KPI30G-GIGA, KPI30GTA-GIGA, KPI30GT-GIGA, KPI30VTA-GIGA, KPI30VT-GIGA, KPI50EA-GIGA, KPI50E-GIGA, KPI50ETA-GIGA, KPI50ET-GIGA, KPI50GA-GIGA, KPI50G-GIGA, KPI50GTA-GIGA, KPI50GT-GIGA, KPI50VTA-GIGA, KPI50VT-GIGA, KPIGN37G-GIGA, PM9.G170GN-FAGOR, PM9.G270GN-FAGOR, PM9.G370GN-FAGOR |          |          |
| spare parts for   | 541062  |          |          |
|   | GEV No.   | 541130   | Ref. No. |
|   |  glass panel ø 58mm thickness 2mm  |          |          |

## valves and tank inlets

### shut-off valves

#### universal

|   |  |          |          |
|---|--|----------|----------|
|  |  |          |          |
| GEV No.   | 693107   | Ref. No. | 30200008 |
| description   | shut-off valve connection 1/2" 1/2" cold total length 54mm L1 27mm L2 30mm marking blue rosette thread G2 26x19G connection ø M4x0.7 ITmm  |          |          |
| spare parts for   | 693107   |          |          |
|   | GEV No.  | 514085   | Ref. No. |
|   |  rosette connection 26x19G chrome-plated total lengthmm mounting pos.   |          |          |
|   | GEV No.  | 514086   | Ref. No. |
|   |  hexagonal nut connection 26x19G brass total lengthmm mounting pos. H 6mm WS 34 Qty 1 pcs                               |          |          |
|   | GEV No.  | 540672   | Ref. No. |
|   |  gasket suitable for tap head   |          |          |
|   | GEV No.  | 547711   | Ref. No. |
|   |  hood handle shaft intake ø 8mm marking blue metal H2 21mm D1 ø 33mm type D suitable for MONOLITH shaft length H1 8mm |          |          |
|   | GEV No.  | 548168   | Ref. No. |
|   |  star handle connection hot total lengthmm mounting pos. ø 57mm marking red   |          |          |
|   | GEV No.  | 548169   | Ref. No. |
|   |  star handle connection cold total lengthmm mounting pos. chrome-plated ø 57mm  |          |          |
| accessories for   | 693107   |          |          |
|   | GEV No.  | 514086   | Ref. No. |
|   |  hexagonal nut connection 26x19G brass total lengthmm mounting pos. H 6mm WS 34 Qty 1 pcs                             |          |          |

## consumables

### fuses

#### fine fuses

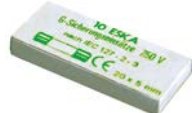
|  |  |          |          |
|--|--|----------|----------|
|  |  |          |          |
| GEV No.  | 358605   | Ref. No. | 40200084 |
| description  | fine fuse size ø5x20mm 3.15A slow-acting rated 250V Qty 10 pcs |          |          |
| For models:  | KPI10ETA-GIGA, KPI10ET-GIGA, KPI15ETA-GIGA, KPI15ET-GIGA       |          |          |



**B**

|                     |    |
|---------------------|----|
| bar burners         | 12 |
| boiling pan gaskets | 18 |

**C**

|                     |    |
|---------------------|----|
| cam switches        | 5  |
| consumables         | 19 |
| control thermostats | 4  |

**F**

|            |       |
|------------|-------|
| fine fuses | 19    |
| fuses      | 6, 19 |

**G**

|                          |    |
|--------------------------|----|
| gas burners              | 12 |
| gas control valves       | 8  |
| gas nozzles              | 13 |
| gas taps                 | 6  |
| gas thermostats          | 8  |
| gaskets for heated units | 18 |

**H**

|  |   |
|--|---|
| heating elements                       | 3 |
| heating elements for tilting bratt pan | 3 |

**I**

|                             |    |
|-----------------------------|----|
| ignition switches           | 12 |
| immersion heating elements  | 3  |
| indicator lights            | 5  |
| indicator lights (complete) | 5  |

**L**

|       |   |
|-------|---|
| lamps | 5 |
|-------|---|

**M**

|                   |   |
|-------------------|---|
| mechanical timers | 6 |
| microswitches     | 5 |

**O**

|         |    |
|---------|----|
| O-rings | 18 |
|---------|----|

**P**

|                              |    |
|------------------------------|----|
| piezoelectric igniters       | 11 |
| pilot burners                | 9  |
| push/momentary push switches | 4  |

**R**

|        |   |
|--------|---|
| relays | 6 |
|--------|---|

**S**

|                    |    |
|--------------------|----|
| safety thermostats | 4  |
| shut-off valves    | 19 |

|                                 |   |
|---------------------------------|---|
| solenoid valves                 | 6 |
| switches and momentary switches | 4 |

**T**

|               |    |
|---------------|----|
| thermocouples | 12 |
| thermostats   | 4  |
| timers        | 6  |

**V**

|                        |    |
|------------------------|----|
| valves and tank inlets | 19 |
|------------------------|----|