



GAS COMPONENTS



ELECTRIC COMPONENTS



WATER TECHNOLOGY



MECHANICAL COMPONENTS



TOOLS

Spare parts suitable for

FIORENZATO-C.S.

Find the complete and up-to-date range of products in our GEV Webshop



Manufacturer catalogue

The most important spare parts and accessories arranged clearly for every manufacturer

- ✓ Complete product range and all appliance data always up to date in the GEV Webshop
- ✓ Alphabetical Index at the end of the catalogue

GEV Webshop

www.gev-online.co.uk

www.gev-online.com







- 🔍 Add to Favourites
- 🔍 Sign In with email address and usual password
- 🔍 Easy-order – place several items in your basket at the same time
- 🔍 Quick Item search – no login needed





heating elements

heating elements for coffee machine

			
GEV No.	417354	Ref. No.	A2100146
description	heating element 2700W 230V heating circuits 3 mounting ϕ 42mm hole distance 74mm L 160mm W 34mm H 45mm L1 20mm L2 70mm L3 80mm H1 32mm H2 13mm hole ϕ 10mm tube ϕ 8.3mm thermostat sleeves ϕ 7mm length thermostat sleeves 140mm thermostat sleeve centre number of thermostat sleeves 1 connection male faston 6.3mm immersion heater 2 hole flange		

			
GEV No.	417355	Ref. No.	A2100213
description	heating element 2700W 230V heating circuits 3 thread 1 1/4" L 160mm W 30mm H 45mm tube ϕ 8mm connection male faston 6.3mm immersion heater flange with thread WS 37		
accessories for	417355		
	GEV No.	528017	Ref. No. —
description	flat gasket fibre ED ϕ 53mm ID ϕ 42mm thickness 2mm for thread 1 1/4" Qty 1 pcs		
	GEV No.	528022	Ref. No. —
description	flat gasket PTFE ED ϕ 52mm ID ϕ 41mm thickness 2mm size 1 1/4" Qty 1 pcs suitable for CARIMALI, FAEMA, MARZOCCO, PAVONI		

			
GEV No.	417353	Ref. No.	A2100031
description	heating element 3500W 230/400V heating circuits 3 mounting ϕ 43mm hole distance 74mm L 295mm W 34mm H 45mm L1 35mm L2 55mm L3 205mm H1 31mm H2 14mm hole ϕ 9.5mm tube ϕ 8.3mm thermostat sleeves ϕ 7mm length thermostat sleeves 210mm thermostat sleeve centre number of thermostat sleeves 1 connection male faston 6.3mm immersion heater 2 hole flange		
accessories for	417353		
	GEV No.	528021	Ref. No. A1200015
description	flat gasket PTFE ED ϕ 53mm ID ϕ 42.5mm thickness 3mm Qty 1 pcs equiv. no. 12001/02286 suitable for Astoria/Aurora/Brasilia/Wega		

			
GEV No.	417352	Ref. No.	A2100120
description	heating element 4000W 230/400V heating circuits 3 mounting ϕ 43mm hole distance 74mm L 545mm W 34mm H 45mm L1 35mm L2 55mm L3 455mm H1 31mm H2 14mm hole ϕ 9.5mm tube ϕ 8.3mm thermostat sleeves ϕ 7mm length thermostat sleeves 210mm thermostat sleeve centre number of thermostat sleeves 1 connection male faston 6.3mm immersion heater 2 hole flange		

accessories

sealing washers

PTFE gaskets

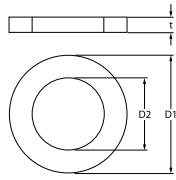
 			
GEV No.	528021	Ref. No.	A1200015
description	flat gasket PTFE ED ϕ 53mm ID ϕ 42.5mm thickness 3mm Qty 1 pcs equiv. no. 12001/02286 suitable for Astoria/Aurora/Brasilia/Wega		

O-rings

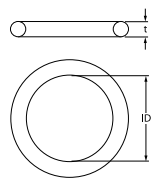
 			
GEV No.	528231	Ref. No.	A1200028
description	O-ring Viton thickness 2.62mm ID ϕ 12.37mm Qty 1 pcs		

thermostats

bi-metal thermostats

bi-metal thermostats

			
GEV No.	390328	Ref. No.	A1400035
description	bi-metal thermostat hole distance mm switch-off temp. 152°C 1NC 1-pole 16A connection F6.3 M4		

switches and momentary switches



rocker/momentary rocker switches



30x22mm

			
GEV No.	301061	Ref. No.	A2100093
description	rocker switch mounting measurements 30x22mm orange 2NO 250V 16A illuminated connection male faston 6.3mm ambient temperature max. 125/55°C protection IP40		



			
1			
GEV No.	301036	Ref. No.	A2800052
description	protective cover internal size 30x22mm for rocker switch mounting measurementsmm		

			
1			
GEV No.	301078	Ref. No.	A2100038
description	momentary rocker switch mounting measurements 30x22mm black 2NO 250V 16A momentary 0-I connection male faston 6.3mm ambient temperature max. 85/125°C protection IP40		
accessories for	301078		
	GEV No.	301036	Ref. No. A2800052
	protective cover internal size 30x22mm for rocker switch mounting measurementsmm		

blank			
			
1			
GEV No.	346144	Ref. No.	340226
description	push switch mounting measurements 30x22mm white 2CO 250V 16A illuminated connection male faston 6.3mm ambient temperature max. 100/55°C protection IP65		
accessories for	346144		
	GEV No.	301036	Ref. No. A2800052
	protective cover internal size 30x22mm for rocker switch mounting measurementsmm		

push/momentary push switches

19x13mm			
			
1			
GEV No.	347292 ¹	Ref. No.	A2100043
description	push switch mounting measurements 19x13mm red 2NO 250V 16A illuminated connection male faston 6.3mm ambient temperature max. 105/55°C protection IP65 with cover cap		

¹illuminated

30x22mm			
			
1			
GEV No.	301036	Ref. No.	A2800052
description	protective cover internal size 30x22mm for rocker switch mounting measurementsmm		

ø25mm			
			
1			
GEV No.	347295	Ref. No.	A2100041
description	push button mounting ø 25mm black 2NO 250V 16A connection male faston 6.3mm ambient temperature max. 85°C protection IP40		

			
1			
GEV No.	347294 ¹	Ref. No.	A2100045
description	push switch mounting ø 25mm red 2NO 250V 16A illuminated connection male faston 6.3mm ambient temperature max. 125/55°C protection IP40		

¹illuminated

			
1			
GEV No.	347293	Ref. No.	A2100094
description	push switch mounting ø 25mm orange 2NO 250V 16A illuminated cup connection male faston 6.3mm ambient temperature max. 85°C protection IP40		

microswitches

pin-plunger actuated			
			
1			
GEV No.	346145	Ref. No.	210031
description	microswitch with plunger 250V 10A 1CO connection male faston 4.8mm ambient temperature max. 125°C mounting distance 22mm black		

			
1			
GEV No.	347757	Ref. No.	A2100297
description	microswitch with plunger 250V 16A 1CO connection male faston 4.8mm ambient temperature max. 125°C mounting distance 22mm actuating force: 120g black		



roller actuated			
roller 90°			
			
1			
GEV No.	345104	Ref. No.	A2100042
description	microswitch with roller plunger 250V 16A 1CO connection male faston 6.3mm L 24mm ambient temperature max. 125°C thread L 12mm thread M10x0.75 mounting distance 22mm actuating force: 280g type EF83161.1		

ø10mm			
with plug-in socket			
			
1			
GEV No.	359140	Ref. No.	A2100046
description	indicator light ø 10mm yellow 230V connection male faston 6.3mm Qty 1 pcs		

rotary switches

miscellaneous			
			
1			
GEV No.	347296	Ref. No.	A2100103 A2100316
description	rotary switch 25A shaft L 15mm with cable 6-pole shaft 5x5mm		

contactors
ISKRA (FANAL)

power contactors			
			
1			
GEV No.	380413	Ref. No.	21003F
description	power contactor resistive load 20A 400VAC (AC3/400V) 8.5A/5.5kW main contacts 3NO auxiliary contacts 1NC connection screw connection type Fanal DSL7 01 type ISKRA K07M 01		

control equipment

MOELLER/EATON

LED signal elements			
			
1			
GEV No.	346487	Ref. No.	A2100319
description	indicator lamp white connection screw LED 85-264VAC		

SIEMENS

power contactors			
			
1			
GEV No.	380526	Ref. No.	A2100154
description	power contactor resistive load 20A 230VAC (AC3/400V) 8.4A/4kW main contacts 4NO auxiliary contacts connection screw connection type 3TG10-10-0A2L2		

lamps

indicator lights

indicator lights (complete)			
ø 6mm			
			
1			
GEV No.	359568	Ref. No.	A2100024
description	indicator light ø 6mm 230V red connection male faston 2.8mm cable length 250mm		



relays

power relays

with bracket mounting



1

GEV No.	380920	Ref. No.	A3200109
description	power relays FINDER 400VAC 10A 3CO connection male faston 4.8mm with mounting strap manuf. no. 60.63.8.400.0000 250V 3-pole		

level relays

GICAR



1

GEV No.	400524	Ref. No.	A1500005
description	level relay 230V voltage AC connection F6.3 type RL30 MICRO ST SAFETY PUMP		

DTI



1

GEV No.	402445	Ref. No.	A1500082
description	level controller 230V voltage AC 50/60Hz 8A connection F6.3 type DCLDD11000		

electronics

PCBs

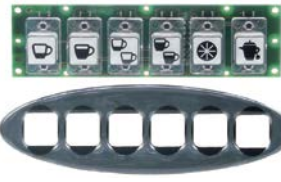

1

GEV No.	402447	Ref. No.	A1500096
description	keypad PCB L 125mm W 35mm with front panel buttons 6		



1

GEV No.	402497	Ref. No.	A1500098
description	keypad PCB L 83mm W 48mm with display buttons 4		



1

GEV No.	402495	Ref. No.	A1500097
description	PCB L 74mm W 64mm 230V		

central units



1

GEV No.	402456	Ref. No.	A1500095
description	central unit 3-group 230V 50/60Hz type SDE3D F13NBV6		



1

GEV No.	402454	Ref. No.	A1500070
description	central unit 3-group 230V type SDE3D F13NAV6		

dosing electronics

miscellaneous



1

GEV No.	402455	Ref. No.	A1500073
description	dosing electronics 230V 50/60Hz type SDE11		

keypads

front foils



1

GEV No.	402453	Ref. No.	A2400055
description	front foil for keypad chrome-plated L 132mm W 42mm		



1

GEV No.	402452	Ref. No.	A1500093
description	keypad foil coffee machine MIA L 79mm W 54mm buttons 6		

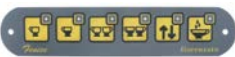

1

GEV No.	402450	Ref. No.	A1500059
description	keypad foil grey L 164mm W 34mm buttons 6		



1

GEV No.	402451	Ref. No.	A1500094
description	keypad foil L 79mm W 54mm buttons 2		



1

GEV No.	525111	Ref. No.	A2400054
description	keypad foil L 90mm W 49mm buttons 4		

keypad units



1

GEV No.	402448	Ref. No.	A1500092
description	keypad unit buttons 2 L 88mm W 60mm		



1

GEV No.	402446	Ref. No.	A1500034
description	keypad unit buttons 6 grey L 164mm W 34mm		



1

GEV No.	402449	Ref. No.	A1500091
description	keypad unit coffee machine FIORENZATO buttons 6 L 88mm W 60mm		

solenoid valves

solenoid valves (water)

metal

ODE

solenoid valves steam (water)

21A series



1

GEV No.	370573	Ref. No.	A1900002	
description	solenoid valve brass 2-ways 230VAC inlet 1/8" outlet 1/8" connection 1/8" L 40mm DN 2.5mm -10 up to 140°C type series 21A coil type ADA membranes FKM (water/steam) p max 14bar 50Hz			
accessories for	370573			
	GEV No.	371091	Ref. No.	—
	power socket plug type DIN 43650B cable lengthmm small			

31A1 series



1

GEV No.	370572	Ref. No.	A1900003
description	solenoid valve brass 3-ways 230VAC DN 1.5mm -10 up to 140°C coil type ADA membranes ruby p max 15bar p min 0bar flange 32x32mm		

4827K series



1

GEV No.	370571	Ref. No.	A1900068
description	solenoid valve brass 2-ways 230VAC DN 2mm -10 up to 140°C coil type ADA membranes FKM (water/steam) p max 22bar p min 0bar 50Hz flange 32x32mm		

solenoid valves (various)



1

GEV No.	370119	Ref. No.	A1900029
description	solenoid valve 2-ways 230VAC flange 25x25mm		

pressure switches

for coffee machines

ø 38mm



1

GEV No.	541725	Ref. No.	A2100051
description	pressure control ø 38mm pressure range 0.5-1.2bar 21A 250V connection 1/4" 1CO pressure connection 1/4"		



1

GEV No.	541726	Ref. No.	A2100305
description	pressure control ø 38mm pressure range 0.5-1.5bar 16A 250V connection 1/4" pressure connection 1/4"		

electrodes



1

GEV No.	402457	Ref. No.	A1400001
description	level electrode 1/4" total length 145mm probe L 124mm insulated probe length 20mm connection curved ø 2.5mm		



1

GEV No.	402458	Ref. No.	A1400003
description	level electrode 1/4" total length 75mm probe L 54mm insulated probe length 20mm connection curved ø 2.5mm		

motors

motors

for coffee grinders

components



1

GEV No.	500239	Ref. No.	190067 270012
description	motor 230V 50Hz 1 phase ø 100mm ID ø 65mm H 195mm shaft ø 16mm type T48		

1

GEV No.	500238	Ref. No.	190050 270003
description	motor 230V 50Hz 1 phase ø 110mm ID ø 65mm H 160mm shaft ø 14mm type T80		

condensators & interference suppression filters

operating capacitors

plastic



1

GEV No.	365019	Ref. No.	A3200030
description	operating capacitor capacity 20µF 400V tolerance 5% 50/60Hz ambient temperature max. -25 to +85°C ø 39.5mm L 70mm M8 plastic connection male faston 6.3mm 16.10.25. protection		

equipment-specific units

for espresso machines

filter holders

filter holders standard

filter holders (complete)



1

GEV No.	525097	Ref. No.	A2200079
description	filter holder 2-way complete ID ø 61.8mm outlet distance 55mm mounting ø 82.4		

filters

for 1 cup



1

GEV No.	526261	Ref. No.	A2200221
description	coffee filter ø 70mm mounting ø 60.5mm H 20.5mm cups 1 amount of coffee 6.5g		



1

GEV No.	529011	Ref. No.	A2200028
description	coffee filter ø 70mm mounting ø 60mm H 24.5mm cups 1 amount of coffee 7g perforation ø 0.4mm		

for 2 cups



1

GEV No.	529197	Ref. No.	A2200029
description	coffee filter ø 70mm mounting ø 60mm H 24.5mm cups 2 amount of coffee 14g		

filter holder springs



1

GEV No.	531243	Ref. No.	N/A
description	filter holder spring L 70mm W 60mm wire gauge ø 1.3mm for espresso filter holder Qty 20 pcs		

brewing units

shower screens

flat



1

GEV No.	529228	Ref. No.	A2200235
description	shower screen ø 51.6mm hole ø 6.2mm		

with upstand



1

GEV No.	528417	Ref. No.	A2200031
description	shower screen ø 58mm H 19mm		

filter holder gaskets

flat

with internal notch



1

GEV No.	525105	Ref. No.	A1200181
description	filter holder gasket with inside notch D1 ø 72mm D2 ø 56mm H 8mm with inside notch Qty 1 pcs		

standard



1

GEV No.	528031	Ref. No.	A1200006
description	filter holder gasket D1 ø 73mm D2 ø 57mm H 8.5mm rubber Qty 1 pcs		



1

GEV No.	525104	Ref. No.	A1200007
description	filter holder gasket D1 ø 73mm D2 ø 57mm H 8mm Qty 1 pcs		

shim gaskets



1







GEV No.	525103	Ref. No.	A1200033
description	shim gasket D1 ø 72mm D2 ø 58mm thickness 0.6mm paper Qty 1 pcs		

brewing units with solenoid valve

universal



1

GEV No.	525495	Ref. No.	A2200035	
description	brewing unit for solenoid valve model E61			
spare parts for	525495			
	GEV No.	529081	Ref. No.	—
	water distributor ø 30mm hole ø 1.5mm H 15mm ET M10x1 grooves 6 2.5mm brass			
accessories for	525495			
	GEV No.	370057	Ref. No.	—
	solenoid valve 3-ways 230VAC body outer cone DN 1.2mm slide-on receptacle DIN -20° up to 140°C PARKER type series VE-128 coil type ZB09 membranes ruby p max 10bar brass flange 32x32mm			
	GEV No.	525984	Ref. No.	—
	filter holder suitable for AURORA/BRASILIA/FAEMA without outlet mounting ø 82.5mm outlet 3/8" ID ø 62mm wedge height 10.5mm wedge position horizontal number of wedges 2 lever straight			
	GEV No.	528030	Ref. No.	—
	filter holder gasket D1 ø 72.7mm D2 ø 57.2mm H 8mm Qty 1 pcs			
	GEV No.	528165	Ref. No.	—
	group gasket L 76mm W 72mm thickness 2.5mm aperture 26x64mm hole distance 55mm			
	GEV No.	528417	Ref. No.	A2200031
	shower screen ø 58mm H 19mm			

brewing units manual

components

drain units

drain valves



1

GEV No.	526002	Ref. No.	A2200208
description	valve support ø 16mm L 27mm brass shaft triangular D1 ø 10mm D2 ø 7mm		







gaskets			
			
1			
GEV No.	529795	Ref. No.	A1200160
description	gasket D1 ø 13mm D2 ø 4mm thickness 4mm coffee machine		

nozzle holders			
			
1			
GEV No.	526783	Ref. No.	02102300
description	nozzle holder thread M30x1.5 IT M16x1.5 IT 1 M8 ø 26mm int. ø 1 15mm int. ø 2 17.5mm L 66.5mm total length 82mm WS 36 chrome-plated brass		

springs			
			
1			
GEV No.	527935	Ref. No.	A2200209
description	compression spring ø 14.6mm L 33mm wire gauge ø 2mm		

camshafts			
			
1			
GEV No.	527940	Ref. No.	A2200188
description	camshaft shaft ø 8mm shaft intake ø 6.2mm L 86.5mm W 20mm H 17mm thread M6 brass		

valves				
				
1				
GEV No.	526008	Ref. No.	A2200178	
description	valve group outflow L 54.3mm ED ø 16mm shaft ø 4.5mm brass			
accessories for	526008			
				
	GEV No.	526003	Ref. No.	—
	compression spring ø 13.8mm L 54.5mm wire gauge ø 1.5mm windings 10 drain valve			
				
	GEV No.	532550	Ref. No.	—
	O-ring NBR 787/70 thickness 2.62mm ID ø 9.13mm Qty 10 pcs			

			
1			
GEV No.	526007	Ref. No.	A2200180
description	valve group supply L 52.8mm ED ø 16mm shaft triangular		

components			
nozzles			
with thread			
			
1			
GEV No.	528486	Ref. No.	A2200174
description	nozzle bore ø 0.7mm thread M6x0.75 L 9mm WS 7		

springs			
			
1			
GEV No.	526561	Ref. No.	A2200192
description	compression spring ø 14.3mm L 21mm wire gauge ø 1.8mm		

expansion valves			
with hose connection			
			
1			
GEV No.	525096	Ref. No.	A1300028 A1300113
description	expansion valve T1: 1/8" ET hose ø 9mm total length 47mm		

			
1			
GEV No.	525703	Ref. No.	A1300028 A1300113
description	expansion valve T1: 1/8" ET hose ø 9mm total length 47mm		

gasket supports			
			
1			
GEV No.	526017	Ref. No.	A2200203
description	gasket support D1 ø 16mm D2 ø 10mm ID ø 7mm L 25mm square brass		

drain pans

drain pans



1

GEV No.	527946	Ref. No.	A1600002
description	drain pan L 69mm W 79mm H 54mm hose ϕ 14mm		



1

GEV No.	526564	Ref. No.	A1600134
description	drain pan ϕ 60mm H 46mm hole ϕ 20mm hose ϕ 10mm		

aerators and air bleeders



1

GEV No.	527981	Ref. No.	A1300007
description	aerator and air bleeder connection 1/4"		

steam/water taps

steam/water taps

steam/water taps



1

GEV No.	525098	Ref. No.	A2200021
description	steam/water tap with gasket, spring and bush inlet 3/8" outlet 3/8" shaft 6.5x8 shaft L 30mm brass		

steam taps

steam taps (complete)



1

GEV No.	527954	Ref. No.	A2200066
description	steam tap mounting pos. external inlet 3/8" outlet 3/8" chrome-plated brass		



1

GEV No.	525094	Ref. No.	A2200048
description	steam tap with lever inlet 3/8" outlet 3/8" chrome-plated brass		

miscellaneous



1

GEV No.	526017	Ref. No.	A2200203
description	gasket support D1 ϕ 16mm D2 ϕ 10mm ID ϕ 7mm L 25mm square brass		

components

gaskets



1

GEV No.	529795	Ref. No.	A1200160
description	gasket D1 ϕ 13mm D2 ϕ 4mm thickness 4mm coffee machine		

springs



1

GEV No.	525093	Ref. No.	A2200002
description	compression spring ϕ 10.6mm L 29.5mm wire gauge ϕ 1.4mm		

steam/water pipes

steam pipes



1

GEV No.	525102	Ref. No.	A2000090
description	steam pipe H 150mm W 70mm tube ϕ 8mm chrome-plated brass		



1

GEV No.	525100	Ref. No.	A2200014
description	steam pipe mounting pos. left thread 3/8" H 200mm tube ø 8mm chrome-plated brass		

1

GEV No.	525101	Ref. No.	A2200015
description	steam pipe mounting pos. right thread 3/8" H 200mm tube ø 8mm chrome-plated brass		

nozzles for steam pipes

1

GEV No.	525099	Ref. No.	A2200044
description	steam nozzle thread M10x1 ø 12mm L 14mm thread L 6mm 4 holes bore ø 1.5mm chrome-plated brass		

nozzles for water pipes

1

GEV No.	525095	Ref. No.	A2200012
description	nozzle D1 ø 24mm H 30mm thread M10x1 int. ø 19mm		

accessories

gaskets

1

GEV No.	528402	Ref. No.	A1200030
description	O-ring Viton thickness 2.62mm ID ø 10.78mm Qty 1 pcs		

1

GEV No.	528231	Ref. No.	A1200028
description	O-ring Viton thickness 2.62mm ID ø 12.37mm Qty 1 pcs		

union nuts

1

GEV No.	528826	Ref. No.	A2200036
description	union nut thread 3/8" L 21mm hole ø 12.5mm chrome-plated brass		

gaskets

flat gaskets

rubber gaskets

1

GEV No.	525107	Ref. No.	A1200155
description	flat gasket rubber ED ø 16mm ID ø 8mm thickness 4mm Qty 1 pcs		

fine filters

1

GEV No.	529979	Ref. No.	A2200175
description	fine filter ø 8.8mm H 22mm		

intake valves

accessories

springs

1

GEV No.	526560	Ref. No.	A2200177
description	compression spring ø 14.3mm L 46mm wire gauge ø 1.5mm		

level glasses

level glasses

level glass pipes

1

GEV No.	529407	Ref. No.	A1400008
description	water level tube ø 11mm H 170mm ID ø 8mm		

non-return valves

pistons



1

GEV No.	526009	Ref. No.	A2200215
description	piston for non-return valve with O-ring \varnothing 12mm L 20mm		

complete



1

GEV No.	529335	Ref. No.	A1300056
description	non-return valve inlet 1/8" outlet 1/8" L 30mm		



1

GEV No.	527978	Ref. No.	A1300109
description	non-return valve inlet 3/8" outlet 3/8" L 38mm		

for coffee grinders

grinding burrs

grinding burrs straight

standard



1

GEV No.	527227	Ref. No.	260001 260003 A3200063
description	grinding burrs pair turn direction right D1 \varnothing 63mm ID \varnothing 38mm H 9.5mm tooth spacing 3mm hole \varnothing 5.5mm bore \varnothing 8.5mm mounting \varnothing 48 straight suitable for FIORENZATO		



1

GEV No.	527228	Ref. No.	260001 260003 A3200083
description	grinding burrs pair turn direction right D1 \varnothing 83mm ID \varnothing 45mm H 10mm tooth spacing 4mm hole \varnothing 5.4mm bore \varnothing 10mm mounting \varnothing 64.5 straight suitable for FIORENZATO		

grinding burrs holders



1

GEV No.	527260	Ref. No.	170090 340182
description	grinding burr holder D1 \varnothing 63mm D2 \varnothing 80mm H 31mm type T80 suitable for FIORENZATO		



1

GEV No.	527261	Ref. No.	340183
description	grinding burr holder D1 \varnothing 83mm D2 \varnothing 90mm H 34mm type T45 suitable for FIORENZATO		

miscellaneous



1

GEV No.	802047	Ref. No.	160097
description	equipment foot rubber \varnothing 22mm mounting measurements 31x18mm T80 Qty 1 pcs		

dosing containers

dosing containers (complete)



1

GEV No.	527508	Ref. No.	340123 RMT480006 RMUNI0007
description	dosing unit \varnothing 120mm suitable for T80		



dosing container lids



1

GEV No.	527320	Ref. No.	160064
description	lid for dosing container mounting ø 114mm ø 122mm H 22mm suitable for M80		



1

GEV No.	525166	Ref. No.	A320008
description	lid for dosing container mounting ø 116mm ø 130mm H 25mm		



1

GEV No.	527323	Ref. No.	160078
description	lid for dosing container mounting ø 130mm ø 135mm H 24mm		

adjusting screws



1

GEV No.	527500	Ref. No.	340120
description	adjusting screw for dosing container thread M8 L 40mm plastic		

springs

group 1



1

GEV No.	525110	Ref. No.	A3200049
description	tension spring ø 7.5mm total length 42mm wire gauge ø 0.8mm L1 29mm		

glass cylinders



1

GEV No.	525167	Ref. No.	A3200009
description	glass cylinder for dosing container ø 125mm H 53mm plexiglas		



1

GEV No.	527322	Ref. No.	160083 340231
description	glass cylinder ø 122mm H 10mm plexiglas		



1

GEV No.	527326	Ref. No.	160079
description	glass cylinder ø 132mm H 75mm plexiglas		

levers

levers



1

GEV No.	527507	Ref. No.	340159
description	lever complete L 110mm shaft ø 8mm plastic		

coffee presses

components

holders



1

GEV No.	525113	Ref. No.	A3200002
description	bracket H 22mm L 65mm plastic		

pressers



1

GEV No.	525112	Ref. No.	A3200001
description	coffee press ø 55mm H 34mm plastic		

coffee presses



1

GEV No.	527506	Ref. No.	160061
description	coffee press ø 57mm L 83mm H 41mm plastic		

automatic grinding

automatic grinding



1

GEV No.	525114	Ref. No.	A3200084
description	housing for microswitch ø 116mm H 45mm plastic		

sector plates



1

GEV No.	527502	Ref. No.	160073
description	sector plates plastic		

stars

central



1

GEV No.	527503	Ref. No.	340196
description	star mounting pos. centre/bottom		

upper



1

GEV No.	527501	Ref. No.	160072
description	star mounting pos. upper ø 107mm hole ø 8mm H 39mm		

bottom



1

GEV No.	527503	Ref. No.	340196
description	star mounting pos. centre/bottom		

adjustment mechanism

setting rings



1

GEV No.	527412	Ref. No.	340181
description	setting ring mounting ø 95mm ø 111mm ID ø 68mm H 41mm suitable for FIORENZATO for T45 equiv. no. 340181		



1

GEV No.	527410	Ref. No.	340147
description	setting ring ø 106mm ID ø 68mm H 30mm suitable for FIORENZATO for T80		

coffee beans containers

container lids



1

GEV No.	527313	Ref. No.	160149
description	lid for coffee beans container mounting ø 174mm ø 178mm		



1

GEV No.	527315	Ref. No.	160081 A3200028
description	lid for coffee beans container mounting ø 200mm ø 204mm		



coffee beans containers



1

GEV No.	527312	Ref. No.	340066
description	coffee beans container 3-piece seat ø 68mm		



1

GEV No.	527311	Ref. No.	340068 RMT800012
description	coffee beans container complete ø 175mm H 220mm seat ø 68mm container capacity 1.2kg T80		





1

GEV No.	527314	Ref. No.	160080
description	coffee beans container ø 172mm H 222mm seat ø 67mm M80		
accessories for	527314		
	GEV No.	527313	Ref. No. 160149
	lid for coffee beans container mounting ø 174mm ø 178mm		
	GEV No.	527318	Ref. No. 160063 A3200031
	catch L 86mm W 48mm thickness 2mm plastic		
	GEV No.	527319	Ref. No. 160067
	protection cap ø 60mm suitable for FIORENZATO plexiglas		





1

GEV No.	527316	Ref. No.	160076 A3200027
description	coffee beans container ø 200mm H 255mm seat ø 67mm M1-T48		
spare parts for	527316		
	GEV No.	527315	Ref. No. 160081 A3200028
	lid for coffee beans container mounting ø 200mm ø 204mm		
	GEV No.	527318	Ref. No. 160063 A3200031
	catch L 86mm W 48mm thickness 2mm plastic		
	GEV No.	527319	Ref. No. 160067
	protection cap ø 60mm suitable for FIORENZATO plexiglas		



protection caps

			
1			
GEV No.	527319	Ref. No.	160067
description	protection cap ø 60mm suitable for FIORENZATO plexiglas		

			
1			
GEV No.	527411	Ref. No.	160091
description	protection cap ø 68mm plastic		

locks

			
1			
GEV No.	527318	Ref. No.	160063 A3200031
description	catch L 86mm W 48mm thickness 2mm plastic		

support for filter holder

			
1			
GEV No.	527518	Ref. No.	170033 170044
description	bracket for filter holder L 105mm W 57mm H 15mm aluminium		

counters

counters

			
1			
GEV No.	527505	Ref. No.	210033
description	counter ø 20mm lever length 35mm for dosing unit		

knobs

steam/water taps

steam/water taps

			
1			
GEV No.	111328	Ref. No.	A1600012
description	turning handle ø 44mm shaft ø 6x8mm black		

handles and hand wheels

cone handles

			
1			
GEV No.	111327	Ref. No.	A1600172
description	cone handle thread M8 ø 30mm L 66mm thermoplastic black		

star handles

			
1			
GEV No.	111333	Ref. No.	A1600004
description	star handle shaft 7x7mm ø 60mm L 24mm black thermoplastic		

equipment feet and end caps

equipment feet with stem

			
1			
GEV No.	802047	Ref. No.	160097
description	equipment foot rubber ømm H 22mm mounting measurements 31x18mm T80 Qty 1 pcs		



gaskets

O-rings

EPDM

1

GEV No.	510177	Ref. No.	A1200039
description	O-ring EPDM thickness 1.78mm ID \varnothing 7.66mm Qty 1 pcs		

1

GEV No.	529412	Ref. No.	A1200040
description	O-ring EPDM thickness 2.62mm ID \varnothing 10.78mm Qty 1 pcs		

Viton

1

GEV No.	528402	Ref. No.	A1200030
description	O-ring Viton thickness 2.62mm ID \varnothing 10.78mm Qty 1 pcs		

1

GEV No.	528231	Ref. No.	A1200028
description	O-ring Viton thickness 2.62mm ID \varnothing 12.37mm Qty 1 pcs		

1

GEV No.	532560	Ref. No.	A1200151
description	O-ring Viton thickness 2.62mm ID \varnothing 20.63mm Qty 1 pcs		

sealing washers

rubber gaskets

1

GEV No.	525107	Ref. No.	A1200155
description	flat gasket rubber ED \varnothing 16mm ID \varnothing 8mm thickness 4mm Qty 1 pcs		

PTFE gaskets

1

GEV No.	527638	Ref. No.	A1200044
description	flat gasket PTFE ED \varnothing 12mm ID \varnothing 10mm thickness 1mm Qty 1 pcs		

1

GEV No.	527154	Ref. No.	A1200153
description	flat gasket PTFE ED \varnothing 22mm ID \varnothing 16.8mm thickness 2mm Qty 1 pcs		

1

GEV No.	526013	Ref. No.	A1200011
description	flat gasket PTFE ED \varnothing 22mm ID \varnothing 17mm thickness 2mm Qty 1 pcs		

1

GEV No.	526265	Ref. No.	A1200009
description	flat gasket PTFE ED \varnothing 24mm ID \varnothing 19mm thickness 2mm Qty 1 pcs		

1

GEV No.	525106	Ref. No.	A1200158
description	flat gasket PTFE ED \varnothing 26mm ID \varnothing 19mm thickness 2mm Qty 1 pcs		

1

GEV No.	526014	Ref. No.	A1200152
description	flat gasket PTFE ED \varnothing 35mm ID \varnothing 30mm thickness 2mm Qty 1 pcs		

mechanical components, equipment accessories

			
1			
GEV No.	528021	Ref. No.	A1200015
description	flat gasket PTFE ED ø 53mm ID ø 42.5mm thickness 3mm Qty 1 pcs equiv. no. 12001/02286 suitable for Astoria/Aurora/Brasilia/Wega		

tension springs

			
1			
GEV No.	525110	Ref. No.	A3200049
description	tension spring ø 7.5mm total length 42mm wire gauge ø 0.8mm L1 29mm		

springs

compression springs

			
1			
GEV No.	527504	Ref. No.	230023
description	compression spring ø 10.3mm L 60mm wire gauge ø 1.3mm		

			
1			
GEV No.	525093	Ref. No.	A2200002
description	compression spring ø 10.6mm L 29.5mm wire gauge ø 1.4mm		

			
1			
GEV No.	525092	Ref. No.	A2200001
description	compression spring ø 12mm L 15mm wire gauge ø 1.5mm		

			
1			
GEV No.	526561	Ref. No.	A2200192
description	compression spring ø 14.3mm L 21mm wire gauge ø 1.8mm		

			
1			
GEV No.	526560	Ref. No.	A2200177
description	compression spring ø 14.3mm L 46mm wire gauge ø 1.5mm		

			
1			
GEV No.	527935	Ref. No.	A2200209
description	compression spring ø 14.6mm L 33mm wire gauge ø 2mm		

manometers

			
1			
GEV No.	541727	Ref. No.	A1400019
description	manometer double scale ø 63mm pressure range 0-3 / 0-18bar connection on the backside thread 1/8"		

			
1			
GEV No.	541728	Ref. No.	A1400020
description	manometer double scale ø 63mm pressure range 0-3 / 0-18bar connection on the backside thread 1/8"		

			
1			
GEV No.	541200	Ref. No.	A1400042
description	manometer ø 52mm pressure range 0 up to 3bar connection on the backside marking 0.7-1 thread 1/8"		

			
1			
GEV No.	541201	Ref. No.	A1400043
description	manometer ø 53.5mm pressure range 0 up to 16bar connection on the backside thread 1/8"		



fastening material

screws

countersunk screws



1

GEV No.	560215	Ref. No.	A1100187
description	countersunk screw thread M5 L 14mm SS DIN 963/ISO 2009 Qty 20 pcs intake slotted head ø 9.2mm		

B

bi-metal thermostats 3, 3

C

condensators & interference suppression filters 9

contactors 5

control equipment 5

countersunk screws 21

E

electrodes 8

F

fastening material 21

H

heating elements 3

heating elements for coffee machine 3

I

indicator lights 5

indicator lights (complete) 5

L

lamps 5

M

microswitches 4

motors 8

O

operating capacitors 9

O-rings 19

P

pressure switches 8

push/momentary push switches 4

R

relays 6

rocker/momentary rocker switches 3

rotary switches 5

S

screws 21

sealing washers 19

solenoid valves 7

switches and momentary switches 3

T

thermostats 3