



**GAS COMPONENTS**



**ELECTRIC COMPONENTS**



**WATER TECHNOLOGY**



**MECHANICAL COMPONENTS**



**TOOLS**

Spare parts suitable for

**FIAMMA**

Find the complete and up-to-date range of products in our GEV Webshop



# Manufacturer catalogue

The most important spare parts and accessories arranged clearly for every manufacturer

- ✓ Complete product range and all appliance data always up to date in the GEV Webshop
- ✓ Alphabetical Index at the end of the catalogue

## GEV Webshop

[www.gev-online.co.uk](http://www.gev-online.co.uk)

[www.gev-online.com](http://www.gev-online.com)



- 🔍 Add to Favourites
- 🔍 Sign In with email address and usual password
- 🔍 Easy-order – place several items in your basket at the same time
- 🔍 Quick Item search – no login needed



## heating elements

### heating elements for fryers

#### 2 hole fixing

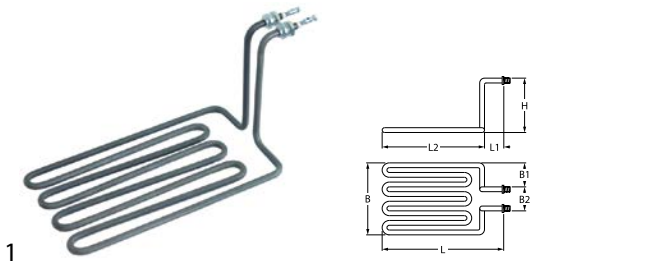

<b>GEV No.</b>	416587	<b>Ref. No.</b>	4.0.085.0005
<b>description</b>	heating element 2500W 230V heating circuits 1 L 300mm W 154mm H 158mm 2 hole fixing connection M4 fryer L1 22mm L2 278mm W1 63mm W2 28mm thread M13x1 windings 4		
<b>For models:</b>	FCF6, FCF6+6, FF6, FF6+6		
<b>accessories for</b>	416587		
	<b>GEV No.</b>	521103	<b>Ref. No.</b> —
	nut thread M4 H 3mm WS 7 brass Qty 20 pcs		
	<b>GEV No.</b>	521104	<b>Ref. No.</b> —
	washer ID ø 4.3mm ED ø 8mm thickness 0.5mm brass Qty 20 pcs for thread M4		
	<b>GEV No.</b>	560111	<b>Ref. No.</b> —
	plain washer ID ø 4.3mm ED ø 9mm thickness 0.8mm SS Qty 20 pcs DIN 125A for thread M4		
	<b>GEV No.</b>	560131	<b>Ref. No.</b> —
	hexagonal nut thread M4 H 3.2mm WS 7 SS DIN/ISO DIN 934 / ISO 4032/8673 Qty 20 pcs		

<b>GEV No.</b>	417095	<b>Ref. No.</b>	5.0.000.0802
<b>description</b>	heating element 3500W 230V heating circuits 2 mounting ø 39mm hole distance 57mm L 330mm W 34mm H 53mm L1 30mm L2 70mm L3 225mm H1 24mm H2 29mm windings 2 hole ø 11mm tube ø 8.3mm connection M6 immersion heater 3 hole flange		
<b>For models:</b>	ATLANTIC-II-CV-NV, ATLANTIC-II-CV-PCI-NV, ATLANTIC-II-CV-TALL-CUPS, ATLANTIC-II-CV-TI-NV, ATLANTIC-II-CV-TI-TALL-CUPS, ATLANTIC-II-NV, ATLANTIC-II-PCI-NV, ATLANTIC-II-TALL-CUPS, ATLANTIC-II-TI-NV, PACIFIC-2CV, Prestige-II, PRESTIGE-II-CV-ECC, PRESTIGE-II-CV-REVOL, PRESTIGE-II-ECC, PRESTIGE-III-CV-REVOL, PRESTIGE-III-REVOL, PRESTIGE-II-REVOL		
<b>accessories for</b>	417095		
	<b>GEV No.</b>	528013	<b>Ref. No.</b> —
	gasket ID ø 40mm fibre thickness 4mm hole ø 11mm hole distance 57mm for heating element coffee machine parts		
	<b>GEV No.</b>	528740	<b>Ref. No.</b> —
	gasket ID ø 44mm PTFE thickness 3.5mm hole ø 9.5mm hole distance 58mm suitable for ITALCREM, VISACREM for heating element coffee machine parts		

<b>GEV No.</b>	417468	<b>Ref. No.</b>	4.0.000.0217
<b>description</b>	heating element 5000W 230V heating circuits 2 mounting ø 38mm hole distance 56mm L 438mm W 35mm H 52mm L1 40mm L2 68mm L3 330mm H1 23mm H2 29mm hole ø 11mm tube ø 8.3mm connection M6 immersion heater 3 hole flange		
<b>For models:</b>	ATLANTIC-III, ATLANTIC-III-CV, ATLANTIC-III-CV-TI, ATLANTIC-III-TI, PACIFIC-3CV, PACIFIC-3CV-W, PRESTIGE-III-CV-REVOL, PRESTIGE-III-REVOL		

### heating elements for coffee machine

<b>GEV No.</b>	417466	<b>Ref. No.</b>	4.0.000.0218
<b>description</b>	heating element 1800W 230V heating circuits 1 thread 1" L 155mm W 21mm H 22mm tube ø 8.3mm connection male faston 6.3mm immersion heater flange with thread WS 30 coffee machine		
<b>For models:</b>	MARINA, MARINA-CV, MARINA-CV-DI		

<b>GEV No.</b>	417467	<b>Ref. No.</b>	4.0.000.0214
<b>description</b>	heating element 1800W 230V heating circuits 2 mounting ø 38mm hole distance 57mm L 178mm W 28mm H 46mm H1 24mm H2 22mm hole ø 11mm tube ø 8.3mm connection M6 immersion heater 3 hole flange		
<b>For models:</b>	ATLANTIC-I-CV-NV, ATLANTIC-I-CV-PCI-NV, ATLANTIC-I-CV-TI-NV, ATLANTIC-II-COMPACT, ATLANTIC-II-CV-COMPACT, ATLANTIC-II-CV-TI-COMPACT, ATLANTIC-I-PCI-NV, ATLANTIC-I-TI-NV		

### heating elements for contact grills

<b>GEV No.</b>	416586	<b>Ref. No.</b>	4.0.066.0083
<b>description</b>	heating element 1150W 240V L 210mm W 230mm H 28mm W1 120mm W2 5mm tube ø 6.5mm connection length 23mm mounting pos. lower connection M4 dry heating element windings 3		
<b>For models:</b>	GR-4.1-L, GR-4.1-LTL, GR-4.2, GR-8, GR-8.1-L, GR-8.2, GR-8.2-L, GR-8.2-LTL, GR-8-L, GR-M, GR-M.1, GR-M.2, GR-M.2-TLC		



<b>GEV No.</b>	418838	<b>Ref. No.</b>	4.0.069.0050
<b>description</b>	heating element 1350W 240V L 200mm W 300mm H 26mm W1 118mm W2 64mm tube ø 6.5mm for contact grill windings 4		
<b>For models:</b>	GR-6.1, GR-6.1-L, GR-6.1-LTL		



<b>GEV No.</b>	418839	<b>Ref. No.</b>	4.0.069.0045
<b>description</b>	heating element 1900W 240V L 200mm W 320mm H 30mm W1 28mm W2 140mm tube ø 6.5mm for contact grill windings 5		
<b>For models:</b>	GR-6.1, GR-6.1-L, GR-6.1-LTL		



<b>GEV No.</b>	416585	<b>Ref. No.</b>	4.0.066.0084
<b>description</b>	heating element 850W 240V L 200mm W 215mm H 26mm W1 70mm W2 75mm tube ø 6.3mm connection M4 connection length 22mm mounting pos. upper dry heating element windings 3		
<b>For models:</b>	GR-4.1-L, GR-4.1-LTL, GR-4.2, GR-8.1-L, GR-8.2, GR-8.2-L, GR-8.2-LTL, GR-M.1, GR-M.2, GR-M.2-TLC		

heating elements for salamanders/toast-



<b>GEV No.</b>	417668	<b>Ref. No.</b>	4.0.130.0007
<b>description</b>	heating element 1300W 230V L 425mm W 230mm tube ø 6.5mm cable lengthmm heating circuits 1 mounting pos. lower suitable for SEF 450 I		
<b>For models:</b>	SEF-450I		

quartz heating elements



<b>GEV No.</b>	416583	<b>Ref. No.</b>	4.0.075.1137
<b>description</b>	quartz heating element 250W 75V L 395mm ø 12mm connection male faston 6.3mm 210hm		
<b>For models:</b>	TOSTI-D3, TOSTI-S3, TRD-30.2, TRS-20.2		



<b>GEV No.</b>	416582	<b>Ref. No.</b>	4.0.075.1135
<b>description</b>	quartz heating element 330W 75V L 395mm ø 12mm connection male faston 6.3mm 170hm		
<b>For models:</b>	TOSTI-D3, TOSTI-S3, TRD-30.2, TRS-20.2		



<b>GEV No.</b>	416584	<b>Ref. No.</b>	4.0.074.1003
<b>description</b>	quartz heating element 450W 115V L 395mm ø 12mm connection male faston 6.3mm 290hm		
<b>For models:</b>	TOSTI-D3, TOSTI-S3, TRD-30.2, TRS-20.2		

immersion heating elements

3 hole flange ø60.0mm

connection straight

group 1









<b>GEV No.</b>	415166	<b>Ref. No.</b>	1324
<b>description</b>	heating element 2000W 230V mounting ø 60mm heating circuits 1 L 180mm W 42mm H 65mm number of thermostat sleeves 1 thermostat sleeves ø 7mm length thermostat sleeves 170mm tube ø 6.3mm hole distance 83mm hole ø 10mm connection male faston 6.3mm 3 hole flange immersion heater		
<b>For models:</b>	F-1221-N, F-1221-REVOL, F-400		

<b>accessories for</b>	415166		
		<b>GEV No.</b>	521121
		<b>Ref. No.</b>	57
	O-ring EPDM thickness 8mm ID ø 62mm Qty 1 pcs		



<b>GEV No.</b>	418711	<b>Ref. No.</b>	1294
<b>description</b>	heating element 3000W 230V mounting ø 60mm heating circuits 1 L 285mm W 42mm H 36mm number of thermostat sleeves 1 thermostat sleeves ø 7mm length thermostat sleeves 185mm tube ø 6.5mm hole distance 84mm hole ø 10mm connection male faston 6.3mm 3 hole flange immersion heater		
<b>For models:</b>	F-1221-N, F-430		

<b>accessories for</b>	418711		
		<b>GEV No.</b>	521121
		<b>Ref. No.</b>	57
	O-ring EPDM thickness 8mm ID ø 62mm Qty 1 pcs		

			
1			
<b>GEV No.</b>	415145	<b>Ref. No.</b>	1350
<b>description</b>	heating element 1500W 230V heating circuits 1 L 254mm W 36mm H 28mm thread M10x1 mounting distance 26mm tube ø 6.6mm connection male faston 6.3mm 2 hole fixing connection length 22mm immersion heater		
<b>For models:</b>	F-1040, F-532		
<b>accessories for</b>	415145		
	<b>GEV No.</b>	510416	<b>Ref. No.</b> —
	flat gasket fibre ED ø 19mm ID ø 10.5mm thickness 1.5mm for thread M10 Qty 1 pcs		
	<b>GEV No.</b>	510893	<b>Ref. No.</b> 697
	O-ring EPDM thickness 2.62mm ID ø 9.92mm Qty 1 pcs		
	<b>GEV No.</b>	520231	<b>Ref. No.</b> 267
	nut thread M10x1 H 6mm WS 14 zinc-coated steel Qty 1 pcs		
	<b>GEV No.</b>	521129	<b>Ref. No.</b> —
	nut thread M10 H 6mm SS WS 17 Qty 1 pcs DIN/ISO DIN 439		

			
1			
<b>GEV No.</b>	416247	<b>Ref. No.</b>	2114
<b>description</b>	heating element 2000W 230V heating circuits 1 L 264mm W 38mm H 19mm thread M10x1 mounting distance 32mm tube ø 6.3mm connection male faston 6.3mm 2 hole fixing immersion heater		
<b>For models:</b>	F-1221-N, F-1221-REVOL, F-400, F-430		
<b>spare parts for</b>	416247		
	<b>GEV No.</b>	510416	<b>Ref. No.</b> —
	flat gasket fibre ED ø 19mm ID ø 10.5mm thickness 1.5mm for thread M10 Qty 1 pcs		
	<b>GEV No.</b>	510893	<b>Ref. No.</b> 697
	O-ring EPDM thickness 2.62mm ID ø 9.92mm Qty 1 pcs		
	<b>GEV No.</b>	520231	<b>Ref. No.</b> 267
	nut thread M10x1 H 6mm WS 14 zinc-coated steel Qty 1 pcs		
	<b>GEV No.</b>	521129	<b>Ref. No.</b> —
	nut thread M10 H 6mm SS WS 17 Qty 1 pcs DIN/ISO DIN 439		

accessories

hexagonal nuts

			
1			
<b>GEV No.</b>	520231	<b>Ref. No.</b>	267
<b>description</b>	nut thread M10x1 H 6mm WS 14 zinc-coated steel Qty 1 pcs		
<b>For models:</b>	F-1040, F-1221-N, F-1221-REVOL, F-400, F-430, F-532		

sealing washers

PTFE gaskets

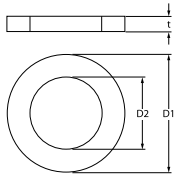
 			
1			
<b>GEV No.</b>	528018	<b>Ref. No.</b>	5.0.000.0305
<b>description</b>	flat gasket PTFE ED ø 41mm ID ø 33mm thickness 3mm size 1" Qty 1 pcs		
<b>For models:</b>	MARINA, MARINA-CV, MARINA-CV-DI, Superbar		

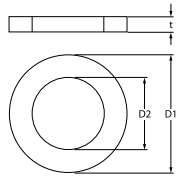
 			
1			
<b>GEV No.</b>	528021	<b>Ref. No.</b>	5.0.000.0307
<b>description</b>	flat gasket PTFE ED ø 53mm ID ø 42.5mm thickness 3mm Qty 1 pcs equiv. no. 12001/02286 suitable for Astoria/Aurora/Brasilia/Wega		
<b>For models:</b>	ATLANTIC-I-CV-NV, ATLANTIC-I-CV-PCI-NV, ATLANTIC-I-CV-TI-NV, ATLANTIC-II-COMPACT, ATLANTIC-II-CV-COMPACT, ATLANTIC-II-CV-NV, ATLANTIC-II-CV-PCI-NV, ATLANTIC-II-CV-TALL-CUPS, ATLANTIC-II-CV-TI-COMPACT, ATLANTIC-II-CV-TI-NV, ATLANTIC-II-CV-TI-TALL-CUPS, ATLANTIC-III, ATLANTIC-III-CV, ATLANTIC-III-CV-TI, ATLANTIC-III-TI, ATLANTIC-II-NV, ATLANTIC-II-PCI-NV, ATLANTIC-II-TALL-CUPS, ATLANTIC-II-TI-NV, ATLANTIC-I-PCI-NV, ATLANTIC-I-TI-NV, PACIFIC-2CV, PACIFIC-3CV, PACIFIC-3CV-W, PRESTIGE-II-CV-ECC, PRESTIGE-II-CV-REVOL, PRESTIGE-II-ECC, PRESTIGE-III-CV-REVOL, PRESTIGE-III-REVOL, PRESTIGE-II-REVOL		

O-rings

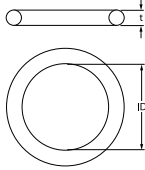
 			
1			
<b>GEV No.</b>	510893	<b>Ref. No.</b>	697
<b>description</b>	O-ring EPDM thickness 2.62mm ID ø 9.92mm Qty 1 pcs		
<b>For models:</b>	F-1040, F-1221-N, F-1221-REVOL, F-400, F-430, F-532		

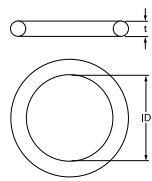
 			
1			
<b>GEV No.</b>	521121	<b>Ref. No.</b>	57
<b>description</b>	O-ring EPDM thickness 8mm ID ø 62mm Qty 1 pcs		
<b>For models:</b>	F-1040, F-1221-N, F-1221-REVOL, F-400, F-430, F-532		

flange gaskets

counterflanges



<b>GEV No.</b>	508080	<b>Ref. No.</b>	1871
<b>description</b>	flange		
<b>For models:</b>	F-1040, F-1221-N, F-430, F-532		

capillary tube clips



<b>GEV No.</b>	550491	<b>Ref. No.</b>	4.0.085.0017
<b>description</b>	capillary tube clip for pipe ø 8.5mm for circular tube heating elements		
<b>For models:</b>	FCF10, FCF10+10, FCF10+10-TR, FCF10-TR, FCF15+15, FCF15-TR, FCF6, FCF6+6, FF10, FF-10, FF10+10, FF-10+10, FF10+10TR, FF-10+10-TR, FF10+10TR-NV, FF10-NV, FF10TR, FF-10-TR, FF10TR-NV, FF15+15TR, FF15TR, FF6, FF6+6, FF6+6-NV		

spring clips



<b>GEV No.</b>	550498	<b>Ref. No.</b>	4.0.085.0014
<b>description</b>	probe clip for pipe ø 8.5mm for probe ø 4mm Qty 1 pcs		
<b>For models:</b>	FCF10, FCF10+10, FCF10+10-TR, FCF10-TR, FCF15+15, FCF15-TR, FCF6, FCF6+6, FF-10, FF-10+10, FF10+10TR, FF-10+10-TR, FF10TR, FF-10-TR, FF6, FF6+6		



<b>GEV No.</b>	550258	<b>Ref. No.</b>	4.0.085.0016
<b>description</b>	probe clip for pipe ø 8mm for probe ø 6mm		
<b>For models:</b>	FF6, FF6+6		



<b>GEV No.</b>	551025	<b>Ref. No.</b>	4.0.085.0114
<b>description</b>	probe clip for pipe ø 2x8.5mm for probe ø 6mm L 36mm Qty 1 pcs		
<b>For models:</b>	FF10, FF10+10, FF10+10TR, FF10+10TR-NV, FF10-NV, FF10TR, FF-10TR-NV, FF15+15TR, FF15TR, FF6, FF6+6, FF6+6-NV		

thermostats

bi-metal thermostats

safety bi-metal thermostats



<b>GEV No.</b>	390367	<b>Ref. No.</b>	4.0.000.0250 4.0.066.0108
<b>description</b>	bi-metal safety thermostat hole distance 39-44mm switch-off temp. 130°C 2NC 2-pole 16A connection F6.3 2 hole fixing		
<b>For models:</b>	ATLANTIC-I-CV-NV, ATLANTIC-I-CV-PCI-NV, ATLANTIC-I-CV-TI-NV, ATLANTIC-II-COMPACT, ATLANTIC-II-CV-COMPACT, ATLANTIC-II-CV-NV, ATLANTIC-II-CV-PCI-NV, ATLANTIC-II-CV-TALL-CUPS, ATLANTIC-II-CV-TI-COMPACT, ATLANTIC-II-CV-TI-NV, ATLANTIC-II-CV-TI-TALL-CUPS, ATLANTIC-III, ATLANTIC-III-CV, ATLANTIC-III-CV-TI, ATLANTIC-III-TI, ATLANTIC-II-NV, ATLANTIC-II-PCI-NV, ATLANTIC-II-TALL-CUPS, ATLANTIC-II-TI-NV, ATLANTIC-I-PCI-NV, ATLANTIC-I-TI-NV, CG2x4GGGG, CG2x4GGS, CG2x4SGGG, CG2x4SGS, CG2x4SSGG, CG2x4SSSS, CG2x4SSSS, CG4GG, CG4SG, CG4SS, CG6GG, CG6GG-VITRO, CG6G-VITRO, CG6SG, CG6SG-VITRO, CG6SS, CG6SS-VITRO, CG6S-VITRO, CG8GG-VITRO, CG8SG-VITRO, CG8SS-VITRO, ECT-2, ECT-2X2, EGP10.6-DIGIT, EGP10.6-MEC, EGP10.8-DIGIT, EGP10.8-MEC, EGP15.10C-MEC...(Other models you can see in the webshop)		



<b>GEV No.</b>	390187	<b>Ref. No.</b>	4.0.066.0108
<b>description</b>	bi-metal safety thermostat hole distance 40mm switch-off temp. 180°C 2NC 2-pole 16A connection F6.3 2 hole fixing		



<b>GEV No.</b>	390462	<b>Ref. No.</b>	4913
<b>description</b>	bi-metal safety thermostat hole distance mm switch-off temp. 105°C 1NC 1-pole 10A connection F6.3 1 hole fixing		
<b>For models:</b>	F-1040, F-1221-N, F-1221-REVOL, F-400, F-430, F-532		
<b>accessories for</b>	390462		
	<b>GEV No.</b>	550388	<b>Ref. No.</b> —



control and safety thermostats

EGO

control thermostats

55.13\_ series



<b>GEV No.</b>	375356	<b>Ref. No.</b>	4.0.085.0009 old
<b>description</b>	thermostat t.max. 180°C temperature range 100-180°C 1-pole 1NO 16A probe ø 6mm probe L 98mm capillary pipe 870mm capillary pipe isolatedmm gland nut shaft ø 6x4.6mm shaft L 23mm shaft position upper rotation 270°		

55.17\_ series

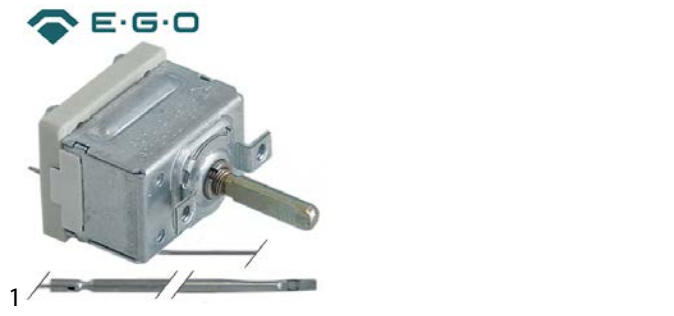

<b>GEV No.</b>	375349	<b>Ref. No.</b>	4.0.066.0114
<b>description</b>	thermostat t.max. 250°C temperature range 50-250°C 1-pole 1NO 16A probe ø 3.03mm probe L 178mm capillary pipe 840mm capillary pipe isolatedmm gland nut shaft ø 6x4.6mm shaft L 23mm shaft position upper rotation 270°		
<b>For models:</b>	CG6GG-VITRO, CG6SG-VITRO, CG6SS-VITRO, CG8GG-VITRO, CG8SG-VITRO, CG8SS-VITRO, EGP10.6-MEC, EGP10.8-MEC, EGP15.10C-MEC, EGP15.10MC-MEC, EGP15.10-MEC, EGP15.10M-MEC, EGP15.6C-MEC, EGP15.6MC-MEC, EGP15.6-MEC, EGP15.6M-MEC, EGP15.8C-MEC, EGP15.8MC-MEC, EGP15.8-MEC, EGP15.8M-MEC, GR-4.1-L, GR-4.1-LTL, GR-4.2, GR-6.1, GR-6.1-L, GR-6.1-LTL, GR-8, GR-8.1-L, GR-8.2, GR-8.2-L, GR-8.2-LTL, GR-8-L, GR-M, GR-M.1, GR-M.2, GR-M.2-TLC, PPEF-600, PPEF-600-CRD, PPEF-800, PPEF-800-CRD, PPEF-800-MN, PPEF-M-600, PPEF-M-600-CRD, PPEF-M-800, PPEF-M-800-CRD, VCR-6C-TC-NV, VCR-6L-TC-NV, VCR-6L-TL-NV, VCR-8C-TC, VCR-8L-TC...(Other models you can see in the webshop)		

safety thermostats

56\_ series



<b>GEV No.</b>	375351	<b>Ref. No.</b>	4.0.085.0011 old
<b>description</b>	safety thermostat switch-off temp. 220°C 1-pole 1NC 16A probe ø 5mm probe L 71mm capillary pipe 960mm capillary pipe isolatedmm gland nut		

IMIT / TEMPOMATIC / ARTERMO

control thermostats

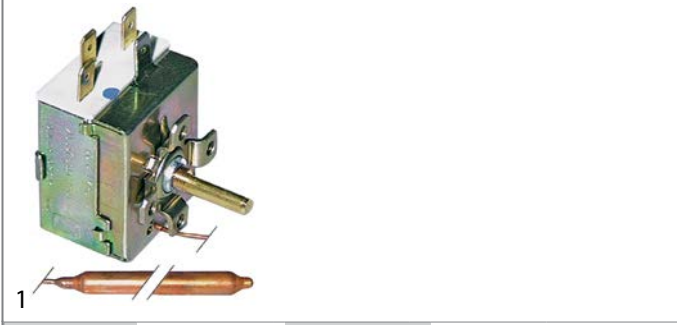

<b>GEV No.</b>	390006	<b>Ref. No.</b>	359	
<b>description</b>	thermostat t.max. 86°C temperature range 0-86°C 1-pole 1CO 16A probe ø 6.5mm probe L 95mm capillary pipe 1500mm capillary pipe isolatedmm gland nut shaft ø 6x4.6mm shaft L 19mm rotation 270°			
<b>For models:</b>	F-1040, F-1221-N, F-1221-REVOL, F-400, F-430, F-532			
<b>accessories for</b>	390006			
	<b>GEV No.</b>	110100	<b>Ref. No.</b>	—
	knob thermostat t.max. 90°C 0-90°C ø 42mm shaft ø 6x4.6mm shaft flat -135° black			
	<b>GEV No.</b>	110105	<b>Ref. No.</b>	—
	rosette knob ø 42mm ø 56mm zero mark			

TECASA

control thermostats



<b>GEV No.</b>	390975	<b>Ref. No.</b>	4.0.085.0008 4.0.085.0009
<b>description</b>	thermostat t.max. 175°C temperature range 50-175°C 1-pole 1NO 16A probe ø 5mm probe L 90mm capillary pipe 620mm capillary pipe isolated 290mm gland nut shaft ø 6x4.6mm shaft L 16mm shaft position upper rotation 270°		
<b>For models:</b>	FCF10, FCF10+10, FCF10+10-TR, FCF10-TR, FCF15+15, FCF15-TR, FCF6, FCF6+6, FF10, FF-10, FF10+10, FF-10+10, FF10+10TR, FF-10+10-TR, FF10+10TR-NV, FF10-NV, FF10TR, FF-10-TR, FF10TR-NV, FF15+15TR, FF-15+15-TR, FF15TR, FF-15-TR, FF6, FF6+6, FF6+6-NV		

safety thermostats



<b>GEV No.</b>	390856	<b>Ref. No.</b>	4.0.085.0011
<b>description</b>	safety thermostat set switch-off temp. 235°C 1-pole 1NC 16A probe ø 5mm probe L 73mm capillary pipe 1030mm capillary pipe isolated 600mm gland nut probe SS		
<b>For models:</b>	FCF10, FCF10+10, FCF10+10-TR, FCF10-TR, FCF15+15, FCF15-TR, FCF6, FCF6+6, FF10, FF-10, FF10+10, FF-10+10, FF10+10TR, FF-10+10-TR, FF10+10TR-NV, FF10-NV, FF10TR, FF-10-TR, FF10TR-NV, FF15+15TR, FF-15+15-TR, FF15TR, FF-15-TR, FF6, FF6+6, FF6+6-NV		

CAMPINI

safety thermostats



<b>GEV No.</b>	375510	<b>Ref. No.</b>	4.0.085.0011
<b>description</b>	safety thermostat t.max. 220°C 1-pole 16A probe ø 5mm probe L 67mm capillary pipe 970mm		

accessories

probe clips

spring clips

for thermostat



<b>GEV No.</b>	550498	<b>Ref. No.</b>	4.0.085.0014
<b>description</b>	probe clip for pipe ø 8.5mm for probe ø 4mm Qty 1 pcs		
<b>For models:</b>	FCF10, FCF10+10, FCF10+10-TR, FCF10-TR, FCF15+15, FCF15-TR, FCF6, FCF6+6, FF-10, FF-10+10, FF10+10TR, FF-10+10-TR, FF10TR, FF-10-TR, FF6, FF6+6		



<b>GEV No.</b>	550258	<b>Ref. No.</b>	4.0.085.0016
<b>description</b>	probe clip for pipe ø 8mm for probe ø 6mm		
<b>For models:</b>	FF6, FF6+6		

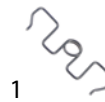

<b>GEV No.</b>	551025	<b>Ref. No.</b>	4.0.085.0114
<b>description</b>	probe clip for pipe ø 2x8.5mm for probe ø 6mm L 36mm Qty 1 pcs		
<b>For models:</b>	FF10, FF10+10, FF10+10TR, FF10+10TR-NV, FF10-NV, FF10TR, FF-10TR-NV, FF15+15TR, FF15TR, FF6, FF6+6, FF6+6-NV		

capillary tube clips



<b>GEV No.</b>	550491	<b>Ref. No.</b>	4.0.085.0017
<b>description</b>	capillary tube clip for pipe ø 8.5mm for circular tube heating elements		
<b>For models:</b>	FCF10, FCF10+10, FCF10+10-TR, FCF10-TR, FCF15+15, FCF15-TR, FCF6, FCF6+6, FF10, FF-10, FF10+10, FF-10+10, FF10+10TR, FF-10+10-TR, FF10+10TR-NV, FF10-NV, FF10TR, FF-10-TR, FF10TR-NV, FF15+15TR, FF15TR, FF6, FF6+6, FF6+6-NV		





switches and momentary switches

rocker/momentary rocker switches

30x22mm



<b>GEV No.</b>	301001	<b>Ref. No.</b>	4.2.000.9236
<b>description</b>	rocker switch mounting measurements 30x22mm red 2NO 250V 16A illuminated 0-I connection male faston 6.3mm ambient temperature max. 125/55°C protection IP65		
<b>For models:</b>	MCF-4, MCF-4A, MCF-6S, MCF-7, MCF-7A, MCF-MC, TOSTI-D3, TOSTI-S3, TRD-30.2, TRS-20.2		

accessories for



<b>GEV No.</b>	301036	<b>Ref. No.</b>	—
<b>description</b>	protective cover internal size 30x22mm for rocker switch mounting measurementsmm		

blank



<b>GEV No.</b>	301165	<b>Ref. No.</b>	1
<b>description</b>	rocker switch mounting measurements 30x22mm black 2CO 250V 16A connection male faston 6.3mm ambient temperature max. 125/55°C protection IP65 with cover cap		
<b>For models:</b>	F-1040		

accessories for



<b>GEV No.</b>	301036	<b>Ref. No.</b>	—
<b>description</b>	protective cover internal size 30x22mm for rocker switch mounting measurementsmm		

labelled



<b>GEV No.</b>	301162	<b>Ref. No.</b>	1146
<b>description</b>	momentary rocker switch mounting measurements 30x22mm orange 2NO 250V 16A illuminated connection male faston 6.3mm ambient temperature max. 100/55°C protection IP65 with cover cap		
<b>For models:</b>	F-1040, F-430, F-532		

accessories for



<b>GEV No.</b>	301036	<b>Ref. No.</b>	—
<b>description</b>	protective cover internal size 30x22mm for rocker switch mounting measurementsmm		



<b>GEV No.</b>	301164	<b>Ref. No.</b>	364
<b>description</b>	rocker switch mounting measurements 30x22mm green 2NO 250V 16A illuminated connection male faston 6.3mm ambient temperature max. 85°C protection IP65 with cover cap		
<b>For models:</b>	F-1040, F-430, F-532		

accessories for



<b>GEV No.</b>	301036	<b>Ref. No.</b>	—
<b>description</b>	protective cover internal size 30x22mm for rocker switch mounting measurementsmm		

push/momentary push switches

28.5x52.6mm



<b>GEV No.</b>	345691	<b>Ref. No.</b>	4.0.000.0520
<b>description</b>	switch combination mounting measurements 28.5x52.6mm black 1NO/NO 250V 16A connection male faston 6.3mm ambient temperature max. 85°C protection IP40		
<b>For models:</b>	TOSTI-D3, TOSTI-S3, TRD-30.2, TRS-20.2		

28.5x77.5mm



<b>GEV No.</b>	345692	<b>Ref. No.</b>	4.0.000.0523 4.0.000.0530
<b>description</b>	switch combination latching mounting measurements 28.5x77.5mm black 1NO/1NO/1NO 250V 16A with indicator connection male faston 6.3mm ambient temperature max. 85°C protection IP40		
<b>For models:</b>	TOSTI-D3, TOSTI-S3, TRD-30.2, TRS-20.2		

30x22mm



<b>GEV No.</b>	301086	<b>Ref. No.</b>	4.0.085.0018
<b>description</b>	push switch mounting measurements 30x22mm black 2NO 250V 12A 0-1 connection male faston 6.3mm ambient temperature max. 85/55°C protection IP54 with protective collar		
<b>For models:</b>	ALF-3, FCF10, FCF10+10, FCF10+10-TR, FCF10-TR, FCF15+15, FCF15-TR, FCF6, FCF6+6, FF10, FF-10, FF10+10, FF-10+10, FF10+10TR, FF-10+10-TR, FF10+10TR-NV, FF10TR, FF-10-TR, FF10TR-NV, FF15+15TR, FF-15+15-TR, FF15TR, FF-15-TR, FF6, FF6+6, VCR-6C-NV, VCR-6L-NV, VCR-8C-TC, VCR-8L-TC, VCR-8L-TL		

ø16mm



<b>GEV No.</b>	301172	<b>Ref. No.</b>	4043
<b>description</b>	momentary push switch mounting ø 16mm black 1NO 250V 16A connection male faston 6.3mm protection IP40 ambient temperature max. 150°C		
<b>For models:</b>	F-1221-N, F-1221-REVOL, F-400		



1

<b>GEV No.</b>	301174	<b>Ref. No.</b>	4042
<b>description</b>	push switch mounting ø 16mm black 2NO 250V 16A connection male faston 6.3mm protection IP40 ambient temperature max. 150°C		
<b>For models:</b>	F-1221-N, F-1221-REVOL, F-400		

## microswitches

### lever actuated



1

<b>GEV No.</b>	345254	<b>Ref. No.</b>	2384
<b>description</b>	microswitch with lever 250V 16A 1CO connection male faston 6.3mm ambient temperature max. 120°C mounting distance 22mm actuating force: 60g lever length 58mm		
<b>For models:</b>	F-1040		

### pin-plunger actuated

#### M10



1

<b>GEV No.</b>	345224	<b>Ref. No.</b>	4.0.085.0021
<b>description</b>	microswitch with plunger thread M10x0.75 250V 16A 1CO connection male faston 6.3mm stroke 6mm		
<b>For models:</b>	AEF-15.30, AEF-30.60, EF-15.30, FCF10, FCF10+10, FCF10+10-TR, FCF10-TR, FCF15+15, FCF15-TR, FCF6, FCF6+6, FF10, FF-10, FF10+10, FF-10+10, FF10+10TR, FF-10+10-TR, FF10+10TR-NV, FF10-NV, FF10TR, FF-10-TR, FF10TR-NV, FF15+15TR, FF-15+15-TR, FF15TR, FF-15-TR, FF6, FF6+6, FF6+6-NV		



1

<b>GEV No.</b>	347864	<b>Ref. No.</b>	3528
<b>description</b>	microswitch with plunger thread M10x0.75 thread L 18mm 230V 10A 1CO connection male faston 6.3mm stroke 4mm mounting distance mm ambient temperature max. 125°C actuating force: 240g		
<b>For models:</b>	F-1221-REVOL, F-400		

#### M12



1

<b>GEV No.</b>	345810	<b>Ref. No.</b>	2651
<b>description</b>	microswitch with plunger thread M12 thread L 14mm 230V 12A 1CO connection male faston 6.3mm stroke 2mm ambient temperature max. 125°C type U83161.3 actuating force: 2000g		
<b>For models:</b>	F-1221-N		

## miscellaneous



1

<b>GEV No.</b>	345811	<b>Ref. No.</b>	4159
<b>description</b>	microswitch with plunger thread M12 thread L 14mm 250V 12A 2CO connection male faston 6.3mm stroke 3mm ambient temperature max. 125°C type U83161.1 actuating force: 1800g		
<b>For models:</b>	F-430, F-532		

## accessories



1

<b>GEV No.</b>	508189	<b>Ref. No.</b>	2832
<b>description</b>	lever for microswitch		
<b>For models:</b>	F-1040		

## system switches (ROLD)



1

<b>GEV No.</b>	345536	<b>Ref. No.</b>	4046
<b>description</b>	element holder mounting ø 16mm flat black		
<b>For models:</b>	F-1221-N		



1

<b>GEV No.</b>	359246	<b>Ref. No.</b>	4048
<b>description</b>	indicator light lens ø 12.2mm yellow		
<b>For models:</b>	F-1221-N		



1

<b>GEV No.</b>	345130	<b>Ref. No.</b>	4322
<b>description</b>	momentary switch unit 1NO 250V 16A connection male faston 6.3mm		
<b>For models:</b>	F-1221-N		



			
1			
<b>GEV No.</b>	345538	<b>Ref. No.</b>	4044
<b>description</b>	push button ø 11.9mm black		
<b>For models:</b>	F-1221-N		

			
1			
<b>GEV No.</b>	345722	<b>Ref. No.</b>	4.0.000.0510
<b>description</b>	switch 1NO 250V 16A connection male faston 6.3mm		
<b>For models:</b>	ATLANTIC-II-CV-NV, ATLANTIC-II-CV-PCI-NV, ATLANTIC-II-CV-TALL-CUPS, ATLANTIC-II-CV-TI-NV, ATLANTIC-II-CV-TI-TALL-CUPS, ATLANTIC-III, ATLANTIC-III-CV, ATLANTIC-III-CV-TI, ATLANTIC-III-TI, ATLANTIC-II-NV, ATLANTIC-II-PCI-NV, ATLANTIC-II-TALL-CUPS, ATLANTIC-II-TI-NV, CG2x4GGGG, CG2x4GGS, CG2x4SGGG, CG2x4SGS, CG2x4SGSG, CG2x4SSGG, CG2x4SSSG, CG2x4SSSS, CG4GG, CG4SG, CG4SS, CG6GG, CG6GG-VITRO, CG6SG, CG6SG-VITRO, CG6SS, CG6SS-VITRO, CG8GG-VITRO, CG8SG-VITRO, CG8SS-VITRO, PRESTIGE-II-CV-ECC, PRESTIGE-II-CV-REVOL, PRESTIGE-II-ECC, PRESTIGE-III-CV-REVOL, PRESTIGE-III-REVOL, PRESTIGE-II-REVOL, TRD-30.2, TRS-20.2		

			
1			
<b>GEV No.</b>	345720	<b>Ref. No.</b>	4.0.000.0513 4323
<b>description</b>	switch 2NO 250V 16A connection male faston 6.3mm		
<b>For models:</b>	ATLANTIC-II-COMPACT, ATLANTIC-II-CV-PCI-NV, ATLANTIC-II-CV-TI-COMPACT, ATLANTIC-II-CV-TI-NV, ATLANTIC-III, ATLANTIC-III-TI, ATLANTIC-II-NV, ATLANTIC-II-PCI-NV, ATLANTIC-II-TALL-CUPS, ATLANTIC-II-TI-NV, ATLANTIC-I-PCI-NV, ATLANTIC-I-TI-NV, F-1040, F-1221-N, F-1221-REVOL, F-430-MN, F-532-TR, MARINA, MARINA-CV, MARINA-CV-DI, MINIBAR-NV, PACIFIC-2CV, PACIFIC-3CV, PACIFIC-3CV-W, Prestige-II, PRESTIGE-II-CV-REVOL, PRESTIGE-II-ECC, Prestige-III, PRESTIGE-III-CV-REVOL, PRESTIGE-III-REVOL, PRESTIGE-II-REVOL, TLF-6		

system switches

RST-FIAMMA

push buttons

			
1			
<b>GEV No.</b>	347402	<b>Ref. No.</b>	4.0.000.0507
<b>description</b>	push button external size 11x21mm black/orange		
<b>For models:</b>	ATLANTIC-II-COMPACT, ATLANTIC-II-CV-NV, ATLANTIC-II-CV-PCI-NV, ATLANTIC-II-CV-TALL-CUPS, ATLANTIC-II-CV-TI-COMPACT, ATLANTIC-II-CV-TI-NV, ATLANTIC-II-CV-TI-TALL-CUPS, ATLANTIC-III, ATLANTIC-III-CV, ATLANTIC-III-CV-TI, ATLANTIC-III-TI, ATLANTIC-II-NV, ATLANTIC-II-PCI-NV, ATLANTIC-II-TALL-CUPS, ATLANTIC-II-TI-NV, ATLANTIC-I-PCI-NV, ATLANTIC-I-TI-NV, CG2x4GGGG, CG2x4GGS, CG2x4SGGG, CG2x4SGS, CG2x4SGSG, CG2x4SSGG, CG2x4SSSG, CG2x4SSSS, CG4GG, CG4SG, CG4SS, CG6GG, CG6GG-VITRO, CG6SG, CG6SG-VITRO, CG6SS, CG6SS-VITRO, CG8GG-VITRO, CG8SG-VITRO, CG8SS-VITRO, MARINA, MARINA-CV, MARINA-CV-DI, MINIBAR-NV, PACIFIC-2CV, PACIFIC-3CV, PACIFIC-3CV-W, Prestige-II, PRESTIGE-II-CV-REVOL, PRESTIGE-II-ECC, PRESTIGE-III-CV-REVOL, PRESTIGE-III-REVOL, PRESTIGE-II-REVOL... (Other models you can see in the webshop)		

element holders

			
1			
<b>GEV No.</b>	347403	<b>Ref. No.</b>	4.0.000.0503
<b>description</b>	frame for pressure switch black		
<b>For models:</b>	ATLANTIC-II-COMPACT, ATLANTIC-II-CV-NV, ATLANTIC-II-CV-PCI-NV, ATLANTIC-II-CV-TALL-CUPS, ATLANTIC-II-CV-TI-COMPACT, ATLANTIC-II-CV-TI-NV, ATLANTIC-II-CV-TI-TALL-CUPS, ATLANTIC-III, ATLANTIC-III-CV, ATLANTIC-III-CV-TI, ATLANTIC-III-TI, ATLANTIC-II-NV, ATLANTIC-II-PCI-NV, ATLANTIC-II-TALL-CUPS, ATLANTIC-II-TI-NV, ATLANTIC-I-PCI-NV, ATLANTIC-I-TI-NV, CG2x4GGGG, CG2x4GGS, CG2x4SGGG, CG2x4SGS, CG2x4SGSG, CG2x4SSGG, CG2x4SSSG, CG2x4SSSS, CG4GG, CG4SG, CG4SS, CG6GG, CG6GG-VITRO, CG6SG, CG6SG-VITRO, CG6SS, CG6SS-VITRO, CG8GG-VITRO, CG8SG-VITRO, CG8SS-VITRO, MARINA, MARINA-CV, MARINA-CV-DI, MINIBAR-NV, PACIFIC-2CV, PACIFIC-3CV, PACIFIC-3CV-W, Prestige-II, PRESTIGE-II-CV-ECC, PRESTIGE-II-CV-REVOL, PRESTIGE-II-ECC, Prestige-III, PRESTIGE-III-CV-REVOL... (Other models you can see in the webshop)		



switches

			
1			
<b>GEV No.</b>	345722	<b>Ref. No.</b>	4.0.000.0510
<b>description</b>	switch 1NO 250V 16A connection male faston 6.3mm		
<b>For models:</b>	ATLANTIC-II-CV-NV, ATLANTIC-II-CV-PCI-NV, ATLANTIC-II-CV-TALL-CUPS, ATLANTIC-II-CV-TI-NV, ATLANTIC-II-CV-TI-TALL-CUPS, ATLANTIC-III, ATLANTIC-III-CV, ATLANTIC-III-CV-TI, ATLANTIC-III-TI, ATLANTIC-II-NV, ATLANTIC-II-PCI-NV, ATLANTIC-II-TALL-CUPS, ATLANTIC-II-TI-NV, CG2x4GGGG, CG2x4GGS, CG2x4SGGG, CG2x4SGS, CG2x4SGSG, CG2x4SSGG, CG2x4SSSG, CG2x4SSSS, CG4GG, CG4SG, CG4SS, CG6GG, CG6GG-VITRO, CG6SG, CG6SG-VITRO, CG6SS, CG6SS-VITRO, CG8GG-VITRO, CG8SG-VITRO, CG8SS-VITRO, PRESTIGE-II-CV-ECC, PRESTIGE-II-CV-REVOL, PRESTIGE-II-ECC, PRESTIGE-III-CV-REVOL, PRESTIGE-III-REVOL, PRESTIGE-II-REVOL, TRD-30.2, TRS-20.2		

rotary switches

BREMAS

A1700 series

			
1			
<b>GEV No.</b>	346397	<b>Ref. No.</b>	5.0.000.0061
<b>description</b>	rotary switch 3 0-1-2 sets of contacts 6 type CA020V200 400V 20A shaft ø 5x5mm shaft L 23mm shaft square connection screw		
<b>For models:</b>	ATLANTIC-I-CV-NV, ATLANTIC-I-CV-PCI-NV, ATLANTIC-I-CV-TI-NV, ATLANTIC-II-COMPACT, ATLANTIC-II-CV-COMPACT, ATLANTIC-II-CV-NV, ATLANTIC-II-CV-PCI-NV, ATLANTIC-II-CV-TALL-CUPS, ATLANTIC-II-CV-TI-COMPACT, ATLANTIC-II-CV-TI-NV, ATLANTIC-II-CV-TI-TALL-CUPS, ATLANTIC-III, ATLANTIC-III-CV, ATLANTIC-III-CV-TI, ATLANTIC-III-TI, ATLANTIC-II-NV, ATLANTIC-II-PCI-NV, ATLANTIC-II-TALL-CUPS, ATLANTIC-II-TI-NV, ATLANTIC-I-PCI-NV, ATLANTIC-I-TI-NV, PRESTIGE-II-CV-ECC, PRESTIGE-II-CV-REVOL, PRESTIGE-II-ECC, PRESTIGE-III-CV-REVOL, PRESTIGE-III-REVOL, PRESTIGE-II-REVOL		
<b>accessories for</b>	346397		
	<b>GEV No.</b>	110619	<b>Ref. No.</b> —
	knob switch zero mark t.max.°C ø 48mm shaft ø 5x5mm shaft flat black		



## lamps

## indicator lights

## indicator lights (complete)

## ø 9mm



1

<b>GEV No.</b>	359134	<b>Ref. No.</b>	6204
<b>description</b>	indicator light ø 9mm 230V clear connection male faston 6.3mm temp.-resist. 120°C		
<b>For models:</b>	F-1221-N		



1

<b>GEV No.</b>	359136	<b>Ref. No.</b>	6207
<b>description</b>	indicator light ø 9mm 230V green connection male faston 6.3mm temp.-resist. 120°C		
<b>For models:</b>	F-1221-N		



1

<b>GEV No.</b>	359137	<b>Ref. No.</b>	4.0.085.0025 6206
<b>description</b>	indicator light ø 9mm 230V yellow connection male faston 6.3mm temp.-resist. 120°C with lens		
<b>For models:</b>	F-1221-N		

## ø10mm

## with plug-in socket



1

<b>GEV No.</b>	359139	<b>Ref. No.</b>	4.0.025.0130
<b>description</b>	indicator light ø 10mm green 230V connection male faston 6.3mm Qty 1 pcs		
<b>For models:</b>	ATLANTIC-I-CV-NV, ATLANTIC-I-CV-PCI-NV, ATLANTIC-I-CV-TI-NV, ATLANTIC-II-COMPACT, ATLANTIC-II-CV-COMPACT, ATLANTIC-II-CV-NV, ATLANTIC-II-CV-PCI-NV, ATLANTIC-II-CV-TALL-CUPS, ATLANTIC-II-CV-TI-COMPACT, ATLANTIC-II-CV-TI-NV, ATLANTIC-II-CV-TI-TALL-CUPS, ATLANTIC-III, ATLANTIC-III-CV, ATLANTIC-III-CV-TI, ATLANTIC-III-TI, ATLANTIC-II-NV, ATLANTIC-II-PCI-NV, ATLANTIC-II-TALL-CUPS, ATLANTIC-II-TI-NV, ATLANTIC-I-PCI-NV, ATLANTIC-I-TI-NV, MARINA, MARINA-CV, MARINA-CV-DI, PACIFIC-2CV, PACIFIC-3CV, PACIFIC-3CV-W, PRESTIGE-II-CV-ECC, PRESTIGE-II-CV-REVOL, PRESTIGE-II-ECC, PRESTIGE-III-CV-REVOL, PRESTIGE-III-REVOL, PRESTIGE-II-REVOL		



1

<b>GEV No.</b>	359140	<b>Ref. No.</b>	4.0.025.0135
<b>description</b>	indicator light ø 16mm yellow 230V connection male faston 6.3mm Qty 1 pcs		
<b>For models:</b>	ATLANTIC-I-CV-NV, ATLANTIC-I-CV-PCI-NV, ATLANTIC-I-CV-TI-NV, ATLANTIC-II-COMPACT, ATLANTIC-II-CV-COMPACT, ATLANTIC-II-CV-NV, ATLANTIC-II-CV-PCI-NV, ATLANTIC-II-CV-TALL-CUPS, ATLANTIC-II-CV-TI-COMPACT, ATLANTIC-II-CV-TI-NV, ATLANTIC-II-CV-TI-TALL-CUPS, ATLANTIC-III, ATLANTIC-III-CV, ATLANTIC-III-CV-TI, ATLANTIC-III-TI, ATLANTIC-II-NV, ATLANTIC-II-PCI-NV, ATLANTIC-II-TALL-CUPS, ATLANTIC-II-TI-NV, ATLANTIC-I-PCI-NV, ATLANTIC-I-TI-NV, FCF10, FCF10+10, FCF10+10-TR, FCF10-TR, FCF15+15, FCF15-TR, FCF6, FCF6+6, IRCT1.8W, IRCT2x1.8W, MARINA, MARINA-CV, MARINA-CV-DI, PACIFIC-2CV, PACIFIC-3CV, PACIFIC-3CV-W, PPEF-M-800, PPEF-M-800-CRD, PRESTIGE-II-CV-ECC, PRESTIGE-II-CV-REVOL, PRESTIGE-II-ECC, PRESTIGE-III-CV-REVOL, PRESTIGE-III-REVOL, PRESTIGE-II-REVOL		

## ø16mm

## with plug-in socket



1

<b>GEV No.</b>	359790	<b>Ref. No.</b>	4092
<b>description</b>	indicator light ø 16mm 230V clear connection male faston 6.3mm		
<b>For models:</b>	F-1221-REVOL, F-400		



1

<b>GEV No.</b>	359788	<b>Ref. No.</b>	4091
<b>description</b>	indicator light ø 16mm 230V green connection male faston 6.3mm		
<b>For models:</b>	F-1221-REVOL, F-400		



1

<b>GEV No.</b>	359789	<b>Ref. No.</b>	4090
<b>description</b>	indicator light ø 16mm 230V yellow connection male faston 6.3mm		
<b>For models:</b>	F-1221-REVOL, F-400		

## 30x22mm



1

<b>GEV No.</b>	301166	<b>Ref. No.</b>	71
<b>description</b>	indicator light mounting measurements 30x22mm 230V blue		
<b>For models:</b>	F-1040, F-430, F-532		
<b>accessories for</b>	301166		
	<b>GEV No.</b>	301036	<b>Ref. No.</b>
			—
	protective cover internal size 30x22mm for rocker switch mounting measurementsmm		



timers

programme timers

			
1			
<b>GEV No.</b>	360077	<b>Ref. No.</b>	1623
<b>description</b>	timer CROUZET engines 1 chambers 2 operation time 120s 230V shaft ømm shaft Lmm manuf. no. 627/5261 motor type 82340		
<b>For models:</b>	F-1040, F-1221-N, F-1221-REVOL, F-400, F-430, F-532		

mechanical timers

			
1			
<b>GEV No.</b>	350032	<b>Ref. No.</b>	4.0.075.0002
<b>description</b>	timer M2 2-pole operation time 15min impulse mechanical 2NO at 250V 16A permanent position no shaft ø 6x4.6mm shaft 6x4.6mm shaft L 18mm mounting distance 28mm connection rear		
<b>For models:</b>	TOSTI-D3, TOSTI-S3, TRD-30.2, TRS-20.2		
<b>accessories for</b>	350032		
	<b>GEV No.</b>	110366	<b>Ref. No.</b> —
	knob switch zero mark t.max.°C ø 44mm shaft ø 6x4.6mm shaft flat upper black		
	<b>GEV No.</b>	110371	<b>Ref. No.</b> —
	dial plate graduation 15min permanent position no rotation 30-330° ø 60mm timers knob ø 45mm		

contactors

GENERAL ELECTRIC (AEG)

power contactors

			
1			
<b>GEV No.</b>	380238	<b>Ref. No.</b>	355
<b>description</b>	power contactor resistive load 20A 230VAC (AC3/400V) 8.4A/4kW main contacts 3NO auxiliary contacts 1NO connection screw connection type LS0510A type AEG LS0510A type GE MC1A 310A		
<b>For models:</b>	F-430		

ISKRA (FANAL)

power contactors

			
1			
<b>GEV No.</b>	380213	<b>Ref. No.</b>	4.0.089.0003 5140
<b>description</b>	power contactor resistive load 20A 230VAC (AC3/400V) 8.5A/5.5kW main contacts 3NO auxiliary contacts 1NO connection screw connection type Fanal DSL7 10 type ISKRA K07M 10		
<b>For models:</b>	F-532, FCF10, FCF10+10, FCF10+10-TR, FCF10-TR, FCF15+15, FCF15-TR, FCF6, FCF6+6, FF10, FF-10, FF10+10, FF-10+10, FF10+10TR, FF-10+10-TR, FF10+10TR-NV, FF10TR, FF-10-TR, FF10TR-NV, FF6, FF6+6, PPEF-800, PPEF-800-CRD, PPEF-M-800, PPEF-M-800-CRD		

			
1			
<b>GEV No.</b>	380204	<b>Ref. No.</b>	4375
<b>description</b>	power contactor resistive load 25A 230VAC (AC3/400V) 9A/4kW main contacts 3NO auxiliary contacts 1NO connection screw connection type Fanal DSL9 10 type ISKRA KNL9 10		
<b>For models:</b>	F-1040		

relays

level relays

miscellaneous

			
1			
<b>GEV No.</b>	402724	<b>Ref. No.</b>	5.0.000.1035 RST1
<b>description</b>	level controller 230V voltage AC 8-pole type RST1		
<b>For models:</b>	ATLANTIC-II-COMPACT, ATLANTIC-II-CV-TI-COMPACT, ATLANTIC-III, ATLANTIC-III-TI, ATLANTIC-II-NV, ATLANTIC-II-PCI-NV, ATLANTIC-II-TALL-CUPS, ATLANTIC-II-TI-NV, ATLANTIC-I-PCI-NV, ATLANTIC-I-TI-NV, MARINA, Prestige-II, PRESTIGE-II-ECC, Prestige-III, PRESTIGE-III-REVOL, PRESTIGE-II-REVOL, Superbar		



## transformers

### miscellaneous



<b>GEV No.</b>	402152	<b>Ref. No.</b>	4.0.080.0006
<b>description</b>	ignition transformer primary 230V secondary 2x2500V 50Hz		
<b>For models:</b>	30.5-INOX, 30.6-INOX, EI30.5, EI30.5-Inox, EI30.6, EI30.6-Inox		

## electronics

### central units



<b>GEV No.</b>	403703	<b>Ref. No.</b>	4.0.000.0953
<b>description</b>	central unit 240V 50/60Hz L 130mm W 120mm suitable for GICAR		
<b>For models:</b>	ATLANTIC-I-CV-NV, ATLANTIC-I-CV-PCI-NV, ATLANTIC-I-CV-TI-NV, ATLANTIC-II-CV-COMPACT, ATLANTIC-II-CV-NV, ATLANTIC-II-CV-PCI-NV, ATLANTIC-II-CV-TALL-CUPS, ATLANTIC-II-CV-TI-COMPACT, ATLANTIC-II-CV-TI-NV, ATLANTIC-II-CV-TI-TALL-CUPS, ATLANTIC-III-CV, ATLANTIC-III-CV-TI, MARINA-CV, PRESTIGE-II-CV-ECC, PRESTIGE-II-CV-REVOL, PRESTIGE-III-CV-REVOL		

## keypads

### keypad units



<b>GEV No.</b>	402667	<b>Ref. No.</b>	4.0.000.0955
<b>description</b>	keypad unit buttons 5 silver/black L 120mm W 50mm		
<b>For models:</b>	ATLANTIC-I-CV-NV, ATLANTIC-I-CV-PCI-NV, ATLANTIC-I-CV-TI-NV, ATLANTIC-II-CV-COMPACT, ATLANTIC-II-CV-NV, ATLANTIC-II-CV-PCI-NV, ATLANTIC-II-CV-TALL-CUPS, ATLANTIC-II-CV-TI-COMPACT, ATLANTIC-II-CV-TI-NV, ATLANTIC-II-CV-TI-TALL-CUPS, ATLANTIC-III-CV, ATLANTIC-III-CV-TI, MARINA-CV, PRESTIGE-II-CV-ECC, PRESTIGE-II-CV-REVOL, PRESTIGE-III-CV-REVOL		



<b>GEV No.</b>	402722	<b>Ref. No.</b>	4.0.000.0980
<b>description</b>	keypad unit coffee machine BUTTERFLY/MARINA buttons 5 black/white/silver type 1d5e GRCZ NKP S10 „Tank Probe“ 230V		
<b>For models:</b>	MARINA-CV, MARINA-CV-DI		

## solenoïd valves

### solenoïd valves (water)

TP







<b>GEV No.</b>	370015	<b>Ref. No.</b>	394
<b>description</b>	solenoïd valve single angled 230VAC inlet 3/4" outlet 11.5mm DN10 TP		
<b>For models:</b>	F-1040, F-1221-N, F-1221-REVOL, F-400, F-430, F-532		

**accessories for** 370015

	<b>GEV No.</b>	371220	<b>Ref. No.</b>	—
				reducer TP flow rate 3l/min red tolerance ±15%
	<b>GEV No.</b>	371221	<b>Ref. No.</b>	—
				reducer TP flow rate 5.5l/min yellow tolerance ±15%
	<b>GEV No.</b>	371222	<b>Ref. No.</b>	—
				reducer TP flow rate 6l/min grey tolerance ±15%
	<b>GEV No.</b>	371223	<b>Ref. No.</b>	—
				reducer TP flow rate 10l/min white tolerance ±15%
	<b>GEV No.</b>	371224	<b>Ref. No.</b>	—
				reducer TP flow rate 12l/min bronze tolerance ±15%
	<b>GEV No.</b>	371225	<b>Ref. No.</b>	—
				reducer TP flow rate 16l/min light brown tolerance ±15%
	<b>GEV No.</b>	371226	<b>Ref. No.</b>	—
				reducer TP flow rate 20l/min red tolerance ±15%
	<b>GEV No.</b>	371230	<b>Ref. No.</b>	—
				reducer TP flow rate 0.25l/min red tolerance ±25%
	<b>GEV No.</b>	371231	<b>Ref. No.</b>	—
				reducer TP flow rate 0.35l/min violet tolerance ±25%
	<b>GEV No.</b>	371232	<b>Ref. No.</b>	—
				reducer TP flow rate 0.5l/min orange tolerance ±25%
	<b>GEV No.</b>	371233	<b>Ref. No.</b>	—
				reducer TP flow rate 0.8l/min white tolerance ±25%
	<b>GEV No.</b>	371234	<b>Ref. No.</b>	—
				reducer TP flow rate 1l/min light blue tolerance ±25%
	<b>GEV No.</b>	371235	<b>Ref. No.</b>	—
				reducer TP flow rate 1.2l/min brown tolerance ±25%
	<b>GEV No.</b>	371236	<b>Ref. No.</b>	—
				reducer TP flow rate 1.5l/min light brown tolerance ±25%

Table continues overleaf



accessories for		370015		
GEV No.	371237	Ref. No.	—	
	reducer TP flow rate 2.5l/min yellow tolerance ±25%			
GEV No.	371238	Ref. No.	—	
	reducer TP flow rate 3.4l/min dark green tolerance ±25%			
GEV No.	371239	Ref. No.	—	
	reducer TP flow rate 5l/min black tolerance ±25%			
GEV No.	371240	Ref. No.	—	
	reducer TP flow rate 8l/min blue tolerance ±20%			

metal  
LUCIFER

3-way  
131F series

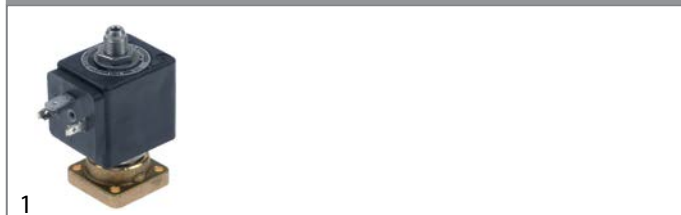



1

GEV No.	370053	Ref. No.	5.0.000.0123	
description	solenoid valve 3-ways 230VAC DN 2.5mm slide-on receptacle DIN -10 up to 140°C type series 131F coil type DZ06S6 membranes FKM (water/steam) p max 10bar flange 32x32mm			

**For models:** ATLANTIC-I-CV-NV, ATLANTIC-I-CV-PCI-NV, ATLANTIC-I-CV-TI-NV, ATLANTIC-II-COMPACT, ATLANTIC-II-CV-COMPACT, ATLANTIC-II-CV-NV, ATLANTIC-II-CV-PCI-NV, ATLANTIC-II-CV-TALL-CUPS, ATLANTIC-II-CV-TI-COMPACT, ATLANTIC-II-CV-TI-NV, ATLANTIC-II-CV-TI-TALL-CUPS, ATLANTIC-III, ATLANTIC-III-CV, ATLANTIC-III-CV-TI, ATLANTIC-III-TI, ATLANTIC-II-NV, ATLANTIC-II-PCI-NV, ATLANTIC-II-TALL-CUPS, ATLANTIC-II-TI-NV, ATLANTIC-I-PCI-NV, ATLANTIC-I-TI-NV, MARINA, MARINA-CV, MARINA-CV-DI, MINIBAR-NV, PACIFIC-2CV, PACIFIC-3CV, PACIFIC-3CV-W, Prestige-II, PRESTIGE-II-CV-ECC, PRESTIGE-II-CV-REVOL, PRESTIGE-II-ECC, Prestige-III, PRESTIGE-III-CV-REVOL, PRESTIGE-III-REVOL, PRESTIGE-II-REVOL

spare parts for 370053

GEV No.	370061	Ref. No.	—	
	solenoid valve body LUCIFER-PARKER 3-ways outer cone			

GEV No.	371031	Ref. No.	—	
	solenoid coil LUCIFER-PARKER 230VAC 9VA coil type DZ06S6 seat ø 15mm			

accessories for 370053

GEV No.	371090	Ref. No.	—	
	power socket plug type DIN 43650A screw			

GEV No.	371095	Ref. No.	—	
	O-ring Viton thickness 1.78mm ID ø 6.07mm Qty 1 pcs			

GEV No.	371100	Ref. No.	—	
	O-ring silicone thickness 1.78mm ID ø 6.07mm Qty 1 pcs			

PARKER

2-way  
VE-161 series

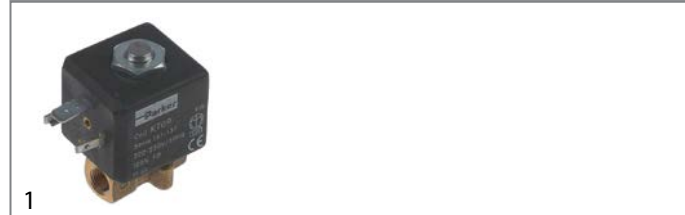

1

GEV No.	370553	Ref. No.	4.0.002.0041	
description	solenoid valve 2-ways 230VAC connection 1/8" L 32mm DN 2.2mm t.max. 80°C -10 up to 140°C type series VE-161.4 coil type KT09 membranes Viton p max 10bar p min 0bar 50Hz brass			
For models:	MARINA, MARINA-CV, MARINA-CV-DI, PACIFIC-3CV-W			

pressure switches  
for warewashing

ø 58mm with male faston 6.3mm  
with connection horizontal

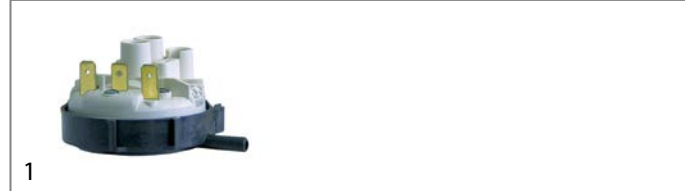

1

GEV No.	541142	Ref. No.	351	
description	pressure control pressure range 123/75mbar connection 6mm ø 58mm pressure connection horizontal warewashing			
For models:	F-1040			



1

GEV No.	541140	Ref. No.	35110	
description	pressure control pressure range 55/30mbar connection 6mm ø 58mm pressure connection horizontal warewashing			
For models:	F-1221-N, F-1221-REVOL, F-400, F-430, F-532			



## pumps





## wash and rinse pumps

## ALBA (C&amp;A)

## pumps









1

<b>GEV No.</b>	500372	<b>Ref. No.</b>	10511
<b>description</b>	pump inlet $\varnothing$ 45mm outlet $\varnothing$ 40mm type C10511 230V 50Hz 1 phase 0.37kW 0.5HP L 200mm rotation direction right capacitor 12.5 $\mu$ F ALBA PUMPS (C&A)		
<b>For models:</b>	F-430		
<b>spare parts for</b>	500372		
	<b>GEV No.</b>	365014	<b>Ref. No.</b> 234
	operating capacitor capacity 12.5 $\mu$ F 450V tolerance 5%Hz ambient temperature max. -25 to +85°C $\varnothing$ 35mm L 70mm M8 plastic connection male faston 6.3mm 45S.C3DS.12.5 protection		
	<b>GEV No.</b>	509021	<b>Ref. No.</b> —
	impeller $\varnothing$ 102mm H 32mm shaft intake $\varnothing$ 9/8mm rotation direction right		
	<b>GEV No.</b>	510692	<b>Ref. No.</b> —
	mechanical shaft seal for shaft $\varnothing$ 11mm slide ring ext. $\varnothing$ 24mm slide ring H 13mm counter ring mounting $\varnothing$ 26mm height counter ring 8mm counter ring int. $\varnothing$ 14mm		
	<b>GEV No.</b>	521531	<b>Ref. No.</b> —
	pump cover ALBA PUMPS (C&A) inlet $\varnothing$ 45mm outlet $\varnothing$ 40mm turn direction right $\varnothing$ 153mm ID $\varnothing$ 127mm inner height 24mm		
	<b>GEV No.</b>	521709	<b>Ref. No.</b> —
	O-ring EPDM thickness 3mm ID $\varnothing$ 126mm Qty 1 pcs		



1

<b>GEV No.</b>	500368	<b>Ref. No.</b>	2868
<b>description</b>	pump inlet $\varnothing$ 45mm outlet $\varnothing$ 40mm type C2868 230V 50Hz 1 phase 0.74kW 1HP L 230mm rotation direction right capacitor 12.5 $\mu$ F ALBA PUMPS (C&A)		
<b>For models:</b>	F-532		
<b>spare parts for</b>	500368		
	<b>GEV No.</b>	365014	<b>Ref. No.</b> 234
	operating capacitor capacity 12.5 $\mu$ F 450V tolerance 5%Hz ambient temperature max. -25 to +85°C $\varnothing$ 35mm L 70mm M8 plastic connection male faston 6.3mm 45S.C3DS.12.5 protection		
	<b>GEV No.</b>	509021	<b>Ref. No.</b> —
	impeller $\varnothing$ 102mm H 32mm shaft intake $\varnothing$ 9/8mm rotation direction right		
	<b>GEV No.</b>	510692	<b>Ref. No.</b> —
	mechanical shaft seal for shaft $\varnothing$ 11mm slide ring ext. $\varnothing$ 24mm slide ring H 13mm counter ring mounting $\varnothing$ 26mm height counter ring 8mm counter ring int. $\varnothing$ 14mm		
	<b>GEV No.</b>	521044	<b>Ref. No.</b> —
	fanwheel cover suitable for ALBA PUMPS (C&A) ID $\varnothing$ 132mm ED $\varnothing$ 138mm H 70mm for wash pump plastic		
	<b>GEV No.</b>	521531	<b>Ref. No.</b> —
	pump cover ALBA PUMPS (C&A) inlet $\varnothing$ 45mm outlet $\varnothing$ 40mm turn direction right $\varnothing$ 153mm ID $\varnothing$ 127mm inner height 24mm		
	<b>GEV No.</b>	521709	<b>Ref. No.</b> —
	O-ring EPDM thickness 3mm ID $\varnothing$ 126mm Qty 1 pcs		



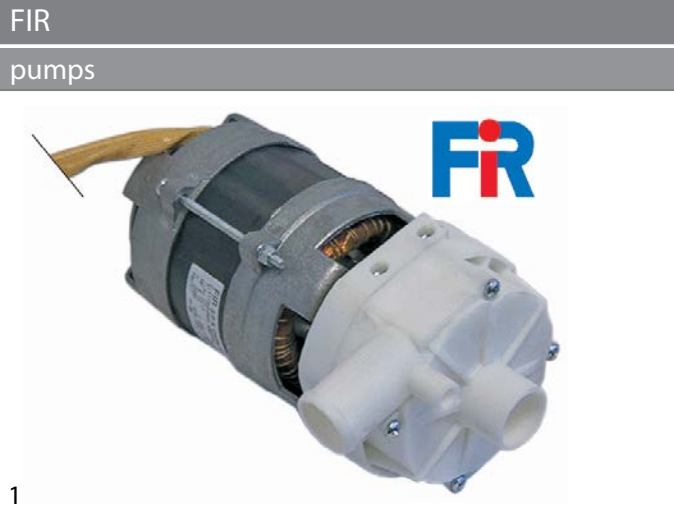

1

<b>GEV No.</b>	500037	<b>Ref. No.</b>	397
<b>description</b>	pump inlet ø 28mm outlet ø 26mm type 2211.1410 230V 50Hz 1 phase 0.074kW 0.1HP L 190mm rotation direction left capacitor 5µF FIR		
<b>For models:</b>	F-1221-N, F-1221-REVOL, F-400		
<b>spare parts for</b>	500037		
	<b>GEV No.</b>	365017	<b>Ref. No.</b> —
	operating capacitor capacity 5µF 450V tolerance 5% 50/60Hz ambient temperature max. -25 to +85°C ø 28mm L 54mm M8 plastic connection male faston 6.3mm 16.10.08 protection		
	<b>GEV No.</b>	510384	<b>Ref. No.</b> —
	pump cover inlet ø 28mm outlet ø 26mm ø 100mm ID ø 76mm		
	<b>GEV No.</b>	510695	<b>Ref. No.</b> —
	mechanical shaft seal height counter ring 5.5mm ID ø 11mm		
	<b>GEV No.</b>	521203	<b>Ref. No.</b> —
	impellor ø 72mm H 18mm thread M7 shaft ø 11mm shaft length 32mm blades 3		
	<b>GEV No.</b>	521703	<b>Ref. No.</b> —
	pump cover gasket EPDM thickness 2.5mm ID ø 75mm Qty 1 pcs		



1

<b>GEV No.</b>	499135	<b>Ref. No.</b>	4054
<b>description</b>	pump inlet ø 45mm outlet ø 40mm type ZF350SX 230/400V 50Hz 3 phase 0.61kW L 220mm rotation direction right LGB		
<b>For models:</b>	F-1040		
<b>spare parts for</b>	499135		
	<b>GEV No.</b>	510702	<b>Ref. No.</b> —
	mechanical shaft seal height counter ring 5.5mm ID ø 12mm		

**spare parts for** 499135

	<b>GEV No.</b>	521278	<b>Ref. No.</b>	—
	impellor ø 93mm H 32mm pump type ZF350SX thread M8L			
	<b>GEV No.</b>	521542	<b>Ref. No.</b>	—
	pump cover LGB inlet ø 45mm outlet ø 40mm auxiliary pressure connection 13mm supporting pressure open ø 150mm ID ø 120mm inner height 25mm			
	<b>GEV No.</b>	521714	<b>Ref. No.</b>	—
	pump cover gasket thickness 4x4mm Qty 1 pcs			

**OLYMPIA**  
pumps



1

<b>GEV No.</b>	499208	<b>Ref. No.</b>	4053	
<b>description</b>	pump inlet ø 45mm outlet ø 40mm type L80.T100 230V 50Hz 1 phase 0.75kW 1HP L 210mm rotation direction right capacitor 12.5µF OLYMPIA			
<b>For models:</b>	F-1040			
<b>spare parts for</b>	499208			
	<b>GEV No.</b>	365014	<b>Ref. No.</b>	234
	operating capacitor capacity 12.5µF 450V tolerance 5%Hz ambient temperature max. -25 to +85°C ø 35mm L 70mm M8 plastic connection male faston 6.3mm 45S.C3DS.12.5 protection			
	<b>GEV No.</b>	510693	<b>Ref. No.</b>	—
	mechanical shaft seal for shaft ø 12mm slide ring ext. ø 24mm slide ring H 15.5mm slide ring int. ø 11mm counter ring mounting ø 24mm height counter ring 8mm counter ring int. ø 13.5mm			



## booster pumps II

## accessories



1

<b>GEV No.</b>	365012	<b>Ref. No.</b>	402
<b>description</b>	operating capacitor capacity 6.3µF 450V tolerance 5% 50Hz ambient temperature max. -25 to +85°C ø 30mm L 61mm M8 plastic connection male faston 6.3mm protection		
<b>For models:</b>	F-1221-N, F-1221-REVOL, F-400		

## condensators &amp; interference suppression filters

## operating capacitors

## plastic



1

<b>GEV No.</b>	365014	<b>Ref. No.</b>	234
<b>description</b>	operating capacitor capacity 12.5µF 450V tolerance 5%Hz ambient temperature max. -25 to +85°C ø 35mm L 70mm M8 plastic connection male faston 6.3mm 45S.C3DS.12.5 protection		
<b>For models:</b>	F-430		



1

<b>GEV No.</b>	365021	<b>Ref. No.</b>	2036
<b>description</b>	operating capacitor capacity 16µF 425V tolerance 5% 50/60Hz ambient temperature max. -25 to +85°C ø 35mm L 73mm single M8 plastic connection male faston 6.3mm 416.10.99 protection		
<b>For models:</b>	F-532		



1

<b>GEV No.</b>	365012	<b>Ref. No.</b>	402
<b>description</b>	operating capacitor capacity 6.3µF 450V tolerance 5% 50Hz ambient temperature max. -25 to +85°C ø 30mm L 61mm M8 plastic connection male faston 6.3mm protection		
<b>For models:</b>	F-1221-N, F-1221-REVOL, F-400		

## filters

## interference suppression filters



1

<b>GEV No.</b>	365044	<b>Ref. No.</b>	2779
<b>description</b>	interference suppression filter type FC701Y2F 250V 50-60Hz conductor 2 with E connection cable 200mm L 42mm ø 23mm Hmm Wmm plastic Qty 1 pcs		
<b>For models:</b>	F-430, F-532		

## electric accessories

## terminals

## terminal blocks

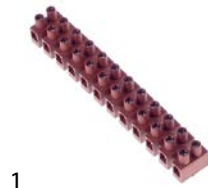

1

<b>GEV No.</b>	550838	<b>Ref. No.</b>	4251 891
<b>description</b>	lustre terminal 12-pole cross section 6mm <sup>2</sup> max. 41A max 750V temp.-resist. 150°C		
<b>For models:</b>	F-1040, F-1221-N, F-1221-REVOL, F-400, F-430, F-532		

## accessories

## miscellaneous







1

<b>GEV No.</b>	508218	<b>Ref. No.</b>	3125
<b>description</b>	signboard		
<b>For models:</b>	F-1221-N, F-430, F-532		



## gas taps

### SABAF

			
1			
<b>GEV No.</b>	106581	<b>Ref. No.</b>	4.0.100.0030
<b>description</b>	gas tap SABAF type 10 gas inlet pipe flange ø14mm bypass nozzle ø 0mm gas outlet 1/4" (tube ø 8mm) front fixing M13x1 thermocouple connection M8x1 shaft ø 8x6.5mm shaft L 31.5/12.5mm shaft flat right		
<b>For models:</b>	GCT2x6, GCT6, GGP10.6, GGP10.8, GGP15.10, GGP15.10M, GGP15.6, GGP15.6M, GGP15.8, GGP15.8M, GGP6.4F, GGP6.6F, GGP6.8F, PGF-1200, PGF-300, PGF-300-F, PGF-600, PGF-600-F, PGF-800, PGF-800-F, PPGF-600, PPGF-600-CRD, PPGF-800, PPGF-800-CRD, PPGF-M-600, PPGF-M-600-CRD, PPGF-M-800, PPGF-M-800-CRD		
<b>spare parts for</b>	106581		
		GEV No.	106724 Ref. No. —
	magnet unit L 30mm D1 ø 12.5mm D2 ø 8.5mm suitable for SABAF		
<b>accessories for</b>	106581		
		GEV No.	101277 Ref. No. —
	olive ID ø 8mm Qty 1 pcs		
		GEV No.	101376 Ref. No. —
	gasket ID ø 8mm ED ø 12mm H 3/5mm		
		GEV No.	101751 Ref. No. —
	bracket		
		GEV No.	520656 Ref. No. —
	union nut thread 1/4" tube ø 6/8mm		

## ignition parts

### electrodes

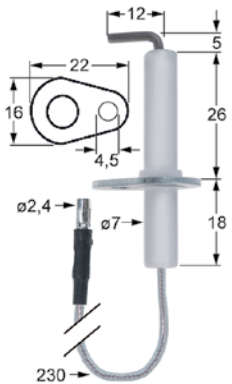
			
1			
<b>GEV No.</b>	106583	<b>Ref. No.</b>	4.0.100.0075
<b>description</b>	ignition electrode flange length 22mm flange width 16mm D1 ø 7mm L1 5mm L2 12mm BL1 26mm BL2 18mm connection ø2.4mm cable length 230mm fixing dimensions ø4.5mm		
<b>For models:</b>	BMF-1-1-G, BMF-1-1-G-SP, BMF-6CG, GGP10.6, GGP10.8, GGP15.10, GGP15.10C, GGP15.10M, GGP15.10MC, GGP15.6, GGP15.6C, GGP15.6M, GGP15.6MC, GGP15.8, GGP15.8C, GGP15.8M, GGP15.8MC, PGF-1200, PGF-300, PGF-300-F, PGF-600, PGF-600-F, PGF-800, PGF-800-F, PPGF-600, PPGF-600-CRD, PPGF-600-CRD-T, PPGF-800, PPGF-800-CRD, PPGF-800-CRD-T, PPGF-M-600, PPGF-M-600-CRD, PPGF-M-800, PPGF-M-800-CRD, PPGF-M-800-CRD-T		

## piezoelectric igniters

### mounting diameter 18mm

			
1			
<b>GEV No.</b>	100009	<b>Ref. No.</b>	4.0.100.0070 4.0.100.0075
<b>description</b>	piezoelectric igniter body plastic blowing mounting ø 18mm connection ø2.4mm front measurements 26mm M18x1.5		
<b>For models:</b>	BMF-1-1-G, BMF-1-1-G-SP, BMF-6CG, GGP10.6, GGP10.8, GGP15.10, GGP15.10C, GGP15.10M, GGP15.10MC, GGP15.6, GGP15.6C, GGP15.6M, GGP15.6MC, GGP15.8, GGP15.8C, GGP15.8M, GGP15.8MC, PGF-1200, PGF-300, PGF-300-F, PGF-600, PGF-600-F, PGF-800, PGF-800-F, PPGF-600, PPGF-600-CRD, PPGF-600-CRD-T, PPGF-800, PPGF-800-CRD, PPGF-800-CRD-T, PPGF-M-600, PPGF-M-600-CRD, PPGF-M-800, PPGF-M-800-CRD, PPGF-M-800-CRD-T		
<b>accessories for</b>	100009		
		GEV No.	101339 Ref. No. —
	cover cap for piezoelectric igniter		
		GEV No.	106869 Ref. No. —
	cover cap for piezoelectric igniter ID ø 22mm ED ø 35mm H 25mm		
		GEV No.	107931 Ref. No. —
	cover cap for piezoelectric igniter ID ø 21mm ED ø 36mm		

## thermocouples

### threaded thermocouples

#### threaded thermocouples standard

#### with socket with thread M8x1

#### SIT

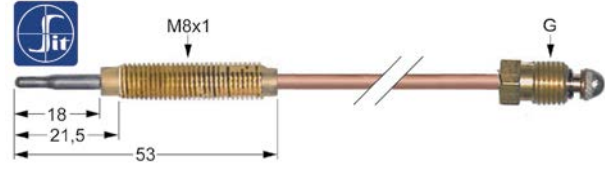
			
1			
<b>GEV No.</b>	107627	<b>Ref. No.</b>	4.0.100.0055
<b>description</b>	thermocouple SIT M8x1 L 220mm M8x1		
<b>For models:</b>	BMF-1-1-G, BMF-1-1-G-SP, GGP10.6, GGP10.8, GGP15.10, GGP15.10M, GGP15.6, GGP15.6M, GGP15.8, GGP15.8M, PGF-1200, PGF-300, PGF-300-F, PGF-600, PGF-600-F, PGF-800, PGF-800-F, PPGF-600, PPGF-600-CRD, PPGF-600-CRD-T, PPGF-800, PPGF-800-CRD, PPGF-800-CRD-T, PPGF-M-600, PPGF-M-600-CRD, PPGF-M-800, PPGF-M-800-CRD, PPGF-M-800-CRD-T		

## gas burners

### bar burners

#### bar burners



<b>GEV No.</b>	104770	<b>Ref. No.</b>	7.0.120.0038
<b>description</b>	bar burner ø 40mm Wmm Hmm L 290mm 5kW chargrill		
<b>For models:</b>	GGP10.6, GGP10.8, GGP15.10, GGP15.10C, GGP15.10M, GGP15.10MC, GGP15.6, GGP15.6C, GGP15.6M, GGP15.6MC, GGP15.8, GGP15.8C, GGP15.8M, GGP15.8MC, PPGF-600, PPGF-600-CRD, PPGF-600-CRD-T, PPGF-800, PPGF-800-CRD, PPGF-800-CRD-T, PPGF-M-600, PPGF-M-600-CRD, PPGF-M-800, PPGF-M-800-CRD, PPGF-M-800-CRD-T		

#### filter holders short



<b>GEV No.</b>	525845	<b>Ref. No.</b>	5.0.000.0657
<b>description</b>	filter holder mounting ø 83mm outlet 3/8" ID ø 62mm handle M12x1.75 wedge height 9mm wedge position horizontal number of wedges 2 lever inclined		
<b>For models:</b>	ATLANTIC-I-CV-NV, ATLANTIC-I-CV-PCI-NV, ATLANTIC-I-CV-TI-NV, ATLANTIC-II-COMPACT, ATLANTIC-II-CV-COMPACT, ATLANTIC-II-CV-NV, ATLANTIC-II-CV-PCI-NV, ATLANTIC-II-CV-TALL-CUPS, ATLANTIC-II-CV-TI-COMPACT, ATLANTIC-II-CV-TI-NV, ATLANTIC-II-CV-TI-TALL-CUPS, ATLANTIC-III, ATLANTIC-III-CV, ATLANTIC-III-CV-TI, ATLANTIC-III-TI, ATLANTIC-II-NV, ATLANTIC-II-PCI-NV, ATLANTIC-II-TALL-CUPS, ATLANTIC-II-TI-NV, ATLANTIC-I-PCI-NV, ATLANTIC-I-TI-NV, MARINA, MARINA-CV, MARINA-CV-DI, MINIBAR-NV, PACIFIC-2CV, PACIFIC-3CV, PACIFIC-3CV-W, PRESTIGE-II-CV-ECC, PRESTIGE-II-CV-REVOL, PRESTIGE-II-ECC, PRESTIGE-III-CV-REVOL, PRESTIGE-III-REVOL, PRESTIGE-II-REVOL		

## gas nozzles

### main nozzles

#### gas nozzles (other)



<b>GEV No.</b>	106582	<b>Ref. No.</b>	4.0.100.0062
<b>description</b>	gas injector T1: 1/4" T2: 1/8" WS 17 bore ø 0.9mm		
<b>For models:</b>	GGP10.6, GGP10.8, GGP15.6, GGP15.6C, GGP15.6M, GGP15.6MC, GGP15.8, GGP15.8C, GGP15.8M, GGP15.8MC, PPGF-600, PPGF-600-CRD, PPGF-600-CRD-T, PPGF-800, PPGF-800-CRD, PPGF-800-CRD-T, PPGF-M-600, PPGF-M-600-CRD, PPGF-M-800, PPGF-M-800-CRD, PPGF-M-800-CRD-T		

#### filters

##### for 1 cup



<b>GEV No.</b>	526261	<b>Ref. No.</b>	5.0.000.0170
<b>description</b>	coffee filter ø 70mm mounting ø 60.5mm H 20.5mm cups 1 amount of coffee 6.5g		
<b>For models:</b>	ATLANTIC-I-CV-NV, ATLANTIC-I-CV-PCI-NV, ATLANTIC-I-CV-TI-NV, ATLANTIC-II-COMPACT, ATLANTIC-II-CV-COMPACT, ATLANTIC-II-CV-NV, ATLANTIC-II-CV-PCI-NV, ATLANTIC-II-CV-TALL-CUPS, ATLANTIC-II-CV-TI-COMPACT, ATLANTIC-II-CV-TI-NV, ATLANTIC-II-CV-TI-TALL-CUPS, ATLANTIC-III, ATLANTIC-III-CV, ATLANTIC-III-CV-TI, ATLANTIC-III-TI, ATLANTIC-II-NV, ATLANTIC-II-PCI-NV, ATLANTIC-II-TALL-CUPS, ATLANTIC-II-TI-NV, ATLANTIC-I-PCI-NV, ATLANTIC-I-TI-NV, MARINA, MARINA-CV, MARINA-CV-DI, Minibar, MINIBAR-NV, PACIFIC-2CV, PACIFIC-3CV, PACIFIC-3CV-W, Prestige-II, PRESTIGE-II-CV-ECC, PRESTIGE-II-CV-REVOL, PRESTIGE-II-ECC, Prestige-III, PRESTIGE-III-CV-REVOL, PRESTIGE-III-REVOL, PRESTIGE-II-REVOL, Superbar		

## equipment-specific units

### for espresso machines

#### filter holders

##### filter holders standard

##### filter holder without spout



<b>GEV No.</b>	525999	<b>Ref. No.</b>	N/A
<b>description</b>	filter holder suitable for RST-FIAMMA without outlet mounting ø 83mm outlet 3/8" ID ø 62mm wedge height 9mm wedge position horizontal number of wedges 2 lever inclined		

##### for 2 cups



<b>GEV No.</b>	529014	<b>Ref. No.</b>	5.0.000.0173
<b>description</b>	coffee filter ø 70mm mounting ø 60mm H 21mm cups 2 amount of coffee 12g perforation ø 0.3mm round		
<b>For models:</b>	ATLANTIC-I-CV-NV, ATLANTIC-I-CV-PCI-NV, ATLANTIC-I-CV-TI-NV, ATLANTIC-II-COMPACT, ATLANTIC-II-CV-COMPACT, ATLANTIC-II-CV-NV, ATLANTIC-II-CV-PCI-NV, ATLANTIC-II-CV-TALL-CUPS, ATLANTIC-II-CV-TI-COMPACT, ATLANTIC-II-CV-TI-NV, ATLANTIC-II-CV-TI-TALL-CUPS, ATLANTIC-III, ATLANTIC-III-CV, ATLANTIC-III-CV-TI, ATLANTIC-III-TI, ATLANTIC-II-NV, ATLANTIC-II-PCI-NV, ATLANTIC-II-TALL-CUPS, ATLANTIC-II-TI-NV, ATLANTIC-I-PCI-NV, ATLANTIC-I-TI-NV, MARINA, MARINA-CV, MARINA-CV-DI, Minibar, MINIBAR-NV, PACIFIC-2CV, PACIFIC-3CV, PACIFIC-3CV-W, Prestige-II, PRESTIGE-II-CV-ECC, PRESTIGE-II-CV-REVOL, PRESTIGE-II-ECC, Prestige-III, PRESTIGE-III-CV-REVOL, PRESTIGE-III-REVOL, PRESTIGE-II-REVOL, Superbar		

brewing units

shower screens

with upstand



1

<b>GEV No.</b>	525844	<b>Ref. No.</b>	5.0.025.0010
<b>description</b>	shower screen ø 55.3mm H 18.2mm		
<b>For models:</b>	ATLANTIC-I-CV-NV, ATLANTIC-I-CV-PCI-NV, ATLANTIC-I-CV-TI-NV, ATLANTIC-II-COMPACT, ATLANTIC-II-CV-COMPACT, ATLANTIC-II-CV-NV, ATLANTIC-II-CV-PCI-NV, ATLANTIC-II-CV-TALL-CUPS, ATLANTIC-II-CV-TI-COMPACT, ATLANTIC-II-CV-TI-NV, ATLANTIC-II-CV-TI-TALL-CUPS, ATLANTIC-III, ATLANTIC-III-CV, ATLANTIC-III-CV-TI, ATLANTIC-III-TI, ATLANTIC-II-NV, ATLANTIC-II-PCI-NV, ATLANTIC-II-TALL-CUPS, ATLANTIC-II-TI-NV, ATLANTIC-I-PCI-NV, ATLANTIC-I-TI-NV, MARINA, MARINA-CV, MARINA-CV-DI, PACIFIC-2CV, PACIFIC-3CV, PACIFIC-3CV-W, PRESTIGE-II-CV-ECC, PRESTIGE-II-CV-REVOL, PRESTIGE-III-CV-REVOL, PRESTIGE-III-REVOL, PRESTIGE-II-REVOL		

filter holder gaskets

flat

standard



1

<b>GEV No.</b>	526064	<b>Ref. No.</b>	5.0.025.0012
<b>description</b>	filter holder gasket D1 ø 73.3mm D2 ø 57.3mm H 8.5mm Qty 1 pcs		
<b>For models:</b>	ATLANTIC-I-CV-NV, ATLANTIC-I-CV-PCI-NV, ATLANTIC-I-CV-TI-NV, ATLANTIC-II-COMPACT, ATLANTIC-II-CV-COMPACT, ATLANTIC-II-CV-NV, ATLANTIC-II-CV-PCI-NV, ATLANTIC-II-CV-TALL-CUPS, ATLANTIC-II-CV-TI-COMPACT, ATLANTIC-II-CV-TI-NV, ATLANTIC-II-CV-TI-TALL-CUPS, ATLANTIC-III, ATLANTIC-III-CV, ATLANTIC-III-CV-TI, ATLANTIC-III-TI, ATLANTIC-II-NV, ATLANTIC-II-PCI-NV, ATLANTIC-II-TALL-CUPS, ATLANTIC-II-TI-NV, ATLANTIC-I-PCI-NV, ATLANTIC-I-TI-NV, MARINA, MARINA-CV, MARINA-CV-DI, MINIBAR-NV, PACIFIC-2CV, PACIFIC-3CV, PACIFIC-3CV-W, PRESTIGE-II-CV-ECC, PRESTIGE-II-CV-REVOL, PRESTIGE-III-CV-REVOL, PRESTIGE-III-REVOL, PRESTIGE-II-REVOL		

brewing units with solenoid valve

components



1

<b>GEV No.</b>	525840	<b>Ref. No.</b>	5.0.016.0105
<b>description</b>	infusor 1/2" L 42mm WS 23		
<b>For models:</b>	ATLANTIC-I-CV-NV, ATLANTIC-I-CV-PCI-NV, ATLANTIC-I-CV-TI-NV, ATLANTIC-II-COMPACT, ATLANTIC-II-CV-COMPACT, ATLANTIC-II-CV-NV, ATLANTIC-II-CV-PCI-NV, ATLANTIC-II-CV-TALL-CUPS, ATLANTIC-II-CV-TI-COMPACT, ATLANTIC-II-CV-TI-NV, ATLANTIC-II-CV-TI-TALL-CUPS, ATLANTIC-III, ATLANTIC-III-CV, ATLANTIC-III-CV-TI, ATLANTIC-III-TI, ATLANTIC-II-NV, ATLANTIC-II-PCI-NV, ATLANTIC-II-TALL-CUPS, ATLANTIC-II-TI-NV, ATLANTIC-I-PCI-NV, ATLANTIC-I-TI-NV, MARINA, MARINA-CV, MARINA-CV-DI, PRESTIGE-II-CV-ECC, PRESTIGE-II-ECC		

components

nozzles

with thread



1

<b>GEV No.</b>	528486	<b>Ref. No.</b>	5.0.016.0110
<b>description</b>	nozzle bore ø 0.7mm thread M6x0.75 L 9mm WS 7		
<b>For models:</b>	ATLANTIC-I-CV-NV, ATLANTIC-I-CV-PCI-NV, ATLANTIC-I-CV-TI-NV, ATLANTIC-II-COMPACT, ATLANTIC-II-CV-COMPACT, ATLANTIC-II-CV-NV, ATLANTIC-II-CV-PCI-NV, ATLANTIC-II-CV-TALL-CUPS, ATLANTIC-II-CV-TI-COMPACT, ATLANTIC-II-CV-TI-NV, ATLANTIC-II-CV-TI-TALL-CUPS, ATLANTIC-III, ATLANTIC-III-CV, ATLANTIC-III-CV-TI, ATLANTIC-III-TI, ATLANTIC-II-NV, ATLANTIC-II-PCI-NV, ATLANTIC-II-TALL-CUPS, ATLANTIC-II-TI-NV, ATLANTIC-I-PCI-NV, ATLANTIC-I-TI-NV, MARINA, MARINA-CV, MARINA-CV-DI, PRESTIGE-II-CV-ECC, PRESTIGE-II-ECC		



1

<b>GEV No.</b>	525250	<b>Ref. No.</b>	5.0.025.0024
<b>description</b>	nozzle bore ø 0.8mm thread M6x0.75 L 9mm		
<b>For models:</b>	PACIFIC-2CV, PACIFIC-3CV, PACIFIC-3CV-W, PRESTIGE-II-CV-REVOL, PRESTIGE-III-CV-REVOL, PRESTIGE-III-REVOL, PRESTIGE-II-REVOL		

water dispersions

water dispersions

group 2



1

<b>GEV No.</b>	525756	<b>Ref. No.</b>	5.0.025.0009
<b>description</b>	water distributor ø 30mm hole ø 1.5mm H 15mm ET M10x1 grooves 6 2.6mm brass 2 holes perforation ø 1mm		
<b>For models:</b>	ATLANTIC-I-CV-NV, ATLANTIC-I-CV-PCI-NV, ATLANTIC-I-CV-TI-NV, ATLANTIC-II-COMPACT, ATLANTIC-II-CV-COMPACT, ATLANTIC-II-CV-NV, ATLANTIC-II-CV-PCI-NV, ATLANTIC-II-CV-TALL-CUPS, ATLANTIC-II-CV-TI-COMPACT, ATLANTIC-II-CV-TI-NV, ATLANTIC-II-CV-TI-TALL-CUPS, ATLANTIC-III, ATLANTIC-III-CV, ATLANTIC-III-CV-TI, ATLANTIC-III-TI, ATLANTIC-II-NV, ATLANTIC-II-PCI-NV, ATLANTIC-II-TALL-CUPS, ATLANTIC-II-TI-NV, ATLANTIC-I-PCI-NV, ATLANTIC-I-TI-NV, MARINA, MARINA-CV, MARINA-CV-DI, PACIFIC-2CV, PACIFIC-3CV, PACIFIC-3CV-W, PRESTIGE-II-CV-ECC, PRESTIGE-II-CV-REVOL, PRESTIGE-II-ECC, PRESTIGE-III-CV-REVOL, PRESTIGE-III-REVOL, PRESTIGE-II-REVOL		

## safety valves

## safety valves

3/8"



1

<b>GEV No.</b>	529879	<b>Ref. No.</b>	4.0.000.0051
<b>description</b>	safety valve connection 3/8" triggering pressure 1.6bar approval CE 0036 sealed		
<b>For models:</b>	ATLANTIC-I-CV-NV, ATLANTIC-I-CV-PCI-NV, ATLANTIC-I-CV-TI-NV, ATLANTIC-II-COMPACT, ATLANTIC-II-CV-COMPACT, ATLANTIC-II-CV-NV, ATLANTIC-II-CV-PCI-NV, ATLANTIC-II-CV-TALL-CUPS, ATLANTIC-II-CV-TI-COMPACT, ATLANTIC-II-CV-TI-NV, ATLANTIC-II-CV-TI-TALL-CUPS, ATLANTIC-III, ATLANTIC-III-CV, ATLANTIC-III-CV-TI, ATLANTIC-III-TI, ATLANTIC-II-NV, ATLANTIC-II-PCI-NV, ATLANTIC-II-TALL-CUPS, ATLANTIC-II-TI-NV, ATLANTIC-I-PCI-NV, ATLANTIC-I-TI-NV, MARINA, MARINA-CV, MARINA-CV-DI, PACIFIC-2CV, PACIFIC-3CV, PACIFIC-3CV-W, Prestige-II, PRESTIGE-II-CV-ECC, PRESTIGE-II-CV-REVOL, PRESTIGE-II-ECC, Prestige-III, PRESTIGE-III-CV-REVOL, PRESTIGE-III-REVOL, PRESTIGE-II-REVOL, Superbar		

## expansion valves

## with hose connection



1

<b>GEV No.</b>	526587	<b>Ref. No.</b>	5.0.016.0220
<b>description</b>	expansion valve T1: 1/4" ET hose ø 9.5mm L 42mm		
<b>For models:</b>	ATLANTIC-I-CV-NV, ATLANTIC-I-CV-PCI-NV, ATLANTIC-I-CV-TI-NV, ATLANTIC-II-COMPACT, ATLANTIC-II-CV-COMPACT, ATLANTIC-II-CV-NV, ATLANTIC-II-CV-PCI-NV, ATLANTIC-II-CV-TALL-CUPS, ATLANTIC-II-CV-TI-COMPACT, ATLANTIC-II-CV-TI-NV, ATLANTIC-II-CV-TI-TALL-CUPS, ATLANTIC-III, ATLANTIC-III-CV, ATLANTIC-III-CV-TI, ATLANTIC-III-TI, ATLANTIC-II-NV, ATLANTIC-II-PCI-NV, ATLANTIC-II-TALL-CUPS, ATLANTIC-II-TI-NV, ATLANTIC-I-PCI-NV, ATLANTIC-I-TI-NV, MARINA, MARINA-CV, MARINA-CV-DI, PACIFIC-2CV, PACIFIC-3CV, PACIFIC-3CV-W, PRESTIGE-II-CV-ECC, PRESTIGE-II-CV-REVOL, PRESTIGE-II-ECC, PRESTIGE-III-CV-REVOL, PRESTIGE-III-REVOL, PRESTIGE-II-REVOL		

## gaskets



1

<b>GEV No.</b>	525822	<b>Ref. No.</b>	5.0.016.0223
<b>description</b>	gasket ED ø 15mm seat ø 6mm H 5.2mm overall height 10mm		
<b>For models:</b>	ATLANTIC-I-CV-NV, ATLANTIC-I-CV-PCI-NV, ATLANTIC-I-CV-TI-NV, ATLANTIC-II-COMPACT, ATLANTIC-II-CV-COMPACT, ATLANTIC-II-CV-NV, ATLANTIC-II-CV-PCI-NV, ATLANTIC-II-CV-TALL-CUPS, ATLANTIC-II-CV-TI-COMPACT, ATLANTIC-II-CV-TI-NV, ATLANTIC-II-CV-TI-TALL-CUPS, ATLANTIC-III, ATLANTIC-III-CV, ATLANTIC-III-CV-TI, ATLANTIC-III-TI, ATLANTIC-II-NV, ATLANTIC-II-PCI-NV, ATLANTIC-II-TALL-CUPS, ATLANTIC-II-TI-NV, ATLANTIC-I-PCI-NV, ATLANTIC-I-TI-NV, MARINA, MARINA-CV, MARINA-CV-DI, PACIFIC-2CV, PACIFIC-3CV, PACIFIC-3CV-W, PRESTIGE-II-CV-ECC, PRESTIGE-II-CV-REVOL, PRESTIGE-II-ECC, PRESTIGE-III-CV-REVOL, PRESTIGE-III-REVOL, PRESTIGE-II-REVOL		

## drain pans

## drain pans



1

<b>GEV No.</b>	525841	<b>Ref. No.</b>	4.0.000.0840
<b>description</b>	drain pan L 110mm W 85mm H 50mm hose ø 15mm		
<b>For models:</b>	ATLANTIC-I-CV-NV, ATLANTIC-I-CV-PCI-NV, ATLANTIC-I-CV-TI-NV, ATLANTIC-II-COMPACT, ATLANTIC-II-CV-COMPACT, ATLANTIC-II-CV-NV, ATLANTIC-II-CV-PCI-NV, ATLANTIC-II-CV-TALL-CUPS, ATLANTIC-II-CV-TI-COMPACT, ATLANTIC-II-CV-TI-NV, ATLANTIC-II-CV-TI-TALL-CUPS, ATLANTIC-III, ATLANTIC-III-CV, ATLANTIC-III-CV-TI, ATLANTIC-III-TI, ATLANTIC-II-NV, ATLANTIC-II-PCI-NV, ATLANTIC-II-TALL-CUPS, ATLANTIC-II-TI-NV, ATLANTIC-I-PCI-NV, ATLANTIC-I-TI-NV, MARINA, MARINA-CV, MARINA-CV-DI, PACIFIC-2CV, PACIFIC-3CV, PACIFIC-3CV-W, PRESTIGE-II-CV-ECC, PRESTIGE-II-CV-REVOL, PRESTIGE-II-ECC, PRESTIGE-III-CV-REVOL, PRESTIGE-III-REVOL, PRESTIGE-II-REVOL		

## aerators and air bleeders



1

<b>GEV No.</b>	529304	<b>Ref. No.</b>	5.0.000.1002
<b>description</b>	aerator and air bleeder screw connection 1/4"		
<b>For models:</b>	ATLANTIC-I-CV-NV, ATLANTIC-I-CV-PCI-NV, ATLANTIC-I-CV-TI-NV, ATLANTIC-II-COMPACT, ATLANTIC-II-CV-COMPACT, ATLANTIC-II-CV-NV, ATLANTIC-II-CV-PCI-NV, ATLANTIC-II-CV-TALL-CUPS, ATLANTIC-II-CV-TI-COMPACT, ATLANTIC-II-CV-TI-NV, ATLANTIC-II-CV-TI-TALL-CUPS, ATLANTIC-III, ATLANTIC-III-CV, ATLANTIC-III-CV-TI, ATLANTIC-III-TI, ATLANTIC-II-NV, ATLANTIC-II-PCI-NV, ATLANTIC-II-TALL-CUPS, ATLANTIC-II-TI-NV, ATLANTIC-I-PCI-NV, ATLANTIC-I-TI-NV, MARINA, MARINA-CV, MARINA-CV-DI, PACIFIC-2CV, PACIFIC-3CV, PACIFIC-3CV-W, Prestige-II, PRESTIGE-II-CV-ECC, PRESTIGE-II-CV-REVOL, PRESTIGE-II-ECC, Prestige-III, PRESTIGE-III-CV-REVOL, PRESTIGE-III-REVOL, PRESTIGE-II-REVOL, Superbar		

## steam/water taps

## steam/water taps

## steam/water taps





1

<b>GEV No.</b>	525833	<b>Ref. No.</b>	5.0.002.0100
<b>description</b>	steam/water tap inlet 1/4" outlet 1/4" series MARINA		
<b>For models:</b>	MARINA, MARINA-CV, MARINA-CV-DI		





			
1			
<b>GEV No.</b>	531053	<b>Ref. No.</b>	5.0.016.0350
<b>description</b>	steam/water tap inlet 1/4" outlet 3/8" shaft 6mm shaft L 14mm		
<b>For models:</b>	ATLANTIC-I-CV-NV, ATLANTIC-I-CV-PCI-NV, ATLANTIC-I-CV-TI-NV, ATLANTIC-II-COMPACT, ATLANTIC-II-CV-COMPACT, ATLANTIC-II-CV-NV, ATLANTIC-II-CV-PCI-NV, ATLANTIC-II-CV-TALL-CUPS, ATLANTIC-II-CV-TI-COMPACT, ATLANTIC-II-CV-TI-NV, ATLANTIC-II-CV-TI-TALL-CUPS, ATLANTIC-III, ATLANTIC-III-CV, ATLANTIC-III-CV-TI, ATLANTIC-III-TI, ATLANTIC-II-NV, ATLANTIC-II-PCI-NV, ATLANTIC-II-TALL-CUPS, ATLANTIC-II-TI-NV, ATLANTIC-I-PCI-NV, ATLANTIC-I-TI-NV, PACIFIC-2CV, PACIFIC-3CV, PACIFIC-3CV-W, PRESTIGE-II-CV-ECC, PRESTIGE-II-CV-REVOL, PRESTIGE-III-CV-REVOL, PRESTIGE-III-REVOL, PRESTIGE-II-REVOL		

<p>steam taps</p> <p>steam taps (complete)</p> 			
1			
<b>GEV No.</b>	525835	<b>Ref. No.</b>	4.0.016.0020
<b>description</b>	steam tap inlet 1/4" thread Tr18x2		
<b>For models:</b>	ATLANTIC-I-CV-NV, ATLANTIC-I-CV-PCI-NV, ATLANTIC-I-CV-TI-NV, ATLANTIC-II-COMPACT, ATLANTIC-II-CV-COMPACT, ATLANTIC-II-CV-NV, ATLANTIC-II-CV-PCI-NV, ATLANTIC-II-CV-TALL-CUPS, ATLANTIC-II-CV-TI-COMPACT, ATLANTIC-II-CV-TI-NV, ATLANTIC-II-CV-TI-TALL-CUPS, ATLANTIC-III, ATLANTIC-III-CV, ATLANTIC-III-CV-TI, ATLANTIC-III-TI, ATLANTIC-II-NV, ATLANTIC-II-PCI-NV, ATLANTIC-II-TALL-CUPS, ATLANTIC-II-TI-NV, ATLANTIC-I-PCI-NV, ATLANTIC-I-TI-NV, PRESTIGE-II-CV-ECC, PRESTIGE-II-CV-REVOL, PRESTIGE-III-CV-REVOL, PRESTIGE-III-REVOL, PRESTIGE-II-REVOL		

<p>components</p> <p>bushes</p> 			
1			
<b>GEV No.</b>	525827	<b>Ref. No.</b>	5.0.016.0305
<b>description</b>	bush for steam-/water-tap D1 ø 9mm D2 ø 10.4mm ID ø 6.2mm H 4.5mm brass		
<b>For models:</b>	ATLANTIC-I-CV-NV, ATLANTIC-I-CV-PCI-NV, ATLANTIC-I-CV-TI-NV, ATLANTIC-II-COMPACT, ATLANTIC-II-CV-COMPACT, ATLANTIC-II-CV-NV, ATLANTIC-II-CV-PCI-NV, ATLANTIC-II-CV-TALL-CUPS, ATLANTIC-II-CV-TI-COMPACT, ATLANTIC-II-CV-TI-NV, ATLANTIC-II-CV-TI-TALL-CUPS, ATLANTIC-III, ATLANTIC-III-CV, ATLANTIC-III-CV-TI, ATLANTIC-III-TI, ATLANTIC-II-NV, ATLANTIC-II-PCI-NV, ATLANTIC-II-TALL-CUPS, ATLANTIC-II-TI-NV, ATLANTIC-I-PCI-NV, ATLANTIC-I-TI-NV, PACIFIC-2CV, PACIFIC-3CV, PACIFIC-3CV-W, PRESTIGE-II-CV-ECC, PRESTIGE-II-CV-REVOL, PRESTIGE-III-CV-REVOL, PRESTIGE-III-REVOL, PRESTIGE-II-REVOL		

<p>gaskets</p> 			
1			
<b>GEV No.</b>	526258	<b>Ref. No.</b>	5.0.016.0301
<b>description</b>	gasket D1 ø 12.5mm thickness 5.5mm silicone		
<b>For models:</b>	ATLANTIC-I-CV-NV, ATLANTIC-I-CV-PCI-NV, ATLANTIC-I-CV-TI-NV, ATLANTIC-II-COMPACT, ATLANTIC-II-CV-COMPACT, ATLANTIC-II-CV-NV, ATLANTIC-II-CV-PCI-NV, ATLANTIC-II-CV-TALL-CUPS, ATLANTIC-II-CV-TI-COMPACT, ATLANTIC-II-CV-TI-NV, ATLANTIC-II-CV-TI-TALL-CUPS, ATLANTIC-III, ATLANTIC-III-CV, ATLANTIC-III-CV-TI, ATLANTIC-III-TI, ATLANTIC-II-NV, ATLANTIC-II-PCI-NV, ATLANTIC-II-TI-NV, ATLANTIC-I-PCI-NV, ATLANTIC-I-TI-NV, PACIFIC-2CV, PACIFIC-3CV, PACIFIC-3CV-W, PRESTIGE-II-CV-ECC, PRESTIGE-II-CV-REVOL, PRESTIGE-III-CV-REVOL, PRESTIGE-III-REVOL, PRESTIGE-II-REVOL		

			
1			
<b>GEV No.</b>	525832	<b>Ref. No.</b>	5.0.002.0113
<b>description</b>	sealing disc D1 ø 7mm thickness 2mm PTFE for steam-/water-tap		
<b>For models:</b>	MARINA, MARINA-CV, MARINA-CV-DI		

<p>water taps</p> <p>water taps</p> 			
1			
<b>GEV No.</b>	525834	<b>Ref. No.</b>	4.0.016.0021
<b>description</b>	water tap inlet 1/4" thread Tr18x2		
<b>For models:</b>	ATLANTIC-I-CV-NV, ATLANTIC-I-CV-PCI-NV, ATLANTIC-I-CV-TI-NV, ATLANTIC-II-COMPACT, ATLANTIC-II-CV-COMPACT, ATLANTIC-II-CV-NV, ATLANTIC-II-CV-PCI-NV, ATLANTIC-II-CV-TALL-CUPS, ATLANTIC-II-CV-TI-COMPACT, ATLANTIC-II-CV-TI-NV, ATLANTIC-II-CV-TI-TALL-CUPS, ATLANTIC-III, ATLANTIC-III-CV, ATLANTIC-III-CV-TI, ATLANTIC-III-TI, ATLANTIC-II-NV, ATLANTIC-II-PCI-NV, ATLANTIC-II-TALL-CUPS, ATLANTIC-II-TI-NV, ATLANTIC-I-PCI-NV, ATLANTIC-I-TI-NV, PACIFIC-2CV, PACIFIC-3CV, PRESTIGE-II-CV-ECC, PRESTIGE-II-CV-REVOL, PRESTIGE-III-CV-REVOL, PRESTIGE-III-REVOL, PRESTIGE-II-REVOL		

<p>steam/water pipes</p> <p>steam pipes</p> 			
1			
<b>GEV No.</b>	525839	<b>Ref. No.</b>	5.0.002.0120
<b>description</b>	steam pipe thread 1/4" H 160mm tube ø 8mm suitable for FIAMMA		
<b>For models:</b>	MARINA, MARINA-CV, MARINA-CV-DI		

			
1			
<b>GEV No.</b>	525838	<b>Ref. No.</b>	5.0.016.0320
<b>description</b>	steam pipe thread 3/8" H 180mm L 210mm $\varnothing$ 14.5mm tube $\varnothing$ 10mm stainless steel		
<b>For models:</b>	ATLANTIC-I-CV-NV, ATLANTIC-I-CV-PCI-NV, ATLANTIC-I-CV-TI-NV, ATLANTIC-II-COMPACT, ATLANTIC-II-CV-COMPACT, ATLANTIC-II-CV-NV, ATLANTIC-II-CV-PCI-NV, ATLANTIC-II-CV-TALL-CUPS, ATLANTIC-II-CV-TI-COMPACT, ATLANTIC-II-CV-TI-NV, ATLANTIC-II-CV-TI-TALL-CUPS, ATLANTIC-III, ATLANTIC-III-CV, ATLANTIC-III-CV-TI, ATLANTIC-III-TI, ATLANTIC-II-NV, ATLANTIC-II-PCI-NV, ATLANTIC-II-TALL-CUPS, ATLANTIC-II-TI-NV, ATLANTIC-I-PCI-NV, ATLANTIC-I-TI-NV, PRESTIGE-II-CV-ECC, PRESTIGE-II-CV-REVOL, PRESTIGE-II-ECC, PRESTIGE-III-CV-REVOL, PRESTIGE-III-REVOL, PRESTIGE-II-REVOL		

## water pipes

			
1			
<b>GEV No.</b>	531054	<b>Ref. No.</b>	5.0.016.0330
<b>description</b>	water pipe $\varnothing$ 23.5mm L 96mm tube $\varnothing$ 8mm head $\varnothing$ 14.5mm		
<b>For models:</b>	ATLANTIC-I-CV-NV, ATLANTIC-I-CV-PCI-NV, ATLANTIC-I-CV-TI-NV, ATLANTIC-II-COMPACT, ATLANTIC-II-CV-COMPACT, ATLANTIC-II-CV-NV, ATLANTIC-II-CV-PCI-NV, ATLANTIC-II-CV-TALL-CUPS, ATLANTIC-II-CV-TI-COMPACT, ATLANTIC-II-CV-TI-NV, ATLANTIC-II-CV-TI-TALL-CUPS, ATLANTIC-III, ATLANTIC-III-CV, ATLANTIC-III-CV-TI, ATLANTIC-III-TI, ATLANTIC-II-NV, ATLANTIC-II-PCI-NV, ATLANTIC-II-TALL-CUPS, ATLANTIC-II-TI-NV, ATLANTIC-I-PCI-NV, ATLANTIC-I-TI-NV, PACIFIC-2CV, PACIFIC-3CV, PACIFIC-3CV-W, PRESTIGE-II-CV-ECC, PRESTIGE-II-CV-REVOL, PRESTIGE-II-ECC, PRESTIGE-III-CV-REVOL, PRESTIGE-III-REVOL, PRESTIGE-II-REVOL		

			
1			
<b>GEV No.</b>	531055	<b>Ref. No.</b>	5.0.002.0130
<b>description</b>	water pipe thread 1/4" $\varnothing$ 23.5mm L 95.5mm tube $\varnothing$ 8mm		
<b>For models:</b>	MARINA, MARINA-CV, MARINA-CV-DI		

## accessories

## bushes

			
1			
<b>GEV No.</b>	525826	<b>Ref. No.</b>	5.0.025.6508
<b>description</b>	bush D1 $\varnothing$ 9mm D2 $\varnothing$ 12mm int. $\varnothing$ 17mm H 5mm brass		
<b>For models:</b>	ATLANTIC-I-CV-NV, ATLANTIC-I-CV-PCI-NV, ATLANTIC-I-CV-TI-NV, ATLANTIC-II-COMPACT, ATLANTIC-II-CV-COMPACT, ATLANTIC-II-CV-NV, ATLANTIC-II-CV-PCI-NV, ATLANTIC-II-CV-TALL-CUPS, ATLANTIC-II-CV-TI-COMPACT, ATLANTIC-II-CV-TI-NV, ATLANTIC-II-CV-TI-TALL-CUPS, ATLANTIC-III, ATLANTIC-III-CV, ATLANTIC-III-CV-TI, ATLANTIC-III-TI, ATLANTIC-II-NV, ATLANTIC-II-PCI-NV, ATLANTIC-II-TALL-CUPS, ATLANTIC-II-TI-NV, ATLANTIC-I-PCI-NV, ATLANTIC-I-TI-NV, PACIFIC-2CV, PACIFIC-3CV, PACIFIC-3CV-W, PRESTIGE-II-CV-ECC, PRESTIGE-II-CV-REVOL, PRESTIGE-II-ECC, PRESTIGE-III-CV-REVOL, PRESTIGE-III-REVOL, PRESTIGE-II-REVOL		

## gaskets

			
1			
<b>GEV No.</b>	510893	<b>Ref. No.</b>	697
<b>description</b>	O-ring EPDM thickness 2.62mm ID $\varnothing$ 9.92mm Qty 1 pcs		
<b>For models:</b>	F-1040, F-1221-N, F-1221-REVOL, F-400, F-430, F-532		

## fine filters

## fine filters

			
1			
<b>GEV No.</b>	528357	<b>Ref. No.</b>	5.0.025.0023
<b>description</b>	fine filter $\varnothing$ 8.5mm H 22mm		
<b>For models:</b>	ATLANTIC-I-CV-NV, ATLANTIC-I-CV-PCI-NV, ATLANTIC-I-CV-TI-NV, ATLANTIC-II-COMPACT, ATLANTIC-II-CV-COMPACT, ATLANTIC-II-CV-NV, ATLANTIC-II-CV-PCI-NV, ATLANTIC-II-CV-TALL-CUPS, ATLANTIC-II-CV-TI-COMPACT, ATLANTIC-II-CV-TI-NV, ATLANTIC-II-CV-TI-TALL-CUPS, ATLANTIC-III, ATLANTIC-III-CV, ATLANTIC-III-CV-TI, ATLANTIC-III-TI, ATLANTIC-II-NV, ATLANTIC-II-PCI-NV, ATLANTIC-II-TALL-CUPS, ATLANTIC-II-TI-NV, ATLANTIC-I-PCI-NV, ATLANTIC-I-TI-NV, MARINA, MARINA-CV, MARINA-CV-DI, PACIFIC-2CV, PACIFIC-3CV, PACIFIC-3CV-W, PRESTIGE-II-CV-ECC, PRESTIGE-II-CV-REVOL, PRESTIGE-II-ECC, PRESTIGE-III-CV-REVOL, PRESTIGE-III-REVOL, PRESTIGE-II-REVOL		

## intake valves

## intake valves

			
1			
<b>GEV No.</b>	523048	<b>Ref. No.</b>	4.0.002.0010
<b>description</b>	intake valve complete with solenoid valve		
<b>For models:</b>	MARINA, MARINA-CV, MARINA-CV-DI		

			
1			
<b>GEV No.</b>	525836	<b>Ref. No.</b>	5.0.000.0032
<b>description</b>	intake valve for FIAMMA		
<b>For models:</b>	PRESTIGE-II-CV-REVOL, PRESTIGE-III-CV-REVOL, PRESTIGE-III-REVOL, PRESTIGE-II-REVOL		



			
1			
<b>GEV No.</b>	525837	<b>Ref. No.</b>	4.0.016.0010
<b>description</b>	intake valve for FIAMMA		
<b>For models:</b>	ATLANTIC-I-CV-NV, ATLANTIC-I-CV-PCI-NV, ATLANTIC-I-CV-TI-NV, ATLANTIC-II-COMPACT, ATLANTIC-II-CV-COMPACT, ATLANTIC-II-CV-NV, ATLANTIC-II-CV-PCI-NV, ATLANTIC-II-CV-TALL-CUPS, ATLANTIC-II-CV-TI-COMPACT, ATLANTIC-II-CV-TI-NV, ATLANTIC-II-CV-TI-TALL-CUPS, ATLANTIC-III, ATLANTIC-III-CV, ATLANTIC-III-CV-TI, ATLANTIC-III-TI, ATLANTIC-II-NV, ATLANTIC-II-PCI-NV, ATLANTIC-II-TALL-CUPS, ATLANTIC-II-TI-NV, ATLANTIC-I-PCI-NV, ATLANTIC-I-TI-NV, PACIFIC-2CV, PACIFIC-3CV, PACIFIC-3CV-W, PRESTIGE-II-CV-ECC, PRESTIGE-II-ECC		

accessories

valves

			
1			
<b>GEV No.</b>	525831	<b>Ref. No.</b>	5.0.016.0212
<b>description</b>	valve for filling valve L 25.2mm square ED ø 16mm		
<b>For models:</b>	PRESTIGE-II-CV-REVOL, PRESTIGE-III-CV-REVOL, PRESTIGE-III-REVOL, PRESTIGE-II-REVOL		

level glasses

level glasses

pressure rings

			
1			
<b>GEV No.</b>	525828	<b>Ref. No.</b>	5.0.000.0000
<b>description</b>	press ring D1 ø 14.6mm ID ø 11.6mm H 3.6mm brass		
<b>For models:</b>	Prestige-II, PRESTIGE-II-CV-REVOL, Prestige-III, PRESTIGE-III-CV-REVOL, PRESTIGE-III-REVOL, PRESTIGE-II-REVOL		

level glasses (complete)

			
1			
<b>GEV No.</b>	525843	<b>Ref. No.</b>	5.0.000.1020
<b>description</b>	level glass pipe suitable for FIAMMA		
<b>For models:</b>	PRESTIGE-II-CV-REVOL, PRESTIGE-III-CV-REVOL, PRESTIGE-III-REVOL, PRESTIGE-II-REVOL		

level glass pipes

			
1			
<b>GEV No.</b>	525842	<b>Ref. No.</b>	5.0.000.1017
<b>description</b>	level glass pipe ø 11mm H 134mm ID ø 7.7mm marking Min/Max black		
<b>For models:</b>	Prestige-II, PRESTIGE-II-CV-REVOL, Prestige-III, PRESTIGE-III-CV-REVOL, PRESTIGE-III-REVOL, PRESTIGE-II-REVOL		

non-return valves

pistons

			
1			
<b>GEV No.</b>	525830	<b>Ref. No.</b>	5.0.016.0231
<b>description</b>	piston for non-return valve triangular ø 12mm L 20.3mm		
<b>For models:</b>	ATLANTIC-I-CV-NV, ATLANTIC-I-CV-PCI-NV, ATLANTIC-I-CV-TI-NV, ATLANTIC-II-COMPACT, ATLANTIC-II-CV-COMPACT, ATLANTIC-II-CV-NV, ATLANTIC-II-CV-PCI-NV, ATLANTIC-II-CV-TALL-CUPS, ATLANTIC-II-CV-TI-COMPACT, ATLANTIC-II-CV-TI-NV, ATLANTIC-II-CV-TI-TALL-CUPS, ATLANTIC-III, ATLANTIC-III-CV, ATLANTIC-III-CV-TI, ATLANTIC-III-TI, ATLANTIC-II-NV, ATLANTIC-II-PCI-NV, ATLANTIC-II-TALL-CUPS, ATLANTIC-II-TI-NV, ATLANTIC-I-PCI-NV, ATLANTIC-I-TI-NV, MARINA, MARINA-CV, MARINA-CV-DI, PACIFIC-2CV, PACIFIC-3CV, PACIFIC-3CV-W, PRESTIGE-II-CV-ECC, PRESTIGE-II-CV-REVOL, PRESTIGE-II-ECC, PRESTIGE-III-CV-REVOL, PRESTIGE-III-REVOL, PRESTIGE-II-REVOL		

for contact grills

miscellaneous

			
1			
<b>GEV No.</b>	700845	<b>Ref. No.</b>	4.0.075.0064
<b>description</b>	foot L 218mm H 40mm mounting distance 160mm for toaster W 75mm		
<b>For models:</b>	GR-4.1-L, GR-4.1-LTL, GR-4.2, GR-6.1, GR-6.1-L, GR-6.1-LTL, GR-8, GR-8.1-L, GR-8.2, GR-8.2-L, GR-8.2-LTL, GR-8-L, GR-M, GR-M.1, GR-M.2, GR-M.2-TLC, SEF-450, SEF-450I, SEF-650, SEF-650I, TOSTI-D3, TOSTI-S3, TRD-30.2, TRS-20.2		

## for dishwashers

## boilers

## boilers for dishwashers



1

<b>GEV No.</b>	508209	<b>Ref. No.</b>	2995
<b>description</b>	boiler		
<b>For models:</b>	F-430, F-532		



1

<b>GEV No.</b>	508283	<b>Ref. No.</b>	4889
<b>description</b>	boiler		
<b>For models:</b>	F-1040		



1

<b>GEV No.</b>	508221	<b>Ref. No.</b>	3161
<b>description</b>	boiler ø 120mm L 210mm		
<b>For models:</b>	F-1221-N, F-1221-REVOL, F-400		

## housing and bezels

## miscellaneous



1

<b>GEV No.</b>	508170	<b>Ref. No.</b>	2748
<b>description</b>	side panel mounting pos. lower		
<b>For models:</b>	F-1040		

## hood mechanics for dishwashers

## bushes



1

<b>GEV No.</b>	508134	<b>Ref. No.</b>	2579
<b>description</b>	cylinder liner hood guide		
<b>For models:</b>	F-1040		



1

<b>GEV No.</b>	508139	<b>Ref. No.</b>	2585
<b>description</b>	cylinder liner hood mechanics		
<b>For models:</b>	F-1040		



1

<b>GEV No.</b>	508130	<b>Ref. No.</b>	2574
<b>description</b>	spacer bush for spindle hood mechanics		
<b>For models:</b>	F-1040		

## spring holders



1

<b>GEV No.</b>	508131	<b>Ref. No.</b>	2576
<b>description</b>	bush for spring holder hood mechanics		
<b>For models:</b>	F-1040		

## guide bars



1

<b>GEV No.</b>	508190	<b>Ref. No.</b>	2862
<b>description</b>	guide bar hood mechanics		
<b>For models:</b>	F-1040		

## linkage



1

<b>GEV No.</b>	508154	<b>Ref. No.</b>	2706
<b>description</b>	spindle for hood handle		
<b>For models:</b>	F-1040		



hood handles



1			
<b>GEV No.</b>	508153	<b>Ref. No.</b>	2705
<b>description</b>	hood handle		
<b>For models:</b>	F-1040		

rollers

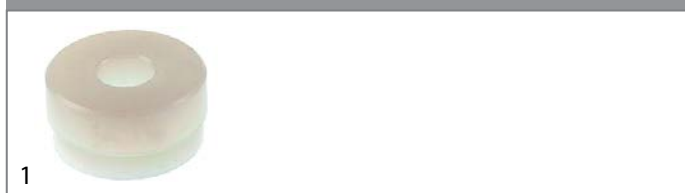

1			
<b>GEV No.</b>	508133	<b>Ref. No.</b>	2578
<b>description</b>	roller hood mechanics		
<b>For models:</b>	F-1040		

miscellaneous



1			
<b>GEV No.</b>	508137	<b>Ref. No.</b>	2582
<b>description</b>	actuator for microswitch hood mechanics		
<b>For models:</b>	F-1040		



1			
<b>GEV No.</b>	508132	<b>Ref. No.</b>	2577
<b>description</b>	bearing bolt hood mechanics		
<b>For models:</b>	F-1040		



1			
<b>GEV No.</b>	508140	<b>Ref. No.</b>	2586
<b>description</b>	bush for spindle with thread hood mechanics		
<b>For models:</b>	F-1040		



1			
<b>GEV No.</b>	508160	<b>Ref. No.</b>	2712
<b>description</b>	con rod for door shaft		
<b>For models:</b>	F-1040		



1			
<b>GEV No.</b>	508136	<b>Ref. No.</b>	2581
<b>description</b>	nut hood mechanics thread M32x1.5		
<b>For models:</b>	F-1040		



1			
<b>GEV No.</b>	508041	<b>Ref. No.</b>	626
<b>description</b>	rubber pad hood mechanics		
<b>For models:</b>	F-1040		



1			
<b>GEV No.</b>	508135	<b>Ref. No.</b>	2580
<b>description</b>	spacer piece hood mechanics		
<b>For models:</b>	F-1040		



1			
<b>GEV No.</b>	508168	<b>Ref. No.</b>	2738
<b>description</b>	spring holder		
<b>For models:</b>	F-1040		



			
1			
<b>GEV No.</b>	508159	<b>Ref. No.</b>	2711
<b>description</b>	spring holder hood mechanics		
<b>For models:</b>	F-1040		

			
1			
<b>GEV No.</b>	508138	<b>Ref. No.</b>	2583
<b>description</b>	stop bolt hood mechanics		
<b>For models:</b>	F-1040		

## air traps

## air traps

			
1			
<b>GEV No.</b>	508202	<b>Ref. No.</b>	2932
<b>description</b>	air trap		
<b>For models:</b>	F-1040, F-1221-N, F-430, F-532		
<b>spare parts for</b>	508202		
	<b>GEV No.</b>	508377	<b>Ref. No.</b> 3536
	hose connector		
<b>accessories for</b>	508202		
	<b>GEV No.</b>	508201	<b>Ref. No.</b> 2927
	formed hose warewashing L-shape equiv. no. 2927		
	<b>GEV No.</b>	508203	<b>Ref. No.</b> 2933
	pipe		
	<b>GEV No.</b>	511322	<b>Ref. No.</b> —
	O-ring EPDM thickness 3.53mm ID ø 20.22mm Qty 1 pcs		

			
1			
<b>GEV No.</b>	508376	<b>Ref. No.</b>	3535
<b>description</b>	air trap		
<b>For models:</b>	F-1221-REVOL		
<b>accessories for</b>	508376		
	<b>GEV No.</b>	508377	<b>Ref. No.</b> 3536
	hose connector		

<b>accessories for</b>	508376		
	<b>GEV No.</b>	511322	<b>Ref. No.</b> —
	O-ring EPDM thickness 3.53mm ID ø 20.22mm Qty 1 pcs		

## air trap accessories

			
1			
<b>GEV No.</b>	508377	<b>Ref. No.</b>	3536
<b>description</b>	hose connector		
<b>For models:</b>	F-1221-REVOL		

## pipes

			
1			
<b>GEV No.</b>	508203	<b>Ref. No.</b>	2933
<b>description</b>	pipe		
<b>For models:</b>	F-1040, F-1221-N, F-1221-REVOL, F-430, F-532		

## backflow preventers



## backflow preventers

			
1			
<b>GEV No.</b>	504140	<b>Ref. No.</b>	2802
<b>description</b>	backflow preventer		
<b>For models:</b>	F-1040		

			
1			
<b>GEV No.</b>	508267	<b>Ref. No.</b>	4728
<b>description</b>	backflow preventer		
<b>For models:</b>	F-1221-N		



 Image not available 1			
<b>GEV No.</b>	508271	<b>Ref. No.</b>	4732
<b>description</b>	backflow preventer		
<b>For models:</b>	F-532		

 2			
<b>GEV No.</b>	516101	<b>Ref. No.</b>	4731
<b>description</b>	backflow preventer dishwasher hose ø 12mm		
<b>For models:</b>	F-430		
<b>spare parts for</b>	516101		
	<b>GEV No.</b>	506367	<b>Ref. No.</b> —
	flat gasket rubber ED ø 40mm ID ø 28mm thickness 1.8mm Qty 1 pcs		

miscellaneous  Image not available 1			
<b>GEV No.</b>	508025	<b>Ref. No.</b>	186
<b>description</b>	bracket for plate		
<b>For models:</b>	F-1221-N		

door mechanics linkage  1			
<b>GEV No.</b>	508275	<b>Ref. No.</b>	4744
<b>description</b>	door pin door pin		
<b>For models:</b>	F-1221-N, F-1221-REVOL, F-400, F-430, F-532		

sliding plates  1			
<b>GEV No.</b>	508198	<b>Ref. No.</b>	2919
<b>description</b>	sliding plate sliding plate		
<b>For models:</b>	F-1221-N, F-1221-REVOL, F-400, F-430, F-532		

hinge pins  1			
<b>GEV No.</b>	508225	<b>Ref. No.</b>	3167
<b>description</b>	hinge pin hinge pin		
<b>For models:</b>	F-1221-N, F-430, F-532		

door bumpers  1			
<b>GEV No.</b>	508256	<b>Ref. No.</b>	4609
<b>description</b>	door bumper guide washer SS		
<b>For models:</b>	F-1221-N, F-430, F-532		

locks  1			
<b>GEV No.</b>	508102	<b>Ref. No.</b>	2194
<b>description</b>	door catch complete catch		
<b>For models:</b>	F-1221-N, F-1221-REVOL, F-400, F-430, F-532		

miscellaneous  1			
<b>GEV No.</b>	508223	<b>Ref. No.</b>	3165
<b>description</b>	bush bush		
<b>For models:</b>	F-1221-N, F-1221-REVOL, F-400, F-430, F-532		

 1			
<b>GEV No.</b>	508362	<b>Ref. No.</b>	4438
<b>description</b>	deflector drop collecting tank		
<b>For models:</b>	F-1221-N, F-430, F-532		

 1			
<b>GEV No.</b>	508360	<b>Ref. No.</b>	897
<b>description</b>	nut microswitch nut		
<b>For models:</b>	F-1221-N, F-1221-REVOL, F-400, F-430, F-532		

1			
<b>GEV No.</b>	508222	<b>Ref. No.</b>	3164
<b>description</b>	nut nut		
<b>For models:</b>	F-1221-N, F-1221-REVOL, F-400, F-430, F-532		

### screw connections

1			
<b>GEV No.</b>	508116	<b>Ref. No.</b>	2450
<b>description</b>	union nut thread M10x1 H 16mm WS 16 plastic Qty 1 pcs		
<b>For models:</b>	F-1040, F-1221-N, F-1221-REVOL, F-400, F-430, F-532		

### washing and rinsing systems

1			
<b>GEV No.</b>	508241	<b>Ref. No.</b>	4120 4807 4808 4810 4943
<b>description</b>	manifold 3-way hose ø 12-12-12mm plastic		
<b>For models:</b>	F-1040, F-1221-N, F-1221-REVOL, F-400, F-430, F-532		

1			
<b>GEV No.</b>	508195	<b>Ref. No.</b>	2904
<b>description</b>	throttle disc		
<b>For models:</b>	F-1040, F-430, F-532		



## knobs

### producer-specific knobs

#### RST-FIAMMA

1			
<b>GEV No.</b>	110432	<b>Ref. No.</b>	4.0.075.0040
<b>description</b>	knob switch zero mark t.max.°C temperature range°C ø 42mm shaft ø 6x4.6mm shaft flat upper black		
<b>For models:</b>	AEF-15.30, AEF-30.60, EF-15.30, FCF10, FCF10+10, FCF10+10-TR, FCF10-TR, FCF15+15, FCF15-TR, FCF6, FCF6+6, FF10, FF-10, FF10+10, FF-10+10, FF10+10TR, FF-10+10-TR, FF10+10TR-NV, FF10-NV, FF10TR, FF-10-TR, FF10TR-NV, FF15+15TR, FF-15+15-TR, FF15TR, FF-15-TR, FF6, FF6+6, FF6+6-NV, TOSTI-D3, TOSTI-S3, TRD-30.2, TRS-20.2		

1			
<b>GEV No.</b>	110439	<b>Ref. No.</b>	4.0.066.0112
<b>description</b>	knob thermostat t.max. 250°C temperature range 50-250°C ø 50mm shaft ø 6x4.6mm shaft flat upper black		
<b>For models:</b>	GR-4.1-L, GR-4.1-LTL, GR-4.2, GR-6.1, GR-6.1-L, GR-6.1-LTL, GR-8, GR-8.1-L, GR-8.2, GR-8.2-L, GR-8.2-LTL, GR-8-L, GR-M, GR-M.1, GR-M.2, GR-M.2-TLC, PPEF-600, PPEF-600-CRD, PPEF-800, PPEF-800-CRD, PPEF-M-600, PPEF-M-600-CRD, PPEF-M-800, PPEF-M-800-CRD		

1				
<b>GEV No.</b>	111487	<b>Ref. No.</b>	4.0.066.0100	
<b>description</b>	knob thermostat t.max. 250°C temperature range 50-250°C ø 53mm shaft ø 6x4.6mm shaft flat upper rotation 270° black			
<b>For models:</b>	PPEF-800-CRD, PPEF-800-MN			
<b>accessories for</b>	111487			
	<b>GEV No.</b>	111490	<b>Ref. No.</b>	—
	gasket for knob ED ø 51mm Qty 1 pcs plastic			

### steam/water taps

#### steam/water taps

1			
<b>GEV No.</b>	111389	<b>Ref. No.</b>	4.0.002.0029
<b>description</b>	knob ø 40mm L 42mm black		
<b>For models:</b>	MARINA, MARINA-CV, MARINA-CV-DI, MINIBAR-NV		





1				
<b>GEV No.</b>	111272	<b>Ref. No.</b>	4.0.016.0023	
<b>description</b>	turning handle ø 42.5mm L 53mm thread Tr18x2 black			
<b>For models:</b>	ATLANTIC-I-CV-NV, ATLANTIC-I-CV-PCI-NV, ATLANTIC-I-CV-TI-NV, ATLANTIC-II-COMPACT, ATLANTIC-II-CV-COMPACT, ATLANTIC-II-CV-NV, ATLANTIC-II-CV-PCI-NV, ATLANTIC-II-CV-TALL-CUPS, ATLANTIC-II-CV-TI-COMPACT, ATLANTIC-II-CV-TI-NV, ATLANTIC-II-CV-TI-TALL-CUPS, ATLANTIC-III, ATLANTIC-III-CV, ATLANTIC-III-CV-TI, ATLANTIC-III-TI, ATLANTIC-II-NV, ATLANTIC-II-PCI-NV, ATLANTIC-II-TALL-CUPS, ATLANTIC-II-TI-NV, ATLANTIC-I-PCI-NV, ATLANTIC-I-TI-NV, PACIFIC-2CV, PACIFIC-3CV, PACIFIC-3CV-W, PRESTIGE-II-CV-ECC, PRESTIGE-II-CV-REVOL, PRESTIGE-II-ECC, PRESTIGE-III-CV-REVOL, PRESTIGE-III-REVOL, PRESTIGE-II-REVOL			
<b>accessories for</b>	111272			
	<b>GEV No.</b>	111269	<b>Ref. No.</b>	4.0.016.0028
	symbol water ø 28mm L 27mm black			
	<b>GEV No.</b>	111270	<b>Ref. No.</b>	4.0.016.0027
	symbol steam ø 28mm L 27mm black			

Table continues overleaf



accessories for 111272			
	GEV No.	111273	Ref. No. 4.0.016.0025
cotter pin ø 1.3mm L 25mm			

## knob dial plates

	1		
GEV No.	525829	Ref. No.	4.0.016.0024
description	plain washer with turning handle ø 21.5mm ID ø 6.5mm thickness 2mm brass		
For models:	ATLANTIC-I-CV-NV, ATLANTIC-I-CV-PCI-NV, ATLANTIC-I-CV-TI-NV, ATLANTIC-II-COMPACT, ATLANTIC-II-CV-COMPACT, ATLANTIC-II-CV-NV, ATLANTIC-II-CV-PCI-NV, ATLANTIC-II-CV-TALL-CUPS, ATLANTIC-II-CV-TI-COMPACT, ATLANTIC-II-CV-TI-NV, ATLANTIC-II-CV-TI-TALL-CUPS, ATLANTIC-III, ATLANTIC-III-CV, ATLANTIC-III-CV-TI, ATLANTIC-III-TI, ATLANTIC-II-NV, ATLANTIC-II-PCI-NV, ATLANTIC-II-TALL-CUPS, ATLANTIC-II-TI-NV, ATLANTIC-I-PCI-NV, ATLANTIC-I-TI-NV, PACIFIC-2CV, PACIFIC-3CV, PACIFIC-3CV-W, PRESTIGE-II-CV-ECC, PRESTIGE-II-CV-REVOL, PRESTIGE-II-ECC, PRESTIGE-III-CV-REVOL, PRESTIGE-III-REVOL, PRESTIGE-II-REVOL		

	1		
GEV No.	111270	Ref. No.	4.0.016.0027
description	symbol steam ø 28mm L 27mm black		
For models:	ATLANTIC-I-CV-NV, ATLANTIC-I-CV-PCI-NV, ATLANTIC-I-CV-TI-NV, ATLANTIC-II-COMPACT, ATLANTIC-II-CV-COMPACT, ATLANTIC-II-CV-NV, ATLANTIC-II-CV-PCI-NV, ATLANTIC-II-CV-TALL-CUPS, ATLANTIC-II-CV-TI-COMPACT, ATLANTIC-II-CV-TI-NV, ATLANTIC-II-CV-TI-TALL-CUPS, ATLANTIC-III, ATLANTIC-III-CV, ATLANTIC-III-CV-TI, ATLANTIC-III-TI, ATLANTIC-II-NV, ATLANTIC-II-PCI-NV, ATLANTIC-II-TALL-CUPS, ATLANTIC-II-TI-NV, ATLANTIC-I-PCI-NV, ATLANTIC-I-TI-NV, PACIFIC-2CV, PACIFIC-3CV, PACIFIC-3CV-W, PRESTIGE-II-CV-ECC, PRESTIGE-II-CV-REVOL, PRESTIGE-II-ECC, PRESTIGE-III-CV-REVOL, PRESTIGE-III-REVOL, PRESTIGE-II-REVOL		

	1		
GEV No.	111269	Ref. No.	4.0.016.0028
description	symbol water ø 28mm L 27mm black		
For models:	ATLANTIC-I-CV-NV, ATLANTIC-I-CV-PCI-NV, ATLANTIC-I-CV-TI-NV, ATLANTIC-II-COMPACT, ATLANTIC-II-CV-COMPACT, ATLANTIC-II-CV-NV, ATLANTIC-II-CV-PCI-NV, ATLANTIC-II-CV-TALL-CUPS, ATLANTIC-II-CV-TI-COMPACT, ATLANTIC-II-CV-TI-NV, ATLANTIC-II-CV-TI-TALL-CUPS, ATLANTIC-III, ATLANTIC-III-CV, ATLANTIC-III-CV-TI, ATLANTIC-III-TI, ATLANTIC-II-NV, ATLANTIC-II-PCI-NV, ATLANTIC-II-TALL-CUPS, ATLANTIC-II-TI-NV, ATLANTIC-I-PCI-NV, ATLANTIC-I-TI-NV, PACIFIC-2CV, PACIFIC-3CV, PRESTIGE-II-CV-ECC, PRESTIGE-II-CV-REVOL, PRESTIGE-II-ECC, PRESTIGE-III-CV-REVOL, PRESTIGE-III-REVOL, PRESTIGE-II-REVOL		

## accessories

	1		
GEV No.	111273	Ref. No.	4.0.016.0025
description	cotter pin ø 1.3mm L 25mm		
For models:	ATLANTIC-I-CV-NV, ATLANTIC-I-CV-PCI-NV, ATLANTIC-I-CV-TI-NV, ATLANTIC-II-COMPACT, ATLANTIC-II-CV-COMPACT, ATLANTIC-II-CV-NV, ATLANTIC-II-CV-PCI-NV, ATLANTIC-II-CV-TALL-CUPS, ATLANTIC-II-CV-TI-COMPACT, ATLANTIC-II-CV-TI-NV, ATLANTIC-II-CV-TI-TALL-CUPS, ATLANTIC-III, ATLANTIC-III-CV, ATLANTIC-III-CV-TI, ATLANTIC-III-TI, ATLANTIC-II-NV, ATLANTIC-II-PCI-NV, ATLANTIC-II-TALL-CUPS, ATLANTIC-II-TI-NV, ATLANTIC-I-PCI-NV, ATLANTIC-I-TI-NV, PACIFIC-2CV, PACIFIC-3CV, PACIFIC-3CV-W, PRESTIGE-II-CV-ECC, PRESTIGE-II-CV-REVOL, PRESTIGE-II-ECC, PRESTIGE-III-CV-REVOL, PRESTIGE-III-REVOL, PRESTIGE-II-REVOL		

## miscellaneous

	1		
GEV No.	111390	Ref. No.	4.0.025.0015
description	knob ø 25.5mm L 38mm black		
For models:	ATLANTIC-I-CV-NV, ATLANTIC-I-CV-PCI-NV, ATLANTIC-I-CV-TI-NV, ATLANTIC-II-COMPACT, ATLANTIC-II-CV-COMPACT, ATLANTIC-II-CV-NV, ATLANTIC-II-CV-PCI-NV, ATLANTIC-II-CV-TALL-CUPS, ATLANTIC-II-CV-TI-COMPACT, ATLANTIC-II-CV-TI-NV, ATLANTIC-II-CV-TI-TALL-CUPS, ATLANTIC-III, ATLANTIC-III-CV, ATLANTIC-III-CV-TI, ATLANTIC-III-TI, ATLANTIC-II-NV, ATLANTIC-II-PCI-NV, ATLANTIC-II-TALL-CUPS, ATLANTIC-II-TI-NV, ATLANTIC-I-PCI-NV, ATLANTIC-I-TI-NV, Prestige-II, PRESTIGE-II-CV-ECC, PRESTIGE-II-CV-REVOL, PRESTIGE-II-ECC, Prestige-III, PRESTIGE-III-CV-REVOL, PRESTIGE-III-REVOL, PRESTIGE-II-REVOL		

## handles and hand wheels

### cone handles

	1		
GEV No.	110461	Ref. No.	4.0.066.0046
description	cone handle plastic black		
For models:	GR-4.1-L, GR-4.2, GR-6.1, GR-6.1-L, GR-6.1-LTL, GR-8.2, GR-8.2-L, GR-M.2		

### handle rails

#### end caps

	1		
GEV No.	508338	Ref. No.	126010
description	end cap mounting pos. left		
For models:	F-430, F-532		

	1		
GEV No.	508339	Ref. No.	126011
description	end cap mounting pos. right		
For models:	F-430, F-532		

## folding grill handles



1

<b>GEV No.</b>	514174	<b>Ref. No.</b>	7.0.066.0023
<b>description</b>	lever ø 10mm left		
<b>For models:</b>	GR-4.1-L, GR-4.1-LTL, GR-4.2, GR-8.1-L, GR-8.2, GR-8.2-L, GR-8.2-LTL, GR-M.1, GR-M.2, GR-M.2-TLC		



1



<b>GEV No.</b>	514173	<b>Ref. No.</b>	7.0.066.0025
<b>description</b>	lever ø 10mm right		
<b>For models:</b>	GR-4.1-L, GR-4.1-LTL, GR-4.2, GR-8.1-L, GR-8.2, GR-8.2-L, GR-8.2-LTL, GR-M.1, GR-M.2, GR-M.2-TLC		

## hinges

## door bearing





1

<b>GEV No.</b>	701297	<b>Ref. No.</b>	10247
<b>description</b>	hinge L 103mm W 33mm H 15mm mounting pos. left with base plate for dishwasher Qty 1 pcs		
<b>For models:</b>	F-1221-REVOL, F-400		
<b>spare parts for</b>	701297		
	<b>GEV No.</b>	701298	<b>Ref. No.</b> 10294
	base plate plastic L 113mm W 33mm thickness 1.5mm for hinge mounting pos. left/right Qty 1 pcs		
<b>accessories for</b>	701297		
	<b>GEV No.</b>	701298	<b>Ref. No.</b> 10294
	base plate plastic L 113mm W 33mm thickness 1.5mm for hinge mounting pos. left/right Qty 1 pcs		



1

<b>GEV No.</b>	701296	<b>Ref. No.</b>	10246
<b>description</b>	hinge L 103mm W 33mm H 15mm mounting pos. right with base plate for dishwasher		
<b>For models:</b>	F-1221-REVOL, F-400		
<b>spare parts for</b>	701296		
	<b>GEV No.</b>	701298	<b>Ref. No.</b> 10294
	base plate plastic L 113mm W 33mm thickness 1.5mm for hinge mounting pos. left/right Qty 1 pcs		
<b>accessories for</b>	701296		
	<b>GEV No.</b>	701298	<b>Ref. No.</b> 10294
	base plate plastic L 113mm W 33mm thickness 1.5mm for hinge mounting pos. left/right Qty 1 pcs		

## accessories

## base plate



1

<b>GEV No.</b>	519414	<b>Ref. No.</b>	3159
<b>description</b>	base plate L 37mm W 15mm for hinge		
<b>For models:</b>	F-1221-N, F-430, F-532		



1

<b>GEV No.</b>	701298	<b>Ref. No.</b>	10294
<b>description</b>	base plate plastic L 113mm W 33mm thickness 1.5mm for hinge mounting pos. left/right Qty 1 pcs		
<b>For models:</b>	F-1221-REVOL, F-400		

## baskets

## fryer baskets

## RST-FIAMMA



1

<b>GEV No.</b>	970336	<b>Ref. No.</b>	4.0.085.0031
<b>description</b>	fryer basket L1 255mm W1 190mm H1 95mm		
<b>For models:</b>	FF6, FF6+6		







1

<b>GEV No.</b>	970991	<b>Ref. No.</b>	4.0.085.1031
<b>description</b>	fryer basket W1 225mm L1 255mm H1 100mm		
<b>For models:</b>	FF10+10TR-NV, FF10-NV, FF10TR-NV, FF6+6-NV		

accessories

cutlery inserts



1

<b>GEV No.</b>	976011	<b>Ref. No.</b>	189
<b>description</b>	cutlery insert Lmm Wmm ø 110mm H 130mm		
<b>For models:</b>	F-1040, F-430, F-532		

warewashing baskets

plastic baskets square

mix baskets



1

<b>GEV No.</b>	971058	<b>Ref. No.</b>	2461 2461S
<b>description</b>	mix basket L 350mm W 350mm H 150mm		
<b>For models:</b>	F-1221-N, F-1221-REVOL		

plate inserts



1

<b>GEV No.</b>	508026	<b>Ref. No.</b>	187
<b>description</b>	plate insert		
<b>For models:</b>	F-1040, F-1221-N, F-1221-REVOL, F-400, F-430, F-532		



1

<b>GEV No.</b>	971078	<b>Ref. No.</b>	2145S
<b>description</b>	mix basket L 400mm W 400mm H 150mm		
<b>For models:</b>	F-400		

gaskets

O-rings

EPDM

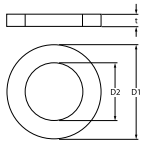
1

<b>GEV No.</b>	510303	<b>Ref. No.</b>	2531
<b>description</b>	O-ring EPDM thickness 1.78mm ID ø 6.75mm Qty 1 pcs		
<b>For models:</b>	F-1040, F-1221-N, F-1221-REVOL, F-400, F-430, F-532		



1

<b>GEV No.</b>	970696	<b>Ref. No.</b>	2491
<b>description</b>	mix basket L 450mm W 450mm H 165mm		
<b>For models:</b>	F-430		

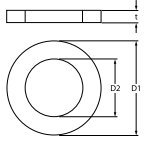
1

<b>GEV No.</b>	525821	<b>Ref. No.</b>	5.0.016.0251
<b>description</b>	O-ring EPDM thickness 1.9mm ID ø 4.9mm Qty 1 pcs		
<b>For models:</b>	PRESTIGE-II-CV-REVOL, PRESTIGE-III-CV-REVOL, PRESTIGE-III-REVOL, PRESTIGE-II-REVOL		

plate baskets



1

<b>GEV No.</b>	970694	<b>Ref. No.</b>	2492
<b>description</b>	plate basket L 450mm W 450mm H 106mm plates 14		
<b>For models:</b>	F-430		



<b>GEV No.</b>	525255	<b>Ref. No.</b>	5.0.000.0565
<b>description</b>	O-ring EPDM thickness 1.9mm ID ø 7.2mm Qty 1 pcs		
<b>For models:</b>	ATLANTIC-I-CV-NV, ATLANTIC-I-CV-PCI-NV, ATLANTIC-I-CV-TI-NV, ATLANTIC-II-COMPACT, ATLANTIC-II-CV-COMPACT, ATLANTIC-II-CV-NV, ATLANTIC-II-CV-PCI-NV, ATLANTIC-II-CV-TALL-CUPS, ATLANTIC-II-CV-TI-COMPACT, ATLANTIC-II-CV-TI-NV, ATLANTIC-II-CV-TI-TALL-CUPS, ATLANTIC-III, ATLANTIC-III-CV, ATLANTIC-III-CV-TI, ATLANTIC-III-TI, ATLANTIC-II-NV, ATLANTIC-II-PCI-NV, ATLANTIC-II-TALL-CUPS, ATLANTIC-II-TI-NV, ATLANTIC-I-PCI-NV, ATLANTIC-I-TI-NV, MARINA, MARINA-CV, MARINA-CV-DI, PACIFIC-2CV, PACIFIC-3CV, PACIFIC-3CV-W, Prestige-II, PRESTIGE-II-CV-ECC, PRESTIGE-II-CV-REVOL, PRESTIGE-II-ECC, Prestige-III, PRESTIGE-III-CV-REVOL, PRESTIGE-III-REVOL, PRESTIGE-II-REVOL, Superbar		



<b>GEV No.</b>	529412	<b>Ref. No.</b>	5.0.000.0560
<b>description</b>	O-ring EPDM thickness 2.62mm ID ø 10.78mm Qty 1 pcs		
<b>For models:</b>	Prestige-II, PRESTIGE-II-CV-REVOL, Prestige-III, PRESTIGE-III-CV-REVOL, PRESTIGE-III-REVOL, PRESTIGE-II-REVOL		



<b>GEV No.</b>	528223	<b>Ref. No.</b>	123 5.0.025.0205
<b>description</b>	O-ring EPDM thickness 2.62mm ID ø 11.91mm Qty 1 pcs		
<b>For models:</b>	ATLANTIC-I-CV-NV, ATLANTIC-I-CV-PCI-NV, ATLANTIC-I-CV-TI-NV, ATLANTIC-II-COMPACT, ATLANTIC-II-CV-COMPACT, ATLANTIC-II-CV-NV, ATLANTIC-II-CV-PCI-NV, ATLANTIC-II-CV-TALL-CUPS, ATLANTIC-II-CV-TI-COMPACT, ATLANTIC-II-CV-TI-NV, ATLANTIC-II-CV-TI-TALL-CUPS, ATLANTIC-III, ATLANTIC-III-CV, ATLANTIC-III-CV-TI, ATLANTIC-III-TI, ATLANTIC-II-NV, ATLANTIC-II-PCI-NV, ATLANTIC-II-TALL-CUPS, ATLANTIC-II-TI-NV, ATLANTIC-I-PCI-NV, ATLANTIC-I-TI-NV, F-1040, F-1221-N, F-430, F-532, PACIFIC-2CV, PACIFIC-3CV, PACIFIC-3CV-W, PRESTIGE-II-CV-ECC, PRESTIGE-II-CV-REVOL, PRESTIGE-II-ECC, PRESTIGE-III-CV-REVOL, PRESTIGE-III-REVOL, PRESTIGE-II-REVOL		

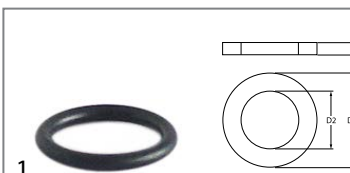

<b>GEV No.</b>	508008	<b>Ref. No.</b>	93
<b>description</b>	O-ring EPDM thickness 2.62mm ID ø 15.88mm Qty 1 pcs		
<b>For models:</b>	F-1040, F-1221-N, F-1221-REVOL, F-400, F-430, F-532		

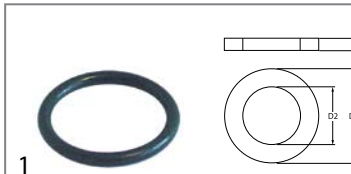

<b>GEV No.</b>	505073	<b>Ref. No.</b>	25 5.0.025.0026
<b>description</b>	O-ring EPDM thickness 2.62mm ID ø 20.63mm Qty 1 pcs		
<b>For models:</b>	F-1040, F-430, F-532, PACIFIC-2CV, PACIFIC-3CV, PACIFIC-3CV-W, PRESTIGE-II-CV-REVOL, PRESTIGE-III-CV-REVOL, PRESTIGE-III-REVOL, PRESTIGE-II-REVOL		

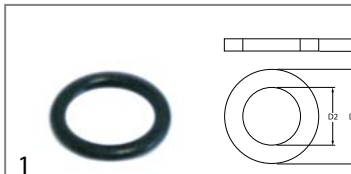

<b>GEV No.</b>	510893	<b>Ref. No.</b>	697
<b>description</b>	O-ring EPDM thickness 2.62mm ID ø 9.92mm Qty 1 pcs		
<b>For models:</b>	F-1040, F-1221-N, F-1221-REVOL, F-400, F-430, F-532		



<b>GEV No.</b>	528813	<b>Ref. No.</b>	5.0.016.0225
<b>description</b>	O-ring EPDM thickness 2mm ID ø 17mm Qty 1 pcs		
<b>For models:</b>	ATLANTIC-I-CV-NV, ATLANTIC-I-CV-PCI-NV, ATLANTIC-I-CV-TI-NV, ATLANTIC-II-COMPACT, ATLANTIC-II-CV-COMPACT, ATLANTIC-II-CV-NV, ATLANTIC-II-CV-PCI-NV, ATLANTIC-II-CV-TALL-CUPS, ATLANTIC-II-CV-TI-COMPACT, ATLANTIC-II-CV-TI-NV, ATLANTIC-II-CV-TI-TALL-CUPS, ATLANTIC-III, ATLANTIC-III-CV, ATLANTIC-III-CV-TI, ATLANTIC-III-TI, ATLANTIC-II-NV, ATLANTIC-II-PCI-NV, ATLANTIC-II-TALL-CUPS, ATLANTIC-II-TI-NV, ATLANTIC-I-PCI-NV, ATLANTIC-I-TI-NV, MARINA, MARINA-CV, MARINA-CV-DI, PACIFIC-2CV, PACIFIC-3CV, PACIFIC-3CV-W, PRESTIGE-II-CV-ECC, PRESTIGE-II-CV-REVOL, PRESTIGE-II-ECC, PRESTIGE-III-CV-REVOL, PRESTIGE-III-REVOL, PRESTIGE-II-REVOL		



<b>GEV No.</b>	361311	<b>Ref. No.</b>	5.0.016.0306
<b>description</b>	O-ring EPDM thickness 2mm ID ø 6mm Qty 1 pcs for type N6		
<b>For models:</b>	ATLANTIC-I-CV-NV, ATLANTIC-I-CV-PCI-NV, ATLANTIC-I-CV-TI-NV, ATLANTIC-II-COMPACT, ATLANTIC-II-CV-COMPACT, ATLANTIC-II-CV-NV, ATLANTIC-II-CV-PCI-NV, ATLANTIC-II-CV-TALL-CUPS, ATLANTIC-II-CV-TI-COMPACT, ATLANTIC-II-CV-TI-NV, ATLANTIC-II-CV-TI-TALL-CUPS, ATLANTIC-III, ATLANTIC-III-CV, ATLANTIC-III-CV-TI, ATLANTIC-III-TI, ATLANTIC-II-NV, ATLANTIC-II-PCI-NV, ATLANTIC-II-TALL-CUPS, ATLANTIC-II-TI-NV, ATLANTIC-I-PCI-NV, ATLANTIC-I-TI-NV, PACIFIC-2CV, PACIFIC-3CV, PACIFIC-3CV-W, PRESTIGE-II-CV-ECC, PRESTIGE-II-CV-REVOL, PRESTIGE-II-ECC, PRESTIGE-III-CV-REVOL, PRESTIGE-III-REVOL, PRESTIGE-II-REVOL		



1			
<b>GEV No.</b>	508061	<b>Ref. No.</b>	1633
<b>description</b>	O-ring EPDM thickness 3.53mm ID ø 42.86mm Qty 1 pcs		
<b>For models:</b>	F-1040, F-1221-N, F-1221-REVOL, F-400, F-430, F-532		

1			
<b>GEV No.</b>	532534	<b>Ref. No.</b>	5206
<b>description</b>	O-ring EPDM thickness 3.53mm ID ø 82.14mm Qty 1 pcs		
<b>For models:</b>	F-1221-N		

1			
<b>GEV No.</b>	508109	<b>Ref. No.</b>	2374
<b>description</b>	O-ring EPDM thickness 5.34mm ID ø 69.22mm Qty 1 pcs		
<b>For models:</b>	F-1040, F-430, F-532		

1			
<b>GEV No.</b>	521121	<b>Ref. No.</b>	57
<b>description</b>	O-ring EPDM thickness 8mm ID ø 62mm Qty 1 pcs		
<b>For models:</b>	F-1040, F-1221-N, F-1221-REVOL, F-400, F-430, F-532		

<p>Viton</p>			
1			
<b>GEV No.</b>	532560	<b>Ref. No.</b>	5.0.025.0005
<b>description</b>	O-ring Viton thickness 2.62mm ID ø 20.63mm Qty 1 pcs		
<b>For models:</b>	PACIFIC-2CV, PACIFIC-3CV, PACIFIC-3CV-W, PRESTIGE-II-CV-REVOL, PRESTIGE-III-CV-REVOL, PRESTIGE-III-REVOL, PRESTIGE-II-REVOL		

sealing washers

rubber gaskets

1			
<b>GEV No.</b>	508011	<b>Ref. No.</b>	109
<b>description</b>	flat gasket rubber D1 ø 45mm D2 ø 26mm thickness 2mm equiv. no. for model Aliseo/Master/Minibar/Gemini/Program		
<b>For models:</b>	F-1221-N, F-1221-REVOL, F-400		

1			
<b>GEV No.</b>	508029	<b>Ref. No.</b>	204
<b>description</b>	flat gasket rubber D1 ø 59mm D2 ø 45mm thickness 2.5mm Qty 1 pcs for model AE/AL/AP/AS/GL/F		
<b>For models:</b>	F-1040, F-430, F-532		

1			
<b>GEV No.</b>	508215	<b>Ref. No.</b>	3086
<b>description</b>	flat gasket rubber ED ø 40mm ID ø 27mm thickness 1.4mm Qty 1 pcs		
<b>For models:</b>	F-1040, F-1221-N, F-430, F-532		

copper gaskets

DIN-7603-A

1			
<b>GEV No.</b>	526461	<b>Ref. No.</b>	5.0.016.0303
<b>description</b>	flat gasket copper ED ø 22mm ID ø 17mm thickness 2mm Qty 1 pcs		
<b>For models:</b>	ATLANTIC-I-CV-NV, ATLANTIC-I-CV-PCI-NV, ATLANTIC-I-CV-TI-NV, ATLANTIC-II-COMPACT, ATLANTIC-II-CV-COMPACT, ATLANTIC-II-CV-NV, ATLANTIC-II-CV-PCI-NV, ATLANTIC-II-CV-TALL-CUPS, ATLANTIC-II-CV-TI-COMPACT, ATLANTIC-II-CV-TI-NV, ATLANTIC-II-CV-TI-TALL-CUPS, ATLANTIC-III, ATLANTIC-III-CV, ATLANTIC-III-CV-TI, ATLANTIC-III-TI, ATLANTIC-II-NV, ATLANTIC-II-PCI-NV, ATLANTIC-II-TALL-CUPS, ATLANTIC-II-TI-NV, ATLANTIC-I-PCI-NV, ATLANTIC-I-TI-NV, PACIFIC-2CV, PACIFIC-3CV, PACIFIC-3CV-W, PRESTIGE-II-CV-ECC, PRESTIGE-II-CV-REVOL, PRESTIGE-II-ECC, PRESTIGE-III-CV-REVOL, PRESTIGE-III-REVOL, PRESTIGE-II-REVOL		

DIN-7603-C

1			
<b>GEV No.</b>	525819	<b>Ref. No.</b>	4.0.000.0013
<b>description</b>	gasket copper ED ø 17mm ID ø 13mm thickness 2mm for thread 1/4" Qty 1 pcs		
<b>For models:</b>	ATLANTIC-I-CV-NV, ATLANTIC-I-CV-PCI-NV, ATLANTIC-I-CV-TI-NV, ATLANTIC-II-COMPACT, ATLANTIC-II-CV-COMPACT, ATLANTIC-II-CV-NV, ATLANTIC-II-CV-PCI-NV, ATLANTIC-II-CV-TALL-CUPS, ATLANTIC-II-CV-TI-COMPACT, ATLANTIC-II-CV-TI-NV, ATLANTIC-II-CV-TI-TALL-CUPS, ATLANTIC-III, ATLANTIC-III-CV, ATLANTIC-III-CV-TI, ATLANTIC-III-TI, ATLANTIC-II-NV, ATLANTIC-II-PCI-NV, ATLANTIC-II-TALL-CUPS, ATLANTIC-II-TI-NV, ATLANTIC-I-PCI-NV, ATLANTIC-I-TI-NV, MARINA, MARINA-CV, MARINA-CV-DI, PACIFIC-2CV, PACIFIC-3CV, PACIFIC-3CV-W, PRESTIGE-II-CV-ECC, PRESTIGE-II-CV-REVOL, PRESTIGE-II-ECC, PRESTIGE-III-CV-REVOL, PRESTIGE-III-REVOL, PRESTIGE-II-REVOL		

PTFE gaskets

			
1			
<b>GEV No.</b>	508049	<b>Ref. No.</b>	1173
<b>description</b>	flat gasket PTFE ED ø 16mm ID ø 10mm thickness 2mm Qty 1 pcs		
<b>For models:</b>	F-1040, F-1221-N, F-1221-REVOL, F-400, F-430, F-532		

			
1			
<b>GEV No.</b>	525609	<b>Ref. No.</b>	5.0.000.0315
<b>description</b>	flat gasket PTFE ED ø 18mm ID ø 13.5mm thickness 2mm Qty 1 pcs		
<b>For models:</b>	ATLANTIC-I-CV-NV, ATLANTIC-I-CV-PCI-NV, ATLANTIC-I-CV-TI-NV, ATLANTIC-II-COMPACT, ATLANTIC-II-CV-COMPACT, ATLANTIC-II-CV-NV, ATLANTIC-II-CV-PCI-NV, ATLANTIC-II-CV-TALL-CUPS, ATLANTIC-II-CV-TI-COMPACT, ATLANTIC-II-CV-TI-NV, ATLANTIC-II-CV-TI-TALL-CUPS, ATLANTIC-III, ATLANTIC-III-CV, ATLANTIC-III-CV-TI, ATLANTIC-III-TI, ATLANTIC-II-NV, ATLANTIC-II-PCI-NV, ATLANTIC-II-TALL-CUPS, ATLANTIC-II-TI-NV, ATLANTIC-I-PCI-NV, ATLANTIC-I-TI-NV, MARINA, MARINA-CV, MARINA-CV-DI, PACIFIC-2CV, PACIFIC-3CV, PACIFIC-3CV-W, Prestige-II, PRESTIGE-II-CV-ECC, PRESTIGE-II-CV-REVOL, PRESTIGE-II-ECC, Prestige-III, PRESTIGE-III-CV-REVOL, PRESTIGE-III-REVOL, PRESTIGE-II-REVOL, Superbar		

			
1			
<b>GEV No.</b>	359332	<b>Ref. No.</b>	5.0.025.1386
<b>description</b>	flat gasket PTFE ED ø 21mm ID ø 16.8mm thickness 1.7mm Qty 1 pcs		
<b>For models:</b>	ATLANTIC-I-CV-NV, ATLANTIC-I-CV-PCI-NV, ATLANTIC-I-CV-TI-NV, ATLANTIC-II-COMPACT, ATLANTIC-II-CV-COMPACT, ATLANTIC-II-CV-NV, ATLANTIC-II-CV-PCI-NV, ATLANTIC-II-CV-TALL-CUPS, ATLANTIC-II-CV-TI-COMPACT, ATLANTIC-II-CV-TI-NV, ATLANTIC-II-CV-TI-TALL-CUPS, ATLANTIC-III, ATLANTIC-III-CV, ATLANTIC-III-CV-TI, ATLANTIC-III-TI, ATLANTIC-II-NV, ATLANTIC-II-PCI-NV, ATLANTIC-II-TALL-CUPS, ATLANTIC-II-TI-NV, ATLANTIC-I-PCI-NV, ATLANTIC-I-TI-NV, MARINA, MARINA-CV, MARINA-CV-DI, PACIFIC-2CV, PACIFIC-3CV, PACIFIC-3CV-W, PRESTIGE-II-CV-ECC, PRESTIGE-II-CV-REVOL, PRESTIGE-II-ECC, PRESTIGE-III-CV-REVOL, PRESTIGE-III-REVOL, PRESTIGE-II-REVOL		

			
1			
<b>GEV No.</b>	525611	<b>Ref. No.</b>	5.0.025.0022
<b>description</b>	flat gasket PTFE ED ø 22mm ID ø 17mm thickness 2mm Qty 1 pcs		
<b>For models:</b>	ATLANTIC-I-CV-NV, ATLANTIC-I-CV-PCI-NV, ATLANTIC-I-CV-TI-NV, ATLANTIC-II-COMPACT, ATLANTIC-II-CV-COMPACT, ATLANTIC-II-CV-NV, ATLANTIC-II-CV-PCI-NV, ATLANTIC-II-CV-TALL-CUPS, ATLANTIC-II-CV-TI-COMPACT, ATLANTIC-II-CV-TI-NV, ATLANTIC-II-CV-TI-TALL-CUPS, ATLANTIC-III, ATLANTIC-III-CV, ATLANTIC-III-CV-TI, ATLANTIC-III-TI, ATLANTIC-II-NV, ATLANTIC-II-PCI-NV, ATLANTIC-II-TALL-CUPS, ATLANTIC-II-TI-NV, ATLANTIC-I-PCI-NV, ATLANTIC-I-TI-NV, MARINA, MARINA-CV, MARINA-CV-DI, PACIFIC-2CV, PACIFIC-3CV, PACIFIC-3CV-W, PRESTIGE-II-CV-ECC, PRESTIGE-II-CV-REVOL, PRESTIGE-II-ECC, PRESTIGE-III-CV-REVOL, PRESTIGE-III-REVOL, PRESTIGE-II-REVOL		

			
1			
<b>GEV No.</b>	526265	<b>Ref. No.</b>	5.0.016.0211
<b>description</b>	flat gasket PTFE ED ø 24mm ID ø 19mm thickness 2mm Qty 1 pcs		
<b>For models:</b>	ATLANTIC-I-CV-NV, ATLANTIC-I-CV-PCI-NV, ATLANTIC-I-CV-TI-NV, ATLANTIC-II-COMPACT, ATLANTIC-II-CV-COMPACT, ATLANTIC-II-CV-NV, ATLANTIC-II-CV-PCI-NV, ATLANTIC-II-CV-TALL-CUPS, ATLANTIC-II-CV-TI-COMPACT, ATLANTIC-II-CV-TI-NV, ATLANTIC-II-CV-TI-TALL-CUPS, ATLANTIC-III, ATLANTIC-III-CV, ATLANTIC-III-CV-TI, ATLANTIC-III-TI, ATLANTIC-II-NV, ATLANTIC-II-PCI-NV, ATLANTIC-II-TALL-CUPS, ATLANTIC-II-TI-NV, ATLANTIC-I-PCI-NV, ATLANTIC-I-TI-NV, PACIFIC-2CV, PACIFIC-3CV, PACIFIC-3CV-W, PRESTIGE-II-CV-ECC, PRESTIGE-II-CV-REVOL, PRESTIGE-II-ECC, PRESTIGE-III-CV-REVOL, PRESTIGE-III-REVOL, PRESTIGE-II-REVOL		

			
1			
<b>GEV No.</b>	528683	<b>Ref. No.</b>	5.0.016.0106
<b>description</b>	flat gasket PTFE ED ø 26mm ID ø 21mm thickness 2mm Qty 1 pcs suitable for GAGGIA, SPAZIALE		
<b>For models:</b>	ATLANTIC-I-CV-NV, ATLANTIC-I-CV-PCI-NV, ATLANTIC-I-CV-TI-NV, ATLANTIC-II-COMPACT, ATLANTIC-II-CV-COMPACT, ATLANTIC-II-CV-NV, ATLANTIC-II-CV-PCI-NV, ATLANTIC-II-CV-TALL-CUPS, ATLANTIC-II-CV-TI-COMPACT, ATLANTIC-II-CV-TI-NV, ATLANTIC-II-CV-TI-TALL-CUPS, ATLANTIC-III, ATLANTIC-III-CV, ATLANTIC-III-CV-TI, ATLANTIC-III-TI, ATLANTIC-II-NV, ATLANTIC-II-PCI-NV, ATLANTIC-II-TALL-CUPS, ATLANTIC-II-TI-NV, ATLANTIC-I-PCI-NV, ATLANTIC-I-TI-NV, MARINA, MARINA-CV, MARINA-CV-DI, PRESTIGE-II-CV-ECC, PRESTIGE-II-ECC		

			
1			
<b>GEV No.</b>	526014	<b>Ref. No.</b>	5.0.025.0002
<b>description</b>	flat gasket PTFE ED ø 35mm ID ø 30mm thickness 2mm Qty 1 pcs		
<b>For models:</b>	ATLANTIC-I-CV-NV, ATLANTIC-I-CV-PCI-NV, ATLANTIC-I-CV-TI-NV, ATLANTIC-II-COMPACT, ATLANTIC-II-CV-COMPACT, ATLANTIC-II-CV-NV, ATLANTIC-II-CV-PCI-NV, ATLANTIC-II-CV-TALL-CUPS, ATLANTIC-II-CV-TI-COMPACT, ATLANTIC-II-CV-TI-NV, ATLANTIC-II-CV-TI-TALL-CUPS, ATLANTIC-III, ATLANTIC-III-CV, ATLANTIC-III-CV-TI, ATLANTIC-III-TI, ATLANTIC-II-NV, ATLANTIC-II-PCI-NV, ATLANTIC-II-TALL-CUPS, ATLANTIC-II-TI-NV, ATLANTIC-I-PCI-NV, ATLANTIC-I-TI-NV, MARINA, MARINA-CV, MARINA-CV-DI, PACIFIC-2CV, PACIFIC-3CV, PACIFIC-3CV-W, PRESTIGE-II-CV-ECC, PRESTIGE-II-CV-REVOL, PRESTIGE-II-ECC, PRESTIGE-III-CV-REVOL, PRESTIGE-III-REVOL, PRESTIGE-II-REVOL		

			
1			
<b>GEV No.</b>	528018	<b>Ref. No.</b>	5.0.000.0305
<b>description</b>	flat gasket PTFE ED ø 41mm ID ø 33mm thickness 3mm size 1" Qty 1 pcs		
<b>For models:</b>	MARINA, MARINA-CV, MARINA-CV-DI, Superbar		



			
<b>GEV No.</b>	528021	<b>Ref. No.</b>	5.0.000.0307
<b>description</b>	flat gasket PTFE ED ø 53mm ID ø 42.5mm thickness 3mm Qty 1 pcs equiv. no. 12001/02286 suitable for Astoria/Aurora/Brasilia/Wega		
<b>For models:</b>	ATLANTIC-I-CV-NV, ATLANTIC-I-CV-PCI-NV, ATLANTIC-I-CV-TI-NV, ATLANTIC-II-COMPACT, ATLANTIC-II-CV-COMPACT, ATLANTIC-II-CV-NV, ATLANTIC-II-CV-PCI-NV, ATLANTIC-II-CV-TALL-CUPS, ATLANTIC-II-CV-TI-COMPACT, ATLANTIC-II-CV-TI-NV, ATLANTIC-II-CV-TI-TALL-CUPS, ATLANTIC-III, ATLANTIC-III-CV, ATLANTIC-III-CV-TI, ATLANTIC-III-TI, ATLANTIC-II-TI-NV, ATLANTIC-I-PCI-NV, ATLANTIC-I-TI-NV, PACIFIC-2CV, PACIFIC-3CV, PACIFIC-3CV-W, PRESTIGE-II-CV-ECC, PRESTIGE-II-CV-REVOL, PRESTIGE-II-ECC, PRESTIGE-III-CV-REVOL, PRESTIGE-III-REVOL, PRESTIGE-II-REVOL		

<h3>compression springs</h3>			
			
<b>GEV No.</b>	526260	<b>Ref. No.</b>	5.0.016.0302
<b>description</b>	compression spring ø 10.3mm L 31.5mm wire gauge ø 1.2mm		
<b>For models:</b>	ATLANTIC-I-CV-NV, ATLANTIC-I-CV-PCI-NV, ATLANTIC-I-CV-TI-NV, ATLANTIC-II-COMPACT, ATLANTIC-II-CV-COMPACT, ATLANTIC-II-CV-NV, ATLANTIC-II-CV-PCI-NV, ATLANTIC-II-CV-TALL-CUPS, ATLANTIC-II-CV-TI-COMPACT, ATLANTIC-II-CV-TI-NV, ATLANTIC-II-CV-TI-TALL-CUPS, ATLANTIC-III, ATLANTIC-III-CV, ATLANTIC-III-CV-TI, ATLANTIC-III-TI, ATLANTIC-II-TI-NV, ATLANTIC-I-PCI-NV, ATLANTIC-I-TI-NV, PACIFIC-2CV, PACIFIC-3CV, PACIFIC-3CV-W, PRESTIGE-II-CV-ECC, PRESTIGE-II-CV-REVOL, PRESTIGE-II-ECC, PRESTIGE-III-CV-REVOL, PRESTIGE-III-REVOL, PRESTIGE-II-REVOL		

<h3>foam rubber gaskets</h3>			
			
<b>GEV No.</b>	508406	<b>Ref. No.</b>	6233
<b>description</b>	foam rubber gasket W 9mm thickness 3mm self-adhesive Qty supplied by meter		
<b>For models:</b>	F-1221-REVOL, F-400		

			
<b>GEV No.</b>	525825	<b>Ref. No.</b>	5.0.025.7060
<b>description</b>	spring ø 12mm L 14.5mm wire gauge ø 1.5mm windings 2		
<b>For models:</b>	ATLANTIC-I-CV-NV, ATLANTIC-I-CV-PCI-NV, ATLANTIC-I-CV-TI-NV, ATLANTIC-II-COMPACT, ATLANTIC-II-CV-COMPACT, ATLANTIC-II-CV-NV, ATLANTIC-II-CV-PCI-NV, ATLANTIC-II-CV-TALL-CUPS, ATLANTIC-II-CV-TI-COMPACT, ATLANTIC-II-CV-TI-NV, ATLANTIC-II-CV-TI-TALL-CUPS, ATLANTIC-III, ATLANTIC-III-CV, ATLANTIC-III-CV-TI, ATLANTIC-III-TI, ATLANTIC-II-TI-NV, ATLANTIC-I-PCI-NV, ATLANTIC-I-TI-NV, PACIFIC-2CV, PACIFIC-3CV, PACIFIC-3CV-W, PRESTIGE-II-CV-ECC, PRESTIGE-II-CV-REVOL, PRESTIGE-II-ECC, PRESTIGE-III-CV-REVOL, PRESTIGE-III-REVOL, PRESTIGE-II-REVOL		

### springs

#### torsion springs

			
<b>GEV No.</b>	697004	<b>Ref. No.</b>	4.0.066.0020
<b>description</b>	torsion spring		

			
<b>GEV No.</b>	525823	<b>Ref. No.</b>	5.0.016.0214
<b>description</b>	spring ø 14.5mm L 27.5mm wire gauge ø 2mm windings 4		
<b>For models:</b>	ATLANTIC-I-CV-NV, ATLANTIC-I-CV-PCI-NV, ATLANTIC-I-CV-TI-NV, ATLANTIC-II-COMPACT, ATLANTIC-II-CV-COMPACT, ATLANTIC-II-CV-NV, ATLANTIC-II-CV-PCI-NV, ATLANTIC-II-CV-TALL-CUPS, ATLANTIC-II-CV-TI-COMPACT, ATLANTIC-II-CV-TI-NV, ATLANTIC-II-CV-TI-TALL-CUPS, ATLANTIC-III, ATLANTIC-III-CV, ATLANTIC-III-CV-TI, ATLANTIC-III-TI, ATLANTIC-II-TI-NV, ATLANTIC-I-PCI-NV, ATLANTIC-I-TI-NV, MARINA, MARINA-CV, MARINA-CV-DI, PACIFIC-2CV, PACIFIC-3CV, PACIFIC-3CV-W, PRESTIGE-II-CV-ECC, PRESTIGE-II-CV-REVOL, PRESTIGE-II-ECC, PRESTIGE-III-CV-REVOL, PRESTIGE-III-REVOL, PRESTIGE-II-REVOL		

			
<b>GEV No.</b>	700167	<b>Ref. No.</b>	4.0.066.0020
<b>description</b>	torsion spring ø 26.9mm L2 87mm wire gauge ø 5.1mm L1 23mm L3 11mm		
<b>For models:</b>	CG2x4GGGG, CG2x4GGS, CG2x4SGGG, CG2x4SGS, CG2x4SGSG, CG2x4SSGG, CG2x4SSSG, CG2x4SSSS, CG4GG, CG4SG, CG4SS, CG6GG, CG6GG-VITRO, CG6SG, CG6SG-VITRO, CG6SS, CG6SS-VITRO, CG8GG-VITRO, CG8SG-VITRO, CG8SS-VITRO, GA 8.2, GR-4.1-L, GR-4.1-LTL, GR-4.2, GR-6.1, GR-6.1-L, GR-6.1-LTL, GR-8.1-L, GR-8.2, GR-8.2-L, GR-8.2-LTL, GR-M.1, GR-M.2, GR-M.2-TLC, VCR-6C-TC-NV, VCR-6L-TC-NV, VCR-6L-TL-NV, VCR-8C-TC, VCR-8L-TC, VCR-8L-TL		

			
<b>GEV No.</b>	525824	<b>Ref. No.</b>	5.0.016.0234
<b>description</b>	spring ø 8mm L 33mm wire gauge ø 0.4mm windings 11.5		
<b>For models:</b>	ATLANTIC-I-CV-NV, ATLANTIC-I-CV-PCI-NV, ATLANTIC-I-CV-TI-NV, ATLANTIC-II-COMPACT, ATLANTIC-II-CV-COMPACT, ATLANTIC-II-CV-NV, ATLANTIC-II-CV-PCI-NV, ATLANTIC-II-CV-TALL-CUPS, ATLANTIC-II-CV-TI-COMPACT, ATLANTIC-II-CV-TI-NV, ATLANTIC-II-CV-TI-TALL-CUPS, ATLANTIC-III, ATLANTIC-III-CV, ATLANTIC-III-CV-TI, ATLANTIC-III-TI, ATLANTIC-II-TI-NV, ATLANTIC-I-PCI-NV, ATLANTIC-I-TI-NV, MARINA, MARINA-CV, MARINA-CV-DI, PACIFIC-2CV, PACIFIC-3CV, PACIFIC-3CV-W, PRESTIGE-II-CV-ECC, PRESTIGE-II-CV-REVOL, PRESTIGE-II-ECC, PRESTIGE-III-CV-REVOL, PRESTIGE-III-REVOL, PRESTIGE-II-REVOL		

tension springs

			
1			
<b>GEV No.</b>	508127	<b>Ref. No.</b>	2543
<b>description</b>	tension spring		
<b>For models:</b>	F-1040		

manometers

			
1			
<b>GEV No.</b>	541767	<b>Ref. No.</b>	5.0.000.0391
<b>description</b>	manometer ø 39mm pressure range 0-16bar thread 1/8" marking 7-9 connection on the backside FIAMMA		
<b>For models:</b>	ATLANTIC-I-CV-NV, ATLANTIC-I-CV-PCI-NV, ATLANTIC-I-CV-TI-NV, ATLANTIC-II-CV-NV, ATLANTIC-II-CV-PCI-NV, ATLANTIC-II-CV-TALL-CUPS, ATLANTIC-II-CV-TI-NV, ATLANTIC-II-CV-TI-TALL-CUPS, ATLANTIC-III, ATLANTIC-III-CV, ATLANTIC-III-CV-TI, ATLANTIC-III-TI, ATLANTIC-II-NV, ATLANTIC-II-PCI-NV, ATLANTIC-II-TALL-CUPS, ATLANTIC-II-TI-NV, ATLANTIC-I-PCI-NV, ATLANTIC-I-TI-NV, PACIFIC-2CV, PACIFIC-3CV, PACIFIC-3CV-W, PRESTIGE-II-CV-ECC, PRESTIGE-II-CV-REVOL, PRESTIGE-II-ECC, PRESTIGE-III-CV-REVOL, PRESTIGE-III-REVOL, PRESTIGE-II-REVOL		

			
1			
<b>GEV No.</b>	541768	<b>Ref. No.</b>	5.0.000.0392
<b>description</b>	manometer ø 39mm pressure range 0-3bar FIAMMA thread 1/8" marking 1.5 connection on the backside		
<b>For models:</b>	ATLANTIC-I-CV-NV, ATLANTIC-I-CV-PCI-NV, ATLANTIC-I-CV-TI-NV, ATLANTIC-II-COMPACT, ATLANTIC-II-CV-COMPACT, ATLANTIC-II-CV-NV, ATLANTIC-II-CV-PCI-NV, ATLANTIC-II-CV-TALL-CUPS, ATLANTIC-II-CV-TI-COMPACT, ATLANTIC-II-CV-TI-NV, ATLANTIC-II-CV-TI-TALL-CUPS, ATLANTIC-III, ATLANTIC-III-CV, ATLANTIC-III-CV-TI, ATLANTIC-III-TI, ATLANTIC-II-NV, ATLANTIC-II-PCI-NV, ATLANTIC-II-TALL-CUPS, ATLANTIC-II-TI-NV, ATLANTIC-I-PCI-NV, ATLANTIC-I-TI-NV, MARINA, MARINA-CV, MARINA-CV-DI, PRESTIGE-II-CV-ECC, PRESTIGE-II-CV-REVOL, PRESTIGE-II-ECC, PRESTIGE-III-CV-REVOL, PRESTIGE-III-REVOL, PRESTIGE-II-REVOL		

dosing pumps

membrane dosing pumps

self-priming

LANG

spare parts

			
1			
<b>GEV No.</b>	361311	<b>Ref. No.</b>	5.0.016.0306
<b>description</b>	O-ring EPDM thickness 2mm ID ø 6mm Qty 1 pcs for type N6		
<b>For models:</b>	ATLANTIC-I-CV-NV, ATLANTIC-I-CV-PCI-NV, ATLANTIC-I-CV-TI-NV, ATLANTIC-II-COMPACT, ATLANTIC-II-CV-COMPACT, ATLANTIC-II-CV-NV, ATLANTIC-II-CV-PCI-NV, ATLANTIC-II-CV-TALL-CUPS, ATLANTIC-II-CV-TI-COMPACT, ATLANTIC-II-CV-TI-NV, ATLANTIC-II-CV-TI-TALL-CUPS, ATLANTIC-III, ATLANTIC-III-CV, ATLANTIC-III-CV-TI, ATLANTIC-III-TI, ATLANTIC-II-NV, ATLANTIC-II-PCI-NV, ATLANTIC-II-TALL-CUPS, ATLANTIC-II-TI-NV, ATLANTIC-I-PCI-NV, ATLANTIC-I-TI-NV, PACIFIC-2CV, PACIFIC-3CV, PACIFIC-3CV-W, PRESTIGE-II-CV-ECC, PRESTIGE-II-CV-REVOL, PRESTIGE-II-ECC, PRESTIGE-III-CV-REVOL, PRESTIGE-III-REVOL, PRESTIGE-II-REVOL		

various

			
1			
<b>GEV No.</b>	361370	<b>Ref. No.</b>	60
<b>description</b>	dosing pump type model 2 rinse aid inlet 4x6mm outlet 4x6mm pressure connection ø 4x6mm suction connection ø 4x6mm		
<b>For models:</b>	F-1040, F-1221-N, F-1221-REVOL, F-400, F-430, F-532		
<b>spare parts for</b>	361370		
	<b>GEV No.</b>	361307	<b>Ref. No.</b>
			—
membrane dosing pump ø 68mm hole ø 6mm for type DIB3P/DIB5P			
	<b>GEV No.</b>	361459	<b>Ref. No.</b>
			—
hose connector ø 6mm for dosing pump			



accessories

T-pieces

without non-return valve



<b>GEV No.</b>	508123	<b>Ref. No.</b>	2503
<b>description</b>	T-piece 3-way hose ø 13-5-13mm plastic		
<b>For models:</b>	F-1040, F-1221-N, F-1221-REVOL, F-400, F-430, F-532		
<b>accessories for</b>	508123		
	<b>GEV No.</b>	508116	<b>Ref. No.</b>
			2450
	union nut thread M10x1 H 16mm WS 16 plastic Qty 1 pcs		

tank inlets



<b>GEV No.</b>	508301	<b>Ref. No.</b>	5073
<b>description</b>	tank inlet plastic M9x1.5 hose ø 4mm		
<b>For models:</b>	F-1040, F-430, F-532		

hoses

supply hoses

PVC supply hoses

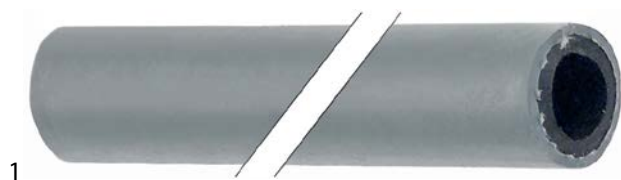

<b>GEV No.</b>	520016	<b>Ref. No.</b>	2800 3051
<b>description</b>	supply hose ID ø 13mm ED ø 20mm L 40m operating p. 20bar burst p. 60bar t.max. 95°C grey Qty 40m		
<b>For models:</b>	F-1221-N, F-1221-REVOL, F-400, F-430, F-532		

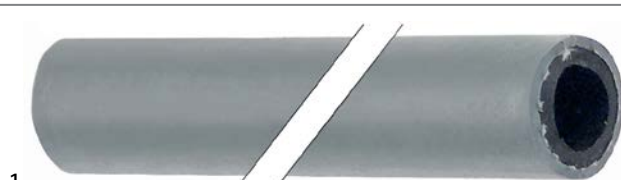

<b>GEV No.</b>	520017	<b>Ref. No.</b>	247
<b>description</b>	supply hose ID ø 13mm ED ø 20mm L 5m operating p. 20bar burst p. 60bar t.max. 95°C grey Qty 5m		
<b>For models:</b>	F-1040		

drain hoses



<b>GEV No.</b>	508043	<b>Ref. No.</b>	638
<b>description</b>	drain hose DN19 L 2000mm straight ø inside 19/30mm straight ext. ø 26/34mm outer hose ø 25mm		
<b>For models:</b>	F-1221-N, F-1221-REVOL, F-400		

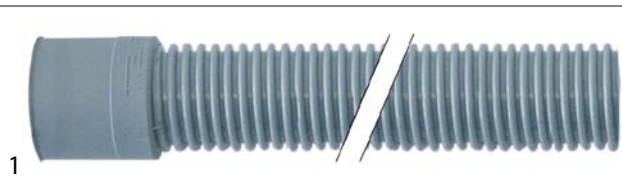

<b>GEV No.</b>	530587	<b>Ref. No.</b>	2188
<b>description</b>	drain hose DN28 L 2000mm straight ø inside 32mm straight ext. ø 40mm outer hose ø 35mm		
<b>For models:</b>	F-1040, F-430, F-532		

industrial hoses

nylon hoses



<b>GEV No.</b>	520091	<b>Ref. No.</b>	135
<b>description</b>	nylon hose ID ø 4mm ED ø 6mm L 2m thickness 1mm operating p. 10bar burst p. 50bar t.max. 100°C transparent		
<b>For models:</b>	F-1040, F-1221-N, F-1221-REVOL, F-400, F-430, F-532		

pressure control hoses



<b>GEV No.</b>	530560	<b>Ref. No.</b>	2329
<b>description</b>	pressure control hose ID ø 5mm ED ø 9mm L 5m operating p. 30bar burst p. 90bar temp.-resist. 60°C		
<b>For models:</b>	F-1040, F-1221-N, F-1221-REVOL, F-400, F-430, F-532		



## formed hoses

## straight



1

<b>GEV No.</b>	508092	<b>Ref. No.</b>	2139
<b>description</b>	formed hose dishwasher straight		
<b>For models:</b>	F-1221-N		



1

<b>GEV No.</b>	508118	<b>Ref. No.</b>	2480
<b>description</b>	formed hose dishwasher straight		
<b>For models:</b>	F-1221-REVOL, F-400, F-430		



1

<b>GEV No.</b>	508290	<b>Ref. No.</b>	4935
<b>description</b>	formed hose dishwasher straight equiv. no. 4935		
<b>For models:</b>	F-1040		



1

<b>GEV No.</b>	508213	<b>Ref. No.</b>	3072
<b>description</b>	formed hose dishwasher straight mounting pos. upper equiv. no. 3072		
<b>For models:</b>	F-1040, F-532		

## form L



1

<b>GEV No.</b>	508147	<b>Ref. No.</b>	2655
<b>description</b>	formed hose warewashing L-shape equiv. no. 2655		
<b>For models:</b>	F-1040, F-430, F-532		



1

<b>GEV No.</b>	508201	<b>Ref. No.</b>	2927
<b>description</b>	formed hose warewashing L-shape equiv. no. 2927		
<b>For models:</b>	F-1040, F-1221-N, F-1221-REVOL, F-430, F-532		



1

<b>GEV No.</b>	508205	<b>Ref. No.</b>	2962
<b>description</b>	formed hose warewashing L-shape equiv. no. 2962		
<b>For models:</b>	F-430, F-532		



1

<b>GEV No.</b>	508214	<b>Ref. No.</b>	3080
<b>description</b>	formed hose warewashing L-shape equiv. no. 3080		
<b>For models:</b>	F-1221-N, F-1221-REVOL, F-400		

## fittings, hose and pipe connectors

## hose connectors

## producer-specific



1

<b>GEV No.</b>	508123	<b>Ref. No.</b>	2503
<b>description</b>	T-piece 3-way hose ø 13-5-13mm plastic		
<b>For models:</b>	F-1040, F-1221-N, F-1221-REVOL, F-400, F-430, F-532		
<b>accessories for</b>	508123		



<b>GEV No.</b>	508116	<b>Ref. No.</b>	2450
union nut thread M10x1 H 16mm WS 16 plastic Qty 1 pcs			





## fastening material

### screws

#### knurled screws



1

<b>GEV No.</b>	508047	<b>Ref. No.</b>	1133 4374
<b>description</b>	Thumb screw ø 22mm thread M6 thread L 6mm		
<b>For models:</b>	F-1040, F-1221-N, F-1221-REVOL, F-400, F-430, F-532		

### nuts

#### hexagonal nuts

##### hexagonal nuts metric (without norm)



1

<b>GEV No.</b>	519546	<b>Ref. No.</b>	10273
<b>description</b>	nut thread M10x0.75 H 3.45mm WS 14 brass Qty 1 pcs		
<b>For models:</b>	F-1221-REVOL, F-400		



1

<b>GEV No.</b>	520231	<b>Ref. No.</b>	267
<b>description</b>	nut thread M10x1 H 6mm WS 14 zinc-coated steel Qty 1 pcs		
<b>For models:</b>	F-1040, F-1221-N, F-1221-REVOL, F-400, F-430, F-532		

### fasteners

#### retaining rings

##### DIN 471



1

<b>GEV No.</b>	508014	<b>Ref. No.</b>	113
<b>description</b>	retaining ring shaft ø 9mm DIN 471		
<b>For models:</b>	F-1040, F-430, F-532		

#### cotter pins



1

<b>GEV No.</b>	111273	<b>Ref. No.</b>	4.0.016.0025
<b>description</b>	cotter pin ø 1.3mm L 25mm		
<b>For models:</b>	ATLANTIC-I-CV-NV, ATLANTIC-I-CV-PCI-NV, ATLANTIC-I-CV-TI-NV, ATLANTIC-II-COMPACT, ATLANTIC-II-CV-COMPACT, ATLANTIC-II-CV-NV, ATLANTIC-II-CV-PCI-NV, ATLANTIC-II-CV-TALL-CUPS, ATLANTIC-II-CV-TI-COMPACT, ATLANTIC-II-CV-TI-NV, ATLANTIC-II-CV-TI-TALL-CUPS, ATLANTIC-III, ATLANTIC-III-CV, ATLANTIC-III-CV-TI, ATLANTIC-III-TI, ATLANTIC-II-NV, ATLANTIC-II-PCI-NV, ATLANTIC-II-TALL-CUPS, ATLANTIC-II-TI-NV, ATLANTIC-I-PCI-NV, ATLANTIC-I-TI-NV, PACIFIC-2CV, PACIFIC-3CV, PACIFIC-3CV-W, PRESTIGE-II-CV-ECC, PRESTIGE-II-CV-REVOL, PRESTIGE-II-ECC, PRESTIGE-III-CV-REVOL, PRESTIGE-III-REVOL, PRESTIGE-II-REVOL		



<b>B</b>		<b>M</b>	
bar burners	20	mechanical timers	13
bi-metal thermostats	6	microswitches	10
booster pumps II	18	<b>N</b>	
<b>C</b>		nuts	41
capillary tube clips	8	nylon hoses	39
condensators & interference suppression filters	18	<b>O</b>	
contactors	13	operating capacitors	18
control thermostats	7, 7	O-rings	33
cotter pins	41	<b>P</b>	
<b>D</b>		piezoelectric igniters	19
dosing pumps	38	pressure control hoses	39
drain hoses	39	pressure switches	15
<b>E</b>		probe clips	8
electric accessories	18	programme timers	13
<b>F</b>		pumps	16
fasteners	41	push/momentary push switches	9
fastening material	41	PVC supply hoses	39
filters	18	<b>Q</b>	
foam rubber gaskets	37	quartz heating elements	4
formed hoses	40	<b>R</b>	
<b>G</b>		relays	13
gas burners	20	retaining rings	41
gas nozzles	20	rocker/momentary rocker switches	9
gas taps	19	rotary switches	11
<b>H</b>		<b>S</b>	
heating elements	3	safety bi-metal thermostats	6
heating elements for coffee machine	3	safety thermostats	7
heating elements for contact grills	3	screws	41
heating elements for fryers	3	sealing washers	35
heating elements for salamanders/toasters	4	solenoid valves	14
hexagonal nuts	41	spring clips	8
hose connectors	40	supply hoses	39
hoses	39	switches and momentary switches	9
<b>I</b>		system switches	11
immersion heating elements	4	system switches (ROLD)	10
indicator lights	12	<b>T</b>	
indicator lights (complete)	12	tank inlets	39
industrial hoses	39	terminals	18
<b>K</b>		thermocouples	19
knurled screws	41	thermostats	6
<b>L</b>		timers	13
lamps	12	transformers	14

**W**

wash and rinse pumps

16