



GAS COMPONENTS



ELECTRIC COMPONENTS



WATER TECHNOLOGY



MECHANICAL COMPONENTS



TOOLS

Spare parts suitable for

FALCON

Find the complete and up-to-date range of products in our GEV Webshop



Manufacturer catalogue

The most important spare parts and accessories arranged clearly for every manufacturer

- ✓ Complete product range and all appliance data always up to date in the GEV Webshop
- ✓ Alphabetical Index at the end of the catalogue

GEV Webshop

www.gev-online.co.uk

www.gev-online.com



- 🔍 Add to Favourites
- 🔍 Sign In with email address and usual password
- 🔍 Easy-order – place several items in your basket at the same time
- 🔍 Quick Item search – no login needed



heating elements

heating elements for ovens



GEV No.	418872	Ref. No.	539110460
description	heating element 1250W 240V L 370mm W 130mm H 40mm flange length 50mm flange width 38mm tube ø 8.5mm connection length 30mm heating circuits 1 hole ø 6mm connection M4 mounting pos. lower windings 3 rectangular flange dry heating element oven		
For models:	E350-30		

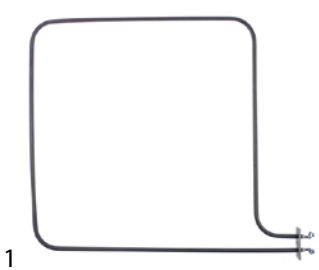

GEV No.	418873	Ref. No.	539110450
description	heating element 650W 240V L 505mm W 440mm L1 78mm L2 430mm W1 35mm W2 405mm flange length 57mm flange width 30mm hole distance 18mm hole ø 6mm tube ø 8mm connection length 28mm connection M4 heating circuits 1 rectangular flange dry heating element oven		
For models:	E350-30		

heating elements for tilting bratt pan



GEV No.	418874	Ref. No.	731750421
description	heating element tilting bratt pan 3200W 240V L 457mm W 185mm H 55mm connection male faston 6.3mm dry heating element heating circuits 1 tube ø 8mm W1 210mm W2 36mm mounting pos. left connection distance 28mm		
For models:	E1962, E1965, E1994, E1995, E2962, E2965, E2995		



GEV No.	418875	Ref. No.	731750420
description	heating element tilting bratt pan 3200W 240V L 457mm W 185mm H 55mm connection male faston 6.3mm dry heating element heating circuits 1 tube ø 8mm W1 210mm W2 36mm mounting pos. right connection distance 28mm		
For models:	E1962, E1965, E1994, E1995, E2962, E2965, E2995		

heating elements for salamanders/toast-

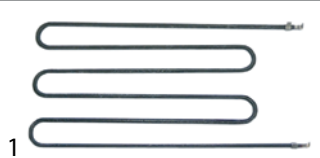







GEV No.	415538	Ref. No.	530102644
description	heating element 2200W 230V heating circuits 1 L 365mm W 178mm connection male faston 6.3mm connection distance 172mm tube ø 6.3mm dry heating element H 6.3mm		

immersion heating elements

with compression flange 50 x 26mm



GEV No.	415151	Ref. No.	738010810
description	heating element 2500W 230V compression flange flange 50x26mm L 273mm heating circuits 1 H 30mm W 130mm L1 144mm L2 129mm connection M4 immersion heater		
accessories for	415151		
	GEV No.	510387	Ref. No. —
	gasket L 46mm W 22mm ømm EPDM for heating element for flange 50x26mm		
	GEV No.	510388	Ref. No. —
	counterflange ømm hole distancemm perforation ømm L 43mm W 21mm SS for heating element for flange 50x26mm		
	GEV No.	521103	Ref. No. —
	nut thread M4 H 3mm WS 7 brass Qty 20 pcs		
	GEV No.	521104	Ref. No. —
	washer ID ø 4.3mm ED ø 8mm thickness 0.5mm brass Qty 20 pcs for thread M4		
	GEV No.	560111	Ref. No. —
	plain washer ID ø 4.3mm ED ø 9mm thickness 0.8mm SS Qty 20 pcs DIN 125A for thread M4		
	GEV No.	560131	Ref. No. —
	hexagonal nut thread M4 H 3.2mm WS 7 SS DIN/ISO DIN 934 / ISO 4032/8673 Qty 20 pcs		





with round flange ø57.5mm



GEV No.	415849	Ref. No.	730570002
description	heating element 15000W 230V heating circuits 3 mounting ø 57.5mm L 530mm W 45mm H 30mm round flange connection M4 immersion heater tube ø 8.5mm connection length 15mm thermostat sleeves ø 7mm number of thermostat sleeves 1 length thermostat sleeves 272mm thermostat sleeve eccentric, clinging		
accessories for	415849		
	GEV No.	550002	Ref. No. —
	tension strap H 10mm L 21mm W 10mm hole ø 6.5mm for heating element		



GEV No.	415848	Ref. No.	730550004
description	heating element 7500W 230V heating circuits 3 mounting ø 57.5mm L 365mm W 36mm H 50mm round flange connection M4 immersion heater tube ø 8.5mm thermostat sleeves ø 7.5mm number of thermostat sleeves 1 length thermostat sleeves 270mm thermostat sleeve eccentric, clinging		
spare parts for	415848		
	GEV No.	510409	Ref. No. 730590010
	O-ring EPDM thickness 5.34mm ID ø 56.52mm Qty 1 pcs		
accessories for	415848		
	GEV No.	550002	Ref. No. —
	tension strap H 10mm L 21mm W 10mm hole ø 6.5mm for heating element		

heating elements for convection



GEV No.	418739	Ref. No.	530742414
description	heating element 10500W 230V heating circuits 3 ID ø 411mm ED ø 428mm L 480mm H 110mm L1 52mm W1 99mm H1 18mm H2 92mm flange length 130mm flange width 54mm hole distance 55mm connection M5 connection length 96mm tube ø 8.5mm convection heating element mounting thread M6 rectangular flange with thread bolt		
accessories for	418739		
	GEV No.	551240	Ref. No. 530749451
	gasket L 129mm W 87mm D1 ø 12mm D2 ø 7mm 12 holes graphite thickness 1mm		



GEV No.	415828	Ref. No.	730560000
description	heating element 15000W 230V heating circuits 3 ID ø 388mm ED ø 408mm L 428mm H 132mm L1 20mm W1 105mm H1 114mm H2 18mm flange length 140mm flange width 25mm hole distance 126mm connection M4 connection length 65mm tube ø 8.5mm convection heating element hole ø 6.3mm rectangular flange		





GEV No.	419252	Ref. No.	530584126
description	heating element 2000W 230V heating circuits 1 ID ø 180mm ED ø 193mm L 258mm H 25mm L1 60mm W1 30mm H1 7mm H2 18mm flange length 70mm flange width 22mm hole distance 56mm connection male faston 6.3mm connection length 55mm tube ø 6.5mm convection heating element hole ø M4mm rectangular flange		

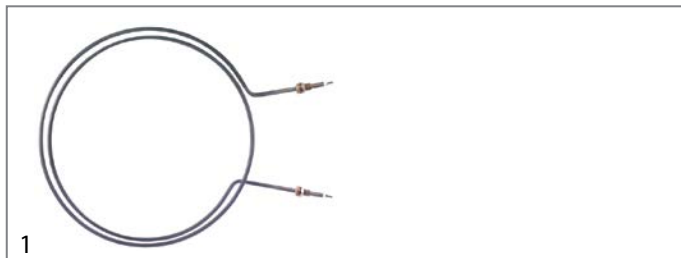

GEV No.	418959	Ref. No.	530742422
description	heating element 21600W 230V heating circuits 6 ID ø 414mm ED ø 466mm L 522mm H 121.5mm L1 88mm W1 97mm H1 30.5mm H2 91mm flange length 130mm flange width 88mm connection M5 connection length 70mm tube ø 6.5mm mounting thread M6 flange with bolt M6		
accessories for	418959		
	GEV No.	551240	Ref. No. 530749451
	gasket L 129mm W 87mm D1 ø 12mm D2 ø 7mm 12 holes graphite thickness 1mm		







GEV No.	418766	Ref. No.	530595110
description	heating element 4500W 230V heating circuits 1 ID ø 380mm ED ø 405mm L 530mm L1 100mm H 17mm thread M14x1.5 connection M4 tube ø 8.5mm		
spare parts for	418766		
	GEV No.	510417	Ref. No. —
	flat gasket fibre ED ø 20mm ID ø 14mm thickness 2mm Qty 1 pcs		
accessories for	418766		
	GEV No.	520228	Ref. No. —
	tooth lock washer ID ø 15.3mm ED ø 24mm steel Qty 1 pcs for thread M14		
	GEV No.	520230	Ref. No. —
	nut thread M14x1.5 H 5mm WS 19 zinc-coated steel Qty 1 pcs		
	GEV No.	521101	Ref. No. —
	nut thread M14x1.5 H 5mm WS 19 SS Qty 1 pcs		
	GEV No.	550262	Ref. No. —
	flat gasket copper ED ø 20mm ID ø 14mm thickness 2mm		

accessories for	415221		
	GEV No.	520231	Ref. No. —
	nut thread M10x1 H 6mm WS 14 zinc-coated steel Qty 1 pcs		
	GEV No.	521129	Ref. No. —
	nut thread M10 H 6mm SS WS 17 Qty 1 pcs DIN/ISO DIN 439		
	GEV No.	528433	Ref. No. —
	flat gasket copper ED ø 14mm ID ø 10mm thickness 1mm		





GEV No.	415805	Ref. No.	530693383
description	heating element 5700W 230V heating circuits 3 ID ø 206mm ED ø 245mm L 290mm H 42mm L1 45mm W1 97mm H1 2mm H2 40mm flange length 110mm flange width 20mm hole distance 35mm connection male faston 6.3mm connection length 58mm tube ø 6.3mm convection heating element hole ø 6.5mm rectangular flange		



GEV No.	415222	Ref. No.	530576581
description	heating element 2300W 230V heating circuits 1 L 90mm W 395mm connection M4 tube ø 8.5mm thread M14x1.5 2 hole fixing dry heating element		
accessories for	415222		
	GEV No.	521103	Ref. No. —
	nut thread M4 H 3mm WS 7 brass Qty 20 pcs		
	GEV No.	521104	Ref. No. —
	washer ID ø 4.3mm ED ø 8mm thickness 0.5mm brass Qty 20 pcs for thread M4		
	GEV No.	560111	Ref. No. —
	plain washer ID ø 4.3mm ED ø 9mm thickness 0.8mm SS Qty 20 pcs DIN 125A for thread M4		
	GEV No.	560131	Ref. No. —
	hexagonal nut thread M4 H 3.2mm WS 7 SS DIN/ISO DIN 934 / ISO 4032/8673 Qty 20 pcs		



GEV No.	415221	Ref. No.	530332429
description	heating element 1430W 230V heating circuits 1 L 90mm W 390mm connection male faston 6.3mm tube ø 6.3mm thread M10x1 2 hole fixing dry heating element mounting distance 376mm		
spare parts for	415221		
	GEV No.	510416	Ref. No. —
	flat gasket fibre ED ø 19mm ID ø 10.5mm thickness 1.5mm for thread M10 Qty 1 pcs		
accessories for	415221		
	GEV No.	510893	Ref. No. —
	O-ring EPDM thickness 2.62mm ID ø 9.92mm Qty 1 pcs		

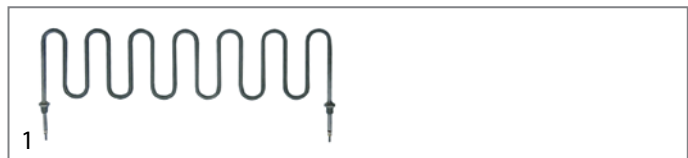

GEV No.	415542	Ref. No.	530318084
description	heating element 2500W 230V heating circuits 1 L 131mm W 485mm connection length 20mm connection M4 tube ø 8.5mm thread M14x1.5 2 hole fixing convection heating element mounting distance 480mm		
accessories for	415542		
	GEV No.	510417	Ref. No. —
	flat gasket fibre ED ø 20mm ID ø 14mm thickness 2mm Qty 1 pcs		
	GEV No.	520228	Ref. No. —
	tooth lock washer ID ø 15.3mm ED ø 24mm steel Qty 1 pcs for thread M14		
	GEV No.	520230	Ref. No. —
	nut thread M14x1.5 H 5mm WS 19 zinc-coated steel Qty 1 pcs		
	GEV No.	521101	Ref. No. —
	nut thread M14x1.5 H 5mm WS 19 SS Qty 1 pcs		
	GEV No.	550262	Ref. No. —
	flat gasket copper ED ø 20mm ID ø 14mm thickness 2mm		



			
1			
GEV No.	415543	Ref. No.	530318083
description	heating element 4000W 230V heating circuits 1 L 131mm W 485mm connection M4 tube ø 8.5mm thread M14x1.5 2 hole fixing dry heating element		

			
1			
GEV No.	490058	Ref. No.	539110360
description	hot plate ø 180mm 2000W 240V		
For models:	E350-30, E350-33		

hot plates

square & rectangular

miscellaneous

			
1			
GEV No.	490199	Ref. No.	703620 730960010
description	hot plate dimensions 560x240mm 240V H 15mm connection cable rectangular		
For models:	E1100-3HP, E1100-4HP, E2101, E2101EU, E2101EU-OTC, E2102, E2121, E3101-3HP, E3101-4HP, E3101OTC-3HP, E3101OTC-4HP, E3121-3HP, E3121-4HP, E3161-3HP, E3161D		

round

with radiused edge

for domestic and commercial kitchens

			
1			
GEV No.	490183	Ref. No.	735110010 820101 LD1/2
description	hot plate ø 180mm 1500W 240V connection 4 screw clamps with 8mm spill ring		

			
1			
GEV No.	490016	Ref. No.	730960050
description	hot plate ø 180mm 2000W 230V connection 4 screw clamps with 8mm spill ring		
For models:	E1100-4HP, E2101, E2101EU, E2102, E2121		

energy regulators

EGO

1-circuit

			
1			
GEV No.	380015	Ref. No.	530314544
description	energy regulator 230V 13A single-circuit turn direction right shaft ø 6x4.6mm shaft L 23mm mounting thread M4 power release 6-100% no. 50.57021.010		

			
1			
GEV No.	380019	Ref. No.	737630011 E2512/22 - LD22 R8549
description	energy regulator 240V 13A single-circuit turn direction right shaft ø 6x4.6mm shaft L 23mm mounting thread M4 power release 6-100% no. 50.57071.010		
For models:	E2512, E3512, E3532		

			
1			
GEV No.	380879	Ref. No.	731750770 E1036 R3799
description	energy regulator 240V 13A turn direction right shaft ø 5x4mm shaft L 14mm mounting thread 1/8"		
For models:	E1962, E1965, E1994, E1995		



thermostats

bi-metal thermostats

miscellaneous



1

GEV No.	390866	Ref. No.	734310270 R2025
description	safety thermostat hole distancemm switch-off temp.°C 1NO 1-poleAV connection male faston 6.3mm 3/4"		
For models:	E4063, E4103, E4203		
spare parts for	390866		
	GEV No.	375442	Ref. No. 737600711 C601275
	safety thermostat capillary pipe 1760mm probe ø 4mm 1-pole probe L 100mm 16A capillary pipe isolated 1600mm gland nut switch-off temp. 320°C probe		

control and safety thermostats

EGO

control thermostats

55.10/19_series



1

GEV No.	375477	Ref. No.	731750711
description	thermostat t.max. 190°C temperature range 48-190°C 1-pole 1NO 16A probe ø 6mm probe L 107mm capillary pipe 1470mm capillary pipe isolatedmm gland nut M9x1 shaft ø 6x4.6mm shaft L 23mm shaft position upper° shaft position lower rotation 270°		
For models:	E1962, E1965, E1994, E1995, E2962, E2965, E2994, E2995		



1

GEV No.	375070	Ref. No.	530091634 EL091634
description	thermostat t.max. 250°C temperature range 55-250°C 1-pole 1CO 16A probe ø 3.1mm probe L 226mm capillary pipe 1170mm capillary pipe isolated 1100mm gland nut M9x1 shaft L 23mm shaft position upper rotation 270°		

55.13_series



1

GEV No.	375677	Ref. No.	737400541 C400541
description	thermostat t.max. 195°C temperature range 103-195°C 1-pole 1NO 16A probe ø 4mm probe L 157mm capillary pipe 2250mm capillary pipe isolated 2020mm gland nut shaft L 18mm shaft position upper rotation 270°		



1

GEV No.	390843	Ref. No.	731910500 RZZ451
description	thermostat t.max. 291°C temperature range 50-291°C 1-pole 1NO 16A probe ø 3mm probe L 160mm capillary pipe 980mm capillary pipe isolated 600mm gland nut shaft ø 6x4.6mm shaft L 25mm shaft position upper rotation 270° outer switch 42.02900.000		
For models:	E3800, E720RS1, E720RS2, E720RS3, G3800		



1

GEV No.	375505	Ref. No.	539110370 539113110 R273
description	thermostat t.max. 320°C temperature range 50-320°C 1-pole 1NO 16A probe ø 3mm probe L 160mm capillary pipe 870mm capillary pipe isolatedmm gland nut shaft ø 6x4.6mm shaft L 23mm shaft position upper rotation 270°		
For models:	E3441, E3441R, E3481, E3481R, E350-30, E350-34, E350-35		



GEV No.	390862	Ref. No.	732920055 R7091
description	thermostat t.max. 90°C temperature range 71-90°C 1-pole 1NO 16A probe ø 3.1mm probe L 201mm capillary pipe 900mm capillary pipe isolated 120mm gland nut shaft ø 6x4.6mm shaft L 25mm shaft position upper rotation 40°		
For models:	E7204, E7208, E7211, G7204, G7208, G7211		



GEV No.	390833	Ref. No.	731300190
description	thermostat t.max. 190°C temperature range 130-190°C 1-pole 1NO 16A probe ø 6mm probe L 115mm capillary pipe 900mm capillary pipe isolatedmm gland nut M9x1 shaft ø 6x4.6mm shaft L 25mm shaft position upper rotation 270°		
For models:	E1830, E1860		

55.18_ series



GEV No.	390703	Ref. No.	539113130 R5887
description	thermostat t.max. 120°C temperature range 32-110°C 1-pole 1NO 16A probe ø 6mm probe L 110mm capillary pipe 870mm capillary pipe isolatedmm gland nut M9x1 shaft ø 6x4.6mm shaft L 25mm shaft position upper rotation 270° 240V		
For models:	E3407, E350-42, E350-43, E350-49		

55.34_ series

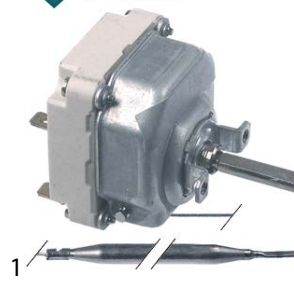

GEV No.	375428	Ref. No.	539215840 735010330
description	thermostat t.max. 190°C temperature range 130-190°C 3-pole 3NO 16A probe ø 6mm probe L 219mm capillary pipe 880mm capillary pipe isolatedmm gland nut shaft ø 6x4.6mm shaft L 23mm shaft position upper rotation 270°		
For models:	E350-37, E350-38, E350-39		



GEV No.	390831	Ref. No.	639052 731320106 R5520
description	thermostat t.max. 190°C temperature range 130-190°C 1-pole 1NO 16A probe ø 6mm probe L 113mm capillary pipe 870mm capillary pipe isolatedmm gland nut M9x1 shaft ø 6x4.6mm shaft L 25mm shaft position upper rotation 270°		
For models:	E3830, E3860		

safety thermostats

55.13_ series

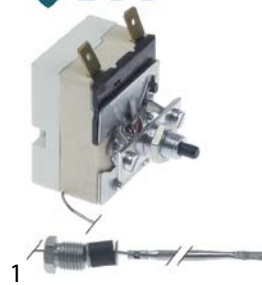

GEV No.	390845	Ref. No.	610046 734311090
description	safety thermostat switch-off temp. 132°C 1-pole 16A probe ø 3.1mm probe L 248mm capillary pipe 830mm capillary pipe isolatedmm gland nut M9x1 probe SS screw connection M12x0.75		
For models:	E4063, E4103, E4203		



E·G·O



1

GEV No.	390895	Ref. No.	55.13519.190
description	safety thermostat switch-off temp. 60°C 1-pole 1NC 16A probe ø 6mm probe L 74mm capillary pipe 520mm capillary pipe isolated 430mm gland nut probe		

55.32_series

E·G·O

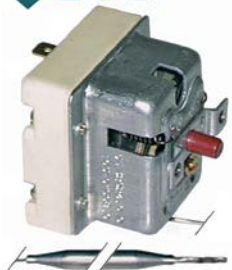

1

GEV No.	390159	Ref. No.	530550024
description	safety thermostat switch-off temp. 150°C 1-pole 20A probe ø 6mm probe L 89mm capillary pipe 900mm capillary pipe isolated 800mm gland nut probe		

E·G·O



1

GEV No.	390921	Ref. No.	530368679
description	safety thermostat switch-off temp. 305°C 3-pole 3NC 20A probe ø 4mm probe L 128mm capillary pipe 890mm capillary pipe isolated 800mm gland nut probe		

E·G·O



1

GEV No.	375684	Ref. No.	530550025
description	safety thermostat switch-off temp. 360°C 1-pole 20A probe ø 11mm probe L 16mm capillary pipe 900mm capillary pipe isolated 900mm gland nut probe screw-in probe probe thread M14x1		

55.33_series

E·G·O



1

GEV No.	390830	Ref. No.	539113830 R6303
description	safety thermostat switch-off temp. 235°C 3-pole 3NC 20A probe ø 6mm probe L 108mm capillary pipe 1470mm capillary pipe isolated 1100mm gland nut probe		
For models:	E350-36, E350-37		

E·G·O



1

GEV No.	375075	Ref. No.	530336017
description	safety thermostat switch-off temp. 305°C 3-pole probe		

E·G·O



1

GEV No.	375118	Ref. No.	530336027
description	safety thermostat switch-off temp. 360°C 3-pole 20A probe ø 15mm probe L 8mm capillary pipe 1150mm capillary pipe isolated 1100mm gland nut probe with knob probe		

56._ series

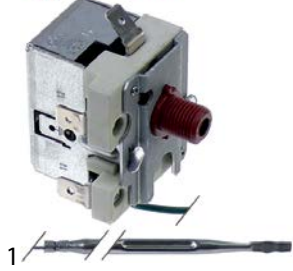

GEV No.	375442	Ref. No.	737600711 C601275
description	safety thermostat capillary pipe 1760mm probe ø 4mm 1-pole probe L 100mm 16A capillary pipe isolated 1600mm gland nut switch-off temp. 320°C probe		



GEV No.	390832	Ref. No.	600575 731310135
description	safety thermostat switch-off temp. 230°C 1-pole 1NC 0.5A probe ø 6mm probe L 77mm capillary pipe 700mm capillary pipe isolatedmm gland nut M9x1 probe kit		
For models:	E1830, E1860		
spare parts for	390832		

	GEV No.	375688	Ref. No.	536430023 539216220 639057 731320111 731350021 750038 802177 835127
	safety thermostat switch-off temp. 230°C 1-pole 1NC 0.5A probe ø 6mm probe L 77mm capillary pipe 700mm capillary pipe isolatedmm gland nut M9x1 probe SS			



GEV No.	375688	Ref. No.	536430023 539216220 639057 731320111 731350021 750038 802177 835127
description	safety thermostat switch-off temp. 230°C 1-pole 1NC 0.5A probe ø 6mm probe L 77mm capillary pipe 700mm capillary pipe isolatedmm gland nut M9x1 probe SS		
For models:	E3830, E3840, E3860, E401, E401F, E402, E402F, E421, E421F, E422, E422F, G2845F, G350-11, G350-12		



GEV No.	390829	Ref. No.	537300025 537300060 801499 801768
description	safety thermostat switch-off temp. 240°C 1-pole 1NC 16A probe ø 6mm probe L 77mm capillary pipe 700mm capillary pipe isolatedmm gland nut M9x1 probe		
For models:	E3407, G1008X, G1830-MK2, G1838X, G1848X, G1860-CE, G1860-MK2, G1865		



GEV No.	390828	Ref. No.	535770070 802052
description	safety thermostat switch-off temp. 245°C 1-pole 1NC 16A probe ø 6mm probe L 78mm capillary pipe 700mm capillary pipe isolatedmm gland nut M9x1 probe		
For models:	G2840, G2841, G2842		



GEV No.	390860	Ref. No.	535670017 638038
description	safety thermostat switch-off temp. 245°C 1-pole 1NC 16A probe ø 6mm probe L 78mm capillary pipe 750mm capillary pipe isolatedmm gland nut M9x1 probe		
For models:	G3203, G3206, G3830, G3860, G3865		
spare parts for	390860		
	GEV No.	390828	Ref. No.
			535770070 802052
description	safety thermostat switch-off temp. 245°C 1-pole 1NC 16A probe ø 6mm probe L 78mm capillary pipe 700mm capillary pipe isolatedmm gland nut M9x1 probe		



GEV No.	375889	Ref. No.	530504602
description	safety thermostat switch-off temp. 360°C 1-pole 16A probe ø 15mm probe L 6.5mm capillary pipe 1140mm capillary pipe isolated 1100mm gland nut probe		
accessories for	375889		
	GEV No.	518669	Ref. No.
			—
description	gasket PTFE ED ø 21mm ID ø 15mm thickness 3.5mm		

control thermostats with operation switch

55.13_ series



GEV No.	390844	Ref. No.	600048 600406 732910210 732920049 735400230
description	thermostat temperature range 50-291°C 1-pole 1NO 16A probe ø 3mm probe L 160mm capillary pipe 980mm capillary pipe isolated 600mm gland nut shaft ø 6x4.6mm shaft L 25mm shaft position upper rotation 270° outer switch 42.02900.000		
For models:	E4069EL, E4109EL, E7202E, E7202S, E7204, E7208, E7211, G7204, G7208, G7211		



GEV No.	390848	Ref. No.	732910090 802450
description	thermostat temperature range 50-291°C 1-pole 1NO 16A probe ø 3mm probe L 160mm capillary pipe 980mm capillary pipe isolated 600mm gland nut shaft ø 6x4.6mm shaft L 25mm shaft position upper rotation 270° outer switch 42.02900.000		
For models:	E7202, E7202S		
spare parts for	390848		
	GEV No.	301115	Ref. No.
			732910481 RZZ277
description	cam switch 2 operating positions 2NO sequence 0-1 16A shaft ø 6x4.6mm shaft L 23mm connection male faston 6.3mm		
	GEV No.	390843	Ref. No.
			731910500 RZZ451
description	thermostat t.max. 291°C temperature range 50-291°C 1-pole 1NO 16A probe ø 3mm probe L 160mm capillary pipe 980mm capillary pipe isolated 600mm gland nut shaft ø 6x4.6mm shaft L 25mm shaft position upper rotation 270° outer switch 42.02900.000		

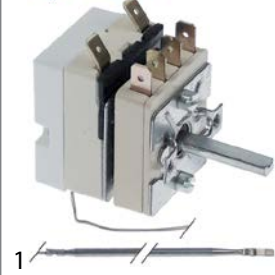

GEV No.	390834	Ref. No.	535420006 731050004 G2101 R4753
description	thermostat temperature range 50-320°C 1-pole 1NO 16A probe ø 3mm probe L 160mm capillary pipe 870mm capillary pipe isolatedmm gland nut shaft ø 6x4.6mm shaft L 23mm shaft position right rotation 270° outer switch 2NO		
For models:	E2101EU-OTC, E2914i, E3101OTC-3HP, E3101OTC-4HP, E3914i, G2101OTC, G3101OTC, G3106		

INVENSYS / ROBERTSHAW

control thermostats



GEV No.	390863	Ref. No.	536012313 736009730 G12313 G9730
description	thermostat t.max. 142°C temperature range 0-142°C 1-pole 1NO 25A probe ø 13mm probe L 230mm capillary pipe 1200mm capillary pipe isolatedmm gland nut 3/8" NPT shaft ø 6x4.6mm shaft L 24mm shaft position lower rotation 315° probe material copper 288°F		

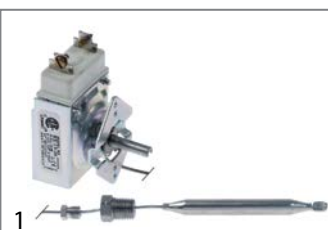

GEV No.	390838	Ref. No.	535710029 537320120 R3758
description	thermostat t.max. 190°C temperature range 90-190°C 1-pole 1NO 0.67A probe ø 9.5mm probe L 95mm capillary pipe 900mm capillary pipe isolatedmm gland nut 1/4" shaft ø 6x4.6mm shaft L 23mm shaft position lower rotation 315° t.max. 374°F operating temperature range 195-374°F		
For models:	G1008X, G1830-MK2, G1838X, G1848X, G1860-MK2, G1865		

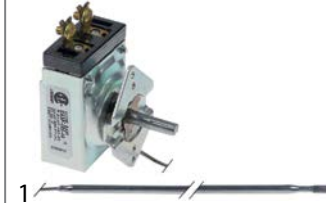

GEV No.	390835	Ref. No.	730962080 RKK4A
description	thermostat t.max. 287°C temperature range 93-287°C 1-pole 1NO 30A probe ø 4.6mm probe L 290mm capillary pipe 1200mm capillary pipe isolatedmm gland nut shaft ø 6x4.6mm shaft L 23mm shaft position lower rotation 315° t.max. 550°F operating temperature range 200-550°F		
For models:	E1100-3HP, E1100-4HP, E2101, E2101EU, E2117, E3101-3HP, E3101-4HP, E3117, E3161-3HP		

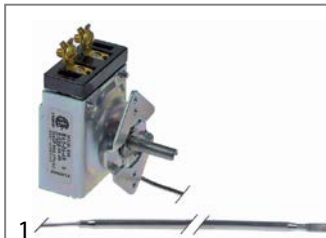

GEV No.	390837	Ref. No.	731880190 RKK4
description	thermostat t.max. 287°C temperature range 93-287°C 1-pole 1NO 30A probe ø 4.7mm probe L 290mm capillary pipe 1200mm capillary pipe isolatedmm gland nut shaft ø 6x4.6mm shaft L 23mm shaft position lower rotation 315° operating temperature range 200-550°F		

safety thermostats



GEV No.	390861	Ref. No.	736094161 G94161
description	safety thermostat switch-off temp. 129.5°C temperature range°C 1-pole 1COA probe ø 6.3mm probe L 133mm capillary pipe 600mm capillary pipe isolatedmm gland nut 1/4" NPT shaft ømm probe SS		

various

control thermostats



GEV No.	390842 ¹	Ref. No.	531740350 600096
description	bi-metal thermostat t.max. 250°C temperature range 100-250°C 1-pole 1NOA probe ø 4mm probe L 133mm capillary pipe 1300mm capillary pipe isolated 950mm gland nut shaft ø 6x4.6mm shaft L 23mm shaft position left rotation 290° replace set		
For models:	G1112		

¹with accessories



1

GEV No.	390864 ¹	Ref. No.	535670014 R5850
description	safety thermostat switch-off temp.°C 1-pole 1NOA probe ø 6mm probe L 110mm capillary pipe 1445mm capillary pipe isolatedmm gland nut M9x1 shaft ø 6x4.6mm probe SS setting range 270°C		
For models:	G3830, G3860, G3865		

¹with accessories



1

GEV No.	390865 ¹	Ref. No.	537350034 600926
description	thermostat t.max. 190°C temperature range 48-190°C 1-pole 1NOA probe ø 6mm probe L 110mm capillary pipe 1445mm capillary pipe isolatedmm gland nut M9x1 shaft ø 6x4.6mm shaft L 22mm shaft position right rotation 270° probe material SS kit		

¹with accessories

safety thermostats



1

GEV No.	390724	Ref. No.	531750502 701255
description	safety thermostat switch-off temp. 266°C temperature range°C 1-pole 1NCA probe ø 6mm probe L 60mm capillary pipe 880mm capillary pipe isolatedmm gland nut M9x1 shaft ømm probe material SS cable length 900mm replace set		
For models:	E2962, E2965, E2994, E2995, G1965, G1995, G2962, G2965, G2994, G2995		



1

GEV No.	390840 ¹	Ref. No.	537350030 600919	
description	safety thermostat switch-off temp.°C 1-pole 1NCA probe ø 6mm probe L 78mm capillary pipe 700mm capillary pipe isolatedmm gland nut M9x1 probe SS replace set			
spare parts for	390840			
	GEV No.	390841	Ref. No.	536300036 750080
	safety thermostat switch-off temp.°C temperature range°C 1-pole 1NCA probe ø 6mm probe L 78mm capillary pipe 700mm capillary pipe isolatedmm gland nut M9x1 probe SS			

¹with accessories



1

GEV No.	390839 ¹	Ref. No.	537350031 600920	
description	safety thermostat switch-off temp.°C 1-poleA probe ø 6mm probe L 78mm capillary pipe 700mm capillary pipe isolatedmm gland nut M9x1 probe SS replace set			
spare parts for	390839			
	GEV No.	390841	Ref. No.	536300036 750080
	safety thermostat switch-off temp.°C temperature range°C 1-pole 1NCA probe ø 6mm probe L 78mm capillary pipe 700mm capillary pipe isolatedmm gland nut M9x1 probe SS			

¹with accessories



1

GEV No.	390841 ¹	Ref. No.	536300036 750080
description	safety thermostat switch-off temp.°C temperature range°C 1-pole 1NCA probe ø 6mm probe L 78mm capillary pipe 700mm capillary pipe isolatedmm gland nut M9x1 probe SS		
For models:	G3840, G401, G401F, G402, G402F		

¹with accessories



switches and momentary switches

accessories

pedals



1

GEV No.	347761	Ref. No.	531860070 700108
description	pedal for air-pressure switch \varnothing 92.5mm hose length 2150mm hose \varnothing 3/6mm		
For models:	E1965, E1995, E2965, E2995, G1965, G1995, G2965, G2995		

microswitches

universal



1

GEV No.	345042	Ref. No.	530570540
description	microswitch with plunger 250V 16A 1CO connection male faston 6.3mm L 28mm ambient temperature max. 125°C mounting distance 22mm type EF83161.3 actuating force: 75g blue/black		
accessories for	345042		
	GEV No.	345043	Ref. No. —
	lever set 5-piece		

lever actuated



1

GEV No.	347758	Ref. No.	531925260 R7391
description	microswitch with lever 250V 5A 1CO connection with cable L 35mm ambient temperature max. 85°C mounting distance 22mm with cable 500mm type V3SY1UL actuating force: 160g lever length 25mm		
For models:	E7204, E7208, E7211, G7004, G7011, G7204, G7208, G7211		



1

GEV No.	345255	Ref. No.	531750540 731750540 RAA20/5
description	microswitch with lever 250V 16A 1CO connection male faston 6.3mm L 35mm L1 28mm ambient temperature max. 125°C mounting distance 22mm actuating force: 136g lever length 27mm		
For models:	E1962, E1965, E1994, E1995, E2962, E2965, E2994, E2995, E3800, G1962, G1965, G1994, G1995, G2962, G2965, G2994, G2995, G3800		

pin-plunger actuated



1

GEV No.	345042	Ref. No.	530570540
description	microswitch with plunger 250V 16A 1CO connection male faston 6.3mm L 28mm ambient temperature max. 125°C mounting distance 22mm type EF83161.3 actuating force: 75g blue/black		
accessories for	345042		
	GEV No.	345043	Ref. No. —
	lever set 5-piece		



1

GEV No.	347793	Ref. No.	735011060 R466
description	microswitch with plunger 250V 16A 1NO connection male faston 6.3mm ambient temperature max. 85°C mounting distance 22mm type XGA52-88 actuating force: 280g green/grey		

M10



1

GEV No.	345032	Ref. No.	730580003
description	microswitch with plunger thread M10x1 thread L 12mm 250V 16A 1CO connection male faston 6.3mm stroke 7mm mounting distance 22mm L 28mm ambient temperature max. 125°C type SP9603 actuating force: 180g		

M16



1

GEV No.	345046	Ref. No.	530092444
description	microswitch with plunger thread M16x1 thread L 25mm 250V 5A 1NC/1NO connection male faston 6.3mm stroke 6mm ambient temperature max. 85°C actuating force: 400g		



cam switches

on/off



1

GEV No.	301115	Ref. No.	732910481 RZZ277
description	cam switch 2 operating positions 2NO sequence 0-1 16A shaft ø 6x4.6mm shaft L 23mm connection male faston 6.3mm		

4-position





1

GEV No.	300022	Ref. No.	537850020 RPP11/1
description	cam switch 4 operating positions 2CO sequence 0-1-2-3 16A shaft ø 6x4.6mm shaft L 23mm connection screw		

7-position



1

GEV No.	300025	Ref. No.	539110400
description	cam switch 7 operating positions 1NO/2CO sequence 0-1-2-3-4-5-6 16A shaft ø 6x4.6mm shaft L 23mm connection screw 7-position ceramic		
For models:	E350-30, E350-33		
accessories for	300025		
	GEV No.	112172	Ref. No. —
	knob universal ø 70mm black without adaptor/dial plate		
	GEV No.	112213	Ref. No. —
	knob dial plate silver switch 7-position t.max.°C ED ø 63mm ID ø 45.5mm		
	GEV No.	112311	Ref. No. —
	knob adapter shaft ø 6x4.6mm L 0mm with spring		



1

GEV No.	300271	Ref. No.	539110420
description	cam switch 7 operating positions 1NO/2CO sequence 0-1-2-3-4-5-6 16A shaft ø 6x4.6mm shaft L 23mm connection screw 7-position ceramic with knob		
For models:	E350-30, E350-33		

4 operating positions

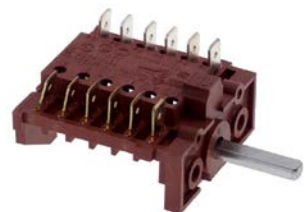

1

GEV No.	300057	Ref. No.	530292664
description	cam switch 4 operating positions 6NO sequence 0-1-2-3 16A shaft ø 6x4.6mm shaft L 23mm connection male faston 6.3mm 6CH/141 plastic		

touch sensitive light switches



1

GEV No.	346388	Ref. No.	530550040
description	touch sensitive light switch 1NOVA for combi-steamer L 47mm W 20mm H 30mm		

magnetic switches

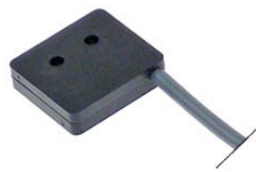

27x25mm



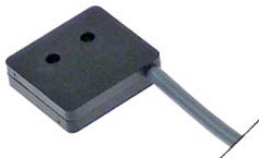
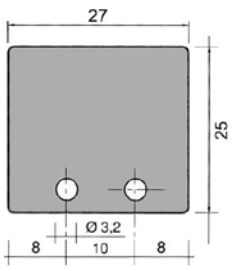

1

GEV No.	347759	Ref. No.	735750014 R5337
description	magnetic switch L 27mm W 25mm 1NO 24V 0.4A P max. 9.6W connection cable cable length 300mm		
For models:	E2203, E2206, E2207, E3830, E3840, E3860, E401, E401F, E402, E402F, E421F, E422F		



 			
GEV No.	347760	Ref. No.	601036 731300240
description	magnetic switch L 27mm W 25mm 1NO 24V 0.4A P max. 9.6W connection cable cable length 300mm		
spare parts for	347760		
			
GEV No.	347759	Ref. No.	735750014 R5337
description	magnetic switch L 27mm W 25mm 1NO 24V 0.4A P max. 9.6W connection cable cable length 300mm		

37x16mm			
			
GEV No.	347790	Ref. No.	530550041
description	magnetic switch L 37mm W 16mm 1NO 250V connection cable cable length 1960mm 10W with magnet nominal 0.04A		

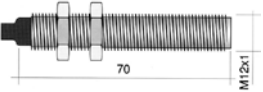
M12x1			
 			
GEV No.	345135	Ref. No.	530320048
description	magnetic switch thread M12x1 1NO 250V 3A P max. 100W connection cable cable length 2000mm L 72mm type 122		



control equipment

SCHLEGEL

push buttons

			
GEV No.	346188	Ref. No.	530320069
description	momentary switch unit mounting measurements $\phi 16/24 \times 24$ mm type momentary black/white square		

switch blocks

			
GEV No.	359756	Ref. No.	530320070
description	contact block latching 1NO/1NC connection male faston 2.8mm illuminable socket T5.5K type BFL5		
accessories for	359756		
			
GEV No.	359593	Ref. No.	—
description	light bulb socket T5.5K 60V 0.02A		

			
GEV No.	359184	Ref. No.	530320024
description	contact block momentary 1NC/1NO connection male faston 2.8mm socket type AT		

encoders and potentiometers

			
GEV No.	300263	Ref. No.	530338536
description	encoder rotation 360° shaft $\phi 6$ mm shaft L 13mm 0.1W		

			
GEV No.	403084	Ref. No.	730580022
description	encoder shaft L 18mm cable length 200mm shaft 6x4.6mm		

lamps

indicator lights

indicator lights (complete)

$\phi 6$mm			
			
GEV No.	359004	Ref. No.	530332771
description	indicator light $\phi 6$ mm 230V green cable length 400mm temp.-resist. 106°C		

			
1			
GEV No.	359005	Ref. No.	530332798
description	indicator light ø 6mm 230V yellow cable length 400mm		

ø10mm			
with screw socket			
			
1			
GEV No.	359237	Ref. No.	539110440 731750490
description	indicator light ø 10mm 230V red connection male faston 6.3mm		
For models:	E1962, E1965, E1994, E1995, E350-30, E350-33, E350-34, E350-35, E350-36, E350-37, E350-38, E350-39, E350-40, E350-41, E350-42, E350-43, E350-49		

			
1			
GEV No.	359524	Ref. No.	539110430 731750480
description	indicator light ø 10mm 230V yellow connection male faston 6.3mm		
For models:	E1962, E1965, E1994, E1995, E350-30, E350-34, E350-35, E350-36, E350-37, E350-38, E350-39, E350-40, E350-41, E350-42, E350-43, E350-49		

			
1			
GEV No.	357261	Ref. No.	730962010
description	indicator light no to be sold in France mounting ø 10mm red 230VAC connection 6.3x0.8 protection IP67 ambient temperature max. 105°C		
For models:	E1100-3HP, E1100-4HP, E3407, E3441, E3441R, E3481, E3481R, E3800, E3862, G3800		

			
1			
GEV No.	346881	Ref. No.	537810060 700025 731000008
description	indicator light ø 10mm 230V red connection male faston 6.3mm		
For models:	E2101, E2101EU, E2101EU-OTC, E2117, E2121, E2161EU, E2914i, E2962, E2965, E2994, E2995, E3101-3HP, E3101-4HP, E3101OTC-3HP, E3101OTC-4HP, E3117, E3121-3HP, E3121-4HP, E3161-3HP, E3161D, E3913i, E3914i, G2962, G2965, G2994, G2995		

			
1			
GEV No.	346883	Ref. No.	730962040
description	indicator light ø 10mm 230V yellow connection male faston 6.3mm		
For models:	E1100-3HP, E1100-4HP, E3405, E3800, E3862, G3800		

with plug-in socket			
			
1			
GEV No.	359140	Ref. No.	530091642
description	indicator light ø 10mm yellow 230V connection male faston 6.3mm Qty 1 pcs		

screw-on/push-on fit			
light bulbs			
for ovens			
			
1			
GEV No.	359612	Ref. No.	530354252
description	light bulb t.max. 300°C socket E14 25W 230V ø 25mm L 56mm lens L 30mm for oven lamp type Philips		

			
1			
GEV No.	359611	Ref. No.	531740340 RGG22/9
description	light bulb t.max. 300°C socket E14 40W 230V ø 45mm L 75mm lens L 50mm for oven lamp IMPORT		
For models:	E2102, E2112, G1112, G2102, G2112		

miscellaneous			
			
1			
GEV No.	362023	Ref. No.	530581488
description	light bulb socket T5.5K 48V 1.2W 0.025A		

halogen lamp			
for socket G4 / G6.35 / G9			
			
1			
GEV No.	359596	Ref. No.	530571954 EL571954
description	halogen lamp socket G4 12V 10W temp.-resist. 500°C		



			
1	500°C		
GEV No.	359599	Ref. No.	530570478
description	halogen lamp socket G4 12V 20W temp.-resist. 500°C		

linear lamps

infrared lamps

with base type Z ceramic

			
1			
GEV No.	359539 ¹	Ref. No.	539215170 R3593
description	infrared lamp socket Z-ceramic L 218mm 240V 500W cable length 205mm jacketed		

¹with double glass

oven lamps

universal oven lamps

mounting diameter 35.5mm

			
1			
GEV No.	359705	Ref. No.	530092339
description	oven lamp glass thr.ø 33.5mm ø 52mm hard glas temp.-resist. 350°C		
accessories for	359705		
	GEV No.	359610	Ref. No. —
	light bulb t.max. 300°C socket E14 15W 230V ø 22mm L 47mm lens L 20mm for oven lamp type Philips		
	GEV No.	359700	Ref. No. —
	gasket for pizza oven fibre glass ID ø 32.5mm ED ø 55mm thickness 5mm		
	GEV No.	359721	Ref. No. 530693421
	gasket silicone ED ø 48mm ID ø 39.5mm thickness 5mm Qty 1 pcs		
	GEV No.	359837	Ref. No. —
	gasket ID ø 33mm ED ø 46mm thickness 1mm graphite		
	GEV No.	359838	Ref. No. —
	gasket ID ø 33mm ED ø 45mm		

			
1			
GEV No.	359721	Ref. No.	530693421
description	gasket silicone ED ø 48mm ID ø 39.5mm thickness 5mm Qty 1 pcs		

55x70mm

			
1			
GEV No.	359375	Ref. No.	730580020
description	lamp socket complete without lamp socket E14 mounting measurements 55x70mm		

lamps

light bulbs

			
1			
GEV No.	359612	Ref. No.	530354252
description	light bulb t.max. 300°C socket E14 25W 230V ø 25mm L 56mm lens L 30mm for oven lamp type Philips		

			
1			
GEV No.	359611	Ref. No.	531740340 RGG22/9
description	light bulb t.max. 300°C socket E14 40W 230V ø 45mm L 75mm lens L 50mm for oven lamp IMPORT		
For models:	E2102, E2112, G1112, G2102, G2112		

halogen lamps

for socket G4 / G6.35 / G9

			
1	500°C		
GEV No.	359596	Ref. No.	530571954 EL571954
description	halogen lamp socket G4 12V 10W temp.-resist. 500°C		

			
1	500°C		
GEV No.	359599	Ref. No.	530570478
description	halogen lamp socket G4 12V 20W temp.-resist. 500°C		

sockets

G4 / G5,3 / G6,35

			
1			
GEV No.	359646	Ref. No.	530577294
description	lamp socket socket G4/G5.3/G6.35 24V ø 17mm H 15mm connection cable 130mm mounting distance 26mm for halogen lamp holder length 31mm cable length 130mm		





timers

electric timers

			
1			
GEV No.	350001	Ref. No.	530330006
description	timer 2CO at 250V 16A permanent position yes impulse electric shaft ø 6x4.6mm shaft L 22mm mounting distance 28mm connection rear 2-pole operation time 120min		

mechanical timers

			
1			
GEV No.	350186	Ref. No.	731910460 804014
description	timer M2 2-pole operation time 120min impulse mechanical 2CO at 250V 16A permanent position yes shaft ø 6x4.6mm shaft 6x4.6mm shaft L 23mm mounting distance 28mm		
For models:	E7002, E72025		
accessories for	350186		
			
GEV No.	112627	Ref. No.	—
knob time 120min ø 58mm shaft ø 6x4.6mm shaft flat lower			

			
1			
GEV No.	350193	Ref. No.	531930460 804012
description	timer M2 2-pole operation time 720min impulse mechanical 2CO at 250V 16A permanent position no shaft ø 6x4.6mm shaft 6x4.6mm shaft L 22mm mounting distance 28mm mounting thread 28 connection male faston 6.3mm		
For models:	E7004, E7008, E7011, G7004, G7008, G7011		

alarm devices

buzzers

			
1			
GEV No.	350051	Ref. No.	530348002
description	buzzer 230VAC connection male faston 6.3mm screw thread M4 buzzer 62dB		

contactors

BENEDIKT & JÄGER

power contactors

			
1			
GEV No.	381161	Ref. No.	535420013 RZZ228
description	power contactor resistive load 20A 230VAC (AC3/400V) 9A/5kW main contacts 3NO auxiliary contacts 1NO connection screw connection type K1-09D10		
For models:	G2101OTC		

			
1			
GEV No.	381079	Ref. No.	731750850
description	power contactor resistive load 25A 230VAC (AC3/400V) 16A/7.5kW main contacts 3NO auxiliary contacts 1NO connection screw connection type K2-16A10230		
For models:	E1962, E1965, E1994, E1995		

			
1			
GEV No.	380774	Ref. No.	731750860
description	power contactor resistive load 32A 230VAC (AC3/400V) 18A/7.5kW main contacts 3NO auxiliary contacts 1NO connection screw connection type K3-18ND10		
For models:	E2962, E2965, E2994, E2995		



ISKRA (FANAL)

power contactors



GEV No.	380214	Ref. No.	530332682
description	power contactor resistive load 20A 230VAC (AC3/400V) 8.5A/5.5kW main contacts 3NO auxiliary contacts 1NO connection screw connection type Fanal DSL7 00 type ISKRA K07M 00		

MOELLER/EATON

power contactors



GEV No.	380550	Ref. No.	530550034
description	power contactor resistive load 20A 230VAC (AC3/400V) 9A/4kW main contacts 3NO auxiliary contacts 1NC connection screw connection type DILM9 01		

accessories for 380550



GEV No.	380555	Ref. No.	—
description	auxiliary contact contacts 2NO/2NC AC15 16A for contactors DILEM connection screw type DILA-XHI22		



GEV No.	380556	Ref. No.	—
description	auxiliary contact contacts 4NO AC15 16A for contactors DILM 7-32 connection screw type DILA-XHI40		



GEV No.	380557	Ref. No.	—
description	auxiliary contact contacts 4NC AC15 16A for contactors DILM 7-32 connection screw type DILA-XHI04		



GEV No.	380558	Ref. No.	—
description	auxiliary contact contacts 3NO/1NC AC15 16A for contactors DILM 7-32 connection screw type DILA-XHI31		



GEV No.	380559	Ref. No.	—
description	auxiliary contact contacts 1NO/3NC AC15 16A for contactors DILM 7-32 connection screw type DILA-XHI13		



GEV No.	380568	Ref. No.	—
description	RC circuit suitable for DILM 9-12 rated 110-240V		



GEV No.	381005	Ref. No.	730550008
description	power contactor resistive load 35A 230VAC (AC3/400V) 17A/7.5kW main contacts 3NO auxiliary contacts 1NC connection screw connection type DILM 17-01		

auxiliary contacts



GEV No.	381007	Ref. No.	730550009
description	auxiliary contact contacts 1NO/1NC AC15 10A for contactors connection screw type DILA-XHI11		



GEV No.	380565	Ref. No.	730560001
description	auxiliary contact contacts 1NO/1NC AC15 10A for contactors DIL 17-32 connection screw type DILM 32-CHI11-S		

SIEMENS

power contactors



GEV No.	380652	Ref. No.	530570031
description	power contactor resistive load 22A 230VAC (AC3/400V) 9A/4kW main contacts 3NO auxiliary contacts 1NC connection screw connection type 3RT10-16-1AP02		

1

GEV No.	380646	Ref. No.	730570003
description	power contactor resistive load 40A 230VAC (AC3/400V) 17A/7.5kW main contacts 3NO auxiliary contacts connection screw connection type 3RT10-25-1AL20		

auxiliary contacts



1

GEV No.	380647	Ref. No.	530570032
description	auxiliary contact contacts 1NO/1NC AC15 3A for contactors 3RT102 3 RT103 connection screw connection type 3RH1921-1EA11 resistive load 10A AC-12 10A		

motor protection circuit breakers



1

GEV No.	382000	Ref. No.	530570034
description	motor protection circuit breaker type 3RU1116-1EBO setting range 2.8-4A (AC3/400V) 1.5kW		

TELEMECANIQUE (Schneider Electric)

power contactors



1

GEV No.	380976	Ref. No.	737400797 C400797
description	power contactor resistive load 32A 230VAC (AC3/400V) 18A/7.5kW main contacts 3NO auxiliary contacts 1NO/1NC connection screw connection		

auxiliary contacts



1

GEV No.	380987	Ref. No.	530751790
description	auxiliary contact contacts 3NO/1NC AC15 10A for contactors LC1K connection screw type LA1KN31		

solid state relays

CELDUC



1

GEV No.	402049	Ref. No.	530752401 EL752401
description	solid state relay CELDUC 1 phase 60A 24-600V 3-32VDC L 58mm W 45mm screw type SO965460		
accessories for	402049		
	GEV No.	401564	Ref. No. —
	heat-conducting foil L 62mm W 45mm for solid state relay		

relays

power relays

with bracket mounting



1

GEV No.	381162	Ref. No.	731560340 800644
description	plug-in relay 230VAC 30A 2CO connection male faston 6.3mm kit 250V 2-pole		
For models:	E1532		
spare parts for	381162		
	GEV No.	380812	Ref. No. —
	power relays FINDER 230VAC 30A 2CO connection F6.3 bracket mounting manuf. no. 66.82.8.230.0000		



transformers

encapsulated transformers

multiple connections



1

GEV No.	400251	Ref. No.	530572217
description	transformer 44VA		



1

GEV No.	402051	Ref. No.	530742775
description	transformer primary 230VAC secondary 16.5VAC 2x15VA connection male faston 50/60Hz		

with screw connection



1

GEV No.	400127	Ref. No.	530560005
description	transformer primary 230VAC secondary 12VAC 40VA secondary 3.2A H 63mm L 75mm W 78mm connection 2-wire connection systems 50/60Hz moulded		

PMA



1

GEV No.	400126	Ref. No.	530550038
description	transformer primary 230VAC secondary 12VAC 20VA secondary 2.1A connection screw 50Hz		



1

GEV No.	380312	Ref. No.	738160210
description	power relays FINDER 230VAC 10A 3CO connection male faston 4.8mm bracket mounting dimensions 52x32.2x36.5mm manuf. no. 60.63.8.230.0000		



1

GEV No.	380950	Ref. No.	600155 731580008 734243005 R6219
description	relay SCHRACK 230VAC 25A 2CO connection F6.3 with mounting strap at 250V 25A manuf. no. RM805730 250V 4-pole		
For models:	E2101EU-OTC, E2512, E2914i, E3101OTC-3HP, E3101OTC-4HP, E3512, E3913i, E3914i, G3101OTC		

time relays

time relays



1

GEV No.	380288	Ref. No.	530332615
description	time relay ELEKTRON VZE 806 time range 60s 24-250 AC/DC 5A connection cable mounting measurements DIN railmm		





electronic controllers

LAE

refrigeration controllers

built-in version 2-piece



1	GEV No.	403413	Ref. No.	00-556225
description	power PCB LAE type LF28B2S3E-1FS mounting measurements 104x91mm 230V voltage AC NTC relay outputs 3 NO-20A(6) NO-12A(4) NO-7A(2) NTC NTC DI DI front measurements 105x63mm built-in depth 45mm protection IP2x -50 up to +80°C display			
accessories for	403413			
	GEV No.	379771	Ref. No.	—
description	keypad unit LAE type LCD5-5 mounting measurements 71x29mmV voltage relay outputs front measurements 77x35x20mm built-in depth 20mm protection IP55°C display 3 digits			
	GEV No.	379784	Ref. No.	—
description	temperature probe NTC 2kOhm cable thermoplastic probe -40 up to +110°C cable -40 up to +110°C probe ø6x35mm cable length 2m without screw connection 2-wire resistor 2kOhm			
	GEV No.	403459	Ref. No.	—
description	connection cable LAE type FC06-20M01			

probes

universal probes

temperature probes



1	GEV No.	381363	Ref. No.	530550052
description	temperature probe thermocouple K (NiCr-Ni) probe -50 up to 1150°C cable -50 up to +180°C cable length 1.5m thread M10x1 adapter length 93mm adapter ø 6mm cable colours silver/yellow probe L 90/14mm probe ø 6/3mm			

producer-specific probes

probes



1	GEV No.	378320	Ref. No.	536430024 802178
description	temperature probe NTC 100kOhm cable glass fibre probe -40 up to +125°C cable -50 up to +350°C connection male faston 6.3mm thread probe ø5x100mm cable length 0.35m			
For models:	G2845F			

1	GEV No.	378317	Ref. No.	536300034 750079
description	temperature probe NTC 100kOhm cable PTFE probe -40 up to +110°C cable -40 up to +250°C connection 2-wire thread M10x1.25 probe ø5x128mm cable length 0.35m			
For models:	G3840, G401, G401F, G402, G402F			

1	GEV No.	378318	Ref. No.	731350020 750199
description	temperature probe NTC 100kOhm cable PVC probe -40 up to +110°C cable -10 up to 100°C connection 2-wire thread probe ø5x300mm cable length 1m			
For models:	E3840, E401, E401F, E402, E402F, E421, E421F, E422, E422F			

1	GEV No.	378325	Ref. No.	534510260 R3502
description	temperature probe NTC cable Vetrotex probe -40 up to +110°C cable -50 up to +350°C connection 2-wire thread 1/8" probe ø4.7x90mm cable length 0.5m			
For models:	G1808-CE, G1808-Pre-CE, G1838-CE, G1848-CE, G1848-Pre-CE			

1	GEV No.	378324	Ref. No.	600534 734310370
description	temperature probe NTC cable Vetrotex probe -40 up to +110°C cable -50 up to +350°C connection 2-wire thread 1/8" probe ø5x100mm cable length 0.4m			
For models:	E4063, E4103, E4203			

1	GEV No.	379087	Ref. No.	530570621 EL570621
description	temperature probe thermocouple K (NiCr-Ni) cable silicone probe -50 up to 1150°C cable -50 up to +180°C connection male faston 2.8mm thread probe ø1x30mm cable length 1.6m			

1	GEV No.	378319	Ref. No.	734510020 R3588
description	temperature probe thermocouple K (NiCr-Ni) cable Vetrotex probe -50 up to 1150°C cable -50 up to +350°C connection 2-wire thread M10x1 probe ø5x280mm cable length 0.55m			
For models:	E1808, E1838, E1848			



core probes



GEV No.	378358	Ref. No.	530747017
description	core temperature probe		

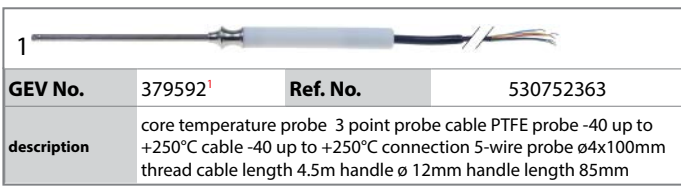

*multipoint probe

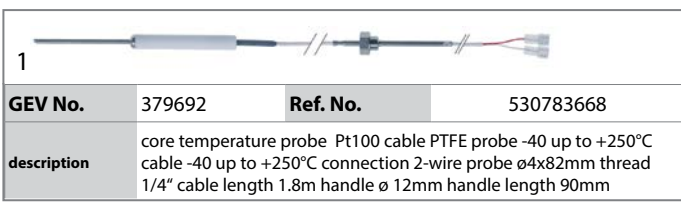

GEV No.	379592 ¹	Ref. No.	530752363
description	core temperature probe 3 point probe cable PTFE probe -40 up to +250°C cable -40 up to +250°C connection 2-wire probe ø4x100mm thread cable length 4.5m handle ø 12mm handle length 85mm		

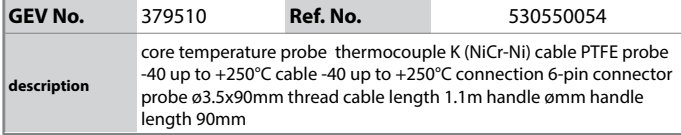

GEV No.	379692	Ref. No.	530783668
description	core temperature probe Pt100 cable PTFE probe -40 up to +250°C cable -40 up to +250°C connection 2-wire probe ø4x82mm thread 1/4" cable length 1.8m handle ø 12mm handle length 90mm		



GEV No.	379510	Ref. No.	530550054
description	core temperature probe thermocouple K (NiCr-Ni) cable PTFE probe -40 up to +250°C cable -40 up to +250°C connection 6-pin connector probe ø3.5x90mm thread cable length 1.1m handle ømm handle length 90mm		



GEV No.	379827	Ref. No.	737601043 C601043
description	temperature probe thermocouple K (NiCr-Ni) cable PTFE probe -40 up to +250°C cable -40 up to +250°C connection 2-wire probe ø5x115/285mm thread cable length 1.5m handle ømm handle length L1 280mm L2 115mm		

electronics

frequency converters

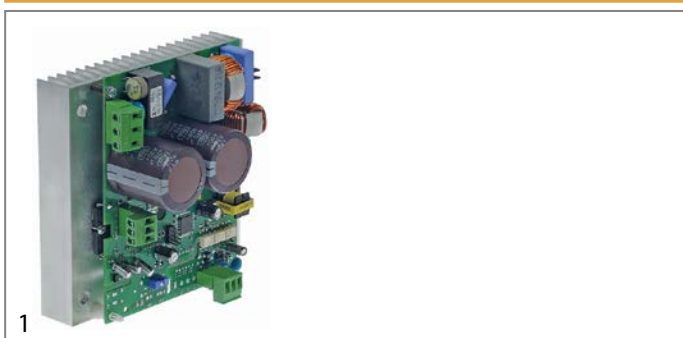

GEV No.	403841	Ref. No.	530550035
description	frequency converter with heat sink for combi-steamer L 135mm W 135mm 800W ECS P0010205-0		

rectifiers



GEV No.	400253	Ref. No.	530570532
description	rectifier		

PCBs

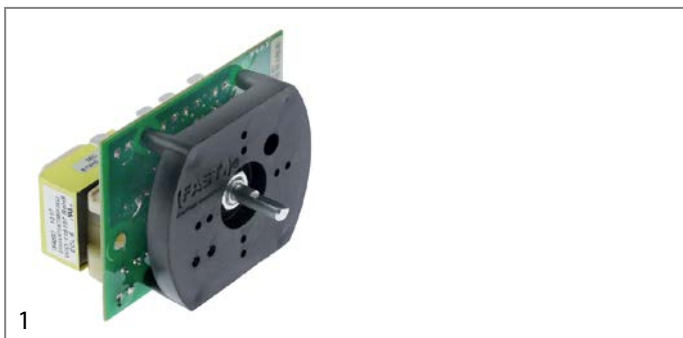

GEV No.	403142	Ref. No.	536430001 731350002 750035
description	control PCB fryer 401/402 L 89mm W 66mm Qty 1 pcs		
For models:	E3840, E401, E401F, E402, E402F, E421, E421F, G2845F, G401, G401F		



1

GEV No.	403181	Ref. No.	530742457 EL742457
description	conversion kit combi-steamer Genius T 6-11 10-11 L 155mm W 115mm cable length 60mm display with PCB		

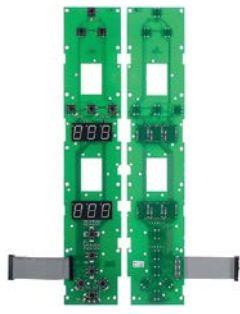

1

GEV No.	403823	Ref. No.	530550132
description	keypad PCB for combi-steamer L 443mm W 83mm		

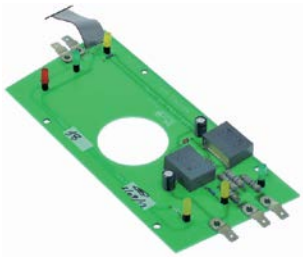

1

GEV No.	403145	Ref. No.	535770055 R5213
description	display PCB fryer G2840 L 200mm W 90mm cable length 150mm		
For models:	G2840		



1

GEV No.	403179	Ref. No.	530791458 EL791458
description	PCB combi-steamer Genius T 6-11 10-11 L 400mm W 155mm		



1

GEV No.	402619	Ref. No.	530742465 EL742465
description	keypad PCB combi-steamer 1121/2021 L 350mm W 121mm with display		



1

GEV No.	401962	Ref. No.	530550044
description	PCB combi-steamer HME 611/1011		

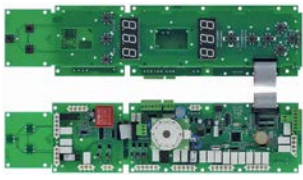

1

GEV No.	403821	Ref. No.	530550049
description	keypad PCB for combi-steamer		

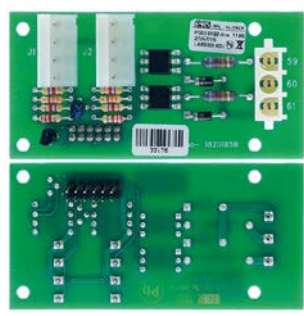

1

GEV No.	403828	Ref. No.	530550047
description	PCB for combi-steamer L 85mm W 42mm		

1

GEV No.	403048	Ref. No.	737214132 C216176
description	PCB for fryer L 135mm W 135mm		



1

GEV No.	403148	Ref. No.	536060006 802101
description	PCB fryer 2840/2841/2842 L 80mm W 140mm		
For models:	G2840, G2841, G2842, G2844F, G2845F		



1

GEV No.	403146	Ref. No.	535770057 801962
description	PCB fryer 2840/FFSE98 L 126mm W 126mm		
For models:	G2840		



1

GEV No.	403147	Ref. No.	734510160 R3640
description	PCB fryer E1808 L 113mm W 100mm		
For models:	E1808, E1838, E1848		



1

GEV No.	400016	Ref. No.	530593648
description	PCB pulse timer for steaming with mounting angle		

solenoid valves

solenoid valves (water)

INTERELEKTRIK

medium temperature: 90°C 90°C 60°C
 ambient temperature: 60°C 25°C 60°C
 duty cycle: 40% 100% 100%



1

GEV No.	370688	Ref. No.	530754463 EL754463
description	solenoid valve 220-240VAC inlet 3/4" outlet 13.5mm DN8 t.max. 90°C plastic		

MÜLLER

medium temperature: 90°C
 duty cycle: 100%



1













GEV No.	370002	Ref. No.	734310265 R2027	
description	solenoid valve single straight 230VAC inlet 3/4" outlet 14.5mm DN10 t.max. 90°C duty cycle 100% MÜLLER			
For models:	E4063, E4103			
spare parts for	370002			
	GEV No.	370127	Ref. No.	—
solenoid valve body single straight inlet 3/4" outlet 14.5mm DN10 t.max. 90°C duty cycle 100% MÜLLER 230V				
	GEV No.	371002	Ref. No.	—
solenoid valve holder MÜLLER flange support				
	GEV No.	371009	Ref. No.	—
compression spring for solenoid coil				
	GEV No.	371011	Ref. No.	—
spare parts kit membrane with long star star hight 8mm MÜLLER				

Table continues overleaf



spare parts for 370002	
	GEV No. 371017 Ref. No. —
solenoid coil MÜLLER 230VAC connection male faston 6.3mm	
	GEV No. 371122 Ref. No. 530249688
solenoid valve filter ø 19mm H 10mm suitable for MÜLLER	
	GEV No. 501161 Ref. No. —
tap head for solenoid valve holder for solenoid coils	
accessories for 370002	
	GEV No. 371010 Ref. No. —
solenoid coil 230VAC connection with cable cable length 2000mm	
	GEV No. 371037 Ref. No. —
solenoid coil 24VAC 50/60Hz connection male faston 6.3mm	
	GEV No. 371038 Ref. No. —
solenoid coil 230VAC connection appliance plug	

			
1			
GEV No.	370715	Ref. No.	735400100 R2920
description	solenoid valve single straight 230VAC inlet 3/4" outlet 3/8" DN10 t.max. 90°C duty cycle 100% MÜLLER SVGW plastic		
For models:	E4069EL, E4069TC-TMS, E4109EL, E4109TC-TMS, G4069, G4109		

spare parts and accessories			
filters			
			
1			
GEV No.	371122	Ref. No.	530249688
description	solenoid valve filter ø 19mm H 10mm suitable for MÜLLER		

RPE			
JOHN GUEST			
			
1			
GEV No.	374032 ¹	Ref. No.	730550006
description	solenoid valve double straight 230VAC inlet 3/4" outlet 10mm DN10 plastic output A w/t membrane (constantly open)		

¹cylindrical outlet

			
1			
GEV No.	370768 ¹	Ref. No.	530550028
description	solenoid valve single straight 230VAC inlet 3/4" outlet 10mm input/min output/min DN10 t.max. 90°C duty cycle 100% RPE		

¹cylindrical outlet

solenoid valves with reducers			
2-fold			
			
1			
GEV No.	374031	Ref. No.	530550029
description	solenoid valve double straight 230VAC inlet 3/4 outlet JG 10 input 10-12l/min t.max. 90°C RPE plastic flow regulating valve inlet white + outlet reducer red		

3-fold			
			
1			
GEV No.	374014 ¹	Ref. No.	530570030
description	solenoid valve triple straight 230VAC inlet 3/4" outlet 10mm input 10-12l/min RPE plastic flow regulating valve inlet white flow regulating valve outlet A red/green flow regulating valve outlet B red/green flow regulating valve outlet C red/green		

¹cylindrical outlet

			
1			
GEV No.	374033	Ref. No.	730580007
description	solenoid valve triple straight 230VAC inlet 3/4" outlet 10mm input 10-12l/min t.max. 90°C RPE plastic flow regulating valve inlet white output B w/t membrane (constantly open)		

metal			
MÜLLER			
2-way			
			
1			
GEV No.	370069 ¹	Ref. No.	530374806
description	solenoid valve 2-ways 230VAC inlet 1/8" IT outlet 1/8" IT L 30mm water MÜLLER DN10		

¹with adjusting screw

solenoid valves (gas)

various



1

GEV No.	370711	Ref. No.	531750320 531930530 701251
description	solenoid valve gas 2-ways 230VAC inlet 1/2" IT outlet 1/2" IT connection cable L 69mm BLACK TEKNIGAS approval IP40 overall height 94mm		
For models:	G1962, G1965, G1994, G1995, G2962, G2965, G2994, G2995, G7004, G7008, G7011, G7204, G7208, G7211		



1

GEV No.	107442	Ref. No.	534510930 RZZ43
description	solenoid valve gas 2-ways triple 230VAC inlet 1/2" outlet 1/2" L 105mm p max 0.065bar overall height 145mm		
For models:	G1808-CE, G1808-Pre-CE, G1838-CE, G1848-CE, G1848-Pre-CE		

Solenoid valve - accessories

filters



1

GEV No.	371122	Ref. No.	530249688
description	solenoid valve filter ø 19mm H 10mm suitable for MÜLLER		



1

GEV No.	530903	Ref. No.	730580018
description	solenoid coil plug type F6.3x0.8 230V for combi-steamer		

ball valves electric



1

GEV No.	403042	Ref. No.	730610000
description	ball valve inlet 3/4" IT outlet 3/4" IT 230V L 68mm closed off-current mode of operation electric connection cable 400mm		



1

GEV No.	403180	Ref. No.	734310960 R2074
description	ball valve inlet 3/4" NPTF outlet 3/4" NPTF 240V L 93mm 50/60Hz brass off-current open mode of operation electric connection cable 1000mm 5/6W for pipe ø 22mm		
For models:	E4063, E4103		

pressure switches

for gas equipment



1

GEV No.	541073	Ref. No.	530550019
description	pressure control ø 45mm pressure range adjustable 5-20mbar pressure connection vertical gas technology connection 1/4" pressure connection ø 1/4"mm		

for steam control





1

GEV No.	541074	Ref. No.	730550001
description	pressure control ø 45mm triggering pressure 0.5bar reset pressure 0.35bar pressure connection vertical steam control pressure range 0.35/0.51bar connection 1/8" pressure connection 1/8"		



for combi-steamers

			
1			
GEV No.	541526	Ref. No.	530784028
description	pressure control p max 0.5bar pressure connection 1/8"		

			
1			
GEV No.	403183	Ref. No.	536070178 G70178
description	level electrode 3/8" total length 162mm probe L 11mm insulated probe length 102mm connection M3 ø 10mm		

			
1			
GEV No.	400130	Ref. No.	530550051
description	level electrode M14x1.25 total length 220mm probe L 194mm insulated probe length 26mm connection male faston 6.3mm ø 2.5mm		

electrodes

			
1			
GEV No.	401209	Ref. No.	735400440 R2950
description	level electrode 1/4" total length 180mm probe L 155mm insulated probe length 70mm PTFE insulated connection male faston 6.3mm stainless steel ø 2.5mm		
For models:	E4069EL, E4069TC-TMS, E4109EL, E4109TC-TMS		

			
1			
GEV No.	403143	Ref. No.	734310300 R2265
description	level electrode 2 hole flange total length 100mm probe Lmm insulated probe lengthmm no probe connection M6x1 ceramic ø 32mm		
For models:	E4063, E4103, E4203, G4069, G4109		

			
1			
GEV No.	403144	Ref. No.	610044 734310310
description	level electrode 2 hole flange total length 215mm probe L 116mm insulated probe lengthmm connection M6x1		
For models:	E4063, E4103, E4203, G4069, G4109		

fans

axial fans

ebm-papst

			
1			
GEV No.	601038 ¹	Ref. No.	534500190 R7272
description	axial fan L 80mm W 80mm H 38mm 230VAC 50/60Hz 12W bearing ball bearing manuf. no. 8556N metal connection cable 300mm ebm-papst fan wheel ø 75mm temp.-resist. 90°C airflow 50m³/h		
For models:	E3913i, E3914i, G1808-CE, G1808-Pre-CE, G1838-CE, G1848-CE, G1848-Pre-CE		
accessories for	601038		
	GEV No.	691102	Ref. No. —
	guard ø 75mm mounting distance 71mm for axial fan 80mm		

¹with ball bearings

import



1

GEV No.	601080 ¹	Ref. No.	FAN095	
description	axial fan L 119mm W 119mm H 38mm 230VAC 50/60Hz 23/20W bearing ball bearing connection male faston 2.8mm metal ADDA fan wheel ø 110mm temp.-resist. 70°C			
accessories for	601080			
	GEV No.	550898	Ref. No.	—
	connecting cable cable length 2000mm connection F 2.8 connection distance 7.9mm for axial flow fan			
	GEV No.	692519	Ref. No.	—
	guard L 120mm W 120mm plastic			

¹with ball bearings



1

GEV No.	601081 ¹	Ref. No.	530560003	
description	axial fan L 80mm W 80mm H 38mm 230VAC 50/60Hz 14/13.5W bearing ball bearing connection male faston 2.8mm metal ADDA fan wheel ø 75mm temp.-resist. 70°C			
accessories for	601081			
	GEV No.	691102	Ref. No.	—
	guard ø 75mm mounting distance 71mm for axial fan 80mm			

¹with ball bearings

hot air motors



1

GEV No.	550859	Ref. No.	530560016
description	counterflange for fan motor ED ø 60mm int. ø 1 34mm int. ø 2 25mm thickness 6mm brass		



1

GEV No.	510675	Ref. No.	530373621
description	counterflange for fan motor ED ø 60mm int. ø 2 30mm thickness 5mm stainless steel		



1

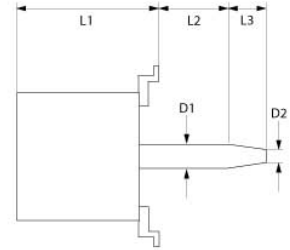

GEV No.	500658	Ref. No.	530560002
description	fan motor 230/400V 3 phase 50/60Hz 0.55kW 1400/1700rpm speeds 1 L1 145mm L2 47mm L3 47mm D1 ø 24mm D2 ø 20mm M12L IT 2.6-2.3/1.5-1.3A (at 50-60Hz)A Cos(φ) 0.73 at 50Hz 200-240/415V at 60Hz 200-240/480V at 50Hz 1400rpm at 60Hz 1700rpm		

spare parts for	500658			
	GEV No.	511172	Ref. No.	530560025
	shaft sealing ID ø 24mm ED ø 29mm thickness 3mm			

accessories for	500658			
	GEV No.	560449	Ref. No.	—
	hexagonal screw thread M12x1.5 L thread L 22mm bore ø 6.3mm WS 19 total length 30mm			

	GEV No.	601244	Ref. No.	530560007
	fan wheel D1 ø 350mm H1 114mm blades 12 D2 ø 19.5mm D3 ø 23mm H2 45mm			



1

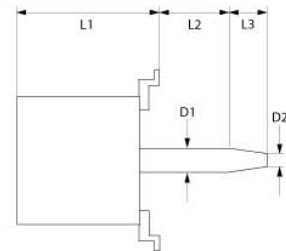

GEV No.	500102	Ref. No.	530332410
description	fan motor 230-240V 1 phase 50Hz 0.09kW 1390rpm speeds 1 L1 150mm L2 32mm L3 27mm ø 125mm M10R IT 1.1A suitable capacitor 4µF/400V power input 200W at 50Hz 1390rpm type L7yzw4B-207 no. X5 D1 ø 17mm D2 ø 14mm		

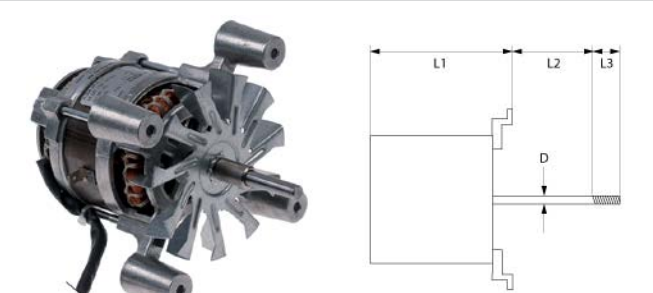

1

GEV No.	601474	Ref. No.	530693286
description	fan motor 230V 1 phase 50/60Hz 0.03kW 3600rpm speeds 1 L1 115mm L2 20mm L3 32mm ϕ 12mm shaft flat length 23mm 7.5/8 0.35/0.56A suitable capacitor 3 μ F400V power input 75/125W at 50Hz 3600rpm type L5ow2B-317 no. W9		
accessories for	601474		
	GEV No.	602166	Ref. No. 530693375
	fan wheel blades 9 D1 ϕ 175mm D2 ϕ 8mm D3 ϕ 8mm H1 30mm H2 28mm ED 6-23		

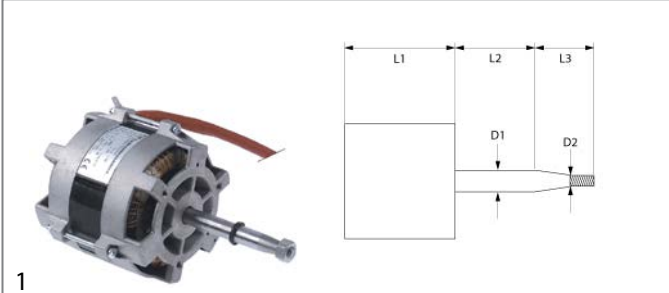

1

GEV No.	500680	Ref. No.	530550117
description	fan motor 230V 1 phase 50Hz 0.37kW 2800rpm speeds 1 L1 121mm L2 77mm L3 31mm D1 ϕ 16mm D2 ϕ 11mm 2.5A Cos(f) 0.95 at 50Hz 230V at 50Hz 2800rpm type 1057.2155		
accessories for	500680		
	GEV No.	601060	Ref. No. —
	fan wheel D1 ϕ 180mm H1 60mm blades 16 D2 ϕ 11mm D3 ϕ 16mm H2 30mm		

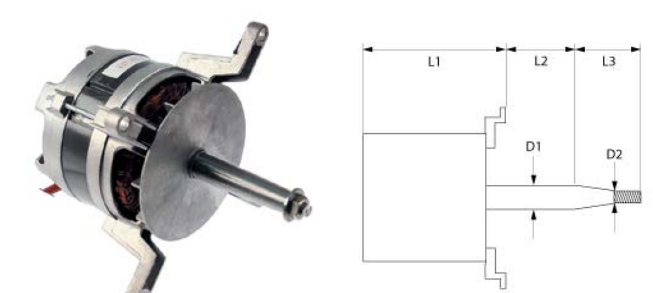

1

GEV No.	500659	Ref. No.	530560023
description	fan motor 230V 1 phase 50/60Hz 0.55kW 1400/1700rpm speeds 1 L1 150mm L2 52mm L3 45mm D1 ϕ 24mm D2 ϕ 20mm M12L IT 3A suitable capacitor 20 μ F/450V Cos(f) 0.9 at 50Hz 1400rpm at 60Hz 1700rpm type 3042A2350		
spare parts for	500659		
	GEV No.	511172	Ref. No. 530560025
	shaft sealing ID ϕ 24mm ED ϕ 29mm thickness 3mm		

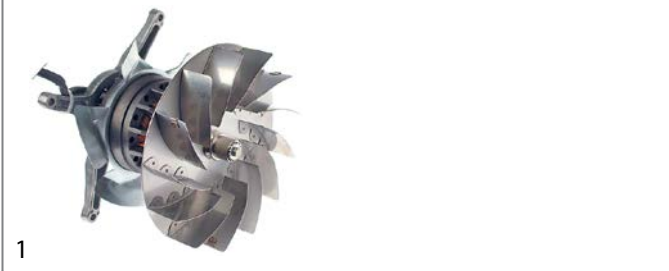

1

GEV No.	601871	Ref. No.	530302821
description	fan motor 230V 1 phase 50Hz 85kW 2400rpm speeds 1 L1 85mm L2 40mm L3 33mm L4 133.5mm fan wheel ϕ 180mm at 50Hz 230V at 60Hz 230V at 50Hz 2600rpm at 60Hz 2850rpm type R2E180-AU01-09		



1

GEV No.	501566	Ref. No.	530550118
description	fan motor 230V 3 phase 50Hz 0.25kW 2700rpm L1 122mm L2 77mm L3 30mm D1 ϕ 15mm D2 ϕ 8mm M10 1.5A type FIR no. 1057.2650		

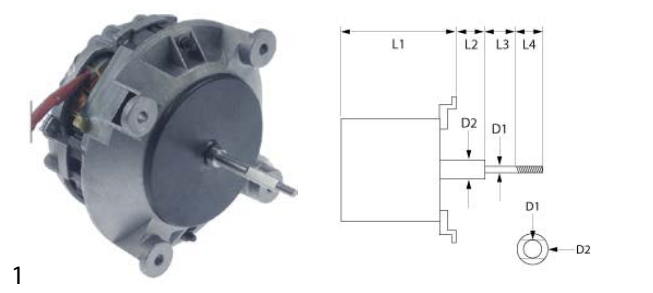

1

GEV No.	601856	Ref. No.	730550005
description	fan motor 230V 1 phase 50Hz 0.075kW 2650rpm speeds 1 L1 85mm L2 30mm L3 23mm L4 12mm D1 ϕ 8x6mm D2 ϕ 8mm 0.6A suitable capacitor 5 μ F/400V		
accessories for	601856		
	GEV No.	365017	Ref. No. —
	operating capacitor capacity 5 μ F 450V tolerance 5% 50/60Hz ambient temperature max. -25 to +85°C ϕ 28mm L 54mm M8 plastic connection male faston 6.3mm 16.10.08 protection		

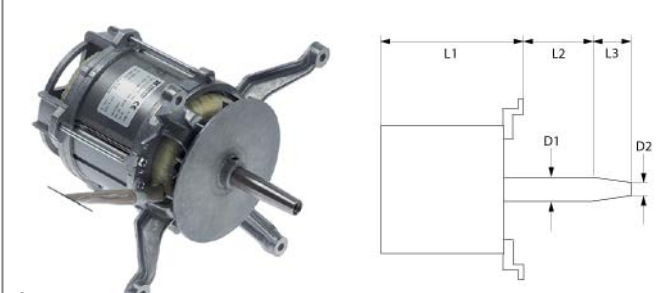

1

GEV No.	500170	Ref. No.	530390052
description	fan motor 3 phase		

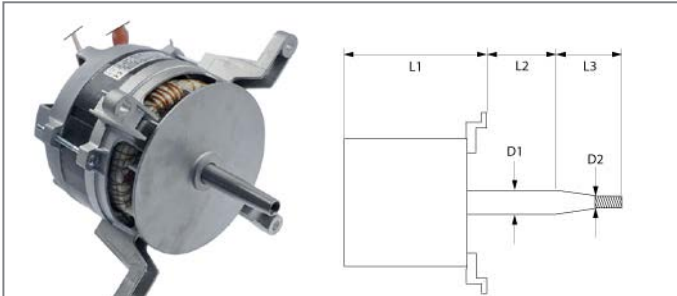

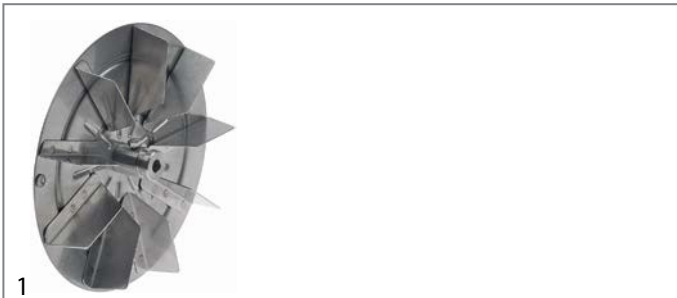

1

GEV No.	601864	Ref. No.	530742740
description	fan motor 380-415V 3 phase 50Hz 0.21kW 700/1400rpm speeds 2 L1 160mm L2 25mm L3 40mm D1 ø 17mm D2 ø 13mm M10R IT at 50Hz 700/1400rpm type 3081DH4052		



1

GEV No.	602166	Ref. No.	530693375
description	fan wheel blades 9 D1 ø 175mm D2 ø 8mm D3 ø 8mm H1 30mm H2 28mm ED 6-23		
accessories for	602166		
	GEV No.	601474	Ref. No. 530693286
description	fan motor 230V 1 phase 50/60Hz 0.03kW 3600rpm speeds 1 L1 115mm L2 20mm L3 32mm ø 12mm shaft flat length 23mm 7.5/8 0.35/0.56A suitable capacitor 3µF400V power input 75/125W at 50Hz 3600rpm type L5ow2B-317 no. W9		



1

GEV No.	601244	Ref. No.	530560007
description	fan wheel D1 ø 350mm H1 114mm blades 12 D2 ø 19.5mm D3 ø 23mm H2 45mm		



1

GEV No.	602168	Ref. No.	530899992
description	fan wheel for motor cooling ED ø 180mm H 20mm ID ø 25mm		



1

GEV No.	550858	Ref. No.	530560015
description	flange for fan motor ED ø 60mm int. ø 1 28.5mm int. ø 2 25mm thickness 4mm brass		



1

GEV No.	510673	Ref. No.	530580600
description	flange for fan motor ED ø 60mm int. ø 1 43mm int. ø 2 29mm thickness 6mm stainless steel		



1

GEV No.	550860	Ref. No.	730580014
description	flange for gasket ED ø 35mm int. ø 1 22mm int. ø 2 9mm thickness 8mm brass		



1

GEV No.	550861	Ref. No.	730580034
description	shaft seal for fan motor ID ø 7.5mm ED ø 22mm thickness 7mm		



1

GEV No.	511172	Ref. No.	530560025
description	shaft sealing ID ø 24mm ED ø 29mm thickness 3mm		



1

GEV No.	694997	Ref. No.	530782939
description	speed sensor for hot air motors cable length 450mm		



hot air fans

ebm-papst

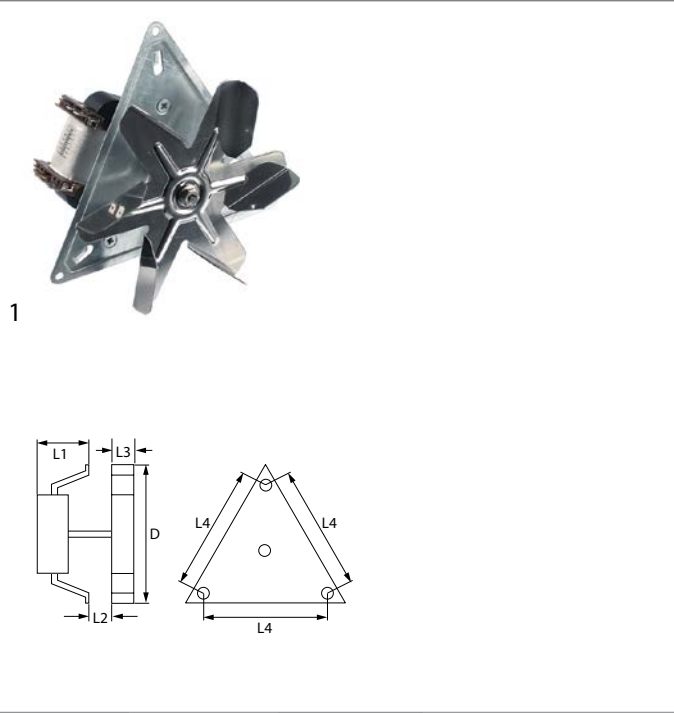

GEV No.	601249	Ref. No.	535420010 RZZ263
description	hot air fan 230V 32W 0.27A L1 60mm L2 20mm L3 20mm L4 157mm fan wheel ø 150mm ebm-papst type R2K150-AC01-15		
For models:	E2101EU-OTC, E3101OTC-3HP, E3101OTC-4HP, G2101OTC, G3101OTC		

radial fans

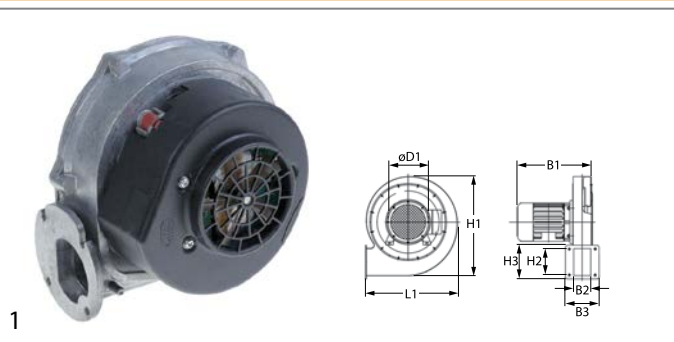

GEV No.	601181	Ref. No.	530550023
description	radial fan 230V voltage AC 50Hz 100W H1 170mm L1 175mm D1 ø 50mm W1 115mm W2 40mm H2 45mm		

motors

gear motors

for drink dispensers

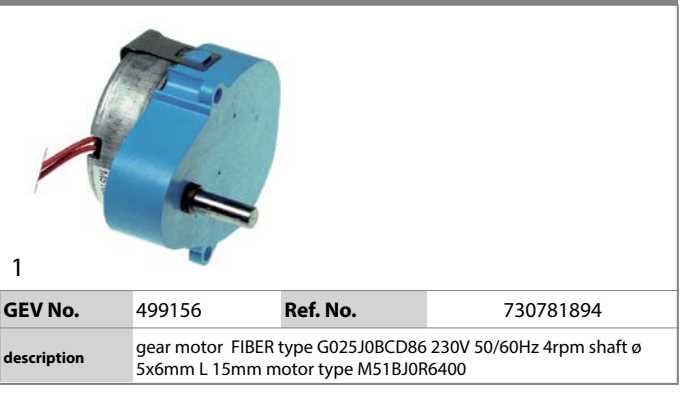

1

GEV No.	499156	Ref. No.	730781894
description	gear motor FIBER type G025J0BCD86 230V 50/60Hz 4rpm shaft ø 5x6mm L 15mm motor type M51BJ0R6400		

for combi-steamers



GEV No.	502288	Ref. No.	530550027
description	gear kit 8W 230V voltage AC 30rpm shaft ø 6mm L 75mm W 87mm H 84mm conversion kit		

spare parts for	502288	GEV No.	502291	Ref. No.	—
		gear motor METEOR type 58U59DB4A1/00 8W 230V voltage AC 50Hz 30rpm shaft ø 6x5mm L 69mm W 49mm H 65mm			



pumps

wash and rinse pumps

OLYMPIA

pumps



1	GEV No.	500199	Ref. No.	738160996
	description	pump inlet \varnothing 32mm outlet \varnothing 30/24mm type T80 230V 50Hz 1 phase 0.25kW 0.34HP L 205mm rotation direction left capacitor 5 μ F OLYMPIA		
	spare parts for	500199		
	GEV No.	365017	Ref. No.	—
	description	operating capacitor capacity 5 μ F 450V tolerance 5% 50/60Hz ambient temperature max. -25 to +85°C \varnothing 28mm L 54mm M8 plastic connection male faston 6.3mm 16.10.08 protection		
	GEV No.	510693	Ref. No.	—
	description	mechanical shaft seal for shaft \varnothing 12mm slide ring ext. \varnothing 24mm slide ring H 15.5mm slide ring int. \varnothing 11mm counter ring mounting \varnothing 24mm height counter ring 8mm counter ring int. \varnothing 13.5mm		
	GEV No.	521151	Ref. No.	—
	description	impeller \varnothing 71mm H 19mm pump type OLYMPIA thread M10R shaft \varnothing 12mm shaft length 8mm		
	GEV No.	521178	Ref. No.	—
	description	pump casing OLYMPIA outlet \varnothing 30/24mm pump type T80		
	GEV No.	521552	Ref. No.	—
	description	pump cover OLYMPIA inlet \varnothing 32mm outlet \varnothing 30/24mm \varnothing 103mm ID \varnothing 93mm		
	GEV No.	521703	Ref. No.	—
	description	pump cover gasket EPDM thickness 2.5mm ID \varnothing 75mm Qty 1 pcs		

booster pumps I



1	GEV No.	500358	Ref. No.	738160720
	description	pump inlet \varnothing 3/8" outlet \varnothing 3/8" type PS46 230V 50Hz 0.45kW \varnothing 100mm L 200mm capacitor 10 μ F LGB		
	spare parts for	500358		
	GEV No.	510713	Ref. No.	—
	description	slide ring for shaft \varnothing 12mm ED \varnothing 24mm H 16mm		
	GEV No.	510723	Ref. No.	—
	description	counter ring H 8mm ED \varnothing 26mm ID \varnothing 13.5mm for mechanical shaft seal		
	GEV No.	698400	Ref. No.	—
	description	pump cover gasket pump type PS46 thickness 2mm ID \varnothing 66mm Qty 1 pcs		
	accessories for	500358		
	GEV No.	365015	Ref. No.	530550039
	description	operating capacitor capacity 10 μ F 400V tolerance 5%Hz ambient temperature max. -25 to +85°C \varnothing 35.5mm L 59mm M8 plastic connection male faston 6.3mm protection		
	GEV No.	511279	Ref. No.	—
	description	hose connector brass straight thread 3/8" hose \varnothing 12mm Qty 1 pcs		
	GEV No.	520202	Ref. No.	—
	description	hose connector nickel-plated brass straight thread 3/8" hose \varnothing 12mm Qty 1 pcs		
	GEV No.	520677	Ref. No.	—
	description	hose connector brass straight thread 3/8" hose \varnothing 13mm Qty 1 pcs		

booster pumps II

accessories





1	GEV No.	365015	Ref. No.	530550039
	description	operating capacitor capacity 10 μ F 400V tolerance 5%Hz ambient temperature max. -25 to +85°C \varnothing 35.5mm L 59mm M8 plastic connection male faston 6.3mm protection		



vibration pumps



1

GEV No.	500568	Ref. No.	530550032
description	vibration pump 230V 32W 50Hz inlet \varnothing 7 outlet \varnothing 1/8" IT CEME type E512/A32		
spare parts for	500568		
	GEV No.	390698	Ref. No. —
description	thermal fuse switch-off temp. 110°C suitable for ULKA pump		
	GEV No.	520153	Ref. No. —
description	bracket rubber dimensions 53x34x28mm		



1

GEV No.	499010	Ref. No.	530772550
description	vibration pump type E512/B46 230V 60W 50/60Hz inlet \varnothing 7 outlet \varnothing 1/8" IT CEME L 125mm		



1

GEV No.	501567	Ref. No.	530550178
description	vibration pump type HF 230V 22W 50Hz inlet \varnothing 6 outlet \varnothing 6 ULKA plastic L 97mm connection male faston 4.8mm		

condensators & interference suppression filters

operating capacitors

plastic



1

GEV No.	365015	Ref. No.	530550039
description	operating capacitor capacity 10 μ F 400V tolerance 5%Hz ambient temperature max. -25 to +85°C \varnothing 35.5mm L 59mm M8 plastic connection male faston 6.3mm protection		

filters

interference suppression filters



1

GEV No.	365044	Ref. No.	530570037
description	interference suppression filter type FC701Y2F 250V 50-60Hz conductor 2 with E connection cable 200mm L 42mm \varnothing 23mm Hmm Wmm plastic Qty 1 pcs		

fuses

fine fuses



1

GEV No.	358532	Ref. No.	530190756
description	fine fuse size \varnothing 5x20mm 2A fast-acting rated 250V Qty 10 pcs		



1

GEV No.	358595	Ref. No.	730580042
description	fine fuse size \varnothing 5x20mm 0.2A slow-acting rated 250V Qty 10 pcs		





1

GEV No.	358703	Ref. No.	530560030
description	fine fuse size \varnothing 5x20mm 0.4A slow-acting rated 250V Qty 10 pcs		





			
1			
GEV No.	358790	Ref. No.	536430009 R5524
description	fine fuse size ø6.3x32mm 5A slow-acting rated 250V Qty 10 pcs		
For models:	E3840, E401F, E402F, E421, E421F, E422, E422F, G2844F, G2845F, G3106, G3840, G401F, G402F		

various			
			
1			
GEV No.	358004	Ref. No.	731750790
description	fuse 20A rated 240V Qty 1 pcs		
For models:	E1962, E1965, E1994, E1995		

fine fuse holders			
			
1			
GEV No.	550105	Ref. No.	730326941
description	rail-mounted terminal WIELAND type WK10/SIU 5X20 /V0 suitable fuse ø5x20mm 1.0-16mm ² 10A rated 250V		

			
1			
GEV No.	551212	Ref. No.	731740420 RHH3/2
description	fuse holder suitable fuse ø6.3x32mm ømm 20A rated 240V L 70mm W 25mm H 48mm connection		
For models:	E1112		

screw locks			
D0-system (NEOZED)			
			
1			
GEV No.	358043	Ref. No.	530658294
description	fuse size D01 16A rated 250/400V E14 ø 11mm L 36mm Qty 10 pcs		

			
1			
GEV No.	358045	Ref. No.	530751863
description	fuse size D02 35A rated 250/400V E18 ø 15mm L 36mm Qty 10 pcs		

gauge pieces (NEOZED)			
			
1			
GEV No.	358067	Ref. No.	530751855
description	gauge piece size D02 suitable for 35A		

overload switches			
			
1			
GEV No.	358515	Ref. No.	530550036
description	overload switch drop-away current 2.5A		

electric accessories			
cables			
power supply cables			
			
1			
GEV No.	551136	Ref. No.	535770061 801949
description	power lead BS1363 3-pole contacts P+N+E 1.5mm ² max. 13A max 250V 2m with fuse countries UK Qty 1 pcs connection eye black H07 RN-F plug type G		
For models:	G2840, G2841, G2842, G2844F, G2845F		

miscellaneous			
			
1			
GEV No.	107315	Ref. No.	539113294 635112
description	circuit breaker cable L 600mm connection Faston 6.3mm		
For models:	G350-11, G350-12		



terminals

connection terminals with screw/faston connections



1

GEV No.	550518	Ref. No.	535770066
description	power terminal block 6-pole max. 40A max 450V connection M6/ male faston 6.3mm temp.-resist. 150°C cross section 6mm ²		
For models:	G2840, G2841, G2842		

rail-mounted terminals

WIELAND

fuse terminal blocks



1

GEV No.	550105	Ref. No.	730326941
description	rail-mounted terminal WIELAND type WK10/SIU 5X20 /V0 suitable fuse ø5x20mm 1.0-16mm ² 10A rated 250V		

gas taps

PEL

22S/V series



1

GEV No.	109139	Ref. No.	537400170 R9103
description	gas tap PEL type 22S/V gas inlet M20x1.5 (tube ø 12mm) bypass nozzle ø 0mm gas outlet M20x1.5 (tube ø 12/10mm) thermocouple connection M9x1 pilot connection M10x1 shaft ø 10x8mm shaft L 25/17mm shaft flat right		
For models:	G1629		

COPRECI

CAL-24200



1

GEV No.	109156	Ref. No.	537220360 600617
description	gas tap COPRECI type CAL-24200 gas inlet pipe flange ø21mm bypass nozzle ø 0.6mm gas outlet M17x1 (tube ø 10mm) thermocouple connection M8x1 pilot connection shaft ø 8x6.5mm shaft flat right shaft L 22/12mm pipe input ø 8mm		



1

GEV No.	109135	Ref. No.	537883000 600618
description	gas tap COPRECI type CAL-24200 gas inlet pipe flange ø21mm bypass nozzle ø 0.6mm gas outlet M17x1 (tube ø 10mm) thermocouple connection M8x1 pilot connection shaft ø 8x6mm shaft flat lower shaft L 48/14mm		



1

GEV No.	109173	Ref. No.	539220480 600626
description	gas tap COPRECI type CAL-24200 gas inlet pipe flange ø21mm bypass nozzle ø 0mm gas outlet M17x1 (tube ø 10mm) thermocouple connection M8x1 pilot connection M8x1 shaft ø 7x5mm shaft flat lower shaft L 43/20mm pipe input ø 8mm		
For models:	G350-2-CE		

1

GEV No.	109133	Ref. No.	539220221 600624
description	gas tap COPRECI type CAL-24200 gas inlet pipe flange ø21mm bypass nozzle ø 0mm gas outlet M17x1 (tube ø 10mm) thermocouple connection M8x1 pilot connection M8x1 shaft ø 7x5mm shaft flat right shaft L 25/14mm internal nozzle ø 0mm pipe input ø 6mm		
For models:	G350-10, G350-9		

2

GEV No.	109155	Ref. No.	539110320 600621
description	gas tap COPRECI type CAL-24200 gas inlet pipe flange ø21mm bypass nozzle ø 0mm gas outlet M17x1 (tube ø 10mm) thermocouple connection M8x1 pilot connection M8x1 shaft ø 8x6.5mm shaft flat right shaft L 22/12mm pipe input ø 8mm		
For models:	G350-7		

1

GEV No.	109132	Ref. No.	535100920 535100921 535100922 600622 600627 R6046
description	gas tap COPRECI type CAL-24200 gas inlet pipe flange ø21mm bypass nozzle ø 0mm gas outlet M17x1 (tube ø 10mm) thermocouple connection M8x1 pilot connection M8x1 shaft ø 8x6mm shaft flat lower shaft L 43/20mm pipe input ø 8mm		

1

GEV No.	109175	Ref. No.	531880800 600632
description	gas tap kit COPRECI type CAL-24200 gas inlet pipe flange bypass nozzle ø 0.6mm gas outlet M17x1 (tube ø 10mm) thermocouple connection M8x1 shaft ø 6x8mm shaft flat lower shaft L 48/14mm pipe input ø 8mm		
spare parts for	109175		
GEV No.	109135	Ref. No.	537883000 600618
description	gas tap COPRECI type CAL-24200 gas inlet pipe flange ø21mm bypass nozzle ø 0.6mm gas outlet M17x1 (tube ø 10mm) thermocouple connection M8x1 pilot connection shaft ø 8x6mm shaft flat lower shaft L 48/14mm		

CAL-3200

1



GEV No.	109136	Ref. No.	537560020 537950020 600614 RZZ50
description	gas tap COPRECI type CAL-3200 gas inlet M18x1.5 (tube ø 12mm) bypass nozzle ø 0mm gas outlet M18x1.5 (tube ø 12mm) thermocouple connection M10x1 pilot connection M8x1 shaft ø 7x5mm shaft flat lower shaft L 34.5/14mm front fixing M14x1		
For models:	G1478, G2512, G2522, G2532, G3512, G3532		

1

GEV No.	109131	Ref. No.	530170090 530840045 537880090 600612 700001 700002
description	gas tap COPRECI type CAL-3200 gas inlet M18x1.5 (tube ø 12mm) bypass nozzle ø 0mm gas outlet M18x1.5 (tube ø 12mm) thermocouple connection M10x1 pilot connection M8x1 shaft ø 8x6mm shaft flat lower shaft L 43/14mm		
For models:	G3478, G6478		





 <p>1</p>			
GEV No.	109137	Ref. No.	531884540 537880290 600050 600613
description	gas tap COPRECI type CAL-3200 gas inlet M18x1.5 (tube ø 12mm) bypass nozzle ø 0mm gas outlet M18x1.5 (tube ø 12mm) thermocouple connection M10x1 pilot connection M8x1 shaft ø 8x6mm shaft flat right shaft L 68/14mm		

 <p>1</p>			
GEV No.	109159	Ref. No.	530840040 600052
description	gas tap COPRECI type CAL-3200 gas inlet M18x1.5 (tube ø 12mm) bypass nozzle ø 0mm gas outlet M18x1.5 (tube ø 12mm) thermocouple connection M10x1 shaft ø 8x6mm shaft flat lower shaft L 43/14mm		
For models:	G5478		
spare parts for	109159		
	GEV No.	109131	Ref. No.
			530170090 530840045 537880090 600612 700001 700002
accessories for	109159		
	GEV No.	107432	Ref. No.
			530840051 705003
knob adapter shaft ø 6x8 to 5x7mm for gas tap shaft flat universal			

<p>CAL-5200</p>  <p>1</p>			
GEV No.	109138	Ref. No.	535200021 670031
description	gas tap COPRECI type CAL-5200 gas inlet pipe flange ø21mm bypass nozzle ø 0.76+0.51mm gas outlet M14x1.5 (tube ø 8mm) thermocouple connection M8x1 pilot connection shaft ø 7x5mm shaft L 45/20mm shaft flat lower pipe input ø 8mm		
For models:	G3101, G3101D, G3101OTC, G3121, G3124, G3161, G3161D		

 <p>1</p>			
GEV No.	107694	Ref. No.	12009406 U872111 U872111000
description	gas tap COPRECI type CAL-5200 gas inlet pipe flange ø21mm bypass nozzle ø 0.7mm gas outlet 3/8" thermocouple connection M8x1 pilot connection shaft ø 8x6.5mm shaft L 55/12mm shaft flat right		

 <p>1</p>			
GEV No.	107252	Ref. No.	535200023 670002
description	gas tap kit COPRECI type CAL-5200 gas inlet pipe flange bypass nozzle ø 0.76+0.51mm gas outlet M16x1.5 (tube ø 8mm) thermocouple connection M8x1 shaft ø 5x7mm shaft L 45/20mm shaft flat lower pipe input ø 8mm		
spare parts for	107252		
	GEV No.	109138	Ref. No.
			535200021 670031
description	gas tap COPRECI type CAL-5200 gas inlet pipe flange ø21mm bypass nozzle ø 0.76+0.51mm gas outlet M14x1.5 (tube ø 8mm) thermocouple connection M8x1 pilot connection shaft ø 7x5mm shaft L 45/20mm shaft flat lower pipe input ø 8mm		

 <p>1</p>			
GEV No.	109174	Ref. No.	535200028 670057
description	gas tap kit COPRECI type CAL-5200 gas inlet pipe flange bypass nozzle ø 0.76+0.51mm gas outlet M16x1.5 (tube ø 8mm) thermocouple connection M8x1 shaft ø 5x7mm shaft L 45/20mm shaft flat lower pipe input ø 8mm		
spare parts for	109174		
	GEV No.	107252	Ref. No.
			535200023 670002
description	gas tap kit COPRECI type CAL-5200 gas inlet pipe flange bypass nozzle ø 0.76+0.51mm gas outlet M16x1.5 (tube ø 8mm) thermocouple connection M8x1 shaft ø 5x7mm shaft L 45/20mm shaft flat lower pipe input ø 8mm		
	GEV No.	109138	Ref. No.
			535200021 670031
description	gas tap COPRECI type CAL-5200 gas inlet pipe flange ø21mm bypass nozzle ø 0.76+0.51mm gas outlet M14x1.5 (tube ø 8mm) thermocouple connection M8x1 pilot connection shaft ø 7x5mm shaft L 45/20mm shaft flat lower pipe input ø 8mm		



gas thermostats

SIT

710 Minisit series

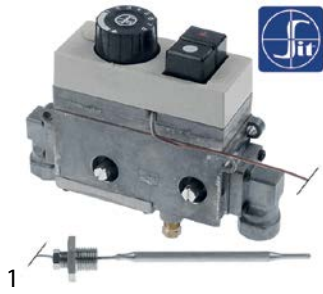

GEV No.	106029	Ref. No.	539113290 R296
description	gas thermostat SIT type MINISIT 710 t.max. 200°C 120-200°C gas inlet 3/8" gas outlet 3/8" thermocouple connection M9x1 pilot connection M10x1 probe ø 6mm probe L 105mm capillary pipe 1050mm probe type type D1 pressure controller no pressure regulator mbar gland nut M14x1.5 ignition gas 6mm		
For models:	G350-11, G350-12		
spare parts for	106029		
	GEV No.	100068	Ref. No. —
	pilot burner 2 flames gas connection 6mm		
	GEV No.	100809	Ref. No. —
	O-ring EPDM thickness 2mm ID ø 21mm Qty 1 pcs		
	GEV No.	101053	Ref. No. —
	magnet unit T1: M9x1 T2: M24x1 L 45mm ø 17mm suitable for Minisit		
	GEV No.	101137	Ref. No. —
	cover cap without piezoelectric igniter		
	GEV No.	101505	Ref. No. —
	gas connection thread 3/8" angled without O-ring MINISIT 710		
	GEV No.	101516	Ref. No. —
	flat-headed bolt thread M4 thread L 16mm SS DIN 7985/ISO 7045 Qty 1 pcs		
	GEV No.	106225	Ref. No. —
	probe 120-200°C probe ø 6mm probe L 102mm capillary pipe 1050mm t.max. 200°C fryer probe type type D1 suitable for MINISIT 710		
accessories for	106029		
	GEV No.	100820	Ref. No. —
	gland duct ET M14x1.5 IT M10x0.75 probe ø max. 6.5mm WS 22		
	GEV No.	101273	Ref. No. —
	olive for pipe ø 12mm L 9.5mm brass Qty 1 pcs suitable for universal		
	GEV No.	101276	Ref. No. —
	union screw thread 3/8" tube ø 12mm Qty 1 pcs		
	GEV No.	101278	Ref. No. —
	olive for pipe ø 10mm Qty 1 pcs		
	GEV No.	101279	Ref. No. —
	union screw thread 3/8" for pipe ø 10mm Qty 1 pcs		

COPRECI





GEV No.	109140	Ref. No.	539000004 670063
description	gas thermostat COPRECI kit type MT7200 gas inlet pipe flange bypass nozzle ø 0.6/0.4mm gas outlet M16x1.5 (tube ø 10mm) pilot connection closed thermocouple connection M8x1 capillary pipe 1000mm probe ø 4.5mm probe L 92mm shaft ø 7x5mm shaft L 41.5/20mm shaft flat right pipe input ø 8mm		



GEV No.	109158	Ref. No.	535241008 670034
description	gas thermostat COPRECI kit type MT7200 gas inlet pipe flange bypass nozzle ø 0.6/0.4mm gas outlet M16x1.5 (tube ø 10mm) thermocouple connection M8x1 capillary pipe 1000mm probe ø 4.5mm probe L 92mm shaft ø 5x7mm shaft L 41.5mm shaft flat right pipe input ø 8mm		



GEV No.	109176	Ref. No.	534101050 670004
description	gas thermostat COPRECI kit type MT7200 gas inlet pipe flange bypass nozzle ø 0.76+0.51mm gas outlet M16x1.5 (tube ø 10mm) thermocouple connection M8x1 capillary pipe 1000mm probe ø 4.5mm probe L 92mm shaft ø 7x5mm shaft L 41.5/20mm shaft flat right pipe input ø 8mm		
spare parts for	109176		
	GEV No.	102078	Ref. No. 535400180 R5033
	thermocouple M10x1 L 600mm M8x1		
	GEV No.	107258	Ref. No. 535400120 R3179
	thermocouple extension thread M10x1 - M8x1 L 1500mm		
	GEV No.	107643	Ref. No. —
	thermocouple SIT M10x1 L 600mm M8x1		



			
GEV No.	109172	Ref. No.	535101091 600634
description	gas thermostat COPRECI kit type MT7200 gas inlet pipe flange ø21mm bypass nozzle ø 0.76mm gas outlet M16x1.5 (tube ø 10mm) pilot connection M10x1 thermocouple connection M8x1 capillary pipe 850mm probe ø 4.5mm probe L 92mm shaft ø 8x6.5mm shaft L 46/12mm shaft flat lower pipe input ø 8mm pipe output ø 9/10mm		

			
GEV No.	109160	Ref. No.	535130132 RZZ69
description	gas thermostat COPRECI type GT-354 gas inlet pipe flange ø21mm bypass nozzle ø 0.95mm gas outlet M15x1 (tube ø 10mm) pilot connection thermocouple connection M8x1 capillary pipe 1200mm probe ø 5mm probe L 97mm shaft ø 8x6mm shaft L 41/20mm shaft flat lower pipe input ø 8mm		

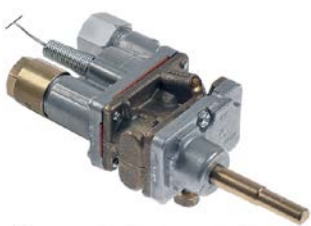
			
GEV No.	109129	Ref. No.	535241007 670033
description	gas thermostat COPRECI type MT7200 gas inlet pipe flange ø21mm bypass nozzle ø 0.6+0.44mm gas outlet M16x1.5 (tube ø 10mm) pilot connection closed thermocouple connection M8x1 capillary pipe 1000mm probe ø 4.5mm probe L 92mm shaft ø 7x5mm shaft L 41.5/20mm shaft flat lower pipe input ø 8mm		
For models:	G3161, G3161D		

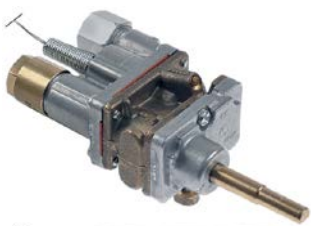
			
GEV No.	109157	Ref. No.	539110756 670058
description	gas thermostat COPRECI type MT7200 gas inlet pipe flange ø21mm bypass nozzle ø 0.6mm gas outlet M16x1.5 (tube ø 10mm) pilot connection closed thermocouple connection M8x1 capillary pipe 1000mm probe ø 4.5mm probe L 92mm shaft ø 7x5mm shaft L 41.5/20mm shaft flat lower pipe input ø 8mm		



			
GEV No.	109130	Ref. No.	535200022 670032
description	gas thermostat COPRECI type MT7200 gas inlet pipe flange ø21mm bypass nozzle ø 0.76+0.52mm gas outlet M16x1.5 (tube ø 10mm) pilot connection closed thermocouple connection M8x1 capillary pipe 1000mm probe ø 4.5mm probe L 92mm shaft ø 7x5mm shaft L 41.5/20mm shaft flat right pipe input ø 8mm		
For models:	G3101, G3101D, G3107, G3107D, G3117, G3117D		

ROBERTSHAW

			
GEV No.	580074	Ref. No.	537880231 600249
description	gas thermostat kit type FDTE 010154 t.max. 287°C up to 287°C gas inlet 1/2" NPT bypass nozzle ø 0mm gas outlet 1/2" NPT thermocouple connection pilot connection closed capillary pipe 1380mm probe ø 5mm probe L 365mm shaft ø 11.1x7.5mm shaft L 21/21mm shaft flat left ROBERTSHAW pipe input ø 12mm pipe output ø 12mm		
spare parts for	580074		
	GEV No.	Ref. No.	531880710
	gas thermostat type FDTE 010154 up to 287°C low-550°F gas inlet 1/2" NPT bypass nozzle ø 0mm gas outlet 1/2" NPT thermocouple connection pilot connection closed capillary pipe 1380mm probe ø 5mm probe L 365mm shaft ø 11.1x7.5mm shaft L 21/21mm shaft flat left ROBERTSHAW		

			
GEV No.	580057	Ref. No.	531880710
description	gas thermostat type FDTE 010154 up to 287°C low-550°F gas inlet 1/2" NPT bypass nozzle ø 0mm gas outlet 1/2" NPT thermocouple connection pilot connection closed capillary pipe 1380mm probe ø 5mm probe L 365mm shaft ø 11.1x7.5mm shaft L 21/21mm shaft flat left ROBERTSHAW		

GEV No.	580052 ¹	Ref. No.	531310100 RMS/1	
description	gas thermostat type GSH30240000 t.max. 190°C 93-190°C 200-375°F gas inlet 1/4" CCT (tube ø 1/4") bypass nozzle ømm gas outlet 1/4" CCT (tube ø 1/4") thermocouple connection pilot connection capillary pipe 24" - 610mm probe ø 3/8" - 9.5mm probe L 5 3/8" - 135mm gland nut 3/8" NPT shaft ø 6.4x4.8mm shaft L 21/21mm shaft flat lower ROBERTSHAW			
For models:	G1860, G1860-CE			
accessories for	580052			
	GEV No.	101481	Ref. No.	—
	olive for pipe ø 1/4" CCT Qty 1 pcs			
	GEV No.	106109	Ref. No.	—
	locking screw thread 7/16"-24 UNS for pipe ø 1/4" L 16mm brass Qty 1 pcs WS 7/16" (11.113mm) hole ø 6.4mm			
	GEV No.	106110	Ref. No.	—
	union screw tube ø 1/4"mm			

¹with gland box 3/8" NPT





GEV No.	580070	Ref. No.	531310110
description	gas thermostat type GSR3024 93-196°C 200-385°F gas inlet 1/4" CCT (tube ø 1/4") gas outlet 1/4" CCT (tube ø 1/4") thermocouple connection pilot connection capillary pipe 600mm probe ø 9.5mm probe L 120mm		
For models:	G1860		

gas valves and ignition boxes



gas control valves

HONEYWELL



GEV No.	106012	Ref. No.	530550016	
description	gas valve type VK4115V 220-240V 50/60Hz gas inlet flange 32x32mm gas outlet flange 32x32mm thermocouple connection pilot connection pressure range 15-60mbar max 60mbar operator type HONEYWELL flange 32x32mm			
accessories for	106012			
	GEV No.	102845	Ref. No.	—
	gas connection angled 1/2" flange 32x32mm hole distance 24x24mm Tandem			
	GEV No.	102846	Ref. No.	—
	gas connection straight 1/2" flange 32x32mm hole distance 24x24mm suitable for Tandem			



GEV No.	106206	Ref. No.	530744050	
description	gas valve type VK4115V 220-240V 50/60Hz gas inlet flange 32x32mm gas outlet flange 32x32mm thermocouple connection pilot connection pressure range 15-60mbar max 60mbar operator type HONEYWELL flange 32x32mm			
accessories for	106206			
	GEV No.	102845	Ref. No.	—
	gas connection angled 1/2" flange 32x32mm hole distance 24x24mm Tandem			
	GEV No.	102846	Ref. No.	—
	gas connection straight 1/2" flange 32x32mm hole distance 24x24mm suitable for Tandem			

1

GEV No.	107456	Ref. No.	536114505 G114505
description	gas valve type VR4605A 230V 50Hz gas inlet 1/2" gas outlet 1/2" thermocouple connection pilot connection pressure range 2.5-20mbar max 60mbar operator type 220/240V (V404A 1329) pressure controller type V5306E HONEYWELL		



1

GEV No.	106127	Ref. No.	531310010
description	gas valve supply Operator gas inlet 1/4" CCT outlet 1/4" CCT gas inlet 3/4" NPT gas outlet 3/4" NPT thermocouple connection 11/32" pilot connection 1/4" CCT type 7000BGOR pressure controller natural gas 5.2" W.C.		
For models:	G1860, G1860-CE		
spare parts for	106127		
	GEV No.	101042	Ref. No. —
	magnet unit T1: 3/8" NEF suitable for ROBERTSHAW for gas operator		
	GEV No.	106109	Ref. No. —
	locking screw thread 7/16"-24 UNS for pipe ø 1/4" L 16mm brass Qty 1 pcs WS 7/16" (11.113mm) hole ø 6.4mm		
	GEV No.	580033	Ref. No. N/A
	knob suitable for ROBERTSHAW		

ROBERTSHAW

gas controlled valves



1

GEV No.	106126	Ref. No.	531300012 RK14
description	gas valve supply Operator gas inlet 1/4" CCT outlet 1/4" CCT gas inlet 1/2" NPT gas outlet 1/2" NPT thermocouple connection 11/32" pilot connection 1/4" CCT type 7000BGOR pressure controller natural gas 5.2" W.C. suitable for ROBERTSHAW		
For models:	G1830		
spare parts for	106126		
	GEV No.	101042	Ref. No. —
	magnet unit T1: 3/8" NEF suitable for ROBERTSHAW for gas operator		
	GEV No.	106109	Ref. No. —
	locking screw thread 7/16"-24 UNS for pipe ø 1/4" L 16mm brass Qty 1 pcs WS 7/16" (11.113mm) hole ø 6.4mm		
	GEV No.	580033	Ref. No. N/A
	knob suitable for ROBERTSHAW		

millivolt controlled valves



1

GEV No.	107354	Ref. No.	535710035 R3835
description	gas valve supply Operator millivolt gas inlet 1/2" NPT gas outlet 1/2" NPT thermocouple connection 11/32" pilot connection 1/4" CCT type U7000MVRL pressure controller natural gas 6.7" W.C.		

SIT





ELETTROSIT



1			
GEV No.	106032	Ref. No.	531750330 RKK24
description	gas valve SIT type ELETTROSIT 230V gas inlet 1/2" gas outlet 1/2" thermocouple connection ASA 11/32 pilot connection M10x1 bottom equiv. no. 0.810.156		
For models:	G1962, G1965, G1994, G1995, G2962, G2965, G2994, G2995		
spare parts for	106032		
	GEV No.	100006	Ref. No. —
piezoelectric igniter suitable for ELETTROSIT body plastic blowing connection ø2.4mm ø 14mm			

NOVASIT



1			
GEV No.	107429	Ref. No.	537350019 801808
description	gas valve SIT series Novasit 820 0.17V gas inlet 1/2" gas outlet 1/2" thermocouple connection M9x1 pilot connection M10x1 pressure range 3-30mbar equiv. no. 0820303 supply Operator millivolt kit		
spare parts for	107429		
	GEV No.	100110	Ref. No. —
pilot burner SIT type 190 series 3 flames nozzle ømm gas connectionmm			
	GEV No.	107239	Ref. No. 537350006
gas valve SIT series Novasit 820 0.17VHz gas inlet 1/2" gas outlet 1/2" thermocouple connection M9x1 pilot connection M10x1 ignition pressure 3-5mbar pressure range 3-30mbar pressure regulator connection blind equiv. no. 0820303 supply Operator millivolt			
	GEV No.	107267	Ref. No. 535480040 535710028 600039 RZZ303
piezoelectric igniter body plastic blowing mounting ø 18mm connection F2.8x0.8			
	GEV No.	107296	Ref. No. 535410011 660019
gas line connection ø6mm L 450mm ED ø 8mm SS flexible thickness 0.5mm connection length 25mm			



1			
GEV No.	107302	Ref. No.	537350016 801433
description	gas valve SIT series Novasit 820 0.17V gas inlet 1/2" gas outlet 1/2" thermocouple connection M9x1 pilot connection M10x1 pressure range 3-30mbar pressure regulator connection M13x1 equiv. no. 0820303 supply Operator millivolt		











1			
GEV No.	107239	Ref. No.	537350006
description	gas valve SIT series Novasit 820 0.17VHz gas inlet 1/2" gas outlet 1/2" thermocouple connection M9x1 pilot connection M10x1 ignition pressure 3-5mbar pressure range 3-30mbar pressure regulator connection blind equiv. no. 0820303 supply Operator millivolt		
spare parts for	107239		
	GEV No.	100110	Ref. No. —
pilot burner SIT type 190 series 3 flames nozzle ømm gas connectionmm			
	GEV No.	101065	Ref. No. —
magnet unit with cable L 44mm D1 ø 30mm D2 ø 20mm suitable for NOVASIT			
	GEV No.	101305	Ref. No. —
gas connection straight 1/2" flange 45x45mm ELETTROSIT/V4400/4600/4605 suitable for SIT/HONEYWELL hole distance 36x36mm			
	GEV No.	101306	Ref. No. —
gas connection angled flange 45x45mm hole distance 36x36mm 1/2" ELETTROSIT/V4400/4600/4605 screw with O-ring suitable for SIT/HONEYWELL			
	GEV No.	101307	Ref. No. —
gas connection straight flange 45x45mm hole distance 36x36mm 3/4" ELETTROSIT/V4400/4600/4605 screw with O-ring suitable for SIT/HONEYWELL			
	GEV No.	101308	Ref. No. —
gas connection angled flange 45x45mm hole distance 36x36mm 3/4" ELETTROSIT/V4400/4600/4605 screw with O-ring suitable for SIT/HONEYWELL			
	GEV No.	101312	Ref. No. —
microswitch			
	GEV No.	101799	Ref. No. —
knob adapter shaft ø 10x8mm shaft L 18mm catch lower suitable for ZANUSSI shaft flat upper			



Table continues overleaf



spare parts for 107239			
	GEV No.	102116	Ref. No. 537350005 R3825
thermopile ROBERTSHAW L 900mm probe ø 9mm probe L 57mm 250-750mV screw connection 7/16"			





GEV No.	107430 ¹	Ref. No.	535670022 638045
description	gas valve SIT series Novasit 820 0.17VHz gas inlet 1/2" gas outlet 1/2" thermocouple connection M9x1 pilot connection M10x1 ignition pressure 3-5mbar pressure range 3-30mbar pressure regulator connection blind equiv. no. 0820303 supply Operator millivolt		
For models:	G3203, G3830, G3865		

spare parts for 107430			
	GEV No.	107239	Ref. No. 537350006
gas valve SIT series Novasit 820 0.17VHz gas inlet 1/2" gas outlet 1/2" thermocouple connection M9x1 pilot connection M10x1 ignition pressure 3-5mbar pressure range 3-30mbar pressure regulator connection blind equiv. no. 0820303 supply Operator millivolt			
	GEV No.	109128	Ref. No. —
pressure controller brass L 25mm ø 11.5mm thread M13x1 for gas valve suitable for gas valves Qty 1 pcs			

¹incl. pressure controller and adaptor M18x1,5 (tube ø12mm)



GEV No.	107245	Ref. No.	536300030 750020
description	gas valve kit type 0840036 230V 50Hz gas inlet 1/2" gas outlet 1/2" pressure range 2-50mbar		
For models:	G3840, G401, G401F, G402, G402F		

spare parts for 107245			
	GEV No.	106214	Ref. No. —
solenoid coil 230V 50Hz Sigma			
	GEV No.	107253	Ref. No. —
gas valve type 0840036 230V 50Hz gas inlet 1/2" gas outlet 1/2" pressure range 2-50mbar			
accessories for 107245			
	GEV No.	107222	Ref. No. —
plug for solenoid valve 3-pole cable length 1070mm			

TANDEM



GEV No.	107303	Ref. No.	534400080 R2885
description	gas valve 230V 50Hz gas inlet 1/2" gas outlet 1/2" pilot connection M10x1 ignition time 3-7s pressure range 3-50mbar power supply for modulator type Tandem 830 SIT equiv. no. 0.830.033		
For models:	G4069, G4109		

ignition boxes

HONEYWELL



GEV No.	101165	Ref. No.	536113060 G113060
description	ignition box HONEYWELL type S4560A 1008 equiv. no. S4560A 1008 electrodes 1 waiting time 0s safety time 10s 220-240V 10VA 50Hz		

spare parts for 101165			
	GEV No.	358696	Ref. No. —
fine fuse size ø5x20mm 4A medium lag rated 250V Qty 10 pcs			



GEV No.	104647	Ref. No.	536060016 R5439
description	ignition box HONEYWELL type S4565BD 3072 electrodes 3 waiting times safety time 3.5s 220-240V 4VA 50/60Hz		
For models:	G2840, G2841, G2842, G2845F		

Honeywell



1

GEV No.	103109	Ref. No.	530550018
description	ignition box HONEYWELL type S4565C 1116 electrodes 2 waiting times safety time 5s 220-240V 4VA 50/60Hz		

SIT



1

GEV No.	102387	Ref. No.	534400107 R2886
description	ignition box SIT type 503EFD electrodes 1 waiting time 1.5s safety time 60s 220/240V 12VA 50-60Hz protection IP20		
For models:	G4069, G4109		



1

GEV No.	107246	Ref. No.	536300024 RV11
description	ignition box SIT type 571DBC electrodes 2 waiting time 1s safety time 10s 230V 12VA 50/60Hz		
For models:	G3106, G3840, G401, G401F, G402, G402F		

miscellaneous



1

GEV No.	107275	Ref. No.	531930500 R3603
description	ignition box PACTROL type P13MKII suitable for FALCON electrodes 2 waiting time 1s safety time 3s 230V 50Hz		
For models:	G1808-CE, G1808-Pre-CE, G1838-CE, G1848-CE, G1848-Pre-CE, G7004, G7008, G7011, G7204, G7208, G7211		

safety valves

miscellaneous



1

GEV No.	107305	Ref. No.	530961050 RRR37/3
description	safety valve BLACK TEKNIGAS type 3703/1/2IN pressure range 0-50mbar gas inlet 1/2" IT gas outlet 1/2" IT thermocouple connection M9x1 M10x1 pilot connection M10x1 IT (tube ø 6mm)		



1

GEV No.	107251	Ref. No.	530962080 RHH28
description	safety valve BLACK TEKNIGAS type G840HG pressure range 0-50mbar gas inlet 1/2" (tube ø 9/16") gas outlet 1/2" (tube ø 9/16") thermocouple connection M9x1		
For models:	G1107CE-OT		



gas solenoid valves

various



1

GEV No.	370711	Ref. No.	531750320 531930530 701251
description	solenoid valve gas 2-ways 230VAC inlet 1/2" IT outlet 1/2" IT connection cable L 69mm BLACK TEKNIGAS approval IP40 overall height 94mm		
For models:	G1962, G1965, G1994, G1995, G2962, G2965, G2994, G2995, G7004, G7008, G7011, G7204, G7208, G7211		



1

GEV No.	107442	Ref. No.	534510930 RZZ43
description	solenoid valve gas 2-ways triple 230VAC inlet 1/2" outlet 1/2" L 105mm p max 0.065bar overall height 145mm		
For models:	G1808-CE, G1808-Pre-CE, G1838-CE, G1848-CE, G1848-Pre-CE		

ignition parts

pilot burners

SIT

140 - 145 - 150 series



1

GEV No.	107249	Ref. No.	531600055 534101002 700019
description	pilot burner SIT type 145 series 2 flames LPG nozzle 19 nozzle ø 0.23/0.26mm gas connection 4mm burner bearing left		
For models:	G3107, G3107D, G3127, G3512, G3532, G401, G401F, G402, G402F		



1

GEV No.	107295	Ref. No.	537130070 700005
description	pilot burner SIT type 145 series 2 flames LPG nozzle 19 nozzle ø 0.23/0.26mm gas connection 6mm burner bearing left		



1

GEV No.	107285	Ref. No.	531600050 60073
description	pilot burner SIT type 145 series 2 flames natural gas nozzle 30 nozzle ø 0.60/0.40mm gas connection 4mm burner bearing left		
For models:	G2512, G2522, G2532, G3512, G3532, G401, G401F, G402, G402F		
spare parts for	107285		

GEV No.	107286	Ref. No.	531600070 R3106
description	pilot burner nozzle SIT natural gas code 30 bore ø 0.60/0.40mm Qty 1 pcs		



1

GEV No.	107451	Ref. No.	531750401 700016
description	pilot burner SIT type 150 series 2 flames LPG nozzle 19 nozzle ø 0.23/0.26mm gas connection 6mm		
For models:	G1962, G1965, G1994, G1995, G2962, G2965, G2994, G2995		



1

GEV No.	107248	Ref. No.	535100961 535101021 700004
description	pilot burner SIT type 150 series 2 flames natural gas nozzle 36 nozzle ø 0.60/0.55mm gas connection 4mm		
For models:	G3441, G3441R, G3641, G3941		
spare parts for	107248		

GEV No.	100206	Ref. No.	530961100 RH36/4
description	pilot burner nozzle SIT natural gas code 36 bore ø 0.60/0.55mm Qty 1 pcs suitable for SIT 150 series		

GEV No.	100897	Ref. No.	—
description	olive for pipe ø 4mm Qty 1 pcs for pilot burner		

Table continues overleaf



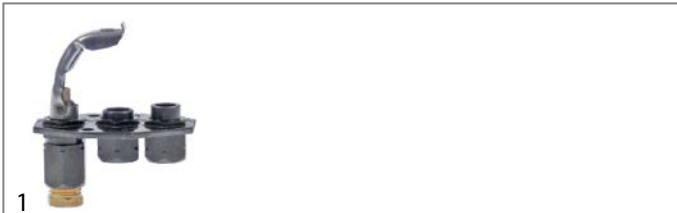

spare parts for 107248			
	GEV No.	100908	Ref. No. —
union screw thread M10x1 for pipe ø 4mm Qty 1 pcs			



GEV No.	107247	Ref. No.	536000028 700006
description	pilot burner SIT type 150 series 2 flames natural gas nozzle 36 nozzle ø 0.60/0.55mm gas connection 6mm		
For models:	G21224B, G21524B, G21824B, G2624B, G2924B		

spare parts for 107247

	GEV No.	100206	Ref. No.	530961100 RH36/4
pilot burner nozzle SIT natural gas code 36 bore ø 0.60/0.55mm Qty 1 pcs suitable for SIT 150 series				

	GEV No.	100898	Ref. No.	—
olive for pipe ø 6mm Qty 1 pcs for pilot burner				

	GEV No.	100909	Ref. No.	—
union screw thread M10x1 for pipe ø 6mm Qty 1 pcs				



GEV No.	107232	Ref. No.	535820022 RH35
description	pilot burner SIT type 150 series 2 flames nozzle ømm gas connectionmm		
For models:	G21223, G21523, G21823, G2623, G2641, G2642, G2642B, G2923, G2941, G2942		

190 series



GEV No.	107250	Ref. No.	537350003 801806
description	pilot burner SIT type 190 series 3 flames natural gas nozzle 51 nozzle ø 0.51mm gas connectionmm kit		

POLIDORO

pilot burners



GEV No.	107274	Ref. No.	536300033 536300048 850083
description	pilot burner POLIDORO 3 flames LPG code 25.2 gas connection 4mm complete incl. holder		
For models:	E3840, G3800, G3840, G401, G401F, G402, G402F		





GEV No.	107424	Ref. No.	535520005 R5066
description	pilot burner POLIDORO 3 flames natural gas code 29.2 gas connection 6mm		
For models:	G2131-OT, G2151EU, G2151-OT		



GEV No.	107425	Ref. No.	537883017 610033
description	pilot burner POLIDORO 3 flames natural gas code 29.2 gas connection 6mm with thermocouple		

spare parts for 107425

	GEV No.	102036	Ref. No.	—
thermocouple M8x1 L 1000mm plug connection ø6.0(6.5)mm				

	GEV No.	107356	Ref. No.	537883019 R3211
pilot burner POLIDORO 3 flames natural gas nozzle 29-2 code 29.2 gas connection 6mm				



GEV No.	107356	Ref. No.	537883019 R3211
description	pilot burner POLIDORO 3 flames natural gas nozzle 29-2 code 29.2 gas connection 6mm		





			
GEV No.	107272	Ref. No.	535010005 896445
description	pilot burner POLIDORO 3 flames natural gas nozzle 31.2 code 31.2 gas connection 4mm with holder		
For models:	G2625, G31225, G31225ES, G31525, G31525ES, G3425, G3625, G3625ES, G3925, G3925ES		

ROBERTSHAW

pilot burners

universal series - type 3

			
GEV No.	580034	Ref. No.	539220540 RZZ98
description	pilot burner ROBERTSHAW type 3CH-6 2 flames natural gas code 18 for pipe ø 1/4" CCT		
For models:	G350-10, G350-9		

			
GEV No.	106083	Ref. No.	537960022 RZZ97
description	pilot burner ROBERTSHAW type 3CHL-6 2 flames natural gas code 18 for pipe ø 1/4" CCT		

universal series - type 6

Width of caps:
 6CH10 = 1" (25,4mm)
 6CH14 = 1½" (38,1mm)
 6CH24 = 2½" (63,5mm)
 6CH30 = 3" (76,2mm)

			
GEV No.	106092	Ref. No.	531300050
description	pilot burner ROBERTSHAW type 6CH14-1 3 flames natural gas code 26 for pipe ø 1/4" CCT		
For models:	G1830		

			
GEV No.	107269	Ref. No.	531720060 537210280 610018 R3032
description	pilot burner ROBERTSHAW type 6CH24-1 3 flames natural gas code 22 for pipe ø 1/4" CCT		

			
GEV No.	106117	Ref. No.	531310050 RM5
description	pilot burner ROBERTSHAW type 6CH24-1 3 flames natural gas code 26 for pipe ø 1/4" CCT gas connection 1/4" CCTmm nozzle ømm		
For models:	G1860, G1860-CE		

universal series with electrodes

			
GEV No.	107270	Ref. No.	535710080 600921
description	pilot burner ROBERTSHAW type 4SHR-44 3 flames LPG code 11 for pipe ø 1/4" CCT		







				
GEV No.	106087	Ref. No.	N/A	
description	pilot burner ROBERTSHAW type 4SHR-44 3 flames LPG code 16 for pipe ø 1/4" CCT			
spare parts for	106087			
	GEV No.	101481	Ref. No.	—
olive for pipe ø 1/4" CCT Qty 1 pcs				
	GEV No.	101482	Ref. No.	—
union nut thread 1/4" long				

Table continues overleaf







spare parts for 106087			
	GEV No.	102116	Ref. No. 537350005 R3825
thermopile ROBERTSHAW L 900mm probe ø 9mm probe L 57mm 250-750mV screw connection 7/16"			
	GEV No.	102277	Ref. No. 535710039 R6450
thermocouple ROBERTSHAW ASA 11/32 L 36" - 915mm 7/16"			
	GEV No.	106105	Ref. No. 531300070 RM5/6
pilot burner nozzle LPG code 16 suitable for ROBERTSHAW			



GEV No.	107271	Ref. No.	535710070 R3761
description	pilot burner ROBERTSHAW type 4SHR-44 3 flames natural gas code 18 for pipe ø 1/4" CCT		



GEV No.	106086	Ref. No.	N/A
description	pilot burner ROBERTSHAW type 4SHR-44 3 flames natural gas code 26 for pipe ø 1/4" CCT		

spare parts for 106086			
	GEV No.	100277	Ref. No. 535710091 RM5/7
pilot burner nozzle natural gas code 26 suitable for ROBERTSHAW			
	GEV No.	101481	Ref. No. —
olive for pipe ø 1/4" CCT Qty 1 pcs			
	GEV No.	101482	Ref. No. —
union nut thread 1/4" long			
	GEV No.	102116	Ref. No. 537350005 R3825
thermopile ROBERTSHAW L 900mm probe ø 9mm probe L 57mm 250-750mV screw connection 7/16"			
	GEV No.	102277	Ref. No. 535710039 R6450
thermocouple ROBERTSHAW ASA 11/32 L 36" - 915mm 7/16"			

HONEYWELL

pilot burners



GEV No.	107448	Ref. No.	536123580 G123580
description	pilot burner HONEYWELL type Q345A 1313 2 flames natural/liquid gas nozzle BCR18/BBR10 1/4"		

producer-specific pilot burners

FALCON



GEV No.	107492	Ref. No.	537400195 537880685 R3131
description	pilot burner 1 flame LPG nozzle 31		
For models:	G1629		

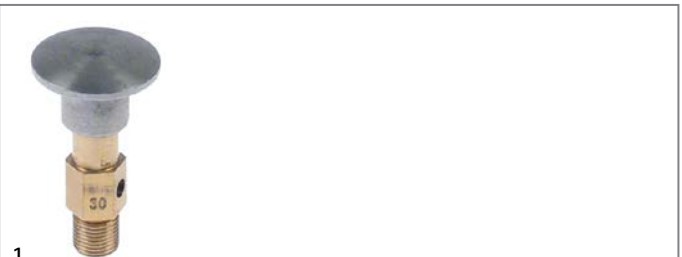

GEV No.	107273	Ref. No.	537400190 537880680 R3130
description	pilot burner cap 1 flame natural gas nozzle 30		
For models:	G1629		



electrodes



GEV No.	107294	Ref. No.	531930585 T466007
description	bracket for ignition electrode L 112mm W 50mm bore \varnothing 14x13mm		
For models:	G7004, G7008, G7011, G7204, G7208, G7211		



GEV No.	107307	Ref. No.	536117003 G117003
description	bracket for ignition electrode L 41mm W 32mm bore \varnothing 8.5mm		



GEV No.	109177	Ref. No.	535770090 R5215
description	gasket for electrode L 80mm W 30mm		



GEV No.	108151	Ref. No.	530507496
description	gasket igniter L 22.5mm W 15.5mm thickness 2mm graphite		

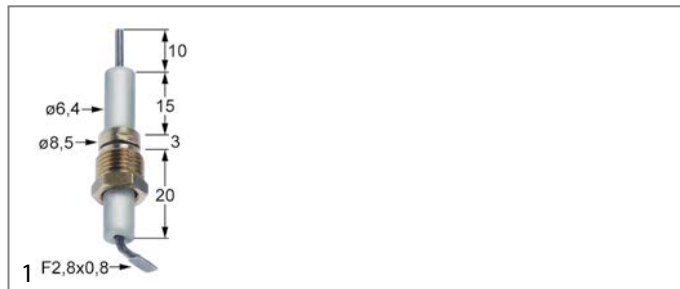

GEV No.	107281	Ref. No.	530760010 537350007 801498 R3823
description	ignition electrode D1 \varnothing 6.4mm D2 \varnothing 8.5mm L1 10mm BL1 15mm BL2 3mm BL3 20mm connection male faston 2.8mm M10x1		
For models:	G2078TC-135L, G3203, G3206, G3830, G3860, G3865		

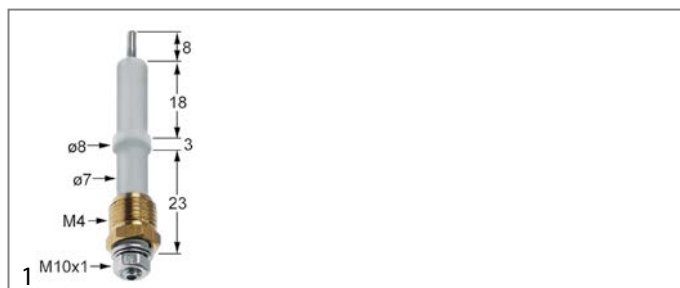

GEV No.	107280	Ref. No.	530780060 531600090 531600100 703445 RH36 RH36/1
description	ignition electrode D1 \varnothing 7mm D2 \varnothing 8.5mm connection M4 L1 8mm BL1 18mm BL2 3mm BL3 23mm M10x1		
For models:	G3080-45L, G3080-90L		



GEV No.	107313	Ref. No.	535950022 703180
description	ignition electrode D1 \varnothing 7mm D2 \varnothing 9mm connection M4 L1 8mm BL1 18mm BL2 3mm BL3 23mm with screw connection		
For models:	G21224B, G21523, G21524B, G21823, G21824B, G2623, G2624B, G2923, G2924B		

1 gas components

GEV No.	107282	Ref. No.	535480033 RZZ304
description	ignition electrode D1 ø 8mm L1 17mm BL1 23mm BL2 27mm connection male faston 2.8mm M14x2		
For models:	G2101EU, G2101-OT, G2107EU, G2107-OT, G2107-SB, G2131-OT, G2151EU, G2161EU, G2161-OT, G2167-OT, G3101, G3101D, G3107, G3107D, G3117, G3117D, G3161, G3161D		

GEV No.	107890	Ref. No.	530507184
description	ignition electrode flange length 24mm flange width 20mm D1 ø 7mm L1 45mm L2 70mm BL1 35mm BL2 22mm connection F6.3 cable length 450mm mounting distance 9mm		

GEV No.	104638	Ref. No.	536003328 G3328
description	ignition electrode D1 ø 9.5mm D2 ø 8mm L1 28mm BL1 9mm BL2 16mm BL3 16mm connection male faston 6.3mm 7/16"		

GEV No.	106996	Ref. No.	530874787	
description	ignition electrode flange length 60mm flange width 22mm D1 ø 9mm L1 17mm L2 45mm L3 6mm L4 34/10mm BL1 37mm BL2 32mm cable length 350mm connection ø 4mm			
accessories for	106996			
	GEV No.	699472	Ref. No.	—
	gasket ignition electrode ID ø 13mm hole ø 6mm L 60mm W 22mm suitable for ELOMA graphite			

GEV No.	106756	Ref. No.	530550017
description	ignition electrode flange length 24mm flange width 17mm D1 ø 9.3mm L1 45mm BL1 57mm BL2 37mm connection ø6 fixing dimensions ø4.5mm A1/B13/C2		

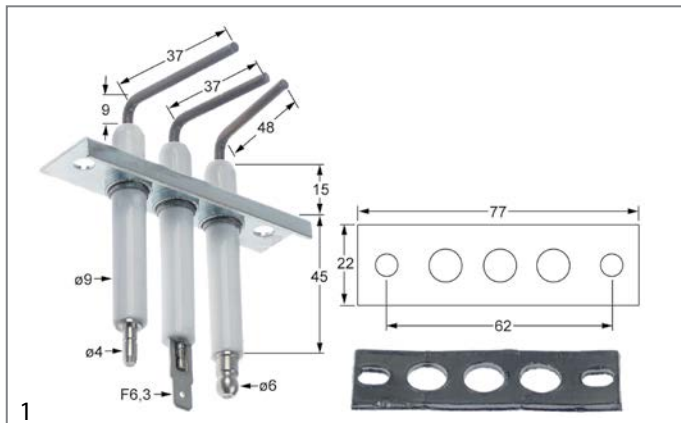

GEV No.	107306	Ref. No.	536060018 802104
description	ignition electrode group flange length 77mm flange width 22mm D1 ø 9.5mm L1 9mm L2 37/37/48mm BL1 15mm BL3 45mm connection ø4/6mm/male Faston 6.3mm mounting distance 62mm		
For models:	G2840, G2841, G2842, G2845F		

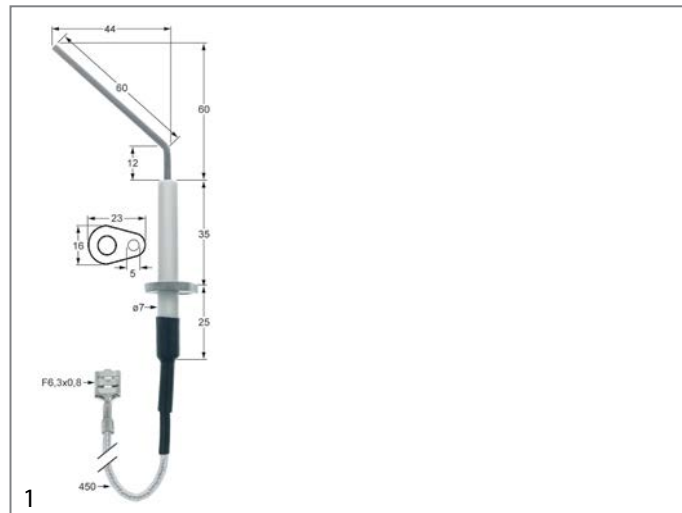

GEV No.	106997	Ref. No.	530874906
description	monitoring electrode connection ø F6.3mm flange length 23mm flange width 16mm D1 ø 7mm L1 60mm L2 44mm L4 12mm L3 60mm BL1 35mm BL2 25mm connection F6.3x0.8 cable length 450mm fixing dimensions ø5mm		



GEV No.	107452	Ref. No.	536060030 802170
description	ignition electrode kit flange length 77mm flange width 25mm D1 ø 9.5mm L1 9mm L2 37/49mm BL1 15mm BL2 43mm connection ø4/6mm/male Faston 6.3mm mounting distance 62mm		
For models:	G2840, G2841, G2842		

spare parts for	107452			
	GEV No.	107306	Ref. No.	536060018 802104
description	ignition electrode group flange length 77mm flange width 22mm D1 ø 9.5mm L1 9mm L2 37/37/48mm BL1 15mm BL3 45mm connection ø4/6mm/male Faston 6.3mm mounting distance 62mm			

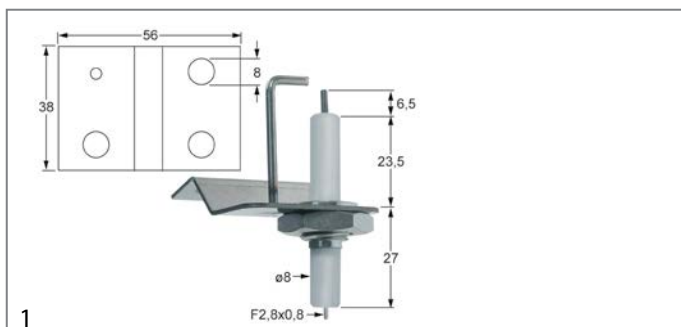

GEV No.	107355	Ref. No.	535700560 899031
description	ignition electrode with holder flange length 56mm flange width 38mm D1 ø 8mm L1 6.5mm BL1 23.5mm BL2 27mm connection male faston 2.8mm fixing dimensions ø8mm mounting distance 22mm		

ignition cables

pre-assembled cables

	GEV No.	100036	Ref. No.	531300122 531310122 700903 700913
description	ignition cable cable length 500mm connection F2.8mm / F2.8mm			
For models:	G1830, G1860, G1860-CE			

	GEV No.	102159	Ref. No.	531750350 537101590 701202 703346
description	ignition cable cable length 600mm connection F2.8mm / F2.8mm			
For models:	G1107CE-OT, G1962, G1965, G1994, G1995, G2962, G2965, G2994, G2995			

	GEV No.	102156	Ref. No.	530730014 530840110 531880741 535010002 539110290 609945 635060 701501 70151 703175 705002
description	ignition cable cable length 600mm connection F2.8mm / lug M4			
For models:	G2078-45L, G2625, G2642B, G3478, G350-11, G350-12, G5478, G6478			

			
GEV No.	100037	Ref. No.	535700580 609904
description	ignition cable cable length 900mm connection F2.8mm / F2.8mm		

			
GEV No.	102195	Ref. No.	530740007 701506
description	ignition cable cable length 900mm connection F2.8mm / lug M4		
For models:	G2078-135L, G2078-90L		

			
GEV No.	107428	Ref. No.	534510220 600017
description	ignition cable set connection male faston 2.8mm		
For models:	G1838-CE		

piezoelectric igniters

mounting diameter 18mm

			
GEV No.	107267	Ref. No.	535480040 535710028 600039 RZZ303
description	piezoelectric igniter body plastic blowing mounting ø 18mm connection F2.8x0.8		
For models:	G2101EU, G2101-OT, G2107EU, G2107-OT, G2107-SB, G2131-OT, G2151EU, G2151-OT, G2161EU, G2161-OT, G2167-OT		

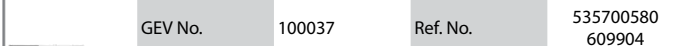
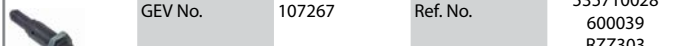
			
GEV No.	107268	Ref. No.	534101016 800150
description	piezoelectric igniter body plastic blowing mounting ø 18mm connection F2.8x0.8 set		
spare parts for	107268		
			
GEV No.	100037	Ref. No.	535700580 609904
ignition cable cable length 900mm connection F2.8mm / F2.8mm			
			
GEV No.	107267	Ref. No.	535480040 535710028 600039 RZZ303
description	piezoelectric igniter body plastic blowing mounting ø 18mm connection F2.8x0.8		

mounting diameter 22mm

			
GEV No.	107266	Ref. No.	535010000 R5812
description	piezoelectric igniter body plastic blowing mounting ø 22mm connection F2.8x0.8 cable lengthmm		
For models:	G2625, G2642B, G3101, G3101D, G3107, G3107D, G3117, G3117D, G31225, G31225ES, G31525, G31525ES, G3161, G3161D, G3425, G3441, G3441R, G3625, G3625ES, G3641, G3830, G3865, G3925, G3925ES, G3941		

miscellaneous

			
GEV No.	107445	Ref. No.	531750340 RAA9
description	piezoelectric igniter connection male faston 2.8mm with holder		
For models:	G1962, G1965, G1994, G1995, G2962, G2965, G2994, G2995		

accessories

			
GEV No.	107308	Ref. No.	531880743 610219
description	bracket for piezoelectric igniter bore ø 18.5mm suitable for FALCON		

ignition units

			
GEV No.	104688	Ref. No.	530550037
description	ignition unit outputs 1 220-240VAC dimensions 84x62x38mm mounting distance 59mm inlet F6.3x0.8 outlet ø4mm type TRK2-30PVD 69VA 50/60Hz 0.3A protection IP00		

			
GEV No.	107278	Ref. No.	531930480 804031
description	ignition unit outputs 2 220-240VAC 50-60Hz		
For models:	G1808-CE, G1808-Pre-CE, G1838-CE, G1848-CE, G1848-Pre-CE, G7004, G7008, G7011, G7204, G7208, G7211		



thermocouples

thermocouple sets universal

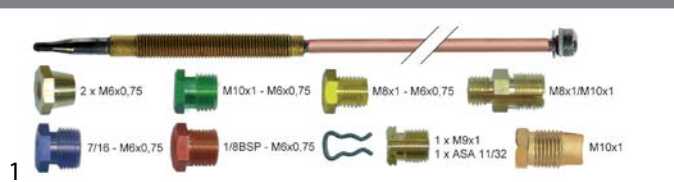

GEV No.	102541	Ref. No.	535101250
description	thermocouple set 12-piece L 900mm		

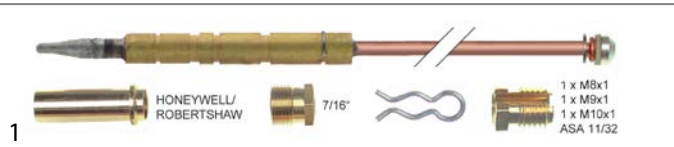

GEV No.	102544	Ref. No.	537960021 RII30
description	thermocouple set 8-piece L 1200mm		



GEV No.	102284	Ref. No.	537060110 539220530 600506 R3158
description	thermocouple set 8-piece L 900mm		
For models:	G350-10, G350-9		

plug-in thermocouples

plug-in thermocouples standard

ROBERTSHAW

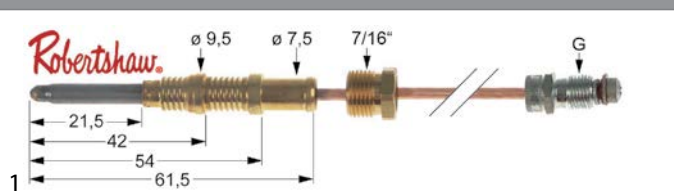

GEV No.	102277	Ref. No.	535710039 R6450
description	thermocouple ROBERTSHAW ASA 11/32 L 36" - 915mm 7/16"		

with barrel socket ø5mm - type Junkers with aluminised tip

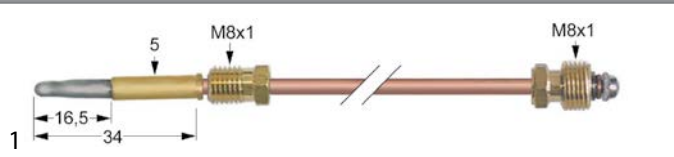

GEV No.	107453	Ref. No.	537060100 R3157
description	thermocouple M8x1 L 320mm plug connection ø5.0mm		

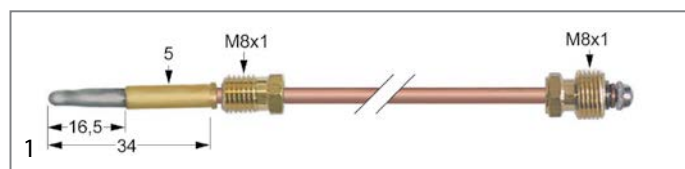

GEV No.	107449	Ref. No.	537060112 610079
description	thermocouple M8x1 L 700mm plug connection ø5.0mm		

with barrel socket ø6mm

SIT

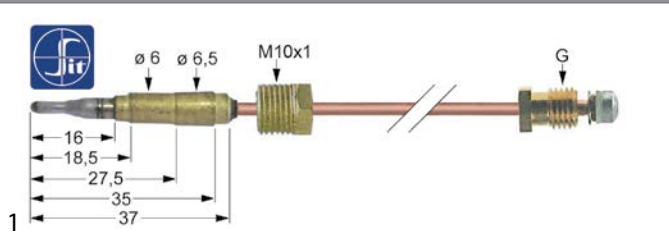

GEV No.	107256	Ref. No.	537880070 R5369
description	thermocouple M10x1 L 1200mm plug connection ø6.0(6.5)mm		

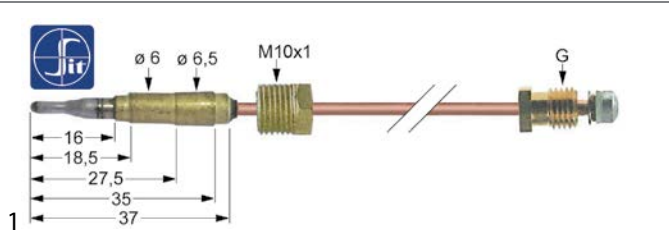

GEV No.	107299	Ref. No.	531750360 R5580
description	thermocouple SIT ASA 11/32 L 750mm plug connection ø6.0mm		
For models:	G1962, G1965, G1994, G1995, G2962, G2965, G2994, G2995		

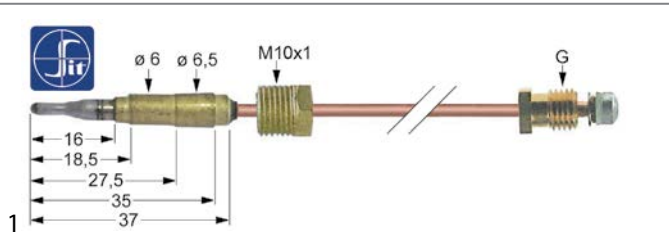

GEV No.	107257	Ref. No.	531610010 R3100
description	thermocouple SIT M10x1 L 1000mm plug connection ø6.0(6.5)mm		
For models:	G2512, G2522, G3512		

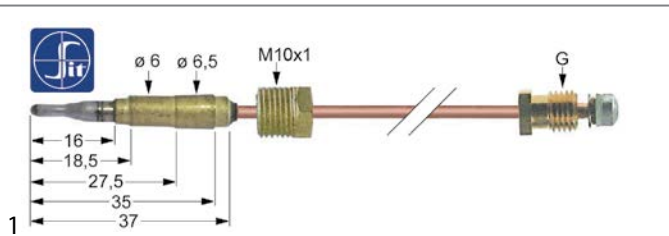

GEV No.	107259	Ref. No.	531600040 R3099
description	thermocouple SIT M10x1 L 500mm plug connection ø6.0mm		
For models:	G2532, G3532		

nickel-plated plug-in thermocouples

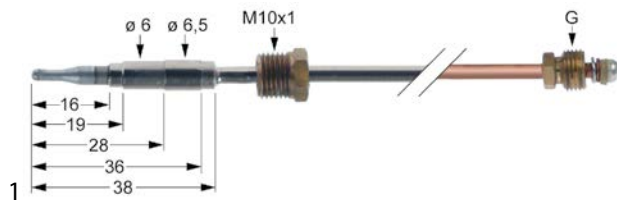

GEV No.	107260	Ref. No.	534101001 P3100
description	thermocouple nickel-plated M10x1 L 1000mm plug connection ø6.0(6.5)mm		
For models:	G3107, G3107D, G3127		

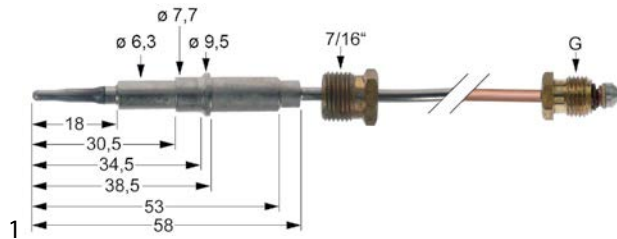

GEV No.	107297	Ref. No.	535101250 R6096
description	thermocouple nickel-plated M10x1 L 600mm plug connection ø6.0mm		

plug-in thermocouples with interruption

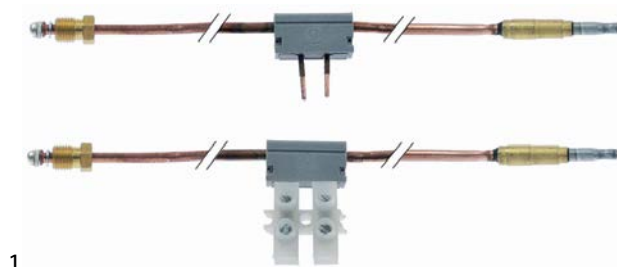

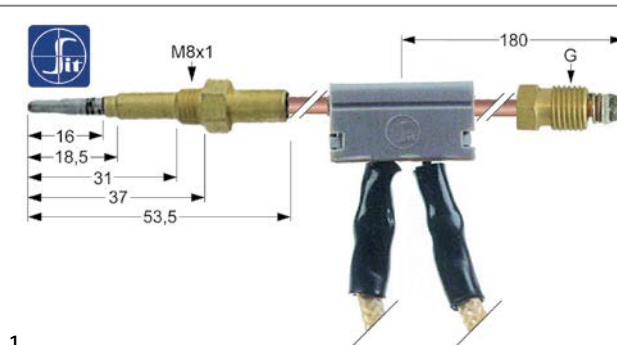

GEV No.	107454	Ref. No.	537350033 R5830
description	thermocouple SIT with interrupter M9x1 L 600mm plug connection ø6.0(6.5)mm soldering connection		

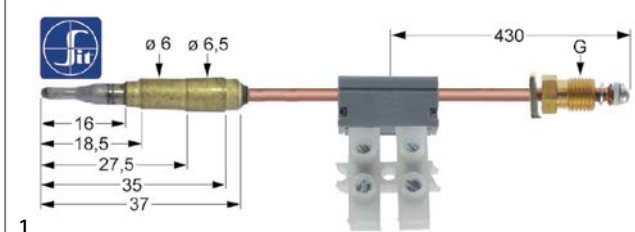

GEV No.	107261	Ref. No.	537350015 801443
description	thermocouple SIT with interrupter M9x1 L 600mm plug connection ø6.0mm cable 350mm		



GEV No.	107455	Ref. No.	535670024 638007
description	thermocouple with interrupter M9x1 L 850mm plug connection ø6.0(6.5)mm soldering connection		
For models:	G3203, G3206, G3830, G3860, G3865		
spare parts for	107455		
	GEV No.	100907	Ref. No. —
	screw connection thread M10x1 Qty 1 pcs type SEF 1 ømm for thermocouple		
	GEV No.	101265	Ref. No. —
	interrupter thread M9x1		
	GEV No.	107460	Ref. No. —
	thermocouple SIT with interrupter M9x1 L 850mm plug connection ø6.0mm soldering connection		

threaded thermocouples

threaded thermocouples standard

with socket with thread M8x1

SIT

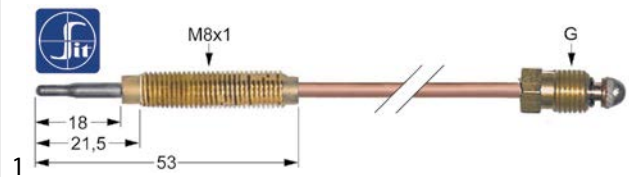

GEV No.	107636	Ref. No.	530962140 RJJ12
description	thermocouple SIT M9x1 L 600mm M8x1		
For models:	G1107CE-OT		
accessories for	107636		
	GEV No.	102067	Ref. No. —
	nut thread M8x1 H 3mm brass Qty 1 pcs type SEF 1		

type Junkers with aluminised tip

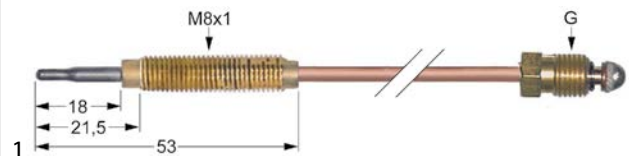

GEV No.	102078	Ref. No.	535400180 R5033
description	thermocouple M10x1 L 600mm M8x1		
For models:	G2101EU, G2101-OT, G2107EU, G2107-OT, G2107-SB, G2131-OT, G2151EU, G2151-OT, G2161EU, G2161-OT, G2167-OT, G3101, G3101D, G3107, G3107D, G3117, G3117D, G3161, G3161D		
accessories for	102078		
	GEV No.	102067	Ref. No. —
	nut thread M8x1 H 3mm brass Qty 1 pcs type SEF 1		

GEV No.	102060	Ref. No.	535130121 RZZ70
description	thermocouple M8x1 L 1500mm M8x1		
accessories for	102060		
	GEV No.	Ref. No.	—
	nut thread M8x1 H 3mm brass Qty 1 pcs type SEF 1		

GEV No.	107298	Ref. No.	537220330 R9004
description	thermocouple nickel-plated M8x1 L 750mm M8x1		

GEV No.	102054	Ref. No.	535480011 RZZ68
description	thermocouple M8x1 L 320mm M8x1		
For models:	G2101EU, G2101-OT, G2101OTC, G2102, G2107-OT, G2131-OT, G2151EU, G2151-OT, G2161EU, G2161-OT, G2167-OT, G3101, G3101D, G3101OTC, G3106, G3121, G3124, G3161, G3161D		
accessories for	102054		
	GEV No.	Ref. No.	—
	nut thread M8x1 H 3mm brass Qty 1 pcs type SEF 1		

producer-specific thermocouples

GEV No.	107265	Ref. No.	531880730 600537
description	thermocouple set 11-piece L 1200mm plug connection ø6.0mm		

GEV No.	102056	Ref. No.	535480012 RZZ67
description	thermocouple M8x1 L 600mm M8x1		
For models:	G2101EU, G2101-OT, G2101OTC, G2102, G2107-OT, G2131-OT, G2151EU, G2151-OT, G2161EU, G2161-OT, G2167-OT, G3101, G3101D, G3106, G3121, G3124, G3161, G3161D		
accessories for	102056		
	GEV No.	Ref. No.	—
	nut thread M8x1 H 3mm brass Qty 1 pcs type SEF 1		

GEV No.	107263	Ref. No.	537880200 600509
description	thermocouple set 13-piece L 900mm plug connection ø6.0mm		



nickel-plated threaded thermocouples

GEV No.	107450	Ref. No.	537880300 RZZ274
description	thermocouple nickel-plated M10x1 L 600mm M8x1		

GEV No.	107264	Ref. No.	536000031 600505
description	thermocouple set 13-piece L 900mm plug connection ø6.0mm		
For models:	G21224B, G21524B, G21824B, G2624B, G2924B		

GEV No.	107444	Ref. No.	537060102 610080
description	thermocouple set 3-piece L 330mm plug connection ø5.0mm M8x1		
spare parts for	107444		
	GEV No.	Ref. No.	—
	thermocouple fitting thread M8x1 Qty 1 pcs		
	GEV No.	Ref. No.	—
	thermocouple M8x1 L 320mm plug connection ø5.0mm		

Table continues overleaf

spare parts for 107444	
	GEV No. 107290 Ref. No. 537060460 610038 thermocouple fitting thread M12x1 IT M8x1 L 45mm ø 10mm Qty 1 pcs
	GEV No. 107291 Ref. No. 537060470 R3160 clamping collet for thermocouple L 24mm ID ø 4.2mm ø 6.5mm Qty 1 pcs

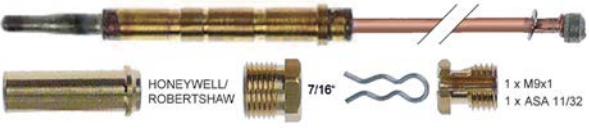
	
GEV No. 107427	Ref. No. 531300140 RX20
description	thermocouple set 6-piece L 900mm plug connection ø6.0mm
For models:	G1830

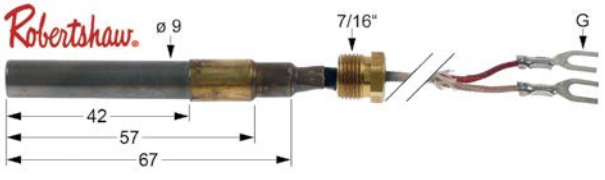
thermopiles	
	
GEV No. 102116	Ref. No. 537350005 R3825
description	thermopile ROBERTSHAW L 900mm probe ø 9mm probe L 57mm 250-750mV screw connection 7/16"
For models:	G3203, G3206, G3830, G3860, G3865

extensions	
	
GEV No. 107258	Ref. No. 535400120 R3179
description	thermocouple extension thread M10x1 - M8x1 L 1500mm
For models:	G2101EU, G2101-OT, G2107EU, G2107-OT, G2107-SB, G2131-OT, G2151EU, G2151-OT, G2161EU, G2161-OT, G2167-OT, G3101, G3101D, G3107, G3107D, G3117, G3117D, G3161, G3161D

accessories

interrupters



GEV No. 107465	Ref. No. 531700070 600507
description	interrupter
spare parts for 107465	
	GEV No. 107279 Ref. No. 531313470 535750044 600633 RA39
interrupter thread 11/32" T2: M9x0.75 L 33mm	

	
GEV No. 107279	Ref. No. 531313470 535750044 600633 RA39
description	interrupter thread 11/32" T2: M9x0.75 L 33mm
For models:	G1830, G1860-CE, G2203, G2206

miscellaneous

	
GEV No. 107315	Ref. No. 539113294 635112
description	circuit breaker cable L 600mm connection Faston 6.3mm
For models:	G350-11, G350-12

	
GEV No. 107291	Ref. No. 537060470 R3160
description	clamping collet for thermocouple L 24mm ID ø 4.2mm ø 6.5mm Qty 1 pcs



			
1			
GEV No.	107290	Ref. No.	537060460 610038
description	thermocouple fitting thread M12x1 IT M8x1 L 45mm ø 10mm Qty 1 pcs		

ignition bridges

			
1			
GEV No.	109143	Ref. No.	531610150 RZZ146
description	ignition bridge L 204mm		
For models:	G2512		

gas burners

hob burners

universal hob burners

GEV

			
1			
GEV No.	104102	Ref. No.	530960030
description	burner head for burner cap ø 100mm ext. ø 130		

producer-specific hob burners

FALCON

hob burners

G10 series

			
1			
GEV No.	107426	Ref. No.	537060160 R3216
description	air mixing tube L 77mm brass ID ø 13mm ED ø 18mm		

			
1			
GEV No.	104653	Ref. No.	537060040 537060070 810657
description	burner ø 114mm total length 245mm H 112mm		

			
1			
GEV No.	104645	Ref. No.	537060080 R3148
description	burner cap ø 114mm 7.5kW H 14mm seat ø 103.5mm		

			
1			
GEV No.	104652	Ref. No.	537060060 537060120 610072
description	burner lower part for burner cap ø 114mm total length 245mm H 102mm		

G11, G21, G31 series

			
1			
GEV No.	104644	Ref. No.	535130133 600147
description	burner ø 137mm 4.3kW complete		
For models:	G1107CE-OT		
spare parts for	104644		
	GEV No.	104642	Ref. No.
			535480006 RZZ64/8
	burner cap ø 118mm seat ø 86mm		
	GEV No.	104643	Ref. No.
			537101560 RZZ64/3
	burner head ø 137mm for burner cap ø 118mm H 11mm seat ø 88mm		

			
1			
GEV No.	104640	Ref. No.	535290000 R6322
description	burner cap ø 105mm seat ø 86mm		
For models:	G3101, G3101D, G3101OTC, G3106, G3121, G3124, G3161, G3161D		
accessories for	104640		
	GEV No.	104639	Ref. No.
			535290001 R6320
	burner head ø 137mm for burner cap ø 105mm H 11mm seat ø 88mm		





			
1			
GEV No.	104642	Ref. No.	535480006 RZZ64/8
description	burner cap ø 118mm seat ø 86mm		
For models:	G2101-OT, G2101OTC, G2102, G2107-OT, G2131-OT, G2151EU, G2161EU, G2161-OT, G2167-OT		

			
1			
GEV No.	104639	Ref. No.	535290001 R6320
description	burner head ø 137mm for burner cap ø 105mm H 11mm seat ø 88mm		
For models:	G3101, G3101D, G3101OTC, G3106, G3121, G3124, G3161, G3161D		
accessories for	104639		
	GEV No.	104640	Ref. No.
			535290000 R6322
	burner cap ø 105mm seat ø 86mm		

			
1			
GEV No.	104641	Ref. No.	535400060 R5896
description	burner head ø 137mm for burner cap ø 118mm H 11mm seat ø 88mm		
For models:	G2101EU, G2101-OT, G2101OTC, G2102, G2107-OT, G2131-OT, G2151EU, G2161EU, G2161-OT, G2167-OT		

			
1			
GEV No.	104643	Ref. No.	537101560 RZZ64/3
description	burner head ø 137mm for burner cap ø 118mm H 11mm seat ø 88mm		
For models:	G1197		

			
1			
GEV No.	107423	Ref. No.	537101096 800157
description	nozzle holder nozzle 175 L 72mm tube ø 8mm screw pipe fitting M12x1 M6x0.75		
For models:	G1197		

miscellaneous			
			
1			
GEV No.	104646	Ref. No.	537880420 610206
description	burner cap ø 92mm H 14mm ID ø 50mm		

pan supports			
			
1			
GEV No.	210045	Ref. No.	535400130 RT604004
description	pan support W 295mm L 560mm H 31mm suitable for FALCON		
For models:	G2101EU, G2101-OT, G2101OTC, G2102, G2124, G2131-OT, G2151EU, G2151-OT, G2161EU, G2161-OT		

			
1			
GEV No.	210048	Ref. No.	534100020 RT405010
description	pan support W 295mm L 560mm H 37mm mounting pos. centre		
For models:	G1107CE-OT, G1197		

			
1			
GEV No.	210047	Ref. No.	534100010 RT405009
description	pan support W 295mm L 560mm H 37mm mounting pos. left/right		
For models:	G1107CE-OT, G1167, G1197		



accessories

pan supports



1

GEV No.	210045	Ref. No.	535400130 RT604004
description	pan support W 295mm L 560mm H 31mm suitable for FALCON		
For models:	G2101EU, G2101-OT, G2101OTC, G2102, G2124, G2131-OT, G2151EU, G2151-OT, G2161EU, G2161-OT		



1

GEV No.	210048	Ref. No.	534100020 RT405010
description	pan support W 295mm L 560mm H 37mm mounting pos. centre		
For models:	G1107CE-OT, G1197		



1

GEV No.	210047	Ref. No.	534100010 RT405009
description	pan support W 295mm L 560mm H 37mm mounting pos. left/right		
For models:	G1107CE-OT, G1167, G1197		

bar burners

bar burners



1

GEV No.	109142	Ref. No.	531750420 701313
description	bar burner 1-row L 370mm W 30mm ømm H 40mm flange width 40mm flange length 50mm tilting bratt pan		
For models:	G1962, G1965, G1994, G1995, G2962, G2965, G2994, G2995		



1

GEV No.	109141	Ref. No.	531600230 R3101
description	bar burner 1-row L 460mm W 35mm ømm H 220mm grill		
For models:	G2512, G2522, G2532, G3512		



1

GEV No.	109151	Ref. No.	537880120 703166
description	bar burner 2 row L 375mm W 230mm ømm H 40mm gas range		



1

GEV No.	109149	Ref. No.	536000034 609901
description	bar burner 2 row L 390mm W 200mm ømm H 43mm chargrill cast iron		
For models:	G21224B, G21524B, G21824B, G2624B, G2924B		



1

GEV No.	109154	Ref. No.	539220590 635657
description	bar burner 2 row L 390mm W 255mm ømm H 40mm chargrill cast iron		
For models:	G350-10, G350-9		

solid top burners



1

GEV No.	109152	Ref. No.	537880700 610077
description	solid top burner ø 150mm H 70mm		

1

GEV No.	109153	Ref. No.	537060350 R3169
description	solid top burner ø 200mm H 70mm		

forced air burners



1

GEV No.	104314	Ref. No.	530560000
description	gasket L 108mm W 103mm H 3mm 6 holes		

accessories

gaskets



1

GEV No.	109165	Ref. No.	536060011 R5435
description	gasket L 84mm W 65mm thickness 1.6mm cork suitable for FALCON		
For models:	G2840, G2841, G2842, G2845F		



1

GEV No.	109180	Ref. No.	535770039 802246
description	seal kit for burner		
For models:	G2840, G2841, G2842		

nozzle holders



1

GEV No.	107443	Ref. No.	537101097 810296
description	nozzle holder nozzle 107 L 72mm screw pipe fitting M12x1 with venturi tube ø 8mm		
For models:	G1197		



1

GEV No.	107284	Ref. No.	535400080 R5004
description	nozzle holder nozzle 195 thread M22x1 L 43mm screw pipe fitting M12x1 M6x0.75		
For models:	G2101-OT, G2101OTC, G2107-OT, G2161-OT, G2167-OT		



1

GEV No.	107437	Ref. No.	531880480 RH33/57
description	nozzle holder thread 1/8" L 24.4mm WS 16		

miscellaneous



1

GEV No.	109150	Ref. No.	531600240 RT615002
description	bracket for ceramic plate L 180mm W 90mm		
For models:	G2512		



1

GEV No.	109161	Ref. No.	537882055 R3193
description	injector L 51mm D1 ø 14.5mm D2 ø 25mm with nozzle nozzle mounting 1/8" nozzle ø 1.4mm WS 14		



1

GEV No.	109148	Ref. No.	537101570 T602045
description	mounting plate for burner L 560mm aluminium W 73mm H 40mm		
For models:	G1107CE-OT, G1197		





1

GEV No.	109168	Ref. No.	534101090 P600012
description	mounting plate for burner L 560mm W 202mm H 12mm mounting pos. centre		
For models:	G1107CE-OT, G1197		



			
1			
GEV No.	109167	Ref. No.	534101080 P600011
description	mounting plate for burner L 560mm W 252mm H 18mm mounting pos. right		
For models:	G1107CE-OT, G1197		

			
1			
GEV No.	109166	Ref. No.	534101070 P600010
description	mounting plate for burner L 567mm W 250mm H 24mm mounting pos. left		
For models:	G1107CE-OT, G1197		

			
1			
GEV No.	107283	Ref. No.	535400100 R5897
description	nut for nozzle holder ø 60mm thread M22x1 WS 54		
For models:	G2101-OT, G2101OTC, G2102, G2107-OT, G2131-OT, G2151EU, G2151-OT, G2161EU, G2161-OT, G2167-OT		

			
1			
GEV No.	109164	Ref. No.	537101533 R8208
description	nut for Venturi brass H 6mm WS 27		
For models:	G1107CE-OT		

gas nozzles

main nozzles

			
1			
GEV No.	107435	Ref. No.	535670021 638042
description	gas injector thread 1/8" WS 10 bore ø 1.57mm code 1.57 Qty 2 pcs		
For models:	G3203, G3830, G3865		

			
1			
GEV No.	107311	Ref. No.	535680011 638044
description	gas injector thread 1/8" WS 10 bore ø 2.15mm code 215 Qty 2 pcs		
For models:	G3206, G3860		

			
1			
GEV No.	107439	Ref. No.	535670020 638041
description	gas injector thread 1/8" WS 10 bore ø 2.38mm code 2.38 Qty 2 pcs		
For models:	G3203, G3830, G3865		

			
1			
GEV No.	107440	Ref. No.	535680010 638043
description	gas injector thread 1/8" WS 10 bore ø 3.2mm code 32 Qty 2 pcs		
For models:	G3206, G3860		

gas nozzles 1/4"

			
1			
GEV No.	109171	Ref. No.	539220680 RZZ100
description	gas injector thread 1/4" IT code 2.9 WS 15 bore ø 2.9mm L 38mm natural gas		
For models:	G350-10, G350-9		

			
1			
GEV No.	109170	Ref. No.	535100890 RZZ110
description	gas injector thread 1/4" IT code 225 WS 15 bore ø 2.25mm L 38mm natural gas		
For models:	G3925ES		

			
1			
GEV No.	109144	Ref. No.	535480036 R5055
description	gas injector thread 1/4" IT code 23 WS 15 bore ø 2.3mm L 38mm natural gas		
For models:	G2101-OT, G2107EU, G2107-OT, G2107-SB, G2151EU, G2151-OT, G3101, G3101D, G3107, G3107D, G3117, G3117D		

			
1			
GEV No.	109146	Ref. No.	530961130 RZZ113
description	gas injector thread 1/4" IT code 26 WS 15 bore ø 2.6mm L 38mm natural gas		
For models:	G2625, G31225, G3625		

			
1			
GEV No.	109147	Ref. No.	535410007 610620
description	gas injector thread 1/4" IT code 360 WS 15 bore ø 1.7mm LPG		
For models:	G2107EU, G2107-SB, G3107, G3107D, G3127		

gas nozzles M6x0.75

			
1			
GEV No.	107310	Ref. No.	537101140 RZZ132
description	gas injector thread M6x0.75 WS 7 bore ø 1.07mm		
For models:	G1107CE-OT, G1197		

			
1			
GEV No.	107287	Ref. No.	535480007 RZZ134
description	gas injector thread M6x0.75 WS 7 bore ø 1.75mm		
For models:	G2101-OT, G2101OTC, G2107-OT, G2161-OT, G2167-OT		

			
1			
GEV No.	107288	Ref. No.	535480009 RZZ135
description	gas injector thread M6x0.75 WS 7 bore ø 1.95mm		
For models:	G2101EU, G2101-OT, G2101OTC, G2102, G2131-OT, G2151EU, G2151-OT, G2161EU, G2161-OT		

gas nozzles M7x1

			
1			
GEV No.	107434	Ref. No.	531400040 RL34
description	gas injector thread M7x1 WS 10 bore ø 1.7mm		
For models:	G1167		

gas nozzles M10x1

			
1			
GEV No.	100654	Ref. No.	536300027 RV92
description	gas injector thread M10x1 WS 11 bore ø 1.7mm inner flat		
For models:	G3840, G401, G401F, G402, G402F		

			
1			
GEV No.	107457	Ref. No.	536300026 RV96
description	gas injector thread M10x1 WS 11 bore ø 2.7mm inner peaked code 270		
For models:	G3840, G401, G401F, G402, G402F		

gas nozzles (other)

			
1			
GEV No.	109145	Ref. No.	531552254 700608
description	gas injector thread 1/2" UNEF code 20 bore ø 0.4mm natural gas WS 6/17 L 42mm		

			
1			
GEV No.	109163	Ref. No.	531550070 700602
description	gas injector thread 1/2" UNEF code 380 bore ø 1.7mm natural gas WS 6/17 L 42mm		

			
1			
GEV No.	109162	Ref. No.	530840020 RR5/1
description	gas injector thread 1/2" UNEF code bore ø 3.2mm natural gas WS 15 L 30mm		
For models:	G3478, G5478, G6478		

			
1			
GEV No.	107458	Ref. No.	531790210 RH33/5
description	gas injector thread No.12 UNF code 140 bore ø 1.05mm LPG WS 6 L 12mm		
For models:	G1994, G1995, G2994, G2995		

			
1			
GEV No.	107436	Ref. No.	531790100 RF53/9
description	gas injector thread No.12 UNF code 20 bore ø 0.4mm LPG WS 6 L 12mm		
For models:	G1994, G1995, G2994, G2995		





 <p>1</p>			
GEV No.	107312	Ref. No.	535930140 RH33/58
description	gas injector thread No.12 UNF code 210 bore ø 1.3mm LPG WS 6 L 12mm		

 <p>1</p>			
GEV No.	107433	Ref. No.	531790180 RGG14
description	gas injector thread No.12 UNF code 400 bore ø 1.74mm natural gas WS 6 L 12mm		
For models:	G1994, G1995, G2994, G2995, G3425		

pilot burner nozzles

pilot burner nozzles ROBERTSHAW

 <p>1</p>			
GEV No.	106107	Ref. No.	537960023 RKK18/3
description	pilot burner nozzle LPG code 11 suitable for ROBERTSHAW		

 <p>1</p>			
GEV No.	106105	Ref. No.	531300070 RMS/6
description	pilot burner nozzle LPG code 16 suitable for ROBERTSHAW		
For models:	G1830, G3203, G3206, G3830, G3860, G3865		

 <p>1</p>			
GEV No.	100276	Ref. No.	535710050 RKK18/4
description	pilot burner nozzle natural gas code 18 suitable for ROBERTSHAW		

 <p>1</p>			
GEV No.	106108	Ref. No.	531720020 R3693
description	pilot burner nozzle natural gas code 22 suitable for ROBERTSHAW		

 <p>1</p>			
GEV No.	100277	Ref. No.	535710091 RM5/7
description	pilot burner nozzle natural gas code 26 suitable for ROBERTSHAW		
For models:	G3203, G3206, G3830, G3860, G3865		

pilot burner nozzles SIT



140/150 series

 <p>1</p>			
GEV No.	100205	Ref. No.	535410015 RH39
description	pilot burner nozzle SIT LPG code 19 bore ø 0.23/0.26mm Qty 1 pcs suitable for SIT 150 series		
For models:	G2107EU, G2107-SB, G3107, G3107D, G3127		

 <p>1</p>			
GEV No.	107286	Ref. No.	531600070 R3106
description	pilot burner nozzle SIT natural gas code 30 bore ø 0.60/0.40mm Qty 1 pcs		
For models:	G2512, G2522, G2532, G3512, G3532, G401, G401F, G402, G402F		

 <p>1</p>			
GEV No.	100206	Ref. No.	530961100 RH36/4
description	pilot burner nozzle SIT natural gas code 36 bore ø 0.60/0.55mm Qty 1 pcs suitable for SIT 150 series		
For models:	G3107, G3107D, G3127		

gas nozzles sets

 <p>1</p>				
GEV No.	107309	Ref. No.	537350017 801804	
description	gas injector set LPG G2865 suitable for FALCON			
spare parts for	107309			
	GEV No.	106105	Ref. No.	531300070 RMS/6
	pilot burner nozzle LPG code 16 suitable for ROBERTSHAW			
	GEV No.	109128	Ref. No.	—
	pressure controller brass L 25mm ø 11.5mm thread M13x1 for gas valve suitable for gas valves Qty 1 pcs			

auxiliary gas parts



accessories

			
1			
GEV No.	107446	Ref. No.	536060001 802023
description	conversion kit LPG to NG suitable for FALCON for Burnertech		

			
1			
GEV No.	109169	Ref. No.	535102325 R5837
description	gas lighter L 275mm refillable		

gas pressure regulators

Standard pressure according to country:
 Germany 50mbar
 France 37mbar
 Italy 30mbar
 Spain 37/50mbar
 UK 20mbar

			
1			
GEV No.	250079	Ref. No.	537560015 800386
description	conversion kit to natural gas G1532 suitable for FALCON		
spare parts for	250079		
			
	GEV No.	Ref. No.	531600070 R3106
	pilot burner nozzle SIT natural gas code 30 bore ø 0.60/0.40mm Qty 1 pcs		
			
	GEV No.	Ref. No.	—
	gas pressure regulator RV48LM connection 1/2" - 1/2" countries UK input pressure max. 0.1bar		

			
1			
GEV No.	250078	Ref. No.	535820026 RZZ335
description	gas pressure regulator RV48LM connection 1/2" countries UK input pressure max. 0.1bar output pressure 12.5-30mbar		
For models:	G21223, G21523, G21823, G2623, G2641, G2642, G2642B, G2923, G2941, G2942, G3441, G3441R, G3641, G3830, G3941		

gas lines

main gas lines

universal

			
1			
GEV No.	107447	Ref. No.	535770080 609943
description	gas line connection 3/8" IT - 3/8" ET L 108mm ED ø 16mm SS flexible DN11		
For models:	G2840, G2841, G2842		

			
1			
GEV No.	107296	Ref. No.	535410011 660019
description	gas line connection ø6mm L 450mm ED ø 8mm SS flexible thickness 0.5mm connection length 25mm		
For models:	G2107EU, G2107-SB		

			
1			
GEV No.	107276	Ref. No.	537101530 660014
description	gas line connection ø8mm L 385mm ED ø 10mm SS flexible thickness 0.5mm connection length 25mm		
For models:	G1107CE-OT, G1197		

			
1			
GEV No.	107277	Ref. No.	537101540 660013
description	gas line connection ø8mm L 650mm ED ø 10mm SS flexible thickness 0.5mm connection length 25mm		
For models:	G1197		

pressure switches

			
1			
GEV No.	541073	Ref. No.	530550019
description	pressure control ø 45mm pressure range adjustable 5-20mbar pressure connection vertical gas technology connection 1/4" pressure connection ø 1/4"mm		



equipment-specific units

for espresso machines

brewing units

filter holder gaskets

O-rings

1 

GEV No.	510409	Ref. No.	730590010
description	O-ring EPDM thickness 5.34mm ID ø 56.52mm Qty 1 pcs		

for solid top ranges

cast plates

1 

GEV No.	694567	Ref. No.	531880300 610012
description	cast plate ø 324mm H 9mm for solid top round		

for griddles

housing and bezels

1 

GEV No.	694576	Ref. No.	535101016 T613097
description	cover for grill L 495mm W 43mm H 25mm		

for convection ovens/combi-steamers

drain units

drip rails

1 

GEV No.	691961	Ref. No.	530550145
description	drain unit L 90mm edition since 2009		

1 
Image not available

GEV No.	692909	Ref. No.	730782432
description	bushing for door hinge H 7mm plastic D1 ø 18mm D2 ø 12mm ID ø 10mm		

injection pipes

1 

GEV No.	692838	Ref. No.	530753793
description	injection pipe for combi-steamer straight ED ø 12mm ID ø 8mm L 180mm -		

1 

GEV No.	692839	Ref. No.	530743267
description	injection pipe for combi-steamer U-shape ED ø 12mm ID ø 10mm L 265mm		

cleaning system

coupling bushings



1

GEV No.	501591	Ref. No.	530753890
description	hose connector stainless steel hose \varnothing 10/13mm M9 for cleaning system combi-steamer		

cleaning arms



1

GEV No.	542416	Ref. No.	530775177
description	mounting flange \varnothing 55mm hub with gasket for wash arm suitable for ELOMA combi-steamer		

hoses



1

GEV No.	694953	Ref. No.	530550164
description	hose ID \varnothing 13mm ED \varnothing 23mm L 1mm EPDM blue/white t.max. 120°C for combi-steamer		

hoses



1

GEV No.	520534	Ref. No.	530550162
description	hose ID \varnothing 50mm ED \varnothing 58mm L 50mm silicone Qty 1 for combi-steamer thickness 4mm		

service kits



1

GEV No.	530902	Ref. No.	530550068
description	flange kit for washing arms suitable for combi-steamer LAINOX		

drip water trays



1

GEV No.	699854	Ref. No.	530550147
description	drip tray L 520mm W 35mm H 70mm		



1

GEV No.	699242	Ref. No.	530550148
description	drip tray L 576mm W 32mm H 51mm		



1

GEV No.	699269	Ref. No.	530781177
description	plug H 10mm \varnothing 20mm		

door mechanics

miscellaneous



1

GEV No.	692909	Ref. No.	730782432
description	bushing for door hinge H 7mm plastic D1 \varnothing 18mm D2 \varnothing 12mm ID \varnothing 10mm		

door bumpers



1

GEV No.	694922	Ref. No.	530886726
description	rubber pad \varnothing 11.5mm H 19mm rubber		



locking mechanism



GEV No.	692714	Ref. No.	530791652
description	disc for catch ø 44mm hole ø 6x8mm		

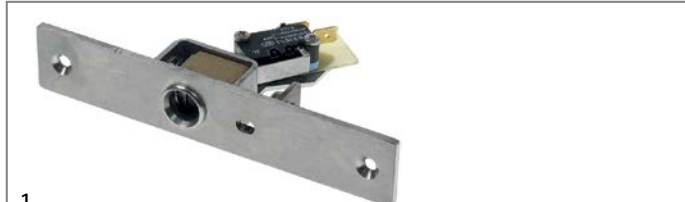

GEV No.	692716	Ref. No.	530588504
description	door catch with switch L 140mm W 25mm H 63mm hole distance 120mm ID ø 12mm		



GEV No.	692715	Ref. No.	530888575
description	sleeve ø 50mm L 72mm W 59mm H 31mm hole distance 60mm ID ø 37mm		

vibration pumps



GEV No.	500568	Ref. No.	530550032
description	vibration pump 230V 32W 50Hz inlet ø 7 outlet ø 1/8" IT CEME type E512/A32		

spare parts for	500568		
------------------------	--------	--	--

	GEV No.	390698	Ref. No.	—
	description	thermal fuse switch-off temp. 110°C suitable for ULKA pump		

	GEV No.	520153	Ref. No.	—
	description	bracket rubber dimensions 53x34x28mm		



GEV No.	499010	Ref. No.	530772550
description	vibration pump type E512/B46 230V 60W 50/60Hz inlet ø 7 outlet ø 1/8" IT CEME L 125mm		



GEV No.	501567	Ref. No.	530550178
description	vibration pump type HF 230V 22W 50Hz inlet ø 6 outlet ø 6 ULKA plastic L 97mm connection male faston 4.8mm		

heat exchangers



GEV No.	520509	Ref. No.	530550092
description	reducing washer gas burner brass ID ø 3mm ED ø 16mm thickness 2.2mm code 3		

miscellaneous

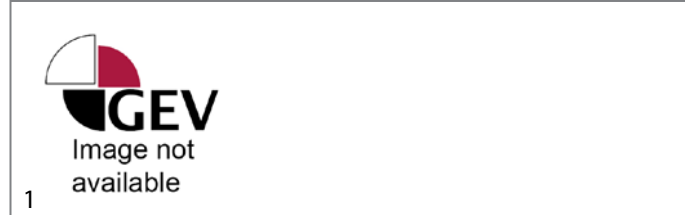

GEV No.	696857	Ref. No.	530566594
description	boot L 42mm D1 ø 12mm D2 ø 36mm		



GEV No.	692363	Ref. No.	531920640 P461407
description	stop for door L 31mm W 65mm H 16mm		
For models:	E7204, E7208, E7211, G7204, G7208, G7211		



GEV No.	692300	Ref. No.	530550161
description	stopper with screw connection for glass plate D1 ø 15mm L 8mm thread M4		

for tilting bratt pans

miscellaneous



1			
GEV No.	701195	Ref. No.	531750210 R447317
description	lid hinge L 248mm mounting pos. left aluminium for tilting bratt pan		
For models:	E1962, E1965, E1994, E1995, E2962, E2965, E2994, E2995, G1962, G1965, G1994, G1995, G2962, G2965, G2994, G2995		

for ovens

miscellaneous



1			
GEV No.	696508	Ref. No.	531880950 T392060
description	flue for oven L 230mm W 27mm H 50mm		
For models:	G1036L, G1036S		

knobs

producer-specific knobs

FALCON



1			
GEV No.	112574	Ref. No.	539110410
description	knob switch 7-position t.max. °C °C ø 56mm shaft ø 6x4.6mm shaft flat upper		
For models:	E350-30, E350-33		



1			
GEV No.	112573	Ref. No.	539110380
description	knob thermostat t.max. 250°C 100-250°C ø 56mm shaft ø 6x4.6mm shaft flat upper		
For models:	E350-30		



1			
GEV No.	112863	Ref. No.	731600009
description	knob 0-3 ø 65mm shaft ø 6x4.6mm shaft flat upper black		
For models:	E3512		



1			
GEV No.	112572	Ref. No.	731320030 731750780
description	knob energy regulator ON/1-4/FULL t.max. °C °C ø 65mm shaft ø 5x3.5mm shaft flat upper		
For models:	E1962, E1965, E1994, E1995		



1			
GEV No.	112701	Ref. No.	537350037 R5851
description	knob thermostat t.max. 190°C 140-190°C ø 66mm shaft ø 5x7mm shaft flat upper black		



1			
GEV No.	112575	Ref. No.	531750460
description	rosette ø 67mm		
For models:	E1962, E1965, E1994, E1995, G1962, G1965, G1994, G1995		



accessories

covers



GEV No.	111510	Ref. No.	530748781
description	lid t.max.°C ø 37mm shaft ømm shaft flat silver for knob ELOMA		
accessories for	111510		
	GEV No.	111498	Ref. No.
			530743690
	knob t.max.°C ø 48mm shaft ø 6.5mm shaft flat blue		

knob adaptors



GEV No.	107432	Ref. No.	530840051 705003
description	knob adapter shaft ø 6x8 to 5x7mm for gas tap shaft flat universal		
For models:	G5478, G6478		

handles and hand wheels

hand wheels

hand wheels



GEV No.	691973	Ref. No.	531750510 701203 731750510
description	hand wheel ø 150mm D1 ø 32mm bore ø 17mm thread groove widthmm L1 20mm L2 60mm handle length 65mm with folding handle		
For models:	E1962, E1994, E2962, E2994, G1962, G1994, G2962, G2994		

spare parts and accessories



GEV No.	514178	Ref. No.	531750511 RG11/6
description	folding handle ø 28mm total length 85mm seat ø 20mm shaft ømm thread M6 with pin L 85mm		
For models:	E2962, E2994, G1962, G1994, G2962, G2994		

bracket handles



GEV No.	701245	Ref. No.	539220150 635214
description	pull handle L 138mm H 53mm mounting distance 116mm thread M8x1.25 W 30mm black		
For models:	G350-1-CE, G350-2-CE		



GEV No.	701243	Ref. No.	735270027 R4946
description	pull handle L 145mm H 56/71mm mounting distance 119mm thread M5 W 30mm black		



GEV No.	701187	Ref. No.	535710003 R5016
description	pull handle L 145mm H 56/73mm mounting distance 118mm thread M5 W 30mm black		



GEV No.	701186	Ref. No.	535480055 600168
description	pull handle L 204mm H 58/74mm mounting distance 177mm thread M8x1.25 W 30mm black		
For models:	E2101, E2101EU, E2101EU-OTC, E2102, E2112, E2117, E2161, E2161EU, G2101EU, G2101-OT, G2101OTC, G2102, G2107EU, G2107-OT, G2107-SB, G2112, G2131-OT, G2151EU, G2151-OT, G2161EU, G2161-OT, G2167-OT		



			
1			
GEV No.	701185	Ref. No.	530783050 610005
description	pull handle L 204mm H 58/74mm mounting distance 177mm thread M8x1.25 W 30mm replace set black		
For models:	E3078-10, E3078-20, E3078-30, E3080-10, E3080-20, G3080-45L, G3080-90L		

recessed handles

			
1			
GEV No.	701188	Ref. No.	539211871 635003
description	recessed handle W 120mm H 80mm mounting distance 103mm mounting measurements 69x112mm plastic		



locks

handle latches

producer-specific

FALCON

			
1			
GEV No.	694067	Ref. No.	530747998
description	door catch with spigot 1-stage L 26mm total length 51mm thread M8		



			
1			
GEV No.	691990	Ref. No.	530748765 EL748765
description	door handle hinged at right L 155mm W 60mm H 58mm spring length 53mm blue mounting distance 40mm mounting thread M4		
spare parts for	691990		
	GEV No.	514450	Ref. No. 530791504
	spring for door handle ø 6mm L 61mm W 27.5mm		

accessories for	691990		
	GEV No.	111510	Ref. No. 530748781
	lid t.max.°C ø 37mm shaft ømm shaft flat silver for knob ELOMA		

edgmount latches

handle latches

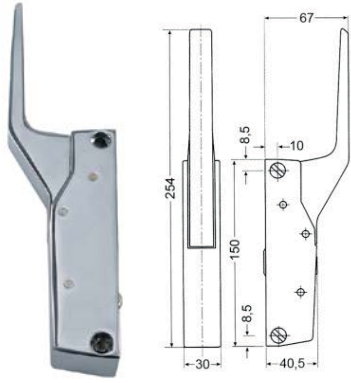
CAFF/FERMOD

			
1			
GEV No.	700060	Ref. No.	530377732
description	handle latch L 150mm mounting distance 133mm non lockable heated units G 791		
accessories for	700060		
	GEV No.	700061	Ref. No. —
	door catch L 58mm W 20mm H 35mm mounting distance 42mm chrome-plated brass for headed units		
	GEV No.	700062	Ref. No. 530292532
	handle protection heated units		

CHG

R35 series

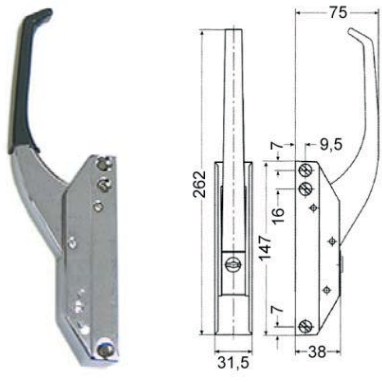
			
1			
GEV No.	690178	Ref. No.	734350140 R2648
description	D-lock L 147mm mounting distance 117/133mm non lockable heated units R35 H 38mm W 31mm complete with door catch total length 263mm overall height 72mm		
For models:	E4063, E4103		

snap locks

producer-specific

FALCON



1

GEV No.	694571	Ref. No.	535480054 RZZ224
description	snap lock L 63mm W 28mm mounting distance 43.5mm		
For models:	E2101, E2101EU, E2101EU-OTC, E2102, E2112, E2117, E2161EU, E2914i, E3101-3HP, E3101-4HP, E3101OTC-3HP, E3101OTC-4HP, E3117, E3161-3HP, E3913i, E3914i, G2101EU, G2101-OT, G2101OTC, G2102, G2107EU, G2107-OT, G2107-SB, G2112, G2131-OT, G2151EU, G2151-OT, G2161EU, G2161-OT, G2167-OT, G3101, G3101OTC, G3106, G3107, G3117, G3161		



1

GEV No.	694573	Ref. No.	534100090 G1107
description	snap lock L 63mm W 28mm mounting distance 43.5mm		



1

GEV No.	694575	Ref. No.	530962150 REE16/2
description	snap lock L 64mm W 26mm mounting distance 48mm		

espagnolette locks

producer-specific

FALCON



1

GEV No.	694572	Ref. No.	530843210 705011
description	door handle H 96mm L 170mm W 55mm for espagnolette lock		
For models:	E5478, E6478, G5478, G6478		

miscellaneous



1

GEV No.	694568	Ref. No.	534510130 600086 600200 731910670
description	door catch L 17mm total length 42mm thread M6x1 thread L 23mm		
For models:	E1808, E1838, E1848, E7002, E7202, E7202S, E720RS1, E720RS2, E720RS3, G1808-CE, G1808-Pre-CE, G1838-CE, G1848-CE, G1848-Pre-CE		

hinges

edgemount hinges

CHG

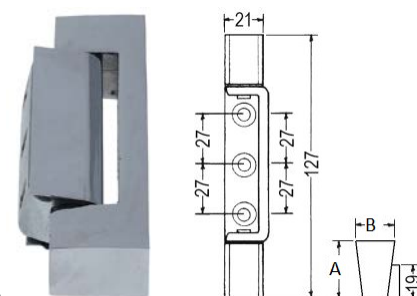

1

GEV No.	690291	Ref. No.	530843125 RO31
description	edgemount hinge L 127mm mounting distance 27/27mm hinging left/right without lift L1 30mm L2 28mm temp.-resist. 240°C series R42		
For models:	E6478, G5478, G6478		

door bearing



1

GEV No.	701193	Ref. No.	536430109 802212
description	bolt L 21mm mounting pos. lower thread M5 ø 10mm for door hinge Qty 1 pcs		
For models:	E401, E401F, E402, E402F, E421, E421F, E422, E422F, G2844F, G2845F, G401, G401F, G402, G402F		



1

GEV No.	701198	Ref. No.	536430108 801936
description	door hinge L 26mm W 15mm H 24mm mounting pos. upper bolt 20mm bolt ø 10mm		
For models:	E401, E401F, E402, E402F, E421, E421F, E422, E422F, G2844F, G2845F, G401, G401F, G402, G402F		



2

GEV No.	701210	Ref. No.	731910110 802455
description	door hinge L 35mm W 38mm H 23mm mounting pos. lower bolt 17mm bolt ø 6.5mm replace set		
For models:	E7002		



1

GEV No.	701211	Ref. No.	731910100 802454
description	door hinge L 35mm W 38mm H 23mm mounting pos. upper bolt 17mm bolt ø 6.5mm replace set		
For models:	E7002		



1

GEV No.	701244	Ref. No.	531740040 800003
description	door hinge L 46mm W 80mm H 24mm mounting pos. upper left with bush for convection oven Qty 1 pcs		
For models:	G1112		



1

GEV No.	701192	Ref. No.	530962190 T403706
description	door hinge L 47mm W 30mm H 19mm mounting pos. upper left Qty 1 pcs		



1

GEV No.	701212	Ref. No.	535400225 600182
description	door hinge L 53mm W 30mm H 23mm kit		



1

GEV No.	701191	Ref. No.	535480058 T603371
description	door hinge L 54mm W 30mm H 24mm mounting pos. upper left Qty 1 pcs		
For models:	E2101, E2117, G2101-OT, G2101OTC, G2107-OT, G2107-SB, G2151-OT		



1

GEV No.	701209	Ref. No.	534101014 T603373
description	door hinge L 55mm W 30mm H 24mm mounting pos. bottom left		
For models:	G1107CE-OT, G1197		



1

GEV No.	701190	Ref. No.	535200006 T603531
description	door hinge L 58mm W 60mm H 23mm mounting pos. upper left Qty 1 pcs		
For models:	E2101EU, E2101EU-OTC, E2914i, E3101-3HP, E3101-4HP, E3101OTC-3HP, E3101OTC-4HP, E3117, E3161-3HP, E3203, E3830, E3860, E3862, E3913i, E3914i, G2101EU, G2107EU, G2151EU, G3101, G3101OTC, G3106, G3107, G3117, G3161, G3203, G3206, G3830, G3860, G3865		





1

GEV No.	701194	Ref. No.	535200007 T603533
description	door hinge L 59mm W 60mm H 23mm mounting pos. left bottom		
For models:	E2101EU, E2101EU-OTC, E3101-3HP, E3101-4HP, E3101OTC-3HP, E3101OTC-4HP, E3117, E3161-3HP, E3203, E3830, E3860, E3862, G2101EU, G2107EU, G2151EU, G3101, G3101OTC, G3106, G3107, G3117, G3161, G3203, G3206, G3830, G3860, G3865		





			
1			
GEV No.	691976	Ref. No.	539210790 739210790
description	door hinge mounting pos. bottom left with bolt		
For models:	E350-30, G350-1-CE, G350-2-CE		

			
1			
GEV No.	691978	Ref. No.	539210800
description	door hinge mounting pos. bottom right with bolt		
For models:	E350-30, G350-1-CE, G350-2-CE		

			
1			
GEV No.	691975	Ref. No.	539210770
description	door hinge mounting pos. upper left with bolt		
For models:	E350-30, G350-1-CE, G350-2-CE		

			
1			
GEV No.	691977	Ref. No.	539210780
description	door hinge mounting pos. upper right with bolt		
For models:	E350-30, G350-1-CE, G350-2-CE		

			
1			
GEV No.	701247	Ref. No.	531740060 800004
description	hinge L 46mm W 28mm H 94mm mounting pos. bottom left with bush for convection oven		

			
1			
GEV No.	701246	Ref. No.	531740050 800005
description	hinge L 46mm W 28mm H 94mm mounting pos. bottom right with bush for convection oven		
For models:	G1112		

			
1			
GEV No.	701248	Ref. No.	531740030 800008
description	hinge L 47mm W 80mm H 52mm mounting pos. upper right with bush for convection oven Qty 1 pcs		
For models:	G1112		

			
1			
GEV No.	691285	Ref. No.	530550083
description	hinge bolt		

accessories

bushes

			
Image not available			
1			
GEV No.	692909	Ref. No.	730782432
description	bushing for door hinge H 7mm plastic D1 ø 18mm D2 ø 12mm ID ø 10mm		

miscellaneous

			
1			
GEV No.	694994	Ref. No.	530875023
description	locking disc for hinge ID ø 12mm ED ø 30mm plastic		

fittings for catering equipment

outlet taps

producer-specific

FALCON

			
1			
GEV No.	541891	Ref. No.	531313040 RM31/4
description	gate valve connection 3/4" IT - 3/4" IT total length 49mm brass		
For models:	G1860		

lid hinges

miscellaneous

spare parts



1

GEV No.	701197	Ref. No.	531750240 T448308
description	hinge bolt for lid ø 16mm L 96mm		
For models:	E1962, E1965, E1994, E1995, E2962, E2965, E2994, E2995, G1962, G1965, G1994, G1995, G2962, G2965, G2994, G2995		



1

GEV No.	701196	Ref. No.	531750180 RT447315
description	hinge camp for lid aluminium ø 16mm L 61mm		
For models:	E1962, E1965, E1994, E1995, E2962, E2965, E2994, E2995, G1962, G1965, G1994, G1995, G2962, G2965, G2994, G2995		



1

GEV No.	701195	Ref. No.	531750210 R447317
description	lid hinge L 248mm mounting pos. left aluminium for tilting bratt pan		
For models:	E1962, E1965, E1994, E1995, E2962, E2965, E2994, E2995, G1962, G1965, G1994, G1995, G2962, G2965, G2994, G2995		

drain taps

brass

drain taps



1

GEV No.	541887	Ref. No.	530730024 530783010 RLF044
description	drain tap 1¼"-1½" A 52mm B 101mm		
For models:	E3078-10, E3078-20, E3078-30, E3080-10, E3080-20, G2078-135L, G2078-45L, G2078-90L, G2078TC-135L, G3080-45L, G3080-90L		

equipment feet and end caps

equipment feet

with fixing plate



1

GEV No.	701199	Ref. No.	535480067 R6285
description	equipment foot tube ø 64mm plate size 90x70mm hole distance 55x70mm H 115-180mm SS size 2 1/2" Qty 1 pcs		
For models:	E3800, E3862, G2101EU, G2101-OT, G2101OTC, G2107EU, G2107-OT, G2107-SB, G2112, G2124, G2131-OT, G2151EU, G2151-OT, G2161EU, G2161-OT, G2167-OT, G3800, G3830, G3860, G3865		

DERBY RUOTE

spare parts and accessories

miscellaneous



1

GEV No.	560193	Ref. No.	530349771
description	tooth lock washer ID ø 10.4mm ED ø 18mm zinc-coated steel DIN/ISO DIN 6798A Qty 1 pcs for thread M10		



miscellaneous

with fixing plate

ø100mm



1

GEV No.	701200 ¹	Ref. No.	530964350 RZZ318
description	swivel castor with swivel brake ø 100mm plates fixing 96x90mm plate size 95x90mm hole distance 70x70 - 70x55mm capacity 120kg bearing slide bearing wheel body polyamide tread TPE tyres H 175mm wheel width 32mm Qty 1 pcs		
For models:	E3101-3HP, E3101-4HP, E3101OTC-3HP, E3101OTC-4HP, E3117, E3121-3HP, E3121-4HP, E3161-3HP, E3161D, E3800, G3101, G3101D, G3101OTC, G3106, G3107, G3107D, G3117, G3117D, G3121, G3124, G3127, G3161, G3161D, G3800		

¹with swivel brake



1

GEV No.	701208	Ref. No.	535400211 899056
description	swivel castor set with swivel brake ø 100mm plates fixing 96x90mm hole distance 70x70 - 70x55mm bearing ball bearing H 175mm wheel width 32mm		

baskets

fryer baskets

FALCON



1

GEV No.	970786	Ref. No.	539211910 R318
description	fryer basket W1 135mm L1 285mm H1 120mm chrome-plated steel		
For models:	E350-36, E350-37, G350-11, G350-12		



1

GEV No.	970784	Ref. No.	535770089 R5313
description	fryer basket W1 144mm L1 435mm H1 155mm chrome-plated steel		
For models:	G2840, G2841, G2842, G2844F, G2845F		

1			
GEV No.	970787	Ref. No.	735010400 R4546
description	fryer basket W1 190mm L1 300mm H1 100mm steel		

1			
GEV No.	970785	Ref. No.	535710023 R5042
description	fryer basket W1 200mm L1 290mm H1 145mm steel		

shelves and shelf rails

chargrill grids

1			
GEV No.	210046	Ref. No.	535101019 RT615007
description	chargrill grid L 535mm W 100mm H 75mm cast iron for grill		

1			
GEV No.	210049	Ref. No.	536000018 RT615016
description	chargrill grid L 535mm W 102mm H 75mm cast iron for grill		
For models:	G21224B, G21524B, G21824B, G2624B, G2924B		

gaskets

gaskets for heated units

door seals



GEV No.	901587	Ref. No.	535480056 703450
description	door seal L 1370mm suitable for FALCON SS braid mounting pos. right		
For models:	G2101-OT, G2107-OT, G2107-SB, G2151-OT		



GEV No.	901640	Ref. No.	531402180 703510
description	door seal L 1430mm suitable for FALCON SS braid		
For models:	G1167		



GEV No.	901589	Ref. No.	535200005 703455
description	door seal L 1700mm suitable for FALCON SS braid		
For models:	E2101EU, E3101-3HP, E3101-4HP, E3117, G2101EU, G2107EU, G2151EU, G3101, G3101D, G3107, G3107D, G3117, G3117D		



GEV No.	901139	Ref. No.	539110010 635004
description	door seal L 335mm suitable for FALCON SS braid		
For models:	E350-30, G350-1-CE, G350-2-CE		



GEV No.	901140	Ref. No.	539110020 635005
description	door seal L 490mm suitable for FALCON SS braid		
For models:	E350-30, G350-1-CE, G350-2-CE		



GEV No.	901642	Ref. No.	531740300 703809
description	door seal L 500mm suitable for FALCON SS braid		
For models:	G1112		



GEV No.	901641	Ref. No.	531740280 703808
description	door seal L 700mm suitable for FALCON SS braid		
For models:	G1112		



GEV No.	901592	Ref. No.	534100250 801083
description	door seal L 920mm suitable for FALCON mounting pos. left		
For models:	G1107CE-OT		

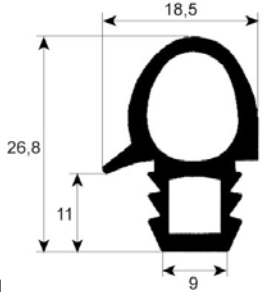

			
1			
GEV No.	901588	Ref. No.	535480057 703451
description	door seal L 930mm suitable for FALCON SS braid mounting pos. left		
For models:	G2101-OT, G2107-OT, G2107-SB, G2151-OT		

			
1			
GEV No.	900100	Ref. No.	530384410
description	door seal profile 2070 W 460mm L 645mm external size Qty 1 6 x 1/1		

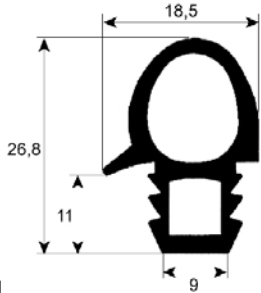
			
1			
GEV No.	900101	Ref. No.	530382310
description	door seal profile 2070 W 645mm L 700mm external size Qty 1 10 x 1/1		

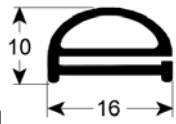
			
1			
GEV No.	901583 ¹	Ref. No.	531930525 600605
description	door seal profile 2229 W 495mm L 635mm external size suitable for FALCON with fixing kit		
For models:	E7004, E7204, G7004, G7204		

¹with fixing kit

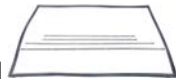
			
1			
GEV No.	901584 ¹	Ref. No.	531920525 600606
description	door seal profile 2229 W 615mm L 770mm external size suitable for FALCON with fixing kit		
For models:	E7008, E7208, G7008, G7208		

¹with fixing kit

			
1			
GEV No.	901585 ¹	Ref. No.	531940090 600607
description	door seal profile 2229 W 770mm L 900mm external size suitable for FALCON with fixing kit		
For models:	E7011, E7211, G7011, G7211		

¹with fixing kit

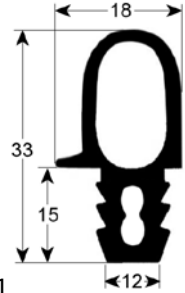
			
1			
GEV No.	900865	Ref. No.	530742368 EL742368
description	door seal profile 2449 W 490mm L 520mm Qty 1		

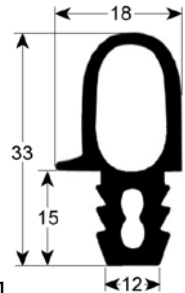
			
1			
GEV No.	901483	Ref. No.	530000423
description	door seal profile 2449 W 520mm L 1505mm Qty 1		

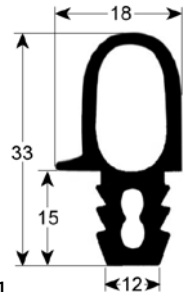
			
1			
GEV No.	900497	Ref. No.	530742376
description	door seal profile 2449 W 520mm L 775mm Qty 1		

GEV No.	901490	Ref. No.	530742406
description	door seal profile 2449 W 690mm L 1550mm Qty 1		

GEV No.	900498	Ref. No.	530693219 EL693219
description	door seal profile 2515 perimeter 1670mm Qty 1		

GEV No.	902392	Ref. No.	730580004
description	door seal profile 2761 W 400mm L 440mm outer plug size suitable for LAINOX		

GEV No.	902023	Ref. No.	530560006
description	door seal profile 2761 W 46mm L 775mm external size Qty 1 suitable for LAINOX		

GEV No.	902024	Ref. No.	530550062
description	door seal profile 2956 W 470mm L 560mm external size Qty 1		

GEV No.	901586	Ref. No.	530843130 RS41
description	door seal profile 2956 L 3600mm suitable for FALCON		
For models:	E5478, G5478, G6478		

GEV No.	901591	Ref. No.	539110025 635001
description	door seal W 350mm L 500mm suitable for FALCON kit		

GEV No.	901590	Ref. No.	531740302 703841
description	door seal W 500mm L 710mm suitable for FALCON set 4-piece		
For models:	E1112, G2102, G2112		

GEV No.	901593	Ref. No.	530962183 703452
description	door seal W 910mm L 1350mm suitable for FALCON set 2-piece		



gaskets for tray rack trolleys

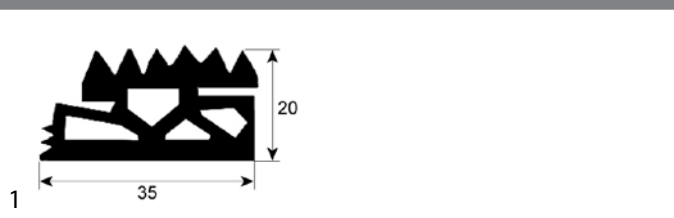

GEV No.	900199	Ref. No.	530549207
description	tray rack trolley gasket profile 4070 L 1000mm Qty 1		

gaskets for control panels



GEV No.	902493	Ref. No.	530742309
description	gasket for control panel W 220mm L 890mm suitable for ELOMA for combi-steamer with 8 mounting clips		

O-rings

EPDM

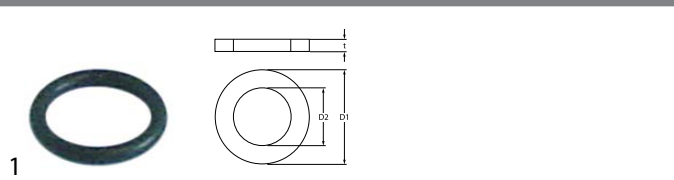

GEV No.	504574	Ref. No.	530013471
description	O-ring EPDM thickness 1.78mm ID ø 9.25mm Qty 1 pcs		

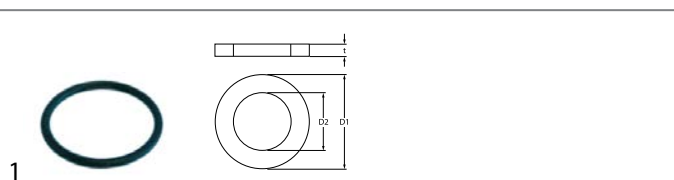

GEV No.	510409	Ref. No.	730590010
description	O-ring EPDM thickness 5.34mm ID ø 56.52mm Qty 1 pcs		

silicone

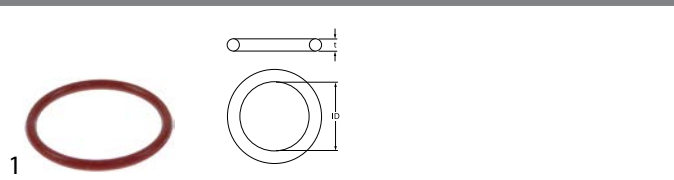

GEV No.	532726	Ref. No.	530577642
description	O-ring silicone thickness 1.5mm ID ø 17mm Qty 10 pcs		

Viton

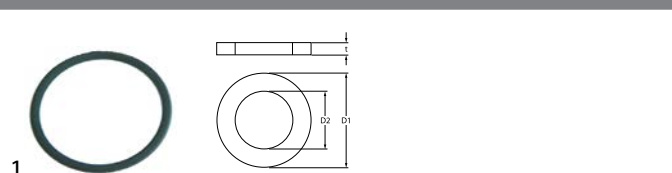

GEV No.	510579	Ref. No.	530581410
description	O-ring Viton thickness 2.62mm ID ø 34.6mm Qty 1 pcs		

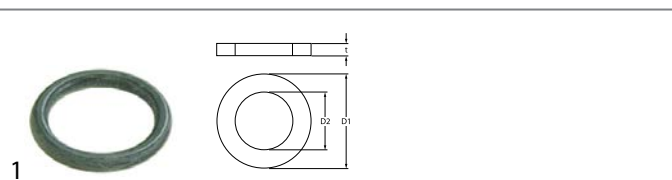

GEV No.	529357	Ref. No.	530753742
description	O-ring Viton thickness 3.53mm ID ø 23.4mm Qty 1 pcs		

NBR

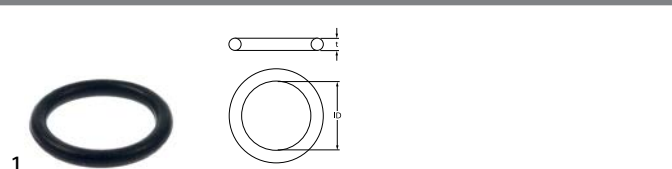

GEV No.	532735	Ref. No.	530503932
description	O-ring NBR 70 thickness 1mm ID ø 6mm		

sealing washers

graphite gaskets



GEV No.	696702	Ref. No.	530550021
description	gasket graphite ED ø 84mm ID ø 61mm thickness 3mm Qty 1 pcs		

silicone gaskets



GEV No.	359721	Ref. No.	530693421
description	gasket silicone ED ø 48mm ID ø 39.5mm thickness 5mm Qty 1 pcs		

shaft gaskets

shaft gaskets



GEV No.	511172	Ref. No.	530560025
description	shaft sealing ID ø 24mm ED ø 29mm thickness 3mm		

special gaskets

for combi-steamers



GEV No.	699471	Ref. No.	530507494
description	gasket suitable for ELOMA for model Genius T 6-11 10-11 for burner chamber L 108mm W 100mm graphite combi-steamer		

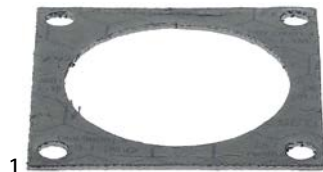

GEV No.	699469	Ref. No.	530505953 530742678
description	gasket suitable for ELOMA for model Genius T 6-11 10-11 L 64mm W 64mm for combi-steamer ID ø 50mm graphite thickness 1.7mm		

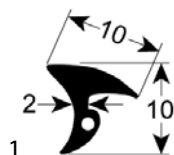

GEV No.	560648	Ref. No.	530584096
description	gasket suitable for ELOMA L 1000mm Qty 1m for combi-steamer		



GEV No.	699383	Ref. No.	530560001
description	gasket suitable for LAINOX Qty 1m ED ø 126mm ID ø 90mm graphite thickness 3mm hole distance 42mm hole ø 7mm		



GEV No.	699247	Ref. No.	530550061
description	gasket set for combi-steamer		

miscellaneous



GEV No.	109165	Ref. No.	536060011 R5435
description	gasket L 84mm W 65mm thickness 1.6mm cork suitable for FALCON		
For models:	G2840, G2841, G2842, G2845F		

thermostat gaskets



GEV No.	512389	Ref. No.	534102050 RL/95
description	gasket for thermostat thickness 1mm L 45mm W 20mm Qty 1 pcs hole distance 30mm suitable for FALCON		

springs

torsion springs



GEV No.	692523	Ref. No.	530503747
description	torsion spring ø 27.8mm ID ø 21.7mm L2 44mm wire gauge ø 3mm L1 13mm L3 44mm Qty 1 pcs		

miscellaneous



GEV No.	514450	Ref. No.	530791504
description	spring for door handle ø 6mm L 61mm W 27.5mm		





manometers

			
1			
GEV No.	541979	Ref. No.	530224758
description	manometer ø 39mm pressure range 0-4bar connection at the rear in the centre thread 1/8"		

hose reels and spray guns

spray guns

			
1			
GEV No.	542062	Ref. No.	530550110
description	spray gun for appliances 1/2" IT L 225mm type LAINOX		

			
1			
GEV No.	542404	Ref. No.	530550111
description	shower hose connections 1/2" L 2500mm unbraided nominal-ø DN8mm		

hose reels

appliance hose reels

			
1			
GEV No.	545067	Ref. No.	530753181
description	hose reel without spray gun hose length 1.55m		

dosing pumps

piston pumps











dosing pumps

			
1			
GEV No.	361941	Ref. No.	5316075
description	dosing pump type 14825-645 230V detergent inlet 7mm outlet 9mm 0.2-0.8l/h GRI PUMPS		

membrane dosing pumps

self-priming

LANG

				
1				
GEV No.	361009	Ref. No.	3086077 5315665	
description	dosing pump type N6 membrane dosing pump rinse aid p min 0.5bar pressure connection ø straight, 4x6mm suction connection ø straight, 4x6mm LANG			
spare parts for	361009			
	GEV No.	361079	Ref. No.	—
	spring for type N5/N6 for ball			
	GEV No.	361080	Ref. No.	—
	O-ring EPDM thickness 2mm ID ø 16mm Qty 1 pcs			
	GEV No.	361085	Ref. No.	—
	O-ring EPDM thickness 2mm ID ø 8mm Qty 1 pcs			
	GEV No.	361309	Ref. No.	—
	ball for type N5/N6			
	GEV No.	361310	Ref. No.	—
	bracket for type N6 ball guide			
	GEV No.	361311	Ref. No.	—
	O-ring EPDM thickness 2mm ID ø 6mm Qty 1 pcs for type N6			
	GEV No.	361314	Ref. No.	—
	valve ring for type N6 holder for O-ring			
	GEV No.	361317	Ref. No.	—
	sealing disc for type N6			
	GEV No.	361886	Ref. No.	—
	non-return valve inletmm outletmm outlet ø 12.4mm L 12.7mm			

hoses

pre-rinse hoses

stainless steel flexi hoses



GEV No.	542404	Ref. No.	530550111
description	shower hose connections 1/2" L 2500mm unbraided nominal-ø DN8mm		

industrial hoses



nylon hoses



GEV No.	520252	Ref. No.	530785857
description	nylon hose ID ø 6mm ED ø 8mm L 5m thickness 1mm operating p. 10bar burst p. 50bar t.max. 100°C white		

PE hoses



GEV No.	520973	Ref. No.	530550067
description	hose John Guest thickness 1.5mm LLDPE blue ID ø 7mm ED ø 10mm		
accessories for	520973		
	GEV No.	440564	Ref. No. —
	push-in fitting John Guest straight thread 1/4" BSP pipe connection ø10mm		
	GEV No.	440565	Ref. No. —
	push-in fitting John Guest straight thread 3/8" BSP pipe connection ø10mm		
	GEV No.	440608	Ref. No. —
	push-in fitting John Guest straight thread 1/2" BSP stub ø 10mm		
	GEV No.	440639	Ref. No. —
	push-in fitting John Guest angled thread 1/4" BSP pipe connection ø10mm		
	GEV No.	520359	Ref. No. 530550007
	push-in fitting John Guest angled pipe connection ø10mm grommet ø 10mm		
	GEV No.	520363	Ref. No. 530550004
	push-in fitting John Guest T-piece pipe connection ø10mm - ø10mm - ø10mm		
	GEV No.	520494	Ref. No. 530550005
	push-in fitting John Guest angled pipe connection ø10mm - ø10mm		

PU hoses



GEV No.	512505	Ref. No.	530550172
description	PU hose ID ø 5mm ED ø 8mm L 1m thickness 1.5mm t.max. -40 up to +60°C polyurethane transparent/colourless		

silicone hoses

without fabric



GEV No.	530899	Ref. No.	530550163
description	silicone hose ID ø 13mm ED ø 18mm L 0.08m thickness 2.5mm red for combi-steamer		

with fabric

with glass fibre sleeving



GEV No.	520024	Ref. No.	530593303
description	silicone hose with glass fibre sleeving ID ø 9.5mm ED ø 17mm L 5m thickness 3.75mm operating p. 4bar burst pressure at 95°C 26bar burst pressure 130°C 14bar t.max. 200°C white		

formed hoses

straight



GEV No.	520534	Ref. No.	530550162
description	hose ID ø 50mm ED ø 58mm L 50mm silicone Qty 1 for combi-steamer thickness 4mm		

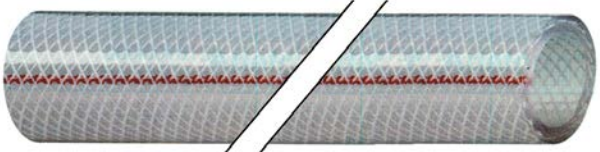

			
1			
GEV No.	520599	Ref. No.	531920490 600552
description	PVC braided hose D1 ø 11mm D2 ø 7mm transparent Qty supplied by meter		

fittings, hose and pipe connectors

hose connectors

miscellaneous

			
1			
GEV No.	501591	Ref. No.	530753890
description	hose connector stainless steel hose ø 10/13mm M9 for cleaning system combi-steamer		

fittings

double nipples

			
1			
GEV No.	520160	Ref. No.	530440092 530754447
description	double nipple nickel-plated brass thread 1/8" - 1/8" Qty 1 pcs		

			
1			
GEV No.	521187	Ref. No.	530570451
description	double nipple nickel-plated brass thread 1/8" - 3/8" Qty 1 pcs int. ø 15mm int. ø 29.3mm		

screw pipe fittings

angle pieces

			
1			
GEV No.	699452	Ref. No.	530550011
description	angle piece thread M14x1 tube ø 10mm brass		

hose connectors

plastic

			
1			
GEV No.	362011	Ref. No.	530550008
description	hose connector plastic straight thread 1/4" hose ø 8x6mm Qty 1 pcs		

stainless steel

			
1			
GEV No.	542385	Ref. No.	530550013
description	hose connector SS angled thread 1/4" hose ø 10mm Qty 1 pcs		

producer-specific

			
1			
GEV No.	440027	Ref. No.	530550006
description	connecting piece for hose ID 6mm WS 15 total length 79mm plastic John Guest		

			
1			
GEV No.	520360	Ref. No.	730580000
description	hose connector thread 1/4" with coupling straight plastic		

push-in fittings

JOHN GUEST



GEV No.	520359	Ref. No.	530550007
description	push-in fitting John Guest angled pipe connection ø10mm grommet ø 10mm		
accessories for	520359		
	GEV No.	520973	Ref. No. 530550067
	hose John Guest thickness 1.5mm LLDPE blue ID ø 7mm ED ø 10mm		



GEV No.	520493	Ref. No.	530550010
description	hose connector John Guest straight pipe connection ø8mm - ø10mm L 41mm PM201008E NSF, SK		



GEV No.	520492	Ref. No.	530561000
description	push-in fitting John Guest straight pipe connection ø10mm - ø10mm		



GEV No.	520494	Ref. No.	530550005
description	push-in fitting John Guest angled pipe connection ø10mm - ø10mm		
accessories for	520494		
	GEV No.	520973	Ref. No. 530550067
	hose John Guest thickness 1.5mm LLDPE blue ID ø 7mm ED ø 10mm		



GEV No.	520363	Ref. No.	530550004
description	push-in fitting John Guest T-piece pipe connection ø10mm - ø10mm - ø10mm		
accessories for	520363		
	GEV No.	520973	Ref. No. 530550067
	hose John Guest thickness 1.5mm LLDPE blue ID ø 7mm ED ø 10mm		



GEV No.	520495	Ref. No.	530550009
description	push-in fitting John Guest straight thread 1/8" BSP stub ø 8mm		
accessories for	520495		
	GEV No.	520971	Ref. No. —
	hose thickness 1mm LLDPE blue ID ø 4mm ED ø 6mm operating pressure at 20°C 16bar		



GEV No.	440031	Ref. No.	530550015
description	push-in fitting John Guest straight thread 1/2" pipe connection ø8mm - ø8mm bulkhead connector		

valves and tank inlets

ball valves

universal

ball valves with lever handle



GEV No.	540758	Ref. No.	534510060 R3611
description	ball valve connection 1" IT - 1" ET DN25 total length 90mm with lever handle handle length 95mm		
For models:	E1808, E1838, E1848, E3862, G1008X, G1808-CE, G1808-Pre-CE, G1830-MK2, G1838-CE, G1838X, G1848-CE, G1848-Pre-CE, G1848X, G1860-MK2, G1865, G3830, G3860, G3865		

producer-specific

FALCON



GEV No.	514432	Ref. No.	535770011 801956
description	ball valve IT 1" set L 82mm butterfly/lever handle		
For models:	G2840, G2841, G2842, G2844F, G2845F		



ball valves electric



1

GEV No.	541892 ¹	Ref. No.	534350605 600378
description	ball valve inlet 28mm outlet 28mm with limit switch 230V L 100mm 50/60Hz off-current open W 78mm H 115mm connection cable 750mm cable 750 IT ET shaft ø 9.5x3mm SUNVIC		

¹off-current open



1

GEV No.	403042	Ref. No.	730610000
description	ball valve inlet 3/4" IT outlet 3/4" IT 230V L 68mm closed off-current mode of operation electric connection cable 400mm		

gate valves



1

GEV No.	541891	Ref. No.	531313040 RM31/4
description	gate valve connection 3/4" IT - 3/4" IT total length 49mm brass		
For models:	G1860		

water cycle components

pressure reduction valves

pressure reduction valves

producer-specific



1

GEV No.	520502	Ref. No.	530871419
description	pressure reduction valve Norgren series R91 connection 1/8" default settingbar setting range 0.1-3bar p max 10bar t.max. 50°C brass		

ancillary products

clamps

security hose clamps

SS/brass



1

GEV No.	520069	Ref. No.	530276634
description	hose clamp SS/brass ø 14-19mm width 11mm Qty 5 pcs		



1

GEV No.	520070	Ref. No.	530276642
description	hose clamp SS/brass ø 16-21mm width 11mm Qty 5 pcs		



1

GEV No.	520071	Ref. No.	530572160
description	hose clamp SS/brass ø 17-22mm width 11mm Qty 5 pcs		



			
1			
GEV No.	520067	Ref. No.	730277665
description	hose clamp SS/brass ø 9-14mm width 10mm Qty 5 pcs		

nuts

hexagonal nuts

hexagonal nuts metric (without norm)

			
1			
GEV No.	550681	Ref. No.	530550002
description	nut thread M12x1.25 H 5mm WS 17 brass Qty 1 pcs		

fastening material

screws

flat-headed bolts

			
Image not available			
1			
GEV No.	560491	Ref. No.	530162469
description	flat-headed bolt thread M3 thread L 16mm stainless steel DIN 7985 Qty 20 pcs intake Phillips head ø 6mm head thickness 2.5mm		

washers

tooth lock washers

DIN 6798A

			
1			
GEV No.	560193	Ref. No.	530349771
description	tooth lock washer ID ø 10.4mm ED ø 18mm zinc-coated steel DIN/ISO DIN 6798A Qty 1 pcs for thread M10		

grub screws

DIN 913/ISO 4026

			
1			
GEV No.	560497	Ref. No.	530753785 EL753785
description	grub screw thread M8 L 8mm A2-A2L DIN 913/ISO 4026 WS 4 Qty 20 pcs		

			
1			
GEV No.	560127	Ref. No.	530510020
description	tooth lock washer ID ø 6.2mm ED ø 11mm SS DIN/ISO DIN 6798A Qty 20 pcs for thread M6		

DIN 916/ISO 4029

			
1			
GEV No.	560173	Ref. No.	530588512
description	grub screw thread M4 L 10mm SS DIN 916/ISO 4029 intake internal hexagon WS 2 Qty 20 pcs		

fasteners

clamps

security hose clamps

SS/brass

			
1			
GEV No.	520069	Ref. No.	530276634
description	hose clamp SS/brass ø 14-19mm width 11mm Qty 5 pcs		

miscellaneous

			
1			
GEV No.	560621	Ref. No.	530399280
description	grub screw thread 1/8" L 5mm brass WS hexagonal 5mm Qty 1 pcs		

			
1			
GEV No.	520070	Ref. No.	530276642
description	hose clamp SS/brass ø 16-21mm width 11mm Qty 5 pcs		



			
1			
GEV No.	520071	Ref. No.	530572160
description	hose clamp SS/brass ø 17-22mm width 11mm Qty 5 pcs		

			
1			
GEV No.	520067	Ref. No.	730277665
description	hose clamp SS/brass ø 9-14mm width 10mm Qty 5 pcs		

consumables

sealants and adhesives

high temperature silicone

			
1			
GEV No.	890107	Ref. No.	530500402
description	high temperature silicone TOMABOND TB76 -40 up to +250°C red/brown tube 90ml		
description	<p>Tomabond TB76 - tube 90ml - red brown Special elastic silicone for general bonding & sealing applications with high thermal loads. TB 76 is primarily used in building services, HVAC and mechanical engineering. Temperature-resistant to 300 °C over the short term</p>		

fuses

fine fuses

			
1			
GEV No.	358532	Ref. No.	530190756
description	fine fuse size ø5x20mm 2A fast-acting rated 250V Qty 10 pcs		

			
1			
GEV No.	358595	Ref. No.	730580042
description	fine fuse size ø5x20mm 0.2A slow-acting rated 250V Qty 10 pcs		

			
1			
GEV No.	358703	Ref. No.	530560030
description	fine fuse size ø5x20mm 0.4A slow-acting rated 250V Qty 10 pcs		

ø6.3x32mm 250V

			
1			
GEV No.	358790	Ref. No.	536430009 R5524
description	fine fuse size ø6.3x32mm 5A slow-acting rated 250V Qty 10 pcs		
For models:	E3840, E401F, E402F, E421, E421F, E422, E422F, G2844F, G2845F, G3106, G3840, G401F, G402F		

			
1			
GEV No.	358004	Ref. No.	731750790
description	fuse 20A rated 240V Qty 1 pcs		
For models:	E1962, E1965, E1994, E1995		

screw locks

D0-system (NEOZED)

			
1			
GEV No.	358043	Ref. No.	530658294
description	fuse size D01 16A rated 250/400V E14 ø 11mm L 36mm Qty 10 pcs		

			
1			
GEV No.	358045	Ref. No.	530751863
description	fuse size D02 35A rated 250/400V E18 ø 15mm L 36mm Qty 10 pcs		

gauge pieces (NEOZED)

			
1			
GEV No.	358067	Ref. No.	530751855
description	gauge piece size D02 suitable for 35A		

A		G	
alarm devices	19	gas burners	59
appliance hose reels	83	gas control valves	42
axial fans	29	gas lines	66
B		gas nozzles	63
ball valves	86	gas pressure regulators	66
ball valves electric	28, 87	gas solenoid valves	47
bar burners	61	gas taps	37
bi-metal thermostats	7	gas thermostats	40
booster pumps I	34	gaskets for control panels	81
booster pumps II	34	gaskets for heated units	78
C		gaskets for tray rack trolleys	81
cables	36	gate valves	87
cam switches	15	grub screws	88
castors and bumper angles	76	H	
clamps	87, 88	halogen lamp	17
condensators & interference suppression filters	35	handle latches	72
consumables	89	heating elements	3
contactors	19	heating elements for convection	4
control equipment	16	heating elements for ovens	3
control thermostats	7	heating elements for salamanders/toasters	3
D		heating elements for tilting bratt pan	3
door seals	78	hexagonal nuts	88
dosing pumps	83	high temperature silicone	89
double nipples	85	hob burners	59
E		hose connectors	85, 85
edgemount hinges	73	hose reels	83
edgemount latches	72	hoses	84
electric accessories	36	hot air fans	33
electric timers	19	hot air motors	30
electrodes	29	hot plates	6
electronic controllers	23	I	
energy regulators	6	ignition boxes	45
espagnolette locks	73	ignition bridges	59
F		ignition cables	53
fans	29	ignition units	54
fasteners	88	immersion heating elements	3
fastening material	88	indicator lights	16
filters	35	indicator lights (complete)	16
fine fuses	89	industrial hoses	84
fittings	85	infrared lamps	18
flat-headed bolts	88	L	
forced air burners	62	lamps	16
formed hoses	84	light bulbs	17
fuses	35, 89	linear lamps	18
		M	
		magnetic switches	15
		mechanical timers	19

microswitches	14	thermocouples	55
motors	33	thermostat gaskets	82
N		thermostats	7
nuts	88	time relays	22
nylon hoses	84	timers	19
O		tooth lock washers	88
operating capacitors	35	touch sensitive light switches	15
O-rings	81	transformers	22
oven lamps	18	U	
P		universal probes	23
PE hoses	84	V	
piezoelectric igniters	54	valves and tank inlets	86
pilot burners	47	vibration pumps	35
power supply cables	36	W	
pre-rinse hoses	84	wash and rinse pumps	34
pressure reduction valves	87, 87	water cycle components	87
pressure switches	28, 66		
probes	23		
PU hoses	84		
pumps	34		
push-in fittings	86		
R			
radial fans	33		
relays	21		
S			
safety thermostats	8		
safety valves	46		
screw locks	89		
screw pipe fittings	85		
screws	88		
sealants and adhesives	89		
sealing washers	81		
security hose clamps	87, 88		
shaft gaskets	82		
shelves and shelf rails	77		
silicone	89		
silicone hoses	84		
snap locks	73		
solenoid valves	26		
solid state relays	21		
solid top burners	61		
spray guns	83		
stainless steel flexi hoses	84		
switches and momentary switches	14		
T			
temperature probes	23		
terminals	37		