



**GAS COMPONENTS**



**ELECTRIC COMPONENTS**



**WATER TECHNOLOGY**



**MECHANICAL COMPONENTS**



**TOOLS**

Spare parts suitable for

**FAGOR**

Find the complete and up-to-date range of products in our GEV Webshop



# Manufacturer catalogue

The most important spare parts and accessories arranged clearly for every manufacturer

- ✓ Complete product range and all appliance data always up to date in the GEV Webshop
- ✓ Alphabetical Index at the end of the catalogue

## GEV Webshop

[www.gev-online.co.uk](http://www.gev-online.co.uk)

[www.gev-online.com](http://www.gev-online.com)



- 🔍 Add to Favourites
- 🔍 Sign In with email address and usual password
- 🔍 Easy-order – place several items in your basket at the same time
- 🔍 Quick Item search – no login needed



# heating elements

## heating elements for ovens

<b>GEV No.</b>	416018	<b>Ref. No.</b>	12024610 U803004
<b>description</b>	heating element 1000W 230V L 515mm W 125mm L1 55mm L2 460mm W1 65mm W2 60mm flange length 80mm flange width 20mm tube ø 6.5mm connection length 50mm connection male faston 6.3mm heating circuits 1 rectangular flange dry heating element		
<b>For models:</b>	CE7-41, CE7-41Q, CE9-41, CE9-41AD, CE9-41PLUS, CG-210G, CG-310G, CGE7-224, CGE7-41, CGE7-41H, CGE9-11, CGE9-41, CGE9-41AD, CGE9-41PLUS, HE9-10, HE9-20		

<b>GEV No.</b>	416608	<b>Ref. No.</b>	12018965 U183030
<b>description</b>	heating element 1000W 230V L 515mm W 170mm L1 70mm L2 445mm W1 110mm W2 60mm flange length 80mm flange width 20mm tube ø 6.3mm connection length 50mm connection male faston 6.3mm heating circuits 1 rectangular flange dry heating element		
<b>For models:</b>	CE-410, CE9-41		

<b>GEV No.</b>	416624	<b>Ref. No.</b>	X363023
<b>description</b>	heating element 1500W 230V heating circuits 1 L 300mm W 50mm H 180mm L1 20mm L2 280mm H1 150mm H2 30mm windings 3 flange length 56mm flange width 16mm hole distance 18mm hole ø 5mm mounting thread M4 tube ø 8mm		

<b>GEV No.</b>	416628	<b>Ref. No.</b>	X373005
<b>description</b>	heating element 2000W 230V heating circuits 1 L 298mm W 49mm H 179mm L1 19mm L2 279mm H1 150mm H2 31mm windings 3 flange length 56mm flange width 16mm hole distance 18mm hole ø 5mm connection M4 connection length 23mm tube ø 8mm rectangular flange immersion heater		

## heating elements for fryers

### center connection

<b>GEV No.</b>	416824	<b>Ref. No.</b>	FAG6000001
<b>description</b>	heating element 7000W 230/400V heating circuits 3 L 325mm W 110mm H 33mm flange length 19.5mm flange length 1 9.5mm flange length 2 9.8mm flange ø1 62mm flange ø2 57mm thermostat sleeves ø 8mm sensor screw connection 2x M10x1 thermostat sleeve upper/lower L1 18mm L2 307mm W1 40mm W2 35mm thread M54x1.5 tube ø 8.5mm cable length 520mm rotation flange immersion heater fryer connection length 50mm 2		
<b>spare parts for</b>	416824		
	<b>GEV No.</b>	<b>Ref. No.</b>	—
	510243		
	O-ring Viton thickness 3.53mm ID ø 55.56mm Qty 1 pcs		
	<b>GEV No.</b>	<b>Ref. No.</b>	—
	550496		
	O-ring Viton thickness 3.53mm ID ø 50.39mm Qty 1 pcs		
<b>accessories for</b>	416824		
	<b>GEV No.</b>	<b>Ref. No.</b>	—
	550447		
	ring nut thread M54x1.5		

<b>GEV No.</b>	416625	<b>Ref. No.</b>	12024654 X373022
<b>description</b>	heating element 2000W 230V heating circuits 1 L 310mm W 50mm H 180mm L1 30mm L2 280mm H1 150mm H2 30mm windings 3 flange length 56mm flange width 16mm hole distance 18mm hole ø 5mm connection M4 tube ø 8mm rectangular flange immersion heater		
<b>For models:</b>	FE-8		

<b>GEV No.</b>	416622	<b>Ref. No.</b>	12024670 12039909 X353005 X353024
<b>description</b>	heating element 3000W 230V heating circuits 1 L 303mm W 45mm H 190mm L1 20mm L2 283mm H1 148mm H2 42mm windings 4 flange length 56mm flange width 16mm hole distance 18mm hole ø 5mm connection M4 connection length 35mm tube ø 8mm rectangular flange fryer		
<b>For models:</b>	FE-4		

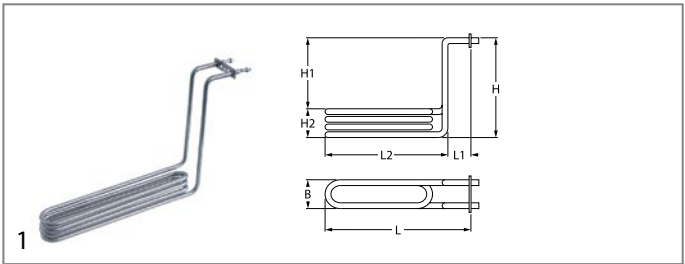

<b>GEV No.</b>	416630	<b>Ref. No.</b>	12024695 X383020
<b>description</b>	heating element 3000W 230V heating circuits 1 L 342mm W 48mm H 220mm L1 47mm L2 295mm H1 174mm H2 46mm windings 4 flange length 56mm flange width 16mm hole distance 18mm hole ø 5mm connection M4 connection length 32mm tube ø 8.5mm rectangular flange immersion heater AISI 304		
<b>For models:</b>	FE-18		

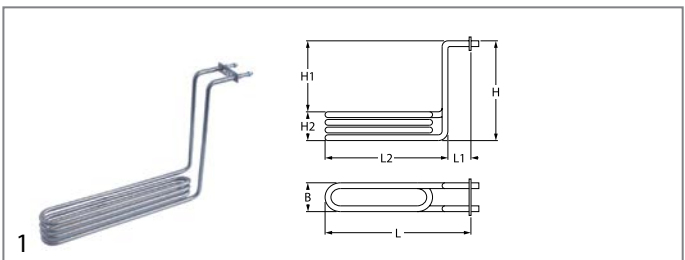

<b>GEV No.</b>	416631	<b>Ref. No.</b>	X393010
<b>description</b>	heating element 4250W windings 4		

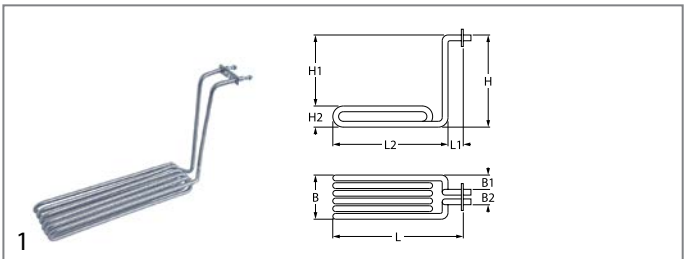







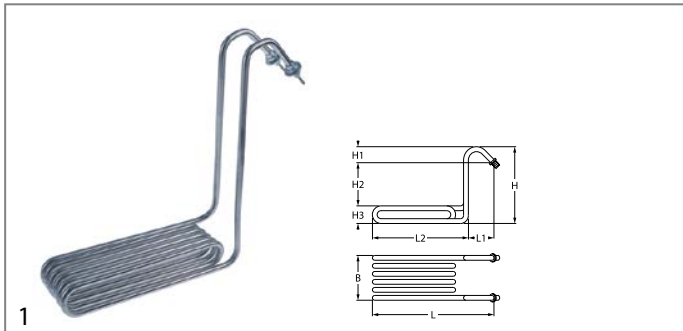

<b>GEV No.</b>	416632	<b>Ref. No.</b>	12024745 X393021
<b>description</b>	heating element 4250W 230V heating circuits 1 L 380mm W 104mm H 230mm L1 46mm L2 335mm W1 28mm W2 48mm H1 194mm H2 40mm windings 6 flange length 57mm flange width 17mm hole distance 18mm hole ø 5mm connection M4 connection length 35mm tube ø 8.5mm rectangular flange immersion heater		
<b>For models:</b>	FE-25		

2 hole fixing group 4











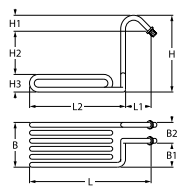

<b>GEV No.</b>	420157	<b>Ref. No.</b>	12024661 J153007
<b>description</b>	heating element 2750W 230V heating circuits 1 L 298mm W 150mm L1 46mm L2 252mm W1 98mm W2 52mm thread 1/4" mounting distance 44mm tube ø 8mm connection length 22mm 2 hole fixing fryer heaters		
<b>For models:</b>	FE6-05, FE6-10		





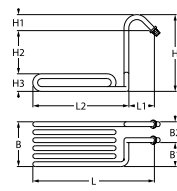





<b>GEV No.</b>	417160	<b>Ref. No.</b>	12000058 12024757 X183021 X183068
<b>description</b>	heating element 6000W 230V heating circuits 1 L 380mm W 90mm H 355mm L1 85mm L2 295mm H1 35mm H2 268mm H3 52mm thread M15x1 tube ø 10mm 2 hole fixing connection M4 immersion heater windings 6		
<b>For models:</b>	FE9-05, FE9-05-1C, FE9-05-2C, FE9-05AD, FE9-05PLUS, FE9-05PLUS-S, FE9-05S, FE9-05S-1C, FE9-05S-2C, FE9-05S-AD, FE9-05USMC, FE9-10, FE9-10-2C, FE9-10-4C, FE9-10AD, FE9-10PLUS		
<b>spare parts for</b>	417160		
	<b>GEV No.</b>	508017	<b>Ref. No.</b> —
	flat gasket FIBER ED ø 24mm ID ø 17mm thickness 2mm Qty 1 pcs		
	<b>GEV No.</b>	528401	<b>Ref. No.</b> —
	flat gasket fibre ED ø 22mm ID ø 16mm thickness 2mm Qty 1 pcs		
<b>accessories for</b>	417160		
	<b>GEV No.</b>	401703	<b>Ref. No.</b> 12024416 X183070
	copper wire 4mm <sup>2</sup> insulation glass fibre connection cable lug ø4mm L 1400mm		
	<b>GEV No.</b>	521103	<b>Ref. No.</b> —
	nut thread M4 H 3mm WS 7 brass Qty 20 pcs		
	<b>GEV No.</b>	521104	<b>Ref. No.</b> —
	washer ID ø 4.3mm ED ø 8mm thickness 0.5mm brass Qty 20 pcs for thread M4		
	<b>GEV No.</b>	560111	<b>Ref. No.</b> 12009987 Q232020
	plain washer ID ø 4.3mm ED ø 9mm thickness 0.8mm SS Qty 20 pcs DIN 125A for thread M4		
	<b>GEV No.</b>	560131	<b>Ref. No.</b> 12009839 Q162020
	hexagonal nut thread M4 H 3.2mm WS 7 SS DIN/ISO DIN 934 / ISO 4032/8673 Qty 20 pcs		



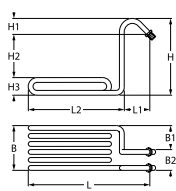



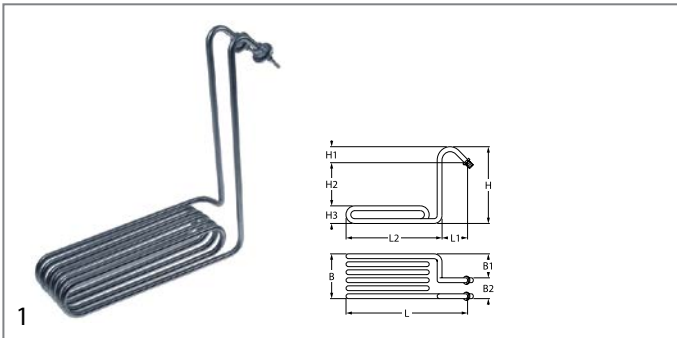

 			
<b>GEV No.</b>	416603	<b>Ref. No.</b>	X323001
<b>description</b>	heating element 4000W 230V heating circuits 1 mounting pos. right + centre L 300mm W 85mm H 300mm L1 40mm L2 260mm W1 41mm W2 44mm H1 40mm H2 210mm H3 50mm mounting distance 35mm thread M14x1.25 tube ø 8.5mm 2 hole fixing connection M4 fryer connection length 27mm		
<b>accessories for</b>	416603		
	<b>GEV No.</b>	521103	<b>Ref. No.</b> —
	nut thread M4 H 3mm WS 7 brass Qty 20 pcs		
	<b>GEV No.</b>	521104	<b>Ref. No.</b> —
	washer ID ø 4.3mm ED ø 8mm thickness 0.5mm brass Qty 20 pcs for thread M4		
	<b>GEV No.</b>	528401	<b>Ref. No.</b> —
	flat gasket fibre ED ø 22mm ID ø 16mm thickness 2mm Qty 1 pcs		
	<b>GEV No.</b>	560111	<b>Ref. No.</b> 12009987 Q232020
	plain washer ID ø 4.3mm ED ø 9mm thickness 0.8mm SS Qty 20 pcs DIN 125A for thread M4		
	<b>GEV No.</b>	560131	<b>Ref. No.</b> 12009839 Q162020
	hexagonal nut thread M4 H 3.2mm WS 7 SS DIN/ISO DIN 934 / ISO 4032/8673 Qty 20 pcs		

 			
<b>GEV No.</b>	416548	<b>Ref. No.</b>	12024704
<b>description</b>	heating element 4000W 230V heating circuits 1 mounting pos. right + centre L 300mm W 85mm H 300mm L1 40mm L2 260mm W1 41mm W2 44mm H1 40mm H2 210mm H3 50mm mounting distance 36mm thread M14x1.25 tube ø 8mm 2 hole fixing connection M4 immersion heater connection length 27mm windings 6 fryer		
<b>For models:</b>	FE7-05-1C, FE7-05-2C, FE7-10-2C, FE7-10-4C		
<b>accessories for</b>	416548		
	<b>GEV No.</b>	401088	<b>Ref. No.</b> 12020238 12024400 X323008 X323011
	copper wire 2.5mm <sup>2</sup> insulation glass fibre connection cable lug ø4mm L 1400mm		
	<b>GEV No.</b>	521103	<b>Ref. No.</b> —
	nut thread M4 H 3mm WS 7 brass Qty 20 pcs		
	<b>GEV No.</b>	521104	<b>Ref. No.</b> —
	washer ID ø 4.3mm ED ø 8mm thickness 0.5mm brass Qty 20 pcs for thread M4		

<b>accessories for</b>	416548		
	<b>GEV No.</b>	560111	<b>Ref. No.</b> 12009987 Q232020
	plain washer ID ø 4.3mm ED ø 9mm thickness 0.8mm SS Qty 20 pcs DIN 125A for thread M4		
	<b>GEV No.</b>	560131	<b>Ref. No.</b> 12009839 Q162020
	hexagonal nut thread M4 H 3.2mm WS 7 SS DIN/ISO DIN 934 / ISO 4032/8673 Qty 20 pcs		

 			
<b>GEV No.</b>	416604	<b>Ref. No.</b>	X323002 X323010
<b>description</b>	heating element 4000W 230V heating circuits 1 mounting pos. left L 285mm W 85mm H 290mm L1 35mm L2 260mm W1 45mm W2 40mm H1 242mm H2 48mm H3 50mm mounting distance 26mm thread M14x1.25 tube ø 8mm 2 hole fixing cable length 1350mm connection M4 immersion heater connection length 26mm		
<b>accessories for</b>	416604		
	<b>GEV No.</b>	521103	<b>Ref. No.</b> —
	nut thread M4 H 3mm WS 7 brass Qty 20 pcs		
	<b>GEV No.</b>	521104	<b>Ref. No.</b> —
	washer ID ø 4.3mm ED ø 8mm thickness 0.5mm brass Qty 20 pcs for thread M4		
	<b>GEV No.</b>	528401	<b>Ref. No.</b> —
	flat gasket fibre ED ø 22mm ID ø 16mm thickness 2mm Qty 1 pcs		
	<b>GEV No.</b>	560111	<b>Ref. No.</b> 12009987 Q232020
	plain washer ID ø 4.3mm ED ø 9mm thickness 0.8mm SS Qty 20 pcs DIN 125A for thread M4		
	<b>GEV No.</b>	560131	<b>Ref. No.</b> 12009839 Q162020
	hexagonal nut thread M4 H 3.2mm WS 7 SS DIN/ISO DIN 934 / ISO 4032/8673 Qty 20 pcs		



<b>GEV No.</b>	417166	<b>Ref. No.</b>	12024707
<b>description</b>	heating element 4000W 230V heating circuits 1 mounting pos. left L 295mm W 90mm H 290mm L1 35mm L2 260mm W1 45mm W2 45mm H1 35mm H2 207mm H3 48mm mounting distance 36mm thread M14x1.25 tube ø 8.5mm 2 hole fixing connection M4 immersion on heater connection length 38mm windings 6		
<b>accessories for</b>	417166		
	<b>GEV No.</b>	401088	<b>Ref. No.</b> 12020238 12024400 X323008 X323011
	copper wire 2.5mm <sup>2</sup> insulation glass fibre connection cable lug ø4mm L 1400mm		
	<b>GEV No.</b>	521103	<b>Ref. No.</b>
	nut thread M4 H 3mm WS 7 brass Qty 20 pcs		
	<b>GEV No.</b>	521104	<b>Ref. No.</b>
	washer ID ø 4.3mm ED ø 8mm thickness 0.5mm brass Qty 20 pcs for thread M4		
	<b>GEV No.</b>	560111	<b>Ref. No.</b> 12009987 Q232020
	plain washer ID ø 4.3mm ED ø 9mm thickness 0.8mm SS Qty 20 pcs DIN 125A for thread M4		
	<b>GEV No.</b>	560131	<b>Ref. No.</b> 12009839 Q162020
	hexagonal nut thread M4 H 3.2mm WS 7 SS DIN/ISO DIN 934 / ISO 4032/8673 Qty 20 pcs		

group 10



<b>GEV No.</b>	419112	<b>Ref. No.</b>	12004358
<b>description</b>	heating element 6000W 230V heating circuits 3 L 385mm W 200mm H 285mm cable length 1700mm tube ø 8.5mm		
<b>For models:</b>	FE6-05TE, FE6-10TE		

heating elements for griddles



<b>GEV No.</b>	416602	<b>Ref. No.</b>	12024616 R893000
<b>description</b>	heating element 1500W 230V heating circuits 1 L 517mm W 87mm H 71mm tube ø 9mm connection M4 connection length 26mm connection distance 78mm dry heating element		
<b>For models:</b>	FTE7-05, FTE7-05L, FTE7-05R, FTE7-10, FTE7-10L, FTE7-10L+R, FTE7-10R, FTEC7-05L, FTEC7-10L		



<b>GEV No.</b>	416633	<b>Ref. No.</b>	12024626 R573010
<b>description</b>	heating element 2000W 230V heating circuits 1 L 585mm W 100mm H 100mm tube ø 8mm connection M4 connection length 25mm connection distance 92mm dry heating element		
<b>For models:</b>	FTE9-05L, FTE9-05L-AD, FTE9-05PLUS-CL, FTE9-05PLUS-CR, FTE9-05PLUS-L, FTE9-05PLUS-R, FTE9-05R, FTE9-05R-AD, FTE9-10L, FTE9-10L+R, FTE9-10L+R-AD, FTE9-10L-AD, FTE9-10PLUS-CL, FTE9-10PLUS-CLR, FTE9-10PLUS-CR, FTE9-10PLUS-L, FTE9-10PLUS-LR, FTE9-10PLUS-R, FTE9-10R, FTE9-10R-AD, FTEC9-05L, FTEC9-05L-AD, FTEC9-05R, FTEC9-05R-AD, FTEC9-05USMC, FTEC9-10L, FTEC9-10L+R, FTEC9-10L+R-AD, FTEC9-10L-AD, FTEC9-10R, FTEC9-10R-AD, FTEC9-10USMC		

heating elements for refrigeration

heating elements for defrosting



<b>GEV No.</b>	417221	<b>Ref. No.</b>	12034275 12034637 6001508021 6021250019
<b>description</b>	heating element 350W 230V L 360mm W 114mm H 12mm cable length 1000mm tube ø 8.5mm defrosting connection with cable		
<b>For models:</b>	AF-1402-MIX, AF-1403-C, AF-1404-C, AF-1602-MIX, AF-1603-C, AF-1604-C, AF-2104-C, AF-2105-C, AF-2106-C, AF-702-C, AF-802-C, AFN-701, AFN-702, AFN-801, AFN-802, AFP-1402-MIX, AP-701, CAF-1402MIXT, CAF-1602MIX, CAF-802-P, CAFN-701, CAFN-702, CAFN-801, CAFN-802, CAP-701, CMFN-135, CMFN-180, CMPN-117-R, CMPN-150, CMPN-169-R, CMPN-202, CMSN-117-R, CMSN-150, CMSN-169-R, CMSN-200, MCN-102-GN-R, MCN-135-GN, MCN-147-GN-R, MCN-180-GN, MCN-192-GN-R, MCN-225-GN, MCN-237-GN-R, MCN-270-GN, MFN-102-GN-R, MFN-135-GN, MFN-147-GN-R, MFN-180-GN, MFN-192-GN-R, MFN-225-GN, MFN-237-GN-R...(Other models you can see in the webshop)		



<b>GEV No.</b>	417527	<b>Ref. No.</b>	12033938 6021250021
<b>description</b>	heating element 350W 230V L 380mm W 115mm H 12mm cable length 1000mm tube ø 8.5mm defrosting connection with cable		
<b>For models:</b>	CAF-1603-C, CAF-1604-C, CAF-702C, MCN-270-GN, MFN-135, MFN-180, MFN-225-GN, MFN-270-GN, MFP-225-GN, MFP-270-GN, MPN-255, MPN-255-C, MPN-274-R, MSN-150, MSN-200, MSN-250, MSN-300		





<b>GEV No.</b>	417223	<b>Ref. No.</b>	12034050 12037967 6001508024 6021250022
<b>description</b>	heating element 650W 220V L 660mm W 180mm W1 65mm W2 115mm cable length 1000mm tube ø 8.5mm connection with cable		
<b>For models:</b>	AFN-1402, AFN-1403, AFN-1404, AFN-1602, AFN-1603, AFN-1604, CAFN-1402, CAFN-1403, CAFN-1404		



heating elements for tilting bratt pan

			
<b>GEV No.</b>	416607	<b>Ref. No.</b>	12024620 X273000
<b>description</b>	heating element 1500W 230V L 417mm W 95mm H 46mm connection M4 dry heating element heating circuits 1 tube ø 9mm connection distance 77mm		
<b>For models:</b>	FTE6-05L, FTE6-05R, SBE7-10		

			
<b>GEV No.</b>	416615	<b>Ref. No.</b>	12018865 X143000
<b>description</b>	heating element 2000W 230V L 523mm W 95mm H 81mm connection M4 dry heating element heating circuits 1 tube ø 8mm connection length 26mm connection distance 87mm		
<b>For models:</b>	SBE9-10, SBE9-10I, SBE9-10IM		

			
<b>GEV No.</b>	416616	<b>Ref. No.</b>	12024617 X143010
<b>description</b>	heating element 2000W 230V L 525mm W 82mm H 46mm connection M4 dry heating element heating circuits 1 tube ø 8.5mm connection distance 69mm		
<b>For models:</b>	SBE9-10, SBE9-10I, SBE9-10I-AD, SBE9-10I-AD-S, SBE9-10IM, SBE9-10IM-AD, SBE9-10IM-AD-S, SBE9-10IMS, SBE9-10IS, SBE9-10M, SBE9-10MS, SBE9-10PLUS-I, SBE9-10PLUS-IM, SBE9-10PLUS-SI, SBE9-10PLUS-SIM, SBE9-10S, SBE9-10USMC, SBE9-15IM, SBE9-15IM-AD, SBE9-15IM-AD-S, SBE9-15IMS, SBE9-15M, SBE9-15MS, SBE9-15PLUS-IM, SBE9-15PLUS-SIM		

heating elements for pasta cookers

			
<b>GEV No.</b>	418799	<b>Ref. No.</b>	12024715 H063002
<b>description</b>	heating element 4000W 230V heating circuits 3 L 348mm W 65mm H 27mm expansion flange connection male faston 6.3mm tube ø 6.2mm pasta cooker flange 70x18mm		
<b>For models:</b>	CPE7-05, CPE7-05NC, CPE9-05, CPE9-05AD, CPE9-05AD-S, CPE9-05NC, CPE9-05PLUS, CPE9-05PLUS-S, CPE9-05S, CPE9-05SNC, EPC-350		

heating elements for heated trolleys

			
<b>GEV No.</b>	418802	<b>Ref. No.</b>	12034205 6021250024
<b>description</b>	heating element dinner cart 1000W 230V L 385mm W 80mm H 35mm connection M4 thread M12x1.25 tube ø 8mm mounting distance 71mm		

			
<b>GEV No.</b>	418801	<b>Ref. No.</b>	12032595 6021250023
<b>description</b>	heating element dinner cart 1500W 230V L 390mm W 80mm H 35mm connection M5 thread M12x1 tube ø 8.5mm mounting distance 72mm		

dry heating elements for dishwashers

			
<b>GEV No.</b>	420561	<b>Ref. No.</b>	12048965
<b>description</b>	heating element 2800W 230V heating circuits 1 L 325mm W 55mm H 40mm tube ø 6.5mm connection F6.3x0.8 dry heating element dishwasher		
<b>For models:</b>	CO-500, CO-500B, CO-500BDD, CO-500DD, CO-501, CO-501B, CO-501BDD, CO-501DD, CO-501-SOFT, CO-502B, CO-502BDD, CO-502DD, CO-502W, COP-503, COP-503B, COP-503BDD, COP-503DD, COP-503-SOFT, COP-504, COP-504B, COP-504BDD, COP-504DD, COP-504W		

heating cables

connection on both sides

with male fastons

			
<b>GEV No.</b>	418807	<b>Ref. No.</b>	12035911 12036102 6001508011 6021250011
<b>description</b>	heating cable 18W 230V L 4750mm silicone connection male faston 6.3mm		
<b>For models:</b>	AF-1403-C, AF-1404-C, AF-1603-C, AF-1604-C, AF-2104-C, AF-2105-C, AF-2106-C, AF-702-C, AFN-1402, AFN-1403, AFN-1404, AFN-1602, AFN-1603, AFN-1604, AFN-701, AFN-702, AFN-801, AFN-802, AFP-1402-MIX, AFP-702, AP-701, CAF-1403C, CAF-1404C, CAF-1603-C, CAF-1604-C, CAF-2104P, CAF-2105P, CAF-2106P, CAF-702C, CAF-802-P, CMPN-117-R, CMPN-150, CMPN-169-R, CMPN-202, CMPN-222-R, CMPN-255, MCN-102-GN-R, MCN-135-GN, MCN-147-GN-R, MCN-180-GN, MCN-192-GN-R, MCN-225-GN, MCN-237-GN-R, MCN-270-GN, MFN-102-GN-R, MFN-135, MFN-135-GN, MFN-147-GN-R, MFN-180, MFN-180-GN...(Other models you can see in the webshop)		

			
<b>GEV No.</b>	418808	<b>Ref. No.</b>	12033714 12036313 6001508005 6021250005
<b>description</b>	heating cable 20W 220V L 3450mm L1 (unheated) 2150mm L2 (heated) 1300mm silicone connection male faston 6.3mm		
<b>For models:</b>	ADAFN-1602, ADAFN-801, ADMCN-135, ADMCN-180, ADMCN-225, ADMFN-135, ADMFN-180, ADMFN-225, AEP-1602, AEP-802, AF-1402-MIX, AF-1403-C, AF-1404-C, AF-1602-MIX, AF-1603-C, AF-1603-P, AF-1604-C, AF-1604-P, AF-2104-C, AF-2105-C, AF-2106-C, AF-702-P, AF-802-C, AFN-1402, AFN-1403, AFN-1404, AFN-1602, AFN-1603, AFN-1604, AFN-701, AFN-702, AFN-801, AFN-802, AFP-1402-MIX, AFP-1602, AFP-1603, AFP-1604, AFP-701, AFP-702, AFP-702-C, AFP-702-P, ANF-1602AD, ANF-1603AD, ANF-1604AD, ANF-801AD, ANF-802AD, AP-701, CAF-1402MIX, CAF-1602MIX, CAFN-1402...(Other models you can see in the webshop)		



<b>GEV No.</b>	418806	<b>Ref. No.</b>	12031355 12035540 6001508007 6021250007
<b>description</b>	heating cable 26W 230V L 6400mm silicone connection male faston 6.3mm		
<b>For models:</b>	AEP-1402, AEP-1403, AEP-1404, AEP-1602, AEP-1603, AEP-1604, AF-1402-MIX, AF-1403-C, AF-1404-C, AF-1602-MIX, AF-1603-C, AF-1604-C, AFN-1402, AFN-1403, AFN-1404, AFN-1602, AFN-1603, AFN-1604, AFN-701, AFP-1402, AFP-1402-MIX, AFP-1403, AFP-1403-C, AFP-1403-FORZ, AFP-1403-P, AFP-1404, AFP-1404-C, AFP-1404-FORZ, AFP-1404-P, AFP-1602, AFP-1602-2, AFP-1603, AFP-1604, CAF-1403C, CAF-1404C, CAF-1603-C, CAF-1604-C, CAFN-1402, CAFN-1403, CAFN-1404, CAFN-1602, CAFN-1603, CAFN-1604		

<b>GEV No.</b>	418803	<b>Ref. No.</b>	12035174 12035494 6001508015 6021250015
<b>description</b>	heating cable 60W 230V 50Hz L 7400mm silicone defrosting connection male faston 6.3mm		
<b>For models:</b>	AFP-2103, AFP-2104, AFP-2104-C, AFP-2104-P, AFP-2105, AFP-2105-C, AFP-2105-P, AFP-2106, AFP-2106-C, AFP-2106-P		

<b>GEV No.</b>	418804	<b>Ref. No.</b>	12032620 12036191 6001508010 6021250010
<b>description</b>	heating cable 31W 230V L 3200mm L1 (unheated) 2000mm L2 (heated) 1200mm silicone connection male faston 6.3mm mounting pos. vertical		
<b>For models:</b>	AEP-1402, AEP-1403, AEP-1404, AEP-1602, AEP-1603, AEP-1604, AF-1402-MIX, AF-1403-C, AF-1404-C, AF-1602-MIX, AF-1603-C, AF-1604-C, AFN-1402, AFN-1403, AFN-1404, AFN-1602, AFN-1603, AFN-1604, AFN-701, AFP-1402, AFP-1402-MIX, AFP-1403, AFP-1403-C, AFP-1403-P, AFP-1404, AFP-1404-C, AFP-1404-P, AFP-1602, AFP-1602-2, AFP-1603, AFP-1604, AFP-2103, AFP-2104, AFP-2104-C, AFP-2104-P, AFP-2105, AFP-2105-C, AFP-2105-P, AFP-2106, AFP-2106-C, AFP-2106-P, ATM-101, CAF-1403C, CAF-1404C, CAF-1603-C, CAF-1604-C, CAFN-1402, CAFN-1403, CAFN-1404, CAFN-1602...(Other models you can see in the webshop)		

<b>heating plates</b>			
<b>GEV No.</b>	420522	<b>Ref. No.</b>	12024702 J303001000
<b>description</b>	hot plate 1600W 230V L 360mm W 110mm		
<b>For models:</b>	BME6-05, CMF6-05, FTE6-05L, FTE6-05R, FTE6-10L, FTE6-10L+R, FTE6-10R, FTE6-05L, FTE6-10L, FTE6-10L+R		

<b>GEV No.</b>	418809	<b>Ref. No.</b>	12034144 12034613 6001508006 6021250006
<b>description</b>	heating cable 41W 220V L 6250mm L1 (unheated) 3550mm L2 (heated) 2700mm silicone connection male faston 6.3mm		
<b>For models:</b>	AEP-1602, AEP-1603, AEP-1604, AEP-801, AEP-802, AF-1602-MIX, AF-1603-C, AF-1603-P, AF-1604-C, AF-1604-P, AF-802-C, AF-802-P, AFN-1402, AFN-1403, AFN-1404, AFN-1602, AFN-1603, AFN-1604, AFN-701, AFN-801, AFN-802, AFP-1402, AFP-1403, AFP-1403-C, AFP-1403-FORZ, AFP-1403-P, AFP-1404, AFP-1404-C, AFP-1404-FORZ, AFP-1404-P, AFP-1602, AFP-1602-2, AFP-1603, AFP-1603-2, AFP-1604, AFP-801, AFP-802, AFP-802-2, AP-701, APP-701, VM-100-I, VM-100-M, VM-135-I, VM-135-M		

<b>coil heating elements</b>			
<b>GEV No.</b>	418969	<b>Ref. No.</b>	12024856 Z276391
<b>description</b>	heating element 1500W 230V L 455mm W 50mm H 25mm tube ø 8mm thread M12x1.25 connection M4 heating circuits 1		
<b>For models:</b>	ECO-160, ECO-160D, ECO-160I, ECO-200, ECO-200D, ECO-200H, ECO-200HD, ECO-200HI, ECO-200I, ECO-2700D, ECO-2700I, ECO-280D, ECO-280I, ECO-370D, ECO-370I, ECO-4000D, ECO-4000I, ECO-460D, ECO-460I, ECO-550D, ECO-550I, ECO-6000D, ECO-6000I, FI-160, FI-160AR, FI-160D, FI-160I, FI-200, FI-200AR, FI-200D, FI-200H, FI-200HD, FI-200HI, FI-200I, FI-200W, FI-200WL, FI-200WR, FI-2700D, FI-2700I, FI-280D, FI-280I, FI-370D, FI-370I, FI-4000D, FI-4000I, FI-460D, FI-460I, FI-550D, FI-550I, FI-6000D...(Other models you can see in the webshop)		

<b>GEV No.</b>	418805	<b>Ref. No.</b>	12032324 12036014 6001508009 6021250009
<b>description</b>	heating cable 43W 230V L 5000mm silicone connection male faston 6.3mm		
<b>For models:</b>	ADAEP-801, ADAFN-1602, ADAFN-801, ADAFP-801, AEP-701, AEP-702, AEP-801, AEP-802, AF-1402-MIX, AF-1403-C, AF-1404-C, AF-1602-MIX, AF-702-C, AF-702-P, AF-802-C, AFN-1402, AFN-701, AFN-702, AFN-801, AFN-802, AFP-1402-FORZ, AFP-1402-MIX, AFP-1403-FORZ, AFP-2103, AFP-2104, AFP-2104-C, AFP-2104-P, AFP-2105, AFP-2105-C, AFP-2105-P, AFP-2106, AFP-2106-C, AFP-2106-P, AFP-701, AFP-702, AFP-702-C, AFP-702-FORZ, AFP-702-P, AFP-801, AFP-802, AFP-802-2, ANF-1602AD, ANF-1603AD, ANF-1604AD, ANF-801AD, ANF-802AD, CAF-1402MIXT, CAF-1602MIX, CAF-702C, CAF-802-P...(Other models you can see in the webshop)		





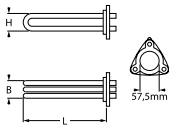

immersion heating elements

3 hole flange ø57.5mm

<b>GEV No.</b>	415021	<b>Ref. No.</b>	12024713 Z313601
<b>description</b>	heating element 6000W 230V mounting ø 57.5mm heating circuits 3 L 343mm W 37mm H 50mm number of thermostat sleeves 1 thermostat sleeves ø 7mm length thermostat sleeves 294mm thermostat sleeve not clinging tube ø 8.5mm hole distance 72mm hole ø 8mm connection M5 3 hole flange		
<b>For models:</b>	ECO-2700D, ECO-2700I, ECO-280D, ECO-280I, ECO-370D, ECO-370I, ECO-4000D, ECO-4000I, ECO-460D, ECO-460I, ECO-550D, ECO-550I, ECO-6000D, ECO-6000I, FI-2700D, FI-2700I, FI-280D, FI-280I, FI-370D, FI-370I, FI-4000D, FI-4000I, FI-460D, FI-460I, FI-550D, FI-550I, FI-6000D, FI-6000I		
<b>spare parts for</b>	415021		
	<b>GEV No.</b>	510409	<b>Ref. No.</b> 12010040 Q307044
	O-ring EPDM thickness 5.34mm ID ø 56.52mm Qty 1 pcs		
<b>accessories for</b>	415021		
	<b>GEV No.</b>	550002	<b>Ref. No.</b> —
	tension strap H 10mm L 21mm W 10mm hole ø 6.5mm for heating element		



<b>GEV No.</b>	418798	<b>Ref. No.</b>	12024214 12040415 Z121740 Z121741
<b>description</b>	heating element 9600W 230V mounting ø 57.5mm heating circuits 3 L 545mm W 36mm H 53mm number of thermostat sleeves 1 thermostat sleeves ø 7mm length thermostat sleeves 190mm tube ø 8mm hole distance 73mm hole ø 8mm connection M4		
<b>For models:</b>	ECO-160, ECO-1600, ECO-160D, ECO-160I, ECO-200, ECO-200D, ECO-200H, ECO-200HD, ECO-200HI, ECO-200I, ECO-2300, ECO-2700D, ECO-2700I, ECO-3000, ECO-4000D, ECO-4000I, ECO-6000D, ECO-6000I, FI-160, FI-1600, FI-160AR, FI-160D, FI-160I, FI-200, FI-200AR, FI-200D, FI-200H, FI-200HD, FI-200HI, FI-200I, FI-200WL, FI-200WR, FI-2300, FI-2700D, FI-2700I, FI-280D, FI-280I, FI-3000, FI-370D, FI-370I, FI-4000D, FI-4000I, FI-460D, FI-460I, FI-550D, FI-550I, FI-6000D, FI-6000I		
<b>accessories for</b>	418798		
	<b>GEV No.</b>	510409	<b>Ref. No.</b> 12010040 Q307044
	O-ring EPDM thickness 5.34mm ID ø 56.52mm Qty 1 pcs		

3 hole flange ø60.0mm

connection straight

group 1





<b>GEV No.</b>	420325	<b>Ref. No.</b>	12024721 Z129502
<b>description</b>	heating element 12000W 230V mounting ø 60mm heating circuits 3 L 545mm W 36mm H 41mm number of thermostat sleeves 1 thermostat sleeves ø 7mm length thermostat sleeves 175mm thermostat sleeve eccentric, non clinging tube ø 8.5mm hole distance 73mm hole ø 10mm connection M4 3 hole flange immersion heater		
<b>For models:</b>	ECO-6000D, ECO-6000I, FI-160D, FI-160I, FI-200AR, FI-200D, FI-200HD, FI-200HI, FI-200I, FI-200W, FI-2700D, FI-2700I, FI-4000D, FI-4000I, FI-460D, FI-460I, FI-550D, FI-550I, FI-6000D, FI-6000I		





<b>GEV No.</b>	420324	<b>Ref. No.</b>	12024740 Z101720 Z101740
<b>description</b>	heating element 6000W 230V mounting ø 60mm heating circuits 3 L 545mm W 36mm H 41mm number of thermostat sleeves 1 thermostat sleeves ø 7mm length thermostat sleeves 175mm thermostat sleeve eccentric, non clinging tube ø 8.5mm hole distance 73mm hole ø 10mm connection M4 3 hole flange immersion heater		
<b>For models:</b>	ECO-1600, ECO-2300, ECO-280D, ECO-280I, ECO-3000, ECO-370D, ECO-370I, ECO-460D, ECO-460I, ECO-550D, ECO-550I, FI-1600, FI-2300, FI-280D, FI-280I, FI-3000, FI-370D, FI-370I, FI-460D, FI-460I, FI-550D, FI-550I		

with expansion flange 70 x 18mm



<b>GEV No.</b>	416380	<b>Ref. No.</b>	12024986 Z733601
<b>description</b>	heating element 1000W 230V heating circuits 1 flange 70x18mm L 273mm W 63mm H 27mm connection M4 immersion heater expansion flange tube ø 6.5mm		
<b>For models:</b>	ECO-120, LVC-12, LVC-15, LVC-21, LVR-10		
<b>accessories for</b>	416380		
	<b>GEV No.</b>	510429	<b>Ref. No.</b> —
	gasket L 76mm W 23mm hole distance 25mm 3 holes for heating element type DB 70 without thermostat sensor hole		



<b>GEV No.</b>	416381	<b>Ref. No.</b>	12024951 R223005
<b>description</b>	heating element 2000W 230V heating circuits 1 flange 70x18mm L 280mm W 78mm H 22mm connection M4 immersion heater expansion flange tube ø 8.5mm		
<b>For models:</b>	AD-15, AD-15D, AD-20C-UK, AD-21, AD-21B, AD-21BDD, AD-21C, AD-21D, AD-21DD, AD-21W, AD-45BBT, BME7-05, BME7-10, BME9-10, BME9-10AD, BME9-10PLUS, BME9-10V-T, FI-30, FI-30AR, FI-30AR+DD, FI-30B-BT-UK, FI-30-UK, LVC-12, LVC-15, LVC-15D, LVC-21, LVC-21B, LVC-21C, LVC-21D, LVC-21W, LVR-14, LVR-14D, LVR-20, LVR-20B, LVR-20D, MF-21		
<b>accessories for</b>	416381		
	<b>GEV No.</b>	510429	<b>Ref. No.</b> —
	gasket L 76mm W 23mm hole distance 25mm 3 holes for heating element type DB 70 without thermostat sensor hole		



<b>GEV No.</b>	416382	<b>Ref. No.</b>	12024645 Z203601
<b>description</b>	heating element 2800W 230V heating circuits 1 flange 70x18mm L 370mm W 102mm H 27mm immersion heater tube ø 8.5mm		
<b>For models:</b>	AD-48, AD-48B, AD-48BDD, AD-48C, AD-48D, AD-48DD, AD-48HY, AD-48W, AD-64, AD-64B, AD-64BBT, AD-64BDD, AD-64BTDD, AD-64C, AD-64CW, AD-64D, AD-64DD, AD-64HY, AD-72, AD-72W, BME9-05, BME9-05AD, BME9-05PLUS, BME9-05V-T, EASY-500, EASY-500B, EASY-500DD, EASY-500HP, EASY-500HPWBDD, ECO-120, ECO-120B, FI-100, FI-120, FI-120W, FI-30, FI-30AR, FI-30AR+DD, FI-30B, FI-30-UK, FI-48, FI-48AR, FI-48B, FI-48B-BT-UK, FI-48C, FI-48D, FI-48HY-CLINIC, FI-48W, FI-50, FI-60DD, FI-64...(Other models you can see in the webshop)		



<b>GEV No.</b>	418800	<b>Ref. No.</b>	12024577 12041359 P533001
<b>description</b>	heating element 2x3000W 230V heating circuits 2 flange 70x18mm L 510mm W 60mm connection M4 tube ø 8mm expansion flange		
<b>For models:</b>	LA-25M, LA-AC-25M, LA-AC-25MA, LA-AC-25MP, LAC-25, LAC-25MP, LAC-25MPP, LAC-55, LAC-55MP, LAC-55MPP, LA-E-25M, LA-E-25MA, LA-E-25MP, LC-25, LC-E-25, LF-25MPP, LF-E-25, LF-E-25MP, LF-E-25MPP, LF-E-55, LF-E-55MP, LF-E-55MPP, LR-AC-25M, LR-AC-25MA, LR-AC-25MP, LR-E-25M, LR-E-25MA, LR-E-25MP		



<b>GEV No.</b>	418832	<b>Ref. No.</b>	12018752 P143002
<b>description</b>	heating element 3000W 230V heating circuits 1 flange 70x18mm L 350mm W 63mm connection M4 tube ø 8mm immersion heater		
<b>For models:</b>	LAC-10, LAC-10MP, LAC-10MPP, LC-10, LC-E-10, LC-E-10A, LF-E-10, LF-E-10A, LF-E-10MP, LF-E-10MPP		



<b>GEV No.</b>	418885	<b>Ref. No.</b>	12023242 P633002
<b>description</b>	heating element 4000W 230V heating circuits 1 flange 70x18mm L 350mm W 63mm H 18mm L1 23mm L2 19mm L3 308mm tube ø 8mm connection M4 immersion heater connection length 37mm expansion flange EPDM		
<b>For models:</b>	LA-18MP, LA-AC-18M, LA-AC-18MA, LA-AC-18MP, LA-E-18M, LA-E-18MA, LA-E-18MP, LF-18MPP, LR-AC-18M, LR-AC-18MA, LR-E-18M, LR-E-18MA, LR-E-18MP		



<b>GEV No.</b>	417236	<b>Ref. No.</b>	12017885 R673003
<b>description</b>	heating element 4200W 230V heating circuits 2 flange 70x18mm L 395mm W 70mm connection male faston 6.3mm tube ø 8mm expansion flange		
<b>For models:</b>	HME-10-11, HME-10-21, HME-2-10-11, HME-6-11, HMM-10-11, HMM-10-21, HMM-2-10-11, HMM-6-11, HMP-10-11, HMP-10-21, HMP-2-10-11, HMP-6-11		





<b>GEV No.</b>	418529	<b>Ref. No.</b>	12023778 Z743601
<b>description</b>	heating element 4500W 230V heating circuits 3 flange 70x18mm L 365mm W 65mm H 27mm connection male faston 6.3mm immersion heater expansion flange tube ø 6.7mm		
<b>For models:</b>	AD-120, AD-120B, AD-120BBTDD-UK, AD-120C, AD-120CW, AD-120HY, AD-90, AD-90BA, AD-90BBT, AD-90BDD, AD-90DD, ADE-120, ADE-120B, ECO-120, ECO-120B, FI-100, FI-100AR, FI-100B, FI-100BBT-UK, FI-120, FI-120AR+DD, FI-120B, FI-120C, FI-120HY-CLINIC, FI-120W, FI-80, FI-80AR, FI-80BBT-UK, FI-80W, FI-E-100, MF-120		



with round flange (miscellaneous)







<b>GEV No.</b>	419284	<b>Ref. No.</b>	12024718 Z201708000
<b>description</b>	heating element 2200W 230V mounting ø 62mm L 422mm W 39mm H 39mm heating circuits 1 flange ø 98mm mounting thread M4 flange tube ø 8.5mm thermostat sleeves ø 7.5mm number of thermostat sleeves 1 length thermostat sleeves 193mm thermostat sleeve centre not clinging		



miscellaneous			
			
1			
<b>GEV No.</b>	416386	<b>Ref. No.</b>	12024146 Z728306
<b>description</b>	heating element 12000W 230V mounting ø 60mm heating circuits 3 L 428mm W 45mm H 44mm thermostat sleeves ø 6.7mm length thermostat sleeves 250mm number of thermostat sleeves 1 thermostat sleeve not clinging tube ø 6.3mm hole distance 82mm hole ø 7mm connection M4 immersion heater 6 hole flange		
<b>For models:</b>	AD-120, AD-120B, AD-120C, AD-120HY, CO-110, CO-110B, CO-110BDD, CO-110DD, CO-170, CO-170B, CO-170BDD, CO-170DD, CO-170HRS, CO-170HRSDD, CO-170HRS-SOFT, CO-170-SOFT, CO-172, CO-172B, CO-172BDD, CO-172DD, ECO-120, ECO-120B, FI-120, FI-120AR+DD, FI-120B, FI-120C, FI-120HY-CLINIC, FI-120W, LABP-1200, MF-120		



			
1			
<b>GEV No.</b>	417678	<b>Ref. No.</b>	12026917 RT4400195
<b>description</b>	heating element 18000W 230V heating circuits 6 L 194mm W 87mm H 68mm hole distance 50mm hole ø 8mm number of thermostat sleeves 2 thermostat sleeves ø 6/2mm length thermostat sleeves 142/105mm thermostat sleeve clinging cable length 730mm immersion heater 10 hole flange		

			
1			
<b>GEV No.</b>	416383	<b>Ref. No.</b>	12017951 12024559 Z401711 Z401738
<b>description</b>	heating element 2400W 230V heating circuits 1 mounting ø 42mm L 278mm W 39mm H 39mm hole distance 64mm hole ø 7mm connection M4 immersion heater 5 hole flange		
<b>For models:</b>	AD-15, AD-15D, LVC-12, LVC-15, LVC-15D, LVC-21D, LVR-10, LVR-14, LVR-14D		
<b>accessories for</b>	416383		
	<b>GEV No.</b>	505092	<b>Ref. No.</b>
			12010062 12016701 Q307053 S312113
O-ring EPDM thickness 5.34mm ID ø 43.82mm Qty 1 pcs			

			
1			
<b>GEV No.</b>	416387	<b>Ref. No.</b>	12017952 Z421711
<b>description</b>	heating element 2800W 230V heating circuits 1 mounting ø 42mm L 275mm W 38mm H 38mm tube ø 8mm hole distance 74mm hole ø 7mm connection M4 immersion heater 5 hole flange		
<b>For models:</b>	LVC-21, LVC-21B, LVC-21D, LVC-21W, LVR-20, LVR-20B, LVR-20D, MF-21		
<b>accessories for</b>	416387		
	<b>GEV No.</b>	505092	<b>Ref. No.</b>
			12010062 12016701 Q307053 S312113
O-ring EPDM thickness 5.34mm ID ø 43.82mm Qty 1 pcs			

			
1			
<b>GEV No.</b>	416375	<b>Ref. No.</b>	12024907 Z421712
<b>description</b>	heating element 2800W 230V heating circuits 1 mounting ø 42mm L 290mm W 37mm H 32mm tube ø 8mm hole distance 42mm hole ø 7mm connection M4 5 hole flange		
<b>For models:</b>	AD-21, AD-21B, AD-21BDD, AD-21C, AD-21D, AD-21DD, AD-21W, LVC-15D, LVC-21, LVC-21B, LVC-21C, LVC-21D, LVC-21W		
<b>accessories for</b>	416375		
	<b>GEV No.</b>	505092	<b>Ref. No.</b>
			12010062 12016701 Q307053 S312113
O-ring EPDM thickness 5.34mm ID ø 43.82mm Qty 1 pcs			
	<b>GEV No.</b>	524478	<b>Ref. No.</b>
			—
O-ring Viton thickness 5.7mm ID ø 44.2mm Qty 1 pcs			

			
1			
<b>GEV No.</b>	416384	<b>Ref. No.</b>	12024683 Z201706
<b>description</b>	heating element 2800W 230V mounting ø 63mm heating circuits 1 L 427mm W 44mm H 43mm thermostat sleeves ø 6.5mm length thermostat sleeves 190mm number of thermostat sleeves 1 thermostat sleeve not clinging hole distance 41mm hole ø 7.5mm connection M4 3 hole flange round flange		
<b>For models:</b>	AD-48, AD-48B, AD-48BDD, AD-48C, AD-48D, AD-48DD, AD-48HY, EASY-500, EASY-500B, EASY-500DD, FI-30, FI-30AR, FI-30AR+DD, FI-30B, FI-48, FI-48AR, FI-48B, FI-48B-BT-UK, FI-48C, FI-48D, FI-48HY-CLINIC, FI-48W, FI-50, FI-64W		
<b>accessories for</b>	416384		
	<b>GEV No.</b>	691033	<b>Ref. No.</b>
			12010051 Q307035
O-ring EPDM thickness 5.34mm ID ø 62.87mm Qty 1 pcs			

			
1			
<b>GEV No.</b>	416385	<b>Ref. No.</b>	12024732 Z241701
<b>description</b>	heating element 6000W 230V mounting ø 63mm heating circuits 3 L 420mm W 39mm H 49mm thermostat sleeves ø 6.3mm length thermostat sleeves 190mm number of thermostat sleeves 1 thermostat sleeve not clinging tube ø 8mm hole distance 41mm hole ø 7mm connection M4 immersion heater 6 hole flange		
<b>For models:</b>	AD-120BTD-UK, AD-45BBD, AD-64, AD-64B, AD-64BBD, AD-64BDD, AD-64BTDD, AD-64C, AD-64D, AD-64DD, AD-64HY, AD-72, AD-90, AD-90BA, AD-90BBD, AD-90BDD, AD-90DD, CO-110, CO-110B, CO-110BDD, CO-110DD, CO-112, CO-112B, CO-112BDD, CO-112DD, EASY-500HP, EASY-500HPWBDD, FI-100, FI-48D, FI-60DD, FI-64, FI-64AR, FI-64B, FI-64B-BT-UK, FI-64C, FI-64D, FI-64HY-CLINIC, FI-64W, FI-72, FI-72AR, FI-80, FI-80AR, FI-80BBD-UK, FI-80W, FI-900, LABP-800, MF-48, MF-64		
<b>accessories for</b>	416385		
	<b>GEV No.</b>	691033	<b>Ref. No.</b>
			12010051 Q307035
O-ring EPDM thickness 5.34mm ID ø 62.87mm Qty 1 pcs			





<b>GEV No.</b>	420326	<b>Ref. No.</b>	12017495 Z691751
<b>description</b>	heating element 9000W 220V mounting ø 63mm heating circuits 3 L 454mm W 48mm H 38mm thermostat sleeves ø 7mm length thermostat sleeves 180mm number of thermostat sleeves 1 thermostat sleeve centre not clinging tube ø 8mm hole distance 41mm hole ø 7mm connection M4 immersion heater 6 hole flange		
<b>For models:</b>	FI-1200, ME9-10BM, ME9-15BM		





<b>GEV No.</b>	417694	<b>Ref. No.</b>	12029395 RT4400194
<b>description</b>	heating element 9000W 230V heating circuits 3 L 192mm W 39mm H 68mm hole distance 90mm hole ø 8mm thermostat sleeves ø 2.5/6.5mm length thermostat sleeves 155mm number of thermostat sleeves 2 thermostat sleeve eccentric, clinging flange length 82mm flange width 82mm tube ø 6.5mm cable length 200mm immersion heater 5 hole flange		





<b>GEV No.</b>	417695	<b>Ref. No.</b>	12027948 12029916 RT32011004 RT32011009
<b>description</b>	heating element 9000W 230V heating circuits 3 L 205mm W 38mm H 70mm number of thermostat sleeves 1 thermostat sleeves ø 2.5mm length thermostat sleeves 120mm thermostat sleeve eccentric, clinging tube ø 6.3mm hole distance 64mm hole ø 8mm connection male faston 6.3mm 4 hole flange immersion heater flange width 82mm flange length 82mm		
<b>accessories for</b>	417695		
	<b>GEV No.</b>	<b>Ref. No.</b>	12036210 RT51101003
	gasket rubber L 82mm W 82mm thickness 4mm hole ø 9mm hole distance 64mm for heating element suitable for RATIONAL 4 holes		





<b>GEV No.</b>	420362	<b>Ref. No.</b>	12024747
<b>description</b>	heating element 9000W 230V heating circuits 3 L 280mm W 77mm H 29mm flange hole distance 47.5mm hole ø 6mm connection male faston 6.3mm tube ø 8.5mm flange length 105mm flange width 60mm immersion heater		
<b>For models:</b>	ACE-102, AE-101, AE-101W, AE-102, AE-102W, AE-201, AE-202, APE-101, APE-101W, APE-102, APE-102W, APE-201, APE-202, HEP-10-21, HEP-20-21, ME9-10BM, ME9-10BMS, ME9-15BM, ME9-15BM316, ME9-15BMS, MPE9-10BM, MPE9-10BMS, MPE9-15BM, MPE9-15BMS, VE-102, VE-201, VE-202, VPE-102, VPE-201, VPE-202		
<b>accessories for</b>	420362		
	<b>GEV No.</b>	<b>Ref. No.</b>	12023680 T323007
	gasket L 105mm W 60mm thickness 3mm for heating element		



<b>GEV No.</b>	417197	<b>Ref. No.</b>	12024752 T323006
<b>description</b>	heating element 9000W 230V heating circuits 3 L 280mm W 78mm H 35mm hole distance 48mm hole ø 6mm tube ø 8.5mm flange length 105mm flange width 60mm immersion heater thermostat sleeves ø 3mm number of thermostat sleeves 1 length thermostat sleeves 115mm		
<b>For models:</b>	ACE-061, ACE-102, AE-061, AE-061W, AE-101, AE-101W, AE-102, AE-102W, AE-201, AE-202, APE-061, APE-061W, APE-101, APE-101W, APE-102, APE-102W, APE-201, APE-202, HEM-10-21, HEM-20-21, HEP-10-21, HEP-20-21, VE-102, VE-201, VE-202, VPE-102, VPE-201, VPE-202		
<b>accessories for</b>	417197		
	<b>GEV No.</b>	<b>Ref. No.</b>	12023680 T323007
	gasket L 105mm W 60mm thickness 3mm for heating element		







<b>GEV No.</b>	416606	<b>Ref. No.</b>	12023494 R143000
<b>description</b>	heating element 9000W 230V heating circuits 3 L 380mm W 75mm H 28mm rectangular flange hole distance 100mm hole ø 5mm connection male faston 6.3mm tube ø 8.1mm flange length 105mm flange width 60mm immersion heater since year of construction 2011		
<b>For models:</b>	HEM-10-11, HEM-20-11, HEM-6-11, HEP-10-11, HEP-20-11, HEP-6-11, HME-10-11, HME-10-21, HME-20-11, HME-20-21, HME-2-10-11, HME-2-20-11, HME-6-11, HMM-10-11, HMM-10-11UL, HMM-10-21, HMM-10-21UL, HMM-20-11, HMM-20-11UL, HMM-20-21, HMM-20-21UL, HMM-2-10-11, HMM-2-20-11, HMM-40-11-USMC, HMM-6-11, HMM-6-11UL, HMP-10-11, HMP-10-21, HMP-20-11, HMP-20-21, HMP-2-10-11, HMP-2-20-11, HMP-6-11, ME7-10BM, ME9-10BM, ME9-10BMS, ME9-15BM, ME9-15BM316, ME9-15BMS, MPE9-10BM, MPE9-10BMS, MPE9-15BM, MPE9-15BMS, VE-101, VE-201, VPE-101, VPE-201		
<b>accessories for</b>	416606		
	<b>GEV No.</b>	<b>Ref. No.</b>	12007832 R145012
	gasket L 105mm W 55mm thickness 5mm for heating element suitable for FAGOR equiv. no. R145012		









<b>GEV No.</b>	417711	<b>Ref. No.</b>	12029915 RT32011006
<b>description</b>	heating element 9000W 255V heating circuits 3 L 204mm W 38mm H 75mm number of thermostat sleeves 1 thermostat sleeves ø 3mm length thermostat sleeves 102mm thermostat sleeve eccentric, clinging tube ø 6.5mm hole distance 65mm hole ø 8mm connection length 38mm connection male faston 6.3mm rectangular flange immersion heater flange width 82mm flange length 82mm		
<b>spare parts for</b>	417711		
	<b>GEV No.</b>	<b>Ref. No.</b>	12036965 RT4400280
	gasket L 81mm W 81mm hole distance 65mm thickness 4mm for heating element suitable for RATIONAL equiv. no. 4400280		





			
1			
<b>GEV No.</b>	416614	<b>Ref. No.</b>	12023926 Z721701
<b>description</b>	heating element 9600W 230V mounting $\phi$ 63mm heating circuits 3 L 425mm W 50mm H 45mm thermostat sleeves $\phi$ 6.5mm length thermostat sleeves 200mm number of thermostat sleeves 1 thermostat sleeve eccentric, non clinging tube $\phi$ 6.5mm hole distance 82mm hole $\phi$ 7mm connection M4 immersion heater 6 hole flange		
<b>For models:</b>	CO-142W, CO-142WDD, FI-100, FI-100AR, FI-100B, FI-100BBT-UK, FI-120, FI-80, FI-80W, FI-E-100, LABP-1000, ME9-10BM, ME9-10BMS, ME9-15BM, ME9-15BM316, ME9-15BMS, MPE9-10BM, MPE9-10BMS, MPE9-15BM, MPE9-15BMS		
<b>spare parts for</b>	416614		
	<b>GEV No.</b>	532163	<b>Ref. No.</b> —
	O-ring EPDM thickness 5.34mm ID $\phi$ 62.87mm Qty 10 pcs		
	<b>GEV No.</b>	691033	<b>Ref. No.</b> 12010051 Q307035
	O-ring EPDM thickness 5.34mm ID $\phi$ 62.87mm Qty 1 pcs		

			
1			
<b>GEV No.</b>	417222	<b>Ref. No.</b>	12017628 Z603601
<b>description</b>	heating element 2000W 230V heating circuits 1 L 280mm W 140mm H 23mm thread 1/4" mounting distance 132mm tube $\phi$ 8mm connection male faston 6.3mm immersion heater 2 hole fixing stainless steel		

			
1			
<b>GEV No.</b>	416235	<b>Ref. No.</b>	12030300 EU80677
<b>description</b>	heating element 3000W 230V heating circuits 1 L 320mm W 50mm H 40mm thread M10x1 mounting distance 44mm tube $\phi$ 6.3mm connection male faston 6.3mm 2 hole fixing L1 32mm L2 288mm		
<b>spare parts for</b>	416235		
	<b>GEV No.</b>	510893	<b>Ref. No.</b> —
	O-ring EPDM thickness 2.62mm ID $\phi$ 9.92mm Qty 1 pcs		
<b>accessories for</b>	416235		
	<b>GEV No.</b>	510416	<b>Ref. No.</b> —
	flat gasket fibre ED $\phi$ 19mm ID $\phi$ 10.5mm thickness 1.5mm for thread M10 Qty 1 pcs		
	<b>GEV No.</b>	510893	<b>Ref. No.</b> —
	O-ring EPDM thickness 2.62mm ID $\phi$ 9.92mm Qty 1 pcs		
	<b>GEV No.</b>	521129	<b>Ref. No.</b> —
	nut thread M10 H 6mm SS WS 17 Qty 1 pcs DIN/ISO DIN 439		
	<b>GEV No.</b>	560192	<b>Ref. No.</b> —
	tooth lock washer ID $\phi$ 10.4mm ED $\phi$ 18mm SS DIN/ISO DIN 6798A Qty 1 pcs for thread M10		

heating elements for convection

			
1			
<b>GEV No.</b>	419270	<b>Ref. No.</b>	12024349 T323034 T323034000
<b>description</b>	heating element 15000W 230V heating circuits 3 ID $\phi$ 540mm ED $\phi$ 560mm L 580mm H 148mm W1 160mm H1 16mm H2 132mm flange length 210mm flange width 30mm hole distance 180mm connection M4 tube $\phi$ 10mm mounting thread M6		
<b>For models:</b>	ACE-102, ACE-202, AE-102, AE-102W, AE-202, APE-102, APE-102W, APE-202		

			
1			
<b>GEV No.</b>	419271	<b>Ref. No.</b>	12024359 T323035 T323035000
<b>description</b>	heating element 15000W 230V heating circuits 3 ID $\phi$ 620mm ED $\phi$ 640mm L 660mm H 152mm W1 160mm H1 20mm H2 132mm flange length 210mm flange width 30mm hole distance 180mm connection M4 tube $\phi$ 10mm mounting thread M6		
<b>For models:</b>	ACE-102, ACE-202, AE-102, AE-102W, AE-202, APE-102, APE-102W, APE-202		

			
1			
<b>GEV No.</b>	417670	<b>Ref. No.</b>	12026971 RT32001002
<b>description</b>	heating element 15000W 230V heating circuits 6 ID $\phi$ 505mm ED $\phi$ 517mm L 620mm H 195mm W1 155mm H1 27mm H2 168mm flange length 210mm flange width 25mm		



1

<b>GEV No.</b>	417198	<b>Ref. No.</b>	12018441 T323002
<b>description</b>	heating element 15000W 230V heating circuits 6 ID ø 508mm ED ø 515mm L 605mm H 205mm L1 30mm H1 35mm H2 170mm flange length 210mm flange width 30mm tube ø 8.5mm mounting pos. inner		
<b>For models:</b>	HEI-10-21, HEM-10-21		





1

<b>GEV No.</b>	417676	<b>Ref. No.</b>	12038126 RT4000265
<b>description</b>	heating element 18000W 230V heating circuits 3 ID ø 410mm ED ø 477mm L 477mm H 110mm W1 110mm H1 20mm H2 90mm flange length 140mm flange width 62mm hole distance 64mm connection cable connection length 70mm tube ø 6.3mm convection heating element		



1

<b>GEV No.</b>	417675	<b>Ref. No.</b>	12026859 12026880 RT32001003 RT32001017	
<b>description</b>	heating element 15000W 230V heating circuits 6 ID ø 635mm ED ø 650mm L 696mm H 200mm L1 23mm W1 156mm H1 35mm H2 165mm flange length 210mm flange width 24mm hole distance 31mm connection male faston 6.3mm connection length 80mm tube ø 6.3mm convection heating element hole ø 7mm mounting pos. outer rectangular flange			
<b>spare parts for</b>	417675			
	<b>GEV No.</b>	512484	<b>Ref. No.</b>	12035774 RT51101009
	gasket L 210mm W 24mm thickness 2mm for heating element			



1

<b>GEV No.</b>	417677	<b>Ref. No.</b>	12025968 RT4000597
<b>description</b>	heating element 18000W 230V heating circuits 6 ID ø 407mm ED ø 485mm L 485mm H 106mm W1 111mm H1 11mm H2 85mm flange length 140mm flange width 72mm hole distance 128mm connection cable connection length 98mm tube ø 6.6mm cable length 600mm convection heating element hole ø 5mm rectangular flange L1 485mm		





1

<b>GEV No.</b>	417199	<b>Ref. No.</b>	12018381 T323000
<b>description</b>	heating element 15000W 230V heating circuits 6 ID ø 650mm ED ø 668mm L 670mm H 213mm W1 158mm H1 35mm H2 165mm flange length 210mm flange width 30mm tube ø 8mm convection heating element mounting pos. outer		
<b>For models:</b>	HEI-10-21, HEM-10-21		



1

<b>GEV No.</b>	417683	<b>Ref. No.</b>	12025672 RT4000267	
<b>description</b>	heating element 30000W 230V heating circuits 6 ID ø 573mm ED ø 630mm L 655mm H 120mm W1 135mm H1 15mm H2 110mm flange length 160mm flange width 75mm hole distance 74mm connection cable connection length 95mm tube ø 8.5mm cable length 600mm convection heating element hole ø 6mm rectangular flange L1 8mm			
<b>accessories for</b>	417683			
	<b>GEV No.</b>	560611	<b>Ref. No.</b>	—
	gasket L 160mm W 75mm for heating element thickness 2mm hole distance 74mm SCC Linie 102/202			

1

<b>GEV No.</b>	417690	<b>Ref. No.</b>	12027912 RT4000261
<b>description</b>	heating element 9000W 230V heating circuits 3 ID ø 407mm ED ø 420mm L 443mm H 105mm W1 107mm H1 21mm H2 88mm flange length 140mm flange width 62mm hole distance 65mm connection cable connection length 90mm tube ø 6.5mm cable length 270mm convection heating element hole ø 5mm rectangular flange L1 6mm		





1

<b>GEV No.</b>	419268	<b>Ref. No.</b>	12039496 T803050 T803050000
<b>description</b>	heating element 9000W 230V heating circuits 3 ID ø 410mm ED ø 417mm L 450mm H 100mm W1 105mm H1 80mm H2 20mm flange length 142mm flange width 25mm mounting distance 125mm connection M4 tube ø 8.5mm mounting thread M6		
<b>For models:</b>	ACE-061, ACE-101, ACE-201, AE-061, AE-061W, AE-101, AE-101W, AE-201, APE-061, APE-061W, APE-101, APE-101W, APE-201		
<b>accessories for</b>	419268		
	<b>GEV No.</b>	521284	<b>Ref. No.</b> 12041165 T803052000
	gasket for heating element L 142mm W 25mm thickness 2mm graphite		



1

<b>GEV No.</b>	417692	<b>Ref. No.</b>	12028209
<b>description</b>	heating element 9000W 230V heating circuits 3 ID ø 445mm ED ø 458mm L 474mm H 130mm W1 156mm H1 33mm H2 97mm flange length 210mm flange width 25mm hole distance 31mm connection male faston 6.3mm connection length 80mm tube ø 6.5mm dry heating element hole ø 7.5mm mounting pos. inner rectangular flange		
<b>accessories for</b>	417692		
	<b>GEV No.</b>	512484	<b>Ref. No.</b> 12035774 RT51101009
	gasket L 210mm W 24mm thickness 2mm for heating element		



1

<b>GEV No.</b>	419269	<b>Ref. No.</b>	T803051 T803051000 12039497
<b>description</b>	heating element 9000W 230V heating circuits 3 ID ø 490mm ED ø 507mm L 53mm H 100mm L1 14mm W1 100mm H1 83mm H2 17mm flange length 142mm flange width 25mm mounting distance 125mm connection M4 tube ø 8.5mm mounting thread M6		
<b>For models:</b>	ACE-101, ACE-201, AE-101, AE-101W, AE-201, APE-101, APE-101W, APE-201		





1

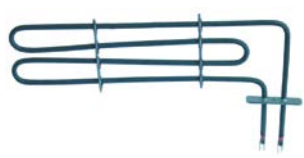

<b>GEV No.</b>	417693	<b>Ref. No.</b>	12026871 RT32001001
<b>description</b>	heating element 9000W 230V heating circuits 3 ID ø 504mm ED ø 516mm L 535mm H 130mm W1 156mm H1 35mm H2 95mm flange length 210mm flange width 25mm hole distance 31mm connection male faston 6.3mm connection length 80mm tube ø 6.5mm dry heating element hole ø 7.5mm mounting pos. outer rectangular flange L1 19mm		





1

<b>GEV No.</b>	416634	<b>Ref. No.</b>	12024692 R663016
<b>description</b>	heating element 1500W 230V heating circuits 1 L 350mm W 102mm L1 30mm L2 320mm W2 82mm flange length 70mm flange width 22mm hole distance 56mm connection length 71mm connection male faston 6.3mm tube ø 6.3mm hole ø 6mm W1 20mm rectangular flange convection heating element windings 2		
<b>For models:</b>	COE-061, HEI-6-11, HEM-6-11, HEP-6-11, HME-6-11, HMI-6-11, HMI-6-11UL, HMM-6-11, HMM-6-11UL, HMP-6-11, VE-061, VPE-061		
<b>spare parts for</b>	416634		
	<b>GEV No.</b>	510368	<b>Ref. No.</b> —
	gasket L 70mm W 23.5mm hole ø 5mm hole distance 56mm FIBER thickness 2mm for heating element		
<b>accessories for</b>	416634		
	<b>GEV No.</b>	550761	<b>Ref. No.</b> 12023637 R693017
	gasket L 69mm W 22mm D1 ø 12mm D2 ø 6mm graphite thickness 2mm for heating element		

			
1			
<b>GEV No.</b>	417658	<b>Ref. No.</b>	12031112 12043757 D01AC02257 D01AC02254 D01AC02257
<b>description</b>	heating element 2000W 230V L 500mm W 86mm connection male faston 6.3mm		
<b>For models:</b>	SF-13, SF-8		

			
1			
<b>GEV No.</b>	416620	<b>Ref. No.</b>	12024727 R673002
<b>description</b>	heating element 3000W 230V heating circuits 2 L 570mm W 100mm L1 70mm L2 500mm W2 70mm flange length 100mm flange width 22mm hole distance 44mm connection length 90mm connection male faston 6.3mm tube ø 8.5mm hole ø M5mm W1 30mm rectangular flange convection heating element		
<b>For models:</b>	COE-101, HEI-10-11, HEM-10-11, HEP-10-11, HME-10-11, HMI-10-11, HMI-10-11UL, HMM-10-11, HMM-10-11UL, HMP-10-11, VE-101, VPE-101		
<b>accessories for</b>	416620		
	<b>GEV No.</b>	550760	<b>Ref. No.</b> 12023655 R673063
gasket L 100mm W 22mm D1 ø 12mm D2 ø 7mm graphite thickness 2mm for heating element			

			
1			
<b>GEV No.</b>	416621	<b>Ref. No.</b>	12017124 R093002
<b>description</b>	heating element 4000W 230V heating circuits 2 L 1155mm W 100mm L1 70mm L2 1085mm W2 75mm flange length 100mm flange width 22mm hole distance 88mm connection length 90mm connection male faston 6.3mm tube ø 8mm hole ø M6mm W1 25mm rectangular flange convection heating element		
<b>For models:</b>	COE-201, HEI-20-11, HEM-20-11, HEP-20-11, HME-20-11, HMM-20-11, HMM-20-11UL, HMP-20-11, MFHMM-20-11, VE-201, VPE-201		

			
1			
<b>GEV No.</b>	416019	<b>Ref. No.</b>	12017453 R683000
<b>description</b>	heating element 4000W 230V heating circuits 2 L 570mm W 100mm L1 70mm L2 500mm W2 70mm flange length 100mm flange width 22mm hole distance 44mm connection length 90mm connection male faston 6.3mm tube ø 8mm W1 30mm rectangular flange convection heating element mounting thread M6		
<b>For models:</b>	HEP-10-11, HME-10-21, HME-20-11, HME-20-21, HME-2-10-11, HME-2-20-11, HMI-10-21, HMI-10-21UL, HMI-2-10-11, HMM-10-21, HMM-10-21UL, HMM-20-21, HMM-20-21UL, HMM-2-10-11, HMM-2-20-11, HMM-40-11-USMC, HMP-10-21, HMP-20-11, HMP-20-21, HMP-2-10-11, HMP-2-20-11		

## hot plates

### square & rectangular

#### with radiused edge

			
1			
<b>GEV No.</b>	490056 <sup>1</sup>	<b>Ref. No.</b>	12024805 U673011
<b>description</b>	hot plate dimensions 300x300mm 3000W 230V with spill ring connection 4 screw clamps protector yes square		
<b>For models:</b>	CE7-20Q, CE7-40Q, CE7-41Q, CE9-20, CE9-20AD, CE9-20PLUS, CE9-40, CE9-40AD, CE9-40PLUS, CE9-41, CE9-41AD, CE9-41PLUS		

<sup>1</sup>incl. protector

			
1			
<b>GEV No.</b>	490073	<b>Ref. No.</b>	12024803 U673012
<b>description</b>	hot plate dimensions 300x300mm 3000W 400V with spill ring connection 4 screw clamps protector no square		
<b>For models:</b>	CE7-20Q, CE7-40Q, CE7-41Q, CE9-20, CE9-40, CE9-41		

			
1			
<b>GEV No.</b>	490071 <sup>1</sup>	<b>Ref. No.</b>	12024806 U673010
<b>description</b>	hot plate dimensions 300x300mm 4000W 230V with spill ring connection 4 screw clamps protector yes square		
<b>For models:</b>	CE9-20, CE9-20AD, CE9-20PLUS, CE9-40, CE9-40AD, CE9-40PLUS, CE9-41, CE9-41AD, CE9-41PLUS		

<sup>1</sup>incl. protector





			
1			
<b>GEV No.</b>	490074 <sup>1</sup>	<b>Ref. No.</b>	12024802 U673013
<b>description</b>	hot plate dimensions 300x300mm 4000W 400V with spill ring connection 4 screw clamps protector yes square		
<b>For models:</b>	CE9-20, CE9-40, CE9-41		

<sup>1</sup>incl. protector

round  
with radiused edge  
for domestic and commercial kitchens

			
1			
<b>GEV No.</b>	490012	<b>Ref. No.</b>	12024602 U803002
<b>description</b>	hot plate ø 145mm 1500W 230V connection 4 screw clamps with 8mm spill ring		
<b>For models:</b>	CE6-40, CE6-41, CE7-20, CE7-40, CE7-41		

			
1			
<b>GEV No.</b>	490020	<b>Ref. No.</b>	12024076 U803000
<b>description</b>	hot plate ø 220mm 2600W 230V connection 4 screw clamps with 8mm spill ring		
<b>For models:</b>	CE7-20, CE7-40, CE7-41		
<b>accessories for</b>	490020		
	<b>GEV No.</b>	<b>Ref. No.</b>	—
	550796		
	fixing plate for hot plate ø220mm		

energy regulators

EGO

1-circuit



			
1			
<b>GEV No.</b>	380015	<b>Ref. No.</b>	12024522 12029890 K002B42045 S333001
<b>description</b>	energy regulator 230V 13A single-circuit turn direction right shaft ø 6x4.6mm shaft L 23mm mounting thread M4 power release 6-100% no. 50.57021.010		
<b>For models:</b>	CPE6-05, CPE7-05, CPE7-05NC, CPE9-05, CPE9-05AD, CPE9-05AD-S, CPE9-05NC, CPE9-05PLUS, CPE9-05PLUS-S, CPE9-05S, CPE9-05SNC, CV6-20, CV6-40, EPC-350, HGV-10-11, HGV-20-11, HVG-10-11, HVG-10-11UL, HVG-10-21, HVG-10-21UL, HVG-20-11, HVG-20-21, HVG-2-10-11, HVG-2-20-21, ME7-10BM, ME9-10BM, ME9-10BMS, ME9-10PLUS-BM, ME9-10PLUS-BMS, ME9-15BM, ME9-15BM316, ME9-15BM-AD, ME9-15BMS, ME9-15PLUS-BM, ME9-15PLUS-BMS, MFHVG-10-11, MFHVG-10-21, MG9-10AD, MG9-10BMAD, MG9-10BMSAD, MG9-10PLUS, MG9-10PLUS-BM, MG9-10PLUS-BMS, MG9-10PLUS-S, MG9-10S-AD, MG9-15AD, MG9-15BMAD, MG9-15BMSAD, MG9-15PLUS, MG9-15PLUS-BM...(Other models you can see in the webshop)		

thermostats

bi-metal thermostats

safety bi-metal thermostats

			
1			
<b>GEV No.</b>	390590	<b>Ref. No.</b>	12033906 BR00C23114
<b>description</b>	bi-metal safety thermostat hole distance 24mm switch-off temp.°C 1NC 1-poleAV connection plug 2 hole fixing		

			
1			
<b>GEV No.</b>	390451	<b>Ref. No.</b>	12025141 R213004
<b>description</b>	bi-metal safety thermostat hole distancemm switch-off temp. 115°C 1NC 1-pole 16A connection F6.3		
<b>For models:</b>	AD-120, AD-120B, AD-120BBTDD-UK, AD-120C, AD-120CW, AD-120HY, AD-90, AD-90BA, AD-90BBT, AD-90BDD, AD-90DD, ADE-120, ADE-120B, BME7-05, BME7-10, BME9-05, BME9-10, ECO-120, ECO-120B, FI-100, FI-100AR, FI-100B, FI-100BBT-UK, FI-120, FI-120AR+DD, FI-120B, FI-120C, FI-120HY-CLINIC, FI-120W, FI-80, FI-80AR, FI-80BBT-UK, FI-80W, FI-E-100, LABP-1000, LABP-1200, MF-120		
<b>accessories for</b>	390451		
	<b>GEV No.</b>	<b>Ref. No.</b>	12024049 N503017
	505093		
	 gasket for thermostat ED ø 35mm ID ø 24mm thickness 7mm equiv. no. N503017		

bi-metal thermostats



<b>GEV No.</b>	391045	<b>Ref. No.</b>	12095019
<b>description</b>	bi-metal thermostat hole distance 23.5mm switch-off temp. 51°C 1NC 1-pole 10A connection F6.3 threaded probe ø 16mm		
<b>For models:</b>	ACE-061, ACE-101, ACE-102, ACE-201, ACE-202, ACG-061, ACG-101, ACG-102, ACG-201, ACG-202, AE-061, AE-101, AE-102, AE-201, AE-202, AG-061, AG-101, AG-102, AG-201, AG-202, CO-350, CO-350-B, CO-350-B-DD, CO-350-COLD, CO-350-COLD-B, CO-350-COLD-B-DD, CO-350-COLD-DD, CO-350-DD, CO-400, CO-400-B, CO-400-B-DD, CO-400-COLD, CO-400-COLD-B, CO-400-COLD-B-DD, CO-400-COLD-DD, CO-400-DD, CO-400-SOFT		



<b>GEV No.</b>	375160	<b>Ref. No.</b>	12035324 RT30140325
<b>description</b>	bi-metal thermostat hole distancemm switch-off temp. 110°C 1NC 1-pole 16A connection F6.3 M4		



<b>GEV No.</b>	390450	<b>Ref. No.</b>	12023708 Z653013 Z718405
<b>description</b>	bi-metal thermostat hole distancemm switch-off temp. 66/57°C NC/NO 2-pole 16A connection F6.3		
<b>For models:</b>	EASY-500, EASY-500B, EASY-500DD, EASY-500HP, EASY-500HPWBDD, ECO-120, ECO-1200, ECO-120B, FI-100, FI-100AR, FI-100B, FI-100BBT-UK, FI-120, FI-1200, FI-120AR+DD, FI-120B, FI-120C, FI-120HY-CLINIC, FI-120W, FI-30, FI-300B, FI-300R, FI-30AR, FI-30AR+DD, FI-30B, FI-30B-BT-UK, FI-30-UK, FI-48, FI-48B, FI-48B-BT-UK, FI-48D, FI-48W, FI-60DD, FI-64, FI-64AR, FI-64B, FI-64C, FI-64D, FI-64W, FI-650R, FI-72, FI-72AR, FI-80, FI-80AR, FI-80BBT-UK, FI-80W, FI-900, LABP-1000, LABP-1200, LABP-800...(Other models you can see in the webshop)		
<b>accessories for</b>	390450		
	<b>GEV No.</b>	505093	<b>Ref. No.</b>
			12024049 N503017
	gasket for thermostat ED ø 35mm ID ø 24mm thickness 7mm equiv. no. N503017		



<b>GEV No.</b>	390428	<b>Ref. No.</b>	12023814 P503025
<b>description</b>	bi-metal thermostat hole distancemm switch-off temp.°C 1NO/1NC 2-pole 15A 250V connection F6.3		
<b>For models:</b>	LA-13M, LA-18MP, LA-25M, LA-AC-10M, LA-AC-10MA, LA-AC-10MP, LA-AC-13M, LA-AC-13MA, LA-AC-13MP, LA-AC-18M, LA-AC-18MA, LA-AC-18MP, LA-AC-25M, LA-AC-25MA, LA-AC-25MP, LAC-10MP, LAC-10MPP, LAC-14MP, LAC-14MPP, LAC-25MP, LAC-25MPP, LAC-55MP, LAC-55MPP, LAC-7MP, LAC-7MPP, LA-E-10M, LA-E-10MA, LA-E-10MP, LA-E-13M, LA-E-13MA, LA-E-13MP, LA-E-18M, LA-E-18MA, LA-E-18MP, LA-E-25M, LA-E-25MA, LA-E-25MP, LA-V-10M, LA-V-10MP, LA-V-13M, LA-V-13MP, LA-V-18M, LA-V-18MP, LA-V-25M, LA-V-25MP, LB-AC-10M, LB-E-10M, LB-V-10M, LF-13MPP, LF-18MPP...(Other models you can see in the webshop)		
<b>accessories for</b>	390428		
	<b>GEV No.</b>	505093	<b>Ref. No.</b>
			12024049 N503017
	gasket for thermostat ED ø 35mm ID ø 24mm thickness 7mm equiv. no. N503017		

control and safety thermostats

EGO

control thermostats

55.13\_ series

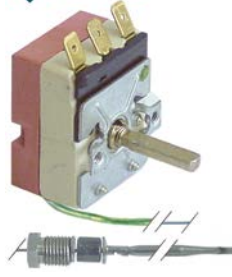

<b>GEV No.</b>	375415	<b>Ref. No.</b>	12018245 R343018
<b>description</b>	thermostat t.max. 105°C temperature range 52-105°C 1-pole 1CO 16A probe ø 3.03mm probe L 201mm capillary pipe 2380mm capillary pipe isolated 2200mm gland nut M9x1 shaft ø 6x4.6mm shaft L 23mm shaft position upper rotation 270°		
<b>For models:</b>	HCV-10-11, HCV-10-21, HCV-2-10-21, HCV-5-11, HCV-6-11, HEI-10-11, HEI-20-11, HEI-6-11, HGV-10-11, HGV-20-11, HMI-10-11, HMI-10-11UL, HMI-10-21, HMI-10-21UL, HMI-2-10-11, HMI-6-11, HMI-6-11UL, HMM-10-11, HMM-10-11UL, HMM-10-21, HMM-10-21UL, HMM-20-11, HMM-20-11UL, HMM-20-21, HMM-20-21UL, HMM-2-10-11, HMM-40-11-USMC, HMM-6-11, HMM-6-11UL, HVG-10-11, HVG-10-11UL, HVG-10-21, HVG-10-21UL, HVG-20-11, HVG-20-21, HVG-2-10-11, HVG-2-20-21, MFHMM-20-11, MFHVG-10-11, MFHVG-10-21		



<b>GEV No.</b>	375123	<b>Ref. No.</b>	12024662 K008B41006 X033000
<b>description</b>	thermostat t.max. 215°C temperature range 60-215°C 1-pole 1NO 16A probe ø 6mm probe L 77mm capillary pipe 2250mm capillary pipe isolated 2100mm gland nut shaft L 23mm shaft position upper rotation 270°		
<b>For models:</b>	FE-18, FE-25, FE-4, FE-6, FE6-05TE, FE6-10TE, FE-71-15, FE-8, FE-91-20		



<b>GEV No.</b>	390086	<b>Ref. No.</b>	12018764 R013002 R013002000
<b>description</b>	thermostat t.max. 300°C temperature range -10 to +300°C 1-pole 1CO probe ø 3mm probe L 201mm capillary pipe 1170mm capillary pipe isolated 1100mm shaft ø 6x4.6mm shaft L 26mm rotation 250° probe material SS		



<b>GEV No.</b>	375204	<b>Ref. No.</b>	12024623 X163010
<b>description</b>	thermostat t.max. 215°C temperature range 61-215°C 1-pole 1NO 16A probe ø 3.1mm probe L 201mm capillary pipe 870mm capillary pipe isolated 600mm gland nut M9x1 shaft L 23mm shaft position upper rotation 270°		
<b>For models:</b>	FE6-05, FE6-10, FE7-05-1C, FE7-05-2C, FE-710, FE7-10-2C, FE7-10-4C, FE-720, FE9-05, FE9-05-1C, FE9-05-2C, FE9-05AD, FE9-05PLUS, FE9-05PLUS-S, FE9-05S, FE9-05S-1C, FE9-05S-2C, FE9-05S-AD, FE9-05US-MC, FE9-10, FE9-10-2C, FE9-10-4C, FE9-10AD, FE9-10PLUS, FE-920, FG7-05-1C, FG7-05-2C, FG-710, FG7-10-2C, FG7-104C, FG7-10-4C, FG-720, FG9-05, FG9-05-1C, FG9-05-2C, FG9-05AD, FG9-05PLUS, FG9-05PLUS-S, FG9-05S, FG9-05S-1C, FG9-05S-2C, FG9-05S-AD, FG9-10, FG9-10-2C, FG9-10-4C, FG9-10AD, FG9-10PLUS, FG-920, FGCL9-05, FGCL9-05-1C...(Other models you can see in the webshop)		



<b>GEV No.</b>	375459	<b>Ref. No.</b>	12024939 Z953001
<b>description</b>	thermostat t.max. 82°C temperature range fixed 82°C 1-pole 1COA probe ø 15/9mm probe L 21mm capillary pipe 1000mm capillary pipe isolated 950mm gland nut shaft ømm shaft Lmm shaft position rotation° probe material SS		
<b>For models:</b>	GA-20, GA-20D, GA-40, GA-40D		



<b>GEV No.</b>	375460	<b>Ref. No.</b>	12018390 R343073
<b>description</b>	thermostat t.max. 255°C temperature range 55-255°C 1-pole 1NO 16A probe ø 3.1mm probe L 201mm capillary pipe 1170mm capillary pipe isolated 1100mm gland nut shaft ø 6x4.6mm shaft L 23mm shaft position upper		
<b>For models:</b>	HCV-10-11, HCV-5-11		

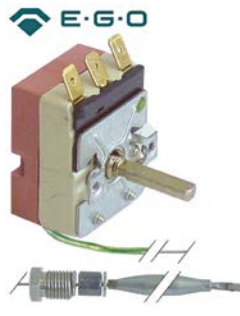

<b>GEV No.</b>	375414	<b>Ref. No.</b>	12024648 R343100
<b>description</b>	thermostat t.max. 85°C temperature range 30-85°C 1-pole 1CO 16A probe ø 6mm probe L 73mm capillary pipe 1540mm capillary pipe isolated 1400mm gland nut M9x1 shaft ø 6x4.6mm shaft L 23mm shaft position upper rotation 270°		
<b>For models:</b>	FI-120W, FI-80W, HCV-10-11, HCV-10-21, HCV-2-10-21, HCV-6-11, HEI-10-21, HEM-10-11, HEM-20-11, HEM-6-11, HEP-10-11, HEP-20-11, HEP-6-11, HGV-10-11, HGV-20-11, HME-10-11, HME-10-21, HME-20-11, HME-20-21, HME-2-10-11, HME-2-20-11, HME-6-11, HMM-10-11, HMM-10-11UL, HMM-10-21, HMM-10-21UL, HMM-20-11, HMM-20-11UL, HMM-20-21, HMM-20-21UL, HMM-2-10-11, HMM-40-11-USMC, HMM-6-11, HMM-6-11UL, HMP-10-11, HMP-10-21, HMP-20-11, HMP-20-21, HMP-2-10-11, HMP-6-11, HVG-10-11, HVG-10-11UL, HVG-10-21, HVG-10-21UL, HVG-20-11, HVG-20-21, HVG-2-10-11, HVG-2-20-21, MFHMM-20-11, MFHVG-10-11...(Other models you can see in the webshop)		

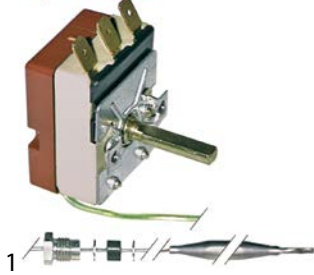

<b>GEV No.</b>	375400	<b>Ref. No.</b>	12024096 Z393005
<b>description</b>	thermostat t.max. 90°C temperature range 30-90°C 1-pole 1CO 16A probe ø 6mm probe L 98mm capillary pipe 2380mm capillary pipe isolated 1700mm gland nut M9x1 shaft ø 6x4.6mm shaft L 18mm shaft position upper rotation 270°		
<b>For models:</b>	AD-15, AD-15D, AD-20C-UK, AD-21, AD-21B, AD-21BDD, AD-21C, AD-21D, AD-21DD, AD-21W, AD-90, AD-90DD, FI-30, FI-30AR, FI-30AR+DD, FI-30B, FI-30B-BT-UK, FI-30-UK, FI-80, FI-80AR, FI-80W, LABP-800, LVC-12, LVC-15, LVC-15D, LVC-21, LVC-21B, LVC-21C, LVC-21D, LVC-21W, LVR-10, LVR-14, LVR-14D, LVR-20, LVR-20B, LVR-20D, MF-21		



<b>GEV No.</b>	375130	<b>Ref. No.</b>	12024573 12030953 AL00000121 Z203014
<b>description</b>	thermostat t.max. 90°C temperature range 32-90°C 1-pole 1CO 16A probe ø 6mm probe L 129mm capillary pipe 710mm capillary pipe isolated 500mm gland nut shaft ø 6x4.6mm shaft L 23mm shaft position upper rotation 270°		
<b>For models:</b>	AD-120, AD-120B, AD-120BBTDD-UK, AD-120C, AD-120CW, AD-120HY, AD-45BBT, AD-48, AD-48B, AD-48BDD, AD-48C, AD-48D, AD-48DD, AD-48HY, AD-48W, AD-64, AD-64B, AD-64BBT, AD-64BDD, AD-64C, AD-64CW, AD-64D, AD-64DD, AD-64HY, AD-72, AD-72W, AD-90, AD-90BA, AD-90BBT, AD-90BDD, AD-90DD, ADE-120, ADE-120B, BME6-05, BME7-05, BME7-10, BME9-05, BME9-05AD, BME9-05PLUS, BME9-05V-T, BME9-10, BME9-10AD, BME9-10PLUS, BME9-10V-T, ECO-120, ECO-120B, ECO-160, ECO-160D, ECO-160I...(Other models you can see in the webshop)		

55.18\_ series



<b>GEV No.</b>	376094	<b>Ref. No.</b>	39FA0010
<b>description</b>	thermostat t.max. 324°C temperature range 54-324°C 1-pole 1NO 16A probe ø 3.03mm probe L 160mm capillary pipe 1130mm capillary pipe isolated 870mm gland nut shaft ø 6x4.6mm shaft L 23mm shaft position upper rotation 270°		

safety thermostats

55.11\_ series



<b>GEV No.</b>	375120	<b>Ref. No.</b>	12024600 X033001
<b>description</b>	safety thermostat switch-off temp. 245°C 1-pole 16A probe ø 6mm probe L 77mm capillary pipe 2290mm capillary pipe isolated 2260mm gland nut probe SS		
<b>For models:</b>	FE-18, FE-25, FE-4, FE-6, FE6-05TE, FE6-10TE, FE-71-15, FE-8, FE-91-20, MG7-10BM, MG9-10BM, MG9-10BMAD, MG9-10BMS, MG9-10BMSAD, MG9-10PLUS-BM, MG9-10PLUS-BMS, MG9-15BM, MG9-15BM316, MG9-15BMAD, MG9-15BMS, MG9-15BMSAD, MG9-15PLUS-BM, MG9-15PLUS-BMS, MPG9-10BM, MPG9-10BMS, MPG9-15BM, MPG9-15BMS		



<b>GEV No.</b>	375461	<b>Ref. No.</b>	12023818 Z953002
<b>description</b>	safety thermostat switch-off temp. 92°C 1-pole 1NC 16A probe ø 9/15mm probe L 20mm capillary pipe 50mm capillary pipe isolated-gland nut shaft ømm probe probe material SS		
<b>For models:</b>	GA-20, GA-20D, GA-40, GA-40D		



55.12\_series



<b>GEV No.</b>	375084	<b>Ref. No.</b>	12030006 RT30140328
<b>description</b>	safety thermostat switch-off temp. 135°C 1-pole 10A probe ø 6mm probe L 83mm capillary pipe 1440mm capillary pipe isolated 1360mm gland nut probe SS		



<b>GEV No.</b>	375775	<b>Ref. No.</b>	12028861 RT4001329
<b>description</b>	safety thermostat switch-off temp. 160°C 1-pole 10A probe ø 6mm probe L 87mm capillary pipe 1440mm capillary pipe isolated 1400mm gland nut probe		

55.13\_series



<b>GEV No.</b>	375205	<b>Ref. No.</b>	12017873 X012130
<b>description</b>	safety thermostat switch-off temp. 225°C 1-pole 16A probe ø 11mm probe L 16.5mm capillary pipe 830mm capillary pipe isolatedmm gland nut probe screw-in probe probe thread M14x1		
<b>For models:</b>	FE-710, FE-720, FE-920, FG-710, FG-720, FG-91-20, FG-920, FG-92-40		



<b>GEV No.</b>	390806	<b>Ref. No.</b>	12024607 X163001
<b>description</b>	safety thermostat switch-off temp. 245°C 1-pole 16A probe ø 3.1mm probe L 201mm capillary pipe 870mm capillary pipe isolated 600mm gland nut M9x1 probe		
<b>For models:</b>	FE6-05, FE6-10, FE7-05-1C, FE7-05-2C, FE7-10-2C, FE7-10-4C, FE9-05, FE9-05-1C, FE9-05-2C, FE9-05AD, FE9-05PLUS, FE9-05PLUS-S, FE9-05S, FE9-05S-1C, FE9-05S-2C, FE9-05S-AD, FE9-10, FE9-10-2C, FE9-10-4C, FE9-10AD, FE9-10PLUS, FG6-05, FG6-10, FG7-05-1C, FG7-05-2C, FG7-10-2C, FG7-104C, FG7-10-4C, FG9-05, FG9-05-1C, FG9-05-2C, FG9-05AD, FG9-05PLUS, FG9-05PLUS-S, FG9-05S, FG9-05S-1C, FG9-05S-2C, FG9-05S-AD, FG9-10, FG9-10-2C, FG9-10-4C, FG9-10AD, FG9-10PLUS, FGCL9-05, FGCL9-05-1C, FGCL9-05-2C, FGCL9-05S-1C, FGCL9-05S-2C		



<b>GEV No.</b>	375131	<b>Ref. No.</b>	12018982 X163040
<b>description</b>	safety thermostat switch-off temp. 245°C 1-pole 16A probe ø 3.1mm probe L 201mm capillary pipe 870mm capillary pipe isolated 600mm gland nut probe		

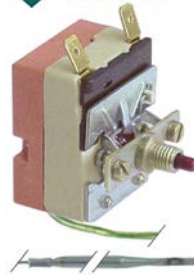

<b>GEV No.</b>	375416	<b>Ref. No.</b>	12019062 R243016
<b>description</b>	safety thermostat switch-off temp. 329°C 1-pole 16A probe ø 3.03mm probe L 160mm capillary pipe 1230mm capillary pipe isolated 1060mm gland nut probe		
<b>For models:</b>	HCG-10-11, HCG-10-21, HCG-20-11, HCG-20-21, HCG-2-10-11, HCG-2-20-11, HCG-6-11, HCV-10-11, HCV-10-21, HCV-2-10-21, HCV-5-11, HCV-6-11, HE-10-11, HE-10-21, HE-2-10-11, HE-5-11, HE-6-11, HEI-10-11, HEI-20-11, HEI-6-11, HEM-10-11, HEM-20-11, HEM-6-11, HEP-10-11, HEP-20-11, HEP-6-11, HG-10-11, HG-10-21, HG-2-10-11, HGC-10-11, HGC-20-11, HGC-6-11, HGV-10-11, HGV-20-11, HME-10-11, HME-10-21, HME-20-11, HME-2-10-11, HME-2-20-11, HME-6-11, HMG-10-11, HMG-10-11UL, HMG-10-21, HMG-10-21UL, HMG-20-11, HMG-2-10-11, HMG-6-11, HMI-10-11, HMI-10-11UL... (Other models you can see in the webshop)		



<b>GEV No.</b>	375441	<b>Ref. No.</b>	12024591 T303009
<b>description</b>	safety thermostat switch-off temp. 360°C 1-pole 1NC 16A probe ø 3mm probe L 110mm capillary pipe 870mm capillary pipe isolated 700mm gland nut probe screw connection M8x1		



<b>GEV No.</b>	375121	<b>Ref. No.</b>	12024691 R612103
<b>description</b>	safety thermostat switch-off temp. 420°C 1-pole 1NO 16A probe ø 3.9mm probe L 228mm capillary pipe 1130mm capillary pipe isolated 700mm gland nut starting temperature 394°C probe		
<b>For models:</b>	CMF6-05, FTE6-05L, FTE6-05R, FTE6-10L, FTE6-10L+R, FTE6-10R, FTE7-05, FTE7-05L, FTE7-05R, FTE7-10, FTE7-10L, FTE7-10L+R, FTE7-10R, FTE9-05L, FTE9-05L-AD, FTE9-05PLUS-CL, FTE9-05PLUS-CR, FTE9-05PLUS-L, FTE9-05PLUS-R, FTE9-05R, FTE9-05R-AD, FTE9-10L, FTE9-10L+R, FTE9-10L+R-AD, FTE9-10L-AD, FTE9-10PLUS-CL, FTE9-10PLUS-CLR, FTE9-10PLUS-CR, FTE9-10PLUS-L, FTE9-10PLUS-LR, FTE9-10PLUS-R, FTE9-10R, FTE9-10R-AD, FTEC6-05L, FTEC6-10L, FTEC6-10L+R, FTEC7-05L, FTEC7-10L, FTEC9-05, FTEC9-05L, FTEC9-05L-AD, FTEC9-05R, FTEC9-05R-AD, FTEC9-05USMC, FTEC9-10, FTEC9-10L, FTEC9-10L+R, FTEC9-10L+R-AD, FTEC9-10L-AD, FTEC9-10R...(Other models you can see in the webshop)		

55.33\_series



<b>GEV No.</b>	375764	<b>Ref. No.</b>	12124621
<b>description</b>	safety thermostat switch-off temp. 282°C 3-pole 20A probe ø 4mm probe L 157mm capillary pipe 1770mm capillary pipe isolated 1490mm gland nut probe SS		

56.\_series



<b>GEV No.</b>	375447	<b>Ref. No.</b>	12024884 Z953035
<b>description</b>	safety thermostat switch-off temp. 150°C 1-pole 1CO 16A probe ø 6mm probe L 77mm capillary pipe 1460mm capillary pipe isolated 1100mm gland nut M9x1 starting temperature 139°C probe		
<b>For models:</b>	AE-061, AE-061W, AE-101, AE-101W, AE-102, AE-102W, AE-201, AE-202, AG-061, AG-061W, AG-101, AG-101W, AG-102, AG-102W, AG-201, AG-202, APE-061, APE-061W, APE-101, APE-101W, APE-102, APE-102W, APE-201, APE-202, APG-061, APG-061W, APG-101, APG-101W, APG-102, APG-102W, APG-201, APG-202, GA-20, GA-20D, GA-40, GA-40D, HEM-10-21, HEM-20-21, HEP-10-21, HEP-20-21, HGP-10-21, HGP-20-21, HGV-10-11, HGV-10-21, HGV-20-11, HVG-10-11, HVG-10-11UL, HVG-10-21, HVG-10-21UL, HVG-20-11...(Other models you can see in the webshop)		



<b>GEV No.</b>	390854	<b>Ref. No.</b>	12048400
<b>description</b>	safety thermostat switch-off temp. 245°C 1-pole 1NC 16A probe ø 3.1mm probe L 155mm capillary pipe 1130mm capillary pipe isolatedmm gland nut M9x1 probe		



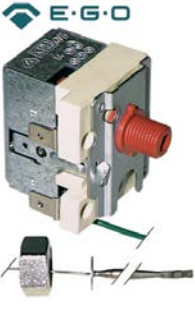

<b>GEV No.</b>	375774	<b>Ref. No.</b>	12028972 12029862 RT4000605 RT4001482
<b>description</b>	safety thermostat switch-off temp. 365°C 1-pole 16A probe ø 4mm probe L 96mm capillary pipe 1160mm capillary pipe isolated 1100mm gland nut probe SS with special screwing screw connection M10x1		

			
<b>GEV No.</b>	375159	<b>Ref. No.</b>	12029569 RT30140326
<b>description</b>	safety thermostat switch-off temp. 365°C 1-pole 16A probe ø 4mm probe L 96mm capillary pipe 1160mm capillary pipe isolated 1100mm gland nut probe with special screwing screw connection M14x1		

TECASA

control thermostats

			
<b>GEV No.</b>	376058	<b>Ref. No.</b>	12024549 X153110
<b>description</b>	thermostat t.max. 310°C temperature range 50-310°C 1-pole 16A probe ø 3mm probe L 160mm capillary pipe 850mm capillary pipe isolated 700mm shaft ø 6x4.6mm		
<b>For models:</b>	BME6-05, CE6-41, CE7-41, CE7-41Q, CE9-41, CE9-41AD, CE9-41PLUS, CGE6-41, CGE7-227, CGE7-41, CGE7-41H, CGE9-11, CGE9-41, CGE9-41AD, CGE9-41PLUS, CMF6-05, FTE6-05L, FTE6-05R, FTE6-10L, FTE6-10L+R, FTE6-10R, FTE7-05, FTE7-05L, FTE7-05R, FTE7-10, FTE7-10L, FTE7-10L+R, FTE7-10R, FTE9-05L, FTE9-05L-AD, FTE9-05PLUS-CL, FTE9-05PLUS-CR, FTE9-05PLUS-L, FTE9-05PLUS-R, FTE9-05R, FTE9-05R-AD, FTE9-10L, FTE9-10L+R, FTE9-10L+R-AD, FTE9-10L-AD, FTE9-10PLUS-CL, FTE9-10PLUS-CLR, FTE9-10PLUS-CR, FTE9-10PLUS-L, FTE9-10PLUS-LR, FTE9-10PLUS-R, FTE9-10R, FTE9-10R-AD, FTEC6-05L, FTEC6-10L...(Other models you can see in the webshop)		

			
<b>GEV No.</b>	375448	<b>Ref. No.</b>	12034068 6021350005
<b>description</b>	thermostat t.max. 85°C temperature range 30-90°C 1-pole 1NO 16A probe ø 6mm probe L 90mm capillary pipe 2000mm capillary pipe isolated 1950mm gland nut shaft ø 6x4.6mm shaft L 23mm shaft position upper rotation 270° probe material SS		
<b>For models:</b>	AC-120, AC-180, CCF-10, CCF-10Cl, CCF-20, CCF-20Cl, CCF-40, CCF-40Cl		

safety thermostats

			
<b>GEV No.</b>	390452	<b>Ref. No.</b>	12023830 R34312400 Z213014
<b>description</b>	safety thermostat switch-off temp. 125°C 1-pole 16A probe ø 6mm probe L 73mm capillary pipe 870mm capillary pipe isolated 690mm gland nut M9x1 probe SS		
<b>For models:</b>	AD-120, AD-120B, AD-120BBTDD-UK, AD-120C, AD-120CW, AD-120HY, AD-125, AD-125HRS, AD-125-SOFT, AD-21W, AD-45BBT, AD-48, AD-48B, AD-48BDD, AD-48C, AD-48D, AD-48DD, AD-48HY, AD-48W, AD-505, AD-505-SOFT, AD-64, AD-64B, AD-64BBT, AD-64BDD, AD-64BTDD, AD-64C, AD-64CW, AD-64D, AD-64DD, AD-64HY, AD-72, AD-72W, AD-90, AD-90BA, AD-90BBT, AD-90BDD, AD-90DD, BME6-05, BME7-05, BME7-10, BME9-05, BME9-05AD, BME9-05PLUS, BME9-05V-T, BME9-10, BME9-10AD, BME9-10PLUS, BME9-10V-T, CO-110...(Other models you can see in the webshop)		

			
<b>GEV No.</b>	376078	<b>Ref. No.</b>	12038157 12135898 DO1DG11154
<b>description</b>	thermostat switch-off temp. 180°C 2-pole 16A probe ø 6mm probe L 59mm capillary pipe 2000mm capillary pipe isolatedmm shaft ømm 240V		
<b>For models:</b>	SF-13, SF-8, SR-10MP-PSM, SR-13MP-PSM, SR-32MP-PSM		

			
<b>GEV No.</b>	376074	<b>Ref. No.</b>	12044749
<b>description</b>	thermostat switch-off temp. 290°C 1-pole 1NO 20A probe ø 6mm probe L 52mm capillary pipe 1500mm capillary pipe isolated 1300mm gland nut starting temperature 245°C probe SS		
<b>For models:</b>	FE-18, FE-25, FE-4, FE-6, FE6-05TE, FE6-10TE, FE-8, MG7-10BM, MG9-10BM, MG9-10BMS, MG9-10PLUS-BM, MG9-10PLUS-BMS, MG9-15BM, MG9-15BM316, MG9-15BMS, MG9-15PLUS-BM, MG9-15PLUS-BMS, MPG9-10BM, MPG9-10BMS, MPG9-15BM, MPG9-15BMS		

various			
safety thermostats			
			
1			
<b>GEV No.</b>	390798	<b>Ref. No.</b>	12032244 GR51000028
<b>description</b>	safety thermostat switch-off temp. 235°C 1-pole 1CO probe ø 6mm probe L 63mm capillary pipe 1600mm capillary pipe isolated 80mm		
<b>For models:</b>	PE-18-100, PE-18-120		

refrigeration thermostats			
DANFOSS			
control thermostats			
			
1			
<b>GEV No.</b>	390677	<b>Ref. No.</b>	6021350023
<b>description</b>	thermostat type 077B0028 capillary pipe 1200mm temperature range -4,5 up to +10,5°C probe ømm probe Lmm		
<b>For models:</b>	BFP-100A, BFP-100I, BFP-150A, BFP-150I, BFP-200A, BFP-200I, BFP-250A, BFP-250I, BFP-300I		

RANCO			
K22 series			
			
1			
<b>GEV No.</b>	390524	<b>Ref. No.</b>	12033335 12033350 BR00023004 BR00023591
<b>description</b>	thermostat RANCO type K22L1082 probe ømm probe Lmm capillary pipe 2000mm temperature range -22 up to -3°C		

K50 series			
			
1			
<b>GEV No.</b>	390427 <sup>1</sup>	<b>Ref. No.</b>	12035536 6021350009
<b>description</b>	thermostat RANCO type K50L3389 capillary pipe 1200mm		
<b>For models:</b>	BFP-150, BFP-200, BFP-250, BFP-300		

<sup>1</sup>incl. knob

accessories			
probe clips			
miscellaneous			
			
1			
<b>GEV No.</b>	550770	<b>Ref. No.</b>	12011614 R662630
<b>description</b>	probe clip for combi-steamer		
<b>For models:</b>	HCG-10-11, HCG-10-21, HCG-20-11, HCG-20-21, HCG-2-10-11, HCG-2-20-11, HCG-6-11, HME-10-11, HME-10-21, HME-20-11, HME-20-21, HME-2-10-11, HME-2-20-11, HME-6-11, HMG-10-11, HMG-10-11UL, HMG-10-21, HMG-10-21UL, HMG-20-11, HMG-2-10-11, HMG-6-11, HMI-10-11, HMI-10-11UL, HMI-10-21, HMI-10-21UL, HMI-2-10-11, HMI-6-11, HMI-6-11UL, HMM-10-11, HMM-10-11UL, HMM-10-21, HMM-10-21UL, HMM-20-11, HMM-20-11UL, HMM-20-21, HMM-20-21UL, HMM-2-10-11, HMM-40-11-USMC, HMM-6-11, HMM-6-11UL, HMP-10-11, HMP-10-21, HMP-20-11, HMP-20-21, HMP-2-10-11, HMP-6-11, HVG-10-11, HVG-10-11UL, HVG-10-21, HVG-10-21UL...(Other models you can see in the webshop)		

gland nut accessories			
ducts			
			
1			
<b>GEV No.</b>	691731	<b>Ref. No.</b>	12020538 X166113
<b>description</b>	duct ET M14x1 IT M9x1		
<b>For models:</b>	FE-710, FE-720, FE-920, FG-710, FG-720, FG-920		







plunger sockets

 <p>1</p>			
<b>GEV No.</b>	505207	<b>Ref. No.</b>	12022418 Z263002
<b>description</b>	thermowell thread M12x1.75 IT ET M12x1.75 ID ø 8mm L 95mm SS/brass single ø 10mm		
<b>For models:</b>	ECO-120, ECO-1200, ECO-120B, ECO-160, ECO-160D, ECO-160I, ECO-200, ECO-200D, ECO-200H, ECO-200HD, ECO-200HI, ECO-200I, ECO-2700D, ECO-2700I, ECO-280D, ECO-280I, ECO-370D, ECO-370I, ECO-4000D, ECO-4000I, ECO-460D, ECO-460I, ECO-550D, ECO-550I, ECO-6000D, ECO-6000I, FI-100, FI-100AR, FI-100B, FI-100BBT-UK, FI-120, FI-1200, FI-120AR+DD, FI-120B, FI-120C, FI-120HY-CLINIC, FI-120W, FI-160, FI-160AR, FI-160D, FI-160I, FI-200, FI-200AR, FI-200D, FI-200H, FI-200HD, FI-200HI, FI-200I, FI-200W, FI-200WL...(Other models you can see in the webshop)		

connecting bows



 <p>1</p>			
<b>GEV No.</b>	691005	<b>Ref. No.</b>	12001816 X313001
<b>description</b>	support bracket for thermostat and switch		
<b>For models:</b>	BME7-05, BME7-10, BME9-05, BME9-05V-T, BME9-10, BME9-10V-T, FE7-05-1C, FE7-05-2C, FE-710, FE7-10-2C, FE7-10-4C, FE-720, FE9-05, FE9-05-1C, FE9-05-2C, FE9-05S, FE9-05S-1C, FE9-05S-2C, FE9-05USMC, FE9-10, FE9-10-2C, FE9-10-4C, FG7-05-1C, FG7-05-2C, FG-710, FG7-10-2C, FG7-104C, FG7-10-4C, FG-720, FG9-05, FG9-05-1C, FG9-05-2C, FG9-05S, FG9-05S-1C, FG9-05S-2C, FG9-10, FG9-10-2C, FG9-10-4C, FGCL9-05, FI-120, FI-180, FI-250, FTE7-05, FTE7-05L, FTE7-05R, FTE7-10, FTE7-10L, FTE7-10L+R, FTE7-10R, FTE9-05L...(Other models you can see in the webshop)		

miscellaneous

 <p>1</p>			
<b>GEV No.</b>	510214	<b>Ref. No.</b>	12016656 X163015
<b>description</b>	union screw thread M9x1 hole ø 3.7mm L 12mm		
<b>For models:</b>	FE9-05, FE9-05S, FE9-05USMC, FE9-10, FG9-05, FG9-05S, FG9-10		

switches and momentary switches

rocker/momentary rocker switches

<p>19x13mm</p>  <p>1</p>			
<b>GEV No.</b>	301066	<b>Ref. No.</b>	12016888 R743008
<b>description</b>	rocker switch mounting measurements 19x13mm black 2NO 250V 6A 0-I connection male faston 4.8mm ambient temperature max. 85°C protection IP40		
<b>For models:</b>	HGV-10-11, HGV-20-11, HME-20-11, HMG-10-11, HMG-10-11UL, HMG-10-21, HMG-10-21UL, HMG-20-11, HMG-2-10-11, HMG-6-11, HMM-10-11, HMM-10-11UL, HMM-10-21, HMM-10-21UL, HMM-20-11, HMM-20-11UL, HMM-20-21, HMM-20-21UL, HMM-2-10-11, HMM-40-11-USMC, HMM-6-11, HMM-6-11UL, HMP-20-11, HVG-10-11, HVG-10-11UL, HVG-10-21, HVG-10-21UL, HVG-20-11, HVG-20-21, HVG-2-10-11, HVG-2-20-21, MFHMM-20-11, MFHVG-10-11, MFHVG-10-21		
<b>accessories for</b>	301066		
		<b>GEV No.</b>	301064
		<b>Ref. No.</b>	—
	protective cover for pressure switch external size 23.4x17.4mm internal size 19x13mm H 7.5mm clear mounting measurementsmm		



<p>28x13.5mm</p>  <p>1</p>			
<b>GEV No.</b>	347873	<b>Ref. No.</b>	12024372 Z20307
<b>description</b>	momentary rocker switch mounting measurements 27.4x12.4mm black 1NO 250V 16A connection male faston 6.3mm ambient temperature max. 85°C protection IP40		
<b>For models:</b>	FI-48D, FI-64D, LVC-15, LVC-15D, LVC-21, LVC-21D		



<p>30x11mm</p>  <p>1</p>			
<b>GEV No.</b>	345489	<b>Ref. No.</b>	12023616 Z403033
<b>description</b>	momentary rocker switch mounting measurements 30x11mm orange 1NO 250V 16A connection male faston 6.3mm ambient temperature max. 90°C protection IP40		
<b>For models:</b>	FI-48, FI-48AR, FI-48B, FI-48B-BT-UK, FI-48C, FI-48D, FI-48HY-CLINIC, FI-48W, FI-64, FI-64AR, FI-64B, FI-64B-BT-UK, FI-64C, FI-64D, FI-64HY-CLINIC, FI-64W, LVC-12, LVC-15, LVC-15D, LVC-21, LVC-21B, LVC-21C, LVC-21D, LVC-21W, LVR-14, LVR-14D, LVR-20, LVR-20D		

			
<b>1</b>			
<b>GEV No.</b>	301011	<b>Ref. No.</b>	12037353 6021130002
<b>description</b>	rocker switch mounting measurements 30x11mm orange 1NO/indicator light 250V 16A 0-I connection male faston 6.3mm ambient temperature max. 85/125°C protection IP40		
<b>For models:</b>	AEP-1402, AEP-1602, AEP-2103, AEP-701, AEP-801, AEP-802, AF-1402-MIX, AF-1403-C, AF-1403-P, AF-1404-C, AF-1404-P, AF-1602-MIX, AF-1603-C, AF-1603-P, AF-1604-C, AF-1604-P, AF-2104-C, AF-2104-P, AF-2105-C, AF-2105-P, AF-2106-C, AF-2106-P, AF-702-C, AF-702-P, AF-802-C, AF-802-P, AFN-1402, AFN-1403, AFN-1404, AFN-1602, AFN-1603, AFN-1604, AFN-701, AFN-702, AFN-801, AFN-802, AFP-1402, AFP-1403, AFP-1404, AFP-1404-USMC, AFP-1602, AFP-1602-2, AFP-1603, AFP-1603-2, AFP-1604, AFP-2103, AFP-2104, AFP-2105, AFP-2106, AFP-701...(Other models you can see in the webshop)		

			
<b>1</b>			
<b>GEV No.</b>	346787	<b>Ref. No.</b>	12037702 6003010074
<b>description</b>	dummy element external size 30x11mm black		
<b>For models:</b>	AF-1402-MIX, AF-1403-C, AF-1403-P, AF-1404-C, AF-1404-P, AF-1602-MIX, AF-1603-C, AF-1603-P, AF-1604-C, AF-1604-P, AF-2104-C, AF-2104-P, AF-2105-C, AF-2105-P, AF-2106-C, AF-2106-P, AF-702-C, AF-702-P, AF-802-C, AF-802-P, AFN-1402, AFN-1403, AFN-1404, AFN-1602, AFN-1603, AFN-1604, AFN-702, AFN-801, AFN-802, MFP-135-B, MFP-180-B, MFP-225-B, MFP-270-B		



30x22mm

			
<b>1</b>			
<b>GEV No.</b>	301002	<b>Ref. No.</b>	12024356 12035989 12036781 12037293 6001507003 6021130001 Z203003 Z203033 ZAINTE0009
<b>description</b>	rocker switch mounting measurements 30x22mm orange 2NO 250V 16A illuminated 0-I connection male faston 6.3mm ambient temperature max. 85/125°C protection IP65		
<b>For models:</b>	AC-120, AC-180, AEP-1402, AEP-1403, AEP-1404, AEP-1602, AEP-1603, AEP-1604, AEP-2103, AEP-701, AEP-702, AEP-801, AEP-802, AF-1402-MIX, AF-1403-C, AF-1403-P, AF-1404-C, AF-1404-P, AF-1602-MIX, AF-1603-C, AF-1603-P, AF-1604-C, AF-1604-P, AF-2104-C, AF-2104-P, AF-2105-C, AF-2105-P, AF-2106-C, AF-2106-P, AF-702-C, AF-702-P, AF-802-C, AF-802-P, AFN-1402, AFN-1403, AFN-1404, AFN-1602, AFN-1603, AFN-1604, AFN-701, AFN-702, AFN-801, AFN-802, AFP-1402, AFP-1402-FORZ, AFP-1402-MIX, AFP-1403, AFP-1403-C, AFP-1403-FORZ, AFP-1403-P...(Other models you can see in the webshop)		
<b>accessories for</b>	301002		
	<b>GEV No.</b>	301036	<b>Ref. No.</b> —
	protective cover internal size 30x22mm for rocker switch mounting measurementsmm		

			
<b>1</b>			
<b>GEV No.</b>	345491	<b>Ref. No.</b>	12039115 Z213001 Z213033
<b>description</b>	momentary rocker switch mounting measurements 30x22mm orange 1NO/indicator light 250V 16A connection male faston 6.3mm ambient temperature max. 100/55°C protection IP40		
<b>For models:</b>	EASY-500, EASY-500B, EASY-500DD, EASY-500HP, EASY-500HPWBDD, FI-48, FI-48AR, FI-48B, FI-48B-BT-UK, FI-48C, FI-48D, FI-48HY-CLINIC, FI-48W, FI-64, FI-64AR, FI-64B, FI-64B-BT-UK, FI-64C, FI-64D, FI-64HY-CLINIC, FI-64W, FI-72, GA-20, GA-20D, GA-40, GA-40D, HCG-10-11, HCG-10-21, HCG-20-11, HCG-20-21, HCG-2-10-11, HCG-2-20-11, HCG-6-11, HCG-10-11, HCG-20-11, HCG-6-11, HGV-10-11, HGV-20-11, HVG-10-11, HVG-10-11UL, HVG-10-21, HVG-10-21UL, HVG-20-11, HVG-20-21, HVG-2-10-11, HVG-2-20-21, LAC-10MP, LAC-10MPP, LAC-14MP, LAC-14MPP...(Other models you can see in the webshop)		
<b>accessories for</b>	345491		
	<b>GEV No.</b>	301036	<b>Ref. No.</b> —
	protective cover internal size 30x22mm for rocker switch mounting measurementsmm		

			
<b>1</b>			
<b>GEV No.</b>	346689	<b>Ref. No.</b>	12024213 Z203080
<b>description</b>	momentary rocker switch mounting measurements 30x22mm orange 1NO/indicator light 230V 16A illuminated connection male faston 6.3mm ambient temperature max. 125°C protection IP40		
<b>For models:</b>	FI-48, FI-48AR, FI-48B, FI-48B-BT-UK, FI-48C, FI-48D, FI-48HY-CLINIC, FI-48W, FI-64, FI-64AR, FI-64B, FI-64B-BT-UK, FI-64C, FI-64D, FI-64HY-CLINIC, FI-64W, FI-72, FI-72AR, FI-72W, GA-20, GA-40, LVC-15, LVC-15D, LVC-21, LVC-21B, LVC-21C, LVC-21D, LVC-21W		

			
<b>1</b>			
<b>GEV No.</b>	301061	<b>Ref. No.</b>	12025209 Z203071
<b>description</b>	rocker switch mounting measurements 30x22mm orange 2NO 250V 16A illuminated connection male faston 6.3mm ambient temperature max. 125/55°C protection IP40		
<b>For models:</b>	FI-30, FI-30AR, FI-30AR+DD, FI-30-UK, FI-60DD, LVC-12, LVC-15, LVC-21		

			
<b>1</b>			
<b>GEV No.</b>	346377	<b>Ref. No.</b>	12037317 12049461
<b>description</b>	rocker switch mounting measurements 30x22mm black 2CO 230V 16A 0-I connection male faston 6.3mm ambient temperature max. 125/55°C protection IP40		
<b>accessories for</b>	346377		
	<b>GEV No.</b>	301036	<b>Ref. No.</b> —
	protective cover internal size 30x22mm for rocker switch mounting measurementsmm		



			
1			
<b>GEV No.</b>	345423	<b>Ref. No.</b>	12020632 X343002
<b>description</b>	momentary rocker switch mounting measurements 30x22mm black 2CO 230V 16A with neutral position arrow up/down connection male faston 6.3mm ambient temperature max. 125/55°C protection IP40		
<b>For models:</b>	SBE9-10IM, SBE9-10IMS, SBE9-10M, SBE9-10MS, SBE9-15IM, SBE9-15IMS, SBG9-10IM, SBG9-10IMS, SBG9-10M, SBG9-10MS, SBG9-15IM, SBG9-15IMS		

			
1			
<b>GEV No.</b>	345689 <sup>1</sup>	<b>Ref. No.</b>	12020974 R723027
<b>description</b>	momentary rocker switch mounting measurements 30x22mm orange 1NO 250V 16A illuminated, lamp 12 V connection male faston 6.3mm ambient temperature max. 85/125°C protection IP40		
<b>For models:</b>	HCG-10-11, HCG-10-21, HCG-20-11, HCG-2-10-11, HCG-6-11, HMG-10-11, HMG-10-11UL, HMG-10-21, HMG-10-21UL, HMG-20-11, HMG-2-10-11, HMG-6-11		

<sup>1</sup>illuminated

			
1			
<b>GEV No.</b>	347092	<b>Ref. No.</b>	12035896 OSC0000107
<b>description</b>	rocker switch mounting measurements 30x22mm red/black 1CO/indicator light 250V 16A connection male faston 6.3mm ambient temperature max. 85°C protection IP65 with cover cap		

push/momentary push switches

<p>19x13mm</p> 			
1			
<b>GEV No.</b>	345690	<b>Ref. No.</b>	12016811 R663032
<b>description</b>	momentary push switch mounting measurements 19x13mm black 1NO 250V 16A connection male faston 4.8mm ambient temperature max. 105°C protection IP40		
<b>For models:</b>	FF-35, HCG-10-11, HCG-10-21, HCG-20-11, HCG-20-21, HCG-2-10-11, HCG-2-20-11, HCG-6-11, HEI-10-11, HEI-20-11, HEI-6-11, HEM-10-11, HEM-20-11, HEM-6-11, HEP-10-11, HEP-20-11, HEP-6-11, HGC-10-11, HGC-20-11, HGC-6-11, HME-10-11, HME-10-21, HME-20-11, HME-20-21, HME-2-10-11, HME-2-20-11, HME-6-11, HMG-10-11, HMG-10-11UL, HMG-10-21, HMG-10-21UL, HMG-20-11, HMG-2-10-11, HMG-6-11, HMI-10-11, HMI-10-11UL, HMI-10-21, HMI-10-21UL, HMI-2-10-11, HMI-6-11, HMI-6-11UL, HMP-10-11, HMP-10-21, HMP-20-11, HMP-20-21, HMP-2-10-11, HMP-6-11		

<p>30x22mm</p> 			
1			
<b>GEV No.</b>	301047 <sup>1</sup>	<b>Ref. No.</b>	12024373 Z853001
<b>description</b>	push switch mounting measurements 30x22mm green 2NO 250V 16A illuminated connection male faston 6.3mm ambient temperature max. 85°C protection IP40 latching		
<b>For models:</b>	FE-18, FE-25, FE-4, FE-6, FE-71-15, FE-8, FE-91-20, FI-300R, FI-650R, HCV-10-11, HCV-10-21, HCV-2-10-21		

<sup>1</sup>illuminated

<p>ø22mm</p> 			
1			
<b>GEV No.</b>	348233	<b>Ref. No.</b>	12023927 T723009000
<b>description</b>	momentary push switch mounting ø 22mm black 1NO/1NC 250V 3A connection F2,8x0,5		
<b>For models:</b>	ACE-061, ACE-101, AE-061, AE-101, APE-061, APE-101, APE-102, APE-201, APE-202, APG-061, APG-101, APG-102, APG-201, APG-202, CG9-31PLUS-D, CG9-31PLUS-I		

			
1			
<b>GEV No.</b>	348220	<b>Ref. No.</b>	12115383
<b>description</b>	momentary push switch mounting ø 22mm silver 1NO/1NC/indicator light 220V 5A connection male faston 2.8mm round		
<b>For models:</b>	CO-350, CO-350-B, CO-350-B-DD, CO-350-COLD, CO-350-COLD-B, CO-350-COLD-B-DD, CO-350-COLD-DD, CO-350-DD, CO-400, CO-400-B, CO-400-B-DD, CO-400-COLD, CO-400-COLD-B, CO-400-COLD-B-DD, CO-400-COLD-DD, CO-400-DD, CO-400-SOFT, CO-500, CO-500B, CO-500BDD, CO-500DD, CO-501, CO-501B, CO-501BDD, CO-501DD, CO-501-SOFT		

			
1			
<b>GEV No.</b>	346662	<b>Ref. No.</b>	12000066 X022108
<b>description</b>	protective cover internal size 30x55mm		
<b>For models:</b>	SBE9-10I, SBE9-10IM, SBE9-10IMS, SBE9-10IS, SBE9-10M, SBE9-10MS, SBE9-15IM, SBE9-15IMS, SBE9-15M, SBE9-15MS, SBG9-10IM, SBG9-10IMS, SBG9-10M, SBG9-10MS, SBG9-15IM, SBG9-15IMS		



ø25mm



1

<b>GEV No.</b>	345039	<b>Ref. No.</b>	12036803 FX40100036
<b>description</b>	protective cover round ED ø 33mm external size 23mm internal size 21mm H 12mm clear mounting ø 25mm		
<b>accessories for</b>	345039		
	GEV No.	345001	Ref. No. —
<b>description</b>	momentary push switch mounting ø 25mm yellow 1NO/indicator light 250V 16A cover connection male faston 6.3mm ambient temperature max. 85°C protection IP65		

accessories

fitting parts

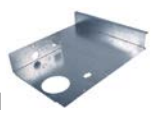

1

<b>GEV No.</b>	691716	<b>Ref. No.</b>	12013476 T093000
<b>description</b>	mounting plate electric suitable for convection oven		
<b>For models:</b>	HCG-20-11, HMG-20-11		



1

<b>GEV No.</b>	691717	<b>Ref. No.</b>	12012593 T083003
<b>description</b>	mounting plate electric suitable for convection oven		
<b>For models:</b>	HCG-10-11, HCG-10-21, HCG-20-11, HCG-20-21, HCG-2-10-11, HCG-2-20-11, HCG-6-11, HGC-10-11, HGC-20-11, HGC-6-11		



1

<b>GEV No.</b>	401784	<b>Ref. No.</b>	12003412 X342608
<b>description</b>	mounting plate for switch		
<b>For models:</b>	SBE9-10, SBE9-10I, SBE9-10IM, SBE9-10IMS, SBE9-10IS, SBE9-10M, SBE9-10MS, SBE9-10S, SBE9-15IM, SBE9-15IMS, SBE9-15M, SBE9-15MS, SBG9-10IM, SBG9-10IMS, SBG9-10M, SBG9-10MS, SBG9-15IM, SBG9-15IMS		



1

<b>GEV No.</b>	401785	<b>Ref. No.</b>	12012103 S322613
<b>description</b>	mounting plate for switch		
<b>For models:</b>	MG7-10BM		



1

<b>GEV No.</b>	691005	<b>Ref. No.</b>	12001816 X313001
<b>description</b>	support bracket for thermostat and switch		
<b>For models:</b>	BME7-05, BME7-10, BME9-05, BME9-05V-T, BME9-10, BME9-10V-T, FE7-05-1C, FE7-05-2C, FE-710, FE7-10-2C, FE7-10-4C, FE-720, FE9-05, FE9-05-1C, FE9-05-2C, FE9-05S, FE9-05S-1C, FE9-05S-2C, FE9-05USMC, FE9-10, FE9-10-2C, FE9-10-4C, FG7-05-1C, FG7-05-2C, FG-710, FG7-10-2C, FG7-104C, FG7-10-4C, FG-720, FG9-05, FG9-05-1C, FG9-05-2C, FG9-05S, FG9-05S-1C, FG9-05S-2C, FG9-10, FG9-10-2C, FG9-10-4C, FGCL9-05, FI-120, FI-180, FI-250, FTE7-05, FTE7-05L, FTE7-05R, FTE7-10, FTE7-10L, FTE7-10L+R, FTE7-10R, FTE9-05L...(Other models you can see in the webshop)		

microswitches

lever actuated



1

<b>GEV No.</b>	345254	<b>Ref. No.</b>	12033747 GMP831613
<b>description</b>	microswitch with lever 250V 16A 1CO connection male faston 6.3mm ambient temperature max. 120°C mounting distance 22mm actuating force: 60g lever length 58mm		

roller-lever actuated

microswitches



1

<b>GEV No.</b>	345216	<b>Ref. No.</b>	12035139 RT30160101
<b>description</b>	microswitch 250V 16A 1CO connection male faston 6.3mm ambient temperature max. 125°C mounting distance 22mm with handle with a switch blue/black		





1

<b>GEV No.</b>	347949	<b>Ref. No.</b>	12035191 RT30160102
<b>description</b>	microswitch with handle with a switch 250V 0.1A 1NC connection male faston 6.3mm L 21mm L1 12mm mounting distance 24mm white		





			
1			
<b>GEV No.</b>	345250	<b>Ref. No.</b>	12025193 R010534
<b>description</b>	microswitch with handle with a switch 250V 16A 1CO connection male faston 6.3mm L 27mm L1 36mm ambient temperature max. 125°C mounting distance 22mm type RL6-1-FGE-P12-5-L actuating force: 90g		
<b>For models:</b>	ACE-061, ACE-101, ACE-102, ACE-201, ACE-202, ACG-061, ACG-101, ACG-102, ACG-201, ACG-202, AE-061, AE-061W, AE-101, AE-101W, AE-102, AE-102W, AE-201, AE-202, AG-061, AG-061W, AG-101, AG-101W, AG-102, AG-102W, AG-201, AG-202, APE-061, APE-061W, APE-101, APE-101W, APE-102, APE-102W, APE-201, APE-202, APG-061, APG-061W, APG-101, APG-101W, APG-102, APG-102W, APG-201, APG-202, COE-061, COE-101, COE-102, COE-201, COE-202, FE-710, FE-720, FE-905...(Other models you can see in the webshop)		

pin-plunger actuated			
			
1			
<b>GEV No.</b>	345105	<b>Ref. No.</b>	12037903 BR00023055
<b>description</b>	microswitch with plunger 250V 16A 1CO connection male faston 6.3mm L 28mm ambient temperature max. 125°C mounting distance 22mm type SM-51 actuating force: 280g black		

M10			
			
1			
<b>GEV No.</b>	345032	<b>Ref. No.</b>	12040850 GMP831318
<b>description</b>	microswitch with plunger thread M10x1 thread L 12mm 250V 16A 1CO connection male faston 6.3mm stroke 7mm mounting distance 22mm L 28mm ambient temperature max. 125°C type SP9603 actuating force: 180g		
<b>For models:</b>	FE-18, FE-25, FE-4, FE-6, FE-8, SBE7-10, SBE9-10, SBE9-10I, SBE9-10IM, SBE9-10IMS, SBE9-10IS, SBE9-10M, SBE9-10MS, SBE9-10PLUS-I, SBE9-10PLUS-IM, SBE9-10PLUS-SI, SBE9-10PLUS-SIM, SBE9-10S, SBE9-15IM, SBE9-15IMS, SBE9-15M, SBE9-15MS, SBE9-15PLUS-IM, SBE9-15PLUS-SIM, SBG7-10, SBG9-10, SBG9-10I, SBG9-10IM, SBG9-10IMS, SBG9-10IS, SBG9-10M, SBG9-10MS, SBG9-10PLUS-I, SBG9-10PLUS-IM, SBG9-10PLUS-SI, SBG9-10PLUS-SIM, SBG9-10S, SBG9-15IM, SBG9-15IMS, SBG9-15PLUS-IM, SBG9-15PLUS-SIM		

with push button			
switches with snap-fit			
			
1			
<b>GEV No.</b>	346724	<b>Ref. No.</b>	12037396 6021130008
<b>description</b>	microswitch with push button 250V 0.25A 1NO connection male faston 4.8mm L 25x12.5mm ambient temperature max. 85°C actuating force: 900g		
<b>For models:</b>	AEP-1402, AEP-1602, AEP-2103, AEP-701, AEP-801, AEP-802, AF-1402-MIX, AF-1403-C, AF-1403-P, AF-1404-C, AF-1404-P, AF-1602-MIX, AF-1603-C, AF-1603-P, AF-1604-C, AF-1604-P, AF-2104-C, AF-2104-P, AF-2105-C, AF-2105-P, AF-2106-C, AF-2106-P, AF-702-C, AF-702-P, AF-802-C, AF-802-P, AFN-1402, AFN-1403, AFN-1404, AFN-1602, AFN-1603, AFN-1604, AFN-702, AFN-801, AFN-802, AFP-1402, AFP-1403, AFP-1404, AFP-1404-USMC, AFP-1602, AFP-1602-2, AFP-1603, AFP-1603-2, AFP-1604, AFP-2103, AFP-2104, AFP-2105, AFP-2106, AFP-701, AFP-702...(Other models you can see in the webshop)		

			
1			
<b>GEV No.</b>	348207	<b>Ref. No.</b>	12036888 12037050 6021130032 6021130041
<b>description</b>	switch 250V 5A 1CO connection F4.8 L 27.5mm type 5E4 25T85 actuating force: 150g		
<b>For models:</b>	ADAEP-1602, ADAEP-1602, ADAFN-1602, ADAFN-801, ADAFP-1602, ADAFP-801, AEF-801AD, AEF-802AD, AEP-1402, AEP-1602, AEP-1602AD, AEP-1603AD, AEP-1604AD, AEP-2103, AEP-701, AEP-801, AEP-802, AF-1402-MIX, AF-1403-C, AF-1403-P, AF-1404-C, AF-1404-P, AF-1602-MIX, AF-1603-C, AF-1603-P, AF-1604-C, AF-1604-P, AF-2104-C, AF-2104-P, AF-2105-C, AF-2105-P, AF-2106-C, AF-2106-P, AF-702-C, AF-702-P, AF-802-C, AF-802-P, AFN-1402, AFN-1403, AFN-1404, AFN-1602, AFN-1603, AFN-1604, AFN-701, AFN-702, AFN-801, AFN-802, AFP-1402, AFP-1403, AFP-1404...(Other models you can see in the webshop)		

accessories			
			
1			
<b>GEV No.</b>	505166	<b>Ref. No.</b>	Z653010
<b>description</b>	actuator for microswitch		

			
1			
<b>GEV No.</b>	691863	<b>Ref. No.</b>	12020591 X153007
<b>description</b>	bar L 200mm ø 8mm		
<b>For models:</b>	SBE7-10, SBE9-10, SBE9-10I, SBE9-10IM, SBE9-10IMS, SBE9-10IS, SBE9-10M, SBE9-10MS, SBE9-10S, SBE9-15IM, SBE9-15IMS, SBE9-15M, SBE9-15MS, SBE9-15PLUS-IM, SBE9-15PLUS-SIM, SBE9-15S, SBE9-15MS, SBE9-15PLUS-IM, SBE9-15PLUS-SIM		

			
<b>GEV No.</b>	691077	<b>Ref. No.</b>	12009985 R010535
<b>description</b>	insulation L 45mm for microswitch W 30mm thickness 1mm		
<b>For models:</b>	ACE-061, ACE-101, ACE-102, ACE-201, ACE-202, ACG-061, ACG-101, ACG-102, ACG-201, ACG-202, AE-061, AE-061W, AE-101, AE-101W, AE-102, AE-102W, AE-201, AE-202, AG-061, AG-061W, AG-101, AG-101W, AG-102, AG-102W, AG-201, AG-202, APE-061, APE-061W, APE-101, APE-101W, APE-102, APE-102W, APE-201, APE-202, APG-061, APG-061W, APG-101, APG-101W, APG-102, APG-102W, APG-201, APG-202, COE-061, COE-101, COE-102, COE-201, COE-202, FE-710, FE-720, FE9-05...(Other models you can see in the webshop)		

			
<b>GEV No.</b>	691079	<b>Ref. No.</b>	12020976 R010533
<b>description</b>	pressure pin for microswitch		
<b>For models:</b>	FE-710, FE-720, FE9-05, FE9-05S, FE9-05USMC, FE9-10, FE-920, HCG-10-11, HCG-10-21, HCG-20-11, HCG-2-10-11, HCG-6-11, HCV-10-11, HCV-10-21, HCV-2-10-21, HE-10-11, HE-10-21, HE-2-10-11, HE-6-11, HG-10-21, HG-2-10-11, HME-10-11, HME-10-21, HME-20-11, HME-20-21, HME-2-10-11, HME-6-11, HMG-10-11, HMG-10-11UL, HMG-10-21, HMG-10-21UL, HMG-20-11, HMG-2-10-11, HMG-6-11, HMI-10-11, HMI-10-11UL, HMI-10-21, HMI-10-21UL, HMI-2-10-11, HMI-6-11, HMI-6-11UL, HMM-10-11, HMM-10-11UL, HMM-10-21, HMM-10-21UL, HMM-20-11, HMM-20-11UL, HMM-20-21, HMM-2-10-11, HMM-6-11...(Other models you can see in the webshop)		

system switches (ROLD)

			
<b>GEV No.</b>	346499	<b>Ref. No.</b>	12009331 X022107
<b>description</b>	element holder mounting measurements 28.5x52.6mm black two-fold element holder		
<b>For models:</b>	SBE9-10, SBE9-10I, SBE9-10IM, SBE9-10IM-AD, SBE9-10IM-AD-S, SBE9-10IMS, SBE9-10IS, SBE9-10M, SBE9-10MS, SBE9-10PLUS-IM, SBE9-10PLUS-SIM, SBE9-10S, SBE9-15IM, SBE9-15IM-AD, SBE9-15IM-AD-S, SBE9-15IMS, SBE9-15M, SBE9-15MS, SBE9-15PLUS-IM, SBE9-15PLUS-SIM, SBG9-10IM, SBG9-10IM-AD, SBG9-10IM-AD-S, SBG9-10IMS, SBG9-10M, SBG9-10MS, SBG9-10PLUS-IM, SBG9-10PLUS-SIM, SBG9-15IM, SBG9-15IM-AD, SBG9-15IM-AD-S, SBG9-15IMS, SBG9-15PLUS-IM, SBG9-15PLUS-SIM		

			
<b>GEV No.</b>	345650	<b>Ref. No.</b>	12024804 X022109
<b>description</b>	momentary switch unit 2CO 250V 16A connection male faston 6.3mm		
<b>For models:</b>	SBE9-10, SBE9-10I, SBE9-10IM, SBE9-10IM-AD, SBE9-10IM-AD-S, SBE9-10IMS, SBE9-10IS, SBE9-10M, SBE9-10MS, SBE9-10PLUS-IM, SBE9-10PLUS-SIM, SBE9-10S, SBE9-15IM, SBE9-15IM-AD, SBE9-15IM-AD-S, SBE9-15IMS, SBE9-15M, SBE9-15MS, SBE9-15PLUS-IM, SBE9-15PLUS-SIM, SBG9-10IM, SBG9-10IM-AD, SBG9-10IM-AD-S, SBG9-10IMS, SBG9-10M, SBG9-10MS, SBG9-10PLUS-IM, SBG9-10PLUS-SIM, SBG9-15IM, SBG9-15IM-AD, SBG9-15IM-AD-S, SBG9-15IMS, SBG9-15PLUS-IM, SBG9-15PLUS-SIM		

			
<b>GEV No.</b>	346626	<b>Ref. No.</b>	12009956 X022106
<b>description</b>	push button ø 23mm black arrow		
<b>For models:</b>	SBE9-10, SBE9-10I, SBE9-10IM, SBE9-10IM-AD, SBE9-10IM-AD-S, SBE9-10IMS, SBE9-10IS, SBE9-10M, SBE9-10MS, SBE9-10PLUS-IM, SBE9-10PLUS-SIM, SBE9-10S, SBE9-15IM, SBE9-15IM-AD, SBE9-15IM-AD-S, SBE9-15IMS, SBE9-15M, SBE9-15MS, SBE9-15PLUS-IM, SBE9-15PLUS-SIM, SBG9-10IM, SBG9-10IM-AD, SBG9-10IM-AD-S, SBG9-10IMS, SBG9-10M, SBG9-10MS, SBG9-10PLUS-IM, SBG9-10PLUS-SIM, SBG9-15IM, SBG9-15IM-AD, SBG9-15IM-AD-S, SBG9-15IMS, SBG9-15PLUS-IM, SBG9-15PLUS-SIM		

cam switches

on/off

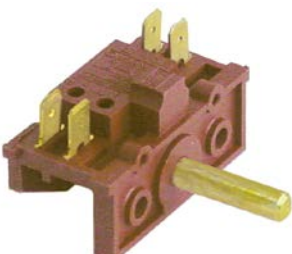
			
<b>GEV No.</b>	345686	<b>Ref. No.</b>	12020265 R753000
<b>description</b>	cam switch 2 operating positions 2NO sequence 0-1 10A shaft ø 6x4.6mm shaft L 23mm connection male faston 6.3mm ON-OFF plastic		
<b>For models:</b>	HEI-10-11, HEI-20-11, HME-20-11, HMI-10-11, HMI-10-11UL, HMI-10-21, HMI-10-21UL, HMI-2-10-11, HMM-10-11, HMM-10-11UL, HMM-10-21, HMM-10-21UL, HMM-20-11, HMM-20-11UL, HMM-20-21, HMM-20-21UL, HMM-2-10-11, HMM-6-11, HMP-20-11, MFHMM-20-11		

7-position

			
<b>GEV No.</b>	300031	<b>Ref. No.</b>	12024405 U673007
<b>description</b>	cam switch 7 operating positions 1NO/2CO sequence 0-1-2-3-4-5-6 16A shaft ø 6x4.6mm shaft L 23mm connection male faston 6.3mm 7-position plastic		
<b>For models:</b>	CE6-20, CE6-40, CE6-41, CE7-20, CE7-20Q, CE7-40, CE7-40Q, CE7-41, CE7-41Q, CE9-20, CE9-20AD, CE9-20PLUS, CE9-40, CE9-40AD, CE9-40PLUS, CE9-41, CE9-41AD, CE9-41PLUS		

2 operating positions



<b>GEV No.</b>	301316	<b>Ref. No.</b>	12024465 T343008
<b>description</b>	cam switch 2 operating positions 2NO sequence 0-1 16A shaft ø 6x4.6mm shaft L 23mm connection male faston 6.3mm 660201		
<b>For models:</b>	BME7-05, BME7-10, BMG7-10, CPE9-05, CPE9-05NC, CPE9-05S, CPE9-05SNC, CPG9-05, CPG9-05NC, CPG9-05S, CPG9-05SNC, HGC-10-21, HGC-20-21, MV7-10BM, MV9-10BM, MV9-15BM, SBE7-10, SBE9-10, SBE9-10I, SBE9-10IM, SBE9-10IMS, SBE9-10IS, SBE9-10M, SBE9-10MS, SBE9-10S, SBE9-15IM, SBE9-15IMS, SBE9-15M, SBE9-15MS, SBG7-10, SBG9-10, SBG9-10I, SBG9-10IM, SBG9-10IMS, SBG9-10IS, SBG9-10M, SBG9-10MS, SBG9-10S, SBG9-15IM, SBG9-15IMS		

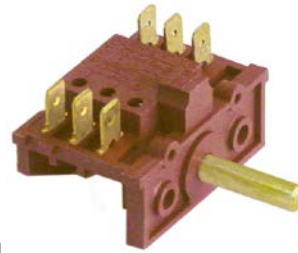

<b>GEV No.</b>	345687	<b>Ref. No.</b>	12019852 T013001	
<b>description</b>	cam switch 3 operating positions sequence 1-0-2 16A shaft ø 6x4.6mm shaft L 23mm connection male faston 6.3mm plastic			
<b>For models:</b>	HCG-10-11, HCG-10-21, HCG-20-11, HCG-20-21, HCG-2-10-11, HCG-2-20-11, HCG-6-11, HGC-10-11, HGC-20-11, HGC-6-11			
<b>accessories for</b>	345687			
	<b>GEV No.</b>	691074	<b>Ref. No.</b>	12024516 R663046
	gasket switch shaft			

3 operating positions



<b>GEV No.</b>	345684	<b>Ref. No.</b>	12019182 R663026
<b>description</b>	cam switch 3 operating positions 10NO sequence 1-2-3 16A shaft ø 6x4.6mm shaft L 34mm connection male faston 6.3mm plastic		
<b>For models:</b>	HEI-10-21, HEI-20-21, HEM-10-11, HEM-10-21, HEM-20-11, HEM-20-21, HEM-6-11, HEP-10-11, HEP-20-11, HEP-6-11, HGC-10-21, HGC-20-21, HGV-10-21, HGV-20-21, HME-10-11, HME-10-21, HME-20-11, HME-20-21, HME-2-10-11, HME-2-20-11, HME-6-11, HMP-10-11, HMP-10-21, HMP-20-11, HMP-20-21, HMP-2-10-11, HMP-6-11		

4 operating positions



<b>GEV No.</b>	347386	<b>Ref. No.</b>	12024733 Z273005
<b>description</b>	cam switch 4 operating positions 6NO sequence 0-1-2-3 16A shaft ø 6x4.6mm shaft L 23mm connection male faston 6.3mm 7LA 840601		
<b>For models:</b>	ECO-160, ECO-160D, ECO-160I, ECO-200, ECO-200D, ECO-200H, ECO-200HD, ECO-200HI, ECO-200I, ECO-2700D, ECO-2700I, ECO-280D, ECO-280I, ECO-370D, ECO-370I, ECO-4000D, ECO-4000I, ECO-460D, ECO-460I, ECO-550D, ECO-550I, ECO-6000D, ECO-6000I, FI-160, FI-160AR, FI-160D, FI-160I, FI-200, FI-200AR, FI-200D, FI-200H, FI-200HD, FI-200HI, FI-200I, FI-200W, FI-200WL, FI-200WR, FI-2700D, FI-2700I, FI-280D, FI-280I, FI-370D, FI-370I, FI-4000D, FI-4000I, FI-460D, FI-460I, FI-550D, FI-550I, FI-6000D... (Other models you can see in the webshop)		



<b>GEV No.</b>	345492	<b>Ref. No.</b>	12025105 Z213003
<b>description</b>	cam switch 3 operating positions 3NO sequence 1-0-2 16A shaft ø 6x4.6mm shaft L 23mm connection male faston 6.3mm		



<b>GEV No.</b>	347638	<b>Ref. No.</b>	12023800 R693004
<b>description</b>	cam switch 4 operating positions 6NO sequence 0-1-2-3 16A shaft ø 6x4.6mm shaft L 23mm connection male faston 6.3mm plastic		
<b>For models:</b>	CPE9-05, CPE9-05AD, CPE9-05AD-S, CPE9-05NC, CPE9-05PLUS, CPE9-05PLUS-S, CPE9-05S, CPE9-05SNC, CPG9-05, CPG9-05AD, CPG9-05AD-S, CPG9-05NC, CPG9-05PLUS, CPG9-05PLUS-S, CPG9-05S, CPG9-05SNC, HEI-10-11, HEI-20-11, HEI-6-11, HMI-10-11, HMI-10-11UL, HMI-10-21, HMI-10-21UL, HMI-2-10-11, HMI-6-11, HMI-6-11UL, ME7-10BM, ME9-10BM, ME9-10BMS, ME9-10PLUS-BM, ME9-10PLUS-BMS, ME9-15BM, ME9-15BM316, ME9-15BM-AD, ME9-15BMS, ME9-15PLUS-BM, ME9-15PLUS-BMS, MG7-10, MG7-10BM, MG9-10, MG9-10AD, MG9-10BM, MG9-10BMAD, MG9-10BMS, MG9-10BMSAD, MG9-10PLUS, MG9-10PLUS-BM, MG9-10PLUS-BMS, MG9-10PLUS-S, MG9-10S... (Other models you can see in the webshop)		



1

<b>GEV No.</b>	345409	<b>Ref. No.</b>	12023918 U673006
<b>description</b>	cam switch 4 operating positions 8NO sequence 0-1-2-3 16A shaft ø 6x4.6mm shaft L 23mm connection male faston 6.3mm plastic		
<b>For models:</b>	CE6-41, CE7-41, CE7-41Q, CE9-41, CE9-41AD, CE9-41PLUS, CGE6-41, CGE7-229, CGE7-41, CGE7-41H, CGE9-11, CGE9-41, CGE9-41AD, CGE9-41PLUS, HE9-10, HE9-20		

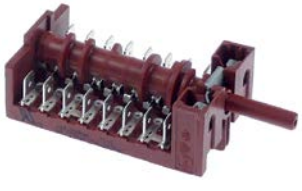

1

<b>GEV No.</b>	347817	<b>Ref. No.</b>	12024445
<b>description</b>	cam switch 4 operating positions 8NO sequence 1-0-2-3 16A shaft ø 6x4.6mm shaft L 23mm connection male faston 6.3mm plastic		
<b>For models:</b>	CO-500, CO-500B, CO-500BDD, CO-500DD, CO-501, CO-501B, CO-501BDD, CO-501DD, CO-501-SOFT, EASY-500, EASY-500B, EASY-500DD, EASY-500HP, EASY-500HPWBDD		



1

<b>GEV No.</b>	345494	<b>Ref. No.</b>	12024972 old version Z433001
<b>description</b>	cam switch 4 operating positions sequence 1-0-2-3 momentary 16A(4)A shaft ø 6x4.6mm shaft L 23mm connection male faston 6.3mm plastic		
<b>For models:</b>	LVC-15D, LVC-21B, LVC-21C, LVC-21D, LVC-21W, LVR-14D, LVR-20, LVR-20B, LVR-20D, MF-21		



1

<b>GEV No.</b>	348225	<b>Ref. No.</b>	12024972 new version
<b>description</b>	cam switch 4 operating positions sequence 1-0-2-3 momentary 16A(4)A shaft ø 6x4.6mm shaft L 23mm connection male faston 6.3mm plastic		



1

<b>GEV No.</b>	345493	<b>Ref. No.</b>	Z223001
<b>description</b>	cam switch 4 operating positions sequence 1-0-2-3 shaft ø 6x4.6mm connection male faston 8-pole		
<b>For models:</b>	FI-30, FI-30AR, FI-30AR+DD, FI-30B, FI-30B-BT-UK, FI-30-UK, FI-48, FI-48AR, FI-48B, FI-48B-BT-UK, FI-48C, FI-48D, FI-48HY-CLINIC, FI-48W, FI-64, FI-64AR, FI-64B, FI-64B-BT-UK, FI-64C, FI-64D, FI-64HY-CLINIC, FI-64W, MF-48, MF-64		

6 operating positions



1

<b>GEV No.</b>	345683	<b>Ref. No.</b>	12019003 R663025
<b>description</b>	cam switch 6 operating positions 7NO sequence 0-1-2-3-4-5 16A shaft ø 6x4.6mm shaft L 23mm connection male faston 6.3mm plastic		
<b>For models:</b>	HEM-10-11, HEM-20-11, HEM-6-11, HEP-10-11, HEP-20-11, HEP-6-11, HME-10-11, HME-10-21, HME-20-11, HME-20-21, HME-2-10-11, HME-2-20-11, HME-6-11, HMP-10-11, HMP-10-21, HMP-20-11, HMP-20-21, HMP-2-10-11, HMP-6-11		



1

<b>GEV No.</b>	347578	<b>Ref. No.</b>	12024290 Z683085
<b>description</b>	cam switch 6 operating positions 7NO sequence 0-1-2-3-4-5 16A shaft ø 6x4.6mm shaft L 23mm connection male faston 6.3mm plastic		
<b>For models:</b>	ECO-120, ECO-120B, FI-100, FI-100AR, FI-100B, FI-120, FI-1200, FI-120AR+DD, FI-120B, FI-120W, FI-900, LABP-1000, LABP-1200, MF-120		



1

<b>GEV No.</b>	345688	<b>Ref. No.</b>	12019026 R723011
<b>description</b>	cam switch 6 operating positions sequence 0-1-2-3-4-5 16A shaft ø 6x4.6mm shaft L 23mm connection male faston 6.3mm plastic		
<b>For models:</b>	HMG-10-11, HMG-10-11UL, HMG-10-21, HMG-10-21UL, HMG-20-11, HMG-2-10-11, HMG-6-11		





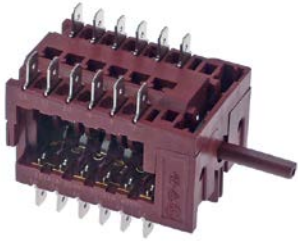

			
1			
<b>GEV No.</b>	347091	<b>Ref. No.</b>	12018564 T113030
<b>description</b>	cam switch 6 operating positions sequence 0-1-2-3-4-5 16A shaft ø 6x4.6mm shaft L 23mm connection male faston 6.3mm plastic		
<b>For models:</b>	HGV-10-11, HGV-20-11, HVG-10-11, HVG-10-11UL, HVG-10-21, HVG-10-21UL, HVG-20-11, HVG-20-21, HVG-2-10-11, HVG-2-20-21, MFHVG-10-11, MFHVG-10-21		

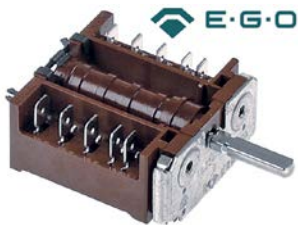
7 operating positions			
			
1			
<b>GEV No.</b>	301298	<b>Ref. No.</b>	12024932 Z713097
<b>description</b>	cam switch 7 operating positions 12NO sequence 0-1-2-3-4-5-6 16A shaft ø 6x4.6mm shaft L 23mm connection male faston 6.3mm plastic 12-pole		
<b>For models:</b>	CO-110, CO-110B, CO-110BDD, CO-110DD, CO-170, CO-170B, CO-170BDD, CO-170DD, CO-170HRS, CO-170HRSDD, CO-170HRS-SOFT, CO-170-SOFT, ECO-120B, FI-100B, FI-100BBT-UK, FI-120B, FI-120C, FI-120HY-CLINIC		

operation switches			
			
1			
<b>GEV No.</b>	301109	<b>Ref. No.</b>	12024459 X163007
<b>description</b>	cam switch 2 operating positions 4NO 16A sequence 0-1 shaft ø 6x4.6mm shaft L 23mm connection male faston 6.3mm plastic 4-pole		
<b>For models:</b>	BME6-05, BME7-05, BME7-10, BME9-05, BME9-05AD, BME9-05PLUS, BME9-05V-T, BME9-10, BME9-10AD, BME9-10PLUS, BME9-10V-T, CMF6-05, CPE6-05, FE6-05, FE6-05TE, FE6-10, FE6-10TE, FE7-05-1C, FE7-05-2C, FE-710, FE7-10-2C, FE7-10-4C, FE-720, FE9-05, FE9-05-1C, FE9-05-2C, FE9-05AD, FE9-05PLUS, FE9-05PLUS-S, FE9-05S, FE9-05S-1C, FE9-05S-2C, FE9-05S-AD, FE9-05USMC, FE9-10, FE9-10-2C, FE9-10-4C, FE9-10AD, FE9-10PLUS, FE-920, FG7-05-1C, FG7-05-2C, FG-710, FG7-10-2C, FG7-104C, FG7-10-4C, FG-720, FG9-05, FG9-05-1C, FG9-05-2C...(Other models you can see in the webshop)		

rotary switches			
GOTTAK			
			
1			
<b>GEV No.</b>	347874	<b>Ref. No.</b>	12023965 Z743019
<b>description</b>	rotary switch 5 0-1-2-3-4 sets of contacts 10 type 46RCTH 400V 16A shaft ø 6x4.6mm shaft L 23mm shaft 6x4.6 connection male faston 6.3mm		
<b>For models:</b>	FI-80BBT-UK		

magnetic switches			
32x15mm			
			
1			
<b>GEV No.</b>	346510	<b>Ref. No.</b>	12032901 RT4000335
<b>description</b>	magnetic switch		

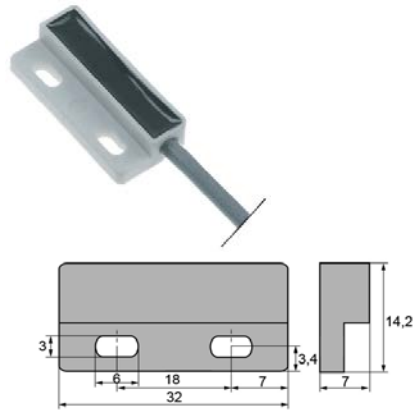
			
1			
<b>GEV No.</b>	345109	<b>Ref. No.</b>	12034091 RT30161415
<b>description</b>	magnetic switch L 32mm W 15mm 1NO 250V 1A P max. 40W connection cable length 2000mm		

65x20mm

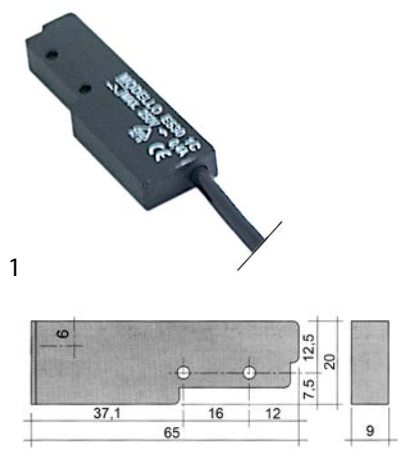

<b>GEV No.</b>	345116	<b>Ref. No.</b>	12024560 Z100522
<b>description</b>	magnetic switch L 65mm W 20mm 1NO 250V 0.4A P max. 100W connection cable cable length 3000mm		
<b>For models:</b>	ACE-061, ACE-101, ACE-102, ACE-201, ACE-202, ACG-061, ACG-101, ACG-102, ACG-201, ACG-202, AE-061, AE-061W, AE-101, AE-101W, AE-102, AE-102W, AE-201, AE-202, AG-061, AG-061W, AG-101, AG-101W, AG-102, AG-102W, AG-201, AG-202, APE-061, APE-061W, APE-101, APE-101W, APE-102, APE-102W, APE-201, APE-202, APG-061, APG-061W, APG-101, APG-101W, APG-102, APG-102W, APG-201, APG-202, COE-061, COE-101, COE-102, COE-201, COE-202, COG-061, COG-101, COG-102...(Other models you can see in the webshop)		
<b>accessories for</b>	345116		
	<b>GEV No.</b>	345399	<b>Ref. No.</b> —
magnet ø 3.3mm L 40mm H 8mm W 13mm hole distance 30mm M3			

84x30mm



<b>GEV No.</b>	347089	<b>Ref. No.</b>	12039784 Z100511
<b>description</b>	magnetic switch L 84mm W 30mm		

ø 6mm



<b>GEV No.</b>	345202	<b>Ref. No.</b>	12024477 Z203009
<b>description</b>	magnetic switch 250V 0.04A P max. 10W probe L 29mm 1NO connection plug cable length 1400mm		
<b>For models:</b>	AD-120, AD-120B, AD-120BBTDD-UK, AD-120C, AD-120CW, AD-120HY, AD-125, AD-125HRS, AD-125-SOFT, AD-15, AD-15D, AD-20C-UK, AD-21, AD-21B, AD-21BDD, AD-21C, AD-21D, AD-21DD, AD-21W, AD-45BBT, AD-48, AD-48B, AD-48BDD, AD-48C, AD-48D, AD-48DD, AD-48HY, AD-48W, AD-505, AD-505-SOFT, AD-64, AD-64B, AD-64BBT, AD-64BDD, AD-64BTDD, AD-64C, AD-64CW, AD-64D, AD-64DD, AD-64HY, AD-72, AD-72W, AD-90, AD-90BA, AD-90BBT, AD-90BDD, AD-90DD, ADE-120, ADE-120B, ATA-061...(Other models you can see in the webshop)		

ø 8mm



<b>GEV No.</b>	346511	<b>Ref. No.</b>	12031820 RT30161417
<b>description</b>	magnetic switch 230V 0.2A P max. 50W probe L 60mm 1NO connection cable cable length 2500mm		

accessories

magnets



<b>GEV No.</b>	346514	<b>Ref. No.</b>	12033601 RT30161409
<b>description</b>	magnet ø 10mm L 40mm Hmm Wmm		



			
1			
<b>GEV No.</b>	347093	<b>Ref. No.</b>	12024499 Z271207
<b>description</b>	magnet ø 31mm Lmm H 15mm Wmm M5		
<b>For models:</b>	ECO-160, ECO-160D, ECO-160I, ECO-200, ECO-200D, ECO-200H, ECO-200HD, ECO-200HI, ECO-200I, ECO-280D, ECO-280I, ECO-370D, ECO-370I, ECO-460D, ECO-460I, ECO-550D, ECO-550I, FI-160, FI-160AR, FI-160D, FI-160I, FI-200, FI-200AR, FI-200D, FI-200H, FI-200HD, FI-200HI, FI-200I, FI-200W, FI-200WL, FI-200WR, FI-280D, FI-280I, FI-370D, FI-370I, FI-460D, FI-460I, FI-550D, FI-550I		

			
1			
<b>GEV No.</b>	505004	<b>Ref. No.</b>	12024303 Z200506
<b>description</b>	magnet ømm L 17mm H 12mm W 14mm		
<b>For models:</b>	ACE-061, ACE-101, ACE-102, ACG-061, ACG-101, ACG-102, AD-120, AD-120B, AD-120BTDD-UK, AD-120C, AD-120CW, AD-120HY, AD-15, AD-15D, AD-20C-UK, AD-21, AD-21B, AD-21BDD, AD-21C, AD-21D, AD-21DD, AD-21W, AD-45BBT, AD-48, AD-48B, AD-48BDD, AD-48C, AD-48D, AD-48DD, AD-48HY, AD-48W, AD-64, AD-64B, AD-64BBT, AD-64BDD, AD-64BTDD, AD-64C, AD-64CW, AD-64D, AD-64DD, AD-64HY, AD-72, AD-72W, AD-90, AD-90BA, AD-90BBT, AD-90BDD, AD-90DD, ADE-120, ADE-120B...(Other models you can see in the webshop)		

magnetic holders			
			
1			
<b>GEV No.</b>	700816	<b>Ref. No.</b>	12024094 Z200507
<b>description</b>	protection cap for magnet internal size 14x17mm H 17mm for dishwasher		
<b>For models:</b>	AD-120, AD-120B, AD-120BTDD-UK, AD-120C, AD-120CW, AD-120HY, AD-15, AD-15D, AD-20C-UK, AD-21, AD-21B, AD-21BDD, AD-21C, AD-21D, AD-21DD, AD-21W, AD-45BBT, AD-48, AD-48B, AD-48BDD, AD-48C, AD-48D, AD-48DD, AD-48HY, AD-48W, AD-64, AD-64B, AD-64BBT, AD-64BDD, AD-64BTDD, AD-64C, AD-64CW, AD-64D, AD-64DD, AD-64HY, AD-72, AD-72W, AD-90, AD-90BA, AD-90BBT, AD-90BDD, AD-90DD, ADE-120, ADE-120B, COE-061, COE-101, COE-102, COG-061, COG-101, COG-102...(Other models you can see in the webshop)		

## control equipment

### TELEMECANIQUE (EFA)

#### XB2 series

#### rotary switches

			
1			
<b>GEV No.</b>	345222	<b>Ref. No.</b>	12024490 Z103044
<b>description</b>	rotary selector mounting measurements ø22mm black latching sequence 0-1		
<b>For models:</b>	ECO-1600, ECO-2300, ECO-3000, FI-1600, FI-2300, FI-3000		

### lamps

			
1			
<b>GEV No.</b>	359807	<b>Ref. No.</b>	12039863 Z103056
<b>description</b>	light bulb socket Ba9s 24V 2W ø 10mm L 28mm clear		
<b>For models:</b>	ECO-1600, ECO-2300, ECO-3000, FI-1600, FI-2300, FI-3000		

## encoders and potentiometers

			
1			
<b>GEV No.</b>	300198	<b>Ref. No.</b>	12030862 RT4000404
<b>description</b>	encoder		

			
1			
<b>GEV No.</b>	300253	<b>Ref. No.</b>	12024753 T513009
<b>description</b>	encoder shaft L 16mm for combi-steamer cable length 125mm shaft 6x4.6mm		
<b>For models:</b>	VE-061, VE-101, VE-102, VE-201, VE-202, VG-101, VG-102, VG-201, VG-202		

			
<b>GEV No.</b>	300254	<b>Ref. No.</b>	12018546 T303022
<b>description</b>	encoder shaft L 16mm for combi-steamer cable length 160mm shaft 6x4.6mm		
<b>For models:</b>	HEI-10-21, HEI-20-21, HEM-10-21, HEM-20-21, HEP-10-21, HEP-20-21, HGC-10-21, HGC-20-21, HGP-10-21, HGP-20-21, HGV-10-21, HGV-20-21		

			
<b>GEV No.</b>	401717	<b>Ref. No.</b>	12020078 T303020
<b>description</b>	potentiometer		
<b>For models:</b>	HEI-10-21, HEI-20-21, HEM-10-21, HEM-20-21, HGV-10-21, HGV-20-21		

			
<b>GEV No.</b>	300197	<b>Ref. No.</b>	12032034 RT4000464
<b>description</b>	potentiometer 4.7KOhm rotation 360° shaft ø 5.9mm with switch shaft L 22mm		

			
<b>GEV No.</b>	403747	<b>Ref. No.</b>	12043405
<b>description</b>	potentiometer rotation 360° shaft ø 6x4.6mm shaft L 13mm		
<b>For models:</b>	ACE-061, ACE-101, AE-061, AE-061W, AE-101, AE-101W, AE-102, AE-102W, AE-201, AE-202, AG-061, AG-061W, AG-101, AG-101W, AG-102, AG-102W, AG-201, AG-202, APE-061, APE-101		

			
<b>GEV No.</b>	400106	<b>Ref. No.</b>	12027410 RT88171303
<b>description</b>	pulsar KOhm rotation 360° shaft ø 6mm type CPC		

## lamps

### indicator lights

#### indicator lights 3-piece (housing, lens and bulb)

#### lamps

#### light bulbs

			
<b>GEV No.</b>	359807	<b>Ref. No.</b>	12039863 Z103056
<b>description</b>	light bulb socket Ba9s 24V 2W ø 10mm L 28mm clear		
<b>For models:</b>	ECO-1600, ECO-2300, ECO-3000, FI-1600, FI-2300, FI-3000		

#### indicator lights (complete)

#### 32x14mm

			
<b>GEV No.</b>	348218	<b>Ref. No.</b>	12037303 6021130010
<b>description</b>	indicator light mounting measurements 32x14mm 230V connection male faston 6.3mm temp.-resist. 105°C		
<b>For models:</b>	AEP-1402, AEP-1602, AEP-2103, AEP-701, AEP-801, AEP-802, AF-1402-MIX, AF-1403-C, AF-1403-P, AF-1404-C, AF-1404-P, AF-1602-MIX, AF-1603-C, AF-1603-P, AF-1604-C, AF-1604-P, AF-2104-C, AF-2104-P, AF-2105-C, AF-2105-P, AF-2106-C, AF-2106-P, AF-702-C, AF-702-P, AF-802-C, AF-802-P, AFN-1402, AFN-1403, AFN-1404, AFN-1602, AFN-1603, AFN-1604, AFN-702, AFN-801, AFN-802, AFP-1402, AFP-1403, AFP-1404, AFP-1404-USMC, AFP-1602, AFP-1602-2, AFP-1603, AFP-1603-2, AFP-1604, AFP-2103, AFP-2104, AFP-2105, AFP-2106, AFP-701, AFP-702...(Other models you can see in the webshop)		

#### ø 9mm

			
<b>GEV No.</b>	359137	<b>Ref. No.</b>	12024344
<b>description</b>	indicator light ø 9mm 230V yellow connection male faston 6.3mm temp.-resist. 120°C with lens		
<b>For models:</b>	ECO-120, ECO-120B, FI-100, FI-100AR, FI-100B, FI-100BBT-UK, FI-120, FI-120AR+DD, FI-120B, FI-120C, FI-120HY-CLINIC, FI-120W, FI-80, FI-80AR, FI-80BBT-UK, FI-80W, GA-20, GA-20D, GA-40, GA-40D		

#### ø12mm

#### with screw socket

			
<b>GEV No.</b>	359048	<b>Ref. No.</b>	12035239 ICR13205
<b>description</b>	indicator light ø 12mm 230V yellow connection male faston 6.3mm		





			
1			
<b>GEV No.</b>	359027	<b>Ref. No.</b>	12025211 12036324 DO1DL14313 R693055
<b>description</b>	indicator light ø 12mm 250V green connection male faston 6.3mm		
<b>For models:</b>	BME6-05, BME7-05, BME7-10, BME9-05, BME9-05AD, BME9-05PLUS, BME9-05V-T, BME9-10, BME9-10AD, BME9-10PLUS, BME9-10V-T, CE6-41, CE7-41, CE7-41Q, CE9-41, CGE6-41, CGE7-41, CGE7-41H, CGE9-11, CGE9-41, CGE9-41AD, CGE9-41PLUS, CMF6-05, CPE6-05, CPE7-05, CPE7-05NC, CPE9-05, CPE9-05AD, CPE9-05AD-S, CPE9-05NC, CPE9-05PLUS, CPE9-05PLUS-S, CPE9-05S, CPE9-05SNC, EASY-500, EASY-500B, EASY-500DD, EASY-500HP, EASY-500HPWBDD, EPC-350, FE-18, FE-25, FE-4, FE-6, FE6-05, FE6-05TE, FE6-10, FE6-10TE, FE7-05-1C, FE7-05-2C...(Other models you can see in the webshop)		

with plug-in socket			
			
1			
<b>GEV No.</b>	359898	<b>Ref. No.</b>	12021166 Z203004
<b>description</b>	indicator light ø 12mm 230V green connection male faston 6.3mm		
<b>For models:</b>	BME7-05, BME7-10, BME9-05, BME9-10, CE7-41, CE9-41, CGE7-203, CGE7-41, CGE9-41, FE-18, FE-25, FE-4, FE-6, FE-710, FE-8, FE9-05, FE9-05S, FE9-10, FE-920, FG-710, FG-720, FG9-05, FG9-05S, FG9-10, FG-920, FG-940, FI-30, FI-48, FI-48B, FI-48W, FI-64, FI-64B, FI-64W, FTE7-05, FTE7-10, FTE9-05L, FTE9-05R, FTE9-10L, FTE9-10L+R, FTE9-10R, FTEC9-05, FTEC9-05L, FTEC9-05R, FTEC9-10, FTEC9-10L, FTEC9-10L+R, FTEC9-10R, GA-20, GA-40, HCG-10-11...(Other models you can see in the webshop)		

			
1			
<b>GEV No.</b>	505099	<b>Ref. No.</b>	12016901 12024254 12036445 K008B41002 R214902 R693056 X353021 Z203005
<b>description</b>	indicator light ø 12mm 230V yellow		
<b>For models:</b>	BME6-05, BME7-05, BME7-10, BME9-05, BME9-05AD, BME9-05PLUS, BME9-05V-T, BME9-10, BME9-10AD, BME9-10PLUS, BME9-10V-T, CE6-20, CE6-40, CE6-41, CE7-20, CE7-20Q, CE7-40, CE7-40Q, CE7-41, CE7-41Q, CE9-20, CE9-20AD, CE9-20PLUS, CE9-40, CE9-40AD, CE9-40PLUS, CE9-41, CE9-41AD, CE9-41PLUS, CGE6-41, CGE7-41, CGE7-41H, CGE9-11, CGE9-41, CGE9-41AD, CGE9-41PLUS, CMF6-05, CPE6-05, CPE7-05, CPE7-05NC, CPE9-05, CPE9-05AD, CPE9-05AD-S, CPE9-05NC, CPE9-05PLUS, CPE9-05PLUS-S, CPE9-05S, CPE9-05SNC, CV6-20, CV6-40...(Other models you can see in the webshop)		

			
1			
<b>GEV No.</b>	359493	<b>Ref. No.</b>	12023599 X143017
<b>description</b>	indicator light ø 12mm 250V green connection male faston 6.3mm temp.-resist. 120°C		
<b>For models:</b>	CE9-41AD, CE9-41PLUS, ME7-10BM, SBE7-10, SBE9-10, SBE9-10I, SBE9-10I-AD, SBE9-10I-AD-S, SBE9-10IM, SBE9-10IM-AD, SBE9-10IM-AD-S, SBE9-10IMS, SBE9-10IS, SBE9-10M, SBE9-10MS, SBE9-10PLUS-I, SBE9-10PLUS-IM, SBE9-10S, SBE9-10USMC, SBE9-15IM, SBE9-15IM-AD, SBE9-15IM-AD-S, SBE9-15IMS, SBE9-15M, SBE9-15MS, SBE9-15PLUS-IM, SBG7-10, SBG9-10, SBG9-10I, SBG9-10I-AD, SBG9-10I-AD-S, SBG9-10IM, SBG9-10IM-AD, SBG9-10IM-AD-S, SBG9-10IMS, SBG9-10IS, SBG9-10M, SBG9-10MS, SBG9-10PLUS-I, SBG9-10PLUS-IM, SBG9-10PLUS-SI, SBG9-10PLUS-SIM, SBG9-10S, SBG9-15IM, SBG9-15IM-AD, SBG9-15IM-AD-S, SBG9-15IMS, SBG9-15PLUS-IM, SBG9-15PLUS-SIM		

ø13mm			
with plug-in socket			
			
1			
<b>GEV No.</b>	359142	<b>Ref. No.</b>	Z203004
<b>description</b>	indicator light ø 13mm green 230V connection male faston 6.3mm temp.-resist. 120°C Qty 1 pcs		

ø14mm			
with plug-in socket			
			
1			
<b>GEV No.</b>	359148	<b>Ref. No.</b>	12021153 12039891 R343123 U183044
<b>description</b>	indicator light ø 14mm green 230V connection male faston 6.3mm temp.-resist. 120°C voltage AC		
<b>For models:</b>	CE-410, FE-18, FE-25, FE-4, FE-6, FE-8, FE-91-20, HCV-10-11, HCV-10-21, HCV-2-10-21, HE-10-11, HE-10-21, HE-2-10-11, HE-6-11, HG-10-21, HG-2-10-11		

			
1			
<b>GEV No.</b>	359149	<b>Ref. No.</b>	12039886 R343125
<b>description</b>	indicator light ø 14mm yellow 230V connection male faston 6.3mm temp.-resist. 105°C		
<b>For models:</b>	CE-410, FE-18, FE-25, FE-4, FE-6, FE-8, FE-91-20, HCV-10-11, HCV-10-21, HCV-2-10-21, HE-10-11, HE-10-21, HE-2-10-11, HE-6-11, HG-10-21, HG-2-10-11		



ø18mm



1

<b>GEV No.</b>	358197	<b>Ref. No.</b>	12024669 Z313080000
<b>description</b>	indicator light ø 18mm yellow 250V connection F6.3 temp.-resist. 120°C plastic/metal complete		
<b>For models:</b>	BME6-05, BME7-05, BME7-10, BME9-05, BME9-05PLUS, BME9-05V-T, BME9-10, BME9-10PLUS, BME9-10V-T, CE6-20, CE6-40, CE6-41, CE7-20, CE7-20Q, CE7-40, CE7-40Q, CE7-41, CE7-41Q, CE9-20, CE9-20PLUS, CE9-40, CE9-40PLUS, CE9-41, CE9-41PLUS, CGE6-41, CGE7-41, CGE7-41H, CGE9-11, CGE9-41, CGE9-41PLUS, CMF6-05, CPE6-05, CPE7-05, CPE7-05NC, CPE9-05, CPE9-05NC, CPE9-05PLUS, CPE9-05PLUS-S, CPE9-05S, CPE9-05SNC, CV6-20, CV6-40, CV9-20PLUS, CV9-40PLUS, FE-18, FE-25, FE-4, FE-6, FE6-05TE, FE6-10TE...(Other models you can see in the webshop)		

## screw-on/push-on fit

## light bulbs

## for indicator lights



1

<b>GEV No.</b>	359807	<b>Ref. No.</b>	12039863 Z103056
<b>description</b>	light bulb socket Ba9s 24V 2W ø 10mm L 28mm clear		
<b>For models:</b>	ECO-1600, ECO-2300, ECO-3000, FI-1600, FI-2300, FI-3000		

## halogen lamp

## for socket G4 / G6.35 / G9



1

500°C

<b>GEV No.</b>	359596	<b>Ref. No.</b>	12025123 12036215 R663013 RT30240201
<b>description</b>	halogen lamp socket G4 12V 10W temp.-resist. 500°C		
<b>For models:</b>	ACE-061, ACE-101, ACE-102, ACE-201, ACE-202, ACG-061, ACG-101, ACG-102, ACG-201, ACG-202, AE-061, AE-061W, AE-101, AE-101W, AE-102, AE-102W, AE-201, AE-202, AG-061, AG-061W, AG-101, AG-101W, AG-102, AG-102W, AG-201, AG-202, APE-061, APE-061W, APE-101, APE-101W, APE-102, APE-102W, APE-201, APE-202, APG-061, APG-061W, APG-101, APG-101W, APG-102, APG-102W, APG-201, APG-202, HCG-10-11, HCG-10-21, HCG-20-11, HCG-20-21, HCG-2-10-11, HCG-2-20-11, HCG-6-11, HEI-10-21...(Other models you can see in the webshop)		

## linear lamps

## sockets for linear lamps

## R7s

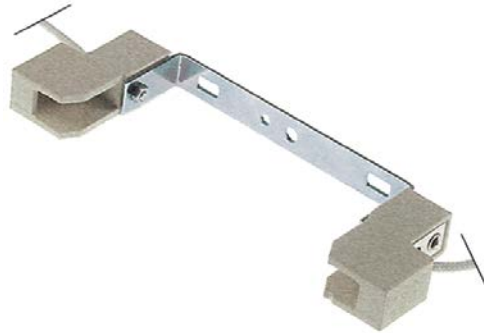

1

<b>GEV No.</b>	359663	<b>Ref. No.</b>	12035430 6021290015
<b>description</b>	lamp socket socket R7s 250V ømm for length of lamp 117.6mm H 47mm connection cable 150mm mounting distance 65mm holder length 140.5mm Qty 1 pcs		

## fluorescent lamps

## fluorescent lamps

## G13



1

<b>GEV No.</b>	359383	<b>Ref. No.</b>	12036923 12037057 6001509001 6021290001
<b>description</b>	fluorescent lamp socket G13 L 438mm 15W 230V Qty 1 pcs light colour 640		
<b>For models:</b>	AEP-1402, AEP-1403, AEP-1404, AEP-1602, AEP-1603, AEP-1604, AEP-2103, AEP-701, AEP-702, AEP-801, AEP-802, AF-1402-MIX, AF-1403-C, AF-1403-P, AF-1404-C, AF-1404-P, AF-1602-MIX, AF-1603-C, AF-1603-P, AF-1604-C, AF-1604-P, AF-2104-C, AF-2104-P, AF-2105-C, AF-2105-P, AF-2106-C, AF-2106-P, AF-702-C, AF-702-P, AF-802-C, AF-802-P, AFP-1402, AFP-1402-FORZ, AFP-1402-MIX, AFP-1403, AFP-1403-C, AFP-1403-FORZ, AFP-1403-P, AFP-1404, AFP-1404-C, AFP-1404-FORZ, AFP-1404-P, AFP-1404-USMC, AFP-1602, AFP-1602-2, AFP-1603, AFP-1603-2, AFP-1604, AFP-2103, AFP-2104...(Other models you can see in the webshop)		





1

<b>GEV No.</b>	359371	<b>Ref. No.</b>	12036885 12036938 6001509002 6021290002
<b>description</b>	fluorescent lamp socket G13 L 590mm 18W 230V Qty 1 pcs		
<b>For models:</b>	VM-100-I, VM-100-M, VM-135-I, VM-135-M		





complete with holder			
			
<b>GEV No.</b>	360610	<b>Ref. No.</b>	12033320 12058986 6021290052
<b>description</b>	fluorescent lamp L 343mm W 23mm 8W 220-240V plug type Euro-8 (C7) type T5/T4 for FAGOR		
<b>For models:</b>	AEP-1402, AEP-1602, AEP-2103, AEP-701, AEP-801, AEP-802, AF-1402-MIX, AF-1403-C, AF-1403-P, AF-1404-C, AF-1404-P, AF-1602-MIX, AF-1603-C, AF-1603-P, AF-1604-C, AF-1604-P, AF-2104-C, AF-2104-P, AF-2105-C, AF-2105-P, AF-2106-C, AF-2106-P, AF-702-C, AF-702-P, AF-802-C, AF-802-P, AFP-1402, AFP-1403, AFP-1404, AFP-1602, AFP-1602-2, AFP-1603, AFP-1603-2, AFP-1604, AFP-2103, AFP-2104, AFP-2105, AFP-2106, AFP-701, AFP-702, AFP-801, AFP-802, AFP-802-2, AFP-802-2C, AFP-802-3C, ERM-150		

covers			
			
<b>GEV No.</b>	550772	<b>Ref. No.</b>	12033470 12036835 6000202505 6007170105
<b>description</b>	cover for fluorescent lamps L 540mm		
<b>For models:</b>	AEP-1402, AEP-1403, AEP-1404, AEP-1602, AEP-1603, AEP-1604, AEP-2103, AEP-701, AEP-702, AEP-801, AEP-802, AF-1402-MIX, AF-1403-C, AF-1403-P, AF-1404-C, AF-1404-P, AF-1602-MIX, AF-1603-C, AF-1603-P, AF-1604-C, AF-1604-P, AF-2104-C, AF-2104-P, AF-2105-C, AF-2105-P, AF-2106-C, AF-2106-P, AF-702-C, AF-702-P, AF-802-C, AF-802-P, AFP-1402, AFP-1402-FORZ, AFP-1402-MIX, AFP-1403, AFP-1403-C, AFP-1403-FORZ, AFP-1403-P, AFP-1404, AFP-1404-C, AFP-1404-FORZ, AFP-1404-P, AFP-1404-USMC, AFP-1602, AFP-1602-2, AFP-1603, AFP-1603-2, AFP-1604, AFP-2103, AFP-2104...(Other models you can see in the webshop)		





accessories			
ballasts			
			
<b>GEV No.</b>	401504	<b>Ref. No.</b>	12035299 6001507022
<b>description</b>	electrical ballast 18W 230V Qty 1 pcs		
<b>For models:</b>	AEP-701, AEP-702, AEP-801, AEP-802, AFP-1402-MIX, AFP-2103, AFP-2104, AFP-2104-C, AFP-2104-P, AFP-2105, AFP-2105-C, AFP-2105-P, AFP-2106, AFP-2106-C, AFP-2106-P, AFP-701, AFP-702, AFP-702-C, AFP-702-P, AFP-801, AFP-802, AFP-802-2, VC-14-I, VC-14-M, VM-100-I, VM-100-M, VTP-139-C, VTP-139-P		

oven lamps			
producer-specific oven lamps			
FAGOR			
			
<b>GEV No.</b>	359433	<b>Ref. No.</b>	12017827 R660535
<b>description</b>	gasket		
<b>For models:</b>	HCG-10-11, HCG-10-21, HCG-20-11, HCG-2-10-11, HCG-6-11, HME-10-11, HME-10-21, HME-20-11, HME-20-21, HME-2-10-11, HME-6-11, HMG-10-11, HMG-10-11UL, HMG-10-21, HMG-10-21UL, HMG-20-11, HMG-2-10-11, HMG-6-11, HMI-10-11, HMI-10-11UL, HMI-10-21, HMI-10-21UL, HMI-2-10-11, HMI-6-11, HMI-6-11UL, HMM-10-11, HMM-10-11UL, HMM-10-21, HMM-10-21UL, HMM-20-11, HMM-20-11UL, HMM-20-21, HMM-2-10-11, HMM-6-11, HMM-6-11UL, HMP-10-11, HMP-10-21, HMP-20-11, HMP-20-21, HMP-2-10-11, HMP-6-11		

			
<b>GEV No.</b>	401505	<b>Ref. No.</b>	12035296 12036849 6001507023 6021290014
<b>description</b>	electrical ballast 36W 230V Qty 1 pcs		
<b>For models:</b>	AEP-1402, AEP-1403, AEP-1404, AEP-1602, AEP-1603, AEP-1604, AEP-2103, AEP-701, AEP-801, AEP-802, AF-1602-MIX, AF-1603-C, AF-1603-P, AF-1604-C, AF-1604-P, AF-2104-C, AF-2104-P, AF-2105-C, AF-2105-P, AF-2106-C, AF-2106-P, AF-702-C, AF-702-P, AF-802-C, AF-802-P, AFP-1402, AFP-1403, AFP-1403-C, AFP-1403-P, AFP-1404, AFP-1404-C, AFP-1404-P, AFP-1602, AFP-1602-2, AFP-1603, AFP-1603-2, AFP-1604, AFP-2103, AFP-2104, AFP-2105, AFP-2106, AFP-701, AFP-702, AFP-801, AFP-802, AFP-802-2, AP-701, APP-701, VC-14-I, VC-14-M...(Other models you can see in the webshop)		

			
<b>GEV No.</b>	359432	<b>Ref. No.</b>	12019933 R663058
<b>description</b>	lamp socket 25V socket G4 cable length 350mm connection male faston 4.8mm ømm H 18mm with 2 hole fixing mounting distance 16mm holder length 23mm Qty 1 pcs		
<b>For models:</b>	HCG-10-11, HCG-10-21, HCG-20-11, HCG-20-21, HCG-2-10-11, HCG-2-20-11, HCG-6-11, HEI-20-11, HEM-20-11, HEP-20-11, HME-10-11, HME-10-21, HME-20-11, HME-20-21, HME-2-10-11, HME-2-20-11, HME-6-11, HMG-10-11, HMG-10-11UL, HMG-10-21, HMG-10-21UL, HMG-20-11, HMG-2-10-11, HMG-6-11, HMI-10-11, HMI-10-11UL, HMI-10-21, HMI-10-21UL, HMI-2-10-11, HMI-6-11, HMI-6-11UL, HMM-10-11, HMM-10-11UL, HMM-10-21, HMM-10-21UL, HMM-20-11, HMM-20-11UL, HMM-20-21, HMM-2-10-11, HMM-2-20-11, HMM-40-11-USMC, HMM-6-11, HMM-6-11UL, HMP-10-11, HMP-10-21, HMP-20-11, HMP-20-21, HMP-2-10-11, HMP-2-20-11...(Other models you can see in the webshop)		





			
1			
<b>GEV No.</b>	359424	<b>Ref. No.</b>	12012381 R670608
<b>description</b>	frame L 75mm W 75mm mounting distance 61mm		
<b>For models:</b>	HCG-10-11, HCG-10-21, HCG-20-11, HCG-20-21, HCG-2-10-11, HCG-2-20-11, HCG-6-11, HEI-20-11, HEM-20-11, HEP-20-11, HME-10-11, HME-10-21, HME-20-11, HME-20-21, HME-2-10-11, HME-2-20-11, HME-6-11, HMI-10-11, HMI-10-11UL, HMI-10-21, HMI-10-21UL, HMI-2-10-11, HMI-6-11, HMI-6-11UL, HMM-10-11, HMM-10-11UL, HMM-10-21, HMM-10-21UL, HMM-20-11, HMM-20-11UL, HMM-20-21, HMM-20-21UL, HMM-2-10-11, HMM-2-20-11, HMM-40-11-USMC, HMM-6-11, HMM-6-11UL, HMP-10-11, HMP-10-21, HMP-20-11, HMP-20-21, HMP-2-10-11, HMP-2-20-11, HMP-6-11, HVG-10-11, HVG-10-11UL, HVG-10-21, HVG-10-21UL, HVG-20-11, HVG-20-21...(Other models you can see in the webshop)		
<b>accessories for</b>	359424		
			
<b>GEV No.</b>	359425	<b>Ref. No.</b>	12020892 R670609
<b>description</b>	gasket L 71mm W 71mm rubber thickness 1.5mm for oven lamp		
			
<b>GEV No.</b>	359426	<b>Ref. No.</b>	12016678 R670618
<b>description</b>	lamp glass L 38mm W 38mm thickness 3mm		
			
<b>GEV No.</b>	359432	<b>Ref. No.</b>	12019933 R663058
<b>description</b>	lamp socket 25V socket G4 cable length 350mm connection male faston 4.8mm ømm H 18mm with 2 hole fixing mounting distance 16mm holder length 23mm Qty 1 pcs		

			
1			
<b>GEV No.</b>	359425	<b>Ref. No.</b>	12020892 R670609
<b>description</b>	gasket L 71mm W 71mm rubber thickness 1.5mm for oven lamp		
<b>For models:</b>	HCG-10-11, HCG-10-21, HCG-20-11, HCG-20-21, HCG-2-10-11, HCG-2-20-11, HCG-6-11, HEI-20-11, HEM-20-11, HEP-20-11, HME-10-11, HME-10-21, HME-20-11, HME-20-21, HME-2-10-11, HME-2-20-11, HME-6-11, HMI-10-11, HMI-10-11UL, HMI-10-21, HMI-10-21UL, HMI-2-10-11, HMI-6-11, HMI-6-11UL, HMM-10-11, HMM-10-11UL, HMM-10-21, HMM-10-21UL, HMM-20-11, HMM-20-11UL, HMM-20-21, HMM-20-21UL, HMM-2-10-11, HMM-2-20-11, HMM-40-11-USMC, HMM-6-11, HMM-6-11UL, HMP-10-11, HMP-10-21, HMP-20-11, HMP-20-21, HMP-2-10-11, HMP-2-20-11, HMP-6-11, HVG-10-11, HVG-10-11UL, HVG-10-21, HVG-10-21UL, HVG-20-11, HVG-20-21...(Other models you can see in the webshop)		

			
1			
<b>GEV No.</b>	359426	<b>Ref. No.</b>	12016678 R670618
<b>description</b>	lamp glass L 38mm W 38mm thickness 3mm		
<b>For models:</b>	HCG-10-11, HCG-10-21, HCG-20-11, HCG-20-21, HCG-2-10-11, HCG-2-20-11, HCG-6-11, HEI-20-11, HEM-20-11, HEP-20-11, HME-10-11, HME-10-21, HME-20-11, HME-20-21, HME-2-10-11, HME-2-20-11, HME-6-11, HMI-10-11, HMI-10-11UL, HMI-10-21, HMI-10-21UL, HMI-2-10-11, HMI-6-11, HMI-6-11UL, HMM-10-11, HMM-10-11UL, HMM-10-21, HMM-10-21UL, HMM-20-11, HMM-20-11UL, HMM-20-21, HMM-20-21UL, HMM-2-10-11, HMM-2-20-11, HMM-40-11-USMC, HMM-6-11, HMM-6-11UL, HMP-10-11, HMP-10-21, HMP-20-11, HMP-20-21, HMP-2-10-11, HMP-2-20-11, HMP-6-11, HVG-10-11, HVG-10-11UL, HVG-10-21, HVG-10-21UL, HVG-20-11, HVG-20-21...(Other models you can see in the webshop)		

			
1			
<b>GEV No.</b>	359432	<b>Ref. No.</b>	12019933 R663058
<b>description</b>	lamp socket 25V socket G4 cable length 350mm connection male faston 4.8mm ømm H 18mm with 2 hole fixing mounting distance 16mm holder length 23mm Qty 1 pcs		
<b>For models:</b>	HCG-10-11, HCG-10-21, HCG-20-11, HCG-20-21, HCG-2-10-11, HCG-2-20-11, HCG-6-11, HEI-20-11, HEM-20-11, HEP-20-11, HME-10-11, HME-10-21, HME-20-11, HME-20-21, HME-2-10-11, HME-2-20-11, HME-6-11, HMI-10-11, HMI-10-11UL, HMI-10-21, HMI-10-21UL, HMI-2-10-11, HMI-6-11, HMI-6-11UL, HMM-10-11, HMM-10-11UL, HMM-10-21, HMM-10-21UL, HMM-20-11, HMM-20-11UL, HMM-20-21, HMM-20-21UL, HMM-2-10-11, HMM-2-20-11, HMM-40-11-USMC, HMM-6-11, HMM-6-11UL, HMP-10-11, HMP-10-21, HMP-20-11, HMP-20-21, HMP-2-10-11, HMP-2-20-11, HMP-6-11, HVG-10-11, HVG-10-11UL, HVG-10-21, HVG-10-21UL, HVG-20-11, HVG-20-21...(Other models you can see in the webshop)		

			
1			
<b>GEV No.</b>	359428	<b>Ref. No.</b>	12012053 R670610
<b>description</b>	reflector		
<b>For models:</b>	HCG-10-11, HCG-10-21, HCG-20-11, HCG-20-21, HCG-2-10-11, HCG-2-20-11, HCG-6-11, HEI-20-11, HEM-20-11, HEP-20-11, HME-10-11, HME-10-21, HME-20-11, HME-20-21, HME-2-10-11, HME-2-20-11, HME-6-11, HMI-10-11, HMI-10-11UL, HMI-10-21, HMI-10-21UL, HMI-2-10-11, HMI-6-11, HMI-6-11UL, HMM-10-11, HMM-10-11UL, HMM-10-21, HMM-10-21UL, HMM-20-11, HMM-20-11UL, HMM-20-21, HMM-20-21UL, HMM-2-10-11, HMM-2-20-11, HMM-40-11-USMC, HMM-6-11, HMM-6-11UL, HMP-10-11, HMP-10-21, HMP-20-11, HMP-20-21, HMP-2-10-11, HMP-2-20-11, HMP-6-11, HVG-10-11, HVG-10-11UL, HVG-10-21, HVG-10-21UL, HVG-20-11, HVG-20-21...(Other models you can see in the webshop)		

			
1			
<b>GEV No.</b>	359423	<b>Ref. No.</b>	12024464 T303047
<b>description</b>	frame L 95mm W 80mm for oven lamp thickness 6mm		
<b>For models:</b>	ACE-061, ACE-101, ACE-102, ACE-201, ACE-202, ACG-061, ACG-101, ACG-102, ACG-201, ACG-202, AE-061, AE-061W, AE-101, AE-101W, AE-102, AE-102W, AE-201, AE-202, AG-061, AG-061W, AG-101, AG-101W, AG-102, AG-102W, AG-201, AG-202, APE-061, APE-061W, APE-101, APE-101W, APE-102, APE-102W, APE-201, APE-202, APG-061, APG-061W, APG-101, APG-101W, APG-102, APG-102W, APG-201, APG-202, COE-061, COE-101, COE-102, COE-201, COE-202, COG-061, COG-101, COG-102...(Other models you can see in the webshop)		









			
1			
<b>GEV No.</b>	359415	<b>Ref. No.</b>	12023532 T303027
<b>description</b>	gasket for oven lamp L 78mm W 62mm thickness 1mm graphite		
<b>For models:</b>	ACE-061, ACE-101, ACE-102, ACE-201, ACE-202, ACG-061, ACG-101, ACG-102, ACG-201, ACG-202, AE-061, AE-061W, AE-101, AE-101W, AE-102, AE-102W, AE-201, AE-202, AG-061, AG-061W, AG-101, AG-101W, AG-102, AG-102W, AG-201, AG-202, APE-061, APE-061W, APE-101, APE-101W, APE-102, APE-102W, APE-201, APE-202, APG-061, APG-061W, APG-101, APG-101W, APG-102, APG-102W, APG-201, APG-202, COE-061, COE-101, COE-102, COE-201, COE-202, COG-061, COG-101, COG-102...(Other models you can see in the webshop)		

			
2			
<b>GEV No.</b>	359405	<b>Ref. No.</b>	12023578 T303026
<b>description</b>	gasket L 95mm W 80mm thickness 2mm graphite hole ø 5mm		
<b>For models:</b>	ACE-061, ACE-101, ACE-102, ACE-201, ACE-202, ACG-061, ACG-101, ACG-102, ACG-201, ACG-202, AE-061, AE-061W, AE-101, AE-101W, AE-102, AE-102W, AE-201, AE-202, AG-061, AG-061W, AG-101, AG-101W, AG-102, AG-102W, AG-201, AG-202, APE-061, APE-061W, APE-101, APE-101W, APE-102, APE-102W, APE-201, APE-202, APG-061, APG-061W, APG-101, APG-101W, APG-102, APG-102W, APG-201, APG-202, COE-061, COE-101, COE-102, COE-201, COE-202, COG-061, COG-101, COG-102...(Other models you can see in the webshop)		

			
1			
<b>GEV No.</b>	359408	<b>Ref. No.</b>	12023668
<b>description</b>	glass panel L 74mm W 59mm thickness 3mm		
<b>For models:</b>	ACE-061, ACE-101, ACE-102, ACE-201, ACE-202, ACG-061, ACG-101, ACG-102, ACG-201, ACG-202, AE-061, AE-061W, AE-101, AE-101W, AE-102, AE-102W, AE-201, AE-202, AG-061, AG-061W, AG-101, AG-101W, AG-102, AG-102W, AG-201, AG-202, APE-061, APE-061W, APE-101, APE-101W, APE-102, APE-102W, APE-201, APE-202, APG-061, APG-061W, APG-101, APG-101W, APG-102, APG-102W, APG-201, APG-202, COE-061, COE-101, COE-102, COE-201, COE-202, COG-061, COG-101, COG-102...(Other models you can see in the webshop)		

			
1			
<b>GEV No.</b>	359295	<b>Ref. No.</b>	12024545 T303023
<b>description</b>	lamp socket for halogen lamp 12V 20W socket G4 mounting measurements 55 x 70mm cable length 135mm		
<b>For models:</b>	ACE-061, ACE-101, ACE-102, ACE-201, ACE-202, ACG-061, ACG-101, ACG-102, ACG-201, ACG-202, AE-061, AE-061W, AE-101, AE-101W, AE-102, AE-102W, AE-201, AE-202, AG-061, AG-061W, AG-101, AG-101W, AG-102, AG-102W, AG-201, AG-202, APE-061, APE-061W, APE-101, APE-101W, APE-102, APE-102W, APE-201, APE-202, APG-061, APG-061W, APG-101, APG-101W, APG-102, APG-102W, APG-201, APG-202, COE-061, COE-101, COE-102, COE-201, COE-202, COG-061, COG-101, COG-102...(Other models you can see in the webshop)		
<b>spare parts for</b>	359295		
		<b>GEV No.</b>	359599 <b>Ref. No.</b> —
	halogen lamp socket G4 12V 20W temp.-resist. 500°C		

<b>accessories for</b>	359295		
	<b>GEV No.</b>	359296	<b>Ref. No.</b> —
lamp glass L 74mm W 58mm thickness 3mm			
	<b>GEV No.</b>	551336	<b>Ref. No.</b> —
gasket for lamp L 92mm W 92mm thickness 2.3mm			

lamps

halogen lamps

for socket G4 / G6.35 / G9

			
1 <b>500°C</b>			
<b>GEV No.</b>	359596	<b>Ref. No.</b>	12025123 12036215 R663013 RT30240201
<b>description</b>	halogen lamp socket G4 12V 10W temp.-resist. 500°C		
<b>For models:</b>	ACE-061, ACE-101, ACE-102, ACE-201, ACE-202, ACG-061, ACG-101, ACG-102, ACG-201, ACG-202, AE-061, AE-061W, AE-101, AE-101W, AE-102, AE-102W, AE-201, AE-202, AG-061, AG-061W, AG-101, AG-101W, AG-102, AG-102W, AG-201, AG-202, APE-061, APE-061W, APE-101, APE-101W, APE-102, APE-102W, APE-201, APE-202, APG-061, APG-061W, APG-101, APG-101W, APG-102, APG-102W, APG-201, APG-202, HCG-10-11, HCG-10-21, HCG-20-11, HCG-20-21, HCG-2-10-11, HCG-2-20-11, HCG-6-11, HEI-10-21...(Other models you can see in the webshop)		

lamp accessories

lenses

glass panels

			
1			
<b>GEV No.</b>	699473	<b>Ref. No.</b>	12037049
<b>description</b>	lamp glass L 135mm W 30mm half-round		

timers

programme timers

			
1			
<b>GEV No.</b>	361353	<b>Ref. No.</b>	Z683099
<b>description</b>	timer		

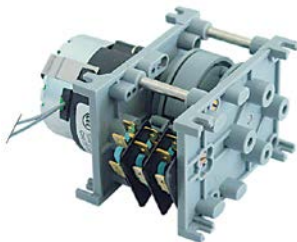



1

<b>GEV No.</b>	361350	<b>Ref. No.</b>	12024867 Z613003
<b>description</b>	timer CDC 4803F1 engines 1 chambers 3 operation time 20min 230V shaft ømm shaft Lmm		
<b>For models:</b>	CO-170-SOFT, CO-400-SOFT, CO-501-SOFT, FI-48, FI-48AR, FI-48B, FI-48B-BT-UK, FI-48C, FI-48D, FI-48HY-CLINIC, FI-48W, FI-64, FI-64AR, FI-64B, FI-64B-BT-UK, FI-64C, FI-64D, FI-64HY-CLINIC, FI-64W, LVC-15D, LVC-21D, LVR-14D, LVR-20D		



1

<b>GEV No.</b>	360525	<b>Ref. No.</b>	12030573 BR00023247
<b>description</b>	timer CDC 11904 engines 1 chambers 4 operation time 10min 230V shaft ømm shaft Lmm manuf. no. 11904F1 / BCR000.0000 motor type M48R ATS		
<b>spare parts for</b>	360525		
	<b>GEV No.</b>	360118	<b>Ref. No.</b> —
	motor CDC pinion ø 4.9mm teeth 10 230V voltage AC 50/60Hz turn direction right motor ø 47mm H 19.3mm motor type M48R ATS for timer cable length 260mm 1.9/2.5W		



1

<b>GEV No.</b>	360566	<b>Ref. No.</b>	12030499 BR00023259
<b>description</b>	timer CDC 11904 engines 1 chambers 4 operation time 15min 115V 60Hz shaft ømm shaft Lmm manuf. no. 11904F1BEI000.0010 motor type M48R ATS voltage AC		



1

<b>GEV No.</b>	361358	<b>Ref. No.</b>	12017510 Z728302
<b>description</b>	timer CDC 4905DV engines 2 chambers 5 operation time 6s / 2min 230V 60Hz shaft ømm shaft Lmm motor type M48R ATS / M48L ATS		
<b>For models:</b>	ECO-120, ECO-120B, FI-100, FI-100AR, FI-100B, FI-120, FI-120B, FI-120W, MF-120		



1

<b>GEV No.</b>	360683	<b>Ref. No.</b>	12024571 Z713055
<b>description</b>	timer CDC 4905DV engines 2 chambers 5 operation time 6s / 2min 230V shaft ømm shaft Lmm		
<b>For models:</b>	FI-100, FI-100AR, FI-100B, FI-120, FI-120AR+DD, FI-120B, FI-120C, LABP-1000, LABP-1200		



1

<b>GEV No.</b>	360696	<b>Ref. No.</b>	12023458
<b>description</b>	timer CDC 4906DV engines 2 chambers 6 operation time 6s / 2min 230V 50Hz shaft ømm shaft Lmm manuf. no. 4906DV0AOE000.1010		



1

<b>GEV No.</b>	360441	<b>Ref. No.</b>	12023466 Z728412
<b>description</b>	timer CDC 4906DV engines 2 chambers 6 operation time 6s / 2min 230V 60Hz shaft ømm shaft Lmm manuf. no. 4906DV0ADY000.0000		
<b>For models:</b>	FI-120W, MF-120		



1

<b>GEV No.</b>	361357	<b>Ref. No.</b>	12024873 Z433002
<b>description</b>	timer CDC 7803 engines 1 chambers 3 operation time 120s 230V shaft ømm shaft Lmm motor type M37LN		
<b>For models:</b>	CO-350, CO-350-B, CO-350-B-DD, CO-350-COLD, CO-350-COLD-B, CO-350-COLD-B-DD, CO-350-COLD-DD, CO-350-DD, CO-400, CO-400-B, CO-400-B-DD, CO-400-COLD, CO-400-COLD-B, CO-400-COLD-B-DD, CO-400-COLD-DD, CO-400-DD, CO-400-SOFT, EASY-500, EASY-500B, EASY-500DD, LVC-21B, LVC-21C, LVR-20, LVR-20B		



1

<b>GEV No.</b>	360586	<b>Ref. No.</b>	12017931 R763006
<b>description</b>	timer CDC 7803 engines 1 chambers 3 operation time 240s 230V shaft ømm shaft Lmm motor type M37LN type 7903F3 voltage AC		
<b>For models:</b>	HEI-10-11, HEI-20-11, HEI-6-11, HEM-10-11, HEM-20-11, HEM-6-11, HEP-10-11, HEP-20-11, HEP-6-11, HGC-10-11, HGC-20-11, HGC-6-11, HGV-10-11, HGV-20-11		



1

<b>GEV No.</b>	360438	<b>Ref. No.</b>	12024202 Z258412
<b>description</b>	timer CDC 7805DV engines 2 chambers 5 operation time 6s / 3min 230V 60Hz shaft ømm shaft Lmm		
<b>For models:</b>	FI-48W, FI-64B, FI-64W, FI-72, FI-72W, FI-80BBT-UK, FI-80W, MF-48, MF-64		



1

<b>GEV No.</b>	361354	<b>Ref. No.</b>	12024178 Z213008
<b>description</b>	timer CDC 7804DV engines 2 chambers 4 operation time 6s / 3min 230V shaft ømm shaft Lmm motor type M37RN/M37LN		
<b>For models:</b>	FI-48, FI-48B, FI-48D, FI-48W		



1

<b>GEV No.</b>	360439	<b>Ref. No.</b>	12024204 Z243001
<b>description</b>	timer CDC 7805DV engines 2 chambers 5 operation time 6s/180s 230V 50Hz shaft ømm shaft Lmm		
<b>For models:</b>	EASY-500HPWBDD, FI-48, FI-48B, FI-48W, FI-64, FI-64B, FI-64B-BT-UK, FI-64HY-CLINIC, FI-64W, MF-48, MF-64		



1

<b>GEV No.</b>	361355	<b>Ref. No.</b>	12024177 Z243004
<b>description</b>	timer CDC 7804DV engines 2 chambers 4 operation time 6s / 3min 230V shaft ømm shaft Lmm motor type M37RN/M37LN		
<b>For models:</b>	EASY-500HP, FI-64, FI-64AR, FI-64B, FI-64C, FI-64D, FI-72, FI-72AR, FI-80, FI-80AR, LABP-800		



1

<b>GEV No.</b>	361352	<b>Ref. No.</b>	12024089 Z403002
<b>description</b>	timer CDC 7903F engines 1 chambers 3 operation time 120s 230V shaft ø 6x4.6mm shaft L 13mm dishwasher		
<b>For models:</b>	LVC-12, LVC-15, LVC-15D, LVC-21, LVC-21D, LVC-21W, LVR-10, LVR-14, LVR-14D, LVR-20, LVR-20D		



1

<b>GEV No.</b>	360440	<b>Ref. No.</b>	12024203 Z213002
<b>description</b>	timer CDC 7805DV engines 2 chambers 5 operation time 6s / 3min 230V 50Hz shaft ømm shaft Lmm		
<b>For models:</b>	FI-48, FI-48AR, FI-48B, FI-48B-BT-UK, FI-48C, FI-48D, FI-48HY-CLINIC, FI-48W, FI-64, FI-64B, FI-64W, MF-48, MF-64		



1

<b>GEV No.</b>	361351	<b>Ref. No.</b>	12017667 12024087 Z203030 Z268302
<b>description</b>	timer CDC 7903F engines 1 chambers 3 operation time 4min 230V shaft ø 6x4.6mm shaft L 13mm		
<b>For models:</b>	FI-30, FI-30AR, FI-30AR+DD, FI-30B, FI-30B-BT-UK, FI-30-UK, FI-60DD, FI-64, FI-64B, FI-64W, FI-72, FI-80, FI-80W		





1

<b>GEV No.</b>	360557	<b>Ref. No.</b>	12095827 IT4864
<b>description</b>	timer FIBER P19 engines 1 chambers 2 operation time 15min 230V shaft ømm shaft Lmm manu. no. P195JE2J730 motor type M51B-J0L6400 cable length 250mm voltage AC		
<b>For models:</b>	FIM-110A, FIM-110W, FIM-150A, FIM-150W, FIM-20A, FIM-20W, FIM-30A, FIM-30W, FIM-40A, FIM-40W, FIM-55A, FIM-55W, FIM-80A, FIM-80W		
<b>spare parts for</b>	360557		
	<b>GEV No.</b>	<b>Ref. No.</b>	—
	motor kit pinion ø 6.8mm teeth 15 230V voltage AC 50/60Hz turn direction counterclockwise motor ø 48mm H 18.5mm motor type UDS40NE1RNZ165 cable length 150mm with holder		



1

<b>GEV No.</b>	360154	<b>Ref. No.</b>	12029594 12030574 BR00023222 BR00023248
<b>description</b>	timer FIBER P20 engines 1 chambers 4 operation time 15min 230V shaft ømm shaft Lmm manu. no. P205J04J714 motor type M51B-J0R6400		
<b>spare parts for</b>	360154		
	<b>GEV No.</b>	<b>Ref. No.</b>	—
	motor kit pinion ø 6.8mm teeth 15 230V voltage AC 50/60Hz turn direction clockwise motor ø 48mm H 18.5mm motor type UDS-40NE1RNZ165 cable length 150mm with holder		



1

<b>GEV No.</b>	360532	<b>Ref. No.</b>	12023458 (old version) Z718937
<b>description</b>	timer FIBER P25 engines 2 chambers 6 operation time 6s / 2min 230V 50Hz shaft ømm shaft Lmm manu. no. P255J06JDU2 motor type M51BJ0L0000/M51BJ0R0000 voltage AC		



1

<b>GEV No.</b>	361356	<b>Ref. No.</b>	12017561 Z703004
<b>description</b>	timer M48L ATS engines 2 chambers 5 operation time 6s / 2min 230V shaft ømm shaft Lmm		
<b>For models:</b>	ECO-120, ECO-1200, ECO-120B		

mechanical timers



1

<b>GEV No.</b>	350066	<b>Ref. No.</b>	12018407 R723000
<b>description</b>	timer C20 2-pole operation time 120min impulse mechanical 1NO/1NC at 250V 16A permanent position yes shaft ø 6x4.6mm shaft 6x4.6mm shaft L 23mm mounting distance 28mm connection lateral		
<b>For models:</b>	HCG-10-11, HCG-10-21, HCG-20-11, HCG-20-21, HCG-2-10-11, HCG-2-20-11, HCG-6-11, HEI-10-11, HEI-20-11, HEI-6-11, HGC-10-11, HGC-20-11, HGC-6-11, HGV-10-11, HGV-20-11, HME-20-11, HMG-10-11, HMG-10-11UL, HMG-10-21, HMG-10-21UL, HMG-20-11, HMG-2-10-11, HMG-6-11, HMI-10-11, HMI-10-11UL, HMI-10-21, HMI-10-21UL, HMI-2-10-11, HMI-6-11, HMI-6-11UL, HMM-10-11, HMM-10-11UL, HMM-10-21, HMM-10-21UL, HMM-20-11, HMM-20-11UL, HMM-20-21, HMM-20-21UL, HMM-2-10-11, HMM-40-11-USMC, HMM-6-11, HMM-6-11UL, HMP-20-11, HVG-10-11, HVG-10-11UL, HVG-10-21, HVG-10-21UL, HVG-20-11, HVG-20-21, HVG-2-10-11...(Other models you can see in the webshop)		



1

<b>GEV No.</b>	360732	<b>Ref. No.</b>	12030066 12049916 DO1DI13315 DO1DL13350
<b>description</b>	timer MT59 2-pole operation time 60min impulse mechanical 2NO at 250V 16A permanent position no shaft ø 6x4.6mm shaft L 21mm mounting distance 28mm connection lateral shaft flat lower		
<b>For models:</b>	SF-10, SF-13, SF-15, SF-22, SF-31, SF-8, SR-10MP-PSM, SR-13MP-PSM, SR-32MP-PSM		

			
1			
<b>GEV No.</b>	360447	<b>Ref. No.</b>	12029415 K017C21101
<b>description</b>	timer T203 1-pole operation time 5min impulse mechanical 1NO at 250V 16(3)A permanent position no shaft ø 6x4.6mm shaft 6x4.6mm shaft L 16mm mounting distance 30mm connection rear ambient temperature max. 55°C		

alarm devices

buzzer boards

			
1			
<b>GEV No.</b>	400879	<b>Ref. No.</b>	12018224 R723033
<b>description</b>	buzzer board connection connector		
<b>For models:</b>	HCG-10-11, HCG-10-21, HCG-20-11, HCG-2-10-11, HCG-6-11, HMG-10-11, HMG-10-11UL, HMG-10-21, HMG-10-21UL, HMG-20-11, HMG-2-10-11, HMG-6-11		

buzzers

			
1			
<b>GEV No.</b>	350053	<b>Ref. No.</b>	12032927 12033283 RT30060107
<b>description</b>	buzzer 12VAC connection male faston 3.2mm screw mounting buzzer		

			
1			
<b>GEV No.</b>	350067	<b>Ref. No.</b>	12018850 R693067
<b>description</b>	buzzer buzzer		
<b>For models:</b>	HCG-10-11, HCG-10-21, HCG-20-11, HCG-20-21, HCG-2-10-11, HCG-2-20-11, HCG-6-11, HEI-10-11, HEI-20-11, HEI-6-11, HGC-10-11, HGC-20-11, HGC-6-11, HGV-10-11, HGV-20-11, HMG-20-11, HMI-10-11, HMI-10-11UL, HMI-10-21, HMI-10-21UL, HMI-2-10-11, HMI-6-11, HMI-6-11UL, HMM-10-11, HMM-10-11UL, HMM-10-21, HMM-10-21UL, HMM-20-11, HMM-20-11UL, HMM-20-21, HMM-20-21UL, HMM-2-10-11, HMM-40-11-USMC, HMM-6-11, HMM-6-11UL, HVG-10-11, HVG-10-21, HVG-20-11, HVG-20-21, HVG-2-10-11, HVG-2-20-21, MFHMM-20-11		

contactors

ABB

power contactors

			
1			
<b>GEV No.</b>	380117	<b>Ref. No.</b>	SAM2600123
<b>description</b>	power contactor resistive load 25A 230VAC (AC3/400V) 9A/4kW main contacts 4NO auxiliary contacts connection screw connection type A9-40-00		

			
1			
<b>GEV No.</b>	381175	<b>Ref. No.</b>	12024040 (old version) Z203050 (old version)
<b>description</b>	power contactor resistive load 22A 230VAC (AC3/400V) 5.5kW main contacts 3NO auxiliary contacts 1NO connection plug-in connection type AS12-30-10S-26 50/60Hz		

<b>GEV No.</b>	381175	<b>Ref. No.</b>	12024040 (old version) Z203050 (old version)
<b>description</b>	power contactor resistive load 22A 230VAC (AC3/400V) 5.5kW main contacts 3NO auxiliary contacts 1NO connection plug-in connection type AS12-30-10S-26 50/60Hz		

BENEDIKT & JÄGER

power contactors

			
1			
<b>GEV No.</b>	381501	<b>Ref. No.</b>	12030536 RT30280557
<b>description</b>	power contactor resistive load 32A 230VAC (AC3/400V) 17A/7.5kW main contacts 3NO auxiliary contacts 1NC connection screw connection		



1





<b>GEV No.</b>	382001	<b>Ref. No.</b>	12030415 RT30280569
<b>description</b>	power contactor resistive load 32A 230VAC (AC3/400V) 17A/7.5kW main contacts 4NO auxiliary contacts connection screw connection		

**GENERAL ELECTRIC (AEG)**

power contactors



1

<b>GEV No.</b>	380267	<b>Ref. No.</b>	12027712 RT4001558	
<b>description</b>	power contactor resistive load 110A 230VAC (AC3/400V) 65A/30kW main contacts 3NO auxiliary contacts connection screw connection type AEG LS30K 00A type GE CL07A 300			
<b>accessories for</b>	380267			
	<b>GEV No.</b>	380268	<b>Ref. No.</b>	12034954 RT30280560
	auxiliary contact contacts 1NO for contactors CL+LS_K connection screw AC-12 10A type AEG HS07K 10 type GE BCLF 10			
	<b>GEV No.</b>	380269	<b>Ref. No.</b>	12035138 RT30280561
	auxiliary contact contacts 1NC AC15 6A for contactors CL+LS_K connection screw AC-12 10A type AEG HS07K 01 type GE BCLF 01			
	<b>GEV No.</b>	380270	<b>Ref. No.</b>	—
	auxiliary contact contacts 1NO/1NC for contactors CL+LS_K connection screw AC-12 10A type AEG HS08K 11 type GE BCLL 11			
	<b>GEV No.</b>	380271	<b>Ref. No.</b>	—
	auxiliary contact contacts 2NO for contactors CL+LS_K connection screw AC-12 10A type AEG HS08K 20 type GE BCLL 20			



1

<b>GEV No.</b>	380237	<b>Ref. No.</b>	12024011 Z213007
<b>description</b>	power contactor resistive load 16A 230VAC (AC3/400V) 6A/3kW main contacts 3NO auxiliary contacts 1NC connection male faston 6.3mm type AEG LS0701F		
<b>For models:</b>	ACE-061, ACE-101, ACE-102, ACE-201, ACE-202, ACG-061, ACG-101, ACG-102, ACG-201, ACG-202, AD-125, AD-125HRS, AD-125-SOFT, AD-15, AD-15D, AD-21, AD-21B, AD-21BDD, AD-21D, AD-21W, AD-505, AD-505-SOFT, AD-64BTDD, AE-061, AE-061W, AE-101, AE-101W, AE-102, AE-102W, AE-201, AE-202, AG-061, AG-061W, AG-101, AG-101W, AG-102, AG-102W, AG-201, AG-202, APE-061, APE-061W, APE-101, APE-101W, APE-102, APE-102W, APE-201, APE-202, APG-061, APG-061W, APG-101...(Other models you can see in the webshop)		



1

<b>GEV No.</b>	380498	<b>Ref. No.</b>	12030013 RT4000451
<b>description</b>	power contactor resistive load 20A 230VAC (AC3/400V) 9A/4kW main contacts 4NO auxiliary contacts connection male faston 6.3mm type MC1A 400A type AEG LS05 01 FA type GE MC1A 400A		



1

<b>GEV No.</b>	380245	<b>Ref. No.</b>	12031082 RT30280550
<b>description</b>	power contactor resistive load 25A 230VAC (AC3/400V) 9A/4kW main contacts 3NO auxiliary contacts 1NC connection screw connection type AEG LS4K 01A type GE CL00A 301 H 85mm		

1

<b>GEV No.</b>	380244	<b>Ref. No.</b>	12018159 12027320 12029911 12031081 R663031 RT30280551 RT4001554 RT4001556
<b>description</b>	power contactor resistive load 25A 230VAC (AC3/400V) 9A/4kW main contacts 3NO auxiliary contacts 1NO connection screw connection type AEG LS4K 10A type GE CL00A 310		
<b>For models:</b>	ECO-1600, ECO-160D, ECO-160I, ECO-200D, ECO-200HD, ECO-200HI, ECO-200I, ECO-2300, ECO-280D, ECO-280I, ECO-3000, ECO-370D, ECO-370I, ECO-460D, ECO-460I, ECO-550D, ECO-550I, FE-18, FE-25, FE-710, FI-120, FI-120B, FI-1600, FI-160D, FI-160I, FI-200D, FI-200HD, FI-200HI, FI-200I, FI-2300, FI-280D, FI-280I, FI-3000, FI-370D, FI-370I, FI-460D, FI-460I, FI-550D, FI-550I, HME-10-11, HME-10-21, HME-20-11, HME-20-21, HME-2-10-11, HME-6-11, HMI-10-11, HMI-10-11UL, HMI-10-21, HMI-10-21UL, HMI-2-10-11...(Other models you can see in the webshop)		



2

<b>GEV No.</b>	380261	<b>Ref. No.</b>	12028282 12029618 12030540 ICR13042 RT30280552 RT4001555
<b>description</b>	power contactor resistive load 32A 230VAC (AC3/400V) 17A/7.5kW main contacts 3NO auxiliary contacts 1NO connection screw connection type AEG LS7K 10A type GE CL02A 310		



1

<b>GEV No.</b>	380265	<b>Ref. No.</b>	12028308 RT30280554
<b>description</b>	power contactor resistive load 60A 230VAC (AC3/400V) 32A/16kW main contacts 3NO auxiliary contacts 1NO connection screw connection type AEG LS15K 00A type GE CL04A 310 H 98mm L 87mm W 55mm		

auxiliary contacts



1

<b>GEV No.</b>	380269	<b>Ref. No.</b>	12035138 RT30280561
<b>description</b>	auxiliary contact contacts 1NC AC15 6A for contactors CL+LS_K connection screw AC-12 10A type AEG HS07K 01 type GE BCLF 01		



1

<b>GEV No.</b>	380268	<b>Ref. No.</b>	12034954 RT30280560
<b>description</b>	auxiliary contact contacts 1NO for contactors CL+LS_K connection screw AC-12 10A type AEG HS07K 10 type GE BCLF 10		

ISKRA (FANAL)

power contactors



1

<b>GEV No.</b>	380212	<b>Ref. No.</b>	12000219 P453023
<b>description</b>	power contactor resistive load 20A 230VAC (AC3/400V) 8.5A/5.5kW main contacts 3NO auxiliary contacts 1NC connection screw connection type Fanal K07M 01 type ISKRA DSL7 01		
<b>For models:</b>	FE-6, FE-8, FI-300B, FI-300R, FI-650R		



## SIEMENS

## power contactors



1

<b>GEV No.</b>	380614	<b>Ref. No.</b>	12024040 12111795 Z203050
<b>description</b>	power contactor resistive load 22A 230VAC (AC3/400V) 9A/4kW main contacts 3NO auxiliary contacts 1NO connection elastic terminals type 3RT2016-2AP01		
<b>For models:</b>	ACE-061, ACE-101, AD-120, AD-120B, AD-120BBTDD-UK, AD-120C, AD-120CW, AD-120HY, AD-125, AD-125HRS, AD-125-SOFT, AD-90, AD-90BA, AD-90BBT, AD-90BDD, AD-90DD, ADE-120, ADE-120B, AE-061, AE-061W, AE-101, AE-101W, APE-061, APE-061W, APE-101, APE-101W, CO-110, CO-110B, CO-110BDD, CO-110DD, CO-112, CO-112B, CO-112BDD, CO-112DD, CO-142W, CO-142WDD, CO-170, CO-170B, CO-170BDD, CO-170DD, CO-170HRS, CO-170HRSDD, CO-170HRS-SOFT, CO-170-SOFT, CO-172, CO-172B, CO-172BDD, CO-172DD, COE-061, COE-101...(Other models you can see in the webshop)		



2

<b>GEV No.</b>	380389	<b>Ref. No.</b>	12018160 12024039 P433030 Z743009
<b>description</b>	power contactor resistive load 22A 230VAC (AC3/400V) 9A/4kW main contacts 3NO auxiliary contacts 1NO connection screw connection type 3RT10-16-1AP01		
<b>For models:</b>	ECO-160, ECO-200, ECO-200D, ECO-200H, ECO-200HD, ECO-200HI, ECO-200I, ECO-2700D, ECO-2700I, ECO-280D, ECO-280I, ECO-370D, ECO-370I, ECO-4000D, ECO-4000I, ECO-460D, ECO-460I, ECO-550D, ECO-550I, ECO-6000D, ECO-6000I, FI-120W, FI-160, FI-160AR, FI-160D, FI-160I, FI-200, FI-200AR, FI-200D, FI-200H, FI-200HD, FI-200HI, FI-200I, FI-200W, FI-2700D, FI-2700I, FI-280D, FI-280I, FI-370D, FI-370I, FI-4000D, FI-4000I, FI-460D, FI-460I, FI-48, FI-48AR, FI-48B, FI-48B-BT-UK, FI-48C, FI-48D...(Other models you can see in the webshop)		



1

<b>GEV No.</b>	380390	<b>Ref. No.</b>	12024075 12039754 12040142 R143002 R673007 X183011
<b>description</b>	power contactor resistive load 40A 230VAC (AC3/400V) 12A/5.5kW main contacts 3NO auxiliary contacts connection screw connection type 3RT10-24-1AL20 50/60Hz		
<b>For models:</b>	COE-102, COE-201, ECO-160, ECO-1600, ECO-160D, ECO-160I, ECO-200, ECO-200D, ECO-200H, ECO-200HD, ECO-200HI, ECO-200I, ECO-2300, ECO-2700D, ECO-2700I, ECO-280D, ECO-280I, ECO-3000, ECO-370D, ECO-370I, ECO-4000D, ECO-4000I, ECO-460D, ECO-460I, ECO-550D, ECO-550I, ECO-6000D, ECO-6000I, FE9-05, FE9-05-1C, FE9-05-2C, FE9-05AD, FE9-05PLUS, FE9-05PLUS-S, FE9-05S, FE9-05S-1C, FE9-05S-2C, FE9-05S-AD, FE9-05USMC, FE9-10, FE9-10-2C, FE9-10-4C, FE9-10AD, FE9-10PLUS, FE-920, FI-160, FI-1600, FI-160AR, FI-160D, FI-160I...(Other models you can see in the webshop)		



1

<b>GEV No.</b>	381543	<b>Ref. No.</b>	12041014
<b>description</b>	power contactor resistive load 40A 230VAC (AC3/400V) 5.5kW main contacts 3NO auxiliary contacts 1NO/1NC connection plug-in connection type 3RT2024-2AL20		
<b>For models:</b>	ACE-102, ACE-201, AE-102, AE-102W, AE-201, APE-102, APE-102W, APE-201, LA-E-25M, LA-E-25MA, LA-E-25MP, LR-E-25M, LR-E-25MA, LR-E-25MP		





auxiliary contacts



<b>GEV No.</b>	380539	<b>Ref. No.</b>	12023704 Z103070
<b>description</b>	auxiliary contact contacts 1NO AC15 3A for contactors 3RT102 3 RT103 connection screw connection type 3RH1921-1CA10 resistive load 10A AC-12 10A		
<b>For models:</b>	ECO-160, ECO-1600, ECO-160D, ECO-160I, ECO-200, ECO-200D, ECO-200H, ECO-200HD, ECO-200HI, ECO-200I, ECO-2300, ECO-2700D, ECO-2700I, ECO-280D, ECO-280I, ECO-3000, ECO-370D, ECO-370I, ECO-4000D, ECO-4000I, ECO-460D, ECO-460I, ECO-550D, ECO-550I, ECO-6000D, ECO-6000I, FI-160, FI-1600, FI-160AR, FI-160D, FI-160I, FI-200, FI-200AR, FI-200D, FI-200H, FI-200HD, FI-200HI, FI-200I, FI-200W, FI-2300, FI-2700D, FI-2700I, FI-280D, FI-280I, FI-3000, FI-370D, FI-370I, FI-4000D, FI-4000I, FI-460D...(Other models you can see in the webshop)		

small relay switches



<b>GEV No.</b>	380696	<b>Ref. No.</b>	12024012 Z683087
<b>description</b>	small relay switch 230V (AC3/400V) 9A/4kW main contacts 3NO auxiliary contacts 1NC connection male faston 6.3mm resistive load 16A		
<b>For models:</b>	AD-15, AD-15D, AD-20C-UK, AD-21, AD-21B, AD-21BDD, AD-21C, AD-21D, AD-21DD, AD-48, AD-48BDD, AD-48C, AD-48D, AD-48DD, AD-64, AD-64B, AD-64BDD, AD-64C, AD-64D, AD-64DD, AD-72, CO-110, CO-110B, CO-110BDD, CO-110DD, CO-112, CO-112B, CO-112BDD, CO-112DD, CO-170, CO-170B, CO-170BDD, CO-170DD, CO-170HRS, CO-170HRSDD, CO-170HRS-SOFT, CO-170-SOFT, CO-172, CO-172B, CO-172BDD, CO-172DD, COP-173, COP-173B, COP-173BDD, COP-173DD, COP-173HRS, COP-173HRSDD, COP-173-SOFT, COP-174, COP-174B...(Other models you can see in the webshop)		

solid state relays

CELDUC



<b>GEV No.</b>	400105	<b>Ref. No.</b>	12028184 12029297 12029298 RT30280533 RT4000453 RT4000453P
<b>description</b>	solid state relay CELDUC 2 phase 65A 400V 24VDC L 58mm W 45mm plug-in connection screw type 40.00.453		
<b>accessories for</b>	400105		
	<b>GEV No.</b>	401794	<b>Ref. No.</b> —
	connecting cable L 1440mm 4-pole suitable for RATIONAL		

relays

power relays

with DIN rail mounting

upper



<b>GEV No.</b>	380610	<b>Ref. No.</b>	1200002018 12019647 12038273 Z203018
<b>description</b>	power relays connection male faston DIN rail		
<b>For models:</b>	ECO-1600, ECO-2300, ECO-3000, FI-1200, FI-1600, FI-2300, FI-30, FI-3000, FI-48, FI-48B, FI-48W, FI-64, FI-64B, FI-64W, FI-72, FI-900, LVC-12, LVC-15, LVC-15D, LVC-21, LVC-21B, LVC-21D, LVC-21W, LVR-10, LVR-14, LVR-14D, LVR-20, LVR-20B, LVR-20D		



<b>GEV No.</b>	380809	<b>Ref. No.</b>	12023706 12033296 12034668 6021130007 6021130033 Z203062
<b>description</b>	power relays FINDER 230VAC 16A 2NO connection male faston 6.3mm bracket mounting manuf. no. 62.82.8.230.0307		
<b>For models:</b>	AD-120, AD-120B, AD-120BTTDD-UK, AD-120C, AD-120CW, AD-120HY, AD-15, AD-15D, AD-20C-UK, AD-21, AD-21B, AD-21BDD, AD-21C, AD-21D, AD-21DD, AD-21W, AD-90, AD-90BA, AD-90BBT, AD-90BDD, AD-90DD, ADE-120, ADE-120B, ATM-051, ATM-051ECO, ATM-051VCH, ATM-051VCH-60Hz, ATM-081VCH, ATM-081VCH-60Hz, ATM-101, ATM-101VCH, ATM-101VCH-60Hz, CM-201, CM-202, CMP-201, CO-352-COLD, CO-352-COLD-B, CO-352-COLD-B-DD, CO-352-COLD-DD, CO-400-SOFT, CO-402-COLD, CO-402-COLD-B, CO-402-COLD-B-DD, CO-402-COLD-DD, CO-402W, CO-500, CO-500B, CO-500BDD, CO-500DD, CO-501...(Other models you can see in the webshop)		

with bracket mounting



<b>GEV No.</b>	380139	<b>Ref. No.</b>	12031875 EU929115
<b>description</b>	power relays FINDER 230VAC 16A 2CO connection F6.3 bracket mounting dimensions 68x38.2x35.8mm manuf. no. 62.82.8.230.0000		

with male contacts

female contact 2.0mm



<b>GEV No.</b>	380502	<b>Ref. No.</b>	12030936 RT30350485
<b>description</b>	power relays connection 2.0 plug-in connection		

plug-in/print relays



<b>GEV No.</b>	380501	<b>Ref. No.</b>	12032188 RT30350486
<b>description</b>	print relay 12VDC		

relay sockets



<b>GEV No.</b>	380136	<b>Ref. No.</b>	12024185 R743009
<b>description</b>	relay socket 11-pole connection plug-in connection round 11-pole dimensions 65x28x40mm 250V voltage AC 10A Italiana Relè manuf. no. ZVE11		
<b>For models:</b>	GA-20, GA-20D, GA-40, GA-40D, HGV-10-11, HGV-20-11, HMM-10-11, HMM-10-11UL, HMM-10-21, HMM-10-21UL, HMM-20-11, HMM-20-11UL, HMM-20-21, HMM-20-21UL, HMM-2-10-11, HMM-40-11-USMC, HMM-6-11, HMM-6-11UL, HVG-10-11, HVG-10-11UL, HVG-10-21, HVG-10-21UL, HVG-20-11, HVG-20-21, HVG-2-10-11, HVG-2-20-21, ME9-10PLUS-BM, ME9-10PLUS-BMS, ME9-15BM-AD, ME9-15PLUS-BM, ME9-15PLUS-BMS, MFHMM-20-11, MFHVG-10-11, MFHVG-10-21, MG9-10BMAD, MG9-10BMSAD, MG9-10PLUS-BM, MG9-10PLUS-BMS, MG9-15BMAD, MG9-15BMSAD, MG9-15PLUS-BM, MG9-15PLUS-BMS		
<b>accessories for</b>	380136		
	<b>GEV No.</b>	380805	<b>Ref. No.</b> —
	support bracket		

accessories



<b>GEV No.</b>	691697	<b>Ref. No.</b>	12011818 U805615
<b>description</b>	fastening angle for contactor suitable for		
<b>For models:</b>	CE7-41, CGE7-217, CGE7-41		

level relays

miscellaneous



<b>GEV No.</b>	400880	<b>Ref. No.</b>	12017268 12024209 R343072
<b>description</b>	level relay 50/60Hz 230/400V contacts 1CO type VyF		
<b>For models:</b>	GA-20, GA-20D, GA-40, GA-40D, HCV-10-11, HCV-10-21, HCV-2-10-21, HCV-5-11, HCV-6-11, HGV-10-11, HGV-20-11, HMM-10-11, HMM-10-21, HMM-20-11, HMM-20-21, HMM-2-10-11, HMM-2-20-11, HMM-6-11, HVG-10-11, HVG-10-21, HVG-20-11, HVG-20-21, HVG-2-10-11, HVG-2-20-21, ME9-10PLUS-BM, ME9-10PLUS-BMS, ME9-15BM-AD, ME9-15PLUS-BM, ME9-15PLUS-BMS, MG9-10BMAD, MG9-10BMSAD, MG9-10PLUS-BM, MG9-10PLUS-BMS, MG9-15BMAD, MG9-15BMSAD, MG9-15PLUS-BM, MG9-15PLUS-BMS		



time relays

time relays



1

<b>GEV No.</b>	360318	<b>Ref. No.</b>	12017722 12039922 R013030 R723061
<b>description</b>	time relay FIBER E58F47 time range 0-12min 230VAC 5A mounting measurements 45x45mm connection plug-in connection round 8-pole		
<b>For models:</b>	HCG-10-11, HCG-10-21, HCG-20-11, HCG-2-10-11, HCG-6-11, HMG-10-11, HMG-10-21, HMG-20-11, HMG-2-10-11, HMG-6-11		
<b>accessories for</b>	360318		
	<b>GEV No.</b>	380638	<b>Ref. No.</b> —
	relay socket 8-pole dimensions 51x41x23mm 250V 10A FINDER manuf. no. 90.26		



1

<b>GEV No.</b>	360554	<b>Ref. No.</b>	12024079 Z123022 Z123022000
<b>description</b>	time relay TELEMECANIQUE RE17RMMU time range 0.1s-100h 24-240VAC/24VDC 8A mounting measurements DIN railmm 1 CO connection screw connection		
<b>For models:</b>	ECO-160, ECO-1600, ECO-160D, ECO-160I, ECO-200, ECO-200D, ECO-200H, ECO-200HD, ECO-200HI, ECO-200I, ECO-2300, ECO-2700D, ECO-2700I, ECO-280D, ECO-280I, ECO-3000, ECO-370D, ECO-370I, ECO-4000D, ECO-4000I, ECO-460D, ECO-460I, ECO-550D, ECO-550I, ECO-6000D, ECO-6000I, FI-160, FI-1600, FI-160AR, FI-160D, FI-160I, FI-200, FI-200AR, FI-200D, FI-200H, FI-200HD, FI-200HI, FI-200I, FI-200W, FI-2300, FI-2700D, FI-2700I, FI-280D, FI-280I, FI-3000, FI-370D, FI-370I, FI-4000D, FI-4000I, FI-460D...(Other models you can see in the webshop)		

transformers

open transformers

with clamp terminal



1

<b>GEV No.</b>	400888	<b>Ref. No.</b>	12017582 R723044
<b>description</b>	transformer primary 220VAC secondary 230VAC 150VA secondary 0.65A connection spring terminal 50/60Hz		
<b>For models:</b>	HCG-20-11, HMG-20-11		



1

<b>GEV No.</b>	400887	<b>Ref. No.</b>	12024153 12024173 12033065 12040013 50GL951275 R503005 R663039
<b>description</b>	transformer primary 230VAC secondary 12/24VAC 65VA connection screw 50-60Hz		
<b>For models:</b>	ACE-061, ACE-101, ACE-102, ACE-201, ACE-202, ACG-061, ACG-101, ACG-102, ACG-201, ACG-202, AE-061, AE-101, AE-102, AE-201, AE-202, AG-061, AG-101, AG-102, AG-201, AG-202, APE-061, APE-101, APE-102, APE-201, APE-202, APG-061, APG-101, APG-102, APG-201, APG-202, COE-061, COE-101, COE-102, COE-201, COE-202, COG-061, COG-101, COG-102, COG-201, COG-202, HCG-10-11, HCG-10-21, HCG-20-11, HCG-20-21, HCG-2-10-11, HCG-2-20-11, HCG-6-11, HEI-10-11, HEI-10-21, HEI-20-11...(Other models you can see in the webshop)		



1

<b>GEV No.</b>	400104	<b>Ref. No.</b>	12028922 RT30370242
<b>description</b>	transformer primary 230VAC secondary 24VAC 40VA secondary 1.7A connection screw 50/60Hz with fuse		



with plug connection



			
1			
<b>GEV No.</b>	400101	<b>Ref. No.</b>	12029247 RT30370240
<b>description</b>	transformer primary 200-260VAC secondary 4.2/14.4/11.5VAC 68.4VA		

toroidal core transformers

			
1			
<b>GEV No.</b>	401791	<b>Ref. No.</b>	12016605 R693060 R723063
<b>description</b>	transformer primary 230VAC secondary 12VAC 15/50VA secondary 2.1A 50/60Hz		
<b>For models:</b>	HMG-10-11UL, HMG-10-21UL, HMI-10-11UL, HMI-10-21UL, HMI-6-11UL, HMM-10-11UL, HMM-10-21UL, HMM-20-11, HMM-20-11UL, HMM-20-21UL, HMM-40-11-USMC, HMM-6-11UL, HVG-10-11, HVG-10-11UL, HVG-10-21, HVG-10-21UL, HVG-2-10-11, MFHMM-20-11, MFHVG-10-11, MFHVG-10-21		

encapsulated transformers

with plug connection

			
1			
<b>GEV No.</b>	401472	<b>Ref. No.</b>	12028416 RT4000277
<b>description</b>	transformer 1/20/50VA secondary A H 70mm L 76mm W 104mm connection plug 50/60Hz type 110170 with fuse secondary 2.1/11.5/12VAC primary 230VAC		
<b>spare parts for</b>	401472		
	<b>GEV No.</b>	358602	<b>Ref. No.</b> —
fine fuse size ø5x20mm 1.6A slow-acting rated 250V Qty 10 pcs			

			
1			
<b>GEV No.</b>	401473	<b>Ref. No.</b>	12028264 RT4000592
<b>description</b>	transformer 21.6VA H 70mm L 94mm W 71mm connection plug 50-60Hz type 40.00.592 moulded secondary 12VDC primary 200-250VAC		

electronic controllers

CAREL

refrigeration controllers

built-in version

			
1			
<b>GEV No.</b>	378527	<b>Ref. No.</b>	6021350106
<b>description</b>	electronic controller CAREL PYCO1L051G mounting measurements 71x29mm built-in depth 74mm 230V voltage AC NTC relay outputs 1 CO-12A(2) NTC NTC DI yes protection IP54 -50 up to +90°C display 3½ digits		

			
1			
<b>GEV No.</b>	379779	<b>Ref. No.</b>	12038178 12049777 6021350010
<b>description</b>	electronic controller CAREL PYCO1LOXXX mounting measurements 71x29mm built-in depth 74mm 230V voltage AC NTC relay outputs 3 CO-8A(4) NO-8A(4) NO-8A(4) NTC NTC DI yes 2x NTC 10K protection IP54 -50 up to +90°C display 3½ digits		
<b>For models:</b>	AEP-802, AF-1402-MIX, AF-1403-C, AF-1403-P, AF-1404-C, AF-1404-P, AF-1602-MIX, AF-1603-C, AF-1603-P, AF-1604-C, AF-1604-P, AF-2104-C, AF-2104-P, AF-2105-C, AF-2105-P, AF-2106-C, AF-2106-P, AF-702-C, AF-702-P, AF-802-C, AF-802-P, AFN-1402, AFN-1403, AFN-1404, AFN-1602, AFN-1603, AFN-1604, AFN-701, AFN-702, AFN-801, AFN-802, AFP-702, AP-701, APP-701, MCN-135-GN, MCN-180-GN, MCN-270-GN, MFN-135, MFN-135-GN, MFN-180, MFN-180-GN, MFN-225-GN, MFN-270-GN, MPN-117-R, MPN-150, MPN-169-R, MPN-202, MPN-255, MPN-255-C, MPN-274-R...(Other models you can see in the webshop)		



			
1			
<b>GEV No.</b>	378673	<b>Ref. No.</b>	12047691 6021350115
<b>description</b>	electronic controller CAREL PYCO1SN50P mounting measurements 71x29mm built-in depth 59mm 230V voltage AC NTC		

accessories

			
1			
<b>GEV No.</b>	378669	<b>Ref. No.</b>	12110849 6003010410
<b>description</b>	frame L 162mm W 35mm H 1mm CAREL plastic black		

DIXELL

refrigeration controllers

built-in version

			
1			
<b>GEV No.</b>	378526	<b>Ref. No.</b>	6021350114
<b>description</b>	electronic controller DIXELL mounting measurements 30x150mm built-in depth 42mm 230V voltage AC NTC relay outputs 3 NO-16A(8) NO-5A NO-8(3) NTC DI DI incl. probe -40 up to 110°C display 2.5		

ELIWELL

universal controllers

built-in version

			
1			
<b>GEV No.</b>	379622	<b>Ref. No.</b>	12016193 12017189
<b>description</b>	electronic controller ELIWELL type IC912 mounting measurements 71x29mm 12V Pt100/TC (J,K) temperature controller protection IP65 defr. funct. no 8A		
<b>For models:</b>	HGV-10-11, HGV-20-11		

refrigeration controllers

built-in version

			
1			
<b>GEV No.</b>	378214	<b>Ref. No.</b>	12016682 R743003 T133004
<b>description</b>	electronic controller ELIWELL type EWPC902T mounting measurements 71x29mm 12V voltage AC/DC TC/J compressor relay 8A		

			
1			
<b>GEV No.</b>	379018	<b>Ref. No.</b>	R743005
<b>description</b>	electronic controller ELIWELL type EWPC902T thermocouple J		

			
1			

<b>GEV No.</b>	379645	<b>Ref. No.</b>	12029316 12029317 12031127 12031161 6001507039 6001567002 6021350006 6021350015
----------------	--------	-----------------	--

**description** electronic controller ELIWELL type ID961 mounting measurements 71x29mm 230V voltage AC NTC/PTC relay outputs 1 relay -55 up to +150°C display 3½ digits compressor relay 15A

**For models:** AEP-1402, AEP-1403, AEP-1404, AEP-1602, AEP-1603, AEP-1604, AEP-2103, AEP-701, AEP-702, AEP-801, AEP-802, AF-1402-MIX, AF-1403-C, AF-1403-P, AF-1404-C, AF-1404-P, AF-1602-MIX, AF-1603-C, AF-1603-P, AF-1604-C, AF-1604-P, AF-2104-C, AF-2104-P, AF-2105-C, AF-2105-P, AF-2106-C, AF-2106-P, AF-702-C, AF-702-P, AF-802-C, AF-802-P, AFP-1402, AFP-1403, AFP-1403-C, AFP-1403-P, AFP-1404, AFP-1404-C, AFP-1404-P, AFP-1404-USMC, AFP-1602, AFP-1602-2, AFP-1603, AFP-1603-2, AFP-1604, AFP-2103, AFP-2104, AFP-2104-C, AFP-2104-P, AFP-2105, AFP-2105-C...(Other models you can see in the webshop)

<b>accessories for</b>	379645		
	<b>GEV No.</b>	379053	<b>Ref. No.</b>
			—
		temperature probe PTC 1kOhm cable PVC probe -50 up to +150°C cable -10 up to 100°C probe ø6x30mm cable length 3m without screw connection 2-wire	
	<b>GEV No.</b>	379064	<b>Ref. No.</b>
			—
		temperature probe PTC 1kOhm cable silicone probe -50 up to +150°C cable -50 up to +180°C probe ø6x40mm cable length 3m without screw connection 2-wire	

Table continues overleaf



<b>accessories for</b> 379645			
GEV No.	379161	Ref. No.	—
temperature probe NTC 10kOhm cable thermoplastic probe -40 up to +110°C cable -40 up to +110°C probe ø6x14mm cable length 3m without screw connection 2-wire			
GEV No.	379782	Ref. No.	—
temperature probe PTC 1kOhm cable thermoplastic probe -50 up to +150°C cable -40 up to +110°C probe ø6x14mm cable length 3m 2-wire resistor 1kOhm			



<b>GEV No.</b>	379571	<b>Ref. No.</b>	12028942 6001507002
<b>description</b>	electronic controller ELIWELL type ID961 mounting measurements 71x29mm 230V voltage AC NTC/PTC relay outputs 1 relay -55 up to +150°C display 3½ digits RoomTempIN yes compressor relay 8A		
<b>For models:</b>	AEP-1402, AEP-1403, AEP-1404, AEP-1602, AEP-1603, AEP-1604, AEP-701, AEP-702, AEP-801, AEP-802, AFP-1402, AFP-1402-FORZ, AFP-1403, AFP-1403-C, AFP-1403-FORZ, AFP-1403-P, AFP-1404, AFP-1404-C, AFP-1404-FORZ, AFP-1404-P, AFP-1602, AFP-1602-2, AFP-1603, AFP-1604, AFP-2103, AFP-2104, AFP-2104-C, AFP-2104-P, AFP-2105, AFP-2105-C, AFP-2105-P, AFP-2106, AFP-2106-C, AFP-2106-P, AFP-701, AFP-701-FORZ, AFP-702, AFP-702-C, AFP-702-FORZ, AFP-702-P, AFP-801, AFP-802, AFP-802-2, APP-701, FMP-117-R, FMP-150, FMP-169-R, FMP-200, FMP-222-R, FMP-250...(Other models you can see in the webshop)		
<b>accessories for</b> 379571			
GEV No.	379053	Ref. No.	—
temperature probe PTC 1kOhm cable PVC probe -50 up to +150°C cable -10 up to 100°C probe ø6x30mm cable length 3m without screw connection 2-wire			
GEV No.	379064	Ref. No.	—
temperature probe PTC 1kOhm cable silicone probe -50 up to +150°C cable -50 up to +180°C probe ø6x40mm cable length 3m without screw connection 2-wire			
GEV No.	379161	Ref. No.	—
temperature probe NTC 10kOhm cable thermoplastic probe -40 up to +110°C cable -40 up to +110°C probe ø6x14mm cable length 3m without screw connection 2-wire			
GEV No.	379782	Ref. No.	—
temperature probe PTC 1kOhm cable thermoplastic probe -50 up to +150°C cable -40 up to +110°C probe ø6x14mm cable length 3m 2-wire resistor 1kOhm			



<b>GEV No.</b>	379577	<b>Ref. No.</b>	12028377 12028398 12029857 12029858 12030168 6001507012 6001507042 6021350002 6021350007 6021350019
<b>description</b>	electronic controller ELIWELL type ID974 mounting measurements 71x29mm 230V voltage AC NTC/PTC relay outputs 3 relays -50 up to +150°C display 3½ digits RoomTempIN yes DEF Probe yes DEF Relay 8A fan relay 5A compressor relay 8A		
<b>For models:</b>	AF-1402-MIX, AF-1403-C, AF-1403-P, AF-1404-C, AF-1404-P, AF-1602-MIX, AF-1603-C, AF-1603-P, AF-1604-C, AF-1604-P, AF-2104-C, AF-2104-P, AF-2105-C, AF-2105-P, AF-2106-C, AF-2106-P, AF-702-C, AF-702-P, AF-802-C, AF-802-P, AFN-1402, AFN-1403, AFN-1404, AFN-1602, AFN-1603, AFN-1604, AFN-701, AFN-702, AFN-801, AFN-802, AFP-1402-MIX, AP-701, APP-701, MCN-102-GN-R, MCN-102-R, MCN-135, MCN-135-GN, MCN-147-GN-R, MCN-147-R, MCN-180, MCN-180-GN, MCN-192-GN-R, MCN-192-R, MCN-225, MCN-225-GN, MCN-237-GN-R, MCN-237-R, MCN-270, MCN-270-GN, MFN-102-GN-R...(Other models you can see in the webshop)		
<b>accessories for</b> 379577			
GEV No.	379053	Ref. No.	—
temperature probe PTC 1kOhm cable PVC probe -50 up to +150°C cable -10 up to 100°C probe ø6x30mm cable length 3m without screw connection 2-wire			
GEV No.	379064	Ref. No.	—
temperature probe PTC 1kOhm cable silicone probe -50 up to +150°C cable -50 up to +180°C probe ø6x40mm cable length 3m without screw connection 2-wire			
GEV No.	379161	Ref. No.	—
temperature probe NTC 10kOhm cable thermoplastic probe -40 up to +110°C cable -40 up to +110°C probe ø6x14mm cable length 3m without screw connection 2-wire			
GEV No.	379782	Ref. No.	—
temperature probe PTC 1kOhm cable thermoplastic probe -50 up to +150°C cable -40 up to +110°C probe ø6x14mm cable length 3m 2-wire resistor 1kOhm			







EVCO - EVERY CONTROL

universal controllers

built-in version



<b>1</b>	<b>GEV No.</b>	378131	<b>Ref. No.</b>	12017197
<b>description</b>	electronic controller EVERY CONTROL EVK411M mounting measurements 71x29mm 12V voltage AC/DC NTC/PTC/Pt100/Pt1000 relay outputs 1 CO-16A(8) NTC/PTC/Pt100/Pt1000/TC(J,K)/mV/mA yes protection IP65 depend on probe°C display 3½ digits			
<b>accessories for</b>	378131			
	<b>GEV No.</b>	379050	<b>Ref. No.</b>	—
<b>description</b>	temperature probe Pt100 cable Vetrotex probe -200 up to +600°C cable -50 up to +350°C probe ø6x100mm cable length 2.7m without screw connection 3-wire			
	<b>GEV No.</b>	379160	<b>Ref. No.</b>	—
<b>description</b>	temperature probe NTC 10kOhm cable thermoplastic probe -40 up to +110°C cable -40 up to +110°C probe ø6x14mm cable length 1.5m without screw connection 2-wire			
	<b>GEV No.</b>	379781	<b>Ref. No.</b>	—
<b>description</b>	temperature probe PTC 1kOhm cable thermoplastic probe -50 up to +150°C cable -40 up to +110°C probe ø6x14mm cable length 1.5m without screw connection 2-wire			
	<b>GEV No.</b>	379944	<b>Ref. No.</b>	—
<b>description</b>	temperature probe Pt1000 cable Vetrotex probe -70 up to +500°C cable -50 up to +350°C connection 2-wire thread probe ø6x180mm cable length 1.7m			

probes

universal probes

temperature probes



<b>1</b>	<b>GEV No.</b>	379343	<b>Ref. No.</b>	12040436 6021350013
<b>description</b>	temperature probe NTC 10kOhm cable silicone probe -40 up to +110°C cable -50 up to +180°C probe ø6x40mm cable length 3m 2-wire			
<b>For models:</b>	AEP-1402, AEP-1602, AEP-2103, AEP-701, AEP-801, AEP-802, AF-1402-MIX, AF-1403-C, AF-1403-P, AF-1404-C, AF-1404-P, AF-1602-MIX, AF-1603-C, AF-1603-P, AF-1604-C, AF-1604-P, AF-2104-C, AF-2104-P, AF-2105-C, AF-2105-P, AF-2106-C, AF-2106-P, AF-702-C, AF-702-P, AF-802-C, AF-802-P, AFN-1402, AFN-1403, AFN-1404, AFN-1602, AFN-1603, AFN-1604, AFN-702, AFN-801, AFN-802, AFP-1402, AFP-1403, AFP-1404, AFP-1404-USMC, AFP-1602, AFP-1602-2, AFP-1603, AFP-1603-2, AFP-1604, AFP-2103, AFP-2104, AFP-2105, AFP-2106, AFP-701, AFP-702...(Other models you can see in the webshop)			



<b>1</b>	<b>GEV No.</b>	379630	<b>Ref. No.</b>	6021350083
<b>description</b>	temperature probe NTC 10kOhm cable thermoplastic probe -40 up to +110°C cable -40 up to +110°C probe ø6x14mm cable length 2.5m without screw connection 2-wire resistor 10kOhm			



<b>1</b>	<b>GEV No.</b>	379478	<b>Ref. No.</b>	12038239 6002000057
<b>description</b>	temperature probe NTC 10kOhm cable thermoplastic probe -40 up to +110°C cable -40 up to +110°C probe ø6x40mm cable length 3m cable colours white/red 2-wire			

<b>1</b>	<b>GEV No.</b>	379142	<b>Ref. No.</b>	12033839 6021350026
<b>description</b>	temperature probe PTC 1kOhm cable PVC probe -50 up to +150°C cable -10 up to 100°C probe ø6x30mm cable length 1.5m without screw connection 2-wire			
<b>For models:</b>	ATM-101, VTP-139-C, VTP-139-CD, VTP-139-P, VTP-139-PD, VTP-139-RC, VTP-139-RCD, VTP-139-RP, VTP-139-RPD, VTP-175-C, VTP-175-CD, VTP-175-P, VTP-175-PD, VTP-175-RC, VTP-175-RCD, VTP-175-RP, VTP-175-RPD			

<b>1</b>	<b>GEV No.</b>	379487	<b>Ref. No.</b>	12032993 FR995562
<b>description</b>	temperature probe PTC cable silicone probe -50 up to +150°C cable -50 up to +180°C probe ø6x30mm cable length 2.5m without screw connection 2-wire			

<b>1</b>	<b>GEV No.</b>	379553	<b>Ref. No.</b>	12017340 T113088
<b>description</b>	core temperature probe thermocouple K (NiCr-Ni) cable PTFE probe -40 up to +250°C cable -40 up to +250°C probe ø4x120mm cable length 2m thread handle ø 10mm handle length 60mm 2-wire			
<b>For models:</b>	HGV-10-11, HGV-20-11			

core probes

<b>1</b>	<b>GEV No.</b>	379529	<b>Ref. No.</b>	12017395 R673059 R673076
<b>description</b>	temperature probe thermocouple J (Fe-CuNi) cable PTFE probe -50 up to +750°C cable -40 up to +250°C probe ø4x120mm cable length 1.9m 2-wire			
<b>For models:</b>	HEM-10-11, HEM-20-11, HEM-6-11, HEP-10-11, HEP-20-11, HEP-6-11, HME-10-11, HME-10-21, HME-2-10-11, HMM-10-11, HMM-10-11UL, HMM-10-21, HMM-10-21UL, HMM-2-10-11, HMP-10-11, HMP-10-21, HMP-2-10-11			
<b>accessories for</b>	379529			
	<b>GEV No.</b>	691097	<b>Ref. No.</b>	12024241 T133037
<b>description</b>	holding plate for probe mounting pos. upper L 35mm W 12mm H 4mm SS			
	<b>GEV No.</b>	691098	<b>Ref. No.</b>	12024243 T133036
<b>description</b>	holding plate for probe mounting pos. lower L 35mm W 12mm H 4mm SS			



producer-specific probes

probes



<b>GEV No.</b>	379489	<b>Ref. No.</b>	12024649 T303007
<b>description</b>	core temperature probe thermocouple J (Fe-CuNi) cable PTFE probe -50 up to +750°C cable -40 up to +250°C connection male faston thread probe ø4x120mm cable length 1.85m		
<b>For models:</b>	HEM-10-21, HEM-20-21, HGV-10-21, HGV-20-21, VE-102, VE-202, VG-102, VG-202		



<b>GEV No.</b>	379430	<b>Ref. No.</b>	12040499 RT4001095
<b>description</b>	core temperature probe thermocouple K (NiCr-Ni) cable silicone probe -50 up to +1150°C cable -50 up to +180°C connection coded plug thread probe ø1.5x140mm cable length 1.65m		



<b>GEV No.</b>	379554	<b>Ref. No.</b>	12020413 R073008
<b>description</b>	probe PTC cable silicone probe -50 up to +150°C cable -50 up to +180°C connection plug-in connection thread probe ø4x13mm cable length 0.05m		
<b>For models:</b>	HCG-10-11, HCG-10-21, HCG-20-11, HCG-20-21, HCG-2-10-11, HCG-2-20-11, HCG-6-11, HG-10-21, HG-2-10-11, HMG-10-11, HMG-10-11UL, HMG-10-21, HMG-10-21UL, HMG-20-11, HMG-2-10-11, HMG-6-11, HVG-10-11, HVG-10-11UL, HVG-10-21, HVG-10-21UL, HVG-20-11, HVG-20-21, HVG-2-10-11, HVG-2-20-11, MFHVG-10-11, MFHVG-10-21		



<b>GEV No.</b>	381544	<b>Ref. No.</b>	12039678 T953051000
<b>description</b>	temperature probe connection plug probe 4x540mm cable length 2m		
<b>For models:</b>	ACE-202, ACG-202, AE-202, AG-202, APE-102, APE-202, APG-102, APG-202		



<b>GEV No.</b>	403925	<b>Ref. No.</b>	12041634
<b>description</b>	temperature probe connection plug probe ø4x362 cable length 2m		
<b>For models:</b>	ACE-061, ACE-101, ACE-102, ACE-201, ACG-061, ACG-101, ACG-102, ACG-201, AE-061, AE-101, AE-102, AE-201, AG-061, AG-101, AG-102, AG-201		



<b>GEV No.</b>	403924	<b>Ref. No.</b>	12044609
<b>description</b>	temperature probe connection plug probe ø4x425mm cable length 2m		
<b>For models:</b>	APE-061, APE-101, APE-201, APG-061, APG-101, APG-201		



<b>GEV No.</b>	403929	<b>Ref. No.</b>	12047675
<b>description</b>	temperature probe connection plug probe ø4x627 cable length 2m		
<b>For models:</b>	ACE-202, ACG-202, AE-202, AG-202		



<b>GEV No.</b>	379550	<b>Ref. No.</b>	12019258 Z233007
<b>description</b>	temperature probe NTC 10kOhm cable silicone probe -40 up to +110°C cable -50 up to +180°C connection male faston thread probe ø6x30mm cable length 0.35m		
<b>For models:</b>	FI-50		



<b>GEV No.</b>	378339	<b>Ref. No.</b>	12025036 Z713028
<b>description</b>	temperature probe NTC 64kOhm cable silicone probe -40 up to +110°C cable -50 up to +180°C connection plug thread probe ø6x14mm cable length 2.5m		
<b>For models:</b>	AD-120, AD-120B, AD-120BBTDD-UK, AD-120C, AD-120CW, AD-120HY, AD-125, AD-125HRS, AD-125-SOFT, AD-15, AD-15D, AD-20C-UK, AD-21, AD-21B, AD-21BDD, AD-21C, AD-21D, AD-21DD, AD-21W, AD-45BBT, AD-48, AD-48B, AD-48BDD, AD-48C, AD-48D, AD-48DD, AD-48HY, AD-48W, AD-505, AD-505-SOFT, AD-64, AD-64B, AD-64BBT, AD-64BDD, AD-64BTDD, AD-64C, AD-64CW, AD-64D, AD-64DD, AD-64HY, AD-72, AD-72W, AD-90, AD-90BA, AD-90BBT, AD-90BDD, AD-90DD, ADE-120, ADE-120B, CO-112...(Other models you can see in the webshop)		





<b>GEV No.</b>	402005	<b>Ref. No.</b>	62040410
<b>description</b>	temperature probe PTC 2kOhm cable TPE probe -50 up to +150°C cable -40 up to +110°C connection plug thread probe ø6x50mm cable length 1.6m		





<b>GEV No.</b>	400874	<b>Ref. No.</b>	12018718 R663090
<b>description</b>	temperature probe thermocouple J (Fe-CuNi) cable PTFE probe -50 up to +750°C cable -40 up to +250°C connection male faston thread probe ø3x70mm cable length 1.5m		
<b>For models:</b>	HCG-10-11, HCG-10-21, HCG-20-11, HCG-20-21, HCG-2-10-11, HCG-2-20-11, HCG-6-11, HEI-10-11, HEI-20-11, HEI-6-11, HEM-10-11, HEM-20-11, HEM-6-11, HEP-10-11, HEP-20-11, HEP-6-11, HGC-10-11, HGC-20-11, HGC-6-11, HME-10-11, HME-10-21, HME-20-11, HME-20-21, HME-2-10-11, HME-2-20-11, HME-6-11, HMG-20-11, HMI-10-11, HMI-10-11UL, HMI-10-21, HMI-10-21UL, HMI-2-10-11, HMI-6-11, HMI-6-11UL, HMM-10-11, HMM-10-11UL, HMM-10-21, HMM-10-21UL, HMM-20-11, HMM-20-11UL, HMM-20-21, HMM-20-21UL, HMM-2-10-11, HMM-40-11-USMC, HMM-6-11, HMM-6-11UL, HMP-10-11, HMP-10-21, HMP-20-11, HMP-20-21...(Other models you can see in the webshop)		





			
<b>GEV No.</b>	400873	<b>Ref. No.</b>	12018312 R663089
<b>description</b>	temperature probe thermocouple J (Fe-CuNi) cable PTFE probe -50 up to 1150°C cable -40 up to +250°C connection 2-wire thread probe ø3x70mm cable length 2.5m		
<b>For models:</b>	HEM-10-11, HEM-20-11, HEM-6-11, HEP-10-11, HEP-20-11, HEP-6-11, HGV-10-11, HGV-20-11, HME-10-11, HME-10-21, HME-20-11, HME-20-21, HME-2-10-11, HME-2-20-11, HME-6-11, HMP-10-11, HMP-10-21, HMP-20-11, HMP-20-21, HMP-2-10-11, HMP-6-11		

			
<b>GEV No.</b>	381430	<b>Ref. No.</b>	12031446
<b>description</b>	temperature probe thermocouple K (NiCr-Ni) cable silicone probe -50 up to 1150°C cable -50 up to +180°C connection 2-wire thread probe ø2x100mm cable length 0.25m		



			
<b>GEV No.</b>	379525	<b>Ref. No.</b>	12024642 T323011
<b>description</b>	temperature probe thermocouple K (NiCr-Ni) cable PTFE probe -50 up to 1150°C cable -40 up to +250°C connection male faston 6.3mm thread probe ø3x70mm cable length 1m		
<b>For models:</b>	ACE-061, ACE-101, ACE-102, ACE-201, ACE-202, ACG-061, ACG-101, ACG-102, ACG-201, ACG-202, AE-061, AE-101, AE-102, AE-201, AE-202, AG-061, AG-101, AG-102, AG-201, AG-202, APE-061, APE-101, APE-102, APE-201, APE-202, APG-061, APG-101, APG-102, APG-201, APG-202, COE-061, COE-101, COE-102, COE-201, COE-202, COG-061, COG-101, COG-102, COG-201, COG-202, HEI-10-21, HEI-20-21, HEM-10-21, HEM-20-21, HEP-10-21, HEP-20-21, HGC-10-21, HGC-20-21, HGP-10-21, HGP-20-21, HGV-10-21...(Other models you can see in the webshop)		

			
<b>GEV No.</b>	381433	<b>Ref. No.</b>	12038044 RT30141004
<b>description</b>	temperature probe thermocouple K (NiCr-Ni) cable silicone probe -50 up to 1150°C cable -50 up to +180°C connection 2-wire thread probe ø2x100mm cable length 2.2m		

			
<b>GEV No.</b>	381424	<b>Ref. No.</b>	12029772 RT87201003
<b>description</b>	temperature probe thermocouple K (NiCr-Ni) cable silicone probe -50 up to 1150°C cable -50 up to +180°C connection 2-wire thread probe ø2x100mm cable length 2m		

			
<b>GEV No.</b>	379528	<b>Ref. No.</b>	12023901 T323024
<b>description</b>	temperature probe thermocouple K (NiCr-Ni) cable PTFE probe -50 up to 1150°C cable -40 up to +250°C connection male faston thread probe ø3x70mm cable length 1.6m		
<b>For models:</b>	ACE-061, ACE-102, AE-061, AE-101, AE-102, AE-201, AE-202, AG-061, AG-101, AG-102, AG-201, AG-202, APE-061, APE-101, APE-102, APE-201, APE-202, APG-061, APG-101, APG-102, APG-201, APG-202, COE-061, COE-101, COE-102, COE-201, COE-202, HEI-10-21, HEI-20-21, HEM-10-21, HEM-20-21, HEP-10-21, HEP-20-21, HGP-10-21, HGP-20-21, HGV-10-21, HGV-20-21, VE-061, VE-101, VE-102, VE-201, VE-202, VG-101, VG-102, VG-201, VG-202, VPE-061, VPE-101, VPE-102, VPE-201...(Other models you can see in the webshop)		

			
<b>GEV No.</b>	379077	<b>Ref. No.</b>	12029895 RT87201002
<b>description</b>	temperature probe thermocouple K (NiCr-Ni) cable silicone probe -50 up to 1150°C cable -50 up to +180°C connection 2-wire thread probe ø2x40mm cable length 2.6m		

<b>accessories for</b>	379077			
	<b>GEV No.</b>	550365	<b>Ref. No.</b>	12037350 RT30140162
gasket for thermocouple				
	<b>GEV No.</b>	550366	<b>Ref. No.</b>	12037422 RT30140163
screw for thermocouple				

			
<b>GEV No.</b>	381431	<b>Ref. No.</b>	12031553 RT30140165
<b>description</b>	temperature probe thermocouple K (NiCr-Ni) cable silicone probe -50 up to 1150°C cable -50 up to +180°C connection 2-wire thread probe ø1.5x100mm cable length 1.8m		

			
<b>GEV No.</b>	379429	<b>Ref. No.</b>	12030579 RT30141020
<b>description</b>	temperature probe thermocouple K (NiCr-Ni) cable silicone probe -50 up to 1150°C cable -50 up to +180°C connection 2-wire thread probe ø10.5mm cable length 1.7m		

			
<b>GEV No.</b>	379864	<b>Ref. No.</b>	12029713 RT4000594
<b>description</b>	temperature probe thermocouple K (NiCr-Ni) cable silicone probe -50 up to 1150°C cable -50 up to +180°C connection coded plug thread M8 probe ø2x50mm cable length 1.2m		





			
<b>GEV No.</b>	379873	<b>Ref. No.</b>	12031261 RT4000292
<b>description</b>	temperature probe thermocouple K (NiCr-Ni) cable silicone probe -50 up to 1150°C cable -50 up to +180°C connection coded plug thread probe ø1.5x180mm cable length 1.6m		

			
<b>GEV No.</b>	379441	<b>Ref. No.</b>	12031482 RT4000291
<b>description</b>	temperature probe thermocouple K (NiCr-Ni) cable silicone probe -50 up to 1150°C cable -50 up to +180°C connection coded plug thread probe ø2x125mm cable length 1.5m		

			
<b>GEV No.</b>	379869	<b>Ref. No.</b>	12029187 12029188 12036625 RT4000287 RT4000398 RT8700058
<b>description</b>	temperature probe thermocouple K (NiCr-Ni) cable silicone probe -50 up to 1150°C cable -50 up to +180°C connection coded plug thread probe ø2x70mm cable length 2.5m		

			
<b>GEV No.</b>	379442	<b>Ref. No.</b>	12040500 RT4001094
<b>description</b>	temperature probe thermocouple K (NiCr-Ni) cable silicone probe -50 up to 1150°C cable -50 up to +180°C connection coded plug thread probe ø2x90mm cable length 1.5m		

			
<b>GEV No.</b>	379870	<b>Ref. No.</b>	12033003 RT4000399
<b>description</b>	temperature probe thermocouple K (NiCr-Ni) cable silicone probe -50 up to 1150°C cable -50 up to +180°C connection coded plug thread probe ø4.2mm cable length 1.7m		

<b>core probes</b>			
			
<b>GEV No.</b>	379867	<b>Ref. No.</b>	12026815 RT4000298P
<b>description</b>	conversion kit thermocouple K (NiCr-Ni) cable PTFE probe -40 up to +250°C cable -40 up to +250°C connection plug probe ø3x100mm thread M16 cable length 2.2m handle ø 10mm handle length 40mm		

			
<b>GEV No.</b>	379167	<b>Ref. No.</b>	12028770 6021350027
<b>description</b>	core temperature probe PTC cable silicone probe -50 up to +150°C cable -50 up to +180°C connection 2-wire probe ø6x180mm thread cable length 3.1m handle ø 12mm handle length 120/40mm L1 130mm L2 50mm		
<b>For models:</b>	ATM-051, ATM-101, ATM-102		

			
<b>GEV No.</b>	400875	<b>Ref. No.</b>	12039138 12040015 R663015
<b>description</b>	core temperature probe thermocouple J (Fe-CuNi) cable SS corrugated hose probe -40 up to +250°C cable -40 up to +250°C connection 2-wire probe ø3x90mm thread cable length 1.5m handle ø 8mm handle length 60mm		
<b>For models:</b>	HME-6-11, HMG-6-11, HMM-10-11, HMM-10-21, HMM-2-10-11, HMM-6-11, HMM-6-11UL, HMP-6-11		



			
<b>GEV No.</b>	400876	<b>Ref. No.</b>	R673001
<b>description</b>	core temperature probe thermocouple J (Fe-CuNi) cable SS corrugated hose probe -40 up to +250°C cable -40 up to +250°C connection 2-wire probe ø3x90mm thread cable length 1.65m handle ø 8mm handle length 60mm		

			
<b>GEV No.</b>	400877	<b>Ref. No.</b>	12000187 R093000 R093019
<b>description</b>	core temperature probe thermocouple J (Fe-CuNi) cable SS corrugated hose probe -40 up to +250°C cable -40 up to +250°C connection 2-wire probe ø3x90mm thread cable length 2.2m handle ø 8mm handle length 60mm		
<b>For models:</b>	HME-20-11, HME-20-21, HME-2-20-11, HMG-20-11, HMM-20-11, HMM-20-11UL, HMM-20-21, HMM-20-21UL, HMP-20-11, HMP-20-21, MFHMM-20-11		

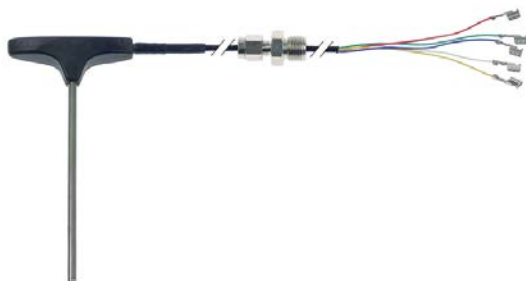
			
<b>GEV No.</b>	381426	<b>Ref. No.</b>	12027356 RT30350709
<b>description</b>	core temperature probe thermocouple K (NiCr-Ni) cable PTFE probe -40 up to +250°C cable -40 up to +250°C connection 2-wire probe ø3.2x100mm thread M12 cable length 1.9m handle ø 10mm handle length 100mm		

			
<b>GEV No.</b>	378670	<b>Ref. No.</b>	12039548 T843062000
<b>description</b>	core temperature probe thermocouple K (NiCr-Ni) cable PTFE probe -40 up to +250°C cable -40 up to +250°C connection 5-wire probe ø4x100mm thread 1/4" cable length 2m handle ømm handle length 55mm multipoint probe		

<b>For models:</b>	ACE-061, ACE-101, ACE-102, ACE-201, ACE-202, ACG-061, ACG-101, ACG-102, ACG-201, ACG-202, AE-061, AE-061W, AE-101, AE-101W, AE-102, AE-102W, AE-201, AE-202, AG-061, AG-061W, AG-101, AG-101W, AG-102, AG-102W, AG-201, AG-202, APE-061, APE-061W, APE-101, APE-101W, APE-102, APE-102W, APE-201, APE-202, APG-061, APG-061W, APG-101, APG-101W, APG-102, APG-102W, APG-201, APG-202		
--------------------	--	--	--

				
<b>GEV No.</b>	379792 <sup>1</sup>	<b>Ref. No.</b>	12026252 RT30350717	
<b>description</b>	core temperature probe thermocouple K (NiCr-Ni) cable PTFE probe -40 up to +250°C cable -40 up to +250°C connection grip connection probe ø3.2x100mm thread M16x2 cable length 1.9m handle ø 10mm handle length 40mm			
<b>accessories for</b>	379792			
	<b>GEV No.</b>	510179	<b>Ref. No.</b>	12010145 Q306012
	flat gasket fibre ED ø 18mm ID ø 13mm thickness 1.5mm Qty 1 pcs			
	<b>GEV No.</b>	560519	<b>Ref. No.</b>	—
	nut thread M12x1 H 5mm WS 17 SS Qty 1 pcs			

<sup>1</sup>multipoint probe

			
<b>GEV No.</b>	379868 <sup>1</sup>	<b>Ref. No.</b>	12026495 12103868 RT4000295 RT8700096
<b>description</b>	core temperature probe thermocouple K (NiCr-Ni) cable PTFE probe -40 up to +250°C cable -40 up to +250°C connection plug probe ø3x100mm thread M16 cable length 2.2m handle ø 10mm handle length 40mm		

<sup>1</sup>multipoint probe

			
<b>GEV No.</b>	379866 <sup>1</sup>	<b>Ref. No.</b>	12026609 12027340 RT4000606 RT4000606P
<b>description</b>	core temperature probe thermocouple K (NiCr-Ni) cable PTFE probe -40 up to +250°C cable -40 up to +250°C connection plug probe ø3x100mm thread M16 cable length 2.3m handle ømm handle length 50mm		



<sup>1</sup>multipoint probe

			
<b>GEV No.</b>	379552	<b>Ref. No.</b>	12039150 T113007
<b>description</b>	core temperature probe thermocouple K (NiCr-Ni) cable Vetrotex probe -40 up to +250°C cable -50 up to +350°C connection 2-wire probe ø3x90mm thread cable length 1.65m handle ø 8mm handle length 50mm		
<b>For models:</b>	HVG-10-11, HVG-10-11UL, HVG-10-21, HVG-10-21UL, HVG-2-10-11, MFHVG-10-11, MFHVG-10-21		



accessories

fasteners

			
<b>GEV No.</b>	691084	<b>Ref. No.</b>	12023773 R662659
<b>description</b>	duct for probe		
<b>For models:</b>	COE-061, COE-101, COG-061, COG-101, HCG-10-11, HCG-10-21, HCG-20-11, HCG-20-21, HCG-2-10-11, HCG-2-20-11, HCG-6-11, HEI-10-11, HEI-20-11, HEI-6-11, HEM-10-11, HEM-20-11, HEM-6-11, HEP-10-11, HEP-20-11, HEP-6-11, HGC-10-11, HGC-20-11, HGC-6-11, HGV-10-11, HGV-20-11, HME-10-11, HME-10-21, HME-20-11, HME-20-21, HME-2-10-11, HME-2-20-11, HME-6-11, HMG-10-11, HMG-10-11UL, HMG-10-21, HMG-10-21UL, HMG-20-11, HMG-2-10-11, HMG-6-11, HMI-10-11, HMI-10-11UL, HMI-10-21, HMI-10-21UL, HMI-2-10-11, HMI-6-11, HMI-6-11UL, HMM-10-11, HMM-10-11UL, HMM-10-21, HMM-10-21UL... (Other models you can see in the webshop)		



				
<b>GEV No.</b>	691098	<b>Ref. No.</b>	12024243 T133036	
<b>description</b>	holding plate for probe mounting pos. lower L 35mm W 12mm H 4mm SS			
<b>For models:</b>	HEM-10-11, HEM-20-11, HEM-6-11, HEP-10-11, HEP-20-11, HEP-6-11, HGV-10-11, HGV-20-11, VE-061, VE-101, VE-201, VPE-061, VPE-101, VPE-201			
<b>accessories for</b>	691098			
	<b>GEV No.</b>	691097	<b>Ref. No.</b>	12024241 T133037
	holding plate for probe mounting pos. upper L 35mm W 12mm H 4mm SS			



			
1			
<b>GEV No.</b>	691097	<b>Ref. No.</b>	12024241 T133037
<b>description</b>	holding plate for probe mounting pos. upper L 35mm W 12mm H 4mm SS		
<b>For models:</b>	COE-061, COE-101, HEM-10-11, HEM-20-11, HEM-6-11, HEP-10-11, HEP-20-11, HEP-6-11, HGV-10-11, HGV-20-11, VE-061, VE-101, VE-201, VPE-061, VPE-101, VPE-201		
<b>accessories for</b>	691097		
	<b>GEV No.</b>	691098	<b>Ref. No.</b>
			12024243 T133036
	holding plate for probe mounting pos. lower L 35mm W 12mm H 4mm SS		

			
1			
<b>GEV No.</b>	551462	<b>Ref. No.</b>	12021987 Z718446000
<b>description</b>	holding plate for temperature probe L 35mm W 35mm H 2mm hole ø 4mm		
<b>For models:</b>	LVC-21W		

screw connections

			
1			
<b>GEV No.</b>	550366	<b>Ref. No.</b>	12037422 RT30140163
<b>description</b>	screw for thermocouple		
<b>accessories for</b>	550366		
	<b>GEV No.</b>	550365	<b>Ref. No.</b>
			12037350 RT30140162
	gasket for thermocouple		

			
1			
<b>GEV No.</b>	691086	<b>Ref. No.</b>	12023581 R662629
<b>description</b>	union screw		
<b>For models:</b>	ACE-061, ACE-101, ACE-102, ACE-201, ACE-202, ACG-061, ACG-101, ACG-102, ACG-201, ACG-202, AE-061, AE-061W, AE-101, AE-101W, AE-102, AE-102W, AE-201, AE-202, AG-061, AG-061W, AG-101, AG-101W, AG-102, AG-102W, AG-201, AG-202, APE-061, APE-061W, APE-101, APE-101W, APE-102, APE-102W, APE-201, APE-202, APG-061, APG-061W, APG-101, APG-101W, APG-102, APG-102W, APG-201, APG-202, COE-061, COE-101, COE-102, COE-201, COE-202, COG-061, COG-101, COG-102...(Other models you can see in the webshop)		

miscellaneous

			
1			
<b>GEV No.</b>	550365	<b>Ref. No.</b>	12037350 RT30140162
<b>description</b>	gasket for thermocouple		

			
1			
<b>GEV No.</b>	691085	<b>Ref. No.</b>	12024247 R662652
<b>description</b>	sealing ring for probe		
<b>For models:</b>	ACE-061, ACE-101, ACE-102, ACE-201, ACE-202, ACG-061, ACG-101, ACG-102, ACG-201, ACG-202, AE-061, AE-061W, AE-101, AE-101W, AE-102, AE-102W, AE-201, AE-202, AG-061, AG-061W, AG-101, AG-101W, AG-102, AG-102W, AG-201, AG-202, APE-061, APE-061W, APE-101, APE-101W, APE-102, APE-102W, APE-201, APE-202, APG-061, APG-061W, APG-101, APG-101W, APG-102, APG-102W, APG-201, APG-202, COE-061, COE-101, COE-102, COE-201, COE-202, COG-061, COG-101, COG-102...(Other models you can see in the webshop)		

electronics

electronics accessories

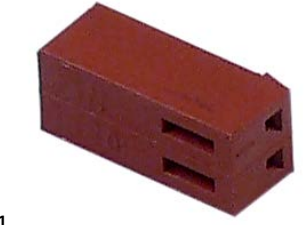
			
1			
<b>GEV No.</b>	401792	<b>Ref. No.</b>	12018408 R663092
<b>description</b>	female connector 2-pole		
<b>For models:</b>	HCG-10-11, HCG-10-21, HCG-20-11, HCG-20-21, HCG-2-10-11, HCG-2-20-11, HCG-6-11, HEI-10-11, HEI-20-11, HEI-6-11, HGC-10-11, HGC-20-11, HGC-6-11, HGV-10-11, HGV-20-11, HMG-20-11, HMI-10-11, HMI-10-11UL, HMI-10-21, HMI-10-21UL, HMI-2-10-11, HMI-6-11, HMI-6-11UL, HMM-10-11, HMM-10-11UL, HMM-10-21, HMM-10-21UL, HMM-20-11, HMM-20-11UL, HMM-20-21, HMM-20-21UL, HMM-2-10-11, HMM-40-11-USMC, HMM-6-11, HMM-6-11UL, HVG-10-11, HVG-10-11UL, HVG-10-21, HVG-10-21UL, HVG-20-11, HVG-20-21, HVG-2-10-11, HVG-2-20-21, MFHMM-20-11, MFHVG-10-11, MFHVG-10-21		



EPROMS



1

<b>GEV No.</b>	403018	<b>Ref. No.</b>	12040195 RT30400311
<b>description</b>	EPROM type CPC CODE XS5.06S		

frequency converters



1

<b>GEV No.</b>	403922	<b>Ref. No.</b>	12048794
<b>description</b>	frequency converter with heat sink for combi-steamer 200-240V 47-63 Hz L 150mm W 115mm H 90mm output frequency 0-550Hz 6.2A output current 2.3A SIEMENS SINAMICS G110 CPM110 AIN 6SL3211-0AB13-7UA1		
<b>For models:</b>	ACE-061, AE-061, AE-061W, APE-061, APE-061W		



1

<b>GEV No.</b>	403935	<b>Ref. No.</b>	12048798
<b>description</b>	frequency converter with heat sink for combi-steamer 200-240V L 150mm W 115mm H 90mm output frequency 0-550Hz 6.2A output current 2.3A		
<b>For models:</b>	ACE-101, ACE-102, ACE-201, ACE-202, ACG-061, ACG-101, ACG-102, ACG-201, ACG-202, AE-101, AE-101W, AE-102, AE-102W, AE-201, AE-202, AG-061, AG-101, AG-102, AG-201, AG-202, APE-101, APE-101W, APE-102, APE-102W, APE-201, APE-202, APG-061, APG-101, APG-102, APG-201, APG-202		

PCBs



1

<b>GEV No.</b>	400098	<b>Ref. No.</b>	12025859 RT30403001
<b>description</b>	control PCB combi-steamer CD 101/CM 101 without EPROM		



1

<b>GEV No.</b>	400103	<b>Ref. No.</b>	12026014 RT30403020
<b>description</b>	control PCB combi-steamer CM 61-202 L 460mm W 154mm 61-202		

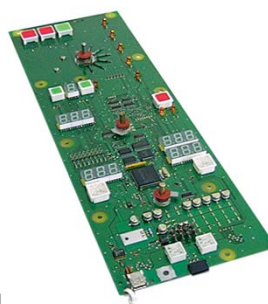

1



<b>GEV No.</b>	400099	<b>Ref. No.</b>	12026123 RT30403010
<b>description</b>	control PCB combi-steamer CM101		



1

<b>GEV No.</b>	403319	<b>Ref. No.</b>	12026065 RT30403210
<b>description</b>	control PCB combi-steamer CPC-Linie CM 61-202/G model since 10/1997		

			
1			
<b>GEV No.</b>	400862	<b>Ref. No.</b>	12018475 12040110 R663044 R663051 R663085
<b>description</b>	control PCB combi-steamer HME 611/1011		
<b>For models:</b>	HEM-10-11, HEM-20-11, HEM-6-11, HEP-10-11, HEP-20-11, HEP-6-11, HME-10-11, HME-10-21, HME-20-11, HME-20-21, HME-2-10-11, HME-2-20-11, HME-6-11, HMP-10-11, HMP-10-21, HMP-20-11, HMP-20-21, HMP-2-10-11, HMP-6-11		

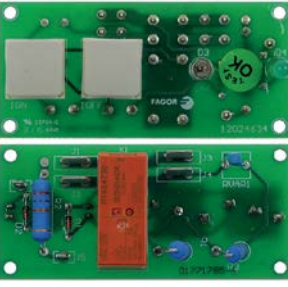

			
1			
<b>GEV No.</b>	401475	<b>Ref. No.</b>	12016327 12025432 RT4200002 RT4200002P
<b>description</b>	control PCB combi-steamer SCC Line		
<b>accessories for</b>	401475		
	<b>GEV No.</b>	358791	<b>Ref. No.</b> 12037374 RT40010224
fine fuse size ø6.3x32mm 6.3A slow-acting rated 250V Qty 10 pcs			

			
1			
<b>GEV No.</b>	400810	<b>Ref. No.</b>	12016516 Z233005
<b>description</b>	control PCB dishwasher FI-50 with display		
<b>For models:</b>	FI-50		



			
1			
<b>GEV No.</b>	403743	<b>Ref. No.</b>	12024634 Z218030 Z218030000
<b>description</b>	control PCB for dishwasher L 75mm W 35mm suitable for FAGOR		
<b>For models:</b>	LA-AC-10M, LA-AC-10MP, LA-AC-13M, LA-AC-13MP, LA-AC-18M, LA-AC-18MP, LA-AC-25M, LA-AC-25MP, LA-E-10M, LA-E-10MP, LA-E-13M, LA-E-13MP, LA-E-18M, LA-E-18MP, LA-E-25M, LA-E-25MP, LA-V-10M, LA-V-10MP, LA-V-13M, LA-V-13MP, LA-V-18M, LA-V-18MP, LA-V-25M, LA-V-25MP, LB-AC-10M, LB-E-10M, LB-V-10M, LR-AC-10M, LR-AC-10MP, LR-AC-13M, LR-AC-13MP, LR-AC-18M, LR-AC-18MP, LR-AC-25M, LR-AC-25MP, LR-E-10M, LR-E-10MP, LR-E-13M, LR-E-13MP, LR-E-18M, LR-E-18MP, LR-E-25M, LR-E-25MP, LR-V-10M, LR-V-10MP, LR-V-13M, LR-V-13MP, LR-V-18M, LR-V-18MP, LR-V-25M...(Other models you can see in the webshop)		

			
1			
<b>GEV No.</b>	402226	<b>Ref. No.</b>	12009372 12023361 12046658 T913003
<b>description</b>	display combi-steamer		

			
1			
<b>GEV No.</b>	403632	<b>Ref. No.</b>	12010836 T623004
<b>description</b>	display for combi-steamer VPE202 L 195mm W 145mm		
<b>For models:</b>	VPE-102, VPE-202		

			
1			
<b>GEV No.</b>	402147	<b>Ref. No.</b>	12029542 6021250061
<b>description</b>	display PCB blast freezer ATM101		
<b>For models:</b>	ATM-051, ATM-101		
<b>accessories for</b>	402147		
	<b>GEV No.</b>	403056	<b>Ref. No.</b> 12031295 6003010194
keypad foil blast freezer ATM101 L 200mm W 60mm buttons 8			





			
1			
<b>GEV No.</b>	403076	<b>Ref. No.</b>	12009355 12024311 12046671 T533001
<b>description</b>	display PCB combi-steamer COE061 L 160mm W 110mm with potentiometer		
<b>For models:</b>	ACE-061, ACE-101, ACE-102, ACE-201, ACE-202, ACG-061, ACG-101, ACG-102, ACG-201, ACG-202, AE-061, AE-101, APE-061, APE-101, COE-061, COE-101, COE-102, COE-201, COE-202, COG-061, COG-101, COG-102, COG-201, COG-202		
<b>accessories for</b>	403076		
			
<b>GEV No.</b>	402230	<b>Ref. No.</b>	12007938 12024255 12097540 T553003
PCB for combi-steamer			

			
1			
<b>GEV No.</b>	401719	<b>Ref. No.</b>	12018452 T303018
<b>description</b>	display PCB combi-steamer HEI 1021/HGV 1021		
<b>For models:</b>	HEI-10-21, HEI-20-21, HEM-10-21, HEM-20-21, HGC-10-21, HGC-20-21, HGV-10-21, HGV-20-21		

			
1			
<b>GEV No.</b>	403237	<b>Ref. No.</b>	12024028 Z713017
<b>description</b>	display PCB dishwasher AD15/21/48 L 100mm W 35mm		
<b>For models:</b>	AD-120, AD-120B, AD-120BBTDD-UK, AD-120C, AD-120HY, AD-15, AD-15D, AD-20C-UK, AD-21, AD-21B, AD-21BDD, AD-21C, AD-21D, AD-21DD, AD-45BBT, AD-48, AD-48B, AD-48BDD, AD-48C, AD-48D, AD-48DD, AD-48HY, AD-64, AD-64B, AD-64BBT, AD-64BDD, AD-64BTDD, AD-64C, AD-64D, AD-64DD, AD-64HY, AD-72, AD-90, AD-90BA, AD-90BBT, AD-90BDD, AD-90DD, ADE-120, ADE-120B, CO-112, CO-112B, CO-112BDD, CO-112DD, CO-172, CO-172B, CO-172BDD, CO-172DD, CO-352-COLD, CO-352-COLD-B, CO-352-COLD-B-DD... (Other models you can see in the webshop)		

			
1			
<b>GEV No.</b>	401720	<b>Ref. No.</b>	12018666 T303019
<b>description</b>	keypad PCB combi-steamer HEI 1021/HGV 1021 buttons 4		
<b>For models:</b>	HEI-10-21, HEI-20-21, HEM-10-21, HEM-20-21, HEP-10-21, HEP-20-21, HGC-10-21, HGC-20-21, HGP-10-21, HGP-20-21, HGV-10-21, HGV-20-21		

			
1			
<b>GEV No.</b>	401897	<b>Ref. No.</b>	12016770
<b>description</b>	keypad PCB combi-steamer HGP1021		
<b>For models:</b>	HEP-10-21, HEP-20-21, HGP-10-21, HGP-20-21		

			
1			
<b>GEV No.</b>	401788	<b>Ref. No.</b>	12024457 P613005
<b>description</b>	main PCB washing machine LA 10-13-18-25		
<b>For models:</b>	LA-18MP, LA-AC-10MP, LA-AC-13MP, LA-AC-18MP, LA-AC-25MP, LA-E-10MP, LA-E-13MP, LA-E-18MP, LA-E-25MP, LA-V-10MP, LA-V-13MP, LA-V-18MP, LA-V-25MP, LF-13MPP, LF-18MPP, LF-25MPP, LF-8MPP, LR-AC-10MP, LR-AC-13MP, LR-AC-18MP, LR-AC-25MP, LR-E-10MP, LR-E-13MP, LR-E-18MP, LR-E-25MP, LR-V-10MP, LR-V-13MP, LR-V-18MP, LR-V-25MP		

			
1			
<b>GEV No.</b>	401487	<b>Ref. No.</b>	12025785 RT30403040
<b>description</b>	PCB combi-steamer CD 101/CM 101 with axial flow fan for fan motor		

			
1			
<b>GEV No.</b>	401662	<b>Ref. No.</b>	12025798 RT4200004P
<b>description</b>	PCB combi-steamer CM101 conversion kit		

			
1			
<b>GEV No.</b>	401789	<b>Ref. No.</b>	12017191 T083002 T303048
<b>description</b>	PCB combi-steamer HCG1011		
<b>For models:</b>	HCG-10-11, HCG-10-21, HCG-20-11, HCG-20-21, HCG-2-10-11, HCG-2-20-11, HCG-6-11, HGC-10-11, HGC-10-21, HGC-20-11, HGC-20-21, HGC-6-11, HGP-10-21, HGP-20-21, HGV-10-11, HGV-10-21, HGV-20-11, HGV-20-21, HVG-10-11, HVG-10-11UL, HVG-10-21, HVG-10-21UL, HVG-20-11, HVG-20-21, HVG-2-10-11, HVG-2-20-21, MFHVG-10-11, MFHVG-10-21		

			
1			
<b>GEV No.</b>	400860	<b>Ref. No.</b>	12018459 R743013
<b>description</b>	PCB combi-steamer t.max. 270°C		
<b>For models:</b>	HCG-10-11, HCG-10-21, HCG-20-11, HCG-20-21, HCG-2-10-11, HCG-2-20-11, HCG-6-11, HEI-10-11, HEI-20-11, HEI-6-11, HGC-10-11, HGC-20-11, HGC-6-11, HGV-10-11, HGV-20-11, HMG-10-11, HMG-10-21, HMG-20-11, HMG-2-10-11, HMG-6-11, HMI-10-11, HMI-10-21, HMI-2-10-11, HMI-6-11, HMM-10-11, HMM-10-21, HMM-20-11, HMM-20-21, HMM-2-10-11, HMM-2-20-11, HMM-6-11, HVG-10-11, HVG-10-11UL, HVG-10-21, HVG-10-21UL, HVG-20-11, HVG-20-21, HVG-2-10-11, HVG-2-20-21, MFHVG-10-11, MFHVG-10-21		

			
1			
<b>GEV No.</b>	401721	<b>Ref. No.</b>	12018453 T353003
<b>description</b>	PCB combi-steamer HEI 1021/HGV 1021		
<b>For models:</b>	HEI-10-21, HEI-20-21, HGC-10-21, HGC-20-21		

			
1			
<b>GEV No.</b>	402225	<b>Ref. No.</b>	12024266 12046670 T553002
<b>description</b>	PCB combi-steamer VE101/202		
<b>For models:</b>	ACE-061, ACE-101, AE-061, AE-061W, AE-101, AE-101W, AE-102, AE-102W, AE-201, AE-202, AG-061, AG-061W, AG-101, AG-101W, AG-102, AG-102W, AG-201, AG-202, APE-061, APE-061W, APE-101, APE-101W, APE-102, APE-102W, APE-201, APE-202, APG-061, APG-061W, APG-101, APG-101W, APG-102, APG-102W, APG-201, APG-202, VE-061, VE-101, VE-102, VE-201, VE-202, VG-101, VG-102, VG-201, VG-202, VPE-061, VPE-101, VPE-102, VPE-201, VPE-202, VPG-101, VPG-102...(Other models you can see in the webshop)		

			
1			
<b>GEV No.</b>	400863	<b>Ref. No.</b>	12017162 R663004
<b>description</b>	PCB combi-steamer HMP 611/1011/2011		
<b>For models:</b>	HEP-10-11, HEP-20-11, HEP-6-11, HMP-10-11, HMP-10-21, HMP-20-11, HMP-20-21, HMP-2-10-11, HMP-6-11		

			
1			
<b>GEV No.</b>	403308	<b>Ref. No.</b>	12008750 Z213073
<b>description</b>	PCB dishwasher AD-72/48/64 L 128mm W 118mm suitable for FAGOR with housing H 55mm for dishwasher Qty 1 pcs		
<b>For models:</b>	AD-120, AD-120B, AD-120BBTDD-UK, AD-120C, AD-120CW, AD-120HY, AD-15, AD-15D, AD-20C-UK, AD-21, AD-21B, AD-21BDD, AD-21C, AD-21D, AD-21DD, AD-21W, AD-45BBT, AD-48, AD-48B, AD-48BDD, AD-48C, AD-48D, AD-48DD, AD-48HY, AD-48W, AD-64, AD-64B, AD-64BBT, AD-64BDD, AD-64BTDD, AD-64C, AD-64CW, AD-64D, AD-64DD, AD-64HY, AD-72, AD-72W, AD-90, AD-90BA, AD-90BBT, AD-90BDD, AD-90DD, ADE-120, ADE-120B, CO-112, CO-112B, CO-112BDD, CO-112DD, CO-142W, CO-142WDD...(Other models you can see in the webshop)		

			
1			
<b>GEV No.</b>	400110	<b>Ref. No.</b>	12026627 RT30403100
<b>description</b>	PCB combi-steamer level control		





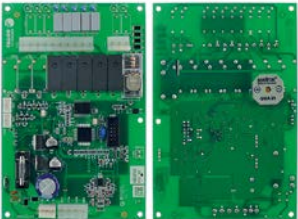

			
1			
<b>GEV No.</b>	403633	<b>Ref. No.</b>	12016866
<b>description</b>	PCB for boiler VPE202		
<b>For models:</b>	VPE-102, VPE-201, VPE-202		

			
1			
<b>GEV No.</b>	402230	<b>Ref. No.</b>	12007938 12024255 12097540 T553003
<b>description</b>	PCB for combi-steamer		
<b>For models:</b>	COE-061, COE-101, COE-102, COE-201, COE-202, COG-061, COG-101, COG-102, COG-201, COG-202, VE-061, VE-101, VE-102, VE-201, VE-202, VG-101, VG-102, VG-201, VG-202, VPE-061, VPE-101, VPE-102, VPE-201, VPE-202, VPG-101, VPG-102, VPG-201, VPG-202		

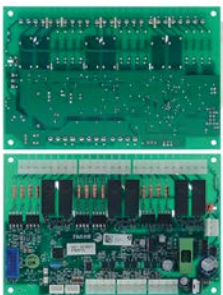
			
1			
<b>GEV No.</b>	403923	<b>Ref. No.</b>	12046673
<b>description</b>	PCB for combi-steamer 61/101 L 150mm W 100mm suitable for FAGOR		
<b>For models:</b>	ACG-061, ACG-101, ACG-102, ACG-201, ACG-202, AG-061, AG-061W, AG-101, AG-101W, AG-102, AG-102W, AG-201, AG-202, APG-061, APG-061W, APG-101, APG-101W, APG-102, APG-102W, APG-201, APG-202		

			
1			
<b>GEV No.</b>	403932	<b>Ref. No.</b>	12130677
<b>description</b>	PCB for combi-steamer L 150mm W 100mm suitable for FAGOR		
<b>For models:</b>	ACG-061, ACG-101, ACG-102, ACG-201, ACG-202, AG-061, AG-101, AG-102, AG-201, AG-202, APG-061, APG-101, APG-102, APG-201, APG-202		

			
1			
<b>GEV No.</b>	403934	<b>Ref. No.</b>	12046659
<b>description</b>	PCB for combi-steamer L 155mm W 100mm		
<b>For models:</b>	ACE-061, ACE-101, ACE-102, ACE-201, ACE-202, ACG-061, ACG-101, ACG-102, ACG-201, ACG-202, AE-061, AE-061W, AE-101, AE-101W, AE-102, AE-102W, AE-201, AE-202, AG-061, AG-061W, AG-101, AG-101W, AG-102, AG-102W, AG-201, AG-202, APE-061, APE-061W, APE-101, APE-101W, APE-102, APE-102W, APE-201, APE-202, APG-061, APG-061W, APG-101, APG-101W, APG-102, APG-102W, APG-201, APG-202, COE-061, COE-101, COG-061, COG-101, VE-061, VE-101, VG-101, VPE-061...(Other models you can see in the webshop)		

			
1			
<b>GEV No.</b>	403931	<b>Ref. No.</b>	12130672
<b>description</b>	PCB for combi-steamer L 155mm W 100mm suitable for FAGOR		
<b>For models:</b>	ACE-061, ACE-101, ACE-102, ACE-201, ACE-202, ACG-061, ACG-101, ACG-102, ACG-201, ACG-202, AE-061, AE-101, AE-102, AE-201, AE-202, AG-061, AG-101, AG-102, AG-201, AG-202, APE-061, APE-101, APE-102, APE-201, APE-202, APG-061, APG-101, APG-102, APG-201, APG-202		

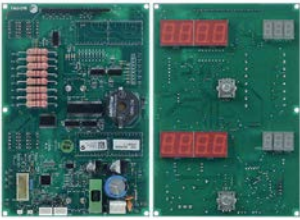
			
1			
<b>GEV No.</b>	403933	<b>Ref. No.</b>	12130674
<b>description</b>	PCB for combi-steamer L 160mm W 110mm		
<b>For models:</b>	ACE-061, ACE-101, ACE-102, ACE-201, ACE-202, ACG-061, ACG-101, ACG-102, ACG-201, ACG-202, AE-061, AE-101, APE-061, APE-101		



1

<b>GEV No.</b>	403930	<b>Ref. No.</b>	12046672
<b>description</b>	PCB for combi-steamer L 176mm W 96mm		
<b>For models:</b>	ACE-061, ACE-101, AE-061, AE-061W, AE-101, AE-101W, AE-102, AE-102W, AE-201, AE-202, AG-061, AG-061W, AG-101, AG-101W, AG-102, AG-102W, AG-201, AG-202, APE-061, APE-101, VE-061, VE-101, VG-101		



1

<b>GEV No.</b>	403918	<b>Ref. No.</b>	12130675
<b>description</b>	PCB for combi-steamer L 177mm W 96mm suitable for FAGOR		
<b>For models:</b>	ACE-061, ACE-101, AE-061, AE-101, AE-102, AE-201, AE-202, AG-061, AG-101, AG-102, AG-201, AG-202, APE-061, APE-101		



1

<b>GEV No.</b>	401629	<b>Ref. No.</b>	12026129 12026671 RT4000049 RT4000049P
<b>description</b>	relay shroud I/O-Board SCC Line		
<b>accessories for</b>	401629		
	<b>GEV No.</b>	<b>Ref. No.</b>	—
	fine fuse size ø6.3x32mm 2A slow-acting rated 250V Qty 10 pcs		



1

<b>GEV No.</b>	401787	<b>Ref. No.</b>	12016841 R693007
<b>description</b>	temperatur p.c.b combi-steamer HEI 6/11 HMI 6/11 °C		



1

<b>GEV No.</b>	401786	<b>Ref. No.</b>	12016954 R693058
<b>description</b>	temperatur p.c.b combi-steamer HMI1011		
<b>For models:</b>	HMG-10-11UL, HMG-10-21UL, HMI-10-11UL, HMI-10-21UL, HMI-6-11UL, HMM-10-11UL, HMM-10-21UL, HMM-20-11, HMM-20-11UL, HMM-20-21UL, HMM-40-11-USMC, HMM-6-11UL, HVG-10-11, HVG-10-11UL, HVG-10-21, HVG-10-21UL, HVG-2-10-11, MFHMM-20-11, MFHVG-10-11, MFHVG-10-21		

central units



1

<b>GEV No.</b>	401790	<b>Ref. No.</b>	12023465 Z953004
<b>description</b>	control box burner regulation		
<b>For models:</b>	COG-061, COG-101, COG-201, GA-20, GA-40, HCG-10-11, HCG-10-21, HCG-20-11, HCG-20-21, HCG-2-10-11, HCG-2-20-11, HCG-6-11, HGC-10-11, HGC-20-11, HGC-6-11, HGV-10-11, HGV-20-11, HVG-10-11, HVG-10-21, HVG-20-11, HVG-20-21, HVG-2-10-11, HVG-2-20-21, VG-101, VG-201, VPG-101, VPG-201		



1

<b>GEV No.</b>	402991	<b>Ref. No.</b>	12024809 Z213069
<b>description</b>	control box for dishwasher 230V		
<b>For models:</b>	AD-120, AD-120B, AD-120C, AD-120HY, AD-15, AD-15D, AD-20C-UK, AD-21, AD-21B, AD-21BDD, AD-21C, AD-21D, AD-21DD, AD-45BBT, AD-48, AD-48B, AD-48BDD, AD-48C, AD-48D, AD-48DD, AD-48HY, AD-64, AD-64B, AD-64BBT, AD-64BDD, AD-64C, AD-64D, AD-64DD, AD-64HY, AD-72, AD-90, AD-90DD, ADE-120, ADE-120B		



# keypads

## front foils



<b>GEV No.</b>	403816	<b>Ref. No.</b>	12024760 T813005000
<b>description</b>	front foil combi-steamer FAGOR L 480mm W 125mm		
<b>For models:</b>	VE-061, VE-101, VE-201		

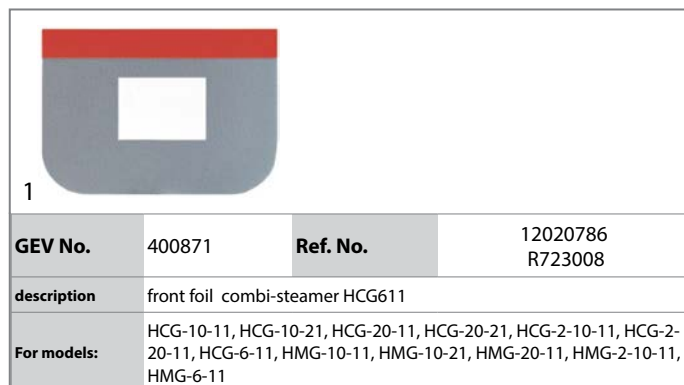

<b>GEV No.</b>	400871	<b>Ref. No.</b>	12020786 R723008
<b>description</b>	front foil combi-steamer HCG611		
<b>For models:</b>	HCG-10-11, HCG-10-21, HCG-20-11, HCG-20-21, HCG-2-10-11, HCG-2-20-11, HCG-6-11, HMG-10-11, HMG-10-21, HMG-20-11, HMG-2-10-11, HMG-6-11		

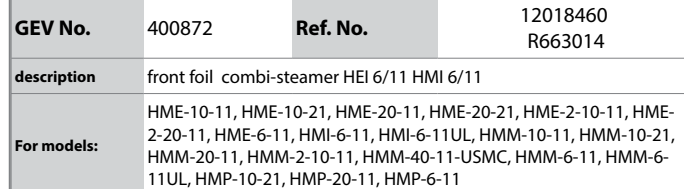

<b>GEV No.</b>	400872	<b>Ref. No.</b>	12018460 R663014
<b>description</b>	front foil combi-steamer HEI 6/11 HMI 6/11		
<b>For models:</b>	HME-10-11, HME-10-21, HME-20-11, HME-20-21, HME-2-10-11, HME-2-20-11, HME-6-11, HMI-6-11, HMI-6-11UL, HMM-10-11, HMM-10-21, HMM-20-11, HMM-2-10-11, HMM-40-11-USMC, HMM-6-11, HMM-6-11UL, HMP-10-21, HMP-20-11, HMP-6-11		

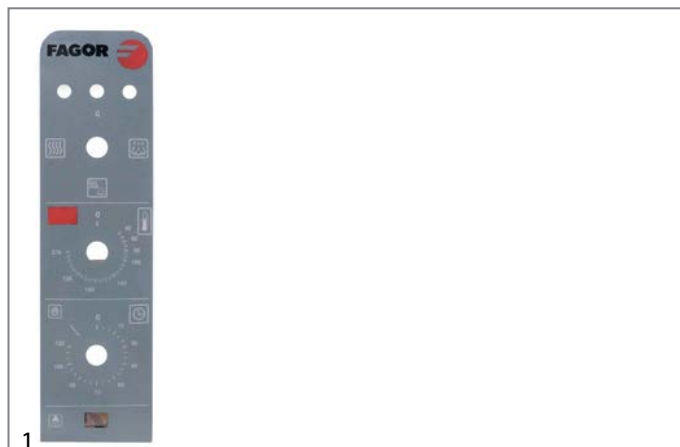

<b>GEV No.</b>	401723	<b>Ref. No.</b>	12019869 R693014
<b>description</b>	front foil combi-steamer HEI611/1011/1021 L 365mm W 98mm		
<b>For models:</b>	HMI-10-11, HMI-10-21, HMI-2-10-11, HMI-6-11		

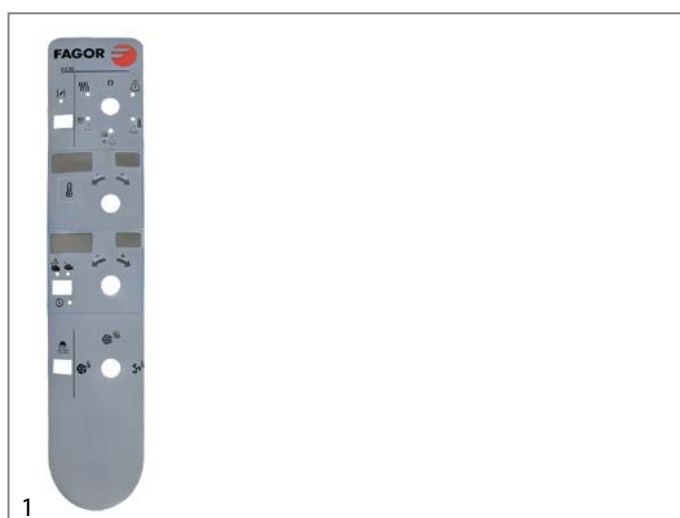

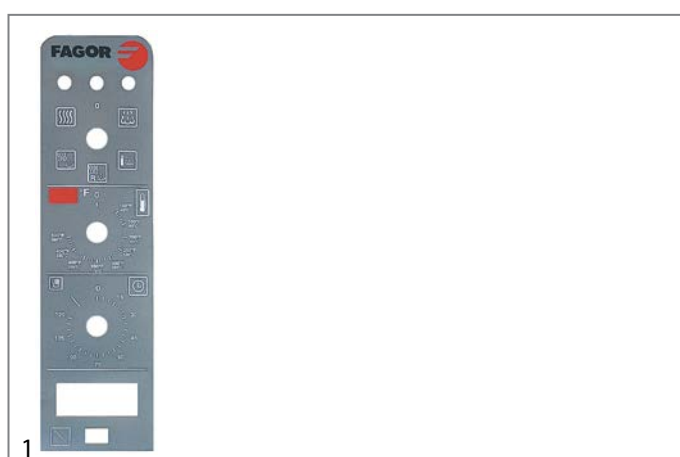

<b>GEV No.</b>	401783	<b>Ref. No.</b>	12018494 R673067
<b>description</b>	front foil combi-steamer HEM 10/11-20/11 L 480mm W 100mm		
<b>For models:</b>	HEM-10-11, HEM-20-11		





<b>GEV No.</b>	400866	<b>Ref. No.</b>	12019113 R693030
<b>description</b>	front foil combi-steamer HMI1011		
<b>For models:</b>	HMI-10-11UL, HMI-10-21UL, HMI-6-11UL		

1 electric components

			
1			
<b>GEV No.</b>	505205	<b>Ref. No.</b>	12020129 Z732901
<b>description</b>	front foil dishwasher ECO120		
<b>For models:</b>	ECO-120, ECO-120B		

			
1			
<b>GEV No.</b>	401843	<b>Ref. No.</b>	12017916 Z322902
<b>description</b>	front foil dishwasher ECO200 L 645mm W 173mm		
<b>For models:</b>	ECO-200, ECO-200D, ECO-200H, ECO-200HD, ECO-200HI, ECO-200I		

			
1			
<b>GEV No.</b>	505125	<b>Ref. No.</b>	12020028 Z710516
<b>description</b>	front foil dishwasher FI-100		
<b>For models:</b>	ECO-120, ECO-120B, ECO-160D, ECO-160I, ECO-200D, ECO-200I, ECO-280D, ECO-280I, ECO-370D, ECO-370I, ECO-460D, ECO-460I, ECO-550D, ECO-550I, FI-100, FI-100AR, FI-100B, FI-100I, FI-120, FI-120B, FI-120W, FI-160D, FI-160I, FI-200D, FI-200I, FI-280D, FI-280I, FI-370D, FI-370I, FI-460D, FI-460I, FI-550D, FI-550I, FI-80, FI-80W		

			
1			
<b>GEV No.</b>	505117	<b>Ref. No.</b>	12020315 Z202909
<b>description</b>	front foil dishwasher FI30		
<b>For models:</b>	FI-30		

			
1			
<b>GEV No.</b>	403240	<b>Ref. No.</b>	12025130
<b>description</b>	front foil dishwasher FI30 grey model FI30 suitable for FAGOR L 585mm W 62.5mm		
<b>For models:</b>	FI-30, FI-30AR, FI-30AR+DD, FI-30-UK		

			
1			
<b>GEV No.</b>	403238	<b>Ref. No.</b>	12023961 Z222903
<b>description</b>	front foil dishwasher FI48 grey model FI-48B suitable for FAGOR L 585mm W 62.5mm		
<b>For models:</b>	FI-48, FI-48B		

			
1			
<b>GEV No.</b>	505119	<b>Ref. No.</b>	12020146 Z212910
<b>description</b>	front foil dishwasher FI-48 run-time 120/180s		
<b>For models:</b>	FI-48, FI-48W		

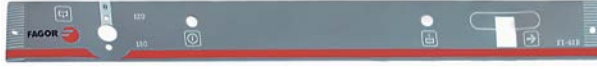
			
1			
<b>GEV No.</b>	505120	<b>Ref. No.</b>	12020147 Z222902
<b>description</b>	front foil dishwasher FI-48B model FI-48B drain pump		
<b>For models:</b>	FI-48B		

			
1			
<b>GEV No.</b>	505118	<b>Ref. No.</b>	12019162 Z232901
<b>description</b>	front foil dishwasher FI-50 model FI-50		
<b>For models:</b>	FI-50		

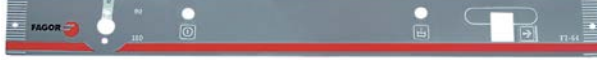
			
1			
<b>GEV No.</b>	505121	<b>Ref. No.</b>	12018990 Z242901
<b>description</b>	front foil dishwasher FI-64 run-time 90/180s		
<b>For models:</b>	FI-64, FI-64W		

			
1			
<b>GEV No.</b>	505124	<b>Ref. No.</b>	12018622 Z262906
<b>description</b>	front foil dishwasher FI-72		
<b>For models:</b>	FI-72		

			
1			
<b>GEV No.</b>	505123	<b>Ref. No.</b>	12018989 Z252901
<b>description</b>	front foil warewashing FI-64B/FI64W		
<b>For models:</b>	FI-64B		

			
1			
<b>GEV No.</b>	505122	<b>Ref. No.</b>	12019191 Z258501
<b>description</b>	front foil warewashing FI-64B/FI64W model FI-64B/FI64W drain pump		
<b>For models:</b>	FI-64B, MF-64		

1





Image not available

<b>GEV No.</b>	505128	<b>Ref. No.</b>	Z718502
<b>description</b>	keypad foil		

2



<b>GEV No.</b>	403056	<b>Ref. No.</b>	12031295 6003010194
<b>description</b>	keypad foil blast freezer ATM101 L 200mm W 60mm buttons 8		
<b>For models:</b>	ATM-051, ATM-101		

1



<b>GEV No.</b>	400867	<b>Ref. No.</b>	12019107 12019204 T013006
<b>description</b>	keypad foil combi-steamer HCG611/1011		
<b>For models:</b>	HCG-10-11, HCG-10-21, HCG-20-11, HCG-20-21, HCG-2-10-11, HCG-2-20-11, HCG-6-11, HGC-10-11, HGC-20-11, HGC-6-11		

1



<b>GEV No.</b>	400868	<b>Ref. No.</b>	12019010 R723022
<b>description</b>	keypad foil combi-steamer HCG611/1011		
<b>For models:</b>	HCG-10-11, HCG-10-21, HCG-2-10-11, HCG-6-11, HMG-10-11, HMG-10-21, HMG-20-11, HMG-2-10-11, HMG-6-11		

1



<b>GEV No.</b>	401718	<b>Ref. No.</b>	12018060 T353004
<b>description</b>	keypad foil combi-steamer HEI 1021/HGV 1021 L 670mm W 160mm		
<b>For models:</b>	HEI-10-21, HEI-20-21		

1

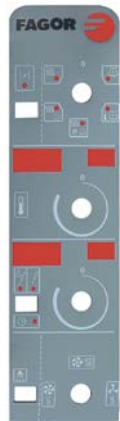

<b>GEV No.</b>	400865	<b>Ref. No.</b>	12019205 R673000
<b>description</b>	keypad foil combi-steamer HEM1011/2011 HME1011/1021/2011		
<b>For models:</b>	HME-10-11, HME-10-21, HME-20-11, HME-20-21, HME-2-10-11, HME-2-20-11, HMP-10-11, HMP-10-21, HMP-20-11, HMP-20-21, HMP-2-10-11, HMP-2-20-11		

1

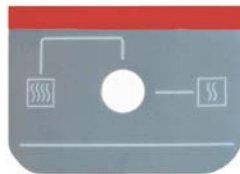

<b>GEV No.</b>	400869	<b>Ref. No.</b>	12020664 R693000
<b>description</b>	keypad foil combi-steamer HMI1011		
<b>For models:</b>	HMI-10-11, HMI-10-11UL, HMI-10-21, HMI-10-21UL, HMI-2-10-11, HMM-10-11, HMM-10-11UL, HMM-10-21, HMM-10-21UL, HMM-20-11, HMM-20-11UL, HMM-20-21, HMM-20-21UL, HMM-2-10-11, HMM-2-20-11, HMM-6-11		

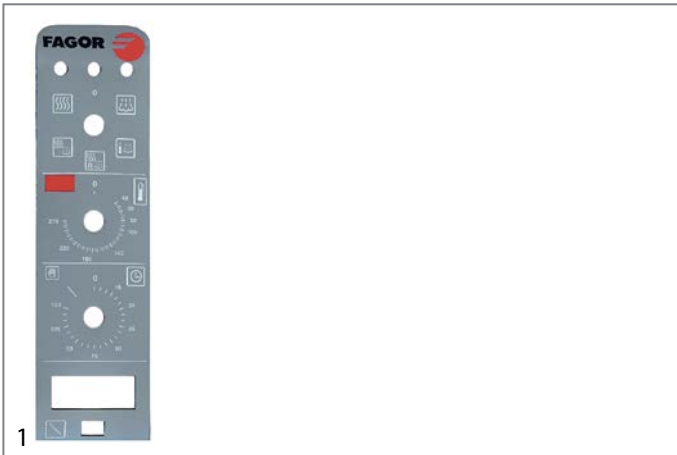

<b>GEV No.</b>	400864	<b>Ref. No.</b>	12020040 12020107 R743012
<b>description</b>	keypad foil combi-steamer HMM2011/2021/22011		
<b>For models:</b>	HMM-10-11, HMM-10-21, HMM-20-11, HMM-20-21, HMM-2-10-11, HMM-2-20-11, HMM-6-11		

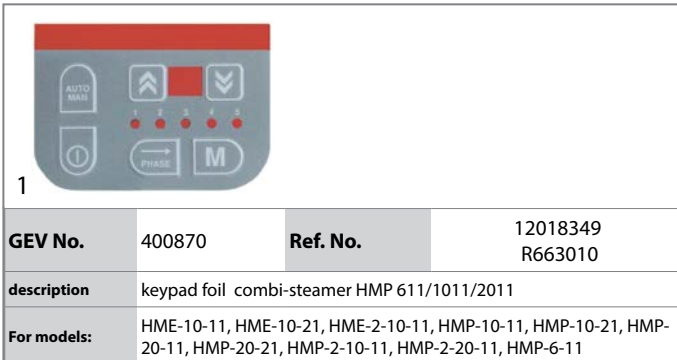

<b>GEV No.</b>	400870	<b>Ref. No.</b>	12018349 R663010
<b>description</b>	keypad foil combi-steamer HMP 611/1011/2011		
<b>For models:</b>	HME-10-11, HME-10-21, HME-2-10-11, HMP-10-11, HMP-10-21, HMP-20-11, HMP-20-21, HMP-2-10-11, HMP-2-20-11, HMP-6-11		

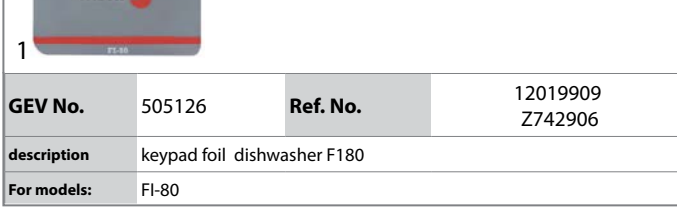

<b>GEV No.</b>	505126	<b>Ref. No.</b>	12019909 Z742906
<b>description</b>	keypad foil dishwasher FI80		
<b>For models:</b>	FI-80		

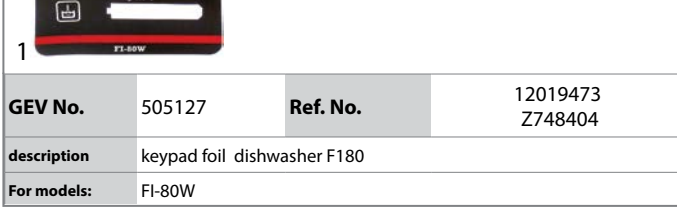

<b>GEV No.</b>	505127	<b>Ref. No.</b>	12019473 Z748404
<b>description</b>	keypad foil dishwasher FI180		
<b>For models:</b>	FI-80W		

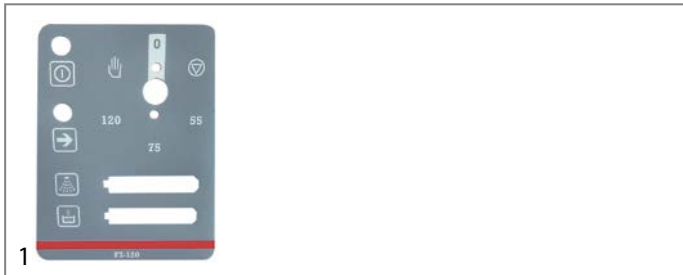

<b>GEV No.</b>	505204	<b>Ref. No.</b>	12019475 Z722901
<b>description</b>	keypad foil dishwasher FI120		
<b>For models:</b>	FI-120, FI-120B		



<b>GEV No.</b>	505108	<b>Ref. No.</b>	12020486 Z462901
<b>description</b>	keypad foil dishwasher LVC12		
<b>For models:</b>	LVC-12, LVC-15, LVC-21, LVR-10, LVR-14, LVR-20		



<b>GEV No.</b>	505109	<b>Ref. No.</b>	12018909 Z412901
<b>description</b>	keypad foil dishwasher LVC15		
<b>For models:</b>	LVC-12, LVC-15, LVC-21, LVR-10, LVR-14, LVR-20		



<b>GEV No.</b>	505115	<b>Ref. No.</b>	12019307 Z482901
<b>description</b>	keypad foil dishwasher LVC15D		
<b>For models:</b>	LVC-15D		



<b>GEV No.</b>	505113	<b>Ref. No.</b>	12018973 Z472902
<b>description</b>	keypad foil dishwasher LVC15D/21D/14D/20D		
<b>For models:</b>	LVR-14D		



<b>GEV No.</b>	505114	<b>Ref. No.</b>	Z492902
<b>description</b>	keypad foil dishwasher LVC15D/21D/14D/20D		

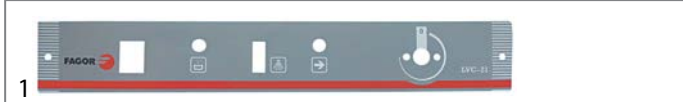

<b>GEV No.</b>	505110	<b>Ref. No.</b>	12020451 Z442901
<b>description</b>	keypad foil dishwasher LVC21		
<b>For models:</b>	LVC-12, LVC-15, LVC-21, LVC-21W, LVR-10, LVR-14, LVR-20		

1

<b>GEV No.</b>	505112	<b>Ref. No.</b>	12019096 Z452901
<b>description</b>	keypad foil dishwasher LVC21B		
<b>For models:</b>	LVC-21B, LVR-20B		

1

<b>GEV No.</b>	505116	<b>Ref. No.</b>	12018125 Z502901
<b>description</b>	keypad foil dishwasher LVC21D		
<b>For models:</b>	LVC-21D		

1

<b>GEV No.</b>	505105	<b>Ref. No.</b>	12019135 Z392901
<b>description</b>	keypad foil dishwasher LVR10		
<b>For models:</b>	LVC-12, LVC-15, LVC-21, LVR-10, LVR-14, LVR-20		

1

<b>GEV No.</b>	505106	<b>Ref. No.</b>	Z402909
<b>description</b>	keypad foil dishwasher LVR14		

1

<b>GEV No.</b>	403927	<b>Ref. No.</b>	12044109
<b>description</b>	keypad foil for combi-steamer black L 540mm W 173mm		
<b>For models:</b>	ACE-061, ACE-101, ACE-102, ACE-201, ACE-202, AE-061, AE-101, APE-061, APE-101		

1

<b>GEV No.</b>	403928	<b>Ref. No.</b>	12044176
<b>description</b>	keypad foil for combi-steamer black L 540mm W 173mm		
<b>For models:</b>	ACG-061, ACG-101, ACG-102, ACG-201, ACG-202		

1

<b>GEV No.</b>	403920	<b>Ref. No.</b>	12129465
<b>description</b>	keypad foil for combi-steamer black suitable for FAGOR L 540mm W 173mm		

1

<b>GEV No.</b>	505202	<b>Ref. No.</b>	12020127 Z712908
<b>description</b>	keypad foil warewashing FI100		
<b>For models:</b>	FI-100, FI-100AR, FI-100B		



<b>GEV No.</b>	505203	<b>Ref. No.</b>	12020324 Z728501
<b>description</b>	keypad foil warewashing FI120		
<b>For models:</b>	FI-120W, MF-120		

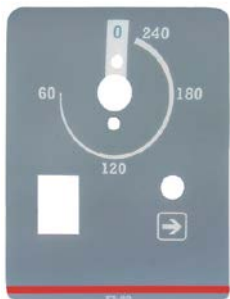

<b>GEV No.</b>	505201	<b>Ref. No.</b>	Z742901
<b>description</b>	keypad foil warewashing FI80		

### membrane keypads



<b>GEV No.</b>	403466	<b>Ref. No.</b>	12024723
<b>description</b>	membrane keypad dishwasher AD48/AD64 buttons 4 suitable for FAGOR Qty 1 pcs L 585mm W 50mm		
<b>For models:</b>	AD-45BBT, AD-48B, AD-48BDD, AD-48C, AD-64B, AD-64BBT, AD-64BDD, AD-64C		



<b>GEV No.</b>	403467	<b>Ref. No.</b>	12023437
<b>description</b>	membrane keypad dishwasher AD90 buttons 4 suitable for FAGOR Qty 1 pcs L 200mm W 120mm		
<b>For models:</b>	AD-90, AD-90DD		



<b>GEV No.</b>	402579	<b>Ref. No.</b>	12023215
<b>description</b>	membrane keypad warewashing LA13 buttons 6 L 640mm W 160mm		
<b>For models:</b>	LA-13M, LB-AC-10M, LB-E-10M, LB-V-10M		

### control panel



<b>GEV No.</b>	403637	<b>Ref. No.</b>	12044139
<b>description</b>	keypad foil combi-steamer APE-061/101 L 540mm W 172mm thickness 1mm		
<b>For models:</b>	ACE-061, ACE-101, AE-061, AE-061W, AE-101, AE-101W, AE-102, AE-102W, AE-201, AE-202, AG-061, AG-061W, AG-101, AG-101W, AG-102, AG-102W, AG-201, AG-202, APE-061, APE-101		

### solenoid valves

#### solenoid valves (water)

ELBI

straight



<b>GEV No.</b>	373021	<b>Ref. No.</b>	12032024 RT30020330
----------------	--------	-----------------	------------------------

**description** solenoid valve double straight 230VAC inlet 3/4" outlet 11.5mm output 1x 4.7l/min DN10 ELBI

**spare parts for** 373021

<b>GEV No.</b>	370467	<b>Ref. No.</b>	—
----------------	--------	-----------------	---

**description** solenoid valve filter suitable for ELBI

Table continues overleaf





<b>spare parts for</b> 373021			
	<b>GEV No.</b>	371263	<b>Ref. No.</b> —
reducer ELBI type EATON (INVENSYS) flow rate 4.7l/min pressure range 0 up to 10bar tolerance ±15/25% grey			

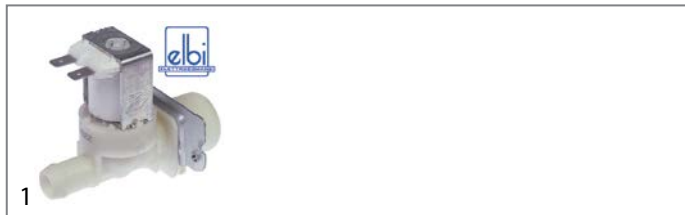

<b>GEV No.</b>	373018	<b>Ref. No.</b>	RT30020331
<b>description</b>	solenoid valve single straight 230VAC inlet 3/4" outlet 14mm DN10 ELBI		

<b>spare parts for</b> 373018			
	<b>GEV No.</b>	370467	<b>Ref. No.</b> —
solenoid valve filter suitable for ELBI			



<b>GEV No.</b>	373025	<b>Ref. No.</b>	12023921 Z611123
<b>description</b>	solenoid valve triple straight 230VAC inlet 3/4" outlet 11.5mm DN10 ELBI		

**For models:** AE-061, AE-061W, AE-101, AE-101W, AE-102, AE-102W, AE-201, AE-202, AG-061, AG-061W, AG-101, AG-101W, AG-102, AG-102W, AG-201, AG-202, APE-061, APE-061W, APE-101, APE-101W, APE-102, APE-102W, APE-201, APE-202, APG-061, APG-061W, APG-101, APG-101W, APG-102, APG-102W, APG-201, APG-202, HEM-10-11, HEM-20-11, HEM-6-11, HEP-10-11, HEP-20-11, HEP-6-11, LA-13M, LA-18MP, LA-25M, LA-AC-10M, LA-AC-10MA, LA-AC-10MP, LA-AC-13M, LA-AC-13MA, LA-AC-13MP, LA-AC-18M, LA-AC-18MA, LA-AC-18MP...(Other models you can see in the webshop)

<b>spare parts for</b> 373025			
	<b>GEV No.</b>	370467	<b>Ref. No.</b> —
solenoid valve filter suitable for ELBI			

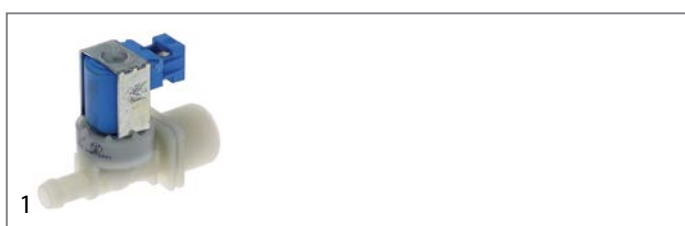

<b>GEV No.</b>	370852	<b>Ref. No.</b>	12032546 RT5000139
<b>description</b>	solenoid valve single straight 230VAC inlet 3/4" outlet 11.5mm DN10		



<b>GEV No.</b>	370851	<b>Ref. No.</b>	12031080 RT5000138
<b>description</b>	solenoid valve double straight 230VAC inlet 3/4" outlet 11.5mm DN10		



<b>GEV No.</b>	370849	<b>Ref. No.</b>	12115418
<b>description</b>	solenoid valve triple straight 220-240V/50-60Hz inlet 3/4" outlet 10.5 t.max. 90°C duty cycle 100% ELBI 369 plastic flow regulating valve inlet black		
<b>For models:</b>	AE-061, AE-061W, AE-101, AE-101W, AE-102, AE-102W, AE-201, AE-202, AG-061, AG-061W, AG-101, AG-101W, AG-102, AG-102W, AG-201, AG-202, APE-061, APE-061W, APE-101, APE-101W, APE-102, APE-102W, APE-201, APE-202, APG-061, APG-061W, APG-101, APG-101W, APG-102, APG-102W, APG-201, APG-202		

**ROBERTSHAW/INVENSYS**

*medium temperature:* 90°C 90°C 60°C  
*ambient temperature:* 60°C 25°C 60°C  
*duty cycle:* 40% 100% 100%

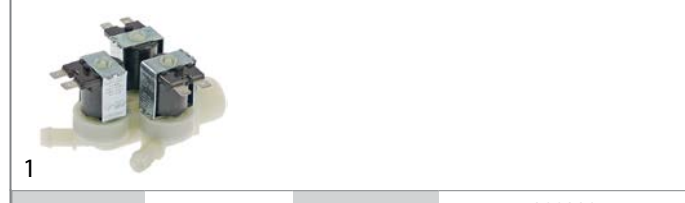

<b>GEV No.</b>	372025	<b>Ref. No.</b>	12003285 Z611124
<b>description</b>	solenoid valve triple straight 230VAC inlet 3/4" outlet 11.5mm DN10 EATON (INVENSYS)		
<b>For models:</b>	AD-15D, AD-21D, LVC-15D, LVC-21D, LVR-14D, LVR-20D		









**with coded terminal**



<b>GEV No.</b>	370270	<b>Ref. No.</b>	12029780 RT30020343
<b>description</b>	solenoid valve single straight 230VAC inlet 3/8" outlet 3/8" DN10 Invensys		



<b>RPE</b>			
solenoid valves with reducers			
single			
			
1			
<b>GEV No.</b>	370440	<b>Ref. No.</b>	BR00010368
<b>description</b>	solenoid valve 1-fold, without membrane (constantly open) angled inlet 3/4" outlet 11.5mm input 10-12l/min RPE plastic flow regulating valve inlet white		

<b>TP</b>			
			
1			
<b>GEV No.</b>	370021	<b>Ref. No.</b>	12023794 12032085 EU929172 P255001
<b>description</b>	solenoid valve double straight 230VAC inlet 3/4" outlet 11.5mm DN10 TP flow regulating valve inlet white		
<b>For models:</b>	ACE-061, ACE-101, ACE-102, ACE-201, ACE-202, ACG-061, ACG-101, ACG-102, ACG-201, ACG-202, AD-15, AD-20C-UK, AD-21, AD-21B, AD-21BDD, AD-21C, AD-21DD, AD-21W, AD-48D, AD-64D, AE-061, AE-101, AE-102, AE-201, AE-202, AG-061, AG-101, AG-102, AG-201, AG-202, COE-061, COE-101, COE-102, COE-201, COE-202, CPE9-05, CPE9-05AD, CPE9-05AD-S, CPE9-05NC, CPE9-05PLUS, CPE9-05PLUS-S, CPE9-05S, CPE9-05SNC, CPG9-05, CPG9-05AD, CPG9-05AD-S, CPG9-05NC, CPG9-05PLUS, CPG9-05PLUS-S, CPG9-05S...(Other models you can see in the webshop)		
<b>spare parts for</b>	370021		
	<b>GEV No.</b>	371013	<b>Ref. No.</b> —
solenoid coil TP 230VAC 50/60Hz			
<b>accessories for</b>	370021		
	<b>GEV No.</b>	371220	<b>Ref. No.</b> —
reducer TP flow rate 3l/min red tolerance ±15%			
	<b>GEV No.</b>	371221	<b>Ref. No.</b> —
reducer TP flow rate 5.5l/min yellow tolerance ±15%			
	<b>GEV No.</b>	371222	<b>Ref. No.</b> —
reducer TP flow rate 6l/min grey tolerance ±15%			
	<b>GEV No.</b>	371223	<b>Ref. No.</b> —
reducer TP flow rate 10l/min white tolerance ±15%			
	<b>GEV No.</b>	371224	<b>Ref. No.</b> —
reducer TP flow rate 12l/min bronze tolerance ±15%			
	<b>GEV No.</b>	371225	<b>Ref. No.</b> —
reducer TP flow rate 16l/min light brown tolerance ±15%			
	<b>GEV No.</b>	371226	<b>Ref. No.</b> —
reducer TP flow rate 20l/min red tolerance ±15%			

<b>accessories for</b>	370021		
	<b>GEV No.</b>	371230	<b>Ref. No.</b> —
reducer TP flow rate 0.25l/min red tolerance ±25%			
	<b>GEV No.</b>	371231	<b>Ref. No.</b> —
reducer TP flow rate 0.35l/min violet tolerance ±25%			
	<b>GEV No.</b>	371232	<b>Ref. No.</b> —
reducer TP flow rate 0.5l/min orange tolerance ±25%			
	<b>GEV No.</b>	371233	<b>Ref. No.</b> —
reducer TP flow rate 0.8l/min white tolerance ±25%			
	<b>GEV No.</b>	371234	<b>Ref. No.</b> 12025263 P305013
reducer TP flow rate 1l/min light blue tolerance ±25%			
	<b>GEV No.</b>	371235	<b>Ref. No.</b> —
reducer TP flow rate 1.2l/min brown tolerance ±25%			
	<b>GEV No.</b>	371236	<b>Ref. No.</b> —
reducer TP flow rate 1.5l/min light brown tolerance ±25%			
	<b>GEV No.</b>	371237	<b>Ref. No.</b> —
reducer TP flow rate 2.5l/min yellow tolerance ±25%			
	<b>GEV No.</b>	371238	<b>Ref. No.</b> —
reducer TP flow rate 3.4l/min dark green tolerance ±25%			
	<b>GEV No.</b>	371239	<b>Ref. No.</b> —
reducer TP flow rate 5l/min black tolerance ±25%			
	<b>GEV No.</b>	371240	<b>Ref. No.</b> —
reducer TP flow rate 8l/min blue tolerance ±20%			



			
1			
<b>GEV No.</b>	370017	<b>Ref. No.</b>	12025161 Z701135
<b>description</b>	solenoid valve single straight 230VAC inlet 3/4" outlet 11.5mm DN10 TP p max 10bar		
<b>For models:</b>	ACE-061, ACE-101, ACE-102, ACE-201, ACE-202, ACG-061, ACG-101, ACG-102, ACG-201, ACG-202, AD-120, AD-120B, AD-120BTTDD-UK, AD-120C, AD-120HY, AD-45BBT, AD-48, AD-48B, AD-48BDD, AD-48C, AD-48DD, AD-48HY, AD-48W, AD-64, AD-64B, AD-64BBT, AD-64BDD, AD-64BTTDD, AD-64C, AD-64CW, AD-64D, AD-64DD, AD-64HY, AD-72, AD-72W, AD-90, AD-90BA, AD-90BBT, AD-90BDD, AD-90DD, AE-061, AE-061W, AE-101, AE-101W, AE-102, AE-102W, AE-201, AE-202, AG-061, AG-061W...(Other models you can see in the webshop)		
<b>spare parts for</b>	370017		
	<b>GEV No.</b>	371013	<b>Ref. No.</b> —
solenoid coil TP 230VAC 50/60Hz			
<b>accessories for</b>	370017		
	<b>GEV No.</b>	371220	<b>Ref. No.</b> —
reducer TP flow rate 3l/min red tolerance ±15%			



Table continues overleaf



accessories for		370017		
	GEV No.	371221	Ref. No.	—
reducer TP flow rate 5.5l/min yellow tolerance ±15%				
	GEV No.	371222	Ref. No.	—
reducer TP flow rate 6l/min grey tolerance ±15%				
	GEV No.	371223	Ref. No.	—
reducer TP flow rate 10l/min white tolerance ±15%				
	GEV No.	371224	Ref. No.	—
reducer TP flow rate 12l/min bronze tolerance ±15%				
	GEV No.	371225	Ref. No.	—
reducer TP flow rate 16l/min light brown tolerance ±15%				
	GEV No.	371226	Ref. No.	—
reducer TP flow rate 20l/min red tolerance ±15%				
	GEV No.	371230	Ref. No.	—
reducer TP flow rate 0.25l/min red tolerance ±25%				
	GEV No.	371231	Ref. No.	—
reducer TP flow rate 0.35l/min violet tolerance ±25%				
	GEV No.	371232	Ref. No.	—
reducer TP flow rate 0.5l/min orange tolerance ±25%				
	GEV No.	371233	Ref. No.	—
reducer TP flow rate 0.8l/min white tolerance ±25%				
	GEV No.	371234	Ref. No.	12025263 P305013
reducer TP flow rate 1l/min light blue tolerance ±25%				
	GEV No.	371235	Ref. No.	—
reducer TP flow rate 1.2l/min brown tolerance ±25%				
	GEV No.	371236	Ref. No.	—
reducer TP flow rate 1.5l/min light brown tolerance ±25%				
	GEV No.	371237	Ref. No.	—
reducer TP flow rate 2.5l/min yellow tolerance ±25%				
	GEV No.	371238	Ref. No.	—
reducer TP flow rate 3.4l/min dark green tolerance ±25%				
	GEV No.	371239	Ref. No.	—
reducer TP flow rate 5l/min black tolerance ±25%				
	GEV No.	371240	Ref. No.	—
reducer TP flow rate 8l/min blue tolerance ±20%				

  <b>1</b>			
<b>GEV No.</b>	370018	<b>Ref. No.</b>	12034078
<b>description</b>	solenoid valve single straight 230VAC inlet 3/4" outlet 14mm DN10 TP		
<b>spare parts for</b>	370018		
	GEV No.	371013	Ref. No. —
solenoid coil TP 230VAC 50/60Hz			
<b>accessories for</b>	370018		
	GEV No.	371220	Ref. No. —
reducer TP flow rate 3l/min red tolerance ±15%			
	GEV No.	371221	Ref. No. —
reducer TP flow rate 5.5l/min yellow tolerance ±15%			
	GEV No.	371222	Ref. No. —
reducer TP flow rate 6l/min grey tolerance ±15%			
	GEV No.	371223	Ref. No. —
reducer TP flow rate 10l/min white tolerance ±15%			
	GEV No.	371224	Ref. No. —
reducer TP flow rate 12l/min bronze tolerance ±15%			
	GEV No.	371225	Ref. No. —
reducer TP flow rate 16l/min light brown tolerance ±15%			
	GEV No.	371226	Ref. No. —
reducer TP flow rate 20l/min red tolerance ±15%			
	GEV No.	371230	Ref. No. —
reducer TP flow rate 0.25l/min red tolerance ±25%			
	GEV No.	371231	Ref. No. —
reducer TP flow rate 0.35l/min violet tolerance ±25%			
	GEV No.	371232	Ref. No. —
reducer TP flow rate 0.5l/min orange tolerance ±25%			
	GEV No.	371233	Ref. No. —
reducer TP flow rate 0.8l/min white tolerance ±25%			
	GEV No.	371234	Ref. No. 12025263 P305013
reducer TP flow rate 1l/min light blue tolerance ±25%			
	GEV No.	371235	Ref. No. —
reducer TP flow rate 1.2l/min brown tolerance ±25%			
	GEV No.	371236	Ref. No. —
reducer TP flow rate 1.5l/min light brown tolerance ±25%			
	GEV No.	371237	Ref. No. —
reducer TP flow rate 2.5l/min yellow tolerance ±25%			

Table continues overleaf

accessories for		370018	
	GEV No.	371238	Ref. No. —
reducer TP flow rate 3.4l/min dark green tolerance ±25%			
	GEV No.	371239	Ref. No. —
reducer TP flow rate 5l/min black tolerance ±25%			
	GEV No.	371240	Ref. No. —
reducer TP flow rate 8l/min blue tolerance ±20%			

### solenoid valves with reducers



1			
GEV No.	370427	Ref. No.	12033258 BR00023001
description	solenoid valve single angled 230VAC inlet 3/4" outlet 11.5mm input/ min output 1.2l/min DN10 t.max. 90°C TP plastic flow regulating valve outlet dark brown		



1			
GEV No.	370245	Ref. No.	EPGC3120530
description	solenoid valve single straight 24VAC inlet 3/4" outlet 11.5mm input 16l/min t.max. 90°C TP plastic flow regulating valve inlet light brown		



1			
GEV No.	370250	Ref. No.	P443018000
description	solenoid valve triple straight 230VAC inlet 3/4" outlet 11.5mm t.max. 90°C TP plastic output B 0.25l/min flow regulating valve outlet B red		

### spare parts and accessories

#### reducers

#### outlet side



1			
GEV No.	691081	Ref. No.	12024509 R665041
description	reducer flow rate 0.25l/min green tolerance ±25%		
For models:	ACE-061, ACE-101, ACE-102, ACE-201, ACG-061, ACG-101, AE-061, AE-061W, AE-101, AE-101W, AE-102, AE-102W, AE-201, AG-061, AG-061W, AG-101, AG-101W, AG-102, AG-102W, AG-201, AG-202, APE-061, APE-061W, APE-101, APE-101W, APE-102, APE-102W, APE-201, APG-061, APG-061W, APG-101, APG-101W, APG-102, APG-102W, APG-201, APG-202, COE-061, COE-101, COE-201, COG-061, COG-101, HCG-10-11, HCG-10-21, HCG-2-10-11, HCG-6-11, HEI-10-11, HEI-20-11, HEI-6-11, HEM-10-11, HEM-10-21...(Other models you can see in the webshop)		



1			
GEV No.	691080	Ref. No.	12024083 P443042
description	reducer flow rate 3l/min light green tolerance ±25%		
For models:	COE-061, COE-101, COE-102, COE-201, COE-202, CPE9-05, CPE9-05AD, CPE9-05AD-S, CPE9-05NC, CPE9-05PLUS, CPE9-05PLUS-S, CPE9-05S, CPE9-05SNC, CPG9-05, CPG9-05AD, CPG9-05AD-S, CPG9-05NC, CPG9-05PLUS, CPG9-05PLUS-S, CPG9-05S, CPG9-05SNC, ECO-160, ECO-160D, ECO-160D, ECO-160I, ECO-200, ECO-200D, ECO-200H, ECO-200HD, ECO-200HI, ECO-200I, ECO-2300, ECO-2700D, ECO-2700I, ECO-280D, ECO-280I, ECO-3000, ECO-370D, ECO-370I, ECO-4000D, ECO-4000I, ECO-460D, ECO-460I, ECO-550D, ECO-550I, ECO-6000D, ECO-6000I, FI-160, FI-160D, FI-160D...(Other models you can see in the webshop)		





1			
GEV No.	691082	Ref. No.	12024045 Z601156
description	reducer flow rate 8l/min violet tolerance ±25%		
For models:	AD-45BBT, AD-48HY, AD-64BBT, AD-64BTDD, AD-64HY, AE-061, AE-101, AE-102, AE-201, AE-202, AG-061, AG-101, AG-102, AG-201, AG-202, APE-061, APE-101, APE-102, APE-201, APE-202, APG-061, APG-101, APG-102, APG-201, APG-202, BME7-05, BME7-10, BMG7-10, CPE9-05, CPE9-05AD, CPE9-05AD-S, CPE9-05NC, CPE9-05PLUS, CPE9-05PLUS-S, CPE9-05S, CPE9-05SNC, CPG9-05, CPG9-05AD, CPG9-05AD-S, CPG9-05NC, CPG9-05PLUS, CPG9-05PLUS-S, CPG9-05S, CPG9-05SNC, ECO-2700D, ECO-2700I, ECO-4000D, ECO-4000I, ECO-550D, ECO-550I...(Other models you can see in the webshop)		



1			
GEV No.	371234	Ref. No.	12025263 P305013
description	reducer TP flow rate 1l/min light blue tolerance ±25%		
For models:	ACE-061, ACE-101, ACE-102, ACE-201, ACE-202, ACG-061, ACG-101, AD-48D, AD-64D, AE-061, AE-101, AE-102, AE-201, AE-202, AG-061, AG-101, AG-102, AG-201, AG-202, APE-061, APE-101, APE-102, APE-201, APE-202, APG-061, APG-101, APG-102, APG-201, APG-202, COE-202, FI-48, FI-48AR, FI-48B, FI-48B-BT-UK, FI-48C, FI-48D, FI-48HY-CLINIC, FI-48W, FI-64, FI-64AR, FI-64B, FI-64B-BT-UK, FI-64C, FI-64D, FI-64HY-CLINIC, FI-64W, HCV-10-11, HCV-5-11, HE-10-11, HE-10-21...(Other models you can see in the webshop)		





drain valves

 <p>1</p>			
<b>GEV No.</b>	401889	<b>Ref. No.</b>	12026018 RT5400357
<b>description</b>	drain valve 12V single inlet 40mm outlet 40mm for combi-steamer		
<b>accessories for</b>	401889		
			
<b>GEV No.</b>	532727	<b>Ref. No.</b>	12037152 RT1000512
<b>description</b>	O-ring silicone thickness 3.5mm ID ø 26mm Qty 5 pcs for model SCC, CM		
			
<b>GEV No.</b>	532728	<b>Ref. No.</b>	12037113 RT1000511
<b>description</b>	O-ring silicone thickness 3.5mm ID ø 46mm Qty 5 pcs for model SCC, CM		

 <p>1</p>			
<b>GEV No.</b>	370789	<b>Ref. No.</b>	12024781 P302120
<b>description</b>	drain valve 220-240V 50/60Hz NO inlet 50mm outlet 50/35mm MDB-O-2-SO		
<b>For models:</b>	LA-13M, LA-18MP, LA-AC-10M, LA-AC-10MA, LA-AC-10MP, LA-AC-13M, LA-AC-13MA, LA-AC-13MP, LA-AC-18M, LA-AC-18MA, LA-AC-18MP, LAC-10, LAC-10MP, LAC-10MPP, LAC-14, LAC-14MP, LAC-14MPP, LAC-7, LAC-7MP, LAC-7MPP, LA-E-10M, LA-E-10MA, LA-E-10MP, LA-E-13M, LA-E-13MA, LA-E-13MP, LA-E-18M, LA-E-18MA, LA-E-18MP, LA-V-10M, LA-V-10MP, LA-V-13M, LA-V-13MP, LA-V-18M, LA-V-18MP, LB-AC-10M, LB-E-10M, LB-V-10M, LC-10, LC-14, LC-7, LC-AC-10, LC-AC-10A, LC-AC-14, LC-AC-14A, LC-AC-7, LC-AC-7A, LC-E-10, LC-E-10A, LC-E-14... (Other models you can see in the webshop)		

Solenoid valve - accessories

 <p>1</p>			
<b>GEV No.</b>	500738	<b>Ref. No.</b>	12039924 R725047
<b>description</b>	fastening angle for solenoid coil		
<b>For models:</b>	HMG-10-11, HMG-10-11UL, HMG-10-21, HMG-10-21UL, HMG-2-10-11, HMG-6-11		

 <p>1</p>			
<b>GEV No.</b>	699812	<b>Ref. No.</b>	12036665 RT5000086
<b>description</b>	locking plate for solenoid valve L 37mm W 29mm H 4mm		

pressure switches

for warewashing

<p>ø 58mm with male faston 6.3mm</p> <p>with connection horizontal</p>			
 <p>1</p>			
<b>GEV No.</b>	541137	<b>Ref. No.</b>	12025063 Z513001
<b>description</b>	pressure control pressure range 155/40mbar connection 6mm ø 58mm pressure connection horizontal warewashing		
<b>For models:</b>	ECO-2700D, ECO-2700I, ECO-4000D, ECO-4000I, ECO-6000D, ECO-6000I, FI-120HY-CLINIC, FI-2700D, FI-2700I, FI-4000D, FI-4000I, FI-6000D, FI-6000I		

 <p>1</p>			
<b>GEV No.</b>	541776	<b>Ref. No.</b>	12023804 Z713002
<b>description</b>	pressure control pressure range 170/95mbar connection 6mm ø 58mm pressure connection horizontal warewashing		
<b>For models:</b>	AD-120, AD-120B, AD-120BTTDD-UK, AD-120C, AD-120CW, AD-120HY, AD-45BBT, AD-48HY, AD-64BBT, AD-64HY, AD-90, AD-90BA, AD-90BBT, AD-90BDD, AD-90DD, ADE-120, ADE-120B, ECO-120, ECO-120B, FI-100, FI-100AR, FI-100B, FI-100BBT-UK, FI-120, FI-120AR+DD, FI-120B, FI-120C, FI-120HY-CLINIC, FI-120W, FI-80, FI-80AR, FI-80BBT-UK, FI-80W, FI-E-100, LABP-1000, LABP-1200, LABP-800, MF-120		

 <p>1</p>			
<b>GEV No.</b>	541885	<b>Ref. No.</b>	12023855 Z273006
<b>description</b>	pressure control pressure range 205/40mbar connection 6mm ø 58mm pressure connection horizontal pressure connection ø 5.5mm		
<b>For models:</b>	ECO-160, ECO-160D, ECO-160I, ECO-200, ECO-200D, ECO-200H, ECO-200HD, ECO-200HI, ECO-200I, ECO-280D, ECO-280I, ECO-370D, ECO-370I, ECO-460D, ECO-460I, ECO-550D, ECO-550I, FI-160, FI-160AR, FI-160D, FI-160I, FI-200, FI-200AR, FI-200D, FI-200H, FI-200HD, FI-200HI, FI-200I, FI-200W, FI-200WL, FI-200WR, FI-280D, FI-280I, FI-370D, FI-370I, FI-460D, FI-460I, FI-550D, FI-550I		



<b>GEV No.</b>	541683	<b>Ref. No.</b>	Z273006 old
<b>description</b>	pressure control pressure range 205/40mbar connection male faston 6.3mm ø 58mm pressure connection horizontal pressure connection ø 6mm		



<b>GEV No.</b>	541832	<b>Ref. No.</b>	12023856 Z713098
<b>description</b>	pressure control pressure range 24.7/22.2mbar connection 6mm ø 58mm pressure connection horizontal warewashing pressure connection ø 6mm		
<b>For models:</b>	AD-120B, AD-120BBTDD-UK, AD-120C, AD-120HY, AD-90BA, AD-90BBT, AD-90BDD, ADE-120B, ECO-120B, FI-100, FI-100AR, FI-100B, FI-100BBT-UK, FI-120B, FI-120C, FI-120HY-CLINIC, FI-80BBT-UK		



<b>GEV No.</b>	541864	<b>Ref. No.</b>	12023803 Z403021
<b>description</b>	pressure control pressure range 28/13mbar connection 6mm ø 58mm pressure connection horizontal warewashing suitable for FAGOR		
<b>For models:</b>	AD-15, AD-15D, AD-21, AD-21B, AD-21C, AD-21D, AD-21DD, CO-350, CO-350-B, CO-350-B-DD, CO-350-COLD, CO-350-COLD-B, CO-350-COLD-B-DD, CO-350-COLD-DD, CO-352-COLD, CO-352-COLD-B, CO-352-COLD-B-DD, CO-352-COLD-DD, CO-400, CO-400-B, CO-400-B-DD, CO-400-COLD, CO-400-COLD-B, CO-400-COLD-B-DD, CO-400-COLD-DD, CO-400-DD, CO-400-SOFT, CO-402-COLD, CO-402-COLD-B, CO-402-COLD-B-DD, CO-402-COLD-DD, ECO-280D, ECO-280I, ECO-370D, ECO-370I, ECO-460D, ECO-460I, ECO-550D, ECO-550I, FI-160AR, FI-160D, FI-160I, FI-200AR, FI-200D, FI-200HD, FI-200HI, FI-200I, FI-200WL, FI-200WR...(Other models you can see in the webshop)		



<b>GEV No.</b>	541302	<b>Ref. No.</b>	12023802 Z203023
<b>description</b>	pressure control pressure range 40/15mbar connection 6mm ø 58mm pressure connection horizontal warewashing		
<b>For models:</b>	AD-45BBT, AD-48, AD-48B, AD-48BDD, AD-48C, AD-48D, AD-48DD, AD-48HY, AD-48W, AD-64, AD-64B, AD-64BBT, AD-64BDD, AD-64BTDD, AD-64C, AD-64CW, AD-64D, AD-64DD, AD-64HY, AD-72, AD-72W, EASY-500, EASY-500B, EASY-500DD, EASY-500HP, EASY-500HPWBDD, FI-120HY-CLINIC, FI-30, FI-30AR, FI-30AR+DD, FI-30B, FI-30B-BT-UK, FI-30-UK, FI-48, FI-48AR, FI-48B, FI-48B-BT-UK, FI-48C, FI-48D, FI-48HY-CLINIC, FI-48W, FI-50, FI-60DD, FI-64, FI-64AR, FI-64B, FI-64B-BT-UK, FI-64C, FI-64D, FI-64HY-CLINIC...(Other models you can see in the webshop)		



<b>GEV No.</b>	541593	<b>Ref. No.</b>	12023854 Z313006
<b>description</b>	pressure control pressure range 50/35mbar connection 6mm ø 58mm pressure connection horizontal		
<b>For models:</b>	ECO-2700D, ECO-2700I, ECO-280D, ECO-280I, ECO-370D, ECO-370I, ECO-4000D, ECO-4000I, ECO-460D, ECO-460I, ECO-550D, ECO-550I, ECO-6000D, ECO-6000I, FI-2700D, FI-2700I, FI-280D, FI-280I, FI-370D, FI-370I, FI-4000D, FI-4000I, FI-460D, FI-460I, FI-550D, FI-550I, FI-6000D, FI-6000I		



<b>GEV No.</b>	541594	<b>Ref. No.</b>	12020076 Z683071
<b>description</b>	pressure control pressure range 85/50mbar connection 6mm ø 58mm pressure connection horizontal pressure connection ø 6mm		
<b>For models:</b>	ECO-1200, FI-1200, FI-900		



<b>GEV No.</b>	541299	<b>Ref. No.</b>	12023805 Z223005
<b>description</b>	pressure control pressure range 95/75mbar connection 6mm ø 58mm pressure connection horizontal warewashing pressure connection ø 6mm		
<b>For models:</b>	AD-48B, AD-48BDD, AD-48C, AD-48HY, AD-48W, AD-64B, AD-64BBT, AD-64BDD, AD-64C, AD-64CW, AD-64HY, AD-72W, EASY-500B, EASY-500HPWBDD, FI-30, FI-30AR, FI-30AR+DD, FI-30B, FI-30B-BT-UK, FI-30-UK, FI-48, FI-48AR, FI-48B, FI-48B-BT-UK, FI-48C, FI-48D, FI-48HY-CLINIC, FI-48W, FI-64, FI-64AR, FI-64B, FI-64B-BT-UK, FI-64C, FI-64D, FI-64HY-CLINIC, FI-64W, MF-48, MF-64		



ø 84mm with coded plug



<b>GEV No.</b>	541296	<b>Ref. No.</b>	12024981 Z433011
<b>description</b>	pressure control 2 pressure ranges pressure range 28/13 65/50mbar connection 6mm ø 84mm pressure connection horizontal warewashing pressure connection ø 5.5mm		
<b>For models:</b>	AD-20C-UK, AD-21B, AD-21BDD, AD-21C, AD-21W, CO-350, CO-350-B, CO-350-B-DD, CO-350-COLD, CO-350-COLD-B, CO-350-COLD-B-DD, CO-350-COLD-DD, CO-350-DD, CO-352-COLD, CO-352-COLD-B, CO-352-COLD-B-DD, CO-352-COLD-DD, CO-400, CO-400-B, CO-400-B-DD, CO-400-COLD, CO-400-COLD-B, CO-400-COLD-B-DD, CO-400-COLD-DD, CO-400-DD, CO-400-SOFT, CO-402-COLD, CO-402-COLD-B, CO-402-COLD-B-DD, CO-402-COLD-DD, CO-402W, LVC-21B, LVC-21C, LVC-21W, MF-21		



<b>GEV No.</b>	541592	<b>Ref. No.</b>	12024269 Z213059
<b>description</b>	pressure control 3 pressure ranges pressure range 40/15 120/60 150/95mbar connection 6mm ø 84mm pressure connection ø 6mm		
<b>For models:</b>	AD-120BTTDD-UK, AD-120HY, AD-45BBT, AD-48HY, AD-64BBT, AD-64BTDD, AD-64HY, AD-90BA, AD-90BBT, AD-90BDD, EASY-500HPWBDD, FI-100BBT-UK, FI-120HY-CLINIC, FI-30B-BT-UK, FI-48B-BT-UK, FI-48HY-CLINIC, FI-64B-BT-UK, FI-64HY-CLINIC, FI-80BBT-UK		



<b>GEV No.</b>	541297	<b>Ref. No.</b>	12020019 Z103074
<b>description</b>	pressure control pressure range 28/13mbar connection 6mm ø 84mm pressure connection horizontal warewashing suitable for FAGOR pressure connection ø 6mm		
<b>For models:</b>	ECO-160, ECO-1600, ECO-200, ECO-200H, ECO-2300, ECO-2700D, ECO-2700I, ECO-280D, ECO-280I, ECO-3000, ECO-370D, ECO-370I, ECO-4000D, ECO-4000I, ECO-460D, ECO-460I, ECO-550D, ECO-550I, ECO-6000D, ECO-6000I, FI-160, FI-1600, FI-160D, FI-160I, FI-200, FI-200D, FI-200H, FI-200HD, FI-200HI, FI-200I, FI-200W, FI-2300, FI-2700D, FI-2700I, FI-280D, FI-280I, FI-3000, FI-370D, FI-370I, FI-4000D, FI-4000I, FI-460D, FI-460I, FI-550D, FI-550I, FI-6000D, FI-6000I, LVC-12, LVC-15, LVC-15D...(Other models you can see in the webshop)		

miscellaneous



<b>GEV No.</b>	541603	<b>Ref. No.</b>	12040359 Z433003
<b>description</b>	pressure control pressure range 28/13 65/50mbar connection coded plug ø 75mm pressure connection horizontal warewashing pressure connection ø 5.5mm		
<b>For models:</b>	LVC-21B, LVR-20, LVR-20B		

accessories



<b>GEV No.</b>	541598	<b>Ref. No.</b>	12023163 Z602923
<b>description</b>	bracket stainless steel H 37mm L 60mm W 12mm for pressure switch		
<b>For models:</b>	AD-120, AD-120B, AD-120BTTDD-UK, AD-120C, AD-120CW, AD-120HY, AD-45BBT, AD-48HY, AD-48W, AD-64BBT, AD-64BTDD, AD-64CW, AD-64HY, AD-72W, AD-90, AD-90BA, AD-90BBT, AD-90BDD, AD-90DD, ADE-120, ADE-120B, CO-350, CO-350-B, CO-350-B-DD, CO-350-COLD, CO-350-COLD-B, CO-350-COLD-B-DD, CO-350-COLD-DD, CO-350-DD, CO-352-COLD, CO-352-COLD-B, CO-352-COLD-B-DD, CO-352-COLD-DD, CO-400, CO-400-B, CO-400-B-DD, CO-400-COLD, CO-400-COLD-B, CO-400-COLD-B-DD, CO-400-COLD-DD, CO-400-DD, CO-400-SOFT, CO-402-COLD, CO-402-COLD-B, CO-402-COLD-B-DD, CO-402-COLD-DD, CO-402W, EASY-500, EASY-500B, EASY-500DD...(Other models you can see in the webshop)		

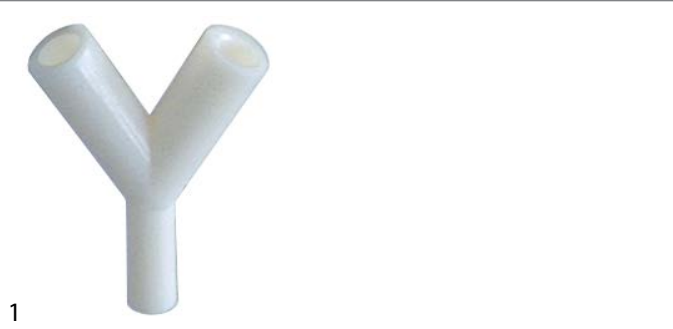



<b>GEV No.</b>	541109	<b>Ref. No.</b>	12023510 Z103077
<b>description</b>	Y-piece plastic hose ø 8-6-8mm for pressure switch		
<b>For models:</b>	AD-120B, AD-120BTTDD-UK, AD-120C, AD-120HY, AD-45BBT, AD-48B, AD-48BDD, AD-48C, AD-48HY, AD-48W, AD-64B, AD-64BBT, AD-64BDD, AD-64BTDD, AD-64C, AD-64CW, AD-64HY, AD-72W, AD-90BA, AD-90BBT, AD-90BDD, ADE-120B, CO-500, CO-500B, CO-500BDD, CO-500DD, CO-501, CO-501B, CO-501BDD, CO-501DD, CO-501-SOFT, CO-502B, CO-502BDD, CO-502DD, CO-502W, COP-503, COP-503B, COP-503BDD, COP-503DD, COP-503-SOFT, COP-504, COP-504B, COP-504BDD, COP-504DD, COP-504W, EASY-500B, EASY-500HPWBDD, ECO-120B, ECO-160, ECO-1600...(Other models you can see in the webshop)		



for gas equipment

			
1			
<b>GEV No.</b>	541108	<b>Ref. No.</b>	12029376 RT30171004
<b>description</b>	pressure control		

			
1			
<b>GEV No.</b>	541304	<b>Ref. No.</b>	12018227 R723004
<b>description</b>	pressure control pressure range 2.7/2.15mbar pressure connection horizontal gas technology connection 6mm		
<b>For models:</b>	HCG-10-11, HCG-10-21, HCG-20-11, HCG-2-10-11, HCG-6-11, HMG-10-11, HMG-10-21, HMG-20-11, HMG-2-10-11, HMG-6-11		

			
1			
<b>GEV No.</b>	541111	<b>Ref. No.</b>	12030211 RT30171010
<b>description</b>	pressure control pressure range adjustable 0.2- 3mbar pressure connection horizontal gas technology connection 6mm suitable for RATIONAL		

for steam control

			
1			
<b>GEV No.</b>	541769	<b>Ref. No.</b>	12024188 S093000
<b>description</b>	pressure control ø 45mm kettle pressure range up to 1.0bar connection 1/4" 250V 8A p max 1bar pressure connection 1/4"		
<b>For models:</b>	ME7-10BM, ME9-10BM, ME9-10BMS, ME9-10PLUS-BM, ME9-10PLUS-BMS, ME9-15BM, ME9-15BM316, ME9-15BM-AD, ME9-15BMS, ME9-15PLUS-BM, ME9-15PLUS-BMS, MG9-10BMAD, MG9-10BMSAD, MG9-10PLUS-BM, MG9-10PLUS-BMS, MG9-15BMAD, MG9-15BMSAD, MG9-15PLUS-BM, MG9-15PLUS-BMS, MPE9-10BM, MPE9-10BMS, MPE9-15BM, MPE9-15BMS		

for combi-steamers

			
1			
<b>GEV No.</b>	345709	<b>Ref. No.</b>	12027847 RT30171011
<b>description</b>	pressure control ø 84mm pressure range 0-3mbar for humidity measuring connection 6mm p max 0.025bar pressure connection 6mm		

			
1			
<b>GEV No.</b>	345218	<b>Ref. No.</b>	12026621 RT30171002
<b>description</b>	pressure control pressure range 0-3mbar connection 6mm pressure connection 6mm		

for refrigeration

<b>SAGI NO MIYA</b>			
			
1			
<b>GEV No.</b>	541479	<b>Ref. No.</b>	12030110 12031100 BR00023117 BR00023175
<b>description</b>	pressure control HD reset automatic refrigeration type HTB-X114 connection 2.4mm		

miscellaneous

			
1			
<b>GEV No.</b>	542434	<b>Ref. No.</b>	507476
<b>description</b>	pressure control switch-off pressure 16bar switch-on pressure 18bar reset automatic type NSDHF10A00101 refrigeration -30 up to +85°C pressure connection soldering connection 6.35mmmm connection male faston 6.3mm		







electrodes

 <p>1</p>			
<b>GEV No.</b>	694804	<b>Ref. No.</b>	12024460 R345069
<b>description</b>	duct for level electrode screw mounting total length 49mm plastic ø 8mm		
<b>For models:</b>	ACE-061, ACE-102, AE-061, AE-061W, AE-101, AE-101W, AE-102, AE-102W, AE-201, AE-202, AG-061, AG-061W, AG-101, AG-101W, AG-102, AG-102W, AG-201, AG-202, APE-061, APE-061W, APE-101, APE-101W, APE-102, APE-102W, APE-201, APE-202, APG-061, APG-061W, APG-101, APG-101W, APG-102, APG-102W, APG-201, APG-202, GA-20, GA-20D, GA-40, GA-40D, ME9-10PLUS-BM, ME9-10PLUS-BMS, ME9-15BM-AD, ME9-15PLUS-BM, ME9-15PLUS-BMS, MG9-10BMAD, MG9-10BMSAD, MG9-10PLUS-BM, MG9-10PLUS-BMS, MG9-15BMAD, MG9-15BMSAD, MG9-15PLUS-BM...(Other models you can see in the webshop)		

<b>accessories for</b>	400022		
	<b>GEV No.</b>	550574	<b>Ref. No.</b>
			—
	nut thread PG9 H 3mm WS 28 nickel-plated brass Qty 1 pcs mounting ømm cable ømm		

 <p>1</p>			
<b>GEV No.</b>	400884	<b>Ref. No.</b>	12023573 R345060
<b>description</b>	level electrode push-in total length 105mm probe L 95mm insulated probe lengthmm connection M4		
<b>For models:</b>	ACE-061, ACE-102, AE-061, AE-061W, AE-101, AE-101W, AE-102, AE-102W, AE-201, AE-202, AG-061, AG-061W, AG-101, AG-101W, AG-102, AG-102W, AG-201, AG-202, APE-061, APE-061W, APE-101, APE-101W, APE-102, APE-102W, APE-201, APE-202, APG-061, APG-061W, APG-101, APG-101W, APG-102, APG-102W, APG-201, APG-202, GA-20, GA-20D, GA-40, GA-40D, HCV-10-11, HCV-10-21, HCV-2-10-21, HCV-5-11, HCV-6-11, HEM-10-11, HEM-10-21, HEM-20-11, HEM-20-21, HEM-6-11, HEP-10-11, HEP-10-21...(Other models you can see in the webshop)		

 <p>2</p>			
<b>GEV No.</b>	400163	<b>Ref. No.</b>	12038015 RT30020409
<b>description</b>	level electrode PG9 total length 100mm probe L 72/43/22mm insulated probe length 70/62/52mm with 3 probes connection grip connection		



 <p>1</p>			
<b>GEV No.</b>	400885	<b>Ref. No.</b>	12023574 R345063
<b>description</b>	level electrode push-in total length 120mm probe L 110mm insulated probe lengthmm connection M4		
<b>For models:</b>	ACE-061, ACE-102, AE-061, AE-061W, AE-101, AE-101W, AE-102, AE-102W, AE-201, AE-202, AG-061, AG-061W, AG-101, AG-101W, AG-102, AG-102W, AG-201, AG-202, APE-061, APE-061W, APE-101, APE-101W, APE-102, APE-102W, APE-201, APE-202, APG-061, APG-061W, APG-101, APG-101W, APG-102, APG-102W, APG-201, APG-202, GA-20, GA-20D, GA-40, GA-40D, HCV-10-11, HCV-10-21, HCV-2-10-21, HCV-5-11, HCV-6-11, HEM-10-11, HEM-10-21, HEM-20-11, HEM-20-21, HEM-6-11, HEP-10-11, HEP-10-21...(Other models you can see in the webshop)		

 <p>1</p>			
<b>GEV No.</b>	403138	<b>Ref. No.</b>	12130422 RT8701220
<b>description</b>	level electrode PG9 total length 100mm probe L 85mm insulated probe length 70mm with connection cable connection coded plug		

 <p>1</p>			
<b>GEV No.</b>	400886	<b>Ref. No.</b>	12023575 R345064
<b>description</b>	level electrode push-in total length 130mm probe L 120mm insulated probe lengthmm connection M4		
<b>For models:</b>	ACE-061, ACE-102, AE-061, AE-061W, AE-101, AE-101W, AE-102, AE-102W, AE-201, AE-202, AG-061, AG-061W, AG-101, AG-101W, AG-102, AG-102W, AG-201, AG-202, APE-061, APE-061W, APE-101, APE-101W, APE-102, APE-102W, APE-201, APE-202, APG-061, APG-061W, APG-101, APG-101W, APG-102, APG-102W, APG-201, APG-202, GA-20, GA-20D, GA-40, GA-40D, HCV-10-11, HCV-10-21, HCV-2-10-21, HCV-5-11, HCV-6-11, HEM-10-11, HEM-10-21, HEM-20-11, HEM-20-21, HEM-6-11, HEP-10-11, HEP-10-21...(Other models you can see in the webshop)		

 <p>1</p>			
<b>GEV No.</b>	400021	<b>Ref. No.</b>	12032499 RT30020401
<b>description</b>	level electrode PG9 total length 110mm probe L 70/47/24mm insulated probe length 62/38/16mm with 3 probes connection grip connection		

 <p>1</p>			
<b>GEV No.</b>	403804	<b>Ref. No.</b>	12031074 RT4400287
<b>description</b>	level electrode with cable M15x1.5 probe L 12mm total length 325mm insulated probe length 114mm straight connection plug-in connection ø 1.5mm EPDM		

 <p>1</p>			
<b>GEV No.</b>	400022	<b>Ref. No.</b>	12031231 RT30020402
<b>description</b>	level electrode PG9 total length 135mm probe L 89/59/28mm insulated probe length 80mm with 3 probes connection grip connection		
<b>accessories for</b>	400022		
	<b>GEV No.</b>	379729	<b>Ref. No.</b>
			—
	connection cable L 1230mm 4-pole for level electrode plug type coded		

electric components

## flow meters and flow sensors

### flow sensors

			
1			
<b>GEV No.</b>	402256	<b>Ref. No.</b>	12028357 12028358 RT30171050 RT4400211
<b>description</b>	flow sensor inlet ø 10mm outlet ø 10mm L 110mm flow rate 1-25l/min		

## cooling aggregates

<b>GEV No.</b>	379304***	<b>Ref. No.</b>	123456
<b>description</b>			
<b>For models:</b>			

<b>GEV No.</b>	379304***	<b>Ref. No.</b>	123456
<b>description</b>			
<b>For models:</b>			

## compressors

### EMBRACO / ASPERA

R404a/R507

LBP monophase

Lower evaporation temperature below -20°C

			
1			
<b>GEV No.</b>	605174	<b>Ref. No.</b>	6021010006
<b>description</b>	compressor coolant R404a/R507 type NJ2192GK 220-240V 50Hz LBP 20.4kg 1 1/4HP cylinder capacity 26.2cm <sup>3</sup> CSR H 265mm 685W 989W 1342W 1745W 2196W 2196WWWWWW		

## SECOF DANFOSS

R134A

HMBP monophase

High/Medium evaporation temperature above -20/-15 °C

			
1			
<b>GEV No.</b>	605088	<b>Ref. No.</b>	12027501 12029101 12048631 2040900039 6001700003 6021010004
<b>description</b>	compressor coolant R134a type FR7.5G 220-240V 50Hz HMBP fully hermetic 10.6kg 1/5HP power input 175W cylinder capacity 6.93cm <sup>3</sup> RSIR/CSIR H 196mm 62W 99W 142W 193W 254W 325W 408W 505W 618W test method ASHRAEW		
<b>For models:</b>	AF-702-P, BFP-150, BFP-150A, BFP-150I, CFMP-150, CFMP-150F, CFMP-150PC, CFMP-150TV, CMFP-135, CMFP-135-B, CMFP-135-B2, CMFP-135-BP, CMFP-135F, CMFP-135-GR, CMFP-135HD, CMFP-135HH, CMFP-135PC, CMMZ-150, CMMZ-180-7, CMMZ-202, CMPP-150, CMPP-150-C, ERM-250, FMP-150, FMP-150-TV, FMP-202, FMP-255, FMP-307, MCP-135, MCP-135-AD, MCP-135-GN, MCP-180-AD, MEP-100, MEP-100G, MFP-135, MFP-135-2C, MFP-135-2C-GN, MFP-135-4C, MFP-135-4C-GN, MFP-135-AD, MFP-135-AD-2C, MFP-135-AD-4C, MFP-135-AD-PC, MFP-135-B, MFP-135-B2-GN, MFP-135-B-GN, MFP-135-BP-GN, MFP-135-F, MFP-135-F-GN, MFP-135-GN...(Other models you can see in the webshop)		
<b>spare parts for</b>	605088		
	<b>GEV No.</b>	381529	<b>Ref. No.</b> —
start relay DANFOSS 117U6001			



1

<b>GEV No.</b>	605091	<b>Ref. No.</b>	12027431 12028976 6001700004 6021010007
<b>description</b>	compressor coolant R134a type FR8.5G 220-240V 50Hz HMBP 10.6kg 1/4HP power input 261W cylinder capacity 7.95cm <sup>3</sup> RSIR/CSIR H 196mm 85W 123W 171W 228W 298W 381W 478W 592W 722WW		
<b>For models:</b>	AEP-701, AEP-702, AEP-801, AEP-802, AF-1402-MIX, AF-1602-MIX, AF-1603-C, AF-1603-P, AF-1604-C, AF-1604-P, AF-702-C, AF-702-P, AFP-1402-MIX, AFP-1602, AFP-1602-2, AFP-1603, AFP-1603-2, AFP-701, AFP-701-FORZ, AFP-702, AFP-702-C, AFP-702-FORZ, AFP-702-P, AFP-801, AFP-802, AFP-802-2C, AFP-802-3C, BFP-200, BFP-200A, BFP-200I, CAEP-701, CAEP-801, CAEP-802, CAF-1402MIXT, CAF-1602MIX, CAFP-1602-2, CAFP-1603-2, CAFP-701, CAFP-702, CAFP-801, CAFP-802, CAFP-802-2C, CAFP-802-3C, CFMP-202, CFMP-202F, CFMP-202PC, CFMP-202TV, CMFP-180, CMFP-180-B, CMFP-180-B2...(Other models you can see in the webshop)		
<b>spare parts for</b>	605076		
	<b>GEV No.</b>	380058	<b>Ref. No.</b> —
start relay DANFOSS 117U6019/F278 HST			



1

<b>GEV No.</b>	605076	<b>Ref. No.</b>	12027766 6001700009 6021010009
<b>description</b>	compressor coolant R134a type SC18G 220-240V 50Hz HMBP fully hermetic 13.7kg 1/2HP power input 495W cylinder capacity 17.7cm <sup>3</sup> CSIR H 219mmW 348W 485W 649W 844W 1074W 1343W 1655W 2014W test method ASHRAE		
<b>For models:</b>	AEP-2103, AF-2104-C, AF-2104-P, AF-2105-C, AF-2105-P, AF-2106-C, AF-2106-P, AFP-2103, AFP-2104, AFP-2104-C, AFP-2104-P, AFP-2105, AFP-2105-C, AFP-2105-P, AFP-2106, AFP-2106-C, AFP-2106-P		
<b>spare parts for</b>	605076		
	<b>GEV No.</b>	380058	<b>Ref. No.</b> —
start relay DANFOSS 117U6019/F278 HST			



1

<b>GEV No.</b>	605087	<b>Ref. No.</b>	12026937 12028366 6001700007 6021010008
<b>description</b>	compressor coolant R134a type SC12G 220-240V 50Hz HMBP fully hermetic 12.6kg 1/3HP power input 470W cylinder capacity 12.9cm <sup>3</sup> RSIR/CSIR H 203mm 140W 216W 312W 430W 574W 746W 951W 1191W 1469W test method ASHRAE 79.6W 1790W		
<b>For models:</b>	AEP-1402, AEP-1403, AEP-1404, AEP-1602, AEP-1603, AEP-1604, AF-1403-C, AF-1403-P, AF-1404-C, AF-1404-P, AFP-1402, AFP-1402-FORZ, AFP-1403, AFP-1403-C, AFP-1403-FORZ, AFP-1403-P, AFP-1404, AFP-1404-C, AFP-1404-FORZ, AFP-1404-P, AFP-1404-USMC, AFP-1602, AFP-1602-2, AFP-1603, AFP-1603-2, AFP-1604, AP-701, APP-701, BFP-250, BFP-300, FMP-250, FMP-300, MCP-270-GN, MEP-180, MFP-225-B, MFP-270-B, MFP-270-GN, MPP-255, MPP-255-C, MPP-307, MPP-307-C, MPZ1-200, MSP-200-F, MSP-250, MSP-250-F, MSP-300, VC-14-I, VC-14-M, VC-20-I, VC-20-M...(Other models you can see in the webshop)		
<b>spare parts for</b>	605087		
	<b>GEV No.</b>	380483	<b>Ref. No.</b> 12019417 12034971 12035095 12058828 6004000003 6009990224 6021010019
start relay DANFOSS 117U6003 HST			

**R404a/R507**

LBP monophase

Lower evaporation temperature below -20°C





1

<b>GEV No.</b>	605058	<b>Ref. No.</b>	12027322 6021010002
<b>description</b>	compressor coolant R404a/R507 type SC15CL 220-240V 50Hz LBP fully hermetic 13.8kg 1/2HP cylinder capacity 15.28cm <sup>3</sup> CSIR H 219mm 486W 637W 813W 1017W 1251W 1699W test method ASHRAE 175W 358W		
<b>For models:</b>	ADMEN-180, ADMFN-180, AF-1402-MIX, AF-1602-MIX, AFN-701, AFN-702, AFN-801, AFN-802, ANF-801AD, ANF-802AD, CAF-1402MIXT, CAF-1602MIX, CAFN-701, CAFN-702, CAFN-801, CAFN-802, CMFN-180, CMFN-225, CMFN-270, CMPN-202, CMPN-255, CMSN-200, CMSN-250, CMSN-300, CPAFN-801, MCN-180, MFN-180, MPN-202, MPN-202-C, MSN-200, MSN-250, MSN-300		

accessories

			
1			
<b>GEV No.</b>	380483	<b>Ref. No.</b>	12019417 12034971 12035095 12058828 6004000003 6009990224 6021010019
<b>description</b>	start relay DANFOSS 117U6003 HST		
<b>For models:</b>	AEP-1402, AEP-1403, AEP-1404, AEP-1602, AEP-1603, AEP-1604, AF-1403-C, AF-1404-C, AF-702-C, AFP-1402, AFP-1403, AFP-1403-C, AFP-1403-P, AFP-1404, AFP-1404-C, AFP-1404-P, AFP-1404-USMC, AFP-1602, AFP-1602-2, AFP-1603, AFP-1603-2, AFP-1604, AP-701, APP-701, BFP-250, BFP-300, FMP-250, FMP-300, MCP-270-GN, MEP-180, MFP-270-GN, MPP-255, MPP-255-C, MPP-307, MPP-307-C, MPZ1-200, MSP-200-F, MSP-250, MSP-250-F, MSP-300, VC-14-I, VC-14-M, VC-20-I, VC-20-M, VM-100-I, VM-100-M, VM-135-I, VM-135-M		

			
1			
<b>GEV No.</b>	380534	<b>Ref. No.</b>	12040409 6004000006
<b>description</b>	start relay DANFOSS 117U6015/F082 HST		
<b>For models:</b>	AFP-2103, AFP-2104, AFP-2104-C, AFP-2104-P, AFP-2105, AFP-2105-C, AFP-2105-P, AFP-2106, AFP-2106-C, AFP-2106-P		

			
1			
<b>GEV No.</b>	380572	<b>Ref. No.</b>	12034743 6002000031
<b>description</b>	start relay DANFOSS 117U6015/F331 HST		
<b>For models:</b>	AEP-701, AEP-702, AEP-801, AEP-802, AFP-1402-MIX, AFP-1602-2, AFP-701, AFP-701-FORZ, AFP-702, AFP-702-C, AFP-702-FORZ, AFP-702-P, AFP-801, AFP-802, BFP-200, FMP-200, MCP-180-GN, MCP-225-GN, MEP-135, MFP-147-GN-R, MFP-180-GN, MFP-192-GN-R, MFP-225-GN, MPP-202, MPP-202-C, MSP-200, MSP-200-F, VM-100-I, VM-100-M		

			
1			
<b>GEV No.</b>	380484	<b>Ref. No.</b>	12034947 12058829 6021010025
<b>description</b>	start relay DANFOSS 117U6015/F394 HST		
<b>For models:</b>	AEP-701, AEP-801, AEP-802, AF-1402-MIX, AF-1602-MIX, AF-1603-C, AF-1603-P, AF-1604-C, AF-1604-P, AF-702-C, AF-702-P, AFN-701, AFP-1602, AFP-1602-2, AFP-1603, AFP-1603-2, AFP-701, AFP-702, AFP-801, AFP-802, AFP-802-2C, AFP-802-3C, BFP-150, BFP-200, BFP-200A, BFP-200I, CAEP-701, CAEP-801, CAEP-802, CAF-1402MIXT, CAF-1602MIX, CAFP-1602-2, CAFP-1603-2, CAFP-701, CAFP-702, CAFP-801, CAFP-802, CAFP-802-2C, CAFP-802-3C, CFMP-202, CFMP-202F, CFMP-202PC, CFMP-202TV, CMFP-135-GR, CMFP-180, CMFP-180-B, CMFP-180-B2, CMFP-180-BP, CMFP-180F, CMFP-180-GR...(Other models you can see in the webshop)		

			
1			
<b>GEV No.</b>	380573	<b>Ref. No.</b>	6004000004
<b>description</b>	start relay DANFOSS 117U6019/F152 HST		
<b>For models:</b>	AFN-701, AFN-702, AFN-801, AFN-802, AFP-1402-MIX, MCN-135-GN, MCN-180-GN, MFN-135-GN, MFN-180-GN, MPN-150, MPN-150-C, MSN-150, MSN-200		

miscellaneous

accessories

			
1			
<b>GEV No.</b>	381135	<b>Ref. No.</b>	12031673 6021010050
<b>description</b>	start relay GENERAL ELECTRIC 3ARR3B3AV3 220V connection screw clamp		
<b>For models:</b>	AFN-1402, AFN-1403, AFN-1404, AFN-1602, AFN-1603, AFN-1604, ATM-051, ATM-101, MCN-270, MFN-270, MPN-255, MPN-255-C, MPN-307, MPN-307-C		



fans

axial fans

ebm-papst



<b>GEV No.</b>	601309 <sup>1</sup>	<b>Ref. No.</b>	12027993 RT4000474
<b>description</b>	axial fan L 127mm W 127mm H 38mm 12VDC 21W bearing ball bearing manuf. no. DV5212N metal connection cable ebm-papst suitable for RATIONAL fan wheel ø 120mm temp.-resist. 65°C		

<sup>1</sup>with ball bearings

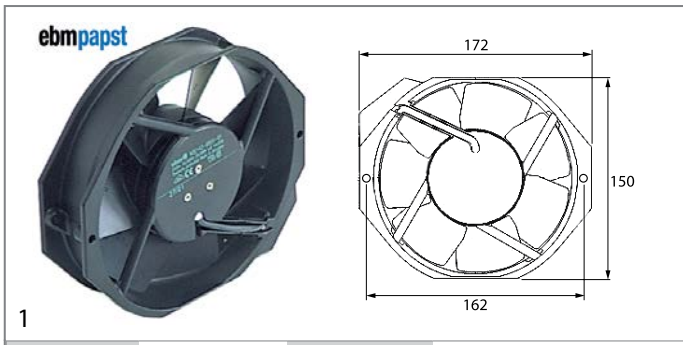

<b>GEV No.</b>	601113 <sup>1</sup>	<b>Ref. No.</b>	12026852 RT31011013
<b>description</b>	axial fan L 172mm W 150mm H 38mm 230VAC 50/60Hz 27/28W bearing ball bearing connection male faston 2.8mm manuf. no. 7056ES metal ebm-papst fan wheel ø 145mm temp.-resist. 55°C		

<sup>1</sup>with ball bearings

import





<b>GEV No.</b>	601510 <sup>1</sup>	<b>Ref. No.</b>	12032884 12033472 6001506003 6021050008
<b>description</b>	axial fan L 119mm W 119mm H 38mm 230VAC 50/60Hz 22/21W bearing ball bearing connection male faston 6.3mm SUNON temp.-resist. 70°C		
<b>For models:</b>	AEP-1402, AEP-701, AFP-1402, AFP-1402-FORZ, AFP-1403, AFP-1403-C, AFP-1403-FORZ, AFP-1403-P, AFP-1404, AFP-1404-C, AFP-1404-P, AFP-2103, AFP-2104, AFP-2104-C, AFP-2104-P, AFP-2105, AFP-2105-C, AFP-2105-P, AFP-2106, AFP-2106-C, AFP-2106-P, AFP-701, AFP-701-FORZ, AFP-702, AFP-702-C, AFP-702-FORZ, AFP-702-P, APP-701, CMPZ1-135, CMPZ1-180, ECE-80, ERM-150, ERM-250, ERM-350, ERMS-250, MEP-100, MEP-100G, MEP-135, MEP-135-GN, MEP-180, MEP-180-GN, MI-202, MPZ1-135, MPZ1-150, MPZ1-180, MPZ1-200, MPZ1-225, MPZ1-250, MPZ1-250, VTP-139-C...(Other models you can see in the webshop)		

<sup>1</sup>with ball bearings



<b>GEV No.</b>	601080 <sup>1</sup>	<b>Ref. No.</b>	12023862 12031028 12031777 12032776 6021050006 RT31011008 ST25000040 Z103066
<b>description</b>	axial fan L 119mm W 119mm H 38mm 230VAC 50/60Hz 23/20W bearing ball bearing connection male faston 2.8mm metal ADDA fan wheel ø 110mm temp.-resist. 70°C		
<b>For models:</b>	ACE-061, ACE-101, ACE-102, ACG-061, ACG-101, ACG-102, AD-120, AD-120B, AD-120BTTDD-UK, AD-120C, AD-120CW, AD-120HY, AD-90, AD-90BA, AD-90BBT, AD-90BDD, AD-90DD, AE-061, AE-101, AE-102, AG-061, AG-101, AG-102, APE-061, APE-101, APE-102, APG-061, APG-101, APG-102, CI9-20, CI9-40, COE-061, COE-101, COE-102, COE-201, COG-061, COG-101, COG-102, COG-201, ECO-120, ECO-120B, ECO-160, ECO-1600, ECO-160D, ECO-160I, ECO-200, ECO-200D, ECO-200H, ECO-200HD, ECO-200HI...(Other models you can see in the webshop)		

<b>accessories for</b>	601080			
	<b>GEV No.</b>	550898	<b>Ref. No.</b>	—
	connecting cable cable length 2000mm connection F 2.8 connection distance 7.9mm for axial flow fan			
	<b>GEV No.</b>	692519	<b>Ref. No.</b>	12025177 Z713015
	guard L 120mm W 120mm plastic			

<sup>1</sup>with ball bearings

1 electric components



<b>GEV No.</b>	601670 <sup>1</sup>	<b>Ref. No.</b>	12031029 RT31011018
<b>description</b>	axial fan L 80mm W 80mm H 25mm 12VDC 1.8W bearing ball bearing connection cable 300mm fan wheel ø 75mm		

<sup>1</sup>with ball bearings

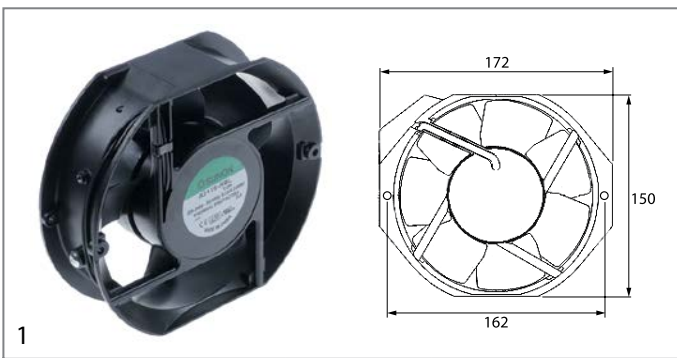

<b>GEV No.</b>	601654 <sup>1</sup>	<b>Ref. No.</b>	12024106 T453005
<b>description</b>	axial fan L 172mm W 150mm H 38mm 230VAC 50/60Hz 28/24W bearing ball bearing manif. no. A2175-HBL T.GN connection cable length 280mm metal SUNON fan wheel ø 142mm temp.-resist. -10 up to +80°C mounting distance 162mm		
<b>For models:</b>	ACE-201, ACE-202, ACG-201, ACG-202, AE-201, AE-202, AG-201, AG-202, APE-201, APE-202, APG-201, APG-202, COE-201, COE-202, COG-201, COG-202, HEI-20-21, HEM-20-21, HEP-20-21, HGC-20-21, HGP-20-21, HGV-20-21, VE-201, VE-202, VG-102, VG-201, VG-202, VPE-201, VPE-202, VPG-102, VPG-201, VPG-202		

<sup>1</sup>with ball bearings

accessories

fan guards



<b>GEV No.</b>	692519	<b>Ref. No.</b>	12025177 Z713015
<b>description</b>	guard L 120mm W 120mm plastic		
<b>For models:</b>	AD-120, AD-120B, AD-120BBTDD-UK, AD-120C, AD-120CW, AD-120HY, AD-90, AD-90BA, AD-90BBT, AD-90BDD, AD-90DD, ADE-120, ADE-120B, ECO-120, ECO-120B, FI-100, FI-100AR, FI-100B, FI-100BBT-UK, FI-120, FI-120AR+DD, FI-120B, FI-120C, FI-120HY-CLINIC, FI-120W, FI-80, FI-80AR, FI-80BBT-UK, FI-80W, FI-E-100, LABP-1000, LABP-1200		

<b>accessories for</b>	692519			
	<b>GEV No.</b>	601080	<b>Ref. No.</b>	12023862 12031028 12031777 12032776 6021050006 RT31011008 ST25000040 Z103066
<b>description</b>	axial fan L 119mm W 119mm H 38mm 230VAC 50/60Hz 23/20W bearing ball bearing connection male faston 2.8mm metal ADDA fan wheel ø 110mm temp.-resist. 70°C			



<b>GEV No.</b>	602141	<b>Ref. No.</b>	12030835 RT84551393
<b>description</b>	guard with filter for axial flow fan L 126mm W 126mm H 13.5mm mounting distance 115mm suitable for ebm-papst		

refrigeration fans

refrigeration motors universal

ELCO

N series - standard



<b>GEV No.</b>	601359	<b>Ref. No.</b>	12031842 6021050055
<b>description</b>	fan motor 18W 230V 50/60Hz bearing slide bearing W 83mm connection 3-wire cable length 1000mm 1300/1550rpm 3 mounting options VNT18-30/150		
<b>spare parts for</b>	601359		
	<b>GEV No.</b>	601413	<b>Ref. No.</b> —
	fixing plate suitable for fanwheel ED ø 32mm shaft ø 7 mounting distance 26mm		

accessories

fan wheels

plastic

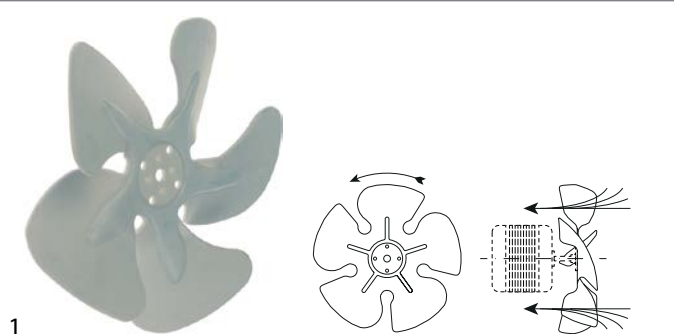

<b>GEV No.</b>	601412	<b>Ref. No.</b>	12037081 BR00010213
<b>description</b>	fan wheel sucking ø 154mm fan wheel mounting 25.4mm blade angle 28° W 34mm plastic		

cooling motors (complete)



<b>GEV No.</b>	601394	<b>Ref. No.</b>	6021050004
<b>description</b>	fan 230V 5W 50/60Hz fan wheel ø 200mm shaft L 12mm feet depth 71mm L 60mm W 83mm H 83mm blade angle 28° connection cable 500mm		
<b>For models:</b>	AF-1403-P, AF-1404-P, AF-1603-P, AF-1604-P, AF-2104-P, AF-2105-P, AF-2106-P, AF-702-C, AF-702-P, AF-802-C, AFP-802, AFP-802-2, EC-150, ECC-150, ERM-250, ERM-350, ERMS-250, VM-100-I, VM-100-M, VM-135-I, VM-135-M, VTP-139-RC, VTP-139-RCD, VTP-139-RP, VTP-139-RPD, VTP-175-RC, VTP-175-RCD, VTP-175-RP, VTP-175-RPD		



<b>GEV No.</b>	601693	<b>Ref. No.</b>	12033477 6001506002 6021050002
<b>description</b>	fan motor 230V 10W 50/60Hz fan wheel ø 254mm feet depth 85mm W 84mm 1300rpm		
<b>For models:</b>	AEP-1402, AEP-1403, AEP-1404, AEP-1602, AEP-1603, AEP-1604, AEP-2103, AEP-701, AEP-702, AEP-801, AEP-802, AF-1402-MIX, AF-1403-C, AF-1403-P, AF-1404-C, AF-1404-P, AF-1602-MIX, AF-1603-C, AF-1603-P, AF-1604-C, AF-1604-P, AF-2104-C, AF-2104-P, AF-2105-C, AF-2105-P, AF-2106-C, AF-2106-P, AF-702-C, AF-702-P, AF-802-C, AF-802-P, AFN-1402, AFN-1403, AFN-1404, AFN-1602, AFN-1603, AFN-1604, AFN-701, AFN-702, AFN-801, AFN-802, AFP-1402, AFP-1402-FORZ, AFP-1402-MIX, AFP-1403, AFP-1403-C, AFP-1403-FORZ, AFP-1403-P, AFP-1404, AFP-1404-C...(Other models you can see in the webshop)		

			
1			
<b>GEV No.</b>	601511	<b>Ref. No.</b>	12018609 12038161 6004000012 6021050010
<b>description</b>	fan 230V 10W 50Hz fan wheel ø 195mm blade angle 22° connection cable 500mm		
<b>For models:</b>	ADAFN-1602, ADMCN-180, ADMCN-225, ADMCP-225, ADMFN-180, ADMFN-225, ADMFP-225, ADMFP-225-GR, ADMFP-225HDDD, ADMFP-225HHDD, ADMFP-225HHHD, ADMFP-225HHHH, ADMFP-225PC, AEP-2103, AF-2104-C, AF-2104-P, AF-2105-C, AF-2105-P, AF-2106-C, AF-2106-P, AFN-1402, AFN-1403, AFN-1404, AFN-1602, AFN-1603, AFN-1604, AFN-801, AFN-802, AFP-2103, AFP-2104, AFP-2105, AFP-2106, ATA-061, ATA-061-60Hz, ATM-051VCH, ATM-051VCH-60Hz, ATM-081VCH, ATM-081VCH-60Hz, ATM-101VCH, ATM-101VCH-60Hz, CPAFN-1602, MCN-192-GN-R, MCN-225-GN, MCN-237-GN-R, MCN-270-GN, MFN-192-GN-R, MFN-225-GN, MFN-237-GN-R, MFN-270-GN, MSN-222-R...(Other models you can see in the webshop)		

			
1			
<b>GEV No.</b>	601512	<b>Ref. No.</b>	6004000011
<b>description</b>	fan 230V 5W 50Hz fan wheel ø 200mm blade angle 28° connection cable 1500mm		
<b>For models:</b>	AFN-1402, AFN-1403, AFN-1404, AFN-701, AFN-702, AFP-1402-MIX, AP-701, APP-701, MCN-102-GN-R, MCN-135-GN, MCN-147-GN-R, MCN-180-GN, MFN-102-GN-R, MFN-135-GN, MFN-147-GN-R, MFN-180-GN, MSN-117-R, MSN-150, MSN-169-R, MSN-200		

cold air circulating fans (complete)

			
1			
<b>GEV No.</b>	601811	<b>Ref. No.</b>	12026785 6021050019
<b>description</b>	fan type R09R-3030HP-4M-2543 fan wheel ø 300mm 230V 50/60Hz 65/90W suitable capacitor 2.5µF HIDRIA suitable for blast chiller suitable for FRIULINOX 1400/1500rpm blowing H 138mm cable lengthmm mounting distance 265mm		
<b>For models:</b>	ATA-061, ATA-061-60Hz, ATA-101, ATA-101-60Hz, ATM-051, ATM-081VCH, ATM-081VCH-60Hz, ATM-101, ATM-101VCH, ATM-101VCH-60Hz, ATM-121VCH, ATM-121VCH-60Hz, ATM-121VCHP, ATM-161VCH, CM-201, CS-201		

			
2			
<b>GEV No.</b>	601552	<b>Ref. No.</b>	12032883 12033165 6001506001 6021050001
<b>description</b>	fan 230V 5W 50/60Hz fan wheel ø 165mm shaft L 15mm blade angle 34° connection cable		
<b>For models:</b>	AEP-1402, AEP-1403, AEP-1404, AEP-1602, AEP-1603, AEP-1604, AEP-701, AEP-702, AEP-801, AEP-802, AF-1402-MIX, AF-1403-C, AF-1403-P, AF-1404-C, AF-1404-P, AF-1602-MIX, AF-1603-C, AF-1603-P, AF-1604-C, AF-1604-P, AF-702-C, AF-702-P, AF-802-C, AF-802-P, AFP-1402, AFP-1403, AFP-1404, AFP-1404-USMC, AFP-1602, AFP-1602-2, AFP-1603, AFP-1603-2, AFP-1604, AFP-701, AFP-702, AFP-801, AFP-802, AFP-802-2, FMP-117-R, FMP-150, FMP-169-R, FMP-200, FMP-202, FMP-222-R, FMP-250, FMP-255, FMP-274-R, FMP-300, FMP-307, MCN-102-R...(Other models you can see in the webshop)		

cross flow fans

			
1			
<b>GEV No.</b>	602084	<b>Ref. No.</b>	12031541 6021050046
<b>description</b>	cross flow fan ebm-papst RL76/8600Z roller ø 58mm roller length 84mm laminated core thickness 1mm motor position right connection F6.3 W 190mm H 135mm D 135		





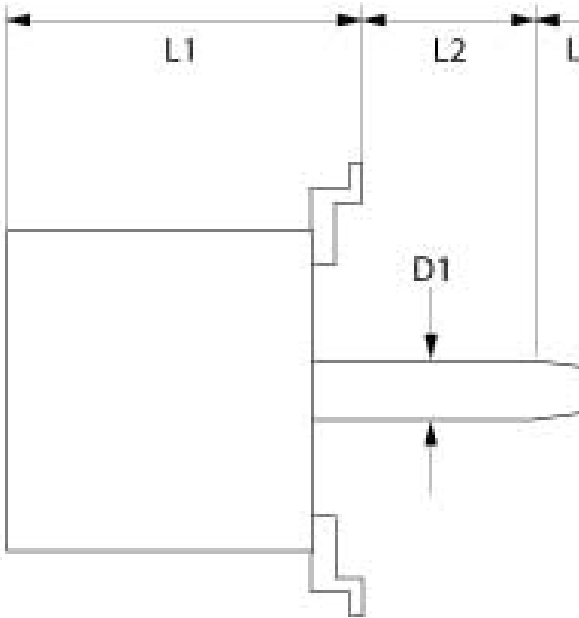

hot air motors

			
1			
<b>GEV No.</b>	697780	<b>Ref. No.</b>	12032334 RT2200083
<b>description</b>	engine shaft gasket plastic for fan ID ø 15mm ED ø 29.5mm thickness 4.5mm		

 <p>Image not available</p>			
			
1			
<b>GEV No.</b>	601321	<b>Ref. No.</b>	12025899 RT31001064
<b>description</b>	fan motor		

			
1			
<b>GEV No.</b>	601301	<b>Ref. No.</b>	12025570 RT4000274P
<b>description</b>	fan motor 100-240V 1 phase 50/60Hz 0.45kW 2000rpm speeds 1 L1 160mm L2mm L3mm L4mm M8R IT fan wheel ø 130mm type M3G084-FA22-16		
<b>accessories for</b>	601301		
	<b>GEV No.</b>	511685	<b>Ref. No.</b> —
	shaft seal kit ID ø 15mm ED ø 27mm shaft seal flange mounting gauge with mountign material		

<b>accessories for</b>	601301		
	<b>GEV No.</b>	601327	<b>Ref. No.</b> 12027162 22.00.192S RT2200192
	fan wheel D1 ø 340mm H1 135mm blades 9 D2 ø 13mm D3 ø 16mm H2 38mm		

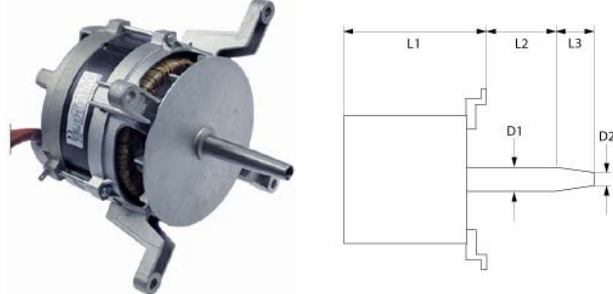
			
1			
<b>GEV No.</b>	601629	<b>Ref. No.</b>	12018605 T493004
<b>description</b>	fan motor 208/240V 3 phase 50/60Hz 0.66/0.18kW 1400/700rpm speeds 2 L1 150mm L2 40mm L3 35mm D1 ø 17mm D2 ø 13.5mm 2.2/0.85A at 50Hz 208/240V at 60Hz 208/240V at 50Hz 1400/700rpm at 60Hz 1700/850rpm type 3036E2470		
<b>For models:</b>	HEI-20-21, HEM-10-11, HEM-20-11, HEM-20-21, HEM-6-11, HEP-10-11, HEP-20-11, HEP-6-11, HGC-20-21, HGV-20-21		

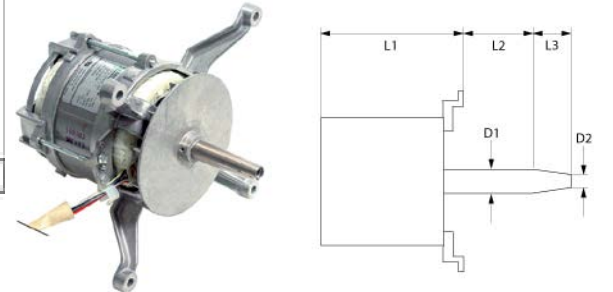
			
1			
<b>GEV No.</b>	500506	<b>Ref. No.</b>	12016554 R663034
<b>description</b>	fan motor 220-230V 3 phase 50Hz 0.02/0.16kW 710/1390rpm speeds 2 L1 152mm L2 31mm L3 35mm M10R IT 0.35/0.9A power input 60/250W at 50Hz 220-230V at 60Hz 220-230V at 50Hz 710/1390rpm at 60Hz 840/1660rpm Y/YY type L7mw84D-380 no. T7 D1 ø 17mm D2 ø 13mm		
<b>For models:</b>	HME-10-11, HME-10-21, HME-20-11, HME-20-21, HME-2-10-11, HME-2-20-11, HME-6-11, HMP-10-11, HMP-10-21, HMP-20-11, HMP-20-21, HMP-2-10-11, HMP-2-20-11, HMP-6-11		

→ electric components

**1**

<b>GEV No.</b>	500505	<b>Ref. No.</b>	12016565 R253049
<b>description</b>	fan motor 220-240/380-415V 3 phase 50/60Hz 0.16-0.26kW 1440/1700rpm speeds 2 L1 140mm L2 27mm L3 35mm M10R IT 1.2/0.7A Cos(fi) 0.63 type L7zAw4D-014 D1 ø 17mm D2 ø 13mm		
<b>For models:</b>	HCG-10-11, HCG-10-21, HCG-20-11, HCG-20-21, HCG-2-10-11, HCG-2-20-11, HCG-6-11, HCV-10-11, HCV-10-21, HCV-2-10-21, HCV-5-11, HCV-6-11, HE-10-11, HE-10-21, HE-2-10-11, HE-5-11, HE-6-11, HG-10-11, HG-10-21, HG-2-10-11, HME-20-11, HMG-10-11, HMG-10-11UL, HMG-10-21, HMG-10-21UL, HMG-20-11, HMG-2-10-11, HMG-6-11, HMI-10-11, HMI-10-11UL, HMI-10-21, HMI-10-21UL, HMI-2-10-11, HMI-6-11, HMI-6-11UL, HMM-10-11, HMM-10-11UL, HMM-10-21, HMM-10-21UL, HMM-20-11, HMM-20-11UL, HMM-20-21, HMM-20-21UL, HMM-2-10-11, HMM-2-20-11, HMM-40-11-USMC, HMM-6-11, HMM-6-11UL, HMP-20-11, HVG-10-11...(Other models you can see in the webshop)		
<b>accessories for</b>	500505		
	<b>GEV No.</b>	601503	<b>Ref. No.</b> 12016581 R253042
	fan wheel D1 ø 350mm H1 125mm blades 12 D2 ø 13mm D3 ø 16mm		

**1**

<b>GEV No.</b>	601551	<b>Ref. No.</b>	12018468 R703049
<b>description</b>	fan motor 230-415V 3 phase 50/60Hz 0.65kW 1400/1650rpm speeds 1 L1 147mm L2 41mm L3 36mm M10R IT at 50Hz 1400rpm at 60Hz 1650rpm D1 ø 17mm D2 ø 13.5mm		
<b>For models:</b>	HEI-10-11, HEI-20-11, HEI-6-11, HGC-10-11, HGC-20-11, HGC-6-11, HGV-10-11, HGV-20-11		

**1**

<b>GEV No.</b>	601300	<b>Ref. No.</b>	RT31001080
<b>description</b>	fan motor 240V 3 phase 60Hz 0.68kW 1730rpm speeds 1 L1 145mm L2 24mm L3 34mm M10R IT 2.9A number of pole pairs 2 power input 870W at 60Hz 1730rpm Y type L9DFw4D-518 no. X6 D1 ø 17mm D2 ø 13mm		

**1**

<b>GEV No.</b>	601318	<b>Ref. No.</b>	12025810 RT31001044
<b>description</b>	fan motor 230-240V 1 phase 50Hz 0.450/0.615kW 1440rpm speeds 1 L1 150mm L2 34mm L3 35mm M10x1.5 3.1A type L9Fw4D-397 no. CO D1 ø 17mm D2 ø 13mm		

**1**

<b>GEV No.</b>	601308	<b>Ref. No.</b>	12025795 12025796 RT31001081 RT31001084
<b>description</b>	fan motor 240V 3 phase 60Hz 0.68kW 1730rpm speeds 1 L1 155mm L2 47mm L3 35mm M10R IT 2.9A power input 870W at 60Hz 1730rpm type L9DFw4D-519 no. W8 D1 ø 17mm D2 ø 13mm		
<b>accessories for</b>	601308		
	<b>GEV No.</b>	510573	<b>Ref. No.</b> 12033667 RT50010207
	shaft seal ID ø 17mm ED ø 29mm thickness 4.5mm		

**1**

<b>GEV No.</b>	601815	<b>Ref. No.</b>	12026105 RT31001061
<b>description</b>	fan motor 230-240V 1 phase 50Hz 0.450/0.615kW 1440rpm speeds 1 L1 150mm L2 34mm L3 35mm ø 125mm M10x1.5 3.1A type L9Fw4D-397 no. CO D1 ø 17mm D2 ø 13mm kit		

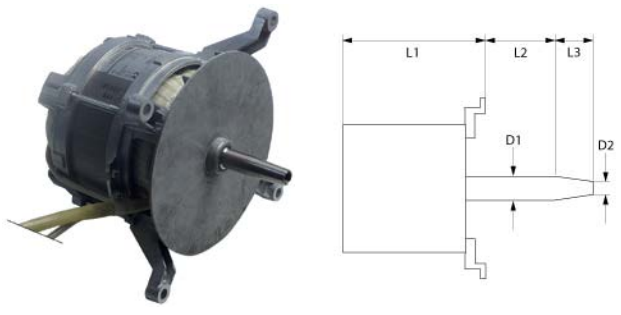

1

<b>GEV No.</b>	601704	<b>Ref. No.</b>	12025608 12026125 RT31001041 RT31001062
<b>description</b>	fan motor 240V 3 phase 60Hz 0.7kW 1720rpm speeds 1 L1 152mm L2 31mm L3 35mm M10L 3A D1 ø 17mm D2 ø 13.5mm		



1

<b>GEV No.</b>	602129	<b>Ref. No.</b>	12026111 RT31001049
<b>description</b>	fan motor 380-415V 3 phase 50Hz 0.08/0.45kW 700/1400rpm speeds 2 L1 147mm L2 35mm L3 35mm ø 125mm M10R IT 0.4/1.15A at 50Hz 700/1400rpm Y/YY type L9xw84D-393 no. V2 D1 ø 17mm D2 ø 13mm		
<b>spare parts for</b>	602129		
	<b>GEV No.</b>	551350	<b>Ref. No.</b> —
	gasket set for motor CPC, CM, CD		



1

<b>GEV No.</b>	602143	<b>Ref. No.</b>	12024325 T323040000
<b>description</b>	fan motor 3 phase 50Hz 0.75kW 1400rpm L1 150mm L2 45mm L3 37mm D1 ø 17mm D2 ø 14mm 3.2A type 3036AB2350		
<b>For models:</b>	ACE-061, ACE-101, ACE-102, ACE-201, ACE-202, ACG-061, ACG-101, ACG-102, ACG-201, ACG-202, AE-061, AE-061W, AE-101, AE-101W, AE-102, AE-102W, AE-201, AE-202, AG-061, AG-061W, AG-101, AG-101W, AG-102, AG-102W, AG-201, AG-202, APE-061, APE-061W, APE-101, APE-101W, APE-102, APE-102W, APE-201, APE-202, APG-061, APG-061W, APG-101, APG-101W, APG-102, APG-102W, APG-201, APG-202, COE-101, COE-201, COG-101, COG-201, VE-101, VE-201, VG-101, VG-201...(Other models you can see in the webshop)		

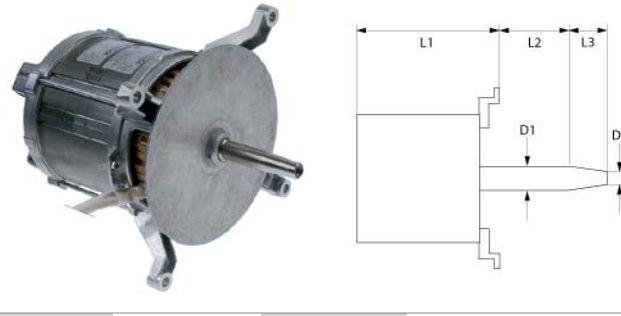

1

<b>GEV No.</b>	601504	<b>Ref. No.</b>	12018488 T323022
<b>description</b>	fan motor 380-415V 3 phase 50Hz 0.12/0.9kW 700/1380rpm speeds 2 L1 202mm L2 48mm L3 35mm M10R IT 0.9/2.1A power input 240/1200W at 50Hz 380-415V at 60Hz 380-480V at 50Hz 700/1380rpm at 60Hz 820/1690rpm Y/YY type L9zw84D-565 no. W4 D1 ø 17mm D2 ø 13.5mm		
<b>For models:</b>	HEI-10-21, HEM-10-21, HEP-10-21, HGC-10-21, HGP-10-21, HGV-10-21		

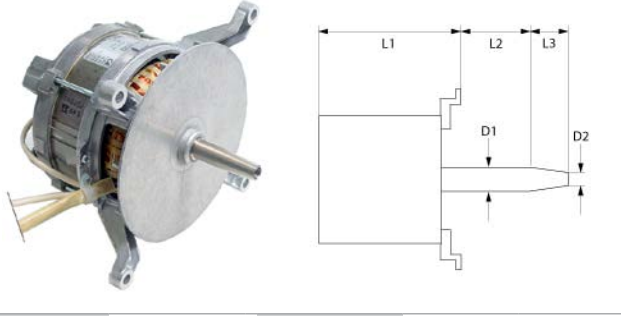

1

<b>GEV No.</b>	500162	<b>Ref. No.</b>	12025820 RT31001020
<b>description</b>	fan motor 380-415V 3 phase 50Hz 0.08/0.45kW 700/1400rpm speeds 2 L1 147mm L2 35mm L3 35mm ø 125mm M10R IT 0.4/1.15A at 50Hz 700/1400rpm Y/YY type L9xw84D-393 no. V2 D1 ø 17mm D2 ø 13mm		
<b>spare parts for</b>	500162		
	<b>GEV No.</b>	601730	<b>Ref. No.</b> —
	fan wheel for motor cooling ED ø 180mm H 20mm ID ø 20mm		

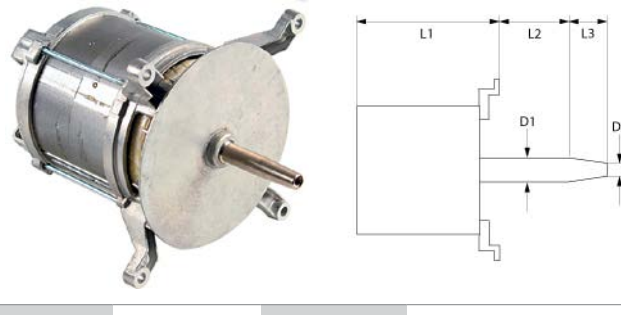

1

<b>GEV No.</b>	601299	<b>Ref. No.</b>	12025895 RT31001068
<b>description</b>	fan motor 380-415V 3 phase 50Hz 0.12/0.9kW 700/1380rpm speeds 2 L1 205mm L2 40mm L3 35mm M10R IT 0.9/2.1A power input 240/1200W at 50Hz 700/1380rpm type L9zw84D-394 no. X4 D1 ø 17mm D2 ø 13mm		

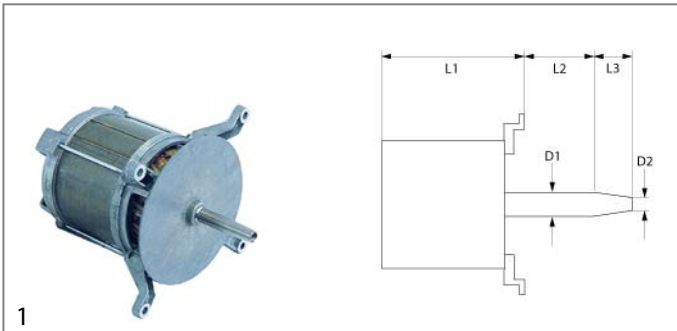

1

<b>GEV No.</b>	500168	<b>Ref. No.</b>	12025825 RT31001022
<b>description</b>	fan motor 380-415V 3 phase 50Hz 0.12/0.9kW 700/1380rpm speeds 2 L1 205mm L2 47mm L3 35mm 0.9/2.1A power input 240/1200W at 50Hz 700/1380rpm type L9zw84D-394 no. X6 D1 ø 13mm D2 ø 13mm L4 17mm		



1

<b>GEV No.</b>	602182	<b>Ref. No.</b>	12024786 T083005000
<b>description</b>	fan wheel blades 12 D1 ø 280mm D2 ø 13mm D3 ø 16.5mm H1 128mm H2 20.5mm H3 80mm		
<b>For models:</b>	ACG-061, AG-061, AG-061W, APG-061, APG-061W		

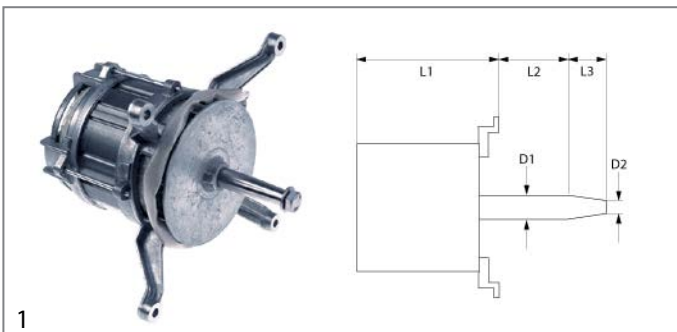

1

<b>GEV No.</b>	500507	<b>Ref. No.</b>	12016547 R663033
<b>description</b>	fan motor 400V 3 phase 50Hz 0.02/0.16kW 710/1390rpm speeds 2 L1 140mm L2 30mm L3 35mm M10R IT 0.2/0.5A power input 50/250W at 50Hz 380-400V at 60Hz 380-400V at 50Hz 710/1390rpm at 60Hz 840/1660rpm Y/YY type L7mw84D-379 no. X2 D1 ø 17mm D2 ø 13mm		
<b>For models:</b>	HME-10-11, HME-10-21, HME-20-11, HME-20-21, HME-2-10-11, HME-2-20-11, HME-6-11, HMP-10-11, HMP-10-21, HMP-20-11, HMP-20-21, HMP-2-10-11, HMP-2-20-11, HMP-6-11		



1

<b>GEV No.</b>	601327	<b>Ref. No.</b>	12027162 22.00.192S RT2200192
<b>description</b>	fan wheel D1 ø 340mm H1 135mm blades 9 D2 ø 13mm D3 ø 16mm H2 38mm		



1

<b>GEV No.</b>	601326	<b>Ref. No.</b>	12025751 RT20120514
<b>description</b>	fan wheel		



1

<b>GEV No.</b>	601306	<b>Ref. No.</b>	12027559 RT2200188
<b>description</b>	fan wheel D1 ø 340mm H1 95mm blades 9 D2 ø 13mm D3 ø 16mm H2 37mm		



1

<b>GEV No.</b>	601503	<b>Ref. No.</b>	12016581 R253042
<b>description</b>	fan wheel D1 ø 350mm H1 125mm blades 12 D2 ø 13mm D3 ø 16mm		
<b>For models:</b>	HCG-10-11, HCG-10-21, HCG-20-11, HCG-20-21, HCG-2-10-11, HCG-2-20-11, HCV-10-11, HCV-10-21, HCV-2-10-21, HE-10-11, HE-10-21, HE-2-10-11, HG-10-11, HME-10-11, HME-10-21, HME-20-11, HME-20-21, HME-2-10-11, HME-2-20-11, HME-6-11, HMG-10-11, HMG-10-11UL, HMG-10-21, HMG-10-21UL, HMG-20-11, HMG-2-10-11, HMI-10-11, HMI-10-11UL, HMI-10-21, HMI-10-21UL, HMI-2-10-11, HMI-6-11, HMI-6-11UL, HMM-10-11, HMM-10-11UL, HMM-10-21, HMM-10-21UL, HMM-20-11, HMM-20-11UL, HMM-20-21, HMM-20-21UL, HMM-2-10-11, HMM-2-20-11, HMM-40-11-USMC, HMM-6-11, HMM-6-11UL, HMP-10-11, HMP-10-21, HMP-20-11, HMP-20-21...(Other models you can see in the webshop)		
<b>accessories for</b>	601503		
	<b>GEV No.</b>	500505	<b>Ref. No.</b> 12016565 R253049
	fan motor 220-240/380-415V 3 phase 50/60Hz 0.16-0.26kW 1440/1700rpm speeds 2 L1 140mm L2 27mm L3 35mm M10R IT 1.2/0.7A Cos(φ) 0.63 type L7zAw4D-014 D1 ø 17mm D2 ø 13mm		



1

<b>GEV No.</b>	601322	<b>Ref. No.</b>	12026355 RT20120507
<b>description</b>	fan wheel D1 ø 350mm H1 125mm blades 12 D2 ø 13mm D3 ø 16mm H2 37mm		



1

<b>GEV No.</b>	601323	<b>Ref. No.</b>	12026699 RT20120512
<b>description</b>	fan wheel D1 ø 350mm H1 135mm blades 12 D2 ø 13mm D3 ø 16mm H2 45mm		



1

<b>GEV No.</b>	601795	<b>Ref. No.</b>	12024306 12024789 T493017
<b>description</b>	fan wheel D1 ø 350mm H1 125mm blades 12 D2 ø 13mm D3 ø 16mm H2 15mm		
<b>For models:</b>	ACE-061, ACE-101, ACE-102, ACE-201, ACE-202, ACG-101, ACG-102, ACG-201, ACG-202, AE-061, AE-061W, AE-101, AE-101W, AE-102, AE-102W, AE-201, AE-202, AG-101, AG-101W, AG-102, AG-102W, AG-201, AG-202, APE-061, APE-061W, APE-101, APE-101W, APE-102, APE-102W, APE-201, APE-202, APG-101, APG-101W, APG-102, APG-102W, APG-201, APG-202, COE-101, COE-102, COE-201, COE-202, COG-102, COG-202, HEI-20-21, HEM-10-11, HEM-20-11, HEM-20-21, HEM-6-11, HEP-10-11, HEP-20-11...(Other models you can see in the webshop)		



1

<b>GEV No.</b>	601324	<b>Ref. No.</b>	12025824 RT20120508
<b>description</b>	fan wheel D1 ø 450mm H1 155mm blades 12 D2 ø 13.5mm D3 ø 17mm H2 45mm		





1

<b>GEV No.</b>	601502	<b>Ref. No.</b>	12018490 T303015
<b>description</b>	fan wheel D1 ø 450mm H1 160mm blades 12 D2 ø 13mm D3 ø 17mm		
<b>For models:</b>	HEI-10-21, HEM-10-21, HEP-10-21, HGC-10-21, HGP-10-21, HGV-10-21		

			
1			
<b>GEV No.</b>	601325	<b>Ref. No.</b>	12026227 RT20120513
<b>description</b>	fan wheel D1 ø 450mm H1 165mm blades 12 D2 ø 14mm D3 ø 17mm H2 45mm		

			
1			
<b>GEV No.</b>	510587	<b>Ref. No.</b>	12033987 RT20160876
<b>description</b>	flange for fan motor ED ø 60mm int. ø 1 24mm int. ø 2 18.5mm thickness 3mm steel		

			
1			
<b>GEV No.</b>	691680	<b>Ref. No.</b>	12017909 R662623
<b>description</b>	flange for fan motor ED ø 60mm int. ø 1 28mm int. ø 2 19mm thickness 20mm SS		
<b>For models:</b>	HCG-10-11, HCG-10-21, HCG-20-11, HCG-20-21, HCG-2-10-11, HCG-2-20-11, HCG-6-11, HME-10-11, HME-10-21, HME-20-11, HME-20-21, HME-2-10-11, HME-2-20-11, HME-6-11, HMG-10-11, HMG-10-11UL, HMG-10-21, HMG-10-21UL, HMG-20-11, HMG-2-10-11, HMG-6-11, HMI-10-11, HMI-10-11UL, HMI-10-21, HMI-10-21UL, HMI-2-10-11, HMI-6-11, HMI-6-11UL, HMM-10-11, HMM-10-11UL, HMM-10-21, HMM-10-21UL, HMM-20-11, HMM-20-11UL, HMM-20-21, HMM-20-21UL, HMM-2-10-11, HMM-2-20-11, HMM-40-11-USMC, HMM-6-11, HMM-6-11UL, HMP-10-11, HMP-10-21, HMP-20-11, HMP-20-21, HMP-2-10-11, HMP-2-20-11, HMP-6-11, HVG-10-11, HVG-10-11UL...(Other models you can see in the webshop)		
<b>accessories for</b>	691680		
	<b>GEV No.</b>	691049	<b>Ref. No.</b> 12024510 R012635000 R662627
	shaft seal ID ø 17mm ED ø 28mm thickness 7mm		

			
1			
<b>GEV No.</b>	691049	<b>Ref. No.</b>	12024510 R012635000 R662627
<b>description</b>	shaft seal ID ø 17mm ED ø 28mm thickness 7mm		
<b>For models:</b>	ACE-061, ACE-101, ACE-102, ACE-201, ACE-202, ACG-061, ACG-101, ACG-102, ACG-201, ACG-202, AE-061, AE-061W, AE-101, AE-101W, AE-102, AE-102W, AE-201, AE-202, AG-061, AG-061W, AG-101, AG-101W, AG-102, AG-102W, AG-201, AG-202, APE-061, APE-061W, APE-101, APE-101W, APE-102, APE-102W, APE-201, APE-202, APG-061, APG-061W, APG-101, APG-101W, APG-102, APG-102W, APG-201, APG-202, COE-061, COE-101, COE-102, COE-201, COE-202, COG-061, COG-101, COG-102...(Other models you can see in the webshop)		

			
1			
<b>GEV No.</b>	510573	<b>Ref. No.</b>	12033667 RT50010207
<b>description</b>	shaft seal ID ø 17mm ED ø 29mm thickness 4.5mm		

			
1			
<b>GEV No.</b>	511682	<b>Ref. No.</b>	12034102 RT85141343
<b>description</b>	shaft seal kit ID ø 17mm ED ø 29mm shaft seal flange mounting gauge with mountign material		

			
1			
<b>GEV No.</b>	691891	<b>Ref. No.</b>	12024172 R663057
<b>description</b>	spacer bush for fan motor ED ø 9mm H 11mm ID ø 6.5mm		
<b>For models:</b>	COE-061, COE-101, COE-102, COE-201, COE-202, COG-061, COG-101, COG-201, HEM-10-11, HEM-20-11, HEM-6-11, HEP-10-11, HEP-20-11, HEP-6-11, HME-10-11, HME-10-21, HME-20-11, HME-20-21, HME-2-10-11, HME-2-20-11, HME-6-11, HMM-20-11, HMM-20-11UL, HMM-20-21, HMP-10-11, HMP-10-21, HMP-20-11, HMP-20-21, HMP-2-10-11, HMP-2-20-11, HMP-6-11, VE-061, VE-101, VE-102, VE-201, VE-202, VG-101, VG-201, VPE-061, VPE-101, VPE-102, VPE-201, VPE-202, VPG-101, VPG-201		



hot air fans

ebm-papst

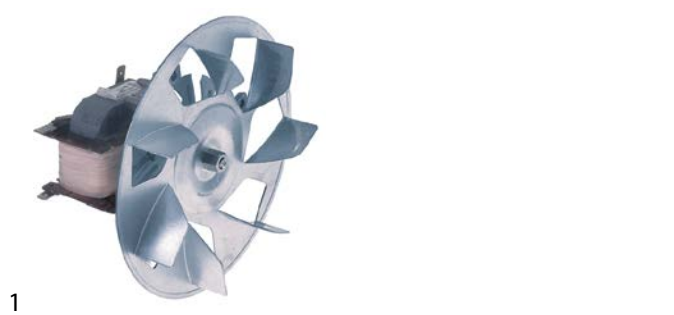

1

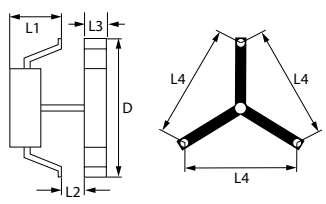

<b>GEV No.</b>	601513	<b>Ref. No.</b>	12032214 6021050005
<b>description</b>	hot air fan 220-240V 41W L1 60mm L2 12mm L3 25mm L4 87mm fan wheel ø 154mm type RRL140/0024 A36-3020LH-459 ebm-papst WS 10		
<b>For models:</b>	AC-120, AC-180, CCF-10, CCF-10CI, CCF-20, CCF-20CI, CCF-40, CCF-40CI		

miscellaneous



1

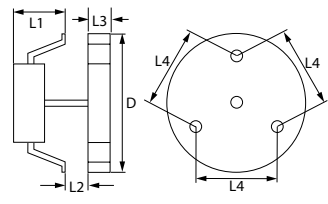

<b>GEV No.</b>	601448	<b>Ref. No.</b>	12031294 AS30480001
<b>description</b>	hot air fan 220-240V 32W 50/60Hz L1 60mm L2 11mm L3 25mm L4 87mm fan wheel ø 155mm FIME type C20X0E01/11		
<b>spare parts for</b>	601448		
		<b>GEV No.</b>	601261
		<b>Ref. No.</b>	—
	fan wheel ø 154mm W 25mm shaft intake ø 6x5mm chrome-plated blades 7		
<b>accessories for</b>	601448		
		<b>GEV No.</b>	550879
		<b>Ref. No.</b>	—
	insulation ø 130mm thickness 3mm hole ø 20mm for hot air fan		

radial fans



1

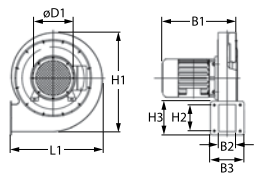

<b>GEV No.</b>	602181	<b>Ref. No.</b>	12039373 T543052000
<b>description</b>	radial fan 230V voltage AC 50/60Hz 135W H1 193mm L1 182mm D1 ø 90mm W1 145mm W2 28mm H2 50mm W3 83mm H3 80mm combi-steamer		
<b>For models:</b>	AG-202, APG-202		

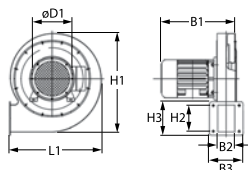
1

<b>GEV No.</b>	601709	<b>Ref. No.</b>	12025823 RT31011017
<b>description</b>	radial fan 230V voltage AC 50/60Hz H1 180mm L1 175mm D1 ø 43mm W1 82mm W2 33mm H2 60mm W3 83mm H3 83mm for combi-steamer		

1

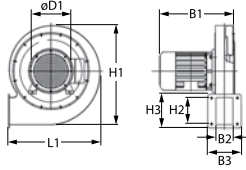
<b>GEV No.</b>	601295	<b>Ref. No.</b>	12024797 12026033 RT7000028 T083000
<b>description</b>	radial fan 230V voltage AC 50Hz 50W H1 180mm L1 180mm D1 ø 43mm W1 105mm W2 33mm H2 59mm W3 66mm H3 83mm		
<b>For models:</b>	COG-061, COG-101, COG-201, HCG-10-11, HCG-10-21, HCG-20-11, HCG-2-10-11, HCG-6-11, HGC-10-11, HGC-20-11, HGC-6-11, HGV-10-11, HGV-20-11, HVG-10-11, HVG-10-11UL, HVG-10-21, HVG-10-21UL, HVG-20-11, HVG-2-10-11, MFHVG-10-11, MFHVG-10-21, VG-101, VG-201, VPG-101, VPG-201		

1

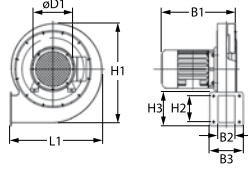
<b>GEV No.</b>	601296	<b>Ref. No.</b>	12025691 RT7000067
<b>description</b>	radial fan 230V voltage AC 50Hz 140W H1 190mm L1 190mm D1 ø 50mm W1 133mm W2 28mm H2 55mm W3 83mm H3 83mm		

1

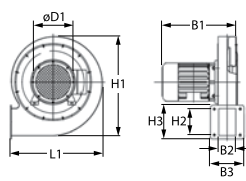
<b>GEV No.</b>	602183	<b>Ref. No.</b>	12044607
<b>description</b>	radial fan 230V voltage AC 50Hz 55W H1 156mm L1 160mm D1 ø 126mm W1 90mm H2 50mm W3 83mm combi-steamer		
<b>For models:</b>	ACG-061, ACG-101, ACG-102, ACG-201, ACG-202, AG-061, AG-101, AG-102, AG-201, AG-202, APG-061, APG-101, APG-102, APG-201, APG-202		

1

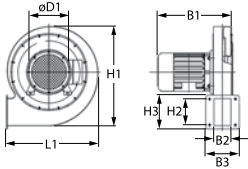
<b>GEV No.</b>	500798	<b>Ref. No.</b>	12026360 RT31011016
<b>description</b>	radial fan 230V voltage AC 50Hz 25W H1 143mm L1 127mm D1 ø 27mm W1 85mm W2 23mm H2 43mm W3 76mm H3 83mm		

1

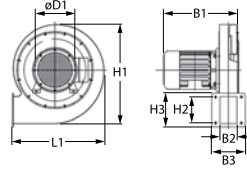
<b>GEV No.</b>	601114	<b>Ref. No.</b>	12026776 RT87201418
<b>description</b>	radial fan 24V voltage AC 50Hz 20W H1 141mm L1 130mm D1 ø 27mm W1 86mm W2 23mm H2 42.5mm W3 75.5mm H3 83mm gas burner		





<b>GEV No.</b>	601115	<b>Ref. No.</b>	12026189 RT31011014
<b>description</b>	radial fan 24V voltage AC 50Hz H1 180mm L1 175mm D1 ø 43mm W1 84mm W2 33mm H2 59mm W3 82mm H3 83mm		

<b>GEV No.</b>	691058	<b>Ref. No.</b>	12016374 T093001
<b>description</b>	radial fan 230V voltage AC 50Hz 370W		
<b>For models:</b>	HCG-20-11, HMG-20-11		

Image not available

<b>GEV No.</b>	691868	<b>Ref. No.</b>	12016428 R723025
<b>description</b>	radial fan 230V voltage AC 60Hz 200W		
<b>For models:</b>	HCG-10-11, HCG-10-21, HCG-2-10-11, HCG-6-11, HMG-10-11, HMG-10-11UL, HMG-10-21, HMG-10-21UL, HMG-2-10-11, HMG-6-11		

Image not available

<b>GEV No.</b>	691867	<b>Ref. No.</b>	12016367 T093002
<b>description</b>	radial fan 230V voltage AC 60Hz 370W		
<b>For models:</b>	HCG-20-11, HMG-20-11		

**motors**

**gear motors**

**for tilting bratt pans**

<b>GEV No.</b>	500348	<b>Ref. No.</b>	12016368 X343000
<b>description</b>	gear motor ERREKA type 65-T2100CF01 220W 230V 50Hz 1 phase 0.27rpm shaft ø 59.5mm L 460mm W 88mm H 88mm for tilting bratt pan		
<b>For models:</b>	SBE9-10IM, SBE9-10IMS, SBE9-10M, SBE9-10MS, SBE9-15IM, SBE9-15IMS, SBG9-10IM, SBG9-10IMS, SBG9-10M, SBG9-10MS, SBG9-15IM, SBG9-15IMS		

**for ovens**

**for flues**

<b>GEV No.</b>	361999	<b>Ref. No.</b>	12031548 RT31011010 RT31011010S
<b>description</b>	gear motor CROUZET type 82841042 12V voltage DC shaft ø 4mm L 65mm W 50mm H 51mm for oven		

<b>GEV No.</b>	530008	<b>Ref. No.</b>	12024638 T323010
<b>description</b>	gear motor MECHTEX type SOE-40 3.5W 230V voltage AC 50/60Hz 10rpm shaft ø 6x5mm L 65mm W 51mm H 40mm chimney motor		
<b>For models:</b>	ACE-061, ACE-101, ACE-102, ACE-201, ACE-202, ACG-061, ACG-101, ACG-102, ACG-201, ACG-202, AE-061, AE-061W, AE-101, AE-101W, AE-102, AE-102W, AE-201, AE-202, AG-061, AG-061W, AG-101, AG-101W, AG-102, AG-102W, AG-201, AG-202, APE-061, APE-061W, APE-101, APE-101W, APE-102, APE-102W, APE-201, APE-202, APG-061, APG-061W, APG-101, APG-101W, APG-102, APG-102W, APG-201, APG-202, COE-061, COE-101, COE-102, COE-201, COE-202, HEI-10-21, HEI-20-21, HEM-10-21...(Other models you can see in the webshop)		
<b>spare parts for</b>	530008		
	<b>GEV No.</b>	360673	<b>Ref. No.</b> —
	motor kit pinion ø 6.8mm teeth 15 230V voltage AC 50/60Hz turn direction clockwise motor ø 48mm H 18.5mm motor type UDS-40NE1RNZ165 cable length 150mm with holder		

pumps

wash and rinse pumps

FIR

pumps



<b>GEV No.</b>	499353	<b>Ref. No.</b>	12024782 T360715 T360715000
<b>description</b>	pump inlet ø 30mm outlet ø 26mm type 5213E2451 230V 50Hz 1 phase 0.22kW 0.1HP L 190mm rotation direction left capacitor 5µF FIR		
<b>For models:</b>	APE-201, APE-202, APG-201, APG-202, HEP-10-21, HEP-20-21, HGP-10-21, HGP-20-21, VPE-102, VPE-201, VPE-202, VPG-102, VPG-201, VPG-202		





<b>GEV No.</b>	499334	<b>Ref. No.</b>	EU929174
<b>description</b>	pump inlet ø 62mm outlet ø 62mm type 2250.2731 230/400V 50Hz 1 phase 3kW FIR		
<b>spare parts for</b>	499334		
	<b>GEV No.</b>	510687	<b>Ref. No.</b> —
	mechanical shaft seal for shaft ø 18mm height counter ring 8mm ID ø 17mm ED ø 39mm H 15mm mounting ø 42mm int. ø 1 21mm		
	<b>GEV No.</b>	512455	<b>Ref. No.</b> —
	fan wheel ø 155mm H 18mm shaft intake ø 18mm plastic blades 12		
	<b>GEV No.</b>	521026	<b>Ref. No.</b> —
	pump cover gasket ID ø 182.5mm thickness 5x4.5mm		

Table continues overleaf

<b>GEV No.</b>	500873	<b>Ref. No.</b>	12027771 RT2200318
<b>description</b>	ventilation valve CROUZET type G70C10AFTEG 12V voltage DC shaft ø 6mm L 95mm W 63mm H 136mm for combi-steamer ø 50mm		

for dishwashers



<b>GEV No.</b>	601662	<b>Ref. No.</b>	12023304 Z315001 Z315006
<b>description</b>	gear motor C.M.E type 71 B 6/4 0.18/0.25W 230V 50Hz 1 phase 1380rpm MI 50 transmission 60/1 for dishwasher		
<b>For models:</b>	ECO-280D, ECO-280I, ECO-370D, ECO-370I, ECO-460D, ECO-460I, ECO-550D, ECO-550I, FI-280D, FI-280I, FI-370D, FI-370I, FI-460D, FI-460I, FI-550D, FI-550I		





<b>GEV No.</b>	500783	<b>Ref. No.</b>	12024739 Z275073 Z275074
<b>description</b>	gear motor type 71E00147 250W 230/400V 50/60Hz 3 phase L 365mm W 200mm H 170mm MI 50 transmission 100/1 for dishwasher		
<b>For models:</b>	ECO-160, ECO-160D, ECO-160I, FI-160, FI-160AR, FI-160D, FI-160I		

miscellaneous



<b>GEV No.</b>	501518	<b>Ref. No.</b>	12024754
<b>description</b>	gear motor 230V 50/60Hz		
<b>For models:</b>	AE-102W, APE-061, APE-061W, APE-101, APE-101W, APE-102, APE-102W, APE-201, APE-202, APG-061, APG-061W, APG-101, APG-101W, APG-102, APG-102W, APG-201, APG-202, HEP-10-21, HEP-20-21, HGP-10-21, HGP-20-21, VG-101, VPE-061, VPE-101, VPE-102, VPE-201, VPE-202, VPG-101, VPG-102, VPG-201, VPG-202		

<b>spare parts for</b> 499334				
	GEV No.	521028	Ref. No.	—
pump cover FIR inlet ø 62mm outlet ø 62mm turn direction right ø 215mm ID ø 175mm inner height 40mm				
	GEV No.	521277	Ref. No.	12038035 EU929181
impellor ø 135mm H 39mm pump type Fir 2275 - 3.6HP thread M14L				



1

<b>GEV No.</b>	500705	<b>Ref. No.</b>	12024812 Z101001	
<b>description</b>	pump inlet ø 63mm outlet ø 53mm type 1243 230/400V 50Hz 3 phase 2.39kW 3.2HP L 363mm rotation direction left FIR			
<b>For models:</b>	ECO-1600, ECO-2300, ECO-280D, ECO-280I, ECO-3000, ECO-370D, ECO-370I, ECO-460D, ECO-460I, ECO-550D, ECO-550I, FI-1600, FI-2300, FI-280D, FI-280I, FI-3000, FI-370D, FI-370I, FI-460D, FI-460I, FI-550D, FI-550I			
<b>spare parts for</b>	500705			
	GEV No.	510357	Ref. No.	—
impellor ø 124mm H 34/16mm thread M8R blades 6				

HANNING

pumps

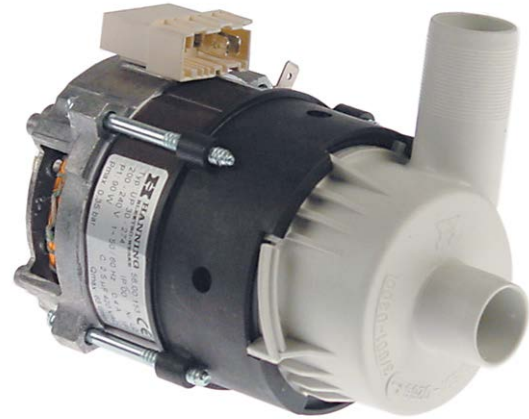

1

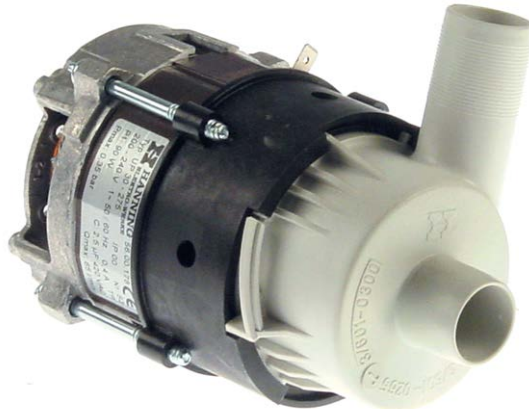

<b>GEV No.</b>	500578	<b>Ref. No.</b>	12026928 RT5600153P	
<b>description</b>	pump inlet ø 24mm outlet ø 24mm type UP30-274 230V 50/60Hz 1 phase 0.09kW 0.12HP L 145mm rotation direction left capacitor 2.5µF HANNING			
<b>spare parts for</b>	500578			
	GEV No.	501345	Ref. No.	—
O-ring EPDM thickness 3mm ID ø 58mm Qty 1 pcs				

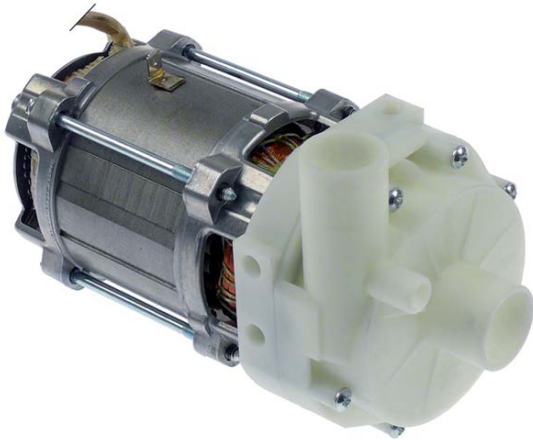

1

<b>GEV No.</b>	500579	<b>Ref. No.</b>	12026728 RT5600178P	
<b>description</b>	pump inlet ø 24mm outlet ø 24mm type UP30-275 230V 50/60Hz 1 phase 0.09kW 0.12HP L 145mm rotation direction left capacitor 2.5µF HANNING			
<b>spare parts for</b>	500579			
	GEV No.	501345	Ref. No.	—
O-ring EPDM thickness 3mm ID ø 58mm Qty 1 pcs				





<b>1</b>			
<b>GEV No.</b>	499166	<b>Ref. No.</b>	12024233
<b>description</b>	pump inlet $\varnothing$ 28mm outlet $\varnothing$ 26mm type UP60-414 220-240V 50/60Hz 1 phase 0.25kW L 190mm rotation direction right capacitor 5 $\mu$ F HANNING p max 1bar Qmax. 150l/min		
<b>For models:</b>	AD-125, AD-125HRS, AD-125-SOFT, AD-45BBT, AD-48HY, AD-505, AD-64BBT, AD-64BTDD, AD-64HY, COP-173, COP-173B, COP-173BDD, COP-173DD, COP-173HRS, COP-173HRSDD, COP-173-SOFT, COP-174, COP-174B, COP-174BDD, COP-174DD, COP-174HRS, COP-174HRSDD, COP-174W, COP-174WHRS, COP-503, COP-503B, COP-503BDD, COP-503DD, COP-503-SOFT, COP-504, COP-504B, COP-504BDD, COP-504DD, COP-504W, EASY-500HPWBDD, FI-30B-BT-UK, FI-48B-BT-UK, FI-48HY-CLINIC, FI-64B-BT-UK, FI-64HY-CLINIC		
<b>spare parts for</b>	499166		
	<b>GEV No.</b>	365017	<b>Ref. No.</b> —
	operating capacitor capacity 5 $\mu$ F 450V tolerance 5% 50/60Hz ambient temperature max. -25 to +85°C $\varnothing$ 28mm L 54mm M8 plastic connection male faston 6.3mm 16.10.08 protection		
	<b>GEV No.</b>	507558	<b>Ref. No.</b> —
	mechanical shaft seal for shaft $\varnothing$ 7mm height counter ring 5mm ID $\varnothing$ 6.75mm ED $\varnothing$ 20mm mounting $\varnothing$ counter ring 18.5/slide ring 20mm		
	<b>GEV No.</b>	532644	<b>Ref. No.</b> —
	O-ring EPDM thickness 3mm ID $\varnothing$ 78mm Qty 1 pcs		

INSERT STAR

pumps



<b>1</b>			
<b>GEV No.</b>	500321	<b>Ref. No.</b>	12023429 Z401001
<b>description</b>	pump inlet $\varnothing$ 38mm outlet $\varnothing$ 38mm type 2/102FA10 230V 50/60Hz 1 phase 0.26kW 0.35HP L 195mm rotation direction right capacitor 6 $\mu$ F INSERTSTAR		
<b>For models:</b>	AD-120BBTDD-UK, AD-120HY, AD-15, AD-15D, AD-20C-UK, AD-21, AD-21B, AD-21BDD, AD-21C, AD-21D, AD-21DD, AD-21W, AD-90BBT, ADE-120, ADE-120B, CO-350, CO-350-B, CO-350-B-DD, CO-350-COLD, CO-350-COLD-B, CO-350-COLD-B-DD, CO-350-COLD-DD, CO-350-DD, CO-352-COLD, CO-352-COLD-B, CO-352-COLD-B-DD, CO-352-COLD-DD, CO-400, CO-400-B, CO-400-B-DD, CO-400-COLD, CO-400-COLD-B, CO-400-COLD-B-DD, CO-400-COLD-DD, CO-400-DD, CO-400-SOFT, CO-402-COLD, CO-402-COLD-B, CO-402-COLD-B-DD, CO-402-COLD-DD, CO-402W, ECO-120, ECO-1200, ECO-120B, ECO-160, ECO-160D, ECO-160I, ECO-200, ECO-200D, ECO-200H...(Other models you can see in the webshop)		
<b>spare parts for</b>	500321		
	<b>GEV No.</b>	504578	<b>Ref. No.</b> —
	O-ring EPDM thickness 3.53mm ID $\varnothing$ 94.84mm Qty 1 pcs		
	<b>GEV No.</b>	510693	<b>Ref. No.</b> 12018735 Z201081
	mechanical shaft seal for shaft $\varnothing$ 12mm slide ring ext. $\varnothing$ 24mm slide ring H 15.5mm slide ring int. $\varnothing$ 11mm counter ring mounting $\varnothing$ 24mm height counter ring 8mm counter ring int. $\varnothing$ 13.5mm		
<b>accessories for</b>	500321		
	<b>GEV No.</b>	365093	<b>Ref. No.</b> 12024346 V817100
	operating capacitor capacity 6 $\mu$ F 400V tolerance 5% 50/60Hz ambient temperature max. -25 to +85°C $\varnothing$ 31.5mm L 55mm M8 plastic connection male faston 6.3mm protection		



<b>1</b>			
<b>GEV No.</b>	501562	<b>Ref. No.</b>	12043287
<b>description</b>	pump inlet ø 38mm outlet ø 38mm type 2/123 FA-22 230V 50Hz 1 phase 0.59kW 0.8HP rotation direction right capacitor 10µF INSERT-STAR		
<b>For models:</b>	AD-120C, AD-120HY, AD-125, AD-125HRS, AD-125-SOFT, AD-505, AD-505-SOFT, AD-64BTDD, CO-110, CO-110B, CO-110BDD, CO-110DD, CO-112, CO-112B, CO-112BDD, CO-112DD, CO-170, CO-170B, CO-170BDD, CO-170DD, CO-170HRS, CO-170HRSDD, CO-170HRS-SOFT, CO-170-SOFT, CO-172, CO-172B, CO-172BDD, CO-172DD, CO-500, CO-500B, CO-500BDD, CO-500DD, CO-501, CO-501B, CO-501BDD, CO-501DD, CO-501-SOFT, CO-502B, CO-502BDD, CO-502DD, COP-173, COP-173B, COP-173BDD, COP-173DD, COP-173HRS, COP-173HRSDD, COP-173-SOFT, COP-174, COP-174B, COP-174BDD...(Other models you can see in the webshop)		

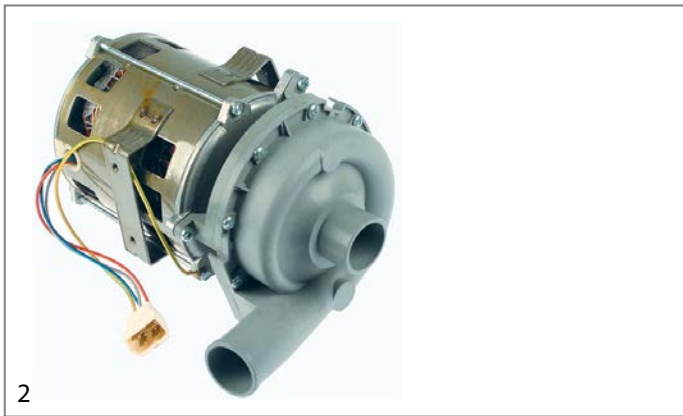

<b>2</b>			
<b>GEV No.</b>	499075	<b>Ref. No.</b>	12024270 Z203501 Z203511
<b>description</b>	pump inlet ø 38mm outlet ø 38mm type 2/123 FA31 230V 60Hz 1 phase 0.59kW L 240mm rotation direction right capacitor 10µF INSERTSTAR		
<b>For models:</b>	AD-120, AD-120B, AD-120CW, AD-48, AD-48W, AD-64, AD-64CW, AD-72, AD-72W, AD-90, AD-90BA, AD-90BDD, AD-90DD, ADE-120, ADE-120B, EASY-500, EASY-500B, EASY-500DD, EASY-500HP, EASY-500HPWBDD, ECO-120, ECO-1200, ECO-120B, ECO-160D, ECO-160I, ECO-200D, ECO-200HD, ECO-200HI, ECO-200I, ECO-370D, ECO-370I, ECO-550D, ECO-550I, FI-100, FI-100AR, FI-100B, FI-100BTT-UK, FI-120, FI-1200, FI-120AR+DD, FI-120B, FI-120C, FI-120HY-CLINIC, FI-120W, FI-160AR, FI-160D, FI-160I, FI-200AR, FI-200D...(Other models you can see in the webshop)		
<b>spare parts for</b>	499075		
	<b>GEV No.</b>	510693	<b>Ref. No.</b> 12018735 Z201081
	mechanical shaft seal for shaft ø 12mm slide ring ext. ø 24mm slide ring H 15.5mm slide ring int. ø 11mm counter ring mounting ø 24mm height counter ring 8mm counter ring int. ø 13.5mm		
	<b>GEV No.</b>	521000	<b>Ref. No.</b> 12019782 Z201085
	pump cover FAGOR inlet ø 38mm outlet ø 38mm		
	<b>GEV No.</b>	532491	<b>Ref. No.</b> —
	O-ring EPDM thickness 3.53mm ID ø 120.2mm Qty 1 pcs		
	<b>GEV No.</b>	650238	<b>Ref. No.</b> —
	impellor ø 77mm H 32mm pump type 2/123 FA31 shaft intake ø 8mm rotation direction right thread M8L suitable for INSERTSTAR shaft ø 12mm shaft length 26mm blades 6		

<b>accessories for</b>	499075		
	<b>GEV No.</b>	365015	<b>Ref. No.</b> 12024376 V321300
	operating capacitor capacity 10µF 400V tolerance 5%Hz ambient temperature max. -25 to +85°C ø 35.5mm L 59mm M8 plastic connection male faston 6.3mm protection		

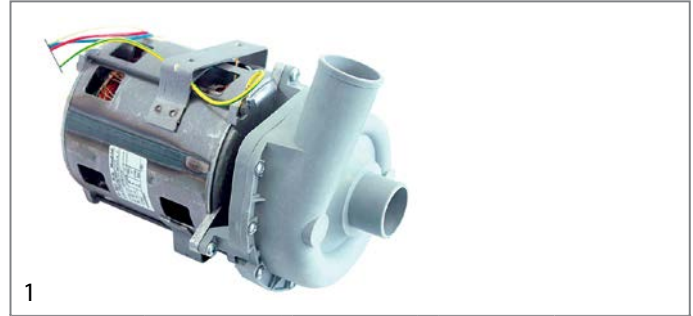

<b>1</b>			
<b>GEV No.</b>	500320	<b>Ref. No.</b>	12024265 Z201001 Z201011
<b>description</b>	pump inlet ø 38mm outlet ø 38mm type 2/123/FA30 230V 50Hz 1 phase 0.59kW 0.8HP L 235mm rotation direction right capacitor 10µF INSERTSTAR		
<b>For models:</b>	AD-120, AD-120B, AD-120BBTDD-UK, AD-120C, AD-120HY, AD-45BBT, AD-48, AD-48B, AD-48BDD, AD-48C, AD-48D, AD-48DD, AD-48HY, AD-64, AD-64B, AD-64BBT, AD-64BDD, AD-64BTDD, AD-64C, AD-64D, AD-64DD, AD-64HY, AD-72, AD-90, AD-90BA, AD-90BBT, AD-90BDD, AD-90DD, ADE-120, ADE-120B, EASY-500, EASY-500B, EASY-500DD, EASY-500HP, EASY-500HPWBDD, ECO-120, ECO-1200, ECO-120B, ECO-160, ECO-1600, ECO-160D, ECO-160I, ECO-200, ECO-200D, ECO-200H, ECO-200HD, ECO-200HI, ECO-200I, ECO-2300, ECO-3000...(Other models you can see in the webshop)		

<b>spare parts for</b>	500320		
	<b>GEV No.</b>	510693	<b>Ref. No.</b> 12018735 Z201081
	mechanical shaft seal for shaft ø 12mm slide ring ext. ø 24mm slide ring H 15.5mm slide ring int. ø 11mm counter ring mounting ø 24mm height counter ring 8mm counter ring int. ø 13.5mm		
	<b>GEV No.</b>	521000	<b>Ref. No.</b> 12019782 Z201085
	pump cover FAGOR inlet ø 38mm outlet ø 38mm		
	<b>GEV No.</b>	521255	<b>Ref. No.</b> 12018550 Z201082
	impellor ø 88mm H 33mm M8L pump type 2/123/FA30 shaft ø 12mm		
	<b>GEV No.</b>	532491	<b>Ref. No.</b> —
	O-ring EPDM thickness 3.53mm ID ø 120.2mm Qty 1 pcs		

<b>accessories for</b>	500320		
	<b>GEV No.</b>	365015	<b>Ref. No.</b> 12024376 V321300
	operating capacitor capacity 10µF 400V tolerance 5%Hz ambient temperature max. -25 to +85°C ø 35.5mm L 59mm M8 plastic connection male faston 6.3mm protection		
	<b>GEV No.</b>	551227	<b>Ref. No.</b> —
	female faston size 6.3x0.8mm 1.0-2.5mm <sup>2</sup> straight CuZn gal Sn t.max. 110°C Qty 10 pcs		



### booster pumps I



1

<b>GEV No.</b>	499155	<b>Ref. No.</b>	12023344 Z209508
<b>description</b>	pump inlet ø 1" IT outlet ø 1" IT type PRISMA15 230V 50Hz 0.6kW L 400mm capacitor 12µF		
<b>For models:</b>	ECO-120, ECO-1200, FI-100, FI-120, FI-1200, FI-120W, FI-30, FI-30AR, FI-30AR+DD, FI-30-UK, FI-48, FI-48AR, FI-48B, FI-48B-BT-UK, FI-48C, FI-48D, FI-48HY-CLINIC, FI-48W, FI-50, FI-64, FI-64AR, FI-64B, FI-64B-BT-UK, FI-64C, FI-64D, FI-64HY-CLINIC, FI-64W, FI-72, FI-72AR, FI-72W, FI-900, MF-48, MF-64		



1

<b>GEV No.</b>	499073	<b>Ref. No.</b>	12017575 12017826 12024708
<b>description</b>	pump inlet ø 31 outlet ø 27 type 887084885 230V 50Hz 0.75kW L 146mm capacitor 2.5µF NIDEC		
<b>For models:</b>	APE-061, APE-101, APE-102, APG-061, APG-101, APG-102, FI-30B-BT-UK, FI-48B-BT-UK, FI-48HY-CLINIC, FI-64B-BT-UK, FI-64HY-CLINIC, VPE-061, VPE-101		

### drain pumps

COPRECI



1

<b>GEV No.</b>	500322	<b>Ref. No.</b>	12024273 Z220901
<b>description</b>	drain pump inlet ø 25mm outlet ø 22mm 230V 30W 50Hz COPRECI		
<b>For models:</b>	AD-20C-UK, AD-21B, AD-21BDD, AD-21C, AD-45BBT, AD-48B, AD-48BDD, AD-48C, AD-48HY, AD-64B, AD-64BBT, AD-64BDD, AD-64C, AD-64HY, FI-30, FI-30AR, FI-30AR+DD, FI-30B, FI-30B-BT-UK, FI-30-UK, FI-48, FI-48AR, FI-48B, FI-48B-BT-UK, FI-48C, FI-48D, FI-48HY-CLINIC, FI-48W, FI-64, FI-64AR, FI-64B, FI-64B-BT-UK, FI-64C, FI-64D, FI-64HY-CLINIC, FI-64W, GA-20, GA-20D, GA-40, GA-40D, HEM-10-21, HEM-20-21, HEP-10-21, HEP-20-21, HGP-10-21, HGP-20-21, HGV-10-21, HGV-20-21, LVC-21B, LVC-21C...(Other models you can see in the webshop)		

HANNING



1

<b>GEV No.</b>	500573	<b>Ref. No.</b>	12029471 RT4400207P
<b>description</b>	drain pump 30W 4-piece 230V inlet ø 24/30mm outlet ø 24mm 50Hz HANNING type DPS25-032 1x pump, 3x pump cover		



1

<b>GEV No.</b>	501561	<b>Ref. No.</b>	12094265
<b>description</b>	drain pump 38W 200-240V inlet ø 30mm outlet ø 24mm 50/60Hz HANNING type DP25R-396		
<b>For models:</b>	AD-505, AD-505-SOFT, CO-350-B, CO-350-B-DD, CO-350-COLD-B, CO-350-COLD-B-DD, CO-352-COLD-B, CO-352-COLD-B-DD, CO-400-B, CO-400-B-DD, CO-400-COLD-B, CO-400-COLD-B-DD, CO-402-COLD-B, CO-402-COLD-B-DD, CO-402W, CO-500B, CO-500BDD, CO-501B, CO-501BDD, CO-502B, CO-502BDD, CO-502W, COP-503B, COP-503BDD, COP-504B, COP-504BDD, COP-504W, EASY-500B, EASY-500DD		



1

<b>GEV No.</b>	501595	<b>Ref. No.</b>	12039546 T843060000
<b>description</b>	drain pump 38W 200-240V inlet ø 30mm outlet ø 24mm 50-60Hz HANNING type DPS25R-391 max. 15min input current 0.4A		
<b>For models:</b>	ACE-061, ACE-102, AE-061, AE-061W, AE-101, AE-101W, AE-102, AE-102W, AE-201, AE-202, AG-061, AG-061W, AG-101, AG-101W, AG-102, AG-102W, AG-201, AG-202, APE-061, APE-061W, APE-101, APE-101W, APE-102, APE-102W, APE-201, APE-202, APG-061, APG-061W, APG-101, APG-101W, APG-102, APG-102W, APG-201, APG-202		

1

<b>GEV No.</b>	500737	<b>Ref. No.</b>	12023456 Z711007
<b>description</b>	drain pump inlet ø 24mm outlet ø 24mm 230V 95W 50Hz HANNING type BE38B5-017		
<b>For models:</b>	AD-120B, AD-120BBTDD-UK, AD-120C, AD-120HY, AD-125, AD-125HRS, AD-125-SOFT, AD-90BA, AD-90BBT, AD-90BDD, ADE-120B, CO-110B, CO-110BDD, CO-112B, CO-112BDD, CO-170B, CO-170BDD, CO-172B, CO-172BDD, COP-173B, COP-173BDD, COP-174B, COP-174BDD, ECO-120B, FI-100, FI-100AR, FI-100B, FI-100BBT-UK, FI-120B, FI-120C, FI-120HY-CLINIC, FI-80BBT-UK		



1

<b>GEV No.</b>	500044	<b>Ref. No.</b>	12029264 12029492 RT30021000P
<b>description</b>	drain pump inlet ø 30mm outlet ø 24mm 230V 100W 50Hz HANNING type BE28B4-017		
<b>spare parts for</b>	500044		
	<b>GEV No.</b>	510168	<b>Ref. No.</b> —
	fan wheel shaft intake ø 5mm ø 62mm H 14mm		



1

<b>GEV No.</b>	501542	<b>Ref. No.</b>	12029791 RT30021005
<b>description</b>	drain pump inlet ø 30mm outlet ø 24mm 230V 32W		

service kits



1

<b>GEV No.</b>	500573	<b>Ref. No.</b>	12029471 RT4400207P
<b>description</b>	drain pump 30W 4-piece 230V inlet ø 24/30mm outlet ø 24mm 50Hz HANNING type DPS25-032 1x pump, 3x pump cover		

booster pumps II

accessories



1

<b>GEV No.</b>	365015	<b>Ref. No.</b>	12024376 V321300
<b>description</b>	operating capacitor capacity 10µF 400V tolerance 5%Hz ambient temperature max. -25 to +85°C ø 35.5mm L 59mm M8 plastic connection male faston 6.3mm protection		
<b>For models:</b>	AD-120, AD-120B, AD-120BBTDD-UK, AD-120C, AD-120CW, AD-120HY, AD-125, AD-125HRS, AD-125-SOFT, AD-45BBT, AD-48, AD-48B, AD-48BDD, AD-48C, AD-48D, AD-48DD, AD-48HY, AD-48W, AD-505, AD-505-SOFT, AD-64, AD-64B, AD-64BBT, AD-64BDD, AD-64BTDD, AD-64C, AD-64CW, AD-64D, AD-64DD, AD-64HY, AD-72, AD-72W, AD-90, AD-90BA, AD-90BBT, AD-90BDD, AD-90DD, ADE-120, ADE-120B, CO-110, CO-110B, CO-110BDD, CO-110DD, CO-112, CO-112B, CO-112BDD, CO-112DD, CO-142W, CO-142WDD, CO-170...(Other models you can see in the webshop)		



1

<b>GEV No.</b>	365012	<b>Ref. No.</b>	SAM4420032
<b>description</b>	operating capacitor capacity 6.3µF 450V tolerance 5% 50Hz ambient temperature max. -25 to +85°C ø 30mm L 61mm M8 plastic connection male faston 6.3mm protection		



vibration pumps



1

<b>GEV No.</b>	500580	<b>Ref. No.</b>	12028569 RT87201526
<b>description</b>	vibration pump 230V 60W 50/60Hz inlet ø 7 outlet ø 1/8" IT CEME type E512 with accessories duty cycle 1/2 ambient temperature max. 60°C medium temp max. 35°C overheating protection 110°C CleanJet		

<b>spare parts for</b>	500165			
	<b>GEV No.</b>	601413	<b>Ref. No.</b>	—
	fixing plate suitable for fanwheel ED ø 32mm shaft ø 7 mounting distance 26mm			

pumps for ice machines







1

<b>GEV No.</b>	500590	<b>Ref. No.</b>	12028429 BR00023377	
<b>description</b>	pump FIR type 4240.2300 120W 230V 50/60Hz inlet ø 22mm outlet ø 22mm L 240mm rotation direction right for ice-cube maker capacitor 5µF			
<b>spare parts for</b>	500590			
	<b>GEV No.</b>	601412	<b>Ref. No.</b>	12037081 BR00010213
	fan wheel sucking ø 154mm fan wheel mounting 25.4mm blade angle 28° W 34mm plastic			
	<b>GEV No.</b>	601413	<b>Ref. No.</b>	—
	fixing plate suitable for fanwheel ED ø 32mm shaft ø 7 mounting distance 26mm			





1

<b>GEV No.</b>	500166	<b>Ref. No.</b>	12028448 BR00023068	
<b>description</b>	pump REBO type 63/45 150W 230V 50/60Hz inlet ø 28mm outlet ø 26mm L 200mm rotation direction right capacitor 5µF			
<b>spare parts for</b>	500166			
	<b>GEV No.</b>	365017	<b>Ref. No.</b>	—
	operating capacitor capacity 5µF 450V tolerance 5% 50/60Hz ambient temperature max. -25 to +85°C ø 28mm L 54mm M8 plastic connection male faston 6.3mm 16.10.08 protection			
	<b>GEV No.</b>	601412	<b>Ref. No.</b>	12037081 BR00010213
	fan wheel sucking ø 154mm fan wheel mounting 25.4mm blade angle 28° W 34mm plastic			
	<b>GEV No.</b>	601413	<b>Ref. No.</b>	—
	fixing plate suitable for fanwheel ED ø 32mm shaft ø 7 mounting distance 26mm			



1

<b>GEV No.</b>	500165	<b>Ref. No.</b>	12028445 BR00023002	
<b>description</b>	pump REBO type 63/35 120W 230V 50/60Hz inlet ø 28mm outlet ø 26mm L 180mm rotation direction right for ice-cube maker capacitor 5µF			
<b>spare parts for</b>	500165			
	<b>GEV No.</b>	365017	<b>Ref. No.</b>	—
	operating capacitor capacity 5µF 450V tolerance 5% 50/60Hz ambient temperature max. -25 to +85°C ø 28mm L 54mm M8 plastic connection male faston 6.3mm 16.10.08 protection			
	<b>GEV No.</b>	601412	<b>Ref. No.</b>	12037081 BR00010213
	fan wheel sucking ø 154mm fan wheel mounting 25.4mm blade angle 28° W 34mm plastic			



1

<b>GEV No.</b>	500161	<b>Ref. No.</b>	12026128 BR00C23076	
<b>description</b>	pump REBO type NR40 55W 230V 50Hz outlet ø 17mm L 110mm rotation direction left for ice-cube maker			
<b>spare parts for</b>	500161			
	<b>GEV No.</b>	500970	<b>Ref. No.</b>	—
	pump motor 55W 230V 50Hz REBO L 205mm type outlet ømm suitable for for ice maker			





# condensators & interference suppression filters

## starting capacitors

### starting capacitors



1

<b>GEV No.</b>	365061	<b>Ref. No.</b>	12033454 6004000008 6021010037
<b>description</b>	starting capacitor 220/300V 50Hz DANFOSS duty cycle 1.7/0.10% capacity 80µF for FR/NL		
<b>For models:</b>	AEP-701, AEP-702, AEP-801, AEP-802, AF-1402-MIX, AF-1602-MIX, AF-1603-C, AF-1603-P, AF-1604-C, AF-1604-P, AF-702-C, AF-702-P, AFN-701, AFP-1402-MIX, AFP-1602, AFP-1602-2, AFP-1603, AFP-1603-2, AFP-701, AFP-702, AFP-702-C, AFP-702-P, AFP-801, AFP-802, AFP-802-2, AFP-802-2C, AFP-802-3C, BFP-150, BFP-150A, BFP-150I, BFP-200, BFP-200A, BFP-200I, CAEP-701, CAEP-801, CAEP-802, CAF-1402MIXT, CAF-1602MIX, CAFP-1602-2, CAFP-1603-2, CAFP-701, CAFP-702, CAFP-801, CAFP-802, CAFP-802-2C, CAFP-802-3C, CFMP-150, CFMP-150F, CFMP-150PC, CFMP-150TV...(Other models you can see in the webshop)		



1

<b>GEV No.</b>	365062	<b>Ref. No.</b>	12018649 6004000009 6021010035
<b>description</b>	starting capacitor 80µF 220/300V 50/60Hz duty cycle 3min/1min ø 38mm L 98mm plastic connection cable 100mm		
<b>For models:</b>	AEP-1402, AEP-1403, AEP-1404, AEP-1602, AEP-1603, AEP-1604, AEP-2103, AF-1402-MIX, AF-1403-C, AF-1403-P, AF-1404-C, AF-1404-P, AF-1602-MIX, AF-1603-C, AF-1604-C, AF-2104-C, AF-2104-P, AF-2105-C, AF-2105-P, AF-2106-C, AF-2106-P, AF-702-C, AF-702-P, AF-802-C, AFN-701, AFN-702, AFN-801, AFN-802, AFP-1402, AFP-1402-MIX, AFP-1403, AFP-1403-C, AFP-1403-P, AFP-1404, AFP-1404-C, AFP-1404-P, AFP-1602, AFP-1602-2, AFP-1603, AFP-1603-2, AFP-1604, AFP-2103, AFP-2104, AFP-2104-C, AFP-2104-P, AFP-2105, AFP-2105-C, AFP-2105-P, AFP-2106, AFP-2106-C...(Other models you can see in the webshop)		

## operating capacitors

### plastic



1

<b>GEV No.</b>	365015	<b>Ref. No.</b>	12024376 V321300
<b>description</b>	operating capacitor capacity 10µF 400V tolerance 5%Hz ambient temperature max. -25 to +85°C ø 35.5mm L 59mm M8 plastic connection male faston 6.3mm protection		
<b>For models:</b>	AD-120, AD-120B, AD-120BBTDD-UK, AD-120C, AD-120CW, AD-120HY, AD-125, AD-125SHRS, AD-125-SOFT, AD-45BBT, AD-48, AD-48B, AD-48BDD, AD-48C, AD-48D, AD-48DD, AD-48HY, AD-48W, AD-505, AD-505-SOFT, AD-64, AD-64B, AD-64BBT, AD-64BDD, AD-64BTDD, AD-64C, AD-64CW, AD-64D, AD-64DD, AD-64HY, AD-72, AD-72W, AD-90, AD-90BA, AD-90BBT, AD-90BDD, AD-90DD, ADE-120, ADE-120B, CO-110, CO-110B, CO-110BDD, CO-110DD, CO-112, CO-112B, CO-112BDD, CO-112DD, CO-142W, CO-142WDD, CO-170...(Other models you can see in the webshop)		



1

<b>GEV No.</b>	365020	<b>Ref. No.</b>	12020898 R293000
<b>description</b>	operating capacitor capacity 14µF 400V tolerance 5%Hz ambient temperature max. -25 to +85°C ø 35mm L 70mm M8 plastic connection male faston 6.3mm protection		
<b>For models:</b>	HCG-10-11, HCG-10-21, HCG-2-10-11, HCG-6-11, HCV-10-11, HCV-10-21, HCV-2-10-21, HCV-5-11, HCV-6-11, HE-5-11, HG-10-11, HG-10-21, HG-2-10-11, HMG-10-11, HMG-10-11UL, HMG-10-21, HMG-10-21UL, HMG-2-10-11, HMG-6-11, HVG-10-11, HVG-10-11UL, HVG-10-21, HVG-10-21UL, HVG-2-10-11, MFHVG-10-11, MFHVG-10-21		



1

<b>GEV No.</b>	365226	<b>Ref. No.</b>	12025135 Z258927000
<b>description</b>	operating capacitor capacity 3µF 450V with plastic sheathing tolerance 5% 50/60Hz ø 34mm L 64mm		
<b>For models:</b>	ACE-102, AE-061W, AE-101W, AE-102, AG-061W, APE-061, APE-061W, APE-101, APE-101W, APE-102, APE-102W, APG-061, APG-061W, APG-101, APG-101W, APG-102, APG-102W		



1

<b>GEV No.</b>	365035	<b>Ref. No.</b>	12020052 T093005
<b>description</b>	operating capacitor capacity 30µF 400V tolerance 5% 50/60Hz ambient temperature max. -25 to +85°C ø 45mm L 95mm M8 plastic connection male faston 6.3mm protection		
<b>For models:</b>	HCG-20-11, HCG-20-21, HCG-2-20-11, HMG-20-11, HVG-20-11, HVG-20-21, HVG-2-20-21		

1 electric components



			
1			
<b>GEV No.</b>	365029	<b>Ref. No.</b>	12039812 X343001
<b>description</b>	operating capacitor capacity 5µF with plastic sheathing		
<b>For models:</b>	SBE9-10IM, SBE9-10IMS, SBE9-10M, SBE9-10MS, SBE9-15IM, SBE9-15IMS, SBG9-10IM, SBG9-10IMS, SBG9-10M, SBG9-10MS, SBG9-15IM, SBG9-15IMS		

			
1			
<b>GEV No.</b>	365012	<b>Ref. No.</b>	SAM4420032
<b>description</b>	operating capacitor capacity 6.3µF 450V tolerance 5% 50Hz ambient temperature max. -25 to +85°C ø 30mm L 61mm M8 plastic connection male faston 6.3mm protection		

			
1			
<b>GEV No.</b>	365093	<b>Ref. No.</b>	12024346 V817100
<b>description</b>	operating capacitor capacity 6µF 400V tolerance 5% 50/60Hz ambient temperature max. -25 to +85°C ø 31.5mm L 55mm M8 plastic connection male faston 6.3mm protection		
<b>For models:</b>	AD-120BBTDD-UK, AD-120HY, AD-15, AD-15D, AD-20C-UK, AD-21, AD-21B, AD-21BDD, AD-21C, AD-21D, AD-21DD, AD-21W, AD-90BBT, ADE-120, ADE-120B, CO-350, CO-350-B, CO-350-B-DD, CO-350-COLD, CO-350-COLD-B, CO-350-COLD-B-DD, CO-350-COLD-DD, CO-350-DD, CO-352-COLD, CO-352-COLD-B, CO-352-COLD-B-DD, CO-352-COLD-DD, CO-400, CO-400-B, CO-400-B-DD, CO-400-COLD, CO-400-COLD-B, CO-400-COLD-B-DD, CO-400-COLD-DD, CO-400-SOFT, CO-402-COLD, CO-402-COLD-B, CO-402-COLD-B-DD, CO-402-COLD-DD, CO-402W, ECO-120, ECO-120B, ECO-160, ECO-160D, ECO-160I, ECO-200, ECO-200D, ECO-200H, ECO-200HD...(Other models you can see in the webshop)		

<b>metal</b>			
			
1			
<b>GEV No.</b>	365139	<b>Ref. No.</b>	12032744 EU206002
<b>description</b>	operating capacitor capacity 10µF 450V tolerance 5% 60Hz ambient temperature max. -25 up to +70°C ø 40mm L 83mm M8 aluminium connection male faston 6.3mm C.87.8BF2 MKP protection		

## filters

<b>interference suppression filters</b>			
			
1			
<b>GEV No.</b>	365217	<b>Ref. No.</b>	12035029
<b>description</b>	interference suppression filter capacity 1.5µF 250V for combi-steamer CPC-Linie 61-202		

			
1			
<b>GEV No.</b>	365108	<b>Ref. No.</b>	12029809 RT30010455
<b>description</b>	interference suppression filter type 3001.0455 250/440V 50/60Hz conductor 3 with E connection male faston 6.3mm L 52mm ø 60mm Hmm Wmm M8 aluminium Qty 1 pcs		

## line filters

<b>with housing</b>			
			
1			
<b>GEV No.</b>	365103	<b>Ref. No.</b>	12017894 T113023
<b>description</b>	line filter type FF-6Z 110/250V 50/60Hz conductor 2 with E connection male faston 6.3mm L 90mm H 29.5mm W 51mm flange metal Qty 1 pcs		
<b>For models:</b>	HCG-10-11, HCG-10-21, HCG-20-11, HCG-20-21, HCG-2-10-11, HCG-2-20-11, HCG-6-11, HEI-10-21, HEM-10-21, HGC-10-11, HGC-10-21, HGC-20-11, HGC-6-11, HGV-10-11, HGV-10-21, HGV-20-11, HVG-10-11, HVG-10-11UL, HVG-10-21, HVG-10-21UL, HVG-20-11, HVG-20-21, HVG-2-10-11, HVG-2-20-21, MFHVG-10-11, MFHVG-10-21		

## RC circuits

			
1			
<b>GEV No.</b>	380272	<b>Ref. No.</b>	12034748 RT30280562
<b>description</b>	RC circuit for contactors type 910-304-585-50 130-250V 50-60Hz conductor 2 connection cable plastic Qty 1 pcs for contactors LS4_LS15K type AEG LR2K A250 type GE BS2R2R		



			
1			
<b>GEV No.</b>	380177	<b>Ref. No.</b>	12034804 RT30350508
<b>description</b>	RC circuit type 20002 110/220V 50/60/DChz conductor 2 connection cable 230mm L 29mm ømm H 15mm W 20mm adhesive tape plastic Qty 1 pcs		

## fuses

### fine fuses

			
1			
<b>GEV No.</b>	358671	<b>Ref. No.</b>	12039844 R663101
<b>description</b>	fine fuse size ø5x20mm 1A fast-acting rated 250V Qty 10 pcs		
<b>For models:</b>	HME-10-11, HME-10-21, HME-20-11, HME-20-21, HME-2-10-11, HME-2-20-11, HME-6-11, HMP-10-11, HMP-10-21, HMP-20-11, HMP-20-21, HMP-2-10-11, HMP-6-11		

			
1			
<b>GEV No.</b>	358677	<b>Ref. No.</b>	12024333 12035393 P184011 RT30190112
<b>description</b>	fine fuse size ø5x20mm 4A fast-acting rated 250V Qty 10 pcs		
<b>For models:</b>	CE-15, CE-9, ECO-160, ECO-1600, ECO-160D, ECO-160I, ECO-200, ECO-200D, ECO-200H, ECO-200HD, ECO-200HI, ECO-200I, ECO-2300, ECO-280D, ECO-280I, ECO-3000, ECO-370D, ECO-370I, ECO-460D, ECO-460I, ECO-550D, ECO-550I, FF-35, FI-160, FI-1600, FI-160AR, FI-160D, FI-160I, FI-200, FI-200AR, FI-200D, FI-200H, FI-200HD, FI-200HI, FI-200I, FI-200W, FI-2300, FI-280D, FI-280I, FI-3000, FI-370D, FI-370I, FI-460D, FI-460I, FI-550D, FI-550I, GA-20, GA-40, HCV-10-11, HCV-10-21... (Other models you can see in the webshop)		

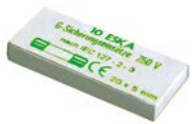
			
1			
<b>GEV No.</b>	358603	<b>Ref. No.</b>	12034888 RT30190120
<b>description</b>	fine fuse size ø5x20mm 2A slow-acting rated 250V Qty 10 pcs		

			
1			
<b>GEV No.</b>	358792	<b>Ref. No.</b>	12035115 RT40010225
<b>description</b>	fine fuse size ø6.3x32mm 10A slow-acting rated 250V Qty 10 pcs		

			
1			
<b>GEV No.</b>	358791	<b>Ref. No.</b>	12037374 RT40010224
<b>description</b>	fine fuse size ø6.3x32mm 6.3A slow-acting rated 250V Qty 10 pcs		

### fine fuse holders

			
1			
<b>GEV No.</b>	358382	<b>Ref. No.</b>	12035986 RT40011295
<b>description</b>	fuse holder suitable fuse ø5x30mm 10A rated 250V connection screw connection		

			
1			
<b>GEV No.</b>	550536	<b>Ref. No.</b>	12025158 R073005
<b>description</b>	fuse holder suitable fuse ø10x38mm 30A rated 600V		
<b>For models:</b>	ACE-061, ACE-101, ACE-102, ACE-201, ACE-202, ACG-061, ACG-101, ACG-102, ACG-201, ACG-202, AD-120, AD-120B, AD-120BBTDD-UK, AD-120C, AD-120CW, AD-120HY, AD-125, AD-125HRS, AD-125-SOFT, AD-90, AD-90BA, AD-90BBT, AD-90BDD, AD-90DD, ADE-120, ADE-120B, AE-061, AE-061W, AE-101, AE-101W, AE-102, AE-102W, AE-201, AE-202, AG-061, AG-061W, AG-101, AG-101W, AG-102, AG-102W, APE-061, APE-061W, APE-101, APE-101W, APE-102, APE-102W, APE-201, APE-202, APG-061, APG-061W...(Other models you can see in the webshop)		

			
1			
<b>GEV No.</b>	550348	<b>Ref. No.</b>	12033785 RT40011283
<b>description</b>	fuse holder WIELAND type WK4/THSI 6.3 U/V0 suitable fuse ø6.3x32mm 6.3A rated 600V		



## screw locks

## D0-system (NEOZED)



1

<b>GEV No.</b>	358043	<b>Ref. No.</b>	12033846 RT30190401
<b>description</b>	fuse size D01 16A rated 250/400V E14 ø 11mm L 36mm Qty 10 pcs		



1

<b>GEV No.</b>	358047	<b>Ref. No.</b>	12032709 RT30190405
<b>description</b>	fuse size D02 63A rated 250/400V E18 ø 15mm L 36mm Qty 10 pcs		

## gauge pieces (NEOZED)



1

<b>GEV No.</b>	358064	<b>Ref. No.</b>	12037278 RT40011238
<b>description</b>	gauge piece size D02 suitable for 16A		

## fuse holders



1

<b>GEV No.</b>	358060	<b>Ref. No.</b>	12032263 RT40011234
<b>description</b>	fuse holder suitable fuse D02 3-pole-pole 63A rated 400V		



1

<b>GEV No.</b>	358061	<b>Ref. No.</b>	12036497 RT40011235
<b>description</b>	fuse holder suitable fuse D02 ø 25mm mounting ø 18mm rated 400V L 30mm		

## overload switches



1

<b>GEV No.</b>	358524	<b>Ref. No.</b>	12033449 RT30140402
<b>description</b>	overload switch drop-away current 0.05A		

## electric accessories

## cables

## accessories

## protection hoses

## JOHN GUEST



1

<b>GEV No.</b>	550788	<b>Ref. No.</b>	12008694 X033027
<b>description</b>	screw connection ID ø 14mm for protection hose plastic Qty 1 pcs thread PG11		
<b>For models:</b>	FE7-05-1C, FE7-05-2C, FE-710, FE7-10-2C, FE7-10-4C, FE-71-15, FE-720, FE9-05, FE9-05-1C, FE9-05-2C, FE9-05AD, FE9-05PLUS, FE9-05PLUS-S, FE9-05S, FE9-05S-1C, FE9-05S-2C, FE9-05S-AD, FE9-05USMC, FE9-10, FE9-10-2C, FE9-10-4C, FE9-10AD, FE9-10PLUS, FE-91-20, FE-920, FG-710, FG-720, FI-200W		

## miscellaneous



1

<b>GEV No.</b>	550787	<b>Ref. No.</b>	11000146 3712300
<b>description</b>	protection pipe ID ø 23mm ED ø 28mm Qty 1m plastic for cable		
<b>For models:</b>	ECO-120, ECO-120B, ECO-160, ECO-160D, ECO-160I, ECO-200, ECO-200D, ECO-200H, ECO-200HD, ECO-200HI, ECO-200I, ECO-2700D, ECO-2700I, ECO-280D, ECO-280I, ECO-370D, ECO-370I, ECO-4000D, ECO-4000I, ECO-460D, ECO-460I, ECO-550D, ECO-550I, ECO-6000D, ECO-6000I, FE7-05-1C, FE7-05-2C, FE-710, FE7-10-2C, FE7-10-4C, FE-720, FE9-05, FE9-05-1C, FE9-05-2C, FE9-05AD, FE9-05PLUS, FE9-05PLUS-S, FE9-05S, FE9-05S-1C, FE9-05S-2C, FE9-05S-AD, FE9-05USMC, FE9-10, FE9-10-2C, FE9-10-4C, FE9-10AD, FE9-10PLUS, FI-160, FI-160AR, FI-160D...(Other models you can see in the webshop)		

## cable glands

## cable glands



1

<b>GEV No.</b>	551102	<b>Ref. No.</b>	6003010082
<b>description</b>	cable gland ID ø 10mm mounting ø 12mm Neoprene -30 up to +120°C Qty 1 pcs		
<b>For models:</b>	ATM-031, ATM-031-60Hz, ATM-051VCH, ATM-051VCH-60Hz, ATM-081VCH, ATM-081VCH-60Hz, ATM-101VCH, ATM-101VCH-60Hz, ATM-121VCH, ATM-121VCH-60Hz, ATM-121VCHP, ATM-161VCH		

			
1			
<b>GEV No.</b>	550998	<b>Ref. No.</b>	12037670 RT20220111
<b>description</b>	cable gland ID ø 2.5mm mounting ø 7mm rubber Qty 5 pcs		

			
1			
<b>GEV No.</b>	550311	<b>Ref. No.</b>	12018128 N023064
<b>description</b>	cable gland ID ø 6mm mounting ø 9mm ED ø 14mm Neoprene -30 up to +90°C Qty 10 pcs		
<b>For models:</b>	ECO-120, ECO-120B, FI-100, FI-100AR, FI-100B, FI-120, FI-120B, FI-120W, FI-30, FI-48, FI-48B, FI-48W, FI-50, FI-64, FI-64B, FI-64W, FI-72, MF-120, MF-48, MF-64		

threaded cable glands

screw connections

			
1			
<b>GEV No.</b>	550971	<b>Ref. No.</b>	12009963 R013022
<b>description</b>	cable gland thread PG16 cable ø 14mm mounting ø 22.5mm Qty 1 pcs plastic WS 27		
<b>For models:</b>	ACE-061, AE-061, AE-061W, APE-061, APE-061W, BME7-05, BME7-10, BME9-05, BME9-10, CGE6-41, FTE7-05, FTE7-05L, FTE7-05R, FTE9-05L, FTE9-05L-AD, FTE9-05PLUS-CL, FTE9-05PLUS-CR, FTE9-05PLUS-L, FTE9-05PLUS-R, FTE9-05R, FTE9-05R-AD, FTEC7-05L, FTEC9-05, FTEC9-05L, FTEC9-05L-AD, FTEC9-05R, FTEC9-05R-AD, FTEC9-05USMC, HCG-10-11, HCG-10-21, HCG-2-10-11, HCV-6-11, HE-6-11, HMG-10-11, HMG-10-21, HMG-2-10-11, HMM-6-11		

fastening nuts

			
1			
<b>GEV No.</b>	550578	<b>Ref. No.</b>	12009764 Q223016
<b>description</b>	nut thread PG21 H 4.6mm WS 32 nickel-plated brass Qty 1 pcs mounting ømm cable ømm		
<b>For models:</b>	ECO-120, ECO-120B, FI-100, FI-100AR, FI-100B, FI-120, FI-120B, FI-120W, FI-30, FI-48, FI-48B, FI-48W, FI-50, FI-64, FI-64B, FI-64W, FI-72, FI-80, FI-80W, LA-13M, LA-18MP, LA-AC-10M, LA-AC-10MA, LA-AC-10MP, LA-AC-13M, LA-AC-13MA, LA-AC-13MP, LA-AC-18M, LA-AC-18MA, LA-AC-18MP, LA-AC-25M, LA-AC-25MA, LA-AC-25MP, LA-E-10M, LA-E-10MA, LA-E-10MP, LA-E-13M, LA-E-13MA, LA-E-13MP, LA-E-18M, LA-E-18MA, LA-E-18MP, LA-E-25M, LA-E-25MA, LA-E-25MP, LA-V-10M, LA-V-10MP, LA-V-13M, LA-V-13MP, LA-V-18M...(Other models you can see in the webshop)		

			
1			
<b>GEV No.</b>	550974	<b>Ref. No.</b>	12010063 R023025
<b>description</b>	nut thread PG21 WS 34 plastic Qty 1 pcs thickness 7.5mm mounting ømm cable ømm		
<b>For models:</b>	ACE-061, ACE-101, AE-061, AE-101, AE-101W, APE-061, APE-101, APE-101W, CE9-20, CE9-20AD, CE9-20PLUS, CE9-40, CE9-40AD, CE9-40PLUS, CE9-41, CGE9-41, COE-061, CPE7-05, CPE7-05NC, CPE9-05, CPE9-05AD, CPE9-05AD-S, CPE9-05NC, CPE9-05PLUS, CPE9-05PLUS-S, CPE9-05S, CPE9-05SNC, CPG9-05, CPG9-05NC, CPG9-05S, CPG9-05SNC, ECO-160, ECO-160D, ECO-160I, ECO-200, ECO-200D, ECO-200H, ECO-200HD, ECO-200HI, ECO-200I, ECO-2700D, ECO-2700I, ECO-280D, ECO-280I, ECO-370D, ECO-370I, ECO-4000D, ECO-4000I, ECO-460D, ECO-460I...(Other models you can see in the webshop)		

ribbon cables

group 1

			
1			
<b>GEV No.</b>	402970	<b>Ref. No.</b>	12034267 EU41523
<b>description</b>	ribbon cable 10-pole L 1200mm plug type 2 row coded Qty 1m		

			
1			
<b>GEV No.</b>	400878	<b>Ref. No.</b>	12020200 R663102
<b>description</b>	ribbon cable 26-pole L 100mm plug type FC-26P raster size 2.54mm		
<b>For models:</b>	HME-10-11, HME-10-21, HME-20-11, HME-20-21, HME-2-10-11, HME-2-20-11, HME-6-11, HMP-10-11, HMP-10-21, HMP-20-11, HMP-20-21, HMP-2-10-11, HMP-6-11		

cable harnesses

			
1			
<b>GEV No.</b>	550774	<b>Ref. No.</b>	12018040 12018658 T113037 T113075
<b>description</b>	cable harness		
<b>For models:</b>	HVG-10-11, HVG-10-11UL, HVG-10-21, HVG-10-21UL, HVG-2-10-11, MFHVG-10-11, MFHVG-10-21		

			
1			
<b>GEV No.</b>	691855	<b>Ref. No.</b>	Z743001
<b>description</b>	cable harness for dishwasher		



## miscellaneous

1

<b>GEV No.</b>	550773	<b>Ref. No.</b>	12018558 T113036
<b>description</b>	connecting cable L 1.9m		
<b>For models:</b>	HCG-10-11, HCG-10-21, HCG-2-10-11, HCG-6-11, HGC-10-11, HGC-6-11, HGV-10-11, HVG-10-11, HVG-10-21, HVG-2-10-11		

## connection cables



<b>GEV No.</b>	403815	<b>Ref. No.</b>	12033832 RT88171040
<b>description</b>	connection cable 9-pole RS232/USB L 790mm		



<b>GEV No.</b>	403812	<b>Ref. No.</b>	12032677 RT4000235
<b>description</b>	connection cable L 1500mm 8-pole for combi-steamer suitable for SCC Linie 202 connection plug-in connection		



<b>GEV No.</b>	403811	<b>Ref. No.</b>	12033169 RT87201302
<b>description</b>	connection cable L 525mm 7-pole for combi-steamer CPC-Linie CPC/CM 61-202 connection plug-in connection plug type coded for PCB		



<b>GEV No.</b>	579001	<b>Ref. No.</b>	12035183 RT4000472
<b>description</b>	data cable L 1300mm 8-pole suitable for RATIONAL plug type RJ45		



<b>GEV No.</b>	579005	<b>Ref. No.</b>	12034255 RT87201300
<b>description</b>	data cable L 550mm 4-pole for combi-steamer suitable for CPC-Linie CPC/CM 61-202 plug type USB		



<b>GEV No.</b>	579002	<b>Ref. No.</b>	12035364 RT4000471
<b>description</b>	data cable L 800mm 8-pole for combi-steamer suitable for SCC Line plug type RJ45		

## terminals and connectors

## not insulated

## female fastons

## iron nickel-plated



<b>GEV No.</b>	550001	<b>Ref. No.</b>	12034541 RT40020100
<b>description</b>	female faston size 6.3x0.8mm 1.0-2.5mm <sup>2</sup> straight Fe gal Ni t.max. 340°C Qty 100 pcs		

## terminals

## terminal blocks



<b>GEV No.</b>	550239	<b>Ref. No.</b>	12025086 Z743006
<b>description</b>	lustre terminal 12-pole cross section 16mm <sup>2</sup> max. 75A max 500V temp.-resist. 150°C		
<b>For models:</b>	AD-90, AD-90DD, ADE-120, ADE-120B, ECO-120, ECO-120B, FI-80, FI-80AR, FI-80BBT-UK, FI-80W		

## connection terminals with screw/faston connections





<b>GEV No.</b>	505212	<b>Ref. No.</b>	12024110 Z603025
<b>description</b>	power terminal block 2-pole max. 20A max 600V connection ø2.5mm <sup>2</sup> / F6.3 temp.-resist. 150°C cross section 4mm <sup>2</sup>		
<b>For models:</b>	AD-15, AD-15D, AD-20C-UK, AD-21, AD-21B, AD-21BDD, AD-21C, AD-21D, AD-21DD, AD-21W, AD-505, AD-505-SOFT, CG-210G, CG-310G, CO-500, CO-500B, CO-500BDD, CO-500DD, CO-501, CO-501B, CO-501BDD, CO-501DD, CO-501-SOFT, CO-502B, CO-502BDD, CO-502DD, CO-502W, COP-503, COP-503B, COP-503BDD, COP-503DD, COP-503-SOFT, COP-504, COP-504B, COP-504BDD, COP-504DD, COP-504W, LVC-12, LVC-15, LVC-15D, LVC-21, LVC-21B, LVC-21C, LVC-21D, LVC-21W, LVR-10, LVR-14, LVR-14D, LVR-20, LVR-20B...(Other models you can see in the webshop)		





			
1			
<b>GEV No.</b>	550278	<b>Ref. No.</b>	12024382 U183046
<b>description</b>	power terminal block 3-pole max. 40A max 400V connection $\phi 6\text{mm}^2$ / F6.3 temp.-resist. 150°C cross section $6\text{mm}^2$		
<b>For models:</b>	BME6-05, BME7-05, BME9-05, BME9-05AD, BME9-05PLUS, BME9-05V-T, CE-410, CO-350, CO-350-B, CO-350-B-DD, CO-350-COLD, CO-350-COLD-B, CO-350-COLD-B-DD, CO-350-COLD-DD, CO-350-DD, CO-352-COLD, CO-352-COLD-B, CO-352-COLD-B-DD, CO-352-COLD-DD, CO-400, CO-400-B, CO-400-B-DD, CO-400-COLD, CO-400-COLD-B, CO-400-COLD-B-DD, CO-400-COLD-DD, CO-400-DD, CO-400-SOFT, CO-402-COLD, CO-402-COLD-B, CO-402-COLD-B-DD, CO-402-COLD-DD, CO-402W, CPG9-05, CPG9-05NC, CPG9-05S, CPG9-05SNC, CV6-20, CV6-40, FE-4, FG7-05-1C, FG7-05-2C, FG-710, FG7-10-2C, FG7-104C, FG7-10-4C, FG-720, FG9-05, FG9-05-1C, FG9-05-2C...(Other models you can see in the webshop)		

			
2			
<b>GEV No.</b>	550411	<b>Ref. No.</b>	12025183 12034943 EU220011 R253044
<b>description</b>	power terminal block 6-pole max. 40A max 450V connection $\phi 6\text{mm}^2$ / F6.3 temp.-resist. 150°C cross section $6\text{mm}^2$		
<b>For models:</b>	AD-45BBT, AD-48, AD-48B, AD-48BDD, AD-48C, AD-48D, AD-48DD, AD-48HY, AD-48W, AD-505, AD-505-SOFT, AD-64, AD-64B, AD-64BBT, AD-64BDD, AD-64BTDD, AD-64C, AD-64CW, AD-64D, AD-64DD, AD-64HY, AD-72, AD-72W, BME7-10, BME9-10, BME9-10AD, BME9-10PLUS, BME9-10V-T, CE6-20, CE6-40, CE6-41, CE7-20, CE7-20Q, CE7-40, CE7-40Q, CE7-41, CE7-41Q, CGE6-41, CGE7-231, CI9-20AD, CI9-20PLUS, CI9-40AD, CI9-40PLUS, CMF6-05, CO-500, CO-500B, CO-500BDD, CO-500DD, CO-501, CO-501B...(Other models you can see in the webshop)		

<h3>PCB terminal blocks</h3>			
			
1			
<b>GEV No.</b>	550779	<b>Ref. No.</b>	12019476 R663043
<b>description</b>	PCB terminal block 2-pole raster size 5mm PCB		
<b>For models:</b>	HCG-10-11, HCG-10-21, HCG-2-10-11, HCG-6-11, HME-20-11, HMG-10-11, HMG-10-11UL, HMG-10-21, HMG-10-21UL, HMG-2-10-11, HMG-6-11, HMI-10-11, HMI-10-11UL, HMI-10-21, HMI-10-21UL, HMI-2-10-11, HMI-6-11, HMI-6-11UL, HMM-10-11, HMM-10-11UL, HMM-10-21, HMM-10-21UL, HMM-20-11, HMM-20-11UL, HMM-20-21, HMM-2-10-11, HMM-6-11, HMM-6-11UL, HMP-20-11		

<h3>rail-mounted terminals</h3>			
WEIDMÜLLER			
<h3>feed-through terminals</h3>			
			
1			
<b>GEV No.</b>	550792	<b>Ref. No.</b>	12024229 Z103029
<b>description</b>	rail-mounted terminal 2.5mm <sup>2</sup> for DIN rail 35mm grey 1-pole		
<b>For models:</b>	ECO-160, ECO-1600, ECO-160D, ECO-160I, ECO-200, ECO-200D, ECO-200HI, ECO-200HD, ECO-200H, ECO-200I, ECO-2300, ECO-2700D, ECO-2700I, ECO-280D, ECO-280I, ECO-280H, ECO-3000, ECO-370D, ECO-370I, ECO-4000D, ECO-4000I, ECO-460D, ECO-460I, ECO-550D, ECO-550I, ECO-6000D, ECO-6000I, FI-160, FI-1600, FI-160AR, FI-160D, FI-160I, FI-200, FI-200AR, FI-200D, FI-200H, FI-200HD, FI-200HI, FI-200I, FI-200W, FI-200WL, FI-200WR, FI-2300, FI-2700D, FI-2700I, FI-280D, FI-280I, FI-3000, FI-370D, FI-370I, FI-4000D...(Other models you can see in the webshop)		

			
1			
<b>GEV No.</b>	551230	<b>Ref. No.</b>	12024942 R143011
<b>description</b>	rail-mounted terminal 70mm <sup>2</sup> for DIN rail 35mm grey 1-pole		
<b>For models:</b>	ACE-202, AE-202, APE-202, COE-202, ECO-280D, ECO-280I, ECO-370D, ECO-370I, ECO-460D, ECO-460I, ECO-550D, ECO-550I, FI-160, FI-160AR, FI-160D, FI-160I, FI-200, FI-200AR, FI-200D, FI-200H, FI-200HD, FI-200HI, FI-200I, FI-200W, FI-200WL, FI-200WR, FI-2700D, FI-2700I, FI-280D, FI-280I, FI-370D, FI-370I, FI-4000D, FI-4000I, FI-460D, FI-460I, FI-550D, FI-550I, FI-6000D, FI-6000I, HEI-20-21, HEM-20-21, HEP-20-21, HME-20-21, HME-2-20-11, HMM-20-21, HMM-20-21UL, HMM-40-11-USMC, HMP-20-21, VE-202...(Other models you can see in the webshop)		

<h3>accessories</h3>			
			
1			
<b>GEV No.</b>	550789	<b>Ref. No.</b>	12024199 Z263303
<b>description</b>	rail-mounted terminal grey for DIN rail 35mm		
<b>For models:</b>	ACG-061, ACG-101, ACG-102, ACG-201, ACG-202, AD-125, AD-125HRS, AD-125-SOFT, AG-061, AG-061W, AG-101, AG-101W, AG-102, AG-102W, AG-201, AG-202, APG-061, APG-061W, APG-101, APG-101W, APG-102, APG-102W, APG-201, APG-202, CE6-20, CE6-40, CE6-41, CE7-20, CE7-20Q, CE7-40, CE7-40Q, CE7-41, CE9-20, CE9-20AD, CE9-20PLUS, CGE6-41, CGE7-211, CGE7-41, CGE7-41H, CGE9-11, CGE9-41, CGE9-41AD, CGE9-41PLUS, CO-110, CO-110B, CO-110BDD, CO-110DD, CO-112, CO-112B, CO-112BDD...(Other models you can see in the webshop)		



## WIELAND

## rail-mounted terminals type 9700A



1

<b>GEV No.</b>	550374	<b>Ref. No.</b>	12025191 12035926 RT40011250 Z683097
<b>description</b>	rail-mounted terminal WIELAND type 9700A/10 S35 1.5-16mm <sup>2</sup> top-hat rail 35mm blue W 10mm L 49mm		
<b>For models:</b>	AD-120, AD-120B, AD-120BBTDD-UK, AD-120C, AD-120HY, AD-90, AD-90BA, AD-90BBT, AD-90BDD, AD-90DD, ADE-120, ADE-120B, CE6-20, CE6-40, CE6-41, CE7-41, CE9-40, FE9-05, FE9-05-1C, FE9-05-2C, FE9-05AD, FE9-05PLUS, FE9-05PLUS-S, FE9-05S, FE9-05S-1C, FE9-05S-2C, FE9-05S-AD, FE9-05USMC, FE9-10, FE9-10-2C, FE9-10-4C, FE9-10AD, FE9-10PLUS, FE-920, FI-100, FI-100AR, FI-100B, FI-100BBT-UK, FI-120, FI-1200, FI-120AR+DD, FI-120B, FI-120C, FI-120HY-CLINIC, FI-120W, FI-80BBT-UK, FI-80W, FI-900, FI-E-100, FTE9-10L...(Other models you can see in the webshop)		



1

<b>GEV No.</b>	550373	<b>Ref. No.</b>	12025214 12035988 RT40011202 Z683069
<b>description</b>	rail-mounted terminal WIELAND type 9700A/10 S35 1.5-16mm <sup>2</sup> top-hat rail 35mm grey W 10mm L 49mm		
<b>For models:</b>	AD-120, AD-120B, AD-120BBTDD-UK, AD-120C, AD-120HY, AD-90, AD-90BA, AD-90BBT, AD-90BDD, AD-90DD, ADE-120, ADE-120B, CE-410, CE9-40, CE9-41, CE9-41AD, CE9-41PLUS, FE9-05, FE9-05-1C, FE9-05-2C, FE9-05AD, FE9-05PLUS, FE9-05PLUS-S, FE9-05S, FE9-05S-1C, FE9-05S-2C, FE9-05S-AD, FE9-05USMC, FE9-10, FE9-10-2C, FE9-10-4C, FE9-10AD, FE9-10PLUS, FE-920, FI-100, FI-100AR, FI-100B, FI-100BBT-UK, FI-120, FI-1200, FI-120AR+DD, FI-120B, FI-120C, FI-120HY-CLINIC, FI-120W, FI-650R, FI-80BBT-UK, FI-80W, FI-900, FI-E-100...(Other models you can see in the webshop)		



1

<b>GEV No.</b>	550375	<b>Ref. No.</b>	12023727 Z683070
<b>description</b>	rail-mounted terminal WIELAND type 9700A/10 SL2 S35 1.5-16mm <sup>2</sup> top-hat rail 35mm yellow/green W 10mm L 53mm		
<b>For models:</b>	AD-120, AD-120B, AD-120BBTDD-UK, AD-120C, AD-120CW, AD-120HY, AD-90, AD-90BA, AD-90BBT, AD-90BDD, AD-90DD, ADE-120, ADE-120B, CE-410, CE9-40, FE9-05, FE9-05-1C, FE9-05-2C, FE9-05AD, FE9-05PLUS, FE9-05PLUS-S, FE9-05S, FE9-05S-1C, FE9-05S-2C, FE9-05S-AD, FE9-05USMC, FE9-10, FE9-10-2C, FE9-10-4C, FE9-10AD, FE9-10PLUS, FE-920, FI-100, FI-100AR, FI-100B, FI-100BBT-UK, FI-120, FI-1200, FI-120AR+DD, FI-120B, FI-120C, FI-120HY-CLINIC, FI-120W, FI-650R, FI-80BBT-UK, FI-80W, FI-900, FI-E-100, FTE9-10L, FTE9-10L+R...(Other models you can see in the webshop)		



1

<b>GEV No.</b>	550377	<b>Ref. No.</b>	12034956 RT40011252
<b>description</b>	rail-mounted terminal WIELAND type 9700A/16 S35 2.5-35mm <sup>2</sup> top-hat rail 35mm blue W 16mm L 59mm		



1

<b>GEV No.</b>	550376	<b>Ref. No.</b>	12034955 RT40011206
<b>description</b>	rail-mounted terminal WIELAND type 9700A/16 S35 2.5-35mm <sup>2</sup> top-hat rail 35mm grey W 16mm L 59mm		



1

<b>GEV No.</b>	550378	<b>Ref. No.</b>	12033543 RT40011233
<b>description</b>	rail-mounted terminal WIELAND type 9700A/16 SL2 S35 2.5-35mm <sup>2</sup> top-hat rail 35mm yellow/green W 16mm L 53mm		



1

<b>GEV No.</b>	550371	<b>Ref. No.</b>	12036964 RT40011216
<b>description</b>	rail-mounted terminal WIELAND type 9700A/6 S35 0.5-4mm <sup>2</sup> top-hat rail 35mm grey W 6mm L 46.6mm		





1

<b>GEV No.</b>	550372	<b>Ref. No.</b>	12035662 RT40011222
<b>description</b>	rail-mounted terminal WIELAND type 9700A/6 SL2 S35 0.5-4mm <sup>2</sup> top-hat rail 35mm yellow/green W 6mm L 48.5mm		







			
1			
<b>GEV No.</b>	550381	<b>Ref. No.</b>	12023373 P453025
<b>description</b>	rail-mounted terminal WIELAND type 9700A/8 S35 1.0-10mm <sup>2</sup> top-hat rail 35mm grey W 8mm L 46.6mm		
<b>For models:</b>	ACE-061, AD-125, AD-125HRS, AD-125-SOFT, AE-061, AE-061W, APE-061, APE-061W, CE6-20, CE6-40, CE6-41, CE7-20, CE7-20Q, CE7-40, CE7-40Q, CE7-41, CE9-20, CE9-20AD, CE9-20PLUS, CGE6-41, CGE7-208, CGE7-41, CGE7-41H, CGE9-11, CGE9-41, CGE9-41AD, CGE9-41PLUS, CO-110, CO-110B, CO-110BDD, CO-110DD, CO-112, CO-112B, CO-112BDD, CO-112DD, CO-142W, CO-142WDD, CO-170, CO-170B, CO-170BDD, CO-170DD, CO-170HRS, CO-170HRSDD, CO-170HRS-SOFT, CO-170-SOFT, CO-172, CO-172B, CO-172BDD, CO-172DD, COE-061...(Other models you can see in the webshop)		

<b>fuse terminal blocks</b>			
			
1			
<b>GEV No.</b>	550348	<b>Ref. No.</b>	12033785 RT40011283
<b>description</b>	fuse holder WIELAND type WK4/THSI 6.3 U/V0 suitable fuse ø6.3x-32mm 6.3A rated 600V		

<b>accessories</b>			
			
1			
<b>GEV No.</b>	550370	<b>Ref. No.</b>	12036737 RT40011203
<b>description</b>	terminal block end bracket clampsmm <sup>2</sup>		

<b>accessories</b>			
<b>marking labels</b>			
			
1			
<b>GEV No.</b>	505000	<b>Ref. No.</b>	12017607 12023957 Z213005 Z743005
<b>description</b>	signboard R/S/T/N		
<b>For models:</b>	AD-45BBT, AD-48, AD-48B, AD-48BDD, AD-48C, AD-48D, AD-48DD, AD-48HY, AD-48W, AD-64, AD-64B, AD-64BBT, AD-64BDD, AD-64BTDD, AD-64C, AD-64CW, AD-64D, AD-64DD, AD-64HY, AD-72, AD-72W, ECO-120, ECO-120B, FI-48, FI-48AR, FI-48B, FI-48B-BT-UK, FI-48C, FI-48D, FI-48HY-CLINIC, FI-48W, FI-50, FI-60DD, FI-64, FI-64AR, FI-64B, FI-64B-BT-UK, FI-64C, FI-64D, FI-64HY-CLINIC, FI-64W, FI-72, FI-72AR, FI-72W, FI-80, FI-80W, MF-48, MF-64		

<b>DIN rails</b>			
			
1			
<b>GEV No.</b>	551017	<b>Ref. No.</b>	12022603 Z103084
<b>description</b>	DIN rail W 35mm L 138mm hole distance 118mm		
<b>For models:</b>	COE-102, ECO-1600, ECO-2300, ECO-3000, FI-1600, FI-2300, FI-3000, FI-48, FI-48B, FI-48W, FI-50, FI-64, FI-64B, FI-64W, FI-72, HEI-10-21, HEM-10-11, HEM-10-21, HEM-20-11, HEM-6-11, HEP-10-11, HEP-10-21, HEP-20-11, HEP-6-11, HGC-10-21, HGP-10-21, HGV-10-21, HME-10-11, HME-10-21, HME-20-11, HME-2-10-11, HME-6-11, HMM-10-11, HMM-10-11UL, HMM-10-21, HMM-10-21UL, HMM-20-11, HMM-20-11UL, HMM-2-10-11, HMM-6-11, HMM-6-11UL, HMP-10-11, HMP-10-21, HMP-20-11, HMP-2-10-11, HMP-6-11, LC-AC-10, LC-AC-10A, LC-AC-14, LC-AC-14A...(Other models you can see in the webshop)		

			
1			
<b>GEV No.</b>	551016	<b>Ref. No.</b>	12022790 Z123018
<b>description</b>	DIN rail W 35mm L 55mm hole distance 35mm		
<b>For models:</b>	CE6-41, CE7-41, CGE6-41, CGE7-220, CGE7-41, CGE7-41H, CMF6-05, COE-102, COE-202, CPE6-05, ECO-1600, ECO-2300, ECO-3000, FE6-05, FE6-05TE, FE6-10, FE6-10TE, FI-1600, FI-2300, FI-30, FI-3000, FI-30AR+DD, FI-30B-BT-UK, FI-30-UK, FI-48, FI-48B, FI-48B-BT-UK, FI-48D, FI-48HY-CLINIC, FI-48W, FI-50, FI-64W, FTE6-05L, FTE6-05R, FTE6-10L, FTE6-10L+R, FTE6-10R, FTE7-05, FTE7-05L, FTE7-05R, FTE7-10, FTE7-10L, FTE7-10L+R, FTE7-10R, FTE9-05L, FTE9-05L-AD, FTE9-05PLUS-CL, FTE9-05PLUS-CR, FTE9-05PLUS-L, FTE9-05PLUS-R...(Other models you can see in the webshop)		

			
1			
<b>GEV No.</b>	551018	<b>Ref. No.</b>	12022528 Z103083
<b>description</b>	DIN rail W 35mm L 72mm hole distance 52mm		
<b>For models:</b>	ACE-061, ACE-101, ACE-102, ACE-201, ACE-202, AD-120, AD-120B, AD-120BBTDD-UK, AD-120C, AD-120CW, AD-120HY, AD-90, AD-90BA, AD-90BBT, AD-90BDD, AD-90DD, ADE-120, ADE-120B, AE-061, AE-101, AE-102, AE-201, AE-202, APE-061, APE-101, APE-102, APE-201, APE-202, CE6-20, CE6-40, CE6-41, CE7-20, CE7-20Q, CE7-40, CE7-40Q, CE7-41, CE7-41Q, CE9-20, CE9-40, CGE6-41, CGE7-207, CGE7-41, CGE7-41H, ECO-120, ECO-120B, ECO-1600, ECO-2300, ECO-3000, FF-35, FI-100...(Other models you can see in the webshop)		



### electronic magnets

1



<b>GEV No.</b>	691059	<b>Ref. No.</b>	12017119 R663030
<b>description</b>	lifting magnet 230V voltage AC 50/60Hz duty cycle 100% 0.1A		
<b>For models:</b>	HEI-10-11, HEI-20-11, HEI-6-11, HEM-10-11, HEM-20-11, HEM-6-11, HEP-10-11, HEP-20-11, HEP-6-11, HME-10-11, HME-10-21, HME-20-11, HME-20-21, HME-2-10-11, HME-2-20-11, HME-6-11, HMI-10-11, HMI-10-11UL, HMI-10-21, HMI-10-21UL, HMI-2-10-11, HMI-6-11, HMI-6-11UL, HMM-10-11, HMM-10-11UL, HMM-10-21, HMM-10-21UL, HMM-20-11, HMM-20-11UL, HMM-20-21, HMM-20-21UL, HMM-2-10-11, HMM-2-20-11, HMM-40-11-USMC, HMM-6-11, HMM-6-11UL, HMP-10-11, HMP-10-21, HMP-20-11, HMP-20-21, HMP-2-10-11, HMP-2-20-11, HMP-6-11, MFHMM-20-11		

2



<b>GEV No.</b>	691052	<b>Ref. No.</b>	12017052 R723012
<b>description</b>	lifting magnet 230V voltage AC 50/60Hz duty cycle 100% 0.2A		
<b>For models:</b>	HMG-10-11, HMG-10-11UL, HMG-10-21, HMG-10-21UL, HMG-2-10-11, HMG-6-11		

1



<b>GEV No.</b>	691057	<b>Ref. No.</b>	12016965 R723060
<b>description</b>	lifting magnet 230V voltage AC 50/60Hz duty cycle 100% 0.3A		
<b>For models:</b>	HMG-20-11		

### gas taps

PEL

22S/O series



1



<b>GEV No.</b>	109513	<b>Ref. No.</b>	12017435 T032101	
<b>description</b>	gas tap PEL type 22S/O gas inlet M20x1.5 (tube ø 12mm) bypass nozzle ø 1.1mm gas outlet M20x1.5 (tube ø 12/10mm) thermocouple connection M8x1 pilot connection M10x1 shaft ø 10x8mm shaft L 25/17mm shaft flat right			
<b>For models:</b>	BG7-05, BG7-10			
<b>spare parts for</b>	109513			
	<b>GEV No.</b>	100436	<b>Ref. No.</b>	—
	bypass nozzle type PEL22 bore ø 1.1mm thread M6x0.5			
	<b>GEV No.</b>	101058	<b>Ref. No.</b>	—
	magnet unit L 39mm D1 ø 15.4mm D2 ø 13.5mm suitable for PEL22/EGA24197 standard			
	<b>GEV No.</b>	101202	<b>Ref. No.</b>	—
	gas tap front part shaft ø 8x10mm shaft L 25/17mm shaft flat right/left suitable for PEL22			
	<b>GEV No.</b>	101230	<b>Ref. No.</b>	—
	thermocouple nut T1: M8x1 T2: M18x1 aluminium			
	<b>GEV No.</b>	101240	<b>Ref. No.</b>	—
	gas connection thread M20x1.5 tube ø 12/10mm for PEL gas taps with gasket and screws horizontal			
	<b>GEV No.</b>	101460	<b>Ref. No.</b>	—
	O-ring ø 12.37mm D1 ø 2.62mm suitable for PEL22			
	<b>GEV No.</b>	101461	<b>Ref. No.</b>	—
	screw kit suitable for PEL22 Qty 4 pcs			
<b>accessories for</b>	109513			
	<b>GEV No.</b>	100908	<b>Ref. No.</b>	12017481 T052101
	union screw thread M10x1 for pipe ø 4mm Qty 1 pcs			
	<b>GEV No.</b>	100909	<b>Ref. No.</b>	12008740 12016658 S312107 U265703
	union screw thread M10x1 for pipe ø 6mm Qty 1 pcs			
	<b>GEV No.</b>	101241	<b>Ref. No.</b>	—
	gas connection thread M20x1.5 tube ø 12/10mm for PEL gas taps vertical			
	<b>GEV No.</b>	101246	<b>Ref. No.</b>	12018994 U265026
	olive for pipe ø 4mm Qty 1 pcs			
	<b>GEV No.</b>	101248	<b>Ref. No.</b>	—
	olive for pipe ø 12mm Qty 1 pcs suitable for PEL			
	<b>GEV No.</b>	101249	<b>Ref. No.</b>	—
	olive for pipe ø 10mm Qty 1 pcs			
	<b>GEV No.</b>	101250	<b>Ref. No.</b>	—
	union nut thread M20x1.5 for pipe ø 10mm			



Table continues overleaf

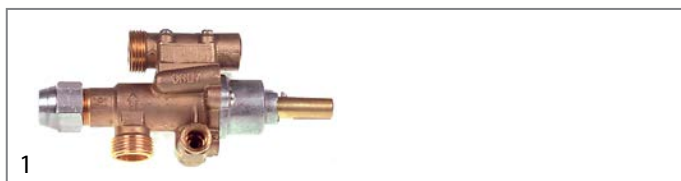

<b>accessories for</b> 109513				
	GEV No.	101251	Ref. No.	—
union nut thread M20x1.5 for pipe ø 12mm				
	GEV No.	101286	Ref. No.	12008476 S312108000 X205028
olive ID ø 6mm Qty 1 pcs				



1	GEV No.	109510	Ref. No.	12017451 T052100
<b>description</b> gas tap PEL type 22S/O gas inlet M20x1.5 (tube ø 12mm) bypass nozzle ø 1.3mm gas outlet M20x1.5 (tube ø 12/10mm) thermocouple connection M8x1 pilot connection M10x1 shaft ø 10x8mm shaft L 25/17mm shaft flat right				
<b>For models:</b> BG9-05, BG9-05I, BG9-10, BG9-10I				
<b>spare parts for</b> 109510				
	GEV No.	100438	Ref. No.	—
bypass nozzle type PEL22 bore ø 1.2mm thread M6x0.5				
	GEV No.	101058	Ref. No.	—
magnet unit L 39mm D1 ø 15.4mm D2 ø 13.5mm suitable for PEL22/EGA24197 standard				
	GEV No.	101202	Ref. No.	—
gas tap front part shaft ø 8x10mm shaft L 25/17mm shaft flat right/left suitable for PEL22				
	GEV No.	101230	Ref. No.	—
thermocouple nut T1: M8x1 T2: M18x1 aluminium				
	GEV No.	101240	Ref. No.	—
gas connection thread M20x1.5 tube ø 12/10mm for PEL gas taps with gasket and screws horizontal				
	GEV No.	101460	Ref. No.	—
O-ring ø 12.37mm D1 ø 2.62mm suitable for PEL22				
	GEV No.	101461	Ref. No.	—
screw kit suitable for PEL22 Qty 4 pcs				
<b>accessories for</b> 109510				
	GEV No.	100908	Ref. No.	12017481 T052101
union screw thread M10x1 for pipe ø 4mm Qty 1 pcs				
	GEV No.	100909	Ref. No.	12008740 12016658 S312107 U265703
union screw thread M10x1 for pipe ø 6mm Qty 1 pcs				
	GEV No.	101241	Ref. No.	—
gas connection thread M20x1.5 tube ø 12/10mm for PEL gas taps vertical				
	GEV No.	101246	Ref. No.	12018994 U265026
olive for pipe ø 4mm Qty 1 pcs				
	GEV No.	101248	Ref. No.	—
olive for pipe ø 12mm Qty 1 pcs suitable for PEL				
	GEV No.	101249	Ref. No.	—
olive for pipe ø 10mm Qty 1 pcs				

<b>accessories for</b> 109510				
	GEV No.	101250	Ref. No.	—
union nut thread M20x1.5 for pipe ø 10mm				
	GEV No.	101251	Ref. No.	—
union nut thread M20x1.5 for pipe ø 12mm				
	GEV No.	101286	Ref. No.	12008476 S312108000 X205028
olive ID ø 6mm Qty 1 pcs				

22S/V series









1	GEV No.	106421	Ref. No.	12026757 K002B42010
<b>description</b> gas tap PEL type 22S/V gas inlet M20x1.5 (tube ø 12mm) bypass nozzle ø 0mm gas outlet M20x1.5 (tube ø 12/10mm) thermocouple connection M9x1 pilot connection M10x1 shaft ø 10x8mm shaft L 25/17mm shaft flat lower				
<b>spare parts for</b> 106421				
	GEV No.	101058	Ref. No.	—
magnet unit L 39mm D1 ø 15.4mm D2 ø 13.5mm suitable for PEL22/EGA24197 standard				
	GEV No.	101201	Ref. No.	—
gas tap front part shaft ø 10x8mm shaft L 25/17mm shaft flat upper/lower suitable for PEL22				
	GEV No.	101231	Ref. No.	—
thermocouple nut T1: M9x1 T2: M18x1				
	GEV No.	101241	Ref. No.	—
gas connection thread M20x1.5 tube ø 12/10mm for PEL gas taps vertical				
	GEV No.	101460	Ref. No.	—
O-ring ø 12.37mm D1 ø 2.62mm suitable for PEL22				
	GEV No.	101461	Ref. No.	—
screw kit suitable for PEL22 Qty 4 pcs				
	GEV No.	106191	Ref. No.	—
bypass nozzle type PEL22 bore ø 0mm thread M6x0.5				
<b>accessories for</b> 106421				
	GEV No.	100908	Ref. No.	12017481 T052101
union screw thread M10x1 for pipe ø 4mm Qty 1 pcs				
	GEV No.	100909	Ref. No.	12008740 12016658 S312107 U265703
union screw thread M10x1 for pipe ø 6mm Qty 1 pcs				
	GEV No.	101240	Ref. No.	—
gas connection thread M20x1.5 tube ø 12/10mm for PEL gas taps with gasket and screws horizontal				











Table continues overleaf

accessories for		106421		
	GEV No.	101246	Ref. No.	12018994 U265026
olive for pipe ø 4mm Qty 1 pcs				
	GEV No.	101248	Ref. No.	—
olive for pipe ø 12mm Qty 1 pcs suitable for PEL				
	GEV No.	101249	Ref. No.	—
olive for pipe ø 10mm Qty 1 pcs				
	GEV No.	101250	Ref. No.	—
union nut thread M20x1.5 for pipe ø 10mm				
	GEV No.	101251	Ref. No.	—
union nut thread M20x1.5 for pipe ø 12mm				
	GEV No.	101286	Ref. No.	12008476 S312108000 X205028
olive ID ø 6mm Qty 1 pcs				
	GEV No.	101331	Ref. No.	—
adapter suitable for PEL22 for flanged cable 10/12mm				

**23S/O series**



<b>1</b>	<b>GEV No.</b>	101091	<b>Ref. No.</b>	12027178 ICR10038
<b>description</b>	gas tap PEL type 23S/O gas inlet M28x1.5 (tube ø 20mm) bypass nozzle ø 0.35mm gas outlet M24x1.5 (tube ø 16mm) thermocouple connection M9x1 pilot connection M10x1 shaft ø 10x8mm shaft L 35/19mm shaft flat upper			
<b>spare parts for</b>	101091			
	GEV No.	100455	Ref. No.	—
bypass nozzle type PEL23/24 bore ø 0.35mm thread M8x0.5				
	GEV No.	101045	Ref. No.	—
magnet unit T1: M9x1 T2: M22x1 L 46mm ø 18mm suitable for PEL23S M9x1				
	GEV No.	101244	Ref. No.	—
gas connection thread M24x1.5 tube ø 12/16mm horizontal for PEL gas taps				
	GEV No.	101336	Ref. No.	—
gas tap front part shaft ø 10x8mm shaft L 35/17mm shaft flat upper/lower suitable for PEL23S				
	GEV No.	101463	Ref. No.	—
screw suitable for PEL23S Qty 4 pcs				
	GEV No.	528455	Ref. No.	—
O-ring Viton thickness 2.62mm ID ø 18.72mm Qty 1 pcs				
<b>accessories for</b>	101091			
	GEV No.	100908	Ref. No.	12017481 T052101
union screw thread M10x1 for pipe ø 4mm Qty 1 pcs				

accessories for		101091		
	GEV No.	100909	Ref. No.	12008740 12016658 S312107 U2650703
union screw thread M10x1 for pipe ø 6mm Qty 1 pcs				
	GEV No.	101246	Ref. No.	12018994 U265026
olive for pipe ø 4mm Qty 1 pcs				
	GEV No.	101252	Ref. No.	—
union nut thread M24x1.5 for pipe ø 12mm				
	GEV No.	101253	Ref. No.	12008865 S312105
union nut thread M24x1.5 PEL for pipe ø 16mm				
	GEV No.	101254	Ref. No.	12008921 S312103
union nut thread M28x1.5 tube ø 20mm				
	GEV No.	101255	Ref. No.	—
olive for pipe ø 12mm Qty 1 pcs				
	GEV No.	101256	Ref. No.	12008773
olive for pipe ø 16mm Qty 1 pcs				
	GEV No.	101257	Ref. No.	12008828 S312104
olive for pipe ø 20mm Qty 1 pcs				
	GEV No.	101286	Ref. No.	12008476 S312108000 X205028
olive ID ø 6mm Qty 1 pcs				
	GEV No.	110080	Ref. No.	12032882 ICR15738
knob ø 70mm shaft ø 10x8mm shaft flat universal				
	GEV No.	112206	Ref. No.	—
knob dial plate silver gas tap PEL21/22/23 t.max.°C ED ø 63mm ID ø 45.5mm				

**23S/V series**



<b>1</b>	<b>GEV No.</b>	109511	<b>Ref. No.</b>	12009525 S312101
<b>description</b>	gas tap PEL type 23S/V gas inlet M28x1.5 (tube ø 20mm) bypass nozzle ø 1.4mm gas outlet M24x1.5 (tube ø 16/12mm) thermocouple connection M9x1 pilot connection M10x1 shaft ø 10x8mm shaft L 25/17mm shaft flat lower			
<b>For models:</b>	MG7-10, MG7-10BM, MG9-10, MG9-10BM, MG9-10BMS, MG9-10S, MG9-15, MG9-15BM, MG9-15BM316, MG9-15BMS, MG9-15S, MG9-20, MG9-20S, MPG9-10, MPG9-10BM, MPG9-10BMS, MPG9-10S, MPG9-15, MPG9-15BM, MPG9-15BMS, MPG9-15S, MPG9-20, MPG9-20S			
<b>spare parts for</b>	109511			
	GEV No.	100455	Ref. No.	—
bypass nozzle type PEL23/24 bore ø 0.35mm thread M8x0.5				

Table continues overleaf



spare parts for		109511		
	GEV No.	101059	Ref. No.	—
magnet unit T1: M10x1 T2: M22x1 L 46mm ø 18mm suitable for PEL23S M10x1				
	GEV No.	101204	Ref. No.	—
gas tap front part shaft ø 10x8mm shaft L 25/17mm shaft flat upper/lower suitable for PEL23S				
	GEV No.	101245	Ref. No.	—
gas connection thread M24x1.5 tube ø 12/16mm vertical for PEL gas taps				
	GEV No.	101463	Ref. No.	—
screw suitable for PEL23S Qty 4 pcs				
	GEV No.	528455	Ref. No.	—
O-ring Viton thickness 2.62mm ID ø 18.72mm Qty 1 pcs				
accessories for		109511		
	GEV No.	100908	Ref. No.	12017481 T052101
union screw thread M10x1 for pipe ø 4mm Qty 1 pcs				
	GEV No.	100909	Ref. No.	12008740 12016658 S312107 U265703
union screw thread M10x1 for pipe ø 6mm Qty 1 pcs				
	GEV No.	101246	Ref. No.	12018994 U265026
olive for pipe ø 4mm Qty 1 pcs				
	GEV No.	101252	Ref. No.	—
union nut thread M24x1.5 for pipe ø 12mm				
	GEV No.	101253	Ref. No.	12008865 S312105
union nut thread M24x1.5 PEL for pipe ø 16mm				
	GEV No.	101254	Ref. No.	12008921 S312103
union nut thread M28x1.5 tube ø 20mm				
	GEV No.	101255	Ref. No.	—
olive for pipe ø 12mm Qty 1 pcs				
	GEV No.	101256	Ref. No.	12008773
olive for pipe ø 16mm Qty 1 pcs				
	GEV No.	101257	Ref. No.	12008828 S312104
olive for pipe ø 20mm Qty 1 pcs				
	GEV No.	101286	Ref. No.	12008476 S312108000 X205028
olive ID ø 6mm Qty 1 pcs				
	GEV No.	110080	Ref. No.	12032882 ICR15738
knob ø 70mm shaft ø 10x8mm shaft flat universal				
	GEV No.	112206	Ref. No.	—
knob dial plate silver gas tap PEL21/22/23 t.max.°C ED ø 63mm ID ø 45.5mm				

**COPRECI**
**CAL-3200**



spare parts for		109503		
	GEV No.	106173	Ref. No.	—
magnet unit L 43mm D1 ø 19mm D2 ø 15.5mm suitable for COPRECI				
accessories for		109503		
	GEV No.	100944	Ref. No.	12007951 Q221336
union nut thread M18x1.5 for pipe ø 12mm				
	GEV No.	101273	Ref. No.	12008501 U055043
olive for pipe ø 12mm L 9.5mm brass Qty 1 pcs suitable for universal				

spare parts for		109500		
	GEV No.	106173	Ref. No.	—
magnet unit L 43mm D1 ø 19mm D2 ø 15.5mm suitable for COPRECI				
accessories for		109500		
	GEV No.	100944	Ref. No.	12007951 Q221336
union nut thread M18x1.5 for pipe ø 12mm				
	GEV No.	101273	Ref. No.	12008501 U055043
olive for pipe ø 12mm L 9.5mm brass Qty 1 pcs suitable for universal				

description		12017387 12040023 R642100 R642100000 U262106		
gas tap COPRECI type CAL-3200 gas inlet M18x1.5 (tube ø 12mm) bypass nozzle ø 0.55mm gas outlet M18x1.5 (tube ø 12mm) thermo-couple connection M8x1 pilot connection 1/8" shaft ø 10x8mm shaft flat right shaft L 46/12mm with pipe outlet				
For models:		CG7-20, CG-7200, CG7-40, CG-7400, CG7-41, CG-7415, CG7-61, CG-7615, CGB7-61, CGE7-140, CGE7-41, FTG-7050L, FTG-7050R, FTG-7100L, FTG-7100L+R, FTG-7100R		







1

<b>GEV No.</b>	109509	<b>Ref. No.</b>	12017385 R612100
<b>description</b>	gas tap COPRECI type CAL-3200 gas inlet M18x1.5 (tube ø 12mm) bypass nozzle ø 0.8mm gas outlet M18x1.5 (tube ø 12mm) thermo-couple connection M8x1 pilot connection 1/8" shaft ø 10x8mm shaft flat right shaft L 29/12mm with pipe outlet		
<b>For models:</b>	CG-110, CG-2000-2P, CPG7-05, FTG-9050L, FTG-9050R, FTG9-05L, FTG9-05R, FTG9-05VL, FTG9-05VR, FTG-9100L, FTG-9100L+R, FTG-9100R, FTG9-10L, FTG9-10L+R, FTG9-10R, FTG9-10VL, FTG9-10VL+R, FTG9-10VR, FTG9-11L, FTG9-11L+R, FTG9-11R, FTGC9-05L, FTGC9-05R, FTGC9-10L, FTGC9-10L+R, FTGC9-10R, FTGC9-11L, FTGC9-11L+R, FTGC9-11R		
<b>spare parts for</b>	109509		
	<b>GEV No.</b>	106173	<b>Ref. No.</b> —
magnet unit L 43mm D1 ø 19mm D2 ø 15.5mm suitable for COPRECI			
<b>accessories for</b>	109509		
	<b>GEV No.</b>	100944	<b>Ref. No.</b> 12007951 Q221336
union nut thread M18x1.5 for pipe ø 12mm			
	<b>GEV No.</b>	101273	<b>Ref. No.</b> 12008501 U055043
olive for pipe ø 12mm L 9.5mm brass Qty 1 pcs suitable for universal			





1

<b>GEV No.</b>	109501	<b>Ref. No.</b>	12017386 U262107
<b>description</b>	gas tap COPRECI type CAL-3200 gas inlet M18x1.5 (tube ø 12mm) bypass nozzle ø 0.9mm gas outlet M18x1.5 (tube ø 12mm) thermo-couple connection M8x1 pilot connection 1/8" shaft ø 10x8mm shaft flat right shaft L 46/12mm with pipe outlet		
<b>For models:</b>	CG-7115, CG-7200, CG7-40, CG-7400, CG7-41, CG-7415, CG7-61, CG-7615, CGB7-61, CGE7-137, CGE7-41		
<b>spare parts for</b>	109501		
	<b>GEV No.</b>	106173	<b>Ref. No.</b> —
magnet unit L 43mm D1 ø 19mm D2 ø 15.5mm suitable for COPRECI			
	<b>GEV No.</b>	109413	<b>Ref. No.</b> 12016664 U022111
bypass nozzle type COPRECI CAL-3200 bore ø 0.9mm thread M8x0.75 WS 11			
<b>accessories for</b>	109501		
	<b>GEV No.</b>	100944	<b>Ref. No.</b> 12007951 Q221336
union nut thread M18x1.5 for pipe ø 12mm			
	<b>GEV No.</b>	101273	<b>Ref. No.</b> 12008501 U055043
olive for pipe ø 12mm L 9.5mm brass Qty 1 pcs suitable for universal			





1



<b>GEV No.</b>	109504	<b>Ref. No.</b>	12009464 U249402 U262113
<b>description</b>	gas tap COPRECI type CAL-3200 gas inlet M18x1.5 (tube ø 12mm) bypass nozzle ø 0.9mm gas outlet M18x1.5 (tube ø 12mm) thermo-couple connection M8x1 pilot connection 1/8" shaft ø 10x8mm shaft flat right shaft L 30/12mm with pipe outlet		
<b>For models:</b>	CG-1002, CG-1502, CG-2000, CG-2000-2P, CG-2002, CG-2002P, CG-2005, CG-210, CG-210G, CG-300S, CG-310, CG-310G, CG9-20, CG9-40, CG9-41, CG9-51L, CG9-51LC, CG9-51R, CG9-51RC, CG9-60, CG9-61, CG9-82, CGE9-41, CPG9-05, CPG9-05NC, CPG9-05S, CPG9-05SNC, FTG7-05VL, FTG7-05VR, FTG7-10VL, FTG7-10VL+R, FTG7-10VR		
<b>spare parts for</b>	109504		
	<b>GEV No.</b>	106173	<b>Ref. No.</b> —
magnet unit L 43mm D1 ø 19mm D2 ø 15.5mm suitable for COPRECI			
	<b>GEV No.</b>	109413	<b>Ref. No.</b> 12016664 U022111
bypass nozzle type COPRECI CAL-3200 bore ø 0.9mm thread M8x0.75 WS 11			
<b>accessories for</b>	109504		
	<b>GEV No.</b>	100944	<b>Ref. No.</b> 12007951 Q221336
union nut thread M18x1.5 for pipe ø 12mm			
	<b>GEV No.</b>	101273	<b>Ref. No.</b> 12008501 U055043
olive for pipe ø 12mm L 9.5mm brass Qty 1 pcs suitable for universal			











1





<b>GEV No.</b>	109506	<b>Ref. No.</b>	12018189 U262111
<b>description</b>	gas tap COPRECI type CAL-3200 gas inlet M18x1.5 (tube ø 12mm) bypass nozzle ø 0.9mm gas outlet M18x1.5 (tube ø 12mm) thermo-couple connection pilot connection 1/8" shaft ø 10x8mm shaft flat right shaft L 29/12mm with pipe outlet		
<b>For models:</b>	CG-2000, CG-2000-2P, CG9-41, CG9-61, CG9-82		
<b>spare parts for</b>	109506		
	<b>GEV No.</b>	106173	<b>Ref. No.</b> —
magnet unit L 43mm D1 ø 19mm D2 ø 15.5mm suitable for COPRECI			
	<b>GEV No.</b>	109413	<b>Ref. No.</b> 12016664 U022111
bypass nozzle type COPRECI CAL-3200 bore ø 0.9mm thread M8x0.75 WS 11			
<b>accessories for</b>	109506		
	<b>GEV No.</b>	100944	<b>Ref. No.</b> 12007951 Q221336
union nut thread M18x1.5 for pipe ø 12mm			
	<b>GEV No.</b>	101273	<b>Ref. No.</b> 12008501 U055043
olive for pipe ø 12mm L 9.5mm brass Qty 1 pcs suitable for universal			



 <p>1</p>			
<b>GEV No.</b>	109049	<b>Ref. No.</b>	12018190 U262101
<b>description</b>	gas tap COPRECI type CAL-3200 gas inlet M18x1.5 (tube ø 12mm) bypass nozzle ø 0.9mm gas outlet M18x1.5 (tube ø 12mm) thermo-couple connection pilot connection 1/8" shaft ø 10x8mm shaft flat right shaft L 46/12mm		
<b>For models:</b>	CG-7200, CG-7400, CG-7415, CG-7615		
<b>spare parts for</b>	109049		
	<b>GEV No.</b>	106173	<b>Ref. No.</b> —
	magnet unit L 43mm D1 ø 19mm D2 ø 15.5mm suitable for COPRECI		
	<b>GEV No.</b>	109413	<b>Ref. No.</b> 12016664 U022111
	bypass nozzle type COPRECI CAL-3200 bore ø 0.9mm thread M8x0.75 WS 11		
<b>accessories for</b>	109049		
	<b>GEV No.</b>	100944	<b>Ref. No.</b> 12007951 Q221336
	union nut thread M18x1.5 for pipe ø 12mm		
	<b>GEV No.</b>	101273	<b>Ref. No.</b> 12008501 U055043
	olive for pipe ø 12mm L 9.5mm brass Qty 1 pcs suitable for universal		



 <p>1</p>			
<b>GEV No.</b>	109060	<b>Ref. No.</b>	12018400 T032103
<b>description</b>	gas tap COPRECI type CAL-3200 gas inlet M18x1.5 (tube ø 12mm) bypass nozzle ø 1.1mm gas outlet M18x1.5 (tube ø 12mm) thermo-couple connection M8x1 pilot connection 1/8" shaft ø 10x8mm shaft flat right shaft L 29/12mm		
<b>For models:</b>	BG7-05, BG7-05I, BG7-10, BG7-10I		
<b>spare parts for</b>	109060		
	<b>GEV No.</b>	106173	<b>Ref. No.</b> —
	magnet unit L 43mm D1 ø 19mm D2 ø 15.5mm suitable for COPRECI		
<b>accessories for</b>	109060		
	<b>GEV No.</b>	100944	<b>Ref. No.</b> 12007951 Q221336
	union nut thread M18x1.5 for pipe ø 12mm		
	<b>GEV No.</b>	101273	<b>Ref. No.</b> 12008501 U055043
	olive for pipe ø 12mm L 9.5mm brass Qty 1 pcs suitable for universal		

 <p>1</p>			
<b>GEV No.</b>	109508	<b>Ref. No.</b>	12012263 U222101
<b>description</b>	gas tap COPRECI type CAL-3200 gas inlet M18x1.5 (tube ø 12mm) bypass nozzle ø 1.2mm gas outlet M18x1.5 (tube ø 12mm) thermo-couple connection M8x1 pilot connection 1/8" shaft ø 10x8mm shaft flat right shaft L 30/12mm with pipe outlet		
<b>For models:</b>	CG9-10, CG9-11, CG-9110, HP-G-15		
<b>spare parts for</b>	109508		
	<b>GEV No.</b>	106173	<b>Ref. No.</b> —
	magnet unit L 43mm D1 ø 19mm D2 ø 15.5mm suitable for COPRECI		
<b>accessories for</b>	109508		
	<b>GEV No.</b>	100944	<b>Ref. No.</b> 12007951 Q221336
	union nut thread M18x1.5 for pipe ø 12mm		
	<b>GEV No.</b>	101273	<b>Ref. No.</b> 12008501 U055043
	olive for pipe ø 12mm L 9.5mm brass Qty 1 pcs suitable for universal		

 <p>1</p>			
<b>GEV No.</b>	109502	<b>Ref. No.</b>	12011453 U772100
<b>description</b>	gas tap COPRECI type CAL-3200 gas inlet M18x1.5 (tube ø 12mm) bypass nozzle ø 1.2mm gas outlet M18x1.5 (tube ø 12mm) thermo-couple connection M8x1 pilot connection 1/8" shaft ø 10x8mm shaft flat right shaft L 46/12mm with pipe outlet		
<b>For models:</b>	CG7-10, CG7-11		
<b>spare parts for</b>	109502		
	<b>GEV No.</b>	106173	<b>Ref. No.</b> —
	magnet unit L 43mm D1 ø 19mm D2 ø 15.5mm suitable for COPRECI		
<b>accessories for</b>	109502		
	<b>GEV No.</b>	100944	<b>Ref. No.</b> 12007951 Q221336
	union nut thread M18x1.5 for pipe ø 12mm		
	<b>GEV No.</b>	101273	<b>Ref. No.</b> 12008501 U055043
	olive for pipe ø 12mm L 9.5mm brass Qty 1 pcs suitable for universal		



1

<b>GEV No.</b>	109505	<b>Ref. No.</b>	12009462 U702101
<b>description</b>	gas tap COPRECI type CAL-3200 gas inlet M18x1.5 (tube ø 12mm) bypass nozzle ø 1.3mm gas outlet M18x1.5 (tube ø 12mm) thermocouple connection M8x1 pilot connection 1/8" shaft ø 10x8mm shaft flat right shaft L 29/12mm with pipe outlet		
<b>For models:</b>	BG9-05, BG9-05I, BG9-10, BG9-10I, CG-1002, CG-1502, CG-2002, CG-2002P, CG9-40, CG9-41, CG9-51L, CG9-51LC, CG9-51R, CG9-51RC, CG9-60, CG9-61, CG9-82, CGE9-41, HP-G-15, HPG-15		
<b>spare parts for</b>	109505		
	GEV No.	106173	Ref. No. —
	magnet unit L 43mm D1 ø 19mm D2 ø 15.5mm suitable for COPRECI		
<b>accessories for</b>	109505		
	GEV No.	100944	Ref. No. 12007951 Q221336
	union nut thread M18x1.5 for pipe ø 12mm		
	GEV No.	101273	Ref. No. 12008501 U055043
	olive for pipe ø 12mm L 9.5mm brass Qty 1 pcs suitable for universal		







1

<b>GEV No.</b>	109185	<b>Ref. No.</b>	12009457 U912102
<b>description</b>	gas tap COPRECI type CAL-3200 gas inlet pipe flange ø21mm bypass nozzle ø 1mm gas outlet 3/8" (tube ø 10mm) thermocouple connection M8x1 pilot connection 1/8" shaft ø 8x6.5mm shaft flat upper shaft L 29/12mm		
<b>For models:</b>	CPG9-05, CPG9-05AD, CPG9-05AD-S, CPG9-05NC, CPG9-05PLUS, CPG9-05PLUS-S, CPG9-05S, CPG9-05SNC		





1

<b>GEV No.</b>	109000	<b>Ref. No.</b>	12017322 U022101
<b>description</b>	gas tap COPRECI type CAL-3200 gas inlet pipe flange ø27mm bypass nozzle ø 0.55mm gas outlet 3/8" (tube ø 10mm) thermocouple connection M8x1 pilot connection 1/8" shaft ø 10x8mm shaft flat right shaft L 30/12mm		
<b>For models:</b>	CG9-10, CG9-11, CG9-20, CG9-40, CG9-41, CG9-51L, CG9-51LC, CG9-51R, CG9-51RC, CG9-60, CG9-61, CG9-82, CGE9-41, CGF9-120D, CGF9-120I, CGF9-121D, CGF9-121I, CPG9-05, CPG9-05S		
<b>spare parts for</b>	109000		
	GEV No.	106173	Ref. No. —
	magnet unit L 43mm D1 ø 19mm D2 ø 15.5mm suitable for COPRECI		

<b>accessories for</b>	109000			
	GEV No.	100944	Ref. No.	12007951 Q221336
	union nut thread M18x1.5 for pipe ø 12mm			
	GEV No.	101273	Ref. No.	12008501 U055043
	olive for pipe ø 12mm L 9.5mm brass Qty 1 pcs suitable for universal			
	GEV No.	109195	Ref. No.	12016681 U022113
	bypass nozzle type COPRECI bore ø 1.3mm thread M8x0.75 WS 11			





1

<b>GEV No.</b>	109095	<b>Ref. No.</b>	12011431 U022108
<b>description</b>	gas tap COPRECI type CAL-3200 gas inlet pipe flange ø27mm bypass nozzle ø 1.3mm gas outlet M18x1.5 (tube ø 12mm) thermocouple connection M8x1 pilot connection 1/8" shaft ø 10x8mm shaft flat right shaft L 29/12mm		
<b>For models:</b>	BG9-05, BG9-05I, BG9-10, BG9-10I		
<b>spare parts for</b>	109095		
	GEV No.	106173	Ref. No. —
	magnet unit L 43mm D1 ø 19mm D2 ø 15.5mm suitable for COPRECI		
<b>accessories for</b>	109095		
	GEV No.	100944	Ref. No. 12007951 Q221336
	union nut thread M18x1.5 for pipe ø 12mm		
	GEV No.	101273	Ref. No. 12008501 U055043
	olive for pipe ø 12mm L 9.5mm brass Qty 1 pcs suitable for universal		

### CAL-5200



1

<b>GEV No.</b>	107693	<b>Ref. No.</b>	12018254 U872107
<b>description</b>	gas tap COPRECI type CAL-5200 gas inlet pipe flange ø21mm bypass nozzle ø 0.7mm gas outlet 3/8" thermocouple connection M8x1 pilot connection shaft ø 8x6.5mm shaft L 32/12mm shaft flat right		
<b>For models:</b>	CGP9-10, CGP9-11		
<b>accessories for</b>	107693		
	GEV No.	101537	Ref. No. 12010025 12017549 Q307034
	gasket ID ø 8mm ED ø 11.5mm H 3mm Qty 1 pcs		
	GEV No.	101538	Ref. No. 12025294 Z982018
	clamp		







**CPMM18700**



1

<b>GEV No.</b>	106665	<b>Ref. No.</b>	12009411 12038526 H122103 U912101
<b>description</b>	gas tap COPRECI type CPMM18700 gas inlet pipe flange ø21mm bypass nozzle ø 0.5 / 0.75 / 0.9 / 1.15 / 1.45mm gas outlet 3/8" (tube ø 10mm) thermocouple connection M8x1 pilot connection M10x1 shaft ø 8x6.5mm shaft flat upper shaft L 41/12mm front fixing M15x1		
<b>For models:</b>	CG7-20, CG7-30D, CG7-30I, CG7-31D, CG7-31I, CG7-40, CG7-41, CG7-50, CG7-51, CG7-60, CG7-61, CGB7-61, CGB7-61R, CGE7-41		
<b>spare parts for</b>	106665		
	<b>GEV No.</b>	107563	<b>Ref. No.</b> 12002030
	flange for gas tap L 48mm		





1

<b>GEV No.</b>	107314	<b>Ref. No.</b>	12003724 12038522 R902102
<b>description</b>	gas tap with ignition flame COPRECI type CPMM18700 gas inlet pipe flange ø21mm bypass nozzle ø 0.9mm gas outlet 3/8" (tube ø 10mm) thermocouple connection M8x1 pilot connection M10x1 shaft ø 8x6.5mm shaft L 41/12mm shaft flat right front fixing M15x1		
<b>For models:</b>	FTG7-05VL, FTG7-05VR, FTG7-10VL, FTG7-10VL+R, FTG7-10VR, FTG9-05LV-AD, FTG9-05PLUS-LV, FTG9-05PLUS-RV, FTG9-05RV-AD, FTG9-05VL, FTG9-05VR, FTG9-10L+RV-AD, FTG9-10LV-AD, FTG9-10PLUS-LRV, FTG9-10PLUS-LV, FTG9-10PLUS-RV, FTG9-10RV-AD, FTG9-10VL, FTG9-10VL+R, FTG9-10VR		



1

<b>GEV No.</b>	106958	<b>Ref. No.</b>	11U9121090 12038507
<b>description</b>	gas tap with ignition flame COPRECI type CPMM18700 gas inlet pipe flange ø21mm bypass nozzle ø 1.15mm gas outlet 3/8" (tube ø 10mm) thermocouple connection M8x1 pilot connection M10x1 shaft ø 8x6.5mm shaft flat right shaft L 41/12mm with pipe outlet front fixing M15x1		
<b>spare parts for</b>	106958		
	<b>GEV No.</b>	101060	<b>Ref. No.</b> 608205 608205000
	magnet unit standard L 39mm D1 ø 15.4mm D2 ø 11mm suitable for PEL20-21/JUNKERS/EGA		



1

<b>GEV No.</b>	106948	<b>Ref. No.</b>	12003728 12038505 U912117
<b>description</b>	gas tap with ignition flame COPRECI type CPMM18700 gas inlet pipe flange ø21mm bypass nozzle ø 1.45mm gas outlet 3/8" (tube ø 10mm) thermocouple connection M8x1 pilot connection M10x1 shaft ø 8x6.5mm shaft flat left shaft L 41/12mm with pipe outlet front fixing M15x1		
<b>For models:</b>	CG9-20AD-H, CG9-20H, CG9-20PLUS, CG9-20PLUS-H, CG9-40, CG9-40AD, CG9-40AD-H, CG9-40H, CG9-40PLUS, CG9-40PLUS-H, CG9-41, CG9-41AD, CG9-41AD-H, CG9-41H, CG9-41PLUS, CG9-41PLUS-H, CG9-51L, CG9-51LC, CG9-51R, CG9-51RC, CG9-60, CG9-60AD, CG9-60AD-H, CG9-60H, CG9-60PLUS, CG9-60PLUS-H, CG9-61, CG9-61AD, CG9-61AD-H, CG9-61H, CG9-61OP, CG9-61PLUS, CG9-61PLUS-H, CG9-82, CG9-82AD, CG9-82PLUS, CGE9-41, CGE9-41AD, CGE9-41PLUS		



1

<b>GEV No.</b>	106947	<b>Ref. No.</b>	11U9121150 12003727 12038506
<b>description</b>	gas tap with ignition flame type CPMM18700 gas inlet pipe flange ø21mm bypass nozzle ø 0.75mm gas outlet 3/8" (tube ø 10mm) thermocouple connection M8x1 pilot connection M10x1 shaft ø 8x6.5mm shaft flat upper shaft L 41/12mm with pipe outlet front fixing M15x1		
<b>For models:</b>	CG9-05AD, CG9-05PLUS, CG9-20, CG9-20AD, CG9-20H, CG9-20PLUS, CG9-31PLUS-D, CG9-31PLUS-I, CG9-40, CG9-40AD, CG9-40H, CG9-40PLUS, CG9-41, CG9-41AD, CG9-41H, CG9-41PLUS, CG9-51L, CG9-51LC, CG9-51R, CG9-51RC, CG9-60, CG9-60AD, CG9-60H, CG9-60PLUS, CG9-61, CG9-61AD, CG9-61H, CG9-61OP, CG9-61PLUS, CG9-82, CG9-82AD, CG9-82PLUS, CGE9-41, CGE9-41AD, CGE9-41PLUS, CGF9-120D, CGF9-120D-AD, CGF9-120I, CGF9-120I-AD, CGF9-120PLUS-D, CGF9-120PLUS-I, CGF9-121D, CGF9-121D-AD, CGF9-121I, CGF9-121I-AD, CGF9-121PLUS-D, CGF9-121PLUS-I		

gas thermostats

SIT

630 Eurosit series













1

<b>GEV No.</b>	106164	<b>Ref. No.</b>	12023415 R152102
<b>description</b>	gas thermostat type 630 Eurosit series t.max. 340°C 100-340°C gas inlet 3/8" gas outlet 3/8" thermocouple connection M9x1 pilot connection M10x1 probe ø 4mm probe L 72mm capillary pipe 1050mm pressure regulator 13-18mbar ambient temperature max. 0-120°C		
<b>For models:</b>	CG7-11, CG7-31D, CG7-31I, CG7-41, CG7-41H, CG7-51, CG7-61, CG7-61H, CG9-51L, CG9-51LC, CG9-51R, CG9-51RC, CGB7-61, CGB7-61H, CGB7-61R, CGB7-61RH, CGP9-11, FTG9-05L, FTG9-05L-AD, FTG9-05PLUS-CL, FTG9-05PLUS-CR, FTG9-05PLUS-L, FTG9-05PLUS-R, FTG9-05R, FTG9-05R-AD, FTG9-05VL, FTG9-05VR, FTG9-10L, FTG9-10L+R, FTG9-10L+R-AD, FTG9-10L-AD, FTG9-10PLUS-CL, FTG9-10PLUS-CLR, FTG9-10PLUS-CR, FTG9-10PLUS-L, FTG9-10PLUS-LR, FTG9-10PLUS-R, FTG9-10R, FTG9-10R-AD, FTG9-10VL, FTG9-10VL+R, FTG9-10VR, FTG9-11L, FTG9-11L+R, FTG9-11R, FTGC9-05L, FTGC9-05L-AD, FTGC9-05R, FTGC9-05R-AD, FTGC9-10L...(Other models you can see in the webshop)		
<b>accessories for</b>	106164		
	<b>GEV No.</b>	100904	<b>Ref. No.</b> 12008755
	locking screw M10x1 for pipe ø 4mm Qty 1 pcs		
	<b>GEV No.</b>	100905	<b>Ref. No.</b> 12008715 U134323
	locking screw M10x1 for pipe ø 6mm Qty 1 pcs		
	<b>GEV No.</b>	101273	<b>Ref. No.</b> 12008501 U055043
	olive for pipe ø 12mm L 9.5mm brass Qty 1 pcs suitable for universal		
	<b>GEV No.</b>	101276	<b>Ref. No.</b> 12008081 U264310
	union screw thread 3/8" tube ø 12mm Qty 1 pcs		
	<b>GEV No.</b>	101333	<b>Ref. No.</b> 12008964
	plug thread 3/8" with O-ring		



1

<b>GEV No.</b>	101125	<b>Ref. No.</b>	12009504 T982100
<b>description</b>	gas thermostat type 630 Eurosit series t.max. 340°C 100-340°C gas inlet 3/8" gas outlet 3/8" thermocouple connection M9x1 pilot connection M10x1 probe ø 4mm probe L 72mm capillary pipe 1050mm SIT		
<b>For models:</b>	CG-210, CG-210G, CG-310, CG-310G, CG7-11, CG7-31D, CG7-31I, CG7-41, CG7-41H, CG7-51, CG7-61, CG7-61H, CG9-51L, CG9-51LC, CG9-51R, CG9-51RC, CGB7-61, CGB7-61H, CGB7-61R, CGB7-61RH, CGP9-11, FTG7-05L, FTG7-05R, FTG7-10L, FTG7-10L+R, FTG7-10R, FTG9-05L, FTG9-05R, FTG9-10L, FTG9-10L+R, FTG9-10R, FTG9-11L, FTG9-11L+R, FTG9-11R, FTGC7-05L, FTGC7-10L, FTGC9-05L, FTGC9-05R, FTGC9-10L, FTGC9-10L+R, FTGC9-10R, FTGC9-11L, FTGC9-11L+R, FTGC9-11R, HG9-10, HG9-20		
<b>accessories for</b>	101125		
	<b>GEV No.</b>	100825	<b>Ref. No.</b> —
	gas tap spindle shaft ø 8x6.5mm shaft L 22/14mm suitable for EUROISIT		
	<b>GEV No.</b>	100904	<b>Ref. No.</b> 12008755
	locking screw M10x1 for pipe ø 4mm Qty 1 pcs		
	<b>GEV No.</b>	100905	<b>Ref. No.</b> 12008715 U134323
	locking screw M10x1 for pipe ø 6mm Qty 1 pcs		
	<b>GEV No.</b>	100949	<b>Ref. No.</b> —
	gasket suitable for 630 Eurosit series		
	<b>GEV No.</b>	101273	<b>Ref. No.</b> 12008501 U055043
	olive for pipe ø 12mm L 9.5mm brass Qty 1 pcs suitable for universal		
	<b>GEV No.</b>	101276	<b>Ref. No.</b> 12008081 U264310
	union screw thread 3/8" tube ø 12mm Qty 1 pcs		
	<b>GEV No.</b>	101333	<b>Ref. No.</b> 12008964
	plug thread 3/8" with O-ring		
	<b>GEV No.</b>	101390	<b>Ref. No.</b> —
	gas tap spindle shaft ø 6x4.6mm shaft L 32/15mm gas tap with ignition flame suitable for ZANUSSI, MARENO for gas thermostat EUROISIT		
	<b>GEV No.</b>	101392	<b>Ref. No.</b> —
	adapter suitable for 630 Eurosit series		
	<b>GEV No.</b>	110357	<b>Ref. No.</b> —
	gas tap spindle shaft ø 8x6.5mm shaft L 36/12mm suitable for 630 Eurosit series		
	<b>GEV No.</b>	110358	<b>Ref. No.</b> —
	adapter shaft ø 10x8mm shaft L 29/18mm suitable for 630 Eurosit series		



710 Minisit series



<b>GEV No.</b>	101435	<b>Ref. No.</b>	12009530 U134316 U134324
<b>description</b>	gas thermostat SIT type MINISIT 710 t.max. 340°C 100-340°C gas inlet 1/2" gas outlet 3/8" thermocouple connection M9x1 pilot connection M10x1 probe ø 4mm probe L 72mm capillary pipe 1050mm probe type type C1 pressure controller no pressure regulator mbar gland nut		
<b>For models:</b>	CG-1002, CG-1502, CG-2000, CG-2000-2P, CG-2002, CG-2002P, CG9-11, CG-9110, CG9-11AD, CG9-11PLUS, CG9-31PLUS-D, CG9-31PLUS-I, CG9-41, CG9-41AD, CG9-41AD-H, CG9-41H, CG9-41PLUS, CG9-41PLUS-H, CG9-51L, CG9-51LC, CG9-51R, CG9-51RC, CG9-61, CG9-61AD, CG9-61AD-H, CG9-61H, CG9-61OP, CG9-61PLUS, CG9-61PLUS-H, CG9-82, CG9-82AD, CG9-82PLUS, CGF9-121D, CGF9-121D-AD, CGF9-121I, CGF9-121PLUS-D, CGF9-121PLUS-I, CG-HP-20, FI-5420, FI-7630, FTG9-11L, FTG9-11L+R, FTG9-11R, FTGC9-11L, FTGC9-11L+R, FTGC9-11R, HG9-10, HG9-15, HG9-20		
<b>spare parts for</b>	101435		
	<b>GEV No.</b>	101053	<b>Ref. No.</b> 12019677 U264399
	magnet unit T1: M9x1 T2: M24x1 L 45mm ø 17mm suitable for Minisit		
	<b>GEV No.</b>	102107	<b>Ref. No.</b> —
	probe 100-340°C probe ø 4mm probe L 72mm capillary pipe 1050mm t.max. 340°C oven/grill probe type type C1 suitable for MINISIT 710		
<b>accessories for</b>	101435		
	<b>GEV No.</b>	100809	<b>Ref. No.</b> —
	O-ring EPDM thickness 2mm ID ø 21mm Qty 1 pcs		
	<b>GEV No.</b>	100904	<b>Ref. No.</b> 12008755
	locking screw M10x1 for pipe ø 4mm Qty 1 pcs		
	<b>GEV No.</b>	100905	<b>Ref. No.</b> 12008715 U134323
	locking screw M10x1 for pipe ø 6mm Qty 1 pcs		
	<b>GEV No.</b>	101054	<b>Ref. No.</b> —
	magnet unit T1: M10x1 T2: M24x1 L 45mm ø 17mm suitable for Minisit		
	<b>GEV No.</b>	101136	<b>Ref. No.</b> —
	piezoelectric igniter suitable for Minisit with cover cap ømm connection F6.3x0.8		
	<b>GEV No.</b>	101137	<b>Ref. No.</b> 12008932 U134318
	cover cap without piezoelectric igniter		
	<b>GEV No.</b>	101267	<b>Ref. No.</b> —
	reducer IT 3/8" ET 1/2" L 21mm		
	<b>GEV No.</b>	101268	<b>Ref. No.</b> 12008944 U264300
	gas connection thread 3/8" angled with O-ring MINISIT 710		
	<b>GEV No.</b>	101269	<b>Ref. No.</b> —
	gas connection thread 1/2" angled with O-ring MINISIT 710		

<b>accessories for</b>	101435		
	<b>GEV No.</b>	101270	<b>Ref. No.</b> —
	screw connection IT 3/8" ET 3/8" L 28mm		
	<b>GEV No.</b>	101272	<b>Ref. No.</b> —
	screw connection IT 1/2" ET 3/8" L 57mm		
	<b>GEV No.</b>	101273	<b>Ref. No.</b> 12008501 U055043
	olive for pipe ø 12mm L 9.5mm brass Qty 1 pcs suitable for universal		
	<b>GEV No.</b>	101274	<b>Ref. No.</b> X012105
	olive for pipe ø 16mm Qty 1 pcs		
	<b>GEV No.</b>	101275	<b>Ref. No.</b> 12008951 X012104
	union screw thread 1/2" for pipe ø 16mm Qty 1 pcs		
	<b>GEV No.</b>	101276	<b>Ref. No.</b> 12008081 U264310
	union screw thread 3/8" tube ø 12mm Qty 1 pcs		
	<b>GEV No.</b>	110068	<b>Ref. No.</b> 12008789 U134317
	knob suitable for Minisit ø 37mm		



<b>GEV No.</b>	106332	<b>Ref. No.</b>	11U2643150 12003345 12007319
<b>description</b>	gas thermostat SIT type MINISIT 710 t.max. 340°C 100-340°C gas inlet 3/8" pipe input ø 12mm gas outlet 3/8" pipe output ø 12mm thermocouple connection M9x1 probe ø 4mm probe L 72mm pressure controller no		
<b>For models:</b>	CG-1002, CG-1502, CG-2000, CG-2000-2P, CG-2002, CG9-11, CG9-41, CG9-51L, CG9-51LC, CG9-51R, CG9-51RC, CG9-61, CG9-82, FTG9-11L, FTG9-11L+R, FTG9-11R, FTGC9-11L, FTGC9-11L+R, FTGC9-11R		
<b>spare parts for</b>	106332		
	<b>GEV No.</b>	100809	<b>Ref. No.</b> —
	O-ring EPDM thickness 2mm ID ø 21mm Qty 1 pcs		
	<b>GEV No.</b>	101053	<b>Ref. No.</b> 12019677 U264399
	magnet unit T1: M9x1 T2: M24x1 L 45mm ø 17mm suitable for Minisit		
	<b>GEV No.</b>	101137	<b>Ref. No.</b> 12008932 U134318
	cover cap without piezoelectric igniter		
	<b>GEV No.</b>	101268	<b>Ref. No.</b> 12008944 U264300
	gas connection thread 3/8" angled with O-ring MINISIT 710		
	<b>GEV No.</b>	102107	<b>Ref. No.</b> —
	probe 100-340°C probe ø 4mm probe L 72mm capillary pipe 1050mm t.max. 340°C oven/grill probe type type C1 suitable for MINISIT 710		
	<b>GEV No.</b>	110068	<b>Ref. No.</b> 12008789 U134317
	knob suitable for Minisit ø 37mm		

Table continues overleaf

accessories for		106332	
	GEV No.	100904	Ref. No. 12008755
locking screw M10x1 for pipe ø 4mm Qty 1 pcs			
	GEV No.	100905	Ref. No. 12008715 U134323
locking screw M10x1 for pipe ø 6mm Qty 1 pcs			
	GEV No.	101054	Ref. No. —
magnet unit T1: M10x1 T2: M24x1 L 45mm ø 17mm suitable for Minisit			
	GEV No.	101136	Ref. No. —
piezoelectric igniter suitable for Minisit with cover cap ømm connection F6.3x0.8			
	GEV No.	101267	Ref. No. —
reducer IT 3/8" ET 1/2" L 21mm			
	GEV No.	101269	Ref. No. —
gas connection thread 1/2" angled with O-ring MINISIT 710			
	GEV No.	101270	Ref. No. —
screw connection IT 3/8" ET 3/8" L 28mm			
	GEV No.	101272	Ref. No. —
screw connection IT 1/2" ET 3/8" L 57mm			
	GEV No.	101273	Ref. No. 12008501 U055043
olive for pipe ø 12mm L 9.5mm brass Qty 1 pcs suitable for universal			
	GEV No.	101274	Ref. No. X012105
olive for pipe ø 16mm Qty 1 pcs			
	GEV No.	101275	Ref. No. 12008951 X012104
union screw thread 1/2" for pipe ø 16mm Qty 1 pcs			
	GEV No.	101276	Ref. No. 12008081 U264310
union screw thread 3/8" tube ø 12mm Qty 1 pcs			

accessories

probes

	1		
GEV No.	102102	Ref. No.	12018712 U264398
description probe 100-340°C probe ø 5mm probe L 68mm capillary pipe 1750mm t.max. 340°C oven/grill probe type type B1 suitable for MINISIT 710			
For models: CG-1002, CG-1502, CG-2000, CG-2000-2P, CG-2002, CG9-11, CG9-41, CG9-51L, CG9-51LC, CG9-51R, CG9-51RC, CG9-61, CG9-82, FTG9-11L, FTG9-11L+R, FTG9-11R, FTGC9-11L, FTGC9-11L+R, FTGC9-11R			



	1		
GEV No.	102104 <sup>1</sup>	Ref. No.	12017711 X012198
description probe 110-190°C probe ø 11mm probe thread 1/4" probe L 26mm capillary pipe 1050mm t.max. 190°C fryer probe type type F3 suitable for MINISIT 710			
accessories for		102104	
	GEV No.	361182	Ref. No. —
nut thread 1/4" H 5mm nickel-plated brass WS 17 Qty 1 pcs			
	GEV No.	510420	Ref. No. —
gasket copper ED ø 19.9mm ID ø 14.3mm thickness 2mm Qty 1 pcs			
	GEV No.	529251	Ref. No. —
O-ring EPDM thickness 2.62mm ID ø 15.08mm Qty 1 pcs			



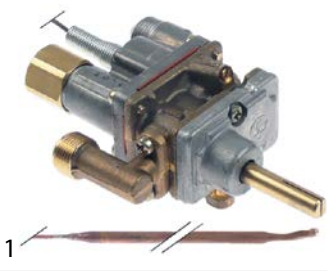

<sup>1</sup>probe thread 1/4"

COPRECI



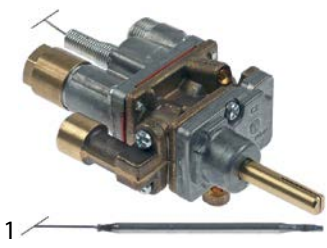

	1		
GEV No.	101533	Ref. No.	12017423 R202104 R432102 U262102
description gas thermostat COPRECI t.max. 110°C gas inlet pipe flange ø21mm bypass nozzle ø 0.35mm gas outlet 3/8" pilot connection 1/8" thermocouple connection M8x1 capillary pipe 1000mm probe ø 6mm probe L 135mm shaft ø 8x6.5mm shaft L 33/12mm shaft flat right			
For models: BMG7-10, BMG9-05, BMG9-10, FTG7-05, FTG7-10			
spare parts for		101533	
	GEV No.	101060	Ref. No. 608205 608205000
magnet unit standard L 39mm D1 ø 15.4mm D2 ø 11mm suitable for PEL20-21/JUNKERS/EGA			
	GEV No.	101537	Ref. No. 12010025 12017549 Q307034
gasket ID ø 8mm ED ø 11.5mm H 3mm Qty 1 pcs			
accessories for		101533	
	GEV No.	101538	Ref. No. 12025294 Z982018
clamp			

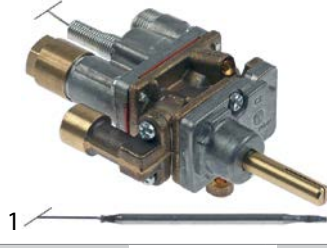

			
<b>GEV No.</b>	109050	<b>Ref. No.</b>	12017437 U018700
<b>description</b>	gas thermostat COPRECI t.max. 300°C gas inlet pipe flange ø21mm bypass nozzle ø 0.64mm gas outlet 3/8" pilot connection 1/8" thermocouple connection 2x M8x1 capillary pipe 1000mm probe ø 5mm probe L 110mm shaft ø 8x6.5mm shaft L 33/12mm shaft flat right		
<b>For models:</b>	CG-210G, CG-310G		
<b>spare parts for</b>	109050		
	<b>GEV No.</b>	101060	<b>Ref. No.</b> 608205 608205000
	magnet unit standard L 39mm D1 ø 15.4mm D2 ø 11mm suitable for PEL20-21/JUNKERS/EGA		
	<b>GEV No.</b>	101537	<b>Ref. No.</b> 12010025 12017549 Q307034
	gasket ID ø 8mm ED ø 11.5mm H 3mm Qty 1 pcs		
<b>accessories for</b>	109050		
	<b>GEV No.</b>	101538	<b>Ref. No.</b> 12025294 Z982018
	clamp		

			
<b>GEV No.</b>	109051	<b>Ref. No.</b>	11R5321030 12012011 12012114 12017288 12040477 R532101 R612101
<b>description</b>	gas thermostat COPRECI t.max. 300°C gas inlet pipe flange ø21mm bypass nozzle ø 0.6mm gas outlet 3/8" pilot connection 1/8" thermocouple connection M8x1 capillary pipe 1100mm probe ø 4mm probe L 84mm shaft ø 8x6.5mm shaft L 33/12mm shaft flat right		
<b>For models:</b>	FTG9-05L, FTG9-05R, FTG9-05VL, FTG9-05VR, FTG9-10L, FTG9-10L+R, FTG9-10R, FTG9-10VL, FTG9-10VL+R, FTG9-10VR, FTG9-11L, FTG9-11L+R, FTG9-11R, FTGC9-05, FTGC9-9050, FTGC9-05L, FTGC9-05R, FTGC9-10, FTGC9-100, FTGC9-10L, FTGC9-10L+R, FTGC9-10R, FTGC9-11L, FTGC9-11L+R, FTGC9-11R, PL-105C, PL-110C		
<b>spare parts for</b>	109051		
	<b>GEV No.</b>	101060	<b>Ref. No.</b> 608205 608205000
	magnet unit standard L 39mm D1 ø 15.4mm D2 ø 11mm suitable for PEL20-21/JUNKERS/EGA		
	<b>GEV No.</b>	101537	<b>Ref. No.</b> 12010025 12017549 Q307034
	gasket ID ø 8mm ED ø 11.5mm H 3mm Qty 1 pcs		
<b>accessories for</b>	109051		
	<b>GEV No.</b>	101376	<b>Ref. No.</b> —
	gasket ID ø 8mm ED ø 12mm H 3/5mm		

<b>accessories for</b>	109051		
	<b>GEV No.</b>	101538	<b>Ref. No.</b> 12025294 Z982018
	clamp		

			
<b>GEV No.</b>	109534	<b>Ref. No.</b>	12009479 12015257 329200 R782130 U329200 U742130
<b>description</b>	gas thermostat COPRECI type CAL-5200 t.max. 300°C gas inlet pipe flange ø21mm bypass nozzle ø 0.5mm gas outlet 3/8" pilot connection closed thermocouple connection M8x1 capillary pipe 1100mm probe ø 4mm probe L 82mm shaft ø 8x6.5mm shaft L 33/12mm shaft flat right		
<b>For models:</b>	CG-210, CG-210G, CG-310, CG-310G, CG6-41, CG7-11, CG-7115, CG7-41, CG-7415, CG7-61, CG-7615, CGB7-61, FTG7-05, FTG7-10, FTGC6-05L, FTGC6-10L, FTGC6-10L+R		
<b>spare parts for</b>	109534		
	<b>GEV No.</b>	101060	<b>Ref. No.</b> 608205 608205000
	magnet unit standard L 39mm D1 ø 15.4mm D2 ø 11mm suitable for PEL20-21/JUNKERS/EGA		
<b>accessories for</b>	109534		
	<b>GEV No.</b>	101537	<b>Ref. No.</b> 12010025 12017549 Q307034
	gasket ID ø 8mm ED ø 11.5mm H 3mm Qty 1 pcs		
	<b>GEV No.</b>	101538	<b>Ref. No.</b> 12025294 Z982018
	clamp		

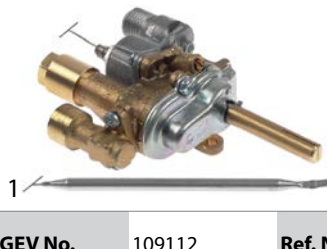
			
<b>GEV No.</b>	109112	<b>Ref. No.</b>	12007980 H352101
<b>description</b>	gas thermostat COPRECI type MTZ22300 gas inlet pipe flange ø21mm bypass nozzle ø 0.5mm gas outlet M14x1.5 pilot connection 1/8" thermocouple connection M8x1 capillary pipe 850mm probe ø 6mm probe L 130mm shaft ø 8x6.5mm shaft L 42/12mm shaft flat right		
<b>For models:</b>	BMG7-10, BMG9-05, BMG9-05V-T, BMG9-10, BMG9-10V-T		



## gas valves and ignition boxes

### gas control valves

#### DUNGS



<b>GEV No.</b>	106050	<b>Ref. No.</b>	12026701 RT7000220
<b>description</b>	gas valve 230V 50/60Hz gas inlet 1/2" gas outlet 1/2" DUNGS type GB 055 243 443		



<b>GEV No.</b>	106051	<b>Ref. No.</b>	12026482 RT7000031
<b>description</b>	gas valve 230V 50/60Hz gas inlet 1/2" gas outlet 1/2" DUNGS type GB-WND 055 243 442		



<b>GEV No.</b>	107554	<b>Ref. No.</b>	12026440 RT7000029
<b>description</b>	gas valve 230V 50/60Hz gas inlet 1/2" gas outlet 1/2" total length 105mm DUNGS type GB-WND 055 D01 S02 243442		



<b>GEV No.</b>	107555	<b>Ref. No.</b>	12040554 RT7000033
<b>description</b>	gas valve 230V 50/60Hz gas inlet 1/2" IT gas outlet 1/2" IT total length 105mm DUNGS type GB-ND 055 D01 S02 243443		

#### HONEYWELL



<b>GEV No.</b>	101186	<b>Ref. No.</b>	12027429 RT30390241
<b>description</b>	gas valve type VK4105C 220-240V 50/60Hz gas inlet flange 32x32mm gas outlet flange 32x32mm thermocouple connection pilot connection pressure range 15-60mbar max 60mbar operator type pressure controller type V5360E 1226 1 HONEYWELL flange 32x32mm		
<b>accessories for</b>	101186		
	<b>GEV No.</b>	102845	<b>Ref. No.</b> —
	gas connection angled 1/2" flange 32x32mm hole distance 24x24mm Tandem		
	<b>GEV No.</b>	102846	<b>Ref. No.</b> —
	gas connection straight 1/2" flange 32x32mm hole distance 24x24mm suitable for Tandem		



<b>GEV No.</b>	106420	<b>Ref. No.</b>	12024609 T303017
<b>description</b>	gas valve type VK4115V 220/240V 50/60Hz gas inlet 1/2" NPT gas outlet flange 32x32mm thermocouple connection pilot connection pressure range 15-60mbar max 60mbar operator type HONEYWELL flange 32x32mm		
<b>For models:</b>	COG-102, HGC-10-21, HGC-20-21, HGP-10-21, HGP-20-21, HGV-10-21, HGV-20-21, VG-102, VPG-102		
<b>accessories for</b>	106420		
	<b>GEV No.</b>	102845	<b>Ref. No.</b> —
	gas connection angled 1/2" flange 32x32mm hole distance 24x24mm Tandem		
	<b>GEV No.</b>	102846	<b>Ref. No.</b> —
	gas connection straight 1/2" flange 32x32mm hole distance 24x24mm suitable for Tandem		





1

<b>GEV No.</b>	106054	<b>Ref. No.</b>	12027246 RT30390245
<b>description</b>	gas valve type VK4115V 220-240V 50/60Hz gas inlet flange 32x32mm gas outlet flange 32x32mm thermocouple connection pilot connection pressure range 15-60mbar operator type HONEYWELL flange 32x32mm		
<b>accessories for</b>	106054		
	<b>GEV No.</b>	102845	<b>Ref. No.</b> —
	gas connection angled 1/2" flange 32x32mm hole distance 24x24mm Tandem		
	<b>GEV No.</b>	102846	<b>Ref. No.</b> —
	gas connection straight 1/2" flange 32x32mm hole distance 24x24mm suitable for Tandem		



1

<b>GEV No.</b>	106417	<b>Ref. No.</b>	11T1350370 12003943 12038515
<b>description</b>	gas valve type VR4605V LPG 230V 50Hz gas inlet 1/2" gas outlet 1/2" thermocouple connection pilot connection operator type 230V (V4346A 1006)		
<b>For models:</b>	COG-201, HCG-20-11, HGC-20-11, HGV-20-11, HVG-20-11, VG-201, VPG-201		



1









<b>GEV No.</b>	106419	<b>Ref. No.</b>	12003940 12038517 T115098
<b>description</b>	gas valve type VR4605V natural gas 230V 50Hz gas inlet 1/2" gas outlet 1/2" thermocouple connection pilot connection operator type 230V (V4346A 1006)		
<b>For models:</b>	COG-101, HCG-10-11, HCG-10-21, HCG-2-10-11, HGC-10-11, HGV-10-11, HVG-10-11, HVG-10-21, HVG-2-10-11, VG-101, VPG-101		

SIT

ELETTROSIT



1

<b>GEV No.</b>	101127	<b>Ref. No.</b>	R275003000
<b>description</b>	gas valve SIT type ELETTROSIT 230V gas inlet 3/4" gas outlet 3/4" thermocouple connection M9x1 pilot connection M10x1 lateral equiv. no. 0.810.175		
<b>spare parts for</b>	101127		
	<b>GEV No.</b>	101312	<b>Ref. No.</b> 12024469 R275027
	microswitch		
	<b>GEV No.</b>	101352	<b>Ref. No.</b> —
	solenoid coil 230V 50Hz suitable for ELETTROSIT		
<b>accessories for</b>	101127		
	<b>GEV No.</b>	100006	<b>Ref. No.</b> T982001000
	piezoelectric igniter suitable for ELETTROSIT body plastic blowing connection ø2.4mm ø 14mm		
	<b>GEV No.</b>	100904	<b>Ref. No.</b> 12008755
	locking screw M10x1 for pipe ø 4mm Qty 1 pcs		
	<b>GEV No.</b>	100905	<b>Ref. No.</b> 12008715 U134323
	locking screw M10x1 for pipe ø 6mm Qty 1 pcs		
	<b>GEV No.</b>	101301	<b>Ref. No.</b> —
	gas connection thread 1/2" straight ELETTROSIT screw with O-ring		
	<b>GEV No.</b>	101303	<b>Ref. No.</b> —
	gas connection straight thread 3/4" ELETTROSIT		
	<b>GEV No.</b>	101309	<b>Ref. No.</b> —
	extension		



**NOVASIT**



<b>1</b>			
<b>GEV No.</b>	101908	<b>Ref. No.</b>	12024768 12097292 X163000
<b>description</b>	gas valve SIT series Novasit 820 230V 50Hz gas inlet 1/2" gas outlet 1/2" thermocouple connection M9x1 pilot connection M10x1 ignition pressurebar pressure regulator connection blind equiv. no. 0.820.018 output pilot burner M10x1 input pressure max. 60bar setting range 3-30bar		
<b>For models:</b>	FG7-05-1C, FG7-05-2C, FG-710, FG7-10-2C, FG7-104C, FG7-10-4C, FG-720, FG9-05, FG9-05-1C, FG9-05-2C, FG9-05AD, FG9-05PLUS, FG9-05PLUS-S, FG9-05S, FG9-05S-1C, FG9-05S-2C, FG9-05S-AD, FG9-10, FG9-10-2C, FG9-10-4C, FG9-10AD, FG9-10PLUS, FG-920, FG-940, FGCL9-05, FGCL9-05-1C, FGCL9-05-2C, FGCL9-05S-1C, FGCL9-05S-2C, MG9-10AD, MG9-10BMAD, MG9-10BMSAD, MG9-10PLUS, MG9-10PLUS-BM, MG9-10PLUS-BMS, MG9-10PLUS-S, MG9-10S-AD, MG9-15AD, MG9-15BMAD, MG9-15BMSAD, MG9-15PLUS, MG9-15PLUS-BM, MG9-15PLUS-BMS, MG9-15PLUS-S, MG9-15S-AD, MG9-20AD, MG9-20PLUS, MG9-20PLUS-S, MG9-20S-AD, SBG7-10...(Other models you can see in the webshop)		
<b>spare parts for</b>	101908		
	<b>GEV No.</b>	101065	<b>Ref. No.</b> 12033710 X163098
	magnet unit with cable L 44mm D1 ø 30mm D2 ø 20mm suitable for NOVASIT		
	<b>GEV No.</b>	101313	<b>Ref. No.</b> 12018959 X163099
	solenoid coil 230V 50Hz		
<b>accessories for</b>	101908		
	<b>GEV No.</b>	100006	<b>Ref. No.</b> T982001000
	piezoelectric igniter suitable for ELETTROSIT body plastic blowing connection ø2.4mm ø 14mm		
	<b>GEV No.</b>	101305	<b>Ref. No.</b> 12020648 X153005
	gas connection straight 1/2" flange 45x45mm ELETTROSIT/V4400/4600/4605 suitable for SIT/HONEYWELL hole distance 36x36mm		
	<b>GEV No.</b>	101306	<b>Ref. No.</b> 12009216 X153004
	gas connection angled flange 45x45mm hole distance 36x36mm 1/2" ELETTROSIT/V4400/4600/4605 screw with O-ring suitable for SIT/HONEYWELL		
	<b>GEV No.</b>	101307	<b>Ref. No.</b> —
	gas connection straight flange 45x45mm hole distance 36x36mm 3/4" ELETTROSIT/V4400/4600/4605 screw with O-ring suitable for SIT/HONEYWELL		
	<b>GEV No.</b>	101308	<b>Ref. No.</b> —
	gas connection angled flange 45x45mm hole distance 36x36mm 3/4" ELETTROSIT/V4400/4600/4605 screw with O-ring suitable for SIT/HONEYWELL		
	<b>GEV No.</b>	101312	<b>Ref. No.</b> 12024469 R275027
	microswitch		
	<b>GEV No.</b>	101314	<b>Ref. No.</b> —
	solenoid coil 24V 50Hz		

<b>accessories for</b>	101908		
	<b>GEV No.</b>	101317	<b>Ref. No.</b> 12024504 X163008
	plug with cable L 1000mm suitable for NOVASIT		
	<b>GEV No.</b>	101318	<b>Ref. No.</b> —
	cover cap for solenoid coil suitable for NOVASIT		

**SIGMA**



<b>1</b>			
<b>GEV No.</b>	107926	<b>Ref. No.</b>	12046364
<b>description</b>	gas valve type 0848160 230V 50Hz gas inlet 3/4" gas outlet 3/4" pressure range 0.5-12mbar SIT equiv. no. 0848160		
<b>For models:</b>	ACG-061, ACG-101, ACG-102, ACG-201, ACG-202, AG-061, AG-101, AG-102, AG-201, AG-202, APG-061, APG-101, APG-102, APG-201, APG-202		

**TANDEM**



<b>1</b>			
<b>GEV No.</b>	101684	<b>Ref. No.</b>	12023419 Z952201
<b>description</b>	gas valve 230V 50Hz gas inlet 1/2" gas outlet 1/2" pilot connection level slow ignition standard ignition time 3-7s pressure range 3-50mbar power supply for modulator type SIT equiv. no. 0.830.034		
<b>For models:</b>	GA-20, GA-40, HCG-10-11, HCG-10-21, HCG-20-11, HCG-2-10-11, HCG-6-11, HGV-10-11, HGV-20-11, HMG-10-11, HMG-10-21, HMG-20-11, HMG-2-10-11, HMG-6-11, HVG-10-11, HVG-10-21, HVG-20-11, HVG-20-21, HVG-2-10-11, HVG-2-20-21, VG-101, VG-201, VPG-101, VPG-201		
<b>spare parts for</b>	101684		
	<b>GEV No.</b>	101379	<b>Ref. No.</b> —
	solenoid coil 230V 50Hz suitable for Tandem		
<b>accessories for</b>	101684		
	<b>GEV No.</b>	101274	<b>Ref. No.</b> X012105
	olive for pipe ø 16mm Qty 1 pcs		
	<b>GEV No.</b>	101275	<b>Ref. No.</b> 12008951 X012104
	union screw thread 1/2" for pipe ø 16mm Qty 1 pcs		
	<b>GEV No.</b>	102845	<b>Ref. No.</b> —
	gas connection angled 1/2" flange 32x32mm hole distance 24x24mm Tandem		

Table continues overleaf





accessories for	101684		
	GEV No.	102846	Ref. No. —
	GEV No.	102847	Ref. No. —

ignition boxes

HONEYWELL

Honeywell



1

GEV No.	102381	Ref. No.	12026363 RT30390107
description	ignition box HONEYWELL type S4565BD 1064 electrodes 3 waiting times safety time 5s 220-240V 4VA 50/60Hz		

Honeywell



1

GEV No.	103330	Ref. No.	12023720 T303013 T303013000
description	ignition box HONEYWELL type S4565BD 2005U electrodes 3 waiting times safety time 5s 220-240V 4VA 50/60Hz		
For models:	COG-102, GA-20, GA-20D, GA-40, GA-40D, HGC-10-21, HGC-20-21, HGP-10-21, HGP-20-21, HGV-10-21, HGV-20-21, VG-102, VG-202, VPG-102, VPG-202		

Honeywell



1

GEV No.	101184	Ref. No.	12027187 RT30390105
description	ignition box HONEYWELL type S4565C 1033 equiv. no. S4565C 1033 electrodes 2 waiting times safety time 5s 220-240V 4VA 50/60Hz		

Honeywell



1

GEV No.	104598	Ref. No.	12027445 DO1AB01416
description	ignition box HONEYWELL type S4565XXXXX electrodes 3 waiting times safety time 10s 220-240V 4VA 50/60Hz		
For models:	SF-10, SF-10MP, SF-10MPP, SF-13, SF-15, SF-15MP, SF-15MPP, SF-22, SF-22MP, SF-22MPP, SF-31, SF-31MP, SF-31MPP, SF-8, SR-10MP-PSM, SR-13MP-PSM, SR-32MP-PSM		

SIT



1

GEV No.	107497	Ref. No.	12039440 T643002000
description	ignition box SIT type 579DBC electrodes 1 waiting time 1s safety time 5s 220/240V 12VA 50/60Hz		

miscellaneous



1

GEV No.	102380	Ref. No.	12026073 RT7400221
description	ignition box type 3a9PHC070-R1		

White  
Rodgers



1

GEV No.	101377	Ref. No.	12016821 R723010
description	ignition box WHITE RODGERS type 50A72-213 waiting time 0s safety time 2s		
For models:	HCG-10-11, HCG-10-21, HCG-2-10-11, HMG-10-11, HMG-10-21, HMG-2-10-11		



1

<b>GEV No.</b>	101569	<b>Ref. No.</b>	12016800 R723032
<b>description</b>	ignition box WHITE RODGERS type 50A72-250-04 waiting time 0s safety time 5s 220/240V 50/60Hz		
<b>For models:</b>	HCG-10-11, HCG-10-21, HCG-20-11, HCG-2-10-11, HCG-6-11, HMG-10-11, HMG-10-11UL, HMG-10-21, HMG-10-21UL, HMG-20-11, HMG-2-10-11, HMG-6-11		

## ignition parts

### pilot burners

#### SIT

#### 100 series



1

<b>GEV No.</b>	102445	<b>Ref. No.</b>	11U4421340 12003282 12004905
<b>description</b>	pilot burner SIT type 100 series 2 flames nozzle $\varnothing$ 0.25mm gas connection 4mm		
<b>For models:</b>	CG-1002, CG-1502, CG-2000, CG-2000-2P, CG-2002, CG-2002P, CG-2005, CG-210, CG-210G, CG-3005, CG-310, CG-310G, CG7-20, CG-7200, CG7-40, CG-7400, CG7-41, CG-7415, CG7-61, CG-7615, CG9-20, CG9-40, CG9-41, CG9-51L, CG9-51LC, CG9-51R, CG9-51RC, CG9-60, CG9-61, CG9-82, CGB7-61, CGE7-100, CGE7-41, CGE9-41, CGF9-120D, CGF9-120I, CGF9-121D, CGF9-121I		





1



<b>GEV No.</b>	106906	<b>Ref. No.</b>	12009166 12034540 FX30100005 U322118
<b>description</b>	pilot burner SIT type 100 series 3 flames nozzle $\varnothing$ 0.2mm gas connection 6mm		
<b>For models:</b>	BG7-05, BG7-05I, BG7-10, BG7-10I, BG9-05, BG9-05AD, BG9-05I, BG9-05PF, BG9-05PI, BG9-05PLUS-I, BG9-10, BG9-10AD, BG9-10I, BG9-10PF, BG9-10PI, BG9-10PLUS-I, BMG7-10, BMG-9045, CG-1002, CG-1502, CG-2000, CG-2000-2P, CG-2002, CG-2002P, CG6-41, CG7-11, CG-7115, CG7-31D, CG7-31I, CG7-41, CG-7415, CG7-41H, CG7-51, CG7-61, CG-7615, CG7-61H, CG9-11, CG-9110, CG9-11AD, CG9-11PLUS, CG9-31PLUS-D, CG9-31PLUS-I, CG9-41, CG9-41AD, CG9-41AD-H, CG9-41H, CG9-41PLUS, CG9-41PLUS-H, CG9-51L, CG9-51LC...(Other models you can see in the webshop)		
<b>spare parts for</b>	106906		
	<b>GEV No.</b>	100245	<b>Ref. No.</b> 12021187 U442138
			pilot burner nozzle LPG code 20 bore $\varnothing$ 0.2mm Qty 1 pcs thread M8x0.75



<b>spare parts for</b>	106906		
	<b>GEV No.</b>	100855	<b>Ref. No.</b> —
			pilot burner bracket triple
	<b>GEV No.</b>	100885	<b>Ref. No.</b> 12008510 X012122
			air mixing sleeve for pilot burner Qty 1 pcs
	<b>GEV No.</b>	100916	<b>Ref. No.</b> —
			compression spring for pilot burner Qty 1 pcs
	<b>GEV No.</b>	100917	<b>Ref. No.</b> —
			gasket for pilot burner Qty 1 pcs aluminium
	<b>GEV No.</b>	100918	<b>Ref. No.</b> —
			screw for pilot burner
	<b>GEV No.</b>	107162	<b>Ref. No.</b> —
			pilot burner cap SIT 3 flames Hmm Lmm Qty 1 pcs
	<b>GEV No.</b>	107701	<b>Ref. No.</b> 12009076 X012126
			pilot burner bottom part SIT 100 series nozzle $\varnothing$ 0.2mm
<b>accessories for</b>	106906		
	<b>GEV No.</b>	100245	<b>Ref. No.</b> 12021187 U442138
			pilot burner nozzle LPG code 20 bore $\varnothing$ 0.2mm Qty 1 pcs thread M8x0.75
	<b>GEV No.</b>	100246	<b>Ref. No.</b> —
			pilot burner nozzle natural gas bore $\varnothing$ 0.35mm Qty 1 pcs thread M8x0.75
	<b>GEV No.</b>	100904	<b>Ref. No.</b> 12008755
			locking screw M10x1 for pipe $\varnothing$ 4mm Qty 1 pcs
	<b>GEV No.</b>	100905	<b>Ref. No.</b> 12008715 U134323
			locking screw M10x1 for pipe $\varnothing$ 6mm Qty 1 pcs
	<b>GEV No.</b>	102110	<b>Ref. No.</b> 12019428
			pilot tube copper pipe $\varnothing$ 4mm thickness 1mm L 3000mm
	<b>GEV No.</b>	102111	<b>Ref. No.</b> —
			pilot tube copper pipe $\varnothing$ 6mm thickness 1mm L 3000mm
	<b>GEV No.</b>	107171	<b>Ref. No.</b> —
			pilot burner nozzle SIT natural/liquid gas bore $\varnothing$ 0.25mm Qty 1 pcs
	<b>GEV No.</b>	107700	<b>Ref. No.</b> —
			pilot burner bottom part SIT 100 series nozzle $\varnothing$ 0.25mm
	<b>GEV No.</b>	107702	<b>Ref. No.</b> —
			pilot burner bottom part SIT 100 series nozzle $\varnothing$ 0.35mm





accessories			
pilot burner caps			
 <p>1</p>			
<b>GEV No.</b>	100837	<b>Ref. No.</b>	12009152 X012117
<b>description</b>	pilot burner cap 3 flames H 24mm L 48mm Qty 1 pcs		
<b>For models:</b>	FG7-05-1C, FG7-05-2C, FG-710, FG7-10-2C, FG7-104C, FG7-10-4C, FG-71-15, FG-720, FG-72-30, FG9-05, FG9-05-1C, FG9-05-2C, FG9-05AD, FG9-05PLUS, FG9-05PLUS-S, FG9-05S, FG9-05S-1C, FG9-05S-2C, FG9-05S-AD, FG9-10, FG9-10-2C, FG9-10-4C, FG9-10AD, FG9-10PLUS, FG-91-20, FG-920, FG-92-40, FG-940		

 <p>1</p>			
<b>GEV No.</b>	102665	<b>Ref. No.</b>	12009214 X502103
<b>description</b>	pilot burner cap 3 flames suitable for 100 series H 28mm L 87mm Qty 1 pcs		
<b>For models:</b>	FGCL9-05, FGCL9-05-1C, FGCL9-05-2C, FGCL9-05S-1C, FGCL9-05S-2C		

pilot burner bottom parts			
 <p>1</p>			
<b>GEV No.</b>	107701	<b>Ref. No.</b>	12009076 X012126
<b>description</b>	pilot burner bottom part SIT 100 series nozzle $\varnothing$ 0.2mm		
<b>For models:</b>	CG-1002, CG-1502, CG-2002, CG-2002P, CG7-20, CG7-20H, CG7-30D, CG7-30I, CG7-31D, CG7-31I, CG7-40, CG7-40H, CG7-41, CG7-41H, CG7-50, CG7-51, CG7-60, CG7-60H, CG7-61, CG7-61H, CG9-20, CG9-20H, CG9-40, CG9-40H, CG9-41, CG9-41H, CG9-51L, CG9-51LC, CG9-51R, CG9-51RC, CG9-60, CG9-60H, CG9-61, CG9-61H, CG9-61OP, CG9-82, CGB7-61, CGB7-61H, CGB7-61R, CGB7-61RH, CGE7-41, CGE7-41H, CGE9-41, CGE9-41H, CGF9-120D, CGF9-120I, CGF9-121D, CGF9-121I, FG7-05-1C, FG7-05-2C, FG-710...(Other models you can see in the webshop)		
<b>spare parts for</b>	107701		
	<b>GEV No.</b>	100245	<b>Ref. No.</b>
			12021187 U442138
<b>description</b>	pilot burner nozzle LPG code 20 bore $\varnothing$ 0.2mm Qty 1 pcs thread M8x0.75		
	<b>GEV No.</b>	100916	<b>Ref. No.</b>
			—
<b>description</b>	compression spring for pilot burner Qty 1 pcs		
	<b>GEV No.</b>	100917	<b>Ref. No.</b>
			—
<b>description</b>	gasket for pilot burner Qty 1 pcs aluminium		
	<b>GEV No.</b>	100918	<b>Ref. No.</b>
			—
<b>description</b>	screw for pilot burner		

accessories for 107701			
	<b>GEV No.</b>	100246	<b>Ref. No.</b>
			—
<b>description</b>	pilot burner nozzle natural gas bore $\varnothing$ 0.35mm Qty 1 pcs thread M8x0.75		
	<b>GEV No.</b>	100904	<b>Ref. No.</b>
			12008755
<b>description</b>	locking screw M10x1 for pipe $\varnothing$ 4mm Qty 1 pcs		
	<b>GEV No.</b>	100905	<b>Ref. No.</b>
			12008715 U134323
<b>description</b>	locking screw M10x1 for pipe $\varnothing$ 6mm Qty 1 pcs		
	<b>GEV No.</b>	102110	<b>Ref. No.</b>
			12019428
<b>description</b>	pilot tube copper pipe $\varnothing$ 4mm thickness 1mm L 3000mm		
	<b>GEV No.</b>	102111	<b>Ref. No.</b>
			—
<b>description</b>	pilot tube copper pipe $\varnothing$ 6mm thickness 1mm L 3000mm		
	<b>GEV No.</b>	102742	<b>Ref. No.</b>
			—
<b>description</b>	pilot burner nozzle LPG code 25 bore $\varnothing$ 0.25mm Qty 1 pcs		

 <p>1</p>			
<b>GEV No.</b>	100880	<b>Ref. No.</b>	12009075 U442136
<b>description</b>	pilot burner bottom part SIT 100 series nozzle $\varnothing$ 0.4mm		
<b>For models:</b>	CG7-20, CG7-20H, CG7-30D, CG7-30I, CG7-31D, CG7-31I, CG7-40, CG7-40H, CG7-41, CG7-41H, CG7-50, CG7-51, CG7-60, CG7-60H, CG7-61, CG7-61H, CG9-20, CG9-20H, CG9-40, CG9-40H, CG9-41, CG9-41H, CG9-60, CG9-60H, CG9-61, CG9-61H, CG9-61OP, CG9-82, CGB7-61, CGB7-61H, CGB7-61R, CGB7-61RH, CGE7-41, CGE7-41H, CGE9-41, FG7-05-1C, FG7-05-2C, FG7-10-2C, FG7-104C, FG7-10-4C, FG9-05-1C, FG9-05-2C, FG9-05S-1C, FG9-05S-2C, FG9-10-2C, FG9-10-4C		

pilot burner brackets			
universal			
 <p>1</p>			
<b>GEV No.</b>	100887	<b>Ref. No.</b>	12008620 X012114
<b>description</b>	opposite support for pilot burner suitable for 100 series		
<b>For models:</b>	FG7-05-1C, FG7-05-2C, FG-710, FG7-10-2C, FG7-104C, FG7-10-4C, FG-71-15, FG-720, FG-72-30, FG9-05, FG9-05-1C, FG9-05-2C, FG9-05AD, FG9-05PLUS, FG9-05PLUS-S, FG9-05S, FG9-05S-1C, FG9-05S-2C, FG9-05S-AD, FG9-10, FG9-10-2C, FG9-10-4C, FG9-10AD, FG9-10PLUS, FG-91-20, FG-920, FG-92-40, FG-940		





			
1			
<b>GEV No.</b>	100886	<b>Ref. No.</b>	12008676 X012113
<b>description</b>	pilot burner bracket suitable for 100 series 3-piece		
<b>For models:</b>	FG7-05-1C, FG7-05-2C, FG-710, FG7-10-2C, FG7-104C, FG7-10-4C, FG-71-15, FG-720, FG-72-30, FG9-05, FG9-05-1C, FG9-05-2C, FG9-05AD, FG9-05PLUS, FG9-05PLUS-S, FG9-05S, FG9-05S-1C, FG9-05S-2C, FG9-05S-AD, FG9-10, FG9-10-2C, FG9-10-4C, FG9-10AD, FG9-10PLUS, FG-91-20, FG-920, FG-92-40, FG-940		

			
2			
<b>GEV No.</b>	100888	<b>Ref. No.</b>	12008458 X012116
<b>description</b>	screw bolt for pilot burner		
<b>For models:</b>	CG-1002, CG-1502, CG-2002, CG-2002P, CG7-20, CG7-20H, CG7-30D, CG7-30I, CG7-31D, CG7-31I, CG7-40, CG7-40H, CG7-41, CG7-41H, CG7-50, CG7-51, CG7-60, CG7-60H, CG7-61, CG7-61H, CG9-20, CG9-20H, CG9-40, CG9-40H, CG9-41, CG9-41H, CG9-51L, CG9-51LC, CG9-51R, CG9-51RC, CG9-60, CG9-60H, CG9-61, CG9-61H, CG9-61OP, CG9-82, CGB7-61, CGB7-61H, CGB7-61R, CGB7-61RH, CGE7-41, CGE7-41H, CGE9-41, CGF9-120D, CGF9-120I, CGF9-121D, CGF9-121I, FG7-05-1C, FG7-05-2C, FG-710...(Other models you can see in the webshop)		

producer-specific

			
1			
<b>GEV No.</b>	101022	<b>Ref. No.</b>	12011611 U745418
<b>description</b>	pilot burner bracket		
<b>For models:</b>	CG7-20, CG7-40, CG7-41, CG7-61, CGB7-61, CGE7-41		

			
1			
<b>GEV No.</b>	104742	<b>Ref. No.</b>	12002362 R302130
<b>description</b>	pilot burner bracket suitable for 100 series		
<b>For models:</b>	HP-G-15, HPG-15		

pilot burner nozzles			
			
1			
<b>GEV No.</b>	100245	<b>Ref. No.</b>	12021187 U442138
<b>description</b>	pilot burner nozzle LPG code 20 bore ø 0.2mm Qty 1 pcs thread M8x0.75		
<b>For models:</b>	BG7-05, BG7-05I, BG7-10, BG7-10I, BG9-05, BG9-05I, BG9-10, BG9-10I, BMG7-10, BMG9-05, BMG9-10, CG-1002, CG-1502, CG-2002, CG-200S, CG-210, CG-210G, CG-300S, CG-310, CG-310G, CG7-10, CG7-11, CG7-20, CG7-40, CG7-41, CG7-61, CG9-10, CG9-11, CG9-20, CG9-40, CG9-41, CG9-51L, CG9-51LC, CG9-51R, CG9-51RC, CG9-60, CG9-61, CG9-82, CGB7-61, CGE7-41, CGE9-41, CGF9-120D, CGF9-120I, CGF9-121D, CGF9-121I, CGP9-11, CPG7-05, CPG9-05, CPG9-05NC, CPG9-05S...(Other models you can see in the webshop)		

			
1			
<b>GEV No.</b>	102972	<b>Ref. No.</b>	12008938 U442137
<b>description</b>	pilot burner nozzle natural gas code 40 bore ø 0.4mm Qty 1 pcs		
<b>For models:</b>	BG6-05I, BG7-05, BG7-05I, BG7-10, BG7-10I, BG9-05, BG9-05AD, BG9-05I, BG9-05PF, BG9-05PI, BG9-05PLUS-I, BG9-10, BG9-10AD, BG9-10I, BG9-10PF, BG9-10PI, BG9-10PLUS-I, BMG7-10, BMG9-05, BMG9-05V-T, BMG9-10, BMG9-10V-T, CG-1002, CG-1502, CG-2002, CG-2002P, CG-200S, CG-210, CG-210G, CG-300S, CG-310, CG-310G, CG7-10, CG7-11, CG7-20, CG7-20H, CG7-30D, CG7-30I, CG7-31D, CG7-31I, CG7-40, CG7-40H, CG7-41, CG7-41H, CG7-50, CG7-51, CG7-60, CG7-60H, CG7-61, CG7-61H...(Other models you can see in the webshop)		

ignition electrodes

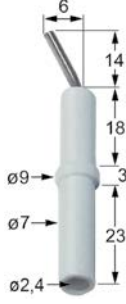







			
1			
<b>GEV No.</b>	100707	<b>Ref. No.</b>	12008994 X012101
<b>description</b>	ignition electrode D1 ø 7mm D2 ø 9mm connection ø2.4mm L1 14mm L2 6mm BL1 18mm BL2 3mm BL3 23mm to clip Qty 1 pcs		
<b>For models:</b>	BG7-05, BG7-05I, BG7-10, BG7-10I, BG9-05, BG9-05I, BG9-10, BG9-10I, BMG-9045, BMG9-05, BMG9-10, CG-1002, CG-110, CG-1502, CG-2000, CG-2000-2P, CG-2002, CG-7115, CG-7415, CG-7615, CG9-05AD, CG9-05PLUS, CG9-10, CG9-11, CG-9110, CG9-20AD, CG9-20AD-H, CG9-20PLUS, CG9-20PLUS-H, CG9-31PLUS-D, CG9-31PLUS-I, CG9-40AD, CG9-40AD-H, CG9-40PLUS, CG9-40PLUS-H, CG9-41, CG9-41AD, CG9-41AD-H, CG9-41PLUS, CG9-41PLUS-H, CG9-51L, CG9-51LC, CG9-51R, CG9-51RC, CG9-60AD, CG9-60AD-H, CG9-60PLUS, CG9-60PLUS-H, CG9-61, CG9-61AD...(Other models you can see in the webshop)		



miscellaneous			
			
<b>GEV No.</b>	100885	<b>Ref. No.</b>	12008510 X012122
<b>description</b>	air mixing sleeve for pilot burner Qty 1 pcs		
<b>For models:</b>	CG-1002, CG-1502, CG-2002, CG-2002P, CG7-20, CG7-20H, CG7-30D, CG7-30I, CG7-31D, CG7-31I, CG7-40, CG7-40H, CG7-41, CG7-41H, CG7-50, CG7-51, CG7-60, CG7-60H, CG7-61, CG7-61H, CG9-20, CG9-20H, CG9-40, CG9-40H, CG9-41, CG9-41H, CG9-51L, CG9-51LC, CG9-51R, CG9-51RC, CG9-60, CG9-60H, CG9-61, CG9-61H, CG9-61OP, CG9-82, CGB7-61, CGB7-61H, CGB7-61R, CGB7-61RH, CGE7-41, CGE7-41H, CGE9-41, CGF9-120D, CGF9-120I, CGF9-121D, CGF9-121I, FG7-05-1C, FG7-05-2C, FG-710...(Other models you can see in the webshop)		

			
<b>GEV No.</b>	102876	<b>Ref. No.</b>	12040640 ICR10042
<b>description</b>	pilot burner POLIDORO 3 flames code gas connection 6mm		

**POLIDORO**  
pilot burners

			
<b>GEV No.</b>	102800	<b>Ref. No.</b>	12037976 ICR08122
<b>description</b>	pilot burner POLIDORO 3 flames code gas connection 6mm		
<b>spare parts for</b>	102800		
	<b>GEV No.</b>	100906	<b>Ref. No.</b> —
	screw connection thread M10x1 for ignition electrode brass Qty 1 pcs WS 10		
	<b>GEV No.</b>	100907	<b>Ref. No.</b> —
	screw connection thread M10x1 Qty 1 pcs type SEF 1 0mm for thermocouple		
	<b>GEV No.</b>	100909	<b>Ref. No.</b> 12008740 12016658 S312107 U265703
	union screw thread M10x1 for pipe ø 6mm Qty 1 pcs		
	<b>GEV No.</b>	101287	<b>Ref. No.</b> —
	olive for pipe ø 6mm Qty 1 pcs		
<b>accessories for</b>	102800		
	<b>GEV No.</b>	100208	<b>Ref. No.</b> —
	pilot burner nozzle POLIDORO LPG code 20 bore ø 0.2mm Qty 1 pcs		
	<b>GEV No.</b>	100209	<b>Ref. No.</b> —
	pilot burner nozzle POLIDORO natural gas code 40 bore ø 0.4mm Qty 1 pcs		
	<b>GEV No.</b>	100701	<b>Ref. No.</b> —
	ignition electrode connection M4 Qty 1 pcs		
	<b>GEV No.</b>	100908	<b>Ref. No.</b> 12017481 T052101
	union screw thread M10x1 for pipe ø 4mm Qty 1 pcs		
	<b>GEV No.</b>	101280	<b>Ref. No.</b> —
	olive for pipe ø 4mm Qty 1 pcs		

**PRO-GAS**  
100 series  
pilot burners











			
<b>GEV No.</b>	100124	<b>Ref. No.</b>	12001371 R202100
<b>description</b>	pilot burner PRO-GAS type 100 series 3 flames nozzle ø 0.25mm		
<b>For models:</b>	BMG7-10, BMG9-05, BMG9-05V-T, BMG9-10, BMG9-10V-T, CG7-10, CG7-11, FTGC6-05L, FTGC6-10L, FTGC6-10L+R, MG7-10, MG7-10BM, MG9-10, MG9-10BM, MG9-10BMS, MG9-10S, MG9-15, MG9-15BM, MG9-15BM316, MG9-15BMS, MG9-15S, MG9-20, MG9-20S, MPG9-10, MPG9-10BM, MPG9-10BMS, MPG9-10S, MPG9-15, MPG9-15BM, MPG9-15BMS, MPG9-15S, MPG9-20, MPG9-20S		
<b>spare parts for</b>	100124		
	<b>GEV No.</b>	100764	<b>Ref. No.</b> —
	pilot burner bracket with angle		
	<b>GEV No.</b>	100843	<b>Ref. No.</b> —
	pilot burner cap 3 flames Qty 1 pcs		
	<b>GEV No.</b>	100885	<b>Ref. No.</b> 12008510 X012122
	air mixing sleeve for pilot burner Qty 1 pcs		
	<b>GEV No.</b>	100916	<b>Ref. No.</b> —
	compression spring for pilot burner Qty 1 pcs		
	<b>GEV No.</b>	100917	<b>Ref. No.</b> —
	gasket for pilot burner Qty 1 pcs aluminium		
	<b>GEV No.</b>	100918	<b>Ref. No.</b> —
	screw for pilot burner		
	<b>GEV No.</b>	102742	<b>Ref. No.</b> —
	pilot burner nozzle LPG code 25 bore ø 0.25mm Qty 1 pcs		
<b>accessories for</b>	100124		
	<b>GEV No.</b>	100245	<b>Ref. No.</b> 12021187 U442138
	pilot burner nozzle LPG code 20 bore ø 0.2mm Qty 1 pcs thread M8x0.75		
	<b>GEV No.</b>	100246	<b>Ref. No.</b> —
	pilot burner nozzle natural gas bore ø 0.35mm Qty 1 pcs thread M8x0.75		

Table continues overleaf



accessories for 100124				
	GEV No.	100882	Ref. No.	—
pilot burner bottom part PRO-GAS 100 series nozzle ø 0.25mm				
	GEV No.	100883	Ref. No.	—
pilot burner bottom part PRO-GAS 100 series nozzle ø 0.35mm				
	GEV No.	100904	Ref. No.	12008755
locking screw M10x1 for pipe ø 4mm Qty 1 pcs				
	GEV No.	100905	Ref. No.	12008715 U134323
locking screw M10x1 for pipe ø 6mm Qty 1 pcs				
	GEV No.	102110	Ref. No.	12019428
pilot tube copper pipe ø 4mm thickness 1mm L 3000mm				
	GEV No.	102111	Ref. No.	—
pilot tube copper pipe ø 6mm thickness 1mm L 3000mm				



1

GEV No.	100139	Ref. No.	12005122 U192104	
<b>description</b>	pilot burner type 100 series 3 flames nozzle ø 0.25mm nozzle A			
<b>For models:</b>	CG-7115, CG9-10, CG9-10AD, CG9-10PLUS, CG9-11, CG-9110, CG9-11AD, CG9-11PLUS, CGE9-11, CGF9-120D, CGF9-120D-AD, CGF9-120I, CGF9-120I-AD, CGF9-120PLUS-D, CGF9-120PLUS-I, CGF9-121D, CGF9-121D-AD, CGF9-121I, CGF9-121I-AD, CGF9-121PLUS-D, CGF9-121PLUS-I, MG-9100, MG-9150, MG-9150BM, MG-9200, MPG-9150, MPG-9200			
spare parts for 100139				
	GEV No.	100843	Ref. No.	—
pilot burner cap 3 flames Qty 1 pcs				
	GEV No.	100882	Ref. No.	—
pilot burner bottom part PRO-GAS 100 series nozzle ø 0.25mm				
	GEV No.	100885	Ref. No.	12008510 X012122
air mixing sleeve for pilot burner Qty 1 pcs				
	GEV No.	100916	Ref. No.	—
compression spring for pilot burner Qty 1 pcs				
	GEV No.	100917	Ref. No.	—
gasket for pilot burner Qty 1 pcs aluminium				
	GEV No.	100918	Ref. No.	—
screw for pilot burner				
	GEV No.	102742	Ref. No.	—
pilot burner nozzle LPG code 25 bore ø 0.25mm Qty 1 pcs				
accessories for 100139				
	GEV No.	100245	Ref. No.	12021187 U442138
pilot burner nozzle LPG code 20 bore ø 0.2mm Qty 1 pcs thread M8x0.75				

accessories for 100139				
	GEV No.	100246	Ref. No.	—
pilot burner nozzle natural gas bore ø 0.35mm Qty 1 pcs thread M8x0.75				
	GEV No.	100881	Ref. No.	—
pilot burner bottom part PRO-GAS 100 series nozzle ø 0.2mm				
	GEV No.	100883	Ref. No.	—
pilot burner bottom part PRO-GAS 100 series nozzle ø 0.35mm				
	GEV No.	100904	Ref. No.	12008755
locking screw M10x1 for pipe ø 4mm Qty 1 pcs				
	GEV No.	100905	Ref. No.	12008715 U134323
locking screw M10x1 for pipe ø 6mm Qty 1 pcs				
	GEV No.	102110	Ref. No.	12019428
pilot tube copper pipe ø 4mm thickness 1mm L 3000mm				
	GEV No.	102111	Ref. No.	—
pilot tube copper pipe ø 6mm thickness 1mm L 3000mm				

producer-specific pilot burners

FAGOR



1

GEV No.	102445	Ref. No.	11U4421340 12003282 12004905
<b>description</b>	pilot burner SIT type 100 series 2 flames nozzle ø 0.25mm gas connection 4mm		
<b>For models:</b>	CG-1002, CG-1502, CG-2000, CG-2000-2P, CG-2002, CG-2002P, CG-2005, CG-210, CG-210G, CG-300S, CG-310, CG-310G, CG7-20, CG-7200, CG7-40, CG-7400, CG7-41, CG-7415, CG7-61, CG-7615, CG9-20, CG9-40, CG9-41, CG9-51L, CG9-51LC, CG9-51R, CG9-51RC, CG9-60, CG9-61, CG9-82, CGB7-61, CGE7-100, CGE7-41, CGE9-41, CGF9-120D, CGF9-120I, CGF9-121D, CGF9-121I		



accessories universal

pilot burner brackets



1

<b>GEV No.</b>	107847	<b>Ref. No.</b>	12002953 U445441000
<b>description</b>	pilot burner bracket chrome-plated steel suitable for FAGOR H 85mm		
<b>For models:</b>	CG-200S, CG-210, CG-210G, CG-300S, CG-310, CG-310G		

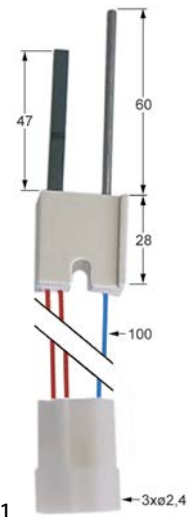

1

<b>GEV No.</b>	100730	<b>Ref. No.</b>	12027683
<b>description</b>	glow plug cable length 100mm connection $\varnothing$ 2.4mm L1 47mm L2 60mm		

electrodes



1

<b>GEV No.</b>	106829	<b>Ref. No.</b>	12037099 RT7400290
<b>description</b>	gasket for ignition electrode ID $\varnothing$ 10mm hole $\varnothing$ 4.5mm L 27mm W 17mm		



1

<b>GEV No.</b>	109065	<b>Ref. No.</b>	12018030 R725079
<b>description</b>	gasket hole $\varnothing$ 10mm L 27mm W 17mm		
<b>For models:</b>	HCG-10-11, HCG-10-21, HCG-20-11, HCG-20-21, HCG-2-10-11, HCG-6-11, HMG-10-11, HMG-10-11UL, HMG-10-21, HMG-10-21UL, HMG-20-11, HMG-2-10-11, HMG-6-11, HVG-10-11, HVG-10-21, HVG-20-11, HVG-20-21, HVG-2-10-11		



1

<b>GEV No.</b>	550897	<b>Ref. No.</b>	12036535 RT4400250
<b>description</b>	gasket ignition electrode graphite thickness 2.5mm hole distance 27mm		

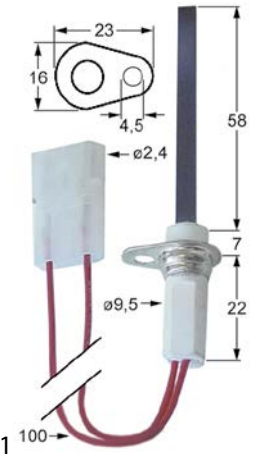



1

<b>GEV No.</b>	100757	<b>Ref. No.</b>	12017356 R723005
<b>description</b>	glow plug flange length 23mm flange width 16mm $\varnothing$ 9.5mm cable length 100mm connection $\varnothing$ 2.4mm total length 220mm L1 58mm fixing dimensions 4.5mm		
<b>For models:</b>	HCG-10-11, HCG-10-21, HCG-20-11, HCG-2-10-11, HCG-6-11, HMG-10-11, HMG-10-11UL, HMG-10-21, HMG-10-21UL, HMG-20-11, HMG-2-10-11, HMG-6-11		

			
<b>GEV No.</b>	107848	<b>Ref. No.</b>	12009060 X022131000
<b>description</b>	ignition electrode D1 ø 7mm D2 ø 8mm L1 2mm L2 8mm BL1 23mm BL2 3mm BL3 18mm		
<b>For models:</b>	BG6-05I, BG7-05, BG7-05I, BG7-10, BG7-10I, BG9-05AD, BG9-05PF, BG9-05PI, BG9-05PLUS-I, BG9-10AD, BG9-10PF, BG9-10PI, BG9-10PLUS-I, BMG9-05, BMG9-05V-T, BMG9-10, BMG9-10V-T, CG-1002, CG-1502, CG-2002, CG-2002P, CG6-41, CG9-10, CG9-10AD, CG9-10PLUS, CG9-11, CG9-11AD, CG9-11PLUS, CG9-31PLUS-D, CG9-31PLUS-I, CG9-41, CG9-41AD, CG9-41AD-H, CG9-41H, CG9-41PLUS, CG9-41PLUS-H, CG9-51L, CG9-51LC, CG9-51R, CG9-51RC, CG9-61, CG9-61AD, CG9-61AD-H, CG9-61H, CG9-61OP, CG9-61PLUS, CG9-61PLUS-H, CG9-82, CG9-82AD, CG9-82PLUS...(Other models you can see in the webshop)		

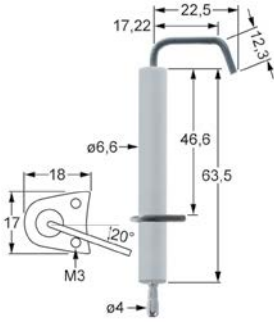
			
<b>GEV No.</b>	100707	<b>Ref. No.</b>	12008994 X012101
<b>description</b>	ignition electrode D1 ø 7mm D2 ø 9mm connection ø2.4mm L1 14mm L2 6mm BL1 18mm BL2 3mm BL3 23mm to clip Qty 1 pcs		
<b>For models:</b>	BG7-05, BG7-05I, BG7-10, BG7-10I, BG9-05, BG9-05I, BG9-10, BG9-10I, BMG-9045, BMG9-05, BMG9-10, CG-1002, CG-110, CG-1502, CG-2000, CG-2000-2P, CG-2002, CG-7115, CG-7415, CG-7615, CG9-05AD, CG9-05PLUS, CG9-10, CG9-11, CG-9110, CG9-20AD, CG9-20AD-H, CG9-20PLUS, CG9-20PLUS-H, CG9-31PLUS-D, CG9-31PLUS-I, CG9-40AD, CG9-40AD-H, CG9-40PLUS, CG9-40PLUS-H, CG9-41, CG9-41AD, CG9-41AD-H, CG9-41PLUS, CG9-41PLUS-H, CG9-51L, CG9-51LC, CG9-51R, CG9-51RC, CG9-60AD, CG9-60AD-H, CG9-60PLUS, CG9-60PLUS-H, CG9-61, CG9-61AD...(Other models you can see in the webshop)		

			
<b>GEV No.</b>	107858	<b>Ref. No.</b>	12033209 RT20680300
<b>description</b>	ignition electrode flange length 18mm flange width 17mm D1 ø 7mm D2 ø 7.5mm L1 5.5mm L2 23mm L3 14mm BL1 46.5mm BL2 13.5mm mounting distance 10mm connection ø 4mm		

			
<b>GEV No.</b>	104806	<b>Ref. No.</b>	12039586 T855753000
<b>description</b>	ignition electrode flange length 23mm flange width 1 16mm D1 ø 9.4mm D2 ø 9.4mm L1 25mm BL1 17mm BL2 36mm		
<b>For models:</b>	AG-061, AG-061W, AG-101, AG-101W, APG-061, APG-061W, APG-101, APG-101W		

			
<b>GEV No.</b>	104803	<b>Ref. No.</b>	12039448 T645746000
<b>description</b>	ignition electrode flange length 23mm flange width 1 16mm D1 ø 9.5mm D2 ø 9.5mm L1 10mm L2 79mm BL1 72.5mm BL2 24mm flange		
<b>For models:</b>	ACG-102, ACG-202, AG-102, AG-102W, AG-202, APG-102, APG-102W, APG-202		



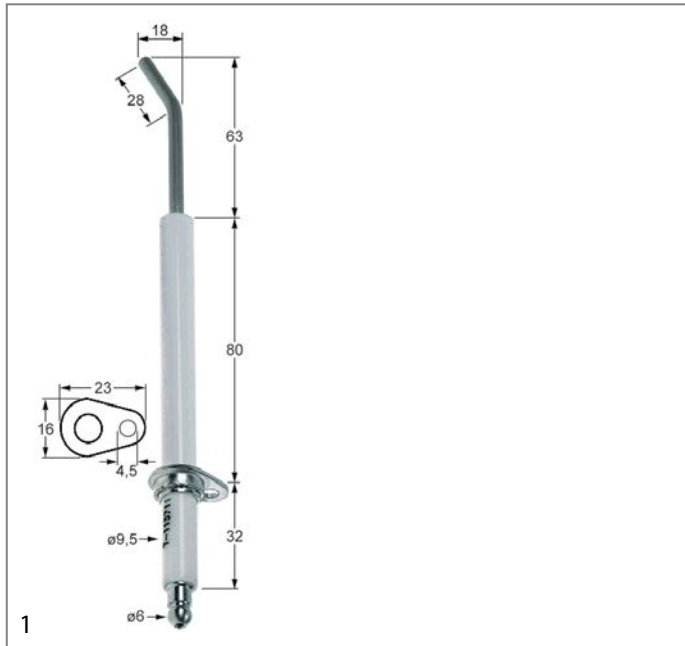

<b>GEV No.</b>	102448	<b>Ref. No.</b>	12018798 T115711
<b>description</b>	ignition electrode flange length 23mm flange width 16mm D1 ø 9.5mm L1 63mm L2 18mm L3 28mm BL1 80mm BL2 32mm fixing dimensions 4.5mm flange connection ø 6mm		
<b>For models:</b>	HCG-10-11, HCG-10-21, HCG-2-10-11, HVG-10-11, HVG-10-21, HVG-2-10-11		

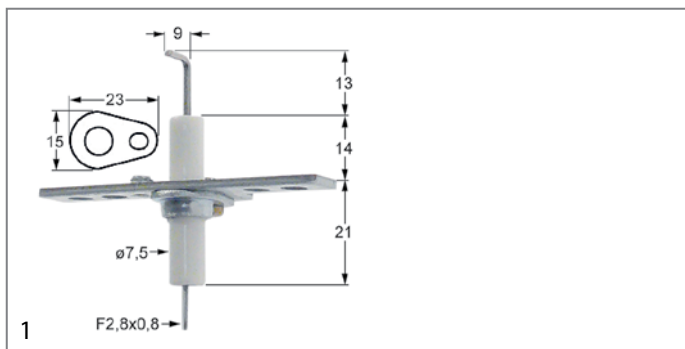

<b>GEV No.</b>	102446	<b>Ref. No.</b>	12025163 Z955803
<b>description</b>	ignition electrode flange length 23mm flange width 15mm D1 ø 7.5mm L1 13mm L2 9mm BL1 14mm BL2 21mm connection F2.8x0.8		
<b>For models:</b>	GA-20, GA-20D, GA-40, GA-40D, HGP-10-21, HGP-20-21, HGV-10-11, HGV-10-21, HGV-20-11, HGV-20-21, HVG-10-11, HVG-10-11UL, HVG-10-21, HVG-10-21UL, HVG-20-11, HVG-20-21, HVG-2-10-11, HVG-2-20-21, MFHVG-10-11, MFHVG-10-21, VG-101, VG-102, VG-201, VG-202, VPG-101, VPG-102, VPG-201, VPG-202		



<b>GEV No.</b>	104804	<b>Ref. No.</b>	12039685 T955755000
<b>description</b>	ignition electrode flange length 23mm flange width 16mm D1 ø 9mm D2 ø 9mm L1 17mm L2 79mm BL1 80mm BL2 17mm connection M4 flange		
<b>For models:</b>	ACG-061, ACG-101, ACG-201, AG-061, AG-061W, AG-101, AG-101W, AG-201, APG-061, APG-061W, APG-101, APG-101W, APG-201		

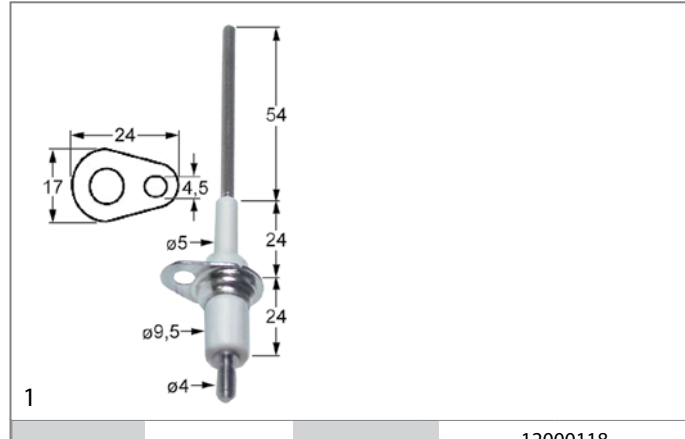

<b>GEV No.</b>	100759	<b>Ref. No.</b>	12000118 12023896 12040020 R725014 T115059 T135705
<b>description</b>	ignition electrode flange length 24mm flange width 17mm D1 ø 5mm D2 ø 9.5mm L1 54mm BL1 24mm BL2 24mm fixing dimensions ø4.5mm with flange connection ø 4mm A1/B13/C2		
<b>For models:</b>	COG-201, COG-202, HCG-10-11, HCG-10-21, HCG-20-11, HCG-20-21, HCG-2-10-11, HCG-2-20-11, HCG-6-11, HGC-20-11, HGC-20-21, HGP-20-21, HGV-20-11, HGV-20-21, HMG-10-11, HMG-10-11UL, HMG-10-21, HMG-10-21UL, HMG-20-11, HMG-2-10-11, HMG-6-11, HVG-20-11, HVG-20-21, HVG-2-20-21, VG-201, VG-202, VPG-201, VPG-202		
<b>accessories for</b>	100759		

	<b>GEV No.</b>	109065	<b>Ref. No.</b>	12018030 R725079
gasket hole ø 10mm L 27mm W 17mm				



<b>GEV No.</b>	103302	<b>Ref. No.</b>	12038022 RT7400230
<b>description</b>	ignition electrode flange length 26mm flange width 16mm D1 ø 9mm L1 9mm L2 73mm BL1 82mm BL2 14mm connection F 4.8x0.8mm cable length 400mm mounting distance 19mm with flange		

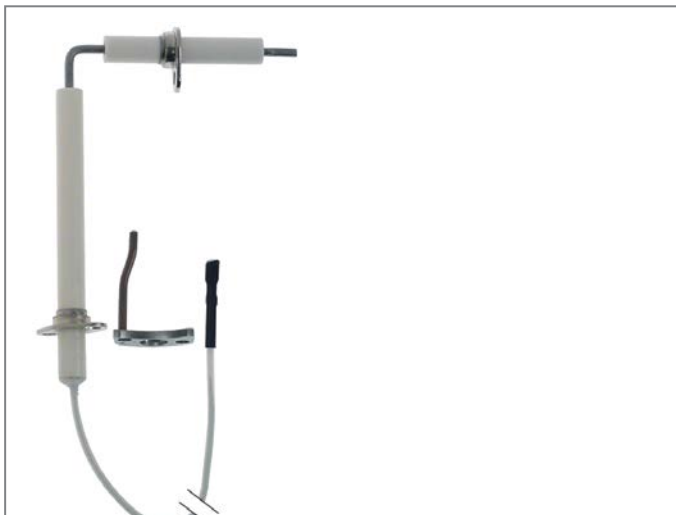

<b>GEV No.</b>	104805	<b>Ref. No.</b>	12039684 T955754000
<b>description</b>	ignition electrode flange length 28mm flange width 16mm D1 ø 9mm D2 ø 9mm L1 16.5mm L2 80mm BL1 81mm BL2 16.5mm connection F2.8 cable length 250mm mounting distance 20mm flange		
<b>For models:</b>	ACG-061, ACG-101, ACG-201, AG-061, AG-061W, AG-101, AG-101W, AG-201, APG-061, APG-061W, APG-101, APG-101W, APG-201		



<b>GEV No.</b>	104802	<b>Ref. No.</b>	12039447
<b>description</b>	ignition electrode flange length 28mm flange width 16mm D1 ø 9.4mm D2 ø 9.4mm L1 9mm L2 73mm BL1 72.5mm BL2 26mm connection F2.8 cable length 260mm mounting distance 20mm flange		
<b>For models:</b>	ACG-102, ACG-202, AG-102, AG-102W, AG-202, APG-102, APG-102W, APG-202		

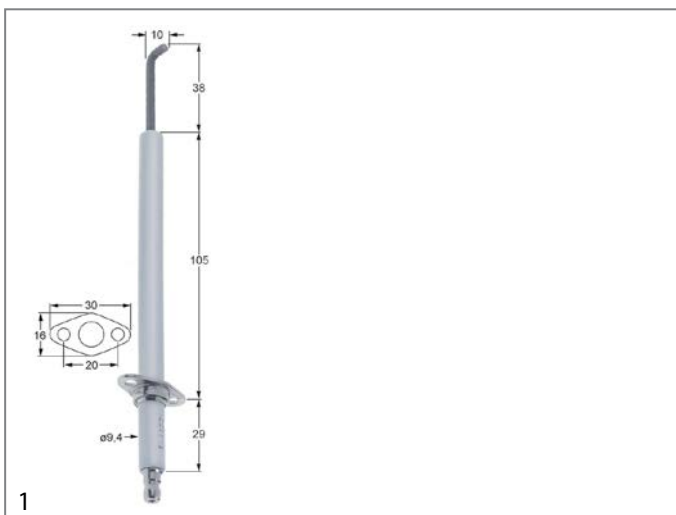

<b>GEV No.</b>	109111	<b>Ref. No.</b>	12024726
<b>description</b>	ignition electrode flange length 30mm flange width 16mm D1 ø 9.4mm L1 38mm L2 10mm BL1 105mm BL2 29mm mounting distance 20mm flange connection		
<b>For models:</b>	COG-201, COG-202, HGC-20-11, HGC-20-21, HGP-20-21, HGV-20-11, HGV-20-21, VG-201, VG-202, VPG-201, VPG-202		

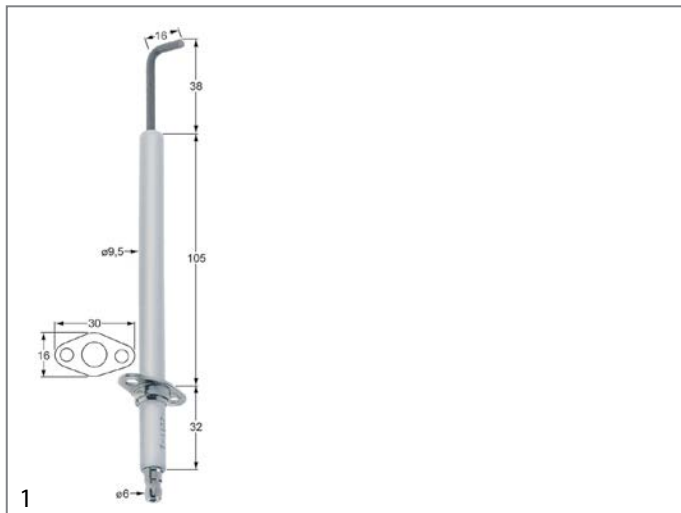

<b>GEV No.</b>	102765	<b>Ref. No.</b>	12024719 T115781
<b>description</b>	ignition electrode flange length 30mm flange width 16mm D1 9.5mm L1 38mm L2 16mm BL1 105mm BL2 32mm connection 6mm		
<b>For models:</b>	COG-101, COG-102, HCG-10-11, HCG-10-21, HCG-2-10-11, HGC-10-11, HGC-10-21, HGP-10-21, HGV-10-11, HGV-10-21, HVG-10-11, HVG-10-11UL, HVG-10-21, HVG-10-21UL, HVG-2-10-11, MFHVG-10-11, MFHVG-10-21, VG-101, VG-102, VPG-101, VPG-102		

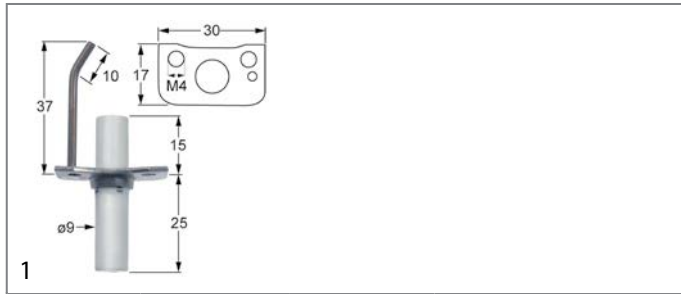

<b>GEV No.</b>	103333	<b>Ref. No.</b>	12037972 RT7400235
<b>description</b>	ignition electrode flange length 30mm flange width 17mm D1 9mm L1 37mm L2 10mm BL1 15mm BL2 25mm fixing dimensions M4mm with flange with earthing contact		

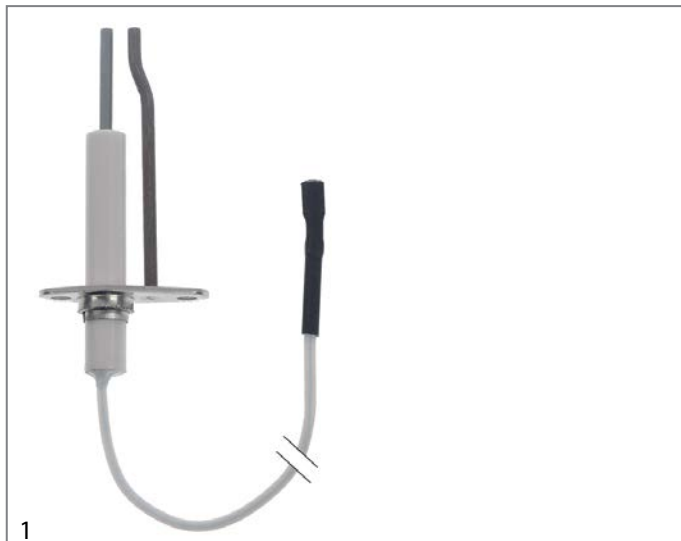

<b>GEV No.</b>	104807	<b>Ref. No.</b>	12039585 T855752000
<b>description</b>	ignition electrode flange length 38mm flange width 16mm D1 9.4mm D2 9.4mm L1 25mm BL1 17mm BL2 36mm connection F2.8 cable length 250mm fixing dimensions 4mm mounting distance 28mm flange		
<b>For models:</b>	AG-061, AG-061W, AG-101, AG-101W, APG-061, APG-061W, APG-101, APG-101W		

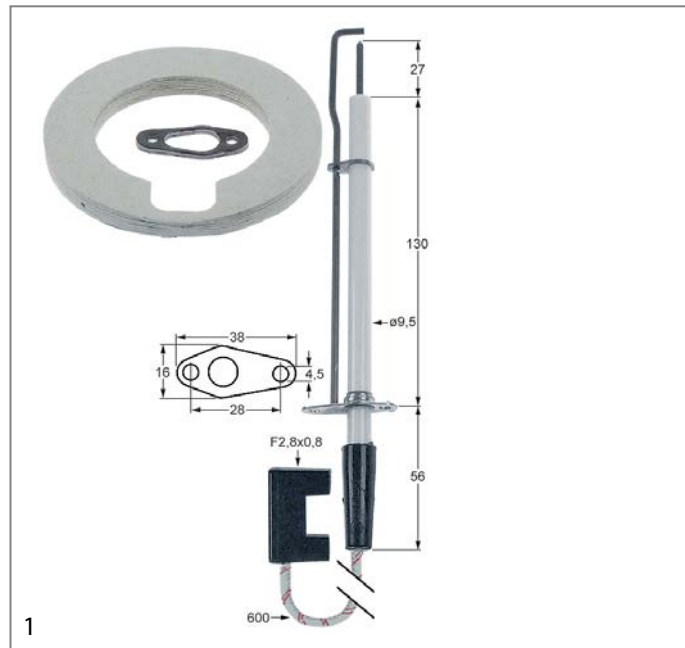

<b>GEV No.</b>	102884	<b>Ref. No.</b>	12028814 87.00.662 RT4400249
<b>description</b>	ignition electrode flange length 38mm flange width 16mm D1 9.5mm L1 27mm BL1 130mm BL2 56mm connection F 2.8x0.8mm cable length 600mm fixing dimensions 4.5mm mounting distance 28mm with flange with earthing contact		



<b>GEV No.</b>	107849	<b>Ref. No.</b>	12025155 Z955802000
<b>description</b>	ignition electrode flange length 66mm flange width 24mm D1 7mm D2 2mm L1 11mm L2 10mm BL1 15mm BL2 6mm BL3 15mm connection 2.8		
<b>For models:</b>	GA-20, GA-20D, GA-40, GA-40D, HGP-10-21, HGP-20-21, HGV-10-11, HGV-20-11, HGV-20-21, VG-101, VG-102, VG-201, VG-202, VPG-101, VPG-102, VPG-201, VPG-202		





mounting diameter 22mm



<b>GEV No.</b>	100005	<b>Ref. No.</b>	12024807 S113034
<b>description</b>	piezoelectric igniter body plastic blowing mounting ø 22mm connection ø2.4mm cable lengthmm SIT		
<b>For models:</b>	BG6-05I, BG7-05, BG7-05I, BG7-10, BG7-10I, BG9-05, BG9-05I, BG9-05PF, BG9-05PI, BG9-10, BG9-10I, BG9-10PF, BG9-10PI, BMG9-05, BMG9-05V-T, BMG9-10, BMG9-10V-T, CG-1002, CG-1502, CG-2000, CG-2000-2P, CG-2002, CG-2002P, CG6-20, CG6-40, CG6-41, CG9-10, CG9-11, CG9-40H, CG9-41, CG9-41H, CG9-51L, CG9-51LC, CG9-51R, CG9-51RC, CG9-61, CG9-61H, CG9-61OP, CG9-82, CGB7-61, CGB7-61H, CGB7-61R, CGB7-61RH, CGE6-41, CGE9-11, CGF9-120D, CGF9-120I, CGF9-121D, CGF9-121I, CGP9-11...(Other models you can see in the webshop)		

miscellaneous



<b>GEV No.</b>	100006	<b>Ref. No.</b>	T982001000
<b>description</b>	piezoelectric igniter suitable for ELETROSIT body plastic blowing connection ø2.4mm ø 14mm		

ignition units



<b>GEV No.</b>	101012	<b>Ref. No.</b>	12020231 12024347 R073007 X163014
<b>description</b>	ignition unit outputs 2 230VAC dimensions 48x32x32mm mounting distance 56mm inlet F2.8x0.8 outlet F2.8x0.8 type ZIG2 50-60Hz		
<b>For models:</b>	BG9-05AD, BG9-05PLUS-I, BG9-10AD, BG9-10PLUS-I, CG-7200, CG-7415, CG9-05AD, CG9-05PLUS, CG9-10AD, CG9-10PLUS, CG9-11AD, CG9-11PLUS, CG9-20AD, CG9-20AD-H, CG9-20PLUS, CG9-20PLUS-H, CG9-31PLUS-D, CG9-31PLUS-I, CG9-41AD, CG9-41AD-H, CG9-41PLUS, CG9-41PLUS-H, CG9-61AD, CG9-61AD-H, CG9-61PLUS, CG9-61PLUS-H, CG9-82AD, CG9-82PLUS, CGF9-121D-AD, CGF9-121PLUS-D, CGF9-121PLUS-I, CPG9-05AD, CPG9-05AD-S, CPG9-05PLUS, CPG9-05PLUS-S, FG7-05-1C, FG7-05-2C, FG-710, FG7-10-2C, FG7-10-4C, FG7-10-4C, FG-720, FG9-05, FG9-05-1C, FG9-05-2C, FG9-05AD, FG9-05PLUS, FG9-05PLUS-S, FG9-05S, FG9-05S-1C...(Other models you can see in the webshop)		

thermocouples

plug-in thermocouples

plug-in thermocouples standard

with barrel socket ø6(6.5)mm

thermocouples SIT

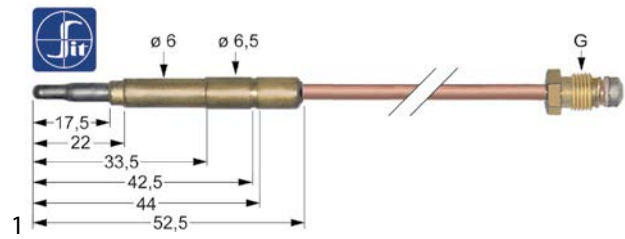

<b>GEV No.</b>	107621	<b>Ref. No.</b>	12037971 ICR10070
<b>description</b>	thermocouple SIT M10x1 L 1500mm plug connection ø6.0(6.5)mm		

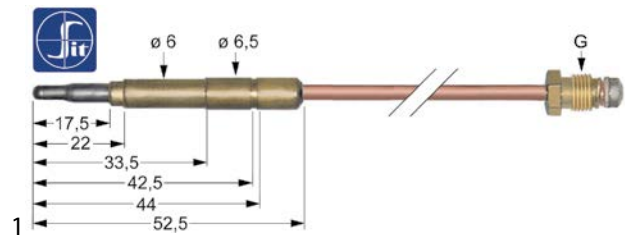

<b>GEV No.</b>	107605	<b>Ref. No.</b>	12020122 12020138 U322101 U322130
<b>description</b>	thermocouple SIT M8x1 L 1500mm plug connection ø6.0(6.5)mm		
<b>For models:</b>	CG7-11, CG7-41, CG-7415, CG7-61, CG-7615, CGB7-61, CGP9-11		

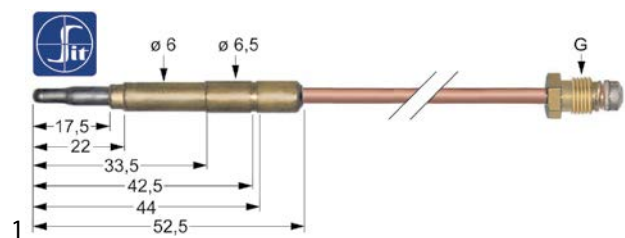

<b>GEV No.</b>	107601	<b>Ref. No.</b>	12020688 U222100
<b>description</b>	thermocouple SIT M8x1 L 600mm plug connection ø6.0(6.5)mm		
<b>For models:</b>	BG7-05, BG7-10, BG9-05, BG9-10, BMG7-10, BMG-9045, BMG9-05, BMG9-10, CG-2000, CG-2000-2P, CG-2005, CG-210, CG-210G, CG-300S, CG-310, CG-310G, CG7-10, CG7-11, CG7-20, CG-7200, CG7-40, CG-7400, CG7-41, CG-7415, CG7-61, CG-7615, CG9-20, CG9-40, CG9-41, CG9-51L, CG9-51LC, CG9-51R, CG9-51RC, CG9-60, CG9-61, CG9-82, CGE7-134, FG-91-20, FG-92-40, FTG7-05, FTG-7050L, FTG-7050R, FTG7-10, FTG-7100L, FTG-7100L+R, FTG-7100R, FTG-9050L, FTG-9050R, FTG9-05L, FTG9-05R...(Other models you can see in the webshop)		

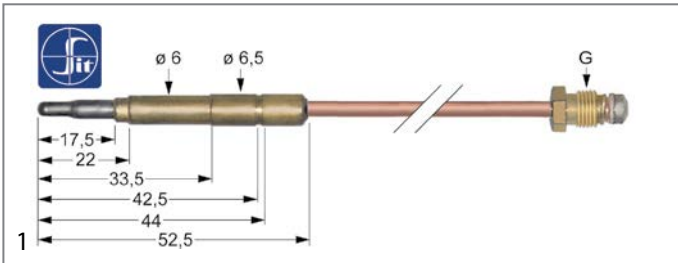

<b>GEV No.</b>	107612	<b>Ref. No.</b>	U562120
<b>description</b>	thermocouple SIT M9x1 L 1000mm plug connection ø6.0(6.5)mm		

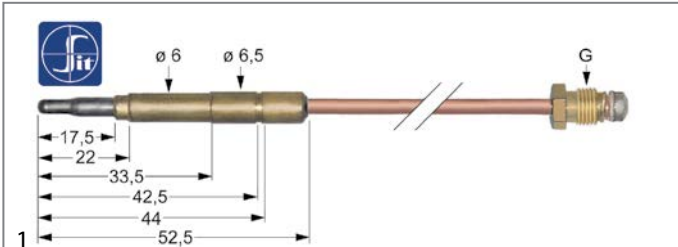

<b>GEV No.</b>	107614	<b>Ref. No.</b>	12009208
<b>description</b>	thermocouple SIT M9x1 L 1500mm plug connection ø6.0(6.5)mm		
<b>For models:</b>	CG7-11, CG7-31D, CG7-31I, CG7-41, CG7-41H, CG7-51, CG7-61, CG7-61H, CGB7-61, CGB7-61H, CGB7-61R, CGB7-61RH, CGP9-11		

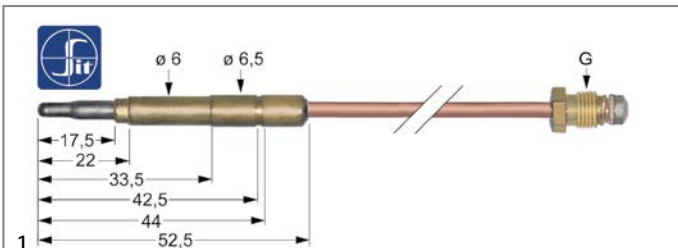

<b>GEV No.</b>	107611	<b>Ref. No.</b>	12009182 U562130
<b>description</b>	thermocouple SIT M9x1 L 850mm plug connection ø6.0(6.5)mm		
<b>For models:</b>	CG-1002, CG-1502, CG-2002, CG-2002P, CG-210, CG-210G, CG-310, CG-310G, CG9-11, CG9-11AD, CG9-11PLUS, CG9-31PLUS-D, CG9-31PLUS-I, CG9-41, CG9-41AD, CG9-41AD-H, CG9-41H, CG9-41PLUS, CG9-41PLUS-H, CG9-51L, CG9-51LC, CG9-51R, CG9-51RC, CG9-61, CG9-61AD, CG9-61AD-H, CG9-61H, CG9-61OP, CG9-61PLUS, CG9-61PLUS-H, CG9-82, CG9-82AD, CG9-82PLUS, CGF9-121D, CGF9-121D-AD, CGF9-121I, CGF9-121PLUS-D, CGF9-121PLUS-I, CPG7-05, CPG9-05, CPG9-05NC, CPG9-05S, CPG9-05SNC, FG7-05-1C, FG7-05-2C, FG-710, FG7-10-2C, FG7-104C, FG7-10-4C, FG-720...(Other models you can see in the webshop)		

thermocouples with aluminised tip

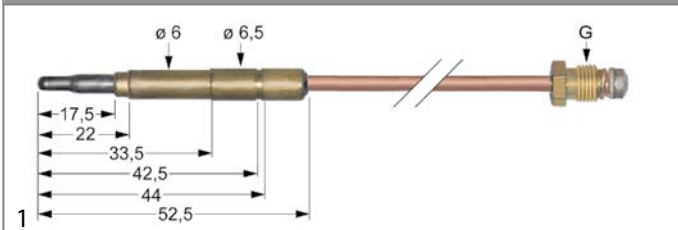

<b>GEV No.</b>	102042	<b>Ref. No.</b>	12021360 U262120 X152120
<b>description</b>	thermocouple M9x1 L 850mm plug connection ø6.0(6.5)mm		

threaded thermocouples (miscellaneous)

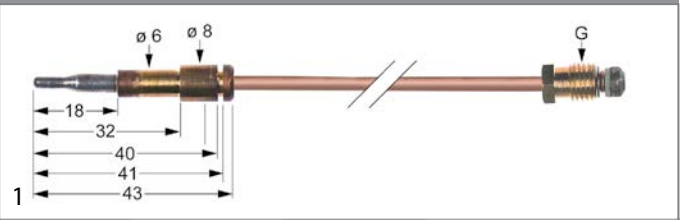

<b>GEV No.</b>	102462	<b>Ref. No.</b>	12008344 U262130
<b>description</b>	thermocouple M8x1 L 1000mm barrel socket		
<b>For models:</b>	CG-210, CG-210G, CG-310, CG-310G, CG6-41, CG9-20, CG9-20H, CG9-40, CG9-40H, CG9-41, CG9-41H, CG9-51L, CG9-51LC, CG9-51R, CG9-51RC, CG9-60, CG9-60H, CG9-61, CG9-61H, CG9-61OP, CG9-82, CGE9-41, CGF9-120D, CGF9-120I, CGF9-121D, CGF9-121I, CPG7-05, CPG7-05NC, CPG9-05, CPG9-05AD, CPG9-05AD-S, CPG9-05NC, CPG9-05PLUS, CPG9-05PLUS-S, CPG9-05S, CPG9-05SNC, GPC-350		

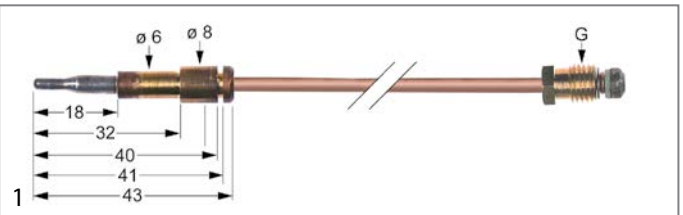

<b>GEV No.</b>	102451	<b>Ref. No.</b>	12009768 U222130
<b>description</b>	thermocouple M8x1 L 600mm barrel socket		
<b>For models:</b>	BG6-05I, BG7-05, BG7-05I, BG7-10, BG7-10I, BG9-05, BG9-05AD, BG9-05I, BG9-05PF, BG9-05PI, BG9-05PLUS-I, BG9-10, BG9-10AD, BG9-10I, BG9-10PF, BG9-10PI, BG9-10PLUS-I, BMG7-10, BMG9-05, BMG9-05V-T, BMG9-10, BMG9-10V-T, CG-1002, CG-1502, CG-2002, CG-2002P, CG-2005, CG-210, CG-210G, CG-300S, CG-310, CG-310G, CG7-10, CG7-11, CG7-20, CG7-20H, CG7-30D, CG7-30I, CG7-31D, CG7-31I, CG7-40, CG7-40H, CG7-41, CG7-41H, CG7-50, CG7-51, CG7-60, CG7-60H, CG7-61, CG7-61H...(Other models you can see in the webshop)		

plug-in thermocouples with interruption

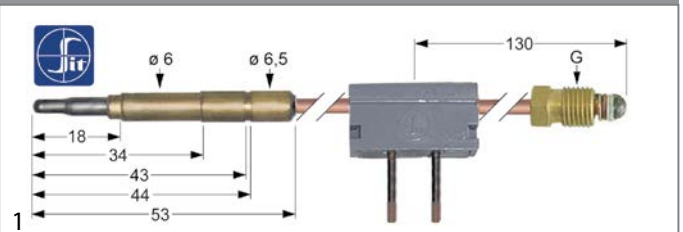

<b>GEV No.</b>	107164	<b>Ref. No.</b>	12008273 S042106
<b>description</b>	thermocouple SIT with interrupter M9x1 L 1000mm plug connection ø6.0(6.5)mm soldering connection		
<b>For models:</b>	FG6-05, FG6-10, MG7-10BM, MG9-10BM, MG9-10BMS, MG9-10S, MG9-15BM, MG9-15BM316, MG9-15BMS, MG9-15S, MG9-20S, MPG9-10BM, MPG9-10BMS, MPG9-15BM, MPG9-15BMS		

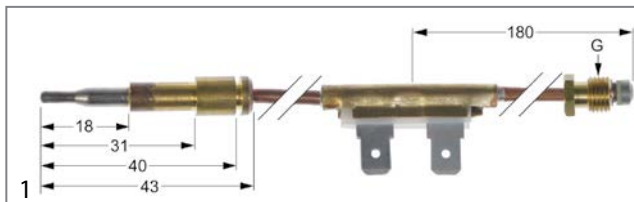
<b>GEV No.</b>	102269	<b>Ref. No.</b>	12019901 X022130
<b>description</b>	thermocouple with interrupter M9x1 L 850mm F 6.3mm		
<b>For models:</b>	FTGC9-05, FTGC-9050, FTGC9-10, FTGC-9100, MG7-10BM, MG9-10BM, MG9-10BMS, MG-9150BM, MG9-15BM, MG9-15BMS, MPG9-10BM, MPG9-10BMS, MPG9-15BM, MPG9-15BMS, SBG-9040		

accessories

screws



<b>GEV No.</b>	102464	<b>Ref. No.</b>	12021477 R275014
<b>description</b>	thermocouple fitting thread M10x1 brass Qty 1 pcs		
<b>For models:</b>	HG-10-11, HG-10-21, HG-2-10-11		



<b>GEV No.</b>	101261	<b>Ref. No.</b>	12009969 U264301
<b>description</b>	thermocouple fitting thread M9x1 Qty 1 pcs		

interrupters



<b>GEV No.</b>	101264	<b>Ref. No.</b>	12018684 X123002
<b>description</b>	interrupter thread M8x1		

miscellaneous



<b>GEV No.</b>	102449	<b>Ref. No.</b>	12023595 S223002
<b>description</b>	circuit breaker cable L 450mm Qty 2 pcs		
<b>For models:</b>	FG6-05, FG6-10, MG7-10BM, MG9-10BM, MG9-10BMS, MG-9150BM, MG9-15BM, MG9-15BM316, MG9-15BMS, MPG9-10BM, MPG9-10BMS, MPG9-15BM, MPG9-15BMS		

ignition bridges



<b>GEV No.</b>	109194	<b>Ref. No.</b>	12038892 X155035
<b>description</b>	ignition pipe L 146mm ø 21.3mm for tilting bratt pan		
<b>For models:</b>	SBG7-10, SBG9-10, SBG9-10I, SBG9-10IM, SBG9-10IMS, SBG9-10IS, SBG9-10M, SBG9-10MS, SBG9-10S, SBG9-15IM, SBG9-15IMS		



<b>GEV No.</b>	109054	<b>Ref. No.</b>	12011332 12011699 12038573 R155013 R165011
<b>description</b>	ignition pipe L 177mm ø 20mm		
<b>For models:</b>	CG9-51L, CG9-51LC, CG9-51R, CG9-51RC, FTG7-05, FTG7-05L, FTG7-05R, FTG7-05VL, FTG7-05VR, FTG7-10, FTG7-10L, FTG7-10L+R, FTG7-10R, FTG7-10VL, FTG7-10VL+R, FTG7-10VR, FTG9-05L, FTG9-05R, FTG9-05VL, FTG9-05VR, FTG9-10L, FTG9-10L+R, FTG9-10R, FTG9-10VL, FTG9-10VL+R, FTG9-10VR, FTG9-11L, FTG9-11L+R, FTG9-11R, FTG9-11R, FTGC7-05L, FTGC7-10L, FTGC9-05, FTGC9-05L, FTGC9-05R, FTGC9-10, FTGC9-10L, FTGC9-10L+R, FTGC9-10R, FTGC9-11L, FTGC9-11L+R, FTGC9-11R, FTGC9-11R, SBG7-10, SBG9-10, SBG9-10I, SBG9-10IM, SBG9-10IMS, SBG9-10IS, SBG9-10M, SBG9-10MS, SBG9-10S...(Other models you can see in the webshop)		

gas burners

hob burners



producer-specific hob burners





FAGOR



700, 900 series



<b>GEV No.</b>	109003	<b>Ref. No.</b>	12008071 U265702	
<b>description</b>	air mixing sleeve ø 40mm L 55mm			
<b>For models:</b>	CG-1002, CG-1502, CG-2000, CG-2000-2P, CG-2002, CG-2002P, CG-2005, CG-210, CG-210G, CG-300S, CG-310, CG-310G, CG7-20, CG7-200, CG7-20H, CG7-30D, CG7-30I, CG7-31D, CG7-31I, CG7-40, CG-7400, CG7-40H, CG7-41, CG-7415, CG7-41H, CG7-50, CG7-51, CG7-60, CG7-60H, CG7-61, CG-7615, CG7-61H, CG9-05AD, CG9-05PLUS, CG9-20, CG9-20AD, CG9-20AD-H, CG9-20H, CG9-20PLUS, CG9-20PLUS-H, CG9-31PLUS-D, CG9-31PLUS-I, CG9-40, CG9-40AD, CG9-40AD-H, CG9-40H, CG9-40PLUS, CG9-40PLUS-H, CG9-41, CG9-41AD...(Other models you can see in the webshop)			
<b>accessories for</b>	109003			
	<b>GEV No.</b>	109004	<b>Ref. No.</b>	12009292 U445730
<b>description</b>	burner head ø 100mm 4.6kW			
	<b>GEV No.</b>	109007	<b>Ref. No.</b>	12007684 12040161 U565701
<b>description</b>	burner head ø 120mm 7kW			

			
1			
<b>GEV No.</b>	109024	<b>Ref. No.</b>	12019997 U235704
<b>description</b>	air mixing sleeve ø 46mm L 55mm		
<b>accessories for</b>	109024		
	<b>GEV No.</b>	109026	<b>Ref. No.</b> 12013457 U235700
burner head ø 120mm for burner cap ø 130mm 12kW			



			
1			
<b>GEV No.</b>	109005	<b>Ref. No.</b>	12008124 12039162 U445731 U4457315 U445731500
<b>description</b>	burner cap ø 100mm 4kW with central hole		
<b>For models:</b>	CG-1002, CG-1502, CG-2000, CG-2002, CG-2002P, CG-2005, CG-210, CG-210G, CG-300S, CG-310, CG-310G, CG-7115, CG-7200, CG7-20H, CG7-30D, CG7-30I, CG7-31D, CG7-31I, CG7-40, CG-7400, CG7-41, CG-7415, CG7-50, CG7-51, CG7-60, CG7-60H, CG7-61, CG-7615, CG9-05AD, CG9-05PLUS, CG9-20, CG9-20AD, CG9-20H, CG9-20PLUS, CG9-31PLUS-D, CG9-31PLUS-I, CG9-40, CG9-40AD, CG9-40H, CG9-40PLUS, CG9-41, CG9-41AD, CG9-41H, CG9-41PLUS, CG9-51L, CG9-51LC, CG9-51R, CG9-51RC, CG9-60, CG9-60AD, CG9-60H, CG9-60PLUS...(Other models you can see in the webshop)		
<b>accessories for</b>	109005		
	<b>GEV No.</b>	109004	<b>Ref. No.</b> 12009292 U445730
burner head ø 100mm 4.6kW			
	<b>GEV No.</b>	109704	<b>Ref. No.</b> 12014055 U745417
drain tray L 340mm W 310mm H 41mm ø 130mm for burner cap ø 120mm			
	<b>GEV No.</b>	109710	<b>Ref. No.</b> 12005899 12038914 12120850 U505408
drain tray L 420mm W 344mm H 39mm ø 115mm for burner cap ø 100mm			

			
1			
<b>GEV No.</b>	109002	<b>Ref. No.</b>	12009109 12017945 U135702 U1357025 U135702500 U445732
<b>description</b>	burner cap ø 120mm 9.3kW with central hole		
<b>For models:</b>	CG-1002, CG-1502, CG-2000, CG-2000-2P, CG-2002, CG-2002P, CG-2005, CG-210, CG-210G, CG-300S, CG-310, CG-310G, CG-7115, CG-7200, CG7-20H, CG7-30D, CG7-30I, CG7-31D, CG7-31I, CG7-40, CG-7400, CG7-40H, CG7-41, CG-7415, CG7-41H, CG7-50, CG7-51, CG7-60, CG7-60H, CG7-61, CG-7615, CG7-61H, CG9-20, CG9-20AD, CG9-20AD-H, CG9-20H, CG9-20PLUS, CG9-20PLUS-H, CG9-31PLUS-D, CG9-31PLUS-I, CG9-40, CG9-40AD, CG9-40AD-H, CG9-40H, CG9-40PLUS, CG9-40PLUS-H, CG9-41, CG9-41AD, CG9-41AD-H, CG9-41H...(Other models you can see in the webshop)		
<b>accessories for</b>	109002		
	<b>GEV No.</b>	109007	<b>Ref. No.</b> 12007684 12040161 U565701
burner head ø 120mm 7kW			





			
1			
<b>GEV No.</b>	109027	<b>Ref. No.</b>	12007682 12009367 12047137 U235701 U235701500
<b>description</b>	burner cap ø 130mm 11.6kW with central hole		
<b>For models:</b>	CG-1002, CG-1502, CG-2002, CG-2002P, CG9-20AD-H, CG9-20H, CG9-20PLUS-H, CG9-40, CG9-40AD, CG9-40AD-H, CG9-40H, CG9-40PLUS, CG9-40PLUS-H, CG9-41, CG9-41AD, CG9-41AD-H, CG9-41H, CG9-41PLUS, CG9-41PLUS-H, CG9-51L, CG9-51LC, CG9-51R, CG9-51RC, CG9-60, CG9-60AD, CG9-60AD-H, CG9-60H, CG9-60PLUS, CG9-60PLUS-H, CG9-61, CG9-61AD, CG9-61AD-H, CG9-61H, CG9-61OP, CG9-61PLUS, CG9-61PLUS-H, CG9-82, CG9-82AD, CG9-82PLUS, CGE9-41, CGE9-41AD, CGE9-41PLUS, HP-G-15, HPG-15		
<b>accessories for</b>	109027		
	<b>GEV No.</b>	109026	<b>Ref. No.</b> 12013457 U235700
burner head ø 120mm for burner cap ø 130mm 12kW			













 <p>1</p>			
<b>GEV No.</b>	109004	<b>Ref. No.</b>	12009292 U445730
<b>description</b>	burner head ø 100mm 4.6kW		
<b>For models:</b>	CG-1002, CG-1502, CG-2000, CG-2002, CG-2005, CG-210, CG-210G, CG-300S, CG-310, CG-310G, CG7-20, CG-7200, CG7-40, CG-7400, CG7-41, CG-7415, CG7-61, CG-7615, CG9-20, CG9-40, CG9-41, CG9-51L, CG9-51LC, CG9-51R, CG9-51RC, CG9-60, CG9-61, CG9-82, CGB7-61, CGE7-118, CGE7-41, CGE9-41		
<b>accessories for</b>	109004		
	<b>GEV No.</b>	109001	<b>Ref. No.</b>
			12009400 U125720
	venturi ø 11.5mm L 90mm		
	<b>GEV No.</b>	109003	<b>Ref. No.</b>
			12008071 U265702
	air mixing sleeve ø 40mm L 55mm		
	<b>GEV No.</b>	109005	<b>Ref. No.</b>
			12008124 12039162 U445731 U4457315 U445731500
	burner cap ø 100mm 4kW with central hole		



 <p>1</p>			
<b>GEV No.</b>	109205	<b>Ref. No.</b>	12008471 U915702000
<b>description</b>	burner head ø 120mm 7kW suitable for FAGOR		
<b>For models:</b>	CG7-20H, CG7-30D, CG7-30I, CG7-31D, CG7-31I, CG7-40, CG7-40H, CG7-41, CG7-41H, CG7-50, CG7-51, CG7-60, CG7-60H, CG7-61, CG7-61H, CGB7-61, CGB7-61H, CGB7-61R, CGB7-61RH, CGE7-41, CGE7-41H		
<b>accessories for</b>	109205		
	<b>GEV No.</b>	109002	<b>Ref. No.</b>
			12009109 12017945 U135702 U1357025 U135702500 U445732
	burner cap ø 120mm 9.3kW with central hole		

 <p>1</p>			
<b>GEV No.</b>	109007	<b>Ref. No.</b>	12007684 12040161 U565701
<b>description</b>	burner head ø 120mm 7kW		
<b>For models:</b>	CG-1002, CG-1502, CG-2000, CG-2000-2P, CG-2002, CG-2005, CG-210, CG-210G, CG-300S, CG-310, CG-310G, CG7-40, CG7-41, CG7-61, CG9-20, CG9-40, CG9-41, CG9-51L, CG9-51LC, CG9-51R, CG9-51RC, CG9-60, CG9-61, CG9-82, CGB7-61, CGE7-108, CGE7-41, CGE9-41		
<b>accessories for</b>	109007		
	<b>GEV No.</b>	109002	<b>Ref. No.</b>
			12009109 12017945 U135702 U1357025 U135702500 U445732
	burner cap ø 120mm 9.3kW with central hole		
	<b>GEV No.</b>	109003	<b>Ref. No.</b>
			12008071 U265702
	air mixing sleeve ø 40mm L 55mm		
	<b>GEV No.</b>	109006	<b>Ref. No.</b>
			12008429 U565700
	venturi ø 27.7mm L 90mm		

 <p>1</p>			
<b>GEV No.</b>	109026	<b>Ref. No.</b>	12013457 U235700
<b>description</b>	burner head ø 120mm for burner cap ø 130mm 12kW		
<b>For models:</b>	CG-1002, CG-1502, CG-2002, CG9-40, CG9-41, CG9-51L, CG9-51LC, CG9-51R, CG9-51RC, CG9-60, CG9-61, CG9-82, CGE9-41		
<b>accessories for</b>	109026		
	<b>GEV No.</b>	109024	<b>Ref. No.</b>
			12019997 U235704
	air mixing sleeve ø 46mm L 55mm		
	<b>GEV No.</b>	109025	<b>Ref. No.</b>
			12008019 12008611 U235702
	venturi ø 40mm L 160mm		
	<b>GEV No.</b>	109027	<b>Ref. No.</b>
			12007682 12009367 12047137 U235701 U235701500
	burner cap ø 130mm 11.6kW with central hole		



			
<b>GEV No.</b>	109001	<b>Ref. No.</b>	12009400 U125720
<b>description</b>	venturi ø 11.5mm L 90mm		
<b>For models:</b>	CG-1002, CG-1502, CG-2000, CG-2002, CG-2002P, CG-2005, CG-210, CG-210G, CG-300S, CG-310, CG-310G, CG7-20, CG-7200, CG7-30D, CG7-30I, CG7-31D, CG7-31I, CG7-40, CG-7400, CG7-41, CG-7415, CG7-50, CG7-51, CG7-60, CG7-61, CG-7615, CG9-05AD, CG9-05PLUS, CG9-20, CG9-20AD, CG9-20H, CG9-20PLUS, CG9-31PLUS-D, CG9-31PLUS-I, CG9-40, CG9-40AD, CG9-40H, CG9-40PLUS, CG9-41, CG9-41AD, CG9-41H, CG9-41PLUS, CG9-51L, CG9-51LC, CG9-51R, CG9-51RC, CG9-60, CG9-60AD, CG9-60H, CG9-60PLUS...(Other models you can see in the webshop)		
<b>accessories for</b>	109001		
			
<b>GEV No.</b>	109004	<b>Ref. No.</b>	12009292 U445730
burner head ø 100mm 4.6kW			





			
<b>GEV No.</b>	109006	<b>Ref. No.</b>	12008429 U565700
<b>description</b>	venturi ø 27.7mm L 90mm		
<b>For models:</b>	CG-1002, CG-1502, CG-2000, CG-2000-2P, CG-2002, CG-2002P, CG-2005, CG-210, CG-210G, CG-300S, CG-310, CG-310G, CG7-20H, CG7-30D, CG7-30I, CG7-31D, CG7-31I, CG7-40, CG7-40H, CG7-41, CG7-41H, CG7-50, CG7-51, CG7-60, CG7-60H, CG7-61, CG7-61H, CG9-20, CG9-20AD, CG9-20AD-H, CG9-20H, CG9-20PLUS, CG9-20PLUS-H, CG9-31PLUS-D, CG9-31PLUS-I, CG9-40, CG9-40AD, CG9-40AD-H, CG9-40H, CG9-40PLUS, CG9-40PLUS-H, CG9-41, CG9-41AD, CG9-41AD-H, CG9-41H, CG9-41PLUS, CG9-41PLUS-H, CG9-51L, CG9-51LC, CG9-51R...		
<b>accessories for</b>	109006		
			
<b>GEV No.</b>	109007	<b>Ref. No.</b>	12007684 12040161 U565701
burner head ø 120mm 7kW			

			
<b>GEV No.</b>	109025	<b>Ref. No.</b>	12008019 12008611 U235702
<b>description</b>	venturi ø 40mm L 160mm		
<b>For models:</b>	CG-1002, CG-1502, CG-2002, CG-2002P, CG9-40, CG9-41, CG9-51L, CG9-51LC, CG9-51R, CG9-51RC, CG9-60, CG9-61, CG9-82, CG9-41		
<b>accessories for</b>	109025		
			
<b>GEV No.</b>	109026	<b>Ref. No.</b>	12013457 U235700
burner head ø 120mm for burner cap ø 130mm 12kW			

900 (since 2006) series

			
<b>GEV No.</b>	109062	<b>Ref. No.</b>	12008073 U025706
<b>description</b>	air mixing sleeve L 56mm D1 ø 49mm D2 ø 51mm		
<b>For models:</b>	CG-1002, CG-1502, CG-2002, CG-2002P, CG9-20AD-H, CG9-20H, CG9-20PLUS-H, CG9-40, CG9-40AD, CG9-40AD-H, CG9-40H, CG9-40PLUS, CG9-40PLUS-H, CG9-41, CG9-41AD, CG9-41AD-H, CG9-41H, CG9-41PLUS, CG9-41PLUS-H, CG9-51L, CG9-51LC, CG9-51R, CG9-51RC, CG9-60, CG9-60AD, CG9-60AD-H, CG9-60H, CG9-60PLUS, CG9-60PLUS-H, CG9-61, CG9-61AD, CG9-61AD-H, CG9-61H, CG9-61OP, CG9-61PLUS, CG9-61PLUS-H, CG9-82, CG9-82AD, CG9-82PLUS, CG9-41, CG9-41AD, CG9-41PLUS		

			
<b>GEV No.</b>	109003	<b>Ref. No.</b>	12008071 U265702
<b>description</b>	air mixing sleeve ø 40mm L 55mm		
<b>For models:</b>	CG-1002, CG-1502, CG-2000, CG-2000-2P, CG-2002, CG-2002P, CG-2005, CG-210, CG-210G, CG-300S, CG-310, CG-310G, CG7-20, CG-7200, CG7-30D, CG7-30I, CG7-31D, CG7-31I, CG7-40, CG-7400, CG7-40H, CG7-41, CG-7415, CG7-41H, CG7-50, CG7-51, CG7-60, CG7-60H, CG7-61, CG-7615, CG7-61H, CG9-05AD, CG9-05PLUS, CG9-20, CG9-20AD, CG9-20AD-H, CG9-20H, CG9-20PLUS, CG9-20PLUS-H, CG9-31PLUS-D, CG9-31PLUS-I, CG9-40, CG9-40AD, CG9-40AD-H, CG9-40H, CG9-40PLUS, CG9-40PLUS-H, CG9-41, CG9-41AD...(Other models you can see in the webshop)		
<b>accessories for</b>	109003		
			
<b>GEV No.</b>	109004	<b>Ref. No.</b>	12009292 U445730
burner head ø 100mm 4.6kW			
			
<b>GEV No.</b>	109007	<b>Ref. No.</b>	12007684 12040161 U565701
burner head ø 120mm 7kW			

			
<b>GEV No.</b>	109005	<b>Ref. No.</b>	12008124 12039162 U445731 U4457315 U445731500
<b>description</b>	burner cap ø 100mm 4kW with central hole		
<b>For models:</b>	CG-1002, CG-1502, CG-2000, CG-2002, CG-2002P, CG-2005, CG-210, CG-210G, CG-300S, CG-310, CG-310G, CG7-20, CG-7200, CG7-30D, CG7-30I, CG7-31D, CG7-31I, CG7-40, CG-7400, CG7-41, CG-7415, CG7-50, CG7-51, CG7-60, CG7-61, CG-7615, CG9-05AD, CG9-05PLUS, CG9-20, CG9-20AD, CG9-20H, CG9-20PLUS, CG9-31PLUS-D, CG9-31PLUS-I, CG9-40, CG9-40AD, CG9-40AD-H, CG9-40H, CG9-40PLUS, CG9-40PLUS-H, CG9-41, CG9-41AD, CG9-41AD-H, CG9-41H, CG9-41PLUS, CG9-51L, CG9-51LC, CG9-51R, CG9-51RC, CG9-60, CG9-60AD, CG9-60H, CG9-60PLUS...(Other models you can see in the webshop)		
<b>accessories for</b>	109005		
			
<b>GEV No.</b>	109004	<b>Ref. No.</b>	12009292 U445730
burner head ø 100mm 4.6kW			
			
<b>GEV No.</b>	109704	<b>Ref. No.</b>	12014055 U745417
drain tray L 340mm W 310mm H 41mm ø 130mm for burner cap ø 120mm			
			
<b>GEV No.</b>	109710	<b>Ref. No.</b>	12005899 12038914 12120850 U505408
drain tray L 420mm W 344mm H 39mm ø 115mm for burner cap ø 100mm			





			
1			
<b>GEV No.</b>	109002	<b>Ref. No.</b>	12009109 12017945 U135702 U1357025 U135702500 U445732
<b>description</b>	burner cap ø 120mm 9.3kW with central hole		
<b>For models:</b>	CG-1002, CG-1502, CG-2000, CG-2000-2P, CG-2002, CG-2002P, CG-2005, CG-210, CG-210G, CG-300S, CG-310, CG-310G, CG-7115, CG-7200, CG7-20H, CG7-30D, CG7-30I, CG7-31D, CG7-31I, CG7-40, CG-7400, CG7-40H, CG7-41, CG-7415, CG7-41H, CG7-50, CG7-51, CG7-60, CG7-60H, CG7-61, CG-7615, CG7-61H, CG9-20, CG9-20AD, CG9-20AD-H, CG9-20H, CG9-20PLUS, CG9-20PLUS-H, CG9-31PLUS-D, CG9-31PLUS-I, CG9-40, CG9-40AD, CG9-40AD-H, CG9-40H, CG9-40PLUS, CG9-40PLUS-H, CG9-41, CG9-41AD, CG9-41AD-H, CG9-41H... (Other models you can see in the webshop)		
<b>accessories for</b>	109002		
			
<b>GEV No.</b>	109007	<b>Ref. No.</b>	12007684 12040161 U565701
burner head ø 120mm 7kW			



			
1			
<b>GEV No.</b>	109027	<b>Ref. No.</b>	12007682 12009367 12047137 U235701 U235701500
<b>description</b>	burner cap ø 130mm 11.6kW with central hole		
<b>For models:</b>	CG-1002, CG-1502, CG-2002, CG-2002P, CG9-20AD-H, CG9-20H, CG9-20PLUS-H, CG9-40, CG9-40AD, CG9-40AD-H, CG9-40H, CG9-40PLUS, CG9-40PLUS-H, CG9-41, CG9-41AD, CG9-41AD-H, CG9-41H, CG9-41PLUS, CG9-41PLUS-H, CG9-51L, CG9-51LC, CG9-51R, CG9-51RC, CG9-60, CG9-60AD, CG9-60AD-H, CG9-60H, CG9-60PLUS, CG9-60PLUS-H, CG9-61, CG9-61AD, CG9-61AD-H, CG9-61H, CG9-61OP, CG9-61PLUS, CG9-61PLUS-H, CG9-82, CG9-82AD, CG9-82PLUS, CGE9-41, CGE9-41AD, CGE9-41PLUS, HP-G-15, HPG-15		
<b>accessories for</b>	109027		
			
<b>GEV No.</b>	109026	<b>Ref. No.</b>	12013457 U235700
burner head ø 120mm for burner cap ø 130mm 12kW			



			
1			
<b>GEV No.</b>	109063	<b>Ref. No.</b>	12009498 U025701
<b>description</b>	burner head ø 100mm 4.7kW 4kcal for burner cap ø 100mm L 280mm H 113mm		
<b>For models:</b>	CG-1002, CG-1502, CG-2002, CG-2002P, CG9-20, CG9-40, CG9-41, CG9-51L, CG9-51LC, CG9-51R, CG9-51RC, CG9-60, CG9-61, CG9-82, CGE9-41, CGF9-120D, CGF9-120I, CGF9-121D, CGF9-121I		

			
1			
<b>GEV No.</b>	109106	<b>Ref. No.</b>	12009326 U025702
<b>description</b>	burner head ø 118mm 9.3kW 8000kcal for burner cap ø 120mm L 280mm H 90mm		
<b>For models:</b>	CG-1002, CG-1502, CG-2002, CG-2002P, CG9-20, CG9-40, CG9-41, CG9-51L, CG9-51LC, CG9-51R, CG9-51RC, CG9-60, CG9-61, CG9-82, CGE9-41, CGF9-120D, CGF9-120I, CGF9-121D, CGF9-121I		

			
1			
<b>GEV No.</b>	109102	<b>Ref. No.</b>	12008525 U025703
<b>description</b>	burner head ø 120mm 11.6kW for burner cap ø 130mm L 280mm H 94mm		
<b>For models:</b>	CG-1002, CG-1502, CG-2002, CG-2002P, CG9-40, CG9-41, CG9-51L, CG9-51LC, CG9-51R, CG9-51RC, CG9-60, CG9-61, CG9-82, CGE9-41		
<b>accessories for</b>	109102		
			
<b>GEV No.</b>	109003	<b>Ref. No.</b>	12008071 U265702
air mixing sleeve ø 40mm L 55mm			





			
1			
<b>GEV No.</b>	109001	<b>Ref. No.</b>	12009400 U125720
<b>description</b>	venturi ø 11.5mm L 90mm		
<b>For models:</b>	CG-1002, CG-1502, CG-2000, CG-2002, CG-2002P, CG-2005, CG-210, CG-210G, CG-300S, CG-310, CG-310G, CG7-20, CG-7200, CG7-30D, CG7-30I, CG7-31D, CG7-31I, CG7-40, CG-7400, CG7-41, CG-7415, CG7-50, CG7-51, CG7-60, CG7-61, CG-7615, CG9-05AD, CG9-05PLUS, CG9-20, CG9-20AD, CG9-20H, CG9-20PLUS, CG9-31PLUS-D, CG9-31PLUS-I, CG9-40, CG9-40AD, CG9-40H, CG9-40PLUS, CG9-41, CG9-41AD, CG9-41H, CG9-41PLUS, CG9-51L, CG9-51LC, CG9-51R, CG9-51RC, CG9-60, CG9-60AD, CG9-60H, CG9-60PLUS... (Other models you can see in the webshop)		
<b>accessories for</b>	109001		
			
<b>GEV No.</b>	109004	<b>Ref. No.</b>	12009292 U445730
burner head ø 100mm 4.6kW			





			
<b>GEV No.</b>	109006	<b>Ref. No.</b>	12008429 U565700
<b>description</b>	venturi ø 27.7mm L 90mm		
<b>For models:</b>	CG-1002, CG-1502, CG-2000, CG-2000-2P, CG-2002, CG-2002P, CG-2005, CG-210, CG-210G, CG-3005, CG-310, CG-310G, CG7-20H, CG7-30D, CG7-30I, CG7-31D, CG7-31I, CG7-40, CG7-40H, CG7-41, CG7-41H, CG7-50, CG7-51, CG7-60, CG7-60H, CG7-61, CG7-61H, CG9-20, CG9-20AD, CG9-20AD-H, CG9-20H, CG9-20PLUS, CG9-20PLUS-H, CG9-31PLUS-D, CG9-31PLUS-I, CG9-40, CG9-40AD, CG9-40AD-H, CG9-40H, CG9-40PLUS, CG9-40PLUS-H, CG9-41, CG9-41AD, CG9-41AD-H, CG9-41H, CG9-41PLUS, CG9-41PLUS-H, CG9-51L, CG9-51LC, CG9-51R... (Other models you can see in the webshop)		
<b>accessories for</b>	109006		
	<b>GEV No.</b>	109007	<b>Ref. No.</b> 12007684 12040161 U565701
burner head ø 120mm 7kW			





			
<b>GEV No.</b>	109025	<b>Ref. No.</b>	12008019 12008611 U235702
<b>description</b>	venturi ø 40mm L 160mm		
<b>For models:</b>	CG-1002, CG-1502, CG-2002, CG-2002P, CG9-40, CG9-41, CG9-51L, CG9-51LC, CG9-51R, CG9-51RC, CG9-60, CG9-61, CG9-82, CGE9-41		
<b>accessories for</b>	109025		
	<b>GEV No.</b>	109026	<b>Ref. No.</b> 12013457 U235700
burner head ø 120mm for burner cap ø 130mm 12kW			

solid tops / stockpot stoves





			
<b>GEV No.</b>	109031	<b>Ref. No.</b>	U195704
<b>description</b>	air mixing tube		

			
<b>GEV No.</b>	109014	<b>Ref. No.</b>	12009172 12040022 U195701 U1957015 U195701500
<b>description</b>	burner cap ø 120mm with central hole		
<b>For models:</b>	CG-110, CG7-10, CG7-11, CG9-10, CG9-10AD, CG9-10PLUS, CG9-11, CG9-11PLUS, CGE9-11, CGF9-120D, CGF9-120D-AD, CGF9-120I, CGF9-120I-AD, CGF9-120PLUS-D, CGF9-120PLUS-I, CGF9-121D, CGF9-121D-AD, CGF9-121I, CGF9-121I-AD, CGF9-121PLUS-D, CGF9-121PLUS-I		
<b>accessories for</b>	109014		
	<b>GEV No.</b>	109015	<b>Ref. No.</b> 12007687 U195702
burner head for burner cap ø 120mm			
	<b>GEV No.</b>	109016	<b>Ref. No.</b> 12009160 U775701
venturi			
	<b>GEV No.</b>	109017	<b>Ref. No.</b> 12009164 12014412 U615700 U615700500
burner holder			

			
<b>GEV No.</b>	109015	<b>Ref. No.</b>	12007687 U195702
<b>description</b>	burner head for burner cap ø 120mm		
<b>For models:</b>	CG-110, CG7-10, CG7-11, CG-7115, CG9-10, CG9-10AD, CG9-10PLUS, CG9-11, CG-9110, CG9-11AD, CG9-11PLUS, CGE9-11, CGF9-120D, CGF9-120D-AD, CGF9-120I, CGF9-120I-AD, CGF9-120PLUS-D, CGF9-120PLUS-I, CGF9-121D, CGF9-121D-AD, CGF9-121I, CGF9-121I-AD, CGF9-121PLUS-D, CGF9-121PLUS-I, HP-G-15, HPG-15		
<b>accessories for</b>	109015		
	<b>GEV No.</b>	109014	<b>Ref. No.</b> 12009172 12040022 U195701 U1957015 U195701500
burner cap ø 120mm with central hole			
	<b>GEV No.</b>	109016	<b>Ref. No.</b> 12009160 U775701
venturi			
	<b>GEV No.</b>	109017	<b>Ref. No.</b> 12009164 12014412 U615700 U615700500
burner holder			

			
<b>GEV No.</b>	109017	<b>Ref. No.</b>	12009164 12014412 U615700 U615700500
<b>description</b>	burner holder		
<b>For models:</b>	CG7-10, CG7-11, CG9-10, CG9-10AD, CG9-10PLUS, CG9-11, CG9-11AD, CG9-11PLUS, CGE9-11, CGF9-120D, CGF9-120D-AD, CGF9-120I, CGF9-120I-AD, CGF9-120PLUS-D, CGF9-120PLUS-I, CGF9-121D, CGF9-121D-AD, CGF9-121I, CGF9-121I-AD, CGF9-121PLUS-D, CGF9-121PLUS-I, HP-G-15, HPG-15		
<b>accessories for</b>	109017		
	<b>GEV No.</b>	109014	<b>Ref. No.</b> 12009172 12040022 U195701 U1957015 U195701500
burner cap ø 120mm with central hole			
	<b>GEV No.</b>	109015	<b>Ref. No.</b> 12007687 U195702
burner head for burner cap ø 120mm			
	<b>GEV No.</b>	109016	<b>Ref. No.</b> 12009160 U775701
venturi			





1 			
<b>GEV No.</b>	109016	<b>Ref. No.</b>	12009160 U775701
<b>description</b>	venturi		
<b>For models:</b>	CG7-10, CG7-11, CG9-10, CG9-10AD, CG9-10PLUS, CG9-11, CG9-11AD, CG9-11PLUS, CGE9-11, CGF9-120D, CGF9-120D-AD, CGF9-120I, CGF9-120I-AD, CGF9-120PLUS-D, CGF9-120PLUS-I, CGF9-121D, CGF9-121D-AD, CGF9-121I, CGF9-121I-AD, CGF9-121PLUS-D, CGF9-121PLUS-I, HP-G-15, HPG-15		
<b>accessories for</b>	109016		
	<b>GEV No.</b>	109014	<b>Ref. No.</b> 12009172 12040022 U195701 U1957015 U195701500
burner cap ø 120mm with central hole			
	<b>GEV No.</b>	109015	<b>Ref. No.</b> 12007687 U195702
burner head for burner cap ø 120mm			
	<b>GEV No.</b>	109017	<b>Ref. No.</b> 12009164 12014412 U615700 U615700500
burner holder			

1 			
<b>GEV No.</b>	109702	<b>Ref. No.</b>	12016262 U745413
<b>description</b>	pan support W 310mm L 350mm suitable for FAGOR for burner cap ø 100mm		
<b>For models:</b>	CG7-20, CG7-40, CG7-41, CG7-61, CGE7-88		

1 			
<b>GEV No.</b>	109701	<b>Ref. No.</b>	12016263 U745412
<b>description</b>	pan support W 310mm L 350mm suitable for FAGOR for burner cap ø 120mm		
<b>For models:</b>	CG7-20, CG7-40, CG7-41, CG7-61, CGE7-89		

<b>pan supports</b>			
1 			
<b>GEV No.</b>	109705	<b>Ref. No.</b>	12016228 U745415
<b>description</b>	pan support W 310mm L 345mm H 50mm suitable for FAGOR black, varnished		
<b>For models:</b>	CG7-20, CG7-40, CG7-41, CG7-61, CGB7-61, CGE7-41		

1 			
<b>GEV No.</b>	109716	<b>Ref. No.</b>	12007691 U565403
<b>description</b>	pan support W 345mm L 425mm		
<b>For models:</b>	CG-1002, CG-1502, CG-2000, CG-2000-2P, CG-2002, CG-2005, CG-210, CG-210G, CG-3005, CG-310, CG-310G, CG9-20, CG9-40, CG9-41, CG9-51L, CG9-51LC, CG9-51R, CG9-51RC, CG9-60, CG9-61, CG9-82, CGE9-41		

1 			
<b>GEV No.</b>	109069	<b>Ref. No.</b>	12009419 U915413
<b>description</b>	pan support W 310mm L 348mm H 54mm suitable for FAGOR cast iron		
<b>For models:</b>	CG7-20, CG7-20H, CG7-30D, CG7-30I, CG7-31D, CG7-31I, CG7-40, CG7-40H, CG7-41, CG7-41H, CG7-50, CG7-51, CG7-60, CG7-60H, CG7-61, CG7-61H, CGB7-61, CGB7-61H, CGB7-61R, CGB7-61RH, CGE7-41, CGE7-41H		

<b>spillage trays</b>			
1 			
<b>GEV No.</b>	109703	<b>Ref. No.</b>	12014294 U745416
<b>description</b>	drain tray L 340mm W 310mm H 38mm ø 115mm for burner cap ø 100mm		
<b>For models:</b>	CG7-20, CG7-40, CG7-41, CG7-61, CGB7-61, CGE7-41		



			
1			
<b>GEV No.</b>	109706	<b>Ref. No.</b>	12002032 U025404
<b>description</b>	drain tray L 405mm W 348mm H 50mm for burner cap ø 100mm		
<b>For models:</b>	CG-1002, CG-1502, CG9-20, CG9-40, CG9-41, CG9-51L, CG9-51LC, CG9-51R, CG9-51RC, CG9-60, CG9-61, CG9-82, CGE9-41, CGF9-120D, CGF9-120I, CGF9-121D, CGF9-121I		

			
1			
<b>GEV No.</b>	109721	<b>Ref. No.</b>	12002033 U025405
<b>description</b>	drain tray L 405mm W 348mm H 50mm for burner cap ø 120mm		
<b>For models:</b>	CG-1002, CG-1502, CG-2002, CG-2002P, CG9-20, CG9-40, CG9-41, CG9-51L, CG9-51LC, CG9-51R, CG9-51RC, CG9-60, CG9-61, CG9-82, CGE9-41, CGF9-120D, CGF9-120I, CGF9-121D, CGF9-121I		

			
1			
<b>GEV No.</b>	109710	<b>Ref. No.</b>	12005899 12038914 12120850 U505408
<b>description</b>	drain tray L 420mm W 344mm H 39mm ø 115mm for burner cap ø 100mm		
<b>For models:</b>	CG-1002, CG-1502, CG-200S, CG-210, CG-210G, CG-300S, CG-310, CG-310G, CG9-20, CG9-40, CG9-41, CG9-51L, CG9-51LC, CG9-51R, CG9-51RC, CG9-60, CG9-61, CG9-82, CGE9-41		

			
1			
<b>GEV No.</b>	109711	<b>Ref. No.</b>	12005898 12038913 U505409
<b>description</b>	drain tray L 420mm W 344mm H 45mm ø 140mm for burner cap ø 120mm		
<b>For models:</b>	CG-1002, CG-1502, CG-2000, CG-2000-2P, CG-2002, CG-200S, CG-210, CG-210G, CG-300S, CG-310, CG-310G, CG9-20, CG9-40, CG9-41, CG9-51L, CG9-51LC, CG9-51R, CG9-51RC, CG9-60, CG9-61, CG9-82, CGE9-41		

<b>solid tops</b>			
			
1			
<b>GEV No.</b>	109087	<b>Ref. No.</b>	12007681 U195421
<b>description</b>	cast plate ø 260mm		
<b>For models:</b>	CG-110, CG7-10, CG7-11, CG9-05AD, CG9-05PLUS, CG9-10, CG9-10AD, CG9-10PLUS, CG9-11, CG-9110, CG9-11AD, CG9-11PLUS, CG9-31PLUS-D, CG9-31PLUS-I, CGE9-11, CGF9-120D, CGF9-120I, CGF9-121D, CGF9-121I		

<b>simmering plates</b>			
			
1			
<b>GEV No.</b>	109088	<b>Ref. No.</b>	12009018 U915414
<b>description</b>	simmer plate L 343mm W 310mm H 32mm for gas range		

			
1			
<b>GEV No.</b>	109700	<b>Ref. No.</b>	12011961 U745411
<b>description</b>	simmer plate L 345mm W 310mm H 40mm		
<b>For models:</b>	CG7-20, CG7-40, CG7-41, CG7-61, CGB7-61, CGE7-41, CGE7-90		

			
1			
<b>GEV No.</b>	109709	<b>Ref. No.</b>	12007699 U565406
<b>description</b>	simmer plate L 420mm W 345mm H 25mm		
<b>For models:</b>	CG-1002, CG-1502, CG-2000, CG-2002, CG-200S, CG-210, CG-210G, CG-300S, CG-310, CG-310G, CG9-20, CG9-40, CG9-41, CG9-60, CG9-61, CG9-82, CGE9-41		



accessories

pan supports

 <p>1</p>			
<b>GEV No.</b>	109705	<b>Ref. No.</b>	12016228 U745415
<b>description</b>	pan support W 310mm L 345mm H 50mm suitable for FAGOR black, varnished		
<b>For models:</b>	CG7-20, CG7-40, CG7-41, CG7-61, CGB7-61, CGE7-41		

 <p>1</p>			
<b>GEV No.</b>	109069	<b>Ref. No.</b>	12009419 U915413
<b>description</b>	pan support W 310mm L 348mm H 54mm suitable for FAGOR cast iron		
<b>For models:</b>	CG7-20, CG7-20H, CG7-30D, CG7-30I, CG7-31D, CG7-31I, CG7-40, CG7-40H, CG7-41, CG7-41H, CG7-50, CG7-51, CG7-60, CG7-60H, CG7-61, CG7-61H, CGB7-61, CGB7-61H, CGB7-61R, CGB7-61RH, CGE7-41, CGE7-41H		

 <p>1</p>			
<b>GEV No.</b>	109702	<b>Ref. No.</b>	12016262 U745413
<b>description</b>	pan support W 310mm L 350mm suitable for FAGOR for burner cap ø 100mm		
<b>For models:</b>	CG7-20, CG7-40, CG7-41, CG7-61, CGE7-88		

 <p>1</p>			
<b>GEV No.</b>	109701	<b>Ref. No.</b>	12016263 U745412
<b>description</b>	pan support W 310mm L 350mm suitable for FAGOR for burner cap ø 120mm		
<b>For models:</b>	CG7-20, CG7-40, CG7-41, CG7-61, CGE7-89		

 <p>1</p>			
<b>GEV No.</b>	109716	<b>Ref. No.</b>	12007691 U565403
<b>description</b>	pan support W 345mm L 425mm		
<b>For models:</b>	CG-1002, CG-1502, CG-2000, CG-2000-2P, CG-2002, CG-2005, CG-210, CG-210G, CG-300S, CG-310, CG-310G, CG9-20, CG9-40, CG9-41, CG9-51L, CG9-51LC, CG9-51R, CG9-51RC, CG9-60, CG9-61, CG9-82, CGE9-41		

<p>spillage trays</p>  <p>1</p>			
<b>GEV No.</b>	109703	<b>Ref. No.</b>	12014294 U745416
<b>description</b>	drain tray L 340mm W 310mm H 38mm ø 115mm for burner cap ø 100mm		
<b>For models:</b>	CG7-20, CG7-40, CG7-41, CG7-61, CGB7-61, CGE7-41		

 <p>1</p>			
<b>GEV No.</b>	109706	<b>Ref. No.</b>	12002032 U025404
<b>description</b>	drain tray L 405mm W 348mm H 50mm for burner cap ø 100mm		
<b>For models:</b>	CG-1002, CG-1502, CG9-20, CG9-40, CG9-41, CG9-51L, CG9-51LC, CG9-51R, CG9-51RC, CG9-60, CG9-61, CG9-82, CGE9-41, CGF9-120D, CGF9-120I, CGF9-121D, CGF9-121I		

 <p>1</p>			
<b>GEV No.</b>	109721	<b>Ref. No.</b>	12002033 U025405
<b>description</b>	drain tray L 405mm W 348mm H 50mm for burner cap ø 120mm		
<b>For models:</b>	CG-1002, CG-1502, CG-2002, CG-2002P, CG9-20, CG9-40, CG9-41, CG9-51L, CG9-51LC, CG9-51R, CG9-51RC, CG9-60, CG9-61, CG9-82, CGE9-41, CGF9-120D, CGF9-120I, CGF9-121D, CGF9-121I		



			
1			
<b>GEV No.</b>	109710	<b>Ref. No.</b>	12005899 12038914 12120850 U505408
<b>description</b>	drain tray L 420mm W 344mm H 39mm ø 115mm for burner cap ø 100mm		
<b>For models:</b>	CG-1002, CG-1502, CG-2005, CG-210, CG-210G, CG-3005, CG-310, CG-310G, CG9-20, CG9-40, CG9-41, CG9-51L, CG9-51LC, CG9-51R, CG9-51RC, CG9-60, CG9-61, CG9-82, CGE9-41		

			
1			
<b>GEV No.</b>	109711	<b>Ref. No.</b>	12005898 12038913 U505409
<b>description</b>	drain tray L 420mm W 344mm H 45mm ø 140mm for burner cap ø 120mm		
<b>For models:</b>	CG-1002, CG-1502, CG-2000, CG-2000-2P, CG-2002, CG-2005, CG-210, CG-210G, CG-3005, CG-310, CG-310G, CG9-20, CG9-40, CG9-41, CG9-51L, CG9-51LC, CG9-51R, CG9-51RC, CG9-60, CG9-61, CG9-82, CGE9-41		

## simmering plates

			
1			
<b>GEV No.</b>	109088	<b>Ref. No.</b>	12009018 U915414
<b>description</b>	simmer plate L 343mm W 310mm H 32mm for gas range		

			
1			
<b>GEV No.</b>	109700	<b>Ref. No.</b>	12011961 U745411
<b>description</b>	simmer plate L 345mm W 310mm H 40mm		
<b>For models:</b>	CG7-20, CG7-40, CG7-41, CG7-61, CGB7-61, CGE7-41, CGE7-90		

			
1			
<b>GEV No.</b>	109709	<b>Ref. No.</b>	12007699 U565406
<b>description</b>	simmer plate L 420mm W 345mm H 25mm		
<b>For models:</b>	CG-1002, CG-1502, CG-2000, CG-2002, CG-2005, CG-210, CG-210G, CG-3005, CG-310, CG-310G, CG9-20, CG9-40, CG9-41, CG9-60, CG9-61, CG9-82, CGE9-41		

## air mixers

			
1			
<b>GEV No.</b>	109032	<b>Ref. No.</b>	12039944 X015705
<b>description</b>	air mixing tube L 36mm ø 20mm		
<b>For models:</b>	FG-71-15, FG-72-30, FG-91-20, FG-920, FG-92-40, FG-940		

			
1			
<b>GEV No.</b>	109013	<b>Ref. No.</b>	12008047 U325707
<b>description</b>	air mixing tube L 43mm ø 20mm		
<b>For models:</b>	BG6-05I, BG7-05, BG7-05I, BG7-10, BG7-10I, BG9-05, BG9-05AD, BG9-05I, BG9-05PF, BG9-05PI, BG9-05PLUS-I, BG9-10, BG9-10AD, BG9-10I, BG9-10PF, BG9-10PI, BG9-10PLUS-I, BMG7-10, BMG-9045, BMG9-05, BMG9-05V-T, BMG9-10, BMG9-10V-T, CG-1002, CG-1502, CG-2000, CG-2000-2P, CG-2002, CG-2002P, CG-210, CG-210G, CG-310, CG-310G, CG6-41, CG7-11, CG-7115, CG7-41, CG-7415, CG7-61, CG-7615, CG9-11, CG9-41, CG9-51L, CG9-51LC, CG9-51R, CG9-51RC, CG9-61, CG9-82, CGB7-61, CGB7-61H...(Other models you can see in the webshop)		

			
1			
<b>GEV No.</b>	109036	<b>Ref. No.</b>	R425704
<b>description</b>	air mixing tube L 43mm ø 20mm		

## bar burners

## bar burners

			
1			
<b>GEV No.</b>	103029	<b>Ref. No.</b>	12007339 X285710
<b>description</b>	bar burner 10-row L 600mm W 1150mm ømm H 65mm tilting bratt pan		
<b>For models:</b>	SBG9-10, SBG9-10S, SBG9-15IM, SBG9-15IMS		







 <p>1</p>			
<b>GEV No.</b>	109021	<b>Ref. No.</b>	12006607 R405700
<b>description</b>	bar burner 2 row L 490mm W 400mm ømm H 55mm bain marie		
<b>For models:</b>	BMG7-10, BMG-9045, BMG9-10, BMG9-10V-T		

 <p>1</p>			
<b>GEV No.</b>	109020	<b>Ref. No.</b>	12017305 T035700
<b>description</b>	bar burner 2 row L 530mm W 200mm ømm H 45mm chargrill		
<b>For models:</b>	BG7-05, BG7-05I, BG7-10, BG7-10I		

 <p>1</p>			
<b>GEV No.</b>	109099	<b>Ref. No.</b>	12009491 12009491+2x12011165 T035702
<b>description</b>	bar burner 2 row L 530mm W 200mm ømm H 57mm chargrill		
<b>For models:</b>	BG6-05I, BG7-05, BG7-05I, BG7-10, BG7-10I		
<b>spare parts for</b>	109099		
			
<b>GEV No.</b>	691853	<b>Ref. No.</b>	12011165 T035473
bracket L 480mm H 45mm W 20mm			

 <p>1</p>			
<b>GEV No.</b>	109053	<b>Ref. No.</b>	12017260 T035701
<b>description</b>	bar burner 2 row L 530mm W 200mm ømm H 75mm chargrill		

 <p>1</p>			
<b>GEV No.</b>	105431	<b>Ref. No.</b>	12009503 T055703
<b>description</b>	bar burner 2 row L 540mm W 220mm ømm H 60mm chargrill		
<b>For models:</b>	BG9-05, BG9-05AD, BG9-05I, BG9-05PF, BG9-05PI, BG9-05PLUS-I, BG9-10, BG9-10AD, BG9-10I, BG9-10PF, BG9-10PI, BG9-10PLUS-I		

 <p>1</p>			
<b>GEV No.</b>	109030	<b>Ref. No.</b>	12007058 R635700
<b>description</b>	bar burner 2 row L 680mm W 238mm ømm H 110mm griddle		
<b>For models:</b>	CG9-51L, CG9-51LC, CG9-51R, CG9-51RC, FTG-9050L, FTG-9050R, FTG9-05L, FTG9-05L-AD, FTG9-05LV-AD, FTG9-05PLUS-CL, FTG9-05PLUS-CR, FTG9-05PLUS-L, FTG9-05PLUS-LV, FTG9-05PLUS-R, FTG9-05PLUS-RV, FTG9-05R, FTG9-05R-AD, FTG9-05RV-AD, FTG9-05VL, FTG9-05VR, FTG-9100L, FTG-9100L+R, FTG-9100R, FTG9-10L, FTG9-10L+R, FTG9-10L+R-AD, FTG9-10L+RV-AD, FTG9-10L-AD, FTG9-10LV-AD, FTG9-10PLUS-CL, FTG9-10PLUS-CLR, FTG9-10PLUS-CR, FTG9-10PLUS-L, FTG9-10PLUS-LR, FTG9-10PLUS-LRV, FTG9-10PLUS-LV, FTG9-10PLUS-R, FTG9-10PLUS-RV, FTG9-10R, FTG9-10R-AD, FTG9-10RV-AD, FTG9-10VL, FTG9-10VL+R, FTG9-10VR, FTG9-11L, FTG9-11L+R, FTG9-11R, FTGC9-05, FTGC9-05L, FTGC9-05L-AD...(Other models you can see in the webshop)		

 <p>1</p>			
<b>GEV No.</b>	109033	<b>Ref. No.</b>	T055700
<b>description</b>	bar burner 2 row ømm chargrill		

 <p>1</p>			
<b>GEV No.</b>	109034	<b>Ref. No.</b>	12017234 T055701
<b>description</b>	bar burner 2 row ømm chargrill		
<b>For models:</b>	BG9-05, BG9-05I, BG9-10, BG9-10I		





			
1			
<b>GEV No.</b>	109037	<b>Ref. No.</b>	S035700
<b>description</b>	bar burner 4 row L 450mm W 420mm ømm kettle		

			
1			
<b>GEV No.</b>	109039	<b>Ref. No.</b>	S275700
<b>description</b>	bar burner 4 row L 590mm W 248mm ømm H 80mm kettle		

			
1			
<b>GEV No.</b>	109038	<b>Ref. No.</b>	12012385 S275705
<b>description</b>	bar burner 4 row L 595mm W 420mm ømm H 80mm 17.8kW kettle		
<b>For models:</b>	MG9-10, MG9-10BM, MG9-10BMS, MG9-10S, MG9-15, MG9-15BM, MG9-15BM316, MG9-15BMS, MG9-15S, MG9-20, MG9-20S, MPG9-10, MPG9-10BM, MPG9-10BMS, MPG9-10S, MPG9-15, MPG9-15BM, MPG9-15BMS, MPG9-15S, MPG9-20, MPG9-20S		

			
1			
<b>GEV No.</b>	109012	<b>Ref. No.</b>	12006166 U855702
<b>description</b>	bar burner angled L 325mm W 355mm ømm Hmm gas range		
<b>For models:</b>	CG-1502		

			
1			
<b>GEV No.</b>	109008	<b>Ref. No.</b>	12013187 U745700
<b>description</b>	bar burner angled L 570mm W 260mm ømm Hmm gas range		
<b>For models:</b>	CG7-11, CG7-41, CG7-61, CG9-11, CG9-41, CG9-51L, CG9-51LC, CG9-51R, CG9-51RC, CG9-61, CG9-82, CGF9-121D, CGF9-121I, FTG9-11L, FTG9-11L+R, FTG9-11R, FTGC9-11L, FTGC9-11L+R, FTGC9-11R, HG9-10, HG9-20		

			
1			
<b>GEV No.</b>	109009	<b>Ref. No.</b>	12039902 U329201
<b>description</b>	bar burner angled L 660mm W 260mm ømm Hmm gas range		

			
1			
<b>GEV No.</b>	109011	<b>Ref. No.</b>	12006629 U855700
<b>description</b>	bar burner angled L 700mm W 320mm ømm Hmm gas range		

			
1			
<b>GEV No.</b>	109010	<b>Ref. No.</b>	12006657 U705700
<b>description</b>	bar burner angled L 745mm W 260mm ømm Hmm gas range		
<b>For models:</b>	CG-2000, CG-2000-2P, CG-2002, CG-2002P		

			
1			
<b>GEV No.</b>	109187	<b>Ref. No.</b>	12024674 Z955801
<b>description</b>	bar burner multiple L 180mm W 270mm ømm H 45mm flange support combi-steamer zinc-plated FAGOR		
<b>For models:</b>	GA-20, GA-20D, GA-40, GA-40D, HGP-10-21, HGP-20-21, HGV-10-11, HGV-10-21, HGV-20-11, HGV-20-21, HVG-10-11, HVG-10-11UL, HVG-10-21, HVG-10-21UL, HVG-20-11, HVG-20-21, HVG-2-10-11, HVG-2-20-21, MFHVG-10-11, MFHVG-10-21, VG-101, VG-102, VG-201, VG-202, VPG-101, VPG-102, VPG-201, VPG-202		

			
1			
<b>GEV No.</b>	105920	<b>Ref. No.</b>	12030250 ICR10053
<b>description</b>	bar burner ø 50mm Wmm Hmm L 450mm flange with bolt M4 flange width 65mm flange length 71mm kettle		

			
1			
<b>GEV No.</b>	105697	<b>Ref. No.</b>	12030251 ICR09485
<b>description</b>	bar burner ø 50mm Wmm Hmm L 450mm with bolt M5x12 flange width 65mm flange length 71mm kettle		





 <p>1</p>			
<b>GEV No.</b>	109035	<b>Ref. No.</b>	R495700
<b>description</b>	bar burner ømm W 38mm H 33mm L 405mm bain marie		

 <p>1</p>			
<b>GEV No.</b>	109018	<b>Ref. No.</b>	12013487 R795700
<b>description</b>	bar burner U-shape L 500mm W 145mm ø 30mm Hmm griddle		
<b>For models:</b>	FTG7-05, FTG7-05L, FTG7-05R, FTG7-05VL, FTG7-05VR, FTG7-10, FTG7-10L, FTG7-10L+R, FTG7-10R, FTG7-10VL, FTG7-10VL+R, FTG7-10VR, FTGC7-05L, FTGC7-10L		

 <p>1</p>			
<b>GEV No.</b>	109188	<b>Ref. No.</b>	12017291 12024272 R735700 T115710
<b>description</b>	burner fabric ø 38mm Wmm Hmm L 170mm connection thread combi-steamer SS		
<b>For models:</b>	COG-101, COG-102, HCG-10-11, HCG-10-21, HCG-2-10-11, HGC-10-11, HGC-10-21, HGP-10-21, HGV-10-11, HGV-10-21, HMG-10-21, HMG-10-21UL, HMG-2-10-11, HVG-10-11, HVG-10-11UL, HVG-10-21, HVG-10-21UL, HVG-2-10-11, MFHVG-10-11, MFHVG-10-21, VG-101, VG-102, VPG-101, VPG-102		

 <p>1</p>			
<b>GEV No.</b>	211047	<b>Ref. No.</b>	12009424 T035464
<b>description</b>	chargrill grid L 508mm W 339mm H 22mm		
<b>For models:</b>	BG7-05, BG7-10		

 <p>1</p>			
<b>GEV No.</b>	211007	<b>Ref. No.</b>	12016512 T035455 T035481
<b>description</b>	chargrill grid L 570mm W 345mm H 75mm stainless steel chargrill		
<b>For models:</b>	BG7-05I, BG7-10I		

 <p>1</p>			
<b>GEV No.</b>	211046	<b>Ref. No.</b>	12009442 12016227 T055413
<b>description</b>	chargrill grid L 580mm W 410mm H 25mm chargrill		
<b>For models:</b>	BG9-05, BG9-05I, BG9-05PF, BG9-10, BG9-10I, BG9-10PF		

 <p>1</p>			
<b>GEV No.</b>	109708	<b>Ref. No.</b>	12008843 T035425
<b>description</b>	chargrill grid L 585mm W 323mm H 40mm chargrill meat		
<b>For models:</b>	BG7-05, BG7-10		

 <p>1</p>			
<b>GEV No.</b>	211045	<b>Ref. No.</b>	12016527 12040319 T055452 T055462
<b>description</b>	chargrill grid L 655mm W 411mm H 70mm stainless steel chargrill		
<b>For models:</b>	BG9-05, BG9-05I, BG9-10, BG9-10I		

 <p>1</p>			
<b>GEV No.</b>	109715	<b>Ref. No.</b>	12008240 T055439
<b>description</b>	grid handle L 180mm ø 16mm thread M10x1.5		
<b>For models:</b>	BG9-05, BG9-05I, BG9-10, BG9-10I		

 <p>1</p>			
<b>GEV No.</b>	109707	<b>Ref. No.</b>	12011720 T035406
<b>description</b>	lava rock grid L 480mm W 290mm H 20mm		





			
1			
<b>GEV No.</b>	109067	<b>Ref. No.</b>	12002411 H122605
<b>description</b>	lava rock grid L 485mm W 275mm H 40mm		
<b>For models:</b>	BG7-05, BG7-05I, BG7-10, BG7-10I		

			
1			
<b>GEV No.</b>	109090	<b>Ref. No.</b>	12002481
<b>description</b>	lava rock grid L 545mm W 330mm H 30mm SS		
<b>For models:</b>	BG9-05AD, BG9-05PF, BG9-05PI, BG9-05PLUS-I, BG9-10AD, BG9-10PF, BG9-10PI, BG9-10PLUS-I		

			
1			
<b>GEV No.</b>	109714	<b>Ref. No.</b>	12012897 T055405
<b>description</b>	lava rock grid L 555mm W 350mm H 20mm		
<b>For models:</b>	BG9-05, BG9-05I, BG9-10, BG9-10I		

chargrill grids

			
1			
<b>GEV No.</b>	211047	<b>Ref. No.</b>	12009424 T035464
<b>description</b>	chargrill grid L 508mm W 339mm H 22mm		
<b>For models:</b>	BG7-05, BG7-10		

			
1			
<b>GEV No.</b>	211007	<b>Ref. No.</b>	12016512 T035455 T035481
<b>description</b>	chargrill grid L 570mm W 345mm H 75mm stainless steel chargrill		
<b>For models:</b>	BG7-05I, BG7-10I		

			
1			
<b>GEV No.</b>	211046	<b>Ref. No.</b>	12009442 12016227 T055413
<b>description</b>	chargrill grid L 580mm W 410mm H 25mm chargrill		
<b>For models:</b>	BG9-05, BG9-05I, BG9-05PF, BG9-10, BG9-10I, BG9-10PF		

			
1			
<b>GEV No.</b>	109708	<b>Ref. No.</b>	12008843 T035425
<b>description</b>	chargrill grid L 585mm W 323mm H 40mm chargrill meat		
<b>For models:</b>	BG7-05, BG7-10		

			
1			
<b>GEV No.</b>	211045	<b>Ref. No.</b>	12016527 12040319 T055452 T055462
<b>description</b>	chargrill grid L 655mm W 411mm H 70mm stainless steel chargrill		
<b>For models:</b>	BG9-05, BG9-05I, BG9-10, BG9-10I		

lava rock grids

			
1			
<b>GEV No.</b>	109707	<b>Ref. No.</b>	12011720 T035406
<b>description</b>	lava rock grid L 480mm W 290mm H 20mm		

			
1			
<b>GEV No.</b>	109067	<b>Ref. No.</b>	12002411 H122605
<b>description</b>	lava rock grid L 485mm W 275mm H 40mm		
<b>For models:</b>	BG7-05, BG7-05I, BG7-10, BG7-10I		

			
1			
<b>GEV No.</b>	109090	<b>Ref. No.</b>	12002481
<b>description</b>	lava rock grid L 545mm W 330mm H 30mm SS		
<b>For models:</b>	BG9-05AD, BG9-05PF, BG9-05PI, BG9-05PLUS-I, BG9-10AD, BG9-10PF, BG9-10PI, BG9-10PLUS-I		

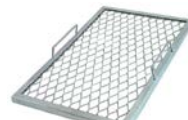
			
1			
<b>GEV No.</b>	109714	<b>Ref. No.</b>	12012897 T055405
<b>description</b>	lava rock grid L 555mm W 350mm H 20mm		
<b>For models:</b>	BG9-05, BG9-05I, BG9-10, BG9-10I		



			
1			
<b>GEV No.</b>	109184	<b>Ref. No.</b>	12034224 RT7200048
<b>description</b>	insulation for burner ø 97.5mm ID ø 62.5mm thickness 9.5mm		

			
1			
<b>GEV No.</b>	109022	<b>Ref. No.</b>	12016252 S135733
<b>description</b>	venturi L 150mm		
<b>For models:</b>	HPG-35, MG7-10, MG7-10BM, MG9-10, MG-9100, MG9-10BM, MG9-10BMS, MG9-10S, MG9-15, MG-9150, MG-9150BM, MG9-15BM, MG9-15BM316, MG9-15BMS, MG9-15S, MG9-20, MG-9200, MG9-20S, MPG9-10, MPG9-10BM, MPG9-10BMS, MPG9-10S, MPG9-15, MPG-9150, MPG9-15BM, MPG9-15BMS, MPG9-15S, MPG9-20, MPG-9200, MPG9-20S		

tube burners

			
1			
<b>GEV No.</b>	109019	<b>Ref. No.</b>	12009433 X015700
<b>description</b>	tubular burner L 340mm W 61mm H 58mm oval		
<b>For models:</b>	FG7-05-1C, FG7-05-2C, FG-710, FG7-10-2C, FG7-104C, FG7-10-4C, FG-71-15, FG-720, FG-72-30, FG9-05, FG9-05-1C, FG9-05-2C, FG9-05AD, FG9-05PLUS, FG9-05PLUS-S, FG9-05S, FG9-05S-1C, FG9-05S-2C, FG9-05S-AD, FG9-10, FG9-10-2C, FG9-10-4C, FG9-10AD, FG9-10PLUS, FG-91-20, FG-920, FG-92-40, FG-940		

round burners

			
1			
<b>GEV No.</b>	106963	<b>Ref. No.</b>	12009065 U875707
<b>description</b>	round burner ø 410mm L 590mm H 100mm D1 ø 220mm		
<b>For models:</b>	CGP9-10, CGP9-11		

forced air burners

			
1			
<b>GEV No.</b>	109070	<b>Ref. No.</b>	12017311 T075709
<b>description</b>	burner L 118mm ø 30.6mm		
<b>For models:</b>	HCG-6-11, HMG-6-11		

			
1			
<b>GEV No.</b>	107930	<b>Ref. No.</b>	12039680 T955750000
<b>description</b>	burner L 250mm ø 38mm combi-steamer FAGOR		
<b>For models:</b>	ACG-061, AG-061, AG-061W, APG-061, APG-061W		

			
1			
<b>GEV No.</b>	107929	<b>Ref. No.</b>	12039583 T855750000
<b>description</b>	burner L 260mm ø 37.5mm for combi-steamer FAGOR		
<b>For models:</b>	AG-061, AG-061W, AG-101, AG-101W, APG-061, APG-061W, APG-101, APG-101W		

			
1			
<b>GEV No.</b>	107927	<b>Ref. No.</b>	12039556 T845750000
<b>description</b>	burner L 270mm ø 38mm for combi-steamer		
<b>For models:</b>	ACG-101, ACG-201, AG-101, AG-101W, AG-201, APG-101, APG-101W, APG-201		

			
<b>GEV No.</b>	107925	<b>Ref. No.</b>	12039442 T645739000
<b>description</b>	burner L 300mm ø 44mm for combi-steamer FAGOR		
<b>For models:</b>	ACG-102, ACG-202, AG-102, AG-102W, AG-202, APG-102, APG-102W, APG-202		

			
<b>GEV No.</b>	107899	<b>Ref. No.</b>	12044424
<b>description</b>	burner L 435mm ø 52mm for combi-steamer FAGOR		
<b>For models:</b>	AG-201, APG-201		

			
<b>GEV No.</b>	101190	<b>Ref. No.</b>	12022913 T015700
<b>description</b>	burner chamber L 190mm ø 150mm		
<b>For models:</b>	COG-101, HCG-10-11, HCG-10-21, HCG-2-10-11, HGC-10-11		

## accessories

### covers

			
<b>GEV No.</b>	104211	<b>Ref. No.</b>	12013981 U745705
<b>description</b>	cover L 550mm W 155mm H 24mm SS for burner		
<b>For models:</b>	CG7-11, CG7-41, CG7-61, CG9-11, CG9-41, CG9-51L, CG9-51LC, CG9-51R, CG9-51RC, CG9-61, CG9-82, CGF9-121D, CGF9-121I, FTG9-11L, FTG9-11L+R, FTG9-11R, FTGC9-11L, FTGC9-11L+R, FTGC9-11R, HG9-10, HG9-20		

			
<b>GEV No.</b>	104796	<b>Ref. No.</b>	12004960 U915703000
<b>description</b>	cover ø 180mm thickness 2mm hole ø 118mm stainless steel for gas range suitable for FAGOR		
<b>For models:</b>	CG7-20H, CG7-30D, CG7-30I, CG7-31D, CG7-31I, CG7-40, CG7-40H, CG7-41, CG7-41H, CG7-50, CG7-51, CG7-60, CG7-60H, CG7-61, CG7-61H, CG9-20, CG9-20AD, CG9-20AD-H, CG9-20H, CG9-20PLUS, CG9-20PLUS-H, CG9-31PLUS-D, CG9-31PLUS-I, CG9-40, CG9-40AD, CG9-40AD-H, CG9-40H, CG9-40PLUS, CG9-40PLUS-H, CG9-41, CG9-41AD, CG9-41AD-H, CG9-41H, CG9-41PLUS, CG9-41PLUS-H, CG9-51L, CG9-51LC, CG9-51R, CG9-51RC, CG9-60, CG9-60AD, CG9-60AD-H, CG9-60H, CG9-60PLUS, CG9-60PLUS-H, CG9-61, CG9-61AD, CG9-61AD-H, CG9-61H, CG9-61OP...(Other models you can see in the webshop)		

### gaskets

			
<b>GEV No.</b>	109044	<b>Ref. No.</b>	12023733 T075013
<b>description</b>	gasket D1 ø 102mm D2 ø 71mm thickness 3.3mm graphite		
<b>For models:</b>	COG-061, HCG-6-11, HGC-6-11, HMG-6-11		

			
<b>GEV No.</b>	109045	<b>Ref. No.</b>	12023765 R725055
<b>description</b>	gasket D1 ø 130mm D2 ø 95mm thickness 3.3mm graphite		
<b>For models:</b>	COG-101, COG-102, COG-201, COG-202, HCG-10-11, HCG-10-21, HCG-20-11, HCG-20-21, HCG-2-10-11, HCG-2-20-11, HGC-10-11, HGC-10-21, HGC-20-11, HGC-20-21, HGP-10-21, HGP-20-21, HGV-10-11, HGV-10-21, HGV-20-11, HGV-20-21, HMG-10-11, HMG-10-11UL, HMG-10-21, HMG-10-21UL, HMG-20-11, HMG-2-10-11, HVG-10-11, HVG-10-11UL, HVG-10-21, HVG-10-21UL, HVG-20-11, HVG-20-21, HVG-2-10-11, HVG-2-20-21, MFHVG-10-11, MFHVG-10-21, VG-101, VG-102, VG-201, VG-202, VPG-101, VPG-102, VPG-201, VPG-202		

			
<b>GEV No.</b>	109046	<b>Ref. No.</b>	12023994 T075014
<b>description</b>	gasket D1 ø 168mm D2 ø 132mm thickness 3.3mm graphite		
<b>For models:</b>	COG-061, HCG-6-11, HGC-6-11, HMG-6-11		





			
1			
<b>GEV No.</b>	109047	<b>Ref. No.</b>	12023991 R725051
<b>description</b>	gasket D1 ø 200mm D2 ø 153mm thickness 3.3mm graphite		
<b>For models:</b>	COG-101, COG-102, HCG-10-11, HCG-10-21, HCG-20-11, HCG-2-10-11, HGC-10-11, HGC-10-21, HGP-10-21, HGV-10-11, HGV-10-21, HMG-10-11, HMG-10-11UL, HMG-10-21, HMG-10-21UL, HMG-20-11, HMG-2-10-11, HVG-10-11, HVG-10-11UL, HVG-10-21, HVG-10-21UL, HVG-2-10-11, MFHVG-10-11, MFHVG-10-21, VG-101, VG-102, VPG-101, VPG-102		

			
2			
<b>GEV No.</b>	104283	<b>Ref. No.</b>	12035017 RT51101318
<b>description</b>	gasket L 100mm W 100mm hole ø 64mm		

			
1			
<b>GEV No.</b>	109048	<b>Ref. No.</b>	12024476 R725052
<b>description</b>	gasket L 110mm W 110mm H 3.3mm hole ø 81mm graphite		
<b>For models:</b>	HGV-10-11, HMG-10-11, HMG-10-11UL, HMG-10-21, HMG-10-21UL, HMG-20-11, HMG-2-10-11, HVG-10-11, HVG-10-11UL, HVG-10-21, HVG-10-21UL, HVG-2-10-11, MFHVG-10-11, MFHVG-10-21, VG-101, VPG-101		

			
1			
<b>GEV No.</b>	510125	<b>Ref. No.</b>	12021217 R725009
<b>description</b>	gasket L 62mm W 42mm H 3mm hole ø 24mm hole distance 49mm graphite oval for gas burner		
<b>For models:</b>	HCG-10-11, HCG-10-21, HCG-2-10-11, HCG-6-11, HMG-10-11, HMG-10-11UL, HMG-10-21, HMG-10-21UL, HMG-2-10-11, HMG-6-11		

			
1			
<b>GEV No.</b>	105583	<b>Ref. No.</b>	12020725 T075015
<b>description</b>	gasket L 70mm W 70mm thickness 3.5mm hole ø 51mm graphite		
<b>For models:</b>	HMG-6-11		

			
1			
<b>GEV No.</b>	510128	<b>Ref. No.</b>	12017015 R725011
<b>description</b>	gasket L 71mm W 46mm H 2mm hole ø 28mm hole distance 55mm rubber oval for gas burner		
<b>For models:</b>	HCG-10-11, HCG-10-21, HCG-20-11, HCG-2-10-11, HCG-6-11, HMG-10-11, HMG-10-11UL, HMG-10-21, HMG-10-21UL, HMG-20-11, HMG-2-10-11, HMG-6-11		

nozzle holders

			
1			
<b>GEV No.</b>	109058	<b>Ref. No.</b>	12013850 12018677 R155012
<b>description</b>	nozzle holder nozzle M10x1 3/8" screw pipe fitting 3/8" with pipe tube ø 10mm		
<b>For models:</b>	FTG9-05L, FTG9-05R, FTGC9-05L, FTGC9-05R		

miscellaneous

			
1			
<b>GEV No.</b>	109043	<b>Ref. No.</b>	12015347 T035472
<b>description</b>	bracket for burner L 480mm W 62mm H 20mm		
<b>For models:</b>	BG9-05, BG9-05I, BG9-10, BG9-10I		

			
1			
<b>GEV No.</b>	104147	<b>Ref. No.</b>	12022614 T075708
<b>description</b>	flange ø 167mm thickness 1.6mm hole ø 9.6mm		
<b>For models:</b>	HCG-6-11, HMG-6-11		

## gas nozzles

### main nozzles

#### gas nozzles M6x0.75



<b>GEV No.</b>	106482	<b>Ref. No.</b>	12023498 Z956104
<b>description</b>	gas injector thread M6x0.75 WS 7 bore ø 1.1mm		
<b>For models:</b>	GA-20, GA-20D, GA-40, GA-40D, HGP-10-21, HGP-20-21, HGV-10-11, HGV-10-21, HGV-20-21, HVG-10-11, HVG-10-21, HVG-20-11, HVG-20-21, HVG-2-10-11, HVG-2-20-21, VG-101, VG-102, VG-201, VG-202, VPG-101, VPG-102, VPG-201, VPG-202		



<b>GEV No.</b>	109414	<b>Ref. No.</b>	12024100 Z956108
<b>description</b>	gas injector thread M6x0.75 WS 7 bore ø 2.25mm		
<b>For models:</b>	GA-20, GA-20D, GA-40, GA-40D		

#### gas nozzles M10x1



<b>GEV No.</b>	109410	<b>Ref. No.</b>	12008787 U322401
<b>description</b>	gas injector thread M10x1 WS 13 bore ø 0.8mm		
<b>For models:</b>	BMG9-05, BMG9-05V-T		



<b>GEV No.</b>	109415	<b>Ref. No.</b>	12008802 U122407
<b>description</b>	gas injector thread M10x1 WS 13 bore ø 1.05mm		
<b>For models:</b>	CG-1002, CG-1502, CG-2000, CG-2002, CG-2002P, CG-2005, CG-210, CG-210G, CG-300S, CG-310, CG-310G, CG7-20, CG-7200, CG7-30D, CG7-30I, CG7-31D, CG7-31I, CG7-40, CG-7400, CG7-41, CG-7415, CG7-50, CG7-51, CG7-60, CG7-61, CG-7615, CG9-05AD, CG9-05PLUS, CG9-20, CG9-20AD, CG9-20H, CG9-20PLUS, CG9-31PLUS-D, CG9-31PLUS-I, CG9-40, CG9-40AD, CG9-40H, CG9-40PLUS, CG9-41, CG9-41AD, CG9-41H, CG9-41PLUS, CG9-51L, CG9-51LC, CG9-51R, CG9-51RC, CG9-60, CG9-60AD, CG9-60H, CG9-60PLUS...(Other models you can see in the webshop)		



<b>GEV No.</b>	109416	<b>Ref. No.</b>	12008800 X312400
<b>description</b>	gas injector thread M10x1 WS 13 bore ø 1.1mm		
<b>For models:</b>	CG-1502, CG6-41, CG7-20, CG7-30D, CG7-30I, CG7-31D, CG7-31I, CG7-40, CG7-41, CG7-50, CG7-51, CG7-60, CG7-61, CG9-20, CG9-20H, CG9-40, CG9-40H, CG9-41, CG9-41H, CG9-51L, CG9-51LC, CG9-51R, CG9-51RC, CG9-60, CG9-60H, CG9-61, CG9-61H, CG9-61OP, CG9-82, CGB7-61, CGB7-61R, CGE7-41, CGE9-41, CGF9-120D, CGF9-120I, CGF9-121D, CGF9-121I, CGP9-10, CGP9-11, CPG7-05, CPG7-05NC, FG7-05-1C, FG7-05-2C, FG-710, FG7-10-2C, FG7-104C, FG7-10-4C, FG-720, GPC-350		



<b>GEV No.</b>	109419	<b>Ref. No.</b>	12008939 12039112 R422400 X162403
<b>description</b>	gas injector thread M10x1 WS 13 bore ø 1.25mm		
<b>For models:</b>	BMG7-10, BMG9-10, BMG9-10V-T, CG-200S, CG-210, CG-210G, CG-300S, CG-310, CG-310G, CG7-11, CG7-20H, CG7-30D, CG7-30I, CG7-31D, CG7-31I, CG7-40, CG7-40H, CG7-41, CG7-41H, CG7-50, CG7-51, CG7-60, CG7-60H, CG7-61, CG7-61H, CGB7-61, CGB7-61H, CGB7-61R, CGB7-61RH, CGE7-104, CGE7-41, CGE7-41H, FG9-05, FG9-05-1C, FG9-05-2C, FG9-05AD, FG9-05PLUS, FG9-05PLUS-S, FG9-05S, FG9-05S-1C, FG9-05S-2C, FG9-05S-AD, FG9-10, FG9-10-2C, FG9-10-4C, FG9-10AD, FG9-10PLUS, FTG7-05, FTG7-05L, FTG7-05R...(Other models you can see in the webshop)		



<b>GEV No.</b>	109418	<b>Ref. No.</b>	12008806 9271300
<b>description</b>	gas injector thread M10x1 WS 13 bore ø 1.2mm		
<b>For models:</b>	BMG9-05, BMG9-05V-T, CG-7415, CG-7615, FG-710, FG-720, FTE7-05, FTE7-10, FTG7-05, FTG7-10, FTGC7-05L, FTGC7-10L		





<b>GEV No.</b>	109421	<b>Ref. No.</b>	12008809 12019845 12020928 R612400 X162400
<b>description</b>	gas injector thread M10x1 WS 13 bore ø 1.35mm		
<b>For models:</b>	BG7-05, BG7-05I, BG7-10, BG7-10I, CG7-31D, CG7-31I, CG7-41, CG7-41H, CG7-51, CG7-61, CG7-61H, CGB7-61, CGB7-61H, CGB7-61R, CGB7-61RH, CGP9-11, FG6-05, FG6-10, FG-920, FG-940, FTG6-10VL, FTG6-10VL+R, FTG6-10VR, FTGC6-10L, FTGC6-10L+R, SBG9-10I-AD, SBG9-10I-AD-S, SBG9-10IIM-AD, SBG9-10IIM-AD-S, SBG9-15IM-AD, SBG9-15IM-AD-S		







			
1			
<b>GEV No.</b>	109420	<b>Ref. No.</b>	12008770 U052402
<b>description</b>	gas injector thread M10x1 WS 13 bore ø 1.3mm		
<b>For models:</b>	BG6-05I, BMG-9045, CG-200S, CG-210, CG-210G, CG-300S, CG-310, CG-310G, CG-7200, CG-7400, CG-7415, CG-7615, FTG-7050L, FTG-7050R, FTG7-05L, FTG7-05R, FTG7-05VL, FTG7-05VR, FTG-7100L, FTG-7100L+R, FTG-7100R, FTG7-10L, FTG7-10L+R, FTG7-10R, FTG7-10VL, FTG7-10VL+R, FTG7-10VR, FTGC7-05L, FTGC7-10L, SBG7-10		

			
1			
<b>GEV No.</b>	109424	<b>Ref. No.</b>	12009579 9105100
<b>description</b>	gas injector thread M10x1 WS 13 bore ø 1.5mm		
<b>For models:</b>	CG-1002, CG-1502, CG-2000, CG-2002, CG-2002P, CG-200S, CG-210, CG-210G, CG-300S, CG-310, CG-310G, CG7-20, CG7-40, CG7-41, CG7-61, CG9-11, CG9-20, CG9-40, CG9-41, CG9-51L, CG9-51C, CG9-51R, CG9-51RC, CG9-60, CG9-61, CG9-82, CGB7-61, CGE7-111, CGE7-41, CGE9-41, CGF9-120D, CGF9-120I, CGF9-121D, CGF9-121I, CG-HP-20, CGP9-10, CGP9-11, FI-5420, FI-7630, FTG9-05L, FTG9-05L-AD, FTG9-05LV-AD, FTG9-05PLUS-CL, FTG9-05PLUS-CR, FTG9-05PLUS-L, FTG9-05PLUS-LV, FTG9-05PLUS-R, FTG9-05PLUS-RV, FTG9-05R, FTG9-05R-AD...(Other models you can see in the webshop)		

			
1			
<b>GEV No.</b>	109423	<b>Ref. No.</b>	12008796 U052401
<b>description</b>	gas injector thread M10x1 WS 13 bore ø 1.45mm		
<b>For models:</b>	CG7-10, CG7-11, CG-7115, CG9-11, CG9-11AD, CG9-11PLUS, CG9-20H, CG9-31PLUS-D, CG9-31PLUS-I, CG9-40H, CG9-41, CG9-41AD, CG9-41AD-H, CG9-41H, CG9-41PLUS, CG9-41PLUS-H, CG9-51L, CG9-51LC, CG9-51R, CG9-51RC, CG9-60H, CG9-61, CG9-61AD, CG9-61AD-H, CG9-61H, CG9-61PLUS, CG9-61PLUS-H, CG9-82, CG9-82AD, CG9-82PLUS, CGF9-121D, CGF9-121D-AD, CGF9-121I, CGF9-121I-AD, CGF9-121PLUS-D, CGF9-121PLUS-I, CPG9-05, CPG9-05AD, CPG9-05AD-S, CPG9-05NC, CPG9-05PLUS, CPG9-05PLUS-S, CPG9-05S, CPG9-05SNC, FTG6-05VL, FTG6-05VR, FTG9-05L, FTG9-05PLUS-CL, FTG9-05PLUS-CR, FTG9-05PLUS-L...(Other models you can see in the webshop)		

			
1			
<b>GEV No.</b>	109427	<b>Ref. No.</b>	12008793 R302400
<b>description</b>	gas injector thread M10x1 WS 13 bore ø 1.65mm		
<b>For models:</b>	BG9-05, BG9-05AD, BG9-05I, BG9-05PF, BG9-05PI, BG9-05PLUS-I, BG9-10, BG9-10AD, BG9-10I, BG9-10PF, BG9-10PI, BG9-10PLUS-I, CG7-20, CG7-30D, CG7-30I, CG7-31D, CG7-31I, CG7-40, CG7-41, CG7-50, CG7-51, CG7-60, CG7-61, CG9-05AD, CG9-05PLUS, CG9-10, CG9-10AD, CG9-10PLUS, CG9-11, CG9-11AD, CG9-11PLUS, CG9-20, CG9-20AD, CG9-20H, CG9-20PLUS, CG9-31PLUS-D, CG9-31PLUS-I, CG9-40, CG9-40AD, CG9-40H, CG9-40PLUS, CG9-41, CG9-41AD, CG9-41H, CG9-41PLUS, CG9-51L, CG9-51LC, CG9-51R, CG9-51RC, CG9-60...(Other models you can see in the webshop)		

			
1			
<b>GEV No.</b>	109422	<b>Ref. No.</b>	12008805 631000 631000000 9631000 O631000
<b>description</b>	gas injector thread M10x1 WS 13 bore ø 1.4mm		
<b>For models:</b>	BG7-05, BG7-05I, BG7-10, BG7-10I, CG-1002, CG-1502, CG-2002, CG-2002P, CG9-20, CG9-20H, CG9-31PLUS-D, CG9-31PLUS-I, CG9-40, CG9-40H, CG9-41, CG9-41H, CG9-51L, CG9-51LC, CG9-51R, CG9-51RC, CG9-60, CG9-60H, CG9-61, CG9-61H, CG9-61OP, CG9-82, CGE9-41, CGF9-120D, CGF9-120I, CGF9-121D, CGF9-121I, HG9-15		

			
1			
<b>GEV No.</b>	109426	<b>Ref. No.</b>	12017204 X102401
<b>description</b>	gas injector thread M10x1 WS 13 bore ø 1.6mm		
<b>For models:</b>	CG-2000-2P, FGCL9-05, FTG-9050L, FTG-9050R, FTG9-05L, FTG9-05R, FTG-9100L, FTG-9100L+R, FTG-9100R, FTG9-10L, FTG9-10L+R, FTG9-10R, FTGC9-05, FTGC-9050, FTGC9-10, FTGC-9100		

			
1			
<b>GEV No.</b>	109425	<b>Ref. No.</b>	12008797 U112401
<b>description</b>	gas injector thread M10x1 WS 13 bore ø 1.55mm		
<b>For models:</b>	BG9-05, BG9-05I, BG9-10, BG9-10I, CG-1002, CG-1502, CG-2002, CG-2002P, CG-200S, CG-210, CG-210G, CG-300S, CG-310, CG-310G, CG-7200, CG-7400, CG-7415, CG-7615, CG9-20AD-H, CG9-20H, CG9-20PLUS-H, CG9-40, CG9-40AD, CG9-40AD-H, CG9-40H, CG9-40PLUS, CG9-40PLUS-H, CG9-41, CG9-41AD, CG9-41AD-H, CG9-41H, CG9-41PLUS, CG9-41PLUS-H, CG9-51L, CG9-51LC, CG9-51R, CG9-51RC, CG9-60, CG9-60AD, CG9-60AD-H, CG9-60H, CG9-60PLUS, CG9-60PLUS-H, CG9-61, CG9-61AD, CG9-61AD-H, CG9-61H, CG9-61OP, CG9-61PLUS, CG9-61PLUS-H...(Other models you can see in the webshop)		

			
1			
<b>GEV No.</b>	109428	<b>Ref. No.</b>	12024249 N502401
<b>description</b>	gas injector thread M10x1 WS 13 bore ø 1.7mm		
<b>For models:</b>	CG-1002, CG-1502, CG-2000, CG-2000-2P, CG-2002, CG-2002P, CG-210, CG-210G, CG-310, CG-310G, CG6-41, CG9-10, CG9-11, CG9-51L, CG9-51C, CG9-51R, CG9-51RC, CGP9-10, CGP9-11, CPG7-05, CPG7-05NC, FG7-05-1C, FG7-05-2C, FG-710, FG7-10-2C, FG7-104C, FG7-10-4C, FG-720, FI-5420, FI-7630, FTG9-05L, FTG9-05R, FTG9-05VL, FTG9-05VR, FTG9-10L, FTG9-10L+R, FTG9-10R, FTG9-10VL, FTG9-10VL+R, FTG9-10VR, FTGC9-05L, FTGC9-05R, FTGC9-10L, FTGC9-10L+R, FTGC9-10R, GPC-350, MG9-15, MG9-15AD, MG9-15BM, MG9-15BM316...(Other models you can see in the webshop)		



<b>GEV No.</b>	109430	<b>Ref. No.</b>	12008808 9429400
<b>description</b>	gas injector thread M10x1 WS 13 bore ø 1.8mm		
<b>For models:</b>	CG-1502, CG-210, CG-210G, CG-310, CG-310G, CG-7415, CG-7615, FG-710, FG-720, FG9-05, FG9-05-1C, FG9-05-2C, FG9-05AD, FG9-05PLUS, FG9-05PLUS-S, FG9-05S, FG9-05S-1C, FG9-05S-2C, FG9-05S-AD, FG9-10, FG9-10-2C, FG9-10-4C, FG9-10AD, FG9-10PLUS, FTE7-05, FTE7-10, FTG7-05, FTG7-10, FTGC7-05L, FTGC7-10L, HP-G-15, HPG-15		



<b>GEV No.</b>	109432	<b>Ref. No.</b>	12008811 9429500
<b>description</b>	gas injector thread M10x1 WS 13 bore ø 1.9mm		
<b>For models:</b>	BG7-05, BG7-05I, BG7-10, BG7-10I, BMG7-10, BMG9-10, BMG9-10V-T, CG-200S, CG-210, CG-210G, CG-300S, CG-310, CG-310G, CG7-11, CG7-40, CG7-41, CG7-61, CGB7-61, CGE7-105, CGE7-41, FG-920, FG-940, FI-5420, FI-7630, FTG7-05, FTG-7050L, FTG-7050R, FTG7-05L, FTG7-05R, FTG7-05VL, FTG7-05VR, FTG7-10, FTG-7100L, FTG-7100L+R, FTG-7100R, FTG7-10L, FTG7-10L+R, FTG7-10R, FTG7-10VL, FTG7-10VL+R, FTG7-10VR, FTGC7-05L, FTGC7-10L, SBG7-10		



<b>GEV No.</b>	109411	<b>Ref. No.</b>	12008813 U149402
<b>description</b>	gas injector thread M10x1 WS 13 bore ø 1mm		
<b>For models:</b>	PL-105C, PL-105L, PL-110C, PL-110L, PL-110L+R, PL-110R, SBG9-10PLUS-I, SBG9-10PLUS-IM, SBG9-10PLUS-SI, SBG9-10PLUS-SIM		



<b>GEV No.</b>	109437	<b>Ref. No.</b>	12008798 U262400
<b>description</b>	gas injector thread M10x1 WS 13 bore ø 2.15mm		
<b>For models:</b>	CG7-10, CG7-11, CG-7115, CG9-11, CG9-11AD, CG9-11PLUS, CG9-20H, CG9-31PLUS-D, CG9-31PLUS-I, CG9-40H, CG9-41, CG9-41AD, CG9-41AD-H, CG9-41H, CG9-41PLUS, CG9-41PLUS-H, CG9-51L, CG9-51LC, CG9-51R, CG9-51RC, CG9-60H, CG9-61, CG9-61AD, CG9-61AD-H, CG9-61H, CG9-61OP, CG9-61PLUS, CG9-61PLUS-H, CG9-82, CG9-82AD, CG9-82PLUS, CGF9-121D, CGF9-121D-AD, CGF9-121I, CGF9-121I-AD, CGF9-121PLUS-D, CGF9-121PLUS-I, CPG9-11, FTG9-05L, FTG9-05PLUS-CL, FTG9-05PLUS-CR, FTG9-05PLUS-L, FTG9-05PLUS-R, FTG9-05R, FTG9-05VL, FTG9-05VR, FTG9-10L, FTG9-10L+R, FTG9-10PLUS-CL, FTG9-10PLUS-CLR...(Other models you can see in the webshop)		



<b>GEV No.</b>	109429	<b>Ref. No.</b>	12008794 U112402
<b>description</b>	gas injector thread M10x1 WS 13 bore ø 2.1mm		
<b>For models:</b>	BG7-05, BG7-05I, BG7-10, BG7-10I, CG9-20, CG9-20AD, CG9-20AD-H, CG9-20H, CG9-20PLUS, CG9-20PLUS-H, CG9-31PLUS-D, CG9-31PLUS-I, CG9-40, CG9-40AD, CG9-40AD-H, CG9-40H, CG9-40PLUS, CG9-40PLUS-H, CG9-41, CG9-41AD, CG9-41AD-H, CG9-41H, CG9-41PLUS, CG9-41PLUS-H, CG9-51L, CG9-51LC, CG9-51R, CG9-51RC, CG9-60, CG9-60AD, CG9-60AD-H, CG9-60H, CG9-60PLUS, CG9-60PLUS-H, CG9-61, CG9-61AD, CG9-61AD-H, CG9-61H, CG9-61OP, CG9-61PLUS, CG9-61PLUS-H, CG9-82, CG9-82AD, CG9-82PLUS, CGE9-41, CGE9-41AD, CGE9-41PLUS, CGF9-120D, CGF9-120D-AD, CGF9-120I...(Other models you can see in the webshop)		



<b>GEV No.</b>	109439	<b>Ref. No.</b>	1011600 12008804 12040507 9101160
<b>description</b>	gas injector thread M10x1 WS 13 bore ø 2.25mm		
<b>For models:</b>	BG7-05, BG7-05I, BG7-10, BG7-10I, BG9-05, BG9-05I, BG9-10, BG9-10I, CG9-11, CG9-41, CG9-51L, CG9-51LC, CG9-51R, CG9-51RC, CG9-61, CG9-82, CGF9-121D, CGF9-121I, CG-HP-20, CPG9-05, CPG9-05AD, CPG9-05AD-S, CPG9-05NC, CPG9-05PLUS, CPG9-05PLUS-S, CPG9-05S, CPG9-05SNC, FTG9-05L, FTG9-05L-AD, FTG9-05LV-AD, FTG9-05PLUS-CL, FTG9-05PLUS-CR, FTG9-05PLUS-L, FTG9-05PLUS-LV, FTG9-05PLUS-R, FTG9-05PLUS-RV, FTG9-05R, FTG9-05R-AD, FTG9-05RV-AD, FTG9-05VL, FTG9-05VR, FTG9-10L, FTG9-10L+R, FTG9-10L+R-AD, FTG9-10L+R-AD, FTG9-10L+R-AD, FTG9-10LV-AD, FTG9-10LV-AD, FTG9-10PLUS-CL, FTG9-10PLUS-CLR, FTG9-10PLUS-CR...(Other models you can see in the webshop)		





<b>GEV No.</b>	109441	<b>Ref. No.</b>	12024248 R275050
<b>description</b>	gas injector thread M10x1 WS 13 bore ø 2.35mm		
<b>For models:</b>	CG-1002, CG-1502, CG-2002, CG-2002P, CG9-40, CG9-41, CG9-51L, CG9-51LC, CG9-51R, CG9-51RC, CG9-60, CG9-61, CG9-82, CGE9-41, FTG7-05L, FTG7-05R, FTG7-05VL, FTG7-05VR, FTG7-10L, FTG7-10L+R, FTG7-10R, FTG7-10VL, FTG7-10VL+R, FTG7-10VR, FTGC7-05L, FTGC7-10L		





<b>GEV No.</b>	109444	<b>Ref. No.</b>	12008803 U054400
<b>description</b>	gas injector thread M10x1 WS 13 bore ø 2.5mm		
<b>For models:</b>	BG9-05, BG9-05AD, BG9-05I, BG9-05PF, BG9-05PI, BG9-05PLUS-I, BG9-10, BG9-10AD, BG9-10I, BG9-10PF, BG9-10PI, BG9-10PLUS-I, BMG9-05, BMG9-05V-T, CG-1002, CG-1502, CG-2000, CG-2000-2P, CG-2002, CG-2002P, CG9-10, CG9-10AD, CG9-10PLUS, CG9-11, CG9-11AD, CG9-11PLUS, CG9-20, CG9-20H, CG9-40, CG9-40H, CG9-41, CG9-41H, CG9-51L, CG9-51LC, CG9-51R, CG9-51RC, CG9-60, CG9-60H, CG9-61, CG9-61H, CG9-61OP, CG9-82, CGE9-11, CGE9-41, CGF9-120D, CGF9-120D-AD, CGF9-120I, CGF9-120I-AD, CGF9-120PLUS-D, CGF9-120PLUS-I...(Other models you can see in the webshop)		





			
1			
<b>GEV No.</b>	109409	<b>Ref. No.</b>	12008799 U054401
<b>description</b>	gas injector thread M10x1 WS 13 bore ø 2.8mm		
<b>For models:</b>	FI-5420, FI-7630, HP-G-15, HPG-15		

			
1			
<b>GEV No.</b>	109417	<b>Ref. No.</b>	12017458 U122408
<b>description</b>	gas injector thread M10x1 WS 13 bore ø 2.95mm		
<b>For models:</b>	CG-200S, CG-210, CG-210G, CG-300S, CG-310, CG-310G, CG-7200, CG-7400, CG-7415, CG-7615, CG9-51L, CG9-51LC, CG9-51R, CG9-51RC, CG-HP-20, FI-5420, FI-7630, FTG9-05L, FTG9-05R, FTG9-05VL, FTG9-05VR, FTG9-10L, FTG9-10L+R, FTG9-10R, FTG9-10VL, FTG9-10VL+R, FTG9-10VR, FTGC9-05L, FTGC9-05R, FTGC9-10L, FTGC9-10L+R, FTGC9-10R		

			
1			
<b>GEV No.</b>	109404	<b>Ref. No.</b>	12008801 R302401
<b>description</b>	gas injector thread M10x1 WS 13 bore ø 2.9mm		
<b>For models:</b>	CG-1002, CG-1502, CG-2000, CG-2002, CG-2002P, CG-200S, CG-210, CG-210G, CG-300S, CG-310, CG-310G, CG7-20, CG7-40, CG7-41, CG7-61, CG9-20, CG9-40, CG9-41, CG9-51L, CG9-51LC, CG9-51R, CG9-51RC, CG9-60, CG9-61, CG9-82, CGB7-61, CGE7-112, CGE7-41, CGE9-41, CGF9-120D, CGF9-120I, CGF9-121D, CGF9-121I, FGCL9-05-1C, FGCL9-05-2C, FGCL9-05S-1C, FGCL9-05S-2C		

			
1			
<b>GEV No.</b>	109434	<b>Ref. No.</b>	12008812 R614500
<b>description</b>	gas injector thread M10x1 WS 13 bore ø 2mm		
<b>For models:</b>	BMG-9045, CG-1002, CG-1502, CG-2000, CG-2000-2P, CG-2002, CG-2002P, CG-200S, CG-210, CG-210G, CG-300S, CG-310, CG-310G, CG-7200, CG-7400, CG-7415, CG-7615, CG9-20, CG9-40, CG9-41, CG9-51L, CG9-51LC, CG9-51R, CG9-51RC, CG9-60, CG9-61, CG9-82, CGB7-61, CGE9-41, CGF9-120D, CGF9-120I, CGF9-121D, CGF9-121I, FG-91-20, FG-92-40, SBG9-10I-AD, SBG9-15IM-AD, SBG9-15IM-AD-S		

			
1			
<b>GEV No.</b>	109405	<b>Ref. No.</b>	12008717 U742400
<b>description</b>	gas injector thread M10x1 WS 13 bore ø 3.6mm		
<b>For models:</b>	CG-200S, CG-210, CG-210G, CG-300S, CG-310, CG-310G, CG7-40, CG7-41, CG7-61, CGB7-61, CGE7-106, CGE7-41		

			
1			
<b>GEV No.</b>	109403	<b>Ref. No.</b>	12008719 R642400
<b>description</b>	gas injector thread M10x1 WS 13 bore ø 3.7mm		
<b>For models:</b>	FG9-05, FG9-05-1C, FG9-05-2C, FG9-05S, FG9-05S-1C, FG9-05S-2C, FG9-10, FG9-10-2C, FG9-10-4C, FG-920, FG-940, FTG-7050L, FTG-7050R, FTG-7100L, FTG-7100L+R, FTG-7100R		

			
1			
<b>GEV No.</b>	109400	<b>Ref. No.</b>	12040563 9483100
<b>description</b>	gas injector thread M10x1 WS 13 bore ø 3mm		
<b>For models:</b>	FG-710, FG-720, HPG-35		

			
1			
<b>GEV No.</b>	109401	<b>Ref. No.</b>	12008774 U262401
<b>description</b>	gas injector thread M10x1 WS 13 bore ø 4.1mm		
<b>For models:</b>	CG-1002, CG-1502, CG-2000, CG-2000-2P, CG-2002, CG-2002P, CG7-10, CG7-11, CG9-20, CG9-40, CG9-41, CG9-51L, CG9-51LC, CG9-51R, CG9-51RC, CG9-60, CG9-61, CG9-82, CGE9-41, CGF9-120D, CGF9-120I, CGF9-121D, CGF9-121I		

			
1			
<b>GEV No.</b>	109402	<b>Ref. No.</b>	12008764 942460
<b>description</b>	gas injector thread M10x1 WS 13 bore ø 4.25mm		
<b>For models:</b>	FE-91-20, FG-91-20, FG-92-40, FGCL9-05-1C, FGCL9-05-2C, FGCL9-05S-1C, FGCL9-05S-2C		

			
1			
<b>GEV No.</b>	109412	<b>Ref. No.</b>	12008718 X102403
<b>description</b>	gas injector thread M10x1 WS 13 bore ø 4.55mm		
<b>For models:</b>	CG9-10, CG9-11, CGF9-120D, CGF9-120I, CGF9-121D, CGF9-121I, CPG9-05, CPG9-05NC, CPG9-05S, CPG9-05SNC, FTG9-05L, FTG9-05R, FTG9-05VL, FTG9-05VR, FTG9-10L, FTG9-10L+R, FTG9-10R, FTG9-10VL, FTG9-10VL+R, FTG9-10VR, FTG9-11L, FTG9-11L+R, FTG9-11R, FTGC9-05L, FTGC9-05R, FTGC9-10L, FTGC9-10L+R, FTGC9-10R, FTGC9-11L, FTGC9-11L+R, FTGC9-11R, SBG7-10, SBG9-10, SBG9-10I, SBG9-10IM, SBG9-10IMS, SBG9-10IS, SBG9-10M, SBG9-10MS, SBG9-10S, SBG9-15IM, SBG9-15IMS		



1

<b>GEV No.</b>	109407	<b>Ref. No.</b>	12008763 U192402
<b>description</b>	gas injector thread M10x1 WS 13 bore ø 4.9mm		
<b>For models:</b>	BMG7-10, BMG9-10, BMG9-10V-T, CG-1002, CG-110, CG-1502, CG-2002, CG-2002P, CG-9110, CG9-40, CG9-41, CG9-51L, CG9-51LC, CG9-51R, CG9-51RC, CG9-60, CG9-61, CG9-82, CGE9-41		



1

<b>GEV No.</b>	109408	<b>Ref. No.</b>	12017462 R792400
<b>description</b>	gas injector thread M10x1 WS 13 bore ø 4mm		
<b>For models:</b>	BG7-05, BG7-05I, BG7-10, BG7-10I, FTG7-05, FTG7-05L, FTG7-05R, FTG7-10, FTG7-10L, FTG7-10L+R, FTG7-10R, FTGC7-05L, FTGC7-10L		



1

<b>GEV No.</b>	109406	<b>Ref. No.</b>	12008818 942450
<b>description</b>	gas injector thread M10x1 WS 13 bore ø 5.35mm		
<b>For models:</b>	BG9-05PF, BG9-05PI, BG9-10PF, BG9-10PI, CG-1002, CG-1502, CG-2002, CG-2002P		

gas nozzles M14x1



1

<b>GEV No.</b>	109450	<b>Ref. No.</b>	12021078 S312400
<b>description</b>	gas injector thread M14x1 WS 17 bore ø 2.05mm		
<b>For models:</b>	MG7-10, MG7-10BM		



1

<b>GEV No.</b>	109452	<b>Ref. No.</b>	12021165 S012400
<b>description</b>	gas injector thread M14x1 WS 17 bore ø 2.2mm		
<b>For models:</b>	MG9-10, MG9-10BM, MG9-10BMS, MG9-10S, MPG9-10, MPG9-10BM, MPG9-10BMS, MPG9-10S		



1

<b>GEV No.</b>	109455	<b>Ref. No.</b>	12021170 S032400
<b>description</b>	gas injector thread M14x1 WS 17 bore ø 2.45mm		
<b>For models:</b>	MG9-15, MG9-15BM, MG9-15BM316, MG9-15BMS, MG9-15S, MPG9-15, MPG9-15BM, MPG9-15BMS, MPG9-15S		



1

<b>GEV No.</b>	109457	<b>Ref. No.</b>	12021195 S172400
<b>description</b>	gas injector thread M14x1 WS 17 bore ø 2.55mm		
<b>For models:</b>	MG9-20, MG-9200, MG9-20S, MPG9-20, MPG-9200, MPG9-20S		



1

<b>GEV No.</b>	109462	<b>Ref. No.</b>	12021077 S312401
<b>description</b>	gas injector thread M14x1 WS 17 bore ø 3.05mm		
<b>For models:</b>	MG7-10, MG7-10BM		



1

<b>GEV No.</b>	109463	<b>Ref. No.</b>	12021206 S012401
<b>description</b>	gas injector thread M14x1 WS 17 bore ø 3.1mm		
<b>For models:</b>	MG9-10, MG9-10BM, MG9-10BMS, MG9-10S, MPG9-10, MPG9-10BM, MPG9-10BMS, MPG9-10S		



1

<b>GEV No.</b>	109465	<b>Ref. No.</b>	12021203 S114401
<b>description</b>	gas injector thread M14x1 WS 17 bore ø 3.65mm		
<b>For models:</b>	MG-9100, MG9-15, MG9-15BM, MG9-15BM316, MG9-15BMS, MG9-15S, MPG9-15, MPG9-15BM, MPG9-15BMS, MPG9-15S		





 <p>1</p>			
<b>GEV No.</b>	109468	<b>Ref. No.</b>	12021216 S114400
<b>description</b>	gas injector thread M14x1 WS 17 bore ø 3.8mm		
<b>For models:</b>	MG-9150, MG-9150BM, MG9-20, MG9-20S, MPG-9150, MPG9-20, MPG9-20S		

 <p>1</p>			
<b>GEV No.</b>	109470	<b>Ref. No.</b>	12040503 S172401
<b>description</b>	gas injector thread M14x1 WS 17 bore ø 3.9mm		
<b>For models:</b>	MG9-20, MG-9200, MG9-20S, MPG9-20, MPG-9200, MPG9-20S		

gas nozzles (other)

 <p>1</p>			
<b>GEV No.</b>	109475	<b>Ref. No.</b>	12039797 T075020
<b>description</b>	gas injector bore ø 1.65mm		
<b>For models:</b>	HCG-6-11, HMG-6-11		

 <p>1</p>			
<b>GEV No.</b>	109477	<b>Ref. No.</b>	12021221 R725066
<b>description</b>	gas injector bore ø 2.2mm		
<b>For models:</b>	HCG-10-11, HCG-6-11, HMG-10-11		

 <p>1</p>			
<b>GEV No.</b>	109497	<b>Ref. No.</b>	12021006 R725084
<b>description</b>	gas injector bore ø 2.2mm		
<b>For models:</b>	HMG-10-11UL		

 <p>1</p>			
<b>GEV No.</b>	109480	<b>Ref. No.</b>	12019416 R735010
<b>description</b>	gas injector bore ø 2.5mm		
<b>For models:</b>	HCG-10-21, HCG-2-10-11, HCG-6-11, HMG-10-21, HMG-2-10-11, HMG-6-11		

 <p>1</p>			
<b>GEV No.</b>	109485	<b>Ref. No.</b>	12019726 T095012
<b>description</b>	gas injector bore ø 2.85mm		
<b>For models:</b>	HCG-20-11, HMG-20-11		

 <p>1</p>			
<b>GEV No.</b>	109492	<b>Ref. No.</b>	12021231 R735009
<b>description</b>	gas injector bore ø 3.5mm		
<b>For models:</b>	HCG-10-21, HCG-2-10-11, HMG-10-21, HMG-2-10-11		

 <p>1</p>			
<b>GEV No.</b>	109488	<b>Ref. No.</b>	12021232 R725067
<b>description</b>	gas injector bore ø 3mm		
<b>For models:</b>	HCG-10-11, HMG-10-11, HMG-6-11		

 <p>1</p>			
<b>GEV No.</b>	109496	<b>Ref. No.</b>	12021233 T095013
<b>description</b>	gas injector bore ø 4.5mm		
<b>For models:</b>	HCG-20-11, HMG-20-11		



## pilot burner nozzles

### pilot burner nozzles SIT

#### 100 series



<b>GEV No.</b>	100245	<b>Ref. No.</b>	12021187 U442138
<b>description</b>	pilot burner nozzle LPG code 20 bore $\varnothing$ 0.2mm Qty 1 pcs thread M8x0.75		
<b>For models:</b>	BG7-05, BG7-05I, BG7-10I, BG9-05, BG9-05I, BG9-10, BG9-10I, BMG7-10, BMG9-05, BMG9-10, CG-1002, CG-1502, CG-2002, CG-200S, CG-210, CG-210G, CG-300S, CG-310, CG-310G, CG7-10, CG7-11, CG7-20, CG7-40, CG7-41, CG7-61, CG9-10, CG9-11, CG9-20, CG9-40, CG9-41, CG9-51L, CG9-51LC, CG9-51R, CG9-51RC, CG9-60, CG9-61, CG9-82, CGB7-61, CGE7-41, CGE9-41, CGF9-120D, CGF9-120I, CGF9-121D, CGF9-121I, CPG9-11, CPG7-05, CPG9-05, CPG9-05NC, CPG9-05S... (Other models you can see in the webshop)		



<b>GEV No.</b>	102972	<b>Ref. No.</b>	12008938 U442137
<b>description</b>	pilot burner nozzle natural gas code 40 bore $\varnothing$ 0.4mm Qty 1 pcs		
<b>For models:</b>	BG6-05I, BG7-05, BG7-05I, BG7-10, BG7-10I, BG9-05, BG9-05AD, BG9-05I, BG9-05PF, BG9-05PI, BG9-05PLUS-I, BG9-10, BG9-10AD, BG9-10I, BG9-10PF, BG9-10PI, BG9-10PLUS-I, BMG7-10, BMG9-05, BMG9-05V-T, BMG9-10, BMG9-10V-T, CG-1002, CG-1502, CG-2002, CG-2002P, CG-200S, CG-210, CG-210G, CG-300S, CG-310, CG-310G, CG7-10, CG7-11, CG7-20, CG7-20H, CG7-30D, CG7-30I, CG7-31D, CG7-31I, CG7-40, CG7-40H, CG7-41, CG7-41H, CG7-50, CG7-51, CG7-60, CG7-60H, CG7-61, CG7-61H... (Other models you can see in the webshop)		

### pilot burner nozzles (other)

#### FAGOR



<b>GEV No.</b>	109471	<b>Ref. No.</b>	12021092 U122401
<b>description</b>	pilot burner nozzle bore $\varnothing$ 0.2mm thread M10x1 WS 12		
<b>For models:</b>	CG-HP-20, FI-5420, FI-7630		

## bypass nozzles

### bypass nozzles COPRECI



<b>GEV No.</b>	109195	<b>Ref. No.</b>	12016681 U022113
<b>description</b>	bypass nozzle type COPRECI bore $\varnothing$ 1.3mm thread M8x0.75 WS 11		
<b>For models:</b>	CG9-40, CG9-41, CG9-51L, CG9-51LC, CG9-51R, CG9-51RC, CG9-60, CG9-61, CG9-82, CGE9-41		

## GAS NOZZLES/AUXILIARY GAS PARTS FAGOR



<b>GEV No.</b>	109413	<b>Ref. No.</b>	12016664 U022111
<b>description</b>	bypass nozzle type COPRECI CAL-3200 bore $\varnothing$ 0.9mm thread M8x0.75 WS 11		
<b>For models:</b>	CG9-20, CG9-40, CG9-41, CG9-51L, CG9-51LC, CG9-51R, CG9-51RC, CG9-60, CG9-61, CG9-82, CGE9-41, CGF9-120D, CGF9-120I, CGF9-121D, CGF9-121I		

## auxiliary gas parts

### screw connections



#### end caps



<b>GEV No.</b>	106342	<b>Ref. No.</b>	12008078 U635008
<b>description</b>	blind screw connection L 18mm thread M26x1.5 WS 30 brass		
<b>For models:</b>	BG7-05, BG7-05I, BG7-10, BG7-10I, BG9-05, BG9-05AD, BG9-05I, BG9-05PF, BG9-05PI, BG9-05PLUS-I, BG9-10, BG9-10AD, BG9-10I, BG9-10PF, BG9-10PI, BG9-10PLUS-I, BMG7-10, BMG9-05, BMG9-05V-T, BMG9-10, BMG9-10V-T, CG-210, CG-210G, CG7-10, CG7-20, CG7-20H, CG7-30D, CG7-30I, CG7-40, CG7-40H, CG7-50, CG7-60, CG7-60H, CG9-05AD, CG9-05PLUS, CG9-10, CG9-10AD, CG9-10PLUS, CG9-20, CG9-40, CG9-60, CGB7-61, CGE7-41, CGE7-41H, CGF9-120D, CGF9-120D-AD, CGF9-120I, CGF9-120I-AD, CGF9-120PLUS-D, CGF9-120PLUS-I... (Other models you can see in the webshop)		



#### olives







<b>GEV No.</b>	101273	<b>Ref. No.</b>	12008501 U055043	
<b>description</b>	olive for pipe $\varnothing$ 12mm L 9.5mm brass Qty 1 pcs suitable for universal			
<b>For models:</b>	BG7-05, BG7-05I, BG7-10, BG7-10I, BG9-05, BG9-05I, BG9-10, BG9-10I, CG-1002, CG-1502, CG-2000, CG-2000-2P, CG-2002, CG-2002P, CG-200S, CG-210, CG-210G, CG-300S, CG-310, CG-310G, CG7-10, CG7-11, CG-7115, CG7-20, CG-7200, CG7-40, CG-7400, CG7-41, CG-7415, CG7-61, CG-7615, CG9-10, CG9-11, CG9-20, CG9-40, CG9-41, CG9-51L, CG9-51LC, CG9-51R, CG9-51RC, CG9-60, CG9-61, CG9-82, CGB7-61, CGE7-138, CGE7-41, CGE9-41, CPG7-05, CPG9-05, CPG9-05NC... (Other models you can see in the webshop)			
<b>accessories for</b>	101273			
	<b>GEV No.</b>	100944	<b>Ref. No.</b>	12007951 Q221336
	union nut thread M18x1.5 for pipe $\varnothing$ 12mm			
	<b>GEV No.</b>	101276	<b>Ref. No.</b>	12008081 U264310
	union screw thread 3/8" tube $\varnothing$ 12mm Qty 1 pcs			





			
1			
<b>GEV No.</b>	101000	<b>Ref. No.</b>	12008775 S312106
<b>description</b>	olive for pipe ø 16mm L 10.5mm brass Qty 1 pcs		
<b>For models:</b>	ACG-102, ACG-201, ACG-202, AG-061, AG-061W, AG-101, AG-101W, AG-102, AG-102W, AG-201, AG-202, APG-061, APG-061W, APG-101, APG-101W, APG-102, APG-102W, APG-201, APG-202, MG7-10, MG7-10BM, MG9-10, MG9-10BM, MG9-10BMS, MG9-10S, MG9-15, MG9-15BM, MG9-15BM316, MG9-15BMS, MG9-15S, MG9-20, MG9-20S, MPG9-10, MPG9-10BM, MPG9-10BMS, MPG9-10S, MPG9-15, MPG9-15BM, MPG9-15BMS, MPG9-15S, MPG9-20, MPG9-20S		

			
1			
<b>GEV No.</b>	101256	<b>Ref. No.</b>	12008773
<b>description</b>	olive for pipe ø 16mm Qty 1 pcs		
<b>For models:</b>	MG9-10AD, MG9-10BMAD, MG9-10BMSAD, MG9-10PLUS, MG9-10PLUS-BM, MG9-10PLUS-BMS, MG9-10PLUS-S, MG9-10S-AD, MG9-15AD, MG9-15BMAD, MG9-15BMSAD, MG9-15PLUS, MG9-15PLUS-BM, MG9-15PLUS-BMS, MG9-15PLUS-S, MG9-15S-AD, MG9-20AD, MG9-20PLUS, MG9-20PLUS-S, MG9-20S-AD, SBG7-10, SBG9-10, SBG9-10I, SBG9-10I-AD, SBG9-10I-AD-S, SBG9-10IM, SBG9-10IM-AD, SBG9-10IM-AD-S, SBG9-10IMS, SBG9-10IS, SBG9-10M, SBG9-10MS, SBG9-10PLUS-I, SBG9-10PLUS-IM, SBG9-10PLUS-SI, SBG9-10PLUS-SIM, SBG9-10S, SBG9-15IM, SBG9-15IM-AD, SBG9-15IM-AD-S, SBG9-15IMS, SBG9-15PLUS-IM, SBG9-15PLUS-SIM		
<b>accessories for</b>	101256		
	<b>GEV No.</b>	101253	<b>Ref. No.</b> 12008865 S312105
union nut thread M24x1.5 PEL for pipe ø 16mm			

			
1			
<b>GEV No.</b>	101274	<b>Ref. No.</b>	X012105
<b>description</b>	olive for pipe ø 16mm Qty 1 pcs		
<b>For models:</b>	FG-710, FG-71-15, FG-720, FG-72-30, FG9-05, FG9-05S, FG9-10, FG-91-20, FG-920, FG-92-40, FG-940, SBG7-10, SBG9-10, SBG9-10I, SBG9-10IM, SBG9-10IMS, SBG9-10IS, SBG9-10M, SBG9-10MS, SBG9-10S, SBG9-15IM, SBG9-15IMS		
<b>accessories for</b>	101274		
	<b>GEV No.</b>	101275	<b>Ref. No.</b> 12008951 X012104
union screw thread 1/2" for pipe ø 16mm Qty 1 pcs			

			
1			
<b>GEV No.</b>	101257	<b>Ref. No.</b>	12008828 S312104
<b>description</b>	olive for pipe ø 20mm Qty 1 pcs		
<b>For models:</b>	MG7-10, MG7-10BM, MG9-10, MG9-10BM, MG9-10BMS, MG9-10S, MG9-15, MG9-15BM, MG9-15BM316, MG9-15BMS, MG9-15S, MG9-20, MG9-20S, MPG9-10, MPG9-10BM, MPG9-10BMS, MPG9-10S, MPG9-15, MPG9-15BM, MPG9-15BMS, MPG9-15S, MPG9-20, MPG9-20S		
<b>accessories for</b>	101257		
	<b>GEV No.</b>	101254	<b>Ref. No.</b> 12008921 S312103
union nut thread M28x1.5 tube ø 20mm			

			
1			
<b>GEV No.</b>	101246	<b>Ref. No.</b>	12018994 U265026
<b>description</b>	olive for pipe ø 4mm Qty 1 pcs		
<b>For models:</b>	BG7-05, BG7-05I, BG7-10, BG7-10I, BG9-05, BG9-05I, BG9-10, BG9-10I, CG-1002, CG-1502, CG-2000, CG-2000-2P, CG-2002, CG-200S, CG-210, CG-210G, CG-300S, CG-310, CG-310G, CG7-20, CG-7200, CG7-40, CG-7400, CG7-41, CG-7415, CG7-61, CG-7615, CG9-20, CG9-40, CG9-41, CG9-51L, CG9-51LC, CG9-51R, CG9-51RC, CG9-60, CG9-61, CG9-82, CGB7-61, CGE7-136, CGE7-41, CGE9-41, CGF9-120D, CGF9-120I, CGF9-121D, CGF9-121I, HMG-10-11UL, HMG-10-21UL		
<b>accessories for</b>	101246		
	<b>GEV No.</b>	100908	<b>Ref. No.</b> 12017481 T052101
union screw thread M10x1 for pipe ø 4mm Qty 1 pcs			

			
1			
<b>GEV No.</b>	101879	<b>Ref. No.</b>	12019962 U135023
<b>description</b>	olive for pipe ø 5mm Qty 1 pcs		
<b>For models:</b>	CG-210, CG-210G, CG-310, CG-310G, CG-HP-20, FI-5420, FI-7630, HPG-15, HPG-35		

			
1			
<b>GEV No.</b>	101286	<b>Ref. No.</b>	12008476 S312108000 X205028
<b>description</b>	olive ID ø 6mm Qty 1 pcs		
<b>For models:</b>	BMG7-10, BMG-9045, BMG9-05, BMG9-05V-T, BMG9-10, BMG9-10V-T, CG-1002, CG-1502, CG-2000, CG-2000-2P, CG-2002, CG-2002P, CG-200S, CG-210, CG-210G, CG-300S, CG-310, CG-310G, CG6-41, CG7-10, CG7-11, CG-7115, CG7-41, CG-7415, CG7-61, CG-7615, CG9-05AD, CG9-05PLUS, CG9-10, CG9-10AD, CG9-10PLUS, CG9-11, CG-9110, CG9-11AD, CG9-11PLUS, CG9-20AD, CG9-20AD-H, CG9-20PLUS, CG9-20PLUS-H, CG9-31PLUS-D, CG9-31PLUS-I, CG9-40AD, CG9-40AD-H, CG9-40PLUS, CG9-40PLUS-H, CG9-41, CG9-41AD, CG9-41AD-H, CG9-41PLUS, CG9-41PLUS-H...(Other models you can see in the webshop)		
<b>accessories for</b>	101286		
	<b>GEV No.</b>	100909	<b>Ref. No.</b> 12008740 12016658 S312107 U265703
union screw thread M10x1 for pipe ø 6mm Qty 1 pcs			
	<b>GEV No.</b>	101464	<b>Ref. No.</b> —
union nut thread M12x1 for pipe ø 6mm			

miscellaneous



1

<b>GEV No.</b>	104628	<b>Ref. No.</b>	12008165
<b>description</b>	bush thread 3/4" tube ø 17mm for ignition gas pipe WS 30 L 30mm metal Qty 1 pcs		
<b>For models:</b>	MG9-10, MG9-10BM, MG9-10BMS, MG9-10S, MG9-15, MG9-15BM, MG9-15BM316, MG9-15BMS, MG9-15S, MG9-20, MG9-20S, MPG9-10, MPG9-10BM, MPG9-10BMS, MPG9-10S, MPG9-15, MPG9-15BM, MPG9-15BMS, MPG9-15S, MPG9-20, MPG9-20S, PL-105C, PL-105L, PL-110C, PL-110L, PL-110L+R, PL-110R, SBE9-10, SBE9-10I, SBE9-10IM, SBE9-10IMS, SBE9-10IS, SBE9-10M, SBE9-10MS, SBE9-10S, SBE9-15IM, SBE9-15IMS, SBE9-15M, SBE9-15MS, SBG9-10, SBG9-10I, SBG9-10IM, SBG9-10IMS, SBG9-10IS, SBG9-10M, SBG9-10MS, SBG9-10S, SBG9-15IM, SBG9-15IMS		

union nuts



1

<b>GEV No.</b>	103035	<b>Ref. No.</b>	12007903 Q221334
<b>description</b>	union nut thread 1/2" WS 24 for pipe ø 12mm		
<b>For models:</b>	CG-1002, CG-1502, CG-2002, CG-2002P, CG9-11, CG9-41, CG9-51L, CG9-51LC, CG9-51R, CG9-51RC, CG9-61, CG9-82, FI-5420, FI-7630, FTG9-11L, FTG9-11L+R, FTG9-11R, FTGC9-11L, FTGC9-11L+R, FTGC9-11R, HG9-10, HG9-20, HGP-10-21, HGV-10-11, HGV-10-21, HGV-20-11, HVG-10-11, HVG-10-11UL, HVG-10-21, HVG-10-21UL, HVG-20-11, HVG-20-21, HVG-2-10-11, HVG-2-20-21, MFHVG-10-11, MFHVG-10-21, VG-101, VG-102, VG-201, VG-202, VPG-101, VPG-102, VPG-201, VPG-202		



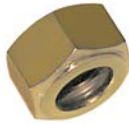

1

<b>GEV No.</b>	100944	<b>Ref. No.</b>	12007951 Q221336	
<b>description</b>	union nut thread M18x1.5 for pipe ø 12mm			
<b>For models:</b>	BG7-05, BG7-05I, BG7-10, BG7-10I, BG9-05, BG9-05I, BG9-10, BG9-10I, CG-1002, CG-1502, CG-2000, CG-2000-2P, CG-2002, CG-2002P, CG-2005, CG-210, CG-210G, CG-300S, CG-310, CG-310G, CG7-10, CG7-11, CG-7115, CG7-20, CG-7200, CG7-40, CG-7400, CG7-41, CG-7415, CG7-61, CG-7615, CG9-10, CG9-11, CG9-20, CG9-40, CG9-41, CG9-51L, CG9-51LC, CG9-51R, CG9-51RC, CG9-60, CG9-61, CG9-82, CGB7-61, CGE7-139, CGE7-41, CGE9-41, CPG7-05, CPG9-05, CPG9-05NC...(Other models you can see in the webshop)			
<b>accessories for</b>	100944			
	<b>GEV No.</b>	101273	<b>Ref. No.</b>	12008501 U055043
olive for pipe ø 12mm L 9.5mm brass Qty 1 pcs suitable for universal				



1

<b>GEV No.</b>	101253	<b>Ref. No.</b>	12008865 S312105	
<b>description</b>	union nut thread M24x1.5 PEL for pipe ø 16mm			
<b>For models:</b>	MG7-10, MG7-10BM, MG9-10, MG9-10BM, MG9-10BMS, MG9-10S, MG9-15, MG9-15BM, MG9-15BM316, MG9-15BMS, MG9-15S, MG9-20, MG9-20S, MPG9-10, MPG9-10BM, MPG9-10BMS, MPG9-10S, MPG9-15, MPG9-15BM, MPG9-15BMS, MPG9-15S, MPG9-20, MPG9-20S			
<b>accessories for</b>	101253			
	<b>GEV No.</b>	101256	<b>Ref. No.</b>	12008773
olive for pipe ø 16mm Qty 1 pcs				



1

<b>GEV No.</b>	106331	<b>Ref. No.</b>	12008085 U725006
<b>description</b>	union nut thread M26x1.5 WS 30 L 17.5mm brass for pipe ø 17mm		
<b>For models:</b>	ACG-102, ACG-201, ACG-202, AG-061, AG-101, AG-102, AG-201, AG-202, APG-061, APG-101, APG-102, APG-201, APG-202, BG7-05, BG7-10, BG9-05, BG9-10, BMG7-10, BMG9-05, BMG9-10, CG-1002, CG-1502, CG-2002, CG7-10, CG7-11, CG7-20, CG7-40, CG7-41, CG7-61, CG9-10, CG9-11, CG9-20, CG9-40, CG9-41, CG9-51L, CG9-51LC, CG9-51R, CG9-51RC, CG9-60, CG9-61, CG9-82, CGB7-61, CGE7-123, CGE7-41, CGE9-41, CPG9-11, CPG7-05, CPG9-05, CPG9-05NC, FG-710...(Other models you can see in the webshop)		

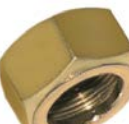

1

<b>GEV No.</b>	101254	<b>Ref. No.</b>	12008921 S312103	
<b>description</b>	union nut thread M28x1.5 tube ø 20mm			
<b>For models:</b>	MG7-10, MG7-10BM, MG9-10, MG9-10BM, MG9-10BMS, MG9-10S, MG9-15, MG9-15BM, MG9-15BM316, MG9-15BMS, MG9-15S, MG9-20, MG9-20S, MPG9-10, MPG9-10BM, MPG9-10BMS, MPG9-10S, MPG9-15, MPG9-15BM, MPG9-15BMS, MPG9-15S, MPG9-20, MPG9-20S			
<b>accessories for</b>	101254			
	<b>GEV No.</b>	101257	<b>Ref. No.</b>	12008828 S312104
olive for pipe ø 20mm Qty 1 pcs				





union screws

1



<b>GEV No.</b>	100904	<b>Ref. No.</b>	12008755
<b>description</b>	locking screw M10x1 for pipe ø 4mm Qty 1 pcs		
<b>For models:</b>	BG9-05, BG9-05I, BG9-10, BG9-10I, CG7-20, CG7-20H, CG7-30D, CG7-30I, CG7-31D, CG7-31I, CG7-40, CG7-40H, CG7-41, CG7-41H, CG7-50, CG7-51, CG7-60, CG7-60H, CG7-61, CG7-61H, CGB7-61, CGB7-61H, CGB7-61R, CGB7-61RH, CGE7-41, CGE7-41H		

2



<b>GEV No.</b>	100905	<b>Ref. No.</b>	12008715 U134323
<b>description</b>	locking screw M10x1 for pipe ø 6mm Qty 1 pcs		
<b>For models:</b>	BG6-05I, BG7-05, BG7-05I, BG7-10, BG7-10I, BMG7-10, BMG9-05, BMG9-05V-T, BMG9-10, BMG9-10V-T, CG-1002, CG-1502, CG-2000, CG-2000-2P, CG-2002, CG-2002P, CG-210, CG-210G, CG-310, CG-310G, CG6-41, CG7-10, CG7-11, CG7-20, CG7-20H, CG7-30D, CG7-30I, CG7-31D, CG7-31I, CG7-40, CG7-40H, CG7-41, CG7-41H, CG7-50, CG7-51, CG7-60, CG7-60H, CG7-61, CG7-61H, CG9-10, CG9-11, CG-9110, CG9-11AD, CG9-11PLUS, CG9-20, CG9-20H, CG9-31PLUS-D, CG9-31PLUS-I, CG9-40, CG9-40H...(Other models you can see in the webshop)		

1



<b>GEV No.</b>	101275	<b>Ref. No.</b>	12008951 X012104
<b>description</b>	union screw thread 1/2" for pipe ø 16mm Qty 1 pcs		
<b>For models:</b>	FG-710, FG-71-15, FG-720, FG-72-30, FG9-05, FG9-05S, FG9-10, FG-91-20, FG-920, FG-92-40, FG-940, MG9-10AD, MG9-10BMAD, MG9-10BMSAD, MG9-10PLUS, MG9-10PLUS-BM, MG9-10PLUS-BMS, MG9-10PLUS-S, MG9-10S-AD, MG9-15AD, MG9-15BMAD, MG9-15BMSAD, MG9-15PLUS, MG9-15PLUS-BM, MG9-15PLUS-BMS, MG9-15PLUS-S, MG9-15S-AD, MG9-20AD, MG9-20PLUS, MG9-20PLUS-S, MG9-20S-AD, SBG7-10, SBG9-10, SBG9-10I, SBG9-10I-AD, SBG9-10I-AD-S, SBG9-10IM, SBG9-10IM-AD, SBG9-10IM-AD-S, SBG9-10IMS, SBG9-10IS, SBG9-10M, SBG9-10MS, SBG9-10PLUS-I, SBG9-10PLUS-IM, SBG9-10PLUS-SI, SBG9-10PLUS-SIM, SBG9-10S, SBG9-15IM, SBG9-15IM-AD...(Other models you can see in the webshop)		
<b>accessories for</b>	101275		
	<b>GEV No.</b>	101274	<b>Ref. No.</b> X012105
	olive for pipe ø 16mm Qty 1 pcs		

1



<b>GEV No.</b>	102453	<b>Ref. No.</b>	12008018 U195009
<b>description</b>	union screw thread 1/8" for pipe ø 1/4" CCT L 12mm brass Qty 1 pcs WS 10		
<b>For models:</b>	BMG7-10, BMG-9045, BMG9-05, BMG9-05V-T, BMG9-10, BMG9-10V-T, CG-1002, CG-1502, CG-2002, CG-2002P, CG-2005, CG-210, CG-210G, CG-300S, CG-310, CG-310G, CG6-41, CG7-10, CG7-11, CG-7115, CG7-41, CG-7415, CG7-61, CG-7615, CG9-10, CG9-11, CG-9110, CGB7-61, CGE9-11, CGF9-120D, CGF9-120I, CGF9-121D, CGF9-121I, CPG7-05, CPG9-05, CPG9-05NC, CPG9-05S, CPG9-05SNC, FTG7-05, FTG-7050L, FTG-7050R, FTG7-05L, FTG7-05R, FTG7-05VL, FTG7-05VR, FTG7-10, FTG-7100L, FTG-7100L+R, FTG-7100R, FTG7-10L...(Other models you can see in the webshop)		

1







<b>GEV No.</b>	102454	<b>Ref. No.</b>	12017406 U322109
<b>description</b>	union screw thread 1/8" for pipe ø 4mm L 11mm brass Qty 1 pcs WS 10		
<b>For models:</b>	BG7-05, BG7-05I, BG7-10, BG7-10I, BG9-05, BG9-05I, BG9-10, BG9-10I, CG-1002, CG-1502, CG-2000, CG-2000-2P, CG-2002, CG-2005, CG-210, CG-210G, CG-300S, CG-310, CG-310G, CG7-20, CG7-40, CG7-41, CG7-61, CG9-20, CG9-40, CG9-41, CG9-51L, CG9-51LC, CG9-51R, CG9-51RC, CG9-60, CG9-61, CG9-82, CGB7-61, CGE7-135, CGE7-41, CGE9-41, CGF9-120D, CGF9-120I, CGF9-121D, CGF9-121I, HMG-10-11UL, HMG-10-21UL		

1



<b>GEV No.</b>	100908	<b>Ref. No.</b>	12017481 T052101
<b>description</b>	union screw thread M10x1 for pipe ø 4mm Qty 1 pcs		
<b>For models:</b>	BG7-05, BG7-10, BG9-05, BG9-05I, BG9-10, BG9-10I, CG-200S, CG-210, CG-210G, CG-300S, CG-310, CG-310G		
<b>accessories for</b>	100908		
	<b>GEV No.</b>	100897	<b>Ref. No.</b> —
	olive for pipe ø 4mm Qty 1 pcs for pilot burner		
	<b>GEV No.</b>	101246	<b>Ref. No.</b> 12018994 U265026
	olive for pipe ø 4mm Qty 1 pcs		
	<b>GEV No.</b>	101280	<b>Ref. No.</b> —
	olive for pipe ø 4mm Qty 1 pcs		
	<b>GEV No.</b>	101282	<b>Ref. No.</b> —
	olive for pipe ø 4mm L 7.4mm Qty 1 pcs		

			
1			
<b>GEV No.</b>	100909	<b>Ref. No.</b>	12008740 12016658 S312107 U265703
<b>description</b>	union screw thread M10x1 for pipe ø 6mm Qty 1 pcs		
<b>For models:</b>	CG-2005, CG-210, CG-210G, CG-3005, CG-310, CG-310G, CG-7200, CG-7400, CG-7415, CG-7615, CG9-05AD, CG9-05PLUS, CG9-10AD, CG9-10PLUS, CG9-11AD, CG9-11PLUS, CG9-20AD, CG9-20AD-H, CG9-20PLUS, CG9-20PLUS-H, CG9-31PLUS-D, CG9-31PLUS-I, CG9-40AD, CG9-40AD-H, CG9-40PLUS, CG9-40PLUS-H, CG9-41AD, CG9-41AD-H, CG9-41PLUS, CG9-41PLUS-H, CG9-60AD, CG9-60AD-H, CG9-60PLUS, CG9-60PLUS-H, CG9-61AD, CG9-61AD-H, CG9-61PLUS, CG9-61PLUS-H, CG9-82AD, CG9-82PLUS, CGE9-41AD, CGE9-41PLUS, CGF9-120D-AD, CGF9-120I-AD, CGF9-120PLUS-D, CGF9-120PLUS-I, CGF9-121D-AD, CGF9-121I-AD, CGF9-121PLUS-D, CGF9-121PLUS-I...(Other models you can see in the webshop)		
<b>accessories for</b>	100909		
	<b>GEV No.</b>	100898	<b>Ref. No.</b> —
	olive for pipe ø 6mm Qty 1 pcs for pilot burner		
	<b>GEV No.</b>	101286	<b>Ref. No.</b> 12008476 S312108000 X205028
	olive ID ø 6mm Qty 1 pcs		
	<b>GEV No.</b>	101287	<b>Ref. No.</b> —
	olive for pipe ø 6mm Qty 1 pcs		
	<b>GEV No.</b>	101288	<b>Ref. No.</b> —
	olive for pipe ø 6mm L 6mm aluminium Qty 1 pcs ED ø 8.5mm		

angle pieces

			
1			
<b>GEV No.</b>	106415	<b>Ref. No.</b>	12009102 S115013
<b>description</b>	angle piece		
<b>For models:</b>	BME7-05, BME9-05, BMG9-05, CPE7-05, CPE7-05NC, CPE9-05, CPE9-05S, CPG7-05, CPG7-05NC, CPG9-05, CPG9-05S, EPC-350, GPC-350, LA-13M, LA-18MP, LA-V-10M, LA-V-10MP, LA-V-13M, LA-V-13MP, LA-V-18M, LA-V-18MP, LB-AC-10M, LB-E-10M, LB-V-10M, LF-13MPP, LF-18MPP, LF-8MPP, LR-V-10M, LR-V-10MP, LR-V-13M, LR-V-13MP, LR-V-18M, LR-V-18MP, LR-V-25M, LR-V-25MP, ME7-10BM, ME9-10BM, ME9-10BMS, ME9-15BM, ME9-15BM316, ME9-15BMS, MG7-10, MG7-10BM, MG9-10, MG-9100, MG9-10BM, MG9-10BMS, MG9-10S, MG9-15, MG-9150...(Other models you can see in the webshop)		

accessories

			
1			
<b>GEV No.</b>	694676	<b>Ref. No.</b>	12009347 U195420
<b>description</b>	cast plate cast iron ø 260mm COCINA CG9-10 suitable for FAGOR		
<b>For models:</b>	CG-110, CG7-10, CG7-11, CG-7115, CG9-05AD, CG9-05PLUS, CG9-10, CG9-10AD, CG9-10PLUS, CG9-11, CG-9110, CG9-11AD, CG9-11PLUS, CGE9-11, CGF9-120D, CGF9-120D-AD, CGF9-120I, CGF9-120I-AD, CGF9-120PLUS-D, CGF9-120PLUS-I, CGF9-121D, CGF9-121D-AD, CGF9-121I, CGF9-121I-AD, CGF9-121PLUS-D, CGF9-121PLUS-I		

			
1			
<b>GEV No.</b>	109100	<b>Ref. No.</b>	12010033 Q153002
<b>description</b>	screw for nozzle holder		
<b>For models:</b>	BG7-05, BG7-05I, BG7-10, BG7-10I, BG9-05, BG9-05AD, BG9-05I, BG9-05PF, BG9-05PI, BG9-05PLUS-I, BG9-10, BG9-10AD, BG9-10I, BG9-10PF, BG9-10PI, BG9-10PLUS-I, BMG7-10, BMG-9045, BMG9-05, BMG9-10, CG-1002, CG-1502, CG-2000, CG-2000-2P, CG-2002, CG-2002P, CG-2005, CG-210, CG-210G, CG-3005, CG-310, CG-310G, CG7-10, CG7-11, CG-7115, CG7-20, CG-7200, CG7-20H, CG7-30D, CG7-30I, CG7-31D, CG7-31I, CG7-40, CG-7400, CG7-40H, CG7-41, CG-7415, CG7-41H, CG7-50, CG7-51...(Other models you can see in the webshop)		

gas lines

main gas lines

producer-specific

			
1			
<b>GEV No.</b>	109061	<b>Ref. No.</b>	12008153 U565007
<b>description</b>	connection angle tube ø 15mm L 70mm		
<b>For models:</b>	CG-1002, CG-1502, CG-2002, CG7-11, CG7-41, CG7-61, CG9-11, CG9-41, CG9-51L, CG9-51LC, CG9-51R, CG9-51RC, CG9-61, CG9-82, CGB7-61, CGE7-41, CGE9-41, CGP9-11, CPG7-05, CPG9-05, CPG9-05NC, FG-710, FG-720, FG9-05, FG9-10, FTG9-11L, FTG9-11L+R, FTG9-11R, FTGC9-11L, FTGC9-11L+R, FTGC9-11R, HG9-10, HG9-20, MG7-10, MG7-10BM, MG9-10, MG9-10BM, MG9-10BMS, MG9-10S, MG9-15, MG9-15BM, MG9-15BM316, MG9-15BMS, MG9-15S, MG9-20, MG9-20S, MPG9-10, MPG9-10BM, MPG9-15, MPG9-15BM...(Other models you can see in the webshop)		

			
1			
<b>GEV No.</b>	106263	<b>Ref. No.</b>	12015649 U725008
<b>description</b>	gas line		
<b>For models:</b>	CG7-20		





1

<b>GEV No.</b>	106416	<b>Ref. No.</b>	S045012
<b>description</b>	gas line L 260mm ø 20mm		



1

<b>GEV No.</b>	107928	<b>Ref. No.</b>	12019022 H015018000
<b>description</b>	gas line tube ø 12mm copper with nozzle holder		



1

<b>GEV No.</b>	106340	<b>Ref. No.</b>	12013654 U745023
<b>description</b>	gas line tube ø 12mm SS with nozzle holder		
<b>For models:</b>	CG7-20, CG7-40, CG7-41, CG7-61, CGB7-61, CGE7-128, CGE7-41		



1

<b>GEV No.</b>	106339	<b>Ref. No.</b>	12008392 12019896 U025014 U565023
<b>description</b>	gas line tube ø 12mm SS without screw connection		
<b>For models:</b>	CG-1002, CG-1502, CG9-11, CG9-41, CG9-51L, CG9-51LC, CG9-51R, CG9-51RC, CG9-61, CG9-82, CGF9-121D, CGF9-121I, FTG9-11L, FTG9-11L+R, FTG9-11R, FTGC9-11L, FTGC9-11L+R, FTGC9-11R, HG9-10, HG9-15, HG9-20		



1

<b>GEV No.</b>	109071	<b>Ref. No.</b>	12019057 T125026
<b>description</b>	gas line tube ø 14mm L 420mm WS 24		
<b>For models:</b>	HVG-10-21		



1

<b>GEV No.</b>	106343	<b>Ref. No.</b>	12017786 S035025
<b>description</b>	gas line tube ø 16mm L 150mm IT M14x1 ET 1/2"		
<b>For models:</b>	MG9-15, MG9-15S, MPG9-15, MPG9-15S		



1

<b>GEV No.</b>	106412	<b>Ref. No.</b>	S045020
<b>description</b>	gas line tube ø 16mm L 310mm		



1

<b>GEV No.</b>	106413	<b>Ref. No.</b>	12014116 12017567 S035030
<b>description</b>	gas line tube ø 21mm		
<b>For models:</b>	MG9-10, MG9-10BM, MG9-15, MG9-15BM, MG9-15S, MG9-20, MG9-20S, MPG9-10, MPG9-10BM, MPG9-15, MPG9-15BM, MPG9-15S, MPG9-20, MPG9-20S		



## pilot tubes

## producer-specific



Image not available

1

<b>GEV No.</b>	109301	<b>Ref. No.</b>	12019938 U745006
<b>description</b>	pilot tube		
<b>For models:</b>	CG7-41, CG7-61		



1

<b>GEV No.</b>	106336	<b>Ref. No.</b>	12019504 U745011
<b>description</b>	pilot tube tube ø 4mm SS without screw connection		
<b>For models:</b>	CG7-40, CG7-41, CG7-61, CGB7-61, CGE7-133, CGE7-41		

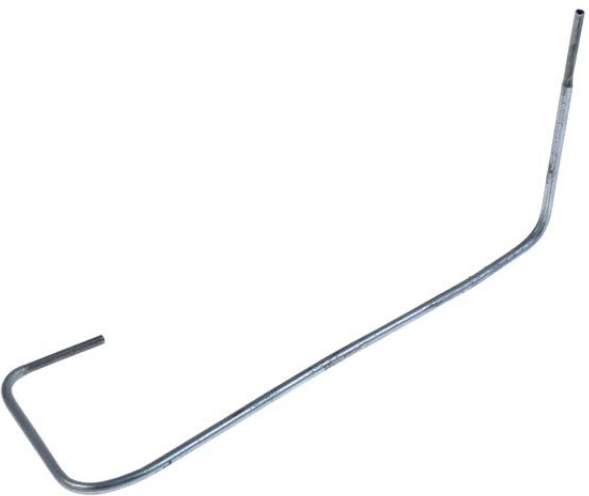

1

<b>GEV No.</b>	106414	<b>Ref. No.</b>	12020132 T035001
<b>description</b>	pilot tube tube ø 4.75mm L 260mm		
<b>For models:</b>	BG7-05, BG7-10		



1

<b>GEV No.</b>	106338	<b>Ref. No.</b>	12019498 U565034
<b>description</b>	pilot tube tube ø 4mm SS without screw connection		
<b>For models:</b>	CG9-20, CG9-40, CG9-41, CG9-51L, CG9-51LC, CG9-51R, CG9-51RC, CG9-60, CG9-61, CG9-82, CGE9-41		

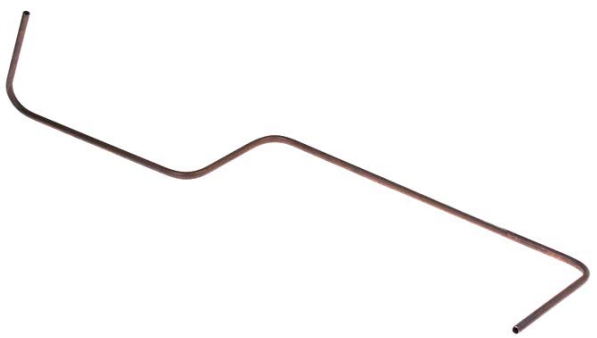

1

<b>GEV No.</b>	106333	<b>Ref. No.</b>	12020165 S015012
<b>description</b>	pilot tube tube ø 6mm copper without screw connection		
<b>For models:</b>	MG9-10, MG9-10BM, MG9-10BMS, MG9-10S, MPG9-10, MPG9-10BM, MPG9-10BMS, MPG9-10S		

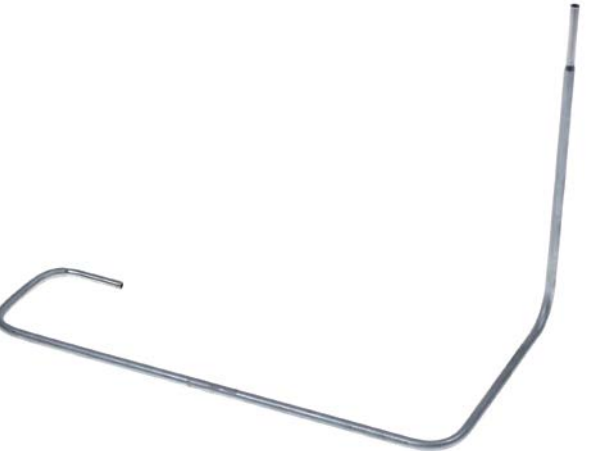

1

<b>GEV No.</b>	106264	<b>Ref. No.</b>	12020093 H015014
<b>description</b>	pilot tube tube ø 4/5mm steel		
<b>For models:</b>	BG9-05, BG9-05I, BG9-10, BG9-10I		



1

<b>GEV No.</b>	106334	<b>Ref. No.</b>	12020169 S045031
<b>description</b>	pilot tube tube ø 6mm copper without screw connection		
<b>For models:</b>	MG9-15BM, MG9-15BM316, MG9-15BMS, MG9-20, MG9-20S, MPG9-15BM, MPG9-15BMS, MPG9-20, MPG9-20S		

1

<b>GEV No.</b>	109110	<b>Ref. No.</b>	12014422
<b>description</b>	pilot tube tube ø 6mm L 640mm copper		
<b>For models:</b>	CG9-20, CG9-40, CG9-41, CG9-51L, CG9-51LC, CG9-51R, CG9-51RC, CG9-60, CG9-61, CG9-82, CGE9-41, CGF9-120D, CGF9-120I, CGF9-121D, CGF9-121I		





1

<b>GEV No.</b>	106337	<b>Ref. No.</b>	12020337 R165019
<b>description</b>	pilot tube tube ø 6mm SS without screw connection		
<b>For models:</b>	FTG9-05L, FTG9-05R, FTG9-05VL, FTG9-05VR, FTG9-10L, FTG9-10L+R, FTG9-10R, FTG9-10VL, FTG9-10VL+R, FTG9-10VR, FTG9-11L, FTG9-11L+R, FTG9-11R, FTGC9-05, FTGC9-05L, FTGC9-05R, FTGC9-10, FTGC9-10L, FTGC9-10L+R, FTGC9-10R, FTGC9-11L, FTGC9-11L+R, FTGC9-11R		

universal



1

<b>GEV No.</b>	102110	<b>Ref. No.</b>	12019428	
<b>description</b>	pilot tube copper pipe ø 4mm thickness 1mm L 3000mm			
<b>For models:</b>	BG9-05, BG9-05I, BG9-10, BG9-10I			
<b>accessories for</b>	102110			
	<b>GEV No.</b>	100908	<b>Ref. No.</b>	12017481 T052101
	union screw thread M10x1 for pipe ø 4mm Qty 1 pcs			
	<b>GEV No.</b>	101246	<b>Ref. No.</b>	12018994 U265026
	olive for pipe ø 4mm Qty 1 pcs			

accessories



1

<b>GEV No.</b>	691761	<b>Ref. No.</b>	12017847 R725060
<b>description</b>	clamping ring ø 33.5mm wire gauge ø 2mm		
<b>For models:</b>	HCG-10-11, HCG-10-21, HCG-20-11, HCG-2-10-11, HCG-6-11, HMG-10-11, HMG-10-11UL, HMG-10-21, HMG-10-21UL, HMG-20-11, HMG-2-10-11, HMG-6-11		

gas hoses

miscellaneous



1

<b>GEV No.</b>	109074	<b>Ref. No.</b>	12017902 R725019
<b>description</b>	gas hose L 400mm nominal-ø 23mm		
<b>For models:</b>	HCG-10-11, HCG-10-21, HCG-2-10-11, HMG-10-11, HMG-10-11UL, HMG-10-21, HMG-10-21UL, HMG-2-10-11		

pressure switches



1

<b>GEV No.</b>	541108	<b>Ref. No.</b>	12029376 RT30171004
<b>description</b>	pressure control		



1

<b>GEV No.</b>	541304	<b>Ref. No.</b>	12018227 R723004
<b>description</b>	pressure control pressure range 2.7/2.15mbar pressure connection horizontal gas technology connection 6mm		
<b>For models:</b>	HCG-10-11, HCG-10-21, HCG-20-11, HCG-2-10-11, HCG-6-11, HMG-10-11, HMG-10-21, HMG-20-11, HMG-2-10-11, HMG-6-11		



<b>GEV No.</b>	541111	<b>Ref. No.</b>	12030211 RT30171010
<b>description</b>	pressure control pressure range adjustable 0.2- 3mbar pressure connection horizontal gas technology connection 6mm suitable for RATIONAL		

for dough mixers

drive shafts



<b>GEV No.</b>	691875	<b>Ref. No.</b>	12039839 R010502
<b>description</b>	spindle L 50mm W 16mm		
<b>For models:</b>	HCV-10-11, HCV-10-21, HCV-2-10-21, HCV-6-11, HE-10-11, HE-10-21, HE-2-10-11, HE-6-11, HG-10-11, HG-10-21, HG-2-10-11		

equipment-specific units

for vegetable slicers

miscellaneous



<b>GEV No.</b>	110703	<b>Ref. No.</b>	12020819 T055434 T055440
<b>description</b>	cylindrical handle thread M10 ø 28mm L 87mm		
<b>For models:</b>	BG7-05, BG7-10, BG9-05, BG9-05I, BG9-10, BG9-10I		

chains

connectors

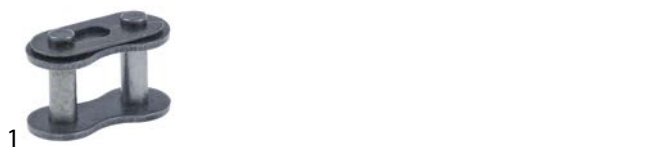

<b>GEV No.</b>	693276	<b>Ref. No.</b>	12023767 Z105012
<b>description</b>	connector single DIN/ISO 08 B-1 splitting 1/2" links 1 L 23mm internal width 11.8mm rollerø 4.3mm metal		
<b>For models:</b>	ECO-160, ECO-1600, ECO-160D, ECO-160I, ECO-200, ECO-200D, ECO-200H, ECO-200HD, ECO-200HI, ECO-200I, ECO-2300, ECO-2700D, ECO-2700I, ECO-280D, ECO-280I, ECO-3000, ECO-370D, ECO-370I, ECO-4000D, ECO-4000I, ECO-460D, ECO-460I, ECO-550D, ECO-550I, ECO-6000D, ECO-6000I, FI-160, FI-1600, FI-160AR, FI-160D, FI-160I, FI-200, FI-200AR, FI-200D, FI-200H, FI-200HD, FI-200HI, FI-200I, FI-200W, FI-200WL, FI-200WR, FI-2300, FI-2700D, FI-2700I, FI-280D, FI-280I, FI-3000, FI-370D, FI-370I, FI-4000D...(Other models you can see in the webshop)		



<b>GEV No.</b>	692145	<b>Ref. No.</b>	12043760
<b>description</b>	pulley disc ø 157mm disc width 31mm shaft intake ø 15mm overall width 30mm plastic for potato peeler device		

for hand blenders

couplings



<b>GEV No.</b>	699275	<b>Ref. No.</b>	12032134 SAM4039060
<b>description</b>	coupling set for hand blender shaft diameter 8mm D1 ø 17.5mm D2 ø 24mm int. ø 1 8mm int. ø 2 17mm L1 11.5mm L2 30mm		

for cheese graters

miscellaneous



<b>GEV No.</b>	110703	<b>Ref. No.</b>	12020819 T055434 T055440
<b>description</b>	cylindrical handle thread M10 ø 28mm L 87mm		
<b>For models:</b>	BG7-05, BG7-10, BG9-05, BG9-05I, BG9-10, BG9-10I		

for fridges

spare parts and accessories



<b>GEV No.</b>	700814	<b>Ref. No.</b>	12037835 6000202201 6003010020
<b>description</b>	bracket for grate for fridge for refrigerated counters plastic		
<b>For models:</b>	AEP-1402, AEP-1403, AEP-1404, AEP-1602, AEP-2103, AEP-701, AEP-702, AEP-801, AEP-802, AF-1402-MIX, AF-1403-C, AF-1403-P, AF-1404-C, AF-1404-P, AF-2104-C, AF-2104-P, AF-2105-C, AF-2105-P, AF-2106-C, AF-2106-P, AF-702-C, AF-702-P, AFN-1402, AFN-1403, AFN-1404, AFN-701, AFN-702, AFP-1402, AFP-1402-FORZ, AFP-1402-MIX, AFP-1403, AFP-1403-C, AFP-1403-FORZ, AFP-1403-P, AFP-1404, AFP-1404-C, AFP-1404-FORZ, AFP-1404-P, AFP-1404-USMC, AFP-2103, AFP-2104, AFP-2104-C, AFP-2104-P, AFP-2105, AFP-2105-C, AFP-2105-P, AFP-2106, AFP-2106-C, AFP-2106-P, AFP-701...(Other models you can see in the webshop)		



<b>GEV No.</b>	698845	<b>Ref. No.</b>	6003010484
<b>description</b>	protection cap L 15mm W 15mm H 4mm		

housing and bezels



<b>GEV No.</b>	691710	<b>Ref. No.</b>	12037397 6003010105
<b>description</b>	front panel W 350mm H 80mm for fridge		
<b>For models:</b>	AEP-1402, AEP-1602, AEP-2103, AEP-701, AEP-801, AEP-802, AF-1402-MIX, AF-1403-C, AF-1403-P, AF-1404-C, AF-1404-P, AF-1602-MIX, AF-1603-C, AF-1603-P, AF-1604-C, AF-1604-P, AF-2104-C, AF-2104-P, AF-2105-C, AF-2105-P, AF-2106-C, AF-2106-P, AFN-1402, AFN-1403, AFN-1404, AFN-1602, AFN-1603, AFN-1604, AFN-702, AFN-801, AFN-802, AFP-1402, AFP-1403, AFP-1404, AFP-1602, AFP-1602-2, AFP-1603, AFP-1603-2, AFP-1604, AFP-2103, AFP-2104, AFP-2105, AFP-2106, AFP-701, AFP-702, AFP-801, AFP-802, AP-701, APP-701, FMP-150...(Other models you can see in the webshop)		

drawers

drawers



<b>GEV No.</b>	691842	<b>Ref. No.</b>	12030222 M177010070
<b>description</b>	control panel L 635mm W 125mm		
<b>For models:</b>	MCP-147-GN-R, MFP-102-GN-R, MFP-147-GN-R, MFP-192-GN-R, MFP-237-GN-R, MSP-117-2RC, MSP-117-4RC, MSP-117-R, MSP-169-R, MSP-169-R2C, MSP-169-R4C, MSP-169-R6C, MSP-222-R, MSP-222-R4C, MSP-222-R6C, MSP-222-R8C, MSP-274-R, MSP-274-R10C		



<b>GEV No.</b>	691886	<b>Ref. No.</b>	12027259 M169120015
<b>description</b>	drawer conversion kit		



1

<b>GEV No.</b>	691889	<b>Ref. No.</b>	12027330 M169120016
<b>description</b>	drawer conversion kit		



1

<b>GEV No.</b>	691850	<b>Ref. No.</b>	141911406
<b>description</b>	drawer for deep freezer L 540mm W 530mm H 100mm		



1

<b>GEV No.</b>	691885	<b>Ref. No.</b>	12032484 M109050066
<b>description</b>	drawer L 475mm W 400mm H 195mm		
<b>For models:</b>	CMSP-150HD, CMSP-150HH, CMSP-200HDD, CMSP-200HHD, CMSP-200HHH, CMSP-250HDDD, CMSP-250HHDD, CMSP-250HHHD, CMSP-250HHHH, MSP-117-2C, MSP-117-4C, MSP-117-R2C, MSP-117-R4C, MSP-150-2C, MSP-150-4C, MSP-169-2C, MSP-169-4C, MSP-169-6C, MSP-169-R2C, MSP-169-R4C, MSP-169-R6C, MSP-200-2C, MSP-200-4C, MSP-200-6C, MSP-222-2C, MSP-222-4C, MSP-222-6C, MSP-222-8C, MSP-222-R2C, MSP-222-R4C, MSP-222-R6C, MSP-222-R8C, MSP-250-2C, MSP-250-4C, MSP-250-6C, MSP-250-8C, MSP-274-10C, MSP-274-2C, MSP-274-4C, MSP-274-6C, MSP-274-8C, MSP-274-R10C, MSP-274-R6C, MSP-300-10C, MSP-300-2C, MSP-300-4C, MSP-300-6C, MSP-300-8C		

accessories

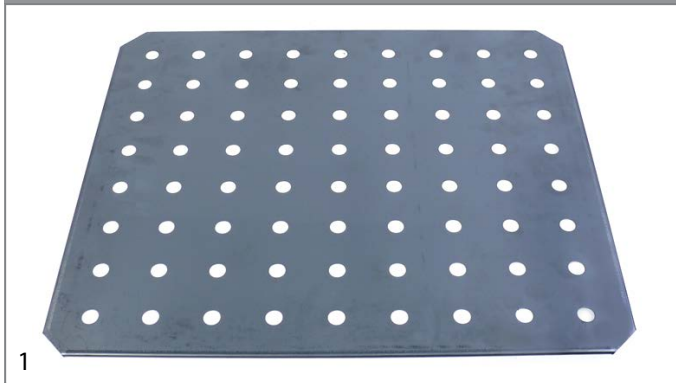

1

<b>GEV No.</b>	691914	<b>Ref. No.</b>	12034642 6009990102 A109050103
<b>description</b>	bottom plate for fish drawer L 445mm W 380mm H 12mm		
<b>For models:</b>	AF-1403-P, AF-1404-P, AF-2104-P, AF-2105-P, AF-2106-P, AF-702-P, CAF-1403P, CAF-1404P, CAF-2104C, CAF-2105C, CAF-2106C, CAF-702P		
<b>accessories for</b>	691914		
	<b>GEV No.</b>	691903	<b>Ref. No.</b> 141911404
	plastic insert drawer L 530mm W 460mm H 100mm fish		

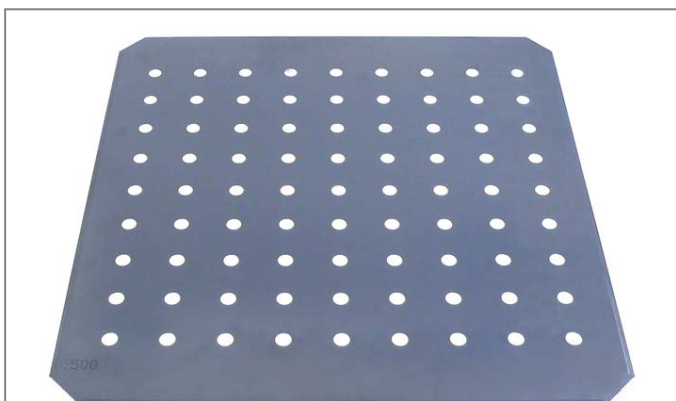

1

<b>GEV No.</b>	691915	<b>Ref. No.</b>	12034466 12034707 6009990101 A109050143
<b>description</b>	bottom plate for fish drawer L 460mm W 480mm H 10mm		
<b>For models:</b>	AF-1603-P, AF-1604-P, AF-802-P, CAF-1603-P, CAF-1604-P, CAF-802-C		
<b>accessories for</b>	691915		
	<b>GEV No.</b>	691850	<b>Ref. No.</b> 141911406
	drawer for deep freezer L 540mm W 530mm H 100mm		





1

<b>GEV No.</b>	691903	<b>Ref. No.</b>	141911404
<b>description</b>	plastic insert drawer L 530mm W 460mm H 100mm fish		
<b>accessories for</b>	691903		
	<b>GEV No.</b>	691914	<b>Ref. No.</b>
			12034642 6009990102 A109050103
	bottom plate for fish drawer L 445mm W 380mm H 12mm		

for upright freezers



1

<b>GEV No.</b>	699342	<b>Ref. No.</b>	12037375 6003010184
<b>description</b>	drip tray L 190mm W 50mm H 50mm		
<b>For models:</b>	AEP-1402, AEP-1602, AEP-2103, AEP-701, AEP-801, AEP-802, AF-1402-MIX, AF-1403-C, AF-1403-P, AF-1404-C, AF-1404-P, AF-1602-MIX, AF-1603-C, AF-1603-P, AF-1604-C, AF-1604-P, AF-2104-C, AF-2104-P, AF-2105-C, AF-2105-P, AF-2106-C, AF-2106-P, AF-702-C, AF-702-P, AF-802-C, AF-802-P, AFN-1402, AFN-1403, AFN-1404, AFN-1602, AFN-1603, AFN-1604, AFN-702, AFN-801, AFN-802, AFP-1402, AFP-1403, AFP-1404, AFP-1602, AFP-1602-2, AFP-1603, AFP-1603-2, AFP-1604, AFP-2103, AFP-2104, AFP-2105, AFP-2106, AFP-701, AFP-702, AFP-801...(Other models you can see in the webshop)		

for blast chiller



1

<b>GEV No.</b>	698847	<b>Ref. No.</b>	6003010326
<b>description</b>	drain pipe ø 40mm H 95mm 3/4"		
<b>For models:</b>	ATM-051, ATM-051VCH, ATM-051VCH-60Hz, ATM-081VCH, ATM-081VCH-60Hz, ATM-101, ATM-101VCH, ATM-101VCH-60Hz, ATM-102, ATM-121VCH, ATM-121VCH-60Hz, ATM-121VCHP, ATM-161VCH, BFP-100A, BFP-100I, BFP-150A, BFP-150I, BFP-200A, BFP-200I, BFP-250A, BFP-250I, BFP-300I, FMP-117-R, FMP-150, FMP-150-TV, FMP-169-R, FMP-200, FMP-202, FMP-202-TV, FMP-222-R, FMP-250, FMP-255, FMP-255-TV, FMP-274-R, FMP-300, FMP-307, FMP-307-TV, MCN-135-GN, MCN-180-GN, MCN-270-GN, MCP-135-AD, MCP-135-GN, MCP-147-GN-R, MCP-180-AD, MCP-180-GN, MCP-192-GN-R, MCP-225-AD, MCP-225-GN, MCP-237-GN-R, MCP-270-GN...(Other models you can see in the webshop)		

for refrigerated counters

lid hinges



1

<b>GEV No.</b>	695176	<b>Ref. No.</b>	12034284 12035092 6009990251 6033110003
<b>description</b>	hinge stainless steel left/right set saladette		
<b>For models:</b>	MEP-100, MEP-135, MEP-180		

spare parts and accessories



1

<b>GEV No.</b>	700814	<b>Ref. No.</b>	12037835 6000202201 6003010020
<b>description</b>	bracket for grate for fridge for refrigerated counters plastic		
<b>For models:</b>	AEP-1402, AEP-1403, AEP-1404, AEP-1602, AEP-2103, AEP-701, AEP-702, AEP-801, AEP-802, AF-1402-MIX, AF-1403-C, AF-1403-P, AF-1404-C, AF-1404-P, AF-2104-C, AF-2104-P, AF-2105-C, AF-2105-P, AF-2106-C, AF-2106-P, AF-702-C, AF-702-P, AFN-1402, AFN-1403, AFN-1404, AFN-701, AFN-702, AFP-1402, AFP-1402-FORZ, AFP-1402-MIX, AFP-1403, AFP-1403-C, AFP-1403-FORZ, AFP-1403-P, AFP-1404, AFP-1404-C, AFP-1404-FORZ, AFP-1404-P, AFP-1404-USMC, AFP-2103, AFP-2104, AFP-2104-C, AFP-2104-P, AFP-2105, AFP-2105-C, AFP-2105-P, AFP-2106, AFP-2106-C, AFP-2106-P, AFP-701...(Other models you can see in the webshop)		



1

<b>GEV No.</b>	699229	<b>Ref. No.</b>	12037381 12037616 12061084 2061700015 6000202215 6003010034
<b>description</b>	drain pipe H 29.5mm ø 29.5mm L 29.5mm		
<b>For models:</b>	CMPP-117-R, CMPP-150, CMPP-150-C, CMPP-169-R, CMPP-202, CMPP-202-C, CMPP-222-R, CMPP-255, CMPP-255-C, CMPP-307, CMPZ1-135, CMPZ1-180, FMP-117-R, FMP-150, FMP-169-R, FMP-202, FMP-222-R, FMP-255, FMP-274-R, FMP-307, MCN-102-R, MCN-135, MCN-147-R, MCN-180, MCN-192-R, MCN-225, MCN-237-R, MCN-270, MCP-135, MCP-180, MCP-225, MCP-225-GN, MEP-135, MEP-135-GN, MEP-180, MEP-180-GN, MFN-102-R, MFN-135, MFN-147-R, MFN-180, MFN-192-R, MFN-225, MFN-237-R, MFN-270, MFP-102-2C, MFP-102-4C, MFP-135, MFP-135-2C, MFP-135-4C, MFP-135-F...(Other models you can see in the webshop)		

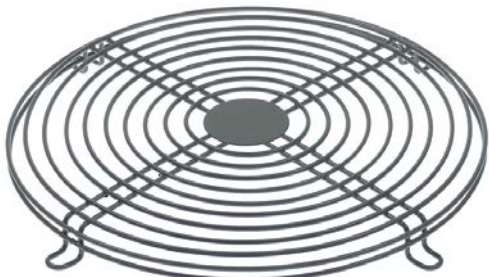

1

<b>GEV No.</b>	692812	<b>Ref. No.</b>	12034663 6027130004
<b>description</b>	guard for evaporator fan round ø 225mm mounting distance 235mm		
<b>For models:</b>	AEP-1402, AEP-1602, AEP-2103, AEP-701, AEP-801, AEP-802, AF-1402-MIX, AF-1403-C, AF-1403-P, AF-1404-C, AF-1404-P, AF-1602-MIX, AF-1603-C, AF-1603-P, AF-1604-C, AF-1604-P, AF-2104-C, AF-2104-P, AF-2105-C, AF-2105-P, AF-2106-C, AF-2106-P, AF-702-C, AF-702-P, AF-802-C, AF-802-P, AFN-1402, AFN-1403, AFN-1404, AFN-1602, AFN-1603, AFN-1604, AFN-701, AFN-702, AFN-801, AFN-802, AFP-1402, AFP-1403, AFP-1404, AFP-1602, AFP-1602-2, AFP-1603, AFP-1603-2, AFP-1604, AFP-2103, AFP-2104, AFP-2105, AFP-2106, AFP-701, AFP-702...(Other models you can see in the webshop)		



1

<b>GEV No.</b>	699629	<b>Ref. No.</b>	12085225 M169090013
<b>description</b>	mounting set for refrigerated counters FAGOR MPZ-1		
<b>For models:</b>	MPZ1-150, MPZ1-200, MPZ1-250		

### housing and bezels



1

<b>GEV No.</b>	210059	<b>Ref. No.</b>	12040457 M109250148
<b>description</b>	cover for evaporator fan stainless steel W 400mm H 80mm L 415mm thickness 1mm		
<b>For models:</b>	CFMP-117-R, CFMP-117-RPC, CFMP-150, CFMP-150F, CFMP-150PC, CFMP-150TV, CFMP-169-R, CFMP-169-RPC, CFMP-202, CFMP-202F, CFMP-202PC, CFMP-202TV, CFMP-222-R, CFMP-222-RPC, CFMP-255, CFMP-255F, CFMP-255PC, CFMP-255TV, CFMP-307, CFMP-307F, CFMP-307TV, CMFN-102-R, CMFN-135, CMFN-147-R, CMFN-180, CMFP-102-R, CMFP-135, CMFP-135-B, CMFP-135-B2, CMFP-135-BP, CMFP-135F, CMFP-135-GR, CMFP-135HD, CMFP-135HH, CMFP-135PC, CMFP-147-R, CMFP-180, CMFP-180-B, CMFP-180-B2, CMFP-180-BP, CMFP-180F, CMFP-180-GR, CMFP-180HDD, CMFP-180HHD, CMFP-180HHH, CMFP-180PC, CMFP-192-R, CMFP-225, CMFP-225-B, CMFP-225-B2...(Other models you can see in the webshop)		



1

<b>GEV No.</b>	691710	<b>Ref. No.</b>	12037397 6003010105
<b>description</b>	front panel W 350mm H 80mm for fridge		
<b>For models:</b>	AEP-1402, AEP-1602, AEP-2103, AEP-701, AEP-801, AEP-802, AF-1402-MIX, AF-1403-C, AF-1403-P, AF-1404-C, AF-1404-P, AF-1602-MIX, AF-1603-C, AF-1603-P, AF-1604-C, AF-1604-P, AF-2104-C, AF-2104-P, AF-2105-C, AF-2105-P, AF-2106-C, AF-2106-P, AFN-1402, AFN-1403, AFN-1404, AFN-1602, AFN-1603, AFN-1604, AFN-701, AFN-702, AFN-801, AFN-802, AFP-1402, AFP-1403, AFP-1404, AFP-1602, AFP-1602-2, AFP-1603, AFP-1603-2, AFP-1604, AFP-2103, AFP-2104, AFP-2105, AFP-2106, AFP-701, AFP-702, AFP-801, AFP-802, AP-701, APP-701, FMP-150...(Other models you can see in the webshop)		



1 

<b>GEV No.</b>	691844	<b>Ref. No.</b>	12032239 6039010009
<b>description</b>	side panel H 224mm L 334mm mounting pos. right thickness 8mm		
<b>For models:</b>	MI-135, MI-150, MI-180, MI-202, MI-225, MI-255, MPZ-150, MPZ-202		

1 

<b>GEV No.</b>	691845	<b>Ref. No.</b>	12031913 6039010010
<b>description</b>	side panel H 224mm L 334mm thickness 8mm		
<b>For models:</b>	MI-135, MI-150, MI-180, MI-202, MI-225, MI-255, MPZ-150, MPZ-202		

1 

<b>GEV No.</b>	505326	<b>Ref. No.</b>	12037176 6023010064
<b>description</b>	sticker FAGOR L 108mm W 33mm ø 2mm		
<b>For models:</b>	MFP-135-B, MFP-180-B, MFP-225-B, MFP-270-B, MMC-100, MMC-150, MMC-200, MMC-250		

drawers

1 

<b>GEV No.</b>	691922	<b>Ref. No.</b>	12031995 M169120021
<b>description</b>	drawer front W 520mm H 430mm thickness 40mm with gasket		



1 

<b>GEV No.</b>	694198	<b>Ref. No.</b>	12033303 M169120024
<b>description</b>	drawer front with gasket W 440mm H 428mm thickness 40mm		

## doors



1

<b>GEV No.</b>	694309	<b>Ref. No.</b>	12030565 M169010084
<b>description</b>	door W 630mm H 435mm thickness 40mm		
<b>accessories for</b>	694309		
	<b>GEV No.</b>	690763	<b>Ref. No.</b> 12038130 6033010100
	spring assisted hinge right/left L 111mm W 75mm refrigerator mounting distance 25mm		
	<b>GEV No.</b>	690764	<b>Ref. No.</b> 12037723 6003010136
	bush W 23.5mm H 53.5mm mounting pos. upper/lower ø 16mm ID ø 10mm grey for hinge		
	<b>GEV No.</b>	901164	<b>Ref. No.</b> 12038156 6045010119
	refrigeration gasket profile 9797 W 365mm L 560mm plug size		

## worktops



1

<b>GEV No.</b>	691905	<b>Ref. No.</b>	12033431 6031010028
<b>description</b>	side panel granite L 1460mm W 120mm thickness 20mm Qty 1 pcs		
<b>For models:</b>	MMZ-150, MPZ-150		



1

<b>GEV No.</b>	691894	<b>Ref. No.</b>	12034667 6031010026
<b>description</b>	side panel Qty 2 pcs granite L 800mm W 120mm thickness 20mm		
<b>For models:</b>	MMZ-150, MMZ-202, MPZ-150, MPZ-202		

## for freezer cabinets

## doors



1

<b>GEV No.</b>	650104	<b>Ref. No.</b>	12031769 12035085 12045302 6009990015 6031030001
<b>description</b>	lid for beverage refrigerator		
<b>For models:</b>	BFP-100, BFP-150, BFP-200, BFP-250, BFP-300		

## for display coolers

## housing and bezels

## side parts

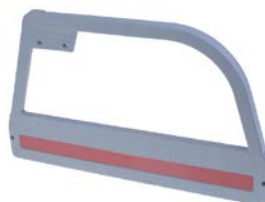

1

<b>GEV No.</b>	691846	<b>Ref. No.</b>	12035234 6003010171
<b>description</b>	side panel L 408mm thickness 20mm H 245mm		
<b>For models:</b>	VTP-139-C, VTP-139-RC, VTP-175-C, VTP-175-RC		



1

<b>GEV No.</b>	694071	<b>Ref. No.</b>	12034937 6003010170
<b>description</b>	side panel mounting pos. left W 410mm H 245mm for tapas display		
<b>For models:</b>	VTP-139-C, VTP-175-C		



			
1			
<b>GEV No.</b>	694072	<b>Ref. No.</b>	12035148 6003010172
<b>description</b>	side panel mounting pos. right W 410mm H 245mm for tapas display		
<b>For models:</b>	VTP-139-P, VTP-139-RP, VTP-175-P, VTP-175-RP		

glass panels

glass panels

			
1			
<b>GEV No.</b>	700839	<b>Ref. No.</b>	12031917 12035036 6002101007 6035050012
<b>description</b>	glass panel L 725mm W 165mm thickness 3mm		
<b>For models:</b>	VTP-175-C, VTP-175-CD, VTP-175-P, VTP-175-PD		

doors

			
1			
<b>GEV No.</b>	694196	<b>Ref. No.</b>	12035230 6035050006
<b>description</b>	door W 550mm H 166mm glas thickness 3mm		
<b>For models:</b>	VTP-139-C, VTP-139-CD, VTP-139-P, VTP-139-PD		

door mechanics



miscellaneous

			
1			
<b>GEV No.</b>	700811	<b>Ref. No.</b>	12035982 E107090005
<b>description</b>	balance weight for sliding door L 400mm W 25mm H 15mm		

for ice-cube maker

drain systems

overflow pipes

			
1			
<b>GEV No.</b>	695622	<b>Ref. No.</b>	12037650 B00010305
<b>description</b>	lid for overflow pipe tube ø 34mm		
<b>accessories for</b>	695622		
	<b>GEV No.</b>	695086	<b>Ref. No.</b>
			—
			
	overflow pipe tube ø 20.5mm pipe length 88.6mm		

doors

doors

			
1			
<b>GEV No.</b>	695514	<b>Ref. No.</b>	12038019
<b>description</b>	door for ice-cube maker W 447mm H 217mm thickness 22mm		

curtains

with holder

			
1			
<b>GEV No.</b>	695507	<b>Ref. No.</b>	12033184 BR00C22035
<b>description</b>	curtain for ice maker W 433mm H 165mm with holder shaft length 438mm shaft ø 7.5mm		

floats

float containers

			
1			
<b>GEV No.</b>	695072	<b>Ref. No.</b>	12030020 BR00C10201
<b>description</b>	float container for ice maker with microswitch plastic		

## for espresso machines

## brewing units

## filter holder gaskets

## O-rings



1

<b>GEV No.</b>	510409	<b>Ref. No.</b>	12010040 Q307044
<b>description</b>	O-ring EPDM thickness 5.34mm ID ø 56.52mm Qty 1 pcs		
<b>For models:</b>	ECO-160, ECO-1600, ECO-160D, ECO-160I, ECO-200, ECO-200D, ECO-200H, ECO-200HD, ECO-200HI, ECO-200I, ECO-2300, ECO-2700D, ECO-2700I, ECO-280D, ECO-280I, ECO-3000, ECO-370D, ECO-370I, ECO-4000D, ECO-4000I, ECO-460D, ECO-460I, ECO-550D, ECO-550I, ECO-6000D, ECO-6000I, FI-160, FI-1600, FI-160AR, FI-160D, FI-160I, FI-200, FI-200AR, FI-200D, FI-200H, FI-200HD, FI-200HI, FI-200I, FI-200W, FI-200WL, FI-200WR, FI-2300, FI-2700D, FI-2700I, FI-280D, FI-280I, FI-3000, FI-370D, FI-370I, FI-4000D...(Other models you can see in the webshop)		

## intake valves

## accessories

## miscellaneous



1

<b>GEV No.</b>	528422	<b>Ref. No.</b>	12039801 Z605922
<b>description</b>	ball ø 8mm SS		

## for bain marie

## spare parts and accessories



1

<b>GEV No.</b>	691650	<b>Ref. No.</b>	12019228
<b>description</b>	connecting fitting brass L 52mm W 30mm H 30mm		



1

<b>GEV No.</b>	691651	<b>Ref. No.</b>	12020990
<b>description</b>	threaded part brass L 27mm ID ø 12.4mm thread 1/2"		

## housing and bezels



1

<b>GEV No.</b>	691722	<b>Ref. No.</b>	12004214 R062811
<b>description</b>	back panel chargin grill		
<b>For models:</b>	BG9-05AD, BG9-05PF, BG9-05PI, BG9-05PLUS-I, BG9-10AD, BG9-10PF, BG9-10PI, BG9-10PLUS-I, BME9-05, BME9-05AD, BME9-05PLUS, BME9-05V-T, BME9-10, BME9-10AD, BME9-10PLUS, BME9-10V-T, BMG9-05, BMG9-05V-T, BMG9-10, BMG9-10V-T, CE9-20, CE9-20AD, CE9-20PLUS, CE9-40, CE9-40AD, CE9-40PLUS, CG9-05AD, CG9-05PLUS, CG9-10, CG9-10AD, CG9-10PLUS, CG9-20, CG9-20AD, CG9-20AD-H, CG9-20H, CG9-20PLUS, CG9-20PLUS-H, CG9-40, CG9-40AD, CG9-40AD-H, CG9-40H, CG9-40PLUS, CG9-40PLUS-H, CG9-60, CG9-60AD, CG9-60AD-H, CG9-60H, CG9-60PLUS, CG9-60PLUS-H, CGF9-120D...(Other models you can see in the webshop)		



1

<b>GEV No.</b>	691708	<b>Ref. No.</b>	12014063 R982802
<b>description</b>	back panel for bain marie		
<b>For models:</b>	BME7-10, BMG7-10		

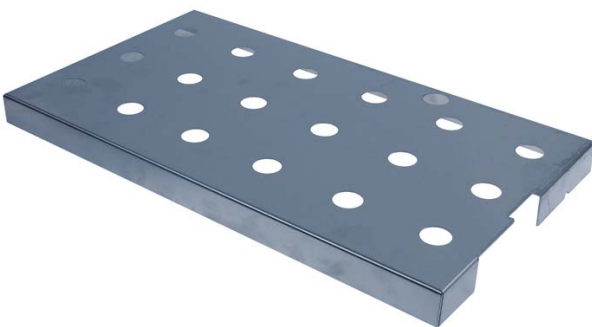



1

<b>GEV No.</b>	691712	<b>Ref. No.</b>	12013779 R966105
<b>description</b>	cover for bain marie		
<b>For models:</b>	BME7-05		





1

<b>GEV No.</b>	210022	<b>Ref. No.</b>	12020193 U452805
<b>description</b>	cover L 177mm W 52mm H 16mm for control panel mounting pos. left suitable for 700 series		
<b>For models:</b>	BG7-05, BG7-05I, BG7-10, BG7-10I, BME7-05, BME7-10, BMG7-10, CE7-20, CE7-40, CE7-41, CG7-10, CG7-11, CG7-20, CG-7200, CG7-40, CG-7400, CG7-41, CG-7415, CG7-61, CG-7615, CGB7-61, CGE7-41, CGE7-69, CPG7-05, EN7-05, EN7-10, FE-710, FE-720, FG-710, FG-720, FTE7-05, FTE7-05L, FTE7-05R, FTE7-10, FTE7-10L, FTE7-10L+R, FTE7-10R, FTEC7-05L, FTEC7-10L, FTG7-05, FTG7-05L, FTG7-05R, FTG7-05VL, FTG7-05VR, FTG7-10, FTG7-10L, FTG7-10L+R, FTG7-10R, FTG7-10VL, FTG7-10VL+R...(Other models you can see in the webshop)		
<b>accessories for</b>	210022		
	<b>GEV No.</b>	210021	<b>Ref. No.</b>
			12020194 U452804
	cover L 177mm W 52mm H 16mm for control panel mounting pos. right suitable for 700 series		



1

<b>GEV No.</b>	210021	<b>Ref. No.</b>	12020194 U452804
<b>description</b>	cover L 177mm W 52mm H 16mm for control panel mounting pos. right suitable for 700 series		
<b>For models:</b>	BG7-05, BG7-05I, BG7-10, BG7-10I, BME7-05, BME7-10, BMG7-10, CE7-20, CE7-40, CE7-41, CG7-10, CG7-11, CG7-20, CG-7200, CG7-40, CG-7400, CG7-41, CG-7415, CG7-61, CG-7615, CGB7-61, CGE7-41, CGE7-62, CPG7-05, EN7-05, EN7-10, FE-710, FE-720, FG-710, FG-720, FTE7-05, FTE7-05L, FTE7-05R, FTE7-10, FTE7-10L, FTE7-10L+R, FTE7-10R, FTEC7-05L, FTEC7-10L, FTG7-05, FTG7-05L, FTG7-05R, FTG7-05VL, FTG7-05VR, FTG7-10, FTG7-10L, FTG7-10L+R, FTG7-10R, FTG7-10VL, FTG7-10VL+R...(Other models you can see in the webshop)		
<b>accessories for</b>	210021		
	<b>GEV No.</b>	210022	<b>Ref. No.</b>
			12020193 U452805
	cover L 177mm W 52mm H 16mm for control panel mounting pos. left suitable for 700 series		



1

<b>GEV No.</b>	700809	<b>Ref. No.</b>	12007564 R205409
<b>description</b>	fastening angle L 120mm W 67mm H 28mm		
<b>For models:</b>	BG9-05, BG9-10, BME9-05, BME9-10, BMG9-05, BMG9-10, CE9-20, CE9-40, CE9-41, CG9-10, CG9-11, CG9-20, CG9-40, CG9-41, CG9-60, CG9-61, CG9-82, EN9-05, EN9-10, FE-920, FG-920, FG-940, FTE9-05L, FTE9-05R, FTE9-10L, FTE9-10L+R, FTE9-10R, FTEC9-05, FTEC9-05L, FTEC9-05R, FTEC9-10, FTEC9-10L, FTEC9-10L+R, FTEC9-10R, FTG9-05L, FTG9-05R, FTG9-05VL, FTG9-05VR, FTG9-10L, FTG9-10L+R, FTG9-10R, FTG9-10VL, FTG9-10VL+R, FTG9-10VR, FTGC9-05, FTGC9-05L, FTGC9-05R, FTGC9-10, FTGC9-10L, FTGC9-10L+R...(Other models you can see in the webshop)		

1

Reglado a BUTANO-PROPANO  
Reglage BUTANE-PROPANE  
Regulated for L.P.G. using

<b>GEV No.</b>	691735	<b>Ref. No.</b>	12008203 U136501
<b>description</b>	sticker Regulated for L.P.G. using		
<b>For models:</b>	BG7-05, BG7-05I, BG7-10, BG7-10I, BG9-05, BG9-05I, BG9-05PF, BG9-05PI, BG9-10, BG9-10I, BG9-10PF, BG9-10PI, BME9-05, BME9-05V-T, BME9-10, BME9-10V-T, BMG7-10, BMG9-05, BMG9-05V-T, BMG9-10, BMG9-10V-T, CG-1002, CG-1502, CG-2000, CG-2005, CG-210, CG-210G, CG-300S, CG-310, CG-310G, CG7-10, CG7-11, CG-7115, CG7-20, CG-7200, CG7-20H, CG7-30D, CG7-30I, CG7-31D, CG7-31I, CG7-40, CG-7400, CG7-40H, CG7-41, CG-7415, CG7-41H, CG7-50, CG7-51, CG7-61, CG-7615...(Other models you can see in the webshop)		

1

Reglado a GAS NATURAL  
Reglage GAZ NATUREL  
Regulated for NATURAL GAS using

<b>GEV No.</b>	691736	<b>Ref. No.</b>	12008202 U134402
<b>description</b>	sticker regulated for NATURAL GAS using		
<b>For models:</b>	BG7-05, BG7-05I, BG7-10, BG7-10I, BG9-05, BG9-05I, BG9-05PF, BG9-05PI, BG9-10, BG9-10I, BG9-10PF, BG9-10PI, BME9-05, BME9-05V-T, BME9-10, BME9-10V-T, BMG7-10, BMG-9045, BMG9-05, BMG9-05V-T, BMG9-10, BMG9-10V-T, CG-1002, CG-1502, CG-2000, CG-2005, CG-210, CG-210G, CG-300S, CG-310, CG-310G, CG7-10, CG7-11, CG-7115, CG7-20, CG-7200, CG7-20H, CG7-30D, CG7-30I, CG7-31D, CG7-31I, CG7-40, CG-7400, CG7-40H, CG7-41, CG-7415, CG7-41H, CG7-50, CG7-51, CG7-61...(Other models you can see in the webshop)		

			
1			
<b>GEV No.</b>	691691	<b>Ref. No.</b>	12009010 12009015 U022836 U262806
<b>description</b>	type plate FAGOR metal		
<b>For models:</b>	BG6-05I, BG7-05, BG7-05I, BG7-10, BG7-10I, BG9-05, BG9-05AD, BG9-05I, BG9-05PF, BG9-05PI, BG9-05PLUS-I, BG9-10, BG9-10AD, BG9-10I, BG9-10PF, BG9-10PI, BG9-10PLUS-I, BME6-05, BME7-05, BME7-10, BME9-05, BME9-05AD, BME9-05PLUS, BME9-05V-T, BME9-10, BME9-10AD, BME9-10PLUS, BME9-10V-T, BMG7-10, BMG9-05, BMG9-05V-T, BMG9-10, BMG9-10V-T, CE6-20, CE6-40, CE6-41, CE7-20, CE7-40, CE7-41, CE9-20, CE9-20AD, CE9-20PLUS, CE9-40, CE9-40AD, CE9-40PLUS, CE9-41, CE9-41AD, CE9-41PLUS, CG-1002, CG-1502...(Other models you can see in the webshop)		

## for deep fryers

## lids

			
1			
<b>GEV No.</b>	691685	<b>Ref. No.</b>	12004790 X352825
<b>description</b>	cover suitable for fryer L 297mm W 175mm FE4		
<b>For models:</b>	FE-4		

## housing and bezels

			
1			
<b>GEV No.</b>	691722	<b>Ref. No.</b>	12004214 R062811
<b>description</b>	back panel chargrill		
<b>For models:</b>	BG9-05AD, BG9-05PF, BG9-05PI, BG9-05PLUS-I, BG9-10AD, BG9-10PF, BG9-10PI, BG9-10PLUS-I, BME9-05, BME9-05AD, BME9-05PLUS, BME9-05V-T, BME9-10, BME9-10AD, BME9-10PLUS, BME9-10V-T, BMG9-05, BMG9-05V-T, BMG9-10, BMG9-10V-T, CE9-20, CE9-20AD, CE9-20PLUS, CE9-40, CE9-40AD, CE9-40PLUS, CG9-05AD, CG9-05PLUS, CG9-10, CG9-10AD, CG9-10PLUS, CG9-20, CG9-20AD, CG9-20AD-H, CG9-20H, CG9-20PLUS, CG9-20PLUS-H, CG9-40, CG9-40AD, CG9-40AD-H, CG9-40H, CG9-40PLUS, CG9-40PLUS-H, CG9-60, CG9-60AD, CG9-60AD-H, CG9-60H, CG9-60PLUS, CG9-60PLUS-H, CGF9-120D...(Other models you can see in the webshop)		

			
1			
<b>GEV No.</b>	700808	<b>Ref. No.</b>	X330504
<b>description</b>	fastening angle for door hinge		

			
1			
<b>GEV No.</b>	700809	<b>Ref. No.</b>	12007564 R205409
<b>description</b>	fastening angle L 120mm W 67mm H 28mm		
<b>For models:</b>	BG9-05, BG9-10, BME9-05, BME9-10, BMG9-05, BMG9-10, CE9-20, CE9-40, CE9-41, CG9-10, CG9-11, CG9-20, CG9-40, CG9-41, CG9-60, CG9-61, CG9-82, EN9-05, EN9-10, FE-920, FG-920, FG-940, FTE9-05L, FTE9-05R, FTE9-10L, FTE9-10L+R, FTE9-10R, FTEC9-05, FTEC9-05L, FTEC9-05R, FTEC9-10, FTEC9-10L, FTEC9-10L+R, FTEC9-10R, FTG9-05L, FTG9-05R, FTG9-05VL, FTG9-05VR, FTG9-10L, FTG9-10L+R, FTG9-10R, FTG9-10VL, FTG9-10VL+R, FTG9-10VR, FTGC9-05, FTGC9-05L, FTGC9-05R, FTGC9-10, FTGC9-10L, FTGC9-10L+R...(Other models you can see in the webshop)		







1

<b>GEV No.</b>	691718	<b>Ref. No.</b>	12014050 X332800
<b>description</b>	front panel for fryer W 700mm H 175mm		
<b>For models:</b>	FE-720, FG-720		

Reglado a BUTANO-PROPANO  
Reglage BUTANE-PROPANE  
Regulated for L.P.G. using

1

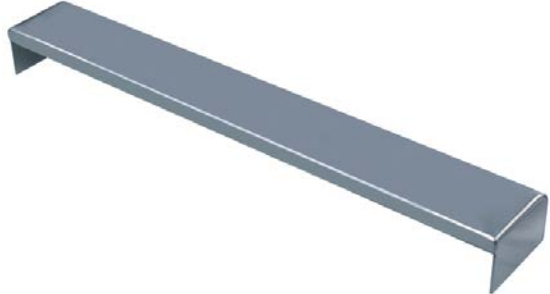
<b>GEV No.</b>	691735	<b>Ref. No.</b>	12008203 U136501
<b>description</b>	sticker Regulated for L.P.G. using		
<b>For models:</b>	BG7-05, BG7-05I, BG7-10, BG7-10I, BG9-05, BG9-05I, BG9-05PF, BG9-05PI, BG9-10, BG9-10I, BG9-10PF, BG9-10PI, BME9-05, BME9-05V-T, BME9-10, BME9-10V-T, BMG7-10, BMG9-05, BMG9-05V-T, BMG9-10, BMG9-10V-T, CG-1002, CG-1502, CG-2000, CG-2005, CG-210, CG-210G, CG-3005, CG-310, CG-310G, CG7-10, CG7-11, CG-7115, CG7-20, CG-7200, CG7-20H, CG7-30D, CG7-30I, CG7-31D, CG7-31I, CG7-40, CG-7400, CG7-40H, CG7-41, CG-7415, CG7-41H, CG7-50, CG7-51, CG7-61, CG-7615...(Other models you can see in the webshop)		



1

<b>GEV No.</b>	506169	<b>Ref. No.</b>	FAG6000005
<b>description</b>	front panel W 400mm H 60mm fryer		

Reglado a GAS NATURAL  
Reglage GAZ NATUREL  
Regulated for NATURAL GAS using

1

<b>GEV No.</b>	691736	<b>Ref. No.</b>	12008202 U134402
<b>description</b>	sticker regulated for NATURAL GAS using		
<b>For models:</b>	BG7-05, BG7-05I, BG7-10, BG7-10I, BG9-05, BG9-05I, BG9-05PF, BG9-05PI, BG9-10, BG9-10I, BG9-10PF, BG9-10PI, BME9-05, BME9-05V-T, BME9-10, BME9-10V-T, BMG7-10, BMG-9045, BMG9-05, BMG9-05V-T, BMG9-10, BMG9-10V-T, CG-1002, CG-1502, CG-2000, CG-2005, CG-210, CG-210G, CG-3005, CG-310, CG-310G, CG7-10, CG7-11, CG-7115, CG7-20, CG-7200, CG7-20H, CG7-30D, CG7-30I, CG7-31D, CG7-31I, CG7-40, CG-7400, CG7-40H, CG7-41, CG-7415, CG7-41H, CG7-50, CG7-51, CG7-61...(Other models you can see in the webshop)		



1

<b>GEV No.</b>	104123	<b>Ref. No.</b>	12013999 U742640
<b>description</b>	mounting plate for gas range L 690mm W 110mm H 25mm		
<b>For models:</b>	CE7-41, CG7-11, CG7-41, CGE7-41, FE-720, FG-720, MB7-10, MG7-10, MG7-10BM		



1

<b>GEV No.</b>	550771	<b>Ref. No.</b>	12004055 X163022
<b>description</b>	terminal box L 170mm W 150mm H 70mm for thermostat		
<b>For models:</b>	FG9-05, FG9-05-1C, FG9-05-2C, FG9-10, FG9-10-2C, FG9-10-4C, FGCL9-05, FGCL9-05-1C, FGCL9-05-2C		

			
1			
<b>GEV No.</b>	691691	<b>Ref. No.</b>	12009010 12009015 U022836 U262806
<b>description</b>	type plate FAGOR metal		
<b>For models:</b>	BG6-05I, BG7-05, BG7-05I, BG7-10, BG7-10I, BG9-05, BG9-05AD, BG9-05I, BG9-05PF, BG9-05PI, BG9-05PLUS-I, BG9-10, BG9-10AD, BG9-10I, BG9-10PF, BG9-10PI, BG9-10PLUS-I, BME6-05, BME7-05, BME7-10, BME9-05, BME9-05AD, BME9-05PLUS, BME9-05V-T, BME9-10, BME9-10AD, BME9-10PLUS, BME9-10V-T, BMG7-10, BMG9-05, BMG9-05V-T, BMG9-10, BMG9-10V-T, CE6-20, CE6-40, CE6-41, CE7-20, CE7-40, CE7-41, CE9-20, CE9-20AD, CE9-20PLUS, CE9-40, CE9-40AD, CE9-40PLUS, CE9-41, CE9-41AD, CE9-41PLUS, CG-1002, CG-1502...(Other models you can see in the webshop)		

## glass panels

			
1			
<b>GEV No.</b>	692158	<b>Ref. No.</b>	12008981 9294600
<b>description</b>	glass panel ø 29.5mm thickness 5mm		
<b>For models:</b>	FE-18, FE-25, FGCL9-05, MG7-10, MG7-10BM, MG9-10, MG9-10AD, MG9-10BM, MG9-10BMAD, MG9-10BMS, MG9-10BMSAD, MG9-10PLUS, MG9-10PLUS-BM, MG9-10PLUS-BMS, MG9-10PLUS-S, MG9-10S, MG9-10S-AD, MG9-15, MG-9150BM, MG9-15AD, MG9-15BM, MG9-15BM316, MG9-15BMAD, MG9-15BMS, MG9-15BMSAD, MG9-15PLUS, MG9-15PLUS-BM, MG9-15PLUS-BMS, MG9-15PLUS-S, MG9-15S, MG9-15S-AD, MG9-20, MG9-20AD, MG9-20PLUS, MG9-20PLUS-S, MG9-20S, MG9-20S-AD, MPG9-10, MPG9-10BM, MPG9-10BMS, MPG9-10S, MPG9-15, MPG9-15BM, MPG9-15BMS, MPG9-15S, MPG9-20, MPG9-20S		

## door magnets

			
1			
<b>GEV No.</b>	691000	<b>Ref. No.</b>	12009033 X960501
<b>description</b>	door magnet ø 32mm H 7mm M4		
<b>For models:</b>	CG-310, CG-310G, CG7-51, CG7-61, CG7-61H, CG9-41H, CG9-51L, CG9-51LC, CG9-51R, CG9-51RC, CG9-61, CG9-61H, CGF9-121D, CGF9-121D-AD, CGF9-121I, CGF9-121I-AD, CGF9-121PLUS-D, CGF9-121PLUS-I, CPE7-05, CPE7-05NC, CPE9-05, CPE9-05AD, CPE9-05AD-S, CPE9-05NC, CPE9-05PLUS, CPE9-05PLUS-S, CPE9-05S, CPE9-05SNC, CPG7-05, CPG7-05NC, CPG9-05, CPG9-05AD, CPG9-05AD-S, CPG9-05NC, CPG9-05PLUS, CPG9-05PLUS-S, CPG9-05S, CPG9-05SNC, EPC-350, FE-18, FE-25, FE7-05-1C, FE7-05-2C, FE-710, FE7-10-2C, FE7-10-4C, FE-720, FE9-05, FE9-05-1C, FE9-05-2C...(Other models you can see in the webshop)		

## sumps

			
Image not available			
1			
<b>GEV No.</b>	691892	<b>Ref. No.</b>	1100002846 1100002848 12038270 12038338 X316100
<b>description</b>	sump for fryer suitable for FAGOR FG7-00		
<b>For models:</b>	FG-710, FG-720		

			
1			
<b>GEV No.</b>	691893	<b>Ref. No.</b>	1100002845 12038344 X166124
<b>description</b>	sump for fryer suitable for FAGOR FG9-00		

## for grills

## spare parts and accessories

			
1			
<b>GEV No.</b>	691853	<b>Ref. No.</b>	12011165 T035473
<b>description</b>	bracket L 480mm H 45mm W 20mm		



<b>GEV No.</b>	691871	<b>Ref. No.</b>	12012807 T052603
<b>description</b>	cover L 73mm H 33mm W 30mm		
<b>For models:</b>	BG7-05, BG7-05I, BG7-10, BG7-10I, BG9-05, BG9-05I, BG9-10, BG9-10I		

for griddles

spare parts and accessories



<b>GEV No.</b>	691703	<b>Ref. No.</b>	12019787 U125409
<b>description</b>	distance washer for handrail		
<b>For models:</b>	CG-HP-20, FI-5420, FI-7630		



<b>GEV No.</b>	691683	<b>Ref. No.</b>	12007464 R152607
<b>description</b>	holding plate for drain L 110mm W 60mm ID ø 48mm		
<b>For models:</b>	CG9-51L, CG9-51LC, CG9-51R, CG9-51RC, FTE7-05, FTE7-05L, FTE7-05R, FTE7-10, FTE7-10L, FTE7-10L+R, FTE7-10R, FTE9-05L, FTE9-05R, FTE9-10L, FTE9-10L+R, FTE9-10R, FTEC7-05L, FTEC7-10L, FTEC9-05L, FTEC9-05R, FTEC9-05USMC, FTEC9-10L, FTEC9-10L+R, FTEC9-10R, FTEC9-10USMC, FTG7-05, FTG7-05L, FTG7-05R, FTG7-05VL, FTG7-05VR, FTG7-10, FTG7-10L, FTG7-10L+R, FTG7-10R, FTG7-10VL, FTG7-10VL+R, FTG7-10VR, FTG9-05L, FTG9-05R, FTG9-05VL, FTG9-05VR, FTG9-10L, FTG9-10L+R, FTG9-10R, FTG9-10VL, FTG9-10VL+R, FTG9-10VR, FTG9-11L, FTG9-11L+R, FTG9-11R...(Other models you can see in the webshop)		

housing and bezels



<b>GEV No.</b>	210022	<b>Ref. No.</b>	12020193 U452805
<b>description</b>	cover L 177mm W 52mm H 16mm for control panel mounting pos. left suitable for 700 series		
<b>For models:</b>	BG7-05, BG7-05I, BG7-10, BG7-10I, BME7-05, BME7-10, BMG7-10, CE7-20, CE7-40, CE7-41, CG7-10, CG7-11, CG7-20, CG-7200, CG7-40, CG-7400, CG7-41, CG-7415, CG7-61, CG-7615, CGB7-61, CGE7-41, CGE7-69, CPG7-05, EN7-05, EN7-10, FE-710, FE-720, FG-710, FG-720, FTE7-05, FTE7-05L, FTE7-05R, FTE7-10, FTE7-10L, FTE7-10L+R, FTE7-10R, FTEC7-05L, FTEC7-10L, FTG7-05, FTG7-05L, FTG7-05R, FTG7-05VL, FTG7-05VR, FTG7-10, FTG7-10L, FTG7-10L+R, FTG7-10R, FTG7-10VL, FTG7-10VL+R...(Other models you can see in the webshop)		

<b>accessories for</b>	210022		
<b>GEV No.</b>	210021	<b>Ref. No.</b>	12020194 U452804
<b>description</b>	cover L 177mm W 52mm H 16mm for control panel mounting pos. right suitable for 700 series		

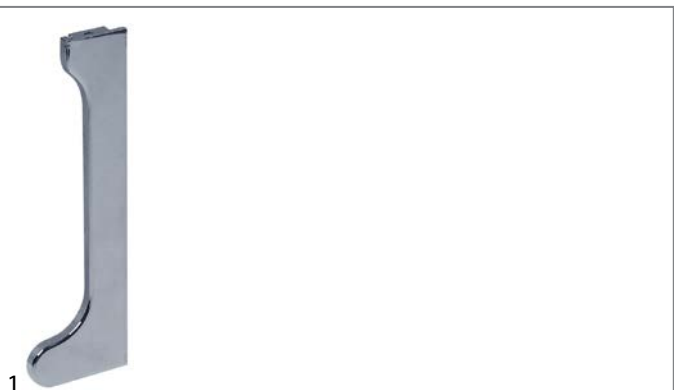

<b>GEV No.</b>	210021	<b>Ref. No.</b>	12020194 U452804
<b>description</b>	cover L 177mm W 52mm H 16mm for control panel mounting pos. right suitable for 700 series		
<b>For models:</b>	BG7-05, BG7-05I, BG7-10, BG7-10I, BME7-05, BME7-10, BMG7-10, CE7-20, CE7-40, CE7-41, CG7-10, CG7-11, CG7-20, CG-7200, CG7-40, CG-7400, CG7-41, CG-7415, CG7-61, CG-7615, CGB7-61, CGE7-41, CGE7-62, CPG7-05, EN7-05, EN7-10, FE-710, FE-720, FG-710, FG-720, FTE7-05, FTE7-05L, FTE7-05R, FTE7-10, FTE7-10L, FTE7-10L+R, FTE7-10R, FTEC7-05L, FTEC7-10L, FTG7-05, FTG7-05L, FTG7-05R, FTG7-05VL, FTG7-05VR, FTG7-10, FTG7-10L, FTG7-10L+R, FTG7-10R, FTG7-10VL, FTG7-10VL+R...(Other models you can see in the webshop)		

<b>accessories for</b>	210021		
<b>GEV No.</b>	210022	<b>Ref. No.</b>	12020193 U452805
<b>description</b>	cover L 177mm W 52mm H 16mm for control panel mounting pos. left suitable for 700 series		

			
1			
<b>GEV No.</b>	700809	<b>Ref. No.</b>	12007564 R205409
<b>description</b>	fastening angle L 120mm W 67mm H 28mm		
<b>For models:</b>	BG9-05, BG9-10, BME9-05, BME9-10, BMG9-05, BMG9-10, CE9-20, CE9-40, CE9-41, CG9-10, CG9-11, CG9-20, CG9-40, CG9-41, CG9-60, CG9-61, CG9-82, EN9-05, EN9-10, FE-920, FG-920, FG-940, FTE9-05L, FTE9-05R, FTE9-10L, FTE9-10L+R, FTE9-10R, FTEC9-05, FTEC9-05L, FTEC9-05R, FTEC9-10, FTEC9-10L, FTEC9-10L+R, FTEC9-10R, FTG9-05L, FTG9-05R, FTG9-05VL, FTG9-05VR, FTG9-10L, FTG9-10L+R, FTG9-10R, FTG9-10VL, FTG9-10VL+R, FTG9-10VR, FTGC9-05, FTGC9-05L, FTGC9-05R, FTGC9-10, FTGC9-10L, FTGC9-10L+R...(Other models you can see in the webshop)		

			
1			
<b>GEV No.</b>	691721	<b>Ref. No.</b>	12012797 R162808
<b>description</b>	front panel for griddle W 850mm H 150mm		
<b>For models:</b>	FTG9-10L, FTG9-10L+R, FTG9-10R, FTG9-10VL, FTG9-10VL+R, FTG9-10VR, FTGC9-10L, FTGC9-10L+R, FTGC9-10R		

<div style="border: 1px solid black; padding: 5px; width: fit-content; margin: 0 auto;"> <p style="color: red; font-size: small;">Reglado a BUTANO-PROPANO Reglage BUTANE-PROPANE Regulated for L.P.G. using</p> </div>			
1			
<b>GEV No.</b>	691735	<b>Ref. No.</b>	12008203 U136501
<b>description</b>	sticker Regulated for L.P.G. using		
<b>For models:</b>	BG7-05, BG7-05I, BG7-10, BG7-10I, BG9-05, BG9-05I, BG9-05PF, BG9-05PI, BG9-10, BG9-10I, BG9-10PF, BG9-10PI, BME9-05, BME9-05V-T, BME9-10, BME9-10V-T, BMG7-10, BMG9-05, BMG9-05V-T, BMG9-10, BMG9-10V-T, CG-1002, CG-1502, CG-2000, CG-200S, CG-210, CG-210G, CG-300S, CG-310, CG-310G, CG7-10, CG7-11, CG-7115, CG7-20, CG-7200, CG7-20H, CG7-30D, CG7-30I, CG7-31D, CG7-31I, CG7-40, CG-7400, CG7-40H, CG7-41, CG-7415, CG7-41H, CG7-50, CG7-51, CG7-61, CG-7615...(Other models you can see in the webshop)		

<div style="border: 1px solid black; padding: 5px; width: fit-content; margin: 0 auto;"> <p style="color: red; font-size: small;">Reglado a GAS NATURAL Reglage GAZ NATUREL Regulated for NATURAL GAS using</p> </div>			
1			
<b>GEV No.</b>	691736	<b>Ref. No.</b>	12008202 U134402
<b>description</b>	sticker regulated for NATURAL GAS using		
<b>For models:</b>	BG7-05, BG7-05I, BG7-10, BG7-10I, BG9-05, BG9-05I, BG9-05PF, BG9-05PI, BG9-10, BG9-10I, BG9-10PF, BG9-10PI, BME9-05, BME9-05V-T, BME9-10, BME9-10V-T, BMG7-10, BMG-9045, BMG9-05, BMG9-05V-T, BMG9-10, BMG9-10V-T, CG-1002, CG-1502, CG-2000, CG-200S, CG-210, CG-210G, CG-300S, CG-310, CG-310G, CG7-10, CG7-11, CG-7115, CG7-20, CG-7200, CG7-20H, CG7-30D, CG7-30I, CG7-31D, CG7-31I, CG7-40, CG-7400, CG7-40H, CG7-41, CG-7415, CG7-41H, CG7-50, CG7-51, CG7-61...(Other models you can see in the webshop)		

## griddles

			
1			
<b>GEV No.</b>	691854	<b>Ref. No.</b>	12015268 R795416
<b>description</b>	griddle L 620mm W 695mm H 80mm		
<b>For models:</b>	FTG7-10, FTG7-10L, FTG7-10VL		



			
1			
<b>GEV No.</b>	691902	<b>Ref. No.</b>	12000919 R065407
<b>description</b>	griddle L 875mm W 720mm H 80mm stainless steel		
<b>For models:</b>	FTG9-10PLUS-CLR, FTGC9-10L+R, FTGC9-10L+R-AD, FTGC9-11L+R		

## sumps

			
1			
<b>GEV No.</b>	691684	<b>Ref. No.</b>	12014843 R792606
<b>description</b>	grease collecting tray L 265mm W 125mm H 50mm		
<b>For models:</b>	FTE7-05, FTE7-05L, FTE7-05R, FTE7-10, FTE7-10L, FTE7-10L+R, FTE7-10R, FTEC7-05L, FTEC7-10L, FTG7-05, FTG7-05L, FTG7-05R, FTG7-05VL, FTG7-05VR, FTG7-10, FTG7-10L, FTG7-10L+R, FTG7-10R, FTG7-10VL, FTG7-10VL+R, FTG7-10VR, FTGC7-05L, FTGC7-10L		

drain stoppers



1				
<b>GEV No.</b>	691686	<b>Ref. No.</b>	12019460 R619912	
<b>description</b>	plug bottom part D1 ø 40mm D2 ø 33.5mm H 30mm			
<b>For models:</b>	CG9-51LC, CG9-51RC, FTE7-05, FTE7-05L, FTE7-05R, FTE7-10, FTE7-10L, FTE7-10L+R, FTE7-10R, FTE9-05L, FTE9-05R, FTE9-10L, FTE9-10L+R, FTE9-10R, FTEC7-05L, FTEC7-10L, FTEC9-05, FTEC9-05L, FTEC9-05R, FTEC9-05USMC, FTEC9-10, FTEC9-10L, FTEC9-10L+R, FTEC9-10R, FTEC9-10USMC, FTG7-05, FTG7-05L, FTG7-05R, FTG7-10, FTG7-10L, FTG7-10L+R, FTG7-10R, FTG9-05L, FTG9-05R, FTG9-05VL, FTG9-05VR, FTG9-10L, FTG9-10L+R, FTG9-10R, FTG9-10VL, FTG9-10VL+R, FTG9-10VR, FTGC7-05L, FTGC7-10L, FTGC9-05, FTGC9-05L, FTGC9-05R, FTGC9-10, FTGC9-10L, FTGC9-10L+R...(Other models you can see in the webshop)			
<b>accessories for</b>	691686			
	<b>GEV No.</b>	111129	<b>Ref. No.</b>	12008060 S116122
	cone handle thread M10 ø 34mm L 55mm plastic black			
	<b>GEV No.</b>	527396	<b>Ref. No.</b>	12020466 R619913
	thread bolt for griddle L 50mm thread M10 stainless steel			



1				
<b>GEV No.</b>	692329	<b>Ref. No.</b>	12023771	
<b>description</b>	drip rail L 700mm ABS plastic W 22mm hole ø 5mm for combi-steamer			
<b>For models:</b>	COE-061, COE-101, COG-061, COG-101, VE-061, VE-101, VG-101, VPE-061, VPE-101, VPG-101			

drain valves



1				
<b>GEV No.</b>	696854	<b>Ref. No.</b>	12126816	
<b>description</b>	drain fitting for combi-steamer			
<b>For models:</b>	APE-201, APE-202, APG-201, APG-202			

for chicken rotisserie

miscellaneous



1				
<b>GEV No.</b>	691877	<b>Ref. No.</b>	12039840 Z200513	
<b>description</b>	bolt ø 8mm L 31.5mm head ø 12mm head thickness 2.5mm SS			

for convection ovens/combi-steamers

drain units

drip rails



1				
<b>GEV No.</b>	696855	<b>Ref. No.</b>	12039485 T800563000	
<b>description</b>	drip rail L 540mm plastic W 44.5mm			
<b>For models:</b>	ACE-061, ACE-101, ACG-061, ACG-101, AE-061, AE-061W, AE-101, AE-101W, AG-061, AG-061W, AG-101, AG-101W, APE-061, APE-061W, APE-101, APE-101W, APG-061, APG-061W, APG-101, APG-101W			



1				
<b>GEV No.</b>	696858	<b>Ref. No.</b>	12043409	
<b>description</b>	bush ID ø 4mm ED ø 8mm L 5.5mm			
<b>For models:</b>	ACE-061, ACE-101, ACE-102, ACE-201, ACE-202, ACG-061, ACG-101, ACG-201, ACG-202, AE-061, AE-061W, AE-101, AE-101W, AE-102, AE-102W, AE-201, AE-202, AG-061, AG-061W, AG-101, AG-101W, AG-201, AG-202, APE-061, APE-061W, APE-101, APE-101W, APE-102, APE-102W, APE-201, APE-202, APG-061, APG-061W, APG-101, APG-101W, APG-201, APG-202			



1				
<b>GEV No.</b>	696856	<b>Ref. No.</b>	12023506 Z608410 Z608410000	
<b>description</b>	bush ID ø 7mm ED ø 11mm L 8mm			
<b>For models:</b>	ACE-201, ACE-202, ACG-201, ACG-202, AE-201, AE-202, AG-201, AG-202, APE-201, APE-202, APG-201, APG-202			

## steam generators

## steam generators



1

<b>GEV No.</b>	692897	<b>Ref. No.</b>	12046049
<b>description</b>	steam generator L 290mm W 120mm H 300mm		
<b>For models:</b>	AE-101, AE-101W, APE-101, APE-101W		



1

<b>GEV No.</b>	692906	<b>Ref. No.</b>	12046048
<b>description</b>	steam generator L 300mm W 120mm H 420mm		
<b>For models:</b>	ACE-061, AE-061, AE-061W, APE-061, APE-061W		



1

<b>GEV No.</b>	696836	<b>Ref. No.</b>	12046053
<b>description</b>	steam generator L 310mm W 120mm H 530mm		
<b>For models:</b>	ACE-102, AE-102, AE-102W, AE-201, APE-102, APE-102W, APE-201		



1

<b>GEV No.</b>	691849	<b>Ref. No.</b>	1100002823 12000181 12010918 R145001
<b>description</b>	steam generator L 425mm W 110mm H 530mm		
<b>For models:</b>	HME-20-21, HME-2-20-11, HMM-20-21, HMM-20-21UL, HMM-2-20-11, HMM-40-11-USMC, HMP-20-21, HMP-2-20-11		



1

<b>GEV No.</b>	697779	<b>Ref. No.</b>	12025526 RT83507100
<b>description</b>	steam generator suitable for RATIONAL		

## steam pipes



1

<b>GEV No.</b>	530875	<b>Ref. No.</b>	12031550 RT4400362
<b>description</b>	steam hose ext. $\varnothing$ 78 ID $\varnothing$ 70mm L 54mm silicone red/black		



1

<b>GEV No.</b>	521283	<b>Ref. No.</b>	12047930
<b>description</b>	steam pipe L 200mm W 85mm ø 53mm for combi-steamer steam generator		
<b>For models:</b>	ACE-061, ACE-102, AE-061, AE-061W, AE-101, AE-101W, AE-102, AE-102W, AE-201, AE-202, APE-061, APE-061W, APE-101, APE-101W, APE-102, APE-102W, APE-201, APE-202		



1

<b>GEV No.</b>	692042	<b>Ref. No.</b>	12012959 R722702
<b>description</b>	injection pipe steam		



1

<b>GEV No.</b>	691729	<b>Ref. No.</b>	12015182 R675019
<b>description</b>	steam pipe T-piece SS L 190mm ID ø 50mm ED ø 53mm		
<b>For models:</b>	HEM-10-11, HEM-6-11, HEP-10-11, HEP-6-11, HME-10-11, HME-10-21, HME-20-21, HME-2-10-11, HME-2-20-11, HME-6-11, HMM-10-11, HMM-10-21, HMM-20-21, HMM-20-21UL, HMM-2-10-11, HMM-2-20-11, HMM-40-11-USMC, HMM-6-11, HMP-10-11, HMP-10-21, HMP-20-21, HMP-2-10-11, HMP-2-20-11, HMP-6-11		

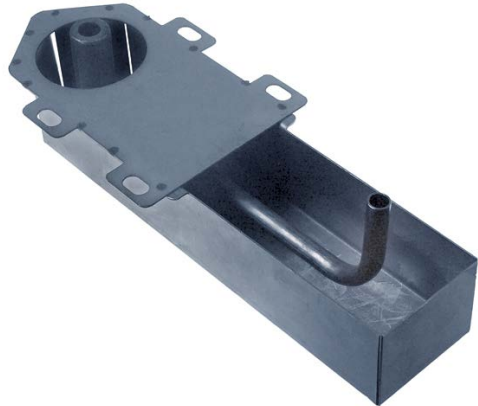

1

<b>GEV No.</b>	692043	<b>Ref. No.</b>	12013564 T072605
<b>description</b>	injection pipe steam		
<b>For models:</b>	HMG-6-11		

injection pipes



1

<b>GEV No.</b>	694069	<b>Ref. No.</b>	12013716 T07500
<b>description</b>	injection pipe L1 180mm L2 65mm tube ø 10mm		



1

<b>GEV No.</b>	691901	<b>Ref. No.</b>	12014384 R665020
<b>description</b>	injector pipe L1 175mm L2 65mm tube ø 10mm mounting distance 36mm		
<b>For models:</b>	HME-6-11, HMI-6-11, HMI-6-11UL, HMP-6-11		



1

<b>GEV No.</b>	694070	<b>Ref. No.</b>	12014333 R675017
<b>description</b>	injection pipe L1 225mm L2 65mm tube ø 10mm mounting distance 36mm		
<b>For models:</b>	HME-10-11, HME-10-21, HME-20-11, HME-20-21, HME-2-10-11, HME-2-20-11, HMI-10-11, HMI-10-11UL, HMI-10-21, HMI-10-21UL, HMI-2-10-11, HMP-10-11, HMP-10-21, HMP-20-11, HMP-20-21, HMP-2-10-11, HMP-2-20-11		

spare parts and accessories



1

<b>GEV No.</b>	551460	<b>Ref. No.</b>	12023647 T723007000
<b>description</b>	cover cap for USB-conection with internal thread ø 38mm		
<b>For models:</b>	ACE-061, ACE-101, AE-061, AE-101, APE-061, APE-061W, APE-101, APE-101W, APE-102, APE-102W, APE-201, APE-202, APG-061, APG-061W, APG-101, APG-101W, APG-102, APG-102W, APG-201, APG-202		

			
1			
<b>GEV No.</b>	403747	<b>Ref. No.</b>	12043405
<b>description</b>	potentiometer rotation 360° shaft ø 6x4.6mm shaft L 13mm		
<b>For models:</b>	ACE-061, ACE-101, AE-061, AE-061W, AE-101, AE-101W, AE-102, AE-102W, AE-201, AE-202, AG-061, AG-061W, AG-101, AG-101W, AG-102, AG-102W, AG-201, AG-202, APE-061, APE-101		

## filters

			
1			
<b>GEV No.</b>	701580	<b>Ref. No.</b>	12032599 RT20050307
<b>description</b>	drain filter ø 71mm H 18mm IT M6 for combi-steamer model CPC-Linie CPC 61/101/201		

## housing and bezels

			
Image not available			
1			
<b>GEV No.</b>	691882	<b>Ref. No.</b>	12011627 R675005
<b>description</b>	fastening angle L 35mm W 35mm H 42mm		
<b>For models:</b>	HEI-10-11, HEI-20-11, HEI-6-11, HEM-10-11, HEM-20-11, HEM-6-11, HEP-10-11, HEP-20-11, HEP-6-11, HME-10-11, HME-10-21, HME-20-11, HME-20-21, HME-2-10-11, HME-2-20-11, HME-6-11, HMI-10-11, HMI-10-11UL, HMI-10-21, HMI-10-21UL, HMI-2-10-11, HMI-6-11, HMI-6-11UL, HMM-10-11, HMM-10-11UL, HMM-10-21, HMM-10-21UL, HMM-20-11, HMM-20-11UL, HMM-20-21, HMM-20-21UL, HMM-2-10-11, HMM-2-20-11, HMM-40-11-USMC, HMM-6-11, HMM-6-11UL, HMP-10-11, HMP-10-21, HMP-20-11, HMP-20-21, HMP-2-10-11, HMP-2-20-11, HMP-6-11		

			
1			
<b>GEV No.</b>	691691	<b>Ref. No.</b>	12009010 12009015 U022836 U262806
<b>description</b>	type plate FAGOR metal		
<b>For models:</b>	BG6-05I, BG7-05, BG7-05I, BG7-10, BG7-10I, BG9-05, BG9-05AD, BG9-05I, BG9-05PF, BG9-05PI, BG9-05PLUS-I, BG9-10, BG9-10AD, BG9-10I, BG9-10PF, BG9-10PI, BG9-10PLUS-I, BME6-05, BME7-05, BME7-10, BME9-05, BME9-05AD, BME9-05PLUS, BME9-05V-T, BME9-10, BME9-10AD, BME9-10PLUS, BME9-10V-T, BMG7-10, BMG9-05, BMG9-05V-T, BMG9-10, BMG9-10V-T, CE6-20, CE6-40, CE6-41, CE7-20, CE7-40, CE7-41, CE9-20, CE9-20AD, CE9-20PLUS, CE9-40, CE9-40AD, CE9-40PLUS, CE9-41, CE9-41AD, CE9-41PLUS, CG-1002, CG-1502...(Other models you can see in the webshop)		

## glass panels

			
1			
<b>GEV No.</b>	692856	<b>Ref. No.</b>	12025892 RT2400212
<b>description</b>	door glass for combi-steamer SCC/CM202 L 1340mm mounting pos. inner W 680mm thickness 6mm		

			
1			
<b>GEV No.</b>	694938	<b>Ref. No.</b>	RT2400200
<b>description</b>	glass panel for door inside combi-steamer SCC/CM102 L 763mm W 680mm thickness 7mm		

			
1			
<b>GEV No.</b>	694492	<b>Ref. No.</b>	12027606 RT2400163
<b>description</b>	glass panel L 485mm W 508mm thickness 6mm mounting pos. inner for combi-steamer		

			
1			
<b>GEV No.</b>	700832	<b>Ref. No.</b>	12017461 R680508
<b>description</b>	glass panel L 820mm W 765mm thickness 5mm rectangular mounting pos. inner		
<b>For models:</b>	HCG-10-21, HCG-2-10-11, HME-10-21, HME-2-10-11, HMG-10-21, HMG-10-21UL, HMG-2-10-11, HMI-10-21, HMI-10-21UL, HMI-2-10-11, HMM-10-21, HMM-10-21UL, HMM-2-10-11, HMP-10-21, HMP-2-10-11		

## air filters

			
1			
<b>GEV No.</b>	692694	<b>Ref. No.</b>	12033202 RT1600673
<b>description</b>	filter L 220mm W 50mm ømm H 150mm SCC Line		







			
1			
<b>GEV No.</b>	692695	<b>Ref. No.</b>	12034505 RT84551377
<b>description</b>	filter insert L 213mm W 60mm ømm H 90mm		

cleaning system

nozzles

			
1			
<b>GEV No.</b>	505230	<b>Ref. No.</b>	12017281 Z651931
<b>description</b>	rinse jet H 12mm thread M10x1 WS 14 hole ø 1.6mm		
<b>For models:</b>	FI-300B, FI-300R, FI-650R, HCV-10-11, HCV-10-21, HCV-2-10-21, HCV-6-11, HEM-10-11, HEM-20-11, HEM-6-11, HEP-10-11, HEP-20-11, HEP-6-11, HME-10-11, HME-10-21, HME-20-11, HME-20-21, HME-2-10-11, HME-2-20-11, HME-6-11, HMM-10-11, HMM-10-11UL, HMM-10-21, HMM-10-21UL, HMM-20-11, HMM-20-11UL, HMM-20-21, HMM-20-21UL, HMM-2-10-11, HMM-2-20-11, HMM-40-11-USMC, HMM-6-11, HMM-6-11UL, HMP-10-11, HMP-10-21, HMP-20-11, HMP-20-21, HMP-2-10-11, HMP-2-20-11, HMP-6-11		

			
1			
<b>GEV No.</b>	505232	<b>Ref. No.</b>	12021186 Z651932
<b>description</b>	swirl H 10.7mm ø 6mm 1.5mm H1 5mm		
<b>For models:</b>	FI-300B, FI-300R, FI-650R, HCV-10-11, HCV-10-21, HCV-2-10-21, HCV-6-11, HEM-10-11, HEM-20-11, HEM-6-11, HEP-10-11, HEP-20-11, HEP-6-11, HME-10-11, HME-10-21, HME-20-11, HME-20-21, HME-2-10-11, HME-2-20-11, HME-6-11, HMM-10-11, HMM-10-11UL, HMM-10-21, HMM-10-21UL, HMM-20-11, HMM-20-11UL, HMM-20-21, HMM-20-21UL, HMM-2-10-11, HMM-2-20-11, HMM-40-11-USMC, HMM-6-11, HMM-6-11UL, HMP-10-11, HMP-10-21, HMP-20-11, HMP-20-21, HMP-2-10-11, HMP-2-20-11, HMP-6-11		

coupling bushings

			
1			
<b>GEV No.</b>	694486	<b>Ref. No.</b>	12031521 RT20620348
<b>description</b>	coupling bush for cleaning system		

			
1			
<b>GEV No.</b>	694487	<b>Ref. No.</b>	12031179 RT20620347
<b>description</b>	coupling bush for cleaning system		

			
1			
<b>GEV No.</b>	694488	<b>Ref. No.</b>	12030870 RT20620350
<b>description</b>	coupling bush for cleaning system		

			
1			
<b>GEV No.</b>	694489	<b>Ref. No.</b>	12029908 RT20620349
<b>description</b>	coupling bush for cleaning system		

pumps

			
1			
<b>GEV No.</b>	500578	<b>Ref. No.</b>	12026928 RT5600153P
<b>description</b>	pump inlet ø 24mm outlet ø 24mm type UP30-274 230V 50/60Hz 1 phase 0.09kW 0.12HP L 145mm rotation direction left capacitor 2.5µF HANNING		
<b>spare parts for</b>	500578		
	<b>GEV No.</b>	<b>Ref. No.</b>	—
	O-ring EPDM thickness 3mm ID ø 58mm Qty 1 pcs		

			
1			
<b>GEV No.</b>	500579	<b>Ref. No.</b>	12026728 RT5600178P
<b>description</b>	pump inlet ø 24mm outlet ø 24mm type UP30-275 230V 50/60Hz 1 phase 0.09kW 0.12HP L 145mm rotation direction left capacitor 2.5µF HANNING		
<b>spare parts for</b>	500579		
	<b>GEV No.</b>	<b>Ref. No.</b>	—
	O-ring EPDM thickness 3mm ID ø 58mm Qty 1 pcs		

## cleaning arms



1

<b>GEV No.</b>	541433	<b>Ref. No.</b>	12026700 RT86552101
<b>description</b>	cleaning arm CleanJet suitable for RATIONAL _101-_202		

## non-return valves



1

<b>GEV No.</b>	531321	<b>Ref. No.</b>	12035266 RT20690107
<b>description</b>	non-return valve		



1

<b>GEV No.</b>	531297	<b>Ref. No.</b>	12033754 RT5000078
<b>description</b>	non-return valve $\varnothing$ 16.4mm L 18mm		

## hoses



1

<b>GEV No.</b>	530794	<b>Ref. No.</b>	12031663 RT21121304
<b>description</b>	formed hose ED $\varnothing$ 29mm ID $\varnothing$ 23mm L 485mm for combi-steamer CPC-Linie 102/201E		



1

<b>GEV No.</b>	530791	<b>Ref. No.</b>	12031730 RT4400242
<b>description</b>	formed hose ED $\varnothing$ 29mm ID $\varnothing$ 23mm L 730mm for combi-steamer SCC Linie 202		



1

<b>GEV No.</b>	530792	<b>Ref. No.</b>	12031089 RT21121305
<b>description</b>	formed hose ID $\varnothing$ 22mm ED $\varnothing$ 29mm L 640mm for combi-steamer CPC 202		



1

<b>GEV No.</b>	694490	<b>Ref. No.</b>	12036856 RT21121310
<b>description</b>	formed hose ID $\varnothing$ 22mm ED $\varnothing$ 30mm L 80mm steam generator		



1

<b>GEV No.</b>	696852	<b>Ref. No.</b>	12024425 T330731000
<b>description</b>	hose ID $\varnothing$ 30/23mm ED $\varnothing$ 36/30mm L 177mm for combi-steamer		
<b>For models:</b>	APE-102, APE-102W, APE-202, APG-102, APG-202		



1

<b>GEV No.</b>	530918	<b>Ref. No.</b>	12039649 T945056000
<b>description</b>	hose ID $\varnothing$ 30mm ED $\varnothing$ 40mm L 110mm for steam generator		
<b>For models:</b>	ACE-102, AE-102, AE-102W, AE-201, AE-202, AG-061, AG-061W, AG-101, AG-101W, AG-102, AG-102W, AG-201, AG-202, APE-102, APE-102W, APE-201, APE-202, APG-061, APG-061W, APG-101, APG-101W, APG-102, APG-102W, APG-201, APG-202		

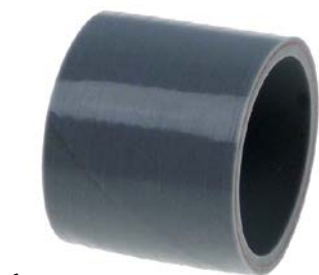

1

<b>GEV No.</b>	692102	<b>Ref. No.</b>	12031714 RT21121006
<b>description</b>	hose ID $\varnothing$ 50mm ED $\varnothing$ 60mm L 50mm		

1

<b>GEV No.</b>	694321	<b>Ref. No.</b>	12037987 RT21121307
<b>description</b>	hose ID ø 70mm ext. ø 80 L 80mm for combi-steamer		



1

<b>GEV No.</b>	530919	<b>Ref. No.</b>	12044832
<b>description</b>	hose ID ø 73mm ED ø 85mm L 150mm for steam generator		
<b>For models:</b>	AG-202, APG-202		



1

<b>GEV No.</b>	530795	<b>Ref. No.</b>	12035289 RT21101029
<b>description</b>	silicone hose ID ø 6mm ED ø 10mm L 1085mm for combi-steamer CPC-Linie CM 61-202/G white		



1

<b>GEV No.</b>	530798	<b>Ref. No.</b>	12034250 RT21101030
<b>description</b>	silicone hose ID ø 6mm ED ø 10mm L 1120mm for combi-steamer CPC-Linie CM 61-202/G		



1

<b>GEV No.</b>	530875	<b>Ref. No.</b>	12031550 RT4400362
<b>description</b>	steam hose ext. ø 78 ID ø 70mm L 54mm silicone red/black		

service kits



1

<b>GEV No.</b>	530874	<b>Ref. No.</b>	12026779 RT87201521	
<b>description</b>	conversion kit - for combi-steamer CPC-Linie 61-102E RATIONAL			
<b>spare parts for</b>	530874			
	<b>GEV No.</b>	692215	<b>Ref. No.</b>	—
	conversion kit for tank inlet fitting			

drip water trays



1

<b>GEV No.</b>	699800	<b>Ref. No.</b>	12033203 RT5000300
<b>description</b>	drip tray plastic L 745mm W 47mm H 20mm		

door mechanics

holders



1

<b>GEV No.</b>	691904	<b>Ref. No.</b>	12002903 U065658
<b>description</b>	bracket for gasket angled L 405mm W 20mm H 20mm mounting distance 98mm stainless steel		

miscellaneous



1

<b>GEV No.</b>	694934	<b>Ref. No.</b>	12031180 RT29401306
<b>description</b>	cover for door latch suitable for combi-steamer CPC-Linie 201/202 aluminium L 96.5mm W 65.5mm		

## accessories



1

<b>GEV No.</b>	696851	<b>Ref. No.</b>	12022138 R660538 R660538000
<b>description</b>	base plate W 40mm zinc-plated sheet steel L 44mm		
<b>For models:</b>	ACE-201, ACE-202, ACG-201, ACG-202, AE-201, AE-202, AG-201, AG-202, APE-201, APE-202, APG-201, APG-202		



1

<b>GEV No.</b>	694656	<b>Ref. No.</b>	12037230 RT20390402
<b>description</b>	door bumper silicone ø 13mm L 19mm		

## vibration pumps



1

<b>GEV No.</b>	500580	<b>Ref. No.</b>	12028569 RT87201526
<b>description</b>	vibration pump 230V 60W 50/60Hz inlet ø 7 outlet ø 1/8" IT CEME type E512 with accessories duty cycle 1/2 ambient temperature max. 60°C medium temp max. 35°C overheating protection 110°C CleanJet		

## heat exchangers



1

<b>GEV No.</b>	109075	<b>Ref. No.</b>	12022680 R725709
<b>description</b>	flange ED ø 85mm thickness 2mm		
<b>For models:</b>	HCG-10-11, HCG-10-21, HCG-20-11, HCG-2-10-11, HMG-10-11, HMG-10-11UL, HMG-10-21, HMG-10-21UL, HMG-20-11, HMG-2-10-11		



1

<b>GEV No.</b>	109072	<b>Ref. No.</b>	12011760 T075700
<b>description</b>	heat exchanger ED ø 405mm H 500mm W 140mm		
<b>For models:</b>	HMG-6-11		



1

<b>GEV No.</b>	109076	<b>Ref. No.</b>	12011269 T135700
<b>description</b>	heat exchanger H 1200mm W 570mm		



1

<b>GEV No.</b>	520404	<b>Ref. No.</b>	12023740 T115084
<b>description</b>	reducing washer gas burner brass ID ø 16mm ED ø 58mm thickness 3mm type 16		



1

<b>GEV No.</b>	520403	<b>Ref. No.</b>	12018367 T115082
<b>description</b>	reducing washer gas burner brass ID ø 18mm ED ø 58mm thickness 3mm type 18		
<b>For models:</b>	HCG-10-11, HCG-10-21, HCG-2-10-11, HGC-10-11, HGV-10-11, HVG-10-11, HVG-10-11UL, HVG-10-21, HVG-10-21UL, HVG-2-10-11, MFHVG-10-11, MFHVG-10-21		



1

<b>GEV No.</b>	109073	<b>Ref. No.</b>	12018368 T115083
<b>description</b>	reducing washer ID ø 20mm ED ø 58mm W 3mm code 20		
<b>For models:</b>	HCG-10-11, HCG-10-21, HCG-2-10-11, HGC-10-11, HGV-10-11, HVG-10-11, HVG-10-11UL, HVG-10-21, HVG-10-21UL, HVG-2-10-11, MFHVG-10-11, MFHVG-10-21		

## miscellaneous



1

<b>GEV No.</b>	694433	<b>Ref. No.</b>	12036082 RT20690108	
<b>description</b>	air valve for combi-steamer bore ø 2mm L 18mm plastic ø 20mm			
<b>accessories for</b>	694433			
	<b>GEV No.</b>	694402	<b>Ref. No.</b>	12033922 RT83541304
valve body for air valve hose ø 10mm				



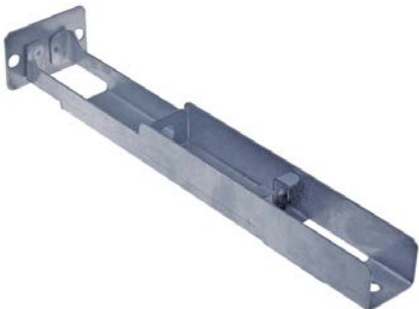

 <p>1</p>			
<b>GEV No.</b>	692330	<b>Ref. No.</b>	12022242
<b>description</b>	atomizer for combi-steamer L 97mm ø 43mm hole ø 10mm		
<b>For models:</b>	ACE-201, ACE-202, COE-061, COE-101, COE-102, COE-201, COE-202, HEI-20-11		

 <p>1</p>			
<b>GEV No.</b>	693533	<b>Ref. No.</b>	12035275 RT29201300
<b>description</b>	bracket for level electrode		

 <p>1</p>			
<b>GEV No.</b>	691689	<b>Ref. No.</b>	12014956 R660539
<b>description</b>	bracket for lighting		
<b>For models:</b>	HCG-10-11, HCG-10-21, HCG-20-11, HCG-2-10-11, HCG-6-11, HME-10-11, HME-10-21, HME-20-11, HME-20-21, HME-2-10-11, HME-6-11, HMG-10-11, HMG-10-11UL, HMG-10-21, HMG-10-21UL, HMG-20-11, HMG-2-10-11, HMG-6-11, HMI-10-11, HMI-10-11UL, HMI-10-21, HMI-10-21UL, HMI-2-10-11, HMI-6-11, HMI-6-11UL, HMM-10-11, HMM-10-11UL, HMM-10-21, HMM-10-21UL, HMM-20-11, HMM-20-11UL, HMM-2-10-11, HMM-6-11, HMM-6-11UL, HMP-10-11, HMP-10-21, HMP-20-11, HMP-20-21, HMP-2-10-11, HMP-6-11		

 <p>1</p>			
<b>GEV No.</b>	692101	<b>Ref. No.</b>	12037114 RT20390331
<b>description</b>	cap D1 ø 19mm D2 ø 10mm		

 <p>1</p>			
<b>GEV No.</b>	699809	<b>Ref. No.</b>	12037366 RT5000156
<b>description</b>	clamp for spray gun L 24mm		

 <p>1</p>			
<b>GEV No.</b>	696553	<b>Ref. No.</b>	12017801 Z883001
<b>description</b>	compression spring ø 7.5mm L 23mm wire gauge ø 0.7mm		
<b>For models:</b>	ECO-280D, ECO-280I, ECO-370D, ECO-370I, ECO-460D, ECO-460I, ECO-550D, ECO-550I, FI-280D, FI-280I, FI-370D, FI-370I, FI-460D, FI-460I, FI-550D, FI-550I, HEI-10-11, HEI-20-11, HEI-6-11, HEM-10-11, HEM-20-11, HEM-6-11, HEP-10-11, HEP-20-11, HEP-6-11, HME-10-11, HME-10-21, HME-20-11, HME-20-21, HME-2-10-11, HME-2-20-11, HME-6-11, HMI-10-11, HMI-10-11UL, HMI-10-21, HMI-10-21UL, HMI-2-10-11, HMI-6-11, HMI-6-11UL, HMM-10-11, HMM-10-11UL, HMM-10-21, HMM-10-21UL, HMM-20-11, HMM-20-11UL, HMM-20-21, HMM-20-21UL, HMM-2-10-11, HMM-2-20-11, HMM-40-11-USMC... (Other models you can see in the webshop)		

 <p>1</p>			
<b>GEV No.</b>	510559	<b>Ref. No.</b>	12034914
<b>description</b>	connection for pump		

 <p>1</p>			
<b>GEV No.</b>	691878	<b>Ref. No.</b>	12011814 R722629
<b>description</b>	cover L 150mm		
<b>For models:</b>	HMG-10-11, HMG-10-11UL, HMG-10-21, HMG-10-21UL, HMG-2-10-11, HVG-10-11, HVG-10-11UL, HVG-10-21, HVG-2-10-11, MFHVG-10-11		

 <p>1</p>			
<b>GEV No.</b>	702000	<b>Ref. No.</b>	12037186 RT1000357
<b>description</b>	cover cap for tray rack trolley D1 ø 20mm H 13.5mm D2 ø 26mm plastic Qty 5 pcs SCC-Linie 201/202		

			
1			
<b>GEV No.</b>	691690	<b>Ref. No.</b>	12020763 R725033
<b>description</b>	disc D1 ø 65mm D2 ø 6.5mm brass thickness 2mm		
<b>For models:</b>	HMG-10-11, HMG-10-11UL, HMG-10-21, HMG-10-21UL, HMG-2-10-11, HMG-6-11		

			
1			
<b>GEV No.</b>	694652	<b>Ref. No.</b>	12035010 RT20700050
<b>description</b>	drain pipe angled D1 ø 54mm D2 ø 40mm L 95mm plastic H 95mm		

			
1			
<b>GEV No.</b>	694391	<b>Ref. No.</b>	12034434 RT5000299
<b>description</b>	drain pipe with sleeve for drip pan L 560mm PE		

			
1			
<b>GEV No.</b>	524459	<b>Ref. No.</b>	12033475 RT5000286
<b>description</b>	drip rail L 540mm plastic W 63mm		
<b>accessories for</b>	524459		
	<b>GEV No.</b>	697931	<b>Ref. No.</b> —
mounting clip plastic W 20mm Qty 5 pcs			

			
1			
<b>GEV No.</b>	691695	<b>Ref. No.</b>	12024231 R662813
<b>description</b>	duct for flues D1 ø 80mm D2 ø 55mm rubber		
<b>For models:</b>	ACE-061, ACE-101, ACE-102, ACE-201, ACG-061, ACG-101, ACG-102, ACG-201, AE-061, AE-061W, AE-101, AE-101W, AE-102, AE-102W, AE-201, AG-061, AG-061W, AG-101, AG-101W, AG-102, AG-102W, AG-201, APE-061, APE-061W, APE-101, APE-101W, APE-102, APE-102W, APE-201, APG-061, APG-061W, APG-101, APG-101W, APG-102, APG-102W, APG-201, COE-061, COE-101, COE-102, COE-201, COE-202, HEI-10-11, HEI-10-21, HEI-20-11, HEI-6-11, HEM-10-11, HEM-10-21, HEM-20-11, HEM-6-11, HEP-10-11...(Other models you can see in the webshop)		

			
1			
<b>GEV No.</b>	694651	<b>Ref. No.</b>	12031441 12032850 RT20050301 RT20050308
<b>description</b>	filter for combi-steamer ø 97mm hole ø 6mm H 17.5mm		

			
1			
<b>GEV No.</b>	691732	<b>Ref. No.</b>	12012292 12022207 R345120 T115105
<b>description</b>	fixing plate bore ø 13mm L 54mm W 29mm		
<b>For models:</b>	HEI-10-11, HEI-20-11, HEI-6-11, HEM-10-11, HEM-20-11, HEM-6-11, HEP-10-11, HEP-20-11, HEP-6-11, HME-10-11, HME-10-21, HME-20-11, HME-20-21, HME-2-10-11, HME-2-20-11, HME-6-11, HMI-10-11, HMI-10-11UL, HMI-10-21, HMI-10-21UL, HMI-2-10-11, HMI-6-11, HMI-6-11UL, HMM-10-11, HMM-10-11UL, HMM-10-21, HMM-10-21UL, HMM-20-11, HMM-20-11UL, HMM-20-21, HMM-20-21UL, HMM-2-10-11, HMM-2-20-11, HMM-40-11-USMC, HMM-6-11, HMM-6-11UL, HMP-10-11, HMP-10-21, HMP-20-11, HMP-20-21, HMP-2-10-11, HMP-2-20-11, HMP-6-11, MFHMM-20-11		

			
1			
<b>GEV No.</b>	520917	<b>Ref. No.</b>	12034964
<b>description</b>	gasket for heat exchanger D1 ø 104mm D2 ø 132mm		

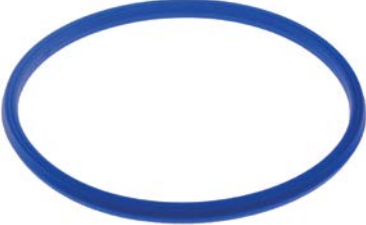
			
1			
<b>GEV No.</b>	694320	<b>Ref. No.</b>	12034776 RT50120566
<b>description</b>	gasket for lid ø 145mm		



1



<b>GEV No.</b>	692520	<b>Ref. No.</b>	12023750 T842809
<b>description</b>	gutter for inner door plastic W 675mm FAGOR		
<b>For models:</b>	COE-061, COE-101, COG-061, COG-101, VE-061, VE-101, VG-101, VPE-061, VPE-101, VPG-101		

1



<b>GEV No.</b>	691706	<b>Ref. No.</b>	12016458 T075003
<b>description</b>	heat exchanger complete SS		
<b>For models:</b>	HMG-6-11		

1



<b>GEV No.</b>	512184	<b>Ref. No.</b>	12032196 RT86641301
<b>description</b>	hose connector plastic thread 3/4" Qty 1 pcs connection distance 60mm T-shape		

1



<b>GEV No.</b>	694936	<b>Ref. No.</b>	12028877 RT50030300
<b>description</b>	insulating mat for combi-steamer CPC-Linie L 1078mm W 635mm H 11mm foam Qty 2 pcs		

1



<b>GEV No.</b>	691857	<b>Ref. No.</b>	12013749 12018338 12039157 R335030 R665046 T325040 T325077
<b>description</b>	level tank L 178mm ø 75mm		
<b>For models:</b>	HCV-5-11, HCV-6-11, HEM-10-11, HEM-10-21, HEM-20-11, HEM-20-21, HEM-6-11, HEP-10-11, HEP-10-21, HEP-20-11, HEP-20-21, HEP-6-11, HGP-10-21, HGP-20-21, HGV-10-11, HGV-10-21, HGV-20-11, HGV-20-21, HME-10-11, HME-10-21, HME-2-10-11, HME-6-11, HMM-6-11, HMM-6-11UL, HMP-10-11, HMP-10-21, HMP-2-10-11, HMP-6-11, HVG-10-11, HVG-10-11UL, HVG-10-21, HVG-10-21UL, HVG-20-11, HVG-20-21, HVG-2-10-11, HVG-2-20-21, MFHVG-10-11, MFHVG-10-21, VE-061, VE-101, VE-102, VE-201, VE-202, VPE-061, VPE-101, VPE-102, VPE-201, VPE-202		

1



<b>GEV No.</b>	691677	<b>Ref. No.</b>	12012047 R025011
<b>description</b>	level tank L 235mm SS ø 75mm		
<b>For models:</b>	HCV-10-11, HCV-10-21, HCV-2-10-21, HME-10-11, HME-10-21, HME-20-11, HME-20-21, HME-2-10-11, HME-2-20-11, HME-6-11, HMM-10-11, HMM-10-11UL, HMM-10-21, HMM-10-21UL, HMM-20-11, HMM-20-11UL, HMM-20-21, HMM-20-21UL, HMM-2-10-11, HMM-2-20-11, HMM-40-11-USMC, HMP-10-11, HMP-10-21, HMP-20-11, HMP-20-21, HMP-2-10-11, HMP-2-20-11, HMP-6-11, MFHMM-20-11		

			
1			
<b>GEV No.</b>	698491	<b>Ref. No.</b>	12024419 12113061 T325079
<b>description</b>	level tank level control bore ø 17mm L 205mm thread M12 W 28mm ø 20.5mm H 80mm		
<b>For models:</b>	ACE-061, ACE-102, AE-061, AE-061W, AE-101, AE-101W, AE-102, AE-102W, AE-201, AE-202, AG-061, AG-061W, AG-101, AG-101W, AG-102, AG-102W, AG-201, AG-202, APE-061, APE-061W, APE-101, APE-101W, APE-102, APE-102W, APE-201, APE-202, APG-061, APG-061W, APG-101, APG-101W, APG-102, APG-102W, APG-201, APG-202, GA-20, GA-20D, GA-40, GA-40D, VE-061, VE-101, VE-102, VE-201, VE-202, VG-101, VG-102, VG-201, VG-202, VPE-061, VPE-101, VPE-102...(Other models you can see in the webshop)		

			
2			
<b>GEV No.</b>	512497	<b>Ref. No.</b>	12037410 RT20390350
<b>description</b>	protection cap for pulser suitable for combi-steamer CPC-Linie CPC/CM 61-202 D1 ø 13.5mm H 8.5mm D2 ø 6mm silicone		

			
1			
<b>GEV No.</b>	691869	<b>Ref. No.</b>	12011086 R142614
<b>description</b>	protective plate for fan motor L 160mm		
<b>For models:</b>	HCG-10-11, HCG-10-21, HCG-20-11, HCG-20-21, HCG-2-10-11, HCG-2-20-11, HCG-6-11, HGC-10-11, HGC-20-11, HGC-6-11, HGV-10-11, HGV-20-11, HME-20-21, HMM-20-21, HMM-40-11-USMC, HMP-20-21, HVG-10-11, HVG-10-11UL, HVG-10-21, HVG-10-21UL, HVG-20-11, HVG-20-21, HVG-2-10-11, HVG-2-20-21, MFHVG-10-11, MFHVG-10-21		

			
1			
<b>GEV No.</b>	696427	<b>Ref. No.</b>	12009970 Q222011
<b>description</b>	rivet nut thread M5 DN 4mm L 12mm SS Qty 1 pcs ø 7mm WS 6		
<b>For models:</b>	ACE-061, ACE-101, ACE-102, ACE-201, ACE-202, ACG-061, ACG-101, ACG-102, ACG-201, ACG-202, AD-45BBT, AD-48HY, AD-64BBT, AD-64BTDD, AD-64HY, AE-061, AE-061W, AE-101, AE-101W, AE-102, AE-102W, AE-201, AE-202, AG-061, AG-061W, AG-101, AG-101W, AG-102, AG-102W, AG-201, AG-202, APE-061, APE-061W, APE-101, APE-101W, APE-102, APE-102W, APE-201, APE-202, APG-061, APG-061W, APG-101, APG-101W, APG-102, APG-102W, APG-201, APG-202, CE9-40, CE9-41, CG-2000...(Other models you can see in the webshop)		

			
1			
<b>GEV No.</b>	696393	<b>Ref. No.</b>	12027056 RT85141346
<b>description</b>	rotary nozzle for combi-steamer L 125mm stainless steel		

			
1			
<b>GEV No.</b>	694322	<b>Ref. No.</b>	12110550 RT5000303
<b>description</b>	sleeve for drip pan D1 ø 15mm D2 ø 20mm L 62mm		

			
1			
<b>GEV No.</b>	691734	<b>Ref. No.</b>	12020472 R675008
<b>description</b>	thread bolt for cavity degassing D1 ø 12mm L 58mm stainless steel thread M6		
<b>For models:</b>	HEI-10-11, HEI-20-11, HEI-6-11, HEM-10-11, HEM-20-11, HEM-6-11, HEP-10-11, HEP-20-11, HEP-6-11, HME-10-11, HME-10-21, HME-20-11, HME-20-21, HME-2-10-11, HME-2-20-11, HME-6-11, HMI-10-11, HMI-10-11UL, HMI-10-21, HMI-10-21UL, HMI-2-10-11, HMI-6-11, HMI-6-11UL, HMM-10-11, HMM-10-11UL, HMM-10-21, HMM-10-21UL, HMM-20-11, HMM-20-11UL, HMM-20-21, HMM-20-21UL, HMM-2-10-11, HMM-2-20-11, HMM-40-11-USMC, HMM-6-11, HMM-6-11UL, HMP-10-11, HMP-10-21, HMP-20-11, HMP-20-21, HMP-2-10-11, HMP-2-20-11, HMP-6-11		





<b>GEV No.</b>	694402	<b>Ref. No.</b>	12033922 RT83541304
<b>description</b>	valve body for air valve hose ø 10mm		
<b>accessories for</b>	694402		
	<b>GEV No.</b>	694433	<b>Ref. No.</b> 12036082 RT20690108
	air valve for combi-steamer bore ø 2mm L 18mm plastic ø 20mm		



<b>GEV No.</b>	542288	<b>Ref. No.</b>	12024796
<b>description</b>	valve body for combi-steamer hose ø 24mm		
<b>For models:</b>	APE-061, APE-061W, APE-101, APE-101W, APE-102, APE-102W, APE-201, APE-202, APG-061, APG-061W, APG-101, APG-101W, APG-102, APG-102W, APG-201, APG-202, HEP-10-21, HEP-20-21, HGP-10-21, HGP-20-21, VG-101, VPE-061, VPE-101, VPE-102, VPE-201, VPE-202, VPG-101, VPG-102, VPG-201, VPG-202		



<b>GEV No.</b>	530799	<b>Ref. No.</b>	12034624 RT5000073
<b>description</b>	water distributor for combi-steamer SCC, CM L 83mm bore ø 13mm thread 3/4"		





<b>GEV No.</b>	691883	<b>Ref. No.</b>	12016138 R675002
<b>description</b>	water pipe L 650mm		
<b>For models:</b>	HCG-10-11, HCG-20-11, HCG-6-11, HEM-10-11, HEM-20-11, HEM-6-11, HEP-10-11, HEP-20-11, HEP-6-11, HGV-10-11, HME-10-11, HME-20-11, HME-6-11, HMG-10-11, HMG-10-11UL, HMG-20-11, HMG-6-11, HMI-10-11, HMI-10-11UL, HMI-6-11, HMI-6-11UL, HMM-10-11, HMM-10-11UL, HMM-20-11, HMM-20-11UL, HMM-6-11, HMM-6-11UL, HMP-10-11, HMP-20-11, HMP-6-11, HVG-10-11, HVG-10-11UL, HVG-2-10-11, MFHMM-20-11, MFHVG-10-11		

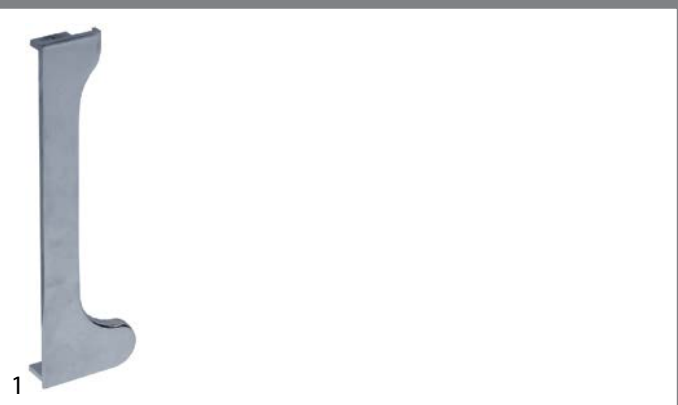

<b>GEV No.</b>	691884	<b>Ref. No.</b>	12015187 R685003
<b>description</b>	water pipe L 860mm		
<b>For models:</b>	HCG-10-21, HCG-20-21, HCG-2-10-11, HCG-2-20-11, HME-10-21, HME-20-21, HME-2-10-11, HMG-10-21, HMG-10-21UL, HMG-2-10-11, HMI-10-21, HMI-10-21UL, HMI-2-10-11, HMM-10-21, HMM-10-21UL, HMM-2-10-11, HMP-10-21, HMP-20-21, HMP-2-10-11, HVG-10-21, HVG-10-21UL, MFHVG-10-21		

for tilting bratt pans

housing and bezels





<b>GEV No.</b>	210022	<b>Ref. No.</b>	12020193 U452805
<b>description</b>	cover L 177mm W 52mm H 16mm for control panel mounting pos. left suitable for 700 series		
<b>For models:</b>	BG7-05, BG7-05I, BG7-10, BG7-10I, BME7-05, BME7-10, BMG7-10, CE7-20, CE7-40, CE7-41, CG7-10, CG7-11, CG7-20, CG-7200, CG7-40, CG-7400, CG7-41, CG-7415, CG7-61, CG-7615, CGB7-61, CGE7-41, CGE7-69, CPG7-05, EN7-05, EN7-10, FE-710, FE-720, FG-710, FG-720, FTE7-05, FTE7-05L, FTE7-05R, FTE7-10, FTE7-10L, FTE7-10L+R, FTE7-10R, FTEC7-05L, FTEC7-10L, FTG7-05, FTG7-05L, FTG7-05R, FTG7-05VL, FTG7-05VR, FTG7-10, FTG7-10L, FTG7-10L+R, FTG7-10R, FTG7-10VL, FTG7-10VL+R...(Other models you can see in the webshop)		
<b>accessories for</b>	210022		
	<b>GEV No.</b>	210021	<b>Ref. No.</b> 12020194 U452804
	cover L 177mm W 52mm H 16mm for control panel mounting pos. right suitable for 700 series		

			
<b>GEV No.</b>	210021	<b>Ref. No.</b>	12020194 U452804
<b>description</b>	cover L 177mm W 52mm H 16mm for control panel mounting pos. right suitable for 700 series		
<b>For models:</b>	BG7-05, BG7-05I, BG7-10, BG7-10I, BME7-05, BME7-10, BMG7-10, CE7-20, CE7-40, CE7-41, CG7-10, CG7-11, CG7-20, CG-7200, CG7-40, CG-7400, CG7-41, CG-7415, CG7-61, CG-7615, CGB7-61, CGE7-41, CGE7-62, CPG7-05, EN7-05, EN7-10, FE-710, FE-720, FG-710, FG-720, FTE7-05, FTE7-05L, FTE7-05R, FTE7-10, FTE7-10L, FTE7-10L+R, FTE7-10R, FTEC7-05L, FTEC7-10L, FTG7-05, FTG7-05L, FTG7-05R, FTG7-05VL, FTG7-05VR, FTG7-10, FTG7-10L, FTG7-10L+R, FTG7-10R, FTG7-10VL, FTG7-10VL+R...(Other models you can see in the webshop)		
<b>accessories for</b>	210021		
	<b>GEV No.</b>	<b>Ref. No.</b>	12020193 U452805
	cover L 177mm W 52mm H 16mm for control panel mounting pos. left suitable for 700 series		

<p>Reglado a BUTANO-PROPANO Reglage BUTANE-PROPANE Regulated for L.P.G. using</p>			
<b>GEV No.</b>	691735	<b>Ref. No.</b>	12008203 U136501
<b>description</b>	sticker Regulated for L.P.G. using		
<b>For models:</b>	BG7-05, BG7-05I, BG7-10, BG7-10I, BG9-05, BG9-05I, BG9-05PF, BG9-05PI, BG9-10, BG9-10I, BG9-10PF, BG9-10PI, BME9-05, BME9-05V-T, BME9-10, BME9-10V-T, BMG7-10, BMG9-05, BMG9-05V-T, BMG9-10, BMG9-10V-T, CG-1002, CG-1502, CG-2000, CG-2005, CG-210, CG-210G, CG-3005, CG-310, CG-310G, CG7-10, CG7-11, CG-7115, CG7-20, CG-7200, CG7-20H, CG7-30D, CG7-30I, CG7-31D, CG7-31I, CG7-40, CG-7400, CG7-40H, CG7-41, CG-7415, CG7-41H, CG7-50, CG7-51, CG7-61, CG-7615...(Other models you can see in the webshop)		

<p>Reglado a GAS NATURAL Reglage GAZ NATUREL Regulated for NATURAL GAS using</p>			
<b>GEV No.</b>	691736	<b>Ref. No.</b>	12008202 U134402
<b>description</b>	sticker regulated for NATURAL GAS using		
<b>For models:</b>	BG7-05, BG7-05I, BG7-10, BG7-10I, BG9-05, BG9-05I, BG9-05PF, BG9-05PI, BG9-10, BG9-10I, BG9-10PF, BG9-10PI, BME9-05, BME9-05V-T, BME9-10, BME9-10V-T, BMG7-10, BMG9-05, BMG9-05V-T, BMG9-10, BMG9-10V-T, CG-1002, CG-1502, CG-2000, CG-2005, CG-210, CG-210G, CG-3005, CG-310, CG-310G, CG7-10, CG7-11, CG-7115, CG7-20, CG-7200, CG7-20H, CG7-30D, CG7-30I, CG7-31D, CG7-31I, CG7-40, CG-7400, CG7-40H, CG7-41, CG-7415, CG7-41H, CG7-50, CG7-51, CG7-61...(Other models you can see in the webshop)		

			
<b>GEV No.</b>	691691	<b>Ref. No.</b>	12009010 12009015 U022836 U262806
<b>description</b>	type plate FAGOR metal		
<b>For models:</b>	BG6-05I, BG7-05, BG7-05I, BG7-10, BG7-10I, BG9-05, BG9-05AD, BG9-05I, BG9-05PF, BG9-05PI, BG9-05PLUS-I, BG9-10, BG9-10AD, BG9-10I, BG9-10PF, BG9-10PI, BG9-10PLUS-I, BME6-05, BME7-05, BME7-10, BME9-05, BME9-05AD, BME9-05PLUS, BME9-05V-T, BME9-10, BME9-10AD, BME9-10PLUS, BME9-10V-T, BMG7-10, BMG9-05, BMG9-05V-T, BMG9-10, BMG9-10V-T, CE6-20, CE6-40, CE6-41, CE7-20, CE7-40, CE7-41, CE9-20, CE9-20AD, CE9-20PLUS, CE9-40, CE9-40AD, CE9-40PLUS, CE9-41, CE9-41AD, CE9-41PLUS, CG-1002, CG-1502...(Other models you can see in the webshop)		

<b>spindles</b>			
			
<b>GEV No.</b>	514183	<b>Ref. No.</b>	12008720 X156113
<b>description</b>	bearing block for spindle		
<b>For models:</b>	SBE7-10, SBE9-10, SBE9-10I, SBE9-10I-AD, SBE9-10I-AD-S, SBE9-10IM, SBE9-10IMS, SBE9-10IS, SBE9-10PLUS-I, SBE9-10PLUS-SI, SBE9-10S, SBE9-10USMC, SBG7-10, SBG9-10, SBG9-10I, SBG9-10I-AD, SBG9-10I-AD-S, SBG9-10IS, SBG9-10PLUS-I, SBG9-10PLUS-SI, SBG9-10S		

			
<b>GEV No.</b>	691699	<b>Ref. No.</b>	12009226 X156114
<b>description</b>	bearing block for spindle		
<b>For models:</b>	SBE7-10, SBE9-10, SBE9-10I, SBE9-10I-AD, SBE9-10I-AD-S, SBE9-10IM, SBE9-10IMS, SBE9-10IS, SBE9-10PLUS-I, SBE9-10PLUS-SI, SBE9-10S, SBE9-10USMC, SBG7-10, SBG9-10, SBG9-10I, SBG9-10I-AD, SBG9-10I-AD-S, SBG9-10IS, SBG9-10PLUS-I, SBG9-10PLUS-SI, SBG9-10S		







			
<b>GEV No.</b>	514199	<b>Ref. No.</b>	12008106 X156115
<b>description</b>	bush for spindle ID $\varnothing$ 18mm ED $\varnothing$ 30mm L 45mm		
<b>For models:</b>	SBE7-10, SBE9-10, SBE9-10I, SBE9-10I-AD, SBE9-10I-AD-S, SBE9-10IM, SBE9-10IMS, SBE9-10IS, SBE9-10PLUS-I, SBE9-10PLUS-SI, SBE9-10S, SBE9-10USMC, SBG7-10, SBG9-10, SBG9-10I, SBG9-10I-AD, SBG9-10I-AD-S, SBG9-10IS, SBG9-10PLUS-I, SBG9-10PLUS-SI, SBG9-10S		
<b>accessories for</b>	514199		
	<b>GEV No.</b>	<b>Ref. No.</b>	12019420 X156116
	spindle for spindle L 165mm		
	<b>GEV No.</b>	<b>Ref. No.</b>	12008262 X156125
	thrust ball bearing shaft $\varnothing$ 20mm ED $\varnothing$ 40mm W 14mm type 51204 DIN 711		

Table continues overleaf





<b>accessories for</b>	514199		
	<b>GEV No.</b>	560028	<b>Ref. No.</b> —
	cylinder head bolt thread M5 thread L 14mm WS 4 SS Qty 20 pcs DIN 912/ISO 4762		

	<b>GEV No.</b>	514182	<b>Ref. No.</b>	12019420 X156116
<b>description</b>	spindle for spindle L 165mm			
<b>For models:</b>	SBE7-10, SBE9-10, SBE9-10I, SBE9-10IS, SBE9-10S, SBG7-10, SBG9-10, SBG9-10I, SBG9-10IS, SBG9-10S			
<b>accessories for</b>	514182			
	<b>GEV No.</b>	514199	<b>Ref. No.</b>	12008106 X156115
	bush for spindle ID ø 18mm ED ø 30mm L 45mm			
	<b>GEV No.</b>	523536	<b>Ref. No.</b>	12008262 X156125
	thrust ball bearing shaft ø 20mm ED ø 40mm W 14mm type 51204 DIN 711			
	<b>GEV No.</b>	560028	<b>Ref. No.</b>	—
	cylinder head bolt thread M5 thread L 14mm WS 4 SS Qty 20 pcs DIN 912/ISO 4762			

	<b>GEV No.</b>	691694	<b>Ref. No.</b>	12017865 12040547 X266111 X266119
<b>description</b>	spindle L 470mm ø 26mm for 700 series			
<b>For models:</b>	SBE7-10, SBG7-10			
<b>accessories for</b>	691694			
	<b>GEV No.</b>	691696	<b>Ref. No.</b>	12017767 X156154
	spindle nut thread TR26x8 right-hand thread W 60.6mm D 35mm H 35mm suitable for 700/900 series			

	<b>GEV No.</b>	514198	<b>Ref. No.</b>	12017861 X266101
<b>description</b>	spindle thread TR26x8 L 525mm ø 26mm total length 565mm for tilting bratt pan			
<b>For models:</b>	SBE7-10, SBG7-10			

	<b>GEV No.</b>	691696	<b>Ref. No.</b>	12017767 X156154
<b>description</b>	spindle nut thread TR26x8 right-hand thread W 60.6mm D 35mm H 35mm suitable for 700/900 series			
<b>For models:</b>	SBE7-10, SBE9-10, SBE9-10I, SBE9-10IM, SBE9-10IMS, SBE9-10IS, SBE9-10M, SBE9-10MS, SBE9-10S, SBE9-10USMC, SBE9-15IM, SBE9-15IMS, SBG7-10, SBG9-10, SBG9-10I, SBG9-10IM, SBG9-10IMS, SBG9-10IS, SBG9-10M, SBG9-10MS, SBG9-10S, SBG9-15IM, SBG9-15IMS			

	<b>GEV No.</b>	691692	<b>Ref. No.</b>	12040024 12040025 X026107 X156152
<b>description</b>	threaded rod L 610mm ø 26mm for 900 series			
<b>For models:</b>	SBE9-10, SBE9-10I, SBE9-10IM, SBE9-10IMS, SBE9-10IS, SBE9-10M, SBE9-10MS, SBE9-10S, SBE9-10USMC, SBE9-15IM, SBE9-15IMS, SBG9-10, SBG9-10I, SBG9-10IM, SBG9-10IMS, SBG9-10IS, SBG9-10M, SBG9-10MS, SBG9-10S, SBG9-15IM, SBG9-15IMS			
<b>accessories for</b>	691692			
	<b>GEV No.</b>	691696	<b>Ref. No.</b>	12017767 X156154
	spindle nut thread TR26x8 right-hand thread W 60.6mm D 35mm H 35mm suitable for 700/900 series			

	<b>GEV No.</b>	692535	<b>Ref. No.</b>	12009467 12046631 X146138
<b>description</b>	threaded rod L 620mm ø 26mm TR26x5 complete			

sumps

	<b>GEV No.</b>	691900	<b>Ref. No.</b>	12009590 X286111
<b>description</b>	sump for tilting bratt pan L 1260mm W 700mm H 200mm stainless steel			
<b>For models:</b>	SBE9-10IM, SBE9-10IMS, SBE9-10M, SBE9-10MS, SBE9-15IM, SBE9-15IMS, SBG9-15IM, SBG9-15IMS			

	<b>GEV No.</b>	691898	<b>Ref. No.</b>	12007698 X146125
<b>description</b>	sump for tilting bratt pan L 840mm W 700mm cast iron since July 2002			
<b>For models:</b>	SBE9-10, SBE9-10I, SBE9-10IM, SBE9-10IMS, SBE9-10IS, SBE9-10M, SBE9-10MS, SBE9-10S, SBE9-15IM, SBE9-15IMS, SBG9-10, SBG9-10IM, SBG9-10IMS, SBG9-10M, SBG9-10MS, SBG9-10S			

			
1			
<b>GEV No.</b>	691899	<b>Ref. No.</b>	12010883 X146116
<b>description</b>	sump for tilting bratt pan L 840mm W 700mm cast iron until June 2002		
<b>For models:</b>	SBE9-10, SBE9-10M, SBE9-10MS, SBE9-10S, SBG9-10M, SBG9-10MS		

			
1			
<b>GEV No.</b>	691897	<b>Ref. No.</b>	12009588 12016309 12016311 X146133 X156150 X156168
<b>description</b>	sump for tilting bratt pan L 840mm W 700mm stainless steel		
<b>For models:</b>	SBE9-10I, SBE9-10IM, SBE9-10IMS, SBE9-10IS, SBE9-10M, SBE9-10MS, SBE9-15IM, SBE9-15IMS, SBG9-10, SBG9-10I, SBG9-10IM, SBG9-10IMS, SBG9-10IS, SBG9-10M, SBG9-10MS, SBG9-10S, SBG9-15IM, SBG9-15IMS		

## miscellaneous

			
1			
<b>GEV No.</b>	505335	<b>Ref. No.</b>	12009773 X109550
<b>description</b>	bushing L 30mm ø 22/28mm for tilting bratt pan brass		
<b>For models:</b>	SBE7-10, SBE9-10, SBE9-10I, SBE9-10I-AD, SBE9-10I-AD-S, SBE9-10IM, SBE9-10IM-AD, SBE9-10IM-AD-S, SBE9-10IMS, SBE9-10IS, SBE9-10M, SBE9-10MS, SBE9-10PLUS-I, SBE9-10PLUS-IM, SBE9-10PLUS-SI, SBE9-10PLUS-SIM, SBE9-10S, SBE9-10USMC, SBE9-15IM, SBE9-15IM-AD, SBE9-15IM-AD-S, SBE9-15IMS, SBE9-15PLUS-IM, SBE9-15PLUS-SIM, SBG7-10, SBG-9040, SBG9-10, SBG9-10I, SBG9-10I-AD, SBG9-10I-AD-S, SBG9-10IM, SBG9-10IM-AD, SBG9-10IM-AD-S, SBG9-10IMS, SBG9-10IS, SBG9-10M, SBG9-10MS, SBG9-10PLUS-I, SBG9-10PLUS-IM, SBG9-10PLUS-SI, SBG9-10PLUS-SIM, SBG9-10S, SBG9-15IM, SBG9-15IM-AD, SBG9-15IM-AD-S, SBG9-15IMS, SBG9-15PLUS-IM, SBG9-15PLUS-SIM		

			
1			
<b>GEV No.</b>	514427	<b>Ref. No.</b>	12002206 X152679
<b>description</b>	fastening angle L 46mm for tilting bratt pan W 24mm H 25mm thickness 2mm		
<b>For models:</b>	SBG7-10, SBG9-10, SBG9-10I, SBG9-10IM, SBG9-10IMS, SBG9-10IS, SBG9-10M, SBG9-10MS, SBG9-10S, SBG9-15IM, SBG9-15IMS		

## for boiling pans

## spare parts and accessories

			
1			
<b>GEV No.</b>	691650	<b>Ref. No.</b>	12019228
<b>description</b>	connecting fitting brass L 52mm W 30mm H 30mm		

			
1			
<b>GEV No.</b>	691651	<b>Ref. No.</b>	12020990
<b>description</b>	threaded part brass L 27mm ID ø 12.4mm thread 1/2"		

## filters



			
1			
<b>GEV No.</b>	514159	<b>Ref. No.</b>	12014430 S316120
<b>description</b>	drain filter for kettle		
<b>For models:</b>	ME7-10BM, MG7-10, MG7-10BM		



			
1			
<b>GEV No.</b>	514503	<b>Ref. No.</b>	12031575 FX30700122
<b>description</b>	drain filter for kettle size 76x145mm		



			
1			
<b>GEV No.</b>	514338	<b>Ref. No.</b>	12031318 ICRE32300340
<b>description</b>	drain filter size 12,5x24mm for kettle		

housing and bezels

			
1			
<b>GEV No.</b>	210022	<b>Ref. No.</b>	12020193 U452805
<b>description</b>	cover L 177mm W 52mm H 16mm for control panel mounting pos. left suitable for 700 series		
<b>For models:</b>	BG7-05, BG7-05I, BG7-10, BG7-10I, BME7-05, BME7-10, BMG7-10, CE7-20, CE7-40, CE7-41, CG7-10, CG7-11, CG7-20, CG-7200, CG7-40, CG-7400, CG7-41, CG-7415, CG7-61, CG-7615, CGB7-61, CGE7-41, CGE7-69, CPG7-05, EN7-05, EN7-10, FE-710, FE-720, FG-710, FG-720, FTE7-05, FTE7-05L, FTE7-05R, FTE7-10, FTE7-10L, FTE7-10L+R, FTE7-10R, FTEC7-05L, FTEC7-10L, FTG7-05, FTG7-05L, FTG7-05R, FTG7-05VL, FTG7-05VR, FTG7-10, FTG7-10L, FTG7-10L+R, FTG7-10R, FTG7-10VL, FTG7-10VL+R...(Other models you can see in the webshop)		
<b>accessories for</b>	210022		
		<b>GEV No.</b>	210021
		<b>Ref. No.</b>	12020194 U452804
	cover L 177mm W 52mm H 16mm for control panel mounting pos. right suitable for 700 series		

			
1			
<b>GEV No.</b>	210021	<b>Ref. No.</b>	12020194 U452804
<b>description</b>	cover L 177mm W 52mm H 16mm for control panel mounting pos. right suitable for 700 series		
<b>For models:</b>	BG7-05, BG7-05I, BG7-10, BG7-10I, BME7-05, BME7-10, BMG7-10, CE7-20, CE7-40, CE7-41, CG7-10, CG7-11, CG7-20, CG-7200, CG7-40, CG-7400, CG7-41, CG-7415, CG7-61, CG-7615, CGB7-61, CGE7-41, CGE7-62, CPG7-05, EN7-05, EN7-10, FE-710, FE-720, FG-710, FG-720, FTE7-05, FTE7-05L, FTE7-05R, FTE7-10, FTE7-10L, FTE7-10L+R, FTE7-10R, FTEC7-05L, FTEC7-10L, FTG7-05, FTG7-05L, FTG7-05R, FTG7-05VR, FTG7-10, FTG7-10L, FTG7-10L+R, FTG7-10R, FTG7-10VL, FTG7-10VL+R...(Other models you can see in the webshop)		
<b>accessories for</b>	210021		
		<b>GEV No.</b>	210022
		<b>Ref. No.</b>	12020193 U452805
	cover L 177mm W 52mm H 16mm for control panel mounting pos. left suitable for 700 series		

			
1			
<b>GEV No.</b>	700809	<b>Ref. No.</b>	12007564 R205409
<b>description</b>	fastening angle L 120mm W 67mm H 28mm		
<b>For models:</b>	BG9-05, BG9-10, BME9-05, BME9-10, BMG9-05, BMG9-10, CE9-20, CE9-40, CE9-41, CG9-10, CG9-11, CG9-20, CG9-40, CG9-41, CG9-60, CG9-61, CG9-82, EN9-05, EN9-10, FE-920, FG-920, FG-940, FTE9-05L, FTE9-05R, FTE9-10L, FTE9-10L+R, FTE9-10R, FTEC9-05, FTEC9-05L, FTEC9-05R, FTEC9-10, FTEC9-10L, FTEC9-10L+R, FTEC9-10R, FTG9-05L, FTG9-05R, FTG9-05VL, FTG9-05VR, FTG9-10L, FTG9-10L+R, FTG9-10R, FTG9-10VL, FTG9-10VL+R, FTG9-10VR, FTGC9-05, FTGC9-05L, FTGC9-05R, FTGC9-10, FTGC9-10L, FTGC9-10L+R...(Other models you can see in the webshop)		

			
1			
<b>GEV No.</b>	691702	<b>Ref. No.</b>	12011406 S312613
<b>description</b>	front panel W 110mm H 70mm thickness 1mm		
<b>For models:</b>	MG7-10, MG7-10BM		

			
1			
<b>GEV No.</b>	691711	<b>Ref. No.</b>	12012336 S312614
<b>description</b>	front panel W 457mm H 80mm for kettle		
<b>For models:</b>	MG7-10, MG7-10BM		

			
1			
<b>GEV No.</b>	104123	<b>Ref. No.</b>	12013999 U742640
<b>description</b>	mounting plate for gas range L 690mm W 110mm H 25mm		
<b>For models:</b>	CE7-41, CG7-11, CG7-41, CGE7-41, FE-720, FG-720, MB7-10, MG7-10, MG7-10BM		

<div style="border: 1px solid black; padding: 5px; text-align: center;"> <p>Reglado a BUTANO-PROPANO Reglage BUTANE-PROPANE Regulated for L.P.G. using</p> </div>			
1			
<b>GEV No.</b>	691735	<b>Ref. No.</b>	12008203 U136501
<b>description</b>	sticker Regulated for L.P.G. using		
<b>For models:</b>	BG7-05, BG7-05I, BG7-10, BG7-10I, BG9-05, BG9-05I, BG9-05PF, BG9-05PI, BG9-10, BG9-10I, BG9-10PF, BG9-10PI, BME9-05, BME9-05V-T, BME9-10, BME9-10V-T, BMG7-10, BMG9-05, BMG9-05V-T, BMG9-10, BMG9-10V-T, CG-1002, CG-1502, CG-2000, CG-200S, CG-210, CG-210G, CG-300S, CG-310, CG-310G, CG7-10, CG7-11, CG-7115, CG7-20, CG-7200, CG7-20H, CG7-30D, CG7-30I, CG7-31D, CG7-31I, CG7-40, CG-7400, CG7-40H, CG7-41, CG-7415, CG7-41H, CG7-50, CG7-51, CG7-61, CG-7615...(Other models you can see in the webshop)		

<div style="border: 1px solid black; padding: 5px; text-align: center;"> <p>Reglado a GAS NATURAL Reglage GAZ NATUREL Regulated for NATURAL GAS using</p> </div>			
1			
<b>GEV No.</b>	691736	<b>Ref. No.</b>	12008202 U134402
<b>description</b>	sticker regulated for NATURAL GAS using		
<b>For models:</b>	BG7-05, BG7-05I, BG7-10, BG7-10I, BG9-05, BG9-05I, BG9-05PF, BG9-05PI, BG9-10, BG9-10I, BG9-10PF, BG9-10PI, BME9-05, BME9-05V-T, BME9-10, BME9-10V-T, BMG7-10, BMG-9045, BMG9-05, BMG9-05V-T, BMG9-10, BMG9-10V-T, CG-1002, CG-1502, CG-2000, CG-200S, CG-210, CG-210G, CG-300S, CG-310, CG-310G, CG7-10, CG7-11, CG-7115, CG7-20, CG-7200, CG7-20H, CG7-30D, CG7-30I, CG7-31D, CG7-31I, CG7-40, CG-7400, CG7-40H, CG7-41, CG-7415, CG7-41H, CG7-50, CG7-51, CG7-61...(Other models you can see in the webshop)		

<b>glass panels</b>			
			
1			
<b>GEV No.</b>	692158	<b>Ref. No.</b>	12008981 9294600
<b>description</b>	glass panel ø 29.5mm thickness 5mm		
<b>For models:</b>	FE-18, FE-25, FGCL9-05, MG7-10, MG7-10BM, MG9-10, MG9-10AD, MG9-10BM, MG9-10BMAD, MG9-10BMS, MG9-10BMSAD, MG9-10PLUS, MG9-10PLUS-BM, MG9-10PLUS-BMS, MG9-10PLUS-S, MG9-10S, MG9-10S-AD, MG9-15, MG-9150BM, MG9-15AD, MG9-15BM, MG9-15BM316, MG9-15BMAD, MG9-15BMS, MG9-15BMSAD, MG9-15PLUS, MG9-15PLUS-BM, MG9-15PLUS-BMS, MG9-15PLUS-S, MG9-15S, MG9-15S-AD, MG9-20, MG9-20AD, MG9-20PLUS, MG9-20PLUS-S, MG9-20S, MG9-20S-AD, MPG9-10, MPG9-10BM, MPG9-10BMS, MPG9-10S, MPG9-15, MPG9-15BM, MPG9-15BMS, MPG9-15S, MPG9-20, MPG9-20S		

<b>level glasses</b>			
<b>components</b>			
<b>gaskets</b>			
			
1			
<b>GEV No.</b>	691010	<b>Ref. No.</b>	12010108 Q307069
<b>description</b>	O-ring thickness 2.62mm ID ø 12.37mm Qty 1 pcs for water level tube		
<b>For models:</b>	ME9-10BM, ME9-10BMS, ME9-15BM, ME9-15BM316, ME9-15BMS, MG9-10BM, MG9-10BMS, MG9-15BM, MG9-15BM316, MG9-15BMS, MPE9-10BM, MPE9-10BMS, MPE9-15BM, MPE9-15BMS, MPG9-10BM, MPG9-10BMS, MPG9-15BM, MPG9-15BMS		

<b>level glass pipes</b>			
			
1			
<b>GEV No.</b>	691071	<b>Ref. No.</b>	12008327 S042102
<b>description</b>	water level tube D1 ø 13mm D2 ø 8.6mm L 138.5mm marking red/blue		
<b>For models:</b>	ME9-10BM, ME9-10BMS, ME9-15BM, ME9-15BM316, ME9-15BMS, MG9-10BM, MG9-10BMS, MG9-15BM, MG9-15BM316, MG9-15BMS, MPE9-10BM, MPE9-10BMS, MPE9-15BM, MPE9-15BMS, MPG9-10BM, MPG9-10BMS, MPG9-15BM, MPG9-15BMS		

screw connections



1

<b>GEV No.</b>	691072	<b>Ref. No.</b>	12008966 S042101
<b>description</b>	connection angle for water level tube thread 3/8" brass hole ø 13.5mm		
<b>For models:</b>	ME9-10BM, ME9-10BMS, ME9-15BM, ME9-15BM316, ME9-15BMS, MG9-10BM, MG9-10BMS, MG9-15BM, MG9-15BM316, MG9-15BMS, MPE9-10BM, MPE9-10BMS, MPE9-15BM, MPE9-15BMS, MPG9-10BM, MPG9-10BMS, MPG9-15BM, MPG9-15BMS		

complete



1

<b>GEV No.</b>	691031	<b>Ref. No.</b>	12000135 S082100
<b>description</b>	water level tube complete		
<b>For models:</b>	ME9-10BM, ME9-10BMS, ME9-15BM, ME9-15BMS, MG9-10BM, MG9-10BMS, MG9-15BM, MG9-15BMS, MPE9-10BM, MPE9-10BMS, MPE9-15BM, MPE9-15BMS, MPG9-10BM, MPG9-10BMS, MPG9-15BM, MPG9-15BMS		

accessories



1

<b>GEV No.</b>	691070	<b>Ref. No.</b>	12004490 S042647
<b>description</b>	protector for level glass		
<b>For models:</b>	ME9-10BM, ME9-10BMS, ME9-15BM, ME9-15BM316, ME9-15BMS, MG9-10BM, MG9-10BMS, MG9-15BM, MG9-15BM316, MG9-15BMS, MPE9-10BM, MPE9-10BMS, MPE9-15BM, MPE9-15BMS, MPG9-10BM, MPG9-10BMS, MPG9-15BM, MPG9-15BMS		

sumps



1

<b>GEV No.</b>	691896	<b>Ref. No.</b>	12016271 S226102
<b>description</b>	sump for kettle ID ø 680mm H 550mm L 850mm W 750mm stainless steel		
<b>For models:</b>	MG9-15BM, MG9-15BMS		

for pasta cookers

spare parts and accessories

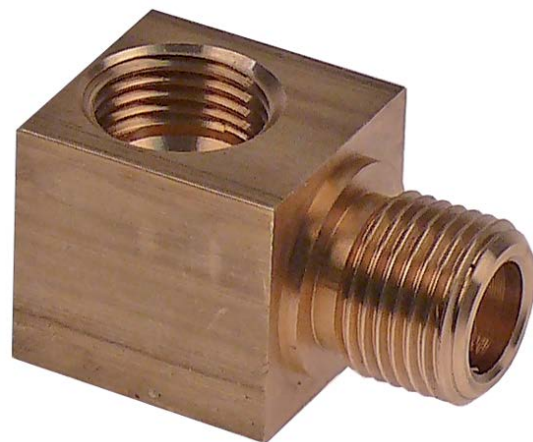

1

<b>GEV No.</b>	691650	<b>Ref. No.</b>	12019228
<b>description</b>	connecting fitting brass L 52mm W 30mm H 30mm		



1

<b>GEV No.</b>	691651	<b>Ref. No.</b>	12020990
<b>description</b>	threaded part brass L 27mm ID ø 12.4mm thread 1/2"		

for ovens

spare parts and accessories



1

<b>GEV No.</b>	691703	<b>Ref. No.</b>	12019787 U125409
<b>description</b>	distance washer for handrail		
<b>For models:</b>	CG-HP-20, FI-5420, FI-7630		



1

<b>GEV No.</b>	691707	<b>Ref. No.</b>	FAG6000009
<b>description</b>	distance washer SS H 10mm ID ø 18mm ext. ø 16		



1

<b>GEV No.</b>	691676	<b>Ref. No.</b>	FAG600008
<b>description</b>	hanging bracket SS L 350mm ø 8mm		



1

<b>GEV No.</b>	691675	<b>Ref. No.</b>	FAG600007
<b>description</b>	hanging bracket SS L 383mm ø 8mm		



1

<b>GEV No.</b>	691683	<b>Ref. No.</b>	12007464 R152607
<b>description</b>	holding plate for drain L 110mm W 60mm ID ø 48mm		
<b>For models:</b>	CG9-51L, CG9-51LC, CG9-51R, CG9-51RC, FTE7-05, FTE7-05L, FTE7-05R, FTE7-10, FTE7-10L, FTE7-10L+R, FTE7-10R, FTE9-05L, FTE9-05R, FTE9-10L, FTE9-10L+R, FTE9-10R, FTEC7-05L, FTEC7-10L, FTEC9-05L, FTEC9-05R, FTEC9-05USMC, FTEC9-10L, FTEC9-10L+R, FTEC9-10R, FTEC9-10USMC, FTG7-05, FTG7-05L, FTG7-05R, FTG7-05VL, FTG7-05VR, FTG7-10, FTG7-10L, FTG7-10L+R, FTG7-10R, FTG7-10VL, FTG7-10VL+R, FTG7-10VR, FTG9-05L, FTG9-05R, FTG9-05VL, FTG9-05VR, FTG9-10L, FTG9-10L+R, FTG9-10R, FTG9-10VL, FTG9-10VL+R, FTG9-10VR, FTG9-11L, FTG9-11L+R, FTG9-11R...(Other models you can see in the webshop)		

housing and bezels

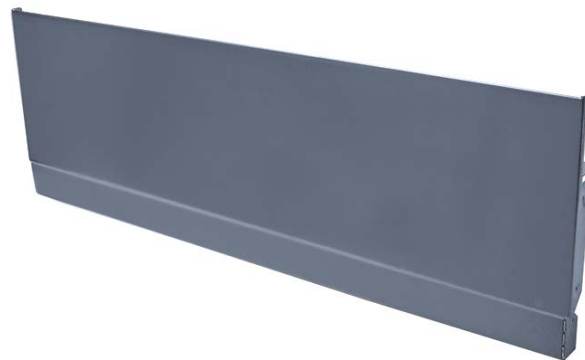

1

<b>GEV No.</b>	691722	<b>Ref. No.</b>	12004214 R062811
<b>description</b>	back panel chargin grill		
<b>For models:</b>	BG9-05AD, BG9-05PF, BG9-05PI, BG9-05PLUS-I, BG9-10AD, BG9-10PF, BG9-10PI, BG9-10PLUS-I, BME9-05, BME9-05AD, BME9-05PLUS, BME9-05V-T, BME9-10, BME9-10AD, BME9-10PLUS, BME9-10V-T, BMG9-05, BMG9-05V-T, BMG9-10, BMG9-10V-T, CE9-20, CE9-20AD, CE9-20PLUS, CE9-40, CE9-40AD, CE9-40PLUS, CG9-05AD, CG9-05PLUS, CG9-10, CG9-10AD, CG9-10PLUS, CG9-20, CG9-20AD, CG9-20AD-H, CG9-20H, CG9-20PLUS, CG9-20PLUS-H, CG9-40, CG9-40AD, CG9-40AD-H, CG9-40H, CG9-40PLUS, CG9-40PLUS-H, CG9-60, CG9-60AD, CG9-60AD-H, CG9-60H, CG9-60PLUS, CG9-60PLUS-H, CGF9-120D...(Other models you can see in the webshop)		





1

<b>GEV No.</b>	210022	<b>Ref. No.</b>	12020193 U452805
<b>description</b>	cover L 177mm W 52mm H 16mm for control panel mounting pos. left suitable for 700 series		
<b>For models:</b>	BG7-05, BG7-05I, BG7-10, BG7-10I, BME7-05, BME7-10, BMG7-10, CE7-20, CE7-40, CE7-41, CG7-10, CG7-11, CG7-20, CG-7200, CG7-40, CG-7400, CG7-41, CG-7415, CG7-61, CG-7615, CGB7-61, CGE7-41, CGE7-69, CPG7-05, EN7-05, EN7-10, FE-710, FE-720, FG-710, FG-720, FTE7-05, FTE7-05L, FTE7-05R, FTE7-10, FTE7-10L, FTE7-10L+R, FTE7-10R, FTEC7-05L, FTEC7-10L, FTG7-05, FTG7-05L, FTG7-05R, FTG7-05VL, FTG7-05VR, FTG7-10, FTG7-10L, FTG7-10L+R, FTG7-10R, FTG7-10VL, FTG7-10VL+R...(Other models you can see in the webshop)		
<b>accessories for</b>	210022		
	<b>GEV No.</b>	210021	<b>Ref. No.</b>
			12020194 U452804
	cover L 177mm W 52mm H 16mm for control panel mounting pos. right suitable for 700 series		



1

<b>GEV No.</b>	210021	<b>Ref. No.</b>	12020194 U452804
<b>description</b>	cover L 177mm W 52mm H 16mm for control panel mounting pos. right suitable for 700 series		
<b>For models:</b>	BG7-05, BG7-05I, BG7-10, BG7-10I, BME7-05, BME7-10, BMG7-10, CE7-20, CE7-40, CE7-41, CG7-10, CG7-11, CG7-20, CG-7200, CG7-40, CG-7400, CG7-41, CG-7415, CG7-61, CG-7615, CGB7-61, CGE7-41, CGE7-62, CPG7-05, EN7-05, EN7-10, FE-710, FE-720, FG-710, FG-720, FTE7-05, FTE7-05L, FTE7-05R, FTE7-10, FTE7-10L, FTE7-10L+R, FTE7-10R, FTEC7-05L, FTEC7-10L, FTG7-05, FTG7-05L, FTG7-05R, FTG7-05VL, FTG7-05VR, FTG7-10, FTG7-10L, FTG7-10L+R, FTG7-10R, FTG7-10VL, FTG7-10VL+R...(Other models you can see in the webshop)		
<b>accessories for</b>	210021		
	<b>GEV No.</b>	210022	<b>Ref. No.</b>
			12020193 U452805
	cover L 177mm W 52mm H 16mm for control panel mounting pos. left suitable for 700 series		

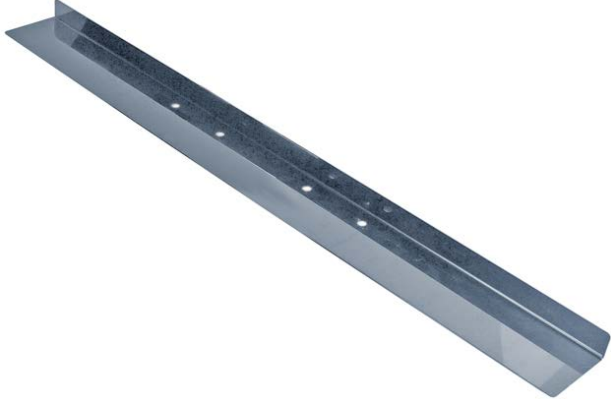

1

<b>GEV No.</b>	550769	<b>Ref. No.</b>	12015009 U805616
<b>description</b>	cover plate for switch		
<b>For models:</b>	CE7-41, CGE7-215, CGE7-41		

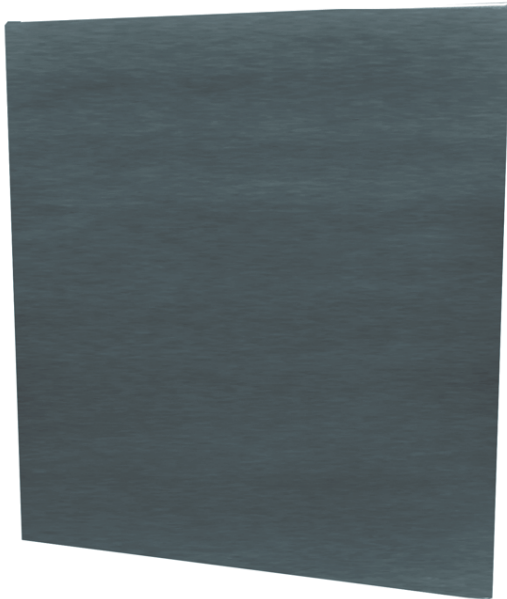

1

<b>GEV No.</b>	691851	<b>Ref. No.</b>	12011376
<b>description</b>	cover plate L 697mm W 623mm plate thickness max. 20mm		





1

<b>GEV No.</b>	700809	<b>Ref. No.</b>	12007564 R205409
<b>description</b>	fastening angle L 120mm W 67mm H 28mm		
<b>For models:</b>	BG9-05, BG9-10, BME9-05, BME9-10, BMG9-05, BMG9-10, CE9-20, CE9-40, CE9-41, CG9-10, CG9-11, CG9-20, CG9-40, CG9-41, CG9-60, CG9-61, CG9-82, EN9-05, EN9-10, FE-920, FG-920, FG-940, FTE9-05L, FTE9-05R, FTE9-10L, FTE9-10L+R, FTE9-10R, FTEC9-05, FTEC9-05L, FTEC9-05R, FTEC9-10, FTEC9-10L, FTEC9-10L+R, FTEC9-10R, FTG9-05L, FTG9-05R, FTG9-05VL, FTG9-05VR, FTG9-10L, FTG9-10L+R, FTG9-10R, FTG9-10VL, FTG9-10VL+R, FTG9-10VR, FTGC9-05, FTGC9-05L, FTGC9-05R, FTGC9-10, FTGC9-10L, FTGC9-10L+R...(Other models you can see in the webshop)		

			
1			
<b>GEV No.</b>	691724	<b>Ref. No.</b>	12014588 R942800
<b>description</b>	front panel		
<b>For models:</b>	EN7-05		

			
1			
<b>GEV No.</b>	691714	<b>Ref. No.</b>	12004071 H012821
<b>description</b>	front panel for drawers 1/2 W 420mm H 80mm		
<b>For models:</b>	BG9-05, BG9-05AD, BG9-05I, BG9-05PF, BG9-05PI, BG9-05PLUS-I, BG9-10, BG9-10AD, BG9-10I, BG9-10PF, BG9-10PI, BG9-10PLUS-I, CG9-10, CG9-20, CG9-40, CG9-60, CGF9-120D, CGF9-120I, FTE9-05L, FTE9-05L-AD, FTE9-05PLUS-CL, FTE9-05PLUS-CR, FTE9-05PLUS-L, FTE9-05PLUS-R, FTE9-05R, FTE9-05R-AD, FTE9-10L, FTE9-10L+R, FTE9-10L+R-AD, FTE9-10L-AD, FTE9-10PLUS-CL, FTE9-10PLUS-LR, FTE9-10PLUS-R, FTE9-10R, FTE9-10R-AD, FTEC9-05L, FTEC9-05L-AD, FTEC9-05R, FTEC9-05R-AD, FTEC9-10L, FTEC9-10L+R, FTEC9-10L+R-AD, FTEC9-10L-AD, FTEC9-10R, FTEC9-10R-AD, FTG9-05L, FTG9-05L-AD...(Other models you can see in the webshop)		

			
1			
<b>GEV No.</b>	691719	<b>Ref. No.</b>	12014273 U732805
<b>description</b>	front panel for gas range W 700mm H 170mm		

 Image not available			
1			
<b>GEV No.</b>	691723	<b>Ref. No.</b>	12008013 U745610
<b>description</b>	insulation		
<b>For models:</b>	CG7-11, CG7-41, CG7-61, CG9-11, CG9-41, CG9-51L, CG9-51LC, CG9-51R, CG9-51RC, CG9-61, CG9-82, CGF9-121D, CGF9-121I, FTG9-11L, FTG9-11L+R, FTG9-11R, FTGC9-11L, FTGC9-11L+R, FTGC9-11R, HG9-10, HG9-20		

			
1			
<b>GEV No.</b>	104123	<b>Ref. No.</b>	12013999 U742640
<b>description</b>	mounting plate for gas range L 690mm W 110mm H 25mm		
<b>For models:</b>	CE7-41, CG7-11, CG7-41, CGE7-41, FE-720, FG-720, MB7-10, MG7-10, MG7-10BM		

<b>Reglado a BUTANO-PROPANO</b> <b>Reglage BUTANE-PROPANE</b> <b>Regulated for L.P.G. using</b>			
1			
<b>GEV No.</b>	691735	<b>Ref. No.</b>	12008203 U136501
<b>description</b>	sticker Regulated for L.P.G. using		
<b>For models:</b>	BG7-05, BG7-05I, BG7-10, BG7-10I, BG9-05, BG9-05I, BG9-05PF, BG9-05PI, BG9-10, BG9-10I, BG9-10PF, BG9-10PI, BME9-05, BME9-05V-T, BME9-10, BME9-10V-T, BMG7-10, BMG9-05, BMG9-05V-T, BMG9-10, BMG9-10V-T, CG-1002, CG-1502, CG-2000, CG-2005, CG-210, CG-210G, CG-300S, CG-310, CG-310G, CG7-10, CG7-11, CG-7115, CG7-20, CG-7200, CG7-20H, CG7-30D, CG7-30I, CG7-31D, CG7-31I, CG7-40, CG-7400, CG7-40H, CG7-41, CG-7415, CG7-41H, CG7-50, CG7-51, CG7-61, CG-7615...(Other models you can see in the webshop)		

<b>Reglado a GAS NATURAL</b> <b>Reglage GAZ NATUREL</b> <b>Regulated for NATURAL GAS using</b>			
1			
<b>GEV No.</b>	691736	<b>Ref. No.</b>	12008202 U134402
<b>description</b>	sticker regulated for NATURAL GAS using		
<b>For models:</b>	BG7-05, BG7-05I, BG7-10, BG7-10I, BG9-05, BG9-05I, BG9-05PF, BG9-05PI, BG9-10, BG9-10I, BG9-10PF, BG9-10PI, BME9-05, BME9-05V-T, BME9-10, BME9-10V-T, BMG7-10, BMG-9045, BMG9-05, BMG9-05V-T, BMG9-10, BMG9-10V-T, CG-1002, CG-1502, CG-2000, CG-2005, CG-210, CG-210G, CG-300S, CG-310, CG-310G, CG7-10, CG7-11, CG-7115, CG7-20, CG-7200, CG7-20H, CG7-30D, CG7-30I, CG7-31D, CG7-31I, CG7-40, CG-7400, CG7-40H, CG7-41, CG-7415, CG7-41H, CG7-50, CG7-51, CG7-61...(Other models you can see in the webshop)		



1 

<b>GEV No.</b>	691691	<b>Ref. No.</b>	12009010 12009015 U022836 U262806
<b>description</b>	type plate FAGOR metal		
<b>For models:</b>	BG6-05I, BG7-05, BG7-05I, BG7-10, BG7-10I, BG9-05, BG9-05AD, BG9-05I, BG9-05PF, BG9-05PI, BG9-05PLUS-I, BG9-10, BG9-10AD, BG9-10I, BG9-10PF, BG9-10PI, BG9-10PLUS-I, BME6-05, BME7-05, BME7-10, BME9-05, BME9-05AD, BME9-05PLUS, BME9-05V-T, BME9-10, BME9-10AD, BME9-10PLUS, BME9-10V-T, BMG7-10, BMG9-05, BMG9-05V-T, BMG9-10, BMG9-10V-T, CE6-20, CE6-40, CE6-41, CE7-20, CE7-40, CE7-41, CE9-20, CE9-20AD, CE9-20PLUS, CE9-40, CE9-40AD, CE9-40PLUS, CE9-41, CE9-41AD, CE9-41PLUS, CG-1002, CG-1502...(Other models you can see in the webshop)		

doors

1 

<b>GEV No.</b>	691848	<b>Ref. No.</b>	1100002599 12015851
<b>description</b>	door W 690mm H 480mm thickness 40mm		

for pizza ovens

glass panels

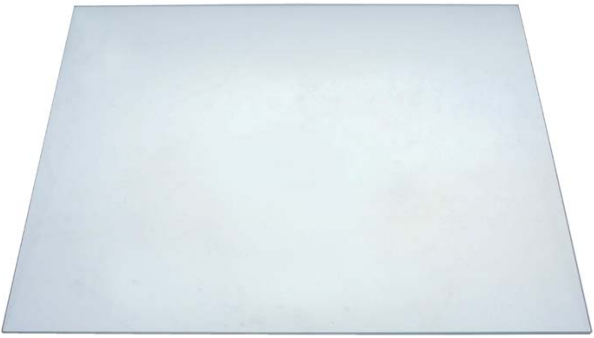
1 

<b>GEV No.</b>	700831	<b>Ref. No.</b>	12018687 R670509
<b>description</b>	glass panel L 460mm H 539mm thickness 5mm rectangular mounting pos. outer		
<b>For models:</b>	HCG-10-11, HCG-10-21, HCG-20-11, HCG-2-10-11, HME-10-11, HME-10-21, HME-20-11, HME-2-10-11, HMG-10-11, HMG-10-11UL, HMG-10-21, HMG-10-21UL, HMG-20-11, HMG-2-10-11, HMI-10-11, HMI-10-11UL, HMI-10-21, HMI-10-21UL, HMI-2-10-11, HMM-10-11, HMM-10-11UL, HMM-10-21, HMM-10-21UL, HMM-20-11, HMM-20-11UL, HMM-2-10-11, HMM-2-10-11UL, HMP-10-11, HMP-10-21, HMP-20-11, HMP-2-10-11		

for dishwashers

drain and intake components

FAGOR

drain /intake bodies

1 

<b>GEV No.</b>	505162	<b>Ref. No.</b>	12025238 Z602101
<b>description</b>	drain connection ED ø 45/27mm ID ø 21/18mm		
<b>For models:</b>	ECO-1200, ECO-1600, ECO-2300, ECO-2700D, ECO-2700I, ECO-280D, ECO-280I, ECO-3000, ECO-370D, ECO-370I, ECO-4000D, ECO-4000I, ECO-460D, ECO-460I, ECO-550D, ECO-550I, ECO-6000D, ECO-6000I, FI-1200, FI-1600, FI-2300, FI-2700D, FI-2700I, FI-280D, FI-280I, FI-3000, FI-300R, FI-370D, FI-370I, FI-4000D, FI-4000I, FI-460D, FI-460I, FI-550D, FI-550I, FI-6000D, FI-6000I, FI-650R, FI-900		

			
<b>GEV No.</b>	515000	<b>Ref. No.</b>	12037642 6003010062
<b>description</b>	drain connection for refrigerated counters thread 1/2" ID ø 146mm L 93.5mm		
<b>For models:</b>	ADM-CN-135, ADM-CN-180, ADM-CN-225, ADMCP-135, ADMCP-180, ADMCP-225, ADMFN-135, ADMFN-180, ADMFN-225, ADMFP-135, ADMFP-135-GR, ADMFP-135HD, ADMFP-135HH, ADMFP-135PC, ADMFP-180, ADMFP-180-GR, ADMFP-180HDD, ADMFP-180HHD, ADMFP-180HHH, ADMFP-180PC, ADMFP-225, ADMFP-225-GR, ADMFP-225HDD, ADMFP-225HHD, ADMFP-225HHH, ADMFP-225HH, ADMFP-225PC, ATA-061, ATA-061-60Hz, ATA-101, ATA-101-60Hz, ATM-051ECO, ATM-051VCH, ATM-051VCH-60Hz, ATM-081VCH, ATM-081VCH-60Hz, ATM-101VCH, ATM-101VCH-60Hz, ATM-121VCH, ATM-121VCH-60Hz, ATM-121VCHP, ATM-161VCH, MCP-135-AD, MCP-180-AD, MCP-225-AD, MEP-100, MEP-100G, MFP-135-AD, MFP-135-AD-2C, MFP-135-AD-4C...(Other models you can see in the webshop)		

			
<b>GEV No.</b>	505259	<b>Ref. No.</b>	12024339 Z102104
<b>description</b>	drain fitting thread 1½" H 42mm		
<b>For models:</b>	ECO-1600, ECO-2300, ECO-2700D, ECO-2700I, ECO-280D, ECO-280I, ECO-3000, ECO-370D, ECO-370I, ECO-4000D, ECO-4000I, ECO-460D, ECO-460I, ECO-550D, ECO-550I, ECO-6000D, ECO-6000I, FI-1600, FI-2300, FI-2700D, FI-2700I, FI-280D, FI-280I, FI-3000, FI-370D, FI-370I, FI-4000D, FI-4000I, FI-460D, FI-460I, FI-550D, FI-550I, FI-6000D, FI-6000I		

			
<b>GEV No.</b>	505193	<b>Ref. No.</b>	12024234 Z710902
<b>description</b>	drain fitting thread 1¾" ID ø 44mm		
<b>For models:</b>	AD-120, AD-120B, AD-120BBTDD-UK, AD-120C, AD-120CW, AD-120HY, AD-90, AD-90BA, AD-90BBT, AD-90BDD, AD-90DD, ADE-120, ADE-120B, ECO-120, ECO-120B, ECO-160, ECO-160D, ECO-160I, ECO-200, ECO-200D, ECO-200H, ECO-200HD, ECO-200HI, ECO-200I, ECO-2700D, ECO-2700I, ECO-280D, ECO-280I, ECO-370D, ECO-370I, ECO-4000D, ECO-4000I, ECO-460D, ECO-460I, ECO-550D, ECO-550I, ECO-6000D, ECO-6000I, FI-100, FI-100AR, FI-100B, FI-100BBT-UK, FI-120, FI-120AR+DD, FI-120B, FI-120C, FI-120HY-CLINIC, FI-120W, FI-160, FI-160AR...(Other models you can see in the webshop)		

			
<b>GEV No.</b>	505104	<b>Ref. No.</b>	12024603 Z220902
<b>description</b>	drain unit ED ø 32/56mm		
<b>For models:</b>	AD-45BBT, AD-48B, AD-48BDD, AD-48C, AD-48HY, AD-48W, AD-64B, AD-64BBT, AD-64BDD, AD-64C, AD-64CW, AD-64HY, FI-30, FI-30AR, FI-30AR+DD, FI-30B, FI-30B-BT-UK, FI-30-UK, FI-48, FI-48AR, FI-48B, FI-48B-BT-UK, FI-48C, FI-48D, FI-48HY-CLINIC, FI-48W, FI-64, FI-64AR, FI-64B, FI-64B-BT-UK, FI-64C, FI-64D, FI-64HY-CLINIC, FI-64W, MF-48, MF-64		

			
<b>GEV No.</b>	505085 <sup>1</sup>	<b>Ref. No.</b>	12024914 Z430901
<b>description</b>	drain unit hose ø 32/38mm		
<b>For models:</b>	AD-20C-UK, AD-21B, AD-21BDD, AD-21C, AD-21W, LVC-21B, LVC-21C, LVC-21W, LVR-20B, MF-21		

<sup>1</sup>for drain pump

			
<b>GEV No.</b>	515018	<b>Ref. No.</b>	12009947 Q307032
<b>description</b>	flat gasket rubber ED ø 32mm ID ø 21mm thickness 3mm Qty 1 pcs		
<b>For models:</b>	AD-120, AD-120B, AD-120BBTDD-UK, AD-120C, AD-120CW, AD-120HY, AD-90, AD-90BA, AD-90BBT, AD-90BDD, AD-90DD, ADE-120, ADE-120B, BME7-05, BME7-10, BME9-05, BME9-05AD, BME9-05PLUS, BME9-05V-T, BME9-10, BME9-10AD, BME9-10PLUS, BME9-10V-T, BMG7-10, BMG9-05, BMG9-05V-T, BMG9-10, BMG9-10V-T, CO-142W, CO-142WDD, COP-174W, COP-174WHR, ECO-120, ECO-1200, ECO-120B, ECO-160, ECO-1600, ECO-160D, ECO-160I, ECO-200, ECO-200D, ECO-200H, ECO-200HD, ECO-200HI, ECO-200I, ECO-2300, ECO-2700D, ECO-2700I, ECO-280D, ECO-280I...(Other models you can see in the webshop)		

			
<b>GEV No.</b>	505161	<b>Ref. No.</b>	12010028 Q307027
<b>description</b>	flat gasket rubber ED ø 45mm ID ø 35mm thickness 2mm Qty 1 pcs		
<b>For models:</b>	BMG-9045, ECO-1200, ECO-1600, ECO-2300, ECO-2700D, ECO-2700I, ECO-280D, ECO-280I, ECO-3000, ECO-370D, ECO-370I, ECO-4000D, ECO-4000I, ECO-460D, ECO-460I, ECO-550D, ECO-550I, ECO-6000D, ECO-6000I, FI-1200, FI-1600, FI-2300, FI-2700D, FI-2700I, FI-280D, FI-280I, FI-3000, FI-300B, FI-300R, FI-370D, FI-370I, FI-4000D, FI-4000I, FI-460D, FI-460I, FI-550D, FI-550I, FI-6000D, FI-6000I, FI-650R, FI-900		

			
<b>GEV No.</b>	505224	<b>Ref. No.</b>	12009960 Q307058
<b>description</b>	flat gasket rubber ED ø 60mm ID ø 44mm thickness 2mm Qty 1 pcs		
<b>For models:</b>	AD-120, AD-120B, AD-120BBTDD-UK, AD-120C, AD-120CW, AD-120HY, AD-90, AD-90BA, AD-90BBT, AD-90BDD, AD-90DD, ADE-120, ADE-120B, ECO-120, ECO-120B, ECO-160, ECO-160D, ECO-160I, ECO-200, ECO-200D, ECO-200H, ECO-200HD, ECO-200HI, ECO-200I, ECO-370D, ECO-370I, ECO-550D, ECO-550I, FI-100, FI-100AR, FI-100B, FI-100BBT-UK, FI-120, FI-120AR+DD, FI-120B, FI-120C, FI-120HY-CLINIC, FI-120W, FI-160, FI-160AR, FI-160D, FI-160I, FI-200, FI-200AR, FI-200D, FI-200H, FI-200HD, FI-200HI, FI-200I, FI-200W...(Other models you can see in the webshop)		



			
<b>GEV No.</b>	505223	<b>Ref. No.</b>	12009939 Q307009
<b>description</b>	flat gasket rubber ED ø 70mm ID ø 48mm thickness 1.5mm Qty 1 pcs		
<b>For models:</b>	BMG-9045, ECO-1200, ECO-1600, ECO-2300, ECO-2700D, ECO-2700I, ECO-280D, ECO-280I, ECO-3000, ECO-370D, ECO-370I, ECO-4000D, ECO-4000I, ECO-460D, ECO-460I, ECO-550D, ECO-550I, ECO-6000D, ECO-6000I, FI-1200, FI-1600, FI-2300, FI-2700D, FI-2700I, FI-280D, FI-280I, FI-3000, FI-300B, FI-300R, FI-370D, FI-370I, FI-4000D, FI-4000I, FI-460D, FI-460I, FI-550D, FI-550I, FI-6000D, FI-6000I, FI-650R, FI-900		

			
<b>GEV No.</b>	505249	<b>Ref. No.</b>	12009936 Q307011
<b>description</b>	gasket ED ø 56mm ID ø 39mm thickness 1mm Qty 1 pcs		
<b>For models:</b>	ECO-1600, ECO-2300, ECO-280D, ECO-280I, ECO-3000, ECO-370D, ECO-370I, ECO-460D, ECO-460I, ECO-550D, ECO-550I, FI-1600, FI-2300, FI-280D, FI-280I, FI-3000, FI-370D, FI-370I, FI-460D, FI-460I, FI-550D, FI-550I		

			
<b>GEV No.</b>	505194	<b>Ref. No.</b>	12009937 Q307059
<b>description</b>	flat gasket rubber ED ø 72mm ID ø 57mm thickness 2mm Qty 1 pcs		
<b>For models:</b>	AD-120, AD-120B, AD-120BBTDD-UK, AD-120C, AD-120CW, AD-120HY, AD-90, AD-90BA, AD-90BBT, AD-90BDD, AD-90DD, ADE-120, ADE-120B, ECO-120, ECO-120B, ECO-160, ECO-160D, ECO-160I, ECO-200, ECO-200D, ECO-200H, ECO-200HD, ECO-200HI, ECO-200I, ECO-2700D, ECO-2700I, ECO-280D, ECO-280I, ECO-370D, ECO-370I, ECO-4000D, ECO-4000I, ECO-460D, ECO-460I, ECO-550D, ECO-550I, ECO-6000D, ECO-6000I, FI-100, FI-100AR, FI-100B, FI-100BBT-UK, FI-120, FI-120AR+DD, FI-120B, FI-120C, FI-120HY-CLINIC, FI-120W, FI-160, FI-160AR...(Other models you can see in the webshop)		

			
<b>GEV No.</b>	518609	<b>Ref. No.</b>	12023618 Z310901
<b>description</b>	inlet valve thread 2 1/4" ED ø 90mm H 131mm		
<b>For models:</b>	ECO-2700D, ECO-2700I, ECO-280D, ECO-280I, ECO-370D, ECO-370I, ECO-4000D, ECO-4000I, ECO-460D, ECO-460I, ECO-550D, ECO-550I, ECO-6000D, ECO-6000I, FI-2700D, FI-2700I, FI-280D, FI-280I, FI-370D, FI-370I, FI-4000D, FI-4000I, FI-460D, FI-460I, FI-550D, FI-550I, FI-6000D, FI-6000I		

			
<b>GEV No.</b>	510832	<b>Ref. No.</b>	12023571 Z310902
<b>description</b>	flat gasket rubber ED ø 92mm ID ø 66mm thickness 2mm Qty 1 pcs equiv. no. 200906/33456		
<b>For models:</b>	ECO-2700D, ECO-2700I, ECO-280D, ECO-280I, ECO-370D, ECO-370I, ECO-4000D, ECO-4000I, ECO-460D, ECO-460I, ECO-550D, ECO-550I, ECO-6000D, ECO-6000I, FI-2700D, FI-2700I, FI-280D, FI-280I, FI-370D, FI-370I, FI-4000D, FI-4000I, FI-460D, FI-460I, FI-550D, FI-550I, FI-6000D, FI-6000I		

			
<b>GEV No.</b>	519617	<b>Ref. No.</b>	12023627 Z330787000
<b>description</b>	intake body ED ø 48mm H 49mm ID ø 30mm		
<b>For models:</b>	ECO-160D, ECO-160I, ECO-200D, ECO-200HD, ECO-200HI, ECO-200I, ECO-280D, ECO-280I, ECO-370D, ECO-370I, ECO-460D, ECO-460I, ECO-550D, ECO-550I, FI-160AR, FI-160D, FI-160I, FI-200AR, FI-200D, FI-200HD, FI-200HI, FI-200I, FI-200WL, FI-200WR, FI-280D, FI-280I, FI-370D, FI-370I, FI-460D, FI-460I, FI-550D, FI-550I		



			
<b>GEV No.</b>	505222	<b>Ref. No.</b>	12009817 Q307026
<b>description</b>	gasket conical ED ø 72mm ID ø 45mm		
<b>For models:</b>	BMG-9045, ECO-1200, ECO-1600, ECO-2300, ECO-2700D, ECO-2700I, ECO-280D, ECO-280I, ECO-3000, ECO-370D, ECO-370I, ECO-4000D, ECO-4000I, ECO-460D, ECO-460I, ECO-550D, ECO-550I, ECO-6000D, ECO-6000I, FI-1200, FI-1600, FI-2300, FI-2700D, FI-2700I, FI-280D, FI-280I, FI-3000, FI-300B, FI-300R, FI-370D, FI-370I, FI-4000D, FI-4000I, FI-460D, FI-460I, FI-550D, FI-550I, FI-6000D, FI-6000I, FI-650R, FI-900		

			
<b>GEV No.</b>	524780	<b>Ref. No.</b>	12025261 Z710903
<b>description</b>	intake body thread 1 1/2" ED ø 60mm H 42mm hose ø 38mm		
<b>For models:</b>	AD-120, AD-120B, AD-120BBTDD-UK, AD-120C, AD-120CW, AD-120HY, AD-90, AD-90BA, AD-90BBT, AD-90BDD, AD-90DD, ADE-120, ADE-120B, ECO-120, ECO-120B, ECO-160, ECO-160D, ECO-160I, ECO-200, ECO-200D, ECO-200H, ECO-200HD, ECO-200HI, ECO-200I, ECO-370D, ECO-370I, ECO-550D, ECO-550I, FI-100, FI-100AR, FI-100B, FI-100BBT-UK, FI-120, FI-120AR+DD, FI-120B, FI-120C, FI-120HY-CLINIC, FI-120W, FI-160, FI-160AR, FI-160D, FI-160I, FI-200, FI-200AR, FI-200D, FI-200H, FI-200HD, FI-200HI, FI-200I, FI-200W...(Other models you can see in the webshop)		

			
1			
<b>GEV No.</b>	505160	<b>Ref. No.</b>	12025225 Z600905
<b>description</b>	intake body thread 1½" ED ø 71mm ID ø 36mm		
<b>For models:</b>	ECO-1200, ECO-2700D, ECO-2700I, ECO-280D, ECO-280I, ECO-370D, ECO-370I, ECO-4000D, ECO-4000I, ECO-460D, ECO-460I, ECO-550D, ECO-550I, ECO-6000D, ECO-6000I, FI-1200, FI-2700D, FI-2700I, FI-280D, FI-280I, FI-370D, FI-370I, FI-4000D, FI-4000I, FI-460D, FI-460I, FI-550D, FI-550I, FI-6000D, FI-6000I, FI-900		

			
1			
<b>GEV No.</b>	505156	<b>Ref. No.</b>	12024315 Z702101
<b>description</b>	nut thread 1½"		
<b>For models:</b>	BMG-9045, ECO-1200, ECO-1600, ECO-2300, ECO-2700D, ECO-2700I, ECO-280D, ECO-280I, ECO-3000, ECO-370D, ECO-370I, ECO-4000D, ECO-4000I, ECO-460D, ECO-460I, ECO-550D, ECO-550I, ECO-6000D, ECO-6000I, FI-1200, FI-1600, FI-2300, FI-2700D, FI-2700I, FI-280D, FI-280I, FI-3000, FI-300B, FI-300R, FI-370D, FI-370I, FI-4000D, FI-4000I, FI-460D, FI-460I, FI-550D, FI-550I, FI-6000D, FI-6000I, FI-650R, FI-900		

			
1			
<b>GEV No.</b>	505163	<b>Ref. No.</b>	12025276 Z602102
<b>description</b>	nut thread 1½"		
<b>For models:</b>	ECO-1200, ECO-1600, ECO-2300, ECO-2700D, ECO-2700I, ECO-280D, ECO-280I, ECO-3000, ECO-370D, ECO-370I, ECO-4000D, ECO-4000I, ECO-460D, ECO-460I, ECO-550D, ECO-550I, ECO-6000D, ECO-6000I, FI-1200, FI-1600, FI-2300, FI-2700D, FI-2700I, FI-280D, FI-280I, FI-3000, FI-300B, FI-300R, FI-370D, FI-370I, FI-4000D, FI-4000I, FI-460D, FI-460I, FI-550D, FI-550I, FI-6000D, FI-6000I, FI-650R, FI-900		

			
1			
<b>GEV No.</b>	518080	<b>Ref. No.</b>	12023537 Z710708
<b>description</b>	nut thread 1½" WS 50 duct thickness 15mm		
<b>For models:</b>	AD-120, AD-120B, AD-120BBTDD-UK, AD-120C, AD-120CW, AD-120HY, AD-90, AD-90BA, AD-90BBT, AD-90BDD, AD-90DD, ADE-120, ADE-120B, ECO-120, ECO-120B, ECO-160, ECO-160D, ECO-160I, ECO-200, ECO-200D, ECO-200H, ECO-200HD, ECO-200HI, ECO-200I, ECO-370D, ECO-370I, ECO-550D, ECO-550I, FI-100, FI-100AR, FI-100B, FI-100BBT-UK, FI-120, FI-120AR+DD, FI-120B, FI-120C, FI-120HY-CLINIC, FI-120W, FI-160, FI-160AR, FI-160D, FI-160I, FI-200, FI-200AR, FI-200D, FI-200H, FI-200HD, FI-200HI, FI-200I, FI-200W...(Other models you can see in the webshop)		
<b>spare parts for</b>	518080		
	<b>GEV No.</b>	507425	<b>Ref. No.</b>
			12018740 Z710707
duct D1 ø 38mm D2 ø 45mm L 72mm int. ø 1 31mm int. ø 2 39mm			

			
1			
<b>GEV No.</b>	505155	<b>Ref. No.</b>	12009844 Q220001
<b>description</b>	nut thread 1¾"		
<b>For models:</b>	AD-120, AD-120B, AD-120BBTDD-UK, AD-120C, AD-120CW, AD-120HY, AD-90, AD-90BA, AD-90BBT, AD-90BDD, AD-90DD, ADE-120, ADE-120B, ECO-120, ECO-120B, ECO-160, ECO-160D, ECO-160I, ECO-200, ECO-200D, ECO-200H, ECO-200HD, ECO-200HI, ECO-200I, ECO-2700D, ECO-2700I, ECO-280D, ECO-280I, ECO-370D, ECO-370I, ECO-4000D, ECO-4000I, ECO-460D, ECO-460I, ECO-550D, ECO-550I, ECO-6000D, ECO-6000I, FI-100, FI-100AR, FI-100B, FI-100BBT-UK, FI-120, FI-120AR+DD, FI-120B, FI-120C, FI-120HY-CLINIC, FI-120W, FI-160, FI-160AR...(Other models you can see in the webshop)		

			
1			
<b>GEV No.</b>	517432	<b>Ref. No.</b>	12025231 Z310903
<b>description</b>	nut thread 2¼"		
<b>For models:</b>	ECO-2700D, ECO-2700I, ECO-280D, ECO-280I, ECO-370D, ECO-370I, ECO-4000D, ECO-4000I, ECO-460D, ECO-460I, ECO-550D, ECO-550I, ECO-6000D, ECO-6000I, FI-2700D, FI-2700I, FI-280D, FI-280I, FI-370D, FI-370I, FI-4000D, FI-4000I, FI-460D, FI-460I, FI-550D, FI-550I, FI-6000D, FI-6000I		

			
1			
<b>GEV No.</b>	505244	<b>Ref. No.</b>	12009949 Q228006
<b>description</b>	nut thread M39x3		
<b>For models:</b>	ECO-1600, ECO-2300, ECO-280D, ECO-280I, ECO-3000, ECO-370D, ECO-370I, ECO-460D, ECO-460I, ECO-550D, ECO-550I, FI-1600, FI-2300, FI-280D, FI-280I, FI-3000, FI-370D, FI-370I, FI-460D, FI-460I, FI-550D, FI-550I		

			
1			
<b>GEV No.</b>	505159	<b>Ref. No.</b>	12009815 Q228005
<b>description</b>	nut thread M48x1.5		
<b>For models:</b>	ECO-1200, ECO-2700D, ECO-2700I, ECO-280D, ECO-280I, ECO-370D, ECO-370I, ECO-4000D, ECO-4000I, ECO-460D, ECO-460I, ECO-550D, ECO-550I, ECO-6000D, ECO-6000I, FI-1200, FI-2700D, FI-2700I, FI-280D, FI-280I, FI-370D, FI-370I, FI-4000D, FI-4000I, FI-460D, FI-460I, FI-550D, FI-550I, FI-6000D, FI-6000I, FI-900		



filters			
			
1			
<b>GEV No.</b>	505141	<b>Ref. No.</b>	12003451 Z270803
<b>description</b>	flat filter H 15mm L 315mm W 223mm		
<b>For models:</b>	ECO-160, ECO-160D, ECO-160I, ECO-200, ECO-200D, ECO-200H, ECO-200HD, ECO-200HI, ECO-200I, FI-160, FI-160AR, FI-160D, FI-160I, FI-200, FI-200AR, FI-200D, FI-200H, FI-200HD, FI-200HI, FI-200I, FI-200W, FI-200WL, FI-200WR		

			
1			
<b>GEV No.</b>	505137	<b>Ref. No.</b>	12003450 12038499 Z270801
<b>description</b>	flat filter H 15mm L 315mm W 225mm		
<b>For models:</b>	ECO-160, ECO-160D, ECO-160I, ECO-200, ECO-200D, ECO-200H, ECO-200HD, ECO-200HI, ECO-200I, FI-160, FI-160AR, FI-160D, FI-160I, FI-200, FI-200AR, FI-200D, FI-200H, FI-200HD, FI-200HI, FI-200I, FI-200W, FI-200WL, FI-200WR		

			
1			
<b>GEV No.</b>	505187	<b>Ref. No.</b>	12003519 12038373 12Z7108010
<b>description</b>	flat filter H 16mm L 630mm W 220mm		
<b>For models:</b>	AD-120, AD-120B, AD-120BBTDD-UK, AD-120C, AD-120CW, AD-120HY, AD-90, AD-90BA, AD-90BBT, AD-90BDD, AD-90DD, ADE-120, ADE-120B, ECO-120, ECO-120B, FI-100, FI-100AR, FI-100B, FI-100BBT-UK, FI-120, FI-120AR+DD, FI-120B, FI-120C, FI-120HY-CLINIC, FI-120W, FI-80, FI-80AR, FI-80BBT-UK, FI-80W, FI-E-100, LABP-1000, LABP-1200, LABP-800, MF-120		

			
1			
<b>GEV No.</b>	505142	<b>Ref. No.</b>	12004370 12011137 12022559 12Z2108010
<b>description</b>	flat filter H 8mm L 263mm W 200mm		
<b>For models:</b>	AD-45BBT, AD-48, AD-48B, AD-48BDD, AD-48C, AD-48D, AD-48DD, AD-48HY, AD-48W, AD-64, AD-64B, AD-64BBT, AD-64BDD, AD-64BTDD, AD-64C, AD-64CW, AD-64D, AD-64DD, AD-64HY, AD-72, AD-72W, EASY-500HP, EASY-500HPWBDD, FI-48, FI-48AR, FI-48B, FI-48B-BT-UK, FI-48C, FI-48D, FI-48HY-CLINIC, FI-48W, FI-50, FI-64, FI-64AR, FI-64B, FI-64B-BT-UK, FI-64C, FI-64D, FI-64HY-CLINIC, FI-64W, FI-72, FI-72AR, FI-72W, MF-48, MF-64		



			
1			
<b>GEV No.</b>	505078	<b>Ref. No.</b>	12024556 Z200907
<b>description</b>	gasket external height 23.5mm for sump ED ø 225mm ID ø 200mm		
<b>For models:</b>	AD-45BBT, AD-48, AD-48B, AD-48BDD, AD-48C, AD-48D, AD-48DD, AD-48HY, AD-48W, AD-64, AD-64B, AD-64BBT, AD-64BDD, AD-64BTDD, AD-64C, AD-64CW, AD-64D, AD-64DD, AD-64HY, AD-72, AD-72W, EASY-500, EASY-500B, EASY-500DD, EASY-500HP, FI-30, FI-30AR, FI-30AR+DD, FI-30B, FI-30B-BT-UK, FI-30-UK, FI-48, FI-48AR, FI-48B, FI-48B-BT-UK, FI-48C, FI-48D, FI-48HY-CLINIC, FI-48W, FI-50, FI-60DD, FI-64, FI-64AR, FI-64B, FI-64B-BT-UK, FI-64C, FI-64D, FI-64HY-CLINIC, FI-64W, FI-72...(Other models you can see in the webshop)		

			
1			
<b>GEV No.</b>	505077	<b>Ref. No.</b>	12024113 Z400902
<b>description</b>	gasket external height 23mm for sump		
<b>For models:</b>	AD-15, AD-15D, AD-20C-UK, AD-21, AD-21B, AD-21BDD, AD-21C, AD-21D, AD-21DD, AD-21W, CO-350, CO-350-B, CO-350-B-DD, CO-350-COLD, CO-350-COLD-B, CO-350-COLD-B-DD, CO-350-COLD-DD, CO-350-DD, CO-352-COLD, CO-352-COLD-B, CO-352-COLD-B-DD, CO-352-COLD-DD, CO-400, CO-400-B, CO-400-B-DD, CO-400-COLD, CO-400-COLD-B, CO-400-COLD-B-DD, CO-400-COLD-DD, CO-400-DD, CO-400-SOFT, CO-402-COLD, CO-402-COLD-B, CO-402-COLD-B-DD, CO-402-COLD-DD, CO-402W, LVC-12, LVC-15, LVC-15D, LVC-21, LVC-21B, LVC-21C, LVC-21D, LVC-21W, LVR-10, LVR-14, LVR-14D, LVR-20, LVR-20B, LVR-20D...(Other models you can see in the webshop)		

			
1			
<b>GEV No.</b>	505274	<b>Ref. No.</b>	12025229 Z310906
<b>description</b>	intake filter ø 88mm H 82mm		
<b>For models:</b>	ECO-2700D, ECO-2700I, ECO-280D, ECO-280I, ECO-370D, ECO-370I, ECO-4000D, ECO-4000I, ECO-460D, ECO-460I, ECO-550D, ECO-550I, ECO-6000D, ECO-6000I, FI-2700D, FI-2700I, FI-280D, FI-280I, FI-370D, FI-370I, FI-4000D, FI-4000I, FI-460D, FI-460I, FI-550D, FI-550I, FI-6000D, FI-6000I		



			
1			
<b>GEV No.</b>	505186	<b>Ref. No.</b>	12003428 12038374 Z710804
<b>description</b>	rectangular filter H 73mm L 150mm W 100mm		
<b>For models:</b>	AD-120, AD-120B, AD-120BBTDD-UK, AD-120C, AD-120CW, AD-120HY, AD-90, AD-90BA, AD-90BBT, AD-90BDD, AD-90DD, ADE-120, ADE-120B, ECO-120, ECO-120B, FI-100, FI-100AR, FI-100B, FI-100BBT-UK, FI-120, FI-120AR+DD, FI-120B, FI-120C, FI-120HY-CLINIC, FI-120W, FI-80, FI-80AR, FI-80BBT-UK, FI-80W, FI-E-100, LABP-1000, LABP-1200, LABP-800, MF-120		

			
1			
<b>GEV No.</b>	505234	<b>Ref. No.</b>	12016636 12025219 Z400920
<b>description</b>	round filters ø 143mm H 125mm		
<b>For models:</b>	AD-15, AD-15D, AD-20C-UK, AD-21, AD-21B, AD-21BDD, AD-21C, AD-21D, AD-21DD, AD-21W, LVC-12, LVC-15, LVC-15D, LVC-21, LVC-21B, LVC-21C, LVC-21D, LVC-21W		

			
1			
<b>GEV No.</b>	505098	<b>Ref. No.</b>	12024410 Z200922
<b>description</b>	round filters ø 204mm H 140mm		
<b>For models:</b>	AD-45BBT, AD-48, AD-48B, AD-48BDD, AD-48C, AD-48D, AD-48DD, AD-48HY, AD-48W, AD-64, AD-64B, AD-64BBT, AD-64BDD, AD-64BTDD, AD-64C, AD-64CW, AD-64D, AD-64DD, AD-64HY, AD-72, AD-72W, EASY-500, EASY-500B, EASY-500DD, EASY-500HP, FI-30, FI-30AR, FI-30AR+DD, FI-30B, FI-30B-BT-UK, FI-30-UK, FI-48, FI-48AR, FI-48B, FI-48B-BT-UK, FI-48C, FI-48D, FI-48HY-CLINIC, FI-48W, FI-60DD, FI-64, FI-64AR, FI-64B, FI-64B-BT-UK, FI-64C, FI-64D, FI-64HY-CLINIC, FI-64W, FI-72, FI-72AR...(Other models you can see in the webshop)		
<b>accessories for</b>	505098		
	<b>GEV No.</b>	505071	<b>Ref. No.</b> 12024323 12153291 Z200909
overflow pipe L 180mm ø 40mm			

			
1			
<b>GEV No.</b>	505164	<b>Ref. No.</b>	12024284 Z600906
<b>description</b>	round filters ø 80mm H 63mm		
<b>For models:</b>	ECO-1200, ECO-2700D, ECO-2700I, ECO-280D, ECO-280I, ECO-370D, ECO-370I, ECO-4000D, ECO-4000I, ECO-460D, ECO-460I, ECO-550D, ECO-550I, ECO-6000D, ECO-6000I, FI-1200, FI-2700D, FI-2700I, FI-280D, FI-280I, FI-370D, FI-370I, FI-4000D, FI-4000I, FI-460D, FI-460I, FI-550D, FI-550I, FI-6000D, FI-6000I, FI-900		

			
1			
<b>GEV No.</b>	505075	<b>Ref. No.</b>	Z400904
<b>description</b>	round filters outflow		
<b>For models:</b>	LVC-12, LVC-15, LVC-15D, LVC-21, LVC-21B, LVC-21D, LVC-21W, LVR-10, LVR-14, LVR-14D, LVR-20, LVR-20B, LVR-20D, MF-21		

			
1			
<b>GEV No.</b>	505076	<b>Ref. No.</b>	Z200901
<b>description</b>	round filters outflow		
<b>For models:</b>	FI-30, FI-48, FI-48B, FI-48W, FI-50, FI-64, FI-64B, FI-64W, FI-72, MF-48, MF-64		
<b>accessories for</b>	505076		
	<b>GEV No.</b>	505071	<b>Ref. No.</b> 12024323 12153291 Z200909
overflow pipe L 180mm ø 40mm			

			
1			
<b>GEV No.</b>	505012	<b>Ref. No.</b>	12023617 Z400901
<b>description</b>	sump for filter ø 158mm H 67mm		
<b>For models:</b>	AD-15, AD-15D, AD-20C-UK, AD-21, AD-21B, AD-21BDD, AD-21C, AD-21D, AD-21DD, AD-21W, LVC-12, LVC-15, LVC-15D, LVC-21, LVC-21B, LVC-21C, LVC-21D, LVC-21W, LVR-10, LVR-14, LVR-14D, LVR-20, LVR-20B, LVR-20D, MF-21		

			
1			
<b>GEV No.</b>	505013	<b>Ref. No.</b>	12024367 Z200906
<b>description</b>	sump for filter ø 220mm H 67mm		
<b>For models:</b>	AD-45BBT, AD-48, AD-48B, AD-48BDD, AD-48C, AD-48D, AD-48DD, AD-48HY, AD-48W, AD-64, AD-64B, AD-64BBT, AD-64BDD, AD-64BTDD, AD-64C, AD-64CW, AD-64D, AD-64DD, AD-64HY, AD-72, AD-72W, EASY-500, EASY-500B, EASY-500DD, EASY-500HP, EASY-500HPWBDD, FI-30, FI-30AR, FI-30AR+DD, FI-30B, FI-30B-BT-UK, FI-30-UK, FI-48, FI-48AR, FI-48B, FI-48B-BT-UK, FI-48C, FI-48D, FI-48HY-CLINIC, FI-48W, FI-50, FI-60DD, FI-64, FI-64AR, FI-64B, FI-64B-BT-UK, FI-64C, FI-64D, FI-64HY-CLINIC, FI-64W...(Other models you can see in the webshop)		

<b>overflow pipes</b>			
			
1			
<b>GEV No.</b>	505073	<b>Ref. No.</b>	12010282 Q307041
<b>description</b>	O-ring EPDM thickness 2.62mm ID ø 20.63mm Qty 1 pcs		
<b>For models:</b>	AD-15, AD-15D, AD-20C-UK, AD-21, AD-21B, AD-21BDD, AD-21C, AD-21D, AD-21W, CG-1002, CG-1502, CG-2000, CG-2000-2P, CG-2002, CG-2002P, CG9-11, CG9-11AD, CG9-11PLUS, CG9-31PLUS-D, CG9-31PLUS-I, CG9-41, CG9-41AD, CG9-41AD-H, CG9-41H, CG9-41PLUS, CG9-41PLUS-H, CG9-51L, CG9-51LC, CG9-51R, CG9-51RC, CG9-61, CG9-61AD, CG9-61AD-H, CG9-61H, CG9-61OP, CG9-61PLUS, CG9-61PLUS-H, CG9-82, CG9-82AD, CG9-82PLUS, CGF9-121D, CGF9-121D-AD, CGF9-121I, CGF9-121PLUS-D, CGF9-121PLUS-I, FF-35, FI-5420, FI-7630, FTG9-11L, FTG9-11L+R...(Other models you can see in the webshop)		









 <p>1</p>			
<b>GEV No.</b>	532494	<b>Ref. No.</b>	12010165 Q307051 Q307061
<b>description</b>	O-ring EPDM thickness 2.62mm ID ø 36.14mm Qty 1 pcs		
<b>For models:</b>	AD-120, AD-120B, AD-120BBTDD-UK, AD-120C, AD-120CW, AD-120HY, AD-45BBT, AD-48, AD-48B, AD-48BDD, AD-48C, AD-48D, AD-48DD, AD-48HY, AD-48W, AD-64, AD-64B, AD-64BBT, AD-64BDD, AD-64BTDD, AD-64C, AD-64CW, AD-64D, AD-64DD, AD-64HY, AD-72, AD-72W, AD-90, AD-90BA, AD-90BBT, AD-90BDD, AD-90DD, ADE-120, ADE-120B, EASY-500, EASY-500B, EASY-500DD, EASY-500HP, ECO-120, ECO-120B, ECO-160, ECO-160D, ECO-160I, ECO-200, ECO-200D, ECO-200H, ECO-200HD, ECO-200HI, ECO-200I, ECO-2700D...(Other models you can see in the webshop)		

 <p>1</p>			
<b>GEV No.</b>	505158	<b>Ref. No.</b>	12040035 Z62104
<b>description</b>	overflow pipe		

 <p>1</p>			
<b>GEV No.</b>	518608	<b>Ref. No.</b>	12023593 Z652101
<b>description</b>	overflow pipe L 150mm ø 42mm		
<b>For models:</b>	ECO-280D, ECO-280I, ECO-370D, ECO-370I, ECO-460D, ECO-460I, ECO-550D, ECO-550I, FI-280D, FI-280I, FI-300R, FI-370D, FI-370I, FI-460D, FI-460I, FI-550D, FI-550I, FI-650R		



 <p>1</p>			
<b>GEV No.</b>	691024	<b>Ref. No.</b>	12019791 R205018
<b>description</b>	overflow pipe L 165mm ø 20mm		
<b>For models:</b>	BME7-05, BME7-10, BME9-05, BME9-10, BMG7-10, BMG9-05, BMG9-10		

 <p>1</p>			
<b>GEV No.</b>	505070	<b>Ref. No.</b>	12025249 Z400907
<b>description</b>	overflow pipe L 165mm ø 25mm		
<b>For models:</b>	AD-15, AD-15D, AD-20C-UK, AD-21, AD-21B, AD-21BDD, AD-21C, AD-21D, AD-21DD, AD-21W, LVC-12, LVC-15, LVC-15D, LVC-21, LVC-21B, LVC-21C, LVC-21D, LVC-21W, LVR-10, LVR-14, LVR-14D, LVR-20, LVR-20B, LVR-20D, MF-21		
<b>accessories for</b>	505070		
	<b>GEV No.</b>	505073	<b>Ref. No.</b> 12010282 Q307041
O-ring EPDM thickness 2.62mm ID ø 20.63mm Qty 1 pcs			

 <p>1</p>			
<b>GEV No.</b>	501337	<b>Ref. No.</b>	12008044 H216111
<b>description</b>	overflow pipe L 172mm ø 16mm		
<b>For models:</b>	BME7-05, BME7-10, BMG7-10		

 <p>1</p>			
<b>GEV No.</b>	505071	<b>Ref. No.</b>	12024323 12153291 Z200909
<b>description</b>	overflow pipe L 180mm ø 40mm		
<b>For models:</b>	AD-45BBT, AD-48, AD-48B, AD-48BDD, AD-48C, AD-48D, AD-48DD, AD-48HY, AD-48W, AD-64, AD-64B, AD-64BBT, AD-64BDD, AD-64C, AD-64CW, AD-64D, AD-64DD, AD-64HY, AD-72, AD-72W, EASY-500, EASY-500DD, EASY-500HP, FI-30, FI-30AR, FI-30AR+DD, FI-30B, FI-30B-BT-UK, FI-30-UK, FI-48, FI-48AR, FI-48B, FI-48B-BT-UK, FI-48C, FI-48D, FI-48HY-CLINIC, FI-48W, FI-50, FI-60DD, FI-64, FI-64AR, FI-64B, FI-64B-BT-UK, FI-64C, FI-64D, FI-64HY-CLINIC, FI-64W, FI-72, FI-72AR, FI-72W...(Other models you can see in the webshop)		
<b>accessories for</b>	505071		
	<b>GEV No.</b>	505098	<b>Ref. No.</b> 12024410 Z200922
round filters ø 204mm H 140mm			
	<b>GEV No.</b>	517004	<b>Ref. No.</b> —
O-ring EPDM thickness 2.62mm ID ø 34.6mm Qty 1 pcs			

 <p>1</p>			
<b>GEV No.</b>	512022	<b>Ref. No.</b>	12016680 Z682101
<b>description</b>	overflow pipe L 195mm ø 42mm plastic dishwasher		
<b>For models:</b>	ECO-1200, FI-1200, FI-900		

			
1			
<b>GEV No.</b>	505072	<b>Ref. No.</b>	12023658 Z710901
<b>description</b>	overflow pipe L 395mm ø 42mm		
<b>For models:</b>	AD-120, AD-120B, AD-120BBTDD-UK, AD-120C, AD-120CW, AD-120HY, AD-90, AD-90BA, AD-90BBT, AD-90BDD, AD-90DD, ADE-120, ADE-120B, ECO-120, ECO-120B, FI-100, FI-100AR, FI-100B, FI-100BBT-UK, FI-120, FI-120AR+DD, FI-120B, FI-120C, FI-120HY-CLINIC, FI-120W, FI-80, FI-80AR, FI-80BBT-UK, FI-80W, FI-E-100, LABP-1000, LABP-1200, LABP-800, MF-120		
<b>accessories for</b>	505072		
	<b>GEV No.</b>	532494	<b>Ref. No.</b>
			12010165 Q307051 Q307061
	O-ring EPDM thickness 2.62mm ID ø 36.14mm Qty 1 pcs		

## containers

## container lids

			
1			
<b>GEV No.</b>	510001	<b>Ref. No.</b>	12018055 Z211108
<b>description</b>	lid ø 66mm suitable for rinse aid container		

## dosing containers

			
1			
<b>GEV No.</b>	505263	<b>Ref. No.</b>	12021190
<b>description</b>	dosing container L 90mm W 80mm H 105mm		

## drive shafts

			
1			
<b>GEV No.</b>	692327	<b>Ref. No.</b>	12024595 Z275011
<b>description</b>	spindle D1 ø 16.5mm warewashing ø 20mm L 165mm D2 ø 20mm FAGOR		
<b>For models:</b>	ECO-160, ECO-160D, ECO-160I, ECO-200, ECO-200D, ECO-200H, ECO-200HD, ECO-200HI, ECO-200I, FI-160, FI-160AR, FI-160D, FI-160I, FI-200, FI-200AR, FI-200D, FI-200H, FI-200HD, FI-200HI, FI-200I, FI-200W, FI-200WL, FI-200WR		

## salt tanks

			
1			
<b>GEV No.</b>	505229	<b>Ref. No.</b>	12023847 Z471105
<b>description</b>	filter L 71mm ø 10mm salt tank conical		
<b>For models:</b>	AD-15D, AD-21D, AD-48D, AD-64D, FI-48, FI-48AR, FI-48B, FI-48B-BT-UK, FI-48C, FI-48D, FI-48HY-CLINIC, FI-48W, FI-64, FI-64AR, FI-64B, FI-64B-BT-UK, FI-64C, FI-64D, FI-64HY-CLINIC, FI-64W, LVC-15D, LVC-21D		



1

<b>GEV No.</b>	505220	<b>Ref. No.</b>	12025267 12047154 Z471107
<b>description</b>	flat gasket for salt tank rubber thickness 3.9mm ID ø 68mm ED ø 86mm		
<b>For models:</b>	AD-15D, AD-21D, AD-48D, AD-64D, CO-400-SOFT, FI-48, FI-48AR, FI-48B, FI-48B-BT-UK, FI-48C, FI-48D, FI-48HY-CLINIC, FI-48W, FI-64, FI-64AR, FI-64B, FI-64B-BT-UK, FI-64C, FI-64D, FI-64HY-CLINIC, FI-64W, LVC-15D, LVC-21D		





2

<b>GEV No.</b>	524177	<b>Ref. No.</b>	12025273 Z471108
<b>description</b>	lid ø 69mm H 20mm for salt tank ID ø 50mm		
<b>For models:</b>	AD-15D, AD-21D, AD-48D, AD-64D, CO-400-SOFT, FI-48, FI-48AR, FI-48B, FI-48B-BT-UK, FI-48C, FI-48D, FI-48HY-CLINIC, FI-48W, FI-64, FI-64AR, FI-64B, FI-64B-BT-UK, FI-64C, FI-64D, FI-64HY-CLINIC, FI-64W, LVC-15D, LVC-21D		
<b>accessories for</b>	524177		
	<b>GEV No.</b>	524148	<b>Ref. No.</b> —
	O-ring EPDM thickness 3.53mm ID ø 40.86mm Qty 1 pcs		

1

<b>GEV No.</b>	517401	<b>Ref. No.</b>	12025272 Z471106
<b>description</b>	nut ø 92mm H 10.5mm for salt tank ID ø 64.5mm		
<b>For models:</b>	AD-15D, AD-21D, AD-48D, AD-64D, CO-400-SOFT, FI-48, FI-48AR, FI-48B, FI-48B-BT-UK, FI-48C, FI-48D, FI-48HY-CLINIC, FI-48W, FI-64, FI-64AR, FI-64B, FI-64B-BT-UK, FI-64C, FI-64D, FI-64HY-CLINIC, FI-64W, LVC-15D, LVC-21D		

1

<b>GEV No.</b>	505101	<b>Ref. No.</b>	12025142 Z471102
<b>description</b>	salt tank ø 90mm H 86mm		
<b>For models:</b>	AD-15D, AD-21D, AD-48D, AD-64D, FI-48, FI-48AR, FI-48B, FI-48B-BT-UK, FI-48C, FI-48D, FI-48HY-CLINIC, FI-48W, FI-64, FI-64AR, FI-64B, FI-64B-BT-UK, FI-64C, FI-64D, FI-64HY-CLINIC, FI-64W, LVC-15D, LVC-21D, LVR-14D, LVR-20D		
<b>accessories for</b>	505101		
	<b>GEV No.</b>	505220	<b>Ref. No.</b> 12025267 12047154 Z471107
	flat gasket for salt tank rubber thickness 3.9mm ID ø 68mm ED ø 86mm		
	<b>GEV No.</b>	506015	<b>Ref. No.</b> 12024031 Z471109
	O-ring EPDM thickness 3.53mm ID ø 39.69mm Qty 1 pcs		
	<b>GEV No.</b>	517401	<b>Ref. No.</b> 12025272 Z471106
	nut ø 92mm H 10.5mm for salt tank ID ø 64.5mm		
	<b>GEV No.</b>	524177	<b>Ref. No.</b> 12025273 Z471108
	lid ø 69mm H 20mm for salt tank ID ø 50mm		

boilers

boilers for dishwashers

1

<b>GEV No.</b>	505209	<b>Ref. No.</b>	1200002017 12022893 12038284 Z401701 Z401730
<b>description</b>	boiler ø 130mm L 310mm		
<b>For models:</b>	AD-15, AD-15D, AD-20C-UK, AD-21, AD-21B, AD-21BDD, AD-21C, AD-21D, AD-21DD, AD-21W, LVC-12, LVC-15, LVC-15D, LVC-21, LVC-21B, LVC-21C, LVC-21D, LVC-21W, LVR-10, LVR-14, LVR-14D, LVR-20, LVR-20B, LVR-20D, MF-21		

			
1			
<b>GEV No.</b>	505210	<b>Ref. No.</b>	1200005017 12022943 12038293 Z201701 Z201710
<b>description</b>	boiler ø 150mm L 460mm inlet ø 10		
<b>For models:</b>	AD-120, AD-120B, AD-120C, AD-120CW, AD-48, AD-48B, AD-48BDD, AD-48C, AD-48D, AD-48DD, AD-48W, AD-64, AD-64B, AD-64BDD, AD-64C, AD-64CW, AD-64D, AD-64DD, AD-72, AD-72W, AD-90, AD-90BA, AD-90BDD, AD-90DD, EASY-500, EASY-500B, EASY-500DD, EASY-500HP, FI-100, FI-100AR, FI-100B, FI-120, FI-120AR+DD, FI-120B, FI-120C, FI-120W, FI-30, FI-30AR, FI-30AR+DD, FI-30B, FI-30-UK, FI-48, FI-48AR, FI-48B, FI-48C, FI-48D, FI-48W, FI-50, FI-60DD, FI-64...(Other models you can see in the webshop)		

			
2			
<b>GEV No.</b>	505296	<b>Ref. No.</b>	12038196 WX0116204
<b>description</b>	boiler ø 180mm L 410mm		

			
Image not available			
1			
<b>GEV No.</b>	501342	<b>Ref. No.</b>	1200003017 12038306 Z101701 Z316426
<b>description</b>	boiler ø 220mm L 580mm flange flange with thread		
<b>For models:</b>	ECO-1600, ECO-2300, ECO-3000, FI-1600, FI-2300, FI-2700D, FI-2700I, FI-3000, FI-4000D, FI-4000I, FI-6000D, FI-6000I		

## accessories

			
1			
<b>GEV No.</b>	518671	<b>Ref. No.</b>	12097453
<b>description</b>	hose connector for boiler L 54mm hose ø 10mm		
<b>For models:</b>	AD-125, AD-125HRS, AD-125-SOFT, AD-505, COP-173, COP-173B, COP-173BDD, COP-173DD, COP-173HRS, COP-173HRSDD, COP-173-SOFT, COP-174, COP-174B, COP-174BDD, COP-174DD, COP-174HRS, COP-174HRSDD, COP-174W, COP-174WHRS, COP-503, COP-503B, COP-503BDD, COP-503DD, COP-503-SOFT, COP-504, COP-504B, COP-504BDD, COP-504DD, COP-504W		

## gaskets

			
1			
<b>GEV No.</b>	699343	<b>Ref. No.</b>	12048366
<b>description</b>	gasket L 118mm W 73mm H 9mm thickness 9mm		
<b>For models:</b>	AD-125, AD-125HRS, AD-125-SOFT, CO-110, CO-110B, CO-110BDD, CO-110DD, CO-112, CO-112B, CO-112BDD, CO-112DD, CO-170, CO-170B, CO-170BDD, CO-170DD, CO-170HRS, CO-170HRSDD, CO-170HRS-SOFT, CO-170-SOFT, CO-172, CO-172B, CO-172BDD, CO-172DD, COP-173, COP-173B, COP-173BDD, COP-173DD, COP-173HRS, COP-173HRSDD, COP-173-SOFT, COP-174, COP-174B, COP-174BDD, COP-174DD, COP-174HRS, COP-174HRSDD		

## rotation plates

			
1			
<b>GEV No.</b>	505144	<b>Ref. No.</b>	12019337 12020267 Z645901 Z645920
<b>description</b>	rotation plate		

			
1			
<b>GEV No.</b>	505170	<b>Ref. No.</b>	12019954 Z405901
<b>description</b>	rotation plate ø 290mm plastic seat ø 22mm overall height 54mm		
<b>For models:</b>	LVR-10, LVR-14, LVR-14D, LVR-20, LVR-20B, LVR-20D		



rotation plate bearings

			
1			
<b>GEV No.</b>	505015	<b>Ref. No.</b>	12024910 old Z405903 old
<b>description</b>	bearing for rotation plate complete		

			
1			
<b>GEV No.</b>	505165	<b>Ref. No.</b>	12019578 12039828 Z605911
<b>description</b>	bearing rotation olate		

			
1			
<b>GEV No.</b>	505154	<b>Ref. No.</b>	12019027 Z645909
<b>description</b>	bearing rotation olate complete		

softener cartridges

softening columns

			
1			
<b>GEV No.</b>	505102	<b>Ref. No.</b>	12024874 Z471101
<b>description</b>	softener 4-fold L 380mm W 180mm		
<b>For models:</b>	AD-15D, AD-21D, AD-48D, AD-64D, CO-400-SOFT, FI-48, FI-48AR, FI-48B, FI-48B-BT-UK, FI-48C, FI-48D, FI-48HY-CLINIC, FI-48W, FI-64, FI-64AR, FI-64B, FI-64B-BT-UK, FI-64C, FI-64D, FI-64HY-CLINIC, FI-64W, LVC-15D, LVC-21D, LVR-14D, LVR-20D		

			
1			
<b>GEV No.</b>	530000	<b>Ref. No.</b>	270064
<b>description</b>	softener 4-fold L 380mm W 180mm		

spare parts and accessories

			
1			
<b>GEV No.</b>	691865	<b>Ref. No.</b>	12018145 Z643013
<b>description</b>	actuator for door for switch L 102mm ext. ø 11.4		
<b>For models:</b>	FI-300B, FI-300R, FI-650R		

			
1			
<b>GEV No.</b>	691767	<b>Ref. No.</b>	12012834 R722631
<b>description</b>	bracket SS L 40mm W 30mm H 50mm		
<b>For models:</b>	FI-30, FI-30AR, FI-30AR+DD, FI-30B, FI-30B-BT-UK, FI-30-UK, FI-48, FI-48AR, FI-48B, FI-48C, FI-48D, FI-48W, FI-50, FI-64, FI-64AR, FI-64B, FI-64C, FI-64D, FI-64W, FI-72, FI-72AR, FI-72W, MF-48, MF-64		

			
1			
<b>GEV No.</b>	530905	<b>Ref. No.</b>	12024487 Z105055000
<b>description</b>	spacer bush for impulse L 24.5mm ID ø 17.5mm ED ø 20mm suitable for FAGOR		
<b>For models:</b>	ECO-160D, ECO-160I, ECO-200D, ECO-200HD, ECO-200HI, ECO-200I, FI-160AR, FI-160D, FI-160I, FI-200AR, FI-200D, FI-200HD, FI-200HI, FI-200I, FI-200WL, FI-200WR		

## housing and bezels

## fastening angles



1

<b>GEV No.</b>	650103	<b>Ref. No.</b>	12015774 Z400106
<b>description</b>	cross rail L 380mm W 50mm H 10mm mounting distance 355mm		
<b>For models:</b>	LVC-12, LVC-15, LVC-15D, LVR-10, LVR-14, LVR-14D		



1

<b>GEV No.</b>	505239	<b>Ref. No.</b>	12021876 Z276354
<b>description</b>	fastening angle L 80mm W 80mm H 38mm		
<b>For models:</b>	ECO-120, ECO-120B, ECO-160, ECO-160D, ECO-160I, ECO-200, ECO-200D, ECO-200H, ECO-200HD, ECO-200HI, ECO-200I, ECO-280D, ECO-280I, ECO-370D, ECO-370I, ECO-460D, ECO-460I, ECO-550D, ECO-550I, FI-100, FI-100AR, FI-100B, FI-120, FI-120B, FI-120W, FI-160, FI-160AR, FI-160D, FI-160I, FI-200, FI-200AR, FI-200D, FI-200H, FI-200HD, FI-200HI, FI-200I, FI-200W, FI-200WL, FI-200WR, FI-280D, FI-280I, FI-370D, FI-370I, FI-460D, FI-460I, FI-550D, FI-550I, FI-80, FI-80W, MF-120		



1

<b>GEV No.</b>	505325	<b>Ref. No.</b>	12023093 Z850111
<b>description</b>	mounting flange for thermostat stainless steel L 48mm W 35mm thickness 1.2mm H 17mm		
<b>For models:</b>	ECO-160, ECO-1600, ECO-160D, ECO-160I, ECO-200, ECO-200D, ECO-200H, ECO-200HD, ECO-200HI, ECO-200I, ECO-2300, ECO-2700D, ECO-2700I, ECO-280D, ECO-280I, ECO-3000, ECO-370D, ECO-370I, ECO-4000D, ECO-4000I, ECO-460D, ECO-460I, ECO-550D, ECO-550I, ECO-6000D, ECO-6000I, FI-160, FI-1600, FI-160AR, FI-160D, FI-160I, FI-200, FI-200AR, FI-200D, FI-200H, FI-200HD, FI-200HI, FI-200I, FI-200W, FI-200WL, FI-200WR, FI-2300, FI-2700D, FI-2700I, FI-280D, FI-280I, FI-3000, FI-370D, FI-370I, FI-4000D...(Other models you can see in the webshop)		

## fascias



1

<b>GEV No.</b>	505337	<b>Ref. No.</b>	12025012 Z208918
<b>description</b>	front foil for dishwasher FI-48C L 583mm W 62mm		
<b>For models:</b>	FI-48AR, FI-48C		

## trapdoors



1

<b>GEV No.</b>	505241	<b>Ref. No.</b>	12014320 Z212902
<b>description</b>	door for rinse aid container W 120mm H 110mm thickness 8mm		
<b>For models:</b>	FI-30, FI-48, FI-48B, FI-50, FI-64, FI-64B, FI-72		





1

<b>GEV No.</b>	505235	<b>Ref. No.</b>	1200002020 12038297
<b>description</b>	trapdoor for dishwasher W 460mm H 340mm thickness 25mm		
<b>For models:</b>	AD-21W, LVC-21, LVC-21B, LVC-21C, LVC-21D, LVC-21W		

hood mechanics for dishwashers			
bolts			
 <p>1</p>			
<b>GEV No.</b>	505219	<b>Ref. No.</b>	12023966 Z710542
<b>description</b>	shaft for roller		
<b>For models:</b>	AD-120, AD-120B, AD-120BBTDD-UK, AD-120C, AD-120CW, AD-120HY, AD-90, AD-90BA, AD-90BBT, AD-90BDD, AD-90DD, ADE-120, ADE-120B, ECO-120, ECO-120B, FI-100, FI-100AR, FI-100B, FI-100BBT-UK, FI-120, FI-120AR+DD, FI-120B, FI-120C, FI-120HY-CLINIC, FI-120W, FI-80, FI-80AR, FI-80BBT-UK, FI-80W, FI-E-100, LABP-1000, LABP-1200, LABP-800, MF-120		

bushes			
 <p>1</p>			
<b>GEV No.</b>	505272	<b>Ref. No.</b>	12025255 Z710515
<b>description</b>	bush ED ø 22mm ID ø 10mm L 7mm plastic		
<b>For models:</b>	AD-120, AD-120B, AD-120BBTDD-UK, AD-120C, AD-120CW, AD-120HY, AD-125, AD-125HRS, AD-125-SOFT, AD-90, AD-90BA, AD-90BBT, AD-90BDD, AD-90DD, ADE-120, ADE-120B, CO-110, CO-110B, CO-110BDD, CO-110DD, CO-112, CO-112B, CO-112BDD, CO-112DD, CO-142W, CO-142WDD, CO-170, CO-170B, CO-170BDD, CO-170DD, CO-170HRS, CO-170HRSDD, CO-170HRS-SOFT, CO-170-SOFT, CO-172, CO-172B, CO-172BDD, CO-172DD, COP-173, COP-173B, COP-173BDD, COP-173DD, COP-173HRS, COP-173HRSDD, COP-173-SOFT, COP-174, COP-174B, COP-174BDD, COP-174DD, COP-174HRS...(Other models you can see in the webshop)		

spring holders			
 <p>1</p>			
<b>GEV No.</b>	505261	<b>Ref. No.</b>	12023671 Z270512
<b>description</b>	spring holder hood mechanics D1 ø 46mm D2 ø 36mm W 27mm		
<b>For models:</b>	ECO-160, ECO-160D, ECO-160I, ECO-200, ECO-200D, ECO-200H, ECO-200HD, ECO-200HI, ECO-200I, ECO-2700D, ECO-2700I, ECO-280D, ECO-280I, ECO-370D, ECO-370I, ECO-4000D, ECO-4000I, ECO-460D, ECO-460I, ECO-550D, ECO-550I, ECO-6000D, ECO-6000I, FI-160, FI-160AR, FI-160D, FI-160I, FI-200, FI-200AR, FI-200D, FI-200H, FI-200HD, FI-200HI, FI-200I, FI-200W, FI-200WL, FI-200WR, FI-2700D, FI-2700I, FI-280D, FI-280I, FI-370D, FI-370I, FI-4000D, FI-4000I, FI-460D, FI-460I, FI-550D, FI-550I, FI-6000D...(Other models you can see in the webshop)		

linkage			
 <p>1</p>			
<b>GEV No.</b>	501482	<b>Ref. No.</b>	12019124 Z680522
<b>description</b>	tie bar L 500mm for hood mechanics for dishwasher		
<b>For models:</b>	ECO-1200, FI-1200, FI-900		

friction rings			
 <p>1</p>			
<b>GEV No.</b>	505226	<b>Ref. No.</b>	12018644 Q308009
<b>description</b>	slide ring PTFE ED ø 19mm ID ø 7.5mm thickness 2mm Qty 1 pcs		
<b>For models:</b>	FI-300B, FI-300R, FI-650R		

 <p>1</p>			
<b>GEV No.</b>	505225	<b>Ref. No.</b>	12009922 Q308012
<b>description</b>	slide ring PTFE ED ø 30mm ID ø 10mm thickness 3mm for hood joint Qty 1 pcs		
<b>For models:</b>	AD-120, AD-120B, AD-120BBTDD-UK, AD-120C, AD-120CW, AD-120HY, AD-90, AD-90BA, AD-90BBT, AD-90BDD, AD-90DD, ADE-120, ADE-120B, ECO-120, ECO-120B, FI-100, FI-100AR, FI-100B, FI-100BBT-UK, FI-120, FI-120AR+DD, FI-120B, FI-120C, FI-120HY-CLINIC, FI-120W, FI-80, FI-80AR, FI-80BBT-UK, FI-80W, FI-E-100, LABP-1000, LABP-1200, LABP-800, MF-120		

rollers			
 <p>1</p>			
<b>GEV No.</b>	505218	<b>Ref. No.</b>	12025210 Z710546
<b>description</b>	roller ø 37mm H 12mm plastic hole ø 12.1mm		
<b>For models:</b>	AD-120, AD-120B, AD-120BBTDD-UK, AD-120C, AD-120CW, AD-120HY, AD-90, AD-90BA, AD-90BBT, AD-90BDD, AD-90DD, ADE-120, ADE-120B, ECO-120, ECO-120B, FI-100, FI-100AR, FI-100B, FI-100BBT-UK, FI-120, FI-120AR+DD, FI-120B, FI-120C, FI-120HY-CLINIC, FI-120W, FI-80, FI-80AR, FI-80BBT-UK, FI-80W, FI-E-100, LABP-1000, LABP-1200, LABP-800, MF-120		

miscellaneous			
 <p>1</p>			
<b>GEV No.</b>	517431	<b>Ref. No.</b>	12011392 Z270515
<b>description</b>	bracket for roller spring ømm L 105mm W 44mm H 20mm		
<b>For models:</b>	ECO-160, ECO-160D, ECO-160I, ECO-200, ECO-200D, ECO-200H, ECO-200HD, ECO-200HI, ECO-200I, FI-160, FI-160AR, FI-160D, FI-160I, FI-200, FI-200AR, FI-200D, FI-200H, FI-200HD, FI-200HI, FI-200I, FI-200W, FI-200WL, FI-200WR		

			
1			
<b>GEV No.</b>	529240	<b>Ref. No.</b>	12010068 Q308000
<b>description</b>	flat washer ED ø 16.5mm ID ø 8.2mm plastic thickness 4mm		
<b>For models:</b>	AD-120, AD-120B, AD-120BBTDD-UK, AD-120C, AD-120CW, AD-120HY, AD-90, AD-90BA, AD-90BBT, AD-90BDD, AD-90DD, ADE-120, ADE-120B, ECO-120, ECO-1200, ECO-120B, ECO-160, ECO-1600, ECO-160D, ECO-160I, ECO-200, ECO-200D, ECO-200H, ECO-200HD, ECO-200HI, ECO-200I, ECO-2300, ECO-280D, ECO-280I, ECO-3000, ECO-370D, ECO-370I, ECO-460D, ECO-460I, ECO-550D, ECO-550I, FI-100, FI-100AR, FI-100B, FI-100BBT-UK, FI-120, FI-1200, FI-120AR+DD, FI-120B, FI-120C, FI-120HY-CLINIC, FI-120W, FI-160, FI-1600, FI-160D... (Other models you can see in the webshop)		

			
1			
<b>GEV No.</b>	529241	<b>Ref. No.</b>	12010132 Q308002
<b>description</b>	plain washer for dishwashers ED ø 13mm ID ø 6mm plastic thickness 3.5mm		
<b>For models:</b>	AD-120, AD-120B, AD-120BBTDD-UK, AD-120C, AD-120CW, AD-120HY, AD-90, AD-90BA, AD-90BBT, AD-90BDD, AD-90DD, ADE-120, ADE-120B, CE-15, CE-9, EASY-500, EASY-500B, EASY-500DD, EASY-500HP, EASY-500HPWBDD, ECO-120, ECO-120B, ECO-160, ECO-1600, ECO-160D, ECO-160I, ECO-200, ECO-200D, ECO-200H, ECO-200HD, ECO-200HI, ECO-200I, ECO-2300, ECO-2700D, ECO-2700I, ECO-280D, ECO-280I, ECO-3000, ECO-370D, ECO-370I, ECO-4000D, ECO-4000I, ECO-460D, ECO-460I, ECO-550D, ECO-550I, ECO-6000D, ECO-6000I, FI-100, FI-100AR... (Other models you can see in the webshop)		

			
1			
<b>GEV No.</b>	691890	<b>Ref. No.</b>	12023973 Z270516
<b>description</b>	rubber pad D1 ø 13mm D2 ø 7mm H 10mm		
<b>For models:</b>	ECO-160, ECO-160D, ECO-160I, ECO-200, ECO-200D, ECO-200H, ECO-200HD, ECO-200HI, ECO-200I, ECO-280D, ECO-280I, ECO-370D, ECO-370I, ECO-460D, ECO-460I, ECO-550D, ECO-550I, FI-160, FI-160AR, FI-160D, FI-160I, FI-200, FI-200AR, FI-200D, FI-200H, FI-200HD, FI-200HI, FI-200I, FI-200W, FI-200WL, FI-200WR, FI-280D, FI-280I, FI-370D, FI-370I, FI-460D, FI-460I, FI-550D, FI-550I		

## basket guides

## guide bars

			
1			
<b>GEV No.</b>	505329	<b>Ref. No.</b>	12038483 12Z3150290
<b>description</b>	basket guide L 593mm H 75mm		
<b>For models:</b>	ECO-280D, ECO-280I, ECO-370D, ECO-370I, ECO-460D, ECO-460I, ECO-550D, ECO-550I, FI-280D, FI-280I, FI-370D, FI-370I, FI-460D, FI-460I, FI-550D, FI-550I		

			
1			
<b>GEV No.</b>	505327	<b>Ref. No.</b>	12041428 12Z3350250
<b>description</b>	basket guide mounting pos. left bottom L 590mm H 70mm		
<b>For models:</b>	ECO-370I, ECO-550I, FI-370I, FI-550I		

			
1			
<b>GEV No.</b>	505328	<b>Ref. No.</b>	12038478 12Z3350050
<b>description</b>	basket guide mounting pos. right bottom L 590mm H 70mm		
<b>For models:</b>	ECO-370D, ECO-550D, FI-370D, FI-550D		





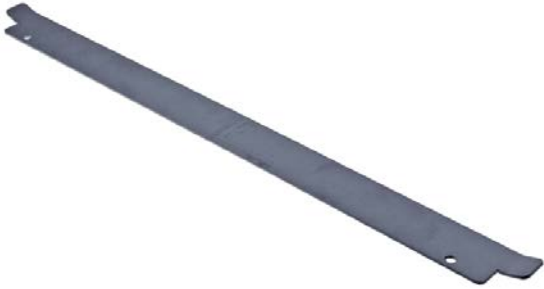







 <p>1</p>			
<b>GEV No.</b>	971056	<b>Ref. No.</b>	12014772 12021776 Z710317 Z710326
<b>description</b>	basket guide mounting pos. upper L 490mm H 36mm hole ø 6mm hole distance 400mm		
<b>For models:</b>	AD-120, AD-120B, AD-120BBTDD-UK, AD-120C, AD-120CW, AD-120HY, AD-90, AD-90BA, AD-90BBT, AD-90BDD, AD-90DD, ADE-120, ADE-120B, ECO-120, ECO-120B, FI-100, FI-100AR, FI-100B, FI-100BBT-UK, FI-120, FI-120AR+DD, FI-120B, FI-120C, FI-120HY-CLINIC, FI-120W, FI-80, FI-80AR, FI-80BBT-UK, FI-80W, FI-E-100, LABP-1000, LABP-1200, LABP-800, MF-120		

 <p>1</p>			
<b>GEV No.</b>	524591	<b>Ref. No.</b>	12024307 Z275041 Z275075
<b>description</b>	sliding block for guide bar L 50mm W 27mm H 16mm		
<b>For models:</b>	ECO-160, ECO-160D, ECO-160I, ECO-200, ECO-200D, ECO-200H, ECO-200HD, ECO-200HI, ECO-200I, ECO-280D, ECO-280I, ECO-370D, ECO-370I, ECO-460D, ECO-460I, ECO-550D, ECO-550I, FI-160, FI-160AR, FI-160D, FI-160I, FI-200, FI-200AR, FI-200D, FI-200H, FI-200HD, FI-200HI, FI-200I, FI-200W, FI-200WL, FI-200WR, FI-280D, FI-280I, FI-370D, FI-370I, FI-460D, FI-460I, FI-550D, FI-550I		

<p>basket holders</p>  <p>1</p>			
<b>GEV No.</b>	504248	<b>Ref. No.</b>	12023365 Z312509
<b>description</b>	basket support L 435m W 420mm H 90mm 90°		

<p>air traps</p>  <p>1</p>				
<b>GEV No.</b>	505094	<b>Ref. No.</b>	12024350 Z203011	
<b>description</b>	air trap			
<b>For models:</b>	AD-120, AD-120B, AD-120BBTDD-UK, AD-120C, AD-120CW, AD-120HY, AD-15, AD-15D, AD-20C-UK, AD-21, AD-21B, AD-21BDD, AD-21C, AD-21D, AD-21DD, AD-21W, AD-45BBT, AD-48, AD-48B, AD-48BDD, AD-48C, AD-48D, AD-48DD, AD-48HY, AD-48W, AD-64, AD-64B, AD-64BBT, AD-64BDD, AD-64BTDD, AD-64C, AD-64CW, AD-64D, AD-64DD, AD-64HY, AD-72, AD-72W, AD-90, AD-90BA, AD-90BBT, AD-90BDD, AD-90DD, ADE-120, ADE-120B, EASY-500, EASY-500B, EASY-500DD, EASY-500HP, EASY-500HPWBDD, ECO-120...(Other models you can see in the webshop)			
<b>accessories for</b>	505094			
	<b>GEV No.</b>	505096	<b>Ref. No.</b>	12024157 Z201312 Z203012
elbow				
	<b>GEV No.</b>	505184	<b>Ref. No.</b>	12024222 Z203013
eye bolt				
	<b>GEV No.</b>	529412	<b>Ref. No.</b>	12009873 Q307003
O-ring EPDM thickness 2.62mm ID ø 10.78mm Qty 1 pcs				

<p>miscellaneous</p>  <p>1</p>			
<b>GEV No.</b>	970861	<b>Ref. No.</b>	12024644 Z105027
<b>description</b>	bush for basket transport system mounting pos. rotation plate ext. ø 40 ID ø 33.5mm H 31.5mm brass		
<b>For models:</b>	ECO-160, ECO-160D, ECO-160I, ECO-200, ECO-200D, ECO-200H, ECO-200HD, ECO-200HI, ECO-200I, ECO-2300, ECO-280D, ECO-280I, ECO-3000, ECO-370D, ECO-370I, ECO-460D, ECO-460I, ECO-550D, ECO-550I, FI-160, FI-160D, FI-160AR, FI-160D, FI-160I, FI-200, FI-200AR, FI-200D, FI-200H, FI-200HD, FI-200HI, FI-200I, FI-200W, FI-200WL, FI-200WR, FI-2300, FI-280D, FI-280I, FI-3000, FI-370D, FI-370I, FI-460D, FI-460I, FI-550D, FI-550I		

			
1			
<b>GEV No.</b>	510103	<b>Ref. No.</b>	12090549 12134442
<b>description</b>	air trap L 85mm W 20mm H 80mm hose ø 6mm plastic		
<b>For models:</b>	CO-350, CO-350-B, CO-350-B-DD, CO-350-COLD, CO-350-COLD-B, CO-350-COLD-B-DD, CO-350-COLD-DD, CO-350-DD, CO-352-COLD, CO-352-COLD-B, CO-352-COLD-B-DD, CO-352-COLD-DD, CO-400, CO-400-B, CO-400-B-DD, CO-400-COLD, CO-400-COLD-B, CO-400-COLD-B-DD, CO-400-COLD-DD, CO-400-DD, CO-400-SOFT, CO-402-COLD, CO-402-COLD-B, CO-402-COLD-B-DD, CO-402-COLD-DD, CO-402W		
<b>spare parts for</b>	510103		
			
<b>GEV No.</b>	505045	<b>Ref. No.</b>	12009912 Q307036
<b>description</b>	O-ring EPDM thickness 1.78mm ID ø 5.28mm Qty 1 pcs		
			
<b>GEV No.</b>	505094	<b>Ref. No.</b>	12024350 Z203011
<b>description</b>	air trap		
			
<b>GEV No.</b>	510016	<b>Ref. No.</b>	—
<b>description</b>	eye bolt for rinse aid container connection		
			
<b>GEV No.</b>	510105	<b>Ref. No.</b>	—
<b>description</b>	hose connector for air trap		

## mechanics for flight type dishwashers

			
1			
<b>GEV No.</b>	505240	<b>Ref. No.</b>	12018670 Z331202
<b>description</b>	actuator		
<b>For models:</b>	ECO-370D, ECO-550D, FI-370D, FI-550D		

			
1			
<b>GEV No.</b>	505338	<b>Ref. No.</b>	12002678 12Z2712130
<b>description</b>	bracket L 70mm W 70mm H 30mm thread M5		
<b>For models:</b>	ECO-160, ECO-160D, ECO-160I, ECO-200, ECO-200D, ECO-200H, ECO-200HD, ECO-200HI, ECO-200I, ECO-280D, ECO-280I, ECO-370D, ECO-370I, ECO-460D, ECO-460I, ECO-550D, ECO-550I, FI-160, FI-160AR, FI-160D, FI-160I, FI-200, FI-200AR, FI-200D, FI-200H, FI-200HD, FI-200HI, FI-200I, FI-200WL, FI-200WR, FI-280D, FI-280I, FI-370D, FI-370I, FI-460D, FI-460I, FI-550D, FI-550I		

			
1			
<b>GEV No.</b>	517826	<b>Ref. No.</b>	12024682 Z270336 Z270336000
<b>description</b>	door guides L 620mm W 37mm H 13mm mounting pos. right		
<b>For models:</b>	ECO-160, ECO-160D, ECO-160I, ECO-200, ECO-200D, ECO-200H, ECO-200HD, ECO-200HI, ECO-200I, ECO-280D, ECO-280I, ECO-370D, ECO-370I, ECO-460D, ECO-460I, ECO-550D, ECO-550I, FI-160, FI-160AR, FI-160D, FI-160I, FI-200, FI-200AR, FI-200D, FI-200H, FI-200HD, FI-200HI, FI-200I, FI-200WL, FI-200WR, FI-280D, FI-280I, FI-370D, FI-370I, FI-460D, FI-460I, FI-550D, FI-550I		

			
1			
<b>GEV No.</b>	519525	<b>Ref. No.</b>	12023176 Z275021
<b>description</b>	flange for drive shaft ø 44mm ID ø 35mm ED ø 119mm suitable for FAGOR		
<b>For models:</b>	ECO-160, ECO-160D, ECO-160I, ECO-200, ECO-200D, ECO-200H, ECO-200HD, ECO-200HI, ECO-200I, FI-160, FI-160AR, FI-160D, FI-160I, FI-200, FI-200AR, FI-200D, FI-200H, FI-200HD, FI-200HI, FI-200I, FI-200W, FI-200WL, FI-200WR		

			
1			
<b>GEV No.</b>	697775	<b>Ref. No.</b>	12024102 Z275007
<b>description</b>	gear wheel DIN/ISO 08 B-1x26T splitting 1/2" teeth 26 shaft intake ø 20mm H 28mm hub ø 43mm		
<b>For models:</b>	ECO-160, ECO-160D, ECO-160I, ECO-200HD, ECO-200HI, ECO-280D, ECO-280I, FI-160, FI-160AR, FI-160D, FI-160I, FI-200HD, FI-200HI, FI-200WL, FI-200WR, FI-280D, FI-280I		

			
1			
<b>GEV No.</b>	505333	<b>Ref. No.</b>	1200000140 12038281 Z335011
<b>description</b>	holder frame for rack conveyor dishwashing machine L 595mm W 480mm H 40mm		
<b>For models:</b>	ECO-370D, ECO-370I, ECO-550D, ECO-550I, FI-370D, FI-370I, FI-550D, FI-550I		





			
1			
<b>GEV No.</b>	505321	<b>Ref. No.</b>	12022145 Z271206
<b>description</b>	magnet holder for transport system ø 35mm hole ø 6mm hole distance 21mm thickness 2mm		
<b>For models:</b>	ECO-160, ECO-160D, ECO-160I, ECO-200, ECO-200D, ECO-200H, ECO-200HD, ECO-200HI, ECO-200I, ECO-280D, ECO-280I, ECO-370D, ECO-370I, ECO-460D, ECO-460I, ECO-550D, ECO-550I, FI-160, FI-160AR, FI-160D, FI-160I, FI-200, FI-200AR, FI-200D, FI-200H, FI-200HD, FI-200HI, FI-200I, FI-200W, FI-200WL, FI-200WR, FI-280D, FI-280I, FI-370D, FI-370I, FI-460D, FI-460I, FI-550D, FI-550I		

			
2			
<b>GEV No.</b>	504451	<b>Ref. No.</b>	12009828 12021015 Q362000 Z105026
<b>description</b>	roll pin ø 6.3mm L 50mm SS		
<b>For models:</b>	ECO-160, ECO-160D, ECO-160I, ECO-200, ECO-200D, ECO-200H, ECO-200HD, ECO-200HI, ECO-200I, ECO-2300, ECO-280D, ECO-280I, ECO-3000, ECO-370D, ECO-370I, ECO-460D, ECO-460I, ECO-550D, ECO-550I, FI-160, FI-160D, FI-160I, FI-200, FI-200AR, FI-200D, FI-200H, FI-200HD, FI-200HI, FI-200I, FI-200W, FI-200WL, FI-200WR, FI-2300, FI-280D, FI-280I, FI-3000, FI-370D, FI-370I, FI-460D, FI-460I, FI-550D, FI-550I		



			
1			
<b>GEV No.</b>	505330	<b>Ref. No.</b>	12031651 12048195 INXC401001
<b>description</b>	roller for rack conveyor dishwashing machine L 500mm ø 40mm plastic shaft ø 10mm shaft L 15mm		

			
1			
<b>GEV No.</b>	505331	<b>Ref. No.</b>	12032894 6020000446
<b>description</b>	roller for rack conveyor dishwashing machine L 505mm ø 40mm thread M8		

			
1			
<b>GEV No.</b>	505332	<b>Ref. No.</b>	12033009 6020000447
<b>description</b>	roller for rack conveyor dishwashing machine short L 100mm ø 40mm		

			
1			
<b>GEV No.</b>	530905	<b>Ref. No.</b>	12024487 Z105055000
<b>description</b>	spacer bush for impulse L 24.5mm ID ø 17.5mm ED ø 20mm suitable for FAGOR		
<b>For models:</b>	ECO-160D, ECO-160I, ECO-200D, ECO-200HD, ECO-200HI, ECO-200I, FI-160AR, FI-160D, FI-160I, FI-200AR, FI-200D, FI-200HD, FI-200HI, FI-200I, FI-200WL, FI-200WR		

			
1			
<b>GEV No.</b>	504387	<b>Ref. No.</b>	12024391 Z271204
<b>description</b>	spring right for transport system shaft diametermm ø 10.5mm L 36mm Wmm Hmm wire gauge ø 1.4mm		
<b>For models:</b>	ECO-160, ECO-160D, ECO-160I, ECO-200, ECO-200D, ECO-200H, ECO-200HD, ECO-200HI, ECO-200I, ECO-280D, ECO-280I, ECO-370D, ECO-370I, ECO-460D, ECO-460I, ECO-550D, ECO-550I, FI-160, FI-160AR, FI-160D, FI-160I, FI-200, FI-200AR, FI-200D, FI-200H, FI-200HD, FI-200HI, FI-200I, FI-200W, FI-200WL, FI-200WR, FI-280D, FI-280I, FI-370D, FI-370I, FI-460D, FI-460I, FI-550D, FI-550I		

							
1							
<b>GEV No.</b>	504450	<b>Ref. No.</b>	12024681 Z275022 Z275025				
<b>description</b>	tension bolt for transport system L 98mm ID ø 45mm ED ø 50/34mm						
<b>For models:</b>	ECO-160, ECO-160D, ECO-160I, ECO-200, ECO-200D, ECO-200H, ECO-200HD, ECO-200HI, ECO-200I, ECO-280D, ECO-280I, ECO-370D, ECO-370I, ECO-460D, ECO-460I, ECO-550D, ECO-550I, FI-160, FI-160AR, FI-160D, FI-160I, FI-200, FI-200AR, FI-200D, FI-200H, FI-200HD, FI-200HI, FI-200I, FI-200W, FI-200WL, FI-200WR, FI-280D, FI-280I, FI-370D, FI-370I, FI-460D, FI-460I, FI-550D, FI-550I						
<b>accessories for</b>	504450						
		<table border="1"> <tr> <td><b>GEV No.</b></td> <td>504451</td> <td><b>Ref. No.</b></td> <td>12009828 12021015 Q362000 Z105026</td> </tr> </table>	<b>GEV No.</b>	504451	<b>Ref. No.</b>	12009828 12021015 Q362000 Z105026	
<b>GEV No.</b>	504451	<b>Ref. No.</b>	12009828 12021015 Q362000 Z105026				
	roll pin ø 6.3mm L 50mm SS						

backflow preventers

backflow preventers

			
1			
<b>GEV No.</b>	505091	<b>Ref. No.</b>	12018668 Z231105
<b>description</b>	backflow preventer dishwasher		
<b>For models:</b>	ECO-120, ECO-120B, FI-100, FI-100AR, FI-100B, FI-120, FI-120B, FI-120W, FI-30, FI-48, FI-48B, FI-48W, FI-50, FI-64, FI-64B, FI-64W, FI-72, FI-80, FI-80W, LVC-21W, MF-120, MF-21, MF-48, MF-64		

			
1			
<b>GEV No.</b>	505183	<b>Ref. No.</b>	12023857 1210305189 Z718418
<b>description</b>	backflow preventer dishwasher		
<b>For models:</b>	AD-120CW, CO-142W, CO-142WDD, FI-120W, FI-200W, FI-200WL, FI-200WR, FI-48, FI-48B, FI-48W, FI-64, FI-64B, FI-64W, FI-80W, MF-120, MF-48, MF-64		

			
1			
<b>GEV No.</b>	516101	<b>Ref. No.</b>	12024568 Z231106
<b>description</b>	backflow preventer dishwasher hose ø 12mm		
<b>For models:</b>	AD-120, AD-120B, AD-120C, AD-20C-UK, AD-21, AD-21B, AD-21BDD, AD-21C, AD-21DD, AD-21W, AD-48, AD-48B, AD-48BDD, AD-48C, AD-48DD, AD-48W, AD-64, AD-64B, AD-64BDD, AD-64C, AD-64CW, AD-64D, AD-64DD, AD-72, AD-72W, AD-90, AD-90BA, AD-90BDD, AD-90DD, CO-110, CO-110B, CO-110BDD, CO-110DD, CO-112, CO-112B, CO-112BDD, CO-112DD, CO-170, CO-170B, CO-170BDD, CO-170DD, CO-170HRS, CO-170HRSDD, CO-170HRS-SOFT, CO-170-SOFT, CO-172, CO-172B, CO-172BDD, CO-172DD, CO-350...(Other models you can see in the webshop)		
<b>spare parts for</b>	516101		
	<b>GEV No.</b>	506367	<b>Ref. No.</b> —
	flat gasket rubber ED ø 40mm ID ø 28mm thickness 1.8mm Qty 1 pcs		

## miscellaneous

			
1			
<b>GEV No.</b>	505151	<b>Ref. No.</b>	Z850603
<b>description</b>	pin plastic		

			
1			
<b>GEV No.</b>	506160	<b>Ref. No.</b>	Q231450000
<b>description</b>	plain washer ID ø 8.6mm ED ø 16mm thickness 1.5mm SS Qty 1 pcs		

## door mechanics

## springs

## roller springs

			
1			
<b>GEV No.</b>	519451	<b>Ref. No.</b>	12024689 Z270513
<b>description</b>	roller spring W 40mm ID ø 35mm lug length 50mm		
<b>For models:</b>	ECO-160, ECO-160D, ECO-160I, ECO-200, ECO-200D, ECO-200H, ECO-200HD, ECO-200HI, ECO-200I, ECO-2700D, ECO-2700I, ECO-280D, ECO-280I, ECO-370D, ECO-370I, ECO-4000D, ECO-4000I, ECO-460D, ECO-460I, ECO-550D, ECO-550I, ECO-6000D, ECO-6000I, FI-160, FI-160AR, FI-160D, FI-160I, FI-200, FI-200AR, FI-200D, FI-200H, FI-200HD, FI-200HI, FI-200I, FI-200W, FI-200WL, FI-200WR, FI-2700D, FI-2700I, FI-280D, FI-280I, FI-370D, FI-370I, FI-4000D, FI-4000I, FI-460D, FI-460I, FI-550D, FI-550I, FI-6000D...(Other models you can see in the webshop)		

## linkage

			
1			
<b>GEV No.</b>	519410	<b>Ref. No.</b>	12019100 Z200521
<b>description</b>	linkage		
<b>For models:</b>	FI-30, FI-30AR, FI-30AR+DD, FI-30B, FI-30B-BT-UK, FI-30-UK, FI-48, FI-48AR, FI-48B, FI-48B-BT-UK, FI-48C, FI-48D, FI-48HY-CLINIC, FI-48W, FI-50, FI-64, FI-64AR, FI-64B, FI-64B-BT-UK, FI-64C, FI-64D, FI-64HY-CLINIC, FI-64W, MF-48, MF-64		

## sliding plates

			
1			
<b>GEV No.</b>	505195	<b>Ref. No.</b>	12024180 Z200310
<b>description</b>	sliding plate sliding plate		
<b>For models:</b>	AD-20C-UK, AD-21, AD-21B, AD-21BDD, AD-21C, AD-21D, AD-21DD, AD-21W, AD-45BBT, AD-48, AD-48B, AD-48BDD, AD-48C, AD-48D, AD-48DD, AD-48HY, AD-48W, AD-64, AD-64B, AD-64BBT, AD-64BDD, AD-64BTDD, AD-64C, AD-64CW, AD-64D, AD-64DD, AD-64HY, AD-72, AD-72W, EASY-500, EASY-500B, EASY-500DD, EASY-500HP, EASY-500HPWBDD, FI-30, FI-30AR, FI-30AR+DD, FI-30B, FI-30B-BT-UK, FI-30-UK, FI-48, FI-48AR, FI-48B, FI-48B-BT-UK, FI-48C, FI-48D, FI-48HY-CLINIC, FI-48W, FI-50, FI-60DD...(Other models you can see in the webshop)		



**hinges**



1

<b>GEV No.</b>	505005	<b>Ref. No.</b>	12022324 Z400514
<b>description</b>	door hinge hinge left mounting pos. left		
<b>For models:</b>	AD-15, AD-15D, AD-20C-UK, AD-21, AD-21B, AD-21BDD, AD-21C, AD-21D, AD-21DD, AD-21W, AD-45BBT, AD-48, AD-48B, AD-48BDD, AD-48C, AD-48D, AD-48DD, AD-48HY, AD-48W, AD-64, AD-64B, AD-64BBT, AD-64BDD, AD-64BTDD, AD-64C, AD-64CW, AD-64D, AD-64DD, AD-64HY, AD-72, AD-72W, EASY-500, EASY-500B, EASY-500DD, EASY-500HP, EASY-500HPWBDD, FI-30, FI-30AR, FI-30AR+DD, FI-30B, FI-30B-BT-UK, FI-30-UK, FI-48, FI-48AR, FI-48B, FI-48B-BT-UK, FI-48C, FI-48D, FI-48HY-CLINIC, FI-48W...(Other models you can see in the webshop)		
<b>spare parts for</b>	505005		
	<b>GEV No.</b>	700818	<b>Ref. No.</b>
			12024071 Z400516
hinge bolt L 32mm stainless steel D1 ø 7.8mm D2 ø 12mm			



1

<b>GEV No.</b>	505006	<b>Ref. No.</b>	12022325 Z400515
<b>description</b>	door hinge hinge right mounting pos. right		
<b>For models:</b>	AD-15, AD-15D, AD-20C-UK, AD-21, AD-21B, AD-21BDD, AD-21C, AD-21D, AD-21DD, AD-21W, AD-45BBT, AD-48, AD-48B, AD-48BDD, AD-48C, AD-48D, AD-48DD, AD-48HY, AD-48W, AD-64, AD-64B, AD-64BBT, AD-64BDD, AD-64BTDD, AD-64C, AD-64CW, AD-64D, AD-64DD, AD-64HY, AD-72, AD-72W, EASY-500, EASY-500B, EASY-500DD, EASY-500HP, EASY-500HPWBDD, FI-30, FI-30AR, FI-30AR+DD, FI-30B, FI-30B-BT-UK, FI-30-UK, FI-48, FI-48AR, FI-48B, FI-48B-BT-UK, FI-48C, FI-48D, FI-48HY-CLINIC, FI-48W...(Other models you can see in the webshop)		



1

<b>GEV No.</b>	501479	<b>Ref. No.</b>	12036714 12037269 6009990017 A169090003
<b>description</b>	door hinge L 130mm for fridge FAGOR		
<b>For models:</b>	AEP-1402, AEP-1403, AEP-1404, AEP-1602, AEP-1603, AEP-1604, AEP-702, AEP-802, AF-1403-C, AF-1403-P, AF-1404-C, AF-1404-P, AF-1603-C, AF-1603-P, AF-1604-C, AF-1604-P, AF-2104-C, AF-2104-P, AF-2105-C, AF-2105-P, AF-2106-C, AF-2106-P, AFN-1402, AFN-1403, AFN-1404, AFN-1603, AFN-1604, AFN-702, AFN-802, AFP-1402, AFP-1403, AFP-1403-C, AFP-1403-FORZ, AFP-1403-P, AFP-1404, AFP-1404-C, AFP-1404-FORZ, AFP-1404-P, AFP-1603, AFP-1603-2, AFP-1604, AFP-2104, AFP-2104-C, AFP-2104-P, AFP-2105, AFP-2105-C, AFP-2105-P, AFP-2106, AFP-2106-C, AFP-2106-P...(Other models you can see in the webshop)		

**doors**



Image not available

1

<b>GEV No.</b>	507439	<b>Ref. No.</b>	1200002010 12038286
<b>description</b>	door W 423mm H 300mm thickness 40mm		
<b>For models:</b>	LVC-12, LVC-15, LVC-15D		



1

<b>GEV No.</b>	507443	<b>Ref. No.</b>	12015782 Z420531
<b>description</b>	door W 455mm H 370mm thickness 35mm FAGOR suitable for LVC / LVR		
<b>For models:</b>	LVC-21, LVC-21B, LVC-21D, LVC-21W, LVR-20, LVR-20B, LVR-20D, MF-21		



1

<b>GEV No.</b>	507442	<b>Ref. No.</b>	1200005030 12006603 12013502 12038302 12Z2005410
<b>description</b>	door W 585mm H 430mm thickness 50mm complete FAGOR		
<b>For models:</b>	FI-30, FI-30AR, FI-30AR+DD, FI-30B, FI-30B-BT-UK, FI-30-UK, FI-48, FI-48AR, FI-48B, FI-48B-BT-UK, FI-48C, FI-48D, FI-48HY-CLINIC, FI-48W, FI-64, FI-64AR, FI-64B, FI-64B-BT-UK, FI-64C, FI-64D, FI-64HY-CLINIC, FI-64W		

			
1			
<b>GEV No.</b>	691912	<b>Ref. No.</b>	12015781 Z420511
<b>description</b>	inner door W 405mm H 340mm thickness 18mm FAGOR suitable for LVC / LVR		
<b>For models:</b>	LVC-21, LVC-21B, LVC-21D, LVC-21W, LVR-20, LVR-20B, LVR-20D, MF-21		

## door guides

			
1			
<b>GEV No.</b>	517826	<b>Ref. No.</b>	12024682 Z270336 Z270336000
<b>description</b>	door guides L 620mm W 37mm H 13mm mounting pos. right		
<b>For models:</b>	ECO-160, ECO-160D, ECO-160I, ECO-200, ECO-200D, ECO-200H, ECO-200HD, ECO-200HI, ECO-200I, ECO-280D, ECO-280I, ECO-370D, ECO-370I, ECO-460D, ECO-460I, ECO-550D, ECO-550I, FI-160, FI-160AR, FI-160D, FI-160I, FI-200, FI-200AR, FI-200D, FI-200H, FI-200HD, FI-200HI, FI-200I, FI-200W, FI-200WL, FI-200WR, FI-280D, FI-280I, FI-370D, FI-370I, FI-460D, FI-460I, FI-550D, FI-550I		

## door frames

			
1			
<b>GEV No.</b>	504239	<b>Ref. No.</b>	12024295 Z200524
<b>description</b>	door frame L 360mm W 15mm H 14mm plastic L-shape mounting distance 150mm		
<b>For models:</b>	AD-45BBT, AD-48, AD-48B, AD-48BDD, AD-48C, AD-48D, AD-48DD, AD-48HY, AD-48W, AD-64, AD-64B, AD-64BBT, AD-64BDD, AD-64BTDD, AD-64C, AD-64CW, AD-64D, AD-64DD, AD-64HY, EASY-500, EASY-500B, EASY-500DD, EASY-500HP, EASY-500HPBDD, FI-30, FI-30AR, FI-30AR+DD, FI-30B, FI-30B-BT-UK, FI-30-UK, FI-48, FI-48AR, FI-48B, FI-48B-BT-UK, FI-48C, FI-48D, FI-48HY-CLINIC, FI-48W, FI-50, FI-60DD, FI-64, FI-64AR, FI-64B, FI-64B-BT-UK, FI-64C, FI-64D, FI-64HY-CLINIC, FI-64W, MF-48, MF-64		

## rod support

			
1			
<b>GEV No.</b>	505238	<b>Ref. No.</b>	12008904 623600000
<b>description</b>	hook L 245mm		
<b>For models:</b>	CG-1002, CG-1502, CG-2002, CG-2002P, CG-210, CG-210G, CG-310, CG-310G		

## door bumpers

			
1			
<b>GEV No.</b>	505149	<b>Ref. No.</b>	12024299 Z200522
<b>description</b>	door bumper door bumper		
<b>For models:</b>	AD-20C-UK, AD-21, AD-21B, AD-21BDD, AD-21C, AD-21D, AD-21DD, AD-21W, AD-45BBT, AD-48, AD-48B, AD-48BDD, AD-48C, AD-48D, AD-48DD, AD-48HY, AD-48W, AD-64, AD-64B, AD-64BBT, AD-64BDD, AD-64BTDD, AD-64C, AD-64CW, AD-64D, AD-64DD, AD-64HY, AD-72, AD-72W, EASY-500, EASY-500B, EASY-500DD, EASY-500HP, EASY-500HPBDD, FI-30, FI-30AR, FI-30AR+DD, FI-30B, FI-30B-BT-UK, FI-30-UK, FI-48, FI-48AR, FI-48B, FI-48B-BT-UK, FI-48C, FI-48D, FI-48HY-CLINIC, FI-48W, FI-50, FI-60DD...(Other models you can see in the webshop)		

			
1			
<b>GEV No.</b>	506266	<b>Ref. No.</b>	12016638 Z105042
<b>description</b>	door bumper H 28mm L 66mm W 7.5mm mounting pos. door plastic		
<b>For models:</b>	ECO-1600, ECO-2300, ECO-3000, FI-1600, FI-2300, FI-3000		

## locks

			
1			
<b>GEV No.</b>	505196	<b>Ref. No.</b>	12024235 Z200601
<b>description</b>	door catch		
<b>For models:</b>	AD-15, AD-15D, AD-20C-UK, AD-21, AD-21B, AD-21BDD, AD-21C, AD-21D, AD-21DD, AD-21W, AD-45BBT, AD-48, AD-48B, AD-48BDD, AD-48C, AD-48D, AD-48DD, AD-48HY, AD-48W, AD-64, AD-64B, AD-64BBT, AD-64BDD, AD-64BTDD, AD-64C, AD-64CW, AD-64D, AD-64DD, AD-64HY, AD-72, AD-72W, EASY-500, EASY-500B, EASY-500DD, EASY-500HP, EASY-500HPBDD, ECO-2700D, ECO-2700I, ECO-4000D, ECO-4000I, ECO-6000D, ECO-6000I, FI-2700D, FI-2700I, FI-30, FI-30AR, FI-30AR+DD, FI-30B, FI-30B-BT-UK, FI-30-UK...(Other models you can see in the webshop)		





 <p>1</p>			
<b>GEV No.</b>	505007	<b>Ref. No.</b>	12003212 12003363 12Z2006070
<b>description</b>	door catch door locking catch		
<b>For models:</b>	AD-15, AD-15D, AD-20C-UK, AD-21, AD-21B, AD-21BDD, AD-21C, AD-21D, AD-21DD, AD-21W, AD-45BBT, AD-48, AD-48B, AD-48BDD, AD-48C, AD-48D, AD-48DD, AD-48HY, AD-48W, AD-64, AD-64B, AD-64BBT, AD-64BDD, AD-64BTDD, AD-64C, AD-64CW, AD-64D, AD-64DD, AD-64HY, AD-72, AD-72W, EASY-500, EASY-500B, EASY-500DD, EASY-500HP, EASY-500HPWBDD, ECO-2700D, ECO-2700I, ECO-4000D, ECO-4000I, ECO-6000D, ECO-6000I, FI-2700D, FI-2700I, FI-30, FI-30AR, FI-30AR+DD, FI-30B, FI-30B-BT-UK, FI-30-UK...(Other models you can see in the webshop)		

 <p>1</p>			
<b>GEV No.</b>	508396	<b>Ref. No.</b>	12021923 Z710543
<b>description</b>	spring rod straight stainless steel L 140mm W 24mm		
<b>For models:</b>	AD-120, AD-120B, AD-120BBTDD-UK, AD-90, AD-90BA, AD-90BBT, AD-90BDD, AD-90DD, ADE-120, ADE-120B, ECO-120, ECO-120B, FI-100, FI-100AR, FI-100B, FI-100BBT-UK, FI-120, FI-120AR+DD, FI-120B, FI-120C, FI-120HY-CLINIC, FI-120W, FI-80, FI-80AR, FI-80BBT-UK, FI-80W, FI-E-100, LABP-1000, LABP-1200, LABP-800, MF-120		

<p>miscellaneous</p>			
 <p>1</p>			
<b>GEV No.</b>	505010	<b>Ref. No.</b>	12023624 Z710544
<b>description</b>	screw screw		
<b>For models:</b>	AD-120, AD-120B, AD-120BBTDD-UK, AD-90, AD-90BA, AD-90BBT, AD-90BDD, AD-90DD, ADE-120, ADE-120B, ECO-120, ECO-120B, FI-100, FI-100AR, FI-100B, FI-100BBT-UK, FI-120, FI-120AR+DD, FI-120B, FI-120C, FI-120HY-CLINIC, FI-120W, FI-80, FI-80AR, FI-80BBT-UK, FI-80W, FI-E-100, LABP-1000, LABP-1200, LABP-800, MF-120		

<p>screw connections</p>			
 <p>1</p>			
<b>GEV No.</b>	505163	<b>Ref. No.</b>	12025276 Z602102
<b>description</b>	nut thread 1½"		
<b>For models:</b>	ECO-1200, ECO-1600, ECO-2300, ECO-2700D, ECO-2700I, ECO-280D, ECO-280I, ECO-3000, ECO-370D, ECO-370I, ECO-4000D, ECO-4000I, ECO-460D, ECO-460I, ECO-550D, ECO-550I, ECO-6000D, ECO-6000I, FI-1200, FI-1600, FI-2300, FI-2700D, FI-2700I, FI-280D, FI-280I, FI-3000, FI-300B, FI-300R, FI-370D, FI-370I, FI-4000D, FI-4000I, FI-460D, FI-460I, FI-550D, FI-550I, FI-6000D, FI-6000I, FI-650R, FI-900		

 <p>1</p>			
<b>GEV No.</b>	505008	<b>Ref. No.</b>	12025166 Z710529
<b>description</b>	spring compressor spring compressor		
<b>For models:</b>	AD-120, AD-120B, AD-120BBTDD-UK, AD-90, AD-90BA, AD-90BBT, AD-90BDD, AD-90DD, ADE-120, ADE-120B, ECO-120, ECO-120B, FI-100, FI-100AR, FI-100B, FI-100BBT-UK, FI-120, FI-120AR+DD, FI-120B, FI-120C, FI-120HY-CLINIC, FI-120W, FI-80, FI-80AR, FI-80BBT-UK, FI-80W, FI-E-100, LABP-1000, LABP-1200, LABP-800, MF-120		

 <p>1</p>			
<b>GEV No.</b>	504369	<b>Ref. No.</b>	12007871 Q223023
<b>description</b>	nut thread 5/8" pipe (22.7mm) H 7.3mm WS 32 brass Qty 1 pcs		
<b>For models:</b>	AD-120, AD-120B, AD-120BBTDD-UK, AD-120C, AD-120CW, AD-120HY, AD-90, AD-90BA, AD-90BBT, AD-90BDD, AD-90DD, ADE-120, ADE-120B, CO-142W, CO-142WDD, COP-174W, COP-174WHR, ECO-120, ECO-1200, ECO-120B, ECO-160, ECO-1600, ECO-160D, ECO-160I, ECO-200, ECO-200D, ECO-200H, ECO-200HD, ECO-200HI, ECO-200I, ECO-2300, ECO-2700D, ECO-2700I, ECO-280D, ECO-280I, ECO-3000, ECO-370D, ECO-370I, ECO-4000D, ECO-4000I, ECO-460D, ECO-460I, ECO-550D, ECO-550I, ECO-6000D, ECO-6000I, FI-100, FI-100AR, FI-100B, FI-100BBT-UK...(Other models you can see in the webshop)		

curtains

curtains



<b>GEV No.</b>	533002	<b>Ref. No.</b>	12039834 Z106405
<b>description</b>	curtain W 615mm H 400mm rubber thickness 2.7mm		
<b>For models:</b>	ECO-1600, ECO-2300, ECO-3000, FI-1600, FI-2300, FI-3000		



<b>GEV No.</b>	533015	<b>Ref. No.</b>	12003701 12006760 12012962 12Z2764290 Z276410
<b>description</b>	curtain W 620mm H 410mm thickness 1.6mm warewashing		
<b>For models:</b>	ECO-160, ECO-160D, ECO-160I, ECO-200, ECO-200D, ECO-200H, ECO-200HD, ECO-200HI, ECO-200I, ECO-2700D, ECO-2700I, ECO-280D, ECO-280I, ECO-370D, ECO-370I, ECO-4000D, ECO-4000I, ECO-460D, ECO-460I, ECO-550D, ECO-550I, ECO-6000D, ECO-6000I, FI-160, FI-160AR, FI-160D, FI-160I, FI-200, FI-200AR, FI-200D, FI-200H, FI-200HD, FI-200HI, FI-200I, FI-200W, FI-200WL, FI-200WR, FI-2700D, FI-2700I, FI-280D, FI-280I, FI-370D, FI-370I, FI-4000D, FI-4000I, FI-460D, FI-460I, FI-550D, FI-550I, FI-6000D... (Other models you can see in the webshop)		



<b>GEV No.</b>	533014	<b>Ref. No.</b>	12006850 12012916 12Z2764190 Z276401
<b>description</b>	curtain W 620mm H 500mm thickness 1.4mm warewashing		
<b>For models:</b>	ECO-160, ECO-160D, ECO-160I, ECO-200, ECO-200D, ECO-200H, ECO-200HD, ECO-200HI, ECO-200I, ECO-2700D, ECO-2700I, ECO-280D, ECO-280I, ECO-370D, ECO-370I, ECO-4000D, ECO-4000I, ECO-460D, ECO-460I, ECO-550D, ECO-550I, ECO-6000D, ECO-6000I, FI-160, FI-160AR, FI-160D, FI-160I, FI-200, FI-200D, FI-200H, FI-200HD, FI-200HI, FI-200I, FI-200W, FI-2700D, FI-2700I, FI-280D, FI-280I, FI-370D, FI-370I, FI-4000D, FI-4000I, FI-460D, FI-460I, FI-550D, FI-550I, FI-6000D, FI-6000I		

washing and rinsing systems



<b>GEV No.</b>	505040	<b>Ref. No.</b>	12023726 12110631 Z650704
<b>description</b>	bush for wash arm		
<b>For models:</b>	AD-45BBT, AD-48, AD-48B, AD-48BDD, AD-48C, AD-48D, AD-48DD, AD-48HY, AD-48W, AD-505, AD-505-SOFT, AD-64, AD-64B, AD-64BBT, AD-64BDD, AD-64BTDD, AD-64C, AD-64CW, AD-64D, AD-64DD, AD-64HY, AD-72, AD-72W, AD-90, AD-90BA, AD-90BBT, AD-90BDD, AD-90DD, CO-110, CO-110B, CO-110BDD, CO-110DD, CO-112, CO-112B, CO-112BDD, CO-112DD, CO-500, CO-500B, CO-500BDD, CO-500DD, CO-501, CO-501B, CO-501BDD, CO-501DD, CO-501-SOFT, CO-502B, CO-502BDD, CO-502DD, CO-502W, COP-503... (Other models you can see in the webshop)		





<b>GEV No.</b>	505041	<b>Ref. No.</b>	12025116 Z710712
<b>description</b>	bush for wash arm		
<b>For models:</b>	AD-120, AD-120B, AD-120BBTDD-UK, AD-120C, AD-120CW, AD-120HY, AD-125, AD-125HRS, AD-125-SOFT, ADE-120, ADE-120B, CO-142W, CO-142WDD, CO-170, CO-170B, CO-170BDD, CO-170DD, CO-170HRS, CO-170HRSDD, CO-170HRS-SOFT, CO-170-SOFT, CO-172, CO-172B, CO-172BDD, CO-172DD, COP-173, COP-173B, COP-173BDD, COP-173DD, COP-173HRS, COP-173HRSDD, COP-173-SOFT, COP-174, COP-174B, COP-174BDD, COP-174DD, COP-174HRS, COP-174HRSDD, COP-174W, COP-174WHRS, ECO-120, ECO-120B, FI-100, FI-100AR, FI-100B, FI-100BBT-UK, FI-120, FI-120AR+DD, FI-120B, FI-120C... (Other models you can see in the webshop)		





<b>GEV No.</b>	507425	<b>Ref. No.</b>	12018740 Z710707	
<b>description</b>	duct D1 ø 38mm D2 ø 45mm L 72mm int. ø 1 31mm int. ø 2 39mm			
<b>For models:</b>	ECO-120, ECO-120B, ECO-160D, ECO-160I, ECO-200D, ECO-200I, FI-100, FI-100AR, FI-100B, FI-120, FI-120AR+DD, FI-120B, FI-120C, FI-120HY-CLINIC, FI-120W, FI-160D, FI-160I, FI-200D, FI-200I, FI-E-100, MF-120			
<b>spare parts for</b>	507425			
	<b>GEV No.</b>	518080	<b>Ref. No.</b>	12023537 Z710708
	nut thread 1½" WS 50 duct thickness 15mm			







 <p>1</p>			
<b>GEV No.</b>	505260	<b>Ref. No.</b>	12024287 Z310721
<b>description</b>	end cap for wash arm ø 32mm L 33mm suitable for FAGOR		
<b>For models:</b>	ECO-2700D, ECO-2700I, ECO-280D, ECO-280I, ECO-370D, ECO-370I, ECO-4000D, ECO-4000I, ECO-460D, ECO-460I, ECO-550D, ECO-550I, ECO-6000D, ECO-6000I, FI-2700D, FI-2700I, FI-280D, FI-280I, FI-370D, FI-370I, FI-4000D, FI-4000I, FI-460D, FI-460I, FI-550D, FI-550I, FI-6000D, FI-6000I		
<b>accessories for</b>	505260		
	<b>GEV No.</b>	502036	<b>Ref. No.</b>
			—
	 <p>O-ring EPDM thickness 2.62mm ID ø 28.25mm Qty 1 pcs</p>		

 <p>1</p>			
<b>GEV No.</b>	505171	<b>Ref. No.</b>	12017466 12020831 12024375 Z200705
<b>description</b>	knurled nut thread M14x1 ø 35mm H 5mm SS		
<b>For models:</b>	AD-45BBT, AD-48, AD-48B, AD-48BDD, AD-48C, AD-48D, AD-48DD, AD-48HY, AD-48W, AD-64, AD-64B, AD-64BBT, AD-64BDD, AD-64BTDD, AD-64C, AD-64CW, AD-64D, AD-64DD, AD-64HY, AD-72, AD-72W, AD-90, AD-90BA, AD-90BBT, AD-90BDD, AD-90DD, EASY-500, EASY-500B, EASY-500DD, EASY-500HP, EASY-500HPWBDD, FI-30, FI-30AR, FI-30AR+DD, FI-30B, FI-30B-BT-UK, FI-30-UK, FI-48, FI-48AR, FI-48B, FI-48B-BT-UK, FI-48C, FI-48D, FI-48HY-CLINIC, FI-48W, FI-50, FI-60DD, FI-64, FI-64AR, FI-64B...(Other models you can see in the webshop)		

 <p>1</p>			
<b>GEV No.</b>	505184	<b>Ref. No.</b>	12024222 Z203013
<b>description</b>	eye bolt		
<b>For models:</b>	AD-120, AD-120B, AD-120BBTDD-UK, AD-120C, AD-120CW, AD-120HY, AD-15, AD-15D, AD-20C-UK, AD-21, AD-21B, AD-21BDD, AD-21C, AD-21D, AD-21DD, AD-21W, AD-45BBT, AD-48, AD-48B, AD-48BDD, AD-48C, AD-48D, AD-48DD, AD-48HY, AD-48W, AD-64, AD-64B, AD-64BBT, AD-64BDD, AD-64BTDD, AD-64C, AD-64CW, AD-64D, AD-64DD, AD-64HY, AD-72, AD-72W, AD-90, AD-90BA, AD-90BBT, AD-90BDD, AD-90DD, ADE-120, ADE-120B, EASY-500, EASY-500B, EASY-500DD, EASY-500HP, EASY-500HPWBDD, ECO-120...(Other models you can see in the webshop)		

 <p>1</p>			
<b>GEV No.</b>	505168	<b>Ref. No.</b>	12017869 Z400708
<b>description</b>	nut		
<b>For models:</b>	LVR-10, LVR-14, LVR-14D, LVR-20, LVR-20B, LVR-20D		

 <p>1</p>			
<b>GEV No.</b>	505227	<b>Ref. No.</b>	12019816 Z270731
<b>description</b>	gasket for wash arm ø 55mm ID ø 39mm thickness 10mm		
<b>For models:</b>	ECO-160, ECO-160D, ECO-160I, ECO-200, ECO-200D, ECO-200H, ECO-200HD, ECO-200HI, ECO-200I, FI-160, FI-160D, FI-160I, FI-200, FI-200D, FI-200H, FI-200HD, FI-200HI, FI-200I, FI-200W		

 <p>1</p>			
<b>GEV No.</b>	518080	<b>Ref. No.</b>	12023537 Z710708
<b>description</b>	nut thread 1½" WS 50 duct thickness 15mm		
<b>For models:</b>	AD-120, AD-120B, AD-120BBTDD-UK, AD-120C, AD-120CW, AD-120HY, AD-90, AD-90BA, AD-90BBT, AD-90BDD, AD-90DD, ADE-120, ADE-120B, ECO-120, ECO-120B, ECO-160, ECO-160D, ECO-160I, ECO-200, ECO-200D, ECO-200H, ECO-200HD, ECO-200HI, ECO-200I, ECO-370D, ECO-370I, ECO-550D, ECO-550I, FI-100, FI-100AR, FI-100B, FI-100BBT-UK, FI-120, FI-120AR+DD, FI-120B, FI-120C, FI-120HY-CLINIC, FI-120W, FI-160, FI-160AR, FI-160D, FI-160I, FI-200, FI-200AR, FI-200D, FI-200H, FI-200HD, FI-200HI, FI-200I, FI-200W...(Other models you can see in the webshop)		
<b>spare parts for</b>	518080		
	<b>GEV No.</b>	507425	<b>Ref. No.</b>
			12018740 Z710707
	 <p>duct D1 ø 38mm D2 ø 45mm L 72mm int. ø 1 31mm int. ø 2 39mm</p>		



 <p>1</p>			
<b>GEV No.</b>	505173	<b>Ref. No.</b>	12023653 Z680738
<b>description</b>	knurled nut		
<b>For models:</b>	AD-120, AD-120B, AD-120BBTDD-UK, AD-120C, AD-120CW, AD-120HY, ADE-120, ADE-120B, ECO-120, ECO-1200, ECO-120B, FI-100, FI-100AR, FI-100B, FI-100BBT-UK, FI-120, FI-1200, FI-120AR+DD, FI-120B, FI-120C, FI-120HY-CLINIC, FI-120W, FI-80BBT-UK, FI-900, FI-E-100, LABP-1000, LABP-1200, MF-120		

 <p>1</p>			
<b>GEV No.</b>	505089	<b>Ref. No.</b>	12017331 Z401913
<b>description</b>	rinse arm support mounting pos. upper		
<b>For models:</b>	LVR-10, LVR-14, LVR-20, LVR-20B		

			
1			
<b>GEV No.</b>	505134	<b>Ref. No.</b>	12023115 12038952 Z821910
<b>description</b>	rinse arm support thread M23x1.75 L 61mm WS 32 hose ø 10mm		
<b>For models:</b>	ECO-1200, ECO-1600, ECO-2300, ECO-2700D, ECO-2700I, ECO-280D, ECO-280I, ECO-3000, ECO-370D, ECO-370I, ECO-4000D, ECO-4000I, ECO-460D, ECO-460I, ECO-550D, ECO-550I, ECO-6000D, ECO-6000I, FI-1200, FI-1600, FI-2300, FI-2700D, FI-2700I, FI-280D, FI-280I, FI-3000, FI-370D, FI-370I, FI-4000D, FI-4000I, FI-460D, FI-460I, FI-550D, FI-550I, FI-6000D, FI-6000I, FI-900		

			
1			
<b>GEV No.</b>	505034	<b>Ref. No.</b>	12009829 Q152016
<b>description</b>	Thumb screw thread M5 thread L 7mm ø 20mm H 3mm SS		
<b>For models:</b>	AD-120, AD-120B, AD-120BBTDD-UK, AD-120C, AD-120CW, AD-120HY, AD-15, AD-15D, AD-20C-UK, AD-21, AD-21B, AD-21BDD, AD-21C, AD-21D, AD-21DD, AD-21W, AD-45BBT, AD-48, AD-48B, AD-48BDD, AD-48C, AD-48D, AD-48DD, AD-48HY, AD-48W, AD-64, AD-64B, AD-64BBT, AD-64BDD, AD-64BTDD, AD-64C, AD-64CW, AD-64D, AD-64DD, AD-64HY, AD-72, AD-72W, AD-90, AD-90BA, AD-90BBT, AD-90BDD, AD-90DD, ADE-120, ADE-120B, CO-110, CO-110B, CO-110BDD, CO-110DD, CO-112, CO-112B...(Other models you can see in the webshop)		

			
1			
<b>GEV No.</b>	505243	<b>Ref. No.</b>	12009769 Q223108
<b>description</b>	union nut ø 14mm thread M24x2.5		
<b>For models:</b>	ECO-160, ECO-160D, ECO-160I, ECO-200, ECO-200D, ECO-200H, ECO-200HD, ECO-200HI, ECO-200I, ECO-2700D, ECO-2700I, ECO-280D, ECO-280I, ECO-370D, ECO-370I, ECO-4000D, ECO-4000I, ECO-460D, ECO-460I, ECO-550D, ECO-550I, ECO-6000D, ECO-6000I, FI-160, FI-160AR, FI-160D, FI-160I, FI-200, FI-200AR, FI-200D, FI-200H, FI-200HD, FI-200HI, FI-200I, FI-200W, FI-200WL, FI-200WR, FI-2700D, FI-2700I, FI-280D, FI-280I, FI-370D, FI-370I, FI-4000D, FI-4000I, FI-460D, FI-460I, FI-550D, FI-550I, FI-6000D...(Other models you can see in the webshop)		

			
1			
<b>GEV No.</b>	501546	<b>Ref. No.</b>	12048173
<b>description</b>	wash arm support mounting pos. upper ø 42mm H 78mm L1 340mm		
<b>For models:</b>	AD-125, AD-125HRS, AD-125-SOFT, CO-110, CO-110B, CO-110BDD, CO-110DD, CO-112, CO-112B, CO-112BDD, CO-112DD, CO-170, CO-170B, CO-170BDD, CO-170DD, CO-170HRS, CO-170HRSDD, CO-170HRS-SOFT, CO-170-SOFT, CO-172, CO-172B, CO-172BDD, CO-172DD, COP-173, COP-173B, COP-173BDD, COP-173DD, COP-173HRS, COP-173HRSDD, COP-173-SOFT, COP-174, COP-174B, COP-174BDD, COP-174DD, COP-174HRS, COP-174HRSDD		
<b>accessories for</b>	501546		
	<b>GEV No.</b>	532103	<b>Ref. No.</b> 12049214
	O-ring EPDM thickness 3.53mm ID ø 13.87mm Qty 10 pcs		
	<b>GEV No.</b>	699343	<b>Ref. No.</b> 12048366
	gasket L 118mm W 73mm H 9mm thickness 9mm		

			
1			
<b>GEV No.</b>	501483	<b>Ref. No.</b>	12024859 Z310753
<b>description</b>	wash distributor 4-fold for dishwasher H 29mm ø 45mm ID ø 30mm hole ø 18mm thread L 20mm		
<b>For models:</b>	ECO-2700D, ECO-2700I, ECO-280D, ECO-280I, ECO-370D, ECO-370I, ECO-4000D, ECO-4000I, ECO-460D, ECO-460I, ECO-550D, ECO-550I, ECO-6000D, ECO-6000I, FI-2700D, FI-2700I, FI-280D, FI-280I, FI-370D, FI-370I, FI-4000D, FI-4000I, FI-460D, FI-460I, FI-550D, FI-550I, FI-6000D, FI-6000I		

			
1			
<b>GEV No.</b>	505181	<b>Ref. No.</b>	12024059 Z410711
<b>description</b>	wash pipe L 530mm		
<b>For models:</b>	AD-15, AD-15D, CO-350, CO-350-B, CO-350-B-DD, CO-350-COLD, CO-350-COLD-B, CO-350-COLD-B-DD, CO-350-COLD-DD, CO-350-DD, CO-352-COLD, CO-352-COLD-B, CO-352-COLD-B-DD, CO-352-COLD-DD, LVC-12, LVC-15, LVC-15D		

			
1			
<b>GEV No.</b>	505182	<b>Ref. No.</b>	12025154 Z440711
<b>description</b>	wash pipe L 605mm		
<b>For models:</b>	AD-20C-UK, AD-21, AD-21B, AD-21BDD, AD-21C, AD-21D, AD-21DD, AD-21W, CO-400, CO-400-B, CO-400-B-DD, CO-400-COLD, CO-400-COLD-B, CO-400-COLD-B-DD, CO-400-COLD-DD, CO-400-DD, CO-400-SOFT, CO-402-COLD, CO-402-COLD-B, CO-402-COLD-B-DD, CO-402-COLD-DD, CO-402W, LVC-21, LVC-21B, LVC-21C, LVC-21D, LVC-21W, MF-21		



			
<b>GEV No.</b>	505169	<b>Ref. No.</b>	12023699 Z200706
<b>description</b>	wash pipe L 681mm		
<b>For models:</b>	AD-45BBT, AD-48, AD-48B, AD-48BDD, AD-48C, AD-48D, AD-48DD, AD-48HY, AD-48W, AD-64, AD-64B, AD-64BBT, AD-64BDD, AD-64BTDD, AD-64C, AD-64CW, AD-64D, AD-64DD, AD-64HY, EASY-500, EASY-500B, EASY-500DD, EASY-500HP, EASY-500HPWBDD, FI-30, FI-30AR, FI-30AR+DD, FI-30B, FI-30B-BT-UK, FI-30-UK, FI-48, FI-48AR, FI-48B, FI-48B-BT-UK, FI-48C, FI-48D, FI-48HY-CLINIC, FI-48W, FI-50, FI-60DD, FI-64, FI-64AR, FI-64B, FI-64B-BT-UK, FI-64C, FI-64D, FI-64HY-CLINIC, FI-64W, MF-48, MF-64		

			
<b>GEV No.</b>	505188	<b>Ref. No.</b>	12024606 Z260701
<b>description</b>	wash pipe L 790mm		
<b>For models:</b>	AD-72, AD-72W, FI-72, FI-72AR, FI-72W		

			
<b>GEV No.</b>	505320	<b>Ref. No.</b>	12040593 12Z3107010
<b>description</b>	wash pipe mounting pos. lower ø 53mm L 40mm suitable for FAGOR		
<b>For models:</b>	ECO-280D, ECO-280I, ECO-370D, ECO-370I, ECO-460D, ECO-460I, ECO-550D, ECO-550I, FI-280D, FI-280I, FI-370D, FI-370I, FI-460D, FI-460I, FI-550D, FI-550I		

			
<b>GEV No.</b>	511991	<b>Ref. No.</b>	12006587 12Z7107090
<b>description</b>	wash pipe ø 38mm L 730mm SS		
<b>For models:</b>	AD-120, AD-120B, AD-120BBTDD-UK, AD-120C, AD-120CW, AD-120HY, AD-90, AD-90BA, AD-90BBT, AD-90BDD, AD-90DD, ADE-120, ADE-120B, ECO-120, ECO-120B, FI-100, FI-100AR, FI-100B, FI-100BBT-UK, FI-120, FI-120AR+DD, FI-120B, FI-120C, FI-120HY-CLINIC, FI-120W, FI-80, FI-80AR, FI-80BBT-UK, FI-80W, FI-E-100, LABP-1000, LABP-1200, LABP-800, MF-120		

washing and rinsing systems (sorted by producer)

<p>FAGOR</p> 			
<b>GEV No.</b>	505038	<b>Ref. No.</b>	12011257 12025122 Z650716
<b>description</b>	wash arm L 490mm nozzles 9 mounting ø 32mm mounting pos. upper/lower		
<b>For models:</b>	AD-45BBT, AD-48, AD-48B, AD-48BDD, AD-48C, AD-48D, AD-48DD, AD-48HY, AD-48W, AD-505, AD-505-SOFT, AD-64, AD-64B, AD-64BBT, AD-64BDD, AD-64BTDD, AD-64C, AD-64CW, AD-64D, AD-64DD, AD-64HY, AD-72, AD-72W, AD-90, AD-90BA, AD-90BBT, AD-90BDD, AD-90DD, CO-110, CO-110B, CO-110BDD, CO-110DD, CO-112, CO-112B, CO-112BDD, CO-112DD, CO-500, CO-500B, CO-500BDD, CO-500DD, CO-501, CO-501B, CO-501BDD, CO-501DD, CO-501-SOFT, CO-502B, CO-502BDD, CO-502DD, CO-502W, COP-503...(Other models you can see in the webshop)		

			
<b>GEV No.</b>	505039	<b>Ref. No.</b>	12003421 12038375 12Z7107010
<b>description</b>	wash arm L 525mm nozzles 14 mounting ø 50mm mounting pos. upper/lower		
<b>For models:</b>	AD-120, AD-120B, AD-120BBTDD-UK, AD-120C, AD-120CW, AD-120HY, AD-125, AD-125HRS, AD-125-SOFT, ADE-120, ADE-120B, CO-142W, CO-142WDD, CO-170, CO-170B, CO-170BDD, CO-170DD, CO-170HRS, CO-170HRSDD, CO-170HRS-SOFT, CO-170-SOFT, CO-172, CO-172B, CO-172BDD, CO-172DD, COP-173, COP-173B, COP-173BDD, COP-173DD, COP-173HRS, COP-173HRSDD, COP-173-SOFT, COP-174, COP-174B, COP-174BDD, COP-174DD, COP-174HRS, COP-174HRSDD, COP-174W, COP-174WHRS, ECO-120, ECO-120B, FI-100, FI-100AR, FI-100B, FI-100BBT-UK, FI-120, FI-120AR+DD, FI-120B, FI-120C...(Other models you can see in the webshop)		

			
<b>GEV No.</b>	505031	<b>Ref. No.</b>	12023710 Z400711
<b>description</b>	opposite support		
<b>For models:</b>	AD-15, AD-15D, AD-20C-UK, AD-21, AD-21B, AD-21BDD, AD-21C, AD-21D, AD-21DD, AD-21W, CO-350, CO-350-B, CO-350-B-DD, CO-350-COLD, CO-350-COLD-B, CO-350-COLD-B-DD, CO-350-COLD-DD, CO-350-DD, CO-352-COLD, CO-352-COLD-B, CO-352-COLD-B-DD, CO-352-COLD-DD, CO-400, CO-400-B, CO-400-B-DD, CO-400-COLD, CO-400-COLD-B, CO-400-COLD-B-DD, CO-400-COLD-DD, CO-400-DD, CO-400-SOFT, CO-402-COLD, CO-402-COLD-B, CO-402-COLD-B-DD, CO-402-COLD-DD, CO-402W, ECO-2700D, ECO-2700I, ECO-280D, ECO-280I, ECO-370D, ECO-370I, ECO-4000D, ECO-4000I, ECO-460D, ECO-460I, ECO-550D, ECO-550I, ECO-6000D, ECO-6000I...(Other models you can see in the webshop)		

			
<b>GEV No.</b>	505046	<b>Ref. No.</b>	12024006 Z201906
<b>description</b>	opposite support rinse jet		
<b>For models:</b>	AD-15, AD-15D, AD-90, AD-90BA, AD-90BDD, AD-90DD, FI-30, FI-30AR, FI-30AR+DD, FI-30B, FI-30B-BT-UK, FI-30-UK, FI-48, FI-48AR, FI-48B, FI-48B-BT-UK, FI-48C, FI-48D, FI-48HY-CLINIC, FI-48W, FI-60DD, FI-80, FI-80AR, FI-80W, FI-E-100, LABP-800, LVC-12, LVC-15, LVC-15D, LVC-21, LVC-21B, LVC-21C, LVC-21D, LVC-21W, LVR-10, LVR-14, LVR-20, LVR-20B, MF-21		

			
<b>GEV No.</b>	505045	<b>Ref. No.</b>	12009912 Q307036
<b>description</b>	O-ring EPDM thickness 1.78mm ID ø 5.28mm Qty 1 pcs		
<b>For models:</b>	AD-15, AD-15D, AD-90, AD-90BA, AD-90BDD, AD-90DD, COG-202, EASY-500, EASY-500B, EASY-500DD, EASY-500HP, EASY-500HPWBDD, FI-30, FI-30AR, FI-30AR+DD, FI-30B, FI-30B-BT-UK, FI-30-UK, FI-48, FI-48AR, FI-48B, FI-48B-BT-UK, FI-48C, FI-48D, FI-48HY-CLINIC, FI-48W, FI-60DD, FI-80, FI-80AR, FI-80W, FI-E-100, HGC-20-21, HGP-10-21, HGP-20-21, HGV-20-21, LABP-800, LF-13MPP, LF-18MPP, LF-25MPP, LF-8MPP, LVC-12, LVC-15, LVC-15D, LVC-21, LVC-21B, LVC-21D, LVC-21W, LVR-10, LVR-14, LVR-20...(Other models you can see in the webshop)		

			
<b>GEV No.</b>	505065	<b>Ref. No.</b>	12020476 Z411902
<b>description</b>	rinse arm		
<b>For models:</b>	CO-350, CO-350-B, CO-350-B-DD, CO-350-COLD, CO-350-COLD-B, CO-350-COLD-B-DD, CO-350-COLD-DD, CO-350-DD, CO-352-COLD, CO-352-COLD-B, CO-352-COLD-B-DD, CO-352-COLD-DD, LVC-12, LVC-15, LVC-15D		

			
<b>GEV No.</b>	505042	<b>Ref. No.</b>	12025253 Z461902
<b>description</b>	rinse arm L 144mm nozzles 2 mounting ø 11.7mm mounting pos. „A“		
<b>For models:</b>	AD-15, AD-15D, LVC-12, LVC-15, LVC-15D		

			
<b>GEV No.</b>	505063	<b>Ref. No.</b>	12024137 Z461901
<b>description</b>	rinse arm L 144mm nozzles 2 mounting ø 7mm mounting pos. „B“		
<b>For models:</b>	AD-15, AD-15D, LVC-12, LVC-15, LVC-15D		



			
<b>GEV No.</b>	505066	<b>Ref. No.</b>	12020475 Z411901
<b>description</b>	rinse arm L 145mm		
<b>For models:</b>	CO-350, CO-350-B, CO-350-B-DD, CO-350-COLD, CO-350-COLD-B, CO-350-COLD-B-DD, CO-350-COLD-DD, CO-350-DD, CO-352-COLD, CO-352-COLD-B, CO-352-COLD-B-DD, CO-352-COLD-DD, LVC-12, LVC-15, LVC-15D		

			
<b>GEV No.</b>	505043	<b>Ref. No.</b>	12022613 Z441901
<b>description</b>	rinse arm L 166mm nozzles 2 mounting ø 11.5mm mounting pos. „A“		
<b>For models:</b>	AD-20C-UK, AD-21, AD-21B, AD-21BDD, AD-21C, AD-21D, AD-21DD, AD-21W, CO-400, CO-400-B, CO-400-B-DD, CO-400-COLD, CO-400-COLD-B, CO-400-COLD-B-DD, CO-400-COLD-DD, CO-400-DD, CO-400-SOFT, CO-402-COLD, CO-402-COLD-B, CO-402-COLD-B-DD, CO-402-COLD-DD, CO-402W, LVC-15D, LVC-21, LVC-21B, LVC-21C, LVC-21D, LVC-21W, MF-21		

			
<b>GEV No.</b>	505064	<b>Ref. No.</b>	12022710 Z441902
<b>description</b>	rinse arm L 166mm nozzles 3 mounting ø 11.5mm mounting pos. „B“		
<b>For models:</b>	AD-20C-UK, AD-21, AD-21B, AD-21BDD, AD-21C, AD-21D, AD-21DD, AD-21W, CO-400, CO-400-B, CO-400-B-DD, CO-400-COLD, CO-400-COLD-B, CO-400-COLD-B-DD, CO-400-COLD-DD, CO-400-DD, CO-400-SOFT, CO-402-COLD, CO-402-COLD-B, CO-402-COLD-B-DD, CO-402-COLD-DD, CO-402W, LVC-15D, LVC-21, LVC-21B, LVC-21C, LVC-21D, LVC-21W, MF-21		

			
<b>GEV No.</b>	505407	<b>Ref. No.</b>	12023525 Z448712 Z448712000
<b>description</b>	rinse arm L 166mm ø 12mm plastic nozzles 3		





			
1			
<b>GEV No.</b>	505044	<b>Ref. No.</b>	12024077 Z201905
<b>description</b>	rinse jet		
<b>For models:</b>	AD-15, AD-15D, AD-90, AD-90BA, AD-90BBT, AD-90BDD, AD-90DD, EASY-500, EASY-500B, EASY-500DD, EASY-500HP, EASY-500HPWBDD, FI-30, FI-30AR, FI-30AR+DD, FI-30B, FI-30B-BT-UK, FI-30-UK, FI-48, FI-48AR, FI-48B, FI-48B-BT-UK, FI-48C, FI-48D, FI-48HY-CLINIC, FI-48W, FI-60DD, FI-80, FI-80AR, FI-80BBT-UK, FI-80W, FI-E-100, LABP-800, LVC-12, LVC-15, LVC-15D, LVC-21, LVC-21B, LVC-21C, LVC-21D, LVC-21W, LVR-10, LVR-14, LVR-20, LVR-20B, MF-21		
<b>accessories for</b>	505044		
	<b>GEV No.</b>	505045	<b>Ref. No.</b> 12009912 Q307036
	O-ring EPDM thickness 1.78mm ID ø 5.28mm Qty 1 pcs		
	<b>GEV No.</b>	505046	<b>Ref. No.</b> 12024006 Z201906
	opposite support rinse jet		

			
1			
<b>GEV No.</b>	505103	<b>Ref. No.</b>	12024252 Z211903
<b>description</b>	rinse jet		
<b>For models:</b>	AD-120, AD-120B, AD-120BBTDD-UK, AD-120C, AD-120CW, AD-120HY, AD-20C-UK, AD-21, AD-21B, AD-21BDD, AD-21C, AD-21D, AD-21DD, AD-21W, AD-45BBT, AD-48, AD-48B, AD-48BDD, AD-48C, AD-48D, AD-48DD, AD-48HY, AD-48W, AD-64, AD-64B, AD-64BBT, AD-64BDD, AD-64BTDD, AD-64C, AD-64CW, AD-64D, AD-64DD, AD-64HY, AD-72, AD-72W, AD-90, AD-90BA, AD-90BDD, AD-90DD, ADE-120, ADE-120B, CO-110, CO-110B, CO-110BDD, CO-110DD, CO-112, CO-112B, CO-112BDD, CO-112DD, CO-142W...(Other models you can see in the webshop)		



			
1			
<b>GEV No.</b>	505147	<b>Ref. No.</b>	12019827 Z410706
<b>description</b>	wash arm		
<b>For models:</b>	CO-350, CO-350-B, CO-350-B-DD, CO-350-COLD, CO-350-COLD-B, CO-350-COLD-B-DD, CO-350-COLD-DD, CO-350-DD, CO-352-COLD, CO-352-COLD-B, CO-352-COLD-B-DD, CO-352-COLD-DD, LVC-12, LVC-15, LVC-15D		



			
1			
<b>GEV No.</b>	505054	<b>Ref. No.</b>	12025251 Z460701
<b>description</b>	wash arm L 140mm nozzles 2 mounting ø 21.5mm mounting pos. „B“		
<b>For models:</b>	AD-15, AD-15D, LVC-12, LVC-15, LVC-15D		

			
1			
<b>GEV No.</b>	505036	<b>Ref. No.</b>	12024138 Z460702
<b>description</b>	wash arm L 140mm nozzles 3 mounting ø 21.5mm mounting pos. „A“		
<b>For models:</b>	AD-15, AD-15D, LVC-12, LVC-15, LVC-15D		

			
1			
<b>GEV No.</b>	505037	<b>Ref. No.</b>	12022381 Z440706
<b>description</b>	wash arm L 163mm nozzles 3 mounting ø 18mm mounting pos. „A“		
<b>For models:</b>	AD-20C-UK, AD-21, AD-21B, AD-21BDD, AD-21C, AD-21D, AD-21DD, AD-21W, CO-400, CO-400-B, CO-400-B-DD, CO-400-COLD, CO-400-COLD-B, CO-400-COLD-B-DD, CO-400-COLD-DD, CO-400-DD, CO-400-SOFT, CO-402-COLD, CO-402-COLD-B, CO-402-COLD-B-DD, CO-402-COLD-DD, CO-402W, LVC-21, LVC-21B, LVC-21C, LVC-21D, LVC-21W, MF-21		

			
1			
<b>GEV No.</b>	505055	<b>Ref. No.</b>	12022382 Z440707
<b>description</b>	wash arm L 163mm nozzles 3 mounting ø 18mm mounting pos. „B“		
<b>For models:</b>	AD-20C-UK, AD-21, AD-21B, AD-21BDD, AD-21C, AD-21D, AD-21DD, AD-21W, CO-400, CO-400-B, CO-400-B-DD, CO-400-COLD, CO-400-COLD-B, CO-400-COLD-B-DD, CO-400-COLD-DD, CO-400-DD, CO-400-SOFT, CO-402-COLD, CO-402-COLD-B, CO-402-COLD-B-DD, CO-402-COLD-DD, CO-402W, LVC-21, LVC-21B, LVC-21C, LVC-21D, LVC-21W, MF-21		

			
1			
<b>GEV No.</b>	505068	<b>Ref. No.</b>	12025216 Z410704
<b>description</b>	wash arm boss		
<b>For models:</b>	AD-15, AD-15D, AD-20C-UK, AD-21, AD-21B, AD-21BDD, AD-21C, AD-21D, AD-21DD, AD-21W, CO-350, CO-350-B, CO-350-B-DD, CO-350-COLD, CO-350-COLD-B, CO-350-COLD-B-DD, CO-350-COLD-DD, CO-350-DD, CO-352-COLD, CO-352-COLD-B, CO-352-COLD-B-DD, CO-352-COLD-DD, CO-400, CO-400-B, CO-400-B-DD, CO-400-COLD, CO-400-COLD-B, CO-400-COLD-B-DD, CO-400-COLD-DD, CO-400-DD, CO-400-SOFT, CO-402-COLD, CO-402-COLD-B, CO-402-COLD-B-DD, CO-402-COLD-DD, CO-402W, LVC-12, LVC-15, LVC-15D, LVC-21, LVC-21B, LVC-21C, LVC-21D, LVC-21W, MF-21		
<b>accessories for</b>	505068		
	<b>GEV No.</b>	505035	<b>Ref. No.</b> 12024086 Z410705
	bushing		



			
<b>GEV No.</b>	505033	<b>Ref. No.</b>	12023732 Z400709
<b>description</b>	wash jet		
<b>For models:</b>	AD-15, AD-15D, AD-20C-UK, AD-21, AD-21B, AD-21BDD, AD-21C, AD-21D, AD-21DD, AD-21W, CO-350, CO-350-B, CO-350-B-DD, CO-350-COLD, CO-350-COLD-B, CO-350-COLD-B-DD, CO-350-COLD-DD, CO-350-DD, CO-352-COLD, CO-352-COLD-B, CO-352-COLD-B-DD, CO-352-COLD-DD, CO-400, CO-400-B, CO-400-B-DD, CO-400-COLD, CO-400-COLD-B, CO-400-COLD-B-DD, CO-400-COLD-DD, CO-400-DD, CO-400-SOFT, CO-402-COLD, CO-402-COLD-B, CO-402-COLD-B-DD, CO-402-COLD-DD, CO-402W, LVC-12, LVC-15, LVC-15D, LVC-21, LVC-21B, LVC-21C, LVC-21D, LVC-21W, LVR-10, LVR-14, LVR-14D, LVR-20, LVR-20B, LVR-20D...(Other models you can see in the webshop)		
<b>accessories for</b>	505033		
			
<b>GEV No.</b>	505031	<b>Ref. No.</b>	12023710 Z400711
	opposite support		



			
<b>GEV No.</b>	505046	<b>Ref. No.</b>	12024006 Z201906
<b>description</b>	opposite support rinse jet		
<b>For models:</b>	AD-15, AD-15D, AD-90, AD-90BA, AD-90BDD, AD-90DD, FI-30, FI-30AR, FI-30AR+DD, FI-30B, FI-30B-BT-UK, FI-30-UK, FI-48, FI-48AR, FI-48B, FI-48B-BT-UK, FI-48C, FI-48D, FI-48HY-CLINIC, FI-48W, FI-60DD, FI-80, FI-80AR, FI-80W, FI-E-100, LABP-800, LVC-12, LVC-15, LVC-15D, LVC-21, LVC-21B, LVC-21C, LVC-21D, LVC-21W, LVR-10, LVR-14, LVR-20, LVR-20B, MF-21		

			
<b>GEV No.</b>	505045	<b>Ref. No.</b>	12009912 Q307036
<b>description</b>	O-ring EPDM thickness 1.78mm ID ø 5.28mm Qty 1 pcs		
<b>For models:</b>	AD-15, AD-15D, AD-90, AD-90BA, AD-90BDD, AD-90DD, COG-202, EASY-500, EASY-500B, EASY-500DD, EASY-500HP, EASY-500HPWBDD, FI-30, FI-30AR, FI-30AR+DD, FI-30B, FI-30B-BT-UK, FI-30-UK, FI-48, FI-48AR, FI-48B, FI-48B-BT-UK, FI-48C, FI-48D, FI-48HY-CLINIC, FI-48W, FI-60DD, FI-80, FI-80AR, FI-80W, FI-E-100, HGC-20-21, HGP-10-21, HGP-20-21, HGV-20-21, LABP-800, LF-13MPP, LF-18MPP, LF-25MPP, LF-8MPP, LVC-12, LVC-15, LVC-15D, LVC-21, LVC-21B, LVC-21D, LVC-21W, LVR-10, LVR-14, LVR-20...(Other models you can see in the webshop)		

			
<b>GEV No.</b>	505061	<b>Ref. No.</b>	12022442 12113596 Z201902
<b>description</b>	rinse arm L 220mm nozzles 3 mounting ø 11.7mm mounting pos. left		
<b>For models:</b>	AD-120, AD-120B, AD-120BTTDD-UK, AD-120C, AD-120CW, AD-120HY, AD-45BBT, AD-48, AD-48B, AD-48BDD, AD-48C, AD-48D, AD-48DD, AD-48HY, AD-48W, AD-64, AD-64B, AD-64BTT, AD-64BDD, AD-64BTDD, AD-64C, AD-64CW, AD-64D, AD-64DD, AD-64HY, AD-72, AD-72W, AD-90, AD-90BA, AD-90BBT, AD-90BDD, AD-90DD, ADE-120, ADE-120B, CO-110, CO-110B, CO-110BDD, CO-110DD, CO-112, CO-112B, CO-112BDD, CO-112DD, CO-142W, CO-142WDD, CO-170, CO-170B, CO-170BDD, CO-170DD, CO-170HRS, CO-170HRSDD...(Other models you can see in the webshop)		

			
<b>GEV No.</b>	505062	<b>Ref. No.</b>	12022441 12113595 Z201901
<b>description</b>	rinse arm L 220mm nozzles 3 mounting ø 12mm mounting pos. right		
<b>For models:</b>	AD-120, AD-120B, AD-120BTTDD-UK, AD-120C, AD-120CW, AD-120HY, AD-45BBT, AD-48, AD-48B, AD-48BDD, AD-48C, AD-48D, AD-48DD, AD-48HY, AD-48W, AD-64, AD-64B, AD-64BTT, AD-64BDD, AD-64BTDD, AD-64C, AD-64CW, AD-64D, AD-64DD, AD-64HY, AD-72, AD-72W, AD-90, AD-90BA, AD-90BBT, AD-90BDD, AD-90DD, ADE-120, ADE-120B, CO-110, CO-110B, CO-110BDD, CO-110DD, CO-112, CO-112B, CO-112BDD, CO-112DD, CO-142W, CO-142WDD, CO-170, CO-170B, CO-170BDD, CO-170DD, CO-170HRS, CO-170HRSDD...(Other models you can see in the webshop)		

			
<b>GEV No.</b>	505069	<b>Ref. No.</b>	12024470 Z201903
<b>description</b>	rinse arm boss mounting pos. upper/lower ø 12mm H 22mm L 59mm		
<b>For models:</b>	AD-120, AD-120B, AD-120BTTDD-UK, AD-120C, AD-120CW, AD-120HY, AD-45BBT, AD-48, AD-48B, AD-48BDD, AD-48C, AD-48D, AD-48DD, AD-48HY, AD-48W, AD-64, AD-64B, AD-64BTT, AD-64BDD, AD-64BTDD, AD-64C, AD-64CW, AD-64D, AD-64DD, AD-64HY, AD-72, AD-72W, AD-90, AD-90BA, AD-90BBT, AD-90BDD, AD-90DD, ADE-120, ADE-120B, CO-110, CO-110B, CO-110BDD, CO-110DD, CO-112, CO-112B, CO-112BDD, CO-112DD, CO-142W, CO-142WDD, CO-170, CO-170B, CO-170BDD, CO-170DD, CO-170HRS, CO-170HRSDD...(Other models you can see in the webshop)		
<b>accessories for</b>	505069		
			
<b>GEV No.</b>	560076	<b>Ref. No.</b>	12009852 12010293 Q152024
	countersunk screw thread M4 L 10mm SS DIN 963/ISO 2009 Qty 20 pcs intake slotted head ø 7.5mm		

			
<b>GEV No.</b>	505044	<b>Ref. No.</b>	12024077 Z201905
<b>description</b>	rinse jet		
<b>For models:</b>	AD-15, AD-15D, AD-90, AD-90BA, AD-90BBT, AD-90BDD, AD-90DD, EASY-500, EASY-500B, EASY-500DD, EASY-500HP, EASY-500HPWBDD, FI-30, FI-30AR, FI-30AR+DD, FI-30B, FI-30B-BT-UK, FI-30-UK, FI-48, FI-48AR, FI-48B, FI-48B-BT-UK, FI-48C, FI-48D, FI-48HY-CLINIC, FI-48W, FI-60DD, FI-80, FI-80AR, FI-80BBT-UK, FI-80W, FI-E-100, LABP-800, LVC-12, LVC-15, LVC-15D, LVC-21, LVC-21B, LVC-21C, LVC-21D, LVC-21W, LVR-10, LVR-14, LVR-20, LVR-20B, MF-21		
<b>accessories for</b>	505044		
			
<b>GEV No.</b>	505045	<b>Ref. No.</b>	12009912 Q307036
	O-ring EPDM thickness 1.78mm ID ø 5.28mm Qty 1 pcs		
			
<b>GEV No.</b>	505046	<b>Ref. No.</b>	12024006 Z201906
	opposite support rinse jet		





 <p>1</p>			
<b>GEV No.</b>	505136	<b>Ref. No.</b>	12018104 Z680742
<b>description</b>	wash arm L 225mm nozzles 4 ø 25mm		
<b>For models:</b>	ECO-1200, FI-1200, FI-900		

 <p>1</p>			
<b>GEV No.</b>	505067	<b>Ref. No.</b>	12017301 Z401915
<b>description</b>	rinse arm mounting pos. upper/lower L 157mm mounting ø 11.5mm nozzles 4		
<b>For models:</b>	LVR-10, LVR-14		



 <p>1</p>			
<b>GEV No.</b>	505217	<b>Ref. No.</b>	12018636 Z680741
<b>description</b>	wash arm L 225mm nozzles 4 ø 25mm		
<b>For models:</b>	ECO-1200, FI-1200, FI-900		

 <p>1</p>			
<b>GEV No.</b>	505090	<b>Ref. No.</b>	12040402 Z421904
<b>description</b>	rinse arm mounting pos. upper/lower L 175mm mounting ø 10mm nozzles 5		
<b>For models:</b>	LVR-20, LVR-20B		

 <p>1</p>			
<b>GEV No.</b>	505216	<b>Ref. No.</b>	12039835 Z680745
<b>description</b>	wash arm boss L 90mm W 90mm H 38mm		
<b>For models:</b>	ECO-1200, FI-1200, FI-900		

 <p>1</p>			
<b>GEV No.</b>	505044	<b>Ref. No.</b>	12024077 Z201905
<b>description</b>	rinse jet		
<b>For models:</b>	AD-15, AD-15D, AD-90, AD-90BA, AD-90BBT, AD-90BDD, AD-90DD, EASY-500, EASY-500B, EASY-500DD, EASY-500HP, EASY-500HPWBDD, FI-30, FI-30AR, FI-30AR+DD, FI-30B, FI-30B-BT-UK, FI-30-UK, FI-48, FI-48AR, FI-48B, FI-48B-BT-UK, FI-48C, FI-48D, FI-48HY-CLINIC, FI-48W, FI-60DD, FI-80, FI-80AR, FI-80BBT-UK, FI-80W, FI-E-100, LABP-800, LVC-12, LVC-15, LVC-15D, LVC-21, LVC-21B, LVC-21C, LVC-21D, LVC-21W, LVR-10, LVR-14, LVR-20, LVR-20B, MF-21		

 <p>1</p>			
<b>GEV No.</b>	505267	<b>Ref. No.</b>	12017814 Z600705
<b>description</b>	wash jet for pipe ø 25mm		
<b>For models:</b>	ECO-1200, FI-1200, FI-900		

<b>accessories for</b>	505044			
	<b>GEV No.</b>	505045	<b>Ref. No.</b>	12009912 Q307036
	O-ring EPDM thickness 1.78mm ID ø 5.28mm Qty 1 pcs			
	<b>GEV No.</b>	505046	<b>Ref. No.</b>	12024006 Z201906
	opposite support rinse jet			

 <p>1</p>			
<b>GEV No.</b>	505046	<b>Ref. No.</b>	12024006 Z201906
<b>description</b>	opposite support rinse jet		
<b>For models:</b>	AD-15, AD-15D, AD-90, AD-90BA, AD-90BDD, AD-90DD, FI-30, FI-30AR, FI-30AR+DD, FI-30B, FI-30B-BT-UK, FI-30-UK, FI-48, FI-48AR, FI-48B, FI-48B-BT-UK, FI-48C, FI-48D, FI-48HY-CLINIC, FI-48W, FI-60DD, FI-80, FI-80AR, FI-80W, FI-E-100, LABP-800, LVC-12, LVC-15, LVC-15D, LVC-21, LVC-21B, LVC-21C, LVC-21D, LVC-21W, LVR-10, LVR-14, LVR-20, LVR-20B, MF-21		



 <p>1</p>			
<b>GEV No.</b>	505046	<b>Ref. No.</b>	12024006 Z201906
<b>description</b>	opposite support rinse jet		
<b>For models:</b>	AD-15, AD-15D, AD-90, AD-90BA, AD-90BDD, AD-90DD, FI-30, FI-30AR, FI-30AR+DD, FI-30B, FI-30B-BT-UK, FI-30-UK, FI-48, FI-48AR, FI-48B, FI-48B-BT-UK, FI-48C, FI-48D, FI-48HY-CLINIC, FI-48W, FI-60DD, FI-80, FI-80AR, FI-80W, FI-E-100, LABP-800, LVC-12, LVC-15, LVC-15D, LVC-21, LVC-21B, LVC-21C, LVC-21D, LVC-21W, LVR-10, LVR-14, LVR-20, LVR-20B, MF-21		



 <p>1</p>			
<b>GEV No.</b>	505045	<b>Ref. No.</b>	12009912 Q307036
<b>description</b>	O-ring EPDM thickness 1.78mm ID ø 5.28mm Qty 1 pcs		
<b>For models:</b>	AD-15, AD-15D, AD-90, AD-90BA, AD-90BDD, AD-90DD, COG-202, EASY-500, EASY-500B, EASY-500DD, EASY-500HP, EASY-500HPWBDD, FI-30, FI-30AR, FI-30AR+DD, FI-30B, FI-30B-BT-UK, FI-30-UK, FI-48, FI-48AR, FI-48B, FI-48B-BT-UK, FI-48C, FI-48D, FI-48HY-CLINIC, FI-48W, FI-60DD, FI-80, FI-80AR, FI-80W, FI-E-100, HGC-20-21, HGP-10-21, HGP-20-21, HGV-20-21, LABP-800, LF-13MPP, LF-18MPP, LF-25MPP, LF-8MPP, LVC-12, LVC-15, LVC-15D, LVC-21, LVC-21B, LVC-21D, LVC-21W, LVR-10, LVR-14, LVR-20...(Other models you can see in the webshop)		

			
<b>GEV No.</b>	505045	<b>Ref. No.</b>	12009912 Q307036
<b>description</b>	O-ring EPDM thickness 1.78mm ID ø 5.28mm Qty 1 pcs		
<b>For models:</b>	AD-15, AD-15D, AD-90, AD-90BA, AD-90BDD, AD-90DD, COG-202, EASY-500, EASY-500B, EASY-500DD, EASY-500HP, EASY-500HPWBDD, FI-30, FI-30AR, FI-30AR+DD, FI-30B, FI-30B-BT-UK, FI-30-UK, FI-48, FI-48AR, FI-48B, FI-48B-BT-UK, FI-48C, FI-48D, FI-48HY-CLINIC, FI-48W, FI-60DD, FI-80, FI-80AR, FI-80W, FI-E-100, HGC-20-21, HGP-10-21, HGP-20-21, HGV-20-21, LABP-800, LF-13MPP, LF-18MPP, LF-25MPP, LF-8MPP, LVC-12, LVC-15, LVC-15D, LVC-21, LVC-21B, LVC-21D, LVC-21W, LVR-10, LVR-14, LVR-20...(Other models you can see in the webshop)		

			
<b>GEV No.</b>	505265	<b>Ref. No.</b>	12023524 Z208712
<b>description</b>	rinse arm L 230mm nozzles 3		
<b>For models:</b>	AD-90, AD-90BA, AD-90BBT, AD-90BDD, AD-90DD, EASY-500, EASY-500B, EASY-500DD, EASY-500HP, EASY-500HPWBDD, FI-30, FI-30AR, FI-30AR+DD, FI-30B, FI-30B-BT-UK, FI-30-UK, FI-48, FI-48AR, FI-48B, FI-48B-BT-UK, FI-48C, FI-48D, FI-48HY-CLINIC, FI-48W, FI-60DD, FI-80, FI-80AR, FI-80W, FI-E-100, LABP-800		

			
<b>GEV No.</b>	505266	<b>Ref. No.</b>	12023527 Z208713
<b>description</b>	rinse arm L 230mm nozzles 3 right		
<b>For models:</b>	AD-90, AD-90BA, AD-90BBT, AD-90BDD, AD-90DD, EASY-500, EASY-500B, EASY-500DD, EASY-500HP, EASY-500HPWBDD, FI-30, FI-30AR, FI-30AR+DD, FI-30B, FI-30B-BT-UK, FI-30-UK, FI-48, FI-48AR, FI-48B, FI-48B-BT-UK, FI-48C, FI-48D, FI-48HY-CLINIC, FI-48W, FI-60DD, FI-80, FI-80AR, FI-80W, FI-E-100, LABP-800		

			
<b>GEV No.</b>	505069	<b>Ref. No.</b>	12024470 Z201903
<b>description</b>	rinse arm boss mounting pos. upper/lower ø 12mm H 22mm L 59mm		
<b>For models:</b>	AD-120, AD-120B, AD-120BBTDD-UK, AD-120C, AD-120CW, AD-120HY, AD-45BBT, AD-48, AD-48B, AD-48BDD, AD-48C, AD-48D, AD-48DD, AD-48HY, AD-48W, AD-64, AD-64B, AD-64BBT, AD-64BDD, AD-64BTDD, AD-64C, AD-64CW, AD-64D, AD-64DD, AD-64HY, AD-72, AD-72W, AD-90, AD-90BA, AD-90BBT, AD-90BDD, AD-90DD, ADE-120, ADE-120B, CO-110, CO-110B, CO-110BDD, CO-110DD, CO-112, CO-112B, CO-112BDD, CO-112DD, CO-142W, CO-142WDD, CO-170, CO-170B, CO-170BDD, CO-170DD, CO-170HRS, CO-170HRSDD...(Other models you can see in the webshop)		
<b>accessories for</b>	505069		
	<b>GEV No.</b>	560076	<b>Ref. No.</b> 12009852 12010293 Q152024
countersunk screw thread M4 L 10mm SS DIN 963/ISO 2009 Qty 20 pcs intake slotted head ø 7.5mm			

			
<b>GEV No.</b>	505044	<b>Ref. No.</b>	12024077 Z201905
<b>description</b>	rinse jet		
<b>For models:</b>	AD-15, AD-15D, AD-90, AD-90BA, AD-90BBT, AD-90BDD, AD-90DD, EASY-500, EASY-500B, EASY-500DD, EASY-500HP, EASY-500HPWBDD, FI-30, FI-30AR, FI-30AR+DD, FI-30B, FI-30B-BT-UK, FI-30-UK, FI-48, FI-48AR, FI-48B, FI-48B-BT-UK, FI-48C, FI-48D, FI-48HY-CLINIC, FI-48W, FI-60DD, FI-80, FI-80AR, FI-80BBT-UK, FI-80W, FI-E-100, LABP-800, LVC-12, LVC-15, LVC-15D, LVC-21, LVC-21B, LVC-21C, LVC-21D, LVC-21W, LVR-10, LVR-14, LVR-20, LVR-20B, MF-21		
<b>accessories for</b>	505044		
	<b>GEV No.</b>	505045	<b>Ref. No.</b> 12009912 Q307036
O-ring EPDM thickness 1.78mm ID ø 5.28mm Qty 1 pcs			
	<b>GEV No.</b>	505046	<b>Ref. No.</b> 12024006 Z201906
opposite support rinse jet			

			
<b>GEV No.</b>	507537	<b>Ref. No.</b>	12007166 12Z3119100
<b>description</b>	rinse arm W 630mm H 645mm nozzles 12		
<b>For models:</b>	ECO-280D, ECO-280I, ECO-370D, ECO-370I, ECO-460D, ECO-460I, ECO-550D, ECO-550I, FI-280D, FI-280I, FI-370D, FI-370I, FI-460D, FI-460I, FI-550D, FI-550I		

			
<b>GEV No.</b>	505031	<b>Ref. No.</b>	12023710 Z400711
<b>description</b>	opposite support		
<b>For models:</b>	AD-15, AD-15D, AD-20C-UK, AD-21, AD-21B, AD-21BDD, AD-21C, AD-21D, AD-21DD, AD-21W, CO-350, CO-350-B, CO-350-B-DD, CO-350-COLD, CO-350-COLD-B, CO-350-COLD-B-DD, CO-350-COLD-DD, CO-350-DD, CO-352-COLD, CO-352-COLD-B, CO-352-COLD-B-DD, CO-352-COLD-DD, CO-400, CO-400-B, CO-400-B-DD, CO-400-COLD, CO-400-COLD-B, CO-400-COLD-B-DD, CO-400-COLD-DD, CO-400-DD, CO-400-SOFT, CO-402-COLD, CO-402-COLD-B, CO-402-COLD-B-DD, CO-402-COLD-DD, CO-402W, ECO-2700D, ECO-2700I, ECO-280D, ECO-280I, ECO-370D, ECO-370I, ECO-4000D, ECO-4000I, ECO-460D, ECO-460I, ECO-550D, ECO-550I, ECO-6000D, ECO-6000I...(Other models you can see in the webshop)		

			
<b>GEV No.</b>	505231	<b>Ref. No.</b>	12021106 Z791931
<b>description</b>	rinse jet ø 14mm H 22mm thread M10x0.9		
<b>For models:</b>	ECO-1600, ECO-2300, ECO-3000, FI-1600, FI-2300, FI-3000		











 <p>1</p>			
<b>GEV No.</b>	505258	<b>Ref. No.</b>	12023568 Z311831
<b>description</b>	wash jet		
<b>For models:</b>	ECO-2700D, ECO-2700I, ECO-280D, ECO-280I, ECO-370D, ECO-370I, ECO-4000D, ECO-4000I, ECO-460D, ECO-460I, ECO-550D, ECO-550I, ECO-6000D, ECO-6000I, FI-2700D, FI-2700I, FI-280D, FI-280I, FI-370D, FI-370I, FI-4000D, FI-4000I, FI-460D, FI-460I, FI-550D, FI-550I, FI-6000D, FI-6000I		

 <p>1</p>			
<b>GEV No.</b>	505324	<b>Ref. No.</b>	12017004 Z100707
<b>description</b>	end cap for wash arm screw mounting H 13mm WS 42		
<b>For models:</b>	ECO-1600, ECO-2300, ECO-3000, FI-1600, FI-2300, FI-3000		

 <p>1</p>			
<b>GEV No.</b>	505233	<b>Ref. No.</b>	12020338 Z100706
<b>description</b>	wash arm with flange L 180mm		
<b>For models:</b>	ECO-1600, ECO-2300, ECO-3000, FI-1600, FI-2300, FI-3000		

 <p>1</p>			
<b>GEV No.</b>	505319	<b>Ref. No.</b>	12020529 Z100705
<b>description</b>	wash arm with flange L 255mm nozzles 3		
<b>For models:</b>	ECO-1600, ECO-2300, ECO-3000, FI-1600, FI-2300, FI-3000		
<b>accessories for</b>	505319		
	<b>GEV No.</b>	<b>Ref. No.</b>	12017004 Z100707
	505324		
	end cap for wash arm screw mounting H 13mm WS 42		
	<b>GEV No.</b>	<b>Ref. No.</b>	12017168 Z100709
	510116		
	wash jet mounting pos. upper H 37mm type B hose ø 37mm		

 <p>1</p>			
<b>GEV No.</b>	510116	<b>Ref. No.</b>	12017168 Z100709
<b>description</b>	wash jet mounting pos. upper H 37mm type B hose ø 37mm		
<b>For models:</b>	ECO-1600, ECO-2300, ECO-3000, FI-1600, FI-2300, FI-3000		

miscellaneous			
 <p>1</p>			
<b>GEV No.</b>	505334	<b>Ref. No.</b>	12024302 Z270721
<b>description</b>	end cap for wash arm ø 27mm L 33mm suitable for FAGOR		
<b>For models:</b>	ECO-160, ECO-160D, ECO-160I, ECO-200, ECO-200D, ECO-200H, ECO-200HD, ECO-200HI, ECO-200I, FI-160, FI-160AR, FI-160D, FI-160I, FI-200, FI-200AR, FI-200D, FI-200H, FI-200HD, FI-200HI, FI-200I, FI-200W, FI-200WL, FI-200WR		
<b>accessories for</b>	505334		
	<b>GEV No.</b>	<b>Ref. No.</b>	12010230 Q307062
	532499		
	O-ring EPDM thickness 2.62mm ID ø 23.47mm Qty 1 pcs		

 <p>1</p>			
<b>GEV No.</b>	505215	<b>Ref. No.</b>	12017837 Z600704
<b>description</b>	wash jet		

wash arm supports			
 <p>1</p>			
<b>GEV No.</b>	505020	<b>Ref. No.</b>	12016686 Z400702
<b>description</b>	opposite support mounting pos. lower		
<b>For models:</b>	LVR-10, LVR-14, LVR-14D, LVR-20, LVR-20B, LVR-20D		

 <p>1</p>			
<b>GEV No.</b>	505021	<b>Ref. No.</b>	12024312 Z710706
<b>description</b>	opposite support mounting pos. lower		
<b>For models:</b>	AD-120, AD-120B, AD-120BBTDD-UK, AD-120C, AD-120CW, AD-120HY, AD-90, AD-90BA, AD-90BBT, AD-90BDD, AD-90DD, ADE-120, ADE-120B, ECO-120, ECO-120B, FI-100, FI-100AR, FI-100B, FI-100BBT-UK, FI-120, FI-120AR+DD, FI-120B, FI-120C, FI-120HY-CLINIC, FI-120W, FI-80, FI-80AR, FI-80BBT-UK, FI-80W, FI-E-100, LABP-1000, LABP-1200, LABP-800, MF-120		

			
1			
<b>GEV No.</b>	505053	<b>Ref. No.</b>	12024703 Z410702
<b>description</b>	opposite support mounting pos. lower		
<b>For models:</b>	AD-15, AD-15D, AD-20C-UK, AD-21, AD-21B, AD-21BDD, AD-21C, AD-21D, AD-21DD, AD-21W, CO-350, CO-350-B, CO-350-B-DD, CO-350-COLD, CO-350-COLD-B, CO-350-COLD-B-DD, CO-350-COLD-DD, CO-350-DD, CO-352-COLD, CO-352-COLD-B, CO-352-COLD-B-DD, CO-352-COLD-DD, CO-400, CO-400-B, CO-400-B-DD, CO-400-COLD, CO-400-COLD-B, CO-400-COLD-B-DD, CO-400-COLD-DD, CO-400-DD, CO-400-SOFT, CO-402-COLD, CO-402-COLD-B, CO-402-COLD-B-DD, CO-402-COLD-DD, CO-402W, LVC-12, LVC-15, LVC-15D, LVC-21, LVC-21B, LVC-21C, LVC-21D, LVC-21W, MF-21		

			
1			
<b>GEV No.</b>	505051	<b>Ref. No.</b>	12023613 Z200703
<b>description</b>	opposite support mounting pos. lower for wash arm support		
<b>For models:</b>	AD-45BBT, AD-48, AD-48B, AD-48BDD, AD-48C, AD-48D, AD-48DD, AD-48HY, AD-48W, AD-64, AD-64B, AD-64BBT, AD-64BDD, AD-64BTDD, AD-64C, AD-64CW, AD-64D, AD-64DD, AD-64HY, AD-72, AD-72W, EASY-500, EASY-500B, EASY-500DD, EASY-500HP, EASY-500HPWBDD, FI-30, FI-30AR, FI-30AR+DD, FI-30B, FI-30B-BT-UK, FI-30-UK, FI-48, FI-48AR, FI-48B, FI-48B-BT-UK, FI-48C, FI-48D, FI-48HY-CLINIC, FI-48W, FI-50, FI-60DD, FI-64, FI-64AR, FI-64B, FI-64B-BT-UK, FI-64C, FI-64D, FI-64HY-CLINIC, FI-64W...(Other models you can see in the webshop)		

			
1			
<b>GEV No.</b>	505017	<b>Ref. No.</b>	12020347 Z400701
<b>description</b>	wash arm support mounting pos. lower		
<b>For models:</b>	LVR-10, LVR-14, LVR-14D, LVR-20, LVR-20B, LVR-20D		

			
1			
<b>GEV No.</b>	505018	<b>Ref. No.</b>	12024480 Z200701 Z210701
<b>description</b>	wash arm support mounting pos. lower		
<b>For models:</b>	AD-45BBT, AD-48, AD-48B, AD-48BDD, AD-48C, AD-48D, AD-48DD, AD-48HY, AD-48W, AD-64, AD-64B, AD-64BBT, AD-64BDD, AD-64BTDD, AD-64C, AD-64CW, AD-64D, AD-64DD, AD-64HY, AD-72, AD-72W, EASY-500, EASY-500B, EASY-500DD, EASY-500HP, EASY-500HPWBDD, FI-30, FI-30AR, FI-30AR+DD, FI-30B, FI-30B-BT-UK, FI-30-UK, FI-48, FI-48AR, FI-48B, FI-48B-BT-UK, FI-48C, FI-48D, FI-48HY-CLINIC, FI-48W, FI-50, FI-60DD, FI-64, FI-64AR, FI-64B, FI-64B-BT-UK, FI-64C, FI-64D, FI-64HY-CLINIC, FI-64W...(Other models you can see in the webshop)		

			
1			
<b>GEV No.</b>	505019	<b>Ref. No.</b>	12020989 12025170 Z740702 Z740705
<b>description</b>	wash arm support mounting pos. lower		
<b>For models:</b>	AD-90, AD-90BA, AD-90BBT, AD-90BDD, AD-90DD, FI-80, FI-80AR, FI-80BBT-UK, FI-80W, FI-E-100, LABP-800		

			
1			
<b>GEV No.</b>	505022	<b>Ref. No.</b>	12023652 Z710704
<b>description</b>	wash arm support mounting pos. lower		
<b>For models:</b>	AD-120, AD-120B, AD-120BBTDD-UK, AD-120C, AD-120CW, AD-120HY, ADE-120, ADE-120B, ECO-120, ECO-120B, FI-100, FI-100AR, FI-100B, FI-120, FI-120AR+DD, FI-120B, FI-120C, FI-120HY-CLINIC, FI-120W, FI-E-100, LABP-1200, MF-120		

			
1			
<b>GEV No.</b>	505275	<b>Ref. No.</b>	12024478 Z710719
<b>description</b>	wash arm support mounting pos. lower D1 ø 47mm H 91mm L1 86mm		
<b>For models:</b>	FI-100, FI-100AR, FI-100B, FI-100BBT-UK, LABP-1000		

			
1			
<b>GEV No.</b>	505050	<b>Ref. No.</b>	12025133 Z410701
<b>description</b>	wash arm support mounting pos. lower H 102mm D1 ø 40mm D2 ø 48mm D3 ø 68mm		
<b>For models:</b>	AD-15, AD-15D, AD-20C-UK, AD-21, AD-21B, AD-21BDD, AD-21C, AD-21D, AD-21DD, AD-21W, LVC-12, LVC-15, LVC-15D, LVC-21, LVC-21B, LVC-21C, LVC-21D, LVC-21W, MF-21		

			
1			
<b>GEV No.</b>	505056	<b>Ref. No.</b>	12023590 Z410703
<b>description</b>	wash arm support mounting pos. upper		
<b>For models:</b>	AD-15, AD-15D, AD-20C-UK, AD-21, AD-21B, AD-21BDD, AD-21C, AD-21D, AD-21DD, AD-21W, LVC-12, LVC-15, LVC-15D, LVC-21, LVC-21B, LVC-21C, LVC-21D, LVC-21W, MF-21		





 <p>1</p>			
<b>GEV No.</b>	505057	<b>Ref. No.</b>	12024471 Z200707
<b>description</b>	wash arm support mounting pos. upper		
<b>For models:</b>	AD-45BBT, AD-48, AD-48B, AD-48BDD, AD-48C, AD-48D, AD-48DD, AD-48HY, AD-48W, AD-64, AD-64B, AD-64BBT, AD-64BDD, AD-64BTDD, AD-64C, AD-64CW, AD-64D, AD-64DD, AD-64HY, AD-72, AD-72W, EASY-500, EASY-500B, EASY-500DD, EASY-500HP, EASY-500HPWBDD, FI-30, FI-30AR, FI-30AR+DD, FI-30B, FI-30B-BT-UK, FI-30-UK, FI-48, FI-48AR, FI-48B, FI-48B-BT-UK, FI-48C, FI-48D, FI-48HY-CLINIC, FI-48W, FI-50, FI-60DD, FI-64, FI-64AR, FI-64B, FI-64B-BT-UK, FI-64C, FI-64D, FI-64HY-CLINIC, FI-64W...(Other models you can see in the webshop)		

 <p>1</p>			
<b>GEV No.</b>	505058	<b>Ref. No.</b>	Z200702
<b>description</b>	wash arm support mounting pos. upper		

 <p>1</p>			
<b>GEV No.</b>	505059	<b>Ref. No.</b>	12024927 Z740703
<b>description</b>	wash arm support mounting pos. upper		
<b>For models:</b>	AD-120BBTDD-UK, AD-90, AD-90BA, AD-90BBT, AD-90BDD, AD-90DD, FI-80, FI-80AR, FI-80BBT-UK, FI-80W, FI-E-100, LABP-800		

 <p>1</p>			
<b>GEV No.</b>	505060	<b>Ref. No.</b>	12024934 Z710705
<b>description</b>	wash arm support mounting pos. upper		
<b>For models:</b>	AD-120, AD-120B, AD-120BBTDD-UK, AD-120C, AD-120CW, AD-120HY, AD-90, AD-90BA, AD-90BDD, AD-90DD, ADE-120, ADE-120B, CO-142W, CO-142WDD, COP-174W, COP-174WHRS, ECO-120, ECO-120B, FI-100, FI-100AR, FI-100B, FI-100BBT-UK, FI-120, FI-120AR+DD, FI-120B, FI-120C, FI-120HY-CLINIC, FI-120W, FI-E-100, LABP-1000, LABP-1200, LABP-800, MF-120		

 <p>1</p>			
<b>GEV No.</b>	501546	<b>Ref. No.</b>	12048173
<b>description</b>	wash arm support mounting pos. upper ø 42mm H 78mm L1 340mm		
<b>For models:</b>	AD-125, AD-125HRS, AD-125-SOFT, CO-110, CO-110B, CO-110BDD, CO-110DD, CO-112, CO-112B, CO-112BDD, CO-112DD, CO-170, CO-170B, CO-170BDD, CO-170DD, CO-170HRS, CO-170HRSDD, CO-170HRS-SOFT, CO-170-SOFT, CO-172, CO-172B, CO-172BDD, CO-172DD, COP-173, COP-173B, COP-173BDD, COP-173DD, COP-173HRS, COP-173HRSDD, COP-173-SOFT, COP-174, COP-174B, COP-174BDD, COP-174DD, COP-174HRS, COP-174HRSDD		
<b>accessories for</b>	501546		
	<b>GEV No.</b>	532103	<b>Ref. No.</b>
			12049214
	 <p>O-ring EPDM thickness 3.53mm ID ø 13.87mm Qty 10 pcs</p>		

<b>accessories for</b>	501546		
	<b>GEV No.</b>	699343	<b>Ref. No.</b>
			12048366
	 <p>gasket L 118mm W 73mm H 9mm thickness 9mm</p>		

<b>rinse arm shafts</b>			
 <p>1</p>			
<b>GEV No.</b>	505047	<b>Ref. No.</b>	12025114 Z410708
<b>description</b>	rinse arm shaft		
<b>For models:</b>	AD-15, AD-15D, AD-20C-UK, AD-21, AD-21B, AD-21BDD, AD-21C, AD-21D, AD-21DD, AD-21W, CO-350, CO-350-B, CO-350-B-DD, CO-350-COLD, CO-350-COLD-B, CO-350-COLD-B-DD, CO-350-COLD-DD, CO-350-DD, CO-352-COLD, CO-352-COLD-B, CO-352-COLD-B-DD, CO-352-COLD-DD, CO-400, CO-400-B, CO-400-B-DD, CO-400-COLD, CO-400-COLD-B, CO-400-COLD-B-DD, CO-400-COLD-DD, CO-400-SOFT, CO-402-COLD, CO-402-COLD-B, CO-402-COLD-B-DD, CO-402-COLD-DD, CO-402W, LVC-12, LVC-15, LVC-15D, LVC-21, LVC-21B, LVC-21C, LVC-21D, LVC-21W, MF-21		

 <p>1</p>			
<b>GEV No.</b>	505048	<b>Ref. No.</b>	12023844 Z200704
<b>description</b>	rinse arm shaft		
<b>For models:</b>	AD-45BBT, AD-48, AD-48B, AD-48BDD, AD-48C, AD-48D, AD-48DD, AD-48HY, AD-48W, AD-64, AD-64B, AD-64BBT, AD-64BDD, AD-64BTDD, AD-64C, AD-64CW, AD-64D, AD-64DD, AD-64HY, AD-72, AD-72W, AD-90, AD-90BA, AD-90BBT, AD-90BDD, AD-90DD, EASY-500, EASY-500B, EASY-500DD, EASY-500HP, EASY-500HPWBDD, FI-30, FI-30AR, FI-30AR+DD, FI-30B, FI-30B-BT-UK, FI-30-UK, FI-48, FI-48AR, FI-48B, FI-48B-BT-UK, FI-48C, FI-48D, FI-48HY-CLINIC, FI-48W, FI-50, FI-60DD, FI-64, FI-64AR, FI-64B...(Other models you can see in the webshop)		

 <p>1</p>			
<b>GEV No.</b>	505049	<b>Ref. No.</b>	12023601 Z710711
<b>description</b>	rinse arm shaft		
<b>For models:</b>	AD-120, AD-120B, AD-120BBTDD-UK, AD-120C, AD-120CW, AD-120HY, ADE-120, ADE-120B, ECO-120, ECO-120B, FI-100, FI-100AR, FI-100B, FI-100BBT-UK, FI-120, FI-120AR+DD, FI-120B, FI-120C, FI-120HY-CLINIC, FI-120W, FI-E-100, LABP-1000, LABP-1200, MF-120		

 <p>1</p>			
<b>GEV No.</b>	513122	<b>Ref. No.</b>	12029990 EU926130
<b>description</b>	rinse arm shaft		

			
1			
<b>GEV No.</b>	505251	<b>Ref. No.</b>	12018232 Z680748
<b>description</b>	rinse arm shaft H 85mm		
<b>For models:</b>	ECO-1200, FI-1200, FI-900		

			
1			
<b>GEV No.</b>	505052	<b>Ref. No.</b>	12023801 Z410712
<b>description</b>	rinse arm shaft L1 102mm L2 84mm L3 26mm		
<b>For models:</b>	AD-15, AD-15D, AD-20C-UK, AD-21, AD-21B, AD-21BDD, AD-21C, AD-21D, AD-21DD, AD-21W, CO-350, CO-350-B, CO-350-B-DD, CO-350-COLD, CO-350-COLD-B, CO-350-COLD-B-DD, CO-350-COLD-DD, CO-350-DD, CO-352-COLD, CO-352-COLD-B, CO-352-COLD-B-DD, CO-352-COLD-DD, CO-400, CO-400-B, CO-400-B-DD, CO-400-COLD, CO-400-COLD-B, CO-400-COLD-B-DD, CO-400-COLD-DD, CO-400-DD, CO-400-SOFT, CO-402-COLD, CO-402-COLD-B, CO-402-COLD-B-DD, CO-402-COLD-DD, CO-402W, LVC-12, LVC-15, LVC-15D, LVC-21, LVC-21B, LVC-21C, LVC-21D, LVC-21W, MF-21		

## for washing machine

			
1			
<b>GEV No.</b>	698504	<b>Ref. No.</b>	12026769 DO00V21001
<b>description</b>	rack FAGOR center piece for washing machine		

## knobs

### producer-specific knobs

#### FAGOR

			
1			
<b>GEV No.</b>	113009	<b>Ref. No.</b>	12021151 12040067 S333005 S333006
<b>description</b>	knob energy regulator 1-9 ø 71mm shaft ø 6x4.6mm shaft flat upper black		
<b>For models:</b>	CPE7-05, ME7-10BM, ME9-10BM, ME9-10BMS, ME9-15BM, ME9-15BMS, MPE9-10BM, MPE9-10BMS, MPE9-15BM, MPE9-15BMS		

			
1			
<b>GEV No.</b>	113020	<b>Ref. No.</b>	12040255 U532130
<b>description</b>	knob gas tap with ignition flame ø 71mm shaft ø 10x8mm shaft flat right		
<b>For models:</b>	CG-200S, CG-210, CG-210G, CG-300S, CG-310, CG-310G		

			
1			
<b>GEV No.</b>	113010	<b>Ref. No.</b>	12008927 U542100 U542101
<b>description</b>	knob gas tap with ignition flame ø 71mm shaft ø 10x8mm shaft flat right black		
<b>For models:</b>	BG7-05, BG7-05I, BG7-10, BG7-10I, BG9-05, BG9-05I, BG9-10, BG9-10I, CG-1002, CG-1502, CG-2000, CG-2000-2P, CG-2002, CG-2002P, CG-2005, CG-210, CG-210G, CG-300S, CG-310, CG-310G, CG7-10, CG7-11, CG7-20, CG7-40, CG7-41, CG7-61, CG9-10, CG9-11, CG9-20, CG9-40, CG9-41, CG9-51L, CG9-51LC, CG9-51R, CG9-51RC, CG9-60, CG9-61, CG9-82, CGB7-61, CGE7-141, CGE7-41, CGE9-41, CPG7-05, CPG9-05, CPG9-05NC, CPG9-05S, CPG9-05SNC, FTG7-05VL, FTG7-05VR, FTG7-10VL... (Other models you can see in the webshop)		

			
1			
<b>GEV No.</b>	113008	<b>Ref. No.</b>	12021150 12040256 S312102 S31211000
<b>description</b>	knob gas tap with ignition flame ø 71mm shaft ø 10x8mm shaft flat right grey		
<b>For models:</b>	BG7-05, BG7-10, BG9-05, BG9-10, CG-200S, CG-210, CG-210G, CG-300S, CG-310, CG-310G, MG7-10, MG7-10BM, MG9-10, MG9-10BM, MG9-10BMS, MG9-10S, MG9-15, MG9-15BM, MG9-15BMS, MG9-15S, MG9-20, MG9-20S, MPG9-10, MPG9-10S, MPG9-15, MPG9-15BM, MPG9-15BMS, MPG9-15S, MPG9-20, MPG9-20S, PL-105L, PL-110L+R		



1

<b>GEV No.</b>	113038	<b>Ref. No.</b>	12007906 H122101
<b>description</b>	knob gas tap with ignition flame ø 72mm shaft ø 8x6mm shaft flat right black		
<b>For models:</b>	BG6-05I, BG7-05, BG7-05I, BG7-10, BG7-10I, CG7-10, CG7-11, CG7-20, CG7-20H, CG7-30D, CG7-30I, CG7-31D, CG7-31I, CG7-40, CG7-40H, CG7-41, CG7-41H, CG7-50, CG7-51, CG7-60, CG7-60H, CG7-61, CG7-61H, CGB7-61, CGB7-61H, CGB7-61R, CGB7-61RH, CGE7-41, CGE7-41H, CPG7-05, CPG7-05NC, FTG7-05VL, FTG7-05VR, FTG7-10VL, FTG7-10VL+R, FTG7-10VR		



1

<b>GEV No.</b>	113015	<b>Ref. No.</b>	12021132 12040259 X152110 X152111
<b>description</b>	knob gas thermostat 1-8 ø 71mm shaft ø 6x4.6mm shaft flat upper black		
<b>For models:</b>	SBG7-10, SBG9-10, SBG9-10I, SBG9-10IM, SBG9-10IMS, SBG9-10IS, SBG9-10M, SBG9-10MS, SBG9-10S, SBG9-15IM, SBG9-15IMS		



2

<b>GEV No.</b>	113040	<b>Ref. No.</b>	12008918 U912105
<b>description</b>	knob gas thermostat 1-7 ø 71mm shaft ø 8x6.5mm shaft flat right black		
<b>For models:</b>	CG7-11, CG7-31D, CG7-31I, CG7-41, CG7-41H, CG7-51, CG7-61, CG7-61H, CGB7-61, CGB7-61H, CGB7-61R, CGB7-61RH		



1

<b>GEV No.</b>	113016	<b>Ref. No.</b>	12040261 X162100
<b>description</b>	knob gas thermostat 1-8 ø 71mm shaft ø 6x4.6mm shaft flat upper black		
<b>For models:</b>	FG-920		



1

<b>GEV No.</b>	113019	<b>Ref. No.</b>	12008928 12040258 U842101 U842102
<b>description</b>	knob gas thermostat 1-7 ø 71mm shaft ø 8x6.5mm shaft flat right grey		
<b>For models:</b>	CG-210, CG-210G, CG-310, CG-310G, CG9-51L, CG9-51LC, CG9-51R, CG9-51RC, CGP9-11, FTG7-05L, FTG7-05R, FTG7-10L, FTG7-10L+R, FTG7-10R, FTG9-05L, FTG9-05R, FTG9-10L, FTG9-10L+R, FTG9-10R, FTGC7-05L, FTGC7-10L, FTGC9-05L, FTGC9-05R, FTGC9-10L, FTGC9-10L+R, FTGC9-10R		



1

<b>GEV No.</b>	113001	<b>Ref. No.</b>	12021178 R202103 R202106
<b>description</b>	knob gas thermostat 1-8 ø 71mm shaft ø 8x6.5mm shaft flat right grey		
<b>For models:</b>	BMG7-10, BMG9-05, BMG9-10, CG-210, CG-210G, CG-310, CG-310G, CG7-11, CG7-41, CG7-61, CGB7-61, FTG7-05, FTG7-10, FTG9-05L, FTG9-05R, FTG9-05VL, FTG9-05VR, FTG9-10L, FTG9-10L+R, FTG9-10R, FTG9-10VL, FTG9-10VL+R, FTG9-10VR, FTG9-11L, FTG9-11L+R, FTG9-11R, FTGC9-05, FTGC9-05L, FTGC9-05R, FTGC9-10, FTGC9-10L, FTGC9-10L+R, FTGC9-10R, FTGC9-11L, FTGC9-11L+R, FTGC9-11R, PL-105C, PL-110C		



1

<b>GEV No.</b>	113018	<b>Ref. No.</b>	X313002
<b>description</b>	knob gas thermostat 1-8 ø 71mm shaft ø 6x4.6mm shaft flat lower		



1

<b>GEV No.</b>	113013	<b>Ref. No.</b>	12021155 U673004 U673016
<b>description</b>	knob oven TH/TH+BH/BH ø 71mm shaft ø 6x4.6mm shaft flat upper black		
<b>For models:</b>	CE7-41, CE9-20, CE9-40, CE9-41, CGE7-204, CGE9-41, HE9-10, HE9-20		



1			
<b>GEV No.</b>	113012	<b>Ref. No.</b>	12021136 12040069 U673003 U673015
<b>description</b>	knob switch 7-position ø 71mm shaft ø 6x4.6mm shaft flat upper grey		
<b>For models:</b>	CE7-20, CE7-40, CE7-41, CE9-20, CE9-40, CE9-41		



1			
<b>GEV No.</b>	113002	<b>Ref. No.</b>	12021133 12040260 R212100
<b>description</b>	knob thermostat 1-8 ø 71mm shaft ø 6x4.6mm shaft flat upper black		
<b>For models:</b>	BME7-05, BME7-10, BME9-05, BME9-10, FI-120, FI-180, FI-250, ME9-10BM, ME9-15BM		



1			
<b>GEV No.</b>	112606	<b>Ref. No.</b>	12008048 U952101
<b>description</b>	knob switch 7-position ø 72mm shaft ø 6x4.6mm shaft flat upper black long pole		
<b>For models:</b>	CE6-20, CE6-40, CE6-41, CE7-20, CE7-20Q, CE7-40, CE7-40Q, CE7-41, CE7-41Q		



1			
<b>GEV No.</b>	113023	<b>Ref. No.</b>	12021135 X313003
<b>description</b>	knob thermostat 1-8 with ignition flame ø 71mm shaft ø 6x4.6mm shaft flat lower black		
<b>For models:</b>	FG-710, FG-720, FG9-05, FG9-05S, FG9-10		



1			
<b>GEV No.</b>	113017	<b>Ref. No.</b>	12021138 12040262 X183020 X183025
<b>description</b>	knob thermostat 1-8 ø 71mm shaft ø 6x4.6mm shaft flat lower black		
<b>For models:</b>	FE-710, FE-720, FE9-05, FE9-05S, FE9-10, FE-920		



1			
<b>GEV No.</b>	113048	<b>Ref. No.</b>	12046201
<b>description</b>	knob ø 48mm shaft ø 6x4mm black		
<b>For models:</b>	ACE-061, ACE-101, ACE-102, ACE-201, ACE-202, ACG-061, ACG-101, ACG-102, ACG-201, ACG-202, AE-061, AE-101, APE-061, APE-101		



1			
<b>GEV No.</b>	113014	<b>Ref. No.</b>	12021137 U673005 U673017
<b>description</b>	knob thermostat 1-8 ø 71mm shaft ø 6x4.6mm shaft flat upper		
<b>For models:</b>	CE7-41, CE9-41, CGE7-205, CGE9-41, FTE7-05, FTE7-05L, FTE7-05R, FTE7-10, FTE7-10L, FTE7-10L+R, FTE7-10R, FTE9-05L, FTE9-05R, FTE9-10L, FTE9-10L+R, FTE9-10R, FTEC7-05L, FTEC7-10L, FTEC9-05, FTEC9-05L, FTEC9-05R, FTEC9-10, FTEC9-10L, FTEC9-10L+R, FTEC9-10R, HE9-10, HE9-20, SBE7-10, SBE9-10, SBE9-10L, SBE9-10IM, SBE9-10IMS, SBE9-10IS, SBE9-10M, SBE9-10MS, SBE9-10S, SBE9-15IM, SBE9-15IMS		





1			
<b>GEV No.</b>	505097	<b>Ref. No.</b>	12040066 Z203008
<b>description</b>	knob switch zero mark ø 34mm shaft ø 6x4.6mm shaft flat lower grey		
<b>For models:</b>	ECO-120, ECO-1200, FI-100, FI-1200, FI-80, FI-900, HCG-10-11, HCG-10-21, HCG-2-10-11, HCG-6-11, HME-10-11, HME-10-21, HME-20-11, HME-2-10-11, HME-6-11, HMG-10-11, HMG-10-21, HMG-2-10-11, HMG-6-11, HMM-10-11, HMM-10-21, HMM-20-11, HMM-2-10-11, HMM-6-11, HMP-10-11, HMP-10-21, HMP-20-11, HMP-2-10-11, HMP-6-11, LVC-12, LVC-15, LVC-15D, LVC-21, LVC-21B, LVC-21D, LVC-21W, LVR-10, LVR-14, LVR-14D, LVR-20, LVR-20B, LVR-20D		

			
1			
<b>GEV No.</b>	112293	<b>Ref. No.</b>	12024300 Z203069
<b>description</b>	knob switch zero mark ø 39mm shaft ø 6x4.6mm shaft flat lower black		
<b>For models:</b>	ECO-160D, ECO-160I, ECO-200D, ECO-200HD, ECO-200HI, ECO-200I, ECO-280D, ECO-280I, ECO-370D, ECO-370I, ECO-460D, ECO-460I, ECO-550D, ECO-550I, FI-160AR, FI-160D, FI-160I, FI-200AR, FI-200D, FI-200HD, FI-200HI, FI-200I, FI-200WL, FI-200WR, FI-280D, FI-280I, FI-30, FI-30AR, FI-30AR+DD, FI-30B, FI-30B-BT-UK, FI-30-UK, FI-370D, FI-370I, FI-460D, FI-460I, FI-48, FI-48AR, FI-48B, FI-48B-BT-UK, FI-48C, FI-48D, FI-48HY-CLINIC, FI-48W, FI-550D, FI-550I, FI-60DD, FI-64, FI-64AR, FI-64B...(Other models you can see in the webshop)		

			
1			
<b>GEV No.</b>	113021	<b>Ref. No.</b>	12018462 R663027000 R663063
<b>description</b>	knob switch zero mark ø 39mm shaft ø 6x4.6mm shaft flat lower white		
<b>For models:</b>	CGE7-41, HCG-10-11, HCG-10-21, HCG-20-11, HCG-20-21, HCG-2-10-11, HCG-2-20-11, HCG-6-11, HEI-10-11, HEI-20-11, HEI-6-11, HEM-10-11, HEM-20-11, HEM-6-11, HEP-10-11, HEP-20-11, HEP-6-11, HGC-10-11, HGC-20-11, HGC-6-11, HGV-10-11, HGV-20-11, HME-10-11, HME-10-21, HME-20-11, HME-20-21, HME-2-10-11, HME-2-20-11, HME-6-11, HMG-10-11, HMG-10-21, HMG-20-11, HMG-2-10-11, HMG-6-11, HMI-10-11, HMI-10-11UL, HMI-10-21, HMI-10-21UL, HMI-2-10-11, HMI-6-11, HMI-6-11UL, HMM-10-11, HMM-10-11UL, HMM-10-21, HMM-10-21UL, HMM-20-11, HMM-20-11UL, HMM-20-21, HMM-2-10-11, HMM-2-10-11UL...(Other models you can see in the webshop)		

			
1			
<b>GEV No.</b>	112296	<b>Ref. No.</b>	12024309 Z214902
<b>description</b>	knob switch zero mark ø 39mm shaft ø 6x4.6mm shaft flat lower black shaft L 19mm		
<b>For models:</b>	ECO-120, ECO-120B, FI-100, FI-100AR, FI-100B, FI-120, FI-120B, FI-120W, FI-30, FI-30AR, FI-30AR+DD, FI-30B, FI-30B-BT-UK, FI-30-UK, FI-48, FI-48AR, FI-48B, FI-48B-BT-UK, FI-48C, FI-48D, FI-48HY-CLINIC, FI-48W, FI-64, FI-64AR, FI-64B, FI-64B-BT-UK, FI-64C, FI-64D, FI-64HY-CLINIC, FI-64W, FI-80, FI-80AR, FI-80BBT-UK, LABP-1000, LABP-1200, LABP-800, LVC-12, LVC-15, LVC-15D, LVC-21, LVC-21B, LVC-21C, LVC-21D, LVC-21W, MF-120, MF-48, MF-64		

			
1			
<b>GEV No.</b>	113043	<b>Ref. No.</b>	12044074
<b>description</b>	knob t.max.°C ø 60mm shaft ø 6mm shaft flat black		
<b>For models:</b>	ACE-061, ACE-101, AE-061, AE-061W, AE-101, AE-101W, AE-102, AE-102W, AE-201, AE-202, AG-061, AG-061W, AG-101, AG-101W, AG-102, AG-102W, AG-201, AG-202, APE-061, APE-101		

			
1			
<b>GEV No.</b>	113005	<b>Ref. No.</b>	12024317 R663062
<b>description</b>	knob switch zero mark ø 39mm shaft ø 6x4.6mm shaft flat lower white		
<b>For models:</b>	ECO-120, ECO-120B, ECO-160, ECO-160D, ECO-160I, ECO-200, ECO-200D, ECO-200H, ECO-200HD, ECO-200HI, ECO-200I, ECO-2700D, ECO-2700I, ECO-280D, ECO-280I, ECO-370D, ECO-370I, ECO-4000D, ECO-4000I, ECO-460D, ECO-460I, ECO-550D, ECO-550I, ECO-6000D, ECO-6000I, FE-18, FE-25, FE-4, FE-6, FE-8, FI-100, FI-100AR, FI-100B, FI-120, FI-120B, FI-120HY-CLINIC, FI-120W, FI-160, FI-160D, FI-160I, FI-200, FI-200D, FI-200H, FI-200HD, FI-200HI, FI-200I, FI-200W, FI-2700D, FI-2700I, FI-280D...(Other models you can see in the webshop)		

			
1			
<b>GEV No.</b>	113003	<b>Ref. No.</b>	12040072 R343043
<b>description</b>	knob zero mark ø 39mm shaft ø 6x4.6mm shaft flat lower		
<b>For models:</b>	FE-18, FE-25, FE-4, FE-6, FE-8, FI-300B, HCV-10-11, HCV-10-21, HCV-2-10-21, HCV-5-11, HE-10-11, HE-10-21, HE-2-10-11, HE-5-11, HE-6-11, HG-10-11, HG-10-21, HG-2-10-11		



<b>GEV No.</b>	113042	<b>Ref. No.</b>	12009885 Z513024000
<b>description</b>	knob zero mark t.max.°C ø 50mm shaft ø 6x4.6mm shaft flat lower black		
<b>For models:</b>	ECO-160D, ECO-160I, ECO-200D, ECO-200HD, ECO-200HI, ECO-200I, ECO-2700D, ECO-2700I, ECO-280D, ECO-280I, ECO-370D, ECO-370I, ECO-4000D, ECO-4000I, ECO-460D, ECO-460I, ECO-550D, ECO-550I, ECO-6000D, ECO-6000I, FI-160AR, FI-160D, FI-160I, FI-200AR, FI-200D, FI-200HD, FI-200HI, FI-200I, FI-200WL, FI-200WR, FI-2700D, FI-2700I, FI-280D, FI-280I, FI-370D, FI-370I, FI-4000D, FI-4000I, FI-460D, FI-460I, FI-550D, FI-550I, FI-6000D, FI-6000I		



<b>GEV No.</b>	113046	<b>Ref. No.</b>	12007854 R042102000
<b>description</b>	knob gas tap ø 75mm shaft ø 8x6mm black/silver		
<b>For models:</b>	CG9-51L, CG9-51LC, CG9-51R, CG9-51RC, CGP9-11, FTG9-05L, FTG9-05L-AD, FTG9-05PLUS-CL, FTG9-05PLUS-CR, FTG9-05PLUS-L, FTG9-05PLUS-R, FTG9-05R, FTG9-05R-AD, FTG9-05VL, FTG9-05VR, FTG9-10L, FTG9-10L+R, FTG9-10L+R-AD, FTG9-10L-AD, FTG9-10PLUS-CL, FTG9-10PLUS-CLR, FTG9-10PLUS-CR, FTG9-10PLUS-L, FTG9-10PLUS-LR, FTG9-10PLUS-R, FTG9-10R, FTG9-10R-AD, FTG9-10VL, FTG9-10VL+R, FTG9-10VR, FTG9-11L, FTG9-11L+R, FTG9-11R, FTGC9-05L, FTGC9-05L-AD, FTGC9-05R, FTGC9-05R-AD, FTGC9-10L, FTGC9-10L+R, FTGC9-10L+R-AD, FTGC9-10L-AD, FTGC9-10R, FTGC9-10R-AD, FTGC9-11L, FTGC9-11L+R, FTGC9-11R		



<b>GEV No.</b>	550438	<b>Ref. No.</b>	12039850 Z603052
<b>description</b>	indicator for knob		
<b>For models:</b>	FE-18, FE-25, FE-4, FE-6, FE-8, FI-300B, FI-300R, FI-650R, HCV-10-11, HCV-10-21, HCV-2-10-21, HCV-5-11, HE-10-11, HE-10-21, HE-2-10-11, HE-5-11, HE-6-11, HG-10-11, HG-10-21, HG-2-10-11, LC-10, LC-14, LC-7, LC-7A		



<b>GEV No.</b>	113039	<b>Ref. No.</b>	12020425 U022105
<b>description</b>	knob gas tap with ignition flame ø 74mm shaft ø 10x8mm shaft flat right black		
<b>For models:</b>	BG9-05, BG9-05I, BG9-10, BG9-10I, CG9-10, CG9-11, CG9-20, CG9-40, CG9-41, CG9-51L, CG9-51LC, CG9-51R, CG9-51RC, CG9-60, CG9-61, CG9-82, CGE9-41, CGF9-120D, CGF9-120I, CGF9-121D, CGF9-121I, CPG9-05, CPG9-05S, FTG9-05VL, FTG9-05VR, FTG9-10VL, FTG9-10VL+R, FTG9-10VR		



<b>GEV No.</b>	113000	<b>Ref. No.</b>	12018461 T303010
<b>description</b>	knob switch zero mark ø 50mm shaft ø 5.5x4mm shaft flat lower grey		
<b>For models:</b>	HEI-10-21, HEI-20-21, HEM-10-21, HEM-20-21, HGC-10-21, HGC-20-21, HGV-10-21, HGV-20-21		



<b>GEV No.</b>	113044	<b>Ref. No.</b>	12009005 U022117 U022117000
<b>description</b>	knob gas tap with ignition flame t.max.°C ø 75mm shaft ø 8x6mm black/silver		
<b>For models:</b>	BG9-05AD, BG9-05PF, BG9-05PI, BG9-05PLUS-I, BG9-10AD, BG9-10PF, BG9-10PI, BG9-10PLUS-I, CG9-05AD, CG9-05PLUS, CG9-10, CG9-10AD, CG9-10PLUS, CG9-11, CG9-11AD, CG9-11PLUS, CG9-20, CG9-20AD, CG9-20AD-H, CG9-20H, CG9-20PLUS, CG9-20PLUS-H, CG9-31PLUS-D, CG9-31PLUS-I, CG9-40, CG9-40AD, CG9-40AD-H, CG9-40H, CG9-40PLUS, CG9-40PLUS-H, CG9-41, CG9-41AD, CG9-41AD-H, CG9-41H, CG9-41PLUS, CG9-41PLUS-H, CG9-51L, CG9-51LC, CG9-51R, CG9-51RC, CG9-60, CG9-60AD, CG9-60AD-H, CG9-60H, CG9-60PLUS, CG9-60PLUS-H, CG9-61, CG9-61AD, CG9-61AD-H, CG9-61H... (Other models you can see in the webshop)		



<b>GEV No.</b>	113006	<b>Ref. No.</b>	12018553 T303011
<b>description</b>	knob t.max.°C ø 50mm shaft ø 6x5mm shaft flat vertical grey		
<b>For models:</b>	HEI-10-21, HEI-20-21, HEM-10-21, HEM-20-21, HEP-10-21, HEP-20-21, HGC-10-21, HGC-20-21, HGP-10-21, HGP-20-21, HGV-10-21, HGV-20-21		





			
1			
<b>GEV No.</b>	112813	<b>Ref. No.</b>	12009011 X022133000
<b>description</b>	knob zero mark ø 75mm shaft ø 6x4.6mm shaft flat upper silver/black		
<b>For models:</b>	CPE9-05, CPE9-05NC, CPE9-05S, CPE9-05SNC, CPG9-05, CPG9-05NC, CPG9-05S, CPG9-05SNC, MV9-10BM, MV9-15BM, SBE9-10, SBE9-10I, SBE9-10IM, SBE9-10IMS, SBE9-10IS, SBE9-10M, SBE9-10MS, SBE9-10S, SBE9-15IM, SBE9-15IMS, SBE9-15M, SBE9-15MS, SBG9-10, SBG9-10I, SBG9-10IM, SBG9-10IMS, SBG9-10IS, SBG9-10M, SBG9-10MS, SBG9-10S, SBG9-15IM, SBG9-15IMS		

			
1			
<b>GEV No.</b>	691074	<b>Ref. No.</b>	12024516 R663046
<b>description</b>	gasket switch shaft		
<b>For models:</b>	CO-350, CO-350-B, CO-350-B-DD, CO-350-COLD, CO-350-COLD-B, CO-350-COLD-B-DD, CO-350-COLD-DD, CO-350-DD, CO-400, CO-400-B, CO-400-B-DD, CO-400-COLD, CO-400-COLD-B, CO-400-COLD-B-DD, CO-400-COLD-DD, CO-400-DD, CO-400-SOFT, CO-500, CO-500B, CO-500BDD, CO-500DD, CO-501, CO-501B, CO-501BDD, CO-501DD, CO-501-SOFT, COP-503, COP-503B, COP-503BDD, COP-503DD, COP-503-SOFT, COP-504, COP-504B, COP-504BDD, COP-504DD, ECO-2700D, ECO-2700I, ECO-4000D, ECO-4000I, ECO-6000D, ECO-6000I, FI-200W, FI-2700D, FI-2700I, FI-4000D, FI-4000I, FI-6000D, FI-6000I, HCG-10-11, HCG-10-21...(Other models you can see in the webshop)		

steam/water taps

steam/water taps

			
1			
<b>GEV No.</b>	505322	<b>Ref. No.</b>	12009121 S102110
<b>description</b>	knob ø 55mm L 49mm shaft 7.5x7.5mm		
<b>For models:</b>	ME9-10BM, ME9-10BMS, ME9-15BM, ME9-15BM316, ME9-15BMS, MG9-10, MG9-10BM, MG9-10BMS, MG9-10S, MG9-15, MG9-15BM, MG9-15BM316, MG9-15BMS, MG9-15S, MG9-20, MG9-20S, MPE9-10BM, MPE9-10BMS, MPE9-15BM, MPE9-15BMS, MPG9-10, MPG9-10BM, MPG9-10BMS, MPG9-10S, MPG9-15, MPG9-15BM, MPG9-15BMS, MPG9-15S, MPG9-20, MPG9-20S		

miscellaneous

			
1			
<b>GEV No.</b>	691075	<b>Ref. No.</b>	12018344 R662810
<b>description</b>	disc for knob ID ø 10mm ED ø 25mm H 1mm		
<b>For models:</b>	HCG-10-11, HCG-10-21, HCG-20-11, HCG-20-21, HCG-2-10-11, HCG-2-20-11, HCG-6-11, HEI-10-11, HEI-20-11, HEI-6-11, HEM-10-11, HEM-20-11, HEM-6-11, HEP-10-11, HEP-20-11, HEP-6-11, HGC-10-11, HGC-20-11, HGC-6-11, HGV-10-11, HGV-20-11, HME-10-11, HME-10-21, HME-20-11, HME-20-21, HME-2-10-11, HME-2-20-11, HME-6-11, HMG-10-11, HMG-10-11UL, HMG-10-21, HMG-10-21UL, HMG-20-11, HMG-2-10-11, HMG-6-11, HMI-10-11, HMI-10-11UL, HMI-10-21, HMI-10-21UL, HMI-2-10-11, HMI-6-11, HMI-6-11UL, HMM-10-11, HMM-10-11UL, HMM-10-21, HMM-10-21UL, HMM-20-11, HMM-20-11UL, HMM-20-21, HMM-20-21UL...(Other models you can see in the webshop)		

accessories

gaskets

			
1			
<b>GEV No.</b>	691076	<b>Ref. No.</b>	12020848 R663045
<b>description</b>	gasket		
<b>For models:</b>	HCG-10-11, HCG-10-21, HCG-20-11, HCG-20-21, HCG-2-10-11, HCG-2-20-11, HCG-6-11, HEI-10-11, HEI-20-11, HEI-6-11, HEM-10-11, HEM-20-11, HEM-6-11, HEP-10-11, HEP-20-11, HEP-6-11, HGC-10-11, HGC-20-11, HGC-6-11, HGV-10-11, HGV-20-11, HME-10-11, HME-10-21, HME-20-11, HME-20-21, HME-2-10-11, HME-2-20-11, HME-6-11, HMG-10-11, HMG-10-11UL, HMG-10-21, HMG-10-21UL, HMG-20-11, HMG-2-10-11, HMG-6-11, HMI-10-11, HMI-10-11UL, HMI-10-21, HMI-10-21UL, HMI-2-10-11, HMI-6-11, HMI-6-11UL, HMM-10-11, HMM-10-11UL, HMM-10-21, HMM-10-21UL, HMM-20-11, HMM-20-11UL, HMM-20-21, HMM-20-21UL...(Other models you can see in the webshop)		

			
1			
<b>GEV No.</b>	113004	<b>Ref. No.</b>	12018348 R662809
<b>description</b>	spacer ring		
<b>For models:</b>	HCG-10-11, HCG-10-21, HCG-20-11, HCG-20-21, HCG-2-10-11, HCG-2-20-11, HCG-6-11, HEI-10-11, HEI-20-11, HEI-6-11, HEM-10-11, HEM-20-11, HEM-6-11, HEP-10-11, HEP-20-11, HEP-6-11, HGC-10-11, HGC-20-11, HGC-6-11, HGV-10-11, HGV-20-11, HME-10-11, HME-10-21, HME-20-11, HME-20-21, HME-2-10-11, HME-2-20-11, HME-6-11, HMG-10-11, HMG-10-11UL, HMG-10-21, HMG-10-21UL, HMG-20-11, HMG-2-10-11, HMG-6-11, HMI-10-11, HMI-10-11UL, HMI-10-21, HMI-10-21UL, HMI-2-10-11, HMI-6-11, HMI-6-11UL, HMM-10-11, HMM-10-11UL, HMM-10-21, HMM-10-21UL, HMM-20-11, HMM-20-11UL, HMM-20-21, HMM-20-21UL...(Other models you can see in the webshop)		



## handles and hand wheels

### hand wheels

#### hand wheels



1

<b>GEV No.</b>	690086	<b>Ref. No.</b>	12009585 X156117 X156139
<b>description</b>	hand wheel ø 200mm D1 ø 48mm bore ø 20mm thread M8 hole distance 9mm groove widthmm L1 30mm L2 60mm handle length 82mm with folding handle		
<b>For models:</b>	SBE7-10, SBE9-10, SBE9-10I, SBE9-10I-AD, SBE9-10I-AD-S, SBE9-10IM, SBE9-10IMS, SBE9-10IS, SBE9-10PLUS-I, SBE9-10PLUS-SI, SBE9-10S, SBE9-10USMC, SBG7-10, SBG9-10, SBG9-10I, SBG9-10I-AD, SBG9-10I-AD-S, SBG9-10IS, SBG9-10PLUS-I, SBG9-10PLUS-SI, SBG9-10S		
<b>spare parts for</b>	690086		
	<b>GEV No.</b>	514255	<b>Ref. No.</b> —
	folding handle ø 26mm total length 85mm seat ø 20mm shaft ømm thread M6 with pin L 85mm		
<b>accessories for</b>	690086		
	<b>GEV No.</b>	560175	<b>Ref. No.</b> 12010091 Q131504 Q131552
	grub screw thread M8 L 16mm DIN 914/ISO 4027 intake internal hexagon WS 4 Qty 1 pcs		

### spare parts and accessories



1

<b>GEV No.</b>	691037	<b>Ref. No.</b>	12009478 X156135
<b>description</b>	folding handle ø 26mm total length 100mm seat ø 20mm thread M6 with pin		
<b>For models:</b>	SBE7-10, SBE9-10, SBE9-10I, SBE9-10IS, SBE9-10S, SBE9-10USMC, SBG7-10, SBG9-10, SBG9-10I, SBG9-10IS, SBG9-10S		



1

<b>GEV No.</b>	514523	<b>Ref. No.</b>	12008845 X156161 X156161000
<b>description</b>	spindle for hand wheel L 280mm for tilting bratt pan		
<b>For models:</b>	SBE7-10, SBE9-10, SBE9-10I, SBE9-10I-AD, SBE9-10I-AD-S, SBE9-10IM, SBE9-10IMS, SBE9-10IS, SBE9-10PLUS-I, SBE9-10PLUS-SI, SBE9-10S, SBG7-10, SBG9-10, SBG9-10I, SBG9-10I-AD, SBG9-10I-AD-S, SBG9-10IS, SBG9-10PLUS-I, SBG9-10PLUS-SI, SBG9-10S		

## cylindrical handles

### fixed



1

<b>GEV No.</b>	110703	<b>Ref. No.</b>	12020819 T055434 T055440
<b>description</b>	cylindrical handle thread M10 ø 28mm L 87mm		
<b>For models:</b>	BG7-05, BG7-10, BG9-05, BG9-05I, BG9-10, BG9-10I		

## cone handles



1

<b>GEV No.</b>	111464	<b>Ref. No.</b>	12021169 Z102105
<b>description</b>	cone handle thread M10 ø 26mm L 42mm plastic black		
<b>For models:</b>	ECO-1600, ECO-2300, ECO-3000, FI-1600, FI-2300, FI-3000		



1

<b>GEV No.</b>	111129	<b>Ref. No.</b>	12008060 S116122
<b>description</b>	cone handle thread M10 ø 34mm L 55mm plastic black		
<b>For models:</b>	CG9-51LC, CG9-51RC, FTE7-05, FTE7-05L, FTE7-05R, FTE7-10, FTE7-10L, FTE7-10L+R, FTE7-10R, FTE9-05L, FTE9-05R, FTE9-10L, FTE9-10L+R, FTE9-10R, FTEC7-05L, FTEC7-10L, FTEC9-05, FTEC9-05L, FTEC9-05R, FTEC9-05USMC, FTEC9-10, FTEC9-10L, FTEC9-10L+R, FTEC9-10R, FTEC9-10USMC, FTG7-05, FTG7-05L, FTG7-05R, FTG7-10, FTG7-10L, FTG7-10L+R, FTG7-10R, FTG9-05L, FTG9-05R, FTG9-05VL, FTG9-05VR, FTG9-10L, FTG9-10L+R, FTG9-10R, FTG9-10VL, FTG9-10VL+R, FTG9-10VR, FTGC7-05L, FTGC7-10L, FTGC9-05, FTGC9-05L, FTGC9-05R, FTGC9-10, FTGC9-10L, FTGC9-10L+R...(Other models you can see in the webshop)		

## handle bars

### consoles



1

<b>GEV No.</b>	694208	<b>Ref. No.</b>	12037118 6003010094
<b>description</b>	console for handle rod tube ø 25mm H 47mm plastic		



## handle rails

### FAGOR



1

<b>GEV No.</b>	507538	<b>Ref. No.</b>	12009630 12019260 Z450502
<b>description</b>	handle rail L 505mm W 29mm H 35mm hole distance 277mm Qty 1 pcs		
<b>For models:</b>	AD-20C-UK, AD-21C		

## bracket handles



Image not available

1

<b>GEV No.</b>	505003	<b>Ref. No.</b>	12014635 Z650531
<b>description</b>	pull handle		



1

<b>GEV No.</b>	505001	<b>Ref. No.</b>	12016135 U580521
<b>description</b>	pull handle L 182mm H 42mm mounting distance 170mm thread M6 W 36mm		
<b>For models:</b>	CG-310, CG-310G, CG7-61, CG9-51L, CG9-51LC, CG9-51R, CG9-51RC, CG9-61, CGB7-61, CPG7-05, ECO-280D, ECO-280I, ECO-370D, ECO-370I, ECO-460D, ECO-460I, ECO-550D, ECO-550I, EN9-05C, EN9-10C, FE-710, FE-720, FE9-05, FE9-05S, FE9-10, FE-920, FG-710, FG-720, FG9-05, FG9-05S, FG9-10, FG-920, FG-940, FI-280D, FI-280I, FI-370D, FI-370I, FI-460D, FI-460I, FI-550D, FI-550I, LVC-12, LVC-15, LVC-15D, LVC-21, LVC-21B, LVC-21D, LVC-21W, LVR-10, LVR-14...(Other models you can see in the webshop)		



1

<b>GEV No.</b>	691681	<b>Ref. No.</b>	12024991 Z400540
<b>description</b>	pull handle L 205mm mounting distance 170mm ø 30mm handle M5		
<b>For models:</b>	CG9-51L, CG9-51LC, CG9-51R, CG9-51RC, CG9-61, CGP9-11, CPG9-05, CPG9-05NC, CPG9-05S, CPG9-05SNC, ECO-2700D, ECO-2700I, ECO-280D, ECO-280I, ECO-370D, ECO-370I, ECO-4000D, ECO-4000I, ECO-460D, ECO-460I, ECO-550D, ECO-550I, ECO-6000D, ECO-6000I, EN9-05C, EN9-10C, FE9-05, FE9-05S, FE9-05USMC, FE9-10, FG9-05, FG9-05S, FG9-10, FI-2700D, FI-2700I, FI-280D, FI-280I, FI-370D, FI-370I, FI-4000D, FI-4000I, FI-460D, FI-460I, FI-550D, FI-550I, FI-6000D, FI-6000I, MB9-05-PUERTA-DCHA, MB9-05-PUERTA-IZDA, MB9-10-PUERTA-DOBLE...(Other models you can see in the webshop)		



1

<b>GEV No.</b>	691687	<b>Ref. No.</b>	12009199 S036123
<b>description</b>	pull handle L 220mm H 60mm mounting distance 200mm W 140mm handle M10		
<b>For models:</b>	ME9-10BM, ME9-10BMS, ME9-15BM, ME9-15BM316, ME9-15BMS, MG9-10, MG9-10BM, MG9-10BMS, MG9-10S, MG9-15, MG9-15BM, MG9-15BMS, MG9-15S, MG9-20, MG9-20S, MPE9-10BM, MPE9-10BMS, MPE9-15BM, MPE9-15BMS, MPG9-10, MPG9-10BM, MPG9-10BMS, MPG9-10S, MPG9-15, MPG9-15BM, MPG9-15BMS, MPG9-15S, MPG9-20, MPG9-20S, MV9-10BM, MV9-15BM, SBE7-10, SBE9-10, SBE9-10I, SBE9-10IM, SBE9-10IMS, SBE9-10IS, SBE9-10M, SBE9-10MS, SBE9-10S, SBE9-10USMC, SBE9-15IM, SBE9-15IMS, SBE9-15M, SBE9-15MS, SBG7-10, SBG9-10, SBG9-10I, SBG9-10IM, SBG9-10IMS...(Other models you can see in the webshop)		



1

<b>GEV No.</b>	505002	<b>Ref. No.</b>	12010961 Z200512
<b>description</b>	pull handle L 272mm H 42mm mounting distance 260mm thread M6 W 36mm		
<b>For models:</b>	ECO-120, ECO-120B, ECO-160D, ECO-160I, ECO-200D, ECO-200I, ECO-280D, ECO-280I, ECO-3000, ECO-370D, ECO-370I, ECO-460D, ECO-460I, ECO-550D, ECO-550I, FI-100, FI-100AR, FI-100B, FI-100BBT-UK, FI-120, FI-120AR+DD, FI-120B, FI-120C, FI-120HY-CLINIC, FI-120W, FI-160D, FI-160I, FI-200D, FI-200I, FI-280D, FI-280I, FI-30, FI-3000, FI-370D, FI-370I, FI-460D, FI-460I, FI-48, FI-48B, FI-48W, FI-50, FI-550D, FI-550I, FI-64, FI-64B, FI-64W, FI-72, FI-80, FI-80AR, FI-80BBT-UK...(Other models you can see in the webshop)		



1

<b>GEV No.</b>	505316	<b>Ref. No.</b>	12024005 Z200550
<b>description</b>	pull handle L 293mm H 65mm mounting distance 260mm thread M6 W 36mm		
<b>For models:</b>	ECO-160, ECO-160D, ECO-160I, ECO-200, ECO-200D, ECO-200H, ECO-200HD, ECO-200HI, ECO-200I, ECO-2700D, ECO-2700I, ECO-280D, ECO-280I, ECO-370D, ECO-370I, ECO-4000D, ECO-4000I, ECO-460D, ECO-460I, ECO-550D, ECO-550I, ECO-6000D, ECO-6000I, FI-100, FI-100AR, FI-100B, FI-100BBT-UK, FI-160, FI-160AR, FI-160D, FI-160I, FI-200, FI-200AR, FI-200D, FI-200H, FI-200HD, FI-200HI, FI-200I, FI-200W, FI-200WL, FI-200WR, FI-2700D, FI-2700I, FI-280D, FI-280I, FI-370D, FI-370I, FI-4000D, FI-4000I, FI-460D...(Other models you can see in the webshop)		

locks

locking devices

producer-specific

FAGOR



1

<b>GEV No.</b>	691856	<b>Ref. No.</b>	12030475 A169150001
<b>description</b>	key cylinder ø 22mm		

electromagnetic closer



1

<b>GEV No.</b>	692613	<b>Ref. No.</b>	12003922 12038364 12038446 12127838 12154822 13P6205160
<b>description</b>	electromagnetic closer L 220mm W 100mm H 50mm		
<b>For models:</b>	LA-25M, LA-AC-10M, LA-AC-10MA, LA-AC-10MP, LA-AC-13M, LA-AC-13MA, LA-AC-13MP, LA-AC-18M, LA-AC-18MA, LA-AC-18MP, LA-AC-25M, LA-AC-25MA, LA-AC-25MP, LA-E-10M, LA-E-10MA, LA-E-10MP, LA-E-13M, LA-E-13MA, LA-E-13MP, LA-E-18M, LA-E-18MA, LA-E-18MP, LA-E-25M, LA-E-25MA, LA-E-25MP, LA-V-10M, LA-V-10MP, LA-V-13M, LA-V-13MP, LA-V-18M, LA-V-18MP, LA-V-25M, LA-V-25MP, LB-AC-10M, LB-E-10M, LB-V-10M, LF-13MPP, LF-18MPP, LF-8MPP, LR-AC-10M, LR-AC-10MA, LR-AC-10MP, LR-AC-13M, LR-AC-13MA, LR-AC-13MP, LR-AC-18M, LR-AC-18MA, LR-AC-18MP, LR-AC-25M, LR-AC-25MA... (Other models you can see in the webshop)		

handle latches

producer-specific

FAGOR



1

<b>GEV No.</b>	693576	<b>Ref. No.</b>	12029692 RT2400176 RT2402762
<b>description</b>	catch L 83mm ø 41mm clamp length 43mm BL 45mm		
<b>spare parts for</b>	693576		
	<b>GEV No.</b>	693577	<b>Ref. No.</b> 12031725 12038017 RT2400506 RT2401100 RT2402761
D-lock W 29mm H 17mm spring length 50mm spring thickness 3mm			

	<b>1</b>		
<b>GEV No.</b>	691679	<b>Ref. No.</b>	12024557 Z400542
<b>description</b>	pull handle L 310mm H 32mm mounting distance 260mm dishwasher since 2007 handle M6		
<b>For models:</b>	ATM-031ECO, CE6-41, CG-310, CG-310G, CG6-41, CGE6-41, FI-100, FI-100AR, FI-100B, FI-100BBT-UK, FI-80, FI-80AR, FI-80BBT-UK, FI-80W, FI-E-100, LVC-12, LVC-15, LVC-15D, LVC-21, LVC-21B, LVC-21C, LVC-21D, LVC-21W		

	<b>1</b>		
<b>GEV No.</b>	691678	<b>Ref. No.</b>	12018087 U560501
<b>description</b>	pull handle L 615mm H 55mm mounting distance 580mm ø 30mm handle M5		
<b>For models:</b>	CE9-41, CG-1002, CG-1502, CG-2002, CG9-11, CG9-41, CG9-51L, CG9-51LC, CG9-51R, CG9-51RC, CG9-61, CG9-82, CGE9-41, FTG9-11L, FTG9-11L+R, FTG9-11R, FTGC9-11L, FTGC9-11L+R, FTGC9-11R		

accessories

extensions

	<b>1</b>		
<b>GEV No.</b>	527396	<b>Ref. No.</b>	12020466 R619913
<b>description</b>	thread bolt for griddle L 50mm thread M10 stainless steel		
<b>For models:</b>	CG9-51LC, CG9-51RC, FTE7-05, FTE7-05L, FTE7-05R, FTE7-10, FTE7-10L, FTE7-10L+R, FTE7-10R, FTE9-05L, FTE9-05R, FTE9-10L, FTE9-10L+R, FTE9-10R, FTEC7-05L, FTEC7-10L, FTEC9-05, FTEC9-05L, FTEC9-05R, FTEC9-05USMC, FTEC9-10, FTEC9-10L, FTEC9-10L+R, FTEC9-10R, FTEC9-10USMC, FTG7-05, FTG7-05L, FTG7-05R, FTG7-10, FTG7-10L, FTG7-10L+R, FTG7-10R, FTG9-05L, FTG9-05R, FTG9-05VL, FTG9-05VR, FTG9-10L, FTG9-10L+R, FTG9-10R, FTG9-10VL, FTG9-10VL+R, FTG9-10VR, FTGC7-05L, FTGC7-10L, FTGC9-05, FTGC9-05L, FTGC9-05R, FTGC9-10, FTGC9-10L, FTGC9-10L+R... (Other models you can see in the webshop)		





1

<b>GEV No.</b>	696850	<b>Ref. No.</b>	12044773 12160858
<b>description</b>	door handle for combi-steamer L 200mm W 108mm H 52mm black		



1

<b>GEV No.</b>	696853	<b>Ref. No.</b>	12044776
<b>description</b>	door handle for combi-steamer L 200mm W 65mm H 50mm black shaft 8x8mm		
<b>For models:</b>	ACE-201, ACE-202, ACG-201, ACG-202, AE-201, AE-202, AG-201, AG-202, APE-201, APE-202, APG-201, APG-202		



1

<b>GEV No.</b>	692902	<b>Ref. No.</b>	12161224
<b>description</b>	door handle L 180mm W 50mm handle ø 50mm spring length 55mm threaded black mounting distance 30mm mounting thread M3		



1

<b>GEV No.</b>	694666	<b>Ref. No.</b>	12024750
<b>description</b>	door handle L 180mm W 56mm H 56mm handle ø 32mm spring length 46mm black plastic mounting distance 40mm mounting thread M5		
<b>For models:</b>	COE-061, COE-101, COE-102, COG-061, COG-101, COG-102, VE-061, VE-101, VE-102, VG-101, VG-102, VPE-061, VPE-101, VPE-102, VPG-101, VPG-102		
<b>spare parts for</b>	694666		
	<b>GEV No.</b>	514390	<b>Ref. No.</b> —
	spring for door handle ø 6mm L 54mm W 27.5mm		



1

<b>GEV No.</b>	693575	<b>Ref. No.</b>	12031594 RT2400152
<b>description</b>	door handle L 200mm W 50mm H 66mm blue plastic		
<b>accessories for</b>	693575		
	<b>GEV No.</b>	693576	<b>Ref. No.</b> 12029692 RT2400176 RT2402762
	catch L 83mm ø 41mm clamp length 43mm BL 45mm		



1





<b>GEV No.</b>	692752	<b>Ref. No.</b>	12044774 12047580
<b>description</b>	door handle L 200mm W 50mm handle ø 50mm spring length 55mm threaded black mounting distance 30mm mounting thread M3		
<b>For models:</b>	ACE-061, ACE-101, ACE-102, ACG-061, ACG-101, ACG-102, AE-061, AE-061W, AE-101, AE-101W, AE-102, AE-102W, AG-061, AG-061W, AG-101, AG-101W, AG-102, AG-102W, APE-061, APE-061W, APE-101, APE-101W, APE-102, APE-102W, APG-061, APG-061W, APG-101, APG-101W, APG-102, APG-102W		

edgmount latches

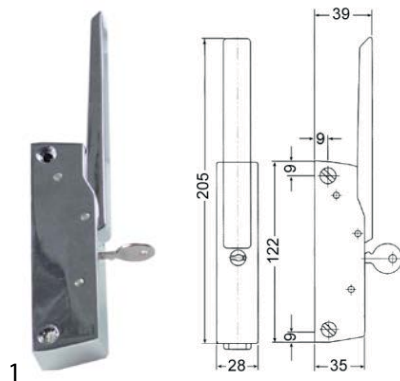
handle latches

CAFF/FERMOD



<b>GEV No.</b>	700556	<b>Ref. No.</b>	12032862 6033010007
<b>description</b>	catch L 122mm mounting distance 104mm lockable refrigeration units G 885 W 28mm handle length 135mm overall height 205mm		
<b>For models:</b>	CCF-10, CCF-10CI, CCF-20, CCF-20CI, CCF-40, CCF-40CI		
<b>accessories for</b>	700556		
	<b>GEV No.</b>	690418	<b>Ref. No.</b> —
	door catch L 36mm W 19mm H 29mm mounting distance 12mm zinc-coated steel for refrigeration units		
	<b>GEV No.</b>	690419	<b>Ref. No.</b> —
	door catch L 52mm W 20mm H 30mm mounting distance 26-37mm zamak for refrigeration units		
	<b>GEV No.</b>	700061	<b>Ref. No.</b> —
	door catch L 58mm W 20mm H 35mm mounting distance 42mm chrome-plated brass for headed units		
	<b>GEV No.</b>	700435	<b>Ref. No.</b> —
	door catch L 58mm W 20mm H 35mm mounting distance 42mm zamak for refrigeration units		

espagnolette locks

universal



<b>GEV No.</b>	690041	<b>Ref. No.</b>	12018701 R260544
<b>description</b>	cam L 148mm mounting distance 32mm		
<b>For models:</b>	HCG-10-11, HCG-10-21, HCG-20-11, HCG-20-21, HCG-2-10-11, HCG-6-11, HCV-10-11, HCV-10-21, HCV-2-10-21, HCV-6-11, HE-10-11, HE-10-21, HE-2-10-11, HE-6-11, HG-10-11, HG-10-21, HG-2-10-11, HME-10-11, HME-10-21, HME-20-11, HME-20-21, HME-2-10-11, HME-6-11, HMG-10-11, HMG-10-11UL, HMG-10-21, HMG-10-21UL, HMG-20-11, HMG-2-10-11, HMG-6-11, HMI-10-11, HMI-10-11UL, HMI-10-21, HMI-10-21UL, HMI-2-10-11, HMI-6-11, HMI-6-11UL, HMM-10-11, HMM-10-11UL, HMM-10-21, HMM-10-21UL, HMM-20-11, HMM-20-11UL, HMM-2-10-11, HMM-40-11-USMC, HMM-6-11, HMM-6-11UL, HMP-10-11, HMP-10-21...(Other models you can see in the webshop)		



<b>GEV No.</b>	700771	<b>Ref. No.</b>	12024673 T130509
<b>description</b>	latch gear opening to the left shaft intake ø 8x8mm L 170mm W 40mm H 40mm		
<b>For models:</b>	ACE-201, ACE-202, ACG-201, ACG-202, AE-201, AE-202, AG-201, AG-202, APE-201, APE-202, APG-201, APG-202, COE-201, COE-202, COG-201, COG-202, HCG-10-11, HCG-10-21, HCG-20-11, HCG-20-21, HCG-2-10-11, HCG-2-20-11, HCG-6-11, HEI-10-11, HEI-10-21, HEI-20-11, HEI-20-21, HEI-6-11, HEM-10-11, HEM-10-21, HEM-20-11, HEM-20-21, HEM-6-11, HEP-10-11, HEP-10-21, HEP-20-11, HEP-20-21, HEP-6-11, HGC-10-11, HGC-10-21, HGC-20-11, HGC-20-21, HGC-6-11, HGP-10-21, HGP-20-21, HGV-10-11, HGV-10-21, HGV-20-11, HGV-20-21, HME-10-11...(Other models you can see in the webshop)		

producer-specific

FAGOR

group 1



<b>GEV No.</b>	694266	<b>Ref. No.</b>	12001539 R090514
<b>description</b>	bar door catch ø 10mm L 415mm		
<b>For models:</b>	COE-201, COG-201, HCG-20-11, HCG-20-21, HCG-2-20-11, HEI-20-11, HEM-20-11, HEP-20-11, HGC-20-11, HGV-20-11, HME-20-11, HME-20-21, HME-2-20-11, HMG-20-11, HMM-20-11, HMM-20-11UL, HMM-20-21, HMM-20-21UL, HMM-2-20-11, HMM-40-11-USMC, HMP-20-11, HMP-20-21, HMP-2-20-11, HVG-20-11, HVG-20-21, HVG-2-20-21, MFHMM-20-11, VE-201, VG-201, VPE-201, VPG-201		





<b>GEV No.</b>	694258	<b>Ref. No.</b>	12014385 T300507
<b>description</b>	bar for door latch ø 10mm L 235mm		
<b>For models:</b>	HEI-10-21, HEM-10-21, HEP-10-21, HGC-10-21, HGP-10-21, HGV-10-21		





<b>GEV No.</b>	691050	<b>Ref. No.</b>	12014653 R020502
<b>description</b>	bar ø 10mm for door latch L 113.5mm		
<b>For models:</b>	HCG-10-11, HCG-10-21, HCG-2-10-11, HCG-6-11, HCV-10-11, HCV-10-21, HCV-2-10-21, HCV-6-11, HE-10-11, HE-10-21, HE-2-10-11, HEI-10-11, HEM-10-11, HEP-10-11, HG-10-11, HG-10-21, HG-2-10-11, HGC-10-11, HGV-10-11, HME-10-11, HME-10-21, HME-2-10-11, HME-6-11, HMG-10-11, HMG-10-11UL, HMG-10-21, HMG-10-21UL, HMG-2-10-11, HMI-10-11, HMI-10-11UL, HMI-10-21, HMI-10-21UL, HMI-2-10-11, HMM-10-11, HMM-10-11UL, HMM-10-21, HMM-10-21UL, HMM-20-11, HMM-20-11UL, HMM-2-10-11, HMM-40-11-USMC, HMM-6-11, HMM-6-11UL, HMP-10-11, HMP-10-21, HMP-2-10-11, HMP-6-11, HVG-10-11, HVG-10-11UL, HVG-10-21, HVG-10-21UL, HVG-2-10-11, MFHVG-10-11, MFHVG-10-21		







 <p>1</p>			
<b>GEV No.</b>	690041	<b>Ref. No.</b>	12018701 R260544
<b>description</b>	cam L 148mm mounting distance 32mm		
<b>For models:</b>	HCG-10-11, HCG-10-21, HCG-20-11, HCG-20-21, HCG-2-10-11, HCG-6-11, HCV-10-11, HCV-10-21, HCV-2-10-21, HCV-6-11, HE-10-11, HE-10-21, HE-2-10-11, HE-6-11, HG-10-11, HG-10-21, HG-2-10-11, HME-10-11, HME-10-21, HME-20-11, HME-20-21, HME-2-10-11, HME-6-11, HMG-10-11, HMG-10-11UL, HMG-10-21, HMG-10-21UL, HMG-20-11, HMG-2-10-11, HMG-6-11, HMI-10-11, HMI-10-11UL, HMI-10-21, HMI-10-21UL, HMI-2-10-11, HMI-6-11, HMI-6-11UL, HMM-10-11, HMM-10-11UL, HMM-10-21, HMM-10-21UL, HMM-20-11, HMM-20-11UL, HMM-20-21, HMM-2-10-11, HMM-40-11-USMC, HMM-6-11, HMM-6-11UL, HMP-10-11, HMP-10-21...(Other models you can see in the webshop)		

 <p>1</p>			
<b>GEV No.</b>	700771	<b>Ref. No.</b>	12024673 T130509
<b>description</b>	latch gear opening to the left shaft intake $\phi$ 8x8mm L 170mm W 40mm H 40mm		
<b>For models:</b>	ACE-201, ACE-202, ACG-201, ACG-202, AE-201, AE-202, AG-201, AG-202, APE-201, APE-202, APG-201, APG-202, COE-201, COE-202, COG-201, COG-202, HCG-10-11, HCG-10-21, HCG-20-11, HCG-20-21, HCG-2-10-11, HCG-2-20-11, HCG-6-11, HEI-10-11, HEI-10-21, HEI-20-11, HEI-20-21, HEI-6-11, HEM-10-11, HEM-10-21, HEM-20-11, HEM-20-21, HEM-6-11, HEP-10-11, HEP-10-21, HEP-20-11, HEP-20-21, HEP-6-11, HGC-10-11, HGC-10-21, HGC-20-11, HGC-20-21, HGC-6-11, HGP-10-21, HGP-20-21, HGV-10-11, HGV-10-21, HGV-20-11, HGV-20-21, HME-10-11...(Other models you can see in the webshop)		

 <p>1</p>			
<b>GEV No.</b>	700766	<b>Ref. No.</b>	12018956 12024495 R260545 T110506
<b>description</b>	door catch heated units L 44mm W 40mm H 42mm SS mounting distance 26mm		
<b>For models:</b>	ACE-201, ACE-202, ACG-201, ACG-202, AE-201, AE-202, AG-201, AG-202, APE-201, APE-202, APG-201, APG-202, COE-201, COE-202, COG-201, COG-202, HCG-10-11, HCG-10-21, HCG-20-11, HCG-20-21, HCG-2-10-11, HCG-2-20-11, HCG-6-11, HCV-10-11, HCV-10-21, HCV-2-10-21, HCV-6-11, HE-10-11, HE-10-21, HE-2-10-11, HE-6-11, HEI-10-11, HEI-10-21, HEI-20-11, HEI-20-21, HEI-6-11, HEM-10-11, HEM-10-21, HEM-20-11, HEM-20-21, HEM-6-11, HEP-10-11, HEP-10-21, HEP-20-11, HEP-20-21, HEP-6-11, HG-10-11, HG-10-21, HG-2-10-11, HGC-10-11...(Other models you can see in the webshop)		

 <p>1</p>			
<b>GEV No.</b>	690042	<b>Ref. No.</b>	12018273 R260543
<b>description</b>	latch gear opening to the right shaft intake $\phi$ 8x8mm L 170mm W 40mm H 40mm		
<b>For models:</b>	HCG-10-11, HCG-10-21, HCG-20-11, HCG-2-10-11, HCG-6-11, HCV-10-11, HCV-10-21, HCV-2-10-21, HCV-6-11, HE-10-11, HE-10-21, HE-2-10-11, HE-6-11, HG-10-11, HG-10-21, HG-2-10-11, HME-10-11, HME-10-21, HME-20-11, HME-20-21, HME-2-10-11, HME-6-11, HMG-10-11, HMG-10-11UL, HMG-10-21, HMG-10-21UL, HMG-20-11, HMG-2-10-11, HMG-6-11, HMI-10-11, HMI-10-11UL, HMI-10-21, HMI-10-21UL, HMI-2-10-11, HMI-6-11, HMI-6-11UL, HMM-10-11, HMM-10-11UL, HMM-10-21, HMM-10-21UL, HMM-20-11, HMM-20-11UL, HMM-20-21, HMM-2-10-11, HMM-6-11, HMM-6-11UL, HMP-10-11, HMP-10-21, HMP-20-11, HMP-20-21...(Other models you can see in the webshop)		

 <p>1</p>										
<b>GEV No.</b>	691044	<b>Ref. No.</b>	12017896 R660532							
<b>description</b>	door handle handle $\phi$ 23mm metal mounting distance 43mm flange 28x68mm shaft 7x7mm									
<b>For models:</b>	HCG-10-11, HCG-10-21, HCG-20-11, HCG-2-10-11, HCG-6-11, HME-10-11, HME-10-21, HME-20-11, HME-20-21, HME-2-10-11, HME-6-11, HMG-10-11, HMG-10-11UL, HMG-10-21, HMG-10-21UL, HMG-20-11, HMG-2-10-11, HMG-6-11, HMI-10-11, HMI-10-11UL, HMI-10-21, HMI-10-21UL, HMI-2-10-11, HMI-6-11, HMI-6-11UL, HMM-10-11, HMM-10-11UL, HMM-10-21, HMM-10-21UL, HMM-20-11, HMM-20-11UL, HMM-20-21, HMM-2-10-11, HMM-6-11, HMM-6-11UL, HMP-10-11, HMP-10-21, HMP-20-11, HMP-20-21, HMP-2-10-11, HMP-6-11									
<b>accessories for</b>	691044									
	 <table border="1"> <tr> <td><b>GEV No.</b></td> <td>690042</td> <td><b>Ref. No.</b></td> <td>12018273 R260543</td> </tr> </table>	<b>GEV No.</b>	690042	<b>Ref. No.</b>	12018273 R260543	<table border="1"> <tr> <td><b>description</b></td> <td colspan="3">latch gear opening to the right shaft intake <math>\phi</math> 8x8mm L 170mm W 40mm H 40mm</td> </tr> </table>	<b>description</b>	latch gear opening to the right shaft intake $\phi$ 8x8mm L 170mm W 40mm H 40mm		
<b>GEV No.</b>	690042	<b>Ref. No.</b>	12018273 R260543							
<b>description</b>	latch gear opening to the right shaft intake $\phi$ 8x8mm L 170mm W 40mm H 40mm									

<b>accessories for</b>	690042									
	 <table border="1"> <tr> <td><b>GEV No.</b></td> <td>690040</td> <td><b>Ref. No.</b></td> <td>—</td> </tr> </table>	<b>GEV No.</b>	690040	<b>Ref. No.</b>	—	<table border="1"> <tr> <td><b>description</b></td> <td colspan="3">door catch with roller H 42mm L 40mm W 40mm zinc die cast mounting distance 26mm type 0751 series</td> </tr> </table>	<b>description</b>	door catch with roller H 42mm L 40mm W 40mm zinc die cast mounting distance 26mm type 0751 series		
<b>GEV No.</b>	690040	<b>Ref. No.</b>	—							
<b>description</b>	door catch with roller H 42mm L 40mm W 40mm zinc die cast mounting distance 26mm type 0751 series									
	 <table border="1"> <tr> <td><b>GEV No.</b></td> <td>690041</td> <td><b>Ref. No.</b></td> <td>12018701 R260544</td> </tr> </table>	<b>GEV No.</b>	690041	<b>Ref. No.</b>	12018701 R260544	<table border="1"> <tr> <td><b>description</b></td> <td colspan="3">cam L 148mm mounting distance 32mm</td> </tr> </table>	<b>description</b>	cam L 148mm mounting distance 32mm		
<b>GEV No.</b>	690041	<b>Ref. No.</b>	12018701 R260544							
<b>description</b>	cam L 148mm mounting distance 32mm									
	 <table border="1"> <tr> <td><b>GEV No.</b></td> <td>691050</td> <td><b>Ref. No.</b></td> <td>12014653 R020502</td> </tr> </table>	<b>GEV No.</b>	691050	<b>Ref. No.</b>	12014653 R020502	<table border="1"> <tr> <td><b>description</b></td> <td colspan="3">bar <math>\phi</math> 10mm for door latch L 113.5mm</td> </tr> </table>	<b>description</b>	bar $\phi$ 10mm for door latch L 113.5mm		
<b>GEV No.</b>	691050	<b>Ref. No.</b>	12014653 R020502							
<b>description</b>	bar $\phi$ 10mm for door latch L 113.5mm									

<b>group 2</b>			
 <p>1</p>			
<b>GEV No.</b>	700836	<b>Ref. No.</b>	12017388 T130504
<b>description</b>	bearing $\phi$ 42.6mm H 12.5mm ID $\phi$ 21mm brass		
<b>For models:</b>	HCG-10-11, HCG-10-21, HCG-20-11, HCG-20-21, HCG-2-10-11, HCG-6-11, HMM-40-11-USMC, HVG-10-11, HVG-10-21, HVG-20-11, HVG-20-21, HVG-2-10-11		

			
1			
<b>GEV No.</b>	700762	<b>Ref. No.</b>	12024389 T130515
<b>description</b>	bearing ø 44mm for door latch H 23mm ID ø 11mm thread M5 brass		
<b>For models:</b>	ACE-201, ACE-202, ACG-201, ACG-202, AE-201, AE-202, AG-201, AG-202, APE-201, APE-202, APG-201, APG-202, COE-201, COE-202, COG-201, COG-202, HCG-10-11, HCG-10-21, HCG-20-11, HCG-20-21, HCG-2-10-11, HCG-2-20-11, HCG-6-11, HEI-10-11, HEI-10-21, HEI-20-11, HEI-20-21, HEI-6-11, HEM-10-11, HEM-10-21, HEM-20-11, HEM-20-21, HEM-6-11, HEP-10-11, HEP-10-21, HEP-20-11, HEP-20-21, HEP-6-11, HGC-10-11, HGC-10-21, HGC-20-11, HGC-20-21, HGC-6-11, HGP-10-21, HGP-20-21, HGV-10-11, HGV-10-21, HGV-20-11, HGV-20-21, HME-10-11...(Other models you can see in the webshop)		

			
1			
<b>GEV No.</b>	700767	<b>Ref. No.</b>	12018457 T130507
<b>description</b>	bolt ø 5.4/8mm for door latch L 22mm		
<b>For models:</b>	HCG-10-11, HCG-10-21, HCG-20-11, HCG-20-21, HCG-2-10-11, HCG-2-20-11, HCG-6-11, HEI-10-11, HEI-10-21, HEI-6-11, HEM-10-11, HEM-10-21, HEM-6-11, HEP-10-11, HEP-10-21, HEP-6-11, HGC-10-11, HGC-10-21, HGC-6-11, HGP-10-21, HGV-10-11, HGV-10-21, HME-10-11, HME-10-21, HME-20-11, HME-20-21, HME-2-10-11, HME-2-20-11, HMI-6-11, HMI-10-11, HMI-10-11UL, HMI-10-21, HMI-10-21UL, HMI-2-10-11, HMI-6-11, HMI-6-11UL, HMM-10-11, HMM-10-11UL, HMM-10-21, HMM-10-21UL, HMM-20-11, HMM-20-11UL, HMM-20-21, HMM-20-21UL, HMM-2-10-11, HMM-2-20-11, HMM-40-11-USMC, HMM-6-11, HMM-6-11UL, HMP-10-11...(Other models you can see in the webshop)		



			
1			
<b>GEV No.</b>	691646	<b>Ref. No.</b>	12022265 T130511
<b>description</b>	bracket L 133mm W 45mm thread M6 SS		
<b>For models:</b>	COE-201, COE-202, COG-201, COG-202, HCG-10-11, HCG-10-21, HCG-20-11, HCG-20-21, HCG-2-10-11, HCG-2-20-11, HCG-6-11, HEI-10-11, HEI-10-21, HEI-20-11, HEI-20-21, HEI-6-11, HEM-10-11, HEM-10-21, HEM-20-11, HEM-20-21, HEM-6-11, HEP-10-11, HEP-10-21, HEP-20-11, HEP-20-21, HEP-6-11, HGC-10-11, HGC-10-21, HGC-20-11, HGC-20-21, HGC-6-11, HGP-10-21, HGP-20-21, HGV-10-11, HGV-10-21, HGV-20-11, HGV-20-21, HME-10-11, HME-10-21, HME-20-11, HME-20-21, HME-2-10-11, HME-2-20-11, HMI-10-11, HMI-10-11UL, HMI-10-21, HMI-10-21UL, HMI-2-10-11, HMI-6-11...(Other models you can see in the webshop)		

			
1			
<b>GEV No.</b>	505273	<b>Ref. No.</b>	12024245 T130505
<b>description</b>	bush for door mechanism		
<b>For models:</b>	ACE-201, ACE-202, ACG-201, ACG-202, AE-201, AE-202, AG-201, AG-202, APE-201, APE-202, APG-201, APG-202, COE-201, COG-201, HCG-10-11, HCG-10-21, HCG-20-11, HCG-20-21, HCG-2-10-11, HCG-2-20-11, HCG-6-11, HEI-10-11, HEI-10-21, HEI-20-11, HEI-20-21, HEI-6-11, HEM-10-11, HEM-10-21, HEM-20-11, HEM-20-21, HEM-6-11, HEP-10-11, HEP-10-21, HEP-20-11, HEP-20-21, HEP-6-11, HGC-10-11, HGC-10-21, HGC-20-11, HGC-20-21, HGC-6-11, HGP-10-21, HGP-20-21, HGV-10-11, HGV-10-21, HGV-20-11, HGV-20-21, HME-10-11, HME-10-21, HME-20-11, HME-20-21, HME-2-10-11, HME-2-20-11, HMI-10-11, HMI-10-11UL, HMI-10-21, HMI-10-21UL, HMI-2-10-11, HMI-6-11...(Other models you can see in the webshop)		

			
1			
<b>GEV No.</b>	700765	<b>Ref. No.</b>	12024164 T130506
<b>description</b>	compression spring ø 8.1mm L 20.4mm wire gauge ø 1.2mm		
<b>For models:</b>	ACE-201, ACE-202, ACG-201, ACG-202, AE-201, AE-202, AG-201, AG-202, APE-201, APE-202, APG-201, APG-202, COE-201, COE-202, COG-201, COG-202, HCG-10-11, HCG-10-21, HCG-20-11, HCG-20-21, HCG-2-10-11, HCG-2-20-11, HCG-6-11, HEI-10-11, HEI-10-21, HEI-20-11, HEI-20-21, HEI-6-11, HEM-10-11, HEM-10-21, HEM-20-11, HEM-20-21, HEM-6-11, HEP-10-11, HEP-10-21, HEP-20-11, HEP-20-21, HEP-6-11, HGC-10-11, HGC-10-21, HGC-20-11, HGC-20-21, HGC-6-11, HGP-10-21, HGP-20-21, HGV-10-11, HGV-10-21, HGV-20-11, HGV-20-21, HME-10-11...(Other models you can see in the webshop)		

			
1			
<b>GEV No.</b>	700770	<b>Ref. No.</b>	12024657 T080504
<b>description</b>	door catch L 149mm W 29mm H 29mm chrome-plated brass		
<b>For models:</b>	ACE-201, ACE-202, ACG-201, ACG-202, AE-201, AE-202, AG-201, AG-202, APE-201, APE-202, APG-201, APG-202, COE-201, COE-202, COG-201, COG-202, HCG-10-11, HCG-10-21, HCG-20-11, HCG-20-21, HCG-2-10-11, HCG-2-20-11, HCG-6-11, HEI-10-11, HEI-10-21, HEI-20-11, HEI-20-21, HEI-6-11, HEM-10-11, HEM-10-21, HEM-20-11, HEM-20-21, HEM-6-11, HEP-10-11, HEP-10-21, HEP-20-11, HEP-20-21, HEP-6-11, HGC-10-11, HGC-10-21, HGC-20-11, HGC-20-21, HGC-6-11, HGP-10-21, HGP-20-21, HGV-10-11, HGV-10-21, HGV-20-11, HGV-20-21, HME-10-11...(Other models you can see in the webshop)		

			
1			
<b>GEV No.</b>	700768	<b>Ref. No.</b>	12024095 T130502
<b>description</b>	door handle ø 50mm shaft intake ø 8x8mm L 180mm		
<b>For models:</b>	COE-201, COE-202, COG-201, COG-202, HCG-10-11, HCG-10-21, HCG-20-11, HCG-20-21, HCG-2-10-11, HCG-2-20-11, HCG-6-11, HEI-10-11, HEI-10-21, HEI-20-11, HEI-20-21, HEI-6-11, HEM-10-11, HEM-10-21, HEM-20-11, HEM-20-21, HEM-6-11, HEP-10-11, HEP-10-21, HEP-20-11, HEP-20-21, HEP-6-11, HGC-10-11, HGC-10-21, HGC-20-11, HGC-20-21, HGC-6-11, HGP-10-21, HGP-20-21, HGV-10-11, HGV-10-21, HGV-20-11, HGV-20-21, HME-10-11, HME-10-21, HME-20-11, HME-20-21, HME-2-10-11, HME-2-20-11, HMI-10-11, HMI-10-11UL, HMI-10-21, HMI-10-21UL, HMI-2-10-11, HMI-6-11...(Other models you can see in the webshop)		

<b>accessories for</b>	700768			
	<b>GEV No.</b>	700762	<b>Ref. No.</b>	12024389 T130515
	bearing ø 44mm for door latch H 23mm ID ø 11mm thread M5 brass			
	<b>GEV No.</b>	700763	<b>Ref. No.</b>	12024505 T130514
	spring holder ø 43mm for door latch H 12.5mm ID ø 20mm brass			
	<b>GEV No.</b>	700771	<b>Ref. No.</b>	12024673 T130509
	latch gear opening to the left shaft intake ø 8x8mm L 170mm W 40mm H 40mm			







			
<b>GEV No.</b>	560068	<b>Ref. No.</b>	12010213 Q032032
<b>description</b>	flat-headed bolt thread M5 thread L 16mm SS DIN 7985/ISO 7045 Qty 20 pcs intake Phillips head ø 10mm head thickness 2mm		
<b>For models:</b>	ACE-201, ACE-202, ACG-201, ACG-202, AD-120B, AD-120BBTDD-UK, AD-120C, AD-120HY, AD-15, AD-15D, AD-20C-UK, AD-21, AD-21B, AD-21BDD, AD-21C, AD-21D, AD-21DD, AD-21W, AD-90BA, AD-90BBT, AD-90BDD, ADE-120B, AE-201, AE-202, AG-201, AG-202, APE-201, APE-202, APG-201, APG-202, COE-201, COE-202, COG-201, COG-202, ECO-120B, FI-100B, FI-100BBT-UK, FI-120B, FI-120C, FI-120HY-CLINIC, FI-80BBT-UK, GA-20, GA-20D, GA-40, GA-40D, HCG-10-11, HCG-10-21, HCG-20-11, HCG-20-21, HCG-2-10-11...(Other models you can see in the webshop)		

			
<b>GEV No.</b>	560549	<b>Ref. No.</b>	12010236
<b>description</b>	grub screw thread M6 L 15mm SS DIN 916/ISO 4029 intake internal hexagon WS 3 Qty 1 pcs		
<b>For models:</b>	ACE-201, ACE-202, ACG-201, ACG-202, AE-201, AE-202, AG-201, AG-202, APE-201, APE-202, APG-201, APG-202, CG9-20, CG9-20AD, CG9-20H, CG9-20PLUS, CG9-40, CG9-40AD, CG9-40H, CG9-40PLUS, CG9-41, CG9-41H, CG9-51L, CG9-51LC, CG9-51R, CG9-51RC, CG9-60, CG9-60AD, CG9-60H, CG9-60PLUS, CG9-61, CG9-61H, CG9-61OP, CG9-82, CGE9-41, CGE9-41AD, CGE9-41PLUS, CGF9-120D, CGF9-120I, CGF9-121D, CGF9-121I, COE-201, COE-202, COG-201, COG-202, HEI-10-11, HEI-20-11, HEI-20-21, HEI-6-11, HEM-10-11...(Other models you can see in the webshop)		

			
<b>GEV No.</b>	560132	<b>Ref. No.</b>	12010194 12010284 Q162030 Q163030
<b>description</b>	hexagonal nut thread M5 H 4mm WS 8 SS DIN/ISO DIN 934 / ISO 4032/8673 Qty 20 pcs		
<b>For models:</b>	ACE-061, ACE-101, ACE-102, ACE-201, ACE-202, ACG-061, ACG-101, ACG-102, ACG-201, ACG-202, AD-120, AD-120B, AD-120BBTDD-UK, AD-120C, AD-120CW, AD-120HY, AD-15, AD-15D, AD-20C-UK, AD-21, AD-21B, AD-21BDD, AD-21C, AD-21D, AD-21DD, AD-21W, AD-45BBT, AD-48, AD-48B, AD-48BDD, AD-48C, AD-48D, AD-48DD, AD-48HY, AD-48W, AD-64, AD-64B, AD-64BBT, AD-64BDD, AD-64BTDD, AD-64C, AD-64CW, AD-64D, AD-64DD, AD-64HY, AD-72, AD-72W, AD-90, AD-90BA, AD-90BBT...(Other models you can see in the webshop)		

			
<b>GEV No.</b>	511212	<b>Ref. No.</b>	12010255 Q162040 Q163140000
<b>description</b>	hexagonal nut thread M6 H 5mm WS 10 SS DIN/ISO DIN 934 / ISO 4032/8673 Qty 1 pcs		
<b>For models:</b>	ACE-061, ACE-101, ACE-102, ACE-201, ACE-202, ACG-061, ACG-101, ACG-102, ACG-201, ACG-202, AD-120, AD-120B, AD-120BBTDD-UK, AD-120C, AD-120CW, AD-120HY, AD-15, AD-15D, AD-20C-UK, AD-21, AD-21B, AD-21BDD, AD-21C, AD-21D, AD-21DD, AD-21W, AD-45BBT, AD-48, AD-48B, AD-48BDD, AD-48C, AD-48D, AD-48DD, AD-48HY, AD-48W, AD-64, AD-64B, AD-64BBT, AD-64BDD, AD-64BTDD, AD-64C, AD-64CW, AD-64D, AD-64DD, AD-64HY, AD-72, AD-72W, AD-90, AD-90BA, AD-90BBT...(Other models you can see in the webshop)		

			
<b>GEV No.</b>	700771	<b>Ref. No.</b>	12024673 T130509
<b>description</b>	latch gear opening to the left shaft intake ø 8x8mm L 170mm W 40mm H 40mm		
<b>For models:</b>	ACE-201, ACE-202, ACG-201, ACG-202, AE-201, AE-202, AG-201, AG-202, APE-201, APE-202, APG-201, APG-202, COE-201, COE-202, COG-201, COG-202, HCG-10-11, HCG-10-21, HCG-20-11, HCG-20-21, HCG-2-10-11, HCG-2-20-11, HCG-6-11, HEI-10-11, HEI-20-11, HEI-20-21, HEI-6-11, HEM-10-11, HEM-20-11, HEM-20-21, HEM-6-11, HEP-10-11, HEP-20-11, HEP-20-21, HEP-6-11, HGC-10-11, HGC-10-21, HGC-20-11, HGC-20-21, HGC-6-11, HGP-10-21, HGP-20-21, HGV-10-11, HGV-20-11, HGV-20-21, HME-10-11...(Other models you can see in the webshop)		

			
<b>GEV No.</b>	560123	<b>Ref. No.</b>	12009872 Q262040
<b>description</b>	lock washer ID ø 6.3mm ED ø 11mm SS DIN127 Qty 20 pcs for thread M6		
<b>For models:</b>	ACE-061, ACE-101, ACE-102, ACE-201, ACE-202, AD-120, AD-120B, AD-120BBTDD-UK, AD-120C, AD-120CW, AD-120HY, AD-15, AD-15D, AD-20C-UK, AD-21, AD-21B, AD-21BDD, AD-21C, AD-21D, AD-21DD, AD-21W, AD-45BBT, AD-48, AD-48B, AD-48BDD, AD-48C, AD-48D, AD-48DD, AD-48HY, AD-48W, AD-64, AD-64B, AD-64BBT, AD-64BDD, AD-64BTDD, AD-64C, AD-64CW, AD-64D, AD-64DD, AD-64HY, AD-72, AD-72W, AD-90, AD-90BA, AD-90BBT, AD-90BDD, AD-90DD, ADE-120, ADE-120B, AE-061...(Other models you can see in the webshop)		

			
<b>GEV No.</b>	516198	<b>Ref. No.</b>	12010285 Q271033 Q301033
<b>description</b>	retaining ring E D1 ø 6mm D2 ø 12mm SS DIN 6799 thickness 0.7mm for shaft ø 7-9mm		
<b>For models:</b>	COE-201, COE-202, COG-201, COG-202, FE-710, FE-720, FE9-05, FE9-05S, FE9-05USMC, FE9-10, FE-920, HCG-10-11, HCG-10-21, HCG-20-11, HCG-20-21, HCG-2-10-11, HCG-2-20-11, HCG-6-11, HCV-10-11, HCV-10-21, HCV-2-10-21, HCV-6-11, HE-10-11, HE-10-21, HE-2-10-11, HE-6-11, HEI-10-21, HEI-20-21, HEM-10-21, HEM-20-21, HEP-10-21, HEP-20-21, HG-10-21, HG-2-10-11, HGC-10-21, HGC-20-21, HGP-10-21, HGP-20-21, HGV-10-11, HGV-10-21, HGV-20-11, HGV-20-21, HME-10-11, HME-10-21, HME-20-11, HME-20-21, HME-2-10-11, HME-2-20-11, HME-6-11, HMG-10-11...(Other models you can see in the webshop)		

			
<b>GEV No.</b>	700769	<b>Ref. No.</b>	12021034 T130508
<b>description</b>	shaft ø 8x8mm for door latch L 80mm		
<b>For models:</b>	HCG-10-11, HCG-10-21, HCG-20-11, HCG-20-21, HCG-2-10-11, HCG-2-20-11, HCG-6-11, HEI-10-11, HEI-10-21, HEI-6-11, HEM-10-11, HEM-10-21, HEM-6-11, HEP-10-11, HEP-10-21, HEP-6-11, HGC-10-11, HGC-10-21, HGC-6-11, HGP-10-21, HGV-10-11, HGV-10-21, HME-10-11, HME-10-21, HME-20-11, HME-20-21, HME-2-10-11, HME-2-20-11, HME-6-11, HMI-10-11, HMI-10-11UL, HMI-10-21, HMI-10-21UL, HMI-2-10-11, HMI-6-11, HMI-6-11UL, HMM-10-11, HMM-10-11UL, HMM-10-21, HMM-10-21UL, HMM-20-11, HMM-20-11UL, HMM-20-21, HMM-20-21UL, HMM-2-10-11, HMM-2-20-11, HMM-40-11-USMC, HMM-6-11, HMM-6-11UL, HMP-10-11...(Other models you can see in the webshop)		

## hinges

### spring assisted hinges

#### producer-specific

#### CORECO



<b>GEV No.</b>	690763	<b>Ref. No.</b>	12038130 6033010100
<b>description</b>	spring assisted hinge right/left L 111mm W 75mm refrigerator mounting distance 25mm		
<b>For models:</b>	ADAEP-1602, ADAEP-801, ADAFN-1602, ADAFN-801, ADAFP-1602, ADAFP-801, ADMCN-135, ADMCN-180, ADMCN-225, ADMCP-135, ADMCP-180, ADMCP-225, ADMFN-135, ADMFN-180, ADMFN-225, ADMFP-135, ADMFP-135-GR, ADMFP-135HD, ADMFP-135PC, ADMFP-180, ADMFP-180-GR, ADMFP-180HDD, ADMFP-180HDD, ADMFP-180PC, ADMFP-225, ADMFP-225-GR, ADMFP-225HDD, ADMFP-225HDD, ADMFP-225HHDD, ADMFP-225PC, AEF-801AD, AEF-802AD, AEP-1402, AEP-1602, AEP-1602AD, AEP-1603AD, AEP-1604AD, AEP-2103, AEP-701, AEP-801, AEP-802, AF-1402-MIX, AF-1403-C, AF-1403-P, AF-1404-C, AF-1404-P, AF-1602-MIX, AF-1603-C, AF-1603-P, AF-1604-C...(Other models you can see in the webshop)		
<b>accessories for</b>	690763		
	<b>GEV No.</b>	691738	<b>Ref. No.</b> 12038085 6033010098
hinge L 100mm W 48mm mounting pos. left thickness 5mm for door for refrigerated counters			
	<b>GEV No.</b>	701161	<b>Ref. No.</b> 12037017 6033010130
hinge camp mounting pos. bottom right L 100mm W 48mm H 17mm shaft diameter 8x8mm			

	<b>GEV No.</b>	700763	<b>Ref. No.</b>	12024505 T130514
<b>description</b>	spring holder ø 43mm for door latch H 12.5mm ID ø 20mm brass			
<b>For models:</b>	ACE-201, ACE-202, ACG-201, ACG-202, AE-201, AE-202, AG-201, AG-202, APE-201, APE-202, APG-201, APG-202, COE-201, COE-202, COG-201, COG-202, HCG-10-11, HCG-10-21, HCG-20-11, HCG-20-21, HCG-2-10-11, HCG-2-20-11, HCG-6-11, HEI-10-11, HEI-10-21, HEI-20-11, HEI-20-21, HEM-10-11, HEM-10-21, HEM-20-11, HEM-20-21, HEM-6-11, HEP-10-11, HEP-10-21, HEP-20-11, HEP-20-21, HEP-6-11, HGC-10-11, HGC-10-21, HGC-20-11, HGC-20-21, HGC-6-11, HGP-10-21, HGP-20-21, HGV-10-11, HGV-10-21, HGV-20-11, HGV-20-21, HME-10-11...(Other models you can see in the webshop)			



	<b>GEV No.</b>	560126	<b>Ref. No.</b>	12009890 Q242030
<b>description</b>	tooth lock washer ID ø 5.2mm ED ø 10mm SS DIN/ISO DIN 6798A Qty 20 pcs for thread M5			
<b>For models:</b>	ACE-061, ACE-101, ACE-102, ACE-201, ACE-202, ACG-061, ACG-101, ACG-102, ACG-201, ACG-202, AD-120, AD-120B, AD-120BTTDD-UK, AD-120C, AD-120CW, AD-120HY, AD-15, AD-15D, AD-20C-UK, AD-21, AD-21B, AD-21BDD, AD-21C, AD-21D, AD-21DD, AD-21W, AD-45BBT, AD-48, AD-48B, AD-48BDD, AD-48C, AD-48D, AD-48DD, AD-48HY, AD-48W, AD-64, AD-64B, AD-64BBT, AD-64BDD, AD-64C, AD-64CW, AD-64D, AD-64DD, AD-64HY, AD-72, AD-72W, AD-90, AD-90BA, AD-90BBT, AD-90BDD...(Other models you can see in the webshop)			

### miscellaneous

	<b>GEV No.</b>	691873	<b>Ref. No.</b>	12019998 U060526
<b>description</b>	bolt			

	<b>GEV No.</b>	691064	<b>Ref. No.</b>	R260546
<b>description</b>	catch hook			

	<b>GEV No.</b>	691872	<b>Ref. No.</b>	12020157 U060518
<b>description</b>	sleeve			



							
1							
<b>GEV No.</b>	700830	<b>Ref. No.</b>	12031972 12034927 12058528 6000300007 6009991521 6033010003 6033010030				
<b>description</b>	spring assisted hinge right/left L 75mm W 26mm H 102mm refrigeration units mounting distance 25mm						
<b>For models:</b>	AEP-1402, AEP-1403, AEP-1404, AEP-1602, AEP-1603, AEP-1604, AEP-2103, AEP-701, AEP-702, AEP-801, AEP-802, AF-1402-MIX, AF-1403-C, AF-1403-P, AF-1404-C, AF-1404-P, AF-1602-MIX, AF-1603-C, AF-1603-P, AF-1604-C, AF-1604-P, AF-2104-C, AF-2104-P, AF-2105-C, AF-2105-P, AF-2106-C, AF-2106-P, AF-702-C, AF-702-P, AF-802-C, AF-802-P, AFN-1402, AFN-1403, AFN-1404, AFN-1602, AFN-1603, AFN-1604, AFN-701, AFN-702, AFN-801, AFN-802, AFP-1402, AFP-1402-FORZ, AFP-1402-MIX, AFP-1403, AFP-1403-C, AFP-1403-FORZ, AFP-1403-P, AFP-1404, AFP-1404-C...(Other models you can see in the webshop)						
<b>accessories for</b>	700830						
		<table border="1"> <tr> <td><b>GEV No.</b></td> <td>700854</td> <td><b>Ref. No.</b></td> <td>12036924 6033010084</td> </tr> </table>	<b>GEV No.</b>	700854	<b>Ref. No.</b>	12036924 6033010084	hinge camp type TRB/L1 36mm mounting pos. bottom right L 100mm W 48mm H 17mm zinc die cast, chrome-plated hole distance 6.5x51x28mm shaft diameter torx 12x12mmmm
<b>GEV No.</b>	700854	<b>Ref. No.</b>	12036924 6033010084				

			
1			
<b>GEV No.</b>	701569	<b>Ref. No.</b>	12058502 2030800022
<b>description</b>	spring assisted hinge left/right L 102mm W 75mm mounting distance 25mm		

							
1							
<b>GEV No.</b>	690763	<b>Ref. No.</b>	12038130 6033010100				
<b>description</b>	spring assisted hinge right/left L 111mm W 75mm refrigerator mounting distance 25mm						
<b>For models:</b>	ADAEP-1602, ADAEP-801, ADAFN-1602, ADAFN-801, ADAFP-1602, ADAFP-801, ADMCN-135, ADMCN-180, ADMCN-225, ADMCP-135, ADMCP-180, ADMCP-225, ADMFN-135, ADMFN-180, ADMFN-225, ADMFP-135, ADMFP-135-GR, ADMFP-135HD, ADMFP-135PC, ADMFP-180, ADMFP-180-GR, ADMFP-180HDD, ADMFP-180HHD, ADMFP-180PC, ADMFP-225, ADMFP-225-GR, ADMFP-225HDD, ADMFP-225HHDD, ADMFP-225HHHD, ADMFP-225PC, AEF-801AD, AEF-802AD, AEP-1402, AEP-1602, AEP-1602AD, AEP-1603AD, AEP-1604AD, AEP-2103, AEP-701, AEP-801, AEP-802, AF-1402-MIX, AF-1403-C, AF-1403-P, AF-1404-C, AF-1404-P, AF-1602-MIX, AF-1603-C, AF-1603-P, AF-1604-C...(Other models you can see in the webshop)						
<b>accessories for</b>	690763						
		<table border="1"> <tr> <td><b>GEV No.</b></td> <td>691738</td> <td><b>Ref. No.</b></td> <td>12038085 6033010098</td> </tr> </table>	<b>GEV No.</b>	691738	<b>Ref. No.</b>	12038085 6033010098	hinge L 100mm W 48mm mounting pos. left thickness 5mm for door for refrigerated counters
<b>GEV No.</b>	691738	<b>Ref. No.</b>	12038085 6033010098				
		<table border="1"> <tr> <td><b>GEV No.</b></td> <td>701161</td> <td><b>Ref. No.</b></td> <td>12037017 6033010130</td> </tr> </table>	<b>GEV No.</b>	701161	<b>Ref. No.</b>	12037017 6033010130	hinge camp mounting pos. bottom right L 100mm W 48mm H 17mm shaft diameter 8x8mm
<b>GEV No.</b>	701161	<b>Ref. No.</b>	12037017 6033010130				

<p>FAGOR</p> 			
1			
<b>GEV No.</b>	701570	<b>Ref. No.</b>	12036986 6033010129
<b>description</b>	hinge camp L 98mm W 46mm mounting distance 80mm mounting pos. bottom left		
<b>For models:</b>	ADAEP-1602, ADAEP-801, ADAFN-1602, ADAFN-801, ADAFP-1602, ADAFP-801, ADMCN-135, ADMCN-180, ADMCN-225, ADMCP-135, ADMCP-180, ADMCP-225, ADMFN-135, ADMFN-180, ADMFN-225, ADMFP-135, ADMFP-135-GR, ADMFP-135HD, ADMFP-135PC, ADMFP-180, ADMFP-180-GR, ADMFP-180HDD, ADMFP-180HHD, ADMFP-180PC, ADMFP-225, ADMFP-225-GR, ADMFP-225HDD, ADMFP-225HHDD, ADMFP-225HHHD, ADMFP-225PC, AEF-801AD, AEF-802AD, AEP-1402, AEP-1602, AEP-1602AD, AEP-1603AD, AEP-1604AD, AEP-2103, AEP-701, AEP-801, AEP-802, AF-1402-MIX, AF-1403-C, AF-1403-P, AF-1404-C, AF-1404-P, AF-1602-MIX, AF-1603-C, AF-1603-P, AF-1604-C...(Other models you can see in the webshop)		



			
1			
<b>GEV No.</b>	701158	<b>Ref. No.</b>	12035423 M169090003
<b>description</b>	hinge camp mounting pos. bottom left L 100mm W 48mm H 17mm zinc die cast, chrome-plated		
<b>For models:</b>	FMP-117-R, FMP-150, FMP-169-R, FMP-200, FMP-222-R, FMP-250, FMP-274-R, FMP-300, MEP-100, MEP-100G, MEP-135, MEP-180, MFN-135, MFN-180, MFP-102-GN-R, MFP-135-F-GN, MFP-135-GN, MFP-147-GN-R, MFP-180-F-GN, MFP-180-GN, MFP-192-GN-R, MFP-225-F-GN, MFP-225-GN, MFP-237-GN-R, MFP-270-F-GN, MFP-270-GN, MPP-150, MPP-202, MPP-255, MPP-307, MPZ1-150, MPZ1-200, MPZ1-250, MSN-150, MSN-200, MSP-117-2RC, MSP-117-R, MSP-150, MSP-150-2C, MSP-150-F, MSP-169-R, MSP-169-R2C, MSP-169-R4C, MSP-200, MSP-200-2C, MSP-200-4C, MSP-200-F, MSP-222-R, MSP-222-R4C, MSP-222-R6C...(Other models you can see in the webshop)		

			
1			
<b>GEV No.</b>	700830	<b>Ref. No.</b>	12031972 12034927 12058528 6000300007 6009991521 6033010003 6033010030
<b>description</b>	spring assisted hinge right/left L 75mm W 26mm H 102mm refrigeration units mounting distance 25mm		
<b>For models:</b>	AEP-1402, AEP-1403, AEP-1404, AEP-1602, AEP-1603, AEP-1604, AEP-2103, AEP-701, AEP-702, AEP-801, AEP-802, AF-1402-MIX, AF-1403-C, AF-1403-P, AF-1404-C, AF-1404-P, AF-1602-MIX, AF-1603-C, AF-1603-P, AF-1604-C, AF-1604-P, AF-2104-C, AF-2104-P, AF-2105-C, AF-2105-P, AF-2106-C, AF-2106-P, AF-702-C, AF-702-P, AF-802-C, AF-802-P, AFN-1402, AFN-1403, AFN-1404, AFN-1602, AFN-1603, AFN-1604, AFN-701, AFN-702, AFN-801, AFN-802, AFP-1402, AFP-1402-FORZ, AFP-1402-MIX, AFP-1403, AFP-1403-C, AFP-1403-FORZ, AFP-1403-P, AFP-1404, AFP-1404-C...(Other models you can see in the webshop)		
<b>accessories for</b>	700830		
	<b>GEV No.</b>	700854	<b>Ref. No.</b> 12036924 6033010084
	hinge camp type TRB/L1 36mm mounting pos. bottom right L 100mm W 48mm H 17mm zinc die cast, chrome-plated hole distance 6.5x51x28mm shaft diameter torx 12x12mmmm		

oven hinges

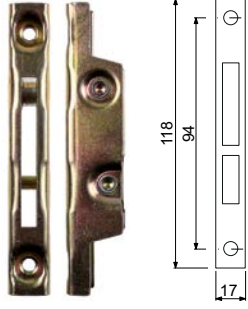
			
1			
<b>GEV No.</b>	691003	<b>Ref. No.</b>	12002123 U010510
<b>description</b>	guide L 128mm W 26mm thickness 1mm cut-out 7x41 7x22.5mm for hinge		
<b>For models:</b>	CE7-41, CE9-41, CG-1002, CG-1502, CG-2000, CG-2000-2P, CG-2002, CG-2002P, CG-210, CG-210G, CG-310, CG-310G, CG7-11, CG-7115, CG7-41, CG-7415, CG7-61, CG-7615, CG9-11, CG9-41, CG9-51L, CG9-51LC, CG9-51R, CG9-51RC, CG9-61, CG9-82, CGE7-195, CGE7-41, CGE9-41, CGF9-121D, CGF9-121I, FTG9-11L, FTG9-11L+R, FTG9-11R, FTGC9-11L, FTGC9-11L+R, FTGC9-11R, HE9-10, HE9-20, HG9-10, HG9-20		

			
1			
<b>GEV No.</b>	700001	<b>Ref. No.</b>	12008998 U010512
<b>description</b>	opposite support L 118mm W 17mm mounting distance 94mm		
<b>For models:</b>	CE6-41, CE7-41, CE7-41Q, CE9-41, CE9-41AD, CE9-41PLUS, CG-1002, CG-1502, CG-2000, CG-2000-2P, CG-2002, CG-2002P, CG-210, CG-210G, CG-310, CG-310G, CG6-41, CG7-11, CG-7115, CG7-31D, CG7-31I, CG7-41, CG-7415, CG7-41H, CG7-51, CG7-61, CG-7615, CG7-61H, CG9-11, CG9-11AD, CG9-11PLUS, CG9-41, CG9-41AD, CG9-41AD-H, CG9-41H, CG9-41PLUS, CG9-41PLUS-H, CG9-51L, CG9-51LC, CG9-51R, CG9-51RC, CG9-61, CG9-61AD, CG9-61AD-H, CG9-61H, CG9-61OP, CG9-61PLUS, CG9-61PLUS-H, CG9-82, CG9-82AD...(Other models you can see in the webshop)		

			
1			
<b>GEV No.</b>	700006	<b>Ref. No.</b>	12019715 U010504
<b>description</b>	oven hinge mounting distance 173mm mounting distance 2 105mm lug mounting 14mm lever length 120mm groove distance 11mm spring thickness 3.5mm mounting ear position left spring length 112mm W 25mm		
<b>For models:</b>	CE7-41, CE9-41, CG-1002, CG-1502, CG-2000, CG-2000-2P, CG-2002, CG-210, CG-210G, CG-310, CG-310G, CG7-11, CG-7115, CG7-41, CG-7415, CG7-61, CG-7615, CG9-11, CG9-41, CG9-51L, CG9-51LC, CG9-51R, CG9-51RC, CG9-61, CG9-82, CGE7-194, CGE7-41, CGE9-41, CGF9-121D, CGF9-121I, FTG9-11L, FTG9-11L+R, FTG9-11R, FTGC9-11L+R, FTGC9-11R, HE9-10, HE9-20, HG9-10, HG9-20		
<b>accessories for</b>	700006		
	<b>GEV No.</b>	700001	<b>Ref. No.</b> 12008998 U010512
	opposite support L 118mm W 17mm mounting distance 94mm		
	<b>GEV No.</b>	700007	<b>Ref. No.</b> 12019714 U010511
	oven hinge mounting distance 173mm mounting distance 2 105mm lug mounting 14mm lever length 120mm groove distance 11mm spring thickness 3.5mm mounting ear position right spring length 112mm W 25mm		



**1**

<b>GEV No.</b>	700007	<b>Ref. No.</b>	12019714 U010511
<b>description</b>	oven hinge mounting distance 173mm mounting distance 2 105mm lug mounting 14mm lever length 120mm groove distance 11mm spring thickness 3.5mm mounting ear position right spring length 112mm W 25mm		
<b>For models:</b>	CE7-41, CE9-41, CG-1002, CG-1502, CG-2000, CG-2000-2P, CG-2002, CG-210, CG-210G, CG-310, CG-310G, CG7-11, CG-7115, CG7-41, CG-7415, CG7-61, CG-7615, CG9-11, CG9-41, CG9-51L, CG9-51LC, CG9-51R, CG9-51RC, CG9-61, CG9-82, CGE7-193, CGE7-41, CGE9-41, CGF9-121D, CGF9-121I, FTG9-11L, FTG9-11L+R, FTG9-11R, FTGC9-11L, FTGC9-11L+R, FTGC9-11R, HE9-10, HE9-20, HG9-10, HG9-20		
<b>accessories for</b>	700007		
	<b>GEV No.</b>	700001	<b>Ref. No.</b> 12008998 U010512
	opposite support L 118mm W 17mm mounting distance 94mm		

**1**

<b>GEV No.</b>	700820	<b>Ref. No.</b>	12009225 U020528
<b>description</b>	oven hinge mounting distance 173mm mounting distance 2mm lug mounting 14mm lever length 119mm groove distance 11mm spring thickness 3.5mm mounting ear position left/right spring length 112mm L 207mm W 25mm		
<b>For models:</b>	CE6-41, CE7-41, CE7-41Q, CE9-41, CE9-41AD, CE9-41PLUS, CG-1002, CG-1502, CG-2002, CG-2002P, CG-210, CG-210G, CG-310, CG-310G, CG6-41, CG7-11, CG7-31D, CG7-31I, CG7-41, CG7-41H, CG7-51, CG7-61, CG7-61H, CG9-11, CG9-11AD, CG9-11PLUS, CG9-31PLUS-D, CG9-31PLUS-I, CG9-41, CG9-41AD, CG9-41AD-H, CG9-41H, CG9-41PLUS, CG9-41PLUS-H, CG9-51L, CG9-51LC, CG9-51R, CG9-51RC, CG9-61, CG9-61AD, CG9-61AD-H, CG9-61H, CG9-61OP, CG9-61PLUS, CG9-61PLUS-H, CG9-82, CG9-82AD, CG9-82PLUS, CGE6-41, CGE7-41... (Other models you can see in the webshop)		
<b>accessories for</b>	700820		
	<b>GEV No.</b>	700001	<b>Ref. No.</b> 12008998 U010512
	opposite support L 118mm W 17mm mounting distance 94mm		

door bearing

**1**

<b>GEV No.</b>	693569	<b>Ref. No.</b>	12034578 RT21201254
<b>description</b>	bolt mounting pos. upper		

**1**

<b>GEV No.</b>	693568	<b>Ref. No.</b>	12032516 RT29401300
<b>description</b>	bush mounting pos. upper		

**1**

<b>GEV No.</b>	690764	<b>Ref. No.</b>	12037723 6003010136
<b>description</b>	bush W 23.5mm H 53.5mm mounting pos. upper/lower ø 16mm ID ø 10mm grey for hinge		

<b>For models:</b>	ADM CN-135, ADM CN-180, ADM CN-225, ADM CP-135, ADM CP-180, ADM CP-225, ADM FN-135, ADM FN-180, ADM FN-225, ADM FP-135, ADM FP-135-GR, ADM FP-135HD, ADM FP-135PC, ADM FP-180, ADM FP-180-GR, ADM FP-180HDD, ADM FP-180HHD, ADM FP-180PC, ADM FP-225, ADM FP-225-GR, ADM FP-225HDD, ADM FP-225HHD, ADM FP-225HHDD, ADM FP-225PC, AEP-1402, AEP-1602, AEP-2103, AEP-701, AEP-801, AEP-802, AF-1402-MIX, AF-1403-C, AF-1403-P, AF-1404-C, AF-1404-P, AF-1602-MIX, AF-1603-C, AF-1603-P, AF-1604-C, AF-1604-P, AF-2104-C, AF-2104-P, AF-2105-C, AF-2105-P, AF-2106-C, AF-2106-P, AF-702-C, AF-702-P, AF-802-C, AF-802-P...(Other models you can see in the webshop)		
<b>accessories for</b>	690764		

**1**

<b>GEV No.</b>	700817	<b>Ref. No.</b>	12038076 6033090064
<b>description</b>	hinge bolt upper ø 10mm L 30mm IT M6 for refrigerated counters mounting pos. upper		

**1**

<b>GEV No.</b>	691647	<b>Ref. No.</b>	12024596 T130500
<b>description</b>	door hinge L 156mm W 50mm mounting pos. upper right thickness 6mm		
<b>For models:</b>	COE-061, COE-101, COG-061, COG-101, HCG-10-11, HCG-10-21, HCG-20-11, HCG-20-21, HCG-2-10-11, HCG-2-20-11, HCG-6-11, HEI-10-11, HEI-6-11, HEM-10-11, HEM-6-11, HEP-10-11, HEP-6-11, HGC-10-11, HGC-6-11, HGV-10-11, HME-10-11, HME-10-21, HME-20-11, HME-20-21, HME-2-10-11, HME-2-20-11, HMI-10-11, HMI-10-11UL, HMI-10-21, HMI-10-21UL, HMI-2-10-11, HMI-6-11, HMI-6-11UL, HMM-10-11, HMM-10-11UL, HMM-10-21, HMM-10-21UL, HMM-20-11, HMM-20-11UL, HMM-20-21, HMM-20-21UL, HMM-2-10-11, HMM-2-20-11, HMM-40-11-USMC, HMM-6-11, HMM-6-11UL, HMP-10-11, HMP-10-21, HMP-20-11...(Other models you can see in the webshop)		



<b>GEV No.</b>	700835	<b>Ref. No.</b>	12011159 U060515
<b>description</b>	door hinge L 96mm W 33mm H 44mm mounting pos. left upper		
<b>For models:</b>	CGB7-61		



<b>GEV No.</b>	700834	<b>Ref. No.</b>	12015573 U060514
<b>description</b>	door hinge L 96mm W 33mm H 44mm mounting pos. right upper		
<b>For models:</b>	CGB7-61		



<b>GEV No.</b>	692297	<b>Ref. No.</b>	12036829 6033010111
<b>description</b>	hinge L 100mm W 17mm H 48mm mounting pos. bottom left thickness 5mm		
<b>For models:</b>	AEP-1402, AEP-1602, AEP-2103, AF-1402-MIX, AF-1403-C, AF-1403-P, AF-1404-C, AF-1404-P, AF-1602-MIX, AF-1603-C, AF-1603-P, AF-1604-C, AF-1604-P, AF-2104-C, AF-2104-P, AF-2105-C, AF-2105-P, AF-2106-C, AF-2106-P, AFN-1402, AFN-1403, AFN-1404, AFN-1602, AFN-1603, AFN-1604, AFP-1402, AFP-1403, AFP-1404, AFP-1602, AFP-1602-2, AFP-1603, AFP-1603-2, AFP-1604, AFP-2103, AFP-2104, AFP-2105, AFP-2106, ERM-150, ERM-250, ERM-350		



<b>GEV No.</b>	691738	<b>Ref. No.</b>	12038085 6033010098
<b>description</b>	hinge L 100mm W 48mm mounting pos. left thickness 5mm for door for refrigerated counters		
<b>For models:</b>	AEP-2103, AF-2104-C, AF-2104-P, AF-2105-C, AF-2105-P, AF-2106-C, AF-2106-P, AFP-2103, AFP-2104, AFP-2105, AFP-2106, FMP-117-R, FMP-150, FMP-169-R, FMP-200, FMP-222-R, FMP-250, FMP-274-R, FMP-300, MCP-135-GN, MCP-147-GN-R, MCP-180-GN, MCP-225-GN, MCP-270-GN, MEP-100, MEP-100G, MEP-135, MEP-180, MFN-135, MFN-180, MFP-102-GN-R, MFP-135-F-GN, MFP-135-GN, MFP-147-GN-R, MFP-180-F-GN, MFP-180-GN, MFP-192-GN-R, MFP-225-F-GN, MFP-225-GN, MFP-237-GN-R, MFP-270-F-GN, MFP-270-GN, MPP-150, MPP-202, MPP-255, MPP-307, MPZ1-150, MPZ1-200, MPZ1-250, MSN-150...(Other models you can see in the webshop)		



<b>GEV No.</b>	691737	<b>Ref. No.</b>	12037938 6033010099 M19090004
<b>description</b>	hinge L 100mm W 48mm mounting pos. right thickness 5mm for door for refrigerated counters		
<b>For models:</b>	AEP-2103, AF-2104-C, AF-2104-P, AF-2105-C, AF-2105-P, AF-2106-C, AF-2106-P, AFP-2103, AFP-2104, AFP-2105, AFP-2106, MCP-135-GN, MCP-147-GN-R, MCP-180-GN, MCP-225-GN, MCP-270-GN, MEP-100, MEP-100G, MSP-150-GI, MSP-200-GI, MSP-250-GI, MSP-300-GI		





<b>GEV No.</b>	690765	<b>Ref. No.</b>	12037372 6033090090
<b>description</b>	hinge L 47mm H 20mm mounting pos. bottom right ø 10mm		
<b>For models:</b>	ADMCN-135, ADMCN-180, ADMCN-225, ADMCP-135, ADMCP-180, ADMCP-225, ADMFN-135, ADMFN-180, ADMFN-225, ADMFP-135, ADMFP-135-GR, ADMFP-135HD, ADMFP-135HH, ADMFP-135PC, ADMFP-180, ADMFP-180-GR, ADMFP-180HDD, ADMFP-180HHD, ADMFP-180HHH, ADMFP-180PC, ADMFP-225, ADMFP-225-GR, ADMFP-225HDD, ADMFP-225HDD, ADMFP-225HHHD, ADMFP-225HHHH, ADMFP-225PC, CFMP-150, CFMP-150F, CFMP-150PC, CFMP-150TV, CFMP-202, CFMP-202F, CFMP-202PC, CFMP-202TV, CFMP-255, CFMP-255F, CFMP-255PC, CFMP-255TV, CFMP-307, CFMP-307F, CFMP-307TV, CMFN-135, CMFN-180, CMFN-225, CMFN-270, CMFP-135, CMFP-135-B, CMFP-135-B2, CMFP-135-BP...(Other models you can see in the webshop)		



<b>GEV No.</b>	701159	<b>Ref. No.</b>	12036086 12038111 6009992205 6009992206
<b>description</b>	hinge L 50mm W 35mm H 39mm mounting pos. bottom right		
<b>For models:</b>	FMP-117-R, FMP-150, FMP-169-R, FMP-200, FMP-222-R, FMP-250, FMP-274-R, FMP-300, MCN-102-GN-R, MCN-135-GN, MCN-147-GN-R, MCN-180-GN, MCN-192-GN-R, MCN-225-GN, MCN-237-GN-R, MCN-270-GN, MCP-102-GN-R, MCP-135-GN, MCP-147-GN-R, MCP-180-GN, MCP-192-GN-R, MCP-225-GN, MCP-237-GN-R, MCP-270-GN, MEP-100, MEP-135, MEP-180, MFN-102-GN-R, MFN-135-GN, MFN-147-GN-R, MFN-180-GN, MFN-192-GN-R, MFN-225-GN, MFN-237-GN-R, MFP-270-GN, MFP-102-GN-R, MFP-135-GN, MFP-147-GN-R, MFP-180-GN, MFP-192-GN-R, MFP-225-GN, MFP-237-GN-R, MFP-270-GN, MPN-117-R, MPN-117-R-C, MPN-150, MPN-150-C, MPN-169-R, MPN-169-R-C, MPN-202...(Other models you can see in the webshop)		



							
<b>GEV No.</b>	701157	<b>Ref. No.</b>	12035983 12036088 6009992203 V169090002				
<b>description</b>	hinge L 50mm W 36mm H 30mm mounting pos. left/upper and bottom kit						
<b>For models:</b>	FMP-117-R, FMP-150, FMP-169-R, FMP-200, FMP-222-R, FMP-250, FMP-274-R, FMP-300, MCN-102-GN-R, MCN-102-R, MCN-135, MCN-135-GN, MCN-147-GN-R, MCN-147-R, MCN-180, MCN-180-GN, MCN-192-GN-R, MCN-192-R, MCN-225, MCN-225-GN, MCN-237-GN-R, MCN-237-R, MCN-270, MCN-270-GN, MCP-102-GN-R, MCP-135, MCP-135-GN, MCP-147-GN-R, MCP-180, MCP-180-GN, MCP-192-GN-R, MCP-225, MCP-225-GN, MCP-237-GN-R, MCP-270-GN, MEP-100, MEP-100G, MEP-135, MEP-180, MFN-102-GN-R, MFN-135-GN, MFN-147-GN-R, MFN-180-GN, MFN-192-GN-R, MFN-225-GN, MFN-237-GN-R, MFN-270-GN, MFP-102-GN-R, MFP-135-GN, MFP-147-GN-R...(Other models you can see in the webshop)						
<b>accessories for</b>	701157						
		<table border="1"> <tr> <td><b>GEV No.</b></td> <td>690764</td> <td><b>Ref. No.</b></td> <td>12037723 6003010136</td> </tr> </table>	<b>GEV No.</b>	690764	<b>Ref. No.</b>	12037723 6003010136	bush W 23.5mm H 53.5mm mounting pos. upper/lower ø 16mm ID ø 10mm grey for hinge
<b>GEV No.</b>	690764	<b>Ref. No.</b>	12037723 6003010136				

			
<b>GEV No.</b>	692903	<b>Ref. No.</b>	12047967
<b>description</b>	hinge L 54mm W 32mm H 12.5mm mounting pos. lower thread M6 ID ø 15.5mm		
<b>For models:</b>	ACE-061, ACE-101, ACE-102, ACE-201, ACE-202, ACG-061, ACG-101, ACG-102, ACG-201, ACG-202, AE-061, AE-061W, AE-101, AE-101W, AE-102, AE-102W, AE-201, AE-202, AG-061, AG-061W, AG-101, AG-101W, AG-102, AG-102W, AG-201, AG-202, APE-061, APE-061W, APE-101, APE-101W, APE-102, APE-102W, APE-201, APE-202, APG-061, APG-061W, APG-101, APG-101W, APG-102, APG-102W, APG-201, APG-202		

			
<b>GEV No.</b>	691728	<b>Ref. No.</b>	12014955 E022608
<b>description</b>	hinge L 85mm W 66mm thickness 2.5mm L-shape for fryer		
<b>For models:</b>	CG7-61, CG9-51L, CG9-51LC, CG9-51R, CG9-51RC, CG9-61, CPG7-05, CPG9-05, CPG9-05NC, FE-710, FE-720, FE9-05, FE9-05USMC, FE9-10, FG-710, FG-720, FG9-05, FG9-10, MB7-05, MB7-10, MB9-05-PUERTA-DCHA, MB9-10-PUERTA-DOBLE, MB9-15-PUERTA-DCHA, MB9-15-PUERTA-IZDA		

			
<b>GEV No.</b>	701160	<b>Ref. No.</b>	12036087 6009992204
<b>description</b>	hinge L 51mm W 36mm H 40mm mounting pos. bottom left		
<b>For models:</b>	FMP-117-R, FMP-150, FMP-169-R, FMP-200, FMP-222-R, FMP-250, FMP-274-R, FMP-300, MCN-102-GN-R, MCN-135-GN, MCN-147-GN-R, MCN-180-GN, MCN-192-GN-R, MCN-225-GN, MCN-237-GN-R, MCN-270-GN, MCP-102-GN-R, MCP-135-GN, MCP-147-GN-R, MCP-180-GN, MCP-192-GN-R, MCP-225-GN, MCP-237-GN-R, MCP-270-GN, MEP-100, MEP-135, MEP-180, MFN-102-GN-R, MFN-135-GN, MFN-147-GN-R, MFN-180-GN, MFN-192-GN-R, MFN-225-GN, MFN-237-GN-R, MFN-270-GN, MFP-102-GN-R, MFP-135-GN, MFP-147-GN-R, MFP-180-GN, MFP-192-GN-R, MFP-225-GN, MFP-237-GN-R, MFP-270-GN, MMZ-202, MPN-117-R, MPN-117-R-C, MPN-150, MPN-150-C, MPN-169-R, MPN-169-R-C...(Other models you can see in the webshop)		

			
<b>GEV No.</b>	700812	<b>Ref. No.</b>	12037672 6003010048
<b>description</b>	hinge mounting distance 12mm mounting pos. upper and bottom for technical chamber door for refrigerated counters shaft ø 9mm		
<b>For models:</b>	FMP-150, FMP-202, FMP-255, FMP-307, MCN-135, MCN-180, MCN-225, MCN-270, MCP-135, MCP-135-GN, MCP-180, MCP-180-GN, MCP-225, MCP-225-GN, MCP-270-GN, MEP-135, MEP-180, MFN-135, MFN-180, MFN-225, MFN-270, MFP-135, MFP-135-2C, MFP-135-4C, MFP-135-F, MFP-180, MFP-180-2C, MFP-180-4C, MFP-180-6C, MFP-180-F, MFP-225, MFP-225-2C, MFP-225-4C, MFP-225-6C, MFP-225-8C, MFP-225-F, MFP-270-10C, MFP-270-2C, MFP-270-4C, MFP-270-6C, MFP-270-8C, MFP-270-F, MMZ-150, MMZ-202, MPN-150, MPN-150-C, MPN-202, MPN-202-C, MPN-255, MPN-255-C...(Other models you can see in the webshop)		

			
<b>GEV No.</b>	692904	<b>Ref. No.</b>	12039311 T540565000
<b>description</b>	hinge L 54mm W 32mm H 10mm mounting pos. lower thread M6 ID ø 15.5mm		
<b>For models:</b>	ACE-061, ACE-101, ACE-102, ACE-201, ACE-202, ACG-061, ACG-101, ACG-102, ACG-201, ACG-202, AE-061, AE-101, AE-102, AE-201, AE-202, AG-061, AG-101, AG-102, AG-201, AG-202, APE-061, APE-101, APE-102, APE-201, APE-202, APG-061, APG-101, APG-102, APG-201, APG-202		

			
<b>GEV No.</b>	700890	<b>Ref. No.</b>	12038100 6009992202 V169090001
<b>description</b>	hinge mounting pos. left/upper and bottom		
<b>For models:</b>	EC-150, ECC-150, FMP-117-R, FMP-150, FMP-169-R, FMP-202, FMP-222-R, FMP-255, FMP-274-R, FMP-307, MCN-102-R, MCN-135, MCN-147-R, MCN-180, MCN-192-R, MCN-225, MCN-237-R, MCN-270, MCP-135, MCP-180, MCP-225, MEP-100, MEP-100G, MEP-135, MEP-180, MFN-102-R, MFN-135, MFN-147-R, MFN-180, MFN-192-R, MFN-225, MFN-237-R, MFN-270, MFP-102-2C, MFP-135, MFP-135-2C, MFP-135-F, MFP-147-2C, MFP-147-4C, MFP-180, MFP-180-2C, MFP-180-4C, MFP-180-F, MFP-192-2C, MFP-192-4C, MFP-192-6C, MFP-225, MFP-225-2C, MFP-225-4C, MFP-225-6C...(Other models you can see in the webshop)		



<b>GEV No.</b>	693567	<b>Ref. No.</b>	12031970 RT29301307
<b>description</b>	hinge mounting pos. upper		



<b>GEV No.</b>	521285	<b>Ref. No.</b>	12039312 T540566000
<b>description</b>	hinge bearing L 152mm W 29mm H 8.5mm mounting pos. upper without bolt		

**For models:** ACE-061, ACE-101, ACE-102, ACE-201, ACE-202, ACG-061, ACG-101, ACG-102, ACG-201, ACG-202, AE-061, AE-061W, AE-101, AE-101W, AE-102, AE-102W, AE-201, AE-202, AG-061, AG-061W, AG-101, AG-101W, AG-102, AG-102W, AG-201, AG-202, APE-061, APE-061W, APE-101, APE-101W, APE-102, APE-102W, APE-201, APE-202, APG-061, APG-061W, APG-101, APG-101W, APG-102, APG-102W, APG-201, APG-202



<b>GEV No.</b>	691091	<b>Ref. No.</b>	12024517 R660507 R660551
<b>description</b>	hinge bearing mounting pos. lower without bolt		

**For models:** COE-061, COE-101, COG-061, COG-101, HCG-10-11, HCG-10-21, HCG-20-11, HCG-20-21, HCG-2-10-11, HCG-2-20-11, HCG-6-11, HME-10-11, HME-10-21, HME-20-11, HME-20-21, HME-2-10-11, HME-2-20-11, HME-6-11, HMG-10-11, HMG-10-11UL, HMG-10-21, HMG-10-21UL, HMG-20-11, HMG-2-10-11, HMG-6-11, HMI-10-11, HMI-10-11UL, HMI-10-21, HMI-10-21UL, HMI-2-10-11, HMI-6-11, HMI-6-11UL, HMM-10-11, HMM-10-11UL, HMM-10-21, HMM-10-21UL, HMM-20-11, HMM-20-11UL, HMM-20-21, HMM-20-21UL, HMM-2-10-11, HMM-2-20-11, HMM-40-11-USMC, HMM-6-11, HMM-6-11UL, HMP-10-11, HMP-10-21, HMP-20-11, HMP-20-21, HMP-2-10-11...(Other models you can see in the webshop)



<b>GEV No.</b>	691088	<b>Ref. No.</b>	12020438 R660517 R660550
<b>description</b>	hinge bearing mounting pos. upper right without bolt		

**For models:** HCG-10-11, HCG-10-21, HCG-20-11, HCG-2-10-11, HCG-6-11, HME-10-11, HME-10-21, HME-20-11, HME-20-21, HME-2-10-11, HME-6-11, HMG-10-11, HMG-10-11UL, HMG-10-21, HMG-10-21UL, HMG-20-11, HMG-2-10-11, HMG-6-11, HMI-10-11, HMI-10-11UL, HMI-10-21, HMI-10-21UL, HMI-2-10-11, HMI-6-11, HMI-6-11UL, HMM-10-11, HMM-10-11UL, HMM-10-21, HMM-10-21UL, HMM-20-11, HMM-20-11UL, HMM-20-21, HMM-2-10-11, HMM-6-11, HMM-6-11UL, HMP-10-11, HMP-10-21, HMP-20-11, HMP-20-21, HMP-2-10-11, HMP-6-11



<b>GEV No.</b>	701161	<b>Ref. No.</b>	12037017 6033010130
<b>description</b>	hinge camp mounting pos. bottom right L 100mm W 48mm H 17mm shaft diameter 8x8mm		
<b>For models:</b>	ADAEP-1602, ADAFN-1602, ADAFP-1602, ADMCN-135, ADMCN-180, ADMCN-225, ADMCP-135, ADMCP-180, ADMCP-225, AEP-1402, AEP-1602, AEP-1602AD, AEP-1603AD, AEP-1604AD, AEP-2103, AF-1402-MIX, AF-1403-C, AF-1403-P, AF-1404-C, AF-1404-P, AF-1602-MIX, AF-1603-C, AF-1603-P, AF-1604-C, AF-1604-P, AF-2104-C, AF-2104-P, AF-2105-C, AF-2105-P, AF-2106-C, AF-2106-P, AFN-1402, AFN-1403, AFN-1404, AFN-1602, AFN-1603, AFN-1604, AFP-1402, AFP-1403, AFP-1404, AFP-1602, AFP-1602-2, AFP-1603, AFP-1603-2, AFP-1604, AFP-2103, AFP-2104, AFP-2105, AFP-2106, ANF-1602AD...(Other models you can see in the webshop)		



<b>GEV No.</b>	701162	<b>Ref. No.</b>	12041472 6033010140
<b>description</b>	hinge camp mounting pos. upper right L 100mm W 48mm H 17mm shaft diameter M6mm		
<b>For models:</b>	ADAEP-1602, ADAFN-1602, ADAFP-1602, AEP-1402, AEP-1602, AEP-1602AD, AEP-1603AD, AEP-1604AD, AEP-2103, AF-1402-MIX, AF-1403-C, AF-1403-P, AF-1404-C, AF-1404-P, AF-1602-MIX, AF-1603-C, AF-1603-P, AF-1604-C, AF-1604-P, AF-2104-C, AF-2104-P, AF-2105-C, AF-2105-P, AF-2106-C, AF-2106-P, AFN-1402, AFN-1403, AFN-1404, AFN-1602, AFN-1603, AFN-1604, AFP-1402, AFP-1403, AFP-1404, AFP-1602, AFP-1602-2, AFP-1603, AFP-1603-2, AFP-1604, AFP-2103, AFP-2104, AFP-2105, AFP-2106, ANF-1602AD, ANF-1603AD, ANF-1604AD, APF-1602AD, APF-1603AD, APF-1604AD, CAEP-1402...(Other models you can see in the webshop)		

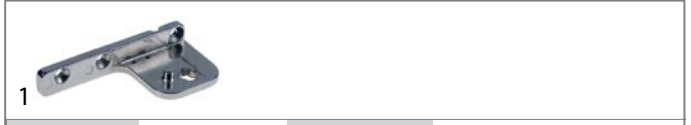



<b>GEV No.</b>	700854	<b>Ref. No.</b>	12036924 6033010084
<b>description</b>	hinge camp type TRB/L1 36mm mounting pos. bottom right L 100mm W 48mm H 17mm zinc die cast, chrome-plated hole distance 6.5x51x28mm shaft diameter torx 12x12mmmm		
<b>For models:</b>	ATM-051, ATM-101, ATM-102		



<b>GEV No.</b>	700855	<b>Ref. No.</b>	12036932 6033010083
<b>description</b>	hinge camp type TRB/R1 36mm mounting pos. bottom left L 100mm W 48mm H 17mm zinc die cast, chrome-plated hole distance 6.5x51x28mm shaft diameter torx 12x12mmmm		
<b>For models:</b>	AEP-1402, AEP-701, AF-1403-C, AF-1404-C, AF-702-C, AF-702-P, AFN-702, AFP-1402, AFP-1403, AFP-1404, AFP-701, AFP-702, AP-701, APP-701		



			
1			
<b>GEV No.</b>	691089	<b>Ref. No.</b>	12023636 R660534
<b>description</b>	hinge pin		
<b>For models:</b>	ACE-061, ACE-101, ACE-102, ACE-201, ACE-202, ACG-061, ACG-101, ACG-102, ACG-201, ACG-202, AE-061, AE-061W, AE-101, AE-101W, AE-102, AE-102W, AE-201, AE-202, AG-061, AG-061W, AG-101, AG-101W, AG-102, AG-102W, AG-201, AG-202, APE-061, APE-061W, APE-101, APE-101W, APE-102, APE-102W, APE-201, APE-202, APG-061, APG-061W, APG-101, APG-101W, APG-102, APG-102W, APG-201, APG-202, COE-061, COE-101, COE-102, COE-201, COE-202, COG-061, COG-101, COG-102...(Other models you can see in the webshop)		



			
2			
<b>GEV No.</b>	691093	<b>Ref. No.</b>	12018292 R660504
<b>description</b>	hinge pin		
<b>For models:</b>	HCG-10-11, HCG-10-21, HCG-20-11, HCG-2-10-11, HCG-6-11, HME-10-11, HME-10-21, HME-20-11, HME-20-21, HME-2-10-11, HME-6-11, HMG-10-11, HMG-10-11UL, HMG-10-21, HMG-10-21UL, HMG-20-11, HMG-2-10-11, HMG-6-11, HMI-10-11, HMI-10-11UL, HMI-10-21, HMI-10-21UL, HMI-2-10-11, HMI-6-11, HMI-6-11UL, HMM-10-11, HMM-10-11UL, HMM-10-21, HMM-10-21UL, HMM-20-11, HMM-20-11UL, HMM-20-21, HMM-2-10-11, HMM-6-11, HMM-6-11UL, HMP-10-11, HMP-10-21, HMP-20-11, HMP-20-21, HMP-2-10-11, HMP-6-11		

miscellaneous

			
1			
<b>GEV No.</b>	691870	<b>Ref. No.</b>	12036878 A169090001
<b>description</b>	hinge L 130mm W 60mm		
<b>For models:</b>	AEP-1602, AF-1403-C, AF-1403-P, AF-1404-C, AF-1404-P, AF-1604-C, AF-1604-P, AF-2104-C, AF-2104-P, AF-2105-C, AF-2105-P, AF-2106-C, AF-2106-P, AF-702-C, AF-702-P, AF-802-C, AF-802-P, AFN-1404, AFN-702, AFN-802, AFP-1404, AFP-1604, AFP-2104, AFP-2105, AFP-2106, AFP-702, AFP-802, AFP-802-2		

accessories

shafts

			
1			
<b>GEV No.</b>	700818	<b>Ref. No.</b>	12024071 Z400516
<b>description</b>	hinge bolt L 32mm stainless steel D1 ø 7.8mm D2 ø 12mm		
<b>For models:</b>	AD-15, AD-15D, AD-20C-UK, AD-21, AD-21B, AD-21BDD, AD-21C, AD-21D, AD-21DD, AD-21W, AD-45BBT, AD-48, AD-48B, AD-48BDD, AD-48C, AD-48D, AD-48DD, AD-48HY, AD-48W, AD-64, AD-64B, AD-64BBT, AD-64BDD, AD-64BTDD, AD-64C, AD-64CW, AD-64D, AD-64DD, AD-64HY, AD-72, AD-72W, EASY-500, EASY-500B, EASY-500DD, EASY-500HP, EASY-500HPWDD, FI-30, FI-30AR, FI-30AR+DD, FI-30B, FI-30B-BT-UK, FI-30-UK, FI-48, FI-48AR, FI-48B, FI-48B-BT-UK, FI-48C, FI-48D, FI-48HY-CLINIC, FI-48W...(Other models you can see in the webshop)		
<b>spare parts for</b>	700818		
			
<b>GEV No.</b>	505005	<b>Ref. No.</b>	12022324 Z400514
door hinge hinge left mounting pos. left			

			
1			
<b>GEV No.</b>	700817	<b>Ref. No.</b>	12038076 6033090064
<b>description</b>	hinge bolt upper ø 10mm L 30mm IT M6 for refrigerated counters mounting pos. upper		
<b>For models:</b>	AEP-1402, AEP-1602, AEP-2103, AEP-701, AEP-801, AEP-802, AF-1402-MIX, AF-1403-C, AF-1403-P, AF-1404-C, AF-1404-P, AF-1602-MIX, AF-1603-C, AF-1603-P, AF-1604-C, AF-1604-P, AF-2104-C, AF-2104-P, AF-2105-C, AF-2105-P, AF-2106-C, AF-2106-P, AF-702-C, AF-702-P, AF-802-C, AF-802-P, AFN-1402, AFN-1403, AFN-1404, AFN-1602, AFN-1603, AFN-1604, AFN-701, AFN-702, AFN-801, AFN-802, AFP-1402, AFP-1403, AFP-1404, AFP-1602, AFP-1602-2, AFP-1603, AFP-1603-2, AFP-1604, AFP-2103, AFP-2104, AFP-2105, AFP-2106, AFP-701, AFP-702...(Other models you can see in the webshop)		

mounting aids

			
1			
<b>GEV No.</b>	691701	<b>Ref. No.</b>	12002537 U746501
<b>description</b>	mounting aid for hinge		
<b>For models:</b>	CE7-41, CE9-41, CG-1002, CG-1502, CG-2002, CG-2002P, CG-210, CG-210G, CG-310, CG-310G, CG7-11, CG7-41, CG7-61, CG9-11, CG9-41, CG9-51L, CG9-51LC, CG9-51R, CG9-51RC, CG9-61, CG9-82, CGE7-41, CGE9-41, CGF9-121D, CGF9-121I, FTG9-11L, FTG9-11L+R, FTG9-11R, FTGC9-11L, FTGC9-11L+R, FTGC9-11R, HE9-10, HE9-20, HG9-10, HG9-20		

miscellaneous



1			
<b>GEV No.</b>	691092	<b>Ref. No.</b>	12024304 870005941 R660531 R660549
<b>description</b>	guide for hinge		
<b>For models:</b>	COE-061, COE-101, COE-102, COE-201, COE-202, COG-061, COG-101, COG-102, COG-201, COG-202, HCG-10-11, HCG-10-21, HCG-20-11, HCG-20-21, HCG-2-10-11, HCG-2-20-11, HCG-6-11, HEI-10-11, HEI-10-21, HEI-20-11, HEI-20-21, HEI-6-11, HEM-10-11, HEM-10-21, HEM-20-11, HEM-20-21, HEM-6-11, HEP-10-11, HEP-10-21, HEP-20-11, HEP-20-21, HEP-6-11, HGC-10-11, HGC-10-21, HGC-20-11, HGC-20-21, HGC-6-11, HGP-10-21, HGP-20-21, HGV-10-11, HGV-10-21, HGV-20-11, HGV-20-21, HME-10-11, HME-10-21, HME-20-11, HME-20-21, HME-2-10-11, HME-2-20-11, HME-6-11...(Other models you can see in the webshop)		



1			
<b>GEV No.</b>	693570	<b>Ref. No.</b>	12033778 RT29401302
<b>description</b>	sleeve latching		



1			
<b>GEV No.</b>	693571	<b>Ref. No.</b>	12033852 RT29401303
<b>description</b>	spigot latching		

pullouts

drawer slides



1			
<b>GEV No.</b>	696478	<b>Ref. No.</b>	12031241 6033050006
<b>description</b>	drawer slide L 550mm W 17mm H 60mm pair		
<b>For models:</b>	AFP-802, AFP-802-2, AFP-802-2C, AFP-802-3C, MFP-102-2C, MFP-102-4C, MFP-102-R2C-GN, MFP-102-R4C-GN, MFP-135-2C, MFP-135-2C-GN, MFP-135-4C, MFP-135-4C-GN, MFP-135-B, MFP-135-B2-GN, MFP-135-B-GN, MFP-147-2C, MFP-147-4C, MFP-147-6C, MFP-147-R2C-GN, MFP-147-R4C-GN, MFP-147-R6C-GN, MFP-180-2C, MFP-180-2C-GN, MFP-180-4C, MFP-180-4C-GN, MFP-180-6C, MFP-180-6C-GN, MFP-180-B, MFP-180-B2-GN, MFP-180-B-GN, MFP-192-2C, MFP-192-4C, MFP-192-6C, MFP-192-8C, MFP-192-R2C-GN, MFP-192-R4C-GN, MFP-192-R6C-GN, MFP-192-R8C-GN, MFP-225-2C, MFP-225-2C-GN, MFP-225-4C, MFP-225-4C-GN, MFP-225-6C, MFP-225-6C-GN, MFP-225-8C, MFP-225-8C-GN, MFP-225-B, MFP-225-B2-GN, MFP-225-B-GN, MFP-237-10C...(Other models you can see in the webshop)		

rollers

rollers



1			
<b>GEV No.</b>	501343	<b>Ref. No.</b>	12034280 12038133 GQ500214 SPQ510708P
<b>description</b>	roller rollerø 75mm B1 12mm overall width 25mm A 75mm B 12mm C 25mm plastic tread rubber		
<b>For models:</b>	SE-7		

accessories



1			
<b>GEV No.</b>	505252	<b>Ref. No.</b>	12037139 12038096 SPQ56461 SPQ56461P
<b>description</b>	shaft for roller		



## fittings for catering equipment

### outlet taps

#### producer-specific

#### FAGOR



1

<b>GEV No.</b>	514325	<b>Ref. No.</b>	12009231 X036107
<b>description</b>	ball valve connection 1" IT - 1" IT DN25 total length 83mm with lever handle		



1

<b>GEV No.</b>	541595	<b>Ref. No.</b>	12019141 X166134
<b>description</b>	drain pipe L 140mm thread 1" ET		
<b>For models:</b>	FE9-05, FE9-05S, FE9-05USMC, FE9-10, FG9-05, FG9-05S, FG9-10		

### aerators and air bleeders



1

<b>GEV No.</b>	540827	<b>Ref. No.</b>	12009434 S022103
<b>description</b>	aerator and air bleeder thread 3/4" ET chrome-plated L 45mm ø 36mm		
<b>For models:</b>	ME7-10BM, ME9-10BM, ME9-10BMS, ME9-10PLUS-BM, ME9-10PLUS-BMS, ME9-15BM, ME9-15BM316, ME9-15BM-AD, ME9-15BMS, ME9-15PLUS-BM, ME9-15PLUS-BMS, MG9-10BM, MG9-10BMAD, MG9-10BMS, MG9-10BMSAD, MG9-10PLUS-BM, MG9-10PLUS-BMS, MG9-15BM, MG9-15BM316, MG9-15BMAD, MG9-15BMS, MG9-15BMSAD, MG9-15PLUS-BM, MG9-15PLUS-BMS, MPE9-10BM, MPE9-10BMS, MPE9-15BM, MPE9-15BMS, MPG9-10BM, MPG9-10BMS, MPG9-15BM, MPG9-15BMS, MV9-10BM, MV9-15BM		



1

<b>GEV No.</b>	540825	<b>Ref. No.</b>	12038036 ICR14945
<b>description</b>	aerator and air bleeder thread 3/8" ET WS 24 chrome-plated L 37mm		

### lid hinges

#### type RUBINETTERIE DEL FRIULI

#### for circular lids

#### spare parts



1

<b>GEV No.</b>	540855	<b>Ref. No.</b>	12032821 ICR08052
<b>description</b>	torsion spring ø 50.8mm wire gauge ø 5.1mm L1 34mm L2 104mm L3 29mm mounting pos. left		



1

<b>GEV No.</b>	540854	<b>Ref. No.</b>	12032818 ICR08051
<b>description</b>	torsion spring ø 50.8mm wire gauge ø 5.1mm L1 34mm L2 104mm L3 29mm mounting pos. right		

#### FIREX

#### spare parts



1

<b>GEV No.</b>	540855	<b>Ref. No.</b>	12032821 ICR08052
<b>description</b>	torsion spring ø 50.8mm wire gauge ø 5.1mm L1 34mm L2 104mm L3 29mm mounting pos. left		



1

<b>GEV No.</b>	540854	<b>Ref. No.</b>	12032818 ICR08051
<b>description</b>	torsion spring ø 50.8mm wire gauge ø 5.1mm L1 34mm L2 104mm L3 29mm mounting pos. right		

#### ICOS



1

<b>GEV No.</b>	514129	<b>Ref. No.</b>	12029452 ICR16158
<b>description</b>	adjusting bush L 100mm ø 70/60mm		



<b>GEV No.</b>	540855	<b>Ref. No.</b>	12032821 ICR08052
<b>description</b>	torsion spring $\varnothing$ 50.8mm wire gauge $\varnothing$ 5.1mm L1 34mm L2 104mm L3 29mm mounting pos. left		



<b>GEV No.</b>	540854	<b>Ref. No.</b>	12032818 ICR08051
<b>description</b>	torsion spring $\varnothing$ 50.8mm wire gauge $\varnothing$ 5.1mm L1 34mm L2 104mm L3 29mm mounting pos. right		



<b>GEV No.</b>	514346	<b>Ref. No.</b>	12032819 ICR08008
<b>description</b>	torsion spring $\varnothing$ 51.5mm wire gauge $\varnothing$ 4.1mm L1 21mm L2 110mm L3 21mm mounting pos. left		

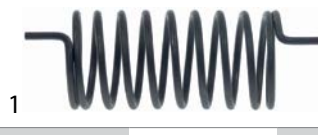

<b>GEV No.</b>	514339	<b>Ref. No.</b>	ICR08007
<b>description</b>	torsion spring $\varnothing$ 51.8mm wire gauge $\varnothing$ 4.1mm L1 20mm L2 106mm L3 20mm mounting pos. right		



<b>GEV No.</b>	514352	<b>Ref. No.</b>	12032815 12033015 ICR08093 ICRI08093
<b>description</b>	torsion spring $\varnothing$ 51mm wire gauge $\varnothing$ 6.5mm L1 28mm L2 101mm L3 28mm mounting pos. left		



<b>GEV No.</b>	514351	<b>Ref. No.</b>	12032816 12033014 ICR08083 ICRI08083
<b>description</b>	torsion spring $\varnothing$ 51mm wire gauge $\varnothing$ 6.5mm L1 28mm L2 101mm L3 28mm mounting pos. right		



<b>GEV No.</b>	514350	<b>Ref. No.</b>	12032817 ICR08055
<b>description</b>	torsion spring $\varnothing$ 51mm wire gauge $\varnothing$ 6mm L1 28mm L2 95mm L3 28mm mounting pos. left		



<b>GEV No.</b>	514349	<b>Ref. No.</b>	12032814 ICR08054
<b>description</b>	torsion spring $\varnothing$ 51mm wire gauge $\varnothing$ 6mm L1 28mm L2 95mm L3 28mm mounting pos. right		

miscellaneous

spare parts



<b>GEV No.</b>	514165	<b>Ref. No.</b>	12009142 S116120
<b>description</b>	adjusting bush for lid hinge		
<b>For models:</b>	ME9-10BM, ME9-10BMS, ME9-15BM, ME9-15BM316, ME9-15BMS, MG9-10, MG-9100, MG9-10BM, MG9-10BMS, MG9-10S, MG9-15, MG-9150, MG-9150BM, MG9-15BM, MG9-15BMS, MG9-15S, MG9-20, MG-9200, MG9-20S, MPE9-10BM, MPE9-10BMS, MPE9-15BM, MPE9-15BMS, MPG9-10, MPG9-10BM, MPG9-10BMS, MPG9-10S, MPG9-15, MPG-9150, MPG9-15BM, MPG9-15BMS, MPG9-15S, MPG9-20, MPG-9200, MPG9-20S, MV9-10BM, MV9-15BM, SBE7-10, SBE9-10, SBE9-10I, SBE9-10IM, SBE9-10IMS, SBE9-10IS, SBE9-10M, SBE9-10MS, SBE9-10S, SBE9-10USMC, SBE9-15IM, SBE9-15IMS, SBE9-15M...(Other models you can see in the webshop)		



1

<b>GEV No.</b>	691727	<b>Ref. No.</b>	12009136 S116118
<b>description</b>	bearing brass H 15mm ID ø 22mm ø 49mm		
<b>For models:</b>	ME9-10BM, ME9-10BMS, ME9-15BM, ME9-15BM316, ME9-15BMS, MG9-10, MG-9100, MG9-10BM, MG9-10BMS, MG9-10S, MG9-15, MG-9150, MG-9150BM, MG9-15BM, MG9-15BM316, MG9-15BMS, MG9-15S, MG9-20, MG-9200, MG9-20S, MPE9-10BM, MPE9-10BMS, MPE9-15BM, MPE9-15BMS, MPG9-10, MPG9-10BM, MPG9-10BMS, MPG9-10S, MPG9-15, MPG-9150, MPG9-15BM, MPG9-15BMS, MPG9-15S, MPG9-20, MPG-9200, MPG9-20S, MV9-10BM, MV9-15BM, SBE7-10, SBE9-10, SBE9-10I, SBE9-10IM, SBE9-10IMS, SBE9-10IS, SBE9-10M, SBE9-10MS, SBE9-10S, SBE9-10USMC, SBE9-15IM, SBE9-15IMS...(Other models you can see in the webshop)		



1

<b>GEV No.</b>	514167	<b>Ref. No.</b>	12008056 S116126
<b>description</b>	bush for lid hinge ID ø 15mm ED ø 20mm H 10mm		
<b>For models:</b>	ME9-10BM, ME9-10BMS, ME9-15BM, ME9-15BM316, ME9-15BMS, MG9-10, MG-9100, MG9-10BM, MG9-10BMS, MG9-10S, MG9-15, MG-9150, MG-9150BM, MG9-15BM, MG9-15BM316, MG9-15BMS, MG9-15S, MG9-20, MG-9200, MG9-20S, MPE9-10BM, MPE9-10BMS, MPE9-15BM, MPE9-15BMS, MPG9-10, MPG9-10BM, MPG9-10BMS, MPG9-10S, MPG9-15, MPG-9150, MPG9-15BM, MPG9-15BMS, MPG9-15S, MPG9-20, MPG-9200, MPG9-20S, MV9-10BM, MV9-15BM, SBE7-10, SBE9-10, SBE9-10I, SBE9-10I-AD, SBE9-10I-AD-S, SBE9-10IM, SBE9-10IMS, SBE9-10IS, SBE9-10M, SBE9-10MS, SBE9-10PLUS-I, SBE9-10PLUS-SI...(Other models you can see in the webshop)		



2

<b>GEV No.</b>	514166	<b>Ref. No.</b>	12008144 S116119
<b>description</b>	bearing for lid hinge		
<b>For models:</b>	ME9-10BM, ME9-10BMS, ME9-15BM, ME9-15BM316, ME9-15BMS, MG9-10, MG-9100, MG9-10BM, MG9-10BMS, MG9-10S, MG9-15, MG-9150, MG-9150BM, MG9-15BM, MG9-15BMS, MG9-15S, MG9-20, MG-9200, MG9-20S, MPE9-10BM, MPE9-10BMS, MPE9-15BM, MPE9-15BMS, MPG9-10, MPG9-10BM, MPG9-10BMS, MPG9-10S, MPG9-15, MPG-9150, MPG9-15BM, MPG9-15BMS, MPG9-15S, MPG9-20, MPG-9200, MPG9-20S, MV9-10BM, MV9-15BM, SBE7-10, SBE9-10, SBE9-10I, SBE9-10IM, SBE9-10IMS, SBE9-10IS, SBE9-10M, SBE9-10MS, SBE9-10S, SBE9-10USMC, SBE9-15IM, SBE9-15IMS, SBE9-15M...(Other models you can see in the webshop)		



1

<b>GEV No.</b>	514162	<b>Ref. No.</b>	12009452 12040017 S036130 S036143
<b>description</b>	lid hinge body		
<b>For models:</b>	ME9-10BM, ME9-10BMS, ME9-15BM, ME9-15BM316, ME9-15BMS, MG9-10, MG9-10BM, MG9-10BMS, MG9-10S, MG9-15, MG9-15BM, MG9-15BMS, MG9-15S, MG9-20, MG9-20S, MPE9-10BM, MPE9-10BMS, MPE9-15BM, MPE9-15BMS, MPG9-10, MPG9-10BM, MPG9-10BMS, MPG9-10S, MPG9-15, MPG9-15BM, MPG9-15BMS, MPG9-15S, MPG9-20, MPG9-20S, MV9-10BM, MV9-15BM		



1

<b>GEV No.</b>	514169	<b>Ref. No.</b>	12038909 12039166 X286102
<b>description</b>	bracket for lid hinge		
<b>For models:</b>	SBE7-10, SBE9-10, SBE9-10I, SBE9-10IM, SBE9-10IMS, SBE9-10IS, SBE9-10M, SBE9-10MS, SBE9-10S, SBE9-10USMC, SBE9-15IM, SBE9-15IMS, SBE9-15M, SBE9-15MS, SBG7-10, SBG9-10, SBG9-10I, SBG9-10IM, SBG9-10IMS, SBG9-10IS, SBG9-10M, SBG9-10MS, SBG9-10S, SBG9-15IM, SBG9-15IMS		



1

<b>GEV No.</b>	514164	<b>Ref. No.</b>	12009439 X156101
<b>description</b>	lid hinge body		
<b>For models:</b>	SBE7-10, SBE9-10, SBE9-10I, SBE9-10IM, SBE9-10IMS, SBE9-10IS, SBE9-10M, SBE9-10MS, SBE9-10S, SBE9-10USMC, SBE9-15IM, SBE9-15IMS, SBE9-15M, SBE9-15MS, SBG7-10, SBG9-10, SBG9-10I, SBG9-10IM, SBG9-10IMS, SBG9-10IS, SBG9-10M, SBG9-10MS, SBG9-10S, SBG9-15IM, SBG9-15IMS		

			
<b>1</b>			
<b>GEV No.</b>	691016	<b>Ref. No.</b>	12009030 S116121
<b>description</b>	torsion spring ø 44mm L 124mm wire gauge ø 5.6mm		
<b>For models:</b>	ME9-10BM, ME9-10BMS, ME9-15BM, ME9-15BM316, ME9-15BMS, MG9-10, MG-9100, MG9-10BM, MG9-10BMS, MG9-10S, MG9-15, MG-9150, MG-9150BM, MG9-15BM, MG9-15BMS, MG9-15S, MG9-20, MG-9200, MG9-20S, MPE9-10BM, MPE9-10BMS, MPE9-15BM, MPE9-15BMS, MPG9-10, MPG9-10BM, MPG9-10BMS, MPG9-10S, MPG9-15, MPG-9150, MPG9-15BM, MPG9-15BMS, MPG9-15S, MPG9-20, MPG-9200, MPG9-20S, MV9-10BM, MV9-15BM, SBE7-10, SBE9-10, SBE9-10I, SBE9-10IM, SBE9-10IMS, SBE9-10IS, SBE9-10M, SBE9-10MS, SBE9-10S, SBE9-10USMC, SBE9-15IM, SBE9-15IMS, SBE9-15M...(Other models you can see in the webshop)		

## lid catches

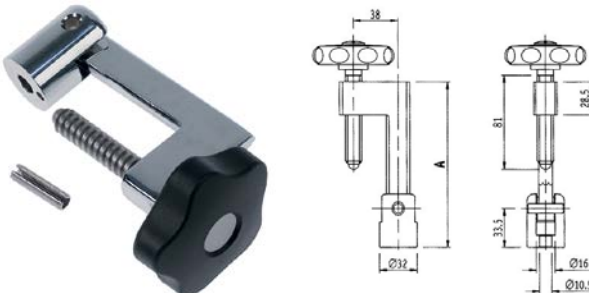
			
<b>1</b>			
<b>GEV No.</b>	514127	<b>Ref. No.</b>	12038051 ICR10030
<b>description</b>	lid lock handle ø 70mm L 143mm		

## drain taps



### brass





### drain taps

			
<b>1</b>			
<b>GEV No.</b>	540132	<b>Ref. No.</b>	12016791 S312100
<b>description</b>	drain tap 1 1/2" IT conical seal kettle A 90mm B 137mm B1 70mm chrome-plated brass		
<b>For models:</b>	ME7-10BM, MG7-10, MG7-10BM		
<b>spare parts for</b>	540132		
	<b>GEV No.</b>	540213	<b>Ref. No.</b> —
	handle ID ø 5mm L 117mm		
	<b>GEV No.</b>	540461	<b>Ref. No.</b> —
	shim for drain tap		
	<b>GEV No.</b>	540464	<b>Ref. No.</b> —
	nut for drain tap thread 1 1/2"		

<b>accessories for</b>	540132		
	<b>GEV No.</b>	510404	<b>Ref. No.</b> —
	flat gasket fibre ED ø 44mm ID ø 34mm thickness 2mm Qty 1 pcs		

			
<b>1</b>			
<b>GEV No.</b>	541673	<b>Ref. No.</b>	12008890 12016692 S312112 S532106
<b>description</b>	drain tap 1 1/2" IT with union nut conical seal		
<b>For models:</b>	ME7-10BM, MG7-10, MG7-10BM, MV7-10BM		
<b>spare parts for</b>	541673		



	<b>GEV No.</b>	540213	<b>Ref. No.</b> —
	handle ID ø 5mm L 117mm		
	<b>GEV No.</b>	540956	<b>Ref. No.</b> —
	gasket for drain tap hose ext. ø 46mm ID ø 38mm H 2mm		

<b>accessories for</b>	541673		
	<b>GEV No.</b>	510404	<b>Ref. No.</b> —
	flat gasket fibre ED ø 44mm ID ø 34mm thickness 2mm Qty 1 pcs		
	<b>GEV No.</b>	890116	<b>Ref. No.</b> —
	fitting grease FERMIT GLISSA tube 60g -20 up to +140°C approval complies with KTW recommendation		
	<b>GEV No.</b>	890118	<b>Ref. No.</b> —
	fitting grease FERMIT GLISSA can 1000g -20 up to +140°C approval complies with KTW recommendation		
	<b>GEV No.</b>	890119	<b>Ref. No.</b> —
	fitting grease FERMIT GLISSA tube 30g -20 up to +140°C approval complies with KTW recommendation		

			
<b>1</b>			
<b>GEV No.</b>	540275	<b>Ref. No.</b>	12026376 ICR10027
<b>description</b>	drain tap 2" IT with union nut A 90mm B 151mm B1 80mm chrome-plated brass		
<b>spare parts for</b>	540275		
	<b>GEV No.</b>	540214	<b>Ref. No.</b> —
	handle ID ø 6mm L 145mm		

Table continues overleaf



<b>accessories for</b> 540275			
	GEV No.	529484	Ref. No. —
flat gasket fibre ED ø 58mm ID ø 50mm thickness 2mm Qty 1 pcs			
	GEV No.	542448	Ref. No. —
gasket silicone 60x49x2 for drain tap 2"			

			
1			
<b>GEV No.</b>	540267	<b>Ref. No.</b>	12016604 12016772 S042107 S112150
<b>description</b>	drain tap connection with union nut thread 2"		
<b>For models:</b>	ME9-10BM, ME9-10BMS, ME9-15BM, ME9-15BM316, ME9-15BMS, MG9-10, MG9-10BM, MG9-10BMS, MG9-10S, MG9-15, MG9-15BM, MG9-15BM316, MG9-15BMS, MG9-15S, MG9-20, MG9-20S, MPE9-10BM, MPE9-10BMS, MPE9-15BM, MPE9-15BMS, MPG9-10, MPG9-10BM, MPG9-10BMS, MPG9-10S, MPG9-15, MPG9-15BM, MPG9-15BMS, MPG9-15S, MPG9-20, MPG9-20S		
<b>spare parts for</b>	540267		
	GEV No.	505517	Ref. No. —
O-ring EPDM thickness 5.34mm ID ø 53.34mm Qty 1 pcs			
	GEV No.	540214	Ref. No. —
handle ID ø 6mm L 145mm			





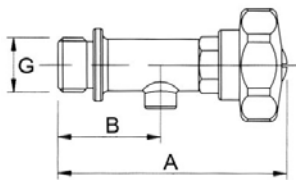

## test taps

### test taps



			
1			
			
<b>GEV No.</b>	540818	<b>Ref. No.</b>	12009417 12030706 12038031 FX30200050 ICR10044 S102124
<b>description</b>	test tap thread 1/2" ET W 88mm W1 38mm		
<b>For models:</b>	ME7-10BM, ME9-10BM, ME9-10BMS, ME9-15BM, ME9-15BM316, ME9-15BMS, MG7-10BM, MG9-10BM, MG9-10BMS, MG9-15BM, MG9-15BM316, MG9-15BMS, MPE9-10BM, MPE9-10BMS, MPE9-15BM, MPE9-15BMS, MPG9-10BM, MPG9-10BMS, MPG9-15BM, MPG9-15BMS		

## safety fittings



### safety fittings

			
1			
<b>GEV No.</b>	514276	<b>Ref. No.</b>	12038064 ICR11032
<b>description</b>	safety fitting thread 3/4" 0.45bar H 165mm ø 65mm		
<b>spare parts for</b>	514276		
	GEV No.	514094	Ref. No. —
angle piece thread 3/8"			
	GEV No.	514276	Ref. No. 12038064 ICR11032
safety fitting thread 3/4" 0.45bar H 165mm ø 65mm			
	GEV No.	540825	Ref. No. 12038036 ICR14945
aerator and air bleeder thread 3/8" ET WS 24 chrome-plated L 37mm			
	GEV No.	540828	Ref. No. 12009418 12030738 ICR10023 S022102
manometer siphon thread 3/8"			
	GEV No.	541579	Ref. No. 12038013 ICR10022
manometer ø 52mm pressure range 0 up to 1bar connection marking 0.5 thread 1/4"			

## accessories

			
1			
<b>GEV No.</b>	540817	<b>Ref. No.</b>	12028301 ICR10014
<b>description</b>	fitting support thread 1/2" ET suitable for manometer		
			
1			
<b>GEV No.</b>	540832	<b>Ref. No.</b>	12009386 S332100
<b>description</b>	fitting support thread 1/2" ET suitable for manometer		
<b>For models:</b>	ME7-10BM		
<b>accessories for</b>	540832		
	GEV No.	510166	Ref. No. 12019584 Q306049
flat gasket fibre ED ø 31.3mm ID ø 26.3mm thickness 1.2mm Qty 1 pcs			

			
1			
<b>GEV No.</b>	540822	<b>Ref. No.</b>	12009448 S022100
<b>description</b>	fitting support thread 3/4"		
<b>For models:</b>	ME9-10BM, ME9-10BMS, ME9-10PLUS-BM, ME9-10PLUS-BMS, ME9-15BM, ME9-15BM316, ME9-15BM-AD, ME9-15BMS, ME9-15PLUS-BM, ME9-15PLUS-BMS, MG9-10BM, MG9-10BMAD, MG9-10BMS, MG9-10BMSAD, MG9-10PLUS-BM, MG9-10PLUS-BMS, MG9-15BM, MG9-15BM316, MG9-15BMAD, MG9-15BMS, MG9-15BMSAD, MG9-15PLUS-BM, MG9-15PLUS-BMS, MPE9-10BM, MPE9-10BMS, MPE9-15BM, MPE9-15BMS, MPG9-10BM, MPG9-10BMS, MPG9-15BM, MPG9-15BMS, MV9-10BM, MV9-15BM		

			
1			
<b>GEV No.</b>	540835	<b>Ref. No.</b>	ICR10013
<b>description</b>	screw cap thread 3/4"		
<b>spare parts for</b>	540835		
	<b>GEV No.</b>	513016	<b>Ref. No.</b> —
	O-ring EPDM thickness 3.53mm ID ø 26.58mm Qty 1 pcs		
<b>accessories for</b>	540835		
	<b>GEV No.</b>	513016	<b>Ref. No.</b> —
	O-ring EPDM thickness 3.53mm ID ø 26.58mm Qty 1 pcs		

			
1			
<b>GEV No.</b>	540828	<b>Ref. No.</b>	12009418 12030738 ICR10023 S022102
<b>description</b>	manometer siphon thread 3/8"		
<b>For models:</b>	ME9-10BM, ME9-10BMS, ME9-10PLUS-BM, ME9-10PLUS-BMS, ME9-15BM, ME9-15BM316, ME9-15BM-AD, ME9-15BMS, ME9-15PLUS-BM, ME9-15PLUS-BMS, MG9-10BM, MG9-10BMAD, MG9-10BMS, MG9-10BMSAD, MG9-10PLUS-BM, MG9-10PLUS-BMS, MG9-15BM, MG9-15BM316, MG9-15BMAD, MG9-15BMS, MG9-15BMSAD, MG9-15PLUS-BM, MG9-15PLUS-BMS, MPE9-10BM, MPE9-10BMS, MPE9-15BM, MPE9-15BMS, MPG9-10BM, MPG9-10BMS, MPG9-15BM, MPG9-15BMS, MV9-10BM, MV9-15BM		

safety valves

			
1			
<b>GEV No.</b>	540722	<b>Ref. No.</b>	12040552 ICR10004
<b>description</b>	safety valve with outlet for lid		

equipment feet and end caps

equipment feet

with screw mounting

universal

			
1			
<b>GEV No.</b>	700810	<b>Ref. No.</b>	12036002 6007050015
<b>description</b>	equipment foot tube ø 50mm thread M10 thread L 14mm H 110-140mm SS size 2" Qty 1 pcs		
<b>For models:</b>	BFP-150, BFP-200, BFP-250, BFP-300, FMP-117-R, FMP-150, FMP-169-R, FMP-202, FMP-222-R, FMP-255, FMP-274-R, FMP-307, MCN-102-R, MCN-135, MCN-147-R, MCN-180, MCN-192-R, MCN-225, MCN-237-R, MCN-270, MCP-135, MCP-180, MCP-225, MEP-100, MEP-100G, MEP-135, MEP-180, MFN-102-R, MFN-135, MFN-147-R, MFN-180, MFN-192-R, MFN-225, MFN-237-R, MFN-270, MFP-102-2C, MFP-102-4C, MFP-135, MFP-135-2C, MFP-135-4C, MFP-135-F, MFP-147-2C, MFP-147-4C, MFP-147-6C, MFP-180, MFP-180-2C, MFP-180-4C, MFP-180-6C, MFP-180-F, MFP-192-2C...(Other models you can see in the webshop)		







with fixing plate			
			
<b>GEV No.</b>	701100	<b>Ref. No.</b>	12009104 12033566 6007050017 X260151
<b>description</b>	equipment foot tube ø 64mm plate size 82x82mm hole distance 65x65mm H 135-200mm SS size 2 1/2" Qty 1 pcs		
<b>For models:</b>	AC-120, AC-180, ACE-061, ACE-101, ACE-102, ACG-061, ACG-101, ACG-102, AD-120, AD-120B, AD-120BBTDD-UK, AD-120C, AD-120CW, AD-120HY, AD-125, AD-125HRS, AD-125-SOFT, AD-72, AD-72W, AD-90, AD-90BA, AD-90BBT, AD-90BDD, AD-90DD, ADAEP-1602, ADAEP-801, ADAFN-1602, ADAFN-801, ADAFP-1602, ADAFP-801, ADE-120, ADE-120B, ADMCN-135, ADMCN-180, ADMCN-225, ADMCP-135, ADMCP-180, ADMCP-225, ADMFN-135, ADMFN-180, ADMFN-225, ADMFP-135, ADMFP-135-GR, ADMFP-135HD, ADMFP-135HH, ADMFP-135PC, ADMFP-180, ADMFP-180-GR, ADMFP-180HDD, ADMFP-180HHD...(Other models you can see in the webshop)		

screw-in feet			
			
<b>GEV No.</b>	510115	<b>Ref. No.</b>	12024163 6003010275 Z200107
<b>description</b>	equipment foot thread M10 thread L 40mm ø 30mm H 10mm Qty 1 pcs		
<b>For models:</b>	AD-15, AD-15D, AD-20C-UK, AD-21, AD-21B, AD-21BDD, AD-21C, AD-21D, AD-21DD, AD-21W, AD-45BBT, AD-48, AD-48B, AD-48BDD, AD-48C, AD-48D, AD-48DD, AD-48HY, AD-48W, AD-505, AD-505-SOFT, AD-64, AD-64B, AD-64BBT, AD-64BDD, AD-64BTDD, AD-64C, AD-64CW, AD-64D, AD-64DD, AD-64HY, BG6-05I, BG7-05, BG7-05I, BG7-10, BG7-10I, BG9-05, BG9-05AD, BG9-05I, BG9-05PF, BG9-05PI, BG9-05PLUS-I, BG9-10, BG9-10AD, BG9-10I, BG9-10PF, BG9-10PI, BG9-10PLUS-I, BME6-05, BME7-05...(Other models you can see in the webshop)		

bullet feet			
plastic/SS			
			
<b>GEV No.</b>	700110	<b>Ref. No.</b>	12024301 R675610
<b>description</b>	equipment foot pipe type 40x40 thickness 1-1.2mm H 23-60mm plastic/SS Qty 1 pcs		
<b>For models:</b>	ECO-120, ECO-120B, ECO-160, ECO-1600, ECO-160D, ECO-160I, ECO-200, ECO-200D, ECO-200H, ECO-200HD, ECO-200HI, ECO-200I, ECO-2300, ECO-280D, ECO-280I, ECO-3000, ECO-370D, ECO-370I, ECO-460D, ECO-460I, ECO-550D, ECO-550I, FI-100, FI-100AR, FI-100B, FI-120, FI-120B, FI-120W, FI-160, FI-1600, FI-160D, FI-160I, FI-200, FI-200D, FI-200H, FI-200HD, FI-200HI, FI-200I, FI-200W, FI-2300, FI-280D, FI-280I, FI-3000, FI-370D, FI-370I, FI-460D, FI-460I, FI-550D, FI-550I, FI-80...(Other models you can see in the webshop)		

end caps and plugs			
for circular pipes			
			
<b>GEV No.</b>	698846	<b>Ref. No.</b>	12037989 6003010262
<b>description</b>	plug ø 20.5mm H 23.5mm Qty 1 pcs		
<b>For models:</b>	ADMFCN-135, ADMFCN-180, ADMFCN-225, ADMCP-135, ADMCP-180, ADMCP-225, ADMFN-135, ADMFN-180, ADMFN-225, ADMFP-135, ADMFP-135-GR, ADMFP-135HD, ADMFP-135HH, ADMFP-135PC, ADMFP-180, ADMFP-180-GR, ADMFP-180HDD, ADMFP-180HHD, ADMFP-180HHH, ADMFP-180PC, ADMFP-225, ADMFP-225-GR, ADMFP-225HDD, ADMFP-225HDD, ADMFP-225HHD, ADMFP-225HH-HH, ADMFP-225PC, ATM-051, ATM-051VCH, ATM-051VCH-60Hz, ATM-081VCH, ATM-081VCH-60Hz, ATM-101, ATM-102, BFP-100, BFP-100A, BFP-100I, BFP-150, BFP-150A, BFP-150I, BFP-200, BFP-200A, BFP-200I, BFP-250, BFP-250A, BFP-250I, BFP-300, BFP-300I, CFMP-117-R, CFMP-117-RPC...(Other models you can see in the webshop)		

zamak/SS			
			
<b>GEV No.</b>	700112	<b>Ref. No.</b>	12029781 RT20390111
<b>description</b>	equipment foot pipe type 40x40 thickness 1mm H 33-60mm Zamak/SS Qty 1 pcs		

DERBY RUOTE			
with bolt hole			
stainless steel			
			
<b>GEV No.</b>	700222	<b>Ref. No.</b>	12031557 RT20050500
<b>description</b>	swivel castor ø 125mm bolt hole bolt hole ø 12mm housing SS capacity 100kg bearing ball bearing wheel body polypropylene tread TPE tyres H 159mm wheel width 30mm Qty 1 pcs		

			
1			
<b>GEV No.</b>	700223 <sup>1</sup>	<b>Ref. No.</b>	12030113 RT20050602
<b>description</b>	swivel castor with swivel brake ø 125mm bolt hole bolt hole ø 12mm housing SS capacity 100kg bearing ball bearing wheel body polypropylene tread TPE tyres H 159mm wheel width 30mm Qty 1 pcs		

<sup>1</sup>with swivel brake**BLICKLE**

plastic

ø125mm

			
1			
<b>GEV No.</b>	701029	<b>Ref. No.</b>	12028289 RT6060100
<b>description</b>	swivel castor with brake ø 125mm threaded shaft M10 housing plastic H 128mm		

			
1			
<b>GEV No.</b>	700988	<b>Ref. No.</b>	12028422 RT6060101
<b>description</b>	swivel castor without brake ø 125mm threaded shaft M10 housing plastic H 127mm		

**bumper angles**

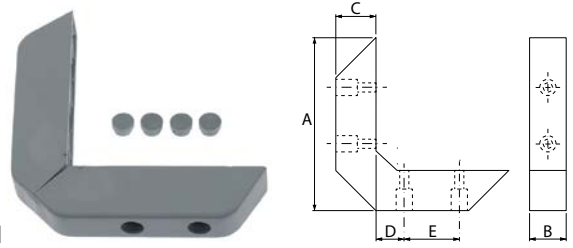
			
1			
<b>GEV No.</b>	691926	<b>Ref. No.</b>	12044928 6003010002
<b>description</b>	bumper angle outer length 152mm inner length 118mm W 35mm H 28mm mounting distance 40mm hole distance 40mm hole ø 7mm plastic grey		

**baskets****fryer baskets****FAGOR**

			
1			
<b>GEV No.</b>	691023	<b>Ref. No.</b>	12017424 X316503
<b>description</b>	fryer basket L1 250mm W1 280mm H1 120mm		
<b>For models:</b>	FE-710, FE-720, FG-710, FG-720		

			
1			
<b>GEV No.</b>	970111	<b>Ref. No.</b>	12008702 X316531
<b>description</b>	fryer basket L1 250mm W1 280mm H1 120mm stainless steel		
<b>For models:</b>	FE7-05-1C, FE7-10-2C, FG7-05-1C, FG7-10-2C		

			
1			
<b>GEV No.</b>	970631	<b>Ref. No.</b>	12009361 12017681 X316530 X316532
<b>description</b>	fryer basket L1 255mm W1 135mm H1 120mm L2 230mm H2 185mm H3 225mm chrome-plated steel		
<b>For models:</b>	FE7-05-2C, FE-710, FE7-10-4C, FE-720, FG7-05-2C, FG-710, FG7-104C, FG7-10-4C, FG-720		

			
1			
<b>GEV No.</b>	970251	<b>Ref. No.</b>	12009390 X376503
<b>description</b>	fryer basket L1 255mm W1 285mm H1 100mm		
<b>For models:</b>	FE-8		

1

<b>GEV No.</b>	970359	<b>Ref. No.</b>	FAG6000002
<b>description</b>	fryer basket L1 310mm W1 130mm H1 120mm chrome-plated steel		
<b>accessories for</b>	970359		
	<b>GEV No.</b>	970632	<b>Ref. No.</b> FAG6000013
	crumb screen L 338mm W 134mm H 100mm		



1

<b>GEV No.</b>	970652	<b>Ref. No.</b>	12017089 X066595
<b>description</b>	fryer basket L1 315mm W1 335mm H1 135mm		
<b>For models:</b>	FE9-05, FE9-05S, FE9-10, FE-920, FG9-05, FG9-05S, FG9-10, FG-920, FG-940		



1

<b>GEV No.</b>	970486	<b>Ref. No.</b>	12009368 X166525
<b>description</b>	fryer basket L1 310mm W1 160mm H1 130mm L2 550mm H2 180mm stainless steel		
<b>For models:</b>	FE9-05, FE9-05-2C, FE9-05AD, FE9-05PLUS, FE9-05PLUS-S, FE9-05S, FE9-05S-2C, FE9-05S-AD, FE9-05USMC, FE9-10, FE9-10-4C, FE9-10AD, FE9-10PLUS, FG9-05, FG9-05-2C, FG9-05AD, FG9-05PLUS, FG9-05PLUS-S, FG9-05S, FG9-05S-2C, FG9-05S-AD, FG9-10, FG9-10-4C, FG9-10AD, FG9-10PLUS, FGCL9-05, FGCL9-05-2C, FGCL9-05S-2C		



1

<b>GEV No.</b>	691009	<b>Ref. No.</b>	X066596
<b>description</b>	fryer basket L1 330mm W1 315mm H1 135mm chrome-plated iron		



1

<b>GEV No.</b>	970487	<b>Ref. No.</b>	12009408 X166526
<b>description</b>	fryer basket L1 310mm W1 330mm H1 130mm stainless steel		
<b>For models:</b>	FE9-05, FE9-05-1C, FE9-05-2C, FE9-05S, FE9-05S-1C, FE9-10, FE9-10-2C, FE9-10-4C, FG9-05, FG9-05-1C, FG9-05S, FG9-05S-1C, FG9-10, FG9-10-2C, FGCL9-05-1C, FGCL9-05S-1C		



1

<b>GEV No.</b>	505130	<b>Ref. No.</b>	12017414 X356502
<b>description</b>	fryer basket W1 130mm L1 250mm H1 105mm stainless steel		
<b>For models:</b>	FE-4, FE-8		



1

<b>GEV No.</b>	691020	<b>Ref. No.</b>	X066590
<b>description</b>	fryer basket L1 315mm W1 160mm H1 130mm		



1





<b>GEV No.</b>	505297	<b>Ref. No.</b>	12009365 X356506
<b>description</b>	fryer basket W1 130mm L1 255mm H1 105mm L2 460mm H2 180mm H3 190mm		
<b>For models:</b>	FE-4, FE-8		

			
1			
<b>GEV No.</b>	505131	<b>Ref. No.</b>	12009483 12017105 X399901 X399902
<b>description</b>	fryer basket W1 150mm L1 325mm H1 120mm		
<b>For models:</b>	FE-25		

			
1			
<b>GEV No.</b>	691065	<b>Ref. No.</b>	12009392 12017245 X366502
<b>description</b>	fryer basket W1 220mm L1 250mm H1 100mm stainless steel		
<b>For models:</b>	FE-6		

			
1			
<b>GEV No.</b>	505129	<b>Ref. No.</b>	12017031 X386501
<b>description</b>	fryer basket W1 233mm L1 265mm H1 120mm		
<b>For models:</b>	FE-18		

			
1			
<b>GEV No.</b>	505270	<b>Ref. No.</b>	12009460
<b>description</b>	fryer basket W1 235mm L1 265mm H1 130mm H3 255mm		
<b>For models:</b>	FE-18		

				
1				
<b>GEV No.</b>	691066	<b>Ref. No.</b>	12017178 X376502	
<b>description</b>	fryer basket W1 280mm L1 250mm H1 100mm			
<b>For models:</b>	FE-8			
<b>accessories for</b>	691066			
	<b>GEV No.</b>	560141	<b>Ref. No.</b>	—
	hexagonal nut thread M5 H 5.4mm SS WS 8 Qty 20 pcs DIN/ISO DIN 985 self-locking			
	<b>GEV No.</b>	560271	<b>Ref. No.</b>	—
	raised countersunk head screw thread M5 thread L 14mm SS DIN 966/ISO 7047 Qty 20 pcs intake Phillips sunk head			
	<b>GEV No.</b>	691001	<b>Ref. No.</b>	12021230 9616402
	handle for fryer basket upper			
	<b>GEV No.</b>	691002	<b>Ref. No.</b>	12021134 9616401
	handle for fryer basket lower			

			
1			
<b>GEV No.</b>	691006	<b>Ref. No.</b>	12009617 12017023 X396501 X396503
<b>description</b>	fryer basket W1 330mm L1 320mm H1 125mm stainless steel		
<b>For models:</b>	FE-25		

			
1			
<b>GEV No.</b>	970649	<b>Ref. No.</b>	12009174 X166527
<b>description</b>	basket support for fryer basket		
<b>For models:</b>	FE9-05, FE9-05-1C, FE9-05-2C, FE9-05AD, FE9-05PLUS, FE9-05PLUS-S, FE9-05S, FE9-05S-1C, FE9-05S-2C, FE9-05S-AD, FE9-10, FE9-10-2C, FE9-10-4C, FE9-10AD, FE9-10PLUS, FG9-05, FG9-05-1C, FG9-05-2C, FG9-05AD, FG9-05PLUS, FG9-05PLUS-S, FG9-05S, FG9-05S-1C, FG9-05S-2C, FG9-05S-AD, FG9-10, FG9-10-2C, FG9-10-4C, FG9-10AD, FG9-10PLUS		

			
1			
<b>GEV No.</b>	970634	<b>Ref. No.</b>	12009173 X316501
<b>description</b>	basket support for fryer basket L 300mm H 90mm		
<b>For models:</b>	FE-710, FE-720, FG-710, FG-720		



1 			
<b>GEV No.</b>	691002	<b>Ref. No.</b>	12021134 9616401
<b>description</b>	handle for fryer basket lower		
<b>For models:</b>	FE-18, FE-25, FE-4, FE-6, FE-710, FE-720, FE-8, FE9-05, FE9-05S, FE9-10, FE-920, FG-1-40, FG-2-80, FG-710, FG-720, FG9-05, FG9-05S, FG9-10, FG-920, FG-940		

1 			
<b>GEV No.</b>	691001	<b>Ref. No.</b>	12021230 9616402
<b>description</b>	handle for fryer basket upper		
<b>For models:</b>	FE-18, FE-25, FE-4, FE-6, FE-710, FE-720, FE-8, FE9-05, FE9-05S, FE9-10, FE-920, FG-1-40, FG-2-80, FG-710, FG-720, FG9-05, FG9-05S, FG9-10, FG-920, FG-940		

## pasta baskets

### FAGOR

1 			
<b>GEV No.</b>	970645	<b>Ref. No.</b>	12008637 H506500
<b>description</b>	pasta basket L1 160mm W1 290mm H1 210mm stainless steel		
<b>For models:</b>	CPE9-05, CPE9-05AD, CPE9-05AD-S, CPE9-05NC, CPE9-05PLUS, CPE9-05PLUS-S, CPE9-05S, CPG9-05, CPG9-05AD, CPG9-05AD-S, CPG9-05NC, CPG9-05PLUS, CPG9-05PLUS-S, CPG9-05S, CPG9-05SNC		

1 			
<b>GEV No.</b>	970646	<b>Ref. No.</b>	12009268 H526501
<b>description</b>	pasta basket L1 170mm W1 115mm H1 265mm stainless steel left		

1 			
<b>GEV No.</b>	970647	<b>Ref. No.</b>	12007730 H526503
<b>description</b>	pasta basket L1 170mm W1 115mm H1 265mm stainless steel right		

1 			
<b>GEV No.</b>	970644	<b>Ref. No.</b>	12009502 H526500
<b>description</b>	pasta basket L1 180mm W1 230mm H1 265mm stainless steel		
<b>For models:</b>	CPE7-05, CPE7-05NC, CPG7-05, CPG7-05NC, EPC-350, GPC-350		

## crumb screens

1 			
<b>GEV No.</b>	691007	<b>Ref. No.</b>	12009154 X316502
<b>description</b>	crumb screen L 332mm W 277mm suitable for fryer		
<b>For models:</b>	FG7-05-1C, FG7-05-2C, FG-710, FG7-10-2C, FG7-104C, FG7-10-4C, FG-720		

1 			
<b>GEV No.</b>	505143	<b>Ref. No.</b>	12009165 X186522
<b>description</b>	crumb screen L 365mm W 350mm suitable for fryer		
<b>For models:</b>	FE9-05, FE9-05-1C, FE9-05-2C, FE9-05S, FE9-05S-1C, FE9-05S-2C, FE9-05USMC, FE9-10, FE9-10-2C, FE9-10-4C		



1

<b>GEV No.</b>	691022	<b>Ref. No.</b>	12009175 X166522
<b>description</b>	crumb screen L 392mm W 342mm suitable for fryer		
<b>For models:</b>	FE9-05AD, FE9-05PLUS, FE9-05PLUS-S, FE9-05S-AD, FE9-10AD, FE9-10PLUS, FG9-05, FG9-05-1C, FG9-05-2C, FG9-05AD, FG9-05PLUS, FG9-05PLUS-S, FG9-05S, FG9-05S-1C, FG9-05S-2C, FG9-05S-AD, FG9-10, FG9-10-2C, FG9-10-4C, FG9-10AD, FG9-10PLUS, FGCL9-05, FGCL9-05-1C, FGCL9-05-2C, FGCL9-05S-1C, FGCL9-05S-2C		



1

<b>GEV No.</b>	691021	<b>Ref. No.</b>	12019119 X166503
<b>description</b>	crumb screen L 395mm W 335mm suitable for fryer		
<b>For models:</b>	FE-920, FG-920, FG-940		

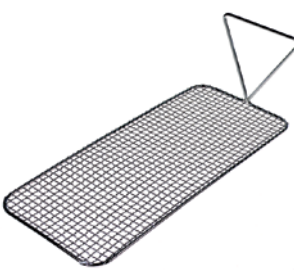

1

<b>GEV No.</b>	970632	<b>Ref. No.</b>	FAG6000013
<b>description</b>	crumb screen L 338mm W 134mm H 100mm		

## warewashing baskets

### plastic baskets round



1

<b>GEV No.</b>	970648	<b>Ref. No.</b>	12020206 Z605304
<b>description</b>	mix basket ED ø 350mm H 120mm seat ø 280mm		
<b>For models:</b>	LVR-10, LVR-14, LVR-14D		

## plastic baskets square

### mix baskets



1

<b>GEV No.</b>	971136	<b>Ref. No.</b>	12024550 Z415320
<b>description</b>	mix basket L 352mm W 352mm H 105mm		
<b>For models:</b>	AD-15, AD-15D, CO-350, CO-350-B, CO-350-B-DD, CO-350-COLD, CO-350-COLD-B, CO-350-COLD-B-DD, CO-350-COLD-DD, CO-350-DD, CO-352-COLD, CO-352-COLD-B, CO-352-COLD-B-DD, CO-352-COLD-DD, LVC-12, LVC-15, LVC-15D		



1

<b>GEV No.</b>	976000	<b>Ref. No.</b>	12025069 Z44532
<b>description</b>	mix basket L 395mm W 395mm H 145mm		
<b>For models:</b>	AD-20C-UK, AD-21, AD-21B, AD-21BDD, AD-21C, AD-21D, AD-21DD, AD-21W, CO-400, CO-400-B, CO-400-B-DD, CO-400-COLD, CO-400-COLD-B, CO-400-COLD-B-DD, CO-400-COLD-DD, CO-400-DD, CO-400-SOFT, CO-402-COLD, CO-402-COLD-B, CO-402-COLD-B-DD, CO-402-COLD-DD, CO-402W, LVC-21, LVC-21B, LVC-21C, LVC-21D, LVC-21W		

## accessories

### cutlery inserts



1

<b>GEV No.</b>	976010	<b>Ref. No.</b>	12025242
<b>description</b>	cutlery insert Lmm Wmm ø 95mm H 105mm plastic		
<b>For models:</b>	AD-15, AD-15D, AD-20C-UK, AD-21, AD-21B, AD-21BDD, AD-21C, AD-21D, AD-21DD, AD-21W, CO-350, CO-350-B, CO-350-B-DD, CO-350-COLD, CO-350-COLD-B, CO-350-COLD-B-DD, CO-350-COLD-DD, CO-350-DD, CO-352-COLD, CO-352-COLD-B, CO-352-COLD-B-DD, CO-352-COLD-DD, CO-400, CO-400-B, CO-400-B-DD, CO-400-COLD, CO-400-COLD-B, CO-400-COLD-B-DD, CO-400-COLD-DD, CO-400-DD, CO-400-SOFT, CO-402-COLD, CO-402-COLD-B, CO-402-COLD-B-DD, CO-402-COLD-DD, CO-402W, LVC-12, LVC-15, LVC-15D, LVC-21, LVC-21B, LVC-21C, LVC-21D, LVC-21W		

### sliding corners



1

<b>GEV No.</b>	970001	<b>Ref. No.</b>	12039794 Z855303
<b>description</b>	sliding corner wire gauge ø 5mm L 120mm W 120mm H 12mm L-shape		
<b>For models:</b>	FI-300B, LVC-12, LVC-15		



basket holders



<b>GEV No.</b>	691910	<b>Ref. No.</b>	12000014 12000235 12012770 12038455 12Z7103250 12Z7103770 Z710311
<b>description</b>	basket support L 540mm W 630mm suitable for FI 80 - 120 stainless steel		
<b>For models:</b>	ECO-120, ECO-120B, FI-100, FI-100AR, FI-100B, FI-100BBT-UK, FI-120, FI-120AR+DD, FI-120B, FI-120C, FI-120HY-CLINIC, FI-120W, FI-80, FI-80AR, FI-80BBT-UK, FI-80W, FI-E-100, MF-120		

plate inserts



<b>GEV No.</b>	976005	<b>Ref. No.</b>	12024286 Z605302
<b>description</b>	plate insert L 335mm W 195mm H 105mm plates 10 plastic-coated		
<b>For models:</b>	AD-15, AD-15D, CO-350, CO-350-B, CO-350-B-DD, CO-350-COLD, CO-350-COLD-B, CO-350-COLD-B-DD, CO-350-COLD-DD, CO-350-COLD-DD, CO-352-COLD, CO-352-COLD-B, CO-352-COLD-B-DD, CO-352-COLD-DD, LVC-12, LVC-15, LVC-15D, LVR-14, LVR-14D		



<b>GEV No.</b>	976014	<b>Ref. No.</b>	12025030 Z625302
<b>description</b>	plate insert L 370mm W 195mm H 105mm plates 11 plastic-coated		
<b>For models:</b>	AD-20C-UK, AD-21, AD-21B, AD-21BDD, AD-21C, AD-21D, AD-21DD, AD-21W, CO-400, CO-400-B, CO-400-B-DD, CO-400-COLD, CO-400-COLD-B, CO-400-COLD-B-DD, CO-400-COLD-DD, CO-400-DD, CO-400-SOFT, CO-402-COLD, CO-402-COLD-B, CO-402-COLD-B-DD, CO-402-COLD-DD, CO-402W, LVC-21, LVC-21B, LVC-21C, LVC-21D, LVC-21W, LVR-20, LVR-20B, LVR-20D, MF-21		

shelves and shelf rails

chargrill grids



<b>GEV No.</b>	211047	<b>Ref. No.</b>	12009424 T035464
<b>description</b>	chargrill grid L 580mm W 339mm H 22mm		
<b>For models:</b>	BG7-05, BG7-10		



<b>GEV No.</b>	211046	<b>Ref. No.</b>	12009442 12016227 T055413
<b>description</b>	chargrill grid L 580mm W 410mm H 25mm chargrill		
<b>For models:</b>	BG9-05, BG9-05I, BG9-05PF, BG9-10, BG9-10I, BG9-10PF		

grates

universal

without upstand



<b>GEV No.</b>	698836	<b>Ref. No.</b>	12035781 6027010003
<b>description</b>	grate W 325mm D 530mm GN 1/1 H 10mm plastic-coated steel wire gauge frame 8mm lengthwise wires gauge 3mm crossing wires 2 grey		
<b>For models:</b>	ADMFCN-135, ADMFCN-180, ADMFCN-225, ADMFCP-135, ADMFCP-180, ADMFCP-225, ADMFCN-135, ADMFCN-180, ADMFCN-225, ADMFCP-135, ADMFCP-180, ADMFCP-135-GR, ADMFCP-135HD, ADMFCP-135PC, ADMFCP-180, ADMFCP-180-GR, ADMFCP-180HDD, ADMFCP-180HHD, ADMFCP-180PC, ADMFCP-225, ADMFCP-225-GR, ADMFCP-225HDD, ADMFCP-225HHDD, ADMFCP-225HHHD, ADMFCP-225PC, CMFCN-102-R, CMFCN-135, CMFCN-147-R, CMFCN-180, CMFCN-192-R, CMFCN-225, CMFCN-237-R, CMFCN-270, CMFCP-102-R, CMFCP-135, CMFCP-135-BP, CMFCP-135F, CMFCP-135-GR, CMFCP-135HD, CMFCP-135PC, CMFCP-147-R, CMFCP-180, CMFCP-180-BP, CMFCP-180F, CMFCP-180-GR, CMFCP-180HDD, CMFCP-180HHD, CMFCP-180PC, CMFCP-192-R, CMFCP-225, CMFCP-225-BP...(Other models you can see in the webshop)		



<b>GEV No.</b>	970883	<b>Ref. No.</b>	12034975 6027010079
<b>description</b>	grate W 460mm D 405mm H 10mm plastic-coated steel enamelled wire gauge frame 8mm lengthwise wires gauge 3mm crossing wires 2 grey		
<b>For models:</b>	CFMP-117-R, CFMP-117-RPC, CFMP-150, CFMP-150F, CFMP-150PC, CFMP-150TV, CFMP-169-R, CFMP-169-RPC, CFMP-202, CFMP-202F, CFMP-202PC, CFMP-202TV, CFMP-222-R, CFMP-222-RPC, CFMP-255, CFMP-255F, CFMP-255PC, CFMP-255TV, CFMP-307, CFMP-307F, CFMP-307TV, CMSN-117-R, CMSN-150, CMSN-169-R, CMSN-200, CMSN-222-R, CMSN-250, CMSN-300, CMSP-117-R, CMSP-150, CMSP-150F, CMSP-150HD, CMSP-150PC, CMSP-169-R, CMSP-200, CMSP-200F, CMSP-200HDD, CMSP-200HDD, CMSP-200PC, CMSP-222-R, CMSP-250, CMSP-250F, CMSP-250HDD, CMSP-250HDD, CMSP-250HDD, CMSP-250PC, CMSP-274-R, CMSP-300, CMSP-300F, FMP-117-R...(Other models you can see in the webshop)		



<b>GEV No.</b>	698838	<b>Ref. No.</b>	6027010009
<b>description</b>	grate W 650mm D 530mm GN 2/1 H 10mm wire gauge frame 8mm lengthwise wires gauge 3mm crossing wires 2 grey		
<b>For models:</b>	AEF-801AD, AEF-802AD, AEP-1602, AEP-1602AD, AEP-1603AD, AEP-1604AD, AEP-801, AEP-802, AF-1602-MIX, AF-1603-C, AF-1603-P, AF-1604-C, AF-1604-P, AF-802-C, AF-802-P, AFN-1602, AFN-1603, AFN-1604, AFN-801, AFN-802, AFP-1602, AFP-1602-2, AFP-1603, AFP-1603-2, AFP-1604, AFP-801, AFP-802, AFP-802-2, AFP-802-2C, AFP-802-3C, ANF-1602AD, ANF-1603AD, ANF-1604AD, ANF-801AD, ANF-802AD, APF-1602AD, APF-1603AD, APF-1604AD, APF-801AD, APF-802AD		

producer-specific



<b>GEV No.</b>	698837	<b>Ref. No.</b>	12034317 6027010087
<b>description</b>	grate W 560mm D 540mm H 10mm wire gauge frame 8mm lengthwise wires gauge 3.5mm crossing wires 3 grey		
<b>For models:</b>	AEP-1402, AEP-2103, AEP-701, AF-1402-MIX, AF-1403-C, AF-1403-P, AF-1404-C, AF-1404-P, AF-2104-C, AF-2104-P, AF-2105-C, AF-2105-P, AF-2106-C, AF-2106-P, AF-702-C, AF-702-P, AFN-1402, AFN-1403, AFN-1404, AFN-701, AFN-702, AFP-1402, AFP-1403, AFP-1404, AFP-2103, AFP-2104, AFP-2105, AFP-2106, AFP-701, AFP-702, CAEP-1402, CAEP-2103, CAEP-701, CAF-1402MIX, CAF-1403C, CAF-1403P, CAF-1404C, CAF-1404P, CAF-2104C, CAF-2104P, CAF-2105C, CAF-2105P, CAF-2106C, CAF-2106P, CAF-702C, CAF-702P, CAFN-1402, CAFN-1403, CAFN-1404, CAFN-701...(Other models you can see in the webshop)		



<b>GEV No.</b>	970654	<b>Ref. No.</b>	12009267 U015630 U015631
<b>description</b>	grate GN 1/1 W 325mm D 530mm H 8mm chrome-plated steel oven wire gauge frame 6mm lengthwise wires gauge 3mm crossing wires 1		
<b>For models:</b>	CG-1502, CG-210, CG-210G, CG-310, CG-310G, HCV-10-11, HCV-10-21, HCV-2-10-21, HCV-6-11, HE-10-11, HE-10-21, HE-2-10-11, HE-6-11, HG-10-11, HG-10-21, HG-2-10-11		



<b>GEV No.</b>	970650	<b>Ref. No.</b>	12009338 12040318 U135635 U135642
<b>description</b>	grate W 650mm D 530mm GN 2/1 chrome-plated steel wire gauge frame 8mm lengthwise wires gauge 3mm crossing wires 2		
<b>For models:</b>	CE-410, CE7-41, CE7-41Q, CE9-41, CG-110, CG-2000, CG-2000-2P, CG7-11, CG-7115, CG7-31D, CG7-31I, CG7-41, CG-7415, CG7-41H, CG7-51, CG7-61, CG-7615, CG7-61H, CG9-11, CG-9110, CG9-41, CG9-51L, CG9-51LC, CG9-51R, CG9-51RC, CG9-61, CG9-82, CGE7-154, CGE7-41, CGE7-41H, CGE9-41, CGF9-121D, CGF9-121I, FI-5420, FI-7630, FTG9-11L, FTG9-11L+R, FTG9-11R, FTG9-11L, FTG9-11L+R, FTG9-11R, HCV-10-21, HCV-2-10-21, HE9-10, HE9-20, HG9-10, HG9-20		





<b>GEV No.</b>	970928	<b>Ref. No.</b>	12035775 6027010002
<b>description</b>	grate W 424mm D 450mm H 14mm wire gauge frame 7mm lengthwise wires gauge 3.5mm crossing wires 1 grey		
<b>For models:</b>	FMP-117-R, FMP-150, FMP-169-R, FMP-202, FMP-222-R, FMP-255, FMP-274-R, FMP-307, MSN-117-R, MSN-150, MSN-169-R, MSN-200, MSN-222-R, MSN-250, MSN-274-R, MSN-300, MSP-117-R, MSP-150, MSP-150-2C, MSP-150-F, MSP-169-R, MSP-200, MSP-200-4C, MSP-200-F, MSP-222-R, MSP-250, MSP-250-F, MSP-274-R, MSP-300, MSP-300-F		







 <p>1</p>			
<b>GEV No.</b>	691858	<b>Ref. No.</b>	12035899 6027010017
<b>description</b>	grate W 430mm D 160mm H 15mm plastic-coated steel refrigeration wire gauge frame 7.4mm lengthwise wires gauge 2.8mm crossing wires 1 grey with holder		
<b>For models:</b>	AEP-1402, AEP-2103, AF-1403-C, AF-1403-P, AF-1404-C, AF-1404-P, AF-2104-C, AF-2104-P, AF-2105-C, AF-2105-P, AF-2106-C, AF-2106-P, AFN-1402, AFN-1403, AFN-1404, AFP-1402, AFP-1403, AFP-1404, AFP-1404-USMC, AFP-2103, AFP-2104, AFP-2105, AFP-2106		

 <p>1</p>			
<b>GEV No.</b>	970761	<b>Ref. No.</b>	12037978 6027010016
<b>description</b>	grate W 525mm D 565mm plastic-coated steel		
<b>For models:</b>	AEP-1402, AEP-2103, AEP-701, AF-1402-MIX, AF-1403-C, AF-1403-P, AF-1404-C, AF-1404-P, AF-2104-C, AF-2104-P, AF-2105-C, AF-2105-P, AF-2106-C, AF-2106-P, AF-702-C, AF-702-P, AFN-1402, AFN-1403, AFN-1404, AFN-702, AFP-1402, AFP-1403, AFP-1404, AFP-1404-USMC, AFP-2103, AFP-2104, AFP-2105, AFP-2106, AFP-701, AFP-702		

 <p>Image not available</p> <p>1</p>			
<b>GEV No.</b>	691859	<b>Ref. No.</b>	12032755 6027010052
<b>description</b>	grate W 826mm D 334mm H 25mm plastic-coated steel refrigeration wire gauge frame 6.5mm lengthwise wires gauge 3.4mm crossing wires 1 grey with hinge camp		
<b>For models:</b>	ERM-250, ERMS-250		

 <p>1</p>			
<b>GEV No.</b>	970651	<b>Ref. No.</b>	12009381 U065624
<b>description</b>	grate W 855mm D 535mm chrome-plated steel with hinge camp wire gauge frame 8mm lengthwise wires gauge 4mm crossing wires 2		
<b>For models:</b>	CGB7-61, CGB7-61H, CGB7-61R, CGB7-61RH		

## grates

 <p>1</p>			
<b>GEV No.</b>	691713	<b>Ref. No.</b>	12004675 H125404
<b>description</b>	chimney grate L 350mm W 75mm H 100mm SS		
<b>For models:</b>	BG7-05, BG7-05I, CE7-20, CG7-20, CG7-20H, CPE7-05, CPE7-05NC, CPG7-05, CPG7-05NC, EN7-05, FG7-05-1C, FG7-05-2C, FG7-10-2C, FG7-104C, FG7-10-4C, FTE7-05L, FTE7-05R, FTEC7-05L, FTG7-05L, FTG7-05R, FTG7-05VL, FTG7-05VR, FTGC7-05L		

 <p>1</p>			
<b>GEV No.</b>	691843	<b>Ref. No.</b>	12007683 R205425
<b>description</b>	chimney grate L 425mm W 101mm H 22mm		
<b>For models:</b>	BG9-05, BG9-05AD, BG9-05I, BG9-05PF, BG9-05PI, BG9-05PLUS-I, BG9-10, BG9-10AD, BG9-10I, BG9-10PF, BG9-10PI, BG9-10PLUS-I, BME9-05, BME9-05AD, BME9-05PLUS, BME9-05V-T, BME9-10, BME9-10AD, BME9-10PLUS, BME9-10V-T, BMG9-05, BMG9-05V-T, BMG9-10, BMG9-10V-T, CE9-20, CE9-20AD, CE9-20PLUS, CE9-40, CE9-40AD, CE9-40PLUS, CE9-41, CE9-41AD, CE9-41PLUS, CG9-05AD, CG9-05PLUS, CG9-10, CG9-10AD, CG9-10PLUS, CG9-11, CG9-11AD, CG9-11PLUS, CG9-20, CG9-20AD, CG9-20AD-H, CG9-20H, CG9-20PLUS, CG9-20PLUS-H, CG9-31PLUS-D, CG9-31PLUS-I, CG9-40...(Other models you can see in the webshop)		

 <p>1</p>			
<b>GEV No.</b>	691720	<b>Ref. No.</b>	12005077 S565401
<b>description</b>	chimney grate L 700mm W 75mm H 90mm SS		
<b>For models:</b>	BG7-10, BG7-10I, CE7-40, CE7-41, CG7-10, CG7-11, CG7-30D, CG7-30I, CG7-31D, CG7-31I, CG7-40, CG7-40H, CG7-41, CG7-41H, CGE7-41, CGE7-41H, EN7-10, FTE7-10L, FTE7-10L+R, FTE7-10R, FTEC7-10L, FTG7-10L, FTG7-10L+R, FTG7-10R, FTG7-10VL, FTG7-10VL+R, FTG7-10VR, FTGC7-10L, ME7-10BM, MG7-10, MG7-10BM, MV7-10BM, SBE7-10, SBG7-10		

grid attachments



<b>GEV No.</b>	691906	<b>Ref. No.</b>	12011674 R662670
<b>description</b>	rack support mounting pos. left L 380mm H 400mm stainless steel suitable for 6/11		
<b>For models:</b>	HCG-6-11, HME-6-11, HMI-6-11, HMI-6-11UL, HMM-6-11, HMM-6-11UL, HMP-6-11		



<b>GEV No.</b>	691909	<b>Ref. No.</b>	12012692 12022802 R662645
<b>description</b>	rack support mounting pos. left L 380mm H 400mm stainless steel suitable for HEI 6/11 HMI 6/11		
<b>For models:</b>	COE-061, COG-061, HCG-6-11, HEI-6-11, HEM-6-11, HEP-6-11, HGC-6-11, HME-6-11, HMG-6-11, HMI-6-11, HMI-6-11UL, HMM-10-11, HMM-10-11UL, HMM-6-11, HMM-6-11UL, HMP-6-11, VE-061, VPE-061		



<b>GEV No.</b>	691921	<b>Ref. No.</b>	12012184 R672646 T112617
<b>description</b>	rack support mounting pos. left L 380mm H 635mm W 40mm stainless steel suitable for 10/11		
<b>For models:</b>	HCG-10-11, HME-10-11, HMG-10-11, HMI-10-11, HMI-10-11UL, HMM-10-11, HMM-10-11UL, HMP-10-11, HVG-10-11, HVG-10-11UL, HVG-2-10-11, MFHVG-10-11		



<b>GEV No.</b>	691918	<b>Ref. No.</b>	12012088 T122616
<b>description</b>	rack support mounting pos. left L 585mm H 635mm W 40mm stainless steel suitable for 10/21		
<b>For models:</b>	HCG-10-21, HME-10-21, HMI-10-21, HMM-10-21, HMP-10-21, HVG-10-21		





<b>GEV No.</b>	691907	<b>Ref. No.</b>	12013088 R662668
<b>description</b>	rack support mounting pos. right L 380mm H 400mm stainless steel suitable for 6/11		
<b>For models:</b>	HCG-6-11, HME-6-11, HMI-6-11, HMI-6-11UL, HMM-6-11, HMM-6-11UL, HMP-6-11		





<b>GEV No.</b>	691908	<b>Ref. No.</b>	12014126 12022801 R662646
<b>description</b>	rack support mounting pos. right L 380mm H 400mm stainless steel suitable for HEI 6/11 HMI 6/11		
<b>For models:</b>	COE-061, COG-061, HCG-6-11, HEI-6-11, HEM-6-11, HEP-6-11, HGC-6-11, HME-6-11, HMG-6-11, HMI-6-11, HMI-6-11UL, HMM-10-11, HMM-10-11UL, HMM-6-11, HMM-6-11UL, HMP-6-11, VE-061, VPE-061		



			
1			
<b>GEV No.</b>	691920	<b>Ref. No.</b>	12012759 R672645 T112615
<b>description</b>	rack support mounting pos. right L 380mm H 635mm W 40mm stainless steel suitable for 10/11		
<b>For models:</b>	HCG-10-11, HME-10-11, HMG-10-11, HMI-10-11, HMI-10-11UL, HMM-10-11, HMM-10-11UL, HMP-10-11, HVG-10-11, HVG-10-11UL, HVG-2-10-11, MFHVG-10-11		

			
1			
<b>GEV No.</b>	700837	<b>Ref. No.</b>	12022577 R672668
<b>description</b>	guide L-shape L 390mm W 24mm H 114mm mounting pos. left		

			
1			
<b>GEV No.</b>	700838	<b>Ref. No.</b>	12022578 R672669
<b>description</b>	guide L-shape L 390mm W 24mm H 114mm mounting pos. right		

			
1			
<b>GEV No.</b>	691919	<b>Ref. No.</b>	12011984 T122614
<b>description</b>	rack support mounting pos. right L 585mm H 635mm W 40mm stainless steel suitable for 10/21		
<b>For models:</b>	HCG-10-21, HME-10-21, HMI-10-21, HMM-10-21, HMP-10-21, HVG-10-21		

			
1			
<b>GEV No.</b>	692123	<b>Ref. No.</b>	12036419 12037055 6003001006 6033050014
<b>description</b>	guide L-shape L 648mm W 15mm H 23mm mounting pos. left/right		
<b>For models:</b>	CMMZ-150, CMMZ-202, CMPN-117-R, CMPN-150, CMPN-169-R, CMPN-202, CMPN-222-R, CMPN-255, CMPP-117-R, CMPP-150, CMPP-150-C, CMPP-169-R, CMPP-202, CMPP-202-C, CMPP-222-R, CMPP-255, CMPP-255-C, CMPP-307, MMZ-150, MMZ-202, MPN-117-R, MPN-150, MPN-169-R, MPN-202, MPN-222-R, MPN-255, MPN-274-R, MPN-307, MPP-117-R, MPP-117-R-G, MPP-150, MPP-150-G, MPP-169-R, MPP-169-R-G, MPP-202, MPP-202-G, MPP-222-R, MPP-222-R-G, MPP-255, MPP-255-G, MPP-274-R, MPP-274-R-G, MPP-307, MPP-307-G, MPP-307-R, MPZ-150, MPZ-202		

## shelf rails and supports

### producer-specific

			
1			
<b>GEV No.</b>	701568	<b>Ref. No.</b>	12037936 6033050015
<b>description</b>	guide L 562mm W 16mm H 25.5mm mounting pos. left/right		
<b>For models:</b>	ADAEP-1602, ADAFN-1602, ADAFP-1602, AEP-1602AD, AEP-1603AD, AEP-1604AD, AF-1403-C, AF-1404-C, AF-1603-C, AF-1604-C, AF-2104-C, AF-2105-C, AF-2106-C, AF-702-C, AFP-702, ANF-1602AD, ANF-1603AD, ANF-1604AD, APF-1602AD, APF-1603AD, APF-1604AD, CAF-1403C, CAF-1404C, CAF-2104P, CAF-2105P, CAF-2106P, CAF-702C, CMFN-102-R, CMFN-135, CMFN-147-R, CMFN-180, CMFN-192-R, CMFN-225, CMFN-237-R, CMFN-270, CMFP-102-R, CMFP-135, CMFP-135-BP, CMFP-135F, CMFP-135-GR, CMFP-135HD, CMFP-135PC, CMFP-147-R, CMFP-180, CMFP-180-BP, CMFP-180F, CMFP-180-GR, CMFP-180HDD, CMFP-180HHD, CMFP-180PC...(Other models you can see in the webshop)		

			
1			
<b>GEV No.</b>	692110	<b>Ref. No.</b>	12036758 12036819 12037054 6009990002 6009990037 6033050011
<b>description</b>	guide U-shape L 549mm W 15mm H 22mm mounting pos. left/right		
<b>For models:</b>	MCN-102-GN-R, MCN-135-GN, MCN-147-GN-R, MCN-180-GN, MCN-192-GN-R, MCN-225-GN, MCN-237-GN-R, MCN-270-GN, MCP-102-GN-R, MCP-135-GN, MCP-147-GN-R, MCP-180-GN, MCP-192-GN-R, MCP-225-GN, MCP-237-GN-R, MCP-270-GN, MEP-100, MEP-100G, MEP-135, MEP-180, MFN-102-GN-R, MFN-102-R, MFN-135, MFN-135-GN, MFN-147-GN-R, MFN-147-R, MFN-180, MFN-180-GN, MFN-192-GN-R, MFN-192-R, MFN-225, MFN-225-GN, MFN-237-GN-R, MFN-237-R, MFN-270, MFN-270-GN, MFP-102-2C, MFP-102-GN-R, MFP-135, MFP-135-2C, MFP-135-F, MFP-135-GN, MFP-147-2C, MFP-147-4C, MFP-147-GN-R, MFP-180, MFP-180-2C, MFP-180-4C, MFP-180-F, MFP-180-GN...(Other models you can see in the webshop)		

			
1			
<b>GEV No.</b>	700884	<b>Ref. No.</b>	12036565 12036836 12037948 6009990004 6009990064 6033050016
<b>description</b>	guide U-shape L 662mm W 15mm mounting pos. left/right inner height 22mm		
<b>For models:</b>	AEP-1602, AEP-1603, AEP-1604, AEP-801, AEP-802, AF-1602-MIX, AF-1603-C, AF-1603-P, AF-1604-C, AF-1604-P, AF-802-C, AF-802-P, AFN-1602, AFN-1603, AFN-1604, AFN-801, AFN-802, AFP-1602, AFP-1602-2, AFP-1603, AFP-1603-2, AFP-1604, AFP-801, AFP-802, AFP-802-2, AFP-802-2C, AFP-802-3C, CAEP-1602, CAEP-801, CAEP-802, CAF-1602MIX, CAF-1603-C, CAF-1603-P, CAF-1604-C, CAF-1604-P, CAF-802-C, CAF-802-P, CAFN-1602, CAFN-1603, CAFN-1604, CAFN-801, CAFN-802, CAFP-1602, CAFP-1602-2, CAFP-1603, CAFP-1603-2, CAFP-1604, CAFP-801, CAFP-802, CAFP-802-2...(Other models you can see in the webshop)		

			
1			
<b>GEV No.</b>	692663	<b>Ref. No.</b>	6033050025
<b>description</b>	pair of setting bar L 662mm W 15mm H 24mm mounting pos. left/right		

			
1			
<b>GEV No.</b>	692662	<b>Ref. No.</b>	6033050028
<b>description</b>	pair of setting bar L 549mm W 15mm H 24mm mounting pos. left/right		

			
1			
<b>GEV No.</b>	700815	<b>Ref. No.</b>	12037855 12090875 2021500320 6003010124
<b>description</b>	shelf support for grate L 26mm W 20mm H 23mm plastic for fridge		
<b>For models:</b>	BFP-100, BFP-100A, BFP-100I, BFP-150, BFP-150A, BFP-150I, BFP-200, BFP-200A, BFP-200I, BFP-250, BFP-250A, BFP-250I, BFP-300, BFP-300I		

			
1			
<b>GEV No.</b>	692660	<b>Ref. No.</b>	6033050027
<b>description</b>	pair of setting bar L 562mm W 15mm mounting pos. left/right mounting distance 525mm hook width 12mm inner height 24mm		

			
1			
<b>GEV No.</b>	691887	<b>Ref. No.</b>	12021988 Z712509
<b>description</b>	shelf support L 28mm W 20mm H 15mm SS		
<b>For models:</b>	ECO-120, ECO-120B, FI-100, FI-100AR, FI-100B, FI-120, FI-120B, FI-120W, FI-80, FI-80W, MF-120		

			
1			
<b>GEV No.</b>	692661	<b>Ref. No.</b>	6033050029
<b>description</b>	pair of setting bar L 613mm W 15mm H 24mm mounting pos. left/right		

			
1			
<b>GEV No.</b>	698843	<b>Ref. No.</b>	6033210019
<b>description</b>	shelf support L 42mm W 22mm H 27mm		

**gaskets**

refrigeration gaskets

plug-in gaskets

profile 9013

We offer custom-made gaskets for this profile

<b>GEV No.</b>	901764	<b>Ref. No.</b>	12034906
<b>description</b>	refrigeration gasket profile 9013 W 1503mm L 685mm plug size		

<b>GEV No.</b>	900902	<b>Ref. No.</b>	12035763 6045010020
<b>description</b>	refrigeration gasket profile 9013 W 155mm L 375mm plug size		

<b>GEV No.</b>	900910	<b>Ref. No.</b>	12035439 12035723 6001401119 6045010024
<b>description</b>	refrigeration gasket profile 9013 W 155mm L 450mm plug size		
<b>For models:</b>	MSN-117-R, MSN-150, MSN-169-R, MSN-200, MSN-222-R, MSN-250, MSN-274-R, MSN-300, MSP-117-R, MSP-150, MSP-150-F, MSP-169-R, MSP-200, MSP-200-F, MSP-222-R, MSP-250, MSP-250-F, MSP-274-R, MSP-300		

<b>GEV No.</b>	901529	<b>Ref. No.</b>	12036161 6045010122
<b>description</b>	refrigeration gasket profile 9013 W 245mm L 370mm plug size		
<b>For models:</b>	CMFP-135HD, CMFP-135HH, CMFP-180HDD, CMFP-180HHD, CMFP-180HHH, CMFP-225HDDD, CMFP-225HHDD, CMFP-225HHHD, CMFP-225HHHH, MFP-102-R2C-GN, MFP-102-R4C-GN, MFP-135-2C-GN, MFP-135-4C-GN, MFP-147-R2C-GN, MFP-147-R4C-GN, MFP-147-R6C-GN, MFP-180-2C-GN, MFP-180-4C-GN, MFP-180-6C-GN, MFP-192-R2C-GN, MFP-192-R4C-GN, MFP-192-R6C-GN, MFP-192-R8C-GN, MFP-225-2C-GN, MFP-225-4C-GN, MFP-225-6C-GN, MFP-225-8C-GN, MFP-237-R2C-GN, MFP-237-R6C-GN, MFP-237-R8C-GN, MFP-270-10C-GN, MFP-270-2C-GN, MFP-270-4C-GN, MFP-270-6C-GN, MFP-270-8C-GN		

<b>GEV No.</b>	900880	<b>Ref. No.</b>	12034834 12036435 6001401107 6045010012
<b>description</b>	refrigeration gasket profile 9013 W 255mm L 375mm plug size		
<b>For models:</b>	MCN-102-GN-R, MCN-135-GN, MCN-147-GN-R, MCN-180-GN, MCN-192-GN-R, MCN-225-GN, MCN-237-GN-R, MCN-270-GN, MCP-102-GN-R, MCP-135-GN, MCP-147-GN-R, MCP-180-GN, MCP-192-GN-R, MCP-225-GN, MCP-237-GN-R, MCP-270-GN, MFN-102-GN-R, MFN-135-GN, MFN-147-GN-R, MFN-180-GN, MFN-192-GN-R, MFN-225-GN, MFN-237-GN-R, MFN-270-GN, MFP-102-GN-R, MFP-135-2C, MFP-135-4C, MFP-135-GN, MFP-147-GN-R, MFP-180-2C, MFP-180-4C, MFP-180-6C, MFP-180-GN, MFP-192-2C, MFP-192-4C, MFP-192-6C, MFP-192-8C, MFP-192-GN-R, MFP-225-2C, MFP-225-4C, MFP-225-6C, MFP-225-8C, MFP-225-GN, MFP-237-10C, MFP-237-4C, MFP-237-6C, MFP-237-8C, MFP-237-GN-R, MFP-270-10C, MFP-270-2C...(Other models you can see in the webshop)		

<b>GEV No.</b>	900911	<b>Ref. No.</b>	12035440 12035441 6001401102 6045010007
<b>description</b>	refrigeration gasket profile 9013 W 380mm L 400mm plug size		
<b>For models:</b>	MEP-100, MEP-100G		

<b>GEV No.</b>	901180	<b>Ref. No.</b>	12035974 6001401101 6045010006
<b>description</b>	refrigeration gasket profile 9013 W 380mm L 585mm plug size		
<b>For models:</b>	MCN-102-GN-R, MCN-102-R, MCN-135, MCN-135-GN, MCN-147-GN-R, MCN-147-R, MCN-180, MCN-180-GN, MCN-192-GN-R, MCN-192-R, MCN-225, MCN-225-GN, MCN-237-GN-R, MCN-237-R, MCN-270, MCN-270-GN, MCP-102-GN-R, MCP-135, MCP-135-GN, MCP-147-GN-R, MCP-180, MCP-180-GN, MCP-192-GN-R, MCP-225, MCP-225-GN, MCP-237-GN-R, MCP-270-GN, MEP-135, MEP-180, MFN-102-GN-R, MFN-102-R, MFN-135, MFN-135-GN, MFN-147-GN-R, MFN-147-R, MFN-180, MFN-180-GN, MFN-192-GN-R, MFN-192-R, MFN-225, MFN-225-GN, MFN-237-GN-R, MFN-237-R, MFN-270, MFN-270-GN, MFP-102-2C, MFP-102-GN-R, MFP-135, MFP-135-2C, MFP-135-F...(Other models you can see in the webshop)		

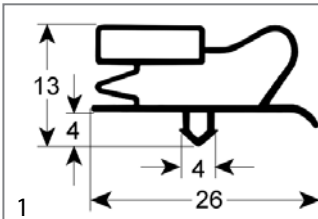

<b>GEV No.</b>	901765	<b>Ref. No.</b>	12036345
<b>description</b>	refrigeration gasket profile 9013 W 450mm L 260mm plug size		

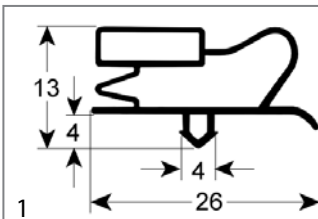

<b>GEV No.</b>	900893	<b>Ref. No.</b>	12034290 12035834 6001401104 6045010009
<b>description</b>	refrigeration gasket profile 9013 W 450mm L 580mm plug size		

**For models:** MMZ-150, MMZ-202, MPN-117-C, MPN-117-R, MPN-117-R-C, MPN-150, MPN-150-C, MPN-169-C, MPN-169-R, MPN-169-R-C, MPN-202, MPN-202-C, MPN-222-C, MPN-222-R, MPN-222-R-C, MPN-255, MPN-255-C, MPN-274-C, MPN-274-R, MPN-274-R-C, MPN-307, MPN-307-C, MPP-117-C, MPP-117-C-G, MPP-117-R, MPP-117-R-C, MPP-117-R-G, MPP-150, MPP-150-C, MPP-150-C-G, MPP-150-G, MPP-169-C, MPP-169-C-G, MPP-169-R, MPP-169-R-C, MPP-169-R-G, MPP-202, MPP-202-C, MPP-202-C-G, MPP-202-G, MPP-222-C, MPP-222-C-G, MPP-222-R, MPP-222-R-C, MPP-222-R-G, MPP-255, MPP-255-C, MPP-255-C-G, MPP-255-G, MPP-274-C...(Other models you can see in the webshop)

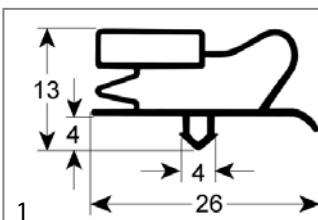

<b>GEV No.</b>	900907	<b>Ref. No.</b>	12034473 12035547 6001401113 6045010018
<b>description</b>	refrigeration gasket profile 9013 W 455mm L 770mm plug size		
<b>For models:</b>	FMP-117-R, FMP-150, FMP-169-R, FMP-200, FMP-202, FMP-222-R, FMP-250, FMP-255, FMP-274-R, FMP-300, FMP-307		

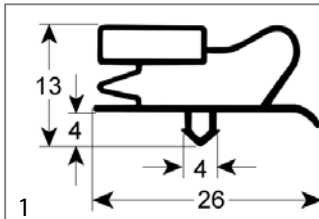

<b>GEV No.</b>	900903	<b>Ref. No.</b>	12033951 12035400 6001401108 6045010013
<b>description</b>	refrigeration gasket profile 9013 W 615mm L 710mm plug size		

**For models:** AEP-1602, AEP-802, AF-1403-C, AF-1403-P, AF-1404-C, AF-1404-P, AF-1603-C, AF-1603-P, AF-1604-C, AF-1604-P, AF-2104-C, AF-2104-P, AF-2105-C, AF-2105-P, AF-2106-C, AF-2106-P, AF-702-C, AF-702-P, AF-802-P, AFN-1402, AFN-1403, AFN-1404, AFN-1603, AFN-1604, AFN-702, AFN-802, AFP-1403, AFP-1403-C, AFP-1403-FORZ, AFP-1403-P, AFP-1404, AFP-1404-C, AFP-1404-FORZ, AFP-1404-P, AFP-1404-USMC, AFP-1603, AFP-1603-2, AFP-1604, AFP-2104, AFP-2104-C, AFP-2104-P, AFP-2105, AFP-2105-C, AFP-2105-P, AFP-2106, AFP-2106-C, AFP-2106-P, AFP-702, AFP-702-C, AFP-702-FORZ...(Other models you can see in the webshop)

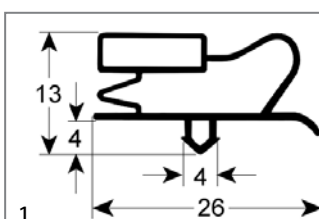

<b>GEV No.</b>	900028	<b>Ref. No.</b>	12034015 12034625 6010220002 6045010002
<b>description</b>	refrigeration gasket profile 9013 W 618mm L 1500mm plug size door		

**description** refrigeration gasket profile 9013 W 618mm L 1500mm plug size door

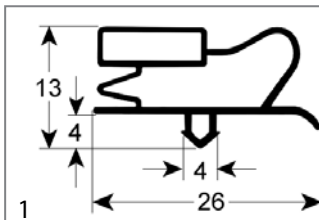

<b>GEV No.</b>	901580	<b>Ref. No.</b>	12035207
<b>description</b>	refrigeration gasket profile 9013 W 618mm L 722mm plug size with magnet		

**description** refrigeration gasket profile 9013 W 618mm L 722mm plug size with magnet

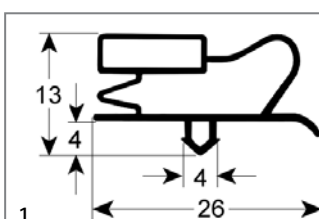

<b>GEV No.</b>	900906	<b>Ref. No.</b>	12034170 12034292 6001401111 6045010016
<b>description</b>	refrigeration gasket profile 9013 W 683mm L 1501mm plug size		

**For models:** AP-701, APP-701



<b>GEV No.</b>	902028	<b>Ref. No.</b>	N/A
<b>description</b>	refrigeration gasket profile 9013 Wmm L 2500mm		

profile 9797

We offer custom-made gaskets for this profile

<b>GEV No.</b>	901763	<b>Ref. No.</b>	12038148 6045010131
<b>description</b>	refrigeration gasket profile 9797 W 1435mm L 615mm plug size		

<b>For models:</b>	AEP-1402, AEP-1602, AEP-2103, AEP-701, AEP-801, AF-1402-MIX, AF-1403-C, AF-1403-P, AF-1602-MIX, AF-1603-C, AF-1603-P, AF-1604-C, AF-1604-P, AF-2104-C, AF-2104-P, AF-2105-C, AF-2105-P, AFN-1402, AFN-1403, AFN-1602, AFN-1603, AFN-1604, AFN-701, AFN-801, AFP-1402, AFP-1403, AFP-1602, AFP-1602-2, AFP-1603, AFP-1603-2, AFP-1604, AFP-2103, AFP-2104, AFP-2105, AFP-701, AFP-801, CAEP-1402, CAEP-1602, CAEP-2103, CAEP-701, CAEP-801, CAF-1402MIXT, CAF-1403C, CAF-1403P, CAF-1602MIX, CAF-1603-C, CAF-1603-P, CAF-2104C, CAF-2104P, CAF-2105C...(Other models you can see in the webshop)		
--------------------	---	--	--

<b>GEV No.</b>	901759	<b>Ref. No.</b>	12034580 12057676 6045010050
<b>description</b>	refrigeration gasket profile 9797 W 1680mm L 580mm plug size		

<b>For models:</b>	AEP-1402, AEP-1602, AEP-2103, AEP-701, AEP-801, AF-1402-MIX, AF-1403-C, AF-1403-P, AF-1602-MIX, AF-1603-C, AF-1603-P, AF-1604-C, AF-1604-P, AF-2104-C, AF-2104-P, AF-2105-C, AF-2105-P, AFN-1402, AFN-1403, AFN-1602, AFN-1603, AFN-1604, AFN-701, AFN-801, AFP-1402, AFP-1403, AFP-1602, AFP-1602-2, AFP-1603, AFP-1603-2, AFP-1604, AFP-2103, AFP-2104, AFP-2105, AFP-701, AFP-801, CAEP-1402, CAEP-1602, CAEP-2103, CAEP-701, CAEP-801, CAF-1402MIXT, CAF-1403C, CAF-1403P, CAF-1602MIX, CAF-1603-C, CAF-1603-P, CAF-2104C, CAF-2104P, CAF-2105C...(Other models you can see in the webshop)		
--------------------	---	--	--

<b>GEV No.</b>	901181	<b>Ref. No.</b>	12036036 12036158 6045010120 6045010152
<b>description</b>	refrigeration gasket profile 9797 W 350mm L 370mm plug size		

<b>For models:</b>	CMFP-135-B, CMFP-135-B2, CMFP-135-BP, CMFP-180-B, CMFP-180-B2, CMFP-180-BP, CMFP-225-B, CMFP-225-B2, CMFP-225-BP, CMFP-270-B, CMFP-270-B2, CMFP-270-BP, MEP-100, MEP-100G, MFP-102-R2C-GN, MFP-102-R4C-GN, MFP-135-2C-GN, MFP-135-4C-GN, MFP-135-B, MFP-135-B2-GN, MFP-135-B-GN, MFP-135-BP-GN, MFP-147-R2C-GN, MFP-147-R4C-GN, MFP-147-R6C-GN, MFP-180-2C-GN, MFP-180-4C-GN, MFP-180-6C-GN, MFP-180-B, MFP-180-B2-GN, MFP-180-B-GN, MFP-180-BP-GN, MFP-192-R2C-GN, MFP-192-R4C-GN, MFP-192-R6C-GN, MFP-192-R8C-GN, MFP-225-2C-GN, MFP-225-4C-GN, MFP-225-6C-GN, MFP-225-8C-GN, MFP-225-B, MFP-225-B2-GN, MFP-225-B-GN, MFP-225-BP-GN, MFP-237-R2C-GN, MFP-237-R6C-GN, MFP-237-R8C-GN, MFP-270-10C-GN, MFP-270-2C-GN, MFP-270-4C-GN...(Other models you can see in the webshop)		
--------------------	---	--	--

<b>GEV No.</b>	901164	<b>Ref. No.</b>	12038156 6045010119
<b>description</b>	refrigeration gasket profile 9797 W 365mm L 560mm plug size		

<b>For models:</b>	CMFN-102-R, CMFN-135, CMFN-147-R, CMFN-180, CMFN-192-R, CMFN-225, CMFN-237-R, CMFN-270, CMFP-102-R, CMFP-135, CMFP-135F, CMFP-135-GR, CMFP-135HD, CMFP-135PC, CMFP-147-R, CMFP-180, CMFP-180F, CMFP-180-GR, CMFP-180HDD, CMFP-180HHD, CMFP-180PC, CMFP-192-R, CMFP-225, CMFP-225F, CMFP-225-GR, CMFP-225HDD, CMFP-225HDD, CMFP-225HHD, CMFP-225PC, CMFP-237-R, CMFP-270, CMMZ-180-7, CMMZ-225-7, CMPZ1-135, CMPZ1-180, MCN-135-GN, MCN-180-GN, MCN-270-GN, MCP-135-GN, MCP-147-GN-R, MCP-180-GN, MCP-192-GN-R, MCP-225-GN, MCP-237-GN-R, MCP-270-GN, MEP-135, MEP-135-GN, MEP-180, MEP-180-GN, MFN-135...(Other models you can see in the webshop)		
--------------------	--	--	--

<b>GEV No.</b>	902188	<b>Ref. No.</b>	12068575 6045010158
<b>description</b>	refrigeration gasket profile 9797 W 370mm L 548mm plug size Qty 1		
<b>For models:</b>	ADM-CN-135, ADM-CN-180, ADM-CN-225, ADMCP-135, ADMCP-180, ADMCP-225, ADMFN-135, ADMFN-180, ADMFN-225, ADMFP-135, ADMFP-135-GR, ADMFP-135HD, ADMFP-135PC, ADMFP-180, ADMFP-180-GR, ADMFP-180HDD, ADMFP-180HHD, ADMFP-180PC, ADMFP-225, ADMFP-225-GR, ADMFP-225HDD, ADMFP-225HHD, ADMFP-225HHHD, ADMFP-225PC, MCP-135-AD, MCP-180-AD, MCP-225-AD, MFP-135-AD, MFP-135-AD-2C, MFP-135-AD-PC, MFP-180-AD, MFP-180-AD-2C, MFP-180-AD-4C, MFP-180-AD-PC, MFP-225-AD, MFP-225-AD-2C, MFP-225-AD-4C, MFP-225-AD-6C, MFP-225-AD-PC, MFPG-135-AD, MFPG-180-AD, MFPG-225-AD		

<b>GEV No.</b>	901754	<b>Ref. No.</b>	12035142 6045010124
<b>description</b>	refrigeration gasket profile 9797 W 440mm L 755mm plug size		
<b>For models:</b>	CFMP-117-R, CFMP-117-RPC, CFMP-150, CFMP-150F, CFMP-150PC, CFMP-150TV, CFMP-169-R, CFMP-169-RPC, CFMP-202, CFMP-202F, CFMP-202PC, CFMP-202TV, CFMP-222-R, CFMP-222-RPC, CFMP-255, CFMP-255F, CFMP-255PC, CFMP-255TV, CFMP-307, CFMP-307F, CFMP-307TV, FMP-117-R, FMP-150, FMP-150-TV, FMP-169-R, FMP-200, FMP-202, FMP-202-TV, FMP-222-R, FMP-250, FMP-255, FMP-255-TV, FMP-274-R, FMP-300, FMP-307, FMP-307-TV		

<b>GEV No.</b>	900904	<b>Ref. No.</b>	12034291
<b>description</b>	refrigeration gasket profile 9797 W 380mm L 585mm plug size		

<b>GEV No.</b>	901751	<b>Ref. No.</b>	12035824 6045010118
<b>description</b>	refrigeration gasket profile 9797 W 445mm L 246mm plug size		
<b>For models:</b>	CMSP-150HD, CMSP-150HH, CMSP-200HDD, CMSP-200HHD, CMSP-200HHH, CMSP-250HDD, CMSP-250HHD, CMSP-250HHH, CMSP-250HHH, MSP-117-2RC, MSP-117-4RC, MSP-117-R2C, MSP-117-R4C, MSP-150-2C, MSP-150-4C, MSP-169-R2C, MSP-169-R4C, MSP-169-R6C, MSP-200-2C, MSP-200-4C, MSP-200-6C, MSP-222-R2C, MSP-222-R4C, MSP-222-R6C, MSP-222-R8C, MSP-250-2C, MSP-250-4C, MSP-250-6C, MSP-250-8C, MSP-274-R10C, MSP-274-R6C, MSP-300-10C, MSP-300-2C, MSP-300-4C, MSP-300-8C		

<b>GEV No.</b>	901530	<b>Ref. No.</b>	12035412 6045010115
<b>description</b>	refrigeration gasket profile 9797 W 440mm L 560mm plug size		
<b>For models:</b>	CMMZ-150, CMMZ-202, CMPN-117-R, CMPN-150, CMPN-169-R, CMPN-202, CMPN-222-R, CMPN-255, CMPP-117-R, CMPP-150, CMPP-150-C, CMPP-169-R, CMPP-202, CMPP-202-C, CMPP-222-R, CMPP-255, CMPP-255-C, CMPP-307, CMSN-117-R, CMSN-150, CMSN-169-R, CMSN-200, CMSN-222-R, CMSN-250, CMSN-300, CMSP-117-R, CMSP-150, CMSP-150F, CMSP-150HD, CMSP-150PC, CMSP-169-R, CMSP-200, CMSP-200F, CMSP-200HDD, CMSP-200HHD, CMSP-200PC, CMSP-222-R, CMSP-250, CMSP-250F, CMSP-250HDD, CMSP-250HHD, CMSP-250HHHD, CMSP-250PC, CMSP-274-R, CMSP-300, CMSP-300F, MMZ-150, MMZ-202, MPN-117-R, MPN-150...(Other models you can see in the webshop)		

<b>GEV No.</b>	901753	<b>Ref. No.</b>	12047040 6045010154
<b>description</b>	refrigeration gasket profile 9797 W 565mm L 440mm plug size		
<b>For models:</b>	ATM-051ECO, ATM-051VCH, ATM-051VCH-60Hz		



<b>GEV No.</b>	900905	<b>Ref. No.</b>	12032337 12033379 12034384 12034419 6001401109 6045010014 6045010026 6045010030
<b>description</b>	refrigeration gasket profile 9797 W 610mm L 1500mm plug size L1 1520mm W1 630mm external size		
<b>For models:</b>	AEP-1402, AEP-1602, AEP-2103, AEP-701, AEP-801, AF-1402-MIX, AF-1403-C, AF-1403-P, AF-1404-C, AF-1404-P, AF-1602-MIX, AF-1603-C, AF-1603-P, AF-1604-C, AF-1604-P, AF-2104-C, AF-2104-P, AF-2105-C, AF-2105-P, AF-2106-C, AF-2106-P, AFN-1402, AFN-1403, AFN-1602, AFN-1603, AFN-701, AFN-801, AFP-1402, AFP-1402-FORZ, AFP-1402-MIX, AFP-1403, AFP-1403-C, AFP-1403-FORZ, AFP-1403-P, AFP-1602, AFP-1602-2, AFP-1603, AFP-1603-2, AFP-2103, AFP-2104, AFP-2104-C, AFP-2104-P, AFP-2105, AFP-2105-C, AFP-2105-P, AFP-701, AFP-801, AP-701, APP-701		

<b>GEV No.</b>	901601	<b>Ref. No.</b>	12038144 12092626 2021700092 6045010132
<b>description</b>	refrigeration gasket profile 9797 W 615mm L 670mm plug size		
<b>For models:</b>	AEP-1602, AEP-802, AF-1403-C, AF-1403-P, AF-1404-C, AF-1404-P, AF-1603-C, AF-1603-P, AF-1604-C, AF-1604-P, AF-2104-C, AF-2104-P, AF-2105-C, AF-2105-P, AF-2106-C, AF-2106-P, AF-702-C, AF-702-P, AF-802-C, AF-802-P, AFN-1403, AFN-1404, AFN-1602, AFN-1603, AFN-1604, AFN-702, AFN-802, AFP-1403, AFP-1404, AFP-1602, AFP-1603, AFP-1603-2, AFP-1604, AFP-2104, AFP-2105, AFP-2106, AFP-702, AFP-802, AFP-802-2, AFP-802-2C, AFP-802-3C, CAEP-802, CAF-1403C, CAF-1403P, CAF-1404C, CAF-1404P, CAF-1603-C, CAF-1603-P, CAF-1604-C, CAF-1604-P...(Other models you can see in the webshop)		

<b>GEV No.</b>	901802	<b>Ref. No.</b>	12033677 12034720 6001401001 6045010001
<b>description</b>	refrigeration gasket profile 9797 W 720mm L 620mm plug size		
<b>For models:</b>	AEP-1403, AEP-1404, AEP-1603, AEP-1604, AEP-702, AEP-802		

<b>GEV No.</b>	901760	<b>Ref. No.</b>	12034676 6045010054
<b>description</b>	refrigeration gasket profile 9797 W 805mm L 460mm plug size		

profile 9333

We offer custom-made gaskets for this profile

<b>GEV No.</b>	902167	<b>Ref. No.</b>	N/A
<b>description</b>	refrigeration gasket profile 9333 Wmm L 2500mm		

profile 9373

We offer custom-made gaskets for this profile

<b>GEV No.</b>	902163	<b>Ref. No.</b>	N/A
<b>description</b>	refrigeration gasket profile 9373 Wmm L 2500mm plug size		

screw-in gaskets

profile 9106

We offer custom-made gaskets for this profile

<b>GEV No.</b>	902262	<b>Ref. No.</b>	N/A
<b>description</b>	refrigeration gasket profile 9106 Wmm L 2500mm		

profile 9170

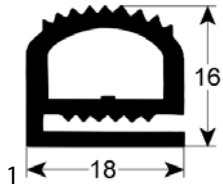

<b>GEV No.</b>	901293	<b>Ref. No.</b>	12030627 6045050004
<b>description</b>	refrigeration gasket profile 9170 W 605mm L 1295mm external size		

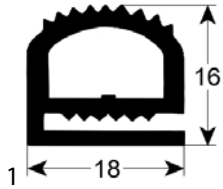

<b>GEV No.</b>	902139	<b>Ref. No.</b>	12029402 6045050008
<b>description</b>	refrigeration gasket profile 9170 W 630mm L 1233mm external size		
<b>For models:</b>	CCF-20, CCF-20CI, CCF-40, CCF-40CI		

gaskets for heated units

window seals



<b>GEV No.</b>	691056	<b>Ref. No.</b>	12039758 3712700
<b>description</b>	window gasket		

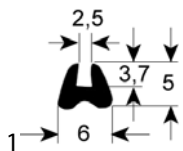

<b>GEV No.</b>	691068	<b>Ref. No.</b>	11000170 3713800
<b>description</b>	window gasket profile 1505 L 1300mm suitable for FAGOR Qty 1		
<b>For models:</b>	HCG-20-11, HMG-20-11		

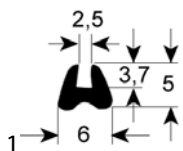

<b>GEV No.</b>	691041	<b>Ref. No.</b>	R660501
<b>description</b>	window gasket profile 1505 L 1700mm suitable for FAGOR Qty 1		



<b>GEV No.</b>	691042	<b>Ref. No.</b>	R670528
<b>description</b>	window gasket profile 1505 L 2800mm suitable for FAGOR Qty 1		

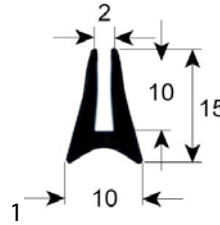

<b>GEV No.</b>	900835	<b>Ref. No.</b>	11000086 3715200
<b>description</b>	window gasket profile 1605 Qty supplied by meter		

**For models:** COE-061, COE-101, COE-102, COE-201, COE-202, COG-061, COG-101, COG-102, COG-201, COG-202, HCG-10-11, HCG-10-21, HCG-20-11, HCG-20-21, HCG-2-10-11, HCG-2-20-11, HCG-6-11, HEI-10-11, HEI-10-21, HEI-20-11, HEI-20-21, HEI-6-11, HEM-10-11, HEM-10-21, HEM-20-11, HEM-20-21, HEM-6-11, HEP-10-11, HEP-10-21, HEP-20-11, HEP-20-21, HEP-6-11, HGC-10-11, HGC-10-21, HGC-20-11, HGC-20-21, HGC-6-11, HGP-10-21, HGP-20-21, HGV-10-11, HGV-10-21, HGV-20-11, HGV-20-21, HME-10-11, HME-10-21, HME-20-11, HME-20-21, HME-2-10-11, HME-2-20-11, HME-6-11...(Other models you can see in the webshop)

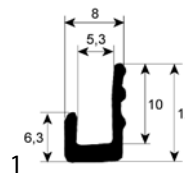

<b>GEV No.</b>	691038	<b>Ref. No.</b>	11000173 R660500
<b>description</b>	window gasket profile 1905 L 2500mm Qty 1		

**For models:** HCG-6-11, HME-6-11, HMG-6-11, HMI-6-11, HMI-6-11UL, HMM-6-11, HMM-6-11UL, HMP-6-11





<b>GEV No.</b>	691096	<b>Ref. No.</b>	R670529
<b>description</b>	window gasket profile 1905 L 3000mm suitable for FAGOR Qty 1 mounting pos. inner		



<b>GEV No.</b>	691040	<b>Ref. No.</b>	R680515
<b>description</b>	window gasket profile 1905 L 4000mm Qty 1		



1 			
<b>GEV No.</b>	691061	<b>Ref. No.</b>	R090515
<b>description</b>	window gasket profile 1905 L 4100mm suitable for FAGOR Qty 1 mounting pos. inner		

 Image not available 1			
<b>GEV No.</b>	691063	<b>Ref. No.</b>	R140508
<b>description</b>	window gasket profile 1905 L 4600mm suitable for FAGOR Qty 1 mounting pos. inner		

door seals

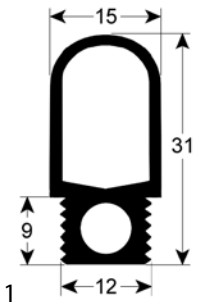
 1			
<b>GEV No.</b>	901706	<b>Ref. No.</b>	12024276 T490500
<b>description</b>	door seal profile 2048 W 675mm L 1450mm external size		
<b>For models:</b>	COE-202, COG-202, HEI-20-21, HEM-20-21, HEP-20-21, HGC-20-21, HGP-20-21, HGV-20-21, VE-202, VG-202, VPE-202, VPG-202		

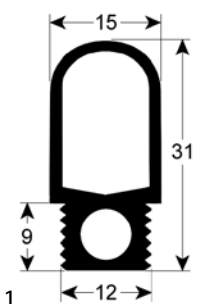
 1			
<b>GEV No.</b>	901707	<b>Ref. No.</b>	12023944 T300500
<b>description</b>	door seal profile 2048 W 675mm L 775mm external size		
<b>For models:</b>	COE-102, COG-102, HEI-10-21, HEM-10-21, HEP-10-21, HGC-10-21, HGP-10-21, HGV-10-21, VE-102, VG-102, VPE-102, VPG-102		

 1			
<b>GEV No.</b>	691035	<b>Ref. No.</b>	12024187 R660503
<b>description</b>	door seal profile 2270 W 465mm L 650mm external size Qty 1		
<b>For models:</b>	COE-061, COG-061, HCG-6-11, HEI-6-11, HEM-6-11, HEP-6-11, HGC-6-11, HME-6-11, HMG-6-11, HMI-6-11, HMI-6-11UL, HMM-6-11, HMM-6-11UL, HMP-6-11, VE-061, VPE-061		

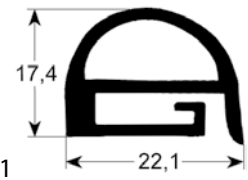
 1			
<b>GEV No.</b>	691055	<b>Ref. No.</b>	12007972 R090510
<b>description</b>	door seal profile 2270 W 650mm L 1300mm external size Qty 1		
<b>For models:</b>	COE-201, COG-201, HCG-20-11, HEI-20-11, HEM-20-11, HEP-20-11, HGC-20-11, HGV-20-11, HME-20-11, HMG-20-11, HMM-20-11, HMM-20-11UL, HMP-20-11, HVG-20-11, MFHMM-20-11, VE-201, VG-201, VPE-201, VPG-201		

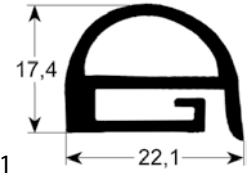
 1			
<b>GEV No.</b>	691036	<b>Ref. No.</b>	12024186 R670500
<b>description</b>	door seal profile 2270 W 650mm L 705mm external size Qty 1		
<b>For models:</b>	COE-101, COG-101, HCG-10-11, HEI-10-11, HEM-10-11, HEP-10-11, HGC-10-11, HGV-10-11, HME-10-11, HMG-10-11, HMG-10-11UL, HMI-10-11, HMI-10-11UL, HMM-10-11, HMM-10-11UL, HMP-10-11, HVG-10-11, HVG-10-11UL, HVG-2-10-11, MFHVG-10-11, VE-101, VG-101, VPE-101, VPG-101		

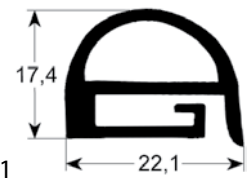
 1			
<b>GEV No.</b>	691062	<b>Ref. No.</b>	12017241 R140506
<b>description</b>	door seal profile 2270 W 775mm L 1300mm external size Qty 1		
<b>For models:</b>	HCG-20-21, HCG-2-20-11, HME-20-21, HME-2-20-11, HMM-20-21, HMM-20-21UL, HMM-2-20-11, HMM-40-11-USMC, HMP-20-21, HMP-2-20-11, HVG-20-21, HVG-2-20-21		

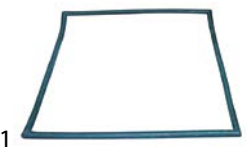
 1			
<b>GEV No.</b>	691069	<b>Ref. No.</b>	12017439 R680500
<b>description</b>	door seal profile 2270 W 775mm L 705mm external size Qty 1		
<b>For models:</b>	HCG-10-11, HCG-10-21, HCG-2-10-11, HME-10-21, HME-2-10-11, HMG-10-11, HMG-10-21, HMG-10-21UL, HMG-2-10-11, HMI-10-21, HMI-10-21UL, HMI-2-10-11, HMM-10-21, HMM-10-21UL, HMM-2-10-11, HMP-10-21, HMP-2-10-11, HVG-10-21, HVG-10-21UL, MFH-VG-10-21		

<b>GEV No.</b>	902219	<b>Ref. No.</b>	12028909 RT51051020
<b>description</b>	door seal profile 2730 W 465mm L 520mm external size Qty 1		

<b>GEV No.</b>	902248	<b>Ref. No.</b>	12038090 RT2000399P
<b>description</b>	door seal profile 2730 W 675mm L 1475mm suitable for RATIONAL for model SCC/CM202 outer plug size		

<b>GEV No.</b>	902246	<b>Ref. No.</b>	12028517 RT2000398P
<b>description</b>	door seal profile 2730 W 470mm L 1475mm suitable for RATIONAL for model SCC/CM201 outer plug size Qty 1		

<b>GEV No.</b>	902197	<b>Ref. No.</b>	12041578
<b>description</b>	door seal profile 2730 W 675mm L 775mm		
<b>For models:</b>	ACE-102, ACG-102, AE-102, AE-102W, AG-102, AG-102W, APE-102, APE-102W, APG-102, APG-102W		

<b>GEV No.</b>	902221	<b>Ref. No.</b>	12029172 12029261 RT2000394 RT2000394P
<b>description</b>	door seal profile 2730 W 470mm L 500mm suitable for RATIONAL for model SCC/CM 61 outer plug size Qty 1		

<b>GEV No.</b>	900292	<b>Ref. No.</b>	RT51051022
<b>description</b>	door seal profile 2730 W 685mm L 780mm outer plug size		

<b>GEV No.</b>	902247	<b>Ref. No.</b>	12028537 RT51051021
<b>description</b>	door seal profile 2730 W 470mm L 785mm suitable for RATIONAL for model CPC 101 outer plug size Qty 1		

<b>GEV No.</b>	902220	<b>Ref. No.</b>	12028287 RT51051022P
<b>description</b>	door seal profile 2730 W 685mm L 780mm suitable for RATIONAL for model SCC/CM102 edition since 11/2011 outer plug size		

 <p>Image not available</p>			
<b>GEV No.</b>	902222	<b>Ref. No.</b>	12028152 12028843 RT2000396 RT2000396P
<b>description</b>	door seal profile 2731 W 470mm L 760mm suitable for RATIONAL for model SCC/CM 101 edition since 05/2011 outer plug size		

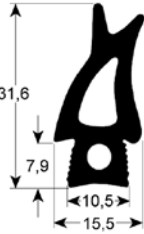
			
<b>GEV No.</b>	902480	<b>Ref. No.</b>	12039475 T800550000
<b>description</b>	door seal profile 2732 W 460mm L 770mm outer plug size for combi-steamer suitable for FAGOR		
<b>For models:</b>	ACE-101, ACG-101, AE-101, AE-101W, AG-101, AG-101W, APE-101, APE-101W, APG-101, APG-101W		

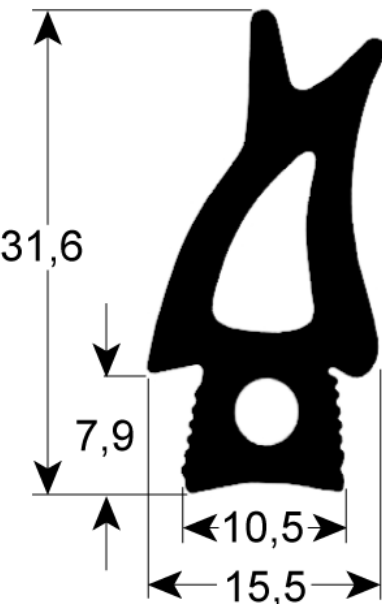
			
<b>GEV No.</b>	902555	<b>Ref. No.</b>	12041134 T740563000
<b>description</b>	door seal profile 2732 W 470mm L 1150mm outer plug size Qty 1 suitable for FAGOR		
<b>For models:</b>	ACE-201, ACG-201, AE-201, AG-201, APE-201, APG-201		

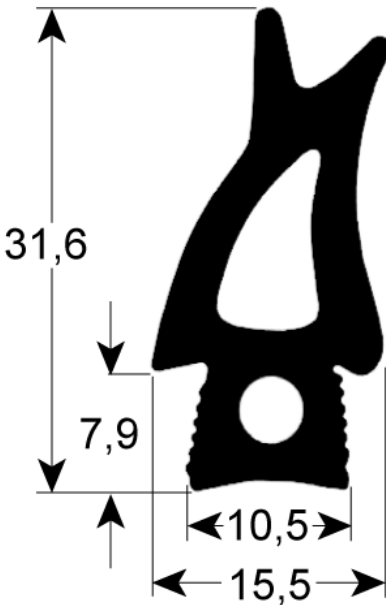
			
<b>GEV No.</b>	902554	<b>Ref. No.</b>	12039599 T910550000
<b>description</b>	door seal profile 2732 W 470mm L 500mm Qty 1 for model outer plug size suitable for FAGOR		
<b>For models:</b>	ACE-061, ACG-061, AE-061, AE-061W, AG-061, AG-061W, APE-061, APE-061W, APG-061, APG-061W		

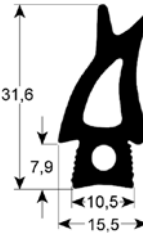
			
<b>GEV No.</b>	902223	<b>Ref. No.</b>	12027994 RT51051023
<b>description</b>	door seal profile 2732 W 485mm L 1495mm external size Qty 1		

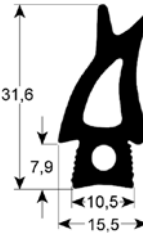
			
<b>GEV No.</b>	902250	<b>Ref. No.</b>	12027846 RT51051024
<b>description</b>	door seal profile 2732 W 680mm L 1495mm suitable for RATIONAL for model CPC 202 outer plug size		

<b>GEV No.</b>	902249	<b>Ref. No.</b>	12029014 RT2000397P
<b>description</b>	door seal profile 2733 W 675mm L 760mm suitable for RATIONAL for model SCC/CM102 edition since 05/2011 outer plug size		

<b>GEV No.</b>	902060	<b>Ref. No.</b>	12009413
<b>description</b>	door seal W 10mm L 1650mm Qty 1		
<b>For models:</b>	CGB7-61, CGB7-61H, CGB7-61R, CGB7-61RH		

door seals with fixing hook

<b>GEV No.</b>	691027	<b>Ref. No.</b>	12020663 U745626
<b>description</b>	door seal W 500mm long side open with 4 mounting clips H 290mm		
<b>For models:</b>	CE7-41, CE9-41, CG-1002, CG-1502, CG-2002, CG-210, CG-210G, CG-310, CG-310G, CG7-11, CG7-41, CG7-61, CG9-11, CG9-41, CG9-51L, CG9-51LC, CG9-51R, CG9-51RC, CG9-61, CG9-82, CGE7-160, CGE7-41, CGE9-41, FTG9-11L, FTG9-11L+R, FTG9-11R, FTGC9-11L, FTGC9-11L+R, FTGC9-11R, HE9-10, HE9-20, HG9-10, HG9-20		

<b>GEV No.</b>	901705	<b>Ref. No.</b>	12008213
<b>description</b>	door seal W 520mm with 4 mounting clips H 300mm		
<b>For models:</b>	CE7-41, CE9-41, CG-1002, CG-1502, CG-2002, CG-2002P, CG-210, CG-210G, CG-310, CG-310G, CG7-11, CG7-31D, CG7-31I, CG7-41, CG7-41H, CG7-51, CG7-61, CG7-61H, CG9-11, CG9-41, CG9-41H, CG9-51L, CG9-51LC, CG9-51R, CG9-51RC, CG9-61, CG9-61H, CG9-82, CGE7-41, CGE7-41H, CGE9-11, CGE9-41, CGF9-121D, CGF9-121I, FTG9-11L, FTG9-11L+R, FTG9-11R, FTGC9-11L, FTGC9-11L+R, FTGC9-11R, HE9-10, HE9-20, HG9-10, HG9-20		

<b>GEV No.</b>	901429	<b>Ref. No.</b>	12009146 U105605
<b>description</b>	door seal W 900mm with 6 mounting clips H 340mm long side open		
<b>For models:</b>	CG9-61OP, HG9-15		

gaskets for tray rack trolleys

<b>GEV No.</b>	902440	<b>Ref. No.</b>	12007990
<b>description</b>	tray rack trolley gasket L 705mm suitable for FAGOR Qty 1		

<b>GEV No.</b>	902229	<b>Ref. No.</b>	12031433 RT51051025
<b>description</b>	tray rack trolley gasket profile 4090 L 615mm Qty 1		

<b>GEV No.</b>	902230	<b>Ref. No.</b>	12030369 RT51051026
<b>description</b>	tray rack trolley gasket profile 4090 L 820mm Qty 1		

<b>GEV No.</b>	902231	<b>Ref. No.</b>	12031375 RT2400187
<b>description</b>	tray rack trolley gasket profile 4095 L 575mm Qty 1		

<b>GEV No.</b>	902232	<b>Ref. No.</b>	12028867 RT2400194
<b>description</b>	tray rack trolley gasket profile 4095 L 780mm Qty 1		

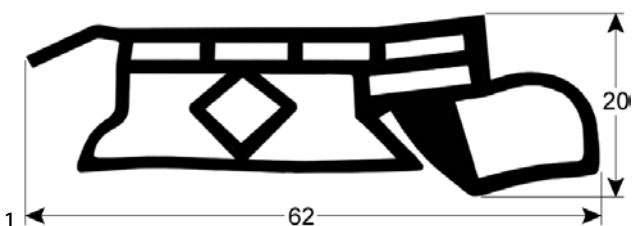

<b>GEV No.</b>	902553	<b>Ref. No.</b>	12041088 T740562000
<b>description</b>	tray rack trolley gasket profile 4160 L 510mm suitable for FAGOR Qty 1		
<b>For models:</b>	ACE-201, ACG-201, AE-201, AG-201, APE-201, APG-201		

**gaskets for control panels**



<b>GEV No.</b>	900575	<b>Ref. No.</b>	12032981 RT1600387
<b>description</b>	gasket for control panel		

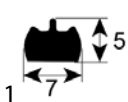

<b>GEV No.</b>	901454	<b>Ref. No.</b>	12034523 RT51001011
<b>description</b>	gasket for control panel L 2000mm foam rubber self-adhesive		

**boiling pan gaskets**

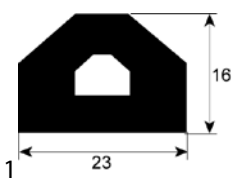

<b>GEV No.</b>	900514	<b>Ref. No.</b>	12026686 ICRE30100030
<b>description</b>	boiling pan gasket profile 3020 L 3200mm		

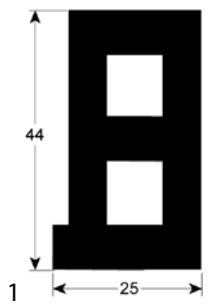

<b>GEV No.</b>	900908	<b>Ref. No.</b>	12009435
<b>description</b>	lid gasket ED ø 65mm		
<b>For models:</b>	MPE9-10BM, MPE9-10BMS, MPE9-15BM, MPE9-15BMS, MPG9-10, MPG9-10BM, MPG9-10BMS, MPG9-10S, MPG9-15, MPG9-15BM, MPG9-15BMS, MPG9-15S, MPG9-20, MPG9-20S		

**O-rings**

**EPDM**

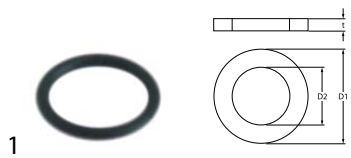

<b>GEV No.</b>	529545	<b>Ref. No.</b>	12009911 Q307056
<b>description</b>	O-ring EPDM thickness 1.78mm ID ø 10.82mm Qty 1 pcs		
<b>For models:</b>	AD-15, AD-15D, AD-20C-UK, AD-21, AD-21B, AD-21BDD, AD-21C, AD-21D, AD-21DD, AD-21W, CO-350, CO-350-B, CO-350-B-DD, CO-350-COLD, CO-350-COLD-B, CO-350-COLD-B-DD, CO-350-COLD-DD, CO-350-DD, CO-352-COLD, CO-352-COLD-B, CO-352-COLD-B-DD, CO-352-COLD-DD, CO-400, CO-400-B, CO-400-B-DD, CO-400-COLD, CO-400-COLD-B, CO-400-COLD-B-DD, CO-400-COLD-DD, CO-400-DD, CO-400-SOFT, CO-402-COLD, CO-402-COLD-B, CO-402-COLD-B-DD, CO-402-COLD-DD, CO-402W, LVC-12, LVC-15, LVC-15D, LVC-21, LVC-21B, LVC-21C, LVC-21D, LVC-21W, MF-21		

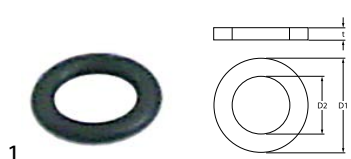

<b>GEV No.</b>	505045	<b>Ref. No.</b>	12009912 Q307036
<b>description</b>	O-ring EPDM thickness 1.78mm ID ø 5.28mm Qty 1 pcs		
<b>For models:</b>	AD-15, AD-15D, AD-90, AD-90BA, AD-90BDD, AD-90DD, COG-202, EASY-500, EASY-500B, EASY-500DD, EASY-500HP, EASY-500HPWBDD, FI-30, FI-30AR, FI-30AR+DD, FI-30B, FI-30B-BT-UK, FI-30-UK, FI-48, FI-48AR, FI-48B, FI-48B-BT-UK, FI-48C, FI-48D, FI-48HY-CLINIC, FI-48W, FI-60DD, FI-80, FI-80AR, FI-80W, FI-E-100, HGC-20-21, HGP-10-21, HGP-20-21, HGV-20-21, LABP-800, LF-13MPP, LF-18MPP, LF-25MPP, LF-8MPP, LVC-12, LVC-15, LVC-15D, LVC-21, LVC-21B, LVC-21D, LVC-21W, LVR-10, LVR-14, LVR-20...(Other models you can see in the webshop)		

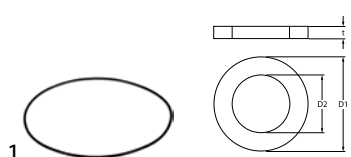

<b>GEV No.</b>	532731	<b>Ref. No.</b>	12037437 RT50120565
<b>description</b>	O-ring EPDM thickness 2.5mm ID ø 115mm Qty 5 pcs suitable for combi-steamer CPC-Linie		



<b>GEV No.</b>	529412	<b>Ref. No.</b>	12009873 Q307003
<b>description</b>	O-ring EPDM thickness 2.62mm ID $\varnothing$ 107.8mm Qty 1 pcs		
<b>For models:</b>	AD-120, AD-120B, AD-120BBTDD-UK, AD-120C, AD-120CW, AD-120HY, AD-15, AD-15D, AD-20C-UK, AD-21, AD-21B, AD-21BDD, AD-21C, AD-21D, AD-21DD, AD-21W, AD-45BBT, AD-48, AD-48B, AD-48BDD, AD-48C, AD-48D, AD-48DD, AD-48HY, AD-48W, AD-64, AD-64B, AD-64BBT, AD-64BDD, AD-64BTDD, AD-64C, AD-64CW, AD-64D, AD-64DD, AD-64HY, AD-72, AD-72W, AD-90, AD-90BA, AD-90BBT, AD-90BDD, AD-90DD, ADE-120, ADE-120B, CO-350, CO-350-B, CO-350-B-DD, CO-350-COLD, CO-350-COLD-B, CO-350-COLD-B-DD... (Other models you can see in the webshop)		

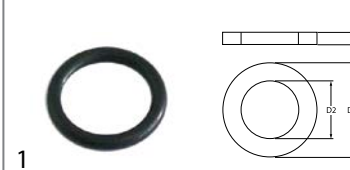

<b>GEV No.</b>	507313	<b>Ref. No.</b>	12009837 Q307050
<b>description</b>	O-ring EPDM thickness 2.62mm ID $\varnothing$ 139.5mm Qty 1 pcs		
<b>For models:</b>	AD-120, AD-120B, AD-120BBTDD-UK, AD-120C, AD-120CW, AD-120HY, AD-45BBT, AD-48, AD-48B, AD-48BDD, AD-48C, AD-48D, AD-48DD, AD-48HY, AD-48W, AD-64, AD-64B, AD-64BBT, AD-64BDD, AD-64BTDD, AD-64C, AD-64CW, AD-64D, AD-64DD, AD-64HY, AD-72, AD-72W, AD-90, AD-90BA, AD-90BBT, AD-90BDD, AD-90DD, ADE-120, ADE-120B, BME7-05, BME7-10, BME9-05, BME9-10, BMG7-10, BMG9-05, BMG9-10, EASY-500, EASY-500B, EASY-500DD, EASY-500HP, EASY-500HPWDD, ECO-120, ECO-120B, FI-100, FI-100AR... (Other models you can see in the webshop)		

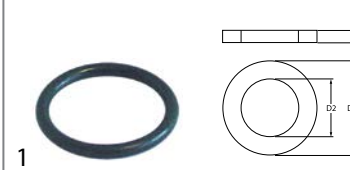

<b>GEV No.</b>	505073	<b>Ref. No.</b>	12010282 Q307041
<b>description</b>	O-ring EPDM thickness 2.62mm ID $\varnothing$ 206.3mm Qty 1 pcs		
<b>For models:</b>	AD-15, AD-15D, AD-20C-UK, AD-21, AD-21B, AD-21BDD, AD-21C, AD-21D, AD-21W, CG-1002, CG-1502, CG-2000, CG-2000-2P, CG-2002, CG-2002P, CG9-11, CG9-11AD, CG9-11PLUS, CG9-31PLUS-D, CG9-31PLUS-I, CG9-41, CG9-41AD, CG9-41AD-H, CG9-41H, CG9-41PLUS, CG9-41PLUS-H, CG9-51L, CG9-51LC, CG9-51R, CG9-51RC, CG9-61, CG9-61AD, CG9-61AD-H, CG9-61H, CG9-61OP, CG9-61PLUS, CG9-61PLUS-H, CG9-82, CG9-82AD, CG9-82PLUS, CGF9-121D, CGF9-121D-AD, CGF9-121I, CGF9-121PLUS-D, CGF9-121PLUS-I, FF-35, FI-5420, FI-7630, FTG9-11L, FTG9-11L+R... (Other models you can see in the webshop)		

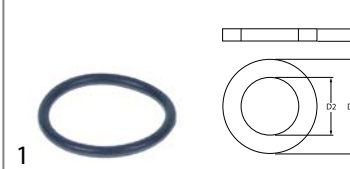

<b>GEV No.</b>	532499	<b>Ref. No.</b>	12010230 Q307062
<b>description</b>	O-ring EPDM thickness 2.62mm ID $\varnothing$ 234.7mm Qty 1 pcs		
<b>For models:</b>	ECO-160, ECO-160D, ECO-160I, ECO-200, ECO-200D, ECO-200H, ECO-200HD, ECO-200HI, ECO-200I, FI-160, FI-160AR, FI-160D, FI-160I, FI-200, FI-200AR, FI-200D, FI-200H, FI-200HD, FI-200HI, FI-200I, FI-200W, FI-200WL, FI-200WR		

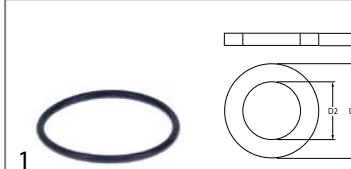

<b>GEV No.</b>	532494	<b>Ref. No.</b>	12010165 Q307051 Q307061
<b>description</b>	O-ring EPDM thickness 2.62mm ID $\varnothing$ 36.14mm Qty 1 pcs		
<b>For models:</b>	AD-120, AD-120B, AD-120BBTDD-UK, AD-120C, AD-120CW, AD-120HY, AD-45BBT, AD-48, AD-48B, AD-48BDD, AD-48C, AD-48D, AD-48DD, AD-48HY, AD-48W, AD-64, AD-64B, AD-64BBT, AD-64BDD, AD-64BTDD, AD-64C, AD-64CW, AD-64D, AD-64DD, AD-64HY, AD-72, AD-72W, AD-90, AD-90BA, AD-90BBT, AD-90BDD, AD-90DD, ADE-120, ADE-120B, EASY-500, EASY-500B, EASY-500DD, EASY-500HP, ECO-120, ECO-120B, ECO-160, ECO-160D, ECO-160I, ECO-200, ECO-200D, ECO-200H, ECO-200HD, ECO-200HI, ECO-200I, ECO-2700D... (Other models you can see in the webshop)		



<b>GEV No.</b>	532546	<b>Ref. No.</b>	12010184 Q307064
<b>description</b>	O-ring EPDM thickness 2.62mm ID $\varnothing$ 52.07mm Qty 1 pcs		
<b>For models:</b>	ECO-280D, ECO-280I, ECO-370D, ECO-370I, ECO-460D, ECO-460I, ECO-550D, ECO-550I, FI-280D, FI-280I, FI-370D, FI-370I, FI-460D, FI-460I, FI-550D, FI-550I		

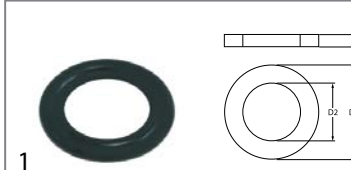

<b>GEV No.</b>	532102	<b>Ref. No.</b>	12010234 Q307063
<b>description</b>	O-ring EPDM thickness 3.53mm ID $\varnothing$ 12.29mm Qty 10 pcs		
<b>For models:</b>	ECO-160, ECO-160D, ECO-160I, ECO-200, ECO-200D, ECO-200H, ECO-200HD, ECO-200HI, ECO-200I, ECO-2700D, ECO-2700I, ECO-280D, ECO-280I, ECO-370D, ECO-370I, ECO-4000D, ECO-4000I, ECO-460D, ECO-460I, ECO-550D, ECO-550I, ECO-6000D, ECO-6000I, FI-160, FI-160AR, FI-160D, FI-160I, FI-200, FI-200AR, FI-200D, FI-200H, FI-200HD, FI-200HI, FI-200I, FI-200W, FI-200WL, FI-200WR, FI-2700D, FI-2700I, FI-280D, FI-280I, FI-370D, FI-370I, FI-4000D, FI-4000I, FI-460D, FI-460I, FI-550D, FI-550I, FI-6000D... (Other models you can see in the webshop)		

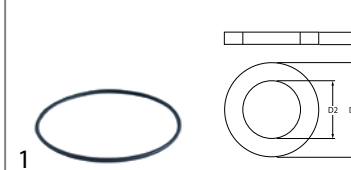

<b>GEV No.</b>	532151	<b>Ref. No.</b>	12021011 Z201084
<b>description</b>	O-ring EPDM thickness 3.53mm ID $\varnothing$ 120.2mm Qty 10 pcs		
<b>For models:</b>	ECO-120, ECO-120B, FI-100, FI-100AR, FI-100B, FI-120, FI-120B, FI-120W, MF-120		





<b>GEV No.</b>	532103	<b>Ref. No.</b>	12049214
<b>description</b>	O-ring EPDM thickness 3.53mm ID $\varnothing$ 13.87mm Qty 10 pcs		
<b>For models:</b>	AD-125, AD-125HRS, AD-125-SOFT, CO-110, CO-110B, CO-110BDD, CO-110DD, CO-112, CO-112B, CO-112BDD, CO-112DD, CO-170, CO-170B, CO-170BDD, CO-170DD, CO-170HRS, CO-170HRSDD, CO-170HRS-SOFT, CO-170-SOFT, CO-172, CO-172B, CO-172BDD, CO-172DD, COP-173, COP-173B, COP-173BDD, COP-173DD, COP-173HRS, COP-173HRSDD, COP-173-SOFT, COP-174, COP-174B, COP-174BDD, COP-174DD, COP-174HRS, COP-174HRSDD		

<b>GEV No.</b>	505180	<b>Ref. No.</b>	12010118 Q307057
<b>description</b>	O-ring EPDM thickness 3.53mm ID $\varnothing$ 47.22mm Qty 1 pcs		
<b>For models:</b>	AD-120, AD-120B, AD-120BBTDD-UK, AD-120C, AD-120CW, AD-120HY, AD-90, AD-90BA, AD-90BBT, AD-90BDD, AD-90DD, ADE-120, ADE-120B, ECO-120, ECO-120B, ECO-160, ECO-160D, ECO-160I, ECO-200, ECO-200D, ECO-200H, ECO-200HD, ECO-200HI, ECO-200I, ECO-280D, ECO-280I, ECO-370D, ECO-370I, ECO-460D, ECO-460I, ECO-550D, ECO-550I, FI-100, FI-100AR, FI-100B, FI-100BBT-UK, FI-120, FI-120AR+DD, FI-120B, FI-120C, FI-120HY-CLINIC, FI-120W, FI-160, FI-160D, FI-160I, FI-200, FI-200D, FI-200H, FI-200HD, FI-200HI... (Other models you can see in the webshop)		

<b>GEV No.</b>	505152	<b>Ref. No.</b>	12009666 Q307000
<b>description</b>	O-ring EPDM thickness 3.53mm ID $\varnothing$ 29mm Qty 1 pcs		
<b>For models:</b>	ECO-1200, ECO-1600, ECO-2300, ECO-3000, FE-18, FE-25, FI-1200, FI-1600, FI-2300, FI-3000, FI-300B, FI-300R, FI-650R, FI-900		

<b>GEV No.</b>	532498	<b>Ref. No.</b>	12010256 Q307048
<b>description</b>	O-ring EPDM thickness 3.53mm ID $\varnothing$ 9.12mm Qty 1 pcs		
<b>For models:</b>	AD-120, AD-120B, AD-120BBTDD-UK, AD-120C, AD-120CW, AD-120HY, AD-45BBT, AD-48, AD-48B, AD-48BDD, AD-48C, AD-48D, AD-48DD, AD-48HY, AD-48W, AD-64, AD-64B, AD-64BBT, AD-64BDD, AD-64BTDD, AD-64C, AD-64CW, AD-64D, AD-64DD, AD-64HY, AD-72, AD-72W, AD-90, AD-90BA, AD-90BBT, AD-90BDD, AD-90DD, ADE-120, ADE-120B, EASY-500, EASY-500B, EASY-500DD, EASY-500HP, EASY-500HPWBDD, ECO-120, ECO-1200, ECO-120B, ECO-160, ECO-1600, ECO-160D, ECO-160I, ECO-200, ECO-200D, ECO-200H, ECO-200HD... (Other models you can see in the webshop)		

<b>GEV No.</b>	512511	<b>Ref. No.</b>	12115850
<b>description</b>	O-ring EPDM thickness 3.53mm ID $\varnothing$ 32mm Qty 10 pcs		
<b>For models:</b>	CO-500, CO-500B, CO-500BDD, CO-500DD, CO-501, CO-501B, CO-501BDD, CO-501DD, CO-501-SOFT, CO-502B, CO-502BDD, CO-502DD, CO-502W, COP-503, COP-503B, COP-503BDD, COP-503DD, COP-503-SOFT, COP-504, COP-504B, COP-504BDD, COP-504DD, COP-504W		

<b>GEV No.</b>	532548	<b>Ref. No.</b>	12010176 Q307068
<b>description</b>	O-ring EPDM thickness 3mm ID $\varnothing$ 27mm Qty 1 pcs		
<b>For models:</b>	ECO-2700D, ECO-2700I, ECO-280D, ECO-280I, ECO-370D, ECO-370I, ECO-4000D, ECO-4000I, ECO-460D, ECO-460I, ECO-550D, ECO-550I, ECO-6000D, ECO-6000I, FI-2700D, FI-2700I, FI-280D, FI-280I, FI-370D, FI-370I, FI-4000D, FI-4000I, FI-460D, FI-460I, FI-550D, FI-550I, FI-6000D, FI-6000I		

<b>GEV No.</b>	506015	<b>Ref. No.</b>	12024031 Z471109
<b>description</b>	O-ring EPDM thickness 3.53mm ID $\varnothing$ 39.69mm Qty 1 pcs		
<b>For models:</b>	AD-15D, AD-21D, AD-48D, AD-64D, CO-400-SOFT, FI-48, FI-48AR, FI-48B, FI-48B-BT-UK, FI-48C, FI-48D, FI-48HY-CLINIC, FI-48W, FI-64, FI-64AR, FI-64B, FI-64B-BT-UK, FI-64C, FI-64D, FI-64HY-CLINIC, FI-64W, LVC-15D, LVC-21D		

<b>GEV No.</b>	505092	<b>Ref. No.</b>	12010062 12016701 Q307053 S312113
<b>description</b>	O-ring EPDM thickness 5.34mm ID $\varnothing$ 43.82mm Qty 1 pcs		
<b>For models:</b>	AD-15, AD-15D, AD-20C-UK, AD-21, AD-21B, AD-21BDD, AD-21C, AD-21D, AD-21DD, AD-21W, LVC-12, LVC-15, LVC-15D, LVC-21, LVC-21B, LVC-21C, LVC-21D, LVC-21W, LVR-10, LVR-14, LVR-14D, LVR-20, LVR-20B, LVR-20D, MF-21		



<b>GEV No.</b>	510408	<b>Ref. No.</b>	12039760 eu456002 Q307020
<b>description</b>	O-ring EPDM thickness 5.34mm ID ø 47mm Qty 1 pcs		
<b>For models:</b>	ECO-1200, FI-1200, FI-300B, FI-300R, FI-650R, FI-900		



<b>GEV No.</b>	505175	<b>Ref. No.</b>	12010079 Q307052
<b>description</b>	O-ring EPDM thickness 5.34mm ID ø 50.16mm Qty 1 pcs		
<b>For models:</b>	AD-15, AD-15D, AD-20C-UK, AD-21, AD-21B, AD-21BDD, AD-21C, AD-21D, AD-21DD, AD-21W, AD-45BBT, AD-48, AD-48B, AD-48BDD, AD-48C, AD-48D, AD-48DD, AD-48HY, AD-48W, AD-64, AD-64B, AD-64BBT, AD-64BDD, AD-64BTDD, AD-64C, AD-64CW, AD-64D, AD-64DD, AD-64HY, AD-72, AD-72W, CO-350, CO-350-B, CO-350-B-DD, CO-350-COLD, CO-350-COLD-B, CO-350-COLD-B-DD, CO-350-COLD-DD, CO-350-DD, CO-352-COLD, CO-352-COLD-B, CO-352-COLD-B-DD, CO-352-COLD-DD, CO-400, CO-400-B, CO-400-B-DD, CO-400-COLD, CO-400-COLD-B, CO-400-COLD-B-DD, CO-400-COLD-DD...(Other models you can see in the webshop)		



<b>GEV No.</b>	510409	<b>Ref. No.</b>	12010040 Q307044
<b>description</b>	O-ring EPDM thickness 5.34mm ID ø 56.52mm Qty 1 pcs		
<b>For models:</b>	ECO-160, ECO-1600, ECO-160D, ECO-160I, ECO-200, ECO-200D, ECO-200H, ECO-200HD, ECO-200HI, ECO-200I, ECO-2300, ECO-2700D, ECO-2700I, ECO-280D, ECO-280I, ECO-3000, ECO-370D, ECO-370I, ECO-4000D, ECO-4000I, ECO-460D, ECO-460I, ECO-550D, ECO-550I, ECO-6000D, ECO-6000I, FI-160, FI-1600, FI-160AR, FI-160D, FI-160I, FI-200, FI-200AR, FI-200D, FI-200H, FI-200HD, FI-200HI, FI-200I, FI-200W, FI-200WL, FI-200WR, FI-2300, FI-2700D, FI-2700I, FI-280D, FI-280I, FI-3000, FI-370D, FI-370I, FI-4000D...(Other models you can see in the webshop)		



<b>GEV No.</b>	691033	<b>Ref. No.</b>	12010051 Q307035
<b>description</b>	O-ring EPDM thickness 5.34mm ID ø 62.87mm Qty 1 pcs		
<b>For models:</b>	AD-120, AD-120B, AD-120BBTDD-UK, AD-120C, AD-120HY, AD-45BBT, AD-48, AD-48B, AD-48BDD, AD-48C, AD-48D, AD-48DD, AD-48HY, AD-48W, AD-64, AD-64B, AD-64BBT, AD-64BDD, AD-64BTDD, AD-64C, AD-64CW, AD-64D, AD-64DD, AD-64HY, AD-72, AD-72W, AD-90, AD-90BA, AD-90BBT, AD-90BDD, AD-90DD, CO-110, CO-110B, CO-110BDD, CO-110DD, CO-112, CO-112B, CO-112BDD, CO-112DD, CO-142W, CO-142WDD, CO-170, CO-170B, CO-170BDD, CO-170DD, CO-170HRS, CO-170HRSDD, CO-170HRS-SOFT, CO-170-SOFT, CO-172...(Other models you can see in the webshop)		



<b>GEV No.</b>	505178	<b>Ref. No.</b>	12009976 Q307049
<b>description</b>	O-ring EPDM thickness 5.34mm ID ø 85.09mm Qty 1 pcs		
<b>For models:</b>	AD-45BBT, AD-48, AD-48B, AD-48BDD, AD-48C, AD-48D, AD-48DD, AD-48HY, AD-48W, AD-64, AD-64B, AD-64BBT, AD-64BDD, AD-64BTDD, AD-64C, AD-64CW, AD-64D, AD-64DD, AD-64HY, AD-72, AD-72W, EASY-500, EASY-500B, EASY-500DD, EASY-500HP, EASY-500HPWBDD, FI-30, FI-30AR, FI-30AR+DD, FI-30B, FI-30B-BT-UK, FI-30-UK, FI-48, FI-48AR, FI-48B, FI-48B-BT-UK, FI-48C, FI-48D, FI-48HY-CLINIC, FI-48W, FI-50, FI-60DD, FI-64, FI-64AR, FI-64B, FI-64B-BT-UK, FI-64C, FI-64D, FI-64HY-CLINIC, FI-64W...(Other models you can see in the webshop)		



<b>GEV No.</b>	532639	<b>Ref. No.</b>	12009995 Q307045
<b>description</b>	O-ring EPDM thickness 5.34mm ID ø 94.62mm Qty 1 pcs		
<b>For models:</b>	ECO-160, ECO-1600, ECO-160D, ECO-160I, ECO-200, ECO-200D, ECO-200H, ECO-200HD, ECO-200HI, ECO-200I, ECO-2300, ECO-280D, ECO-280I, ECO-3000, ECO-370D, ECO-370I, ECO-460D, ECO-460I, ECO-550D, ECO-550I, FI-160, FI-1600, FI-160AR, FI-160D, FI-160I, FI-200, FI-200AR, FI-200D, FI-200H, FI-200HD, FI-200HI, FI-200I, FI-200W, FI-200WL, FI-200WR, FI-2300, FI-280D, FI-280I, FI-3000, FI-370D, FI-370I, FI-460D, FI-460I, FI-550D, FI-550I		

silicone

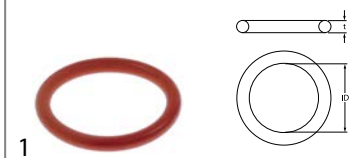

<b>GEV No.</b>	532727	<b>Ref. No.</b>	12037152 RT1000512
<b>description</b>	O-ring silicone thickness 3.5mm ID ø 26mm Qty 5 pcs for model SCC, CM		

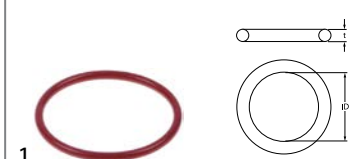

<b>GEV No.</b>	532728	<b>Ref. No.</b>	12037113 RT1000511
<b>description</b>	O-ring silicone thickness 3.5mm ID ø 46mm Qty 5 pcs for model SCC, CM		



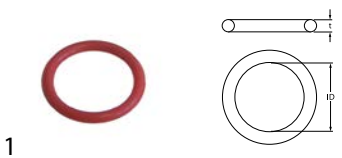

<b>GEV No.</b>	512414	<b>Ref. No.</b>	12036812 RT50120560
<b>description</b>	O-ring silicone thickness 3mm ID ø 47.5mm Qty 5 pcs		

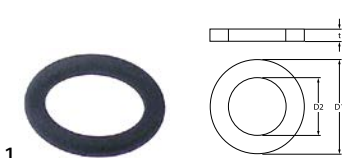

<b>GEV No.</b>	532519	<b>Ref. No.</b>	12021028 S042108
<b>description</b>	O-ring silicone thickness 5.34mm ID ø 53.34mm Qty 1 pcs		

### Viton



<b>GEV No.</b>	530027	<b>Ref. No.</b>	12017304 X012127
<b>description</b>	O-ring Viton thickness 3mm ID ø 14mm Qty 1 pcs		
<b>For models:</b>	FE-710, FE-720, FE-920, FG-710, FG-71-15, FG-720, FG-72-30, FG-91-20, FG-920, FG-92-40		

### miscellaneous

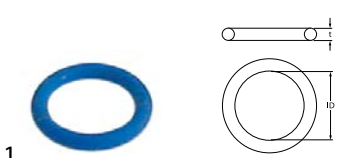

<b>GEV No.</b>	691010	<b>Ref. No.</b>	12010108 Q307069
<b>description</b>	O-ring thickness 2.62mm ID ø 12.37mm Qty 1 pcs for water level tube		
<b>For models:</b>	ME9-10BM, ME9-10BMS, ME9-15BM, ME9-15BM316, ME9-15BMS, MG9-10BM, MG9-10BMS, MG9-15BM, MG9-15BM316, MG9-15BMS, MPE9-10BM, MPE9-10BMS, MPE9-15BM, MPE9-15BMS, MPG9-10BM, MPG9-10BMS, MPG9-15BM, MPG9-15BMS		

## sealing washers

### fibre gaskets



<b>GEV No.</b>	505246	<b>Ref. No.</b>	12016868 Z953097
<b>description</b>	flat gasket FIBER ED ø 17mm ID ø 13.5mm thickness 1.5mm Qty 1 pcs		
<b>For models:</b>	GA-20, GA-20D, GA-40, GA-40D		



<b>GEV No.</b>	510033	<b>Ref. No.</b>	12009977 Q306013
<b>description</b>	flat gasket FIBER ED ø 30mm ID ø 21mm thickness 3mm Qty 1 pcs		
<b>For models:</b>	BME9-05, BME9-05AD, BME9-05PLUS, BME9-05V-T, BME9-10, BME9-10AD, BME9-10PLUS, BME9-10V-T, BMG9-05, BMG9-05V-T, BMG9-10, BMG9-10V-T, CPE7-05, CPE7-05NC, CPE9-05, CPE9-05S, CPG7-05, CPG7-05NC, CPG9-05, CPG9-05NC, CPG9-05S, CPG9-05SNC, EPC-350, FG7-05-1C, FG7-05-2C, FG7-10-2C, FG7-104C, FG7-10-4C, FG9-05, FG9-05-1C, FG9-05-2C, FG9-05AD, FG9-05PLUS, FG9-05PLUS-S, FG9-05S, FG9-05S-1C, FG9-05S-2C, FG9-05S-AD, FG9-10, FG9-10-2C, FG9-10-4C, FG9-10AD, FG9-10PLUS, FGCL9-05, FGCL9-05-1C, FGCL9-05-2C, FGCL9-05S-1C, FGCL9-05S-2C, GA-20, GA-40...(Other models you can see in the webshop)		



<b>GEV No.</b>	510123	<b>Ref. No.</b>	12016709 S112152
<b>description</b>	flat gasket FIBER ED ø 60mm ID ø 46mm thickness 2mm Qty 1 pcs		
<b>For models:</b>	ME9-10BM, ME9-10BMS, ME9-15BM, ME9-15BMS, MG9-10, MG9-10BM, MG9-10BMS, MG9-10S, MG9-15, MG9-15BM, MG9-15BMS, MG9-15S, MG9-20, MG9-20S, MPE9-10BM, MPE9-10BMS, MPE9-15BM, MPE9-15BMS, MPG9-10, MPG9-10BM, MPG9-10BMS, MPG9-10S, MPG9-15, MPG9-15BM, MPG9-15BMS, MPG9-15S, MPG9-20, MPG9-20S		



<b>GEV No.</b>	510153	<b>Ref. No.</b>	12010206 Q306050
<b>description</b>	flat gasket fibre ED ø 12mm ID ø 6.2mm thickness 1.5mm Qty 1 pcs		
<b>For models:</b>	AD-120, AD-120B, AD-120C, AD-120CW, AD-45BBT, AD-48, AD-48B, AD-48C, AD-48D, AD-48DD, AD-48HY, AD-48W, AD-64, AD-64B, AD-64BBT, AD-64BTDD, AD-64C, AD-64CW, AD-64D, AD-64DD, AD-64HY, AD-72, AD-72W, AD-90, AD-90BA, AD-90BBT, AD-90BDD, AD-90DD, ADE-120, ADE-120B, ECO-120, ECO-120B, ECO-160, ECO-160D, ECO-160I, ECO-200, ECO-200D, ECO-200H, ECO-200HD, ECO-200HI, ECO-200I, FI-100, FI-100AR, FI-100B, FI-100BBT-UK, FI-120, FI-120AR+DD, FI-120B, FI-120C, FI-120HY-CLINIC...(Other models you can see in the webshop)		



<b>GEV No.</b>	507332	<b>Ref. No.</b>	12010260 Q306024
<b>description</b>	flat gasket fibre ED ø 18mm ID ø 12mm thickness 2mm Qty 1 pcs		
<b>For models:</b>	AD-120, AD-120B, AD-120BBTDD-UK, AD-120C, AD-120CW, AD-120HY, AD-45BBT, AD-48, AD-48B, AD-48BDD, AD-48C, AD-48D, AD-48DD, AD-48HY, AD-48W, AD-64, AD-64B, AD-64BBT, AD-64BDD, AD-64BTDD, AD-64C, AD-64CW, AD-64D, AD-64DD, AD-64HY, AD-72, AD-72W, AD-90, AD-90BA, AD-90BBT, AD-90BDD, AD-90DD, ADE-120, ADE-120B, BME7-05, BME7-10, BME9-05, BME9-05AD, BME9-05PLUS, BME9-05V-T, BME9-10, BME9-10AD, BME9-10PLUS, BME9-10V-T, BMG7-10, BMG9-04S, BMG9-05, BMG9-05V-T, BMG9-10, BMG9-10V-T...(Other models you can see in the webshop)		



<b>GEV No.</b>	510179	<b>Ref. No.</b>	12010145 Q306012
<b>description</b>	flat gasket fibre ED ø 18mm ID ø 13mm thickness 1.5mm Qty 1 pcs		
<b>For models:</b>	BG9-05, BG9-10, CG-200S, CG-210, CG-210G, CG-300S, CG-310, CG-310G, CG9-51L, CG9-51LC, CG9-51R, CG9-51RC, CG-HP-20, FI-5420, FI-7630, HCG-10-11, HCG-10-21, HCG-20-11, HCG-20-21, HCG-2-10-11, HCG-2-20-11, HCG-6-11, HG-10-11, HG-10-21, HG-2-10-11, HGC-10-11, HGC-10-21, HGC-20-21, HGC-6-11, HGP-10-21, HGP-20-21, HGV-10-11, HGV-10-21, HGV-20-11, HMG-20-11, HVG-10-11, HVG-10-11UL, HVG-10-21, HVG-10-21UL, HVG-20-11, HVG-20-21, HVG-2-10-11, HVG-2-20-21, MFHVG-10-11, MFHVG-10-21, MG9-10, MG9-10BM, MG9-15, MG9-15BM...(Other models you can see in the webshop)		



<b>GEV No.</b>	510164	<b>Ref. No.</b>	12010055 Q306052
<b>description</b>	flat gasket fibre ED ø 24mm ID ø 16mm thickness 3mm Qty 1 pcs		
<b>For models:</b>	BME7-05, BME7-10, BMG7-10, CG-1002, CG-1502, CG-2002, CG7-11, CG7-41, CG7-61, CG9-11, CG9-41, CG9-51L, CG9-51LC, CG9-51R, CG9-51RC, CG9-61, CG9-82, CGB7-61, CGE7-41, CGE9-41, CGP9-11, CPG7-05, CPG9-05, CPG9-05NC, FG7-05-1C, FG7-05-2C, FG-710, FG7-10-2C, FG7-104C, FG7-10-4C, FG-720, FG9-05, FG9-05-1C, FG9-05-2C, FG9-05AD, FG9-05PLUS, FG9-05PLUS-S, FG9-05S-1C, FG9-05S-2C, FG9-05S-AD, FG9-10, FG9-10-2C, FG9-10-4C, FG9-10AD, FG9-10PLUS, FGCL9-05-1C, FGCL9-05-2C, FGCL9-05S-1C, FGCL9-05S-2C, FTG9-11L...(Other models you can see in the webshop)		



<b>GEV No.</b>	510129	<b>Ref. No.</b>	12010207 Q306039
<b>description</b>	flat gasket fibre ED ø 25mm ID ø 16.5mm thickness 1.5mm Qty 1 pcs		
<b>For models:</b>	BME7-05, BME7-10, BME9-05, BME9-05AD, BME9-05PLUS, BME9-05V-T, BME9-10, BME9-10AD, BME9-10PLUS, BME9-10V-T, BMG7-10, BMG-9045, FF-35, HE-10-11, HE-10-21, HE-2-10-11, HE-5-11, HEI-10-21, HEM-10-11, HEM-10-21, HEM-20-11, HEM-6-11, HEP-10-11, HEP-10-21, HEP-20-11, HEP-6-11, HG-10-11, HG-10-21, HG-2-10-11, HGC-10-21, HGP-10-21, HGV-10-11, HGV-10-21, HGV-20-11, ME7-10BM, ME9-10BM, ME9-10BMS, ME9-15BM, ME9-15BMS, MG9-10BM, MG9-10BMS, MG9-15BM, MG9-15BMS, MPE9-10BM, MPE9-10BMS, MPE9-15BM, MPE9-15BMS, MPG9-10BM, MPG9-10BMS, MPG9-15BM...(Other models you can see in the webshop)		



<b>GEV No.</b>	510166	<b>Ref. No.</b>	12019584 Q306049
<b>description</b>	flat gasket fibre ED ø 31.3mm ID ø 26.3mm thickness 1.2mm Qty 1 pcs		
<b>For models:</b>	ME7-10BM, ME9-10BM, ME9-10BMS, ME9-15BM, ME9-15BMS, MG7-10BM, MG9-10BM, MG9-10BMS, MG9-15BM, MG9-15BMS, MPE9-10BM, MPE9-10BMS, MPE9-15BM, MPE9-15BMS, MPG9-10BM, MPG9-10BMS, MPG9-15BM, MPG9-15BMS		



<b>GEV No.</b>	510152	<b>Ref. No.</b>	12010203 Q306038
<b>description</b>	flat gasket fibre ED ø 31mm ID ø 21mm thickness 1.5mm Qty 1 pcs		
<b>For models:</b>	ADE-120, ADE-120B, BME7-05, BME7-10, BME9-05, BME9-10, BMG7-10, BMG-9045, BMG9-05, BMG9-10, CPE9-05, CPE9-05S, CPG7-05, CPG9-05, CPG9-05NC, CPG9-05S, CPG9-05SNC, ECO-120, ECO-1200, ECO-120B, ECO-160, ECO-1600, ECO-160D, ECO-160I, ECO-200, ECO-200D, ECO-200H, ECO-200HD, ECO-200HI, ECO-200I, ECO-2300, ECO-2700D, ECO-2700I, ECO-280D, ECO-280I, ECO-3000, ECO-370D, ECO-370I, ECO-4000D, ECO-4000I, ECO-460D, ECO-460I, ECO-550D, ECO-550I, ECO-6000D, ECO-6000I, GA-20, GA-20D, GA-40, GA-40D...(Other models you can see in the webshop)		



<b>GEV No.</b>	510406	<b>Ref. No.</b>	12035981 ICR09387
<b>description</b>	flat gasket fibre ED ø 60mm ID ø 48mm thickness 3mm for thread 1½" Qty 1 pcs		

rubber gaskets



<b>GEV No.</b>	505245	<b>Ref. No.</b>	12039712 Q307038
<b>description</b>	flat gasket ED ø 77mm ID ø 48mm thickness 1.5mm Qty 1 pcs		
<b>For models:</b>	ECO-1200, FI-1200, FI-900		





<b>GEV No.</b>	510169	<b>Ref. No.</b>	12039857 R725032
<b>description</b>	flat gasket rubber ED ø 16mm ID ø 10mm thickness 2mm Qty 1 pcs		
<b>For models:</b>	HMG-10-11, HMG-10-11UL, HMG-10-21, HMG-10-21UL, HMG-2-10-11, HMG-6-11		





<b>GEV No.</b>	505199	<b>Ref. No.</b>	12010191 Q307031
<b>description</b>	flat gasket rubber ED ø 24mm ID ø 14mm thickness 3mm Qty 1 pcs		
<b>For models:</b>	AD-45BBT, AD-48B, AD-48BDD, AD-48C, AD-48HY, AD-48W, AD-64B, AD-64BBT, AD-64BDD, AD-64C, AD-64CW, AD-64HY, BME7-05, BME7-10, BMG7-10, ECO-120, ECO-1200, FI-100, FI-100AR, FI-100B, FI-100BBT-UK, FI-120, FI-1200, FI-120B, FI-120W, FI-200W, FI-30, FI-300B, FI-300R, FI-30B, FI-30B-BT-UK, FI-48, FI-48AR, FI-48B, FI-48B-BT-UK, FI-48C, FI-48HY-CLINIC, FI-48W, FI-50, FI-64, FI-64AR, FI-64B, FI-64B-BT-UK, FI-64C, FI-64HY-CLINIC, FI-64W, FI-650R, FI-72, FI-80, FI-80BBT-UK...(Other models you can see in the webshop)		





			
1			
<b>GEV No.</b>	900909	<b>Ref. No.</b>	12018710 Z401905
<b>description</b>	flat gasket rubber ED ø 31mm ID ø 18mm thickness 2mm Qty 1 pcs		
<b>For models:</b>	LVR-10, LVR-14, LVR-20, LVR-20B		

			
1			
<b>GEV No.</b>	515018	<b>Ref. No.</b>	12009947 Q307032
<b>description</b>	flat gasket rubber ED ø 32mm ID ø 21mm thickness 3mm Qty 1 pcs		
<b>For models:</b>	AD-120, AD-120B, AD-120BBTDD-UK, AD-120C, AD-120CW, AD-120HY, AD-90, AD-90BA, AD-90BBT, AD-90BDD, AD-90DD, ADE-120, ADE-120B, BME7-05, BME7-10, BME9-05, BME9-05AD, BME9-05PLUS, BME9-05V-T, BME9-10, BME9-10AD, BME9-10PLUS, BME9-10V-T, BMG7-10, BMG9-05, BMG9-05V-T, BMG9-10, BMG9-10V-T, CO-142W, CO-142WDD, COP-174W, COP-174WHR, ECO-120, ECO-1200, ECO-120B, ECO-160, ECO-1600, ECO-160D, ECO-160I, ECO-200, ECO-200D, ECO-200H, ECO-200HD, ECO-200HI, ECO-200I, ECO-2300, ECO-2700D, ECO-2700I, ECO-280D, ECO-280I...(Other models you can see in the webshop)		

			
1			
<b>GEV No.</b>	510154	<b>Ref. No.</b>	12010053 Q307029
<b>description</b>	flat gasket rubber ED ø 33mm ID ø 26mm thickness 2mm Qty 1 pcs		
<b>For models:</b>	ECO-120, FE-18, FE-25, FG-1-40, FG-2-80, FI-100, FI-120, FI-120W, FI-30, FI-48, FI-48B, FI-48W, FI-50, FI-64, FI-64B, FI-64W, FI-72, LVC-21W, MF-21, MF-48, MF-64, MG-9150BM		

			
1			
<b>GEV No.</b>	505161	<b>Ref. No.</b>	12010028 Q307027
<b>description</b>	flat gasket rubber ED ø 45mm ID ø 35mm thickness 2mm Qty 1 pcs		
<b>For models:</b>	BMG-9045, ECO-1200, ECO-1600, ECO-2300, ECO-2700D, ECO-2700I, ECO-280D, ECO-280I, ECO-3000, ECO-370D, ECO-370I, ECO-4000D, ECO-4000I, ECO-460D, ECO-460I, ECO-550D, ECO-550I, ECO-6000D, ECO-6000I, FI-1200, FI-1600, FI-2300, FI-2700D, FI-2700I, FI-280D, FI-280I, FI-3000, FI-300B, FI-300R, FI-370D, FI-370I, FI-4000D, FI-4000I, FI-460D, FI-460I, FI-550D, FI-550I, FI-6000D, FI-6000I, FI-650R, FI-900		

			
1			
<b>GEV No.</b>	501302	<b>Ref. No.</b>	12023554 R675007
<b>description</b>	flat gasket rubber ED ø 57mm ID ø 30mm thickness 2mm Qty 1 pcs		
<b>For models:</b>	AD-45BBT, AD-48HY, AD-64BBT, AD-64BTDD, AD-64HY, EA-SY-500HPWBDD, FI-30B-BT-UK, FI-48B-BT-UK, FI-48HY-CLINIC, FI-64B-BT-UK, FI-64HY-CLINIC, HEI-10-11, HEI-20-11, HEI-6-11, HEM-10-11, HEM-20-11, HEM-6-11, HEP-10-11, HEP-20-11, HEP-6-11, HME-10-11, HME-10-21, HME-20-11, HME-20-21, HME-2-10-11, HME-2-20-11, HME-6-11, HMI-10-11, HMI-10-11UL, HMI-10-21, HMI-10-21UL, HMI-2-10-11, HMI-6-11, HMI-6-11UL, HMM-10-11, HMM-10-11UL, HMM-10-21, HMM-10-21UL, HMM-20-11, HMM-20-11UL, HMM-20-21, HMM-20-21UL, HMM-2-10-11, HMM-2-20-11, HMM-40-11-USMC, HMM-6-11, HMM-6-11UL, HMP-10-11, HMP-10-21, HMP-20-11...(Other models you can see in the webshop)		

			
1			
<b>GEV No.</b>	505224	<b>Ref. No.</b>	12009960 Q307058
<b>description</b>	flat gasket rubber ED ø 60mm ID ø 44mm thickness 2mm Qty 1 pcs		
<b>For models:</b>	AD-120, AD-120B, AD-120BBTDD-UK, AD-120C, AD-120CW, AD-120HY, AD-90, AD-90BA, AD-90BBT, AD-90BDD, AD-90DD, ADE-120, ADE-120B, ECO-120, ECO-120B, ECO-160, ECO-160D, ECO-160I, ECO-200, ECO-200D, ECO-200H, ECO-200HD, ECO-200HI, ECO-200I, ECO-370D, ECO-370I, ECO-550D, ECO-550I, FI-100, FI-100AR, FI-100B, FI-100BBT-UK, FI-120, FI-120AR+DD, FI-120B, FI-120C, FI-120HY-CLINIC, FI-120W, FI-160, FI-160AR, FI-160D, FI-160I, FI-200, FI-200AR, FI-200D, FI-200H, FI-200HD, FI-200HI, FI-200I, FI-200W...(Other models you can see in the webshop)		

			
1			
<b>GEV No.</b>	505223	<b>Ref. No.</b>	12009939 Q307009
<b>description</b>	flat gasket rubber ED ø 70mm ID ø 48mm thickness 1.5mm Qty 1 pcs		
<b>For models:</b>	BMG-9045, ECO-1200, ECO-1600, ECO-2300, ECO-2700D, ECO-2700I, ECO-280D, ECO-280I, ECO-3000, ECO-370D, ECO-370I, ECO-4000D, ECO-4000I, ECO-460D, ECO-460I, ECO-550D, ECO-550I, ECO-6000D, ECO-6000I, FI-1200, FI-1600, FI-2300, FI-2700D, FI-2700I, FI-280D, FI-280I, FI-3000, FI-300B, FI-300R, FI-370D, FI-370I, FI-4000D, FI-4000I, FI-460D, FI-460I, FI-550D, FI-550I, FI-6000D, FI-6000I, FI-650R, FI-900		

			
1			
<b>GEV No.</b>	505247	<b>Ref. No.</b>	12039795 Q307024
<b>description</b>	flat gasket rubber ED ø 72mm ID ø 54mm thickness 2mm Qty 1 pcs		
<b>For models:</b>	ECO-280D, ECO-280I, ECO-370D, ECO-370I, ECO-460D, ECO-460I, ECO-550D, ECO-550I, FI-280D, FI-280I, FI-300B, FI-300R, FI-370D, FI-370I, FI-460D, FI-460I, FI-550D, FI-550I, FI-650R		

			
1			
<b>GEV No.</b>	505194	<b>Ref. No.</b>	12009937 Q307059
<b>description</b>	flat gasket rubber ED ø 72mm ID ø 57mm thickness 2mm Qty 1 pcs		
<b>For models:</b>	AD-120, AD-120B, AD-120BBTDD-UK, AD-120C, AD-120CW, AD-120HY, AD-90, AD-90BA, AD-90BBT, AD-90BDD, AD-90DD, ADE-120, ADE-120B, ECO-120, ECO-120B, ECO-160, ECO-160D, ECO-160I, ECO-200, ECO-200D, ECO-200H, ECO-200HD, ECO-200HI, ECO-200I, ECO-2700D, ECO-2700I, ECO-280D, ECO-280I, ECO-370D, ECO-370I, ECO-4000D, ECO-4000I, ECO-460D, ECO-460I, ECO-550D, ECO-550I, ECO-6000D, ECO-6000I, FI-100, FI-100AR, FI-100B, FI-100BBT-UK, FI-120, FI-120AR+DD, FI-120B, FI-120C, FI-120HY-CLINIC, FI-120W, FI-160, FI-160AR...(Other models you can see in the webshop)		



<b>GEV No.</b>	510832	<b>Ref. No.</b>	12023571 Z310902
<b>description</b>	flat gasket rubber ED ø 92mm ID ø 66mm thickness 2mm Qty 1 pcs equiv. no. 200906/33456		
<b>For models:</b>	ECO-2700D, ECO-2700I, ECO-280D, ECO-280I, ECO-370D, ECO-370I, ECO-4000D, ECO-4000I, ECO-460D, ECO-460I, ECO-550D, ECO-550I, ECO-6000D, ECO-6000I, FI-2700D, FI-2700I, FI-280D, FI-280I, FI-370D, FI-370I, FI-4000D, FI-4000I, FI-460D, FI-460I, FI-550D, FI-550I, FI-6000D, FI-6000I		



<b>GEV No.</b>	691693	<b>Ref. No.</b>	12019066 R725031
<b>description</b>	flat gasket rubber ED ø 94mm ID ø 54mm thickness 4mm Qty 1 pcs		
<b>For models:</b>	HMG-10-11, HMG-10-11UL, HMG-10-21, HMG-10-21UL, HMG-2-10-11, HMG-6-11		



<b>GEV No.</b>	560616	<b>Ref. No.</b>	12037537 RT51101024
<b>description</b>	gasket ED ø 24mm ID ø 15mm thickness 3mm Qty 5 pcs for model C-Line, CPC, SCC 61-202		



<b>GEV No.</b>	505249	<b>Ref. No.</b>	12009936 Q307011
<b>description</b>	gasket ED ø 56mm ID ø 39mm thickness 1mm Qty 1 pcs		
<b>For models:</b>	ECO-1600, ECO-2300, ECO-280D, ECO-280I, ECO-3000, ECO-370D, ECO-370I, ECO-460D, ECO-460I, ECO-550D, ECO-550I, FI-1600, FI-2300, FI-280D, FI-280I, FI-3000, FI-370D, FI-370I, FI-460D, FI-460I, FI-550D, FI-550I		



<b>GEV No.</b>	560617	<b>Ref. No.</b>	12037232 RT50120539
<b>description</b>	gasket rubber ED ø 19.5mm ID ø 12mm thickness 2.3mm Qty 5 pcs		



<b>GEV No.</b>	510213	<b>Ref. No.</b>	12020523 X163016
<b>description</b>	gasket rubber ED ø 7mm ID ø 3mm thickness 6mm Qty 1 pcs		
<b>For models:</b>	FE9-05, FE9-05S, FE9-05USMC, FE9-10, FG9-05, FG9-05S, FG9-10		

plastic gaskets



<b>GEV No.</b>	510212	<b>Ref. No.</b>	12019069 Q308008
<b>description</b>	flat gasket plastic ED ø 12mm ID ø 7.3mm thickness 2mm Qty 1 pcs		
<b>For models:</b>	FI-300B, FI-300R, FI-650R		

copper gaskets

DIN-7603-A



<b>GEV No.</b>	528197	<b>Ref. No.</b>	12037845
<b>description</b>	flat gasket copper ED ø 10mm ID ø 6mm thickness 1mm Qty 1 pcs		



<b>GEV No.</b>	530883	<b>Ref. No.</b>	RT13150101
<b>description</b>	flat gasket copper ED ø 10mm ID ø 6mm thickness 1mm Qty 10 pcs		



<b>GEV No.</b>	560200	<b>Ref. No.</b>	12036402 RT13150105
<b>description</b>	flat gasket copper ED ø 16mm ID ø 10mm thickness 1.5mm Qty 1 pcs		



<b>GEV No.</b>	560615	<b>Ref. No.</b>	12037551 RT13150109
<b>description</b>	gasket copper ED ø 16mm ID ø 8.5mm thickness 1.2mm for combi-steamer suitable for CPC Qty 5 pcs		



<b>GEV No.</b>	560614	<b>Ref. No.</b>	12036587 RT13150104
<b>description</b>	gasket copper ED ø 20mm ID ø 16mm thickness 1.5mm suitable for CPC Qty 10 pcs		



PTFE gaskets

 <p>1</p>			
<b>GEV No.</b>	505226	<b>Ref. No.</b>	12018644 Q308009
<b>description</b>	slide ring PTFE ED $\phi$ 19mm ID $\phi$ 7.5mm thickness 2mm Qty 1 pcs		
<b>For models:</b>	FI-300B, FI-300R, FI-650R		

 <p>1</p>			
<b>GEV No.</b>	505225	<b>Ref. No.</b>	12009922 Q308012
<b>description</b>	slide ring PTFE ED $\phi$ 30mm ID $\phi$ 10mm thickness 3mm for hood joint Qty 1 pcs		
<b>For models:</b>	AD-120, AD-120B, AD-120BBTDD-UK, AD-120C, AD-120CW, AD-120HY, AD-90, AD-90BA, AD-90BBT, AD-90BDD, AD-90DD, ADE-120, ADE-120B, ECO-120, ECO-120B, FI-100, FI-100AR, FI-100B, FI-100BBT-UK, FI-120, FI-120AR+DD, FI-120B, FI-120C, FI-120HY-CLINIC, FI-120W, FI-80, FI-80AR, FI-80BBT-UK, FI-80W, FI-E-100, LABP-1000, LABP-1200, LABP-800, MF-120		

foam rubber gaskets

 <p>1</p>			
<b>GEV No.</b>	505408	<b>Ref. No.</b>	12041815
<b>description</b>	foam rubber gasket W 15mm thickness 2mm self-adhesive Qty 1 suitable for FAGOR control panel combi-steamer L 540mm		
<b>For models:</b>	ACE-061, ACE-101, ACE-102, ACE-201, ACE-202, ACG-061, ACG-101, ACG-102, ACG-201, ACG-202, AE-061, AE-061W, AE-101, AE-101W, AE-102, AE-102W, AE-201, AE-202, AG-061, AG-061W, AG-101, AG-101W, AG-102, AG-102W, AG-201, AG-202, APE-061, APE-061W, APE-101, APE-101W, APE-102, APE-102W, APE-201, APE-202, APG-061, APG-061W, APG-101, APG-101W, APG-102, APG-102W, APG-201, APG-202		

 <p>1</p>			
<b>GEV No.</b>	505250	<b>Ref. No.</b>	12021459 Z680532
<b>description</b>	foam rubber gasket W 20mm thickness 5mm Qty 720mm		
<b>For models:</b>	ECO-1200, FI-1200, FI-900		

 <p>1</p>			
<b>GEV No.</b>	505248	<b>Ref. No.</b>	12023929 Z950318
<b>description</b>	foam rubber gasket W 21mm thickness 1.5mm self-adhesive Qty 350mm		
<b>For models:</b>	GA-20, GA-20D, GA-40, GA-40D		

 <p>1</p>			
<b>GEV No.</b>	505237	<b>Ref. No.</b>	12025277 Z400309
<b>description</b>	foam rubber gasket W 8mm thickness 2mm self-adhesive Qty 450mm		
<b>For models:</b>	AD-15, AD-15D, LVC-12, LVC-15, LVC-15D, LVR-10, LVR-14, LVR-14D		

 <p>1</p>			
<b>GEV No.</b>	505264	<b>Ref. No.</b>	12024174 Z200313
<b>description</b>	foam rubber gasket W 9mm thickness 2.5mm self-adhesive Qty 625mm		
<b>For models:</b>	AD-45BBT, AD-48, AD-48B, AD-48BDD, AD-48C, AD-48D, AD-48DD, AD-48HY, AD-48W, AD-64, AD-64B, AD-64BBT, AD-64BDD, AD-64BTDD, AD-64C, AD-64CW, AD-64D, AD-64DD, AD-64HY, AD-72, AD-72W, EASY-500, EASY-500B, EASY-500DD, EASY-500HP, EASY-500HPWBDD, FI-30, FI-30AR, FI-30AR+DD, FI-30B, FI-30B-BT-UK, FI-30-UK, FI-48, FI-48AR, FI-48B, FI-48B-BT-UK, FI-48C, FI-48D, FI-48HY-CLINIC, FI-48W, FI-50, FI-60DD, FI-64, FI-64AR, FI-64B, FI-64B-BT-UK, FI-64C, FI-64D, FI-64HY-CLINIC, FI-64W...(Other models you can see in the webshop)		

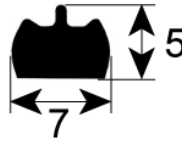
 <p>1</p>			
<b>GEV No.</b>	901454	<b>Ref. No.</b>	12034523 RT51001011
<b>description</b>	gasket for control panel L 2000mm foam rubber self-adhesive		

shaft gaskets

shaft gaskets

 <p>1</p>			
<b>GEV No.</b>	691049	<b>Ref. No.</b>	12024510 R012635000 R662627
<b>description</b>	shaft seal ID $\phi$ 17mm ED $\phi$ 28mm thickness 7mm		
<b>For models:</b>	ACE-061, ACE-101, ACE-102, ACE-201, ACE-202, ACG-061, ACG-101, ACG-102, ACG-201, ACG-202, AE-061, AE-061W, AE-101, AE-101W, AE-102, AE-102W, AE-201, AE-202, AG-061, AG-061W, AG-101, AG-101W, AG-102, AG-102W, AG-201, AG-202, APE-061, APE-061W, APE-101, APE-101W, APE-102, APE-102W, APE-201, APE-202, APG-061, APG-061W, APG-101, APG-101W, APG-102, APG-102W, APG-201, APG-202, COE-061, COE-101, COE-102, COE-201, COE-202, COG-061, COG-101, COG-102...(Other models you can see in the webshop)		



1

<b>GEV No.</b>	698001	<b>Ref. No.</b>	12025169 Z105016
<b>description</b>	shaft seal ID ø 20mm ED ø 35mm thickness 7mm		
<b>For models:</b>	ECO-160, ECO-1600, ECO-160D, ECO-160I, ECO-200, ECO-200D, ECO-200H, ECO-200HD, ECO-200HI, ECO-200I, ECO-2300, ECO-280D, ECO-280I, ECO-3000, ECO-370D, ECO-370I, ECO-460D, ECO-460I, ECO-550D, ECO-550I, FI-160, FI-1600, FI-160AR, FI-160D, FI-160I, FI-200, FI-200AR, FI-200D, FI-200H, FI-200HD, FI-200HI, FI-200I, FI-200W, FI-200WL, FI-200WR, FI-2300, FI-280D, FI-280I, FI-3000, FI-370D, FI-370I, FI-460D, FI-460I, FI-550D, FI-550I		



1

<b>GEV No.</b>	510574	<b>Ref. No.</b>	RT50010211
<b>description</b>	shaft sealing type 20 for fan motor		

miscellaneous



1

<b>GEV No.</b>	510573	<b>Ref. No.</b>	12033667 RT50010207
<b>description</b>	shaft seal ID ø 17mm ED ø 29mm thickness 4.5mm		



1

<b>GEV No.</b>	511682	<b>Ref. No.</b>	12034102 RT85141343
<b>description</b>	shaft seal kit ID ø 17mm ED ø 29mm shaft seal flange mounting gauge with mountign material		

special gaskets  
for combi-steamers



1

<b>GEV No.</b>	560612	<b>Ref. No.</b>	12036211 RT51101310
<b>description</b>	flange gasket ED ø 79mm ID ø 51mm thickness 2mm hole distance 34mm CPC-Linie 101-201/G		



1

<b>GEV No.</b>	560599	<b>Ref. No.</b>	12034765 RT51101311
<b>description</b>	gasket ED ø 132mm ID ø 105mm thickness 2mm CPC-Linie CM 61-202/G		



1

<b>GEV No.</b>	560622	<b>Ref. No.</b>	12036615 RT7000242
<b>description</b>	gasket ED ø 82mm ID ø 50mm thickness 2.5mm hole distance 50mm SCC Line since 04/04		



1

<b>GEV No.</b>	699803	<b>Ref. No.</b>	12040239 RT7200020
<b>description</b>	gasket L 139mm W 130mm silicone thickness 4mm		



1

<b>GEV No.</b>	560613	<b>Ref. No.</b>	12037070 RT7400301
<b>description</b>	gasket L 43mm W 67mm thickness 4mm SCC, CM61-202 since 06/2007 for combi-steamer		



1

<b>GEV No.</b>	560619	<b>Ref. No.</b>	12036104 RT51101327
<b>description</b>	gasket L 76mm W 77mm CPC-Linie CM 61-202/G thickness 1mm		



door seals for dishwashers



1

<b>GEV No.</b>	518215	<b>Ref. No.</b>	12024374
<b>description</b>	door seal L 590mm W 26mm H 6mm silicone FAGOR suitable for dishwasher		
<b>For models:</b>	AD-45BBT, AD-48, AD-48B, AD-48BDD, AD-48C, AD-48D, AD-48DD, AD-48HY, AD-48W, AD-64, AD-64B, AD-64BBT, AD-64BDD, AD-64BTDD, AD-64C, AD-64CW, AD-64D, AD-64DD, AD-64HY, AD-72, AD-72W, EASY-500, EASY-500B, EASY-500DD, EASY-500HP, EASY-500HPWBDD, FI-30, FI-30AR, FI-30AR+DD, FI-30B, FI-30B-BT-UK, FI-30-UK, FI-48, FI-48AR, FI-48B, FI-48B-BT-UK, FI-48C, FI-48D, FI-48HY-CLINIC, FI-48W, FI-60DD, FI-64, FI-64AR, FI-64B, FI-64B-BT-UK, FI-64C, FI-64D, FI-64HY-CLINIC, FI-64W, FI-72...(Other models you can see in the webshop)		



1

<b>GEV No.</b>	505237	<b>Ref. No.</b>	12025277 Z400309
<b>description</b>	foam rubber gasket W 8mm thickness 2mm self-adhesive Qty 450mm		
<b>For models:</b>	AD-15, AD-15D, LVC-12, LVC-15, LVC-15D, LVR-10, LVR-14, LVR-14D		



1

<b>GEV No.</b>	505250	<b>Ref. No.</b>	12021459 Z680532
<b>description</b>	foam rubber gasket W 20mm thickness 5mm Qty 720mm		
<b>For models:</b>	ECO-1200, FI-1200, FI-900		



1

<b>GEV No.</b>	505264	<b>Ref. No.</b>	12024174 Z200313
<b>description</b>	foam rubber gasket W 9mm thickness 2.5mm self-adhesive Qty 625mm		
<b>For models:</b>	AD-45BBT, AD-48, AD-48B, AD-48BDD, AD-48C, AD-48D, AD-48DD, AD-48HY, AD-48W, AD-64, AD-64B, AD-64BBT, AD-64BDD, AD-64BTDD, AD-64C, AD-64CW, AD-64D, AD-64DD, AD-64HY, AD-72, AD-72W, EASY-500, EASY-500B, EASY-500DD, EASY-500HP, EASY-500HPWBDD, FI-30, FI-30AR, FI-30AR+DD, FI-30B, FI-30B-BT-UK, FI-30-UK, FI-48, FI-48AR, FI-48B, FI-48B-BT-UK, FI-48C, FI-48D, FI-48HY-CLINIC, FI-48W, FI-50, FI-60DD, FI-64, FI-64AR, FI-64B, FI-64B-BT-UK, FI-64C, FI-64D, FI-64HY-CLINIC, FI-64W...(Other models you can see in the webshop)		



1

<b>GEV No.</b>	505248	<b>Ref. No.</b>	12023929 Z950318
<b>description</b>	foam rubber gasket W 21mm thickness 1.5mm self-adhesive Qty 350mm		
<b>For models:</b>	GA-20, GA-20D, GA-40, GA-40D		

sealing discs



1

<b>GEV No.</b>	109066	<b>Ref. No.</b>	12009984 Q306051
<b>description</b>	flat gasket ø 23mm thickness 3mm fibre Qty 1 pcs		
<b>For models:</b>	BG7-05, BG7-05I, BG7-10, BG7-10I, BG9-05, BG9-05AD, BG9-05I, BG9-05PF, BG9-05PI, BG9-05PLUS-I, BG9-10, BG9-10AD, BG9-10I, BG9-10PF, BG9-10PI, BG9-10PLUS-I, BMG7-10, BMG9-05, BMG9-05V-T, BMG9-10, BMG9-10V-T, CG-210, CG-210G, CG7-10, CG7-20, CG7-20H, CG7-30D, CG7-30I, CG7-40, CG7-40H, CG7-50, CG7-60, CG7-60H, CG9-05AD, CG9-05PLUS, CG9-10, CG9-10AD, CG9-10PLUS, CG9-20, CG9-40, CG9-60, CGB7-61, CGE7-41, CGE7-41H, CGF9-120D, CGF9-120D-AD, CGF9-120I, CGF9-120I-AD, CGF9-120PLUS-D, CGF9-120PLUS-I...(Other models you can see in the webshop)		

miscellaneous



1

<b>GEV No.</b>	900870	<b>Ref. No.</b>	12037063 V107170001
<b>description</b>	door seal for glass door L 770mm plug-in gasket		
<b>For models:</b>	VM-100-I, VM-100-M, VM-135-I, VM-135-M		

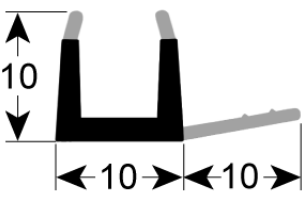

1

<b>GEV No.</b>	900874	<b>Ref. No.</b>	12037220 S107170001
<b>description</b>	door seal L 575mm external weith 5mm		



1

<b>GEV No.</b>	505078	<b>Ref. No.</b>	12024556 Z200907
<b>description</b>	gasket external hight 23.5mm for sump ED ø 225mm ID ø 200mm		
<b>For models:</b>	AD-45BBT, AD-48, AD-48B, AD-48BDD, AD-48C, AD-48D, AD-48DD, AD-48HY, AD-48W, AD-64, AD-64B, AD-64BBT, AD-64BDD, AD-64BTDD, AD-64C, AD-64CW, AD-64D, AD-64DD, AD-64HY, AD-72, AD-72W, EASY-500, EASY-500B, EASY-500DD, EASY-500HP, FI-30, FI-30AR, FI-30AR+DD, FI-30B, FI-30B-BT-UK, FI-30-UK, FI-48, FI-48AR, FI-48B, FI-48B-BT-UK, FI-48C, FI-48D, FI-48HY-CLINIC, FI-48W, FI-50, FI-60DD, FI-64, FI-64AR, FI-64B, FI-64B-BT-UK, FI-64C, FI-64D, FI-64HY-CLINIC, FI-64W, FI-72...(Other models you can see in the webshop)		



1

<b>GEV No.</b>	505077	<b>Ref. No.</b>	12024113 Z400902
<b>description</b>	gasket external hight 23mm for sump		
<b>For models:</b>	AD-15, AD-15D, AD-20C-UK, AD-21, AD-21B, AD-21BDD, AD-21C, AD-21D, AD-21DD, AD-21W, CO-350, CO-350-B, CO-350-B-DD, CO-350-COLD, CO-350-COLD-B, CO-350-COLD-B-DD, CO-350-COLD-DD, CO-350-DD, CO-352-COLD, CO-352-COLD-B, CO-352-COLD-B-DD, CO-352-COLD-DD, CO-400, CO-400-B, CO-400-B-DD, CO-400-COLD, CO-400-COLD-B, CO-400-COLD-B-DD, CO-400-COLD-DD, CO-400-DD, CO-400-SOFT, CO-402-COLD, CO-402-COLD-B, CO-402-COLD-B-DD, CO-402-COLD-DD, CO-402W, LVC-12, LVC-15, LVC-15D, LVC-21, LVC-21B, LVC-21C, LVC-21D, LVC-21W, LVR-10, LVR-14, LVR-14D, LVR-20, LVR-20B, LVR-20D...(Other models you can see in the webshop)		



1

<b>GEV No.</b>	691087	<b>Ref. No.</b>	12039997 R012623
<b>description</b>	gasket suitable for FAGOR equiv. no. R012623 L 20mm silicone		
<b>For models:</b>	HCG-10-11, HCG-10-21, HCG-2-10-11, HCG-6-11, HME-10-11, HME-10-21, HME-20-11, HME-20-21, HME-2-10-11, HME-6-11, HMG-10-11, HMG-10-11UL, HMG-10-21, HMG-10-21UL, HMG-2-10-11, HMG-6-11, HMI-10-11, HMI-10-11UL, HMI-10-21, HMI-10-21UL, HMI-2-10-11, HMI-6-11, HMI-6-11UL, HMM-10-11, HMM-10-11UL, HMM-10-21, HMM-10-21UL, HMM-20-11, HMM-20-11UL, HMM-20-21, HMM-2-10-11, HMM-40-11-USMC, HMM-6-11, HMM-6-11UL, HMP-10-11, HMP-10-21, HMP-20-11, HMP-20-21, HMP-2-10-11, HMP-6-11		



1

<b>GEV No.</b>	511992	<b>Ref. No.</b>	12023517 Z710547
<b>description</b>	gasket suitable for FAGOR for hood mechanics L 100mm W 86mm thickness 2mm hole distance 30/45mm		
<b>For models:</b>	AD-120, AD-120B, AD-120BBTDD-UK, AD-120C, AD-120CW, AD-120HY, AD-90, AD-90BA, AD-90BBT, AD-90BDD, AD-90DD, ADE-120, ADE-120B, ECO-120, ECO-120B, FI-100, FI-100AR, FI-100B, FI-100BBT-UK, FI-120, FI-120AR+DD, FI-120B, FI-120C, FI-120HY-CLINIC, FI-120W, FI-80, FI-80AR, FI-80BBT-UK, FI-80W, FI-E-100, LABP-1000, LABP-1200, LABP-800, MF-120		



1

<b>GEV No.</b>	550895	<b>Ref. No.</b>	12035290 RT51101308
<b>description</b>	gasket suitable for RATIONAL equiv. no. 51101308 L 179mm W 90mm electrode thickness 3mm		



1

<b>GEV No.</b>	505179	<b>Ref. No.</b>	12024227 Z710714
<b>description</b>	gasket D1 ø 82.5mm D2 ø 44mm thickness 2.5mm with 4 screw holes wash arm support equiv. no. Z710714 suitable for FAGOR		
<b>For models:</b>	AD-120, AD-120B, AD-120BBTDD-UK, AD-120C, AD-120CW, AD-120HY, AD-90, AD-90BA, AD-90BBT, AD-90BDD, AD-90DD, ADE-120, ADE-120B, ECO-120, ECO-120B, ECO-160, ECO-160D, ECO-160I, ECO-200, ECO-200D, ECO-200H, ECO-200HD, ECO-200HI, ECO-200I, FI-100, FI-100AR, FI-100B, FI-100BBT-UK, FI-120, FI-120AR+DD, FI-120B, FI-120C, FI-120HY-CLINIC, FI-120W, FI-160, FI-160D, FI-160I, FI-200, FI-200D, FI-200H, FI-200HD, FI-200HI, FI-200I, FI-200W, FI-80, FI-80AR, FI-80BBT-UK, FI-80W, FI-E-100, LABP-1000...(Other models you can see in the webshop)		

### thermostat gaskets



1

<b>GEV No.</b>	505093	<b>Ref. No.</b>	12024049 N503017
<b>description</b>	gasket for thermostat ED ø 35mm ID ø 24mm thickness 7mm equiv. no. N503017		
<b>For models:</b>	AD-120, AD-120B, AD-120BBTDD-UK, AD-120C, AD-120CW, AD-120HY, AD-15, AD-15D, AD-20C-UK, AD-21, AD-21B, AD-21BDD, AD-21C, AD-21D, AD-21DD, AD-21W, AD-45BBT, AD-48, AD-48B, AD-48BDD, AD-48C, AD-48D, AD-48DD, AD-48HY, AD-48W, AD-64, AD-64B, AD-64BBT, AD-64BDD, AD-64BTDD, AD-64C, AD-64CW, AD-64D, AD-64DD, AD-64HY, AD-72, AD-72W, AD-90, AD-90BA, AD-90BBT, AD-90BDD, AD-90DD, ADE-120, ADE-120B, BME7-05, BME7-10, BME9-05, BME9-10, EASY-500, EASY-500B...(Other models you can see in the webshop)		

### gaskets for wash arm support



1

<b>GEV No.</b>	505167	<b>Ref. No.</b>	12023533 Z400703
<b>description</b>	gasket D1 ø 68mm D2 ø 35mm thickness 3.5mm with 4 screw holes equiv. no. Z400703 suitable for FAGOR		
<b>For models:</b>	AD-15, AD-15D, AD-20C-UK, AD-21, AD-21B, AD-21BDD, AD-21C, AD-21D, AD-21DD, AD-21W, CO-350, CO-350-B, CO-350-B-DD, CO-350-COLD, CO-350-COLD-B, CO-350-COLD-B-DD, CO-350-COLD-DD, CO-350-DD, CO-352-COLD, CO-352-COLD-B, CO-352-COLD-B-DD, CO-352-COLD-DD, CO-400, CO-400-B, CO-400-B-DD, CO-400-COLD, CO-400-COLD-B, CO-400-COLD-B-DD, CO-400-COLD-DD, CO-400-DD, CO-400-SOFT, CO-402-COLD, CO-402-COLD-B, CO-402-COLD-B-DD, CO-402-COLD-DD, CO-402W, LVC-12, LVC-15, LVC-15D, LVC-21, LVC-21B, LVC-21C, LVC-21D, LVC-21W, LVR-10, LVR-14, LVR-14D, LVR-20, LVR-20B, LVR-20D...(Other models you can see in the webshop)		

## refrigeration cycle components

### valves

#### Schrader valves

##### valve bodies



1

<b>GEV No.</b>	750097	<b>Ref. No.</b>	12037574 BR00014007
<b>description</b>	valve body for Schrader valve thread 1/4" SAE connection 6mm soldering connection		

### filter driers

#### miscellaneous



1

<b>GEV No.</b>	750119	<b>Ref. No.</b>	12036253 12036970 12048655 6000601003 6047010003
<b>description</b>	dryer size 40g ø 24mm L 167mm connection 6,3/6,3mm		
<b>For models:</b>	AEP-1402, AEP-1403, AEP-1404, AEP-1602, AEP-1603, AEP-1604, AEP-701, AEP-702, AEP-801, AEP-802, AFN-1402, AFN-1403, AFN-1404, AFN-1602, AFN-1603, AFN-1604, AFN-701, AFN-702, AFN-801, AFN-802, AFP-1402, AFP-1402-FORZ, AFP-1402-MIX, AFP-1403, AFP-1403-C, AFP-1403-FORZ, AFP-1403-P, AFP-1404, AFP-1404-C, AFP-1404-FORZ, AFP-1404-P, AFP-1602, AFP-1602-2, AFP-1603, AFP-1604, AFP-2103, AFP-2104, AFP-2104-C, AFP-2104-P, AFP-2105, AFP-2105-C, AFP-2105-P, AFP-2106, AFP-2106-C, AFP-2106-P, AFP-701, AFP-701-FORZ, AFP-702, AFP-702-C, AFP-702-FORZ...(Other models you can see in the webshop)		

## refrigeration pipes

### capillary pipes



1

<b>GEV No.</b>	694200	<b>Ref. No.</b>	12037191 M107020002
<b>description</b>	capillary pipe ED ø 2.4mm ID ø 1.25mm L 1300mm copper		
<b>For models:</b>	MEP-180, MPZ1-200		

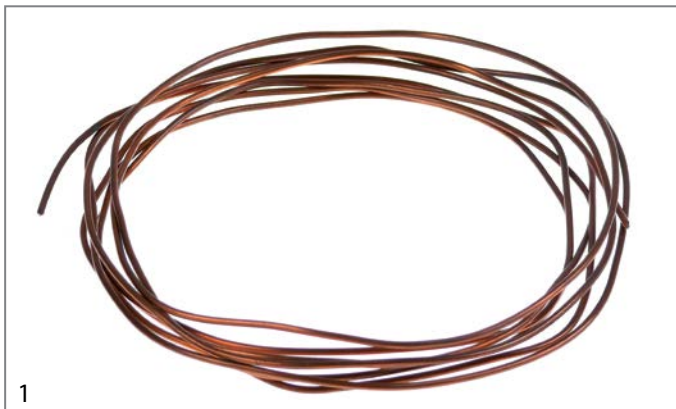

1

<b>GEV No.</b>	694203	<b>Ref. No.</b>	12037496 M107020001
<b>description</b>	capillary pipe ED ø 2mm ID ø 1mm L 3300mm copper		
<b>For models:</b>	BFP-200, FMP-150, FMP-202, FMP-255, FMP-307, MCP-135, MCP-135-AD, MCP-180, MCP-180-AD, MCP-225, MEP-100, MEP-100G, MEP-135, MEP-180, MFP-135, MFP-135-2C, MFP-135-4C, MFP-135-AD, MFP-135-AD-2C, MFP-135-AD-4C, MFP-135-AD-PC, MFP-135-B, MFP-135-F, MFP-180, MFP-180-2C, MFP-180-4C, MFP-180-6C, MFP-180-AD, MFP-180-AD-2C, MFP-180-AD-4C, MFP-180-AD-6C, MFP-180-AD-PC, MFP-180-B, MFP-180-F, MFP-225, MFP-225-2C, MFP-225-4C, MFP-225-6C, MFP-225-8C, MFP-225-B, MFP-225-F, MFP-270-B, MFPG-135-AD, MFPG-180-AD, MMZ-150, MMZ-202, MPN-150-C, MPN-202-C, MPP-150, MPP-150-C...(Other models you can see in the webshop)		

### heating tubes



1

<b>GEV No.</b>	694201	<b>Ref. No.</b>	12035797 M107020004
<b>description</b>	capillary pipe ED ø 2.4mm ID ø 1.25mm L 3500mm copper		
<b>For models:</b>	MPN-150		

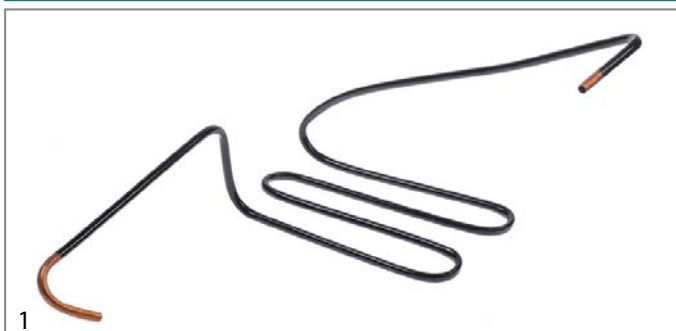

1

<b>GEV No.</b>	701656	<b>Ref. No.</b>	12050455
<b>description</b>	heater ED ø 8mm ID ø 6mm copper Qty 1 for refrigerated counters FAGOR MSN-MFN		



evaporators

for fridges

producer-specific

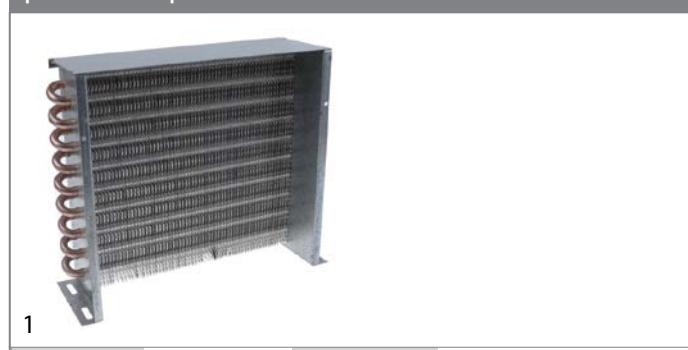

<b>GEV No.</b>	750205	<b>Ref. No.</b>	12032903 6029020002
<b>description</b>	condenser L 330mm W 103mm H 265mm		
<b>For models:</b>	AEP-701, AEP-801, AEP-802, AF-1402-MIX, AF-1602-MIX, AF-1603-C, AF-1603-P, AF-1604-C, AF-1604-P, AF-802-C, AF-802-P, AFP-1602, AFP-1602-2, AFP-1603, AFP-1603-2, AFP-701, AFP-702, AFP-801, AFP-802, AFP-802-2C, AFP-802-3C, BFP-150, BFP-150A, BFP-150I, BFP-200, BFP-200A, BFP-200I, CAEP-701, CAEP-801, CAEP-802, CAF-1402MIXT, CAF-1602MIX, CAF-802-C, CAF-802-P, CAFP-1602-2, CAFP-1603-2, CAFP-701, CAFP-702, CAFP-801, CAFP-802, CAFP-802-2C, CAFP-802-3C, CFMP-150, CFMP-150F, CFMP-150PC, CFMP-150TV, CFMP-202, CFMP-202F, CFMP-202PC, CFMP-202TV...(Other models you can see in the webshop)		



<b>GEV No.</b>	750719	<b>Ref. No.</b>	12030681 6001902002 6029010005 M129010004
<b>description</b>	evaporator L 330mm D 90mm H 205mm total length 450mm overall width 90mm overall height 205mm suitable for FAGOR		
<b>For models:</b>	AEP-801, AEP-802, AFP-1602-2, AFP-701-FORZ, AFP-702-FORZ, AFP-801, AFP-802, FMP-117-R, FMP-150, FMP-169-R, FMP-200, FMP-202, FMP-222-R, FMP-250, FMP-255, FMP-274-R, FMP-300, FMP-307, MCN-237-R, MCP-237-GN-R, MCP-270-GN, MFN-237-R, MFP-225-4C, MFP-225-6C, MFP-225-8C, MFP-237-10C, MFP-237-2C, MFP-237-4C, MFP-237-6C, MFP-237-8C, MFP-237-GN-R, MFP-270-10C, MFP-270-2C, MFP-270-4C, MFP-270-6C, MFP-270-8C, MFP-270-F, MFP-270-GN, MPP-222-R, MPP-222-R-C, MPP-255, MPP-255-C, MPP-274-R, MPP-274-R-C, MPP-307, MPP-307-C, MSP-117-R, MSP-200-F, MSP-250, MSP-250-2C...(Other models you can see in the webshop)		

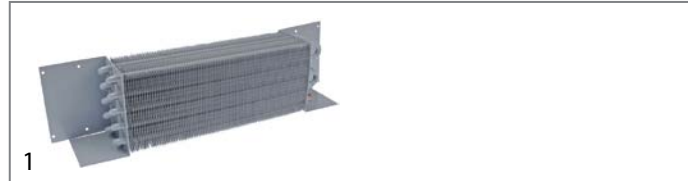

<b>GEV No.</b>	750399	<b>Ref. No.</b>	12031900 6029010140
<b>description</b>	evaporator L 330mm W 125mm H 90mm total length 535mm overall width 130mm overall height 93mm connection 12mm suitable for FAGOR		
<b>For models:</b>	CMPZ1-180, MEP-180, MEP-180-GN, MPZ1-180, MPZ1-200, MPZ1-225, MPZ1-250		



<b>GEV No.</b>	750688	<b>Ref. No.</b>	12031794 6029010146
<b>description</b>	evaporator L 380mm W 95mm H 380mm H2 650mm		
<b>For models:</b>	AEP-701, AEP-801, AEP-802, AF-1402-MIX, AF-1602-MIX, AFP-1602, AFP-1602-2, AFP-1603, AFP-1603-2, AFP-701, AFP-702, AFP-801, AFP-802, AFP-802-2C, AFP-802-3C, APP-701, CAEP-801, CAEP-802, CAF-1602MIX, CAFP-1602-2, CAFP-1603-2, CAFP-801, CAFP-802, CAFP-802-2C, CAFP-802-3C, CAPP-701		



<b>GEV No.</b>	750299	<b>Ref. No.</b>	12030888 12031493 12031626 6029010034 6029010042 A129010010
<b>description</b>	evaporator L 432mm W 90mm H 133mm suitable for FAGOR		
<b>For models:</b>	AEP-701, AF-1402-MIX, AF-702-C, AF-702-P, AF-802-C, AF-802-P, AFP-701, AFP-702, AFP-802, AFP-802-2		

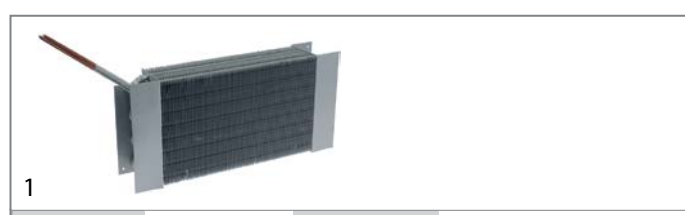

<b>GEV No.</b>	750206	<b>Ref. No.</b>	12030388 12030606 6029010011 6029010040 A129010008
<b>description</b>	evaporator L 440mm W 210mm H 90mm		
<b>For models:</b>	AEP-801, AEP-802, AF-1602-MIX, AF-802-C, AFP-1602, AFP-1602-2, AFP-1603, AFP-1603-2, AFP-801, AFP-802, AFP-802-2		

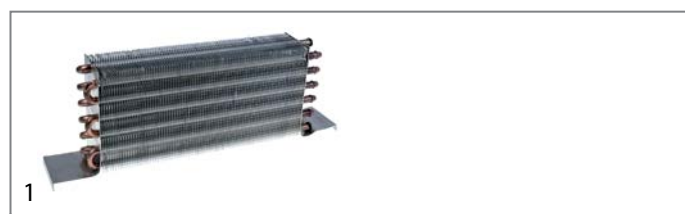

<b>GEV No.</b>	750260	<b>Ref. No.</b>	12031290 12031386 12031866 6001902006 6029010013 M129010007
<b>description</b>	evaporator L 460mm W 65mm H 150mm		
<b>For models:</b>	MEP-100, MEP-100G		

mechanical components, equipment accessories



1

<b>GEV No.</b>	750208	<b>Ref. No.</b>	12029094 12030075 12030785 6001901005 6029010010 A129010003
<b>description</b>	evaporator L 500mm W 300mm H 170mm		
<b>For models:</b>	AEP-701, AFP-1402-MIX, AFP-701, AFP-701-FORZ, AFP-702, AFP-702-C, AFP-702-FORZ, AFP-702-P		



1

<b>GEV No.</b>	750642	<b>Ref. No.</b>	12030276 12030449 6029010039 A129010007
<b>description</b>	evaporator L 515mm W 108mm H 497mm mounting distance 1 437mm suitable for FAGOR		
<b>For models:</b>	AEP-1402, AEP-1602, AF-1403-C, AF-1403-P, AF-1404-C, AF-1404-P, AF-1603-C, AF-1603-P, AF-1604-C, AF-1604-P, AFP-1402, AFP-1403, AFP-1404, AFP-1404-USMC, AFP-1602, AFP-1602-2, AFP-1603, AFP-1603-2, AFP-1604		



1

<b>GEV No.</b>	750207	<b>Ref. No.</b>	12031339 6029010088
<b>description</b>	evaporator L 520mm W 65mm H 170mm		
<b>For models:</b>	FMP-117-R, FMP-150, FMP-169-R, FMP-200, MCP-135-GN, MCP-147-GN-R, MCP-180-GN, MFP-102-GN-R, MFP-135-B-GN, MFP-135-F-GN, MFP-135-GN, MFP-147-GN-R, MFP-180-B-GN, MFP-180-F-GN, MFP-180-GN, MFP-192-GN-R, MSP-117-2RC, MSP-117-4RC, MSP-117-R, MSP-150, MSP-150-2C, MSP-150-4C, MSP-150-F, MSP-150-GI, MSP-169-R, MSP-169-R2C, MSP-169-R4C, MSP-169-R6C, MSP-200, MSP-200-2C, MSP-200-4C, MSP-200-6C, MSP-200-F, MSP-200-GI		



1

<b>GEV No.</b>	750444	<b>Ref. No.</b>	12042017 12044960 6029010036 6029010148
<b>description</b>	evaporator L 565mm W 125mm H 405mm mounting distance 1 650mm suitable for FAGOR		
<b>For models:</b>	AEP-1402, AEP-1602, AF-1402-MIX, AF-1403-C, AF-1403-P, AF-1404-C, AF-1404-P, AF-1603-C, AF-1603-P, AF-1604-C, AF-1604-P, AF-2104-C, AF-2105-C, AF-2106-C, AF-702-C, AF-802-C, AFN-702, AFP-1402, AFP-1403, AFP-1404, AFP-1602, AFP-1602-2, AFP-1603, AFP-1604, AP-701, APP-701		



1

<b>GEV No.</b>	750258	<b>Ref. No.</b>	12028920 12028921 12029453 6029010032 6029010035 A129010004
<b>description</b>	evaporator L 660mm W 120mm H 385mm H2 165mm		
<b>For models:</b>	AEP-2103, AF-2104-C, AF-2104-P, AF-2105-C, AF-2105-P, AF-2106-C, AF-2106-P, AFN-1402, AFN-1403, AFN-1404, AFN-1602, AFN-1603, AFN-1604, AFP-2103, AFP-2104, AFP-2105, AFP-2106		



1

<b>GEV No.</b>	750259	<b>Ref. No.</b>	12028458 6001903002
<b>description</b>	evaporator L 660mm W 120mm H 385mm H2 165mm		
<b>For models:</b>	AFN-1402, AFN-1403, AFN-1404		



			
1			
<b>GEV No.</b>	750727	<b>Ref. No.</b>	12083695 A171010137
<b>description</b>	evaporator total length 370mm overall width 250mm overall height 230mm complete		
<b>For models:</b>	AEP-1602AD, AEP-1603AD, AEP-1604AD, APF-1602AD, APF-1603AD, APF-1604AD, CPAEP-1602, CPAFP-1602		
<b>spare parts for</b>	750727		
	<b>GEV No.</b>	601020	<b>Ref. No.</b> —
	fan motor 5W 230V 50-60Hz L1 44mm L2 48mm L3 79mm W 84mm cable length 500mm 1300rpm YZF5-13-18/26 5 mounting options bearing slide bearing		
	<b>GEV No.</b>	601070	<b>Ref. No.</b> —
	fan wheel sucking ø 200mm fan wheel mounting 25.4mm blade angle 28° W 38mm aluminium		

for saladettes

			
1			
<b>GEV No.</b>	750614	<b>Ref. No.</b>	12031326 12031771 6029010015 M129010009
<b>description</b>	evaporator L 385mm W 130mm D 90mm H 90mm total length 540mm overall width 130mm overall height 90mm mounting distance 1 530mm mounting distance 2 420mm		
<b>For models:</b>	MEP-135, MEP-180, MPZ1-150, MPZ1-200		

for ice-cube maker

for ice cube maker

			
1			
<b>GEV No.</b>	750201	<b>Ref. No.</b>	12028613 BR00D10046
<b>description</b>	evaporator for ice-cube maker 36 cubes L 440mm W 190mm H 40mm		

accessories

housings

			
1			
<b>GEV No.</b>	691847	<b>Ref. No.</b>	12033760 12034208 12034209 12034210 6000201012 6003050001 6003060001 6009992010
<b>description</b>	sump for evaporator L 455mm W 515mm H 98mm		
<b>For models:</b>	MCN-102-R, MCN-135, MCN-147-R, MCN-180, MCN-192-R, MCN-225, MCN-237-R, MCN-270, MCP-102-GN-R, MCP-135, MCP-135-GN, MCP-147-GN-R, MCP-180, MCP-180-GN, MCP-192-GN-R, MCP-225, MCP-225-GN, MCP-237-GN-R, MCP-270-GN, MFN-102-R, MFN-135, MFN-147-R, MFN-180, MFN-192-R, MFN-225, MFN-237-R, MFN-270, MFP-102-2C, MFP-102-4C, MFP-102-GN-R, MFP-135, MFP-135-2C, MFP-135-4C, MFP-135-F, MFP-135-GN, MFP-147-2C, MFP-147-4C, MFP-147-6C, MFP-147-GN-R, MFP-180, MFP-180-2C, MFP-180-4C, MFP-180-6C, MFP-180-F, MFP-180-GN, MFP-192-2C, MFP-192-4C, MFP-192-6C, MFP-192-8C, MFP-192-GN-R...(Other models you can see in the webshop)		

			
1			
<b>GEV No.</b>	692160	<b>Ref. No.</b>	12033558 6003050037
<b>description</b>	sump for evaporator L 525mm W 450mm H 98mm		
<b>For models:</b>	MFP-102-GN-R, MFP-135-B, MFP-135-B-GN, MFP-135-F-GN, MFP-135-GN, MFP-147-GN-R, MFP-180-B, MFP-180-B-GN, MFP-180-F-GN, MFP-180-GN, MFP-192-GN-R, MFP-225-B, MFP-225-F-GN, MFP-225-GN, MFP-237-GN-R, MFP-270-B, MFP-270-F-GN, MFP-270-GN		

condensors

condensors

			
1			
<b>GEV No.</b>	750661	<b>Ref. No.</b>	12029667 BR00020019
<b>description</b>	condenser W 215mm D 270mm H 117mm Qty 1 pcs		

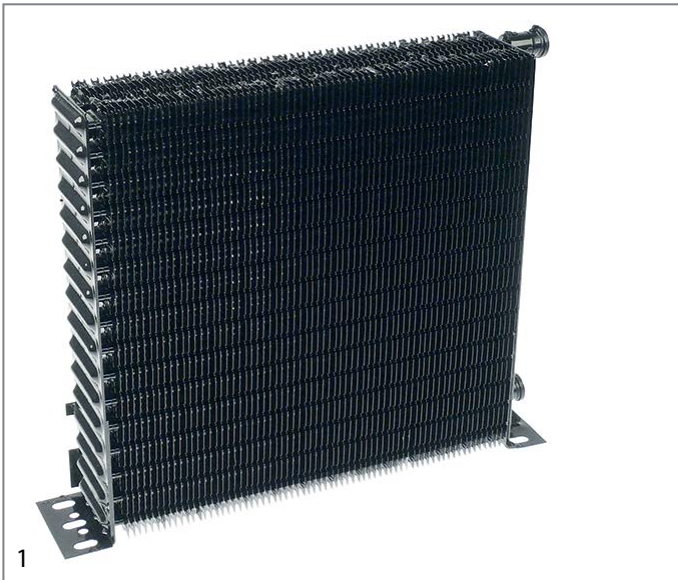

<b>GEV No.</b>	750409	<b>Ref. No.</b>	12029656
<b>description</b>	condenser W 260mm D 60mm H 250mm mounting distance 275mm connection ø 8mm		

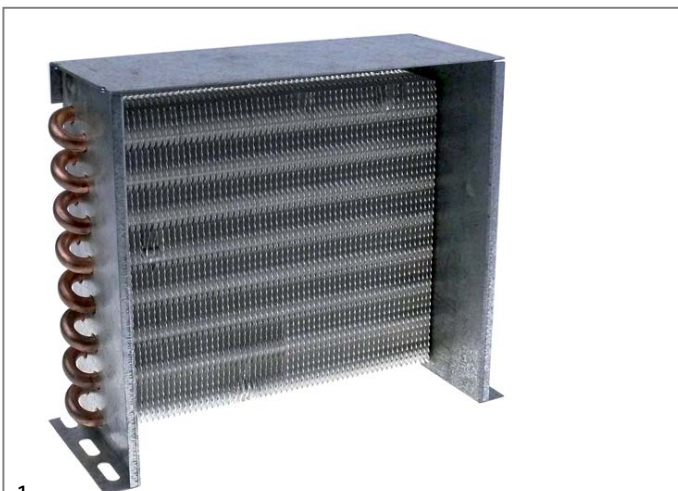

<b>GEV No.</b>	750262	<b>Ref. No.</b>	12031684 12033007 6001911008 6029020008
<b>description</b>	condenser W 290mm D 100mm H 235mm		
<b>For models:</b>	AF-1403-P, AF-1404-P, AF-1603-P, AF-1604-P, AF-2104-P, AF-2105-P, AF-2106-P, AF-702-C, AF-702-P, AF-802-C, AF-802-P, AFP-802, AFP-802-2, BFP-150, CAF-1403P, CAF-1404P, CAF-1603-P, CAF-1604-P, CAF-2104C, CAF-2105C, CAF-2106C, CAF-702C, CAF-702P, CAF-802-C, CAF-802-P, CAF-802-2, VM-100-I, VM-100-M, VM-135-I, VM-135-M		

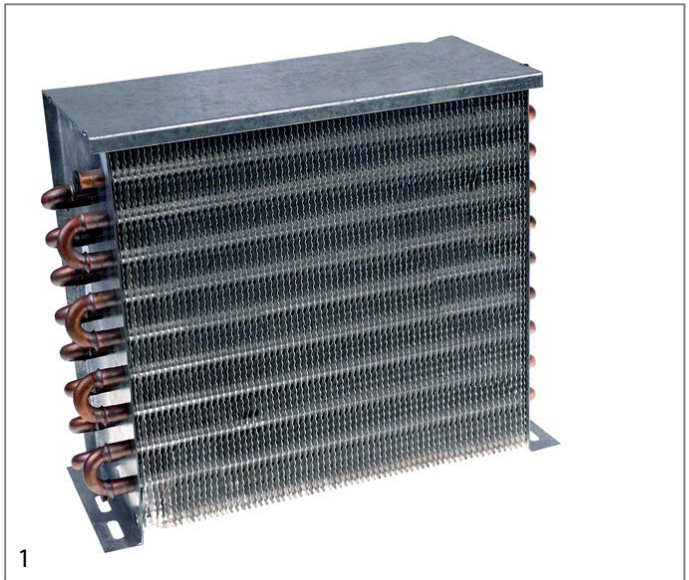

<b>GEV No.</b>	750029	<b>Ref. No.</b>	12030455 12032340 6001911003 6029020003
<b>description</b>	condenser W 320mm D 123mm H 265mm		
<b>For models:</b>	AEP-1402, AEP-1403, AEP-1404, AEP-1602, AEP-1603, AEP-1604, AF-1403-C, AF-1403-P, AF-1404-C, AF-1404-P, AF-1603-C, AF-1603-P, AF-1604-C, AF-1604-P, AFP-1402, AFP-1402-FORZ, AFP-1403, AFP-1403-C, AFP-1403-FORZ, AFP-1403-P, AFP-1404, AFP-1404-C, AFP-1404-FORZ, AFP-1404-P, AFP-1602, AFP-1602-2, AFP-1603, AFP-1604, AP-701, APP-701, BFP-100, BFP-150, BFP-200, BFP-250, BFP-250A, BFP-250I, BFP-300, BFP-300I, CAEP-1402, CAEP-1602, CAF-1403C, CAF-1403P, CAF-1404C, CAF-1404P, CAF-1603-C, CAF-1603-P, CAF-1604-C, CAF-1604-P, CAF-1604, CAF-1403...(Other models you can see in the webshop)		



<b>GEV No.</b>	750261	<b>Ref. No.</b>	12029716 12031310 6001911005 6029020005
<b>description</b>	condenser W 320mm D 130mm H 270mm		
<b>For models:</b>	AEP-2103, AEP-802, AF-1402-MIX, AF-1602-MIX, AF-1603-C, AF-1604-C, AF-2104-C, AF-2104-P, AF-2105-C, AF-2105-P, AF-2106-C, AF-2106-P, AFN-701, AFN-702, AFN-801, AFN-802, AFP-1402-MIX, AFP-2103, AFP-2104, AFP-2104-C, AFP-2104-P, AFP-2105, AFP-2105-C, AFP-2105-P, AFP-2106, AFP-2106-C, AFP-2106-P, CAEP-2103, CAF-1603-C, CAF-1604-C, CAF-2104C, CAF-2104P, CAF-2105C, CAF-2105P, CAF-2106C, CAF-2106P, CAF-2103, CAF-2104, CAF-2105, CAF-2106, CMFN-180, CMPN-202, CMSN-200, MCN-135, MCN-135-GN, MCN-180, MCN-180-GN, MCN-225-GN, MCN-270-GN, MFN-102-GN-R...(Other models you can see in the webshop)		





## evaporation and condensing trays

### unheated condensing trays

			
1			
<b>GEV No.</b>	750067	<b>Ref. No.</b>	12018237 12036623 6000202204 6003010023
<b>description</b>	condensing tray L 255mm W 127mm H 70mm		
<b>For models:</b>	ADMFCN-135, ADMFCN-180, ADMFCN-225, ADMCP-135, ADMCP-180, ADMCP-225, ADMFN-135, ADMFN-180, ADMFN-225, ADMFP-135, ADMFP-135-GR, ADMFP-135HD, ADMFP-135HH, ADMFP-135PC, ADMFP-180, ADMFP-180-GR, ADMFP-180HDD, ADMFP-180HHD, ADMFP-180HHH, ADMFP-180PC, ADMFP-225, ADMFP-225-GR, ADMFP-225HDD, ADMFP-225HDD, ADMFP-225HHDD, ADMFP-225HHH, ADMFP-225PC, AEP-1402, AEP-1403, AEP-1404, AEP-2103, AEP-701, AEP-702, AF-1402-MIX, AF-1403-C, AF-1403-P, AF-1404-C, AF-1404-P, AF-2104-C, AF-2104-P, AF-2105-C, AF-2105-P, AF-2106-C, AF-2106-P, AF-702-C, AF-702-P, AFN-1402, AFN-1403, AFN-1404, AFN-701...(Other models you can see in the webshop)		

### miscellaneous

			
1			
<b>GEV No.</b>	750281	<b>Ref. No.</b>	12033557 12033759 12101127 6003050002 6009992002
<b>description</b>	evaporation tray L 476mm W 427mm H 100mm		
<b>For models:</b>	FMP-117-R, FMP-150, FMP-169-R, FMP-200, FMP-202, FMP-222-R, FMP-255, FMP-274-R, FMP-307, MSN-117-R, MSN-150, MSN-169-R, MSN-200, MSN-222-R, MSN-250, MSN-274-R, MSN-300, MSP-117-2C, MSP-117-4C, MSP-117-R, MSP-150, MSP-150-2C, MSP-150-4C, MSP-150-F, MSP-169-2C, MSP-169-4C, MSP-169-6C, MSP-169-R, MSP-200, MSP-200-2C, MSP-200-4C, MSP-200-6C, MSP-200-F, MSP-222-2C, MSP-222-4C, MSP-222-6C, MSP-222-8C, MSP-222-R, MSP-250, MSP-250-2C, MSP-250-4C, MSP-250-6C, MSP-250-8C, MSP-250-F, MSP-274-10C, MSP-274-2C, MSP-274-4C, MSP-274-6C, MSP-274-8C, MSP-274-R...(Other models you can see in the webshop)		

## transmission technology and ball bearings

### chains

#### roller chains 08B-1 single

			
1			
<b>GEV No.</b>	505339	<b>Ref. No.</b>	12025097 Z275008
<b>description</b>	roller chain DIN/ISO 08 B-1 splitting 1/2" / 12.7mm links 28 internal width 7.75mm rollerø 8.51mm		
<b>For models:</b>	ECO-160, ECO-160D, ECO-160I, ECO-200, ECO-200D, ECO-200H, ECO-200HD, ECO-200HI, ECO-200I, ECO-2700D, ECO-2700H, ECO-280D, ECO-280I, ECO-370D, ECO-370I, ECO-4000D, ECO-4000I, ECO-460D, ECO-460I, ECO-550D, ECO-550I, ECO-6000D, ECO-6000I, FI-160, FI-160AR, FI-160D, FI-160I, FI-200, FI-200AR, FI-200D, FI-200H, FI-200HD, FI-200HI, FI-200I, FI-200W, FI-200WL, FI-200WR, FI-2700D, FI-2700I, FI-280D, FI-280I, FI-370D, FI-370I, FI-4000D, FI-4000I, FI-460D, FI-460I, FI-550D, FI-550I, FI-6000D...(Other models you can see in the webshop)		

### connectors

			
1			
<b>GEV No.</b>	693276	<b>Ref. No.</b>	12023767 Z105012
<b>description</b>	connector single DIN/ISO 08 B-1 splitting 1/2" links 1 L 23mm internal width 11.8mm rollerø 4.3mm metal		
<b>For models:</b>	ECO-160, ECO-160D, ECO-160I, ECO-200, ECO-200D, ECO-200H, ECO-200HD, ECO-200HI, ECO-200I, ECO-2300, ECO-2700D, ECO-2700I, ECO-280D, ECO-280I, ECO-3000, ECO-370D, ECO-370I, ECO-4000D, ECO-4000I, ECO-460D, ECO-460I, ECO-550D, ECO-550I, ECO-6000D, ECO-6000I, FI-160, FI-160D, FI-160AR, FI-160D, FI-160I, FI-200, FI-200AR, FI-200D, FI-200H, FI-200HD, FI-200HI, FI-200I, FI-200W, FI-200WL, FI-200WR, FI-2300, FI-2700D, FI-2700I, FI-280D, FI-280I, FI-3000, FI-370D, FI-370I, FI-4000D...(Other models you can see in the webshop)		

## springs

### torsion springs

			
1			
<b>GEV No.</b>	692159	<b>Ref. No.</b>	12024390 Z271203
<b>description</b>	torsion spring ø 10.3mm L2 20mm wire gauge ø 1.4mm L1 2mm L3 33mm Qty 1 pcs		
<b>For models:</b>	ECO-160, ECO-160D, ECO-160I, ECO-200, ECO-200D, ECO-200H, ECO-200HD, ECO-200HI, ECO-200I, ECO-280D, ECO-280I, ECO-370D, ECO-370I, ECO-460D, ECO-460I, ECO-550D, ECO-550I, FI-160, FI-160AR, FI-160D, FI-160I, FI-200, FI-200AR, FI-200D, FI-200H, FI-200HD, FI-200HI, FI-200I, FI-200W, FI-200WL, FI-200WR, FI-280D, FI-280I, FI-370D, FI-370I, FI-460D, FI-460I, FI-550D, FI-550I		

			
1			
<b>GEV No.</b>	691067	<b>Ref. No.</b>	12009262 S316110
<b>description</b>	torsion spring ø 28.2mm L2 107mm wire gauge ø 4mm L1 42mm		
<b>For models:</b>	ME7-10BM, MG7-10, MG7-10BM, MV7-10BM, SBE7-10, SBG7-10		

			
1			
<b>GEV No.</b>	692811	<b>Ref. No.</b>	12093685
<b>description</b>	torsion spring ø 34mm L2 6mm wire gauge ø 2mm L1 10mm L3 6mm Qty 1 pcs		
<b>For models:</b>	ACE-201, ACE-202, ACG-201, ACG-202, AE-201, AE-202, AG-201, AG-202, APE-201, APE-202, APG-201, APG-202		



<b>GEV No.</b>	540855	<b>Ref. No.</b>	12032821 ICR08052
<b>description</b>	torsion spring ø 50.8mm wire gauge ø 5.1mm L1 34mm L2 104mm L3 29mm mounting pos. left		

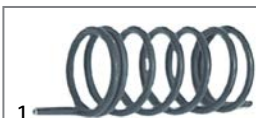

<b>GEV No.</b>	540854	<b>Ref. No.</b>	12032818 ICR08051
<b>description</b>	torsion spring ø 50.8mm wire gauge ø 5.1mm L1 34mm L2 104mm L3 29mm mounting pos. right		



<b>GEV No.</b>	514346	<b>Ref. No.</b>	12032819 ICR08008
<b>description</b>	torsion spring ø 51.5mm wire gauge ø 4.1mm L1 21mm L2 110mm L3 21mm mounting pos. left		



<b>GEV No.</b>	514339	<b>Ref. No.</b>	ICR08007
<b>description</b>	torsion spring ø 51.8mm wire gauge ø 4.1mm L1 20mm L2 106mm L3 20mm mounting pos. right		



<b>GEV No.</b>	514352	<b>Ref. No.</b>	12032815 12033015 ICR08093 ICRI08093
<b>description</b>	torsion spring ø 51mm wire gauge ø 6.5mm L1 28mm L2 101mm L3 28mm mounting pos. left		



<b>GEV No.</b>	514351	<b>Ref. No.</b>	12032816 12033014 ICR08083 ICRI08083
<b>description</b>	torsion spring ø 51mm wire gauge ø 6.5mm L1 28mm L2 101mm L3 28mm mounting pos. right		



<b>GEV No.</b>	514350	<b>Ref. No.</b>	12032817 ICR08055
<b>description</b>	torsion spring ø 51mm wire gauge ø 6mm L1 28mm L2 95mm L3 28mm mounting pos. left		



<b>GEV No.</b>	514349	<b>Ref. No.</b>	12032814 ICR08054
<b>description</b>	torsion spring ø 51mm wire gauge ø 6mm L1 28mm L2 95mm L3 28mm mounting pos. right		

compression springs



<b>GEV No.</b>	505138	<b>Ref. No.</b>	12040429 Z600605
<b>description</b>	compression spring		
<b>For models:</b>	FI-300B, FI-300R, FI-650R, FTG7-05, FTG7-10, FTG9-05L, FTG9-05R, FTG9-10L, FTG9-10L+R, FTG9-10R, FTGC9-05, FTGC9-10, LC-10, LC-14, LC-7, LC-7A		



<b>GEV No.</b>	691008	<b>Ref. No.</b>	12025252 Z700603
<b>description</b>	compression spring ø 10mm L 28mm wire gauge ø 0.9mm		
<b>For models:</b>	BG9-05PLUS-I, BG9-10PLUS-I, CE-15, CE-9, FE-710, FE-720, FE9-05, FE9-05S, FE9-05USMC, FE9-10, FI-300B, FI-300R, FI-650R, FTG9-05PLUS-CL, FTG9-05PLUS-CR, FTG9-05PLUS-L, FTG9-05PLUS-LV, FTG9-05PLUS-R, FTG9-05PLUS-RV, FTG9-10PLUS-CL, FTG9-10PLUS-CLR, FTG9-10PLUS-CR, FTG9-10PLUS-L, FTG9-10PLUS-LR, FTG9-10PLUS-LRV, FTG9-10PLUS-LV, FTG9-10PLUS-R, FTG9-10PLUS-RV, HCG-10-11, HCG-10-21, HCG-20-11, HCG-2-10-11, HCG-6-11, HME-10-11, HME-10-21, HME-20-11, HME-20-21, HME-2-10-11, HME-6-11, HMG-10-11, HMG-10-11UL, HMG-10-21, HMG-10-21UL, HMG-20-11, HMG-2-10-11, HMG-6-11, HMI-10-11, HMI-10-11UL, HMI-10-21, HMI-10-21UL...(Other models you can see in the webshop)		

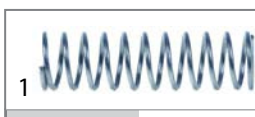



<b>GEV No.</b>	691880	<b>Ref. No.</b>	12016846 R725007
<b>description</b>	compression spring ø 13.3mm L 47.5mm wire gauge ø 1.2mm		
<b>For models:</b>	FF-35, HMG-10-11, HMG-10-11UL, HMG-10-21, HMG-10-21UL, HMG-20-11, HMG-2-10-11, HMG-6-11		





			
<b>GEV No.</b>	691876	<b>Ref. No.</b>	12024277 R725008
<b>description</b>	compression spring $\varnothing$ 14.5mm L 20mm wire gauge $\varnothing$ 1.8mm		
<b>For models:</b>	HGP-10-21, HGP-20-21, HGV-10-11, HGV-10-21, HGV-20-11, HGV-20-21, HMG-10-11, HMG-10-21, HMG-2-10-11, HMG-6-11, HVG-10-11, HVG-10-11UL, HVG-10-21, HVG-10-21UL, HVG-20-11, HVG-20-21, HVG-2-10-11, HVG-2-20-21, MFHVG-10-11, MFHVG-10-21, VG-101, VG-102, VG-201, VG-202, VPG-101, VPG-102, VPG-201, VPG-202		

			
<b>GEV No.</b>	693591	<b>Ref. No.</b>	12037536 RT20010109
<b>description</b>	compression spring $\varnothing$ 14mm L 27mm wire gauge $\varnothing$ 1.5mm		

			
<b>GEV No.</b>	691043	<b>Ref. No.</b>	12017094 R010511
<b>description</b>	compression spring $\varnothing$ 16.1mm L 70mm wire gauge $\varnothing$ 1.8mm		
<b>For models:</b>	FE-920, FF-35, HCG-10-11, HCG-10-21, HCG-20-11, HCG-2-10-11, HCG-6-11, HCV-10-11, HCV-10-21, HCV-2-10-21, HCV-6-11, HE-10-11, HE-10-21, HE-2-10-11, HE-6-11, HG-10-11, HG-10-21, HG-2-10-11, HME-10-11, HME-10-21, HME-20-11, HME-20-21, HME-2-10-11, HME-6-11, HMG-10-11, HMG-10-11UL, HMG-10-21, HMG-10-21UL, HMG-20-11, HMG-2-10-11, HMG-6-11, HMI-10-11, HMI-10-11UL, HMI-10-21, HMI-10-21UL, HMI-2-10-11, HMI-6-11, HMI-6-11UL, HMM-10-11, HMM-10-11UL, HMM-10-21, HMM-10-21UL, HMM-20-11, HMM-20-11UL, HMM-20-21, HMM-2-10-11, HMM-6-11, HMM-6-11UL, HMP-10-11, HMP-10-21...(Other models you can see in the webshop)		

			
<b>GEV No.</b>	691032	<b>Ref. No.</b>	12009265 S136080 S136108
<b>description</b>	compression spring $\varnothing$ 42.6mm L 129mm wire gauge $\varnothing$ 7mm		
<b>For models:</b>	MPE9-10BM, MPE9-10BMS, MPE9-15BM, MPE9-15BMS, MPG9-10, MPG9-10BM, MPG9-10BMS, MPG9-10S, MPG9-15, MPG9-15BM, MPG9-15BMS, MPG9-15S, MPG9-20, MPG9-20S		

			
<b>GEV No.</b>	691881	<b>Ref. No.</b>	12019099 Z850608
<b>description</b>	compression spring $\varnothing$ 6mm L 24mm wire gauge $\varnothing$ 0.8mm		

			
<b>GEV No.</b>	691090	<b>Ref. No.</b>	12023716 Z850519
<b>description</b>	compression spring $\varnothing$ 7.1mm L 25.5mm wire gauge $\varnothing$ 0.7mm		
<b>For models:</b>	ACE-061, ACE-101, ACE-102, ACE-201, ACE-202, ACG-061, ACG-101, ACG-102, ACG-201, ACG-202, AE-061, AE-061W, AE-101, AE-101W, AE-102, AE-102W, AE-201, AE-202, AG-061, AG-061W, AG-101, AG-101W, AG-102, AG-102W, AG-201, AG-202, APE-061, APE-061W, APE-101, APE-101W, APE-102, APE-102W, APE-201, APE-202, APG-061, APG-061W, APG-101, APG-101W, APG-102, APG-102W, APG-201, APG-202, COE-061, COE-101, COE-102, COE-201, COE-202, COG-061, COG-101, COG-102...(Other models you can see in the webshop)		

			
<b>GEV No.</b>	696553	<b>Ref. No.</b>	12017801 Z883001
<b>description</b>	compression spring $\varnothing$ 7.5mm L 23mm wire gauge $\varnothing$ 0.7mm		
<b>For models:</b>	ECO-280D, ECO-280I, ECO-370D, ECO-370I, ECO-460D, ECO-460I, ECO-550D, ECO-550I, FI-280D, FI-280I, FI-370D, FI-370I, FI-460D, FI-460I, FI-550D, FI-550I, HEI-10-11, HEI-20-11, HEI-6-11, HEM-10-11, HEM-20-11, HEM-6-11, HEP-10-11, HEP-20-11, HEP-6-11, HME-10-11, HME-20-11, HME-6-11, HMI-10-11, HMI-10-11UL, HMI-10-21, HMI-10-21UL, HMI-2-10-11, HMI-6-11, HMI-6-11UL, HMM-10-11, HMM-10-11UL, HMM-10-21, HMM-10-21UL, HMM-20-11, HMM-20-11UL, HMM-20-21, HMM-2-10-11, HMM-2-20-11, HMM-40-11-USMC...(Other models you can see in the webshop)		

			
<b>GEV No.</b>	691011	<b>Ref. No.</b>	12008888 S112105
<b>description</b>	compression spring $\varnothing$ 70mm L 95mm wire gauge $\varnothing$ 3mm for drain tap		
<b>For models:</b>	FTE7-05, FTE7-10, FTE9-05L, FTE9-05R, FTE9-10L, FTE9-10L+R, FTE9-10R, FTEC9-05, FTEC9-05L, FTEC9-05R, FTEC9-10, FTEC9-10L, FTEC9-10L+R, FTEC9-10R, FTG7-05, FTG7-10, FTG-9050L, FTG-9050R, FTG9-05L, FTG9-05R, FTG9-05VL, FTG9-05VR, FTG-9100L, FTG-9100L+R, FTG-9100R, FTG9-10L, FTG9-10L+R, FTG9-10R, FTG9-10VL, FTG9-10VL+R, FTG9-10VR, FTG9-05, FTG9-05L, FTG9-05R, FTG9-05R, FTG9-10, FTG9-10L, FTG9-10L+R, FTG9-10R, ME7-10BM, ME9-10BM, ME9-10BMS, ME9-15BM, ME9-15BMS, MG7-10, MG7-10BM, MG9-10, MG-9100, MG9-10AD...(Other models you can see in the webshop)		

			
<b>GEV No.</b>	700765	<b>Ref. No.</b>	12024164 T130506
<b>description</b>	compression spring $\varnothing$ 8.1mm L 20.4mm wire gauge $\varnothing$ 1.2mm		
<b>For models:</b>	ACE-201, ACE-202, ACG-201, ACG-202, AE-201, AE-202, AG-201, AG-202, APE-201, APE-202, APG-201, APG-202, COE-201, COE-202, COG-201, COG-202, HCG-10-11, HCG-10-21, HCG-20-11, HCG-20-21, HCG-2-10-11, HCG-2-20-11, HCG-6-11, HEI-10-11, HEI-10-21, HEI-20-11, HEI-20-21, HEI-6-11, HEM-10-11, HEM-10-21, HEM-20-11, HEM-20-21, HEM-6-11, HEP-10-11, HEP-10-21, HEP-20-11, HEP-20-21, HEP-6-11, HGC-10-11, HGC-10-21, HGC-20-11, HGC-20-21, HGC-6-11, HGP-10-21, HGP-20-21, HGV-10-11, HGV-10-21, HGV-20-11, HGV-20-21, HME-10-11...(Other models you can see in the webshop)		



<b>GEV No.</b>	691016	<b>Ref. No.</b>	12009030 S116121
<b>description</b>	torsion spring $\varnothing$ 44mm L 124mm wire gauge $\varnothing$ 5.6mm		
<b>For models:</b>	ME9-10BM, ME9-10BMS, ME9-15BM, ME9-15BM316, ME9-15BMS, MG9-10, MG-9100, MG9-10BM, MG9-10BMS, MG9-10S, MG9-15, MG-9150, MG-9150BM, MG9-15BM, MG9-15BMS, MG9-15S, MG9-20, MG-9200, MG9-20S, MPE9-10BM, MPE9-10BMS, MPE9-15BM, MPE9-15BMS, MPG9-10, MPG9-10BM, MPG9-10BMS, MPG9-10S, MPG9-15, MPG-9150, MPG9-15BM, MPG9-15BMS, MPG9-15S, MPG9-20, MPG-9200, MPG9-20S, MV9-10BM, MV9-15BM, SBE7-10, SBE9-10, SBE9-10I, SBE9-10IM, SBE9-10IMS, SBE9-10IS, SBE9-10M, SBE9-10MS, SBE9-10S, SBE9-10USMC, SBE9-15IM, SBE9-15IMS, SBE9-15M...(Other models you can see in the webshop)		

## roller springs



<b>GEV No.</b>	501430	<b>Ref. No.</b>	12024877 Z310511
<b>description</b>	roller spring W 40mm ID $\varnothing$ 33mm lug length 49mm mounting distance 10mm		
<b>For models:</b>	ECO-280D, ECO-280I, ECO-370D, ECO-370I, ECO-460D, ECO-460I, ECO-550D, ECO-550I, FI-280D, FI-280I, FI-370D, FI-370I, FI-460D, FI-460I, FI-550D, FI-550I		



<b>GEV No.</b>	519451	<b>Ref. No.</b>	12024689 Z270513
<b>description</b>	roller spring W 40mm ID $\varnothing$ 35mm lug length 50mm		
<b>For models:</b>	ECO-160, ECO-160D, ECO-160I, ECO-200, ECO-200D, ECO-200H, ECO-200HD, ECO-200HI, ECO-200I, ECO-2700D, ECO-2700I, ECO-280D, ECO-280I, ECO-370D, ECO-370I, ECO-4000D, ECO-4000I, ECO-460D, ECO-460I, ECO-550D, ECO-550I, ECO-6000D, ECO-6000I, FI-160, FI-160AR, FI-160D, FI-160I, FI-200, FI-200AR, FI-200D, FI-200H, FI-200HD, FI-200HI, FI-200I, FI-200W, FI-200WL, FI-200WR, FI-2700D, FI-2700I, FI-280D, FI-280I, FI-370D, FI-370I, FI-4000D, FI-4000I, FI-460D, FI-460I, FI-550D, FI-550I, FI-6000D...(Other models you can see in the webshop)		

## accessories

### holders



<b>GEV No.</b>	517431	<b>Ref. No.</b>	12011392 Z270515
<b>description</b>	bracket for roller spring $\varnothing$ mm L 105mm W 44mm H 20mm		
<b>For models:</b>	ECO-160, ECO-160D, ECO-160I, ECO-200, ECO-200D, ECO-200H, ECO-200HD, ECO-200HI, ECO-200I, FI-160, FI-160AR, FI-160D, FI-160I, FI-200, FI-200AR, FI-200D, FI-200H, FI-200HD, FI-200HI, FI-200I, FI-200W, FI-200WL, FI-200WR		

## miscellaneous



<b>GEV No.</b>	513328	<b>Ref. No.</b>	12024244 T840509000
<b>description</b>	spring for combi-steamer L 34mm W 27mm wire gauge $\varnothing$ 0.6mm		



<b>GEV No.</b>	504387	<b>Ref. No.</b>	12024391 Z271204
<b>description</b>	spring right for transport system shaft diametermm $\varnothing$ 10.5mm L 36mm Wmm Hmm wire gauge $\varnothing$ 1.4mm		
<b>For models:</b>	ECO-160, ECO-160D, ECO-160I, ECO-200, ECO-200D, ECO-200H, ECO-200HD, ECO-200HI, ECO-200I, ECO-280D, ECO-280I, ECO-370D, ECO-370I, ECO-460D, ECO-460I, ECO-550D, ECO-550I, FI-160, FI-160AR, FI-160D, FI-160I, FI-200, FI-200AR, FI-200D, FI-200H, FI-200HD, FI-200HI, FI-200I, FI-200W, FI-200WL, FI-200WR, FI-280D, FI-280I, FI-370D, FI-370I, FI-460D, FI-460I, FI-550D, FI-550I		

## tension springs



<b>GEV No.</b>	505009	<b>Ref. No.</b>	12024948 Z710528
<b>description</b>	tension spring $\varnothing$ 35mm total length 420mm wire gauge $\varnothing$ 5mm		
<b>For models:</b>	AD-120, AD-120B, AD-120BBTDD-UK, AD-90, AD-90BA, AD-90BBT, AD-90BDD, AD-90DD, ADE-120, ADE-120B, ECO-120, ECO-120B, FI-100, FI-100AR, FI-100B, FI-100BBT-UK, FI-120, FI-120AR+DD, FI-120B, FI-120C, FI-120HY-CLINIC, FI-120W, FI-80, FI-80AR, FI-80BBT-UK, FI-80W, FI-E-100, LABP-1000, LABP-1200, LABP-800, MF-120		



coffee accessories

coffee grounds drawers

1			
<b>GEV No.</b>	698839	<b>Ref. No.</b>	6009990065
<b>description</b>	coffee drawer bar ø 35mm L 375mm		

kitchen accessories

gastronorm

bridges



1			
<b>GEV No.</b>	700807	<b>Ref. No.</b>	12002780 R966104
<b>description</b>	bridge for Gastronorm container L1 327mm L2 307mm SS W 25mm H 15mm Qty 1 pcs		
<b>For models:</b>	BME6-05, BME7-05		

manometers

1			
<b>GEV No.</b>	541596	<b>Ref. No.</b>	12025146 Z102316
<b>description</b>	manometer ø 52mm pressure range 0 up to 10bar connection dishwasher thread 1/4"		
<b>For models:</b>	ECO-160, ECO-1600, ECO-200, ECO-200H, ECO-2300, ECO-3000, FI-160, FI-1600, FI-160AR, FI-160D, FI-160I, FI-200, FI-200AR, FI-200D, FI-200H, FI-200HD, FI-200HI, FI-200I, FI-2300, FI-2700D, FI-2700I, FI-2800, FI-280I, FI-3000, FI-370D, FI-370I, FI-4000D, FI-4000I, FI-460D, FI-460I, FI-550D, FI-550I, FI-6000D, FI-6000I		

1			
<b>GEV No.</b>	541579	<b>Ref. No.</b>	12038013 ICR10022
<b>description</b>	manometer ø 52mm pressure range 0 up to 1bar connection marking 0.5 thread 1/4"		

1			
<b>GEV No.</b>	541793	<b>Ref. No.</b>	12019289 12024625 Z271125 Z718417
<b>description</b>	manometer ø 52mm pressure range 0-4bar thread 1/4"		
<b>For models:</b>	AD-120CW, CO-142W, CO-142WDD, FI-120W, FI-200W, FI-200WL, FI-200WR, FI-80W, MF-120		

1					
<b>GEV No.</b>	541062	<b>Ref. No.</b>	12009399 9220815		
<b>description</b>	manometer ø 63mm pressure range 0 up to 1bar connection marking adjustable kettle thread 1/4"				
<b>For models:</b>	ME9-10BM, ME9-10BMS, ME9-10PLUS-BM, ME9-10PLUS-BMS, ME9-15BM, ME9-15BM316, ME9-15BM-AD, ME9-15BMS, ME9-15PLUS-BM, ME9-15PLUS-BMS, MG9-10BM, MG9-10BMAD, MG9-10BMS, MG9-10BMSAD, MG9-10PLUS-BM, MG9-10PLUS-BMS, MG-9150BM, MG9-15BM, MG9-15BM316, MG9-15BMAD, MG9-15BMS, MG9-15BMSAD, MG9-15PLUS-BM, MG9-15PLUS-BMS, MPE9-10BM, MPE9-10BMS, MPE9-15BM, MPE9-15BMS, MPG9-10BM, MPG9-10BMS, MPG9-15BM, MPG9-15BMS, MV9-10BM, MV9-15BM				
<b>spare parts for</b>	541062				
		<b>GEV No.</b>	541130	<b>Ref. No.</b>	—
	glass panel ø 58mm thickness 2mm				

hose reels and spray guns

spray guns



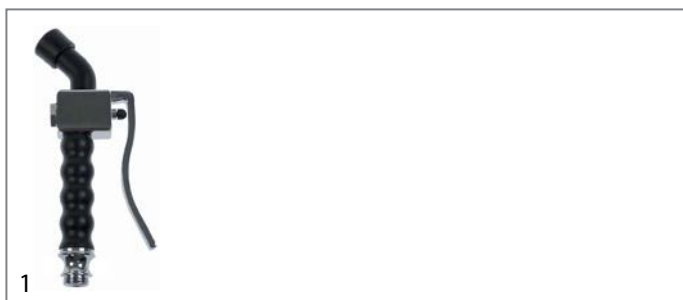

1					
<b>GEV No.</b>	540302	<b>Ref. No.</b>	12030181 RT20601006		
<b>description</b>	spray gun for appliances 1/2" ET L 135mm type RATIONAL				
<b>spare parts for</b>	540302				
		<b>GEV No.</b>	517056	<b>Ref. No.</b>	—
	O-ring EPDM thickness 2mm ID ø 6.5mm Qty 1 pcs				
		<b>GEV No.</b>	532535	<b>Ref. No.</b>	—
	O-ring EPDM thickness 5mm ID ø 10mm Qty 1 pcs				
		<b>GEV No.</b>	548016	<b>Ref. No.</b>	—
	compression spring ø 10mm L 17mm wire gauge ø 0.9mm for hand spray				

Table continues overleaf

<b>spare parts for</b> 540302			
	<b>GEV No.</b>	548017	<b>Ref. No.</b> —
pressure bolt for hand spray			



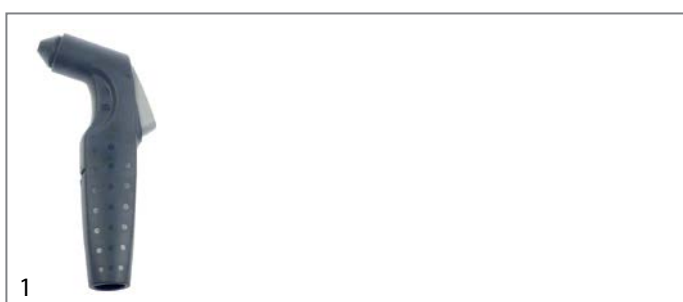

<b>GEV No.</b>	691048	<b>Ref. No.</b>	12004216 R095005
<b>description</b>	spray gun for appliances 1/2" ET L 225mm type STAR		
<b>For models:</b>	HCG-10-11, HCG-10-21, HCG-20-11, HCG-20-21, HCG-2-10-11, HCG-2-20-11, HCG-6-11, HME-10-11, HME-10-21, HME-20-11, HME-20-21, HME-2-10-11, HME-2-20-11, HME-6-11, HMG-10-11, HMG-10-11UL, HMG-10-21, HMG-10-21UL, HMG-20-11, HMG-2-10-11, HMG-6-11, HMI-10-11, HMI-10-11UL, HMI-10-21, HMI-10-21UL, HMI-2-10-11, HMI-6-11, HMI-6-11UL, HMM-10-11, HMM-10-11UL, HMM-10-21, HMM-10-21UL, HMM-20-11, HMM-20-11UL, HMM-20-21, HMM-20-21UL, HMM-2-10-11, HMM-2-20-11, HMM-40-11-USMC, HMM-6-11, HMM-6-11UL, HMP-10-11, HMP-10-21, HMP-20-11, HMP-20-21, HMP-2-10-11, HMP-2-20-11, HMP-6-11, HVG-10-11, HVG-10-11UL...(Other models you can see in the webshop)		

<b>spare parts for</b> 691048			
	<b>GEV No.</b>	507309	<b>Ref. No.</b> —
O-ring EPDM thickness 2.62mm ID ø 17.13mm Qty 1 pcs			
	<b>GEV No.</b>	510322	<b>Ref. No.</b> —
O-ring EPDM thickness 1.78mm ID ø 17.17mm Qty 1 pcs			
	<b>GEV No.</b>	524055	<b>Ref. No.</b> —
flat gasket rubber ED ø 18mm ID ø 12mm thickness 2mm Qty 1 pcs			
	<b>GEV No.</b>	528485	<b>Ref. No.</b> —
O-ring EPDM thickness 1.78mm ID ø 6.07mm Qty 1 pcs			
	<b>GEV No.</b>	528494	<b>Ref. No.</b> —
gasket rubber ED ø 13mm ID ø 4mm thickness 4mm Qty 1 pcs			

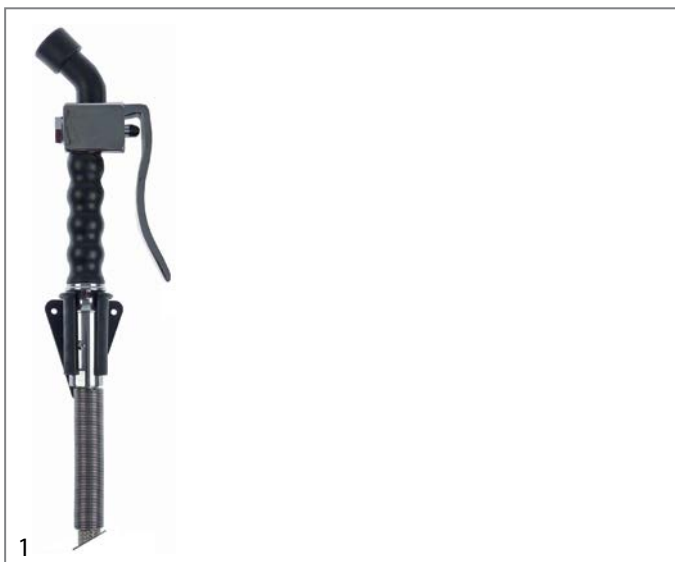

<b>GEV No.</b>	540664	<b>Ref. No.</b>	12030307 RT5000130
<b>description</b>	spray gun for appliances 1/2" (12.83mm) L 165mm		
<b>spare parts for</b> 540664			
	<b>GEV No.</b>	699809	<b>Ref. No.</b> 12037366 RT5000156
clamp for spray gun L 24mm			



<b>GEV No.</b>	691618	<b>Ref. No.</b>	12007934 R095009
<b>description</b>	spray gun for appliances 1/2" ET L 225mm with hose (2m) and wall holder type STAR		
<b>For models:</b>	HEM-10-11, HEM-20-11, HEM-6-11, HEP-10-11, HEP-20-11, HEP-6-11, HGV-10-11, HGV-20-11		
<b>spare parts for</b> 691618			
	<b>GEV No.</b>	542966	<b>Ref. No.</b> —
wall holder for hand spray			



<b>GEV No.</b>	691094	<b>Ref. No.</b>	12020555 R095007
<b>description</b>	wall holder for hand spray		
<b>For models:</b>	HCG-10-11, HCG-10-21, HCG-20-11, HCG-20-21, HCG-2-10-11, HCG-2-20-11, HCG-6-11, HME-10-11, HME-10-21, HME-20-11, HME-20-21, HME-2-10-11, HME-2-20-11, HME-6-11, HMG-10-11, HMG-10-11UL, HMG-10-21, HMG-10-21UL, HMG-20-11, HMG-2-10-11, HMG-6-11, HMI-10-11, HMI-10-11UL, HMI-10-21, HMI-10-21UL, HMI-2-10-11, HMI-6-11, HMI-6-11UL, HMM-10-11, HMM-10-11UL, HMM-10-21, HMM-10-21UL, HMM-20-11, HMM-20-11UL, HMM-20-21, HMM-20-21UL, HMM-2-10-11, HMM-2-20-11, HMM-40-11-USMC, HMM-6-11, HMM-6-11UL, HMP-10-11, HMP-10-21, HMP-20-11, HMP-20-21, HMP-2-10-11, HMP-2-20-11, HMP-6-11, HVG-10-11, HVG-10-11UL...(Other models you can see in the webshop)		



hose reels

appliance hose reels



1

<b>GEV No.</b>	542093	<b>Ref. No.</b>	12024800 12040977
<b>description</b>	hose reel complete with spray gun hose length 1.8m		
<b>For models:</b>	AE-061, AE-061W, AE-101, AE-101W, AE-102, AE-102W, AE-201, AE-202, AG-061, AG-061W, AG-101, AG-101W, AG-102, AG-102W, AG-201, AG-202, APE-061, APE-061W, APE-101, APE-101W, APE-102, APE-102W, APE-201, APE-202, APG-061, APG-061W, APG-101, APG-101W, APG-102, APG-102W, APG-201, APG-202, COG-202, HEM-20-21, HEP-10-21, HEP-20-21, HGP-10-21, HGP-20-21, HGV-20-21, VE-061, VE-101, VE-102, VE-201, VE-202, VG-101, VG-102, VG-201, VG-202, VPE-061, VPE-101...(Other models you can see in the webshop)		



1

<b>GEV No.</b>	541444	<b>Ref. No.</b>	12026185 RT5000176P
<b>description</b>	hose reel without spray gun hose length 1.5m		



1

<b>GEV No.</b>	540661	<b>Ref. No.</b>	12026732 12026734 RT5000140 RT5000140P	
<b>description</b>	hose reel without spray gun hose length 1m			
<b>accessories for</b>	540661			
	<b>GEV No.</b>	540664	<b>Ref. No.</b>	12030307 RT5000130
	spray gun for appliances 1/2" (12.83mm) L 165mm			
	<b>GEV No.</b>	560630	<b>Ref. No.</b>	12037727 RT11070100
	clamping washer nominal-ø 4mm ED ø 11.5mm SS thickness 0.2mm			
	<b>GEV No.</b>	694491	<b>Ref. No.</b>	—
	supply tube for hose reel			
	<b>GEV No.</b>	699802	<b>Ref. No.</b>	—
	cover for spray gun D1 ø 90/145mm L 145mm H 68mm			



1

<b>GEV No.</b>	540483	<b>Ref. No.</b>	12026642 RT86552020
<b>description</b>	hose reel without spray gun hose length 2.1m		

dosing pumps

peristaltic dosing pumps

GERMAC

built-in version

with frequency control









1

<b>GEV No.</b>	361795 <sup>1</sup>	<b>Ref. No.</b>	1200000132 19022347	
<b>description</b>	dosing pump GERMAC frequency control 3l/h 230VAC detergent hose ø 4x6mm hose thermoplastic type G300 3.5W 230V code 82334968 installation kit inclusive			
<b>For models:</b>	CO-110DD, CO-112DD, CO-142WDD, CO-170DD, CO-172DD, CO-350-COLD-DD, CO-350-DD, CO-400-COLD-DD, CO-400-DD, CO-402-COLD, CO-402-COLD-B, CO-402-COLD-B-DD, CO-402-COLD-DD, CO-402W, CO-500DD, CO-501DD, CO-502DD, CO-502W, COP-173DD, COP-174DD, COP-174W, COP-174WHR, COP-503DD, COP-504DD, COP-504W, FI-30, FI-30AR, FI-30AR+DD, FI-30-UK, FI-48, FI-48AR, FI-48B, FI-48B-BT-UK, FI-48C, FI-48D, FI-48HY-CLINIC, FI-48W, FI-64, FI-64AR, FI-64B, FI-64B-BT-UK, FI-64C, FI-64D, FI-64HY-CLINIC, FI-64W, FI-72, FI-72AR, FI-72W			
<b>spare parts for</b>	361795			
	<b>GEV No.</b>	361142	<b>Ref. No.</b>	—
	mounting set detergent hose type 4x6mm hose length 2m PVC 2x hose/container filter/tank intake transparent			
	<b>GEV No.</b>	361268	<b>Ref. No.</b>	12017199 12024224 Z209521 Z209530
	dosing pump GERMAC frequency control 3l/h 230VAC detergent hose ø 4x6mm hose thermoplastic type G300 built-in version dimensions 67x72x101mm			
	<b>GEV No.</b>	361467	<b>Ref. No.</b>	—
	pump hose GERMAC detergent hose type thermoplastic hose ø 6x10mm for model G43/G45/G53/G54/G55/G300/G305			

<sup>1</sup>with accessories













			
1			
<b>GEV No.</b>	361268	<b>Ref. No.</b>	12017199 12024224 Z209521 Z209530
<b>description</b>	dosing pump GERMAC frequency control 3l/h 230VAC detergent hose ø 4x6mm hose thermoplastic type G300 built-in version dimensions 67x72x101mm		
<b>For models:</b>	FI-30, FI-48, FI-48B, FI-48W, FI-50, FI-64, FI-64B, FI-64W, FI-72, MF-48, MF-64		
<b>spare parts for</b>	361268		
	<b>GEV No.</b>	361467	<b>Ref. No.</b> —
	pump hose GERMAC detergent hose type thermoplastic hose ø 6x10mm for model G43/G45/G53/G54/G55/G300/G305		
	<b>GEV No.</b>	361557	<b>Ref. No.</b> —
	control PCB type G300/G302/G305 GERMAC		
	<b>GEV No.</b>	361589	<b>Ref. No.</b> —
	roller assembly GERMAC suitable for G42/43/45/53/54/55/300/302/305/705		
<b>accessories for</b>	361268		
	<b>GEV No.</b>	361106	<b>Ref. No.</b> —
	container filter with weight and non-return valve SS hose ø 4x6mm ø 21mm L 51mm non return valve lip valve		
	<b>GEV No.</b>	520090	<b>Ref. No.</b> —
	PVC hose ID ø 4mm ED ø 6mm L 2m thickness 1mm t.max. 60°C transparent		
	<b>GEV No.</b>	520091	<b>Ref. No.</b> —
	nylon hose ID ø 4mm ED ø 6mm L 2m thickness 1mm operating p. 10bar burst p. 50bar t.max. 100°C transparent		

membrane dosing pumps



self-priming



LANG

			
1			
<b>GEV No.</b>	361221	<b>Ref. No.</b>	12024105 12039170 Z211109 Z651123
<b>description</b>	dosing pump type N6 rinse aid pressure connection ø 4x6mm suction connection ø 6x8mm LANG		
<b>For models:</b>	AD-120, AD-120B, AD-120C, AD-120CW, AD-15, AD-15D, AD-20C-UK, AD-21, AD-21B, AD-21BDD, AD-21C, AD-21D, AD-21DD, AD-21W, AD-48, AD-48B, AD-48BDD, AD-48C, AD-48D, AD-48DD, AD-48W, AD-64, AD-64B, AD-64BDD, AD-64C, AD-64CW, AD-64D, AD-64DD, AD-72, AD-72W, AD-90, AD-90BA, AD-90BDD, AD-90DD, ADE-120, ADE-120B, ECO-120, ECO-1200, ECO-120B, FI-100, FI-100AR, FI-100B, FI-100BBT-UK, FI-120, FI-1200, FI-120AR+DD, FI-120B, FI-120C, FI-120HY-CLINIC, FI-120W...(Other models you can see in the webshop)		
<b>spare parts for</b>	361221		
	<b>GEV No.</b>	361079	<b>Ref. No.</b> —
	spring for type N5/N6 for ball		
	<b>GEV No.</b>	361080	<b>Ref. No.</b> —
	O-ring EPDM thickness 2mm ID ø 16mm Qty 1 pcs		
	<b>GEV No.</b>	361085	<b>Ref. No.</b> —
	O-ring EPDM thickness 2mm ID ø 8mm Qty 1 pcs		
	<b>GEV No.</b>	361309	<b>Ref. No.</b> —
	ball for type N5/N6		
	<b>GEV No.</b>	361310	<b>Ref. No.</b> —
	bracket for type N6 ball guide		
	<b>GEV No.</b>	361311	<b>Ref. No.</b> —
	O-ring EPDM thickness 2mm ID ø 6mm Qty 1 pcs for type N6		
	<b>GEV No.</b>	361314	<b>Ref. No.</b> —
	valve ring for type N6 holder for O-ring		
	<b>GEV No.</b>	361317	<b>Ref. No.</b> —
	sealing disc for type N6		
	<b>GEV No.</b>	361886	<b>Ref. No.</b> —
	non-return valve inletmm outletmm outlet ø 12.4mm L 12.7mm		







accessories			
 <p>1</p>			
<b>GEV No.</b>	101286	<b>Ref. No.</b>	12008476 S312108000 X205028
<b>description</b>	olive ID ø 6mm Qty 1 pcs		
<b>For models:</b>	BMG7-10, BMG-9045, BMG9-05, BMG9-05V-T, BMG9-10, BMG9-10V-T, CG-1002, CG-1502, CG-2000, CG-2000-2P, CG-2002, CG-2002P, CG-200S, CG-210, CG-210G, CG-300S, CG-310, CG-310G, CG6-41, CG7-10, CG7-11, CG-7115, CG7-41, CG-7415, CG7-61, CG-7615, CG9-05AD, CG9-05PLUS, CG9-10, CG9-10AD, CG9-10PLUS, CG9-11, CG-9110, CG9-11AD, CG9-11PLUS, CG9-20AD, CG9-20AD-H, CG9-20PLUS, CG9-20PLUS-H, CG9-31PLUS-D, CG9-31PLUS-I, CG9-40AD, CG9-40AD-H, CG9-40PLUS, CG9-40PLUS-H, CG9-41, CG9-41AD, CG9-41AD-H, CG9-41PLUS, CG9-41PLUS-H...(Other models you can see in the webshop)		
<b>accessories for</b>	101286		
 <p>GEV No. 100909 Ref. No. 12008740 12016658 S312107 U265703</p>			
union screw thread M10x1 for pipe ø 6mm Qty 1 pcs			
 <p>GEV No. 101464 Ref. No. —</p>			
union nut thread M12x1 for pipe ø 6mm			

various			
 <p>1</p>			
<b>GEV No.</b>	361015	<b>Ref. No.</b>	12045206
<b>description</b>	dosing pump membrane dosing pump rinse aid inlet 6x8mm outlet 4x6mm pressure connection ø 4x6mm suction connection ø 6x8mm		
<b>For models:</b>	AD-120, AD-120B, AD-120C, AD-15, AD-15D, AD-20C-UK, AD-21, AD-21B, AD-21BDD, AD-21C, AD-21D, AD-21W, AD-48, AD-48B, AD-48BDD, AD-48C, AD-48D, AD-48DD, AD-48W, AD-64, AD-64B, AD-64BDD, AD-64C, AD-64CW, AD-64DD, AD-72, AD-72W, AD-90, AD-90A, AD-90B, AD-90BDD, AD-90DD, ADE-120, ADE-120B, CO-110, CO-110B, CO-110BDD, CO-110DD, CO-112, CO-112B, CO-112BDD, CO-112DD, CO-142W, CO-142WDD, CO-170, CO-170B, CO-170BDD, CO-170DD, CO-170HRS, CO-170HRSDD, CO-170HRS-SOFT...(Other models you can see in the webshop)		
<b>spare parts for</b>	361015		
 <p>GEV No. 361132 Ref. No. —</p>			
membrane dosing pump			
 <p>GEV No. 510298 Ref. No. —</p>			
lip valve dosing pump suitable for DB2/DS5			

accessories			
 <p>1</p>			
<b>GEV No.</b>	361062	<b>Ref. No.</b>	12011355 Z601153
<b>description</b>	container filter hose ø 4mm		
<b>For models:</b>	AD-125, AD-125HRS, AD-125-SOFT, AD-505, CO-110DD, CO-112DD, CO-142WDD, CO-170DD, CO-172DD, COP-173, COP-173B, COP-173BDD, COP-173DD, COP-173HRS, COP-173HRSDD, COP-173-SOFT, COP-174, COP-174B, COP-174BDD, COP-174DD, COP-174HRS, COP-174HRSDD, COP-174W, COP-174WHRS, COP-503, COP-503B, COP-503BDD, COP-503DD, COP-503-SOFT, COP-504, COP-504B, COP-504BDD, COP-504DD, COP-504W, ECO-120, ECO-1200, ECO-120B, FI-100, FI-100AR, FI-100B, FI-120, FI-1200, FI-120B, FI-120W, FI-30, FI-300B, FI-300R, FI-48, FI-48B, FI-48W...(Other models you can see in the webshop)		

filter weights			
 <p>1</p>			
<b>GEV No.</b>	505409	<b>Ref. No.</b>	12024353
<b>description</b>	filter weight ID ø 7.6mm ext. ø 20 L 6mm 12g SS		
<b>For models:</b>	AD-125, AD-125HRS, AD-125-SOFT, AD-505, AD-505-SOFT, AD-64BTDD, CO-110DD, CO-112DD, CO-142WDD, CO-170DD, CO-172DD, CO-350-COLD-DD, CO-350-DD, CO-400-COLD-DD, CO-400-DD, CO-402-COLD, CO-402-COLD-B, CO-402-COLD-B-DD, CO-402-COLD-DD, CO-402W, CO-500DD, CO-501DD, CO-502DD, CO-502W, COP-173, COP-173B, COP-173BDD, COP-173DD, COP-173HRS, COP-173HRSDD, COP-173-SOFT, COP-174, COP-174B, COP-174BDD, COP-174DD, COP-174HRS, COP-174HRSDD, COP-174W, COP-174WHRS, COP-503, COP-503B, COP-503BDD, COP-503DD, COP-503-SOFT, COP-504, COP-504B, COP-504BDD, COP-504DD, COP-504W, EASY-500...(Other models you can see in the webshop)		

 <p>1</p>			
<b>GEV No.</b>	505197	<b>Ref. No.</b>	12024353 old version Z701152
<b>description</b>	filter weight ID ø 8x9mm ext. ø 14 L 20mm 17g brass		
<b>For models:</b>	AD-120, AD-120B, AD-120C, AD-120CW, AD-120HY, AD-15, AD-15D, AD-20C-UK, AD-21, AD-21B, AD-21BDD, AD-21C, AD-21D, AD-21DD, AD-21W, AD-45BBT, AD-48, AD-48B, AD-48BDD, AD-48C, AD-48D, AD-48DD, AD-48HY, AD-48W, AD-64, AD-64B, AD-64BBT, AD-64BDD, AD-64C, AD-64CW, AD-64D, AD-64DD, AD-64HY, AD-72, AD-72W, AD-90, AD-90A, AD-90BBT, AD-90BDD, AD-90DD, ADE-120, ADE-120B, ECO-120, ECO-1200, FI-100, FI-100AR, FI-100BBT-UK, FI-120, FI-1200, FI-120AR+DD...(Other models you can see in the webshop)		



hose couplings

plastic



<b>GEV No.</b>	361102	<b>Ref. No.</b>	12036243 RT20620339
<b>description</b>	hose connector plastic angled thread M10x1 hose ø 6mm Qty 1 pcs connection M10x1 hose ø 6mm		



<b>GEV No.</b>	361100	<b>Ref. No.</b>	12036489 RT20620351
<b>description</b>	hose connector plastic straight thread M10x1 hose ø 6mm Qty 1 pcs connection M10x1 hose ø 6mm		

T-pieces

without non-return valve

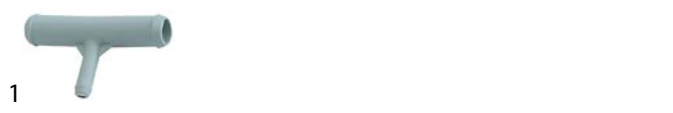

<b>GEV No.</b>	505086	<b>Ref. No.</b>	12025288 Z601157
<b>description</b>	T-piece connection 1: 10mm connection 2: 4mm		

**For models:** AD-120, AD-120B, AD-120C, AD-120CW, AD-125, AD-125HRS, AD-15, AD-15D, AD-20C-UK, AD-21, AD-21B, AD-21BDD, AD-21C, AD-21D, AD-21DD, AD-21W, AD-48, AD-48B, AD-48BDD, AD-48C, AD-48D, AD-48DD, AD-48W, AD-64, AD-64B, AD-64BDD, AD-64C, AD-64CW, AD-64D, AD-64DD, AD-72, AD-72W, AD-90, AD-90BA, AD-90BDD, AD-90DD, ADE-120, ADE-120B, CO-110, CO-110B, CO-110BDD, CO-110DD, CO-112, CO-112B, CO-112BDD, CO-112DD, CO-142W, CO-142WDD, CO-170, CO-170B...(Other models you can see in the webshop)

tank inlets



<b>GEV No.</b>	361105	<b>Ref. No.</b>	FAG1200026
<b>description</b>	tank inlet plastic M10 hose ø 4x6mm		

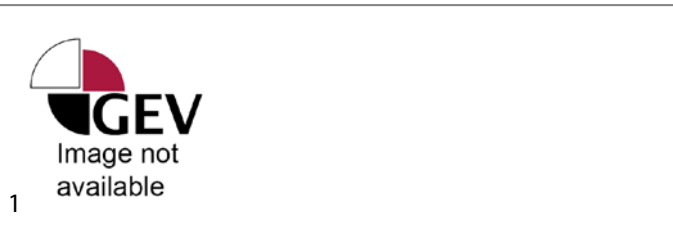

<b>GEV No.</b>	508427	<b>Ref. No.</b>	12024531 Z208927000
<b>description</b>	tank inlet stainless steel M10 hose ø 4mm		



<b>GEV No.</b>	361656	<b>Ref. No.</b>	6000012
<b>description</b>	tank inlet stainless steel M10x1.5 hose ø 4mm		

mounting sets

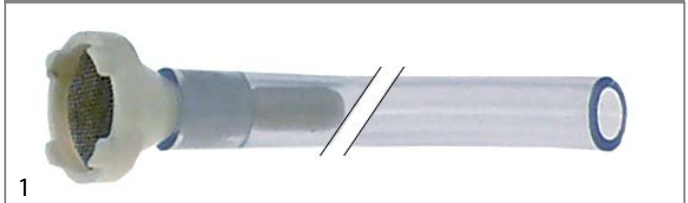

<b>GEV No.</b>	520398	<b>Ref. No.</b>	12003213 12Z60115 12Z6011500
<b>description</b>	hose detergent hose type 4x6mm hose length 1.3m PVC with filter transparent		

hoses

supply hoses

PVC supply hoses

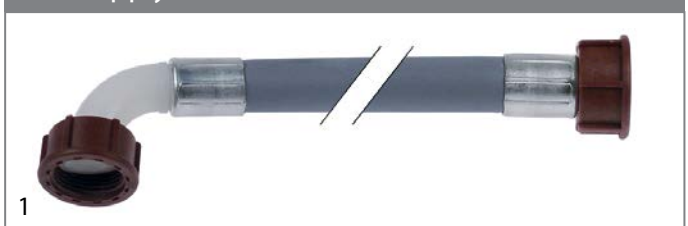

<b>GEV No.</b>	520010	<b>Ref. No.</b>	12024115 Z602121
<b>description</b>	supply hose PVC straight-curved DN13 connections 3/4" L 1500mm operating p. 10bar burst p. 32bar t.max. 90°C blue approval VDE flat seal		

**For models:** AD-120, AD-120B, AD-120BTTDD-UK, AD-120C, AD-120CW, AD-120HY, AD-125, AD-125HRS, AD-125-SOFT, AD-15D, AD-21D, AD-45BBT, AD-48, AD-48B, AD-48BDD, AD-48C, AD-48D, AD-48DD, AD-48HY, AD-48W, AD-505, AD-64, AD-64B, AD-64BBT, AD-64BDD, AD-64BTDD, AD-64C, AD-64CW, AD-64D, AD-64DD, AD-64HY, AD-72, AD-72W, AD-90, AD-90BA, AD-90BBT, AD-90BDD, AD-90DD, ADE-120, ADE-120B, CO-110, CO-110B, CO-110BDD, CO-110DD, CO-112, CO-112B, CO-112BDD, CO-112DD, CO-142W, CO-142WDD...(Other models you can see in the webshop)

**accessories for** 520010

<b>GEV No.</b>	520053	<b>Ref. No.</b>	12025278 Z701132
<b>description</b>	screen connection 3/4" D1 ø 26mm D2 ø 15mm Qty 10 pcs rubber thickness 8mm		

<b>GEV No.</b>	520054	<b>Ref. No.</b>	—
<b>description</b>	flat gasket rubber ED ø 23.5mm ID ø 14mm thickness 2.3mm Qty 10 pcs		

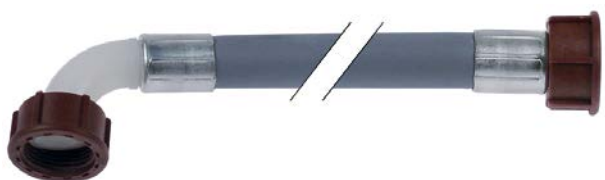
<b>GEV No.</b>	520012	<b>Ref. No.</b>	12025198 Z601114
<b>description</b>	supply hose PVC straight-curved DN13 connections 3/4" L 2500mm operating p. 10bar burst p. 32bar t.max. 90°C approval VDE flat seal		
<b>For models:</b>	ACE-061, ACE-101, ACE-102, ACE-201, ACE-202, ACG-061, ACG-101, ACG-102, ACG-201, ACG-202, AD-15, AD-20C-UK, AD-21, AD-21B, AD-21BDD, AD-21C, AD-21DD, AE-061, AE-061W, AE-101, AE-101W, AE-102, AE-102W, AE-201, AE-202, AG-061, AG-061W, AG-101, AG-101W, AG-102, AG-102W, AG-201, AG-202, APE-061, APE-061W, APE-101, APE-101W, APE-102, APE-102W, APE-201, APE-202, APG-061, APG-061W, APG-101, APG-101W, APG-102, APG-102W, APG-201, APG-202, COG-061...(Other models you can see in the webshop)		

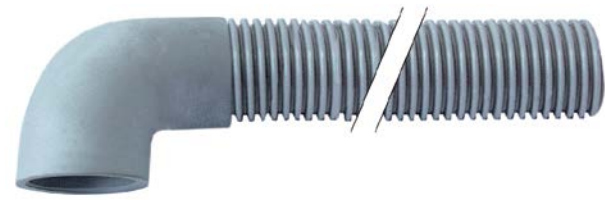

<b>GEV No.</b>	505081	<b>Ref. No.</b>	12024114 Z400908
<b>description</b>	drain hose DN25 L 1600mm elbow ø inside 31mm elbow ext. ø 40mm outer hose ø 30mm		
<b>For models:</b>	AD-15, AD-15D, AD-21, AD-21D, AD-21DD, ATM-051ECO, CO-350, CO-350-COLD, CO-350-COLD-DD, CO-350-DD, CO-352-COLD, CO-352-COLD-DD, CO-400, CO-400-COLD, CO-400-COLD-DD, CO-400-DD, CO-400-SOFT, CO-402-COLD, CO-402-COLD-DD, ECO-2700D, ECO-2700I, ECO-4000D, ECO-4000I, ECO-6000D, ECO-6000I, FI-2700D, FI-2700I, FI-4000D, FI-4000I, FI-6000D, FI-6000I, GA-20, GA-20D, GA-40, GA-40D, LVC-12, LVC-15, LVC-15D, LVC-21, LVC-21B, LVC-21C, LVC-21D, LVC-21W, LVR-10, LVR-14, LVR-14D, LVR-20, LVR-20D		

pre-rinse hoses

stainless steel flexi hoses



<b>GEV No.</b>	691095	<b>Ref. No.</b>	12039111 R095006
<b>description</b>	shower hose SS with flexible fabric		
<b>For models:</b>	HCG-10-11, HCG-10-21, HCG-20-11, HCG-20-21, HCG-2-10-11, HCG-2-20-11, HCG-6-11, HME-10-11, HME-10-21, HME-20-11, HME-20-21, HME-2-10-11, HME-2-20-11, HME-6-11, HMG-10-11, HMG-10-11UL, HMG-10-21, HMG-10-21UL, HMG-20-11, HMG-2-10-11, HMG-6-11, HMI-10-11, HMI-10-11UL, HMI-10-21, HMI-10-21UL, HMI-2-10-11, HMI-6-11, HMI-6-11UL, HMM-10-11, HMM-10-11UL, HMM-10-21, HMM-10-21UL, HMM-20-11, HMM-20-11UL, HMM-20-21, HMM-20-21UL, HMM-2-10-11, HMM-2-20-11, HMM-40-11-USMC, HMM-6-11, HMM-6-11UL, HMP-10-11, HMP-10-21, HMP-20-11, HMP-20-21, HMP-2-10-11, HMP-2-20-11, HMP-6-11, HVG-10-11, HVG-10-11UL...(Other models you can see in the webshop)		

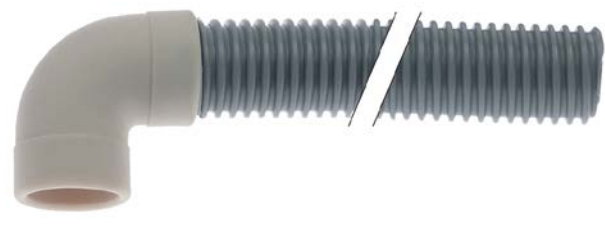

<b>GEV No.</b>	505402	<b>Ref. No.</b>	12115471
<b>description</b>	drain hose DN25 L 2000mm elbow ø inside 27mm elbow ext. ø 35mm inner hose ø 25mm outer hose ø 30mm plastic		
<b>For models:</b>	CO-500, CO-500DD, CO-501, CO-501DD, CO-501-SOFT, CO-502DD, COP-503, COP-503DD, COP-503-SOFT, COP-504, COP-504DD		

drain hoses



<b>GEV No.</b>	505082	<b>Ref. No.</b>	12024473 Z200910
<b>description</b>	drain hose DN25 L 1500mm elbow ø inside 48mm elbow ext. ø 58mm outer hose ø 31mm		
<b>For models:</b>	AD-120, AD-120CW, AD-48, AD-48D, AD-48DD, AD-64, AD-64BTDD, AD-64D, AD-64DD, AD-72, AD-72W, AD-90, AD-90DD, ADE-120, APE-061, APE-101, APE-102, APE-201, APE-202, APG-061, APG-101, APG-102, APG-201, APG-202, CO-110, CO-110B, CO-110BDD, CO-110DD, CO-112DD, CO-142W, CO-142WDD, CO-170, CO-170B, CO-170BDD, CO-170DD, CO-170HRS, CO-170HRSDD, CO-170HRS-SOFT, CO-170-SOFT, CO-172DD, COP-173, COP-173B, COP-173BDD, COP-173DD, COP-173HRS, COP-173HRSDD, COP-173-SOFT, COP-174DD, COP-174W, COP-174WHR... (Other models you can see in the webshop)		



<b>GEV No.</b>	505084	<b>Ref. No.</b>	12023666 Z220903
<b>description</b>	drain hose DN19 L 2000mm straight ø inside 21mm straight ext. ø 26mm elbow ø inside 21mm elbow ext. ø 27mm outer hose ø 27mm		
<b>For models:</b>	AD-120B, AD-120BBTDD-UK, AD-120C, AD-120HY, AD-125, AD-125HRS, AD-125-SOFT, AD-20C-UK, AD-21B, AD-21BDD, AD-21C, AD-21W, AD-45BBT, AD-48B, AD-48BDD, AD-48C, AD-48HY, AD-48W, AD-64B, AD-64BBT, AD-64BDD, AD-64C, AD-64CW, AD-64HY, AD-90BA, AD-90BBT, AD-90BDD, ADE-120B, BME7-05, BME7-10, BMG7-10, CO-350-B, CO-350-B-DD, CO-350-COLD-B, CO-350-COLD-B-DD, CO-352-COLD-B, CO-352-COLD-B-DD, CO-400-B, CO-400-B-DD, CO-400-COLD-B, CO-400-COLD-B-DD, CO-402-COLD-B, CO-402-COLD-B-DD, CO-402W, CO-500B, CO-500BDD, CO-501B, CO-501BDD, CO-502B, CO-502BDD...(Other models you can see in the webshop)		



industrial hoses

Niplaflex hoses



<b>GEV No.</b>	530561	<b>Ref. No.</b>	11000083 S102121000
<b>description</b>	pressure hose ID ø 10mm ED ø 17mm L 5m thickness 3.5mm operating p. 10bar burst p. 30bar t.max. 110°C		
<b>For models:</b>	ACE-061, ACE-101, ACE-102, ACE-201, ACE-202, ACG-061, ACG-101, ACG-102, ACG-201, ACG-202, AD-120, AD-120B, AD-120BBTDD-UK, AD-120C, AD-120CW, AD-120HY, AD-125, AD-125HRS, AD-125-SOFT, AD-15, AD-15D, AD-20C-UK, AD-21, AD-21B, AD-21BDD, AD-21C, AD-21D, AD-21DD, AD-21W, AD-45BBT, AD-48, AD-48B, AD-48BDD, AD-48C, AD-48D, AD-48DD, AD-48HY, AD-48W, AD-505, AD-505-SOFT, AD-64, AD-64B, AD-64BBT, AD-64BDD, AD-64BTDD, AD-64C, AD-64CW, AD-64D, AD-64DD, AD-64HY...(Other models you can see in the webshop)		

pressure control hoses



<b>GEV No.</b>	530560	<b>Ref. No.</b>	11000066 3702400
<b>description</b>	pressure control hose ID ø 5mm ED ø 9mm L 5m operating p. 30bar burst p. 90bar temp.-resist. 60°C		
<b>For models:</b>	AD-120, AD-120B, AD-120BBTDD-UK, AD-120C, AD-120CW, AD-120HY, AD-125, AD-125HRS, AD-125-SOFT, AD-15, AD-15D, AD-20C-UK, AD-21, AD-21B, AD-21BDD, AD-21C, AD-21D, AD-21DD, AD-21W, AD-45BBT, AD-48, AD-48B, AD-48BDD, AD-48C, AD-48D, AD-48DD, AD-48HY, AD-48W, AD-505, AD-505-SOFT, AD-64, AD-64B, AD-64BBT, AD-64BDD, AD-64BTDD, AD-64C, AD-64CW, AD-64D, AD-64DD, AD-64HY, AD-72, AD-72W, AD-90, AD-90BA, AD-90BBT, AD-90BDD, AD-90DD, ADE-120, ADE-120B, CO-110...(Other models you can see in the webshop)		

silicone hoses

without fabric



<b>GEV No.</b>	520399	<b>Ref. No.</b>	11000157 11000158 3715600
<b>description</b>	silicone hose ID ø 18mm ED ø 26mm thickness 4mm t.max. 200°C red		
<b>For models:</b>	ACE-061, ACE-102, AE-061, AE-061W, AE-101, AE-101W, AE-102, AE-102W, AE-201, AE-202, AG-061, AG-061W, AG-101, AG-101W, AG-102, AG-102W, AG-201, AG-202, APE-061, APE-061W, APE-101, APE-101W, APE-102, APE-102W, APE-201, APE-202, APG-061, APG-061W, APG-101, APG-101W, APG-102, APG-102W, APG-201, APG-202, HCG-10-11, HCG-10-21, HCG-20-11, HCG-2-10-11, HCG-6-11, HEI-10-11, HEI-10-21, HEI-6-11, HEM-10-11, HEM-10-21, HEM-20-11, HEM-20-21, HEM-6-11, HEP-10-11, HEP-10-21, HEP-20-11...(Other models you can see in the webshop)		

<b>GEV No.</b>	530052	<b>Ref. No.</b>	11000154 11000171 3710900 3715800 R345021 R345024
<b>description</b>	silicone hose ID ø 43mm ED ø 51mm L 0.8m thickness 4mm t.max. 200°C red		
<b>For models:</b>	COE-102, COG-061, COG-101, COG-102, COG-201, COG-202, HCV-10-11, HCV-10-21, HCV-2-10-21, HCV-5-11, HCV-6-11, HEI-10-11, HEI-10-21, HEI-20-11, HEI-20-21, HEI-6-11, HEM-10-11, HEM-10-21, HEM-20-11, HEM-20-21, HEM-6-11, HEP-10-11, HEP-10-21, HEP-20-11, HEP-20-21, HEP-6-11, HGP-10-21, HGV-20-21, HME-10-11, HME-10-21, HME-20-11, HME-20-21, HME-2-10-11, HME-2-20-11, HME-6-11, HMI-10-11, HMI-10-11UL, HMI-10-21, HMI-10-21UL, HMI-2-10-11, HMI-6-11, HMI-6-11UL, HMM-10-11, HMM-10-11UL, HMM-10-21, HMM-10-21UL, HMM-20-11, HMM-20-11UL, HMM-20-21, HMM-20-21UL...(Other models you can see in the webshop)		

<b>GEV No.</b>	530067	<b>Ref. No.</b>	12034862 RT21121301
<b>description</b>	silicone hose ID ø 50mm ED ø 56mm L 0.13m thickness 3mm t.max. 200°C		

<b>GEV No.</b>	530798	<b>Ref. No.</b>	12034250 RT21101030
<b>description</b>	silicone hose ID ø 6mm ED ø 10mm L 1120mm for combi-steamer CPC-Linie CM 61-202/G		

<b>GEV No.</b>	530550	<b>Ref. No.</b>	12034590 RT21101008
<b>description</b>	silicone hose ID ø 6mm ED ø 10mm L 5m thickness 2mm operating pressure without pressure burst pressure non defined t.max. 200°C transparent Shore 55°		



with fabric

with monofilament braid

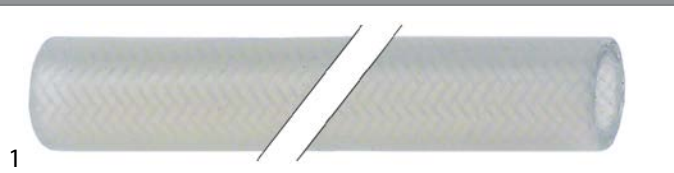

<b>GEV No.</b>	530693	<b>Ref. No.</b>	12033361 RT20670050
<b>description</b>	silicone hose with monofilament braid ID ø 10mm ED ø 17mm L 1m thickness 3.5mm operating p. 4bar t.max. 200°C Qty 1m		

pressure hoses (other)

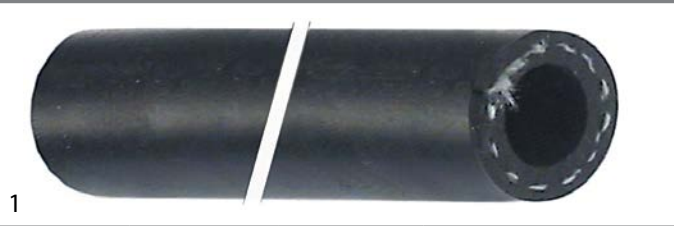

<b>GEV No.</b>	530567	<b>Ref. No.</b>	36769 36769000
<b>description</b>	universal hose ID ø 10mm ED ø 17mm Qty supplied by meter		

formed hoses

straight

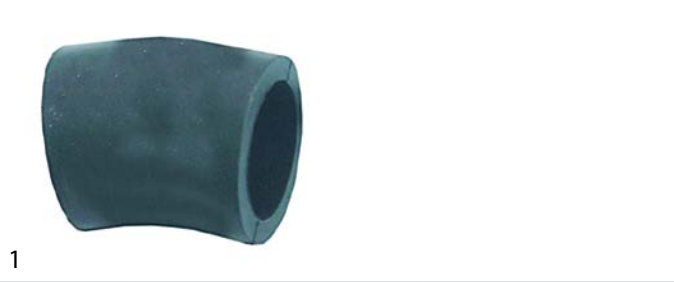

<b>GEV No.</b>	505026	<b>Ref. No.</b>	12023607 Z400906
<b>description</b>	formed hose dishwasher straight		
<b>For models:</b>	AD-15, AD-15D, AD-20C-UK, AD-21, AD-21B, AD-21BDD, AD-21C, AD-21D, AD-21DD, AD-21W, CO-350, CO-350-B, CO-350-B-DD, CO-350-COLD, CO-350-COLD-B, CO-350-COLD-B-DD, CO-350-COLD-DD, CO-350-DD, CO-352-COLD, CO-352-COLD-B, CO-352-COLD-B-DD, CO-352-COLD-DD, CO-400, CO-400-B, CO-400-B-DD, CO-400-COLD, CO-400-COLD-B, CO-400-COLD-B-DD, CO-400-COLD-DD, CO-400-DD, CO-400-SOFT, CO-402-COLD, CO-402-COLD-B, CO-402-COLD-B-DD, CO-402-COLD-DD, CO-402W, LVC-12, LVC-15, LVC-15D, LVC-21, LVC-21B, LVC-21C, LVC-21D, LVC-21W, LVR-10, LVR-14, LVR-14D, LVR-20, LVR-20B, LVR-20D...(Other models you can see in the webshop)		



<b>GEV No.</b>	503150	<b>Ref. No.</b>	12000050 12023567 Z162301 Z740902
<b>description</b>	formed hose hose ext. ø 54mm hose int. ø 38mm L 55mm		
<b>For models:</b>	AD-120BTTDD-UK, AD-120HY, AD-90, AD-90BA, AD-90BBT, AD-90BDD, AD-90DD, ADE-120, ADE-120B, ECO-120, ECO-120B, ECO-160, ECO-1600, ECO-160D, ECO-160I, ECO-200, ECO-200D, ECO-200H, ECO-200HD, ECO-200HI, ECO-200I, ECO-2300, ECO-2700D, ECO-2700I, ECO-280D, ECO-280I, ECO-3000, ECO-370D, ECO-370I, ECO-4000D, ECO-4000I, ECO-460D, ECO-460I, ECO-550D, ECO-550I, ECO-6000D, ECO-6000I, FI-100, FI-100AR, FI-100B, FI-100BBT-UK, FI-120HY-CLINIC, FI-2700D, FI-2700I, FI-280D, FI-280I, FI-370D, FI-370I, FI-4000D, FI-4000I...(Other models you can see in the webshop)		





<b>GEV No.</b>	530880	<b>Ref. No.</b>	12024437
<b>description</b>	formed hose hose int. ø 30.5mm D1 ø 39mm D2 ø 44.5mm L 45mm Qty 1		
<b>For models:</b>	AD-64BTDD, EASY-500HPWBDD		



<b>GEV No.</b>	530025	<b>Ref. No.</b>	12019517 R345020
<b>description</b>	formed hose ID ø 51mm ED ø 62mm L 101mm straight steam		
<b>For models:</b>	HCV-10-11, HCV-10-21, HCV-2-10-21, HCV-5-11, HCV-6-11, HEI-10-11, HEI-10-21, HEI-20-11, HEI-6-11, HEM-10-11, HEM-10-21, HEM-20-11, HEM-6-11, HEP-10-11, HEP-10-21, HEP-20-11, HEP-6-11, HGP-20-21, HGV-20-21, HME-10-11, HME-10-21, HME-20-11, HME-20-21, HME-2-10-11, HME-2-20-11, HME-6-11, HMM-10-11, HMM-10-11UL, HMM-10-21, HMM-10-21UL, HMM-20-11, HMM-20-11UL, HMM-20-21, HMM-20-21UL, HMM-2-10-11, HMM-2-20-11, HMM-40-11-USMC, HMM-6-11, HMM-6-11UL, HMP-10-11, HMP-10-21, HMP-20-11, HMP-20-21, HMP-2-10-11, HMP-2-20-11, HMP-6-11, HVG-20-21, HVG-2-20-21		

			
1			
<b>GEV No.</b>	694706	<b>Ref. No.</b>	12024122 T722608
<b>description</b>	hose ID ø 52mm ext. ø 57 L 363mm silicone discharge air steam generator red Qty 1		
<b>For models:</b>	ACE-061, ACE-101, ACE-102, ACE-201, ACE-202, ACG-061, ACG-101, ACG-102, ACG-201, ACG-202, AE-061, AE-061W, AE-101, AE-101W, AE-102, AE-102W, AE-201, AE-202, AG-061, AG-061W, AG-101, AG-101W, AG-102, AG-102W, AG-201, AG-202, APE-061, APE-061W, APE-101, APE-101W, APE-102, APE-102W, APE-201, APE-202, APG-061, APG-061W, APG-101, APG-101W, APG-102, APG-102W, APG-201, APG-202, COE-061, COE-101, COE-102, COE-201, COE-202, VE-061, VE-101, VE-102...(Other models you can see in the webshop)		

			
2			
<b>GEV No.</b>	694321	<b>Ref. No.</b>	12037987 RT21121307
<b>description</b>	hose ID ø 70mm ext. ø 80 L 80mm for combi-steamer		

			
1			
<b>GEV No.</b>	530067	<b>Ref. No.</b>	12034862 RT21121301
<b>description</b>	silicone hose ID ø 50mm ED ø 56mm L 0.13m thickness 3mm t.max. 200°C		

			
1			
<b>GEV No.</b>	530875	<b>Ref. No.</b>	12031550 RT4400362
<b>description</b>	steam hose ext. ø 78 ID ø 70mm L 54mm silicone red/black		

<p>form L</p> 			
1			
<b>GEV No.</b>	505336	<b>Ref. No.</b>	12024143 Z310904
<b>description</b>	extraction hose ED ø 76mm L 220mm L-shape ID ø 60mm for FAGOR		
<b>For models:</b>	ECO-2700D, ECO-2700I, ECO-280D, ECO-280I, ECO-370D, ECO-370I, ECO-4000D, ECO-4000I, ECO-460D, ECO-460I, ECO-550D, ECO-550I, ECO-6000D, ECO-6000I, FI-2700D, FI-2700I, FI-280D, FI-280I, FI-370D, FI-370I, FI-4000D, FI-4000I, FI-460D, FI-460I, FI-550D, FI-550I, FI-6000D, FI-6000I		

			
1			
<b>GEV No.</b>	524028	<b>Ref. No.</b>	12023698 12Z7409010
<b>description</b>	formed hose 90° L2 120mm L1 190mm ID ø 38mm ED ø 54mm		
<b>For models:</b>	AD-120C, AD-120HY, AD-90, AD-90BA, AD-90BDD, AD-90DD, ECO-160D, ECO-160I, ECO-200D, ECO-200HD, ECO-200HI, ECO-200I, FI-160AR, FI-160D, FI-160I, FI-200AR, FI-200D, FI-200HD, FI-200HI, FI-200I, FI-200WL, FI-200WR, FI-80, FI-80AR, FI-80W, FI-E-100, LABP-800		

			
1			
<b>GEV No.</b>	530794	<b>Ref. No.</b>	12031663 RT21121304
<b>description</b>	formed hose ED ø 29mm ID ø 23mm L 485mm for combi-steamer CPC-Linie 102/201E		

			
1			
<b>GEV No.</b>	530791	<b>Ref. No.</b>	12031730 RT4400242
<b>description</b>	formed hose ED ø 29mm ID ø 23mm L 730mm for combi-steamer SCC Linie 202		





			
<b>GEV No.</b>	505028	<b>Ref. No.</b>	12023689 Z200905
<b>description</b>	formed hose end piece A int. ø 50mm ø end piece B 38mm L 250mm warewashing L-shape equiv. no. Z200905		
<b>For models:</b>	AD-45BBT, AD-48, AD-48B, AD-48BDD, AD-48C, AD-48D, AD-48DD, AD-48HY, AD-48W, AD-64, AD-64B, AD-64BBT, AD-64BDD, AD-64BTDD, AD-64C, AD-64CW, AD-64D, AD-64DD, AD-64HY, AD-72, AD-72W, EASY-500, EASY-500B, EASY-500DD, EASY-500HP, EASY-500HPWBDD, FI-30, FI-30AR, FI-30AR+DD, FI-30B, FI-30B-BT-UK, FI-30-UK, FI-48, FI-48AR, FI-48B, FI-48B-BT-UK, FI-48C, FI-48D, FI-48HY-CLINIC, FI-48W, FI-50, FI-60DD, FI-64, FI-64AR, FI-64B, FI-64B-BT-UK, FI-64C, FI-64D, FI-64HY-CLINIC, FI-64W...(Other models you can see in the webshop)		

			
<b>GEV No.</b>	505029	<b>Ref. No.</b>	12023741 Z710905
<b>description</b>	formed hose warewashing L-shape equiv. no. Z710905 mounting pos. lower		
<b>For models:</b>	AD-120, AD-120B, AD-120BBTDD-UK, AD-120C, AD-120CW, AD-120HY, AD-90BBT, ADE-120, ADE-120B, ECO-120, ECO-120B, ECO-160, ECO-160D, ECO-160I, ECO-200, ECO-200D, ECO-200H, ECO-200HD, ECO-200HI, ECO-200I, ECO-2700D, ECO-2700I, ECO-370D, ECO-370I, ECO-4000D, ECO-4000I, ECO-550D, ECO-550I, ECO-6000D, ECO-6000I, FI-100, FI-100AR, FI-100B, FI-100BBT-UK, FI-120, FI-120AR+DD, FI-120B, FI-120C, FI-120HY-CLINIC, FI-120W, FI-160, FI-160AR, FI-160D, FI-160I, FI-200, FI-200AR, FI-200D, FI-200H, FI-200HD, FI-200HI...(Other models you can see in the webshop)		

			
<b>GEV No.</b>	530792	<b>Ref. No.</b>	12031089 RT21121305
<b>description</b>	formed hose ID ø 22mm ED ø 29mm L 640mm for combi-steamer CPC 202		

			
<b>GEV No.</b>	505030	<b>Ref. No.</b>	12023519 Z710906
<b>description</b>	formed hose warewashing L-shape equiv. no. Z710906 mounting pos. upper		
<b>For models:</b>	AD-120, AD-120B, AD-120BBTDD-UK, AD-120C, AD-120CW, AD-120HY, AD-90BBT, ADE-120, ADE-120B, ECO-120, ECO-120B, ECO-160, ECO-160D, ECO-160I, ECO-200, ECO-200D, ECO-200H, ECO-200HD, ECO-200HI, ECO-200I, ECO-370D, ECO-370I, ECO-550D, ECO-550I, FI-100, FI-100AR, FI-100B, FI-100BBT-UK, FI-120, FI-120AR+DD, FI-120B, FI-120C, FI-120HY-CLINIC, FI-120W, FI-160, FI-160AR, FI-160D, FI-160I, FI-200, FI-200AR, FI-200D, FI-200H, FI-200HD, FI-200HI, FI-200I, FI-200W, FI-200WL, FI-200WR, FI-370D, FI-370I...(Other models you can see in the webshop)		

			
<b>GEV No.</b>	505024	<b>Ref. No.</b>	12023683 Z200904
<b>description</b>	formed hose warewashing L-shape equiv. no. Z200904		
<b>For models:</b>	AD-45BBT, AD-48, AD-48B, AD-48BDD, AD-48C, AD-48D, AD-48DD, AD-48HY, AD-48W, AD-64, AD-64B, AD-64BBT, AD-64BDD, AD-64BTDD, AD-64C, AD-64CW, AD-64D, AD-64DD, AD-64HY, AD-72, AD-72W, EASY-500, EASY-500B, EASY-500DD, EASY-500HP, EASY-500HPWBDD, FI-30, FI-30AR, FI-30AR+DD, FI-30B, FI-30B-BT-UK, FI-30-UK, FI-48, FI-48AR, FI-48B, FI-48B-BT-UK, FI-48C, FI-48D, FI-48HY-CLINIC, FI-48W, FI-50, FI-60DD, FI-64, FI-64AR, FI-64B, FI-64B-BT-UK, FI-64C, FI-64D, FI-64HY-CLINIC, FI-64W...(Other models you can see in the webshop)		

			
<b>GEV No.</b>	505027	<b>Ref. No.</b>	12023625 Z710904
<b>description</b>	formed hose warewashing L-shape equiv. no. Z740901		
<b>For models:</b>	AD-120, AD-120B, AD-120BBTDD-UK, AD-120C, AD-120CW, AD-120HY, AD-90, AD-90BA, AD-90BBT, AD-90BDD, AD-90DD, ADE-120, ADE-120B, ECO-120, ECO-120B, ECO-160, ECO-160D, ECO-160I, ECO-200, ECO-200D, ECO-200H, ECO-200HD, ECO-200HI, ECO-200I, ECO-370D, ECO-370I, ECO-550D, ECO-550I, FI-100, FI-100AR, FI-100B, FI-100BBT-UK, FI-120, FI-120AR+DD, FI-120B, FI-120C, FI-120HY-CLINIC, FI-120W, FI-160, FI-160AR, FI-160D, FI-160I, FI-200, FI-200AR, FI-200D, FI-200H, FI-200HD, FI-200HI, FI-200I, FI-200W...(Other models you can see in the webshop)		

			
<b>GEV No.</b>	505023	<b>Ref. No.</b>	12023670 Z400905
<b>description</b>	formed hose warewashing L-shape equiv. no. Z400905		
<b>For models:</b>	AD-15, AD-15D, AD-20C-UK, AD-21, AD-21B, AD-21BDD, AD-21C, AD-21D, AD-21DD, AD-21W, CO-350, CO-350-B, CO-350-B-DD, CO-350-COLD, CO-350-COLD-B, CO-350-COLD-B-DD, CO-350-COLD-DD, CO-350-DD, CO-352-COLD, CO-352-COLD-B, CO-352-COLD-B-DD, CO-352-COLD-DD, CO-400, CO-400-B, CO-400-B-DD, CO-400-COLD, CO-400-COLD-B, CO-400-COLD-B-DD, CO-400-COLD-DD, CO-400-DD, CO-400-SOFT, CO-402-COLD, CO-402-COLD-B, CO-402-COLD-B-DD, CO-402-COLD-DD, CO-402W, LVC-12, LVC-15, LVC-15D, LVC-21, LVC-21B, LVC-21C, LVC-21D, LVC-21W, LVR-10, LVR-14, LVR-14D, LVR-20, LVR-20B, LVR-20D...(Other models you can see in the webshop)		

			
1			
<b>GEV No.</b>	505032	<b>Ref. No.</b>	12023779 Z740903
<b>description</b>	formed hose warewashing L-shape equiv. no. Z740903 mounting pos. lower		
<b>For models:</b>	AD-90, AD-90BA, AD-90BDD, AD-90DD, FI-80, FI-80AR, FI-80W, FI-E-100, LABP-800		

			
1			
<b>GEV No.</b>	530918	<b>Ref. No.</b>	12039649 T945056000
<b>description</b>	hose ID ø 30mm ED ø 40mm L 110mm for steam generator		
<b>For models:</b>	ACE-102, AE-102, AE-102W, AE-201, AE-202, AG-061, AG-061W, AG-101, AG-101W, AG-102, AG-102W, AG-201, AG-202, APE-102, APE-102W, APE-201, APE-202, APG-061, APG-061W, APG-101, APG-101W, APG-102, APG-102W, APG-201, APG-202		

			
1			
<b>GEV No.</b>	530919	<b>Ref. No.</b>	12044832
<b>description</b>	hose ID ø 73mm ED ø 85mm L 150mm for steam generator		
<b>For models:</b>	AG-202, APG-202		

## for dishwashers

### pressure hoses

			
1			
<b>GEV No.</b>	513136	<b>Ref. No.</b>	11000070
<b>description</b>	pressure hose ext. ø 10 ID ø 4.5mm L 1000mm dosage black Qty 1 rinse aid		
<b>For models:</b>	AD-120, AD-120B, AD-120BBTDD-UK, AD-120C, AD-120CW, AD-120HY, AD-15, AD-15D, AD-20C-UK, AD-21, AD-21B, AD-21BDD, AD-21C, AD-21D, AD-21DD, AD-21W, AD-48, AD-48B, AD-48BDD, AD-48C, AD-48D, AD-48DD, AD-48W, AD-64, AD-64B, AD-64BDD, AD-64C, AD-64CW, AD-64D, AD-64DD, AD-72, AD-72W, AD-90, AD-90BA, AD-90BBT, AD-90BDD, AD-90DD, ADE-120, ADE-120B, CO-110, CO-110B, CO-110BDD, CO-110DD, CO-112, CO-112B, CO-112BDD, CO-112DD, CO-142W, CO-142WDD, CO-170...(Other models you can see in the webshop)		

### miscellaneous

			
1			
<b>GEV No.</b>	511557	<b>Ref. No.</b>	11000142 3715300
<b>description</b>	dosing hose ED ø 26mm ID ø 15mm L 1200mm burst p. 20bar		
<b>For models:</b>	ECO-160, ECO-160D, ECO-160I, ECO-200, ECO-200D, ECO-200H, ECO-200HD, ECO-200HI, ECO-200I, ECO-2700D, ECO-2700I, ECO-280D, ECO-280I, ECO-370D, ECO-370I, ECO-4000D, ECO-4000I, ECO-460D, ECO-460I, ECO-550D, ECO-550I, ECO-6000D, ECO-6000I, FI-2700D, FI-2700I, FI-280D, FI-280I, FI-30B-BT-UK, FI-370D, FI-370I, FI-4000D, FI-4000I, FI-460D, FI-460I, FI-48B-BT-UK, FI-48HY-CLINIC, FI-550D, FI-550I, FI-6000D, FI-6000I, FI-64B-BT-UK, FI-64HY-CLINIC		

			
1			
<b>GEV No.</b>	105503	<b>Ref. No.</b>	12023858 Z951101
<b>description</b>	extraction hose ED ø 35mm IT 1" L 970mm SS		
<b>For models:</b>	ADE-120, ADE-120B, ECO-120, ECO-120B, ECO-160, ECO-1600, ECO-160D, ECO-160I, ECO-200, ECO-200D, ECO-200H, ECO-200HD, ECO-200HI, ECO-200I, ECO-2300, ECO-2700D, ECO-2700I, ECO-280D, ECO-280I, ECO-3000, ECO-370D, ECO-370I, ECO-4000D, ECO-4000I, ECO-460D, ECO-460I, ECO-550D, ECO-550I, ECO-6000D, ECO-6000I, GA-20, GA-20D, GA-40, GA-40D		

			
1			
<b>GEV No.</b>	505336	<b>Ref. No.</b>	12024143 Z310904
<b>description</b>	extraction hose ED ø 76mm L 220mm L-shape ID ø 60mm for FAGOR		
<b>For models:</b>	ECO-2700D, ECO-2700I, ECO-280D, ECO-280I, ECO-370D, ECO-370I, ECO-4000D, ECO-4000I, ECO-460D, ECO-460I, ECO-550D, ECO-550I, ECO-6000D, ECO-6000I, FI-2700D, FI-2700I, FI-280D, FI-280I, FI-370D, FI-370I, FI-4000D, FI-4000I, FI-460D, FI-460I, FI-550D, FI-550I, FI-6000D, FI-6000I		

### accessories

			
1			
<b>GEV No.</b>	520053	<b>Ref. No.</b>	12025278 Z701132
<b>description</b>	screen connection 3/4" D1 ø 26mm D2 ø 15mm Qty 10 pcs rubber thickness 8mm		
<b>For models:</b>	FI-100, FI-100AR, FI-100B, FI-120, FI-1200, FI-120B, FI-120W, FI-30, FI-300B, FI-300R, FI-48, FI-48B, FI-48W, FI-50, FI-64, FI-64B, FI-64W, FI-650R, FI-72, FI-80, FI-80W, FI-900, GA-20, GA-20D, GA-40, GA-40D, HCG-10-11, HCG-10-21, HCG-20-11, HCG-20-21, HCG-2-10-11, HCG-2-20-11, HCG-6-11, HCV-10-11, HCV-10-21, HCV-2-10-21, HCV-5-11, HCV-6-11, HEI-10-11, HEI-10-21, HEI-2-10-11, HEI-5-11, HEI-6-11, HEI-10-11, HEI-10-21, HEI-20-11, HEI-20-21, HEI-6-11, HEM-10-11, HEM-10-21...(Other models you can see in the webshop)		





# fittings, hose and pipe connectors

## hose connectors

### without screw connection



<b>GEV No.</b>	505088	<b>Ref. No.</b>	12023511 Z201106
<b>description</b>	Y-piece plastic hose ø 12-12-12mm L 75mm		
<b>For models:</b>	AD-120, AD-120B, AD-120C, AD-120CW, AD-125, AD-125HRS, AD-125-SOFT, AD-45BBT, AD-48, AD-48B, AD-48BDD, AD-48C, AD-48D, AD-48DD, AD-48HY, AD-48W, AD-64, AD-64B, AD-64BBT, AD-64BDD, AD-64BTDD, AD-64C, AD-64CW, AD-64D, AD-64DD, AD-64HY, AD-72, AD-72W, AD-90, AD-90BA, AD-90BDD, AD-90DD, ADE-120, ADE-120B, CO-110, CO-110B, CO-110BDD, CO-110DD, CO-112, CO-112B, CO-112BDD, CO-112DD, CO-142W, CO-142WDD, CO-170, CO-170B, CO-170BDD, CO-170DD, CO-170HRS, CO-170HRSDD...(Other models you can see in the webshop)		



<b>GEV No.</b>	541109	<b>Ref. No.</b>	12023510 Z103077
<b>description</b>	Y-piece plastic hose ø 8-6-8mm for pressure switch		
<b>For models:</b>	AD-120B, AD-120BBTDD-UK, AD-120C, AD-120HY, AD-45BBT, AD-48B, AD-48BDD, AD-48C, AD-48HY, AD-48W, AD-64B, AD-64BBT, AD-64BDD, AD-64BTDD, AD-64C, AD-64CW, AD-64HY, AD-72W, AD-90BA, AD-90BBT, AD-90BDD, ADE-120B, CO-500, CO-500B, CO-500BDD, CO-500DD, CO-501, CO-501B, CO-501BDD, CO-501DD, CO-501-SOFT, CO-502B, CO-502BDD, CO-502DD, CO-502W, COP-503, COP-503B, COP-503BDD, COP-503DD, COP-503-SOFT, COP-504, COP-504B, COP-504BDD, COP-504DD, COP-504W, EASY-500B, EASY-500HPWBDD, ECO-120B, ECO-160, ECO-1600...(Other models you can see in the webshop)		



<b>GEV No.</b>	505086	<b>Ref. No.</b>	12025288 Z601157
<b>description</b>	T-piece connection 1: 10mm connection 2: 4mm		
<b>For models:</b>	AD-120, AD-120B, AD-120C, AD-120CW, AD-125, AD-125HRS, AD-15, AD-15D, AD-20C-UK, AD-21, AD-21B, AD-21BDD, AD-21C, AD-21D, AD-21DD, AD-21W, AD-48, AD-48B, AD-48BDD, AD-48C, AD-48D, AD-48DD, AD-48W, AD-64, AD-64B, AD-64BDD, AD-64C, AD-64CW, AD-64D, AD-64DD, AD-72, AD-72W, AD-90, AD-90BA, AD-90BDD, AD-90DD, ADE-120, ADE-120B, CO-110, CO-110B, CO-110BDD, CO-110DD, CO-112, CO-112B, CO-112BDD, CO-112DD, CO-142W, CO-142WDD, CO-170, CO-170B...(Other models you can see in the webshop)		



<b>GEV No.</b>	505087	<b>Ref. No.</b>	12024192 Z401108
<b>description</b>	cross fitting		
<b>For models:</b>	AD-15, AD-15D, AD-20C-UK, AD-21, AD-21B, AD-21BDD, AD-21C, AD-21D, AD-21DD, AD-21W, CO-350-COLD, CO-350-COLD-B, CO-350-COLD-B-DD, CO-350-COLD-DD, CO-352-COLD, CO-352-COLD-B, CO-352-COLD-B-DD, CO-352-COLD-DD, CO-400-COLD, CO-400-COLD-B, CO-400-COLD-B-DD, CO-400-COLD-DD, CO-402-COLD, CO-402-COLD-B, CO-402-COLD-B-DD, CO-402-COLD-DD, LVC-15, LVC-15D, LVC-21, LVC-21B, LVC-21C, LVC-21D, LVC-21W, LVR-14, LVR-14D, LVR-20, LVR-20B, LVR-20D, MF-21		

## fittings

### double nipples



<b>GEV No.</b>	520169	<b>Ref. No.</b>	12023958 12024396 Z102301 Z209509
<b>description</b>	double nipple brass thread 3/4" - 3/4" Qty 1 pcs		
<b>For models:</b>	AD-120CW, BME7-05, BME7-10, BMG7-10, CO-142W, CO-142WDD, ECO-120, ECO-1200, ECO-120B, ECO-160, ECO-1600, ECO-200, ECO-200H, ECO-2300, ECO-3000, FI-100, FI-100AR, FI-100B, FI-120, FI-1200, FI-120B, FI-120W, FI-160, FI-1600, FI-160AR, FI-160D, FI-160I, FI-200, FI-200AR, FI-200D, FI-200H, FI-200HD, FI-200HI, FI-200I, FI-200W, FI-200WL, FI-200WR, FI-2300, FI-2700D, FI-2700I, FI-280D, FI-280I, FI-30, FI-3000, FI-30AR, FI-30AR+DD, FI-30-UK, FI-370D, FI-370I, FI-4000D...(Other models you can see in the webshop)		

T-pieces

miscellaneous



1

<b>GEV No.</b>	520456	<b>Ref. No.</b>	12009162 S205022
<b>description</b>	T-piece		
<b>For models:</b>	ME7-10BM, ME9-10BM, ME9-10BMS, ME9-15BM, ME9-15BM316, ME9-15BMS, MG7-10, MG7-10BM, MG9-10, MG-9100, MG9-10BM, MG9-10BMS, MG9-10S, MG9-15, MG-9150, MG-9150BM, MG9-15BM, MG9-15BM316, MG9-15BMS, MG9-15S, MG9-20, MG-9200, MG9-20S, MPE9-10BM, MPE9-10BMS, MPE9-15BM, MPE9-15BMS, MPG9-10, MPG9-10BM, MPG9-10BMS, MPG9-10S, MPG9-15, MPG-9150, MPG9-15BM, MPG9-15BMS, MPG9-15S, MPG9-20, MPG-9200, MPG9-20S		

hose connectors

plastic



1

<b>GEV No.</b>	361100	<b>Ref. No.</b>	12036489 RT20620351
<b>description</b>	hose connector plastic straight thread M10x1 hose ø 6mm Qty 1 pcs connection M10x1 hose ø 6mm		



1

<b>GEV No.</b>	361102	<b>Ref. No.</b>	12036243 RT20620339
<b>description</b>	hose connector plastic angled thread M10x1 hose ø 6mm Qty 1 pcs connection M10x1 hose ø 6mm		

brass



1

<b>GEV No.</b>	505323	<b>Ref. No.</b>	12023772 Z102309
<b>description</b>	hose connector brass straight thread 3/4" hose ø 10mm Qty 1 pcs		
<b>For models:</b>	ECO-1600, ECO-2300, ECO-280D, ECO-280I, ECO-3000, ECO-370D, ECO-370I, ECO-460D, ECO-460I, ECO-550D, ECO-550I, FI-1600, FI-200W, FI-200WL, FI-200WR, FI-2300, FI-280D, FI-280I, FI-3000, FI-370D, FI-370I, FI-460D, FI-460I, FI-550D, FI-550I		

producer-specific



1

<b>GEV No.</b>	505262	<b>Ref. No.</b>	12018650 12019642 12024428 Z208914 Z230902 Z230905
<b>description</b>	duct thread M12x1.75 for hose ID 4mm SS		
<b>For models:</b>	AD-120C, AD-120HY, AD-20C-UK, AD-21B, AD-21BDD, AD-21C, AD-21DD, AD-21W, AD-45BBT, AD-48B, AD-48BDD, AD-48C, AD-48DD, AD-48HY, AD-48W, AD-64B, AD-64BBT, AD-64BDD, AD-64C, AD-64CW, AD-64DD, AD-64HY, AD-90BBT, AD-90BDD, AD-90DD, ECO-120, ECO-1200, FI-100, FI-100AR, FI-100BBT-UK, FI-120, FI-1200, FI-120AR+DD, FI-120C, FI-120HY-CLINIC, FI-120W, FI-30, FI-30AR, FI-30AR+DD, FI-30B, FI-30B-BT-UK, FI-30-UK, FI-48, FI-48AR, FI-48B, FI-48B-BT-UK, FI-48C, FI-48D, FI-48HY-CLINIC, FI-48W...(Other models you can see in the webshop)		



1

<b>GEV No.</b>	505133	<b>Ref. No.</b>	12023967 Z701104
<b>description</b>	hose connector for hose ID 38-11mm brass		
<b>For models:</b>	AD-120BBTDD-UK, AD-120HY, AD-90BBT, ADE-120, ADE-120B, ECO-120, ECO-1200, ECO-120B, ECO-1600, ECO-2300, ECO-3000, FI-100, FI-100AR, FI-100B, FI-100BBT-UK, FI-120HY-CLINIC, FI-80BBT-UK		



1

<b>GEV No.</b>	505236	<b>Ref. No.</b>	12023983 Z2819010
<b>description</b>	hose connector grommet ø 13mm ID ø 11mm grommet length 18mm WS 32 total length 51mm thread L 17mm		
<b>For models:</b>	ECO-160D, ECO-160I, ECO-200D, ECO-200HD, ECO-200HI, ECO-200I, ECO-2700D, ECO-2700I, ECO-280D, ECO-280I, ECO-370D, ECO-370I, ECO-4000D, ECO-4000I, ECO-460D, ECO-460I, ECO-550D, ECO-550I, ECO-6000D, ECO-6000I, FI-2700D, FI-2700I, FI-280D, FI-280I, FI-370D, FI-370I, FI-4000D, FI-4000I, FI-460D, FI-460I, FI-550D, FI-550I, FI-6000D, FI-6000I		

			
1			
<b>GEV No.</b>	361840	<b>Ref. No.</b>	12024395 Z711904
<b>description</b>	hose connector thread M20x2.5 5/8" pipe (22.7mm) grommet ø 11.5mm ID ø chrome-plated brassmm grommet length 20mm total length 52mm thread L 31mm T2: 5/8" pipe (22.7mm)		
<b>For models:</b>	AD-120, AD-120B, AD-120BBTDD-UK, AD-120C, AD-120CW, AD-120HY, AD-90, AD-90BA, AD-90BBT, AD-90BDD, AD-90DD, ADE-120, ADE-120B, ECO-120, ECO-120B, FI-100, FI-100AR, FI-100B, FI-100BBT-UK, FI-120, FI-120AR+DD, FI-120B, FI-120C, FI-120HY-CLINIC, FI-120W, FI-160AR, FI-200AR, FI-280D, FI-280I, FI-370D, FI-370I, FI-460D, FI-460I, FI-550D, FI-550I, FI-80, FI-80AR, FI-80BBT-UK, FI-80W, FI-E-100, LABP-1000, LABP-1200, LABP-800, MF-120		
<b>accessories for</b>	361840		
			
<b>GEV No.</b>	507534	<b>Ref. No.</b>	12009819 Q223107
<b>description</b>	nut thread M20x2.5 WS 24 SS Qty 1 pcs H 13mm for pipe ø 12mm		

			
1			
<b>GEV No.</b>	512517	<b>Ref. No.</b>	12018487 T325063000
<b>description</b>	manifold thread 3/4" IT - 3/4" ET - 3/4" ET 3-way plastic suitable for combi-steamer FAGOR		

			
1			
<b>GEV No.</b>	507534	<b>Ref. No.</b>	12009819 Q223107
<b>description</b>	nut thread M20x2.5 WS 24 SS Qty 1 pcs H 13mm for pipe ø 12mm		
<b>For models:</b>	AD-120, AD-120B, AD-120BBTDD-UK, AD-120C, AD-120CW, AD-120HY, AD-90, AD-90BA, AD-90BBT, AD-90BDD, AD-90DD, ADE-120, ADE-120B, ECO-120, ECO-120B, FI-100, FI-100AR, FI-100B, FI-100BBT-UK, FI-120, FI-120AR+DD, FI-120B, FI-120C, FI-120HY-CLINIC, FI-120W, FI-160AR, FI-200AR, FI-280D, FI-280I, FI-370D, FI-370I, FI-460D, FI-460I, FI-550D, FI-550I, FI-80, FI-80AR, FI-80BBT-UK, FI-80W, FI-E-100, LABP-1000, LABP-1200, LABP-800, MF-120		

			
1			
<b>GEV No.</b>	698612	<b>Ref. No.</b>	12034095 RT86641300
<b>description</b>	T-piece thread 3/4" ET - 1/2" ET - 3/4" IT plastic		

## valves and tank inlets

### ball valves

#### universal

#### ball valves with lever handle

			
1			
<b>GEV No.</b>	514325	<b>Ref. No.</b>	12009231 X036107
<b>description</b>	ball valve connection 1" IT - 1" IT DN25 total length 83mm with lever handle		

### producer-specific

#### TMM

			
1			
<b>GEV No.</b>	514532	<b>Ref. No.</b>	12009691 R015034 R015034000
<b>description</b>	ball valve inlet 3/8" IT outlet 3/8" IT L 54.5mm H 82mm		

### shut-off valves

#### universal

			
1			
<b>GEV No.</b>	514085	<b>Ref. No.</b>	12009132 S012102
<b>description</b>	rosette connection 26x19G chrome-plated total lengthmm mounting pos.		
<b>For models:</b>	BME9-05, BME9-05AD, BME9-05PLUS, BME9-05V-T, BME9-10, BME9-10AD, BME9-10PLUS, BME9-10V-T, BMG9-05, BMG9-05V-T, BMG9-10, BMG9-10V-T, CPE7-05, CPE7-05NC, CPE9-05, CPE9-05S, CPG7-05, CPG7-05NC, CPG9-05, CPG9-05S, EPC-350, GPC-350, ME9-10BM, ME9-10BMS, ME9-15BM, ME9-15BM316, ME9-15BMS, MG9-10, MG9-10BM, MG9-10BMS, MG9-10S, MG9-15, MG9-15BM, MG9-15BM316, MG9-15BMS, MG9-15S, MG9-20, MG9-20S, MPE9-10BM, MPE9-10BMS, MPE9-15BM, MPE9-15BMS, MPG9-10, MPG9-10BM, MPG9-10BMS, MPG9-10S, MPG9-15, MPG9-15BM, MPG9-15BMS, MPG9-15S...(Other models you can see in the webshop)		

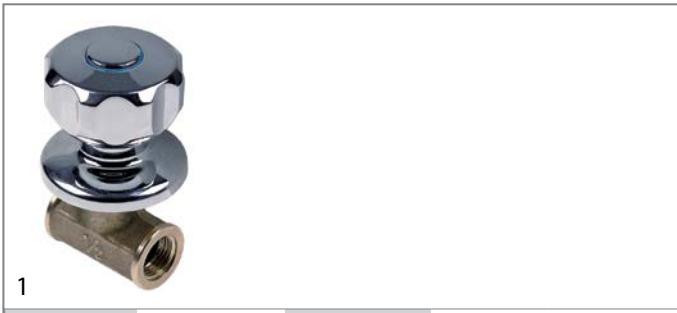



<b>GEV No.</b>	693107	<b>Ref. No.</b>	12039149 S112151
----------------	--------	-----------------	---------------------

**description** shut-off valve connection 1/2" 1/2" cold total length 54mm L1 27mm L2 30mm marking blue rosette thread G2 26x19G connection ø M4x0.7 ITmm

**For models:** BME7-05, BME7-10, BME9-05, BME9-10, BMG7-10, BMG9-05, BMG9-10, CPG7-05, CPG9-05, CPG9-05NC, CPG9-05S, CPG9-05SNC, ME7-10BM, ME9-10BM, ME9-10BMS, ME9-15BM, ME9-15BMS, MG7-10, MG7-10BM, MG9-10, MG9-10BM, MG9-10BMS, MG9-10S, MG9-15, MG9-15BM, MG9-15BMS, MG9-15S, MG9-20, MG9-20S, MPE9-10BM, MPE9-10BMS, MPE9-15BM, MPE9-15BMS, MPG9-10, MPG9-10BM, MPG9-10BMS, MPG9-10S, MPG9-15, MPG9-15BM, MPG9-15BMS, MPG9-15S, MPG9-20, MPG9-20S, SBE7-10, SBE9-10, SBE9-10I, SBE9-10IM, SBE9-10IMS, SBE9-10IS, SBE9-10M...(Other models you can see in the webshop)

**spare parts for** 693107

	<b>GEV No.</b>	514085	<b>Ref. No.</b>	12009132 S012102
	rosette connection 26x19G chrome-plated total lengthmm mounting pos.			

	<b>GEV No.</b>	514086	<b>Ref. No.</b>	—
	hexagonal nut connection 26x19G brass total lengthmm mounting pos. H 6mm WS 34 Qty 1 pcs			

	<b>GEV No.</b>	540672	<b>Ref. No.</b>	—
	gasket suitable for tap head			

	<b>GEV No.</b>	547711	<b>Ref. No.</b>	—
	hood handle shaft intake ø 8mm marking blue metal H2 21mm D1 ø 33mm type D suitable for MONOLITH shaft length H1 8mm			

	<b>GEV No.</b>	548168	<b>Ref. No.</b>	—
	star handle connection hot total lengthmm mounting pos. ø 57mm marking red			

	<b>GEV No.</b>	548169	<b>Ref. No.</b>	12019545 S012104
	star handle connection cold total lengthmm mounting pos. chrome-plated ø 57mm			

**accessories for** 693107

	<b>GEV No.</b>	514086	<b>Ref. No.</b>	—
	hexagonal nut connection 26x19G brass total lengthmm mounting pos. H 6mm WS 34 Qty 1 pcs			

	<b>GEV No.</b>	548169	<b>Ref. No.</b>	12019545 S012104
	star handle connection cold total lengthmm mounting pos. chrome-plated ø 57mm			



<b>GEV No.</b>	514085	<b>Ref. No.</b>	12009132 S012102
----------------	--------	-----------------	---------------------

**description** rosette connection 26x19G chrome-plated total lengthmm mounting pos.

**For models:** BME9-05, BME9-05AD, BME9-05PLUS, BME9-05V-T, BME9-10, BME9-10AD, BME9-10PLUS, BME9-10V-T, BMG9-05, BMG9-05V-T, BMG9-10, BMG9-10V-T, CPE7-05, CPE7-05NC, CPE9-05, CPE9-05S, CPG7-05, CPG7-05NC, CPG9-05, CPG9-05S, EPC-350, GPC-350, ME9-10BM, ME9-10BMS, ME9-15BM, ME9-15BM316, ME9-15BMS, MG9-10, MG9-10BM, MG9-10BMS, MG9-10S, MG9-15, MG9-15BM, MG9-15BM316, MG9-15BMS, MG9-15S, MG9-20, MG9-20S, MPE9-10BM, MPE9-10BMS, MPE9-15BM, MPE9-15BMS, MPG9-10, MPG9-10BM, MPG9-10BMS, MPG9-10S, MPG9-15, MPG9-15BM, MPG9-15BMS, MPG9-15S...(Other models you can see in the webshop)



<b>GEV No.</b>	540415	<b>Ref. No.</b>	12009120 S102109
----------------	--------	-----------------	---------------------

**description** star handle connection cold total lengthmm mounting pos. shaft diameter 7x7mm ø 55mm 35 built-in depth 22mm

**For models:** BME9-05, BME9-05AD, BME9-05PLUS, BME9-05V-T, BME9-10, BME9-10AD, BME9-10PLUS, BME9-10V-T, BMG9-05, BMG9-05V-T, BMG9-10, BMG9-10V-T, CPE7-05, CPE7-05NC, CPE9-05, CPE9-05S, CPG7-05, CPG7-05NC, CPG9-05, CPG9-05S, EPC-350, GPC-350, ME9-10BM, ME9-10BMS, ME9-15BM, ME9-15BM316, ME9-15BMS, MG9-10, MG9-10BM, MG9-10BMS, MG9-10S, MG9-15, MG9-15BM, MG9-15BM316, MG9-15BMS, MG9-15S, MG9-20, MG9-20S, MPE9-10BM, MPE9-10BMS, MPE9-15BM, MPE9-15BMS, MPG9-10, MPG9-10BM, MPG9-10BMS, MPG9-10S, MPG9-15, MPG9-15BM, MPG9-15BMS, MPG9-15S...(Other models you can see in the webshop)









<b>GEV No.</b>	514085	<b>Ref. No.</b>	12009132 S012102
----------------	--------	-----------------	---------------------

**description** rosette connection 26x19G chrome-plated total lengthmm mounting pos.

**For models:** BME9-05, BME9-05AD, BME9-05PLUS, BME9-05V-T, BME9-10, BME9-10AD, BME9-10PLUS, BME9-10V-T, BMG9-05, BMG9-05V-T, BMG9-10, BMG9-10V-T, CPE7-05, CPE7-05NC, CPE9-05, CPE9-05S, CPG7-05, CPG7-05NC, CPG9-05, CPG9-05S, EPC-350, GPC-350, ME9-10BM, ME9-10BMS, ME9-15BM, ME9-15BM316, ME9-15BMS, MG9-10, MG9-10BM, MG9-10BMS, MG9-10S, MG9-15, MG9-15BM, MG9-15BM316, MG9-15BMS, MG9-15S, MG9-20, MG9-20S, MPE9-10BM, MPE9-10BMS, MPE9-15BM, MPE9-15BMS, MPG9-10, MPG9-10BM, MPG9-10BMS, MPG9-10S, MPG9-15, MPG9-15BM, MPG9-15BMS, MPG9-15S...(Other models you can see in the webshop)









producer-specific			
FAGOR			
 <p>1</p>			
<b>GEV No.</b>	514085	<b>Ref. No.</b>	12009132 S012102
<b>description</b>	rosette connection 26x19G chrome-plated total lengthmm mounting pos.		
<b>For models:</b>	BME9-05, BME9-05AD, BME9-05PLUS, BME9-05V-T, BME9-10, BME9-10AD, BME9-10PLUS, BME9-10V-T, BMG9-05, BMG9-05V-T, BMG9-10, BMG9-10V-T, CPE7-05, CPE7-05NC, CPE9-05, CPE9-05S, CPG7-05, CPG7-05NC, CPG9-05, CPG9-05S, EPC-350, GPC-350, ME9-10BM, ME9-10BMS, ME9-15BM, ME9-15BM316, ME9-15BMS, MG9-10, MG9-10BM, MG9-10BMS, MG9-10S, MG9-15, MG9-15BM, MG9-15BM316, MG9-15BMS, MG9-15S, MG9-20, MG9-20S, MPE9-10BM, MPE9-10BMS, MPE9-15BM, MPE9-15BMS, MPG9-10, MPG9-10BM, MPG9-10BMS, MPG9-10S, MPG9-15, MPG9-15BM, MPG9-15BMS, MPG9-15S...(Other models you can see in the webshop)		

 <p>1</p>				
<b>GEV No.</b>	514000	<b>Ref. No.</b>	12009294 S102111	
<b>description</b>	shut-off valve connection 1/2" 1/2" straight total length 54mm square 7x7mm mounting thread 26x19G			
<b>For models:</b>	BME9-05, BME9-05AD, BME9-05PLUS, BME9-05V-T, BME9-10, BME9-10AD, BME9-10PLUS, BME9-10V-T, BMG9-05, BMG9-05V-T, BMG9-10, BMG9-10V-T, CPE7-05, CPE7-05NC, CPE9-05, CPE9-05S, CPG7-05, CPG7-05NC, CPG9-05, CPG9-05S, EPC-350, GPC-350, ME9-10BM, ME9-10BMS, ME9-15BM, ME9-15BM316, ME9-15BMS, MG9-10, MG9-10BM, MG9-10BMS, MG9-10S, MG9-15, MG9-15BM, MG9-15BM316, MG9-15BMS, MG9-15S, MG9-20, MG9-20S, MPE9-10BM, MPE9-10BMS, MPE9-15BM, MPE9-15BMS, MPG9-10, MPG9-10BM, MPG9-10BMS, MPG9-10S, MPG9-15, MPG9-15BM, MPG9-15BMS, MPG9-15S...(Other models you can see in the webshop)			
<b>spare parts for</b>	514000			
	<b>GEV No.</b>	514085	<b>Ref. No.</b>	12009132 S012102
	rosette connection 26x19G chrome-plated total lengthmm mounting pos.			
	<b>GEV No.</b>	514086	<b>Ref. No.</b>	—
	hexagonal nut connection 26x19G brass total lengthmm mounting pos. H 6mm WS 34 Qty 1 pcs			
	<b>GEV No.</b>	540414	<b>Ref. No.</b>	—
	star handle connection hot total lengthmm mounting pos. shaft diameter 7x7mm ø 55mm 35 built-in depth 22mm			
	<b>GEV No.</b>	540415	<b>Ref. No.</b>	12009120 S102109
	star handle connection cold total lengthmm mounting pos. shaft diameter 7x7mm ø 55mm 35 built-in depth 22mm			

 <p>2</p>				
<b>GEV No.</b>	514161	<b>Ref. No.</b>	12009309 S102113	
<b>description</b>	shut-off valve connection 1/2" 1/2" straight total length 28mm mounting pos. left angled shaft intake ø M5x0.8mm rosette thread G2 27x19G shaft 7x7			
<b>For models:</b>	ME9-10BM, ME9-10BMS, ME9-15BM, ME9-15BM316, ME9-15BMS, MG9-10, MG9-10BM, MG9-10BMS, MG9-10S, MG9-15, MG9-15BM, MG9-15BM316, MG9-15BMS, MG9-15S, MG9-20, MG9-20S, MPE9-10BM, MPE9-10BMS, MPE9-15BM, MPE9-15BMS, MPG9-10, MPG9-10BM, MPG9-10BMS, MPG9-10S, MPG9-15, MPG9-15BM, MPG9-15BMS, MPG9-15S, MPG9-20, MPG9-20S, SBE9-10, SBE9-10I, SBE9-10IM, SBE9-10IMS, SBE9-10IS, SBE9-10M, SBE9-10MS, SBE9-10S, SBE9-15IM, SBE9-15IMS, SBG9-10, SBG9-10I, SBG9-10IM, SBG9-10IMS, SBG9-10IS, SBG9-10M, SBG9-10MS, SBG9-10S, SBG9-15IM, SBG9-15IMS			
<b>spare parts for</b>	514161			
	<b>GEV No.</b>	514085	<b>Ref. No.</b>	12009132 S012102
	rosette connection 26x19G chrome-plated total lengthmm mounting pos.			
	<b>GEV No.</b>	514086	<b>Ref. No.</b>	—
	hexagonal nut connection 26x19G brass total lengthmm mounting pos. H 6mm WS 34 Qty 1 pcs			
	<b>GEV No.</b>	540414	<b>Ref. No.</b>	—
	star handle connection hot total lengthmm mounting pos. shaft diameter 7x7mm ø 55mm 35 built-in depth 22mm			
	<b>GEV No.</b>	540415	<b>Ref. No.</b>	12009120 S102109
	star handle connection cold total lengthmm mounting pos. shaft diameter 7x7mm ø 55mm 35 built-in depth 22mm			

 <p>1</p>			
<b>GEV No.</b>	540415	<b>Ref. No.</b>	12009120 S102109
<b>description</b>	star handle connection cold total lengthmm mounting pos. shaft diameter 7x7mm ø 55mm 35 built-in depth 22mm		
<b>For models:</b>	BME9-05, BME9-05AD, BME9-05PLUS, BME9-05V-T, BME9-10, BME9-10AD, BME9-10PLUS, BME9-10V-T, BMG9-05, BMG9-05V-T, BMG9-10, BMG9-10V-T, CPE7-05, CPE7-05NC, CPE9-05, CPE9-05S, CPG7-05, CPG7-05NC, CPG9-05, CPG9-05S, EPC-350, GPC-350, ME9-10BM, ME9-10BMS, ME9-15BM, ME9-15BM316, ME9-15BMS, MG9-10, MG9-10BM, MG9-10BMS, MG9-10S, MG9-15, MG9-15BM, MG9-15BM316, MG9-15BMS, MG9-15S, MG9-20, MG9-20S, MPE9-10BM, MPE9-10BMS, MPE9-15BM, MPE9-15BMS, MPG9-10, MPG9-10BM, MPG9-10BMS, MPG9-10S, MPG9-15, MPG9-15BM, MPG9-15BMS, MPG9-15S...(Other models you can see in the webshop)		

			
<b>GEV No.</b>	514085	<b>Ref. No.</b>	12009132 S012102
<b>description</b>	rosette connection 26x19G chrome-plated total lengthmm mounting pos.		
<b>For models:</b>	BME9-05, BME9-05AD, BME9-05PLUS, BME9-05V-T, BME9-10, BME9-10AD, BME9-10PLUS, BME9-10V-T, BMG9-05, BMG9-05V-T, BMG9-10, BMG9-10V-T, CPE7-05, CPE7-05NC, CPE9-05, CPE9-05S, CPG7-05, CPG7-05NC, CPG9-05, CPG9-05S, EPC-350, GPC-350, ME9-10BM, ME9-10BMS, ME9-15BM, ME9-15BM316, ME9-15BMS, MG9-10, MG9-10BM, MG9-10BMS, MG9-10S, MG9-15, MG9-15BM, MG9-15BM316, MG9-15BMS, MG9-15S, MG9-20, MG9-20S, MPE9-10BM, MPE9-10BMS, MPE9-15BM, MPE9-15BMS, MPG9-10, MPG9-10BM, MPG9-10BMS, MPG9-10S, MPG9-15, MPG9-15BM, MPG9-15BMS, MPG9-15S...(Other models you can see in the webshop)		

			
<b>GEV No.</b>	514160	<b>Ref. No.</b>	12019085 S012101
<b>description</b>	shut-off valve connection 1/2" 1/2" straight total length 54mm mounting pos. star-shaped mounting thread 26x19G		
<b>accessories for</b>	514160		
	<b>GEV No.</b>	514085	<b>Ref. No.</b>
			12009132 S012102
	<b>GEV No.</b>	514086	<b>Ref. No.</b>
			—
	<b>GEV No.</b>	548168	<b>Ref. No.</b>
			—
	<b>GEV No.</b>	548169	<b>Ref. No.</b>
			12019545 S012104
<b>description</b>	star handle connection cold total lengthmm mounting pos. chrome-plated ø 57mm		

			
<b>GEV No.</b>	548169	<b>Ref. No.</b>	12019545 S012104
<b>description</b>	star handle connection cold total lengthmm mounting pos. chrome-plated ø 57mm		

inlet taps

			
<b>GEV No.</b>	691015	<b>Ref. No.</b>	12009374 S052100
<b>description</b>	inlet spout connection 1/2" ET		
<b>For models:</b>	CPE7-05, CPE7-05NC, CPG7-05, CPG7-05NC, EPC-350, GPC-350, ME7-10BM, ME9-10BM, ME9-10BMS, ME9-10PLUS-BM, ME9-10PLUS-BMS, ME9-15BM, ME9-15BM316, ME9-15BM-AD, ME9-15BMS, ME9-15PLUS-BM, ME9-15PLUS-BMS, MG7-10, MG7-10BM, MG9-10, MG9-10AD, MG9-10BM, MG9-10BMAD, MG9-10BMS, MG9-10BMSAD, MG9-10PLUS, MG9-10PLUS-BM, MG9-10PLUS-BMS, MG9-10PLUS-S, MG9-10S, MG9-10S-AD, MG9-15, MG9-15AD, MG9-15BM, MG9-15BM316, MG9-15BMAD, MG9-15BMS, MG9-15BMSAD, MG9-15PLUS, MG9-15PLUS-BM, MG9-15PLUS-BMS, MG9-15PLUS-S, MG9-15S, MG9-15S-AD, MG9-20, MG9-20AD, MG9-20PLUS, MG9-20PLUS-S, MG9-20S, MG9-20S-AD...(Other models you can see in the webshop)		

			
<b>GEV No.</b>	691019	<b>Ref. No.</b>	12014163 12040128 X156104 X156140
<b>description</b>	inlet spout connection 1/2" ET tube ø 14mm projection 110mm overall height 80mm spout height 60mm rotation°		
<b>For models:</b>	SBE7-10, SBE9-10, SBE9-10I, SBE9-10IM, SBE9-10IMS, SBE9-10IS, SBE9-10M, SBE9-10MS, SBE9-10S, SBE9-15IM, SBE9-15IMS, SBG7-10, SBG9-10, SBG9-10I, SBG9-10IM, SBG9-10IMS, SBG9-10IS, SBG9-10M, SBG9-10MS, SBG9-10S, SBG9-15IM, SBG9-15IMS		

accessories

diaphragms

			
<b>GEV No.</b>	542000	<b>Ref. No.</b>	S206121
<b>description</b>	plain washer ID ø 22mm ED ø 50mm thickness 8mm		



## drain systems and wash basins

### drain fittings

#### universal



<b>GEV No.</b>	515041	<b>Ref. No.</b>	12000168 R205019
<b>description</b>	drain fitting size 3/4" usable heightmm overall height 30mm ED ø 38mm chrome-plated brass		
<b>For models:</b>	BME7-05, BME7-10, BME9-05, BME9-10, BMG7-10, BMG9-05, BMG9-10		
<b>accessories for</b>	515041		
	<b>GEV No.</b>	515047	<b>Ref. No.</b> —
	standpipe size 3/4" usable height 28mm overall height 54mm ED ø 20mm chrome-plated brass with O-ring		
	<b>GEV No.</b>	515048	<b>Ref. No.</b> —
	standpipe size 3/4" usable height 48mm overall height 74mm ED ø 20mm chrome-plated brass with O-ring		
	<b>GEV No.</b>	515049	<b>Ref. No.</b> —
	standpipe size 3/4" usable height 68mm overall height 94mm ED ø 20mm chrome-plated brass with O-ring		
	<b>GEV No.</b>	515050	<b>Ref. No.</b> —
	standpipe size 3/4" usable height 98mm overall height 124mm ED ø 20mm chrome-plated brass with O-ring		

### standpipes

#### 3/4"



<b>GEV No.</b>	515041	<b>Ref. No.</b>	12000168 R205019
<b>description</b>	drain fitting size 3/4" usable heightmm overall height 30mm ED ø 38mm chrome-plated brass		
<b>For models:</b>	BME7-05, BME7-10, BME9-05, BME9-10, BMG7-10, BMG9-05, BMG9-10		
<b>accessories for</b>	515041		
	<b>GEV No.</b>	515047	<b>Ref. No.</b> —
	standpipe size 3/4" usable height 28mm overall height 54mm ED ø 20mm chrome-plated brass with O-ring		
	<b>GEV No.</b>	515048	<b>Ref. No.</b> —
	standpipe size 3/4" usable height 48mm overall height 74mm ED ø 20mm chrome-plated brass with O-ring		
	<b>GEV No.</b>	515049	<b>Ref. No.</b> —
	standpipe size 3/4" usable height 68mm overall height 94mm ED ø 20mm chrome-plated brass with O-ring		
	<b>GEV No.</b>	515050	<b>Ref. No.</b> —
	standpipe size 3/4" usable height 98mm overall height 124mm ED ø 20mm chrome-plated brass with O-ring		

### producer-specific

#### FAGOR



<b>GEV No.</b>	515041	<b>Ref. No.</b>	12000168 R205019
<b>description</b>	drain fitting size 3/4" usable heightmm overall height 30mm ED ø 38mm chrome-plated brass		
<b>For models:</b>	BME7-05, BME7-10, BME9-05, BME9-10, BMG7-10, BMG9-05, BMG9-10		
<b>accessories for</b>	515041		
	<b>GEV No.</b>	515047	<b>Ref. No.</b> —
	standpipe size 3/4" usable height 28mm overall height 54mm ED ø 20mm chrome-plated brass with O-ring		
	<b>GEV No.</b>	515048	<b>Ref. No.</b> —
	standpipe size 3/4" usable height 48mm overall height 74mm ED ø 20mm chrome-plated brass with O-ring		
	<b>GEV No.</b>	515049	<b>Ref. No.</b> —
	standpipe size 3/4" usable height 68mm overall height 94mm ED ø 20mm chrome-plated brass with O-ring		
	<b>GEV No.</b>	515050	<b>Ref. No.</b> —
	standpipe size 3/4" usable height 98mm overall height 124mm ED ø 20mm chrome-plated brass with O-ring		



<b>GEV No.</b>	691024	<b>Ref. No.</b>	12019791 R205018
<b>description</b>	overflow pipe L 165mm ø 20mm		
<b>For models:</b>	BME7-05, BME7-10, BME9-05, BME9-10, BMG7-10, BMG9-05, BMG9-10		

### accessories



<b>GEV No.</b>	691004	<b>Ref. No.</b>	12000169 R202617
<b>description</b>	protective plate for drain		
<b>For models:</b>	BMG9-05, BMG9-10		



## water cycle components

### pressure reduction valves

#### pressure reduction valves

##### producer-specific



1			
<b>GEV No.</b>	520558	<b>Ref. No.</b>	12024846 Z102307
<b>description</b>	pressure reduction valve RBM series RINOXDUE connection 3/4" default setting 3bar setting range 0.5-4bar p max 25bar t.max. 80°C nickel-plated brass ACS		
<b>For models:</b>	AD-120CW, CO-142W, CO-142WDD, ECO-160, ECO-1600, ECO-200, ECO-200H, ECO-2300, ECO-3000, FI-120W, FI-160, FI-1600, FI-160AR, FI-160D, FI-160I, FI-200, FI-200AR, FI-200D, FI-200H, FI-200HD, FI-200HI, FI-200I, FI-200W, FI-200WL, FI-200WR, FI-2300, FI-2700D, FI-2700I, FI-280D, FI-280I, FI-3000, FI-370D, FI-370I, FI-4000D, FI-4000I, FI-460D, FI-460I, FI-550D, FI-550I, FI-6000D, FI-6000I, FI-80W		

## ancillary products

### silicone

#### food-grade silicones



1			
<b>GEV No.</b>	890106	<b>Ref. No.</b>	12032727 RT50060200
<b>description</b>	silicone TB40 transparent tube 90g -40 up to +160°C		
<b>description</b>	<p>Tomabond - TB40 - tube 90g - transparent</p> <p>For flexible sealing in drinking water, food, water and industrial kitchen areas. Securely joins glass, metal, wood-based materials, ceramic and plastics with high adhesion (1.1 N/mm<sup>2</sup>).</p> <p>Fungicide-, algicide- and solvent-free, ageing-resistant.</p> <p>Temperature-resistant from -40 °C to +160 °C</p> <p>Tested and approved by KTW / KSW.</p>		

## clamps

### hose clamps

#### DIN 3017 - W2



1			
<b>GEV No.</b>	520111	<b>Ref. No.</b>	12035874 RT20660205
<b>description</b>	hose clamp ø 10-16mm width 9mm Qty 10 pcs DIN 3017		



1			
<b>GEV No.</b>	520114	<b>Ref. No.</b>	12010023 12035505 Q881304 RT20660506
<b>description</b>	hose clamp ø 20-32mm width 9mm Qty 10 pcs DIN 3017		
<b>For models:</b>	AD-120B, AD-120BBTDD-UK, AD-120C, AD-120HY, AD-125, AD-125HRS, AD-125-SOFT, AD-505, AD-505-SOFT, AD-90BA, AD-90BBT, AD-90BDD, ADE-120B, APE-061, APE-061W, APE-101, APE-101W, APE-102, APE-102W, APE-201, APE-202, APG-061, APG-061W, APG-101, APG-101W, APG-102, APG-102W, APG-201, APG-202, BME9-05, BME9-10, BMG9-10, CO-110B, CO-110BDD, CO-112B, CO-112BDD, CO-170B, CO-170BDD, CO-172B, CO-172BDD, CO-500B, CO-500BDD, CO-501B, CO-501BDD, CO-502B, CO-502BDD, CO-502W, COP-173, COP-173B, COP-173BDD...(Other models you can see in the webshop)		



1			
<b>GEV No.</b>	520115	<b>Ref. No.</b>	12009997 Q881305
<b>description</b>	hose clamp ø 25-40mm width 9mm Qty 10 pcs DIN 3017		
<b>For models:</b>	AD-45BBT, AD-48, AD-48B, AD-48BDD, AD-48C, AD-48D, AD-48DD, AD-48HY, AD-48W, AD-505, AD-64, AD-64B, AD-64BBT, AD-64BDD, AD-64BTDD, AD-64C, AD-64CW, AD-64D, AD-64DD, AD-64HY, AD-72, AD-72W, AE-201, AE-202, AG-061, AG-061W, AG-101, AG-101W, AG-102, AG-102W, AG-201, AG-202, APE-061, APE-061W, APE-101, APE-101W, APE-102, APE-102W, APE-201, APE-202, APG-061, APG-061W, APG-101, APG-101W, APG-102, APG-102W, APG-201, APG-202, BME7-05, BME7-10...(Other models you can see in the webshop)		







			
1			
<b>GEV No.</b>	520118	<b>Ref. No.</b>	12009933 12036496 Q881324 RT20660300
<b>description</b>	hose clamp ø 50-70mm width 9mm Qty 5 pcs DIN 3017		
<b>For models:</b>	AD-45BBT, AD-48, AD-48B, AD-48BDD, AD-48C, AD-48D, AD-48DD, AD-48HY, AD-48W, AD-505, AD-505-SOFT, AD-64, AD-64B, AD-64BBT, AD-64BDD, AD-64BTDD, AD-64C, AD-64CW, AD-64D, AD-64DD, AD-64HY, AD-72, AD-72W, CO-500, CO-500B, CO-500BDD, CO-500DD, CO-501, CO-501B, CO-501BDD, CO-501DD, CO-501-SOFT, CO-502B, CO-502BDD, CO-502DD, CO-502W, COP-503, COP-503B, COP-503BDD, COP-503DD, COP-503-SOFT, COP-504, COP-504B, COP-504BDD, COP-504DD, COP-504W, EASY-500, EASY-500B, EASY-500DD, EASY-500HP... (Other models you can see in the webshop)		

			
1			
<b>GEV No.</b>	520117	<b>Ref. No.</b>	12009962 12035446 Q881306000 Q881307 RT20660504
<b>description</b>	hose clamp stainless steel ø 40-60mm width 9mm Qty 5 pcs DIN 3017		
<b>For models:</b>	ACE-061, ACE-101, ACE-102, ACE-201, ACE-202, ACG-061, ACG-101, ACG-102, ACG-201, ACG-202, AD-120, AD-120B, AD-120BBTDD-UK, AD-120C, AD-120CW, AD-120HY, AD-125, AD-125HRS, AD-125-SOFT, AD-15, AD-15D, AD-20C-UK, AD-21, AD-21B, AD-21BDD, AD-21C, AD-21D, AD-21DD, AD-21W, AD-45BBT, AD-48, AD-48B, AD-48BDD, AD-48C, AD-48D, AD-48DD, AD-48HY, AD-48W, AD-505, AD-505-SOFT, AD-64, AD-64B, AD-64BBT, AD-64BDD, AD-64BTDD, AD-64C, AD-64CW, AD-64D, AD-64DD, AD-64HY... (Other models you can see in the webshop)		

			
2			
<b>GEV No.</b>	520119	<b>Ref. No.</b>	12036081 RT20660516
<b>description</b>	hose clamp ø 60-80mm width 9mm Qty 5 pcs DIN 3017		

<b>DIN 3017 - W4</b>			
			
1			
<b>GEV No.</b>	520120	<b>Ref. No.</b>	12010036 Q881302
<b>description</b>	hose clamp SS W4 ø 12-20mm width 9mm Qty 1 pcs DIN 3017		
<b>For models:</b>	ACE-061, ACE-101, ACE-102, ACE-201, ACE-202, ACG-061, ACG-101, ACG-102, ACG-201, ACG-202, AD-120, AD-120B, AD-120BBTDD-UK, AD-120C, AD-120CW, AD-120HY, AD-125, AD-125HRS, AD-125-SOFT, AD-15, AD-15D, AD-20C-UK, AD-21, AD-21B, AD-21BDD, AD-21C, AD-21D, AD-21DD, AD-21W, AD-45BBT, AD-48, AD-48B, AD-48BDD, AD-48C, AD-48D, AD-48DD, AD-48HY, AD-48W, AD-505, AD-505-SOFT, AD-64, AD-64B, AD-64BBT, AD-64BDD, AD-64BTDD, AD-64C, AD-64CW, AD-64D, AD-64DD, AD-64HY... (Other models you can see in the webshop)		

			
1			
<b>GEV No.</b>	520454	<b>Ref. No.</b>	12009914 12036146 Q881326 RT20660505
<b>description</b>	hose clamp ø 70-90mm width 9mm Qty 5 pcs DIN 3017		
<b>For models:</b>	ACE-202, ACG-202, AE-202, AG-202, APE-202, APG-202, COE-202, ECO-2700D, ECO-2700I, ECO-280D, ECO-280I, ECO-370D, ECO-370I, ECO-4000D, ECO-4000I, ECO-460D, ECO-460I, ECO-550D, ECO-550I, ECO-6000D, ECO-6000I, FI-2700D, FI-2700I, FI-280D, FI-280I, FI-370D, FI-370I, FI-4000D, FI-4000I, FI-460D, FI-460I, FI-550D, FI-550I, FI-6000D, FI-6000I, HMG-10-21-STACKING, LA-13M, LA-18MP, LA-25M, LAC-25, LAC-25MP, LAC-25MPP, LAC-55, LAC-55MP, LAC-55MPP, LB-AC-10M, LB-E-10M, LB-V-10M, LC-10, LC-14... (Other models you can see in the webshop)		

<b>double wire clamps</b>			
			
1			
<b>GEV No.</b>	511658	<b>Ref. No.</b>	12035823 RT20660533
<b>description</b>	hose clamp ø 10mm wire gauge ø 1.3mm steel Qty 5 pcs		

			
1			
<b>GEV No.</b>	520110	<b>Ref. No.</b>	12010047 12037543 GH51X003 Q881308
<b>description</b>	hose clamp ø 8-12mm width 9mm Qty 10 pcs DIN 3017		
<b>For models:</b>	AD-120, AD-120B, AD-120BBTDD-UK, AD-120C, AD-120CW, AD-120HY, AD-15, AD-15D, AD-20C-UK, AD-21, AD-21B, AD-21BDD, AD-21C, AD-21D, AD-21DD, AD-21W, AD-48, AD-48B, AD-48BDD, AD-48C, AD-48D, AD-48DD, AD-48W, AD-64, AD-64B, AD-64BDD, AD-64C, AD-64CW, AD-64D, AD-64DD, AD-72, AD-72W, AD-90, AD-90BA, AD-90BBT, AD-90BDD, AD-90DD, ADE-120, ADE-120B, CO-110, CO-110B, CO-110BDD, CO-110DD, CO-112, CO-112B, CO-112BDD, CO-112DD, CO-142W, CO-142WDD, CO-170... (Other models you can see in the webshop)		

			
1			
<b>GEV No.</b>	520916	<b>Ref. No.</b>	12036614 RT20660518
<b>description</b>	hose clamp ø 30mm wire gauge ø 2.7mm chrome-plated steel Qty 1 pcs		

			
1			
<b>GEV No.</b>	560570	<b>Ref. No.</b>	12036450 RT20660519
<b>description</b>	hose clamp ø 35.6mm wire gauge ø 3mm Qty 1 pcs		

			
1			
<b>GEV No.</b>	505190	<b>Ref. No.</b>	12009972 Q901307
<b>description</b>	hose clamp ø 36-42mm wire gauge ø 3mm zinc-coated steel Qty 1 pcs		
<b>For models:</b>	AD-15, AD-15D, AD-20C-UK, AD-21, AD-21B, AD-21BDD, AD-21C, AD-21D, AD-21DD, AD-21W, ECO-1200, FI-1200, FI-900, HEI-10-21, HEM-10-21, HGC-10-21, HGC-20-21, HGV-10-21, LVC-12, LVC-15, LVC-15D, LVC-21, LVC-21B, LVC-21C, LVC-21D, LVC-21W, LVR-10, LVR-14, LVR-14D, LVR-20, LVR-20B, LVR-20D, MF-21		

			
1			
<b>GEV No.</b>	505191	<b>Ref. No.</b>	12007966 Q901308
<b>description</b>	hose clamp ø 52-59mm wire gauge ø 3.5mm Qty 1 pcs		
<b>For models:</b>	AD-45BBT, AD-48, AD-48B, AD-48BDD, AD-48C, AD-48D, AD-48DD, AD-48HY, AD-48W, AD-64, AD-64B, AD-64BBT, AD-64BDD, AD-64BTDD, AD-64C, AD-64CW, AD-64D, AD-64DD, AD-64HY, AD-72, AD-72W, EASY-500, EASY-500B, EASY-500DD, EASY-500HP, FI-30, FI-30AR, FI-30AR+DD, FI-30B, FI-30B-BT-UK, FI-30-UK, FI-48, FI-48AR, FI-48B, FI-48B-BT-UK, FI-48C, FI-48D, FI-48HY-CLINIC, FI-48W, FI-50, FI-60DD, FI-64, FI-64AR, FI-64B, FI-64B-BT-UK, FI-64C, FI-64D, FI-64HY-CLINIC, FI-64W, FI-72...(Other models you can see in the webshop)		

			
1			
<b>GEV No.</b>	505351	<b>Ref. No.</b>	12036929 RT20660527
<b>description</b>	wire clamp ø 11.6-12.2mm wire gauge ø 1.5mm zinc-coated steel Qty 100 pcs		

			
1			
<b>GEV No.</b>	505358	<b>Ref. No.</b>	12036811 RT20660530
<b>description</b>	wire clamp ø 14.4-15.1mm wire gauge ø 1.8mm zinc-coated steel Qty 50 pcs		

<b>double wire clamps with screw</b>			
			
1			
<b>GEV No.</b>	505079	<b>Ref. No.</b>	12025195 Z400903
<b>description</b>	hose clamp ø 186-172mm Qty 1 pcs		
<b>For models:</b>	AD-15, AD-15D, AD-20C-UK, AD-21, AD-21B, AD-21BDD, AD-21C, AD-21D, AD-21DD, AD-21W, CO-350, CO-350-B, CO-350-B-DD, CO-350-COLD, CO-350-COLD-B, CO-350-COLD-B-DD, CO-350-COLD-DD, CO-350-DD, CO-352-COLD, CO-352-COLD-B, CO-352-COLD-B-DD, CO-352-COLD-DD, CO-400, CO-400-B, CO-400-B-DD, CO-400-COLD, CO-400-COLD-B, CO-400-COLD-B-DD, CO-400-COLD-DD, CO-400-DD, CO-400-SOFT, CO-402-COLD, CO-402-COLD-B, CO-402-COLD-B-DD, CO-402-COLD-DD, CO-402W, LVC-12, LVC-15, LVC-15D, LVC-21, LVC-21B, LVC-21C, LVC-21D, LVC-21W, LVR-10, LVR-14, LVR-14D, LVR-20, LVR-20B, LVR-20D...(Other models you can see in the webshop)		

			
1			
<b>GEV No.</b>	505080	<b>Ref. No.</b>	12023841 Z200908
<b>description</b>	hose clamp ø 235-215mm Qty 1 pcs		
<b>For models:</b>	AD-45BBT, AD-48, AD-48B, AD-48BDD, AD-48C, AD-48D, AD-48DD, AD-48HY, AD-48W, AD-64, AD-64B, AD-64BBT, AD-64BDD, AD-64BTDD, AD-64C, AD-64CW, AD-64D, AD-64DD, AD-64HY, AD-72, AD-72W, EASY-500, EASY-500B, EASY-500DD, EASY-500HP, FI-30, FI-30AR, FI-30AR+DD, FI-30B, FI-30B-BT-UK, FI-30-UK, FI-48, FI-48AR, FI-48B, FI-48B-BT-UK, FI-48C, FI-48D, FI-48HY-CLINIC, FI-48W, FI-50, FI-60DD, FI-64, FI-64AR, FI-64B, FI-64B-BT-UK, FI-64C, FI-64D, FI-64HY-CLINIC, FI-64W, FI-72...(Other models you can see in the webshop)		

## pipes

### miscellaneous

			
1			
<b>GEV No.</b>	691674	<b>Ref. No.</b>	12018389 R725005
<b>description</b>	drain pipe ø 30mm L 440mm SS		



			
1			
<b>GEV No.</b>	691673	<b>Ref. No.</b>	12007494 R155010
<b>description</b>	drain pipe ø 38mm L 195mm		
<b>For models:</b>	CG9-51L, CG9-51LC, CG9-51R, CG9-51RC, FTE9-05L, FTE9-05L-AD, FTE9-05PLUS-CL, FTE9-05PLUS-CR, FTE9-05PLUS-L, FTE9-05PLUS-R, FTE9-05R, FTE9-05R-AD, FTE9-10L, FTE9-10L+R, FTE9-10L+R-AD, FTE9-10L-AD, FTE9-10PLUS-CL, FTE9-10PLUS-CLR, FTE9-10PLUS-CR, FTE9-10PLUS-L, FTE9-10PLUS-LR, FTE9-10PLUS-R, FTE9-10R, FTE9-10R-AD, FTEC9-05L, FTEC9-05L-AD, FTEC9-05R, FTEC9-05R-AD, FTEC9-05USMC, FTEC9-10L, FTEC9-10L+R, FTEC9-10L+R-AD, FTEC9-10L-AD, FTEC9-10R, FTEC9-10R-AD, FTEC9-10USMC, FTG9-05L, FTG9-05L-AD, FTG9-05LV-AD, FTG9-05PLUS-CL, FTG9-05PLUS-CR, FTG9-05PLUS-L, FTG9-05PLUS-LV, FTG9-05PLUS-R, FTG9-05PLUS-RV, FTG9-05R, FTG9-05R-AD, FTG9-05RV-AD, FTG9-05VL, FTG9-05VR...(Other models you can see in the webshop)		

			
1			
<b>GEV No.</b>	539003	<b>Ref. No.</b>	12049669
<b>description</b>	thermometer mounting measurements 62x11mm 0 up to +120°C capillary pipe 1700mm probe ø 6mm probe L 25mm		
<b>For models:</b>	COP-503, COP-503B, COP-503BDD, COP-503DD, COP-503-SOFT		

## tools

### cleaning tools

### descaling pumps

### descaling pumps

			
1			
<b>GEV No.</b>	890294	<b>Ref. No.</b>	12027850 RT60040203
<b>description</b>	descaling pump manual 12l/min connection stuff		

			
1			
<b>GEV No.</b>	542447	<b>Ref. No.</b>	12024717
<b>description</b>	thermometer mounting ø 52mm t.max. 105°C 20-105°C probe ø 8mm probe L 63mm capillary pipe 3400mm		

## measuring equipment

### thermometers

### built-in thermometers

			
1			
<b>GEV No.</b>	501492	<b>Ref. No.</b>	12023939 Z513023
<b>description</b>	thermometer mounting measurements 58x25.5mm +20 up to +120°C capillary pipe 3470mm probe ø 6mm probe L 35mm		
<b>For models:</b>	ECO-160D, ECO-160I, ECO-200D, ECO-200HD, ECO-200HI, ECO-200I, ECO-2700D, ECO-2700I, ECO-280D, ECO-280I, ECO-370D, ECO-370I, ECO-4000D, ECO-4000I, ECO-460D, ECO-460I, ECO-550D, ECO-550I, ECO-6000D, ECO-6000I, FI-160AR, FI-160D, FI-160I, FI-200AR, FI-200D, FI-200HD, FI-200HI, FI-200I, FI-2700D, FI-2700I, FI-280D, FI-280I, FI-370D, FI-370I, FI-4000D, FI-4000I, FI-460D, FI-460I, FI-550D, FI-550I, FI-6000D, FI-6000I		

			
1			
<b>GEV No.</b>	541794	<b>Ref. No.</b>	12033869 6021350003
<b>description</b>	thermometer mounting ø 52mm t.max. 120°C 0 up to +120°C probe ø 6.5mm probe L 23mm capillary pipe 2000mm		
<b>For models:</b>	AC-120, AC-180		

## fastening material

### rivets/rivet nuts

### blind rivets DIN 7337 - aluminium

			
1			
<b>GEV No.</b>	560048	<b>Ref. No.</b>	12010266 Q419005
<b>description</b>	blind rivet aluminium ø 4mm L 8mm Qty 1 pcs		
<b>For models:</b>	AD-120, AD-120B, AD-120BBTDD-UK, AD-120C, AD-120CW, AD-120HY, AD-15, AD-15D, AD-20C-UK, AD-21, AD-21B, AD-21BDD, AD-21C, AD-21D, AD-21DD, AD-21W, AD-64BTDD, AD-90, AD-90BA, AD-90BBT, AD-90BDD, AD-90DD, ADE-120, ADE-120B, BG6-05I, BG7-05, BG7-05I, BG7-10, BG7-10I, BG9-05, BG9-05AD, BG9-05I, BG9-05PF, BG9-05PI, BG9-05PLUS-I, BG9-10, BG9-10AD, BG9-10I, BG9-10PF, BG9-10PI, BG9-10PLUS-I, BME6-05, BME7-05, BME7-10, BME9-05, BME9-05AD, BME9-05PLUS, BME9-05V-T, BME9-10, BME9-10AD...(Other models you can see in the webshop)		

## blind rivets DIN 7337 - stainless steel



1

<b>GEV No.</b>	560157	<b>Ref. No.</b>	12010065
<b>description</b>	blind rivet SS $\phi$ 3.2mm L 6mm Qty 50 pcs DIN 1700		
<b>For models:</b>	ACE-201, ACE-202, ACG-201, ACG-202, AE-201, AE-202, AG-201, AG-202, APE-201, APE-202, APG-201, APG-202, COE-202, COG-102, COG-202, EN9-05C, EN9-05C-AD, EN9-05PLUS-C, EN9-10C, EN9-10C-AD, EN9-10PLUS-C, HEI-20-21, HEM-20-21, HEP-10-21, HEP-20-21, HGC-20-21, HGP-10-21, HGP-20-21, HGV-20-21, VE-202, VG-102, VG-202, VPE-202, VPG-102, VPG-202		



1

<b>GEV No.</b>	560049	<b>Ref. No.</b>	12010090 Q412002
<b>description</b>	blind rivet SS $\phi$ 4mm L 7.5mm Qty 50 pcs		
<b>For models:</b>	ACE-061, ACE-101, ACE-102, ACE-201, ACE-202, ACG-061, ACG-101, ACG-102, ACG-201, ACG-202, AE-061, AE-061W, AE-101, AE-101W, AE-102, AE-102W, AE-201, AE-202, AG-061, AG-061W, AG-101, AG-101W, AG-102, AG-102W, AG-201, AG-202, APE-061, APE-061W, APE-101, APE-101W, APE-102, APE-102W, APE-201, APE-202, APG-061, APG-061W, APG-101, APG-101W, APG-102, APG-102W, APG-201, APG-202, BG6-05I, BG7-05, BG7-05I, BG7-10, BG7-10I, CE9-41, CGE9-41, COE-061...(Other models you can see in the webshop)		

## blind rivets DIN 7337 - zinc-coated steel



1

<b>GEV No.</b>	560047	<b>Ref. No.</b>	12010117 Q411304
<b>description</b>	blind rivet steel $\phi$ 4.8mm L 11.3mm Qty 1 pcs		
<b>For models:</b>	AD-120, AD-120B, AD-120BTTDD-UK, AD-120C, AD-120CW, AD-120HY, AD-48BDD, AD-48C, AD-48DD, AD-48W, AD-64BDD, AD-64C, AD-64CW, AD-64DD, AD-72, AD-72W, AD-90, AD-90BA, AD-90BBT, AD-90BDD, AD-90DD, ADE-120, ADE-120B, BG9-05, BG9-10, BME7-05, BME7-10, BME9-05, BME9-05AD, BME9-05PLUS, BME9-05V-T, BME9-10, BME9-10AD, BME9-10PLUS, BME9-10V-T, BMG7-10, BMG9-05, BMG9-05V-T, BMG9-10, BMG9-10V-T, CE6-41, CE7-41, CE7-41Q, CE9-41, CE9-41AD, CE9-41PLUS, CG-1002, CG-1502, CG-2002, CG-2002P...(Other models you can see in the webshop)		

## sealed blind rivets



1

<b>GEV No.</b>	560180	<b>Ref. No.</b>	12037604 RT16030165
<b>description</b>	sealed blank rivets SS $\phi$ 3.2mm L 10mm Qty 50 pcs		

## blind rivet nuts hexagonal



1

<b>GEV No.</b>	550777	<b>Ref. No.</b>	12010024 Q221345
<b>description</b>	rivet nut thread M10 DN 13mm L 22mm Qty 1 pcs		
<b>For models:</b>	BG6-05I, BG7-05, BG7-05I, BG7-10, BG7-10I, BG9-05, BG9-05AD, BG9-05I, BG9-05PF, BG9-05PI, BG9-05PLUS-I, BG9-10, BG9-10AD, BG9-10I, BG9-10PF, BG9-10PI, BG9-10PLUS-I, BME7-05, BME7-10, BME9-05, BME9-05AD, BME9-05PLUS, BME9-05V-T, BME9-10, BME9-10AD, BME9-10PLUS, BME9-10V-T, BMG7-10, BMG9-05, BMG9-05V-T, BMG9-10, BMG9-10V-T, CE7-20, CE7-20Q, CE7-40, CE7-40Q, CE9-20, CE9-20AD, CE9-20PLUS, CE9-40, CE9-40AD, CE9-40PLUS, CG-2005, CG-210, CG-210G, CG-3005, CG-310, CG-310G, CG7-10, CG7-20...(Other models you can see in the webshop)		



1

<b>GEV No.</b>	696427	<b>Ref. No.</b>	12009970 Q222011
<b>description</b>	rivet nut thread M5 DN 4mm L 12mm SS Qty 1 pcs $\phi$ 7mm WS 6		
<b>For models:</b>	ACE-061, ACE-101, ACE-102, ACE-201, ACE-202, ACG-061, ACG-101, ACG-102, ACG-201, ACG-202, AD-45BBT, AD-48HY, AD-64BBT, AD-64BTDD, AD-64HY, AE-061, AE-061W, AE-101, AE-101W, AE-102, AE-102W, AE-201, AE-202, AG-061, AG-061W, AG-101, AG-101W, AG-102, AG-102W, AG-201, AG-202, APE-061, APE-061W, APE-101, APE-101W, APE-102, APE-102W, APE-201, APE-202, APG-061, APG-061W, APG-101, APG-101W, APG-102, APG-102W, APG-201, APG-202, CE9-40, CE9-41, CG-2000...(Other models you can see in the webshop)		



1

<b>GEV No.</b>	551034	<b>Ref. No.</b>	12010163 Q221342
<b>description</b>	rivet nut thread M5 DN 7mm L 12mm Qty 10 pcs		
<b>For models:</b>	ACE-061, ACE-101, ACE-102, ACE-201, ACE-202, ACG-061, ACG-101, ACG-102, ACG-201, ACG-202, AD-120, AD-120B, AD-120BTTDD-UK, AD-120C, AD-120CW, AD-120HY, AD-45BBT, AD-48HY, AD-64, AD-64B, AD-64BBT, AD-64BTDD, AD-64C, AD-64D, AD-64DD, AD-64HY, AD-72, AD-90, AD-90BA, AD-90BBT, AD-90BDD, AD-90DD, ADE-120, ADE-120B, AE-061, AE-061W, AE-101, AE-101W, AE-102, AE-102W, AE-201, AE-202, AG-061, AG-061W, AG-101, AG-101W, AG-102, AG-102W, AG-201, AG-202...(Other models you can see in the webshop)		





			
1			
<b>GEV No.</b>	550776	<b>Ref. No.</b>	12010126 Q221343
<b>description</b>	rivet nut thread M6 DN 10mm L 15mm SS Qty 1 pcs		
<b>For models:</b>	ACE-061, ACE-101, ACE-102, ACE-201, ACE-202, ACG-061, ACG-101, ACG-102, ACG-201, ACG-202, ADE-120, ADE-120B, AE-061, AE-061W, AE-101, AE-101W, AE-102, AE-102W, AE-201, AE-202, AG-061, AG-061W, AG-101, AG-101W, AG-102, AG-102W, AG-201, AG-202, APE-061, APE-061W, APE-101, APE-101W, APE-102, APE-102W, APE-201, APE-202, APG-061, APG-061W, APG-101, APG-101W, APG-102, APG-102W, APG-201, APG-202, BG6-05I, BG7-05, BG7-05I, BG7-10, BG7-10I, BG9-05...(Other models you can see in the webshop)		

countersunk screws			
			
1			
<b>GEV No.</b>	560041	<b>Ref. No.</b>	12010199
<b>description</b>	countersunk screw thread M5 L 16mm WS 3 SS DIN 7991/ISO 10642 Qty 20 pcs intake hexagonal		
<b>For models:</b>	ACE-061, ACE-101, ACE-102, ACG-061, ACG-101, ACG-102, AE-061, AE-061W, AE-101, AE-101W, AE-102, AE-102W, AG-061, AG-061W, AG-101, AG-101W, AG-102, AG-102W, APE-061, APE-061W, APE-101, APE-101W, APE-102, APE-102W, APG-061, APG-061W, APG-101, APG-101W, APG-102, APG-102W		

**SCREWS**

sheet metal screws

			
1			
<b>GEV No.</b>	560098	<b>Ref. No.</b>	12010290 Q082032
<b>description</b>	sheet metal screws ø 3.5mm L 9.5mm SS Qty 20 pcs DIN 7981/ISO 7049 head ø 6.9mm oval head		
<b>For models:</b>	AD-120, AD-120B, AD-120BBTDD-UK, AD-120C, AD-120CW, AD-120HY, AD-15, AD-15D, AD-20C-UK, AD-21, AD-21B, AD-21BDD, AD-21C, AD-21D, AD-21DD, AD-21W, AD-45BBT, AD-48, AD-48B, AD-48BDD, AD-48C, AD-48D, AD-48DD, AD-48HY, AD-48W, AD-64, AD-64B, AD-64BBT, AD-64BDD, AD-64BTDD, AD-64C, AD-64CW, AD-64D, AD-64DD, AD-64HY, AD-72, AD-72W, AD-90, AD-90BA, AD-90BBT, AD-90BDD, AD-90DD, ADE-120, ADE-120B, EASY-500, EASY-500B, EASY-500DD, EASY-500HP, EASY-500HPWBDD, ECO-120...(Other models you can see in the webshop)		

			
1			
<b>GEV No.</b>	560076	<b>Ref. No.</b>	12009852 12010293 Q152024
<b>description</b>	countersunk screw thread M4 L 10mm SS DIN 963/ISO 2009 Qty 20 pcs intake slotted head ø 7.5mm		
<b>For models:</b>	AD-120, AD-120B, AD-120BBTDD-UK, AD-120C, AD-120CW, AD-120HY, AD-15, AD-15D, AD-20C-UK, AD-21, AD-21B, AD-21BDD, AD-21C, AD-21D, AD-21DD, AD-21W, AD-45BBT, AD-48, AD-48B, AD-48BDD, AD-48C, AD-48D, AD-48DD, AD-48HY, AD-48W, AD-64, AD-64B, AD-64BBT, AD-64BDD, AD-64BTDD, AD-64C, AD-64CW, AD-64D, AD-64DD, AD-64HY, AD-72, AD-72W, AD-90, AD-90BA, AD-90BBT, AD-90BDD, AD-90DD, ADE-120, ADE-120B, CGP9-11, EASY-500, EASY-500B, EASY-500DD, EASY-500HP, EASY-500HPWBDD...(Other models you can see in the webshop)		

			
1			
<b>GEV No.</b>	560108	<b>Ref. No.</b>	12010257 Q082005
<b>description</b>	sheet metal screws ø 4.2mm L 13mm SS Qty 20 pcs DIN 7981/ISO 7049 head ø 8.2mm oval head		
<b>For models:</b>	CPG9-05AD, CPG9-05AD-S, CPG9-05PLUS, CPG9-05PLUS-S, CV9-20AD, CV9-20PLUS, CV9-40AD, CV9-40PLUS, ECO-160D, ECO-160I, ECO-200D, ECO-200HD, ECO-200HI, ECO-200I, ECO-280D, ECO-280I, ECO-370D, ECO-370I, ECO-460D, ECO-460I, ECO-550D, ECO-550I, FG7-05-1C, FG7-05-2C, FG7-10-2C, FG7-104C, FG7-10-4C, FG9-05-1C, FG9-05-2C, FG9-05AD, FG9-05PLUS, FG9-05PLUS-S, FG9-05S-1C, FG9-05S-2C, FG9-05S-AD, FG9-10-2C, FG9-10-4C, FG9-10AD, FG9-10PLUS, FGCL9-05-1C, FGCL9-05-2C, FGCL9-05S-1C, FGCL9-05S-2C, FI-160AR, FI-160D, FI-160I, FI-200AR, FI-200D, FI-200HD, FI-200HI...(Other models you can see in the webshop)		

			
1			
<b>GEV No.</b>	560211	<b>Ref. No.</b>	12010262 Q042022
<b>description</b>	countersunk screw thread M4 L 14mm SS DIN 963/ISO 2009 Qty 20 pcs intake slotted head ø 7.5mm		
<b>For models:</b>	ACE-061, ACE-101, ACE-102, ACE-201, ACE-202, ACG-061, ACG-101, ACG-102, ACG-201, ACG-202, AD-120, AD-120B, AD-120BBTDD-UK, AD-120C, AD-120CW, AD-120HY, AD-15, AD-15D, AD-20C-UK, AD-21, AD-21B, AD-21BDD, AD-21C, AD-21D, AD-21DD, AD-21W, AD-45BBT, AD-48, AD-48B, AD-48BDD, AD-48C, AD-48D, AD-48DD, AD-48HY, AD-48W, AD-64, AD-64B, AD-64BBT, AD-64BDD, AD-64BTDD, AD-64C, AD-64CW, AD-64D, AD-64DD, AD-64HY, AD-72, AD-72W, AD-90, AD-90BA, AD-90BBT, AD-90BDD, AD-90DD, ADE-120, ADE-120B...(Other models you can see in the webshop)		

			
1			
<b>GEV No.</b>	560263	<b>Ref. No.</b>	12010287 Q041324
<b>description</b>	countersunk screw thread M4 L 25mm SS DIN 963/ISO 2009 Qty 20 pcs intake slotted head ø 7.5mm		
<b>For models:</b>	AD-45BBT, AD-48, AD-48B, AD-48BDD, AD-48C, AD-48D, AD-48DD, AD-48HY, AD-48W, AD-64, AD-64B, AD-64BBT, AD-64BDD, AD-64BTDD, AD-64C, AD-64CW, AD-64D, AD-64DD, AD-64HY, AD-72, AD-72W, EASY-500, EASY-500B, EASY-500DD, EASY-500HP, EASY-500HPWBDD, ECO-120, ECO-120B, ECO-160, ECO-160D, ECO-160I, ECO-200, ECO-200D, ECO-200H, ECO-200HD, ECO-200HI, ECO-200I, ECO-2700D, ECO-2700I, ECO-280D, ECO-280I, ECO-370D, ECO-370I, ECO-4000D, ECO-4000I, ECO-460D, ECO-460I, ECO-550D, ECO-550I, ECO-6000D...(Other models you can see in the webshop)		



<b>GEV No.</b>	560077	<b>Ref. No.</b>	12010265 Q042031
<b>description</b>	countersunk screw thread M5 L 10mm SS DIN 963/ISO 2009 Qty 20 pcs intake slotted head ø 9.2mm		
<b>For models:</b>	ECO-1200, FE-18, FE-25, FE-4, FE-6, FE-8, FE9-05, FE9-05S, FE9-10, FF-35, FG9-05, FG9-05S, FG9-10, FI-1200, FI-900, HCG-10-11, HCG-10-21, HCG-20-11, HCG-2-10-11, HCG-2-20-11, HCG-6-11, HEI-20-11, HEM-20-11, HEP-20-11, HGP-10-21, HGP-20-21, HGV-10-11, HGV-10-21, HGV-20-11, HGV-20-21, HME-10-11, HME-10-21, HME-20-11, HME-20-21, HME-2-10-11, HME-2-20-11, HME-6-11, HMG-10-11, HMG-10-11UL, HMG-10-21, HMG-10-21UL, HMG-20-11, HMG-2-10-11, HMG-6-11, HMI-10-11, HMI-10-11UL, HMI-10-21, HMI-10-21UL, HMI-2-10-11...(Other models you can see in the webshop)		



<b>GEV No.</b>	560019	<b>Ref. No.</b>	12009838 Q152015 Q153112
<b>description</b>	flat-headed bolt thread M3 thread L 6mm SS DIN 7985/ISO 7045 Qty 20 pcs head ø 6mm head thickness 2mm Phillips		
<b>For models:</b>	AD-45BBT, AD-48, AD-48B, AD-48BDD, AD-48C, AD-48D, AD-48DD, AD-48HY, AD-48W, AD-64, AD-64B, AD-64BBT, AD-64BDD, AD-64BTDD, AD-64C, AD-64CW, AD-64D, AD-64DD, AD-64HY, AD-72, AD-72W, EASY-500, EASY-500B, EASY-500DD, EASY-500HP, EASY-500HPWDD, FI-30, FI-300B, FI-300R, FI-30AR, FI-30AR+DD, FI-30B, FI-30B-BT-UK, FI-30-UK, FI-48, FI-48AR, FI-48B, FI-48B-BT-UK, FI-48C, FI-48D, FI-48HY-CLINIC, FI-48W, FI-50, FI-60DD, FI-64, FI-64AR, FI-64B, FI-64B-BT-UK, FI-64C, FI-64D...(Other models you can see in the webshop)		



<b>GEV No.</b>	560220	<b>Ref. No.</b>	12010192 Q042043
<b>description</b>	countersunk screw thread M6 L 20mm SS DIN 963/ISO 2009 Qty 20 pcs intake slotted head ø 11mm		
<b>For models:</b>	CE7-41, CE9-41, CG-1002, CG-1502, CG-2002, CG-210, CG-210G, CG-310, CG-310G, CG7-11, CG7-41, CG7-61, CG9-11, CG9-41, CG9-51L, CG9-51LC, CG9-51R, CG9-51RC, CG9-61, CG9-61OP, CG9-82, CGE7-41, CGE9-41, CGF9-121D, CGF9-121I, FTG9-11L, FTG9-11L+R, FTG9-11R, FTGC9-11L, FTGC9-11L+R, FTGC9-11R, HCG-10-11, HCG-10-21, HCG-20-11, HCG-2-10-11, HCG-2-20-11, HCG-6-11, HE9-10, HE9-20, HG9-10, HG9-20, HME-10-11, HME-10-21, HME-20-11, HME-20-21, HME-2-10-11, HME-2-20-11, HME-6-11, HMI-10-11...(Other models you can see in the webshop)		



<b>GEV No.</b>	560062	<b>Ref. No.</b>	12010278 Q032021
<b>description</b>	flat-headed bolt thread M4 thread L 10mm SS DIN 7985/ISO 7045 Qty 20 pcs intake Phillips head ø 8mm head thickness 2mm		
<b>For models:</b>	ACE-061, ACE-101, ACE-102, ACE-201, ACE-202, ACG-061, ACG-101, ACG-102, ACG-201, ACG-202, AD-15, AD-15D, AD-20C-UK, AD-21, AD-21B, AD-21BDD, AD-21C, AD-21D, AD-21DD, AD-21W, AE-061, AE-061W, AE-101, AE-101W, AE-102, AE-102W, AE-201, AE-202, AG-061, AG-101, AG-102, AG-201, AG-202, APE-061, APE-061W, APE-101, APE-101W, APE-102, APE-102W, APE-201, APE-202, APG-061, APG-101, APG-102, APG-201, APG-202, BMG7-10, CG-1002, CG-1502, CG-2002...(Other models you can see in the webshop)		

flat-headed bolts



<b>GEV No.</b>	560021	<b>Ref. No.</b>	12010286 Q032011
<b>description</b>	flat-headed bolt thread M3 thread L 10mm SS DIN 7985/ISO 7045 Qty 20 pcs head ø 6mm head thickness 2mm Phillips		
<b>For models:</b>	AD-120, AD-120B, AD-120BBTDD-UK, AD-120C, AD-120CW, AD-120HY, AD-90, AD-90BA, AD-90BBT, AD-90BDD, AD-90DD, ADE-120, ADE-120B, ECO-120, ECO-120B, FI-100, FI-100AR, FI-100B, FI-100BBT-UK, FI-120, FI-120AR+DD, FI-120B, FI-120C, FI-120HY-CLINIC, FI-120W, FI-64, FI-64AR, FI-64B, FI-64B-BT-UK, FI-64C, FI-64D, FI-64HY-CLINIC, FI-64W, FI-E-100, HGC-10-21, HGV-10-21, LABP-1000, LABP-1200, LAC-10, LAC-10MP, LAC-10MPP, LAC-14, LAC-14MP, LAC-14MPP, LAC-7, LAC-7MP, LAC-7MPP, LC-AC-10, LC-AC-10A, LC-AC-14...(Other models you can see in the webshop)		





<b>GEV No.</b>	560063	<b>Ref. No.</b>	12009862
<b>description</b>	flat-headed bolt thread M4 thread L 16mm SS DIN 7985/ISO 7045 Qty 20 pcs intake Phillips head ø 8mm head thickness 2mm		





<b>GEV No.</b>	560061	<b>Ref. No.</b>	12009876 Q151320
<b>description</b>	flat-headed bolt thread M4 thread L 6mm SS DIN 7985/ISO 7045 Qty 20 pcs intake Phillips head ø 8mm head thickness 2mm		
<b>For models:</b>	ACE-061, ACE-101, ACE-102, ACE-201, ACE-202, ACG-061, ACG-101, ACG-102, ACG-201, ACG-202, AE-061, AE-061W, AE-101, AE-101W, AE-102, AE-102W, AE-201, AE-202, AG-061, AG-061W, AG-101, AG-101W, AG-102, AG-102W, AG-201, AG-202, APE-061, APE-061W, APE-101, APE-101W, APE-102, APE-102W, APE-201, APE-202, APG-061, APG-061W, APG-101, APG-101W, APG-102, APG-102W, APG-201, APG-202, BME6-05, BME7-05, BME7-10, BME9-05, BME9-05AD, BME9-05PLUS, BME9-05V-T, BME9-10...(Other models you can see in the webshop)		





			
1			
<b>GEV No.</b>	560068	<b>Ref. No.</b>	12010213 Q032032
<b>description</b>	flat-headed bolt thread M5 thread L 16mm SS DIN 7985/ISO 7045 Qty 20 pcs intake Phillips head ø 10mm head thickness 2mm		
<b>For models:</b>	ACE-201, ACE-202, ACG-201, ACG-202, AD-120B, AD-120BBTDD-UK, AD-120C, AD-120HY, AD-15, AD-15D, AD-20C-UK, AD-21, AD-21B, AD-21BD, AD-21C, AD-21D, AD-21DD, AD-21W, AD-90BA, AD-90BBT, AD-90BDD, ADE-120B, AE-201, AE-202, AG-201, AG-202, APE-201, APE-202, APG-201, APG-202, COE-201, COE-202, COG-201, COG-202, ECO-120B, FI-100B, FI-100BBT-UK, FI-120B, FI-120C, FI-120HY-CLINIC, FI-80BBT-UK, GA-20, GA-20D, GA-40, GA-40D, HCG-10-11, HCG-10-21, HCG-20-11, HCG-20-21, HCG-2-10-11...(Other models you can see in the webshop)		

			
1			
<b>GEV No.</b>	560071	<b>Ref. No.</b>	12010166 Q032035
<b>description</b>	flat-headed bolt thread M5 thread L 30mm SS DIN 7985/ISO 7045 Qty 20 pcs intake Phillips head ø 10mm head thickness 2mm		
<b>For models:</b>	AD-45BBT, AD-48HY, AD-64BBT, AD-64HY, CG-1002, CG-1502, FE-18, FE-25, FE-4, FE-6, FE-8, FI-30B-BT-UK, FI-48B-BT-UK, FI-48HY-CLINIC, FI-64B-BT-UK, FI-64HY-CLINIC, HCV-10-11, HCV-10-21, HCV-2-10-21, HCV-5-11, HCV-6-11, HE-10-11, HE-10-21, HE-2-10-11, HE-5-11, HE-6-11, HG-10-11, HG-10-21, HG-2-10-11, LAC-10, LAC-10MP, LAC-10MPP, LAC-14, LAC-14MP, LAC-14MPP, LAC-25, LAC-25MP, LAC-25MPP, LAC-55, LAC-55MP, LAC-55MPP, LAC-7, LAC-7MP, LAC-7MPP, LC-10, LC-14, LC-25, LC-7, LC-7A		

			
1			
<b>GEV No.</b>	560018	<b>Ref. No.</b>	12010157 Q032041
<b>description</b>	flat-headed bolt thread M6 thread L 10mm SS DIN 7985/ISO 7045 Qty 20 pcs head ø 12mm head thickness 5mm Phillips		
<b>For models:</b>	AD-120, AD-120B, AD-120BBTDD-UK, AD-120HY, AD-90, AD-90BA, AD-90BBT, AD-90BDD, AD-90DD, ADE-120, ADE-120B, EASY-500, EASY-500B, EASY-500DD, EASY-500HP, EASY-500HPWBDD, ECO-120, ECO-120B, FI-100, FI-100AR, FI-100B, FI-100BBT-UK, FI-120, FI-120AR+DD, FI-120B, FI-120C, FI-120HY-CLINIC, FI-120W, FI-30, FI-30AR, FI-30AR+DD, FI-30B, FI-30B-BT-UK, FI-30-UK, FI-48, FI-48AR, FI-48B, FI-48B-BT-UK, FI-48C, FI-48D, FI-48HY-CLINIC, FI-48W, FI-50, FI-60DD, FI-64, FI-64AR, FI-64B, FI-64B-BT-UK, FI-64C, FI-64D...(Other models you can see in the webshop)		

			
1			
<b>GEV No.</b>	560355	<b>Ref. No.</b>	Q062031
<b>description</b>	flat-headed bolt thread M5 thread L 10mm SS DIN 84/ISO 1207 Qty 1 pcs intake slotted head ø 8.3mm head thickness 3.2mm		
<b>For models:</b>	FI-1200, FI-300B, FI-300R, FI-650R, FI-900, HCV-10-11, HCV-10-21, HCV-2-10-21, HCV-5-11, HCV-6-11, HE-10-11, HE-10-21, HE-2-10-11, HE-5-11, HE-6-11, HME-10-11, HME-10-21, HME-20-11, HME-2-10-11, HME-6-11, HMI-10-11, HMI-10-11UL, HMI-10-21, HMI-10-21UL, HMI-2-10-11, HMI-6-11, HMI-6-11UL, HMM-10-11, HMM-10-11UL, HMM-10-21, HMM-10-21UL, HMM-20-11, HMM-20-11UL, HMM-2-10-11, HMM-6-11, HMM-6-11UL, HMP-10-11, HMP-10-21, HMP-20-11, HMP-2-10-11, HMP-6-11, LC-10, LC-14, LC-7, LC-7A, LF-AC-25, LF-AC-25MP, LF-AC-25MPP, LF-AC-55, LF-AC-55MP...(Other models you can see in the webshop)		

<b>oval head screws</b>			
			
1			
<b>GEV No.</b>	560057	<b>Ref. No.</b>	12010242 Q152004
<b>description</b>	oval head screw thread M5 L 13mm stainless steel intake Phillips Qty 10 pcs		
<b>For models:</b>	ACE-061, ACE-101, ACE-102, ACE-201, ACE-202, ACG-061, ACG-101, ACG-102, ACG-201, ACG-202, AD-120, AD-120B, AD-120BBTDD-UK, AD-120C, AD-120CW, AD-120HY, AD-125, AD-125HRS, AD-125-SOFT, AD-15, AD-15D, AD-20C-UK, AD-21, AD-21B, AD-21BD, AD-21C, AD-21D, AD-21DD, AD-21W, AD-45BBT, AD-48, AD-48B, AD-48BDD, AD-48C, AD-48D, AD-48DD, AD-48HY, AD-48W, AD-64, AD-64B, AD-64BBT, AD-64BDD, AD-64BTDD, AD-64C, AD-64CW, AD-64D, AD-64DD, AD-64HY, AD-72, AD-72W...(Other models you can see in the webshop)		

<b>hexagonal screws</b>			
			
1			
<b>GEV No.</b>	560311	<b>Ref. No.</b>	12010030 Q012063
<b>description</b>	hexagonal screw thread M10 thread L 20mm SS WS 17 Qty 1 pcs DIN 933 / ISO 4017		
<b>For models:</b>	ACE-061, ACE-101, ACE-102, ACE-201, ACE-202, ACG-061, ACG-101, ACG-102, ACG-201, ACG-202, AD-120, AD-120B, AD-120C, AD-120CW, AD-48, AD-48B, AD-48BDD, AD-48C, AD-48D, AD-48DD, AD-48W, AD-64, AD-64B, AD-64BDD, AD-64BTDD, AD-64C, AD-64CW, AD-64D, AD-64DD, AD-72, AD-72W, AD-90, AD-90BA, AD-90BDD, AD-90DD, AE-061, AE-061W, AE-101, AE-101W, AE-102, AE-102W, AE-201, AE-202, AG-061, AG-061W, AG-101, AG-101W, AG-102, AG-102W, AG-201...(Other models you can see in the webshop)		

			
1			
<b>GEV No.</b>	560081	<b>Ref. No.</b>	12010249 Q012021
<b>description</b>	hexagonal screw thread M4 thread L 10mm SS WS 7 Qty 20 pcs DIN 933 / ISO 4017		
<b>For models:</b>	ACE-061, ACE-101, ACE-102, ACE-201, ACE-202, ACG-061, ACG-101, ACG-102, ACG-201, ACG-202, AE-061, AE-061W, AE-101, AE-101W, AE-102, AE-102W, AE-201, AE-202, AG-061, AG-061W, AG-101, AG-101W, AG-102, AG-102W, AG-201, AG-202, APE-061, APE-061W, APE-101, APE-101W, APE-102, APE-102W, APE-201, APE-202, APG-061, APG-061W, APG-101, APG-101W, APG-102, APG-102W, APG-201, APG-202, CG-2000, CG-2000-2P, CG-2005, CG-210, CG-210G, CG-3005, CG-310, CG-310G...(Other models you can see in the webshop)		

			
1			
<b>GEV No.</b>	560083	<b>Ref. No.</b>	12010238 Q012031
<b>description</b>	hexagonal screw thread M5 thread L 10mm SS WS 8 Qty 20 pcs DIN 933 / ISO 4017		
<b>For models:</b>	ACE-061, ACE-101, ACE-102, ACE-201, ACE-202, ACG-061, ACG-101, ACG-102, ACG-201, ACG-202, AD-120, AD-120B, AD-120BTTDD-UK, AD-120C, AD-120CW, AD-120HY, AD-20C-UK, AD-21B, AD-21BDD, AD-21C, AD-21DD, AD-21W, AD-45BBT, AD-48, AD-48B, AD-48BDD, AD-48C, AD-48D, AD-48D, AD-48DD, AD-48HY, AD-48W, AD-64, AD-64B, AD-64B, AD-64BBT, AD-64BDD, AD-64BTTDD, AD-64C, AD-64CW, AD-64D, AD-64DD, AD-64HY, AD-72, AD-72W, AD-90, AD-90BA, AD-90BBT, AD-90BDD, AD-90DD, ADE-120, ADE-120B...(Other models you can see in the webshop)		

			
1			
<b>GEV No.</b>	560086	<b>Ref. No.</b>	12010202 Q012041
<b>description</b>	hexagonal screw thread M6 thread L 10mm SS WS 10 Qty 20 pcs DIN 933 / ISO 4017		
<b>For models:</b>	AD-120, AD-120B, AD-120BTTDD-UK, AD-120C, AD-120CW, AD-120HY, AD-45BBT, AD-48, AD-48B, AD-48BDD, AD-48C, AD-48D, AD-48DD, AD-48HY, AD-48W, AD-64, AD-64B, AD-64BBT, AD-64BDD, AD-64BTTDD, AD-64C, AD-64CW, AD-64D, AD-64DD, AD-64HY, AD-72, AD-72W, AD-90, AD-90BA, AD-90BBT, AD-90BDD, AD-90DD, ADE-120, ADE-120B, BME9-05, BME9-10, BMG7-10, BMG9-05, BMG9-10, CE6-41, CE7-41, CE7-41Q, CE9-41, CE9-41AD, CE9-41PLUS, CG-1002, CG-1502, CG-2000, CG-2000-2P, CG-2002...(Other models you can see in the webshop)		

			
2			
<b>GEV No.</b>	560254	<b>Ref. No.</b>	12018360 R725057
<b>description</b>	hexagonal screw thread M5 thread L 30mm SS WS 8 Qty 20 pcs DIN 933 / ISO 4017		
<b>For models:</b>	HCG-10-11, HCG-10-21, HCG-2-10-11, HCG-6-11, HMG-10-11, HMG-10-11UL, HMG-10-21, HMG-10-21UL, HMG-2-10-11, HMG-6-11		

			
1			
<b>GEV No.</b>	560079	<b>Ref. No.</b>	12037772 RT10060761
<b>description</b>	hexagonal screw thread M6 thread L 12mm SS WS 10 Qty 20 pcs DIN 933 / ISO 4017		

			
1			
<b>GEV No.</b>	560253	<b>Ref. No.</b>	12010083 Q011338
<b>description</b>	hexagonal screw thread M5 thread L 60mm SS WS 8 Qty 1 pcs DIN 933 / ISO 4017		
<b>For models:</b>	FG6-05, FG6-10, FTG7-05L, FTG7-05R, FTG7-10L, FTG7-10L+R, FTG7-10R, FTG9-05L, FTG9-05L-AD, FTG9-05PLUS-CL, FTG9-05PLUS-CR, FTG9-05PLUS-L, FTG9-05PLUS-R, FTG9-05R, FTG9-05R-AD, FTG9-05VL, FTG9-05VR, FTG9-10L, FTG9-10L+R, FTG9-10L+R-AD, FTG9-10L-AD, FTG9-10PLUS-CL, FTG9-10PLUS-CLR, FTG9-10PLUS-CR, FTG9-10PLUS-L, FTG9-10PLUS-LR, FTG9-10PLUS-R, FTG9-10R, FTG9-10R-AD, FTG9-10VL, FTG9-10VL+R, FTG9-10VR, FTG9-11L, FTG9-11L+R, FTG9-11R, FTGC7-05L, FTGC7-10L, FTGC9-05L, FTGC9-05L-AD, FTGC9-05R, FTGC9-05R-AD, FTGC9-10L, FTGC9-10L+R, FTGC9-10L+R-AD, FTGC9-10L-AD, FTGC9-10R, FTGC9-10R-AD, FTGC9-11L, FTGC9-11L+R, FTGC9-11R		

			
1			
<b>GEV No.</b>	524118	<b>Ref. No.</b>	12010186 Q012042
<b>description</b>	hexagonal screw thread M6 thread L 16mm SS WS 10 Qty 1 pcs DIN 933 / ISO 4017		
<b>For models:</b>	ACE-061, ACE-101, ACE-102, ACE-201, ACE-202, ACG-061, ACG-101, ACG-102, ACG-201, ACG-202, AD-120, AD-120B, AD-120BTTDD-UK, AD-120C, AD-120CW, AD-120HY, AD-15, AD-15D, AD-20C-UK, AD-21, AD-21B, AD-21BDD, AD-21C, AD-21D, AD-21DD, AD-21W, AD-45BBT, AD-48, AD-48B, AD-48BDD, AD-48C, AD-48D, AD-48DD, AD-48HY, AD-48W, AD-64, AD-64B, AD-64BBT, AD-64BDD, AD-64BTTDD, AD-64C, AD-64CW, AD-64D, AD-64DD, AD-64HY, AD-72, AD-72W, AD-90, AD-90BA, AD-90BBT...(Other models you can see in the webshop)		

			
1			
<b>GEV No.</b>	560448	<b>Ref. No.</b>	12036376 RT10080753
<b>description</b>	hexagonal screw thread M5 thread L 8mm SS WS 8 Qty 1 pcs head thickness 4mm DIN 933 / ISO 4017		

			
1			
<b>GEV No.</b>	560088	<b>Ref. No.</b>	12010180 Q012043
<b>description</b>	hexagonal screw thread M6 thread L 20mm SS WS 10 Qty 20 pcs DIN 933 / ISO 4017		
<b>For models:</b>	ACE-061, ACE-101, ACE-102, ACG-061, ACG-101, ACG-102, AE-061, AE-061W, AE-101, AE-101W, AE-102, AE-102W, AG-061, AG-061W, AG-101, AG-101W, AG-102, AG-102W, APE-061, APE-061W, APE-101, APE-101W, APE-102, APE-102W, APG-061, APG-061W, APG-101, APG-101W, APG-102, APG-102W, BME9-05, BME9-10, BMG9-05, BMG9-10, CE7-41, CE7-41Q, CE9-41, CG-1002, CG-1502, CG7-11, CG7-31D, CG7-31I, CG7-41, CG7-41H, CG7-51, CG7-61, CG7-61H, CG9-10, CG9-11, CG9-11AD...(Other models you can see in the webshop)		







			
<b>GEV No.</b>	560089	<b>Ref. No.</b>	12010153 Q012044
<b>description</b>	hexagonal screw thread M6 thread L 25mm SS WS 10 Qty 20 pcs DIN 933 / ISO 4017		
<b>For models:</b>	AD-120, AD-120B, AD-120BBTDD-UK, AD-120C, AD-120CW, AD-120HY, AD-90, AD-90BA, AD-90BBT, AD-90BDD, AD-90DD, ADE-120, ADE-120B, CE9-41, CG-1002, CG-1502, CG-2000, CG-2000-2P, CG-2002, CG-2005, CG-210, CG-210G, CG-3005, CG-310, CG-310G, CG7-20, CG-7200, CG7-40, CG-7400, CG7-41, CG-7415, CG7-61, CG-7615, CG9-20, CG9-40, CG9-41, CG9-51L, CG9-51LC, CG9-51R, CG9-51RC, CG9-60, CG9-61, CG9-82, CGB7-61, CGE7-41, CGE9-41, COG-061, COG-101, ECO-120, ECO-120B...(Other models you can see in the webshop)		

			
<b>GEV No.</b>	560252	<b>Ref. No.</b>	12010115 Q012046
<b>description</b>	hexagonal screw thread M6 thread L 40mm SS WS 10 Qty 20 pcs DIN 933 / ISO 4017		
<b>For models:</b>	AD-45BBT, AD-48, AD-48B, AD-48C, AD-48D, AD-48DD, AD-48HY, AD-48W, AD-64, AD-64B, AD-64BBT, AD-64BTDD, AD-64C, AD-64CW, AD-64D, AD-64DD, AD-64HY, AD-72, AD-72W, EASY-500, EASY-500B, EASY-500DD, EASY-500HP, EASY-500HPWBDD, ECO-160, ECO-1600, ECO-160D, ECO-160I, ECO-200, ECO-200D, ECO-200H, ECO-200HD, ECO-200HI, ECO-200I, ECO-2300, ECO-280D, ECO-280I, ECO-3000, ECO-370D, ECO-370I, ECO-460D, ECO-460I, ECO-550D, ECO-550I, FI-160, FI-1600, FI-160D, FI-160I, FI-200, FI-200D...(Other models you can see in the webshop)		

			
<b>GEV No.</b>	503122	<b>Ref. No.</b>	12010112 Q012051 Q012051000
<b>description</b>	hexagonal screw thread M8 thread L 10mm SS WS 13 Qty 1 pcs DIN 933 / ISO 4017		

			
<b>GEV No.</b>	506175	<b>Ref. No.</b>	12008844 X152809
<b>description</b>	hexagonal screw thread M8 thread L 14mm SS WS 13 Qty 20 pcs head thickness 3mm DIN 933 / ISO 4017		
<b>For models:</b>	SBE7-10, SBE9-10, SBE9-10I, SBE9-10IM, SBE9-10IMS, SBE9-10IS, SBE9-10M, SBE9-10MS, SBE9-10S, SBE9-10USMC, SBE9-15IM, SBE9-15IMS, SBE9-15M, SBE9-15MS, SBG7-10, SBG9-10, SBG9-10I, SBG9-10IM, SBG9-10IMS, SBG9-10IS, SBG9-10M, SBG9-10MS, SBG9-10S, SBG9-15IM, SBG9-15IMS		

			
<b>GEV No.</b>	550682	<b>Ref. No.</b>	12010076 Q012053
<b>description</b>	hexagonal screw thread M8 thread L 20mm SS WS 13 Qty 1 pcs DIN 933 / ISO 4017		
<b>For models:</b>	AD-120, AD-120B, AD-120BBTDD-UK, AD-120C, AD-120CW, AD-120HY, AD-90, AD-90BA, AD-90BBT, AD-90BDD, AD-90DD, ADE-120, ADE-120B, CE-410, CG-110, CG-9110, CGB7-61H, CGB7-61R, CGB7-61RH, ECO-120, ECO-120B, ECO-160, ECO-1600, ECO-160D, ECO-160I, ECO-200, ECO-200D, ECO-200H, ECO-200HD, ECO-200HI, ECO-200I, ECO-2300, ECO-2700D, ECO-2700I, ECO-280D, ECO-280I, ECO-3000, ECO-370D, ECO-370I, ECO-4000D, ECO-4000I, ECO-460D, ECO-460I, ECO-550D, ECO-550I, ECO-6000D, ECO-6000I, FI-100, FI-100AR, FI-100B...(Other models you can see in the webshop)		

			
<b>GEV No.</b>	560205	<b>Ref. No.</b>	12036562 RT10080766
<b>description</b>	hexagonal screw thread M8 thread L 30mm SS WS 13 Qty 1 pcs DIN 933 / ISO 4017		

			
<b>GEV No.</b>	506446	<b>Ref. No.</b>	12010056 Q012056
<b>description</b>	hexagonal screw thread M8 thread L 40mm SS WS 13 Qty 1 pcs DIN 933 / ISO 4017		
<b>For models:</b>	ACE-061, ACE-101, ACE-102, ACE-201, ACE-202, ACG-061, ACG-101, ACG-102, ACG-201, ACG-202, AE-061, AE-061W, AE-101, AE-101W, AE-102, AE-102W, AE-201, AE-202, AG-061, AG-061W, AG-101, AG-101W, AG-102, AG-102W, AG-201, AG-202, APE-061, APE-061W, APE-101, APE-101W, APE-102, APE-102W, APE-201, APE-202, APG-061, APG-061W, APG-101, APG-101W, APG-102, APG-102W, APG-201, APG-202, COE-102, COE-202, COG-102, COG-201, COG-202, ECO-1600, ECO-2300, ECO-3000...(Other models you can see in the webshop)		

			
<b>GEV No.</b>	550528	<b>Ref. No.</b>	12040516 RT10052000
<b>description</b>	safety screw thread M5 WS 8 Qty 10 pcs L 8mm head ø 11mm		

cylinder head bolts

DIN 912/ISO 4762

			
<b>GEV No.</b>	530454	<b>Ref. No.</b>	12038252 RT10040665
<b>description</b>	cylinder head bolt thread M4 thread L 6mm L 9.5mm WS 3 SS Qty 1 pcs intake internal hexagon DIN 912/ISO 4762		



<b>GEV No.</b>	520455	<b>Ref. No.</b>	12038360 Q052053
<b>description</b>	screw thread M8 thread L 20mm WS 6 SS Qty 1 pcs DIN 912/ISO 4762		
<b>For models:</b>	CE-15, CE-9, SBE7-10, SBE9-10, SBE9-10I, SBE9-10IM, SBE9-10IMS, SBE9-10IS, SBE9-10M, SBE9-10MS, SBE9-10S, SBE9-15IM, SBE9-15IMS, SBG7-10, SBG9-10, SBG9-10I, SBG9-10IM, SBG9-10IMS, SBG9-10IS, SBG9-10M, SBG9-10MS, SBG9-10S, SBG9-15IM, SBG9-15IMS		



<b>GEV No.</b>	560380	<b>Ref. No.</b>	12010084 12018750 Q052046 Q152033
<b>description</b>	cylinder head bolt thread M6 L 40mm thread L 25mm WS 5 SS Qty 1 pcs DIN 912/ISO 4762		
<b>For models:</b>	ACG-061, ACG-101, ACG-102, ACG-201, ACG-202, AG-061, AG-061W, AG-101, AG-101W, AG-102, AG-102W, AG-201, AG-202, APG-061, APG-061W, APG-101, APG-101W, APG-102, APG-102W, APG-201, APG-202, ECO-1200, FI-1200, FI-120W, FI-200W, FI-200WL, FI-200WR, FI-80W, FI-900, LAC-25, LAC-25MP, LAC-25MPP, LAC-55, LAC-55MP, LAC-55MPP, LC-25, LC-AC-25, LC-E-25, LC-V-25, LF-25MPP, LF-AC-25, LF-AC-25MP, LF-AC-25MPP, LF-AC-55, LF-AC-55MP, LF-AC-55MPP, LF-E-25, LF-E-25MP, LF-E-25MPP, LF-E-55...(Other models you can see in the webshop)		

### side bolts



<b>GEV No.</b>	560038	<b>Ref. No.</b>	12010148 Q152017
<b>description</b>	side bolts thread M6 L 13mm Qty 20 pcs intake Phillips head ø 15mm		
<b>For models:</b>	BME9-05, BME9-10, BMG9-05, BMG9-10, CE7-41, CE9-41, CG-1002, CG-1502, CG-2000, CG-2000-2P, CG-2002, CG-2002P, CG-2005, CG-210, CG-210G, CG-300S, CG-310, CG-310G, CG7-11, CG7-41, CG7-61, CG9-11, CG9-20, CG9-40, CG9-41, CG9-51L, CG9-51LC, CG9-51R, CG9-51RC, CG9-60, CG9-61, CG9-82, CGE7-198, CGE7-202, CGE7-41, CGE9-41, CGF9-121D, CGF9-121I, CGP9-11, ECO-120, ECO-120B, ECO-160, ECO-160D, ECO-160I, ECO-200, ECO-200D, ECO-200H, ECO-200HD, ECO-200HI, ECO-200I...(Other models you can see in the webshop)		



<b>GEV No.</b>	560037	<b>Ref. No.</b>	12010129 Q152022
<b>description</b>	side bolts thread M6 L 10mm SS Qty 20 pcs intake Phillips head ø 15mm		
<b>For models:</b>	CE6-41, CE7-41, CE7-41Q, CE9-41, CE9-41AD, CE9-41PLUS, CG-1002, CG-1502, CG-2002, CG-2002P, CG-210, CG-210G, CG-310, CG-310G, CG6-41, CG7-11, CG7-31D, CG7-31I, CG7-41, CG7-41H, CG7-51, CG7-61, CG7-61H, CG9-11, CG9-11AD, CG9-11PLUS, CG9-31PLUS-D, CG9-31PLUS-I, CG9-41, CG9-41AD, CG9-41AD-H, CG9-41H, CG9-41PLUS, CG9-41PLUS-H, CG9-51L, CG9-51LC, CG9-51R, CG9-51RC, CG9-61, CG9-61AD, CG9-61AD-H, CG9-61H, CG9-61OP, CG9-61PLUS, CG9-61PLUS-H, CG9-82, CG9-82AD, CG9-82PLUS, CGE6-41, CGE7-41...(Other models you can see in the webshop)		

### grub screws

#### DIN 913/ISO 4026



<b>GEV No.</b>	560022	<b>Ref. No.</b>	12010279 Q132054
<b>description</b>	grub screw thread M6 L 12mm DIN 913/ISO 4026 WS 3 Qty 20 pcs		
<b>For models:</b>	CG-2002, CG-2002P, CG7-20H, CG7-30D, CG7-30I, CG7-31D, CG7-31I, CG7-40, CG7-40H, CG7-41, CG7-41H, CG7-50, CG7-51, CG7-60, CG7-60H, CG7-61, CG7-61H, CG9-20, CG9-20AD, CG9-20AD-H, CG9-20H, CG9-20PLUS, CG9-20PLUS-H, CG9-31PLUS-D, CG9-31PLUS-I, CG9-40, CG9-40AD, CG9-40AD-H, CG9-40H, CG9-40PLUS, CG9-40PLUS-H, CG9-41, CG9-41AD, CG9-41AD-H, CG9-41H, CG9-41PLUS, CG9-41PLUS-H, CG9-51L, CG9-51LC, CG9-51R, CG9-51RC, CG9-60, CG9-60AD, CG9-60AD-H, CG9-60H, CG9-60PLUS, CG9-60PLUS-H, CG9-61, CG9-61AD, CG9-61AD-H...(Other models you can see in the webshop)		



<b>GEV No.</b>	560024	<b>Ref. No.</b>	12010197 Q131542
<b>description</b>	grub screw thread M6 L 16mm SS DIN 913/ISO 4026 intake internal hexagon WS 3 Qty 20 pcs		
<b>For models:</b>	CG-1002, CG-1502, CG-2002, CG-2005, CG-210, CG-210G, CG-300S, CG-310, CG-310G, CG7-20, CG7-30D, CG7-30I, CG7-31D, CG7-31I, CG7-40, CG7-41, CG7-50, CG7-51, CG7-60, CG7-61, CG9-05AD, CG9-05PLUS, CG9-20, CG9-20AD, CG9-20H, CG9-20PLUS, CG9-40, CG9-40AD, CG9-40H, CG9-40PLUS, CG9-41, CG9-41AD, CG9-41PLUS, CG9-51L, CG9-51LC, CG9-51R, CG9-51RC, CG9-60, CG9-60AD, CG9-60H, CG9-60PLUS, CG9-61, CG9-61AD, CG9-61OP, CG9-61PLUS, CG9-82, CG9-82AD, CG9-82PLUS, CGB7-61, CGB7-61R...(Other models you can see in the webshop)		

#### DIN 914/ISO 4027





<b>GEV No.</b>	560175	<b>Ref. No.</b>	12010091 Q131504 Q131552
<b>description</b>	grub screw thread M8 L 16mm DIN 914/ISO 4027 intake internal hexagon WS 4 Qty 1 pcs		
<b>For models:</b>	SBE7-10, SBE9-10, SBE9-10I, SBE9-10I-AD, SBE9-10I-AD-S, SBE9-10IM, SBE9-10IMS, SBE9-10IS, SBE9-10PLUS-I, SBE9-10PLUS-SI, SBE9-10S, SBE9-10USMC, SBG7-10, SBG-9040, SBG9-10, SBG9-10I, SBG9-10I-AD, SBG9-10I-AD-S, SBG9-10IS, SBG9-10PLUS-I, SBG9-10PLUS-SI, SBG9-10S		





<b>GEV No.</b>	696737	<b>Ref. No.</b>	12024023 Z105051 Z105051000
<b>description</b>	grub screw thread M8 L 16mm DIN 914/ISO 4027 Qty 1 pcs		
<b>For models:</b>	ECO-160, ECO-1600, ECO-160D, ECO-160I, ECO-200, ECO-200D, ECO-200H, ECO-200HD, ECO-200HI, ECO-200I, ECO-2300, ECO-280D, ECO-280I, ECO-3000, ECO-370D, ECO-370I, ECO-460D, ECO-460I, ECO-550D, ECO-550I, FI-160, FI-1600, FI-160AR, FI-160D, FI-160I, FI-200, FI-200AR, FI-200D, FI-200H, FI-200HD, FI-200HI, FI-200I, FI-200W, FI-200WL, FI-200WR, FI-2300, FI-280D, FI-280I, FI-3000, FI-370D, FI-370I, FI-460D, FI-460I, FI-550D, FI-550I		





DIN 916/ISO 4029			
 <p>1</p>			
<b>GEV No.</b>	560549	<b>Ref. No.</b>	12010236
<b>description</b>	grub screw thread M6 L 15mm SS DIN 916/ISO 4029 intake internal hexagon WS 3 Qty 1 pcs		
<b>For models:</b>	ACE-201, ACE-202, ACG-201, ACG-202, AE-201, AE-202, AG-201, AG-202, APE-201, APE-202, APG-201, APG-202, CG9-20, CG9-20AD, CG9-20H, CG9-20PLUS, CG9-40, CG9-40AD, CG9-40H, CG9-40PLUS, CG9-41, CG9-41H, CG9-51L, CG9-51LC, CG9-51R, CG9-51RC, CG9-60, CG9-60AD, CG9-60H, CG9-60PLUS, CG9-61, CG9-61H, CG9-61OP, CG9-82, CGE9-41, CGE9-41AD, CGE9-41PLUS, CGF9-120D, CGF9-120I, CGF9-121D, CGF9-121I, COE-201, COE-202, COG-201, COG-202, HEI-10-11, HEI-20-11, HEI-20-21, HEI-6-11, HEM-10-11...(Other models you can see in the webshop)		

knurled screws			
 <p>1</p>			
<b>GEV No.</b>	505034	<b>Ref. No.</b>	12009829 Q152016
<b>description</b>	Thumb screw thread M5 thread L 7mm ø 20mm H 3mm SS		
<b>For models:</b>	AD-120, AD-120B, AD-120BBTDD-UK, AD-120C, AD-120CW, AD-120HY, AD-15, AD-15D, AD-20C-UK, AD-21, AD-21B, AD-21BDD, AD-21C, AD-21D, AD-21DD, AD-21W, AD-45BBT, AD-48, AD-48B, AD-48BDD, AD-48C, AD-48D, AD-48DD, AD-48HY, AD-48W, AD-64, AD-64B, AD-64BBT, AD-64BDD, AD-64BTDD, AD-64C, AD-64CW, AD-64D, AD-64DD, AD-64HY, AD-72, AD-72W, AD-90, AD-90BA, AD-90BBT, AD-90BDD, AD-90DD, ADE-120, ADE-120B, CO-110, CO-110B, CO-110BDD, CO-110DD, CO-112, CO-112B...(Other models you can see in the webshop)		

miscellaneous			
 <p>1</p>			
<b>GEV No.</b>	505140	<b>Ref. No.</b>	12016848 Z643015
<b>description</b>	screw SS		
<b>For models:</b>	FI-300B, FI-300R, FI-650R		

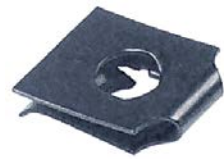
 <p>1</p>			
<b>GEV No.</b>	527391	<b>Ref. No.</b>	12010011 Q151336
<b>description</b>	thread bolt thread M6 L 25mm thread L 10mm ø 7mm		
<b>For models:</b>	BG6-05I, BG7-05, BG7-05I, BG7-10, BG7-10I, BG9-05, BG9-05I, BG9-05PF, BG9-05PI, BG9-10, BG9-10I, BG9-10PF, BG9-10PI, BME7-05, BME7-10, BME9-05, BME9-05AD, BME9-05PLUS, BME9-05V-T, BME9-10, BME9-10AD, BME9-10PLUS, BME9-10V-T, BMG7-10, BMG9-05, BMG9-05V-T, BMG9-10, BMG9-10V-T, CE7-20, CE7-20Q, CE7-40, CE7-40Q, CE7-41, CE7-41Q, CE9-20, CE9-20AD, CE9-20PLUS, CE9-40, CE9-40AD, CE9-40PLUS, CE9-41, CE9-41AD, CE9-41PLUS, CG-2000, CG-2000-2P, CG-2002, CG-2005, CG-210, CG-210G, CG-3005...(Other models you can see in the webshop)		

nuts			
 <p>1</p>			
<b>GEV No.</b>	560046	<b>Ref. No.</b>	12010134 Q221012
<b>description</b>	plate nut hole ø M5mm L 16mm W 10mm		
<b>For models:</b>	AD-15, AD-15D, AD-21, AD-21B, AD-21BDD, AD-21D, AD-21DD, AD-21W, AD-45BBT, AD-48, AD-48B, AD-48BDD, AD-48C, AD-48D, AD-48DD, AD-48HY, AD-48W, AD-64, AD-64B, AD-64BBT, AD-64BDD, AD-64C, AD-64CW, AD-64D, AD-64DD, AD-64HY, AD-72, AD-72W, EASY-500, EASY-500B, EASY-500DD, EASY-500HP, EASY-500HPWBDD, ECO-1200, FI-1200, FI-30, FI-300B, FI-300R, FI-30AR, FI-30AR+DD, FI-30B, FI-30B-BT-UK, FI-30-UK, FI-48, FI-48AR, FI-48B, FI-48B-BT-UK, FI-48C, FI-48D, FI-48HY-CLINIC...(Other models you can see in the webshop)		

cap nuts			
 <p>1</p>			
<b>GEV No.</b>	560136	<b>Ref. No.</b>	12010167 Q212031
<b>description</b>	cap nuts thread M5 WS 8 SS Qty 20 pcs DIN/ISO DIN 1587		
<b>For models:</b>	ECO-160, ECO-160D, ECO-160I, ECO-200, ECO-200D, ECO-200H, ECO-200HD, ECO-200HI, ECO-200I, ECO-2700D, ECO-2700I, ECO-280D, ECO-280I, ECO-370D, ECO-370I, ECO-4000D, ECO-4000I, ECO-460D, ECO-460I, ECO-550D, ECO-550I, ECO-6000D, ECO-6000I, FE9-05, FE9-05S, FE9-05USMC, FE9-10, FG9-05, FG9-05S, FG9-10, FI-160, FI-160AR, FI-160D, FI-160I, FI-200, FI-200AR, FI-200D, FI-200H, FI-200HD, FI-200HI, FI-200I, FI-200W, FI-200WL, FI-200WR, FI-2700D, FI-2700I, FI-280D, FI-280I, FI-370D, FI-370I...(Other models you can see in the webshop)		

 <p>1</p>			
<b>GEV No.</b>	560137	<b>Ref. No.</b>	12010143 12034573 Q212040 RT11060360
<b>description</b>	cap nuts thread M6 WS 10 SS Qty 20 pcs DIN/ISO DIN 1587		
<b>For models:</b>	ECO-160, ECO-160D, ECO-160I, ECO-200, ECO-200D, ECO-200H, ECO-200HD, ECO-200HI, ECO-200I, ECO-2700D, ECO-2700I, ECO-280D, ECO-280I, ECO-370D, ECO-370I, ECO-4000D, ECO-4000I, ECO-460D, ECO-460I, ECO-550D, ECO-550I, ECO-6000D, ECO-6000I, FE-710, FE-720, FE-920, FF-35, FG-710, FG-720, FG-920, FI-160, FI-160AR, FI-160D, FI-160I, FI-200, FI-200AR, FI-200D, FI-200H, FI-200HD, FI-200HI, FI-200I, FI-200W, FI-200WL, FI-200WR, FI-2700D, FI-2700I, FI-280D, FI-280I, FI-370D, FI-370I...(Other models you can see in the webshop)		

			
1			
<b>GEV No.</b>	560138	<b>Ref. No.</b>	12010094 Q212051
<b>description</b>	cap nuts thread M8 WS 13 SS Qty 20 pcs DIN/ISO DIN 1587		
<b>For models:</b>	FF-35, HCG-10-11, HCG-10-21, HCG-20-11, HCG-20-21, HCG-2-10-11, HCG-2-20-11, HCG-6-11, HEI-10-11, HEI-20-11, HEI-6-11, HEM-10-11, HEM-20-11, HEM-6-11, HEP-10-11, HEP-20-11, HEP-6-11, HGC-10-11, HGC-20-11, HGC-6-11, HGV-10-11, HGV-20-11, HME-10-11, HME-20-11, HME-2-10-11, HME-2-20-11, HME-6-11, HMI-10-11, HMI-10-11UL, HMI-10-21, HMI-10-21UL, HMI-2-10-11, HMI-6-11, HMI-6-11UL, HMM-10-11, HMM-10-11UL, HMM-10-21, HMM-10-21UL, HMM-20-11, HMM-20-11UL, HMM-20-21, HMM-20-21UL, HMM-2-10-11, HMM-2-20-11, HMM-40-11-USMC, HMM-6-11, HMM-6-11UL, HMP-10-11...(Other models you can see in the webshop)		

<b>knurled nuts</b>			
			
1			
<b>GEV No.</b>	505173	<b>Ref. No.</b>	12023653 Z680738
<b>description</b>	knurled nut		
<b>For models:</b>	AD-120, AD-120B, AD-120BTTDD-UK, AD-120C, AD-120CW, AD-120HY, ADE-120, ADE-120B, ECO-120, ECO-1200, ECO-120B, FI-100, FI-100AR, FI-100B, FI-100BBT-UK, FI-120, FI-1200, FI-120AR+DD, FI-120B, FI-120C, FI-120HY-CLINIC, FI-120W, FI-80BBT-UK, FI-900, FI-E-100, LABP-1000, LABP-1200, MF-120		

			
1			
<b>GEV No.</b>	505171	<b>Ref. No.</b>	12017466 12020831 12024375 Z200705
<b>description</b>	knurled nut thread M14x1 ø 35mm H 5mm SS		
<b>For models:</b>	AD-45BBT, AD-48, AD-48B, AD-48BDD, AD-48C, AD-48D, AD-48DD, AD-48HY, AD-48W, AD-64, AD-64B, AD-64BBT, AD-64BDD, AD-64BTDD, AD-64C, AD-64CW, AD-64D, AD-64DD, AD-64HY, AD-72, AD-72W, AD-90, AD-90BA, AD-90BBT, AD-90BDD, AD-90DD, EASY-500, EASY-500B, EASY-500DD, EASY-500HP, EASY-500HPWBDD, FI-30, FI-30AR, FI-30AR+DD, FI-30B, FI-30B-BT-UK, FI-30-UK, FI-48, FI-48AR, FI-48B, FI-48B-BT-UK, FI-48C, FI-48D, FI-48HY-CLINIC, FI-48W, FI-50, FI-60DD, FI-64, FI-64AR, FI-64B...(Other models you can see in the webshop)		

<b>hexagonal nuts</b>			
<b>DIN 934 / ISO 4032/8673</b>			
			
1			
<b>GEV No.</b>	560199	<b>Ref. No.</b>	12036825 RT11120110
<b>description</b>	hexagonal nut thread M10 H 8mm WS 17 SS DIN/ISO DIN 934 / ISO 4032/8673 Qty 10 pcs		

			
1			
<b>GEV No.</b>	560131	<b>Ref. No.</b>	12009839 Q162020
<b>description</b>	hexagonal nut thread M4 H 3.2mm WS 7 SS DIN/ISO DIN 934 / ISO 4032/8673 Qty 20 pcs		
<b>For models:</b>	ACE-201, ACE-202, AD-120, AD-120B, AD-120BTTDD-UK, AD-120C, AD-120CW, AD-120HY, AD-15, AD-15D, AD-20C-UK, AD-21, AD-21B, AD-21BDD, AD-21C, AD-21D, AD-21DD, AD-21W, AD-45BBT, AD-48, AD-48B, AD-48BDD, AD-48C, AD-48D, AD-48DD, AD-48HY, AD-48W, AD-64, AD-64B, AD-64BBT, AD-64BDD, AD-64C, AD-64CW, AD-64D, AD-64DD, AD-64HY, AD-72, AD-72W, AD-90, AD-90BA, AD-90BBT, AD-90BDD, AD-90DD, ADE-120, ADE-120B, AE-061, AE-061W, AE-101, AE-101W, AE-102...(Other models you can see in the webshop)		

			
1			
<b>GEV No.</b>	560132	<b>Ref. No.</b>	12010194 12010284 Q162030 Q163030
<b>description</b>	hexagonal nut thread M5 H 4mm WS 8 SS DIN/ISO DIN 934 / ISO 4032/8673 Qty 20 pcs		
<b>For models:</b>	ACE-061, ACE-101, ACE-102, ACE-201, ACE-202, ACG-061, ACG-101, ACG-102, ACG-201, ACG-202, AD-120, AD-120B, AD-120BTTDD-UK, AD-120C, AD-120CW, AD-120HY, AD-15, AD-15D, AD-20C-UK, AD-21, AD-21B, AD-21BDD, AD-21C, AD-21D, AD-21DD, AD-21W, AD-45BBT, AD-48, AD-48B, AD-48BDD, AD-48C, AD-48D, AD-48DD, AD-48HY, AD-48W, AD-64, AD-64B, AD-64BBT, AD-64BDD, AD-64BTDD, AD-64C, AD-64CW, AD-64D, AD-64DD, AD-64HY, AD-72, AD-72W, AD-90, AD-90BA, AD-90BBT...(Other models you can see in the webshop)		





 1			
<b>GEV No.</b>	511212	<b>Ref. No.</b>	12010255 Q162040 Q163140000
<b>description</b>	hexagonal nut thread M6 H 5mm WS 10 SS DIN/ISO DIN 934 / ISO 4032/8673 Qty 1 pcs		
<b>For models:</b>	ACE-061, ACE-101, ACE-102, ACE-201, ACE-202, ACG-061, ACG-101, ACG-102, ACG-201, ACG-202, AD-120, AD-120B, AD-120BBTDD-UK, AD-120C, AD-120CW, AD-120HY, AD-15, AD-15D, AD-20C-UK, AD-21, AD-21B, AD-21BDD, AD-21C, AD-21D, AD-21DD, AD-21W, AD-45BBT, AD-48, AD-48B, AD-48BDD, AD-48C, AD-48D, AD-48DD, AD-48HY, AD-48W, AD-64, AD-64B, AD-64BBT, AD-64BDD, AD-64BTDD, AD-64C, AD-64CW, AD-64D, AD-64DD, AD-64HY, AD-72, AD-72W, AD-90, AD-90BA, AD-90BBT...(Other models you can see in the webshop)		

 2			
<b>GEV No.</b>	560134	<b>Ref. No.</b>	12010210 12037260 Q162050 RT11080260
<b>description</b>	hexagonal nut thread M8 H 6.5mm WS 13 SS DIN/ISO DIN 934 / ISO 4032/8673 Qty 20 pcs		
<b>For models:</b>	ACE-061, ACE-101, ACE-102, ACE-201, ACE-202, ACG-061, ACG-101, ACG-102, ACG-201, ACG-202, AD-120, AD-120B, AD-120BBTDD-UK, AD-120C, AD-120CW, AD-120HY, AD-45BBT, AD-48, AD-48B, AD-48BDD, AD-48C, AD-48D, AD-48DD, AD-48HY, AD-48W, AD-64, AD-64B, AD-64BBT, AD-64BDD, AD-64BTDD, AD-64C, AD-64CW, AD-64D, AD-64DD, AD-64HY, AD-72, AD-72W, AD-90, AD-90BA, AD-90BBT, AD-90BDD, AD-90DD, ADE-120, ADE-120B, AE-061, AE-061W, AE-101, AE-101W, AE-102, AE-102W...(Other models you can see in the webshop)		

 1			
<b>GEV No.</b>	505200	<b>Ref. No.</b>	12010027 Q162070
<b>description</b>	nut thread M12x1.75 H 10mm WS 19 SS DIN/ISO DIN 934 / ISO 4032/8673 Qty 1 pcs		
<b>For models:</b>	AD-120, AD-120B, AD-120BBTDD-UK, AD-120C, AD-120CW, AD-120HY, AD-45BBT, AD-48, AD-48B, AD-48BDD, AD-48C, AD-48D, AD-48DD, AD-48HY, AD-48W, AD-64, AD-64B, AD-64BBT, AD-64BDD, AD-64BTDD, AD-64C, AD-64CW, AD-64D, AD-64DD, AD-64HY, AD-72, AD-72W, AD-90, AD-90BA, AD-90BBT, AD-90BDD, AD-90DD, ADE-120, ADE-120B, EASY-500, EASY-500B, EASY-500DD, EASY-500HP, EASY-500HPWBDD, ECO-120, ECO-1200, ECO-120B, ECO-160, ECO-160D, ECO-160I, ECO-200, ECO-200D, ECO-200H, ECO-200HD, ECO-200HI...(Other models you can see in the webshop)		

DIN 985			
 1			
<b>GEV No.</b>	560140	<b>Ref. No.</b>	12009897
<b>description</b>	hexagonal nut thread M4 H 4.8mm SS WS 7 Qty 20 pcs DIN/ISO DIN 985 self-locking		
<b>For models:</b>	AD-64BTDD		

 1			
<b>GEV No.</b>	560142	<b>Ref. No.</b>	12010251 Q222012
<b>description</b>	hexagonal nut thread M6 H 6mm SS WS 10 Qty 20 pcs DIN/ISO DIN 985 self-locking		
<b>For models:</b>	AD-120, AD-120B, AD-120BBTDD-UK, AD-15, AD-15D, AD-20C-UK, AD-21, AD-21B, AD-21BDD, AD-21C, AD-21D, AD-21DD, AD-21W, AD-45BBT, AD-48, AD-48B, AD-48BDD, AD-48C, AD-48D, AD-48DD, AD-48HY, AD-48W, AD-64, AD-64B, AD-64BBT, AD-64BDD, AD-64BTDD, AD-64C, AD-64CW, AD-64D, AD-64DD, AD-64HY, AD-72, AD-72W, AD-90, AD-90BA, AD-90BBT, AD-90BDD, AD-90DD, ADE-120, ADE-120B, EASY-500, EASY-500B, EASY-500DD, EASY-500HP, EASY-500HPWBDD, ECO-120, ECO-120B, ECO-160, ECO-160D...(Other models you can see in the webshop)		

DIN 6923 / ISO 4161			
 1			
<b>GEV No.</b>	542383	<b>Ref. No.</b>	12103867 RT11050121
<b>description</b>	hexagonal nut thread M5 H 6mm zinc-coated steel WS 8 Qty 10 pcs for combi-steamer SCC WE		

DIN 439 / ISO 4035/8675			
 1			
<b>GEV No.</b>	507533	<b>Ref. No.</b>	12009948 Q222016
<b>description</b>	nut thread M20 H 9.5mm SS WS 29.5 Qty 1 pcs DIN/ISO DIN 439		
<b>For models:</b>	AD-120, AD-120B, AD-120BBTDD-UK, AD-90, AD-90BA, AD-90BBT, AD-90BDD, AD-90DD, ADE-120, ADE-120B, ECO-120, ECO-120B, FI-100, FI-100AR, FI-100B, FI-100BBT-UK, FI-120, FI-120AR+DD, FI-120B, FI-120C, FI-120HY-CLINIC, FI-120W, FI-80, FI-80AR, FI-80BBT-UK, FI-80W, FI-E-100, LABP-1000, LABP-1200, LABP-800, MF-120		

hexagonal nuts metric (without norm)			
 1			
<b>GEV No.</b>	530881	<b>Ref. No.</b>	12037870 RT11060220
<b>description</b>	hexagonal nut thread M6 H 3mm WS 10 SS Qty 25 pcs for combi-steamer CPC-Linie		



1

<b>GEV No.</b>	691860	<b>Ref. No.</b>	12037639 Z9530980
<b>description</b>	nut thread M12x0.75 H 3.4mm WS 17 SS Qty 1 pcs		
<b>For models:</b>	GA-20, GA-20D, GA-40, GA-40D		



1

<b>GEV No.</b>	550261	<b>Ref. No.</b>	12016635 X163012 Z600603
<b>description</b>	nut thread M14x1 H 4mm WS 19 SS Qty 1 pcs		
<b>For models:</b>	BG9-05, BG9-05I, BG9-10, BG9-10I, FE-710, FE-720, FE-920, FG-710, FG-720, FG-920, FI-300B, FI-300R, FI-650R, LVC-15, LVC-21, LVR-14, LVR-20, LVR-20B		



1

<b>GEV No.</b>	101345	<b>Ref. No.</b>	12009877 Q223021
<b>description</b>	nut thread M15x1 H 3mm WS 19 brass Qty 1 pcs		
<b>For models:</b>	BME7-05, BME7-10, BME9-05, BME9-05AD, BME9-05PLUS, BME9-05V-T, BME9-10, BME9-10AD, BME9-10PLUS, BME9-10V-T, FG-1-40, FG-2-80, FG7-05-1C, FG7-05-2C, FG-710, FG7-10-2C, FG7-104C, FG7-10-4C, FG-71-15, FG-720, FG-72-30, FG9-05, FG9-05-1C, FG9-05-2C, FG9-05AD, FG9-05PLUS, FG9-05PLUS-S, FG9-05S, FG9-05S-1C, FG9-05S-2C, FG9-05S-AD, FG9-10, FG9-10-2C, FG9-10-4C, FG9-10AD, FG9-10PLUS, FG-91-20, FG-920, FG-92-40, FG-940, FI-300B, FI-300R, FI-650R		



1

<b>GEV No.</b>	691862	<b>Ref. No.</b>	12016713 Q223011
<b>description</b>	nut thread M18x1.5 H 5mm WS 22 SS Qty 1 pcs		
<b>For models:</b>	FI-300B, FI-300R, FI-650R, LVR-10, LVR-14, LVR-20, LVR-20B		



1

<b>GEV No.</b>	691861	<b>Ref. No.</b>	12016617 U060519
<b>description</b>	nut thread M20x1 H 4mm WS 23 brass Qty 1 pcs		



1

<b>GEV No.</b>	507536	<b>Ref. No.</b>	12018993 Q223022
<b>description</b>	nut thread M8x1 H 3mm WS 11 brass Qty 1 pcs		
<b>For models:</b>	CG-210G, CG-310G, CG-7200, CG-7400, CG-7415, CG-7615, CG-HP-20, ECO-1600, ECO-2300, ECO-3000, FE-710, FE-720, FG-1-40, FG-2-80, FG7-05-1C, FG7-05-2C, FG-710, FG7-10-2C, FG7-104C, FG7-10-4C, FG-71-15, FG-720, FG-72-30, FG-91-20, FG-92-40, FI-100, FI-120, FI-120W, FI-1600, FI-160D, FI-160I, FI-200D, FI-200I, FI-2300, FI-280D, FI-280I, FI-3000, FI-370D, FI-370I, FI-460D, FI-460I, FI-48, FI-48B, FI-48W, FI-50, FI-5420, FI-550D, FI-550I, FI-64, FI-64B...(Other models you can see in the webshop)		

## hexagonal nuts inch thread



1

<b>GEV No.</b>	507532	<b>Ref. No.</b>	12009831 Q223014
<b>description</b>	nut thread 1" H 10mm WS 40 brass Qty 1 pcs		
<b>For models:</b>	AD-45BBT, AD-48HY, AD-64BBT, AD-64BTDD, AD-64HY, EA-SY-500HPWBDD, FE-18, FE-25, FE-710, FE-720, FE-91-20, FG-1-40, FG-2-80, FG-710, FG-720, FG-91-20, FG-920, FG-92-40, FG-940, FGCL9-05, FI-30B-BT-UK, FI-48B-BT-UK, FI-48HY-CLINIC, FI-64B-BT-UK, FI-64HY-CLINIC, HCG-10-11, HCG-10-21, HCG-20-11, HCG-20-21, HCG-2-10-11, HCG-2-20-11, HCG-6-11, HEI-10-11, HEI-20-11, HEI-6-11, HEM-10-11, HEM-20-11, HEM-6-11, HEP-10-11, HEP-20-11, HEP-6-11, HGC-10-11, HGC-20-11, HGC-6-11, HGV-10-11, HGV-20-11, HME-10-11, HME-10-21, HME-20-11, HME-20-21...(Other models you can see in the webshop)		



1

<b>GEV No.</b>	521102	<b>Ref. No.</b>	12009843 12040388 Q221302 Q221401
<b>description</b>	nut thread 1/2" H 8mm SS WS 32 Qty 1 pcs		
<b>For models:</b>	BME7-05, BME7-10, BME9-05, BME9-05AD, BME9-05PLUS, BME9-05V-T, BME9-10, BME9-10AD, BME9-10PLUS, BME9-10V-T, BMG7-10, BMG9-05, BMG9-05V-T, BMG9-10, BMG9-10V-T, CE7-41, CE9-41, CGE7-173, CGE7-41, CGE9-41, CPE9-05, CPE9-05S, CPG7-05, CPG9-05, CPG9-05NC, CPG9-05S, CPG9-05SNC, ECO-1200, ECO-1600, ECO-2300, ECO-3000, FI-1200, FI-1600, FI-2300, FI-3000, FI-300B, FI-300R, FI-5420, FI-650R, FI-7630, FI-900, HE9-10, HE9-20, HPG-15, ME7-10BM, ME9-10BM, ME9-10BMS, ME9-15BM, ME9-15BM316, ME9-15BMS...(Other models you can see in the webshop)		





1

<b>GEV No.</b>	521003	<b>Ref. No.</b>	12039941 X012121
<b>description</b>	nut thread 1/4" H 6.3mm chrome-plated brass WS 20 Qty 1 pcs		
<b>For models:</b>	FG-71-15, FG-72-30, FG-91-20, FG-92-40		





			
1			
<b>GEV No.</b>	507535	<b>Ref. No.</b>	12009899 Q221324
<b>description</b>	nut thread 3/4" H 7mm WS 30 SS Qty 1 pcs		
<b>For models:</b>	BG7-05, BG7-05I, BG7-10, BG7-10I, BG9-05, BG9-05I, BG9-05PF, BG9-05PI, BG9-10, BG9-10I, BG9-10PF, BG9-10PI, BMG7-10, BMG-9045, BMG9-05, BMG9-05V-T, BMG9-10, BMG9-10V-T, CE-410, CE9-41, CG-2000-2P, CG9-51L, CG9-51LC, CG9-51R, CG9-51RC, ECO-160, ECO-200, ECO-200H, ECO-2700D, ECO-2700I, ECO-280D, ECO-280I, ECO-370D, ECO-370I, ECO-4000D, ECO-4000I, ECO-460D, ECO-460I, ECO-550D, ECO-550I, ECO-6000D, ECO-6000I, FG-71-15, FG-72-30, FI-160, FI-160AR, FI-160D, FI-160I, FI-200, FI-200AR...(Other models you can see in the webshop)		

			
1			
<b>GEV No.</b>	503042	<b>Ref. No.</b>	12007923 Q223019
<b>description</b>	nut thread 3/8" H 6mm brass WS 22 Qty 1 pcs		
<b>For models:</b>	BG6-05I, BG7-05, BG7-05I, BG7-10, BG7-10I, BG9-05, BG9-05AD, BG9-05I, BG9-05PF, BG9-05PI, BG9-05PLUS-I, BG9-10, BG9-10AD, BG9-10I, BG9-10PF, BG9-10PI, BG9-10PLUS-I, BMG7-10, BMG-9045, BMG9-05, BMG9-05V-T, BMG9-10, BMG9-10V-T, CG-1002, CG-1502, CG-2000, CG-2000-2P, CG-2002, CG-210, CG-210G, CG-310, CG-310G, CG6-41, CG7-10, CG7-11, CG-7115, CG-7200, CG7-31D, CG7-31I, CG-7400, CG7-41, CG-7415, CG7-41H, CG7-51, CG7-61, CG-7615, CG7-61H, CG9-10, CG9-10AD, CG9-10PLUS...(Other models you can see in the webshop)		

			
1			
<b>GEV No.</b>	514196	<b>Ref. No.</b>	12039127 Q222015
<b>description</b>	nut thread 3/8" H 8.5mm WS 22 SS Qty 1 pcs		
<b>For models:</b>	SBE7-10, SBE9-10, SBE9-10I, SBE9-10IM, SBE9-10IMS, SBE9-10IS, SBE9-10M, SBE9-10MS, SBE9-10S, SBE9-10USMC, SBE9-15IM, SBE9-15IMS, SBG7-10, SBG9-10, SBG9-10I, SBG9-10IM, SBG9-10IMS, SBG9-10IS, SBG9-10M, SBG9-10MS, SBG9-10S, SBG9-15IM, SBG9-15IMS		

<h3>hexagonal nuts with PG thread</h3>			
			
1			
<b>GEV No.</b>	550578	<b>Ref. No.</b>	12009764 Q223016
<b>description</b>	nut thread PG21 H 4.6mm WS 32 nickel-plated brass Qty 1 pcs mounting ømm cable ømm		
<b>For models:</b>	ECO-120, ECO-120B, FI-100, FI-100AR, FI-100B, FI-120, FI-120B, FI-120W, FI-30, FI-48, FI-48B, FI-48W, FI-50, FI-64, FI-64B, FI-64W, FI-72, FI-80, FI-80W, LA-13M, LA-18MP, LA-AC-10M, LA-AC-10MA, LA-AC-10MP, LA-AC-13M, LA-AC-13MA, LA-AC-13MP, LA-AC-18M, LA-AC-18MA, LA-AC-18MP, LA-AC-25M, LA-AC-25MA, LA-AC-25MP, LA-E-10M, LA-E-10MA, LA-E-10MP, LA-E-13M, LA-E-13MA, LA-E-13MP, LA-E-18M, LA-E-18MA, LA-E-18MP, LA-E-25M, LA-E-25MA, LA-E-25MP, LA-V-10M, LA-V-10MP, LA-V-13M, LA-V-13MP, LA-V-18M...(Other models you can see in the webshop)		

<h3>washers</h3>			
<h4>spring rings</h4>			
			
1			
<b>GEV No.</b>	560122	<b>Ref. No.</b>	12009924 Q262030
<b>description</b>	lock washer ID ø 5.2mm ED ø 9mm SS DIN127 Qty 20 pcs for thread M5		
<b>For models:</b>	AD-15, AD-15D, AD-20C-UK, AD-21, AD-21B, AD-21BDD, AD-21C, AD-21D, AD-21DD, AD-21W, AD-45BBT, AD-48, AD-48B, AD-48BDD, AD-48C, AD-48D, AD-48DD, AD-48HY, AD-48W, AD-64, AD-64B, AD-64BBT, AD-64BDD, AD-64BTDD, AD-64C, AD-64CW, AD-64D, AD-64DD, AD-64HY, AD-72, AD-72W, AD-90, AD-90DD, ADE-120, ADE-120B, BG9-05AD, BG9-05PLUS-I, BG9-10AD, BG9-10PLUS-I, BME9-05, BME9-05AD, BME9-05PLUS, BME9-05V-T, BME9-10, BME9-10AD, BME9-10PLUS, BME9-10V-T, BMG7-10, BMG9-05, BMG9-05V-T...(Other models you can see in the webshop)		

			
1			
<b>GEV No.</b>	560123	<b>Ref. No.</b>	12009872 Q262040
<b>description</b>	lock washer ID ø 6.3mm ED ø 11mm SS DIN127 Qty 20 pcs for thread M6		
<b>For models:</b>	ACE-061, ACE-101, ACE-102, ACE-201, ACE-202, AD-120, AD-120B, AD-120BBTDD-UK, AD-120C, AD-120CW, AD-120HY, AD-15, AD-15D, AD-20C-UK, AD-21, AD-21B, AD-21BDD, AD-21C, AD-21D, AD-21DD, AD-21W, AD-45BBT, AD-48, AD-48B, AD-48BDD, AD-48C, AD-48D, AD-48DD, AD-48HY, AD-48W, AD-64, AD-64B, AD-64BBT, AD-64BDD, AD-64BTDD, AD-64C, AD-64CW, AD-64D, AD-64DD, AD-64HY, AD-72, AD-72W, AD-90, AD-90BA, AD-90BBT, AD-90BDD, AD-90DD, ADE-120, ADE-120B, AE-061...(Other models you can see in the webshop)		

			
1			
<b>GEV No.</b>	560124	<b>Ref. No.</b>	12010272 12037421 Q262050 RT12080260
<b>description</b>	lock washer ID ø 8.3mm ED ø 15mm SS DIN127 Qty 20 pcs for thread M8		
<b>For models:</b>	AD-120, AD-120B, AD-120BBTDD-UK, AD-120C, AD-120CW, AD-120HY, AD-90, AD-90BA, AD-90BBT, AD-90BDD, AD-90DD, ADE-120, ADE-120B, CE7-20Q, CE7-40Q, CE7-41Q, CE9-20, CE9-20AD, CE9-20PLUS, CE9-40, CE9-40AD, CE9-40PLUS, CE9-41, CE9-41AD, CE9-41PLUS, CGB7-61H, CGB7-61R, CGB7-61RH, ECO-120, ECO-120B, ECO-160, ECO-1600, ECO-160D, ECO-160I, ECO-200, ECO-200D, ECO-200H, ECO-200HD, ECO-200HI, ECO-200I, ECO-2300, ECO-2700D, ECO-2700I, ECO-280D, ECO-280I, ECO-3000, ECO-370D, ECO-370I, ECO-4000D, ECO-4000I...(Other models you can see in the webshop)		

## spring washers



<b>GEV No.</b>	560056	<b>Ref. No.</b>	12010233 Q301035
<b>description</b>	clamping washer nominal- $\phi$ 4mm ED $\phi$ 10mm spring steel		
<b>For models:</b>	HEI-10-11, HEI-6-11, HEM-10-11, HEM-6-11, HEP-10-11, HEP-6-11, HME-10-11, HME-10-21, HME-20-11, HME-20-21, HME-2-10-11, HME-2-20-11, HME-6-11, HMG-10-11, HMG-10-11UL, HMG-10-21, HMG-10-21UL, HMG-20-11, HMG-2-10-11, HMG-6-11, HMI-10-11, HMI-10-11UL, HMI-10-21, HMI-10-21UL, HMI-2-10-11, HMI-6-11, HMI-6-11UL, HMM-10-11, HMM-10-11UL, HMM-10-21, HMM-10-21UL, HMM-20-11, HMM-20-11UL, HMM-20-21, HMM-2-10-11, HMM-2-20-11, HMM-40-11-USMC, HMM-6-11, HMM-6-11UL, HMP-10-11, HMP-10-21, HMP-20-11, HMP-20-21, HMP-2-10-11, HMP-2-20-11, HMP-6-11, MFHMM-20-11		



<b>GEV No.</b>	560630	<b>Ref. No.</b>	12037727 RT11070100
<b>description</b>	clamping washer nominal- $\phi$ 4mm ED $\phi$ 11.5mm SS thickness 0.2mm		

## washers

## DIN 125A



<b>GEV No.</b>	560312	<b>Ref. No.</b>	12010235 Q232060
<b>description</b>	plain washer ID $\phi$ 10.5mm ED $\phi$ 20mm thickness 2mm SS Qty 1 pcs DIN 125A for thread M10		
<b>For models:</b>	CG-1002, CG-1502, CG-2000, CG-2000-2P, CG-2002, CG-2002P, ECO-280D, ECO-280I, ECO-370D, ECO-370I, ECO-460D, ECO-460I, ECO-550D, ECO-550I, FI-280D, FI-280I, FI-300B, FI-300R, FI-370D, FI-370I, FI-460D, FI-460I, FI-550D, FI-550I, FI-650R, FTEC9-05USMC, FTEC9-10USMC, HCG-10-11, HCG-10-21, HCG-20-11, HCG-20-21, HCG-2-10-11, HCG-6-11, HCV-10-11, HCV-10-21, HCV-2-10-21, HCV-5-11, HCV-6-11, HE-10-11, HE-10-21, HE-2-10-11, HE-5-11, HE-6-11, HG-10-11, HG-10-21, HG-2-10-11, HME-10-11, HME-10-21, HME-20-11, HME-20-21...(Other models you can see in the webshop)		



<b>GEV No.</b>	560111	<b>Ref. No.</b>	12009987 Q232020
<b>description</b>	plain washer ID $\phi$ 4.3mm ED $\phi$ 9mm thickness 0.8mm SS Qty 20 pcs DIN 125A for thread M4		
<b>For models:</b>	ACE-061, ACE-101, ACE-102, ACE-201, ACE-202, ACG-061, ACG-101, ACG-102, ACG-201, ACG-202, AD-120, AD-120B, AD-120BTTDD-UK, AD-120C, AD-120CW, AD-120HY, AD-15, AD-15D, AD-21, AD-21B, AD-21BDD, AD-21C, AD-21D, AD-21DD, AD-21W, AD-48, AD-48B, AD-48C, AD-48D, AD-48DD, AD-64, AD-64B, AD-64BTTDD, AD-64C, AD-64D, AD-64DD, AD-72, AD-90, AD-90BA, AD-90BBT, AD-90BDD, AD-90DD, ADE-120, ADE-120B, AE-061, AE-061W, AE-101, AE-101W, AE-102, AE-102W...(Other models you can see in the webshop)		



<b>GEV No.</b>	560112	<b>Ref. No.</b>	12009944 Q232030
<b>description</b>	plain washer ID $\phi$ 5.3mm ED $\phi$ 10mm thickness 1mm SS Qty 20 pcs DIN 125A for thread M5		
<b>For models:</b>	ACE-061, ACE-101, ACE-102, ACE-201, ACE-202, ACG-061, ACG-101, ACG-102, ACG-201, ACG-202, AD-120, AD-120B, AD-120BTTDD-UK, AD-120C, AD-120CW, AD-120HY, AD-15, AD-15D, AD-20C-UK, AD-21, AD-21B, AD-21BDD, AD-21C, AD-21D, AD-21DD, AD-21W, AD-45BBT, AD-48, AD-48B, AD-48BDD, AD-48C, AD-48D, AD-48DD, AD-48HY, AD-48W, AD-64, AD-64B, AD-64BBT, AD-64BDD, AD-64BTTDD, AD-64C, AD-64CW, AD-64D, AD-64DD, AD-64HY, AD-72, AD-72W, AD-90, AD-90BA, AD-90BBT...(Other models you can see in the webshop)		



<b>GEV No.</b>	560113	<b>Ref. No.</b>	12009868 12038251 Q232040 RT13060120
<b>description</b>	plain washer ID $\phi$ 6.4mm ED $\phi$ 12mm thickness 1.6mm SS Qty 20 pcs DIN 125A for thread M6		
<b>For models:</b>	ACE-061, ACE-101, ACE-102, ACE-201, ACE-202, ACG-061, ACG-101, ACG-102, ACG-201, ACG-202, AD-120, AD-120B, AD-120BTTDD-UK, AD-120C, AD-120CW, AD-120HY, AD-15, AD-15D, AD-20C-UK, AD-21, AD-21B, AD-21BDD, AD-21C, AD-21D, AD-21DD, AD-21W, AD-45BBT, AD-48, AD-48B, AD-48BDD, AD-48C, AD-48D, AD-48DD, AD-48HY, AD-48W, AD-64, AD-64B, AD-64BBT, AD-64BDD, AD-64BTTDD, AD-64C, AD-64CW, AD-64D, AD-64DD, AD-64HY, AD-72, AD-72W, AD-90, AD-90BA, AD-90BBT...(Other models you can see in the webshop)		





<b>GEV No.</b>	560114	<b>Ref. No.</b>	12010268 12037409 Q232050 RT13080160
<b>description</b>	plain washer ID $\phi$ 8.4mm ED $\phi$ 16mm thickness 1.6mm SS Qty 20 pcs DIN 125A for thread M8		
<b>For models:</b>	AD-120, AD-120B, AD-120BTTDD-UK, AD-120C, AD-120CW, AD-120HY, AD-90, AD-90BA, AD-90BBT, AD-90BDD, AD-90DD, ADE-120, ADE-120B, CE7-20Q, CE7-40Q, CE7-41Q, CE9-20, CE9-20AD, CE9-20PLUS, CE9-40, CE9-40AD, CE9-40PLUS, CE9-41, CE9-41AD, CE9-41PLUS, CG7-51, CG7-61, CG7-61H, CGB7-61, CGP9-11, CPE7-05, CPE7-05NC, CPE9-05, CPE9-05AD, CPE9-05AD-S, CPE9-05NC, CPE9-05PLUS, CPE9-05PLUS-S, CPE9-05S, CPE9-05SNC, CPG7-05, CPG7-05NC, CPG9-05, CPG9-05AD, CPG9-05AD-S, CPG9-05NC, CPG9-05PLUS, CPG9-05PLUS-S, CPG9-05S, CPG9-05SNC...(Other models you can see in the webshop)		







DIN 9021			
			
1			
<b>GEV No.</b>	560117	<b>Ref. No.</b>	12010267 Q302022
<b>description</b>	plain washer ID ø 6.4mm ED ø 18mm thickness 1.5mm SS Qty 20 pcs DIN 9021 for thread M6		
<b>For models:</b>	ACE-061, ACE-101, ACE-102, ACE-201, ACE-202, ACG-061, ACG-101, ACG-102, ACG-201, ACG-202, AD-120, AD-120B, AD-120BTTDD-UK, AD-120C, AD-120CW, AD-120HY, AD-15, AD-15D, AD-20C-UK, AD-21, AD-21B, AD-21BDD, AD-21C, AD-21D, AD-21DD, AD-21W, AD-45BBT, AD-48, AD-48B, AD-48BDD, AD-48C, AD-48D, AD-48DD, AD-48HY, AD-48W, AD-64, AD-64B, AD-64BBT, AD-64BDD, AD-64BTDD, AD-64C, AD-64CW, AD-64D, AD-64DD, AD-64HY, AD-72, AD-72W, AD-90, AD-90BA, AD-90BBT...(Other models you can see in the webshop)		

			
1			
<b>GEV No.</b>	560580	<b>Ref. No.</b>	12036873 RT13060222
<b>description</b>	plain washer ID ø 6.4mm ED ø 15mm thickness 1.5mm Qty 10 pcs		

			
1			
<b>GEV No.</b>	506160	<b>Ref. No.</b>	Q231450000
<b>description</b>	plain washer ID ø 8.6mm ED ø 16mm thickness 1.5mm SS Qty 1 pcs		

miscellaneous			
			
1			
<b>GEV No.</b>	529239	<b>Ref. No.</b>	12016722 T075021
<b>description</b>	flat washer ID ø 11mm ED ø 32mm thickness 0.8mm brass Qty 1 pcs		
<b>For models:</b>	HCG-6-11, HMG-6-11		

			
1			
<b>GEV No.</b>	560313	<b>Ref. No.</b>	12035156 RT13280102
<b>description</b>	serrated locking washer ID ø 10mm ED ø 22mm thickness 1.5mm SS Qty 1 pcs for thread M10		

tooth lock washers  
DIN 6798A

			
1			
<b>GEV No.</b>	529238	<b>Ref. No.</b>	12016739 R725065
<b>description</b>	flat washer ID ø 18mm ED ø 32mm thickness 1.2mm brass Qty 1 pcs		
<b>For models:</b>	HCG-10-11, HMG-10-11		

			
1			
<b>GEV No.</b>	560036	<b>Ref. No.</b>	12009953 Q242010
<b>description</b>	tooth lock washer ID ø 3.1mm ED ø 5.7mm SS Qty 10 pcs		
<b>For models:</b>	AD-120, AD-120B, AD-120BTTDD-UK, AD-120C, AD-120CW, AD-120HY, AD-15, AD-15D, AD-20C-UK, AD-21, AD-21B, AD-21BDD, AD-21C, AD-21D, AD-21DD, AD-21W, AD-45BBT, AD-48, AD-48B, AD-48BDD, AD-48C, AD-48D, AD-48DD, AD-48HY, AD-48W, AD-64, AD-64B, AD-64BBT, AD-64BDD, AD-64BTDD, AD-64C, AD-64CW, AD-64D, AD-64DD, AD-64HY, AD-72, AD-72W, AD-90, AD-90BA, AD-90BBT, AD-90BDD, AD-90DD, ADE-120, ADE-120B, CE-15, CE-9, EASY-500, EASY-500B, EASY-500DD, EASY-500HP...(Other models you can see in the webshop)		

			
1			
<b>GEV No.</b>	529242	<b>Ref. No.</b>	12039798 R725034
<b>description</b>	plain washer ID ø 10mm ED ø 16mm thickness 2mm brass Qty 1 pcs		
<b>For models:</b>	HMG-10-11, HMG-10-11UL, HMG-10-21, HMG-10-21UL, HMG-2-10-11, HMG-6-11		

			
1			
<b>GEV No.</b>	560125	<b>Ref. No.</b>	12009928 Q242020
<b>description</b>	tooth lock washer ID ø 4.2mm ED ø 8mm SS DIN/ISO DIN 6798A Qty 20 pcs for thread M4		
<b>For models:</b>	ACE-061, ACE-101, ACE-102, ACE-201, ACE-202, ACG-061, ACG-101, ACG-102, ACG-201, ACG-202, AD-120, AD-120B, AD-120BTTDD-UK, AD-120C, AD-120CW, AD-120HY, AD-15, AD-15D, AD-20C-UK, AD-21, AD-21B, AD-21BDD, AD-21C, AD-21D, AD-21DD, AD-21W, AD-45BBT, AD-48, AD-48B, AD-48BDD, AD-48C, AD-48D, AD-48DD, AD-48HY, AD-48W, AD-64, AD-64B, AD-64BBT, AD-64BDD, AD-64BTDD, AD-64C, AD-64CW, AD-64D, AD-64DD, AD-64HY, AD-72, AD-72W, AD-90, AD-90BA, AD-90BBT, AD-90BDD...(Other models you can see in the webshop)		

			
1			
<b>GEV No.</b>	529237	<b>Ref. No.</b>	12016723 R735011
<b>description</b>	plain washer ID ø 21mm ED ø 32mm thickness 1.2mm brass Qty 1 pcs		
<b>For models:</b>	HCG-10-21, HCG-2-10-11, HMG-10-21, HMG-2-10-11		

<b>GEV No.</b>	560125	<b>Ref. No.</b>	12009928 Q242020
<b>description</b>	tooth lock washer ID ø 4.2mm ED ø 8mm SS DIN/ISO DIN 6798A Qty 20 pcs for thread M4		
<b>For models:</b>	ACE-061, ACE-101, ACE-102, ACE-201, ACE-202, ACG-061, ACG-101, ACG-102, ACG-201, ACG-202, AD-120, AD-120B, AD-120BTTDD-UK, AD-120C, AD-120CW, AD-120HY, AD-15, AD-15D, AD-20C-UK, AD-21, AD-21B, AD-21BDD, AD-21C, AD-21D, AD-21DD, AD-21W, AD-45BBT, AD-48, AD-48B, AD-48BDD, AD-48C, AD-48D, AD-48DD, AD-48HY, AD-48W, AD-64, AD-64B, AD-64BBT, AD-64BDD, AD-64BTDD, AD-64C, AD-64CW, AD-64D, AD-64DD, AD-64HY, AD-72, AD-72W, AD-90, AD-90BA, AD-90BBT, AD-90BDD...(Other models you can see in the webshop)		

			
1			
<b>GEV No.</b>	560126	<b>Ref. No.</b>	12009890 Q242030
<b>description</b>	tooth lock washer ID ø 5.2mm ED ø 10mm SS DIN/ISO DIN 6798A Qty 20 pcs for thread M5		
<b>For models:</b>	ACE-061, ACE-101, ACE-102, ACE-201, ACE-202, ACG-061, ACG-101, ACG-102, ACG-201, ACG-202, AD-120, AD-120B, AD-120BBTDD-UK, AD-120C, AD-120CW, AD-120HY, AD-15, AD-15D, AD-20C-UK, AD-21, AD-21B, AD-21BDD, AD-21C, AD-21D, AD-21DD, AD-21W, AD-45BBT, AD-48, AD-48B, AD-48BDD, AD-48C, AD-48D, AD-48DD, AD-48HY, AD-48W, AD-64, AD-64B, AD-64BBT, AD-64BDD, AD-64C, AD-64CW, AD-64D, AD-64DD, AD-64HY, AD-72, AD-72W, AD-90, AD-90BA, AD-90BBT, AD-90BDD...(Other models you can see in the webshop)		

			
1			
<b>GEV No.</b>	560342	<b>Ref. No.</b>	12009882 Q242040
<b>description</b>	tooth lock washer ID ø 6.5mm ED ø 11mm SS Qty 1 pcs for thread M6		
<b>For models:</b>	ACE-061, ACE-101, ACE-102, ACE-201, ACE-202, ACG-061, ACG-101, ACG-102, ACG-201, ACG-202, AD-120, AD-120B, AD-120BBTDD-UK, AD-120C, AD-120CW, AD-120HY, AD-64BTDD, AD-90, AD-90BA, AD-90BBT, AD-90BDD, AD-90DD, ADE-120, ADE-120B, AE-061, AE-061W, AE-101, AE-101W, AE-102, AE-102W, AE-201, AE-202, AG-061, AG-061W, AG-101, AG-101W, AG-102, AG-102W, AG-201, AG-202, APE-061, APE-061W, APE-101, APE-101W, APE-102, APE-102W, APE-201, APE-202, APG-061, APG-061W...(Other models you can see in the webshop)		

<b>fasteners</b>			
<b>mounting spigots</b>			
			
1			
<b>GEV No.</b>	524031	<b>Ref. No.</b>	12008693 X012612
<b>description</b>	spigot nominal-ø 7mm thread M5 L 38mm		
<b>For models:</b>	BME6-05, BMG7-10, CE6-20, CE6-40, CE6-41, CG-310, CG-310G, CG6-20, CG6-40, CG6-41, CG-7615, CGE6-41, CMF6-05, CPE6-05, CV6-20, CV6-40, EN6-05, EN6-10, FE6-05, FE6-10, FE-71-15, FE-91-20, FG6-05, FG6-10, FG-71-15, FG-72-30, FG-91-20, FG-92-40, HE9-10, HE9-20, HG9-10, HG9-15, HG9-20, LA-13M, LA-18MP, LA-25M, LA-AC-10M, LA-AC-10MA, LA-AC-10MP, LA-AC-13M, LA-AC-13MA, LA-AC-13MP, LA-AC-18M, LA-AC-18MA, LA-AC-18MP, LA-AC-25M, LA-AC-25MA, LA-AC-25MP, LA-E-10M, LA-E-10MA...(Other models you can see in the webshop)		

<b>slot nuts</b>			
			
1			
<b>GEV No.</b>	560286	<b>Ref. No.</b>	12023513 Z105014
<b>description</b>	slot nut W 6mm H 6mm L 25mm		
<b>For models:</b>	ECO-160, ECO-1600, ECO-160D, ECO-160I, ECO-200, ECO-200D, ECO-200H, ECO-200HD, ECO-200HI, ECO-200I, ECO-2300, ECO-2700D, ECO-2700I, ECO-280D, ECO-280I, ECO-3000, ECO-370D, ECO-370I, ECO-4000D, ECO-4000I, ECO-460D, ECO-460I, ECO-550D, ECO-550I, ECO-6000D, ECO-6000I, FI-160, FI-1600, FI-160AR, FI-160D, FI-160I, FI-200, FI-200AR, FI-200D, FI-200H, FI-200HD, FI-200HI, FI-200I, FI-200W, FI-200WL, FI-200WR, FI-2300, FI-2700D, FI-2700I, FI-2700I, FI-280D, FI-280I, FI-3000, FI-370D, FI-370I, FI-4000D...(Other models you can see in the webshop)		

<b>clamps</b>			
<b>hose clamps</b>			
<b>DIN 3017 - W2</b>			
			
1			
<b>GEV No.</b>	520111	<b>Ref. No.</b>	12035874 RT20660205
<b>description</b>	hose clamp ø 10-16mm width 9mm Qty 10 pcs DIN 3017		

			
1			
<b>GEV No.</b>	520114	<b>Ref. No.</b>	12010023 12035505 Q881304 RT20660506
<b>description</b>	hose clamp ø 20-32mm width 9mm Qty 10 pcs DIN 3017		
<b>For models:</b>	AD-120B, AD-120BBTDD-UK, AD-120C, AD-120HY, AD-125, AD-125HRS, AD-125-SOFT, AD-505, AD-505-SOFT, AD-90BA, AD-90BBT, AD-90BDD, ADE-120B, APE-061, APE-061W, APE-101, APE-101W, APE-102, APE-102W, APE-201, APE-202, APG-061, APG-061W, APG-101, APG-101W, APG-102, APG-102W, APG-201, APG-202, BME9-05, BME9-10, BMG9-10, CO-110B, CO-110BDD, CO-112B, CO-112BDD, CO-170B, CO-170BDD, CO-172B, CO-172BDD, CO-500B, CO-500BDD, CO-501B, CO-501BDD, CO-502B, CO-502BDD, CO-502W, COP-173, COP-173B, COP-173BDD...(Other models you can see in the webshop)		



 <p>1</p>			
<b>GEV No.</b>	520115	<b>Ref. No.</b>	12009997 Q881305
<b>description</b>	hose clamp ø 25-40mm width 9mm Qty 10 pcs DIN 3017		
<b>For models:</b>	AD-45BBT, AD-48, AD-48B, AD-48BDD, AD-48C, AD-48D, AD-48DD, AD-48HY, AD-48W, AD-505, AD-64, AD-64B, AD-64BBT, AD-64BDD, AD-64BTDD, AD-64C, AD-64CW, AD-64D, AD-64DD, AD-64HY, AD-72, AD-72W, AE-201, AE-202, AG-061, AG-061W, AG-101, AG-101W, AG-102, AG-102W, AG-201, AG-202, APE-061, APE-061W, APE-101, APE-101W, APE-102, APE-102W, APE-201, APE-202, APG-061, APG-061W, APG-101, APG-101W, APG-102, APG-102W, APG-201, APG-202, BME7-05, BME7-10...(Other models you can see in the webshop)		

 <p>1</p>			
<b>GEV No.</b>	520110	<b>Ref. No.</b>	12010047 12037543 GH51X003 Q881308
<b>description</b>	hose clamp ø 8-12mm width 9mm Qty 10 pcs DIN 3017		
<b>For models:</b>	AD-120, AD-120B, AD-120BBTDD-UK, AD-120C, AD-120CW, AD-120HY, AD-15, AD-15D, AD-20C-UK, AD-21, AD-21B, AD-21BDD, AD-21C, AD-21D, AD-21DD, AD-21W, AD-48, AD-48B, AD-48BDD, AD-48C, AD-48D, AD-48DD, AD-48W, AD-64, AD-64B, AD-64BDD, AD-64C, AD-64CW, AD-64D, AD-64DD, AD-72, AD-72W, AD-90, AD-90BA, AD-90BBT, AD-90BDD, AD-90DD, ADE-120, ADE-120B, CO-110, CO-110B, CO-110BDD, CO-110DD, CO-112, CO-112B, CO-112BDD, CO-112DD, CO-142W, CO-142WDD, CO-170...(Other models you can see in the webshop)		

 <p>2</p>			
<b>GEV No.</b>	520118	<b>Ref. No.</b>	12009933 12036496 Q881324 RT20660300
<b>description</b>	hose clamp ø 50-70mm width 9mm Qty 5 pcs DIN 3017		
<b>For models:</b>	AD-45BBT, AD-48, AD-48B, AD-48BDD, AD-48C, AD-48D, AD-48DD, AD-48HY, AD-48W, AD-505, AD-505-SOFT, AD-64, AD-64B, AD-64BBT, AD-64BDD, AD-64BTDD, AD-64C, AD-64CW, AD-64D, AD-64DD, AD-64HY, AD-72, AD-72W, CO-500, CO-500B, CO-500BDD, CO-500DD, CO-501, CO-501B, CO-501BDD, CO-501DD, CO-501-SOFT, CO-502B, CO-502BDD, CO-502DD, CO-502W, COP-503, COP-503B, COP-503BDD, COP-503DD, COP-503-SOFT, COP-504, COP-504B, COP-504BDD, COP-504DD, COP-504W, EASY-500, EASY-500B, EASY-500DD, EASY-500HP...(Other models you can see in the webshop)		

 <p>1</p>			
<b>GEV No.</b>	520117	<b>Ref. No.</b>	12009962 12035446 Q881306000 Q881307 RT20660504
<b>description</b>	hose clamp stainless steel ø 40-60mm width 9mm Qty 5 pcs DIN 3017		
<b>For models:</b>	ACE-061, ACE-101, ACE-102, ACE-201, ACE-202, ACG-061, ACG-101, ACG-102, ACG-201, ACG-202, AD-120, AD-120B, AD-120BBTDD-UK, AD-120C, AD-120CW, AD-120HY, AD-125, AD-125HRS, AD-125-SOFT, AD-15, AD-15D, AD-20C-UK, AD-21, AD-21B, AD-21BDD, AD-21C, AD-21D, AD-21DD, AD-21W, AD-45BBT, AD-48, AD-48B, AD-48BDD, AD-48C, AD-48D, AD-48DD, AD-48HY, AD-48W, AD-505, AD-505-SOFT, AD-64, AD-64B, AD-64BBT, AD-64BDD, AD-64BTDD, AD-64C, AD-64CW, AD-64D, AD-64DD, AD-64HY...(Other models you can see in the webshop)		

 <p>1</p>			
<b>GEV No.</b>	520119	<b>Ref. No.</b>	12036081 RT20660516
<b>description</b>	hose clamp ø 60-80mm width 9mm Qty 5 pcs DIN 3017		

<p>DIN 3017 - W4</p>  <p>1</p>			
<b>GEV No.</b>	520120	<b>Ref. No.</b>	12010036 Q881302
<b>description</b>	hose clamp SS W4 ø 12-20mm width 9mm Qty 1 pcs DIN 3017		
<b>For models:</b>	ACE-061, ACE-101, ACE-102, ACE-201, ACE-202, ACG-061, ACG-101, ACG-102, ACG-201, ACG-202, AD-120, AD-120B, AD-120BBTDD-UK, AD-120C, AD-120CW, AD-120HY, AD-125, AD-125HRS, AD-125-SOFT, AD-15, AD-15D, AD-20C-UK, AD-21, AD-21B, AD-21BDD, AD-21C, AD-21D, AD-21DD, AD-21W, AD-45BBT, AD-48, AD-48B, AD-48BDD, AD-48C, AD-48D, AD-48DD, AD-48HY, AD-48W, AD-505, AD-505-SOFT, AD-64, AD-64B, AD-64BBT, AD-64BDD, AD-64BTDD, AD-64C, AD-64CW, AD-64D, AD-64DD, AD-64HY...(Other models you can see in the webshop)		

 <p>1</p>			
<b>GEV No.</b>	520454	<b>Ref. No.</b>	12009914 12036146 Q881326 RT20660505
<b>description</b>	hose clamp ø 70-90mm width 9mm Qty 5 pcs DIN 3017		
<b>For models:</b>	ACE-202, ACG-202, AE-202, AG-202, APE-202, APG-202, COE-202, ECO-2700D, ECO-2700I, ECO-280D, ECO-280I, ECO-370D, ECO-370I, ECO-4000D, ECO-4000I, ECO-460D, ECO-460I, ECO-550D, ECO-550I, ECO-6000D, ECO-6000I, FI-2700D, FI-2700I, FI-280D, FI-280I, FI-370D, FI-370I, FI-4000D, FI-4000I, FI-460D, FI-460I, FI-550D, FI-550I, FI-6000D, FI-6000I, HMG-10-21-STACKING, LA-13M, LA-18MP, LA-25M, LAC-25, LAC-25MP, LAC-25MPP, LAC-55, LAC-55MP, LAC-55MPP, LB-AC-10M, LB-E-10M, LB-V-10M, LC-10, LC-14...(Other models you can see in the webshop)		

## double wire clamps



1

<b>GEV No.</b>	511658	<b>Ref. No.</b>	12035823 RT20660533
<b>description</b>	hose clamp ø 10mm wire gauge ø 1.3mm steel Qty 5 pcs		



1

<b>GEV No.</b>	520916	<b>Ref. No.</b>	12036614 RT20660518
<b>description</b>	hose clamp ø 30mm wire gauge ø 2.7mm chrome-plated steel Qty 1 pcs		



1

<b>GEV No.</b>	560570	<b>Ref. No.</b>	12036450 RT20660519
<b>description</b>	hose clamp ø 35.6mm wire gauge ø 3mm Qty 1 pcs		



1

<b>GEV No.</b>	505190	<b>Ref. No.</b>	12009972 Q901307
<b>description</b>	hose clamp ø 36-42mm wire gauge ø 3mm zinc-coated steel Qty 1 pcs		
<b>For models:</b>	AD-15, AD-15D, AD-20C-UK, AD-21, AD-21B, AD-21BDD, AD-21C, AD-21D, AD-21DD, AD-21W, ECO-1200, FI-1200, FI-900, HEI-10-21, HEM-10-21, HGC-10-21, HGC-20-21, HGV-10-21, LVC-12, LVC-15, LVC-15D, LVC-21, LVC-21B, LVC-21C, LVC-21D, LVC-21W, LVR-10, LVR-14, LVR-14D, LVR-20, LVR-20B, LVR-20D, MF-21		



1

<b>GEV No.</b>	505191	<b>Ref. No.</b>	12007966 Q901308
<b>description</b>	hose clamp ø 52-59mm wire gauge ø 3.5mm Qty 1 pcs		
<b>For models:</b>	AD-45BBT, AD-48, AD-48B, AD-48BDD, AD-48C, AD-48D, AD-48DD, AD-48HY, AD-48W, AD-64, AD-64B, AD-64BBT, AD-64BDD, AD-64BTDD, AD-64C, AD-64CW, AD-64D, AD-64DD, AD-64HY, AD-72, AD-72W, EASY-500, EASY-500B, EASY-500DD, EASY-500HP, FI-30, FI-30AR, FI-30AR+DD, FI-30B, FI-30B-BT-UK, FI-30-UK, FI-48, FI-48AR, FI-48B, FI-48B-BT-UK, FI-48C, FI-48D, FI-48HY-CLINIC, FI-48W, FI-50, FI-60DD, FI-64, FI-64AR, FI-64B, FI-64B-BT-UK, FI-64C, FI-64D, FI-64HY-CLINIC, FI-64W, FI-72...(Other models you can see in the webshop)		



1

<b>GEV No.</b>	505351	<b>Ref. No.</b>	12036929 RT20660527
<b>description</b>	wire clamp ø 11.6-12.2mm wire gauge ø 1.5mm zinc-coated steel Qty 100 pcs		



1

<b>GEV No.</b>	505358	<b>Ref. No.</b>	12036811 RT20660530
<b>description</b>	wire clamp ø 14.4-15.1mm wire gauge ø 1.8mm zinc-coated steel Qty 50 pcs		

## double wire clamps with screw



1

<b>GEV No.</b>	505079	<b>Ref. No.</b>	12025195 Z400903
<b>description</b>	hose clamp ø 186-172mm Qty 1 pcs		
<b>For models:</b>	AD-15, AD-15D, AD-20C-UK, AD-21, AD-21B, AD-21BDD, AD-21C, AD-21D, AD-21DD, AD-21W, CO-350, CO-350-B, CO-350-B-DD, CO-350-COLD, CO-350-COLD-B, CO-350-COLD-B-DD, CO-350-COLD-DD, CO-350-DD, CO-352-COLD, CO-352-COLD-B, CO-352-COLD-B-DD, CO-352-COLD-DD, CO-400, CO-400-B, CO-400-B-DD, CO-400-COLD, CO-400-COLD-B, CO-400-COLD-B-DD, CO-400-COLD-DD, CO-400-DD, CO-400-SOFT, CO-402-COLD, CO-402-COLD-B, CO-402-COLD-B-DD, CO-402-COLD-DD, CO-402W, LVC-12, LVC-15, LVC-15D, LVC-21, LVC-21B, LVC-21C, LVC-21D, LVC-21W, LVR-10, LVR-14, LVR-14D, LVR-20, LVR-20B, LVR-20D...(Other models you can see in the webshop)		





1

<b>GEV No.</b>	505080	<b>Ref. No.</b>	12023841 Z200908
<b>description</b>	hose clamp ø 235-215mm Qty 1 pcs		
<b>For models:</b>	AD-45BBT, AD-48, AD-48B, AD-48BDD, AD-48C, AD-48D, AD-48DD, AD-48HY, AD-48W, AD-64, AD-64B, AD-64BBT, AD-64BDD, AD-64BTDD, AD-64C, AD-64CW, AD-64D, AD-64DD, AD-64HY, AD-72, AD-72W, EASY-500, EASY-500B, EASY-500DD, EASY-500HP, FI-30, FI-30AR, FI-30AR+DD, FI-30B, FI-30B-BT-UK, FI-30-UK, FI-48, FI-48AR, FI-48B, FI-48B-BT-UK, FI-48C, FI-48D, FI-48HY-CLINIC, FI-48W, FI-50, FI-60DD, FI-64, FI-64AR, FI-64B, FI-64B-BT-UK, FI-64C, FI-64D, FI-64HY-CLINIC, FI-64W, FI-72...(Other models you can see in the webshop)		



retaining rings			
DIN 471			
			
<b>GEV No.</b>	514030	<b>Ref. No.</b>	12010212 Q301020
<b>description</b>	retaining ring shaft ø 20mm thickness 1.3mm steel DIN 471		
<b>For models:</b>	SBE7-10, SBE9-10, SBE9-10I, SBE9-10I-AD, SBE9-10I-AD-S, SBE9-10IM, SBE9-10IM-AD, SBE9-10IM-AD-S, SBE9-10IMS, SBE9-10IS, SBE9-10M, SBE9-10MS, SBE9-10PLUS-I, SBE9-10PLUS-IM, SBE9-10PLUS-SI, SBE9-10PLUS-SIM, SBE9-10S, SBE9-10USMC, SBE9-15IM, SBE9-15IM-AD, SBE9-15IM-AD-S, SBE9-15IMS, SBE9-15PLUS-IM, SBE9-15PLUS-SIM, SBE9-15IM-AD-S, SBE9-15IMS, SBE9-15PLUS-IM, SBE9-15PLUS-SIM, SBG7-10, SBG-9040, SBG9-10, SBG9-10I, SBG9-10I-AD, SBG9-10I-AD-S, SBG9-10IM, SBG9-10IM-AD, SBG9-10IM-AD-S, SBG9-10IMS, SBG9-10IS, SBG9-10M, SBG9-10MS, SBG9-10PLUS-I, SBG9-10PLUS-IM, SBG9-10PLUS-SI, SBG9-10PLUS-SIM, SBG9-10S, SBG9-15IM, SBG9-15IM-AD, SBG9-15IM-AD-S, SBG9-15IMS, SBG9-15PLUS-IM, SBG9-15PLUS-SIM		

			
<b>GEV No.</b>	523079	<b>Ref. No.</b>	12010155 Q302061000
<b>description</b>	retaining ring shaft ø 6mm thickness 0.7mm steel DIN 471 Qty 10 pcs		
<b>For models:</b>	LA-13M, LA-18MP, LA-25M, LA-AC-10M, LA-AC-10MA, LA-AC-10MP, LA-AC-13M, LA-AC-13MA, LA-AC-13MP, LA-AC-18M, LA-AC-18MA, LA-AC-18MP, LA-AC-25M, LA-AC-25MA, LA-AC-25MP, LA-E-10M, LA-E-10MA, LA-E-10MP, LA-E-13M, LA-E-13MA, LA-E-13MP, LA-E-18M, LA-E-18MA, LA-E-18MP, LA-E-25M, LA-E-25MA, LA-E-25MP, LA-V-10M, LA-V-10MP, LA-V-13M, LA-V-13MP, LA-V-18M, LA-V-18MP, LA-V-25M, LA-V-25MP, LB-AC-10M, LB-E-10M, LB-V-10M, LF-13MPP, LF-18MPP, LF-25MPP, LF-8MPP, LR-AC-10M, LR-AC-10MA, LR-AC-10MP, LR-AC-13M, LR-AC-13MA, LR-AC-13MP, LR-AC-18M, LR-AC-18MA...(Other models you can see in the webshop)		

DIN 472			
			
<b>GEV No.</b>	523106	<b>Ref. No.</b>	12010122 Q302023
<b>description</b>	retaining ring bore ø 28mm thickness 1.3mm steel DIN 472		
<b>For models:</b>	ACE-061, ACE-101, ACE-102, ACE-201, ACE-202, ACG-061, ACG-101, ACG-102, ACG-201, ACG-202, AE-061, AE-061W, AE-101, AE-101W, AE-102, AE-102W, AE-201, AE-202, AG-061, AG-061W, AG-101, AG-101W, AG-102, AG-102W, AG-201, AG-202, APE-061, APE-061W, APE-101, APE-101W, APE-102, APE-102W, APE-201, APE-202, APG-061, APG-061W, APG-101, APG-101W, APG-102, APG-102W, APG-201, APG-202, COE-061, COE-101, COE-102, COE-201, COE-202, COG-061, COG-101, COG-102...(Other models you can see in the webshop)		

DIN 6799			
			
<b>GEV No.</b>	516198	<b>Ref. No.</b>	12010285 Q271033 Q301033
<b>description</b>	retaining ring E D1 ø 6mm D2 ø 12mm SS DIN 6799 thickness 0.7mm for shaft ø 7-9mm		
<b>For models:</b>	COE-201, COE-202, COG-201, COG-202, FE-710, FE-720, FE9-05, FE9-05S, FE9-05USMC, FE9-10, FE-920, HCG-10-11, HCG-10-21, HCG-20-11, HCG-20-21, HCG-2-10-11, HCG-2-20-11, HCG-6-11, HCV-10-11, HCV-10-21, HCV-2-10-21, HCV-6-11, HE-10-11, HE-10-21, HE-2-10-11, HE-6-11, HEI-10-21, HEI-20-21, HEM-10-21, HEM-20-21, HEP-10-21, HEP-20-21, HG-10-21, HG-2-10-11, HGC-10-21, HGC-20-21, HGP-10-21, HGP-20-21, HGV-10-11, HGV-10-21, HGV-20-11, HGV-20-21, HME-10-11, HME-10-21, HME-20-11, HME-20-21, HME-2-10-11, HME-2-20-11, HME-6-11, HMG-10-11...(Other models you can see in the webshop)		

			
<b>GEV No.</b>	691470	<b>Ref. No.</b>	12010014 Q271006
<b>description</b>	retaining ring E D1 ø 8mm D2 ø 16mm SS DIN 6799 thickness 1mm for shaft ø 9-12mm		
<b>For models:</b>	ACE-061, ACE-101, ACE-102, ACE-201, ACE-202, ACG-061, ACG-101, ACG-102, ACG-201, ACG-202, AD-120, AD-120B, AD-120BTTDD-UK, AD-120C, AD-120CW, AD-120HY, AD-90, AD-90BA, AD-90BBT, AD-90BDD, AD-90DD, ADE-120, ADE-120B, AE-061, AE-061W, AE-101, AE-101W, AE-102, AE-102W, AE-201, AE-202, AG-061, AG-061W, AG-101, AG-101W, AG-102, AG-102W, AG-201, AG-202, APE-061, APE-061W, APE-101, APE-101W, APE-102, APE-102W, APE-201, APE-202, APG-061, APG-061W, APG-101...(Other models you can see in the webshop)		

roll pins			
			
<b>GEV No.</b>	560663	<b>Ref. No.</b>	12020402 Q372001 Q372001000
<b>description</b>	roll pin ø 2mm L 10mm spring steel DIN 1481 Qty 10		

			
1			
<b>GEV No.</b>	691398	<b>Ref. No.</b>	12010283 Q371028
<b>description</b>	roll pin ø 3mm L 16mm		
<b>For models:</b>	CG-1002, CG-1502, CG-2002, CG-2002P, CG9-20AD-H, CG9-20H, CG9-20PLUS-H, CG9-40, CG9-40AD, CG9-40AD-H, CG9-40H, CG9-40PLUS, CG9-40PLUS-H, CG9-41, CG9-41AD, CG9-41AD-H, CG9-41H, CG9-41PLUS, CG9-41PLUS-H, CG9-51L, CG9-51LC, CG9-51R, CG9-51RC, CG9-60, CG9-60AD, CG9-60AD-H, CG9-60H, CG9-60PLUS, CG9-60PLUS-H, CG9-61, CG9-61AD, CG9-61AD-H, CG9-61H, CG9-61OP, CG9-61PLUS, CG9-61PLUS-H, CG9-82, CG9-82AD, CG9-82PLUS, CGE9-41, CGE9-41AD, CGE9-41PLUS, LF-AC-55, LF-AC-55MP, LF-AC-55MPP, LF-E-55, LF-E-55MP, LF-E-55MPP, LF-V-55, LF-V-55MP...(Other models you can see in the webshop)		

			
1			
<b>GEV No.</b>	551305	<b>Ref. No.</b>	12010292 Q352001
<b>description</b>	cotter pin ø 2mm L 23mm SS Qty 20 pcs		
<b>For models:</b>	ACE-201, ACE-202, ACG-201, ACG-202, AE-201, AE-202, AG-201, AG-202, APE-201, APE-202, APG-201, APG-202, COE-201, COE-202, COG-201, COG-202, ECO-120, ECO-120B, ECO-160, ECO-160D, ECO-160I, ECO-200, ECO-200D, ECO-200H, ECO-200HD, ECO-200HI, ECO-200I, ECO-2700D, ECO-2700I, ECO-280D, ECO-280I, ECO-370D, ECO-370I, ECO-4000D, ECO-4000I, ECO-460D, ECO-460I, ECO-550D, ECO-550I, ECO-6000D, ECO-6000I, FI-100, FI-100AR, FI-100B, FI-120, FI-120B, FI-120W, FI-160, FI-160AR, FI-160D...(Other models you can see in the webshop)		

			
2			
<b>GEV No.</b>	691725	<b>Ref. No.</b>	12010273 Q371026
<b>description</b>	roll pin ø 4.5mm L 15mm		
<b>For models:</b>	AE-102W, APE-061, APE-061W, APE-101, APE-101W, APE-102, APE-102W, APE-201, APE-202, APG-061, APG-061W, APG-101, APG-101W, APG-102, APG-102W, APG-201, APG-202, CG-1002, CG-1502, CG-2000, CG-2000-2P, CG-2002, CG-2002P, CG-2005, CG-210, CG-210G, CG-3005, CG-310, CG-310G, CG7-20, CG-7200, CG7-20H, CG7-30D, CG7-30I, CG7-31D, CG7-31I, CG7-40, CG-7400, CG7-40H, CG7-41, CG-7415, CG7-41H, CG7-50, CG7-51, CG7-60, CG7-60H, CG7-61, CG-7615, CG7-61H, CG9-05AD...(Other models you can see in the webshop)		

			
1			
<b>GEV No.</b>	551461	<b>Ref. No.</b>	12010169 Q352024 Q352024000
<b>description</b>	cotter pin ø 4mm L 25mm stainless steel Qty 10 pcs DIN 94		

## consumables

### sealants and adhesives

#### food-grade silicones

			
1			
<b>GEV No.</b>	504451	<b>Ref. No.</b>	12009828 12021015 Q362000 Z105026
<b>description</b>	roll pin ø 6.3mm L 50mm SS		
<b>For models:</b>	ECO-160, ECO-1600, ECO-160D, ECO-160I, ECO-200, ECO-200D, ECO-200H, ECO-200HD, ECO-200HI, ECO-200I, ECO-2300, ECO-280D, ECO-280I, ECO-3000, ECO-370D, ECO-370I, ECO-460D, ECO-460I, ECO-550D, ECO-550I, FI-160, FI-1600, FI-160AR, FI-160D, FI-160I, FI-200, FI-200AR, FI-200D, FI-200H, FI-200HD, FI-200HI, FI-200I, FI-200W, FI-200WL, FI-200WR, FI-2300, FI-280D, FI-280I, FI-3000, FI-370D, FI-370I, FI-460D, FI-460I, FI-550D, FI-550I		

			
1			
<b>GEV No.</b>	890106	<b>Ref. No.</b>	12032727 RT50060200
<b>description</b>	silicone TB40 transparent tube 90g -40 up to +160°C		
<b>description</b>	Tomabond - TB40 - tube 90g - transparent For flexible sealing in drinking water, food, water and industrial kitchen areas. Securely joins glass, metal, wood-based materials, ceramic and plastics with high adhesion (1.1 N/mm <sup>2</sup> ). Fungicide-, algicide- and solvent-free, ageing-resistant. Temperature-resistant from -40 °C to +160 °C Tested and approved by KTW / KSW.		



screw fixings



<b>GEV No.</b>	890137	<b>Ref. No.</b>	12030041 RT20010042
<b>description</b>	screw fixing LOCTITE 243 medium-strength bottle 5ml		
<b>description</b>	LOCTITE® 243™ - bottle 5ml Is a general purpose threadlocker of medium bond strength. This threadlocker secures and seal bolts, nuts and studs to prevent loosening due to vibration. The product works on all metals, including passive substrates such as stainless steel, aluminium and plated surfaces. It is proven to be tolerant of minor contamination due to industrial oils, e.g. engine oils, corrosion prevention oils and cutting fluids.		

cleaning agents

combi-steamer detergents/descalers

*Notice: Articles labelled 'DANGEROUS GOODS' are delivered by road through a forwarder for reasons of safety and are charged separately!*



<b>GEV No.</b>	802186	<b>Ref. No.</b>	12029940 RT90060136
<b>description</b>	detergent for combi-steamer 10 litres		

descalers



<b>GEV No.</b>	890045	<b>Ref. No.</b>	12030129 RT60060110
<b>description</b>	descaler RATIONAL descaler 10 litres		

fuses

fine fuses



<b>GEV No.</b>	358671	<b>Ref. No.</b>	12039844 R663101
<b>description</b>	fine fuse size ø5x20mm 1A fast-acting rated 250V Qty 10 pcs		
<b>For models:</b>	HME-10-11, HME-10-21, HME-20-11, HME-20-21, HME-2-10-11, HME-2-20-11, HME-6-11, HMP-10-11, HMP-10-21, HMP-20-11, HMP-20-21, HMP-2-10-11, HMP-6-11		



<b>GEV No.</b>	358677	<b>Ref. No.</b>	12024333 12035393 P184011 RT30190112
<b>description</b>	fine fuse size ø5x20mm 4A fast-acting rated 250V Qty 10 pcs		
<b>For models:</b>	CE-15, CE-9, ECO-160, ECO-1600, ECO-160D, ECO-160I, ECO-200, ECO-200D, ECO-200H, ECO-200HD, ECO-200HI, ECO-200I, ECO-2300, ECO-280D, ECO-280I, ECO-3000, ECO-370D, ECO-370I, ECO-460D, ECO-460I, ECO-550D, ECO-550I, FF-35, FI-160, FI-1600, FI-160AR, FI-160D, FI-160I, FI-200, FI-200AR, FI-200D, FI-200H, FI-200HD, FI-200HI, FI-200I, FI-200W, FI-2300, FI-280D, FI-280I, FI-3000, FI-370D, FI-370I, FI-460D, FI-460I, FI-550D, FI-550I, GA-20, GA-40, HCV-10-11, HCV-10-21... (Other models you can see in the webshop)		



<b>GEV No.</b>	358603	<b>Ref. No.</b>	12034888 RT30190120
<b>description</b>	fine fuse size ø5x20mm 2A slow-acting rated 250V Qty 10 pcs		

ø6.3x32mm 250V



<b>GEV No.</b>	358792	<b>Ref. No.</b>	12035115 RT40010225
<b>description</b>	fine fuse size ø6.3x32mm 10A slow-acting rated 250V Qty 10 pcs		



<b>GEV No.</b>	358791	<b>Ref. No.</b>	12037374 RT40010224
<b>description</b>	fine fuse size ø6.3x32mm 6.3A slow-acting rated 250V Qty 10 pcs		



screw locks

D0-system (NEOZED)



1

<b>GEV No.</b>	358043	<b>Ref. No.</b>	12033846 RT30190401
<b>description</b>	fuse size D01 16A rated 250/400V E14 ø 11mm L 36mm Qty 10 pcs		



1

<b>GEV No.</b>	358047	<b>Ref. No.</b>	12032709 RT30190405
<b>description</b>	fuse size D02 63A rated 250/400V E18 ø 15mm L 36mm Qty 10 pcs		

gauge pieces (NEOZED)



1

<b>GEV No.</b>	358064	<b>Ref. No.</b>	12037278 RT40011238
<b>description</b>	gauge piece size D02 suitable for 16A		



<b>A</b>			
alarm devices	45		
appliance hose reels	319		
axial fans	85		
<b>B</b>			
ball valves	331		
ballasts	39		
bar burners	152		
bi-metal thermostats	17, 18		
boiling pan gaskets	295		
booster pumps I	102		
booster pumps II	103		
<b>C</b>			
cable glands	108, 108		
cables	108		
cam switches	30		
cap nuts	347		
capillary pipes	308		
castors and bumper angles	273		
clamps	336, 354		
cleaning agents	359		
cleaning tools	339		
coffee grounds drawers	317		
coil heating elements	8		
cold air circulating fans (complete)	88		
combi-steamer detergents/descalers	359		
compressors	82		
condensators & interference suppression filters	105		
connection cables	110		
consumables	358		
contactors	45		
container filters	321		
control equipment	35		
control thermostats	18		
cooling aggregates	82		
core probes	55		
cotter pins	358		
countersunk screws	341		
cross flow fans	88		
cylinder head bolts	345		
<b>D</b>			
descalers	359		
DIN rails	113		
door seals	291		
door seals for dishwashers	305		
door seals with fixing hook	294		
dosing pumps	319		
double nipples	329		
double wire clamps	337, 356		
		double wire clamps with screw	338, 356
		drain fittings	335
		drain hoses	323
		drain pumps	102
		drain systems and wash basins	335
<b>E</b>			
		edgemount latches	254
		electric accessories	108
		electrodes	81
		electromagnetic closer	252
		electronic controllers	52
		electronic magnets	114
		end caps and plugs	273
		energy regulators	17
		espagnolette locks	254
		evaporators	309
<b>F</b>			
		fans	85
		fasteners	354
		fastening material	339
		female fastons	110
		filter driers	307
		filter weights	321
		filters	106
		fine fuses	359
		fittings	329
		flat-headed bolts	342
		flow sensors	82
		fluorescent lamps	38, 38
		foam rubber gaskets	303
		food-grade silicones	336, 358
		forced air burners	157
		formed hoses	325
		fuses	107, 359
<b>G</b>			
		gas burners	143
		gas control valves	126
		gas hoses	173
		gas lines	170
		gas nozzles	160
		gas taps	114
		gas thermostats	122
		gaskets for control panels	295
		gaskets for heated units	290
		gaskets for tray rack trolleys	294
		gaskets for wash arm support	307
		gastronorm	317
		grates	279
		group 1	308
		grub screws	346

**H**

halogen lamp	38
handle latches	254
heating cables	7
heating elements	3, 7
heating elements for convection	13
heating elements for defrosting	6
heating elements for fryers	3
heating elements for griddles	6
heating elements for heated trolleys	7
heating elements for ovens	3
heating elements for pasta cookers	7
heating elements for refrigeration	6
heating elements for tilting bratt pan	7
heating plates	8
hexagonal nuts	348
hexagonal screws	343
hob burners	143
hose clamps	336, 354
hose connectors	329, 330
hose couplings	322
hose reels	319
hoses	322
hot air fans	95
hot air motors	89
hot plates	16

**I**

ignition boxes	129
ignition bridges	143
ignition cables	140
ignition units	141
immersion heating elements	9
indicator lights	36
indicator lights (complete)	36
industrial hoses	324
inlet spouts	334
inlet taps	334

**K**

knurled nuts	348
knurled screws	347

**L**

lamp accessories	41
lamps	36
light bulbs	38
linear lamps	38

**M**

magnetic switches	33
measuring equipment	339

mechanical timers	44
microswitches	28
miscellaneous	108
motors	97
mounting spigots	354

**N**

Niplaflex hoses	324
nuts	347

**O**

operating capacitors	105
O-rings	295
oval head screws	343
oven hinges	260
oven lamps	39

**P**

piezoelectric igniters	140
pilot burners	130
plate nuts	347
plug-in gaskets	285
plunger sockets	25
pre-rinse hoses	323
pressure control hoses	324
pressure hoses	328
pressure reduction valves	336, 336
pressure switches	77, 173
probe clips	24
probes	55
programme timers	41
protection hoses	108
pumps	98
pumps for ice machines	104
push/momentary push switches	27
PVC supply hoses	322

**R**

radial fans	95
refrigeration cycle components	307
refrigeration fans	87
refrigeration gaskets	285
refrigeration motors universal	87
refrigeration pipes	308
refrigeration thermostats	24
relays	49
retaining rings	357
ribbon cables	109
rivets/rivet nuts	339
rocker/momentary rocker switches	25
roll pins	357
rotary switches	33
round burners	157

**S**

safety bi-metal thermostats	17
safety thermostats	20
Schrader valves	307
screw fixings	359
screw locks	360
screw-in gaskets	289
screws	341
sealants and adhesives	358
sealing discs	305
sealing washers	299
shaft gaskets	303
sheet metal screws	341
shelves and shelf rails	279
shut-off valves	331
side bolts	346
silicone	336, 358
silicone hoses	324
slot nuts	354
solenoid valves	72
solid state relays	49
spray guns	317
spray guns with external thread	317
spring assisted hinges	258
spring rings	351
spring washers	352
stainless steel flexi hoses	323
standpipes	335
starting capacitors	105
supply hoses	322
switches and momentary switches	25
system switches (ROLD)	30

**T**

tank inlets	322
temperature probes	55
terminals	110
terminals and connectors	110
thermocouples	141
thermostat gaskets	307
thermostats	17
threaded cable glands	109
time relays	51
timers	41
tools	339
tooth lock washers	353
transformers	51
tube burners	157

**U**

universal probes	55
------------------	----

**V**

valves and tank inlets	331
vibration pumps	104

**W**

wash and rinse pumps	98
washers	352
water cycle components	336
window seals	290