



**GAS COMPONENTS**



**ELECTRIC COMPONENTS**



**WATER TECHNOLOGY**



**MECHANICAL COMPONENTS**



**TOOLS**

Spare parts suitable for

**FAEMA**

Find the complete and up-to-date range of products in our GEV Webshop



# Manufacturer catalogue

The most important spare parts and accessories arranged clearly for every manufacturer

- ✓ Complete product range and all appliance data always up to date in the GEV Webshop
- ✓ Alphabetical Index at the end of the catalogue

## GEV Webshop

[www.gev-online.co.uk](http://www.gev-online.co.uk)

[www.gev-online.com](http://www.gev-online.com)





- 🔍 Add to Favourites
- 🔍 Sign In with email address and usual password
- 🔍 Easy-order – place several items in your basket at the same time
- 🔍 Quick Item search – no login needed





# heating elements



## heating elements for coffee machine

 <p>1</p>			
<b>GEV No.</b>	417113	<b>Ref. No.</b>	N/A
<b>description</b>	heating element 1000W 230V heating circuits 1 $\varnothing$ 57mm H 59mm W1 50mm H1 29mm H2 30mm mounting distance 44mm thread M12x1.25 stainless steel windings 3 tube $\varnothing$ 6.3mm immersion heater 2 hole fixing connection male faston 6.3mm		
<b>accessories for</b>	417113		
	<b>GEV No.</b>	550681	<b>Ref. No.</b> —
	 <p>nut thread M12x1.25 H 5mm WS 17 brass Qty 1 pcs</p>		

 <p>1</p>			
<b>GEV No.</b>	417114	<b>Ref. No.</b>	N/A
<b>description</b>	heating element 1000W 230V heating circuits 1 $\varnothing$ 57mm H 60mm W1 38mm H1 29mm H2 31mm mounting distance 32mm thread 1/4" stainless steel windings 4 tube $\varnothing$ 6.3mm immersion heater 2 hole fixing		

 <p>1</p>			
<b>GEV No.</b>	417014	<b>Ref. No.</b>	—
<b>description</b>	heating element 1300W 230V heating circuits 1 hole distance 59mm L 185mm W 40mm H 18mm hole $\varnothing$ 9mm tube $\varnothing$ 8.5mm connection male faston 6.3mm immersion heater 3 hole flange suitable for CIMBALI		
<b>accessories for</b>	417014		
	<b>GEV No.</b>	529484	<b>Ref. No.</b> —
	 <p>flat gasket fibre ED <math>\varnothing</math> 58mm ID <math>\varnothing</math> 50mm thickness 2mm Qty 1 pcs</p>		

 <p>1</p>			
<b>GEV No.</b>	417083	<b>Ref. No.</b>	3541118963
<b>description</b>	heating element 1500W 220V heating circuits 1 mounting $\varnothing$ 42mm hole distance 61mm L 165mm W 25mm H 71mm hole $\varnothing$ 7mm tube $\varnothing$ 8mm connection M6 immersion heater 3 hole flange suitable for FAEMA		

 <p>1</p>			
<b>GEV No.</b>	417002	<b>Ref. No.</b>	N/A
<b>description</b>	heating element 1500W 230V heating circuits 2 mounting $\varnothing$ 42mm hole distance 74mm L 140mm W 25mm H 58mm L1 16mm L2 54mm L3 70mm H1 26mm H2 32mm hole $\varnothing$ 11mm tube $\varnothing$ 8mm connection M6x1 immersion heater 2 hole flange suitable for FAEMA		
<b>accessories for</b>	417002		
	<b>GEV No.</b>	528002	<b>Ref. No.</b> N/A
	 <p>flat gasket PTFE ED <math>\varnothing</math> 57mm ID <math>\varnothing</math> 42mm thickness 3mm Qty 1 pcs equiv. no. 12001/W10470 suitable for</p>		
	<b>GEV No.</b>	528488	<b>Ref. No.</b> —
	 <p>flat gasket fibre ED <math>\varnothing</math> 57mm ID <math>\varnothing</math> 42mm thickness 3mm Qty 1 pcs</p>		

 <p>1</p>			
<b>GEV No.</b>	417116	<b>Ref. No.</b>	N/A
<b>description</b>	heating element 1800W 230V heating circuits 2 mounting $\varnothing$ 42mm hole distance 74mm L 240mm W 36mm H 44mm L1 25mm L2 40mm L3 173mm H1 31mm H2 12mm hole $\varnothing$ 9mm tube $\varnothing$ 8.5mm thermostat sleeves $\varnothing$ 6mm length thermostat sleeves 205mm thermostat sleeve not clinging number of thermostat sleeves 1 connection M4 immersion heater 2 hole flange		

 <p>1</p>			
<b>GEV No.</b>	417011	<b>Ref. No.</b>	421601010 421610000
<b>description</b>	heating element 1800W 230V heating circuits 3 hole distance 59mm L 170mm W 34mm H 35mm hole $\varnothing$ 9.7mm thermostat sleeves $\varnothing$ 7mm length thermostat sleeves 170mm number of thermostat sleeves 1 thermostat sleeve eccentric, non clinging tube $\varnothing$ 8.5mm connection male faston 6.3mm immersion heater 3 hole flange suitable for CIMBALI		
<b>accessories for</b>	417011		
	<b>GEV No.</b>	528002	<b>Ref. No.</b> N/A
	 <p>flat gasket PTFE ED <math>\varnothing</math> 57mm ID <math>\varnothing</math> 42mm thickness 3mm Qty 1 pcs equiv. no. 12001/W10470 suitable for</p>		
	<b>GEV No.</b>	528488	<b>Ref. No.</b> —
	 <p>flat gasket fibre ED <math>\varnothing</math> 57mm ID <math>\varnothing</math> 42mm thickness 3mm Qty 1 pcs</p>		





 <p>1</p>			
<b>GEV No.</b>	417004	<b>Ref. No.</b>	3541116635
<b>description</b>	heating element 2400W 230V heating circuits 2 mounting $\varnothing$ 42mm hole distance 74mm L 175mm W 27mm H 58mm L1 30mm L2 55mm L3 90mm H1 28mm H2 30mm hole $\varnothing$ 9.5mm tube $\varnothing$ 8.5mm connection M6 immersion heater 2 hole flange suitable for FAEMA		
<b>accessories for</b>	417004		
	<b>GEV No.</b>	525652	<b>Ref. No.</b> —
	 <p>grub screw thread M10 L 10mm brass DIN 914 intake hexagonal WS 5 Qty 1 pcs</p>		



Table continues overleaf



electric components







<b>accessories for</b> 417004				
	GEV No.	528002	Ref. No.	N/A
	flat gasket PTFE ED ø 57mm ID ø 42mm thickness 3mm Qty 1 pcs equiv. no. 12001/W10470 suitable for			
	GEV No.	528488	Ref. No.	—
	flat gasket fibre ED ø 57mm ID ø 42mm thickness 3mm Qty 1 pcs			

				
<b>GEV No.</b>	417581	<b>Ref. No.</b>	3541117863 3541134417	
<b>description</b>	heating element 2440/2900W 220/240V heating circuits 2 mounting ø 42mm hole distance 74mm L 295mm W 28mm H 50mm L1 30mm L2 55mm L3 210mm H1 26mm H2 24mm hole ø 10mm tube ø 8.5mm thermostat sleeves ø 7mm length thermostat sleeves 208mm thermostat sleeve bottom/centre number of thermostat sleeves 1 connection M6 immersion heater 2 hole flange			

				
<b>GEV No.</b>	417001	<b>Ref. No.</b>	3541133003	
<b>description</b>	heating element 2600W 230V heating circuits 2 mounting ø 42mm hole distance 74mm L 330mm W 30mm H 60mm L1 23mm L2 65mm L3 202mm H1 30mm H2 30mm hole ø 12mm tube ø 8.5mm thermostat sleeves ø 7mm length thermostat sleeves 195mm thermostat sleeve eccentric, non clinging number of thermostat sleeves 1 connection M6 immersion heater 2 hole flange			
<b>accessories for</b> 417001				
	GEV No.	528002	Ref. No.	N/A
	flat gasket PTFE ED ø 57mm ID ø 42mm thickness 3mm Qty 1 pcs equiv. no. 12001/W10470 suitable for			
	GEV No.	528488	Ref. No.	—
	flat gasket fibre ED ø 57mm ID ø 42mm thickness 3mm Qty 1 pcs			



				
<b>GEV No.</b>	417005	<b>Ref. No.</b>	N/A	
<b>description</b>	heating element 2600W 230V immersion heater			
<b>accessories for</b> 417005				
	GEV No.	528002	Ref. No.	N/A
	flat gasket PTFE ED ø 57mm ID ø 42mm thickness 3mm Qty 1 pcs equiv. no. 12001/W10470 suitable for			
	GEV No.	528488	Ref. No.	—
	flat gasket fibre ED ø 57mm ID ø 42mm thickness 3mm Qty 1 pcs			

				
<b>GEV No.</b>	417007	<b>Ref. No.</b>	N/A	
<b>description</b>	heating element 2600W 230V immersion heater			
<b>accessories for</b> 417007				
	GEV No.	528002	Ref. No.	N/A
	flat gasket PTFE ED ø 57mm ID ø 42mm thickness 3mm Qty 1 pcs equiv. no. 12001/W10470 suitable for			
	GEV No.	528488	Ref. No.	—
	flat gasket fibre ED ø 57mm ID ø 42mm thickness 3mm Qty 1 pcs			

				
<b>GEV No.</b>	417524	<b>Ref. No.</b>	903553010 903553016 903553020 903553030	
<b>description</b>	heating element 3000/3570W 220-240V heating circuits 3 mounting ø 42mm hole distance 70mm L 210mm W 37mm H 69mm L1 25mm L2 60mm L3 125mm H1 33mm H2 36mm hole ø 10mm tube ø 8mm thermostat sleeves ø 6mm length thermostat sleeves 140mm thermostat sleeve centre not clinging number of thermostat sleeves 1 connection F6.3 immersion heater 2 hole flange suitable for FAEMA			
<b>accessories for</b> 417524				
	GEV No.	529484	Ref. No.	—
	flat gasket fibre ED ø 58mm ID ø 50mm thickness 2mm Qty 1 pcs			

				
<b>GEV No.</b>	417582	<b>Ref. No.</b>	3541133004 3541-134418	
<b>description</b>	heating element 3360/4000W 220/240V heating circuits 2 mounting ø 42mm hole distance 74mm L 415mm W 30mm H 46mm L1 45mm L2 45mm L3 325mm H1 22mm H2 24mm hole ø 10mm tube ø 8.5mm thermostat sleeves ø 7mm length thermostat sleeves 200mm thermostat sleeve bottom/centre number of thermostat sleeves 1 connection M6 immersion heater 2 hole fixing			

				
<b>GEV No.</b>	417108	<b>Ref. No.</b>	N/A	
<b>description</b>	heating element 3500W 230V heating circuits 2 mounting ø 42mm hole distance 74mm L 380mm W 30mm H 50mm L1 25mm L2 70mm L3 275mm H1 25mm H2 25mm hole ø 10mm tube ø 8.5mm thermostat sleeves ø 7mm length thermostat sleeves 190mm thermostat sleeve not clinging number of thermostat sleeves 1 connection M4 immersion heater 2 hole flange			

				
<b>GEV No.</b>	417202	<b>Ref. No.</b>	2841135092 3541135077 911544000 911544010	
<b>description</b>	heating element 4000W 230V heating circuits 3 mounting ø 42mm hole distance 74mm L 295mm W 34mm H 63mm L1 30mm L2 70mm L3 190mm H1 31mm H2 32mm hole ø 9mm tube ø 8.5mm thermostat sleeves ø 6.5mm length thermostat sleeves 199mm thermostat sleeve not clinging number of thermostat sleeves 1 connection male faston 6.3mm immersion heater 2 hole flange			
<b>accessories for</b> 417202				
	GEV No.	528022	Ref. No.	—
	flat gasket PTFE ED ø 52mm ID ø 41mm thickness 2mm size 1¼" Qty 1 pcs suitable for CARIMALI, FAEMA, MARZOCCO, PAVONI			
	GEV No.	528488	Ref. No.	—
	flat gasket fibre ED ø 57mm ID ø 42mm thickness 3mm Qty 1 pcs			







			
<b>GEV No.</b>	417583	<b>Ref. No.</b>	911545000 911545010 911545020
<b>description</b>	heating element 4500/5360W 220/240V heating circuits 3 mounting ø 42mm hole distance 74mm L 392mm W 32mm H 65mm L1 32mm L2 55mm L3 305mm H1 30mm H2 35mm hole ø 10mm tube ø 8.5mm thermostat sleeves ø 7mm length thermostat sleeves 150mm thermostat sleeve centre not clinging number of thermostat sleeves 1 connection male faston immersion heater 2 hole fixing		

			
<b>GEV No.</b>	417112	<b>Ref. No.</b>	3541-135 078
<b>description</b>	heating element 4500W 230V heating circuits 3 mounting ø 42mm hole distance 74mm L 390mm W 35mm H 70mm L1 30mm L2 50mm L3 300mm H1 33mm H2 37mm hole ø 9mm tube ø 8mm thermostat sleeves ø 6.5mm length thermostat sleeves 200mm thermostat sleeve not clinging number of thermostat sleeves 1 connection male faston 6.3mm immersion heater 2 hole flange		

			
<b>GEV No.</b>	417110	<b>Ref. No.</b>	3581130091
<b>description</b>	heating element 5000W 230V heating circuits 2 mounting ø 42mm hole distance 74mm L 525mm W 26mm H 45mm L1 25mm L2 80mm L3 420mm H1 30mm H2 15mm hole ø 10mm tube ø 8.5mm thermostat sleeves ø 7mm length thermostat sleeves 210mm thermostat sleeve eccentric, non clinging number of thermostat sleeves 1 connection M6 immersion heater 2 hole flange windings 2		

			
<b>GEV No.</b>	417584	<b>Ref. No.</b>	3541-134419
<b>description</b>	heating element 5040/6000W 220/240V heating circuits 2 mounting ø 42mm hole distance 74mm L 620mm W 25mm H 55mm L1 30mm L2 60mm L3 530mm H1 20mm H2 35mm hole ø 9mm tube ø 8.5mm thermostat sleeves ø 7mm length thermostat sleeves 210mm thermostat sleeve bottom/centre number of thermostat sleeves 1 connection M6 immersion heater 2 hole flange		

			
<b>GEV No.</b>	417585	<b>Ref. No.</b>	927597000 927597010 927597020
<b>description</b>	heating element 5400/6400W 220/240V heating circuits 3 mounting ø 42mm hole distance 74mm L 605mm W 34mm H 75mm L1 30mm L2 50mm L3 525mm H1 35mm H2 40mm hole ø 9mm tube ø 8.5mm thermostat sleeves ø 5.5mm length thermostat sleeves 150mm thermostat sleeve centre not clinging number of thermostat sleeves 1 connection male faston immersion heater 2 hole flange		

			
<b>GEV No.</b>	417099	<b>Ref. No.</b>	—
<b>description</b>	heating element 5790W 230V heating circuits 3 hole distance 59mm L 577mm W 35mm H 34mm hole ø 9.7mm thermostat sleeves ø 7mm length thermostat sleeves 170mm number of thermostat sleeves 1 thermostat sleeve not clinging tube ø 8mm connection male faston 6.3mm immersion heater 3 hole flange suitable for CIMBALI		

## thermostats

### control and safety thermostats

EGO

safety thermostats

55.32\_series

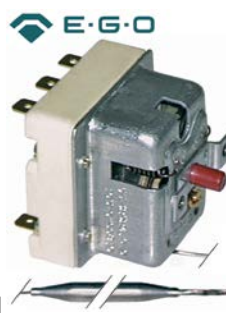

<b>GEV No.</b>	390166	<b>Ref. No.</b>	3231133006
<b>description</b>	safety thermostat switch-off temp. 150°C 3-pole 20A probe ø 6mm probe L 87mm capillary pipe 1490mm capillary pipe isolated 1250mm gland nut M9x1 probe SS		



<b>GEV No.</b>	390324	<b>Ref. No.</b>	3231-135 058 531-193 100
<b>description</b>	safety thermostat switch-off temp. 169°C 3-pole 3NC 20A probe ø 4mm probe L 128mm capillary pipe 890mm capillary pipe isolated 210/210mm gland nut probe SS		

## switches and momentary switches

### rocker/momentary rocker switches

19x13mm



<b>GEV No.</b>	301066	<b>Ref. No.</b>	3302136675 532-006 800
<b>description</b>	rocker switch mounting measurements 19x13mm black 2NO 250V 6A 0-I connection male faston 4.8mm ambient temperature max. 85°C protection IP40		
<b>accessories for</b>	301066		



<b>GEV No.</b>	301064	<b>Ref. No.</b>	—
<b>description</b>	protective cover for pressure switch external size 23.4x17.4mm internal size 19x13mm H 7.5mm clear mounting measurementsmm		





28x13.5mm			
			
1			
<b>GEV No.</b>	347371	<b>Ref. No.</b>	3302-134 423 990-888 000
<b>description</b>	rocker switch mounting measurements 27.4x12.4mm black/green 2NO 250V 16A illuminated O connection male faston 6.3mm ambient temperature max. 85°C protection IP40		

push/momentary push switches

28.5x28.5mm			
			
1			
<b>GEV No.</b>	345142	<b>Ref. No.</b>	3761130381
<b>description</b>	push switch mounting measurements 28.5x28.5mm red/green 2NO 250V 16A connection male faston 6.3mm ambient temperature max. 150°C protection IP40 with indicator		



accessories

push buttons			
			
1			
<b>GEV No.</b>	400308	<b>Ref. No.</b>	4529-132 818 4531-133 348
<b>description</b>	push button black suitable for FAEMA series DUE S		
<b>accessories for</b>	400308		
	<b>GEV No.</b>	345141	<b>Ref. No.</b>
			3341-132 683 532-021 708 800-132 683
	switch 2NO 250V 16A connection male faston 6.3mm		

protective covers

			
1			
<b>GEV No.</b>	347164	<b>Ref. No.</b>	802131619
<b>description</b>	protector H 6mm L 80mm W 26mm		

microswitches

universal			
			
			
1			
<b>GEV No.</b>	345042	<b>Ref. No.</b>	3342-133 738 3761-119 075
<b>description</b>	microswitch with plunger 250V 16A 1CO connection male faston 6.3mm L 28mm ambient temperature max. 125°C mounting distance 22mm type EF83161.3 actuating force: 75g blue/black		
<b>For models:</b>	MC90		
<b>accessories for</b>	345042		
	<b>GEV No.</b>	345043	<b>Ref. No.</b>
			—
	lever set 5-piece		

pin-plunger actuated

			
1			
<b>GEV No.</b>	347269	<b>Ref. No.</b>	3341-133 175 3341-135 175
<b>description</b>	microswitch 230V 16A 1NO connection male faston 6.3mm ambient temperature max. 85°C mounting distance 22mm with plunger red		



			
1			
<b>GEV No.</b>	305004	<b>Ref. No.</b>	3341-133 478
<b>description</b>	microswitch with plunger 250V 16A 1NO/1NC connection male faston 6.3mm ambient temperature max. 85°C mounting distance 22mm type XP2Z11 actuating force: 500g red stroke 8mm		

			
1			
<b>GEV No.</b>	347268	<b>Ref. No.</b>	3301-134 618 965-718 000
<b>description</b>	microswitch with plunger 400V 16A 2NO connection male faston 6.3mm ambient temperature max. 85°C mounting distance 22mm black stroke 15mm		
<b>For models:</b>	MC90		







			
1			
<b>GEV No.</b>	347345	<b>Ref. No.</b>	3301-133 542
<b>description</b>	microswitch with plunger 400V 16A 2NO connection male faston 6.3mm ambient temperature max. 85°C mounting distance 22mm type XTD22P black stroke 15mm		

			
1			
<b>GEV No.</b>	347271	<b>Ref. No.</b>	3301-133 541
<b>description</b>	microswitch 400V 3A 1CO connection male faston 2.8mm ambient temperature max. 85°C mounting distance 22mm green/grey stroke 2mm		
<b>For models:</b>	MC90		



			
			
1			
<b>GEV No.</b>	345042	<b>Ref. No.</b>	3342-133 738 3761-119 075
<b>description</b>	microswitch with plunger 250V 16A 1CO connection male faston 6.3mm L 28mm ambient temperature max. 125°C mounting distance 22mm type EF83161.3 actuating force: 75g blue/black		
<b>For models:</b>	MC90		
<b>accessories for</b>	345042		
	<b>GEV No.</b>	345043	<b>Ref. No.</b> —
	 lever set 5-piece		



 Image not available			
1			
<b>GEV No.</b>	347452	<b>Ref. No.</b>	3341-134 617 965-719 000
<b>description</b>	safety switch 230V		
<b>For models:</b>	MC90		



<p>miscellaneous</p>			
			
1			
<b>GEV No.</b>	347372	<b>Ref. No.</b>	532-015 900
<b>description</b>	momentary switch unit 250V 16A 1NO connection male faston 6.3mm ambient temperature max. 105°C		
<b>accessories for</b>	347372		
	<b>GEV No.</b>	347362	<b>Ref. No.</b> 902-114 000
	 push button grey suitable for FAEMA series E92 ELITE		

			
1			
<b>GEV No.</b>	347373	<b>Ref. No.</b>	3761-132 128
<b>description</b>	switch 250V 16A 1NO connection male faston 6.3mm ambient temperature max. 105°C		
<b>accessories for</b>	347373		
	<b>GEV No.</b>	347362	<b>Ref. No.</b> 902-114 000
	 push button grey suitable for FAEMA series E92 ELITE		

system switches (ROLD)

			
1			
<b>GEV No.</b>	347372	<b>Ref. No.</b>	532-015 900
<b>description</b>	momentary switch unit 250V 16A 1NO connection male faston 6.3mm ambient temperature max. 105°C		
<b>accessories for</b>	347372		
	<b>GEV No.</b>	347362	<b>Ref. No.</b> 902-114 000
	 push button grey suitable for FAEMA series E92 ELITE		

			
1			
<b>GEV No.</b>	347373	<b>Ref. No.</b>	3761-132 128
<b>description</b>	switch 250V 16A 1NO connection male faston 6.3mm ambient temperature max. 105°C		
<b>accessories for</b>	347373		
	<b>GEV No.</b>	347362	<b>Ref. No.</b> 902-114 000
	 push button grey suitable for FAEMA series E92 ELITE		

			
1			
<b>GEV No.</b>	345141	<b>Ref. No.</b>	3341-132 683 532-021 708 800-132 683
<b>description</b>	switch 2NO 250V 16A connection male faston 6.3mm		
<b>accessories for</b>	345141		
	<b>GEV No.</b>	347362	<b>Ref. No.</b> 902-114 000
	 push button grey suitable for FAEMA series E92 ELITE		
	<b>GEV No.</b>	400308	<b>Ref. No.</b> 4529-132 818 4531-133 348
	 push button black suitable for FAEMA series DUE S		



## rotary switches

## BREMAS

## A1600 series



1

<b>GEV No.</b>	345147	<b>Ref. No.</b>	2761130012
----------------	--------	-----------------	------------

<b>description</b>	rotary switch 3 1-0-2 sets of contacts 6 type CS0169873 400V 16A shaft $\varnothing$ 5x5mm shaft L 17mm shaft square connection screw
--------------------	---

## miscellaneous



1

<b>GEV No.</b>	347689	<b>Ref. No.</b>	3761119055
----------------	--------	-----------------	------------

<b>description</b>	rotary switch sets of contacts 2 2 0-1 type CS20-00063 690V 25A shaft $\varnothing$ 5x5mm shaft L 22mm shaft square connection male faston 6.3mm
--------------------	--

## accessories

## knobs



1

<b>GEV No.</b>	111254	<b>Ref. No.</b>	3831-130 501
----------------	--------	-----------------	--------------

<b>description</b>	knob switch zero mark t.max.°C° $\varnothing$ 26mm shaft $\varnothing$ 5x5mm shaft flat black H 20mm L 36mm
--------------------	---

## lamps

## indicator lights

## indicator lights 2-piece (lens and indicator lamp)

## indicator lamps for socket type SRZ / SDK / SDY / SFK



1

<b>GEV No.</b>	359132	<b>Ref. No.</b>	902-524 000
----------------	--------	-----------------	-------------

<b>description</b>	indicator lamp green 250V connection male faston 6.3mm protection IP54 ambient temperature max. 85°C
--------------------	--

## indicator lights (complete)

 $\varnothing$ 10mm

## with plug-in socket



1

<b>GEV No.</b>	357014	<b>Ref. No.</b>	3541-116 308
----------------	--------	-----------------	--------------

<b>description</b>	indicator light $\varnothing$ 10mm 250V red cable length 250mm socket push-in
--------------------	---

 $\varnothing$ 12mm

## with plug-in socket



1

<b>GEV No.</b>	359041	<b>Ref. No.</b>	3541-133 504
----------------	--------	-----------------	--------------

<b>description</b>	indicator light $\varnothing$ 12mm green 230V connection male faston 6.3mm temp.-resist. 120°C Qty 1 pcs
--------------------	--

<b>For models:</b>	MC90
--------------------	------



1

<b>GEV No.</b>	359494	<b>Ref. No.</b>	3491-133 636
----------------	--------	-----------------	--------------

<b>Ref. No.</b>	3591-133 546
<b>Ref. No.</b>	535-573 008

<b>description</b>	indicator light $\varnothing$ 12mm green 400V connection male faston 6.3mm temp.-resist. 120°C Qty 1 pcs
--------------------	--

<b>For models:</b>	MC90
--------------------	------



1

<b>GEV No.</b>	347368	<b>Ref. No.</b>	3342-133 957
----------------	--------	-----------------	--------------

<b>Ref. No.</b>	530-151 900
-----------------	-------------

<b>description</b>	indicator light $\varnothing$ 12mm 250V green
--------------------	---



1

<b>GEV No.</b>	359493	<b>Ref. No.</b>	3402-133 614
----------------	--------	-----------------	--------------

<b>description</b>	indicator light $\varnothing$ 12mm 250V green connection male faston 6.3mm temp.-resist. 120°C
--------------------	--





oven lamps

universal oven lamps

mounting diameter 47.8mm

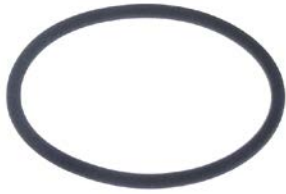

1			
<b>GEV No.</b>	525313	<b>Ref. No.</b>	4701-030 129 915-117 000
<b>description</b>	O-ring Viton ID ø 60.33mm thickness 3.53mm Qty 1 pcs		

contactors

ABB

power contactors



1			
<b>GEV No.</b>	380905	<b>Ref. No.</b>	2492-133 739 535-560 008
<b>description</b>	power contactor resistive load 25A 230/400VAC (AC3/400V) 9A/4kW main contacts 3NO auxiliary contacts 1NO connection screw connection type A9-30-10		
<b>For models:</b>	MC90		



1			
<b>GEV No.</b>	381017	<b>Ref. No.</b>	531506600 531-507 208 531507200
<b>description</b>	power contactor resistive load 30A 230VAC (AC3/400V) 17A/7.5kW main contacts 4NO auxiliary contacts connection screw connection type A16-40-00		

relays

time relays

time relays



1			
<b>GEV No.</b>	360468	<b>Ref. No.</b>	2341-117 504 531-202 308 531202208
<b>description</b>	time relay CDC TN 80 time range 3s-60min 24-230VAC/24-48VDC 6A 1CO 8-pole raster size 35x35mm		
<b>accessories for</b>	360468		
	<b>GEV No.</b>	360230	<b>Ref. No.</b> —
	base		

probes

producer-specific probes

probes



1			
<b>GEV No.</b>	400082	<b>Ref. No.</b>	3761117825
<b>description</b>	temperature probe NTC 10kOhm cable probe -40 up to +110°C cable°C connection male faston 6.3mm thread probe ø10x30mm cable lengthm		

electronics

PCBs





1			
<b>GEV No.</b>	400580	<b>Ref. No.</b>	3301-091 861 3301-133 922
<b>description</b>	control PCB coffee machine		





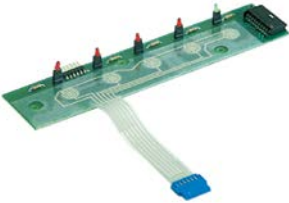

1			
<b>GEV No.</b>	402607	<b>Ref. No.</b>	537-036 700 537-036 708
<b>description</b>	display for coffee machine model E92 C		





1 			
<b>GEV No.</b>	402829	<b>Ref. No.</b>	903-007 000 903-007 008
<b>description</b>	keypad PCB 2 groups L 469mm W 44mm suitable for FAEMA JUBILE buttons 11 for E61		

1 			
<b>GEV No.</b>	400585	<b>Ref. No.</b>	3301135184
<b>description</b>	keypad PCB mounting pos. left		
<b>accessories for</b>	400585		
	<b>GEV No.</b>	400304	<b>Ref. No.</b> 4831-132 302
buttons strip mounting pos. centre buttons 5 L 166mm W 22mm			

1 			
<b>GEV No.</b>	400574	<b>Ref. No.</b>	3301-134 295 3301-134 925
<b>description</b>	keypad PCB suitable for FAEMA DIPLOMAT buttons 3 for E91 A		
<b>accessories for</b>	400574		
	<b>GEV No.</b>	400307	<b>Ref. No.</b> 4533-133 828
push button dark grey suitable for FAEMA			
	<b>GEV No.</b>	400575	<b>Ref. No.</b> 4831-134 292
buttons strip buttons 3 L 77mm W 59mm			

1 			
<b>GEV No.</b>	400302	<b>Ref. No.</b>	3301-132 571 909954008
<b>description</b>	keypad PCB suitable for FAEMA DIPLOMAT mounting pos. right buttons 6 for E91		
<b>accessories for</b>	400302		
	<b>GEV No.</b>	400305	<b>Ref. No.</b> 4831-132 303
buttons strip			

1 			
<b>GEV No.</b>	402611	<b>Ref. No.</b>	902-768 008 902768000
<b>description</b>	keypad PCB suitable for FAEMA ELITE mounting pos. centre buttons 5 for E92 A		



1 			
<b>GEV No.</b>	402614	<b>Ref. No.</b>	902-771 008 902771000
<b>description</b>	keypad PCB suitable for FAEMA ELITE mounting pos. centre buttons 5 for E92 S		

1 			
<b>GEV No.</b>	402613	<b>Ref. No.</b>	902-769 008 902769000
<b>description</b>	keypad PCB suitable for FAEMA ELITE mounting pos. left buttons 6 for E92 S		

1 			
<b>GEV No.</b>	402612	<b>Ref. No.</b>	902-767 008 902767000
<b>description</b>	keypad PCB suitable for FAEMA ELITE mounting pos. right buttons 9 for E92 A		

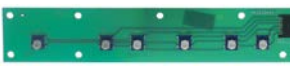

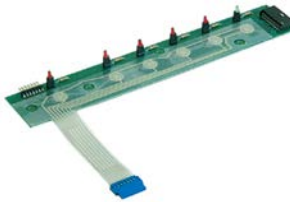
1 			
<b>GEV No.</b>	402615	<b>Ref. No.</b>	902-770 008 902770000
<b>description</b>	keypad PCB suitable for FAEMA ELITE mounting pos. right buttons 9 for E92 S		

1 			
<b>GEV No.</b>	402616	<b>Ref. No.</b>	903-510 018 903510010
<b>description</b>	keypad PCB suitable for FAEMA JUBILE 1 group buttons 6 for E61		

1 			
<b>GEV No.</b>	400300	<b>Ref. No.</b>	3301-132 570
<b>description</b>	keypad PCB suitable for FAEMA mounting pos. left buttons 6 for E91		
<b>accessories for</b>	400300		
	<b>GEV No.</b>	400303	<b>Ref. No.</b> 4831-132 300
buttons strip mounting pos. left buttons 6 L 190mm W 17mm			

1 			
<b>GEV No.</b>	402610	<b>Ref. No.</b>	902-766 008 902766000
<b>description</b>	keypad PCB suitable for FAEMA mounting pos. left buttons 6 for E92 A		

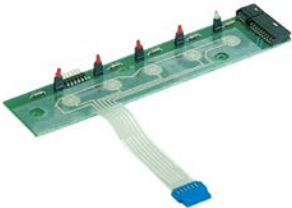



			
1			
<b>GEV No.</b>	400301	<b>Ref. No.</b>	3301-131 572 3301-132 572
<b>description</b>	keypad PCB suitable for FAEMA with LED mounting pos. centre buttons 5 for E91		
<b>accessories for</b>	400301		
	<b>GEV No.</b>	400304	<b>Ref. No.</b> 4831-132 302
	buttons strip mounting pos. centre buttons 5 L 166mm W 22mm		

			
1			
<b>GEV No.</b>	400680	<b>Ref. No.</b>	3341132868 3341135683 537029600
<b>description</b>	PCB		

 Image not available			
1			
<b>GEV No.</b>	400681	<b>Ref. No.</b>	3761130706
<b>description</b>	PCB		

 Image not available			
1			
<b>GEV No.</b>	400682	<b>Ref. No.</b>	3761130707
<b>description</b>	PCB		

			
1			
<b>GEV No.</b>	400683	<b>Ref. No.</b>	3761130708
<b>description</b>	PCB		

			
1			
<b>GEV No.</b>	400684	<b>Ref. No.</b>	3761-119 516
<b>description</b>	PCB coffee machine		

			
1			
<b>GEV No.</b>	403440	<b>Ref. No.</b>	952846000 952846010
<b>description</b>	PCB coffee machine		

			
1			
<b>GEV No.</b>	400685	<b>Ref. No.</b>	3301-132 720 3301-132 721 3301134346 3341-134 037 3341-134 038 3341134039 3341134819 3341-135 069 3342133152 3342133153 3761-132 135 3761-132 142
<b>description</b>	PCB E91 FAEMA series DIPLOMAT		

			
1			
<b>GEV No.</b>	402621	<b>Ref. No.</b>	920-757 008 920-757 018 920-757 028
<b>description</b>	PCB E92 A / EMBLEMA RESTYLING FAEMA		



1

<b>GEV No.</b>	402620	<b>Ref. No.</b>	537-029 500
<b>description</b>	PCB E92 A FAEMA series ELITE		



1

<b>GEV No.</b>	402608	<b>Ref. No.</b>	902-038 000 902-038 008
<b>description</b>	PCB E92 A green LED triple		



1

<b>GEV No.</b>	402609	<b>Ref. No.</b>	902-039 000 902-039 010 902-039 018
<b>description</b>	PCB E92 S cable length 110mm green LED triple		



1

<b>GEV No.</b>	401299	<b>Ref. No.</b>	3341-134 100 5370-296 000 537-031 801 918-910 008
<b>description</b>	PCB FAEMA series E97, E98 NA32		



1

<b>GEV No.</b>	402617	<b>Ref. No.</b>	535-517 008
<b>description</b>	PCB for sensor RESTYLING A series E92		



1

<b>GEV No.</b>	402606	<b>Ref. No.</b>	3341-132 863 3341-135 935 535-514 008 903-011 000
<b>description</b>	PCB level regulator PRESIDENT S L 90mm W 70mm 230V		
<b>For models:</b>	PRESIDENT		

### Triacs



1

<b>GEV No.</b>	400032	<b>Ref. No.</b>	4761117735
<b>description</b>	Triac		

### keypads

#### membrane keypads



1

<b>GEV No.</b>	400437	<b>Ref. No.</b>	3301134529
<b>description</b>	membrane keypad		

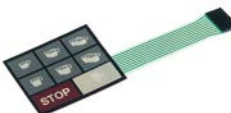

1

<b>GEV No.</b>	400672	<b>Ref. No.</b>	3301132463 3529091848
<b>description</b>	membrane keypad		



1

<b>GEV No.</b>	401407	<b>Ref. No.</b>	3301-134 930
<b>description</b>	membrane keypad		

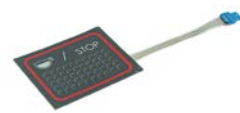

 <p>1 Image not available</p>			
<b>GEV No.</b>	400670	<b>Ref. No.</b>	442127000
<b>description</b>	membrane keypad 1 group suitable for FAEMA		

 <p>1</p>			
<b>GEV No.</b>	400675	<b>Ref. No.</b>	3301-134 530 3301-134 648
<b>description</b>	membrane keypad suitable for FAEMA L 68mm W 58mm		

control panel

 <p>2</p>			
<b>GEV No.</b>	400671	<b>Ref. No.</b>	495286000
<b>description</b>	membrane keypad 2 groups suitable for FAEMA		

 <p>1</p>			
<b>GEV No.</b>	531190	<b>Ref. No.</b>	4538134243
<b>description</b>	keypad housing L 240mm anthracite H 100mm for E91 A FAEMA		

 <p>1</p>			
<b>GEV No.</b>	400674	<b>Ref. No.</b>	3301-134 647
<b>description</b>	membrane keypad coffee machine buttons 6 L 58mm W 68mm		

accessories

 <p>1</p>			
<b>GEV No.</b>	400081	<b>Ref. No.</b>	3761131514
<b>description</b>	membrane keypad coffee machine COMPACT		

 <p>1</p>			
<b>GEV No.</b>	400305	<b>Ref. No.</b>	4831-132 303
<b>description</b>	buttons strip		

 <p>1</p>			
<b>GEV No.</b>	400309	<b>Ref. No.</b>	3301-132 827 3301-132 842
<b>description</b>	membrane keypad coffee machine DUE suitable for FAEMA old edition		

 <p>1</p>			
<b>GEV No.</b>	402599	<b>Ref. No.</b>	902-829 000
<b>description</b>	buttons strip buttons 1 L 30mm W 42mm gold		

 <p>1</p>			
<b>GEV No.</b>	401408	<b>Ref. No.</b>	3301-134 927
<b>description</b>	membrane keypad coffee machine parts buttons 6 suitable for FAEMA L 176mm W 49mm		

 <p>1</p>			
<b>GEV No.</b>	402600	<b>Ref. No.</b>	902-704 000
<b>description</b>	buttons strip buttons 1 L 30mm W 42mm silver		



 <p>1</p>			
<b>GEV No.</b>	400321	<b>Ref. No.</b>	902-037 010 902037000
<b>description</b>	membrane keypad L 149mm W 36mm		

 <p>1</p>			
<b>GEV No.</b>	402601	<b>Ref. No.</b>	902-703 000
<b>description</b>	buttons strip buttons 1 L 38mm W 42mm silver		





			
1			
<b>GEV No.</b>	402595	<b>Ref. No.</b>	902-828 000
<b>description</b>	buttons strip buttons 1 L 42mm W 37mm gold suitable for FAEMA for E92 ELITE		

			
1			
<b>GEV No.</b>	400581	<b>Ref. No.</b>	4831-134 255
<b>description</b>	buttons strip buttons 1 L 52mm W 22mm		

			
1			
<b>GEV No.</b>	400575	<b>Ref. No.</b>	4831-134 292
<b>description</b>	buttons strip buttons 3 L 77mm W 59mm		
<b>accessories for</b>	400575		
	<b>GEV No.</b>	400307	<b>Ref. No.</b> 4533-133 828
	push button dark grey suitable for FAEMA		
	<b>GEV No.</b>	402604	<b>Ref. No.</b> 4538-133 828
	push button dark blue suitable for FAEMA		

			
1			
<b>GEV No.</b>	402597	<b>Ref. No.</b>	902-827 000
<b>description</b>	buttons strip mounting pos. centre buttons 5 L 163mm W 42mm gold		

			
1			
<b>GEV No.</b>	402655	<b>Ref. No.</b>	902-702 000
<b>description</b>	buttons strip mounting pos. centre buttons 5 L 163mm W 42mm silver suitable for FAEMA for E92 A		

			
1			
<b>GEV No.</b>	400304	<b>Ref. No.</b>	4831-132 302
<b>description</b>	buttons strip mounting pos. centre buttons 5 L 166mm W 22mm		

			
1			
<b>GEV No.</b>	400303	<b>Ref. No.</b>	4831-132 300
<b>description</b>	buttons strip mounting pos. left buttons 6 L 190mm W 17mm		

			
1			
<b>GEV No.</b>	402596	<b>Ref. No.</b>	902-826 010
<b>description</b>	buttons strip mounting pos. left buttons 6 L 205mm W 42mm gold suitable for FAEMA for E92 ELITE		

			
1			
<b>GEV No.</b>	402654	<b>Ref. No.</b>	902-701 010 902701000
<b>description</b>	buttons strip mounting pos. left buttons 6 L 205mm W 42mm silver suitable for FAEMA for E92 A		

			
1			
<b>GEV No.</b>	402598	<b>Ref. No.</b>	902-825 000
<b>description</b>	buttons strip mounting pos. right buttons 9 L 305mm W 42mm gold		

			
1			
<b>GEV No.</b>	402656	<b>Ref. No.</b>	902-700 000
<b>description</b>	buttons strip mounting pos. right buttons 9 L 305mm W 42mm silver suitable for FAEMA for E92 A		



			
1			
<b>GEV No.</b>	402605	<b>Ref. No.</b>	903-003 007
<b>description</b>	push button chrome suitable for FAEMA for JUBILE E61		

			
1			
<b>GEV No.</b>	402604	<b>Ref. No.</b>	4538-133 828
<b>description</b>	push button dark blue suitable for FAEMA		

			
1			
<b>GEV No.</b>	402602	<b>Ref. No.</b>	3538-133 898
<b>description</b>	push button dark blue/chrome suitable for FAEMA		



			
1			
<b>GEV No.</b>	400307	<b>Ref. No.</b>	4533-133 828
<b>description</b>	push button dark grey suitable for FAEMA		

			
1			
<b>GEV No.</b>	347362	<b>Ref. No.</b>	902-114 000
<b>description</b>	push button grey suitable for FAEMA series E92 ELITE		
<b>spare parts for</b>	347362		
	<b>GEV No.</b>	346104	<b>Ref. No.</b> —
	rotary switch 2 0-1 sets of contacts 3 type CA0170003 400V 20A shaft ø 5x5mm shaft L 21mm shaft square connection screw		

			
1			
<b>GEV No.</b>	347370	<b>Ref. No.</b>	902-304 004
<b>description</b>	push button LUX gold suitable for FAEMA series E92 ELITE		

			
1			
<b>GEV No.</b>	403053	<b>Ref. No.</b>	3531-134 911 990-728 000
<b>description</b>	push button ø 20mm H 21mm red/chrome		

			
1			
<b>GEV No.</b>	347451	<b>Ref. No.</b>	902-458 000
<b>description</b>	push button suitable for FAEMA series E92 A ELITE		

## solenoid valves

### solenoid valves (water)

metal

LUCIFER

2-way

121F series



			
1			
<b>GEV No.</b>	370592 <sup>1</sup>	<b>Ref. No.</b>	2441-134 294 533-898 300R
<b>description</b>	solenoid valve 2-ways 230VAC DN 1.5mm slide-on receptacle DIN -10 up to 140°C PARKER type series 121F coil type 483510S6 XS03XS6 F membranes ruby p max 20bar with flange plate flange 32x32mm nickel-plated brass inlet 6.1mm outlet 3.3mm		

<sup>1</sup>nickel-plated

			
1			
<b>GEV No.</b>	370626 <sup>1</sup>	<b>Ref. No.</b>	533-893 300 533-893 300R
<b>description</b>	solenoid valve 2-ways 24V DN 1.5mm slide-on receptacle DIN -10 up to 140°C PARKER type series 121F coil type 483510P0 XS03M F membranes ruby p max 20bar flange 32x32mm nickel-plated brass		

<sup>1</sup>nickel-plated

### 7121ZBG series

			
1			
<b>GEV No.</b>	370594 <sup>1</sup>	<b>Ref. No.</b>	2441135475 533-798 300 533-798 310 533-798 310R 533-895-200R
<b>description</b>	solenoid valve 2-ways 230VAC connection 1/8" L 30mm DN 2.5mm slide-on receptacle DIN -10 up to 140°C PARKER type series 7121ZBG coil type 483510S6 XS03XS6 F membranes FKM (water/steam) p max 10bar p min 0bar nickel-plated brass		
<b>spare parts for</b>	370594		
	<b>GEV No.</b>	371031	<b>Ref. No.</b> —
	solenoid coil LUCIFER-PARKER 230VAC 9VA coil type DZ06S6 seat ø 15mm		
<b>accessories for</b>	370594		
	<b>GEV No.</b>	371090	<b>Ref. No.</b> —
	power socket plug type DIN 43650A screw		





<sup>1</sup>nickel-plated





3-way			
131F series			
			
1			
<b>GEV No.</b>	370776	<b>Ref. No.</b>	533-894-600R
<b>description</b>	solenoid valve 2-ways 230VAC DN 1.5/2.5mm -10 up to 140°C PARKER type series 131F coil type DZ06S6 membranes ruby p max 10bar p min 0bar flange 32x32mm nickel-plated brass		
<b>spare parts for</b>	370776		
	<b>GEV No.</b>	371031	<b>Ref. No.</b> —
	solenoid coil LUCIFER-PARKER 230VAC 9VA coil type DZ06S6 seat ø 15mm		
<b>accessories for</b>	370776		
	<b>GEV No.</b>	371090	<b>Ref. No.</b> —
	power socket plug type DIN 43650A screw		

			
1			
<b>GEV No.</b>	370593 <sup>1</sup>	<b>Ref. No.</b>	533795500 533795510 533795510R 533-894 500R
<b>description</b>	solenoid valve 3-ways 24VAC DN 1.5/2.5mm slide-on receptacle DIN -10 up to 140°C PARKER type series 131F coil type 483510P0 XS03M F membranes ruby p max 10bar p min 0bar flange 32x32mm nickel-plated brass		

<sup>1</sup>nickel-plated

			
1			
<b>GEV No.</b>	370054	<b>Ref. No.</b>	484074000
<b>description</b>	solenoid valve 3-ways 24VAC DN 2.5mm slide-on receptacle DIN -10 up to 140°C type series 131F coil type DZ06P0 membranes FKM (water/steam) p max 10bar flange 32x32mm		
<b>spare parts for</b>	370054		
	<b>GEV No.</b>	370061	<b>Ref. No.</b> FA03
	solenoid valve body LUCIFER-PARKER 3-ways outer cone		
	<b>GEV No.</b>	371032	<b>Ref. No.</b> —
	solenoid coil LUCIFER-PARKER 24VAC 9VA 50/60Hz coil type DZ06P0 seat ø 15mm		
<b>accessories for</b>	370054		
	<b>GEV No.</b>	371090	<b>Ref. No.</b> —
	power socket plug type DIN 43650A screw		
	<b>GEV No.</b>	371095	<b>Ref. No.</b> —
	O-ring Viton thickness 1.78mm ID ø 6.07mm Qty 1 pcs		

<b>accessories for</b>	370054		
	<b>GEV No.</b>	371100	<b>Ref. No.</b> —
	O-ring silicone thickness 1.78mm ID ø 6.07mm Qty 1 pcs		

131K series			
			
1			
<b>GEV No.</b>	370595	<b>Ref. No.</b>	533-895 800
<b>description</b>	solenoid valve 3-ways 230VAC connection 1/4" L 40mm DN 2.5mm slide-on receptacle DIN -10 up to 140°C PARKER type series 131K coil type 483510S6 F DZ06S6 membranes ruby p max 5bar brass DN 1 3mm DN 2 2.5mm		

spare parts and accessories			
valve bodies			
			
1			
<b>GEV No.</b>	370061	<b>Ref. No.</b>	FA03
<b>description</b>	solenoid valve body LUCIFER-PARKER 3-ways outer cone		

PARKER			
spare parts and accessories			
valve bodies			
			
1			
<b>GEV No.</b>	370062	<b>Ref. No.</b>	FA02 FA03
<b>description</b>	solenoid valve body PARKER 3-ways outer cone		

<b>accessories for</b>	370062		
	<b>GEV No.</b>	371029	<b>Ref. No.</b> —
	solenoid coil PARKER 230VAC 9VA coil type ZB09 seat ø 14mm H 33mm W 34mm D 43mm		
	<b>GEV No.</b>	371030	<b>Ref. No.</b> —
	solenoid coil 24VDC 12VA coil type ZB12 seat ø 14mm		
	<b>GEV No.</b>	371033	<b>Ref. No.</b> —
	solenoid coil PARKER 230VAC 9VA coil type YB09 with cable seat ø 14mm		
	<b>GEV No.</b>	371036	<b>Ref. No.</b> —
	solenoid coil 24VAC 9VA coil type ZB09 seat ø 14mm		
	<b>GEV No.</b>	371095	<b>Ref. No.</b> —
	O-ring Viton thickness 1.78mm ID ø 6.07mm Qty 1 pcs		

Table continues overleaf







<b>accessories for</b>	370062		
	<b>GEV No.</b>	371100	<b>Ref. No.</b> —
	O-ring silicone thickness 1.78mm ID ø 6.07mm Qty 1 pcs		

## pressure switches

### for coffee machines

#### miscellaneous

	1		
<b>GEV No.</b>	541157	<b>Ref. No.</b>	468901022 537030700 F468901022
<b>description</b>	pressure control		

	1		
<b>GEV No.</b>	541021	<b>Ref. No.</b>	2231116597
<b>description</b>	pressure control pressure range adjustable 0.5-1.4bar connection 1/4" 30A 3-pole type P302 coffee machine parts SIRAI		
<b>accessories for</b>	541021		
	<b>GEV No.</b>	550262	<b>Ref. No.</b> —
	flat gasket copper ED ø 20mm ID ø 14mm thickness 2mm		
	<b>GEV No.</b>	890100	<b>Ref. No.</b> —
	PTFE tape reel L 12m W 12mm -200 up to +260°C approval DIN-DVGW, KTW temperature-resistant, elastic for fine thread thickness 0.1mm		

## flow meters and flow sensors

### flow meters

#### GICAR

	1		
<b>GEV No.</b>	403410	<b>Ref. No.</b>	534391800 534392300 534393100
<b>description</b>	flow controller thread 1/4" stainless steel coded approval NSF		

#### accessories

	1		
<b>GEV No.</b>	400258	<b>Ref. No.</b>	4701030130
<b>description</b>	O-ring for flow meter		

#### DIGMESA

	1		
<b>GEV No.</b>	400005	<b>Ref. No.</b>	2251131855
<b>description</b>	flow meter thread 1/4" brass with piggyback approval NSF reducer ø 1mm connection cable		

#### accessories

	1		
<b>GEV No.</b>	400259	<b>Ref. No.</b>	4831091782
<b>description</b>	impellor for DIGMESA		

## pumps

### booster pumps II



#### pump motors

#### flange connection

	1		
<b>GEV No.</b>	500076	<b>Ref. No.</b>	2441116600
<b>description</b>	pump motor AF type SEC10256/A 170W 230V 50/60Hz connection flange L 190mm W 100mm H 150mm capacitor 10µF		
<b>accessories for</b>	500076		
	<b>GEV No.</b>	500314	<b>Ref. No.</b> —
	coupling ø 40mm shaft diameter 10/11mm		

Table continues overleaf



<b>accessories for</b>	500076		
	GEV No.	520158	Ref. No. —
	elastic coupling ø 40mm rubber		
	GEV No.	525651	Ref. No. —
	coupling ø 40mm for shaft 3.5x7.5 for FAEMA		



<b>GEV No.</b>	500077	<b>Ref. No.</b>	2441133416 530298400
<b>description</b>	pump motor AF type SEC10256/B 170W 230V 50/60Hz connection flange L 185mm W 110mm H 115mm capacitor 10µF		
<b>accessories for</b>	500077		
	GEV No.	500066	Ref. No. —
	coupling set ø 40mm shaft intake ø 10/11mm		

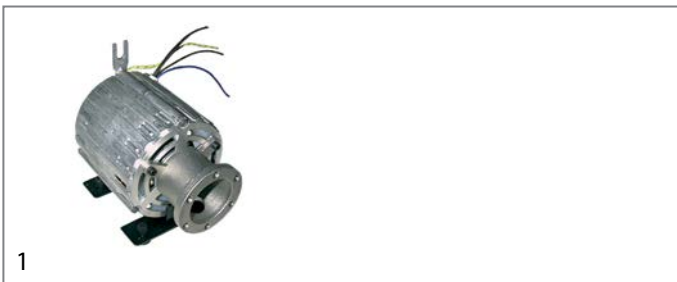

<b>GEV No.</b>	500062	<b>Ref. No.</b>	1000091851
<b>description</b>	pump motor RPM type 11039002 150W 230V 50Hz connection flange L 185mm W 155mm H 170mm capacitor 10µF		
<b>accessories for</b>	500062		
	GEV No.	365015	Ref. No. 2341-119 567
	operating capacitor capacity 10µF 400V tolerance 5%Hz ambient temperature max. -25 to +85°C ø 35.5mm L 59mm M8 plastic connection male faston 6.3mm protection		

clip connection

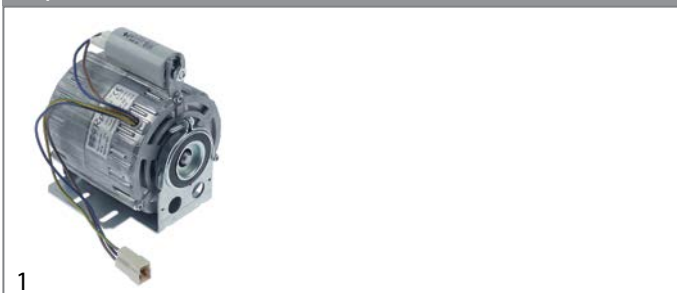

<b>GEV No.</b>	500442	<b>Ref. No.</b>	530-290-800
<b>description</b>	motor RPM type 11002708 165W 230V 50/60Hz connection clip capacitor 10µF shaft ø 13mm		

pump heads

FLUID-O-TECH





<b>GEV No.</b>	500078	<b>Ref. No.</b>	N/A
<b>description</b>	pump head FA204 FLUID-O-TECH L 75mm 200l/h connection 3/8" GAS with bypass brass 2 hole flange for coffee machine shaft ø 11mm		

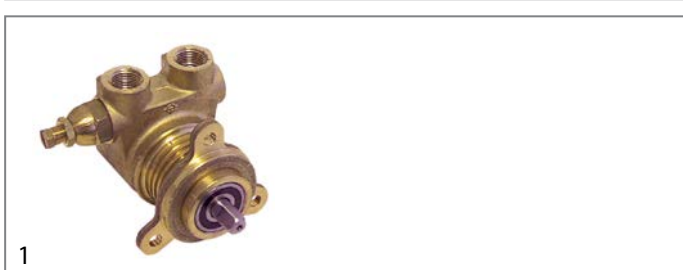

<b>GEV No.</b>	501499	<b>Ref. No.</b>	2241130176 462707010 462713000 462714000 462991000 462991010 533180000 533180010 533197900 533408000 537048400 537048500
<b>description</b>	pump head FLUID-O-TECH 180l/h connection 3/8" GAS		



<b>GEV No.</b>	500065	<b>Ref. No.</b>	N/A
<b>description</b>	pump head PA204F FLUID-O-TECH L 82mm 200l/h connection 3/8" NPT with bypass brass 3 hole flange for coffee machine shaft ø 11/10mm		
<b>accessories for</b>	500065		
	GEV No.	500314	Ref. No. —
	coupling ø 40mm shaft diameter 10/11mm		
	GEV No.	520158	Ref. No. —
	elastic coupling ø 40mm rubber		



miscellaneous



1

<b>GEV No.</b>	499130	<b>Ref. No.</b>	N/A
<b>description</b>	pump head L 71mm 150l/h connection 3/8" GAS shaft ø 3.5x7.5mm		

accessories



1

<b>GEV No.</b>	525210	<b>Ref. No.</b>	4821-135 956
<b>description</b>	coupling ø 35mm H 11.5mm shaft diameter 3.5x7.5mm for FAEMA		



1

<b>GEV No.</b>	525209	<b>Ref. No.</b>	4081-135 955
<b>description</b>	elastic coupling ø 35mm H 5.5mm rubber		



1

<b>GEV No.</b>	365015	<b>Ref. No.</b>	2341-119 567
<b>description</b>	operating capacitor capacity 10µF 400V tolerance 5%Hz ambient temperature max. -25 to +85°C ø 35.5mm L 59mm M8 plastic connection male faston 6.3mm protection		

vibration pumps



1

<b>GEV No.</b>	500123	<b>Ref. No.</b>	125219 533197400
----------------	--------	-----------------	---------------------

<b>description</b>	vibration pump type 1106PAALM1N 230V 50Hz 70W inlet ø 1/8" IT outlet ø 1/8" IT outlet conical L 129mm FLUID-O-TECH		
--------------------	--	--	--

<b>accessories for</b>	500123		
------------------------	--------	--	--

 <b>GEV No.</b>	371090	<b>Ref. No.</b>	—
--	--------	-----------------	---

power socket plug type DIN 43650A screw

<b>GEV No.</b>	371120	<b>Ref. No.</b>	—
----------------	--------	-----------------	---

diode type IN5408

<b>GEV No.</b>	390698	<b>Ref. No.</b>	—
----------------	--------	-----------------	---

thermal fuse switch-off temp. 110°C suitable for ULKA pump



1

<b>GEV No.</b>	500173	<b>Ref. No.</b>	N/A
----------------	--------	-----------------	-----

<b>description</b>	vibration pump type EP 5 230V 48W 50Hz inlet ø 6 outlet ø 1/8" IT ULKA outlet flat plastic L 123mm		
--------------------	--	--	--

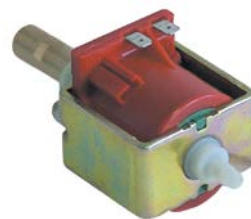

1

<b>GEV No.</b>	500124	<b>Ref. No.</b>	N/A
----------------	--------	-----------------	-----

<b>description</b>	vibration pump type EX 5 230V 48W 50/60Hz inlet ø 6 outlet ø 1/8" IT flat seal ULKA brass L 123mm		
--------------------	---	--	--

<b>accessories for</b>	500124		
------------------------	--------	--	--

 <b>GEV No.</b>	520152	<b>Ref. No.</b>	—
--	--------	-----------------	---

hose connector Santoprene grommet ø 7mm grommet length 14mm

 <b>GEV No.</b>	520330	<b>Ref. No.</b>	—
--	--------	-----------------	---

bracket rubber dimensions 69x44x4mm



pumps for ice machines

			
1			
<b>GEV No.</b>	500047	<b>Ref. No.</b>	889125070
<b>description</b>	pump REBO type MH30F1 30W 230V 50Hz outlet ø 12.7mm L 135mm rotation direction left		

			
1			
<b>GEV No.</b>	365125	<b>Ref. No.</b>	2341-134 750 965473000
<b>description</b>	operating capacitor capacity 8µF 420/470V tolerance 5% ø 35mm L 58mm plastic-coated		

condensators & interference suppression filters

operating capacitors

plastic

			
1			
<b>GEV No.</b>	365015	<b>Ref. No.</b>	2341-119 567
<b>description</b>	operating capacitor capacity 10µF 400V tolerance 5%Hz ambient temperature max. -25 to +85°C ø 35.5mm L 59mm M8 plastic connection male faston 6.3mm protection		

			
1			
<b>GEV No.</b>	365124	<b>Ref. No.</b>	3341-134 535 965-506 000
<b>description</b>	operating capacitor capacity 8µF 420V tolerance 5% 50/60Hz ambient temperature max. -25 to +85°C ø 35mm L 60mm with discharge resistor M8 plastic connection male faston 6.3mm protection		

			
1			
<b>GEV No.</b>	365123	<b>Ref. No.</b>	124744 3341-115 503
<b>description</b>	operating capacitor capacity 12.5µF 425V tolerance 5% 50/60Hz ambient temperature max. -25 to +85°C ø 36mm L 74mm plastic M8 plastic connection male faston 6.3mm 16.10.18SA protection		
<b>For models:</b>	MC90		

<p>metal</p> 			
1			
<b>GEV No.</b>	365131	<b>Ref. No.</b>	531404100 531-492 800
<b>description</b>	capacitor capacity 5µF 450V tolerance 5% 50/60Hz ambient temperature max. -25 to +85°C ø 30mm L 60mm M8 aluminium connection male faston 6.3mm protection		

			
1			
<b>GEV No.</b>	365021	<b>Ref. No.</b>	3341-131 517
<b>description</b>	operating capacitor capacity 16µF 425V tolerance 5% 50/60Hz ambient temperature max. -25 to +85°C ø 35mm L 73mm single M8 plastic connection male faston 6.3mm 416.10.99 protection		
<b>For models:</b>	MC90		

fuses

fine fuses

			
1			
<b>GEV No.</b>	358661	<b>Ref. No.</b>	3501-117 399
<b>description</b>	fine fuse size ø5x20mm 0.1A fast-acting rated 250V Qty 10 pcs		

			
1			
<b>GEV No.</b>	358677	<b>Ref. No.</b>	3501-117 396
<b>description</b>	fine fuse size ø5x20mm 4A fast-acting rated 250V Qty 10 pcs		



			
1			
<b>GEV No.</b>	358533	<b>Ref. No.</b>	530-115 100
<b>description</b>	fine fuse size ø5x20mm 6.3A fast-acting rated 250V Qty 10 pcs		

			
1			
<b>GEV No.</b>	358509	<b>Ref. No.</b>	3501-091 867
<b>description</b>	fine fuse size ø5x20mm 0.05A slow-acting rated 250V Qty 1 pcs		

			
1			
<b>GEV No.</b>	358596	<b>Ref. No.</b>	3501-117 398
<b>description</b>	fine fuse size ø5x20mm 0.25A slow-acting rated 250V Qty 10 pcs		

## electric accessories

### cables

#### accessories

#### cable glands

#### cable glands

			
1			
<b>GEV No.</b>	550310	<b>Ref. No.</b>	532123500
<b>description</b>	cable gland ID ø 5mm mounting ø 7mm ED ø 11mm Neoprene -30 up to +90°C Qty 10 pcs		

## equipment-specific units

### for espresso machines

#### filter holders

#### filter holders standard

#### filter holder without spout

			
1			
<b>GEV No.</b>	525984	<b>Ref. No.</b>	N/A
<b>description</b>	filter holder suitable for AURORA/BRASILIA/FAEMA without outlet mounting ø 82.5mm outlet 3/8" ID ø 62mm wedge height 10.5mm wedge position horizontal number of wedges 2 lever straight		

#### filter holders short

			
1			
<b>GEV No.</b>	529041	<b>Ref. No.</b>	N/A
<b>description</b>	filter holder mounting ø 82.5mm outlet 3/8" ID ø 62mm handle M12x1.75 wedge height 10.5mm wedge position horizontal number of wedges 2 lever straight chrome-plated brass		

			
1			
<b>GEV No.</b>	525650	<b>Ref. No.</b>	N/A
<b>description</b>	filter holder mounting ø 83mm outlet M16x1 ID ø 62mm handle M10x1.5 wedge position horizontal number of wedges 2 lever straight chrome-plated brass		

#### handles

#### with bore

			
1			
<b>GEV No.</b>	529046	<b>Ref. No.</b>	N/A
<b>description</b>	handle ø 31mm aperture 13x13mm L 90mm black		

			
1			
<b>GEV No.</b>	529047	<b>Ref. No.</b>	N/A
<b>description</b>	handle ø 35mm aperture 13x13mm L 95mm black		

#### spouts

#### accessories

			
1			
<b>GEV No.</b>	527633	<b>Ref. No.</b>	4162-015 073
<b>description</b>	cover L 54mm W 13mm H 23mm stainless steel		

filters

for 1 cup



1

<b>GEV No.</b>	531277	<b>Ref. No.</b>	457232000
<b>description</b>	coffee filter ø 69mm mounting ø 60mm H 18mm cups 1 amount of coffee 6g stainless steel		



1

<b>GEV No.</b>	529075	<b>Ref. No.</b>	N/A
<b>description</b>	coffee filter ø 70mm mounting ø 60.5mm H 24.5mm cups 1 amount of coffee 7g ECONOMY		



1

<b>GEV No.</b>	527631	<b>Ref. No.</b>	N/A
<b>description</b>	coffee filter ø 70mm mounting ø 60.7mm H 17mm cups 1 amount of coffee 8g		



1

<b>GEV No.</b>	529012	<b>Ref. No.</b>	N/A
<b>description</b>	coffee filter ø 70mm mounting ø 60.8mm H 19.5mm cups 1 amount of coffee 6g		



1

<b>GEV No.</b>	529011	<b>Ref. No.</b>	N/A
<b>description</b>	coffee filter ø 70mm mounting ø 60mm H 24.5mm cups 1 amount of coffee 7g perforation ø 0.4mm		

for 2 cups



1

<b>GEV No.</b>	531278	<b>Ref. No.</b>	458171000
<b>description</b>	coffee filter ø 68mm mounting ø 60mm H 25.5mm cups 2 amount of coffee 14g		



1

<b>GEV No.</b>	531279	<b>Ref. No.</b>	457233000
<b>description</b>	coffee filter ø 69mm mounting ø 60mm H 22mm cups 2 amount of coffee 12g		



1

<b>GEV No.</b>	529076	<b>Ref. No.</b>	N/A
<b>description</b>	coffee filter ø 70mm mounting ø 60.8mm H 24.5mm cups 2 amount of coffee 14g ECONOMY		

brewing units

shower screens

with upstand



1

<b>GEV No.</b>	529083	<b>Ref. No.</b>	N/A
<b>description</b>	shower screen ø 58mm H 19mm		



1

<b>GEV No.</b>	531275	<b>Ref. No.</b>	457560000
<b>description</b>	shower screen ø 58mm H 19mm		

			
1			
<b>GEV No.</b>	529080	<b>Ref. No.</b>	4771026100
<b>description</b>	shower screen ø 58mm H 20mm		

filter holder gaskets			
flat			
with internal notch			
			
1			
<b>GEV No.</b>	528070	<b>Ref. No.</b>	N/A
<b>description</b>	filter holder gasket D1 ø 74mm D2 ø 57.5mm H 8mm with inside notch Qty 1 pcs		

standard			
			
1			
<b>GEV No.</b>	528032	<b>Ref. No.</b>	N/A
<b>description</b>	filter holder gasket D1 ø 73mm D2 ø 57mm H 9mm Qty 1 pcs		

shim gaskets			
			
1			
<b>GEV No.</b>	528033	<b>Ref. No.</b>	N/A
<b>description</b>	shim gasket D1 ø 71mm D2 ø 58mm thickness 0.8mm paper Qty 1 pcs		

brewing units with solenoid valve			
gaskets			
			
1			
<b>GEV No.</b>	528350	<b>Ref. No.</b>	4701-116 687
<b>description</b>	O-ring Viton thickness 2.62mm ID ø 9.13mm Qty 1 pcs		

brewing units manual			
components			
drain units			
drain pipes			
			
1			
<b>GEV No.</b>	525330	<b>Ref. No.</b>	4822-135 919 903-164 000
<b>description</b>	drain pipe thread M30x1.5 T1: 1/2" int. ø 1 28mm int. ø 2 19mm L 72mm WS 36 L1 36mm L2 23mm suitable for FAEMA for E61		

			
1			
<b>GEV No.</b>	528538	<b>Ref. No.</b>	4152-135 921
<b>description</b>	end piece thread 1/2" int. ø 1 12mm int. ø 2 15mm L 36mm chrome-plated brass WS 26		

gaskets			
			
1			
<b>GEV No.</b>	525309	<b>Ref. No.</b>	402-205 000 4701-019 545
<b>description</b>	gasket ED ø 13mm ID ø 4mm H 4mm Qty 1 pcs Viton		

tap aerators			
			
1			
<b>GEV No.</b>	527872	<b>Ref. No.</b>	4151-135 920
<b>description</b>	tap aerator ID ø 6mm brass ED ø 15mm L 14mm		

bushes			
			
1			
<b>GEV No.</b>	528541	<b>Ref. No.</b>	4151-135 904
<b>description</b>	bush D1 ø 15mm D2 ø 10.8mm ID ø 8mm H 30mm brass		



## gaskets

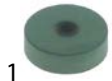

1

<b>GEV No.</b>	525309	<b>Ref. No.</b>	402-205 000 4701-019 545
----------------	--------	-----------------	-----------------------------

**description** gasket ED ø 13mm ID ø 4mm H 4mm Qty 1 pcs Viton



1

<b>GEV No.</b>	525311	<b>Ref. No.</b>	4701-135 888
----------------	--------	-----------------	--------------

**description** group gasket L 77mm W 72mm thickness 2mm aperture 9mm hole distance 56mm suitable for FAEMA PTFE

## miscellaneous



1

<b>GEV No.</b>	528546	<b>Ref. No.</b>	N/A
----------------	--------	-----------------	-----

**description** adjusting ring for brewing unit suitable for FAEMA series E64, E66, P4, P6



1

<b>GEV No.</b>	525341	<b>Ref. No.</b>	4021-135 902
----------------	--------	-----------------	--------------

**description** locking screw for cam shaft suitable for FAEMA E61 series LEGEND



1

<b>GEV No.</b>	525318	<b>Ref. No.</b>	4831-135 865
----------------	--------	-----------------	--------------

**description** shaft bearing suitable for FAEMA E61

## levers

## levers



1

<b>GEV No.</b>	525302	<b>Ref. No.</b>	4831-135 866
----------------	--------	-----------------	--------------

**description** actuator L 56mm for FAEMA model E61 LEGEND

**accessories for** 525302



1

<b>GEV No.</b>	560370	<b>Ref. No.</b>	503-605 160
----------------	--------	-----------------	-------------

countersunk screw thread M5 L 16mm stainless steel DIN 965/ISO 7046 Qty 1 pcs intake Phillips head ø 9mm



1

<b>GEV No.</b>	531057	<b>Ref. No.</b>	2819-136 651
----------------	--------	-----------------	--------------

**description** lever for FAEMA chrome-plated brass

## valves



1

<b>GEV No.</b>	525351	<b>Ref. No.</b>	2161-136 649
----------------	--------	-----------------	--------------

**description** valve group outflow L 61.6mm ED ø 15.5mm shaft ø 4mm



1

<b>GEV No.</b>	525352	<b>Ref. No.</b>	2161-136 656 903-835 000
----------------	--------	-----------------	-----------------------------

**description** valve group supply L 58.6mm ED ø 15.5mm

## components

## nozzles

## bushes



1

<b>GEV No.</b>	528321	<b>Ref. No.</b>	4151-135 895
----------------	--------	-----------------	--------------

**description** filter support D1 ø 13mm ID ø 5mm int. ø 11mm H 9mm brass

## nozzle holders



1

<b>GEV No.</b>	525346	<b>Ref. No.</b>	2211-116 078 922785000
----------------	--------	-----------------	---------------------------

**description** nozzle holder with nozzle

**spare parts for** 525346



<b>GEV No.</b>	528582	<b>Ref. No.</b>	—
----------------	--------	-----------------	---

nozzle



<b>GEV No.</b>	528584	<b>Ref. No.</b>	—
----------------	--------	-----------------	---

nozzle holder

**accessories for** 525346





<b>GEV No.</b>	528350	<b>Ref. No.</b>	4701-116 687
----------------	--------	-----------------	--------------

O-ring Viton thickness 2.62mm ID ø 9.13mm Qty 1 pcs



with thread			
			
1			
<b>GEV No.</b>	528486	<b>Ref. No.</b>	4151-135 890
<b>description</b>	nozzle bore $\phi$ 0.7mm thread M6x0.75 L 9mm WS 7		

			
1			
<b>GEV No.</b>	525343	<b>Ref. No.</b>	903-057 000
<b>description</b>	nozzle bore $\phi$ 1mm thread M6 L 9mm		

springs			
			
1			
<b>GEV No.</b>	525321	<b>Ref. No.</b>	4731-135 896
<b>description</b>	compression spring $\phi$ 13mm L 37.5mm wire gauge $\phi$ 1.1mm windings 7 E61 series LEGEND		

washers			
			
1			
<b>GEV No.</b>	525308	<b>Ref. No.</b>	4051-136 004
<b>description</b>	plain washer ID $\phi$ 6.4mm ED $\phi$ 11mm thickness 1.5mm SS Qty 1 pcs		

screw connections			
			
1			
<b>GEV No.</b>	527270	<b>Ref. No.</b>	4142-135 892
<b>description</b>	end cap thread M16x1.5 ID $\phi$ 8.9mm L 21mm chrome-plated WS 22		

gaskets			
			
1			
<b>GEV No.</b>	525311	<b>Ref. No.</b>	4701-135 888
<b>description</b>	group gasket L 77mm W 72mm thickness 2mm aperture 9mm hole distance 56mm suitable for FAEMA PTFE		

water dispersions			
water dispersions			
group 2			
			
Image not available			
1			
<b>GEV No.</b>	531081	<b>Ref. No.</b>	4161-133 848 457-342 000 902-405 006
<b>description</b>	water distributor brass		

expansion valves			
			
1			
<b>GEV No.</b>	529300	<b>Ref. No.</b>	N/A
<b>description</b>	expansion valve T1: 3/8" ET T2: 3/8" ET L 46mm		

with hose connection			
			
1			
<b>GEV No.</b>	525327	<b>Ref. No.</b>	2211-134 651
<b>description</b>	expansion valve T1: 1/4" ET hose $\phi$ 10mm total length 72mm		

brass 3-way			
			
1			
<b>GEV No.</b>	525356	<b>Ref. No.</b>	415-928 000 415-929 010 415-929 020 415-932 000 415-932 010 427-954 000 537-027 900
<b>description</b>	expansion valve T1: 1/8" connection 7		

## drain valves

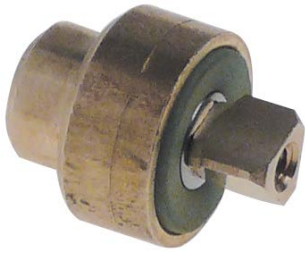

1

<b>GEV No.</b>	531078	<b>Ref. No.</b>	2161-136 648 903-828 000
<b>description</b>	drain fitting		

## drain pans

## covers



1

<b>GEV No.</b>	525345	<b>Ref. No.</b>	4831-134 635 484353000
<b>description</b>	lid for drain pan hole $\varnothing$ 15mm suitable for FAEMA		

## drain units



1

<b>GEV No.</b>	698910	<b>Ref. No.</b>	990073000
<b>description</b>	drain connection connections 3/4" for espresso machine ED $\varnothing$ 58mm ID $\varnothing$ 52mm		

## drain pans



1

<b>GEV No.</b>	525344	<b>Ref. No.</b>	4831-132 932 484352000
<b>description</b>	drain pan suitable for FAEMA		

## aerators and air bleeders



1

<b>GEV No.</b>	525329	<b>Ref. No.</b>	3161-134 654 418911002 418911010 418932000 418941000 418941010 537-040 300
<b>description</b>	aerator and air bleeder connection 1/4" for boiler suitable for CIM-BALI, FAEMA		

## boilers

## gaskets

## unperforated



1

<b>GEV No.</b>	528100	<b>Ref. No.</b>	N/A
<b>description</b>	boiler gasket D1 $\varnothing$ 149mm D2 $\varnothing$ 138mm thickness 3mm PTFE suitable for FAEMA		

## miscellaneous



1

<b>GEV No.</b>	528109	<b>Ref. No.</b>	N/A
<b>description</b>	lid for boiler 12 holes E61		



1

<b>GEV No.</b>	528106	<b>Ref. No.</b>	N/A
<b>description</b>	ring for boiler 16 holes		

steam/water taps

steam/water taps

steam/water taps



1

<b>GEV No.</b>	529500	<b>Ref. No.</b>	2221-091 783
<b>description</b>	steam tap		
<b>accessories for</b>	529500		
	<b>GEV No.</b>	525340	<b>Ref. No.</b> 3121-134 865
	joint for steam pipe		



1

<b>GEV No.</b>	529503	<b>Ref. No.</b>	485-923 012 485-923 022
<b>description</b>	steam tap suitable for FAEMA series E98		
<b>spare parts for</b>	529503		
	<b>GEV No.</b>	528517	<b>Ref. No.</b> —
	plain washer ID ø 16.2mm ED ø 21.8mm thickness 1mm Qty 1 pcs		
	<b>GEV No.</b>	528518	<b>Ref. No.</b> 568-101 000
	retaining ring bore ø 22mm thickness 1.2mm steel DIN 472		
	<b>GEV No.</b>	529412	<b>Ref. No.</b> 400-279 000
	O-ring EPDM thickness 2.62mm ID ø 10.78mm Qty 1 pcs		
	<b>GEV No.</b>	529546	<b>Ref. No.</b> 400-274 010 400-274 020
	gasket D1 ø 12mm D2 ø 4mm thickness 4mm Viton Qty 1 pcs		



1

<b>GEV No.</b>	525326	<b>Ref. No.</b>	2221-134 646
<b>description</b>	steam/water tap inlet 1/4" outlet M20x1.5 suitable for FAEMA series DUE		



1

<b>GEV No.</b>	525328	<b>Ref. No.</b>	485-923 022 485-923 030
<b>description</b>	steam/water tap suitable for FAEMA series E98		
<b>spare parts for</b>	525328		
	<b>GEV No.</b>	528517	<b>Ref. No.</b> —
	plain washer ID ø 16.2mm ED ø 21.8mm thickness 1mm Qty 1 pcs		
	<b>GEV No.</b>	528518	<b>Ref. No.</b> 568-101 000
	retaining ring bore ø 22mm thickness 1.2mm steel DIN 472		
	<b>GEV No.</b>	529412	<b>Ref. No.</b> 400-279 000
	O-ring EPDM thickness 2.62mm ID ø 10.78mm Qty 1 pcs		
	<b>GEV No.</b>	529546	<b>Ref. No.</b> 400-274 010 400-274 020
	gasket D1 ø 12mm D2 ø 4mm thickness 4mm Viton Qty 1 pcs		

components

bushes



1

<b>GEV No.</b>	525355	<b>Ref. No.</b>	4151-030 015
<b>description</b>	bush for steam-/water-tap D1 ø 10.5mm D2 ø 9mm ID ø 6.3mm H 4mm brass		

gaskets



1

<b>GEV No.</b>	528496	<b>Ref. No.</b>	N/A
<b>description</b>	gasket		



1

<b>GEV No.</b>	529546	<b>Ref. No.</b>	400-274 010 400-274 020
<b>description</b>	gasket D1 ø 12mm D2 ø 4mm thickness 4mm Viton Qty 1 pcs		

gasket supports



1

<b>GEV No.</b>	525175	<b>Ref. No.</b>	2151136654
<b>description</b>	valve ø hexagon 16mm L 14mm brass		

springs



1

<b>GEV No.</b>	528509	<b>Ref. No.</b>	4731-030 495
<b>description</b>	compression spring ø 11mm L 31mm wire gauge ø 1.2mm windings 9		



1

<b>GEV No.</b>	525323	<b>Ref. No.</b>	4731-135 884
<b>description</b>	compression spring ø 11mm L 32mm wire gauge ø 1.7mm windings 7 E61		



1

<b>GEV No.</b>	525319	<b>Ref. No.</b>	4731-135 883
<b>description</b>	compression spring ø 15mm L 17mm wire gauge ø 1.8mm windings 5 E61		



1

<b>GEV No.</b>	531262	<b>Ref. No.</b>	4731133611
<b>description</b>	spring L 35mm wire gauge ø 0.85mm for steam valve E92 Elite		

tap bodies



1

<b>GEV No.</b>	530547	<b>Ref. No.</b>	958572010
<b>description</b>	tap body T1: 1/4" T2: 3/8" L 99mm		

screws



1

<b>GEV No.</b>	525350	<b>Ref. No.</b>	590-791 010
<b>description</b>	screw for water tap thread M4		

valve bodies



1

<b>GEV No.</b>	525363	<b>Ref. No.</b>	485751000 485751010 485-910 002 485-910 010 985710000 985710010
<b>description</b>	valve body for steam-/water-tap		

steam/water pipes

steam/water pipes



1

<b>GEV No.</b>	531079	<b>Ref. No.</b>	3951-136 653
<b>description</b>	pipe steam/water E61 edition old edition suitable for FAEMA		

steam pipes



1

<b>GEV No.</b>	525336	<b>Ref. No.</b>	903-505 000
<b>description</b>	pipe thread 1 L 245mm ø 14.1mm for steam/water pipes tube ø 10mm E61		



1

<b>GEV No.</b>	525334	<b>Ref. No.</b>	2221-133 709 3952-133 708
<b>description</b>	steam pipe thread M20x1.5 H 130mm L 180mm ø 16mm tube ø 10mm SS E91 / DUE		





			
1			
<b>GEV No.</b>	525335	<b>Ref. No.</b>	2221-133 434 3951-133 428
<b>description</b>	steam pipe thread M20x1.5 H 145mm L 180mm $\phi$ 14.1mm tube $\phi$ 10mm SS E91 / DUE		

			
1			
<b>GEV No.</b>	525338	<b>Ref. No.</b>	537-033 010 537033000
<b>description</b>	steam pipe with adapter thread M20x1.5 H 140mm L 205mm $\phi$ 14.1mm tube $\phi$ 10mm SS suitable for FAEMA		

nozzles for steam pipes			
			
1			
<b>GEV No.</b>	529585	<b>Ref. No.</b>	4158-135 926
<b>description</b>	steam nozzle thread M10x1 $\phi$ 14mm L 16mm 4 holes bore $\phi$ 2mm chrome-plated brass		

nozzles for water pipes			
tap aerators			
			
1			
<b>GEV No.</b>	525331	<b>Ref. No.</b>	4151-135 927
<b>description</b>	tap aerator D1 $\phi$ 22mm H 45mm thread M10 suitable for FAEMA series E61		

water pipes			
			
1			
<b>GEV No.</b>	525336	<b>Ref. No.</b>	903-505 000
<b>description</b>	pipe thread 1 L 245mm $\phi$ 14.1mm for steam/water pipes tube $\phi$ 10mm E61		

			
1			
<b>GEV No.</b>	525333	<b>Ref. No.</b>	2221-134 421
<b>description</b>	water pipe $\phi$ 23.5mm L 80mm tube $\phi$ 10mm E97		

			
1			
<b>GEV No.</b>	525362	<b>Ref. No.</b>	2221-135 266 485149000 922-792 000 922-792 010 936-960 010 936960000
<b>description</b>	water pipe thread 3/8" $\phi$ 17mm L 65mm		

			
1			
<b>GEV No.</b>	525337	<b>Ref. No.</b>	903-740 000 903-740 010 903-950 000
<b>description</b>	water pipe thread M16x1 $\phi$ 14.1mm L 280mm suitable for FAEMA E61		

			
1			
<b>GEV No.</b>	525332	<b>Ref. No.</b>	2221-134 620 985-718 000
<b>description</b>	water pipe thread M20x1.5 $\phi$ 23.5mm L 64mm suitable for FAEMA		

accessories			
bushes			
			
1			
<b>GEV No.</b>	525324	<b>Ref. No.</b>	485-078 000 485-078 010
<b>description</b>	bush D1 $\phi$ 14.3mm D2 $\phi$ 11.4mm H 6mm PTFE ID $\phi$ 7.1mm		

			
1			
<b>GEV No.</b>	525357	<b>Ref. No.</b>	4161-132 346
<b>description</b>	bush D1 $\phi$ 15mm D2 $\phi$ 10.4mm H 10.3mm PTFE ID $\phi$ 7.6mm		

gaskets			
			
1			
<b>GEV No.</b>	528402	<b>Ref. No.</b>	402-206 000 4701-114 266
<b>description</b>	O-ring Viton thickness 2.62mm ID $\phi$ 10.78mm Qty 1 pcs		

## springs



<b>GEV No.</b>	525317	<b>Ref. No.</b>	485-061 010 F485-061 010
<b>description</b>	compression spring $\varnothing$ 11mm L 23.5mm wire gauge $\varnothing$ 1.9mm		

## tube handles



<b>GEV No.</b>	525301	<b>Ref. No.</b>	430-119 000 430-119 010 4701-134 278
<b>description</b>	tube handle for pipe $\varnothing$ 10mm $\varnothing$ 16mm L 35mm rubber		

## washers



<b>GEV No.</b>	525314	<b>Ref. No.</b>	4051-047 130
<b>description</b>	plain washer ID $\varnothing$ 7.5mm ED $\varnothing$ 15mm thickness 1mm brass Qty 1 pcs		

## fuse terminal blocks



<b>GEV No.</b>	525315	<b>Ref. No.</b>	4731-134 862 485-147 000
<b>description</b>	retainer clip wire gauge $\varnothing$ 1.5mm for steam pipe coffee machine		

## miscellaneous



<b>GEV No.</b>	525340	<b>Ref. No.</b>	3121-134 865
<b>description</b>	joint for steam pipe		

## gaskets

## piston seals



<b>GEV No.</b>	530427	<b>Ref. No.</b>	402199010
<b>description</b>	piston gasket D1 $\varnothing$ 74mm D2 $\varnothing$ 58mm		

## fine filters

## holders



<b>GEV No.</b>	528321	<b>Ref. No.</b>	4151-135 895
<b>description</b>	filter support D1 $\varnothing$ 13mm ID $\varnothing$ 5mm int. $\varnothing$ 11mm H 9mm brass		

## fine filters



<b>GEV No.</b>	528326	<b>Ref. No.</b>	4771-135 894
<b>description</b>	fine filter flat $\varnothing$ 11.2mm		



<b>GEV No.</b>	528562	<b>Ref. No.</b>	4771-116 081
<b>description</b>	fine filter flat $\varnothing$ 9mm		

## intake valves

## accessories

## nozzles



<b>GEV No.</b>	525348	<b>Ref. No.</b>	902-808 000
<b>description</b>	nozzle for filling valve bore $\varnothing$ 0.8mm thread M3 L 6.3mm		

spare parts for 525348



<b>GEV No.</b>	526824	<b>Ref. No.</b>	4701-117 916
----------------	--------	-----------------	--------------

O-ring EPDM thickness 1.9mm ID  $\varnothing$  5.7mm Qty 1 pcs



<b>GEV No.</b>	525349	<b>Ref. No.</b>	2151-133 912
<b>description</b>	nozzle for filling valve bore $\varnothing$ 1.2mm thread M3 L 6.3mm		

## springs



<b>GEV No.</b>	525320	<b>Ref. No.</b>	4731-027 556
<b>description</b>	compression spring $\varnothing$ 6.6mm L 20.5mm wire gauge $\varnothing$ 0.5mm windings 11		

## levers



<b>GEV No.</b>	525339	<b>Ref. No.</b>	4831-117 704
<b>description</b>	lever for filling valve plastic suitable for FAEMA series E91		



miscellaneous

1			
<b>GEV No.</b>	525237	<b>Ref. No.</b>	4831-117 838
<b>description</b>	spring guide for filling valve D1 ø 15mm D2 ø 5mm H 7mm		

1			
<b>GEV No.</b>	525353	<b>Ref. No.</b>	4831-029 417
<b>description</b>	spring guide for filling valve D1 ø 21.2mm D2 ø 17mm int. ø 1 7mm H 11.5mm		

valves

1			
<b>GEV No.</b>	525366	<b>Ref. No.</b>	2211-130 305 419-505 000 922787000
<b>description</b>	inlet tap for filling valve L 42.5mm suitable for FAEMA E97		

1			
<b>GEV No.</b>	525365	<b>Ref. No.</b>	3211-029 421 419-506 000 922788000
<b>description</b>	valve for filling valve L 16mm suitable for FAEMA		

1			
<b>GEV No.</b>	525364	<b>Ref. No.</b>	2211-117 836 419-504 000 922789000
<b>description</b>	valve for filling valve L 25mm suitable for FAEMA		

1			
<b>GEV No.</b>	525347	<b>Ref. No.</b>	2211-132 290
<b>description</b>	valve for filling valve suitable for FAEMA E91 / DUE		

level glasses

level glasses

gaskets

1			
<b>GEV No.</b>	529363	<b>Ref. No.</b>	4701-116 573
<b>description</b>	gasket L 90.5mm W 29.5mm thickness 1.5mm fibre water level glass suitable for FAEMA		

housings

1			
<b>GEV No.</b>	525779	<b>Ref. No.</b>	4831-132 157
<b>description</b>	tray for water level tube plastic suitable for FAEMA		

level glasses

1			
<b>GEV No.</b>	529365	<b>Ref. No.</b>	4831-130 683
<b>description</b>	level glass L 89mm W 30mm thickness 3.5mm for water level tube polycarbonate		

level glasses (complete)

1			
<b>GEV No.</b>	525325	<b>Ref. No.</b>	990-716 010 990716000
<b>description</b>	level glass thread 3/8" suitable for FAEMA		

miscellaneous

1			
<b>GEV No.</b>	531276	<b>Ref. No.</b>	911025000 927237000
<b>description</b>	guide for grate thread M10x1.5 ø 12.5mm L 42mm PTFE		

1			
<b>GEV No.</b>	530548	<b>Ref. No.</b>	533001200
<b>description</b>	level electrode ø 2.5mm L 154mm		

## for coffee grinders

## grinding burrs

## grinding burrs straight

## standard



1

<b>GEV No.</b>	527224	<b>Ref. No.</b>	N/A
<b>description</b>	grinding burrs pair turn direction left D1 ø 54mm ID ø 31mm H 8mm tooth spacing 3.5mm hole ø 4.5mm bore ø 6.5mm mounting ø 45 straight suitable for FAEMA (FP)		



1

<b>GEV No.</b>	527223	<b>Ref. No.</b>	4801-116 730
<b>description</b>	grinding burrs pair turn direction right D1 ø 54mm ID ø 31mm H 8mm tooth spacing 3.5mm hole ø 4.5mm bore ø 6.5mm mounting ø 45 straight suitable for FAEMA (MP,MPN)		



1

<b>GEV No.</b>	527225	<b>Ref. No.</b>	N/A
<b>description</b>	grinding burrs pair turn direction right D1 ø 64mm ID ø 38mm H 9mm tooth spacing 2.5mm hole ø 5mm bore ø 8mm mounting ø 50 straight suitable for FAEMA (Silver)		



1

<b>GEV No.</b>	525647	<b>Ref. No.</b>	4801-133 539
<b>description</b>	grinding burrs pair turn direction right D1 ø 75mm ID ø 43.7mm H 9.3mm tooth spacing 3.5mm hole ø 5.5mm bore ø 9mm mounting ø 57		

## TITAN



1

<b>GEV No.</b>	526274	<b>Ref. No.</b>	990-709 000
<b>description</b>	grinding burrs pair turn direction right D1 ø 75mm ID ø 43.7mm H 9.3mm tooth spacing 3.5mm hole ø 5.5mm bore ø 9mm mounting ø 57 titanium		

## grinding burrs conical



1

<b>GEV No.</b>	527226	<b>Ref. No.</b>	N/A
<b>description</b>	grinding burrs pair turn direction right D1 ø 68mm D2 ø 49mm H 25mm shaft ø 11mm suitable for FAEMA		



1

<b>GEV No.</b>	527431	<b>Ref. No.</b>	2801-131 470
<b>description</b>	grinding burrs pair turn direction right D1 ø 68mm D2 ø 49mm H 25mm shaft ø 11mm suitable for FAEMA		
<b>For models:</b>	MC90		

## dosing containers

## dosing container lids



1

<b>GEV No.</b>	526285	<b>Ref. No.</b>	4529-133 527 990-710 000
<b>description</b>	lid for dosing container ø 121mm 2-piece		





1

<b>GEV No.</b>	526284	<b>Ref. No.</b>	4831-130 210 4831-132 155
<b>description</b>	lid for dosing container ø 58mm H 12mm		





glass cylinders			
			
1			
<b>GEV No.</b>	526278	<b>Ref. No.</b>	4504-133 562 965465000
<b>description</b>	cylinder for dosing container ø 129mm H 121mm		

levers			
levers			
			
1			
<b>GEV No.</b>	526277	<b>Ref. No.</b>	2811-136 553 3529-135 703 4529-133 512 4529-133 513
<b>description</b>	lever right dosing pump hole ø 18mm L 108mm		

			
1			
<b>GEV No.</b>	526276	<b>Ref. No.</b>	4816-132 160
<b>description</b>	lever right dosing pump hole ø 20mm L 120mm brass		
<b>For models:</b>	MC90		

			
1			
<b>GEV No.</b>	526333	<b>Ref. No.</b>	4812-117 455
<b>description</b>	lever right dosing pump hole ø 20mm L 120mm chrome-plated		
<b>For models:</b>	MC90		

coffee presses			
components			
pressers			
			
1			
<b>GEV No.</b>	526287	<b>Ref. No.</b>	465-875 000 4811-133 592 4815-133 591
<b>description</b>	coffee press ø 57mm L 100mm H 11mm thread M10x1.5 plastic		

			
1			
<b>GEV No.</b>	526288	<b>Ref. No.</b>	3831-134 913
<b>description</b>	coffee press with bolt ø 57mm L 129mm H 25mm thread M6x1 plastic		

coffee presses			
			
1			
<b>GEV No.</b>	526286	<b>Ref. No.</b>	1000-091 907 3529-134 432 965-081 000
<b>description</b>	coffee press complete ø 57mm L 70mm H 94mm		
<b>For models:</b>	MC90		

automatic grinding			
automatic grinding			
			
1			
<b>GEV No.</b>	698757	<b>Ref. No.</b>	4529133522
<b>description</b>	housing for microswitch H 26mm L 102mm		
<b>accessories for</b>	698757		
	<b>GEV No.</b>	<b>Ref. No.</b>	4529133521
	698756		
	 lid for microswitch H 20mm		

			
1			
<b>GEV No.</b>	698756	<b>Ref. No.</b>	4529133521
<b>description</b>	lid for microswitch H 20mm		

nuts			
			
1			
<b>GEV No.</b>	560502	<b>Ref. No.</b>	4034008834
<b>description</b>	hexagonal nut thread M12x1.5 H 6mm WS 19 SS Qty 1 pcs zinc-plated		
<b>For models:</b>	MC90		



## miscellaneous



1

<b>GEV No.</b>	531199	<b>Ref. No.</b>	4081025146
<b>description</b>	clamping ring for dosing container $\varnothing$ 26mm internal size 23mm thickness 1.5mm suitable for FAEMA		

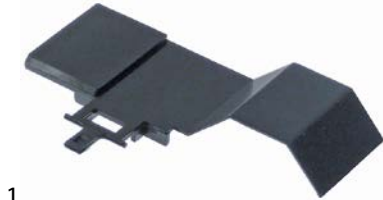

1

<b>GEV No.</b>	531200	<b>Ref. No.</b>	4831119081
<b>description</b>	lever for microswitch L 110mm W 36mm thickness 1mm plastic suitable for FAEMA		



1

<b>GEV No.</b>	560501	<b>Ref. No.</b>	4054043141
<b>description</b>	plain washer ID $\varnothing$ 12.4mm ED $\varnothing$ 25mm thickness 1.5mm SS Qty 1 pcs		
<b>For models:</b>	MC90		



1

<b>GEV No.</b>	531201	<b>Ref. No.</b>	4831119077
<b>description</b>	plate for lid L 25mm W 17mm thickness 3mm plastic suitable for FAEMA		
<b>For models:</b>	MC90		

## ratches

## pins



1

<b>GEV No.</b>	526299	<b>Ref. No.</b>	4061-119 924
<b>description</b>	pin for ratchet $\varnothing$ 5mm D2 $\varnothing$ 4mm L 18mm		
<b>For models:</b>	MC90		



1

<b>GEV No.</b>	526298	<b>Ref. No.</b>	4061-133 599
<b>description</b>	pin for ratchet $\varnothing$ 5mm L 16mm		

## accessories



1

<b>GEV No.</b>	531202	<b>Ref. No.</b>	4831117454
<b>description</b>	bush for pin $\varnothing$ 9mm int. $\varnothing$ 1.5mm plastic		
<b>For models:</b>	MC90		

## adjustment mechanism

## lockable adjustment



1

<b>GEV No.</b>	526289	<b>Ref. No.</b>	3811-133 571
<b>description</b>	pressure pin for setting ring L 30mm W 25mm shaft $\varnothing$ 6mm shaft length 25mm		



1

<b>GEV No.</b>	526290	<b>Ref. No.</b>	3831-117 444
<b>description</b>	pressure pin for setting ring L 49mm W 17mm shaft $\varnothing$ 8mm shaft length 23mm		

## setting rings



1

<b>GEV No.</b>	531189	<b>Ref. No.</b>	3851117441
<b>description</b>	setting ring for coffee grinder $\varnothing$ 104mm ID $\varnothing$ 51mm H 35mm suitable for FAEMA plastic		

## coffee beans containers

## container lids



1

<b>GEV No.</b>	526281	<b>Ref. No.</b>	4529-134 582 4831-130 111 965422000
<b>description</b>	container lid for coffee beans container $\varnothing$ 266mm W 50mm		
<b>For models:</b>	MC90		



1

<b>GEV No.</b>	526283	<b>Ref. No.</b>	4831-130 222 4831-132 087
<b>description</b>	lid coffee beans container L 154mm W 154mm		



1

<b>GEV No.</b>	526282	<b>Ref. No.</b>	4529-133 528
<b>description</b>	lid coffee beans container ø 189mm		



1

<b>GEV No.</b>	527327	<b>Ref. No.</b>	N/A
<b>description</b>	lid for coffee beans container ø 210mm		

coffee beans containers



1

<b>GEV No.</b>	526963	<b>Ref. No.</b>	4504-133 563 4504135040 465-818 000
<b>description</b>	coffee beans container brown ø 193mm H 245mm seat ø 67mm		



1

<b>GEV No.</b>	526279	<b>Ref. No.</b>	3504-133 560
<b>description</b>	coffee beans container brown ø 260mm H 222mm seat ø 55mm		
<b>For models:</b>	MC90		



1

<b>GEV No.</b>	526280	<b>Ref. No.</b>	3527-133 557 3529-133 557
<b>description</b>	coffee beans container L 160mm W 160mm H 240mm seat ø 51mm		



1

<b>GEV No.</b>	531179	<b>Ref. No.</b>	N/A
<b>description</b>	coffee beans container without lid ø 207mm H 245mm universal		
<b>accessories for</b>	531179		
	<b>GEV No.</b>	527327	<b>Ref. No.</b> N/A
lid for coffee beans container ø 210mm			

supports



1

<b>GEV No.</b>	531167	<b>Ref. No.</b>	N/A
<b>description</b>	support for coffee beans container intake conical seat ø 55.5-55mm suitable for FAEMA		

for dishwashers

drain and intake components

miscellaneous

overflow pipes



1

<b>GEV No.</b>	519584	<b>Ref. No.</b>	124724 802111002 802131039 977073000
<b>description</b>	overflow pipe L 90mm ø 27mm		

knobs

producer-specific knobs

FAEMA



1

<b>GEV No.</b>	111365	<b>Ref. No.</b>	3533-133 899 3538-133 899
<b>description</b>	knob switch zero mark ø 40mm shaft ø 5x5mm shaft flat horizontal dark blue		



1

<b>GEV No.</b>	111254	<b>Ref. No.</b>	3831-130 501
<b>description</b>	knob switch zero mark t.max.°C° 26mm shaft ø 5x5mm shaft flat black H 20mm L 36mm		



1

<b>GEV No.</b>	111364	<b>Ref. No.</b>	3529-133 899 4529-133 789 911-737 000
<b>description</b>	knob switch zero mark t.max.°C° 40mm shaft ø 5x5mm shaft flat black		



1

<b>GEV No.</b>	111368	<b>Ref. No.</b>	4529-132 427
<b>description</b>	knob zero mark ø 31mm shaft ø 5x5mm black		

steam/water taps

steam/water taps





1

<b>GEV No.</b>	111360	<b>Ref. No.</b>	3529-132 435
<b>description</b>	handle ø 39mm L 45mm black thread Tr18x2		



			
1			
<b>GEV No.</b>	111370	<b>Ref. No.</b>	4529-134 612
<b>description</b>	knob zero mark ø 31mm shaft ø 8x5.5mm shaft flat right black		

			
1			
<b>GEV No.</b>	111366	<b>Ref. No.</b>	902-033 000 924-828 000
<b>description</b>	turning handle ø 24mm L 45mm shaft 6x5mm black		

			
1			
<b>GEV No.</b>	111367	<b>Ref. No.</b>	3538-133 797 3538-133 797 BM
<b>description</b>	turning handle ø 30mm L 29mm shaft ø 6x5mm dark blue/chrome		

			
1			
<b>GEV No.</b>	111362	<b>Ref. No.</b>	3529-134 824 495-764 000
<b>description</b>	turning handle ø 42mm L 62mm shaft ø 8mm black		

knob dial plates

			
1			
<b>GEV No.</b>	111361	<b>Ref. No.</b>	4529-132 464
<b>description</b>	handle ø 44mm L 27mm black		

			
1			
<b>GEV No.</b>	111356	<b>Ref. No.</b>	4529-134 741
<b>description</b>	symbol steam ø 39mm L 29mm push-in		

handles and hand wheels

cone handles

			
1			
<b>GEV No.</b>	111363	<b>Ref. No.</b>	4741-135 910
<b>description</b>	cone handle thread M10 ø 28mm L 46mm black		

lever handles

			
1			
<b>GEV No.</b>	111450	<b>Ref. No.</b>	4831132313DX 911563010
<b>description</b>	slide mounting pos. right		

miscellaneous

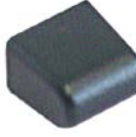
			
1			
<b>GEV No.</b>	111031	<b>Ref. No.</b>	4529-132 819
<b>description</b>	handle for steam tap black suitable for FAEMA DUE		

			
1			
<b>GEV No.</b>	111799	<b>Ref. No.</b>	911736000 930020010
<b>description</b>	handle without symbol black		

accessories

			
1			
<b>GEV No.</b>	525354	<b>Ref. No.</b>	4081-132 841
<b>description</b>	press ring for handle ID ø 9mm		

gaskets

O-rings

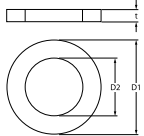
			
			
1			
<b>GEV No.</b>	528485	<b>Ref. No.</b>	4701-134 861 530-501 200
<b>description</b>	O-ring EPDM thickness 1.78mm ID ø 6.07mm Qty 1 pcs		

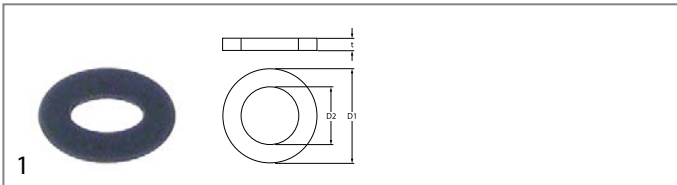

<b>GEV No.</b>	525310	<b>Ref. No.</b>	4701-030 708
<b>description</b>	O-ring EPDM thickness 1.9mm ID ø 4.2mm Qty 1 pcs		

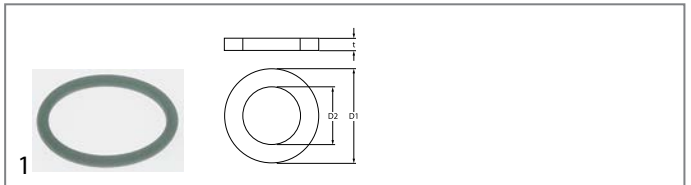

<b>GEV No.</b>	525312	<b>Ref. No.</b>	4701-119 817
<b>description</b>	O-ring Viton thickness 1.78mm ID ø 17.17mm Qty 1 pcs		

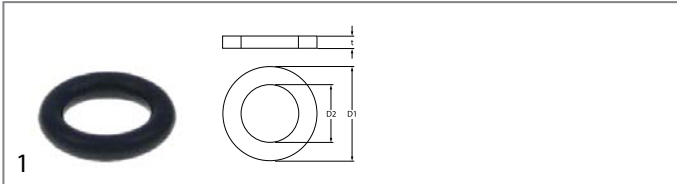

<b>GEV No.</b>	526824	<b>Ref. No.</b>	4701-117 916
<b>description</b>	O-ring EPDM thickness 1.9mm ID ø 5.7mm Qty 1 pcs		

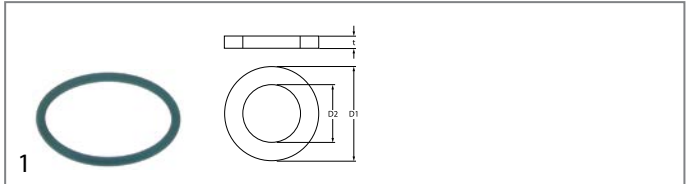

<b>GEV No.</b>	532582	<b>Ref. No.</b>	4701-026 914
<b>description</b>	O-ring Viton thickness 1.78mm ID ø 23.52mm Qty 1 pcs		

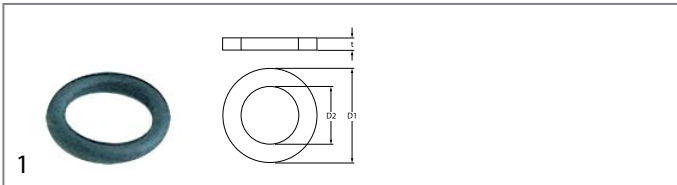

<b>GEV No.</b>	529412	<b>Ref. No.</b>	400-279 000
<b>description</b>	O-ring EPDM thickness 2.62mm ID ø 10.78mm Qty 1 pcs		

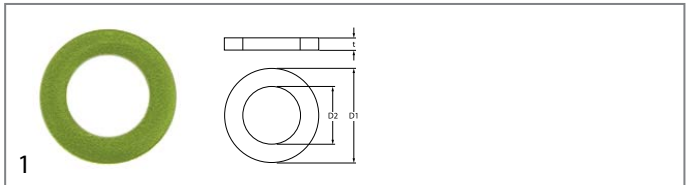

<b>GEV No.</b>	101526	<b>Ref. No.</b>	400-293000
<b>description</b>	O-ring Viton thickness 1.78mm ID ø 4.48mm Qty 1 pcs		

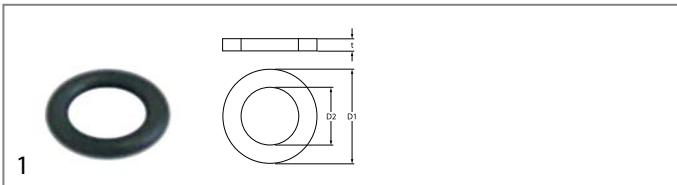

<b>GEV No.</b>	529544	<b>Ref. No.</b>	401-320 000
<b>description</b>	O-ring EPDM thickness 2.62mm ID ø 7.59mm Qty 1 pcs		

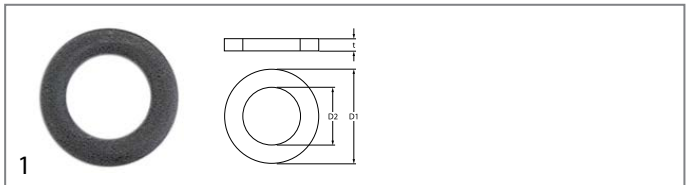

<b>GEV No.</b>	101527	<b>Ref. No.</b>	401-371 000 4701-030 138
<b>description</b>	O-ring Viton thickness 1.78mm ID ø 6.75mm Qty 1 pcs		

Viton

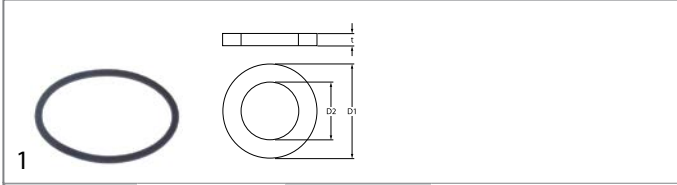

<b>GEV No.</b>	525313	<b>Ref. No.</b>	4701-030 129 915-117 000
<b>description</b>	O-ring Viton ID ø 60.33mm thickness 3.53mm Qty 1 pcs		

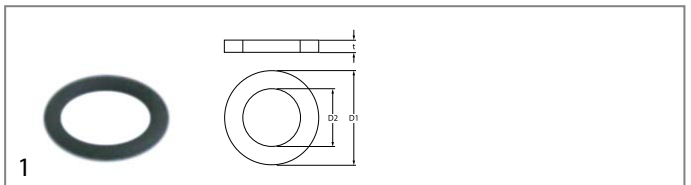

<b>GEV No.</b>	528402	<b>Ref. No.</b>	402-206 000 4701-114 266
<b>description</b>	O-ring Viton thickness 2.62mm ID ø 10.78mm Qty 1 pcs		

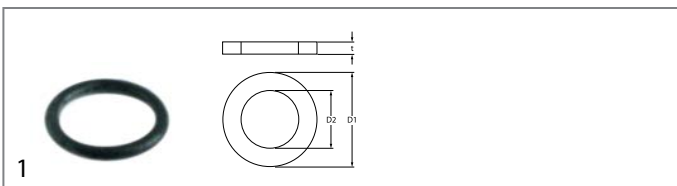

<b>GEV No.</b>	528833	<b>Ref. No.</b>	401-204 000 4701-134 887
<b>description</b>	O-ring Viton thickness 1.78mm ID ø 11.11mm Qty 1 pcs		

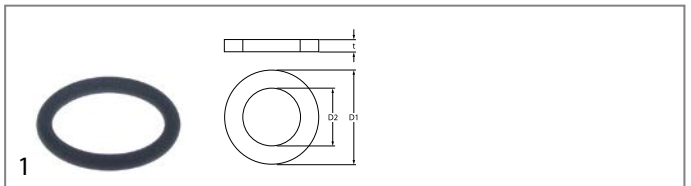

<b>GEV No.</b>	532583	<b>Ref. No.</b>	4701-135 932
<b>description</b>	O-ring Viton thickness 2.62mm ID ø 17.86mm Qty 1 pcs		



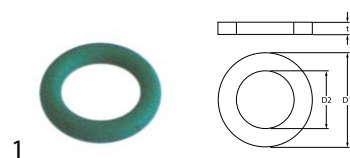

			
1			
<b>GEV No.</b>	528350	<b>Ref. No.</b>	4701-116 687
<b>description</b>	O-ring Viton thickness 2.62mm ID ø 9.13mm Qty 1 pcs		

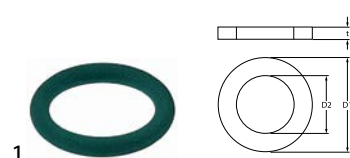
			
1			
<b>GEV No.</b>	528525	<b>Ref. No.</b>	4701-135 898
<b>description</b>	O-ring Viton thickness 3.53mm ID ø 18.64mm Qty 1 pcs		

sealing washers

rubber gaskets

			
1			
<b>GEV No.</b>	526796	<b>Ref. No.</b>	4701-135 903
<b>description</b>	gasket rubber ED ø 15mm ID ø 7.5mm thickness 4mm Qty 1 pcs		

copper gaskets

DIN-7603-C

			
1			
<b>GEV No.</b>	526433	<b>Ref. No.</b>	4701-024 554
<b>description</b>	gasket copper ED ø 18mm ID ø 14mm thickness 2mm		

			
1			
<b>GEV No.</b>	528501	<b>Ref. No.</b>	4701-024 558
<b>description</b>	gasket copper ED ø 22mm ID ø 16mm thickness 3mm		

PTFE gaskets

			
1			
<b>GEV No.</b>	525306	<b>Ref. No.</b>	4701-116 692
<b>description</b>	flat gasket PTFE ED ø 16.5mm ID ø 12.5mm thickness 0.5mm Qty 1 pcs		

			
1			
<b>GEV No.</b>	527154	<b>Ref. No.</b>	4701-135 891
<b>description</b>	flat gasket PTFE ED ø 22mm ID ø 16.8mm thickness 2mm Qty 1 pcs		

			
1			
<b>GEV No.</b>	525304	<b>Ref. No.</b>	401-183 000 401-183 010
<b>description</b>	flat gasket PTFE ED ø 22mm ID ø 17mm thickness 1.5mm Qty 1 pcs		

			
1			
<b>GEV No.</b>	525303	<b>Ref. No.</b>	400-335 000 400-335 010 4701-024 552
<b>description</b>	flat gasket PTFE ED ø 24.5mm ID ø 21mm thickness 1.5mm Qty 1 pcs		

			
1			
<b>GEV No.</b>	525305	<b>Ref. No.</b>	4701-116 694
<b>description</b>	flat gasket PTFE ED ø 26mm ID ø 20.5mm thickness 0.5mm Qty 1 pcs		

			
1			
<b>GEV No.</b>	525778	<b>Ref. No.</b>	4701-136 003
<b>description</b>	flat gasket PTFE ED ø 26mm ID ø 22mm thickness 2mm Qty 1 pcs		

			
1			
<b>GEV No.</b>	528524	<b>Ref. No.</b>	4701-135 912
<b>description</b>	flat gasket PTFE ED ø 36.5mm ID ø 30.5mm thickness 2mm Qty 1 pcs		

			
1			
<b>GEV No.</b>	528002	<b>Ref. No.</b>	N/A
<b>description</b>	flat gasket PTFE ED ø 57mm ID ø 42mm thickness 3mm Qty 1 pcs equiv. no. 12001/W10470 suitable for		

## silicone gaskets



1

<b>GEV No.</b>	508398	<b>Ref. No.</b>	0000124578 802011008 984272000
<b>description</b>	flat gasket silicone ED ø 48mm ID ø 38mm thickness 3mm Qty 1 pcs		

## special gaskets

## group gaskets



1

<b>GEV No.</b>	525311	<b>Ref. No.</b>	4701-135 888
<b>description</b>	group gasket L 77mm W 72mm thickness 2mm aperture 9mm hole distance 56mm suitable for FAEMA PTFE		



1

<b>GEV No.</b>	528115	<b>Ref. No.</b>	N/A
<b>description</b>	group gasket L 79mm W 72mm thickness 2mm hole distance 55mm suitable for FAEMA/FUTURMAT fibre		



1

<b>GEV No.</b>	528113	<b>Ref. No.</b>	N/A
<b>description</b>	group gasket L 80mm W 23mm thickness 2mm suitable for FAEMA/FUTURMAT		

## springs

## torsion springs



1

<b>GEV No.</b>	526291	<b>Ref. No.</b>	4731-133 581
<b>description</b>	spring ø 27mm wire gauge ø 2mm Qty 1 pcs right		



1

<b>GEV No.</b>	526478	<b>Ref. No.</b>	4731-133 582
<b>description</b>	torsion spring ø 26mm wire gauge ø 2mm Qty 1 pcs left		

## compression springs



1

<b>GEV No.</b>	528503	<b>Ref. No.</b>	4731-103 918
<b>description</b>	compression spring ø 10.5mm L 32mm wire gauge ø 1.4mm		

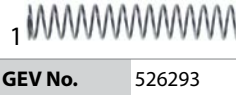

1

<b>GEV No.</b>	526293	<b>Ref. No.</b>	4731117451
<b>description</b>	compression spring ø 10mm L 60mm wire gauge ø 0.7mm for coffee press		



1

<b>GEV No.</b>	525317	<b>Ref. No.</b>	485-061 010 F485-061 010
<b>description</b>	compression spring ø 11mm L 23.5mm wire gauge ø 1.9mm		



1

<b>GEV No.</b>	528509	<b>Ref. No.</b>	4731-030 495
<b>description</b>	compression spring ø 11mm L 31mm wire gauge ø 1.2mm windings 9		



1

<b>GEV No.</b>	525323	<b>Ref. No.</b>	4731-135 884
<b>description</b>	compression spring ø 11mm L 32mm wire gauge ø 1.7mm windings 7 E61		

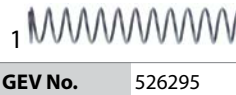

1

<b>GEV No.</b>	526295	<b>Ref. No.</b>	4731-133 593
<b>description</b>	compression spring ø 12.6mm L 76mm wire gauge ø 1mm		



1

<b>GEV No.</b>	528510	<b>Ref. No.</b>	4731-132 350
<b>description</b>	compression spring ø 13mm L 18mm wire gauge ø 2mm		



1

<b>GEV No.</b>	525321	<b>Ref. No.</b>	4731-135 896
<b>description</b>	compression spring ø 13mm L 37.5mm wire gauge ø 1.1mm windings 7 E61 series LEGEND		





			
1			
<b>GEV No.</b>	528533	<b>Ref. No.</b>	4731-135 917
<b>description</b>	compression spring ø 14.6mm L 43mm wire gauge ø 1.4mm		

			
1			
<b>GEV No.</b>	528475	<b>Ref. No.</b>	4731-135 918
<b>description</b>	compression spring ø 14.7mm L 33mm wire gauge ø 2mm		

			
1			
<b>GEV No.</b>	525322	<b>Ref. No.</b>	4731-022 508
<b>description</b>	compression spring ø 14mm L 24mm wire gauge ø 1.5mm windings 6		

			
1			
<b>GEV No.</b>	525319	<b>Ref. No.</b>	4731-135 883
<b>description</b>	compression spring ø 15mm L 17mm wire gauge ø 1.8mm windings 5 E61		

			
1			
<b>GEV No.</b>	528542	<b>Ref. No.</b>	4731-135 905
<b>description</b>	compression spring ø 15mm L 27mm wire gauge ø 1.8mm windings 5		

			
1			
<b>GEV No.</b>	529701	<b>Ref. No.</b>	4731-109 279
<b>description</b>	compression spring ø 25.7mm L 13mm wire gauge ø 1.9mm		

			
1			
<b>GEV No.</b>	526292	<b>Ref. No.</b>	4731-133 577
<b>description</b>	compression spring ø 3.7mm L 20mm wire gauge ø 0.3mm		

			
1			
<b>GEV No.</b>	526294	<b>Ref. No.</b>	4731-027 432
<b>description</b>	compression spring ø 5mm L 24mm wire gauge ø 0.4mm Qty 20		
<b>For models:</b>	MC90		

			
1			
<b>GEV No.</b>	525320	<b>Ref. No.</b>	4731-027 556
<b>description</b>	compression spring ø 6.6mm L 20.5mm wire gauge ø 0.5mm windings 11		

			
1			
<b>GEV No.</b>	528566	<b>Ref. No.</b>	4731-023 460
<b>description</b>	compression spring ø 7.6mm L 26mm wire gauge ø 0.8mm		
<b>For models:</b>	MC90		

			
1			
<b>GEV No.</b>	528521	<b>Ref. No.</b>	4731-135 893
<b>description</b>	compression spring ø 8.3mm L 19mm wire gauge ø 0.9mm windings 5		

tension springs

			
1			
<b>GEV No.</b>	526297	<b>Ref. No.</b>	4731-117 495
<b>description</b>	tension spring ø 6mm total length 44mm wire gauge ø 0.6mm L1 9.8mm		
<b>For models:</b>	MC90		

			
1			
<b>GEV No.</b>	526296	<b>Ref. No.</b>	4731-131 784
<b>description</b>	tension spring ø 9mm total length 51.5mm wire gauge ø 0.8mm L1 31mm		
<b>For models:</b>	MC90		

manometers

			
1			
<b>GEV No.</b>	541203	<b>Ref. No.</b>	3781132064 3781133764
<b>description</b>	manometer double scale ø 63mm pressure range 0-2.5 / 0-15bar connection on the backside thread 1/8"		





			
1			
<b>GEV No.</b>	541202	<b>Ref. No.</b>	N/A
<b>description</b>	manometer double scale ø 63mm pressure range 0-3 / 0-15bar connection on the backside thread 1/8"		

			
1			
<b>GEV No.</b>	541206	<b>Ref. No.</b>	3781118740 3781133399 3781133401
<b>description</b>	manometer ø 42mm pressure range 0 up to 16bar thread 1/8" marking 12 connection on the backside		

			
1			
<b>GEV No.</b>	541200	<b>Ref. No.</b>	3781135802
<b>description</b>	manometer ø 52mm pressure range 0 up to 3bar connection on the backside marking 0.7-1 thread 1/8"		

			
1			
<b>GEV No.</b>	541282	<b>Ref. No.</b>	N/A
<b>description</b>	manometer ø 52mm pressure range 0 up to 3bar connection on the backside marking 1.5 thread 1/4"		

			
1			
<b>GEV No.</b>	541248	<b>Ref. No.</b>	3320019
<b>description</b>	manometer ø 52mm pressure range 0 up to 3bar marking 1.6 thread 1/8"		

			
1			
<b>GEV No.</b>	541201	<b>Ref. No.</b>	3781135801
<b>description</b>	manometer ø 53.5mm pressure range 0 up to 16bar connection on the backside thread 1/8"		

## fastening material

### screws

#### sheet metal screws

			
1			
<b>GEV No.</b>	560323	<b>Ref. No.</b>	4004048325
<b>description</b>	sheet metal screws ø 2.9mm L 19mm SS Qty 20 pcs DIN 7981/ISO 7049 head ø 5.6mm oval head		
<b>For models:</b>	MC90		

#### countersunk screws

			
1			
<b>GEV No.</b>	560370	<b>Ref. No.</b>	503-605 160
<b>description</b>	countersunk screw thread M5 L 16mm stainless steel DIN 965/ISO 7046 Qty 1 pcs intake Phillips head ø 9mm		

#### flat-headed bolts

			
1			
<b>GEV No.</b>	560395	<b>Ref. No.</b>	4004-041 348 4004-041 482
<b>description</b>	flat-headed bolt thread M4 thread L 8mm SS DIN 84/ISO 1207 Qty 1 pcs intake slotted head ø 7mm head thickness 2.5mm		
<b>For models:</b>	MC90		

			
1			
<b>GEV No.</b>	560400	<b>Ref. No.</b>	4004-041 359
<b>description</b>	flat-headed bolt thread M5 thread L 8mm SS DIN 84/ISO 1207 Qty 1 pcs intake slotted head ø 8.3mm head thickness 3.2mm		



hexagonal screws

			
1			
<b>GEV No.</b>	560079	<b>Ref. No.</b>	4004-041 042
<b>description</b>	hexagonal screw thread M6 thread L 12mm SS WS 10 Qty 20 pcs DIN 933 / ISO 4017		

			
1			
<b>GEV No.</b>	560554	<b>Ref. No.</b>	4814132319
<b>description</b>	hexagonal screw thread M6 thread L 11mm ED ø 6mm chrome-plated brass WS 8 Qty 1 pcs		

cylinder head bolts

DIN 912/ISO 4762

			
1			
<b>GEV No.</b>	560025	<b>Ref. No.</b>	4001-051 934 4001-051 935 511804120
<b>description</b>	cylinder head bolt thread M4 thread L 10mm WS 3 SS Qty 20 pcs DIN 912/ISO 4762		

			
1			
<b>GEV No.</b>	560418	<b>Ref. No.</b>	4001-135 922
<b>description</b>	cylinder head bolt thread M6 thread L 8mm L 14mm WS 5 SS Qty 1 pcs intake hexagonal DIN 912/ISO 4762		

grub screws

DIN 913/ISO 4026

			
1			
<b>GEV No.</b>	560419	<b>Ref. No.</b>	4003-042 353
<b>description</b>	grub screw thread M8 L 10mm stainless steel DIN 913 intake hexagonal WS 4 Qty 1 pcs		

nuts

cap nuts

			
1			
<b>GEV No.</b>	560137	<b>Ref. No.</b>	4038-135 913
<b>description</b>	cap nuts thread M6 WS 10 SS Qty 20 pcs DIN/ISO DIN 1587		

hexagonal nuts

DIN 985

			
1			
<b>GEV No.</b>	560553	<b>Ref. No.</b>	4034052287
<b>description</b>	hexagonal nut thread M6 H 8mm SS WS 8 self-locking Qty 1 pcs		

hexagonal nuts metric (without norm)

			
1			
<b>GEV No.</b>	560502	<b>Ref. No.</b>	4034008834
<b>description</b>	hexagonal nut thread M12x1.5 H 6mm WS 19 SS Qty 1 pcs zinc-plated		
<b>For models:</b>	MC90		

washers

washers

DIN 9021

			
1			
<b>GEV No.</b>	560120	<b>Ref. No.</b>	4054-043 423
<b>description</b>	plain washer ID ø 6.4mm ED ø 24mm thickness 2mm SS Qty 20 pcs DIN 9021 for thread M6		

miscellaneous

			
1			
<b>GEV No.</b>	560501	<b>Ref. No.</b>	4054043141
<b>description</b>	plain washer ID ø 12.4mm ED ø 25mm thickness 1.5mm SS Qty 1 pcs		
<b>For models:</b>	MC90		







			
1			
<b>GEV No.</b>	525307	<b>Ref. No.</b>	590-715 000
<b>description</b>	plain washer ID ø 13mm ED ø 22mm thickness 1.2mm SS Qty 1 pcs		

			
1			
<b>GEV No.</b>	525316	<b>Ref. No.</b>	4051-052 071
<b>description</b>	plain washer ID ø 16.3mm ED ø 27mm thickness 1mm brass Qty 1 pcs for thread M16		

			
1			
<b>GEV No.</b>	525308	<b>Ref. No.</b>	4051-136 004
<b>description</b>	plain washer ID ø 6.4mm ED ø 11mm thickness 1.5mm SS Qty 1 pcs		

			
1			
<b>GEV No.</b>	528522	<b>Ref. No.</b>	4041-136 010 4051-135 889
<b>description</b>	plain washer ID ø 6.7mm ED ø 10.8mm thickness 1mm brass Qty 1 pcs		

			
1			
<b>GEV No.</b>	525314	<b>Ref. No.</b>	4051-047 130
<b>description</b>	plain washer ID ø 7.5mm ED ø 15mm thickness 1mm brass Qty 1 pcs		

## fasteners

### retaining rings

#### DIN 471

			
1			
<b>GEV No.</b>	529702	<b>Ref. No.</b>	4081-050 302
<b>description</b>	retaining ring spindle shaft ø 16mm thickness 1mm steel DIN 471		

#### DIN 472

			
1			
<b>GEV No.</b>	528518	<b>Ref. No.</b>	568-101 000
<b>description</b>	retaining ring bore ø 22mm thickness 1.2mm steel DIN 472		

			
1			
<b>GEV No.</b>	528709	<b>Ref. No.</b>	568204051
<b>description</b>	retaining ring E D1 ø 4mm D2 ø 9mm steel DIN 6799 thickness 0.7mm for shaft ø 5-7mm		

### cotter pins

			
1			
<b>GEV No.</b>	695209	<b>Ref. No.</b>	4061-024 965
<b>description</b>	cotter pin ø 2mm L 20mm SS		

## consumables

### fuses

#### fine fuses

			
1			
<b>GEV No.</b>	358661	<b>Ref. No.</b>	3501-117 399
<b>description</b>	fine fuse size ø5x20mm 0.1A fast-acting rated 250V Qty 10 pcs		

			
1			
<b>GEV No.</b>	358677	<b>Ref. No.</b>	3501-117 396
<b>description</b>	fine fuse size ø5x20mm 4A fast-acting rated 250V Qty 10 pcs		

			
1			
<b>GEV No.</b>	358533	<b>Ref. No.</b>	530-115 100
<b>description</b>	fine fuse size ø5x20mm 6.3A fast-acting rated 250V Qty 10 pcs		

			
1			
<b>GEV No.</b>	358509	<b>Ref. No.</b>	3501-091 867
<b>description</b>	fine fuse size ø5x20mm 0.05A slow-acting rated 250V Qty 1 pcs		



1			
<b>GEV No.</b>	358596	<b>Ref. No.</b>	3501-117 398
<b>description</b>	fine fuse size ø5x20mm 0.25A slow-acting rated 250V Qty 10 pcs		



<b>B</b>		
booster pumps II	17	
<b>C</b>		
cable glands	21, 21	
cables	21	
cap nuts	43	
condensators & interference suppression filters	20	
consumables	44	
contactors	9	
cotter pins	44	
countersunk screws	42	
cylinder head bolts	43	
<b>E</b>		
electric accessories	21	
<b>F</b>		
fasteners	44	
fastening material	42	
fine fuses	44	
flat-headed bolts	42	
flow meters	17	
fuses	20, 44	
<b>G</b>		
grub screws	43	
<b>H</b>		
heating elements	3	
heating elements for coffee machine	3	
hexagonal nuts	43	
hexagonal screws	43	
<b>I</b>		
indicator lights	8	
indicator lights (complete)	8	
<b>L</b>		
lamps	8	
<b>M</b>		
microswitches	6	
<b>N</b>		
nuts	43	
<b>O</b>		
operating capacitors	20	
O-rings	37	
oven lamps	9	
<b>P</b>		
pressure switches	17	
probes	9	
pumps	17	
pumps for ice machines	20	
push/momentary push switches	6	
<b>R</b>		
relays	9	
retaining rings	44	
rocker/momentary rocker switches	5	
rotary switches	8	
<b>S</b>		
safety thermostats	5	
screws	42	
sealing washers	39	
sheet metal screws	42	
solenoid valves	15	
switches and momentary switches	5	
system switches (ROLD)	7	
<b>T</b>		
thermostats	5	
time relays	9	
<b>V</b>		
vibration pumps	19	
<b>W</b>		
washers	43	