



GAS COMPONENTS



ELECTRIC COMPONENTS



WATER TECHNOLOGY



MECHANICAL COMPONENTS



TOOLS

Spare parts suitable for

EMAINOX

Find the complete and up-to-date range of products in our GEV Webshop



Manufacturer catalogue

The most important spare parts and accessories arranged clearly for every manufacturer

- ✓ Complete product range and all appliance data always up to date in the GEV Webshop
- ✓ Alphabetical Index at the end of the catalogue

GEV Webshop

www.gev-online.co.uk

www.gev-online.com



- 🔍 Add to Favourites
- 🔍 Sign In with email address and usual password
- 🔍 Easy-order – place several items in your basket at the same time
- 🔍 Quick Item search – no login needed



heating elements

heating elements for bain maries

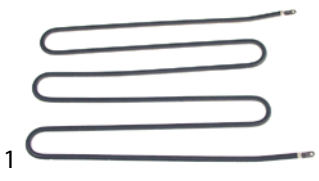
| | | | |
|---|--|-----------------|---------|
|  | | | |
| GEV No. | 418344 | Ref. No. | 3710003 |
| description | heating element 1200W 220V heating circuits 1 L 395mm W 220mm H 24mm connection M4 tube ø 8mm dry heating element L1 50mm L2 345mm connection distance 212mm | | |

heating elements for heated cabinets

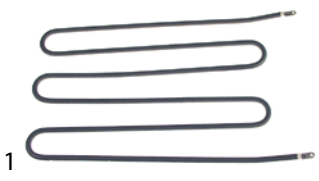

| | | | |
|---|--|-----------------|---------|
|  | | | |
| GEV No. | 418344 | Ref. No. | 3710003 |
| description | heating element 1200W 220V heating circuits 1 L 395mm W 220mm H 24mm connection M4 tube ø 8mm dry heating element L1 50mm L2 345mm connection distance 212mm | | |

heating cartridges

| | | | |
|---|--|-----------------|---------|
|  | | | |
| GEV No. | 418346 | Ref. No. | 3710022 |
| description | heating element 400W 230V ø 10mm L 380mm thread M14x1.25 cable length 110mm flange with thread | | |

| | | | |
|---|---|-----------------|---------|
|  | | | |
| GEV No. | 418841 | Ref. No. | 3710024 |
| description | heating element 500W 230V ø 10mm L 490mm thread M14x1.25 cable length 110mm | | |

heating elements for convection

| | | | |
|---|---|-----------------|---------|
|  | | | |
| GEV No. | 418345 | Ref. No. | 3710004 |
| description | heating element 1600W 230V heating circuits 1 ID ø 178mm ED ø 191mm L 250mm H 40mm L1 50mm W1 32mm H1 16mm H2 24mm flange length 70mm flange width 22mm hole distance 56mm connection male faston 6.3mm tube ø 6.3mm convection heating element hole ø 5mm rectangular flange | | |
| accessories for | 418345 | | |
|  | | | |
| GEV No. | 510368 | Ref. No. | — |
| description | gasket L 70mm W 23.5mm hole ø 5mm hole distance 56mm FIBER thickness 2mm for heating element | | |

foil heating elements

| | | | |
|--|--|-----------------|---------|
|  | | | |
| GEV No. | 418842 | Ref. No. | 3710036 |
| description | foil heating element L 480mm W 280mm 400W 230V probe ø 6mm with temperature limiter 150°C silicone | | |

energy regulators

EGO

1-circuit

| | | | |
|--|---|-----------------|---------|
|  | | | |
| GEV No. | 380015 | Ref. No. | 3700010 |
| description | energy regulator 230V 13A single-circuit turn direction right shaft ø 6x4.6mm shaft L 23mm mounting thread M4 power release 6-100% no. 50.57021.010 | | |

thermostats

control and safety thermostats

EGO

control thermostats

55.10/19_series

| | | | |
|--|--|-----------------|---------|
|  | | | |
| GEV No. | 375381 | Ref. No. | 3700002 |
| description | thermostat t.max. 90°C temperature range 30-90°C 1-pole 1NO 16A probe ø 6mm probe L 130mm capillary pipe 2000mm capillary pipe isolated 2000mm gland nut shaft ø 6x4.6mm shaft L 23mm shaft position upper rotation 270° | | |



safety thermostats

55.11_series



| | | | |
|--------------------|--|-----------------|---------|
| GEV No. | 375767 | Ref. No. | 3700014 |
| description | safety thermostat switch-off temp. 170°C 1-pole 16A probe ø 3.1mm probe L 160mm capillary pipe 650mm capillary pipe isolated 600mm gland nut probe | | |

refrigeration thermostats

universal without housing



| | | | |
|---|--|-----------------|-------------------|
| GEV No. | 390534 | Ref. No. | 3700018 |
| description | thermostat temperature range -35 up to +35°C probe ø6x110mm capillary pipe 1800mm PRODIGY | | |
| accessories for | 390534 | | |
|  | GEV No. | 110305 | Ref. No. — |
| | knob thermostat t.max. 35°C temperature range -35 up to +35°C ø 45mm shaft ø 6x4.6mm shaft flat inclined rotation 270° white | | |

accessories

connecting bows



| | | | |
|--------------------|--|-----------------|---------|
| GEV No. | 550060 | Ref. No. | 3700007 |
| description | connecting bow long for thermostat Qty 1 pcs | | |

switches and momentary switches

rocker/momentary rocker switches

30x22mm



| | | | |
|---|--|-----------------|-------------------|
| GEV No. | 301018 | Ref. No. | 3700102 |
| description | momentary rocker switch mounting measurements 30x22mm orange 2NO 250V 16A illuminated 0-I connection male faston 6.3mm ambient temperature max. 125/55°C protection IP65 | | |
| accessories for | 301018 | | |
|  | GEV No. | 301036 | Ref. No. — |
| | protective cover internal size 30x22mm for rocker switch mounting measurementsmm | | |

labelled



| | | | |
|---|--|-----------------|-------------------|
| GEV No. | 300125 | Ref. No. | 3700100 |
| description | rocker switch mounting measurements 30x22mm green 2NO 230V 16A 0-I connection male faston 6.3mm ambient temperature max. 125/55°C protection IP65 with cover cap | | |
| accessories for | 300125 | | |
|  | GEV No. | 301036 | Ref. No. — |
| | protective cover internal size 30x22mm for rocker switch mounting measurementsmm | | |



| | | | |
|---|---|-----------------|-------------------|
| GEV No. | 301006 | Ref. No. | 3700101 |
| description | rocker switch mounting measurements 30x22mm orange 2NO 250V 16A illuminated connection male faston 6.3mm ambient temperature max. 125/55°C protection IP65 with cover cap | | |
| accessories for | 301006 | | |
|  | GEV No. | 301036 | Ref. No. — |
| | protective cover internal size 30x22mm for rocker switch mounting measurementsmm | | |



cam switches

operation switches



| | | | | |
|--|----------------|--------|-----------------|---------|
| 1 | GEV No. | 300091 | Ref. No. | 3700003 |
| description operation switch EGO 2 operating positions 2NO 16A sequence 0-1 shaft ø 6x4.6mm shaft L 23mm connection screw ceramic | | | | |

lamps

indicator lights

indicator lights (complete)

ø10mm

with screw socket



| | | | | |
|---|----------------|--------|-----------------|---------|
| 1 | GEV No. | 359791 | Ref. No. | 3760004 |
| description indicator light ø 10mm 230V green cable length 250mm | | | | |



| | | | | |
|---|----------------|--------|-----------------|---------|
| 1 | GEV No. | 359387 | Ref. No. | 3760002 |
| description indicator light ø 10mm 230V red cable length 250mm | | | | |

fluorescent lamps

fluorescent lamps

G13



| | | | | |
|--|----------------|--------|-----------------|--------------------|
| 1 | GEV No. | 359386 | Ref. No. | 3760019 3760026 |
| description fluorescent lamp socket G13 L 1198mm 36W 230V Qty 1 pcs | | | | |



| | | | | |
|--|----------------|--------|-----------------|---------|
| 1 | GEV No. | 359390 | Ref. No. | 3760015 |
| description fluorescent lamp socket G13 L 1500mm 58W 230V Qty 1 pcs | | | | |



| | | | | |
|--|----------------|--------|-----------------|---------|
| 1 | GEV No. | 359383 | Ref. No. | 3760025 |
| description fluorescent lamp socket G13 L 438mm 15W 230V Qty 1 pcs light colour 640 | | | | |



| | | | |
|---|--------|-----------------|---------|
| GEV No. | 359372 | Ref. No. | 3760027 |
| description fluorescent lamp socket G13 L 895mm 30W 230V Qty 1 pcs | | | |

complete with holder

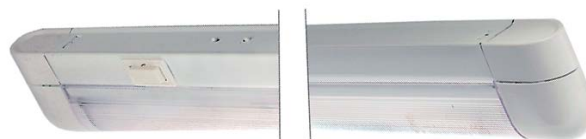

| | | | | |
|---|----------------|--------|-----------------|---------|
| 1 | GEV No. | 359391 | Ref. No. | 3760018 |
| description fluorescent lamp L 1245mm W 37mm 36W | | | | |

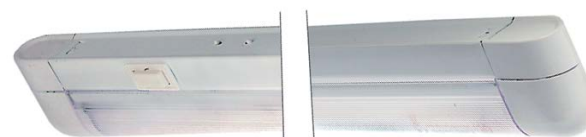

| | | | | |
|---|----------------|--------|-----------------|---------|
| 1 | GEV No. | 359392 | Ref. No. | 3760009 |
| description fluorescent lamp L 1545mm W 37mm 58W | | | | |

accessories

sockets



| | | | | |
|---|----------------|--------|-----------------|--------------|
| 1 | GEV No. | 358175 | Ref. No. | AAG3251/C-TR |
| description lamp socket socket G13 for fluorescent lamps | | | | |



| | | | | |
|---|----------------|--------|-----------------|---------------------|
| 1 | GEV No. | 358176 | Ref. No. | 3760023 AAG251/S |
| description lamp socket socket G13 for fluorescent lamps | | | | |



| | | | | |
|---|----------------|--------|-----------------|---------|
| 1 | GEV No. | 359388 | Ref. No. | 3760024 |
| description lamp socket socket G13 for fluorescent lamps | | | | |



contactors

ISKRA (FANAL)

power contactors

| | | | |
|---|------------------------|-----------------|---------|
|  | | | |
| 1 | | | |
| GEV No. | 380211 | Ref. No. | 3700037 |
| description | power contactor 230VAC | | |



| | | | |
|--|--|-----------------|---------|
|  | | | |
| 1 | | | |
| GEV No. | 380213 | Ref. No. | 3700080 |
| description | power contactor resistive load 20A 230VAC (AC3/400V) 8.5A/5.5kW main contacts 3NO auxiliary contacts 1NO connection screw connection type Fanal DSL7 10 type ISKRA K07M 10 | | |

relays

power relays

with male contacts

female contact 2.0mm

| | | | |
|--|---|-----------------|-----------------|
|  | | | |
| 1 | | | |
| GEV No. | 380494 | Ref. No. | 3700053 |
| description | power relays FINDER 230VAC 7A 4CO connection F2 plug-in connection manuf. no. 55.34.8.230.0054 94.74/ZMD4 250V connection 2mm | | |
| accessories for | 380494 | | |
|  | GEV No. | 380341 | Ref. No. |
| | | | — |
| | relay socket 4-pole contacts 12 300V voltage AC 6A Italiana Relè manuf. no. ZMD4 | | |
|  | GEV No. | 380399 | Ref. No. |
| | | | — |
| | relay socket 4-pole dimensions 76.2x27x86.1mm 250V voltage AC 1A FINDER manuf. no. 94.94.3 | | |

| | | | |
|---|--|-----------------|---------|
|  | | | |
| 1 | | | |
| GEV No. | 359389 | Ref. No. | 3760023 |
| description | lamp socket socket G13 for fluorescent lamps | | |

| | | | |
|---|---------------|-----------------|---------|
| starter | | | |
|  | | | |
| 1 | | | |
| GEV No. | 380464 | Ref. No. | 3760028 |
| description | starter 4-65W | | |

| | | | |
|---|---|-----------------|---------|
| ballasts | | | |
|  | | | |
| 1 | | | |
| GEV No. | 401440 | Ref. No. | 3760020 |
| description | electrical ballast 15W 230V for fluorescent lamps | | |

| | | | |
|---|---|-----------------|---------|
|  | | | |
| 1 | | | |
| GEV No. | 401141 | Ref. No. | 3760021 |
| description | electrical ballast 30W 230V for fluorescent lamps Qty 1 pcs | | |

| | | | |
|---|--|-----------------|---------|
|  | | | |
| 1 | | | |
| GEV No. | 401142 | Ref. No. | 3760022 |
| description | electrical ballast 30W for fluorescent lamps | | |

| | | | |
|---|---|-----------------|---------|
|  | | | |
| 1 | | | |
| GEV No. | 401441 | Ref. No. | 3760022 |
| description | electrical ballast 36-40W for fluorescent lamps | | |



relay sockets



1

| | | | |
|--------------------|---------------------|-----------------|---------|
| GEV No. | 380393 | Ref. No. | 3700054 |
| description | relay socket 4-pole | | |

electronic controllers

EVCO - EVERY CONTROL

refrigeration controllers

built-in version



1

| | | | |
|--------------------|---|-----------------|---------|
| GEV No. | 379998 | Ref. No. | 3700041 |
| description | electronic controller EVERY CONTROL type FK200XN7 mounting measurements 71x29mm 230V voltage AC NTC | | |

electronics

PCBs



1

| | | | |
|--------------------|------------------------------|-----------------|---------|
| GEV No. | 401450 | Ref. No. | 3700120 |
| description | keypad PCB for water filling | | |

solenoid valves

solenoid valves (water)

RPE



1

| | | | |
|--------------------|---|-----------------|---------|
| GEV No. | 374017 | Ref. No. | 3740017 |
| description | solenoid valve single straight 230VAC inlet 3/4" outlet 10mm input 6l/min DN10 RPE polyamide flow regulating valve inlet white membranes NBR pressure range 0.2-10bar | | |



1

| | | | |
|--------------------|---|-----------------|---------|
| GEV No. | 370009 | Ref. No. | 3740017 |
| description | solenoid valve single straight 230VAC inlet 3/4" outlet 3/4" DN10 RPE total length 88.5mm | | |

solenoid valves (refrigeration)

PARKER

valves



1

| | | | | |
|---|--|-----------------|-----------------|---|
| GEV No. | 370366 | Ref. No. | 3740021 | |
| description | solenoid valve NC type YB09 with cable 230V pressure range 0-10bar connection 4mm soldering connection PARKER refrigeration straight | | | |
| spare parts for | 370366 | | | |
|  | GEV No. | 371033 | Ref. No. | — |
| | solenoid coil PARKER 230VAC 9VA coil type YB09 with cable seat ø 14mm | | | |



compressors

EMBRACO / ASPERA

R404a/R507

LBP monophase

Lower evaporation temperature below -20°C



1

| | | | |
|--------------------|--|-----------------|---------|
| GEV No. | 605005 | Ref. No. | 3650048 |
| description | compressor coolant R404a/R507 type T2155GK 230V 50Hz LBP fully hermetic 16.3kg power input 458W cylinder capacity 14.5cm ³ CSR H 221mm 368W 524W 717W 948W 1215W test method ASHRAE | | |

HMBP monophase

High/Medium evaporation temperature above -20/-15 °C



1

| | | | |
|--------------------|--|-----------------|---------|
| GEV No. | 605004 | Ref. No. | 3650047 |
| description | compressor coolant R404a/R507 type EMT6152GK 220-240V 50Hz HMBP fully hermetic 7.8kg 1/5HP cylinder capacity 4.5cm ³ CSIR H 166mm WWW 267W 332W 351W 437W 535W 646W 769W test method ASHRAE | | |



fans

refrigeration fans

cooling motors (complete)



1

| | | | | |
|---|--|-----------------|-----------------|---|
| GEV No. | 601280 | Ref. No. | 3650032 | |
| description | fan 230V 5W 50/60Hz fan wheel ø 172mm | | | |
| spare parts for | 601280 | | | |
|  | GEV No. | 601020 | Ref. No. | — |
| | fan motor 5W 230V 50-60Hz L1 44mm L2 48mm L3 79mm W 84mm cable length 500mm 1300rpm YZF5-13-18/26 5 mounting options bearing slide bearing | | | |
|  | GEV No. | 601069 | Ref. No. | — |
| | fan wheel sucking ø 172mm turn direction left fan wheel mounting 25.4mm blade angle 25° W 32mm aluminium | | | |

hot air fans

miscellaneous



1

| | | | |
|--------------------|--|-----------------|---------|
| GEV No. | 601531 | Ref. No. | 3740035 |
| description | hot air fan 220V 30W 50Hz L1 70mm L2 12mm L3 30mm L4 87mm fan wheel ø 155mm FIME type C30R0407 | | |

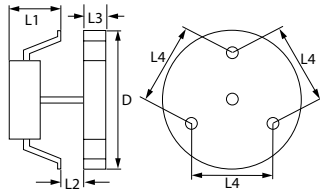



equipment-specific units

for display coolers

doors



1

| | | | |
|--------------------|--------------------------|-----------------|---------|
| GEV No. | 695247 | Ref. No. | 2300550 |
| description | trapdoor W 638mm H 215mm | | |

door mechanics

miscellaneous



1

| | | | |
|--------------------|---|-----------------|---------|
| GEV No. | 700907 | Ref. No. | 3990001 |
| description | bracket complete for glass plate plastic L 80mm W 26mm H 49mm | | |

for bain marie

drain systems



1

| | | | |
|--------------------|--|-----------------|--------------------|
| GEV No. | 515060 | Ref. No. | 3600034 3600077 |
| description | drain fitting thread 3/4" H 18mm ID ø 20mm ED ø 38mm | | |

for dishwashers

drain and intake components

miscellaneous

overflow pipes



1

| | | | |
|--------------------|---------------|-----------------|---------|
| GEV No. | 515061 | Ref. No. | 2300567 |
| description | overflow pipe | | |

knobs

universal knobs



1

| | | | |
|---|---|-----------------|---------|
| GEV No. | 111934 | Ref. No. | 3700057 |
| description | knob thermostat t.max. 90°C ø 50mm shaft ø 6x4.6mm shaft flat upper black temperature range 30-90°C rotation 270° | | |
| accessories for | 111934 | | |
| | GEV No. | Ref. No. | — |
| | 110135 | | |
|  | rosette knob up to ø 52mm | | |

producer-specific knobs

EMAINOX



1

| | | | |
|--------------------|---|-----------------|---------|
| GEV No. | 111933 | Ref. No. | 3700021 |
| description | knob switch zero mark t.max.°C ø 44mm shaft ø 6x4.6mm shaft flat upper silver | | |



1

| | | | |
|---|---|-----------------|---------|
| GEV No. | 111934 | Ref. No. | 3700057 |
| description | knob thermostat t.max. 90°C ø 50mm shaft ø 6x4.6mm shaft flat upper black temperature range 30-90°C rotation 270° | | |
| accessories for | 111934 | | |
| | GEV No. | Ref. No. | — |
| | 110135 | | |
|  | rosette knob up to ø 52mm | | |

pullouts

rollers

roller with holder



| | | | |
|--------------------|--|-----------------|---------|
| 1 | | | |
| GEV No. | 690955 | Ref. No. | 2330706 |
| description | roller rollerø 28mm B1 6mm with holder SS/Nylon mounting pos. upper bearing slide bearing Qty 1 pcs H 5mm L 62mm mounting distance 25/45mm | | |

shelves and shelf rails

shelf rails and supports

producer-specific



| | | | |
|--------------------|--|-----------------|---------|
| 1 | | | |
| GEV No. | 690760 | Ref. No. | 2330094 |
| description | guide U-shape L 503mm W 24mm H 13mm mounting pos. left/right | | |



| | | | |
|--------------------|------------------------------------|-----------------|---------|
| 1 | | | |
| GEV No. | 693481 | Ref. No. | 3380001 |
| description | shelf support L 23mm W 20mm H 26mm | | |

gaskets

refrigeration gaskets

screw-in gaskets

profile 9030

We offer custom-made gaskets for this profile

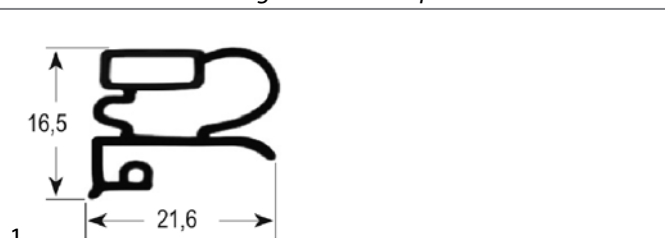

| | | | |
|--------------------|---|-----------------|---------|
| GEV No. | 900541 | Ref. No. | 2320081 |
| description | refrigeration gasket profile 9030 W 175mm L 403mm external size | | |

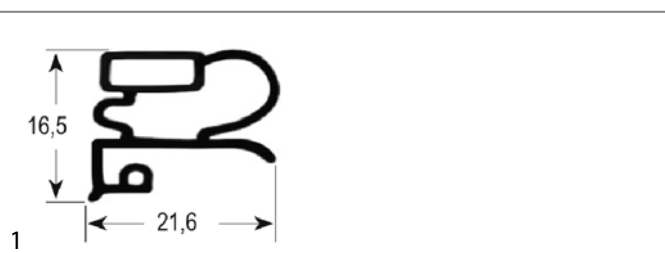

| | | | |
|--------------------|---|-----------------|--------------------|
| GEV No. | 900543 | Ref. No. | 2320082 3965048 |
| description | refrigeration gasket profile 9030 W 188mm L 403mm external size | | |

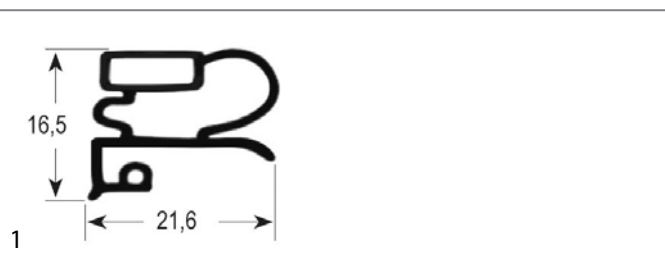

| | | | |
|--------------------|---|-----------------|--------------------|
| GEV No. | 900540 | Ref. No. | 2320043 3960127 |
| description | refrigeration gasket profile 9030 W 372mm L 403mm external size | | |

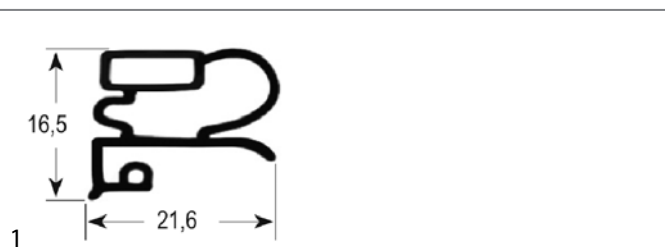

| | | | |
|--------------------|---|-----------------|---------|
| GEV No. | 900542 | Ref. No. | 3965045 |
| description | refrigeration gasket profile 9030 W 410mm L 430mm external size | | |



O-rings

EPDM

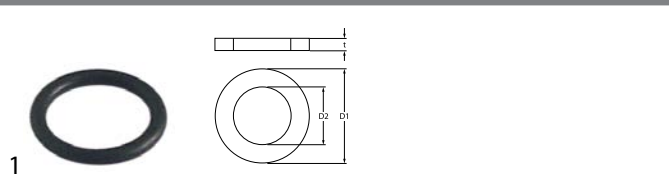

| | | | |
|--------------------|---|-----------------|---------|
| GEV No. | 504618 | Ref. No. | 3600035 |
| description | O-ring EPDM thickness 2.62mm ID ø 15.54mm Qty 1 pcs | | |

refrigeration cycle components

valves

expansion valves

DANFOSS

valves

type TS2/TE2



| | | | |
|--------------------|---|-----------------|---------|
| GEV No. | 750015 | Ref. No. | 3650065 |
| description | expansion valve DANFOSS type TES2 coolant R404a/R507 angled 90° thermostatically controlled inlet 3/8" SAE outlet 1/2" SAE 1/4" p max 34bar -40 up to +10°C capillary pipe 1500mm | | |

accessories for 750015

| | | | | |
|--|--------------------|--|-----------------|---|
| | GEV No. | 750020 | Ref. No. | — |
| | description | nozzle insert size 0X type 068-2002 T/TE 2 DANFOSS | | |
| | GEV No. | 750021 | Ref. No. | — |
| | description | nozzle insert size 00 type 068-2003 T/TE 2 DANFOSS | | |
| | GEV No. | 750022 | Ref. No. | — |
| | description | nozzle insert size 01 type 068-2010 T/TE 2 DANFOSS | | |
| | GEV No. | 750023 | Ref. No. | — |
| | description | nozzle insert size 02 type 068-2015 T/TE 2 DANFOSS | | |
| | GEV No. | 750024 | Ref. No. | — |
| | description | nozzle insert size 03 type 068-2006 T/TE 2 DANFOSS | | |
| | GEV No. | 750483 | Ref. No. | — |
| | description | nozzle insert size 04 type 068-2007 T2/TE2 DANFOSS | | |
| | GEV No. | 750484 | Ref. No. | — |
| | description | nozzle insert size 05 type 068-2008 T2/TE2 DANFOSS | | |
| | GEV No. | 750485 | Ref. No. | — |
| | description | nozzle insert size 06 type 068-2009 T2/TE2 DANFOSS | | |

indicators

CASTEL



| | | | |
|--------------------|---|-----------------|---------|
| GEV No. | 750070 | Ref. No. | 3650018 |
| description | sight glass CASTEL type 3950/22 with indicator connection 7/16" UNF (1/4" SAE) internal/external thread L 68mm -30 jusqu'à +110°C p max 45bar | | |

evaporators

for fridges

producer-specific



| | | | |
|--------------------|-----------------------------------|-----------------|--------------------|
| GEV No. | 750155 | Ref. No. | 3650025 3650105 |
| description | evaporator L 320mm W 90mm H 150mm | | |



| | | | |
|--------------------|---|-----------------|---------|
| GEV No. | 750153 | Ref. No. | 3650007 |
| description | evaporator L 390mm W 75mm H 300mm complete with fan | | |

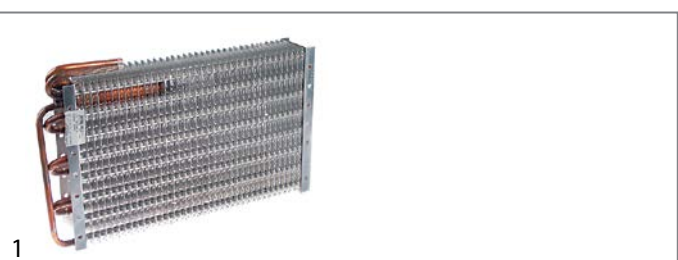

| | | | |
|--------------------|--|-----------------|---------|
| GEV No. | 750154 | Ref. No. | 3650010 |
| description | evaporator L 445mm W 75mm H 280mm total length 510mm | | |

kitchen accessories

gastronorm

gastronorm plates



1

| | | | |
|--------------------|--|-----------------|---------|
| GEV No. | 695246 | Ref. No. | 3400202 |
| description | gastronorm plate size GN 1/1 W 325mm L 530mm | | |

bridges



1

| | | | |
|--------------------|---|-----------------|---------|
| GEV No. | 693484 | Ref. No. | 2300306 |
| description | bridge for Gastronorm container L1 530mm L2 510mm SS W 22mm H 19.5mm Qty 1 pcs thickness 0.75mm | | |

valves and tank inlets

ball valves

universal

ball valves with lever handle



1

| | | | |
|--------------------|--|-----------------|---------|
| GEV No. | 514360 | Ref. No. | 3600259 |
| description | ball valve connection 1/2" IT - 1/2" IT DN15 total length 49mm | | |

tank inlets



1

| | | | |
|--------------------|--|-----------------|---------|
| GEV No. | 693483 | Ref. No. | 3600032 |
| description | tank inlet connection 1/2" WS 27 L1 12mm L2 20mm | | |



drain systems and wash basins

standpipes

3/4"



1

| | | | |
|---|--|-----------------|---------|
| GEV No. | 515048 | Ref. No. | 2300567 |
| description | standpipe size 3/4" usable height 48mm overall height 74mm ED ø 20mm chrome-plated brass with O-ring | | |
| spare parts for | 515048 | | |
| | GEV No. | Ref. No. | — |
|  | 528813 | | |
| | O-ring EPDM thickness 2mm ID ø 17mm Qty 1 pcs | | |
| accessories for | 515048 | | |
| | GEV No. | Ref. No. | — |
|  | 515041 | | |
| | drain fitting size 3/4" usable heightmm overall height 30mm ED ø 38mm chrome-plated brass | | |

producer-specific

EMAINOX



1

| | | | |
|--------------------|--|-----------------|--------------------|
| GEV No. | 515060 | Ref. No. | 3600034 3600077 |
| description | drain fitting thread 3/4" H 18mm ID ø 20mm ED ø 38mm | | |



1

| | | | |
|--------------------|---|-----------------|---------|
| GEV No. | 504618 | Ref. No. | 3600035 |
| description | O-ring EPDM thickness 2.62mm ID ø 15.54mm Qty 1 pcs | | |



1



| | | | |
|---|--|-----------------|---------|
| GEV No. | 515048 | Ref. No. | 2300567 |
| description | standpipe size 3/4" usable height 48mm overall height 74mm ED ø 20mm chrome-plated brass with O-ring | | |
| spare parts for | 515048 | | |
| | GEV No. | Ref. No. | — |
|  | 528813 | | |
| | O-ring EPDM thickness 2mm ID ø 17mm Qty 1 pcs | | |

Table continues overleaf



| | | | |
|---|---|--------|-------------------|
| accessories for | 515048 | | |
|  | GEV No. | 515041 | Ref. No. — |
| | drain fitting size 3/4" usable heightmm overall height 30mm ED ø 38mm chrome-plated brass | | |

measuring equipment

thermometers

built-in thermometers

| | | | |
|---|--|-----------------|---------|
|  | | | |
| 1 | | | |
| GEV No. | 541080 | Ref. No. | 3700042 |
| description | thermometer mounting measurements 58x25.5mm -40 up to +40°C capillary pipe 2500mm probe ø 6mm probe L 30mm | | |

| | | | |
|--|--|-----------------|---------|
| ø52mm | | | |
|  | | | |
| 1 | | | |
| GEV No. | 541413 | Ref. No. | 3700039 |
| description | thermometer mounting ø 52mm t.max. 120°C 0 up to +120°C probe ø 6mm probe L 36mm capillary pipe 1500mm | | |

| | | | |
|--------------------------------------|------|----------------------------------|----|
| B | | | |
| ball valves | 12 | refrigeration gaskets | 10 |
| ballasts | 6 | refrigeration thermostats | 4 |
| C | | relays | 6 |
| cam switches | 5 | rocker/momentary rocker switches | 4 |
| compressors | 8 | S | |
| contactors | 6 | safety thermostats | 4 |
| control thermostats | 3 | screw-in gaskets | 10 |
| D | | shelves and shelf rails | 10 |
| drain systems and wash basins | 12 | solenoid valves | 7 |
| E | | standpipes | 12 |
| electronic controllers | 7 | starter | 6 |
| energy regulators | 3 | switches and momentary switches | 4 |
| evaporators | 11 | T | |
| expansion valves | 11 | tank inlets | 12 |
| F | | thermostats | 3 |
| fans | 8 | V | |
| fluorescent lamps | 5, 5 | valves and tank inlets | 12 |
| foil heating elements | 3 | | |
| G | | | |
| gastronorm | 12 | | |
| H | | | |
| heating cartridges | 3 | | |
| heating elements | 3 | | |
| heating elements for bain maries | 3 | | |
| heating elements for convection | 3 | | |
| heating elements for heated cabinets | 3 | | |
| hot air fans | 8 | | |
| I | | | |
| indicator lights | 5 | | |
| indicator lights (complete) | 5 | | |
| indicators | 11 | | |
| L | | | |
| lamps | 5 | | |
| M | | | |
| measuring equipment | 13 | | |
| O | | | |
| O-rings | 11 | | |
| R | | | |
| refrigeration cycle components | 11 | | |
| refrigeration fans | 8 | | |