



**GAS COMPONENTS**



**ELECTRIC COMPONENTS**



**WATER TECHNOLOGY**



**MECHANICAL COMPONENTS**



**TOOLS**

Spare parts suitable for

**ELVIOMEX-ALFA**

Find the complete and up-to-date range of products in our GEV Webshop



# Manufacturer catalogue

The most important spare parts and accessories arranged clearly for every manufacturer

- ✓ Complete product range and all appliance data always up to date in the GEV Webshop
- ✓ Alphabetical Index at the end of the catalogue

## GEV Webshop

[www.gev-online.co.uk](http://www.gev-online.co.uk)

[www.gev-online.com](http://www.gev-online.com)



- 🔍 Add to Favourites
- 🔍 Sign In with email address and usual password
- 🔍 Easy-order – place several items in your basket at the same time
- 🔍 Quick Item search – no login needed



# heating elements

## immersion heating elements

### with compression flange (miscellaneous)



<b>GEV No.</b>	416251	<b>Ref. No.</b>	003.40.00011 HLE.EU.00011
<b>description</b>	heating element 2500W 230V heating circuits 1 flange ø 60mm L 290mm W 285mm H 45mm connection male faston 6.3mm tube ø 8.5mm immersion heater connection length 34mm thread M6		
<b>For models:</b>	Euroline-40F		

### with round flange ø47.5mm



<b>GEV No.</b>	416254	<b>Ref. No.</b>	003.35.00009 HLE.BL.00009
<b>description</b>	heating element 2400W 230V heating circuits 1 mounting ø 47.5mm L 295mm W 40mm H 46mm round flange connection male faston 6.3mm immersion heater tube ø 9.1mm		
<b>For models:</b>	Barline-35F		

**spare parts for** 416254

	<b>GEV No.</b>	510408	<b>Ref. No.</b>	—
	O-ring EPDM thickness 5.34mm ID ø 47mm Qty 1 pcs			

**accessories for** 416254

	<b>GEV No.</b>	510408	<b>Ref. No.</b>	—
	O-ring EPDM thickness 5.34mm ID ø 47mm Qty 1 pcs			

	<b>GEV No.</b>	510562	<b>Ref. No.</b>	—
	O-ring silicone thickness 5.34mm ID ø 47mm Qty 1 pcs			

	<b>GEV No.</b>	520235	<b>Ref. No.</b>	—
	3 hole flange hole distance 70.5mm perforation ø 6.5mm ID ø 53.5mm			

	<b>GEV No.</b>	520236	<b>Ref. No.</b>	—
	flange for heating element ID ø 50mm ED ø 90mm hole ø 6.5mm 3 holes			

	<b>GEV No.</b>	550002	<b>Ref. No.</b>	—
	tension strap H 10mm L 21mm W 10mm hole ø 6.5mm for heating element			

	<b>GEV No.</b>	550362	<b>Ref. No.</b>	—
	blind flange ø 64mm mounting ø 47.5mm			



<b>GEV No.</b>	416255	<b>Ref. No.</b>	003.40.00006 HLE.EU.00006
<b>description</b>	heating element 2500W 230V heating circuits 1 L 230mm W 34mm H 27mm tube ø 8.5mm connection length 58mm		
<b>For models:</b>	Euroline-40F		

**spare parts for** 416255

	<b>GEV No.</b>	510408	<b>Ref. No.</b>	—
	O-ring EPDM thickness 5.34mm ID ø 47mm Qty 1 pcs			

<b>accessories for</b> 416255	<b>GEV No.</b>	510562	<b>Ref. No.</b>	—
	O-ring silicone thickness 5.34mm ID ø 47mm Qty 1 pcs			
	<b>GEV No.</b>	520235	<b>Ref. No.</b>	—
	3 hole flange hole distance 70.5mm perforation ø 6.5mm ID ø 53.5mm			
	<b>GEV No.</b>	520236	<b>Ref. No.</b>	—
	flange for heating element ID ø 50mm ED ø 90mm hole ø 6.5mm 3 holes			
	<b>GEV No.</b>	550002	<b>Ref. No.</b>	—
	tension strap H 10mm L 21mm W 10mm hole ø 6.5mm for heating element			
	<b>GEV No.</b>	550362	<b>Ref. No.</b>	—
	blind flange ø 64mm mounting ø 47.5mm			



<b>GEV No.</b>	418216	<b>Ref. No.</b>	003.50.00005 HLE.VK.00005
<b>description</b>	heating element 3000W 230V heating circuits 1 mounting ø 47.5mm L 370mm W 40mm H 38mm round flange connection M4 immersion heater tube ø 8.7mm connection length 31mm		
<b>For models:</b>	Vergina-50SF		

**accessories for** 418216

	<b>GEV No.</b>	510408	<b>Ref. No.</b>	—
	O-ring EPDM thickness 5.34mm ID ø 47mm Qty 1 pcs			

	<b>GEV No.</b>	510562	<b>Ref. No.</b>	—
	O-ring silicone thickness 5.34mm ID ø 47mm Qty 1 pcs			

	<b>GEV No.</b>	520235	<b>Ref. No.</b>	—
	3 hole flange hole distance 70.5mm perforation ø 6.5mm ID ø 53.5mm			

	<b>GEV No.</b>	520236	<b>Ref. No.</b>	—
	flange for heating element ID ø 50mm ED ø 90mm hole ø 6.5mm 3 holes			

	<b>GEV No.</b>	550002	<b>Ref. No.</b>	—
	tension strap H 10mm L 21mm W 10mm hole ø 6.5mm for heating element			

	<b>GEV No.</b>	550362	<b>Ref. No.</b>	—
	blind flange ø 64mm mounting ø 47.5mm			



<b>GEV No.</b>	416258	<b>Ref. No.</b>	003.00.00351 HLE.OO.00351
<b>description</b>	heating element 4000W 230V heating circuits 3 mounting ø 47.5mm L 363mm W 33mm H 33mm round flange connection M4 immersion heater tube ø 8.5mm		
<b>For models:</b>	Turbo-1500		

**spare parts for** 416258

	<b>GEV No.</b>	510408	<b>Ref. No.</b>	—
	O-ring EPDM thickness 5.34mm ID ø 47mm Qty 1 pcs			





**accessories for** 416258

	<b>GEV No.</b>	510562	<b>Ref. No.</b>	—
	O-ring silicone thickness 5.34mm ID ø 47mm Qty 1 pcs			

Table continues overleaf

1 electric components







<b>accessories for</b> 416258			
	GEV No.	520235	Ref. No. —
3 hole flange hole distance 70.5mm perforation $\varnothing$ 6.5mm ID $\varnothing$ 53.5mm			
	GEV No.	520236	Ref. No. —
flange for heating element ID $\varnothing$ 50mm ED $\varnothing$ 90mm hole $\varnothing$ 6.5mm 3 holes			
	GEV No.	550002	Ref. No. —
tension strap H 10mm L 21mm W 10mm hole $\varnothing$ 6.5mm for heating element			
	GEV No.	550362	Ref. No. —
blind flange $\varnothing$ 64mm mounting $\varnothing$ 47.5mm			

			
<b>GEV No.</b>	416257	<b>Ref. No.</b>	003.00.00411 HLE.00.00411 HLE.VK.00411
<b>description</b>	heating element 6000W 230/400V heating circuits 3 mounting $\varnothing$ 47.5mm L 360mm W 37mm H 33mm connection male faston 6.3mm immersion heater tube $\varnothing$ 8.5mm		
<b>spare parts for</b>	416257		
	GEV No.	510408	Ref. No. —
O-ring EPDM thickness 5.34mm ID $\varnothing$ 47mm Qty 1 pcs			
<b>accessories for</b>	416257		
	GEV No.	510562	Ref. No. —
O-ring silicone thickness 5.34mm ID $\varnothing$ 47mm Qty 1 pcs			
	GEV No.	520235	Ref. No. —
3 hole flange hole distance 70.5mm perforation $\varnothing$ 6.5mm ID $\varnothing$ 53.5mm			
	GEV No.	520236	Ref. No. —
flange for heating element ID $\varnothing$ 50mm ED $\varnothing$ 90mm hole $\varnothing$ 6.5mm 3 holes			
	GEV No.	550002	Ref. No. —
tension strap H 10mm L 21mm W 10mm hole $\varnothing$ 6.5mm for heating element			
	GEV No.	550362	Ref. No. —
blind flange $\varnothing$ 64mm mounting $\varnothing$ 47.5mm			



with round flange  $\varnothing$ 60.0mm

			
<b>GEV No.</b>	417573	<b>Ref. No.</b>	003.10.00000 HLE.10.00000 HLE.10.00024
<b>description</b>	heating element 3990W 230V heating circuits 3 mounting $\varnothing$ 60mm L 320mm W 120mm H 40mm connection male faston 6.3mm tube $\varnothing$ 8.5mm		

<b>1 1/4"</b>			
			
<b>GEV No.</b>	416253	<b>Ref. No.</b>	003.15.00095 HLE.15.00095
<b>description</b>	heating element 6000W 230V heating circuits 3 thread 1 1/4" L 360mm W 115mm H 50mm L1 180mm L2 10mm W1 41mm W2 32mm H1 24mm H2 30mm tube $\varnothing$ 8.5mm connection M4 flange with thread immersion heater		
<b>For models:</b>	Turbo-1500		
<b>spare parts for</b>	416253		
	GEV No.	510405	Ref. No. —
flat gasket fibre ED $\varnothing$ 56mm ID $\varnothing$ 42mm thickness 2mm for thread 1 1/4" Qty 1 pcs			
	GEV No.	520232	Ref. No. —
nut thread 1 1/4" H 5mm nickel-plated brass WS 47 Qty 1 pcs			
<b>accessories for</b>	416253		
	GEV No.	528021	Ref. No. —
flat gasket PTFE ED $\varnothing$ 53mm ID $\varnothing$ 42.5mm thickness 3mm Qty 1 pcs equiv. no. 12001/02286 suitable for Astoria/Aurora/Brasilia/Wega			

<b>1"</b>			
			
<b>GEV No.</b>	416250	<b>Ref. No.</b>	003.30.00000 HLE.B3.00000
<b>description</b>	heating element 2000W 230V heating circuits 1 thread 1" L 250mm W 25mm H 26mm tube $\varnothing$ 8.5mm connection M4 immersion heater flange with thread		
<b>For models:</b>	Barline-35F		
<b>spare parts for</b>	416250		
	GEV No.	510404	Ref. No. —
flat gasket fibre ED $\varnothing$ 44mm ID $\varnothing$ 34mm thickness 2mm Qty 1 pcs			
	GEV No.	520233	Ref. No. —
nut thread 1" H 6mm brass WS 47 Qty 1 pcs			
<b>accessories for</b>	416250		
	GEV No.	510422	Ref. No. —
gasket copper ED $\varnothing$ 37.7mm ID $\varnothing$ 32.5mm thickness 2.7mm for thread 1"			



 <p>1</p>			
<b>GEV No.</b>	416252	<b>Ref. No.</b>	003.50.00008 003.70.00003 HLE.70.00003 HLE.VK.00008
<b>description</b>	heating element 2800W 230V heating circuits 1 L 370mm W 240mm H 30mm thread M14x1.5 mounting distance 50mm tube ø 8.5mm connection M4 flange with thread immersion heater W1 115mm W2 53mm		
<b>For models:</b>	Vergina-50SF		
<b>spare parts for</b>	416252		
	<b>GEV No.</b>	<b>Ref. No.</b>	—
	521101		nut thread M14x1.5 H 5mm WS 19 SS Qty 1 pcs
<b>accessories for</b>	416252		
	<b>GEV No.</b>	<b>Ref. No.</b>	—
	532103		O-ring EPDM thickness 3.53mm ID ø 13.87mm Qty 10 pcs

accessories

protection caps

 <p>1</p>			
<b>GEV No.</b>	520560	<b>Ref. No.</b>	003.00.00004 HLE.00.00004
<b>description</b>	protection cap for heating element ø 48mm plastic L 48mm		
<b>For models:</b>	Barline-35F, Euroline-40F, Turbo-1500, Vergina-50SF		

thermostats

bi-metal thermostats

safety bi-metal thermostats

 <p>1</p>			
<b>GEV No.</b>	390758	<b>Ref. No.</b>	003.00.00180 HLE.00.00180
<b>description</b>	bi-metal safety thermostat hole distance 23.5mm switch-off temp. 105°C 1NC 1-pole 16A connection F6.3		
<b>For models:</b>	Barline-35F, Euroline-40F, Turbo-1500, Vergina-50SF		

 <p>1</p>			
<b>GEV No.</b>	390759	<b>Ref. No.</b>	003.00.00168 HLE.00.00168
<b>description</b>	bi-metal safety thermostat hole distance 23.5mm switch-off temp. 90°C 1NC 1-pole 16A connection F6.3		
<b>For models:</b>	Barline-35F, Euroline-40F, Turbo-1500, Vergina-50SF		

control and safety thermostats

CAMPINI

control thermostats

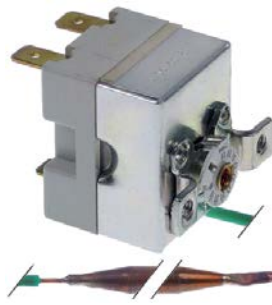
 <p>1</p>			
<b>GEV No.</b>	390465	<b>Ref. No.</b>	003.00.00213 HLE.00.00213
<b>description</b>	thermostat t.max. 90°C temperature range 0-90°C 1-pole 1CO 16A probe ø 6.5mm probe L 87mm capillary pipe 1470mm capillary pipe isolated 1450mm gland nut shaft ømm shaft Lmm shaft position rotation 270° probe material copper 95 CAMPINI		
<b>For models:</b>	Barline-35F, Euroline-40F, Turbo-1500, Vergina-50SF		

switches and momentary switches

push/momentary push switches

28.5x28.5mm

 <p>1</p>			
<b>GEV No.</b>	301178	<b>Ref. No.</b>	003.00.00399 HLE.00.00399
<b>description</b>	momentary push switch mounting measurements 28.5x28.5mm green 1NO 250V 16A connection male faston 6.3mm ambient temperature max. 150°C protection IP40		
<b>For models:</b>	Barline-35F, Euroline-40F, Vergina-50SF		

 <p>1</p>			
<b>GEV No.</b>	301177	<b>Ref. No.</b>	003.00.00247 HLE.00.00247
<b>description</b>	push switch mounting measurements 28.5x28.5mm green 1CO 250V 16A connection male faston 6.3mm ambient temperature max. 150°C protection IP40		
<b>For models:</b>	Vergina-50SF		

			
1			
<b>GEV No.</b>	301179	<b>Ref. No.</b>	003.00.00137 HLE.00.00137
<b>description</b>	push switch mounting measurements 28.5x28.5mm grey/red 2CO 250V 16A connection male faston 6.3mm ambient temperature max. 150°C protection IP40 with indicator		
<b>For models:</b>	Euroline-40F, Vergina-50SF		



			
1			
<b>GEV No.</b>	301176	<b>Ref. No.</b>	003.00.00009 HLE.00.00009
<b>description</b>	push switch mounting measurements 28.5x28.5mm blue/green 2CO 250V 16A connection male faston 6.3mm ambient temperature max. 150°C protection IP40 with indicator		
<b>For models:</b>	Barline-35F, Euroline-40F, Vergina-50SF		

<b>ø22.3mm</b>			
			
1			
<b>GEV No.</b>	347580	<b>Ref. No.</b>	003.15.00019 HLE.15.00019
<b>description</b>	push switch mounting ø 22.3mm green 1CO 250V 10A connection screw ambient temperature max. 85°C protection IP40		

microswitches

lever actuated

			
1			
<b>GEV No.</b>	345813	<b>Ref. No.</b>	003.00.00069 HLE.00.00069
<b>description</b>	microswitch with lever 250V 10A 1CO connection male faston 6.3mm ambient temperature max. 85°C		

			
1			
<b>GEV No.</b>	347583	<b>Ref. No.</b>	003.00.00426 HLE.00.00426
<b>description</b>	microswitch with lever 250V 15A 1CO connection male faston 6.3mm ambient temperature max. 85°C door switch lever length 28mm		
<b>For models:</b>	Barline-35F, Euroline-40F, Vergina-50SF		
<b>spare parts for</b>	347583		
	<b>GEV No.</b>	345813	<b>Ref. No.</b>
			003.00.00069 HLE.00.00069
	microswitch with lever 250V 10A 1CO connection male faston 6.3mm ambient temperature max. 85°C		

<b>non-standard</b>			
			
1			
<b>GEV No.</b>	345814	<b>Ref. No.</b>	003.00.00231 HLE.00.00231
<b>description</b>	microswitch		
<b>For models:</b>	Barline-35F, Euroline-40F, Vergina-50SF		

position switches

<b>LOVATO</b>			
			
1			
<b>GEV No.</b>	347579	<b>Ref. No.</b>	003.15.00003 HLE.15.00003
<b>description</b>	position switch plastic 1NO/1NC 400V 3A L 110mm W 30mm H 44mm protection IP66/67 actuating force: 380g screw connection M16 mounting distance 22mm type ZCP21		

<b>TELEMECANIQUE (EFA)</b>			
			
1			
<b>GEV No.</b>	347579	<b>Ref. No.</b>	003.15.00003 HLE.15.00003
<b>description</b>	position switch plastic 1NO/1NC 400V 3A L 110mm W 30mm H 44mm protection IP66/67 actuating force: 380g screw connection M16 mounting distance 22mm type ZCP21		

control equipment

RENY

<b>switches (complete)</b>			
			
1			
<b>GEV No.</b>	347581	<b>Ref. No.</b>	003.00.00008 HLE.00.00008
<b>description</b>	rotary selector mounting measurements ø22mm green sequence 0-1 latching		
<b>For models:</b>	Turbo-1500		



			
1			
<b>GEV No.</b>	347582	<b>Ref. No.</b>	003.00.00509 HLE.00.00509
<b>description</b>	rotary selector mounting measurements ø22mm green sequence 1-0-2 latching		

## lamps

### indicator lights

#### indicator lights (complete)

ø10mm

with plug-in socket

			
1			
<b>GEV No.</b>	359361	<b>Ref. No.</b>	003.00.00176 HLE.00.00176
<b>description</b>	indicator light ø 10mm 230V green		
<b>For models:</b>	Barline-35F, Euroline-40F, Turbo-1500, Vergina-50SF		

			
1			
<b>GEV No.</b>	359360	<b>Ref. No.</b>	003.00.00028 HLE.00.00028
<b>description</b>	indicator light ø 10mm 230V yellow with cable		
<b>For models:</b>	Barline-35F, Euroline-40F, Turbo-1500, Vergina-50SF		

## timers

### programme timers

			
1			
<b>GEV No.</b>	360518	<b>Ref. No.</b>	003.00.00448 HLE.00.00448
<b>description</b>	timer CDC 7803F1 engines 1 chambers 3 operation time 120s 230V shaft ømm shaft Lmm voltage AC		
<b>For models:</b>	Barline-35F, Euroline-40F		



			
1			
<b>GEV No.</b>	360274 <sup>1</sup>	<b>Ref. No.</b>	003.00.00215 HLE.00.00215
<b>description</b>	timer FIBER P26 engines 1 chambers 3 operation time 120s 230V shaft ø 6x4.6mm shaft L 18mm manif. no. P265J03H358 motor type M61B40L6400		
<b>For models:</b>	Turbo-1500		

<sup>1</sup>incl. knob

## contactors

### LS Industrial Systems

#### overload switches

			
1			
<b>GEV No.</b>	381118	<b>Ref. No.</b>	003.15.00010 HLE.15.00010
<b>description</b>	overload switch setting range 2.5-4A type GTK-12M LS Industrial Systems		
<b>For models:</b>	Turbo-1500		
<b>accessories for</b>	381118		
	<b>GEV No.</b>	<b>Ref. No.</b>	<b>003.00.00056 HLE.00.00056</b>
		380238	
	power contactor resistive load 20A 230VAC (AC3/400V) 8.4A/4kW main contacts 3NO auxiliary contacts 1NO connection screw connection type LS0510A type AEG LS0510A type GE MC1A 310A		

### GENERAL ELECTRIC (AEG)

#### power contactors

			
1			
<b>GEV No.</b>	380238	<b>Ref. No.</b>	003.00.00056 HLE.00.00056
<b>description</b>	power contactor resistive load 20A 230VAC (AC3/400V) 8.4A/4kW main contacts 3NO auxiliary contacts 1NO connection screw connection type LS0510A type AEG LS0510A type GE MC1A 310A		
<b>For models:</b>	Turbo-1500, Vergina-50SF		



## relays

## power relays

## with bracket mounting



1

<b>GEV No.</b>	380815	<b>Ref. No.</b>	003.00.00306
<b>description</b>	power relays 230VAC 16A 2NO connection male faston 6.3mm flange dimensions 36x38x68mm		
<b>For models:</b>	Euroline-40F		



1

<b>GEV No.</b>	380808	<b>Ref. No.</b>	003.00.00082
<b>description</b>	power relays FINDER 230VAC 16A 3CO connection male faston 6.3mm bracket mounting manuf. no. 62.83.8.230.0000		

## with male contacts

## bullet connectors, 11 contacts





1

<b>GEV No.</b>	380132	<b>Ref. No.</b>	003.15.00098 HLE.15.00098	
<b>description</b>	power relays Italiana Relè 230VAC 10A 3CO connection plug-in connection round 11-pole manuf. no. C43-230AC ZVE11 250V 11-pole			
<b>For models:</b>	Turbo-1500			
<b>accessories for</b>	380132			
	<b>GEV No.</b>	380136	<b>Ref. No.</b>	003.15.00099 HLE.15.00099
	relay socket 11-pole connection plug-in connection round 11-pole dimensions 65x28x40mm 250V voltage AC 10A Italiana Relè manuf. no. ZVE11			

## bullet connectors, 8 contacts



1

<b>GEV No.</b>	380134	<b>Ref. No.</b>	003.00.00055 HLE.00.00055	
<b>description</b>	power relays Italiana Relè 230VAC 10A 2CO connection plug-in connection round 8-pole manuf. no. C42-230VAC 90.26/ZVE8 250V			
<b>accessories for</b>	380134			
	<b>GEV No.</b>	380137	<b>Ref. No.</b>	003.00.00034 HLE.00.00034
	relay socket 8-pole connection plug-in connection round 8-pole dimensions 65x28x40mm 380V voltage AC 10A Italiana Relè manuf. no. ZVE8			
	<b>GEV No.</b>	380638	<b>Ref. No.</b>	—
	relay socket 8-pole dimensions 51x41x23mm 250V 10A FINDER manuf. no. 90.26			

## relay sockets



1

<b>GEV No.</b>	380136	<b>Ref. No.</b>	003.15.00099 HLE.15.00099	
<b>description</b>	relay socket 11-pole connection plug-in connection round 11-pole dimensions 65x28x40mm 250V voltage AC 10A Italiana Relè manuf. no. ZVE11			
<b>For models:</b>	Turbo-1500			
<b>accessories for</b>	380136			
	<b>GEV No.</b>	380805	<b>Ref. No.</b>	—
	support bracket			



1

<b>GEV No.</b>	380137	<b>Ref. No.</b>	003.00.00034 HLE.00.00034	
<b>description</b>	relay socket 8-pole connection plug-in connection round 8-pole dimensions 65x28x40mm 380V voltage AC 10A Italiana Relè manuf. no. ZVE8			
<b>accessories for</b>	380137			
	<b>GEV No.</b>	380805	<b>Ref. No.</b>	—
	support bracket			





## keypads

### front foils

1 			
<b>GEV No.</b>	401134	<b>Ref. No.</b>	003.35.00000 HLE.BL.00000
<b>description</b>	front foil		

## solenoid valves

### solenoid valves (water)

ELBI			
1 			
<b>GEV No.</b>	370251	<b>Ref. No.</b>	003.00.00031 HLE.00.00031
<b>description</b>	solenoid valve single straight 230VAC inlet 3/4" outlet 11.5mm input 10l/min t.max. 90°C ELBI plastic flow regulating valve inlet red		
<b>For models:</b>	Barline-35F, Euroline-40F, Turbo-1500, Vergina-50SF		

## pressure switches

### for warewashing

ø 58mm with male faston 6.3mm

with connection horizontal







1 			
<b>GEV No.</b>	541019	<b>Ref. No.</b>	003.00.00033 HLE.00.00033
<b>description</b>	pressure control pressure range 70/30mbar connection 6mm ø 58mm pressure connection horizontal warewashing pressure connection ø 6mm		
<b>For models:</b>	Barline-35F, Euroline-40F, Turbo-1500, Vergina-50SF		

## pumps

### wash and rinse pumps



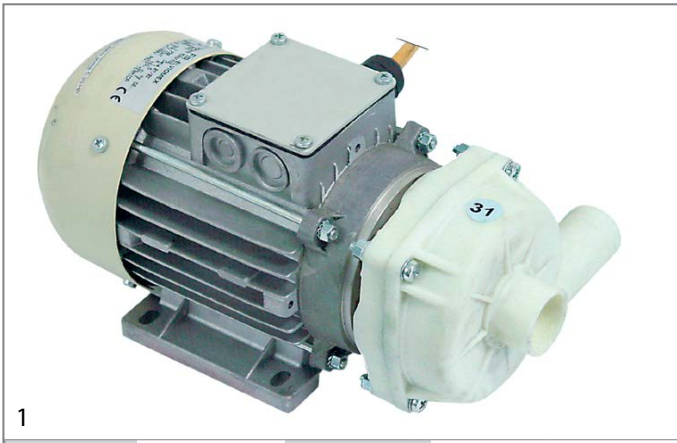

FIR

pumps

1 			
<b>GEV No.</b>	500387	<b>Ref. No.</b>	003.00.00060 HLE.00.00060
<b>description</b>	pump inlet ø 28mm outlet ø 26mm type 2211.1408 220V 50Hz 1 phase 0.074kW 0.1HP L 190mm rotation direction left capacitor 5µF FIR 2600rpm		
<b>For models:</b>	Barline-35F		
<b>spare parts for</b>	500387		
	<b>GEV No.</b>	365017	<b>Ref. No.</b> —
	operating capacitor capacity 5µF 450V tolerance 5% 50/60Hz ambient temperature max. -25 to +85°C ø 28mm L 54mm M8 plastic connection male faston 6.3mm 16.10.08 protection		
	<b>GEV No.</b>	510384	<b>Ref. No.</b> 003.00.00477 HLE.00.00477
	pump cover inlet ø 28mm outlet ø 26mm ø 100mm ID ø 76mm		
	<b>GEV No.</b>	510695	<b>Ref. No.</b> —
	mechanical shaft seal height counter ring 5.5mm ID ø 11mm		
	<b>GEV No.</b>	521203	<b>Ref. No.</b> 003.35.00010 HLE.BL.00010
	impellor ø 72mm H 18mm thread M7 shaft ø 11mm shaft length 32mm blades 3		
	<b>GEV No.</b>	521703	<b>Ref. No.</b> —
	pump cover gasket EPDM thickness 2.5mm ID ø 75mm Qty 1 pcs		



1

<b>GEV No.</b>	500388	<b>Ref. No.</b>	003.40.00005 HLE.EU.00005
<b>description</b>	pump inlet ø 33mm outlet ø 30mm type B265.1500 230V 50Hz 1 phase 0.22kW 0.3HP L 265mm rotation direction left capacitor 6.3µF FIR		
<b>For models:</b>	Euroline-40F		
<b>spare parts for</b>	500388		
	<b>GEV No.</b>	365012	<b>Ref. No.</b> —
	operating capacitor capacity 6.3µF 450V tolerance 5% 50Hz ambient temperature max. -25 to +85°C ø 30mm L 61mm M8 plastic connection male faston 6.3mm protection		
	<b>GEV No.</b>	501309	<b>Ref. No.</b> 003.40.00007
	impellor ø 80mm H 19mm M7R pump type type D1		
	<b>GEV No.</b>	510702	<b>Ref. No.</b> —
	mechanical shaft seal height counter ring 5.5mm ID ø 12mm		
	<b>GEV No.</b>	521500	<b>Ref. No.</b> 003.00.00134 HLE.00.00134
	pump cover		
	<b>GEV No.</b>	521700	<b>Ref. No.</b> —
	pump cover gasket		



1

<b>GEV No.</b>	500710	<b>Ref. No.</b>	003.00.00350 old version HLE.00.00350 old version
<b>description</b>	pump inlet ø 45mm outlet ø 40mm type 1217/A 230V 50Hz 1 phase 0.56kW 0.75HP L 295mm rotation direction right capacitor 12.5µF FIR		



1

<b>GEV No.</b>	500389	<b>Ref. No.</b>	003.00.00083 HLE.00.00083
<b>description</b>	pump inlet ø 45mm outlet ø 40mm type 3911 230V 50Hz 1 phase 0.55kW 0.75HP rotation direction right FIR		



1

<b>GEV No.</b>	500111	<b>Ref. No.</b>	003.00.00063 HLE.00.00063 HLE.VK.00063
<b>description</b>	pump inlet ø 63mm outlet ø 53mm type 1241.2500 230/400V 50Hz 3 phase 1.1kW 1.5HP L 330mm rotation direction left FIR		
<b>For models:</b>	Turbo-1500		
<b>spare parts for</b>	500111		
	<b>GEV No.</b>	510531	<b>Ref. No.</b> 003.00.00480 HLE.00.00480
	pump cover FIR inlet ø 63mm outlet ø 53mm auxiliary pressure connection M16x1.5mm supporting pressure open turn direction left ø 185mm ID ø 150mm inner height 37mm		
	<b>GEV No.</b>	510612	<b>Ref. No.</b> 003.15.00029 HLE.15.00029
	impellor ø 110mm H 34mm M8R		
	<b>GEV No.</b>	510693	<b>Ref. No.</b> —
	mechanical shaft seal for shaft ø 12mm slide ring ext. ø 24mm slide ring H 15.5mm slide ring int. ø 11mm counter ring mounting ø 24mm height counter ring 8mm counter ring int. ø 13.5mm		
	<b>GEV No.</b>	524416	<b>Ref. No.</b> —
	pump cover gasket thickness 4x4mm Qty 1 pcs		



OLYMPIA

pumps





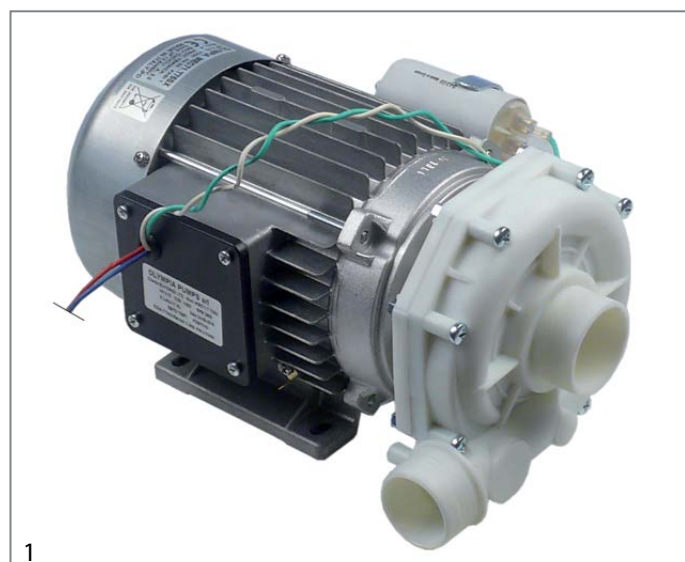

1

<b>GEV No.</b>	499322	<b>Ref. No.</b>	003.40.00005
<b>description</b>	pump inlet $\varnothing$ 33mm outlet $\varnothing$ 30/28mm type L63.T33DX 230V 50Hz 1 phase 0.26kW 0.33HP L 260mm rotation direction left capacitor 5 $\mu$ F OLYMPIA		
<b>spare parts for</b>	499322		
	<b>GEV No.</b>	365017	<b>Ref. No.</b> —
	operating capacitor capacity 5 $\mu$ F 450V tolerance 5% 50/60Hz ambient temperature max. -25 to +85°C $\varnothing$ 28mm L 54mm M8 plastic connection male faston 6.3mm 16.10.08 protection		
	<b>GEV No.</b>	510693	<b>Ref. No.</b> —
	mechanical shaft seal for shaft $\varnothing$ 12mm slide ringext. $\varnothing$ 24mm slide ring H 15.5mm slide ring int. $\varnothing$ 11mm counter ring mounting $\varnothing$ 24mm height counter ring 8mm counter ring int. $\varnothing$ 13.5mm		
	<b>GEV No.</b>	521258	<b>Ref. No.</b> —
	impellor $\varnothing$ 80mm H 13mm thread M10R shaft $\varnothing$ 12mm shaft length 7.5mm blades 6		
	<b>GEV No.</b>	521551	<b>Ref. No.</b> 003.00.00478 HLE.00.00478
	pump cover OLYMPIA inlet $\varnothing$ 33mm outlet $\varnothing$ 30mm outlet 2 $\varnothing$ 28 turn direction left $\varnothing$ 103mm ID $\varnothing$ 93mm inner high 30mm		
	<b>GEV No.</b>	521723	<b>Ref. No.</b> —
	pump cover gasket EPDM thickness 2mm ID $\varnothing$ 90mm Qty 1 pcs		



1

<b>GEV No.</b>	499050	<b>Ref. No.</b>	003.00.00350 HLE.00.00350
<b>description</b>	pump inlet $\varnothing$ 45mm outlet $\varnothing$ 40mm type MEC71.T75SX 230V 50Hz 1 phase 0.55kW 0.75HP L 283mm rotation direction right capacitor 12.5 $\mu$ F OLYMPIA		
<b>For models:</b>	Vergina-50SF		
<b>spare parts for</b>	499050		
	<b>GEV No.</b>	365014	<b>Ref. No.</b> —
	operating capacitor capacity 12.5 $\mu$ F 450V tolerance 5%Hz ambient temperature max. -25 to +85°C $\varnothing$ 35mm L 70mm M8 plastic connection male faston 6.3mm 45S.C3DS.12.5 protection		
	<b>GEV No.</b>	510554	<b>Ref. No.</b> —
	O-ring EPDM thickness 2mm ID $\varnothing$ 120mm Qty 1 pcs		
	<b>GEV No.</b>	510693	<b>Ref. No.</b> —
	mechanical shaft seal for shaft $\varnothing$ 12mm slide ringext. $\varnothing$ 24mm slide ring H 15.5mm slide ring int. $\varnothing$ 11mm counter ring mounting $\varnothing$ 24mm height counter ring 8mm counter ring int. $\varnothing$ 13.5mm		
	<b>GEV No.</b>	517368	<b>Ref. No.</b> —
	impellor $\varnothing$ 102mm H 21mm rotation direction right thread M10L suitable for Dibr blades 8		
	<b>GEV No.</b>	521158	<b>Ref. No.</b> —
	pump cover OLYMPIA inlet 45 inlet $\varnothing$ 40mm pump type MEC71.T75SX		



## drain pumps

## HANNING



1

<b>GEV No.</b>	499339	<b>Ref. No.</b>	003.00.00184 HLE.00.00184
<b>description</b>	drain pump 65W 230V inlet ø 24mm outlet ø 24mm 50Hz type BE20B2-017 HANNING		
<b>For models:</b>	Euroline-40F, Vergina-50SF		



1

<b>GEV No.</b>	499133	<b>Ref. No.</b>	003.00.00635	
<b>description</b>	drain pump 65W 230V inlet ø 24mm outlet ø 24mm 50Hz type BE20B2-017 HANNING kit			
<b>spare parts for</b>	499133			
	<b>GEV No.</b>	499339	<b>Ref. No.</b>	003.00.00184 HLE.00.00184
	drain pump 65W 230V inlet ø 24mm outlet ø 24mm 50Hz type BE20B2-017 HANNING			

## accessories

## pump cover gaskets



1

<b>GEV No.</b>	501312	<b>Ref. No.</b>	002.00.00262
<b>description</b>	O-ring EPDM thickness 1.78mm ID ø 88.62mm Qty 1 pcs		



1

<b>GEV No.</b>	521715	<b>Ref. No.</b>	002.00.00232 YDR.00.00232
<b>description</b>	pump cover gasket		

## fuses

## thermal fuses



1

<b>GEV No.</b>	390734	<b>Ref. No.</b>	003.00.00168 old version HLE.00.00168 old version
<b>description</b>	thermal fuse switch-off temp. 90°C 1NC 1-pole 15A 250V connection male faston 6.3mm hole distance 24mm		

## electric accessories

## terminals

## connection terminals with screw/faston connections



1

<b>GEV No.</b>	550278	<b>Ref. No.</b>	003.00.00392 HLE.00.00392
<b>description</b>	power terminal block 3-pole max. 40A max 400V connection ø6mm <sup>2</sup> / F6.3 temp.-resist. 150°C cross section 6mm <sup>2</sup>		
<b>For models:</b>	Barline-35F, Euroline-40F		



1

<b>GEV No.</b>	550411	<b>Ref. No.</b>	003.00.00030 HLE.00.00030
<b>description</b>	power terminal block 6-pole max. 40A max 450V connection ø6mm <sup>2</sup> / F6.3 temp.-resist. 150°C cross section 6mm <sup>2</sup>		



rail-mounted terminals

WEIDMÜLLER

feed-through terminals



**GEV No.** 551094 **Ref. No.** 003.00.00023  
HLE.00.00023

**description** rail-mounted terminal 10mm<sup>2</sup> for DIN rail 35mm grey 1-pole

**For models:** Turbo-1500

**accessories for** 551094



**GEV No.** 551095 **Ref. No.** 003.00.00024  
HLE.00.00024

**description** isolation barrier clamps 2.5-10mm<sup>2</sup> grey for DIN rail 35mm

accessories



**GEV No.** 551095 **Ref. No.** 003.00.00024  
HLE.00.00024

**description** isolation barrier clamps 2.5-10mm<sup>2</sup> grey for DIN rail 35mm

**For models:** Turbo-1500

equipment-specific units

for dishwashers

drain and intake components

ELVIOMEX-ALFA

drain /intake bodies



**GEV No.** 503323 **Ref. No.** 002.00.00084  
YDR.00.00084

**description** drain fitting

**For models:** Barline-35F, Euroline-40F, Vergina-50SF



**GEV No.** 524613 **Ref. No.** 002.00.00257

**description** drain fitting complete thread M36x1.5 ED ø 60mm H 42mm ID ø 30mm hose ø 30mm

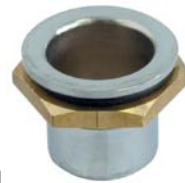

**GEV No.** 503325 **Ref. No.** 002.15.00017  
YDR.15.00017

**description** drain fitting thread 1½" ED ø 60mm H 49mm ID ø 40mm

**For models:** Turbo-1500



**GEV No.** 503329 **Ref. No.** 002.00.00081  
YDR.00.00081

**description** intake body

**For models:** Vergina-50SF

filters



**GEV No.** 524593 **Ref. No.** 002.15.00012  
YDR.15.00012

**description** filter support for drain filter ø 117mm thread M6

**For models:** Turbo-1500



**GEV No.** 517392 **Ref. No.** 001.40.00045

**description** round filters for drain pump ø 106mm H 95mm



**GEV No.** 517391 **Ref. No.** 001.50.00040  
ANO.VK.00040

**description** round filters for drain pump ø 145mm H 90mm

			
1			
<b>GEV No.</b>	503326	<b>Ref. No.</b>	001.30.00030 ANO.30.00030 ANO.B3.00000
<b>description</b>	round filters suction ø 110mm		
<b>For models:</b>	Barline-35F, Euroline-40F		

			
1			
<b>GEV No.</b>	503328	<b>Ref. No.</b>	001.70.00000 ANO.7V.00000
<b>description</b>	round filters suction ø 140mm		
<b>For models:</b>	Vergina-50SF		

			
1			
<b>GEV No.</b>	503327	<b>Ref. No.</b>	001.15.00078 ANO.00.00042 ANO.15.00078
<b>description</b>	round filters suction ø 180mm H 85mm		
<b>For models:</b>	Turbo-1500		

			
1			
<b>GEV No.</b>	518134	<b>Ref. No.</b>	001.00.00017 ANO.00.00017
<b>description</b>	Thumb screw for filter fixing ø 20mm thread M6/M10		

			
1			
<b>GEV No.</b>	503320	<b>Ref. No.</b>	002.30.00007 YDR.BA.00007
<b>description</b>	overflow pipe L 100mm ø 29mm		
<b>For models:</b>	Barline-35F, Euroline-40F		

			
1			
<b>GEV No.</b>	503321	<b>Ref. No.</b>	002.30.00009 YDR.30.00009
<b>description</b>	overflow pipe L 120mm ø 29mm		

			
1			
<b>GEV No.</b>	503322	<b>Ref. No.</b>	002.70.00013 YDR.70.00013
<b>description</b>	overflow pipe L 145mm ø 29mm		
<b>For models:</b>	Vergina-50SF		

			
1			
<b>GEV No.</b>	503324	<b>Ref. No.</b>	002.15.00031 YDR.15.00031
<b>description</b>	overflow pipe L 165mm ø 39mm		
<b>For models:</b>	Turbo-1500		



boilers

boilers for dishwashers



1

<b>GEV No.</b>	524603	<b>Ref. No.</b>	001.40.00026 ANO.EU.00026
<b>description</b>	boiler ø 143mm L 270mm flange 3 hole flange inlet ø 10mm		
<b>For models:</b>	Euroline-40F		



1

<b>GEV No.</b>	524600	<b>Ref. No.</b>	001.50.00017 ANO.VE.00017
<b>description</b>	boiler ø 143mm L 400mm flange 3 hole flange inlet ø 10mm		
<b>For models:</b>	Vergina-50SF		



1

<b>GEV No.</b>	524599	<b>Ref. No.</b>	001.15.00027 ANO.15.00027
<b>description</b>	boiler ø 200mm L 453mm flange 3 hole flange inlet ø 10mm		
<b>For models:</b>	Turbo-1500		



1

<b>GEV No.</b>	524592	<b>Ref. No.</b>	001.35.00055 ANO.BL.00055
<b>description</b>	boiler ø 96mm L 325mm flange 3 hole flange inlet ø 10mm		
<b>For models:</b>	Barline-35F		

accessories



1

<b>GEV No.</b>	524614	<b>Ref. No.</b>	002.50.00001 YDR.VE.00001
<b>description</b>	connecting fitting for boiler thread 1/4"-1/2" ø 30mm L 50mm W 56mm WS 30 hose ø 10mm		
<b>For models:</b>	Vergina-50SF		

hood mechanics for dishwashers

miscellaneous



1

<b>GEV No.</b>	511967	<b>Ref. No.</b>	002.15.00044
<b>description</b>	guide for hood linkage ID ø 31mm L 66mm plastic mounting pos. left/right H 24mm black W 51mm		
<b>For models:</b>	Turbo-1500		

air traps

air traps



1

<b>GEV No.</b>	503337	<b>Ref. No.</b>	003.00.00014 HLE.00.00014
<b>description</b>	air trap		
<b>For models:</b>	Barline-35F, Euroline-40F, Turbo-1500, Vergina-50SF		



1

<b>GEV No.</b>	524607	<b>Ref. No.</b>	003.00.00552
<b>description</b>	air trap ø 49mm H 74mm thread M10x1.5 hose ø 6mm plastic		

backflow preventers

backflow preventers



1

<b>GEV No.</b>	516101	<b>Ref. No.</b>	003.00.00269 HLE.00.00269
<b>description</b>	backflow preventer dishwasher hose ø 12mm		
<b>For models:</b>	Vergina-50SF		
<b>spare parts for</b>	516101		
	<b>GEV No.</b>	506367	<b>Ref. No.</b> —
flat gasket rubber ED ø 40mm ID ø 28mm thickness 1.8mm Qty 1 pcs			

miscellaneous



1

<b>GEV No.</b>	524620	<b>Ref. No.</b>	002.00.00230 YDR.00.00230
<b>description</b>	bush PTFE H 6mm D1 ø 18mm D2 ø 13mm ID ø 10mm for ELVIOMEX ALFA		



1

<b>GEV No.</b>	524598	<b>Ref. No.</b>	002.00.00229 YDR.00.00229
<b>description</b>	bush PTFE H 9.4mm D1 ø 22mm D2 ø 8.5mm ID ø 15mm for ELVIOMEX ALFA		



1

<b>GEV No.</b>	524623	<b>Ref. No.</b>	002.35.00026
<b>description</b>	bush PTFE H 9mm D1 ø 18mm D2 ø 14mm ID ø 10mm for ELVIOMEX ALFA		
<b>For models:</b>	Turbo-1500		

door mechanics

springs

tension springs



1

<b>GEV No.</b>	519518	<b>Ref. No.</b>	001.15.00037 ANO.15.00037
<b>description</b>	tension spring ø 39mm wire gauge ø 5mm total length 510mm for door		
<b>For models:</b>	Turbo-1500		

locks



1

<b>GEV No.</b>	518133	<b>Ref. No.</b>	001.00.00051 ANO.00.00051
<b>description</b>	snap lock mounting pos. upper for door		
<b>For models:</b>	Barline-35F, Euroline-40F, Vergina-50SF		

screw connections



1

<b>GEV No.</b>	524617	<b>Ref. No.</b>	002.00.00224 YDR.00.00224
<b>description</b>	cap thread 1/2" H 21mm metal Qty 1 pcs		
<b>For models:</b>	Turbo-1500		

washing and rinsing systems





1

<b>GEV No.</b>	524620	<b>Ref. No.</b>	002.00.00230 YDR.00.00230
<b>description</b>	bush PTFE H 6mm D1 ø 18mm D2 ø 13mm ID ø 10mm for ELVIOMEX ALFA		







			
1			
<b>GEV No.</b>	524623	<b>Ref. No.</b>	002.35.00026
<b>description</b>	bush PTFE H9mm D1 ø 18mm D2 ø 14mm ID ø 10mm for ELVIOMEX ALFA		
<b>For models:</b>	Turbo-1500		

			
1			
<b>GEV No.</b>	524597	<b>Ref. No.</b>	002.00.00223 YDR.00.00223
<b>description</b>	gasket for wash arm support rubber ø 109mm ID ø 54mm thickness 3mm		
<b>For models:</b>	Turbo-1500		

			
1			
<b>GEV No.</b>	524622	<b>Ref. No.</b>	002.00.00105
<b>description</b>	gasket rubber ø 103mm ID ø 58mm thickness 3mm		

			
1			
<b>GEV No.</b>	517393	<b>Ref. No.</b>	002.00.00083 YDR.00.00083
<b>description</b>	rinse arm support H 60mm thread 1/2" WS 30 hose ø 10mm		

			
1			
<b>GEV No.</b>	503345	<b>Ref. No.</b>	002.15.00011 YDR.15.00011
<b>description</b>	rinse pipe		

			
1			
<b>GEV No.</b>	518131	<b>Ref. No.</b>	002.50.00016 YDR.VK.00016
<b>description</b>	throttle disc ED ø 45mm ID ø 13mm thickness 1mm		

			
1			
<b>GEV No.</b>	518132	<b>Ref. No.</b>	002.15.00103 YDR.15.00103
<b>description</b>	throttle disc L 32mm W 32mm ID ø 14mm thickness 1mm		

			
1			
<b>GEV No.</b>	524624	<b>Ref. No.</b>	002.50.00004 YDR.VK.00004
<b>description</b>	Thumb screw thread M6x1 thread L 8mm ø 19mm H 3.5mm SS Qty 1 pcs		
<b>For models:</b>	Barline-35F, Euroline-40F, Vergina-50SF		

			
1			
<b>GEV No.</b>	524608	<b>Ref. No.</b>	002.50.00017 YDR.VK.00017
<b>description</b>	wash pipe L 143mm plastic		
<b>For models:</b>	Vergina-50SF		

washing and rinsing systems (sorted by producer)

ELVIOMEX-ALFA

			
1			
<b>GEV No.</b>	524601	<b>Ref. No.</b>	001.15.00012 ANO.15.00012
<b>description</b>	flat filter H 21mm SS L 275mm W 231mm		
<b>For models:</b>	Turbo-1500		

			
1			
<b>GEV No.</b>	503304	<b>Ref. No.</b>	002.40.00013 YDR.EU.00013
<b>description</b>	wash and rinse arm mounting pos. upper/lower 2 wash arms/ 2 rinse arms		
<b>For models:</b>	Euroline-40F		



1

<b>GEV No.</b>	503300	<b>Ref. No.</b>	002.35.00035 YDR.BL.00035
<b>description</b>	wash and rinse arm wash arm L 350mm rinse arm L 350mm w. jets 10 r. jets 5 mounting ø 10/32mm mounting pos. lower 2 wash arms/ 2 rinse arms		
<b>For models:</b>	Barline-35F		



1

<b>GEV No.</b>	503317	<b>Ref. No.</b>	002.11.00008 YDR.11.00008
<b>description</b>	rinse jet H 13mm thread M6x1 WS 10 conical seal		
<b>For models:</b>	Barline-35F, Euroline-40F, Turbo-1500, Vergina-50SF		



1

<b>GEV No.</b>	524612	<b>Ref. No.</b>	002.35.00018 002.40.00011 YDR.BL.00018 YDR.EU.00011
<b>description</b>	wash arm boss L 80mm W 64mm H 40mm		
<b>For models:</b>	Barline-35F, Euroline-40F		



1

Image not available

<b>GEV No.</b>	503312	<b>Ref. No.</b>	002.15.00015 YDR.15.00015
<b>description</b>	rinse arm mounting pos. lower		







1

Image not available

<b>GEV No.</b>	503311	<b>Ref. No.</b>	002.15.00016 YDR.15.00016
<b>description</b>	wash and rinse arm mounting pos. lower		



1

<b>GEV No.</b>	503339	<b>Ref. No.</b>	002.15.00091 YDR.15.00091	
<b>description</b>	wash and rinse arm wash arm L 550mm rinse arm L 545mm w. jets 10 r. jets 6 mounting ø 10/55mm mounting pos. upper/lower			
<b>For models:</b>	Turbo-1500			
<b>spare parts for</b>	503339			
	<b>GEV No.</b>	503317	<b>Ref. No.</b>	002.11.00008 YDR.11.00008
	rinse jet H 13mm thread M6x1 WS 10 conical seal			
	<b>GEV No.</b>	524596	<b>Ref. No.</b>	002.15.00085 YDR.15.00085
	wash arm boss ø 61mm L 120mm W 90mm H 51mm			
	<b>GEV No.</b>	524623	<b>Ref. No.</b>	002.35.00026
	bush PTFE H 9mm D1 ø 18mm D2 ø 14mm ID ø 10mm for ELVIOMEX ALFA			
	<b>GEV No.</b>	524927	<b>Ref. No.</b>	002.15.00089 YDR.15.00089
	wash arm mounting pos. upper/lower L 248mm nozzles 5 mounting ø 28mm ø 30mm			
<b>accessories for</b>	503339			
	<b>GEV No.</b>	524610	<b>Ref. No.</b>	002.15.00082 YDR.15.00082
	rinse arm shaft mounting pos. lower ø 20mm H 76mm thread 1/4"/ M8			



1

Image not available

<b>GEV No.</b>	503313	<b>Ref. No.</b>	002.15.00091 YDR.15.00004 YDR.15.00091
<b>description</b>	wash arm mounting pos. lower		



1

<b>GEV No.</b>	503317	<b>Ref. No.</b>	002.11.00008 YDR.11.00008
<b>description</b>	rinse jet H 13mm thread M6x1 WS 10 conical seal		
<b>For models:</b>	Barline-35F, Euroline-40F, Turbo-1500, Vergina-50SF		





1

<b>GEV No.</b>	524927	<b>Ref. No.</b>	002.15.00089 YDR.15.00089
<b>description</b>	wash arm mounting pos. upper/lower L 248mm nozzles 5 mounting ø 28mm ø 30mm		
<b>For models:</b>	Turbo-1500		





 <p>1</p>			
<b>GEV No.</b>	524596	<b>Ref. No.</b>	002.15.00085 YDR.15.00085
<b>description</b>	wash arm boss ø 61mm L 120mm W 90mm H 51mm		

 <p>1</p>			
<b>GEV No.</b>	503301	<b>Ref. No.</b>	002.35.00023 YDR.BL.00023
<b>description</b>	rinse arm L 370mm nozzles 5 mounting ø 10mm mounting pos. upper		
<b>For models:</b>	Barline-35F		

 <p>1</p>			
<b>GEV No.</b>	503308	<b>Ref. No.</b>	002.50.00005 002.50.00026 YDR.VE.00026 YDR.VK.00006
<b>description</b>	rinse arm L 465mm nozzles 6 mounting ø 10mm mounting pos. upper/lower		
<b>For models:</b>	Vergina-50SF		

 <p>1</p>			
<b>GEV No.</b>	503317	<b>Ref. No.</b>	002.11.00008 YDR.11.00008
<b>description</b>	rinse jet H 13mm thread M6x1 WS 10 conical seal		
<b>For models:</b>	Barline-35F, Euroline-40F, Turbo-1500, Vergina-50SF		

 <p>1</p>			
<b>GEV No.</b>	503307	<b>Ref. No.</b>	002.50.00006 YDR.VE.00006
<b>description</b>	wash arm L 510mm nozzles 6 mounting ø 15/62mm mounting pos. lower		
<b>For models:</b>	Vergina-50SF		

 <p>1</p>			
<b>GEV No.</b>	503343	<b>Ref. No.</b>	002.15.00018_3 YDR.15.00018_3
<b>description</b>	wash arm H 105mm L 198mm nozzles 3 mounting pos. upper right		

 <p>1</p>			
<b>GEV No.</b>	503341	<b>Ref. No.</b>	002.15.00018_1 YDR.15.00018_1
<b>description</b>	wash arm H 200mm L 105mm nozzles 3 mounting pos. upper left		

 <p>1</p>			
<b>GEV No.</b>	503342	<b>Ref. No.</b>	002.15.00018_2 YDR.15.00018_2
<b>description</b>	wash arm H 200mm L 160mm nozzles 3 mounting pos. upper left		

 <p>1</p>			
<b>GEV No.</b>	503344	<b>Ref. No.</b>	002.15.00018_4 YDR.15.00018_4
<b>description</b>	wash arm H 200mm L 160mm nozzles 3 mounting pos. upper right		

 <p>1</p>			
<b>GEV No.</b>	503316	<b>Ref. No.</b>	002.15.00021 YDR.15.00021
<b>description</b>	wash jet		

			
1			
<b>GEV No.</b>	503340	<b>Ref. No.</b>	002.15.00035 YDR.15.00035
<b>description</b>	rinse arm H 225mm L 520mm nozzles 10 mounting pos. upper		

			
1			
<b>GEV No.</b>	503318	<b>Ref. No.</b>	002.15.00026 YDR.15.00008 YDR.15.00026
<b>description</b>	rinse jet		

			
1			
<b>GEV No.</b>	503306	<b>Ref. No.</b>	002.50.00007 YDR.VE.00007
<b>description</b>	wash arm H 555mm L 485mm nozzles 8 mounting pos. upper		

			
1			
<b>GEV No.</b>	503314	<b>Ref. No.</b>	002.50.00003 YDR.VE.00003
<b>description</b>	wash jet		

			
1			
<b>GEV No.</b>	503315	<b>Ref. No.</b>	002.50.00030 YDR.VK.00014
<b>description</b>	wash jet		
<b>For models:</b>	Vergina-50SF		

miscellaneous





			
1			
<b>GEV No.</b>	524621	<b>Ref. No.</b>	002.00.00145 YDR.00.00145
<b>description</b>	end cap for rinse arm thread M11x1 ø 12mm H 6mm suitable for ELVIOMEX ALFA		

			
1			
<b>GEV No.</b>	524594	<b>Ref. No.</b>	002.35.00047
<b>description</b>	end cap for rinse arm thread M9x1 ø 10mm H 6mm		

			
1			
<b>GEV No.</b>	503156	<b>Ref. No.</b>	002.1500093 A YDR.15.00093 A
<b>description</b>	rinse arm mounting pos. A L 247mm nozzles 3		

			
1			
<b>GEV No.</b>	503157	<b>Ref. No.</b>	002.1500093 B YDR.15.00093 B
<b>description</b>	rinse arm mounting pos. B L 274mm nozzles 3 tube ø 12mm		

			
1			
<b>GEV No.</b>	503319	<b>Ref. No.</b>	002.15.00022 YDR.15.00022
<b>description</b>	rinse jet		

				
Image not available				
1				
<b>GEV No.</b>	503346	<b>Ref. No.</b>	002.15.00018 YDR.15.00018	
<b>description</b>	wash arm 6-piece			
<b>spare parts for</b>	503346			
	<b>GEV No.</b>	503341	<b>Ref. No.</b>	002.15.00018_1 YDR.15.00018_1
	wash arm H 200mm L 105mm nozzles 3 mounting pos. upper left			
	<b>GEV No.</b>	503342	<b>Ref. No.</b>	002.15.00018_2 YDR.15.00018_2
	wash arm H 200mm L 160mm nozzles 3 mounting pos. upper left			
	<b>GEV No.</b>	503343	<b>Ref. No.</b>	002.15.00018_3 YDR.15.00018_3
	wash arm H 105mm L 198mm nozzles 3 mounting pos. upper right			
	<b>GEV No.</b>	503344	<b>Ref. No.</b>	002.15.00018_4 YDR.15.00018_4
	wash arm H 200mm L 160mm nozzles 3 mounting pos. upper right			

1

<b>GEV No.</b>	503303	<b>Ref. No.</b>	002.35.00029 YDR.BL.00029
<b>description</b>	rinse arm support mounting pos. upper		
<b>For models:</b>	Barline-35F, Vergina-50SF		



1

<b>GEV No.</b>	503309	<b>Ref. No.</b>	002.50.00027 YDR.VE.00010 YDR.VE.00027
<b>description</b>	rinse arm support mounting pos. upper until year of construction 2002		



1

<b>GEV No.</b>	503302	<b>Ref. No.</b>	002.35.00041 YDR.BL.00041
<b>description</b>	wash arm support mounting pos. lower		
<b>For models:</b>	Barline-35F		



1

<b>GEV No.</b>	503310	<b>Ref. No.</b>	002.00.00080 002.50.00036 YDR.00.00080 YDR.VE.00080
<b>description</b>	wash arm support mounting pos. lower		
<b>For models:</b>	Vergina-50SF		



1

<b>GEV No.</b>	524595	<b>Ref. No.</b>	002.35.00019 YDR.BL.00019
<b>description</b>	wash arm support mounting pos. lower H 53mm		
<b>For models:</b>	Barline-35F, Euroline-40F		



1

<b>GEV No.</b>	524604	<b>Ref. No.</b>	002.15.00084 YDR.15.00084
<b>description</b>	wash arm support mounting pos. lower ø 52mm H 252mm ID ø 44mm		
<b>For models:</b>	Turbo-1500		



1

<b>GEV No.</b>	524605	<b>Ref. No.</b>	002.40.00012 YDR.EU.00012
<b>description</b>	wash arm support mounting pos. lower thread M6 ø 30mm H 280mm ID ø 28mm		
<b>For models:</b>	Euroline-40F		



1

<b>GEV No.</b>	503305	<b>Ref. No.</b>	002.40.00014 YDR.EU.00014
<b>description</b>	wash arm support mounting pos. upper		
<b>For models:</b>	Euroline-40F		



1

<b>GEV No.</b>	524606	<b>Ref. No.</b>	002.15.00086 YDR.15.00086
<b>description</b>	wash arm support mounting pos. upper H 60mm		
<b>For models:</b>	Turbo-1500		

rinse arm shafts



1

<b>GEV No.</b>	524625	<b>Ref. No.</b>	002.35.00016 YDR.BL.00016
<b>description</b>	rinse arm shaft mounting pos. lower ø 16mm H 55mm thread M6		
<b>For models:</b>	Barline-35F, Euroline-40F		





1

<b>GEV No.</b>	524611	<b>Ref. No.</b>	002.11.00002 YDR.11.00002
<b>description</b>	rinse arm shaft mounting pos. lower ø 20mm H 75mm thread 1/4\"/>		
<b>For models:</b>	Vergina-50SF		



1

<b>GEV No.</b>	524610	<b>Ref. No.</b>	002.15.00082 YDR.15.00082	
<b>description</b>	rinse arm shaft mounting pos. lower ø 20mm H 76mm thread 1/4\"/>			
<b>For models:</b>	Turbo-1500			
<b>accessories for</b>	524610			
	<b>GEV No.</b>	524619	<b>Ref. No.</b>	002.15.00083 YDR.15.00083
	knurled nut thread M8 ø 25mm H 7mm SS			



1

<b>GEV No.</b>	524618	<b>Ref. No.</b>	002.50.00012 YDR.VK.00012
<b>description</b>	rinse arm shaft mounting pos. upper ø 10mm H 31mm thread M10		
<b>For models:</b>	Vergina-50SF		



1

<b>GEV No.</b>	524609	<b>Ref. No.</b>	002.40.00001 YDR.EU.00001
<b>description</b>	rinse arm shaft mounting pos. upper ø 16mm H 54mm thread M6\"/>		
<b>For models:</b>	Euroline-40F		



1

<b>GEV No.</b>	524615	<b>Ref. No.</b>	002.35.00015 YDR.BL.00015
<b>description</b>	rinse arm shaft ø 12mm H 101mm thread M10		
<b>For models:</b>	Barline-35F		



1 

<b>GEV No.</b>	524616	<b>Ref. No.</b>	002.40.00004
<b>description</b>	rinse arm shaft $\varnothing$ 12mm H 122mm thread M10		
<b>For models:</b>	Euroline-40F		

## handles and hand wheels

### bracket handles

1 

<b>GEV No.</b>	503338	<b>Ref. No.</b>	001.00.00119 ANO.00.00119
<b>description</b>	pull handle		
<b>For models:</b>	Barline-35F, Euroline-40F		

1 

<b>GEV No.</b>	503160	<b>Ref. No.</b>	001.00.00118 ANO.00.00118
<b>description</b>	pull handle L 418mm H 35mm mounting distance 378mm thread M8x1.25 W 25mm complete grey		
<b>For models:</b>	Vergina-50SF		

## equipment feet and end caps

### screw-in feet

1 

<b>GEV No.</b>	701048	<b>Ref. No.</b>	001.00.00016 ANO.00.00016
<b>description</b>	equipment foot thread M10 thread L 26mm $\varnothing$ 40mm H 46mm Qty 1 pcs		
<b>For models:</b>	Barline-35F, Euroline-40F, Vergina-50SF		

## baskets

### warewashing baskets

#### accessories

#### plate inserts

1 

<b>GEV No.</b>	972036	<b>Ref. No.</b>	003.00.00517 HLE.00.00517
<b>description</b>	plate insert L 290mm W 90mm H 75mm plates 12		

1 

<b>GEV No.</b>	971147	<b>Ref. No.</b>	003.40.00015 HLE.EU.00015
<b>description</b>	plate insert L 370mm W 380mm H 75mm plates 8 plastic-coated steel		

## gaskets

### O-rings

#### EPDM

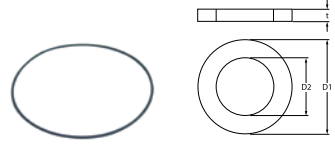
1 

<b>GEV No.</b>	501312	<b>Ref. No.</b>	002.00.00262
<b>description</b>	O-ring EPDM thickness 1.78mm ID $\varnothing$ 88.62mm Qty 1 pcs		

1 

<b>GEV No.</b>	510551	<b>Ref. No.</b>	002.00.00261
<b>description</b>	pump cover gasket ID $\varnothing$ 158.3mm pump type 1214/1293/1225/2243/1226/1204/3473/1241 thickness 3.53mm EPDM Qty 1 pcs		

## special gaskets

### gaskets for wash arm support



1

<b>GEV No.</b>	524622	<b>Ref. No.</b>	002.00.00105
<b>description</b>	gasket rubber ø 103mm ID ø 58mm thickness 3mm		

## industrial hoses

### Niplaflex hoses



1

<b>GEV No.</b>	530561	<b>Ref. No.</b>	002.15.00099 YDR.15.00099
<b>description</b>	pressure hose ID ø 10mm ED ø 17mm L 5m thickness 3.5mm operating p. 10bar burst p. 30bar t.max. 110°C		
<b>For models:</b>	Turbo-1500		

## dosing pumps

### membrane dosing pumps

#### self-priming

#### various



2x

1

<b>GEV No.</b>	361370	<b>Ref. No.</b>	003.00.00268 HLE.00.00268	
<b>description</b>	dosing pump type model 2 rinse aid inlet 4x6mm outlet 4x6mm pressure connection ø 4x6mm suction connection ø 4x6mm			
<b>For models:</b>	Barline-35F, Euroline-40F, Turbo-1500, Vergina-50SF			
<b>spare parts for</b>	361370			
	<b>GEV No.</b>	361307	<b>Ref. No.</b>	—
	membrane dosing pump ø 68mm hole ø 6mm for type DIB3P/DIB5P			
	<b>GEV No.</b>	361459	<b>Ref. No.</b>	—
	hose connector ø 6mm for dosing pump			

## formed hoses

### straight



1

<b>GEV No.</b>	503332	<b>Ref. No.</b>	002.00.00178 YDR.00.00178
<b>description</b>	formed hose dishwasher straight equiv. no. YDR.00.00178		
<b>For models:</b>	Euroline-40F		



1

<b>GEV No.</b>	503336	<b>Ref. No.</b>	002.15.00029 YDR.15.00029
<b>description</b>	formed hose dishwasher straight equiv. no. YDR.15.00029		



1

<b>GEV No.</b>	503331	<b>Ref. No.</b>	002.35.00025 YDR.BL.00025
<b>description</b>	formed hose dishwasher straight equiv. no. YDR.BL.00025		
<b>For models:</b>	Barline-35F		

## hoses

### drain hoses



1

<b>GEV No.</b>	530572	<b>Ref. No.</b>	002.00.00234 YDR.00.00234
<b>description</b>	drain hose DN24 L 2000mm straight ø inside 24mm straight ext. ø 29mm elbow ø inside 29mm elbow ext. ø 35mm outer hose ø 29mm		
<b>For models:</b>	Vergina-50SF		





form L



1

<b>GEV No.</b>	524629	<b>Ref. No.</b>	002.50.00014 YDR.VE.00014
<b>description</b>	formed hose end piece A ext. ø 41mm end piece A int. ø 26mm AD2 ø 41mm ø end piece B 26mm L 62mm plastic Qty 1 warewashing L-shape for drain pump mounting pos. supply		
<b>For models:</b>	Vergina-50SF		



1

<b>GEV No.</b>	524628	<b>Ref. No.</b>	002.35.00048
<b>description</b>	formed hose end piece A ext. ø 41mm end piece A int. ø 27mm AD2 ø 41mm ø end piece B 30/27mm L 100mm plastic Qty 1 warewashing L-shape supply		
<b>For models:</b>	Barline-35F		



1

<b>GEV No.</b>	524627	<b>Ref. No.</b>	002.40.00024
<b>description</b>	formed hose end piece A ext. ø 41mm end piece A int. ø 27mm AD2 ø 41mm ø end piece B 30/27mm L 96mm plastic Qty 1 warewashing L-shape supply		
<b>For models:</b>	Euroline-40F		



1

<b>GEV No.</b>	524626	<b>Ref. No.</b>	002.40.00025
<b>description</b>	formed hose end piece A ext. ø 41mm end piece A int. ø 30mm AD2 ø 41mm ø end piece B 26mm L 90mm plastic Qty 1 warewashing L-shape supply		
<b>For models:</b>	Euroline-40F		



1

<b>GEV No.</b>	517390	<b>Ref. No.</b>	002.15.00027 YDR.15.00027
<b>description</b>	formed hose end piece A ext. ø 51mm end piece A int. ø 41mm AD2 ø 46mm ø end piece B 36mm L 490mm Qty 1 warewashing L-shape		
<b>For models:</b>	Turbo-1500		



1

<b>GEV No.</b>	503333	<b>Ref. No.</b>	002.00.00127 YDR.00.00127
<b>description</b>	formed hose end piece A int. ø 44mm ø end piece B 41mm L 130mm L1 130mm warewashing L-shape equiv. no. YDR.00.00027		
<b>For models:</b>	Vergina-50SF		



1

<b>GEV No.</b>	503330	<b>Ref. No.</b>	002.00.00126 YDR.00.00126
<b>description</b>	formed hose warewashing L-shape equiv. no. YDR.00.00126		



1

<b>GEV No.</b>	503335	<b>Ref. No.</b>	002.15.00058 YDR.15.00058
<b>description</b>	formed hose warewashing L-shape equiv. no. YDR.15.00058		
<b>For models:</b>	Turbo-1500		



1

<b>GEV No.</b>	503334	<b>Ref. No.</b>	002.50.00032 YDR.VK.00013
<b>description</b>	formed hose warewashing L-shape equiv. no. YDR.VK.00013		
<b>For models:</b>	Vergina-50SF		

## form U



1

<b>GEV No.</b>	517389	<b>Ref. No.</b>	002.40.00023
<b>description</b>	formed hose D1 ø 38mm D2 ø 28mm L 590mm warewashing black Qty 1		
<b>For models:</b>	Euroline-40F		

## fittings, hose and pipe connectors

## fittings

## double nipples



1

<b>GEV No.</b>	520168	<b>Ref. No.</b>	002.00.00030
<b>description</b>	double nipple nickel-plated brass thread 1/2" - 1/2" Qty 1 pcs		

## angle pieces



1

<b>GEV No.</b>	541493	<b>Ref. No.</b>	002.00.00225 002.00.00226 YDR.00.00225 YDR.00.00226
<b>description</b>	angle piece thread 1/2" IT - 1/2" ET chrome-plated brass		
<b>For models:</b>	Turbo-1500		

## measuring equipment

## thermometers

## built-in thermometers



1

<b>GEV No.</b>	541306	<b>Ref. No.</b>	003.00.00019 003.00.00505 HLE.00.00019 HLE.00.00505
<b>description</b>	thermometer mounting measurements 62x11mm 0 up to +120°C capillary pipe 3000mm probe ø 6mm probe L 27mm		
<b>For models:</b>	Turbo-1500, Vergina-50SF		

## fastening material

## screws

## knurled screws



1

<b>GEV No.</b>	524624	<b>Ref. No.</b>	002.50.00004 YDR.VK.00004
<b>description</b>	Thumb screw thread M6x1 thread L 8mm ø 19mm H 3.5mm SS Qty 1 pcs		
<b>For models:</b>	Barline-35F, Euroline-40F, Vergina-50SF		

## nuts

## knurled nuts



1

<b>GEV No.</b>	524619	<b>Ref. No.</b>	002.15.00083 YDR.15.00083
<b>description</b>	knurled nut thread M8 ø 25mm H 7mm SS		
<b>For models:</b>	Turbo-1500		

## union nuts



1

<b>GEV No.</b>	520559	<b>Ref. No.</b>	002.00.00144 YDR.00.00144
<b>description</b>	union nut chrome-plated thread 1/2" H 13mm WS 26 Qty 1 pcs for pipe ø 12mm		
<b>For models:</b>	Vergina-50SF		



## consumables

### fuses

#### thermal fuses



<b>GEV No.</b>	390734	<b>Ref. No.</b>	003.00.00168 old version HLE.00.00168 old version
<b>description</b>	thermal fuse switch-off temp. 90°C 1NC 1-pole 15A 250V connection male faston 6.3mm hole distance 24mm		



<b>B</b>			
bi-metal thermostats		5	
<b>C</b>			
consumables		27	
contactors		7	
control equipment		6	
<b>D</b>			
dosing pumps		24	
double nipples		26	
drain hoses		24	
drain pumps		12	
<b>E</b>			
electric accessories		12	
<b>F</b>			
fastening material		26	
fittings		26	
formed hoses		24	
fuses		12, 27	
<b>G</b>			
gaskets for wash arm support		24	
<b>H</b>			
heating elements		3	
hoses		24	
<b>I</b>			
immersion heating elements		3	
indicator lights		7	
indicator lights (complete)		7	
industrial hoses		24	
<b>K</b>			
knurled nuts		26	
knurled screws		26	
<b>L</b>			
lamps		7	
<b>M</b>			
measuring equipment		26	
microswitches		6	
<b>N</b>			
Niplaflex hoses		24	
nuts		26	
<b>O</b>			
O-rings		23	
<b>P</b>			
position switches		6	
pressure switches		9	
programme timers		7	
pumps		9	
push/momentary push switches		5	
<b>R</b>			
relays		8	
<b>S</b>			
safety bi-metal thermostats		5	
screws		26	
solenoid valves		9	
switches and momentary switches		5	
<b>T</b>			
terminals		12	
thermal fuses		27	
thermostats		5	
timers		7	
<b>U</b>			
union nuts		26	
<b>W</b>			
wash and rinse pumps		9	