



GAS COMPONENTS



ELECTRIC COMPONENTS



WATER TECHNOLOGY



MECHANICAL COMPONENTS



TOOLS

Spare parts suitable for

ELETTROBAR

Find the complete and up-to-date range of products in our GEV Webshop



Manufacturer catalogue

The most important spare parts and accessories arranged clearly for every manufacturer

- ✓ Complete product range and all appliance data always up to date in the GEV Webshop
- ✓ Alphabetical Index at the end of the catalogue

GEV Webshop

www.gev-online.co.uk

www.gev-online.com



- 🔍 Add to Favourites
- 🔍 Sign In with email address and usual password
- 🔍 Easy-order – place several items in your basket at the same time
- 🔍 Quick Item search – no login needed



heating elements

heating elements for fryers

1

| | | | |
|--------------------|--|-----------------|--------|
| GEV No. | 416504 | Ref. No. | 230070 |
| description | heating element 3300W 230V heating circuits 1 L 320mm W 131mm H 220mm rectangular flange connection M4 immersion heater L1 14mm L2 306mm H1 25mm H2 130mm H3 45mm windings 5 hole distance 72mm hole ø 6mm flange length 160mm flange width 22mm tube ø 8.5mm connection length 42mm | | |
| For models: | FRI12, FRI12+12, FRI6, FRI6+6, FRI9, FRI9+9 | | |

1

| | | | |
|--------------------|--|-----------------|--------|
| GEV No. | 416506 | Ref. No. | 230072 |
| description | heating element 6600W 230/400V heating circuits 3 L 342mm W 127mm H 230mm rectangular flange connection M4 fryer heaters L1 15mm L2 327mm H1 25mm H2 167mm H3 38mm windings 6 hole distance 72mm hole ø 6mm flange length 160mm flange width 22mm tube ø 8.5mm | | |
| For models: | FRI12, FRI12+12, FRI15, FRI15M, FRI6, FRI6+6, FRI9, FRI9+9 | | |

heating elements for contact grills

1

| | | | |
|--------------------|---|-----------------|--------|
| GEV No. | 416497 | Ref. No. | 921008 |
| description | heating element 1000W 230V L 180mm W 185mm H 15mm W1 45mm W2 97mm connection length 48mm tube ø 6.3mm windings 3 cable length 755mm dry heating element | | |
| For models: | 433, 434, 436, 437, 438, 439, G33, G34, G37, G38, G39 | | |

1

| | | | |
|--------------------|---|-----------------|--------|
| GEV No. | 416496 | Ref. No. | 921017 |
| description | heating element 700W 230V L 176mm W 190mm H 17mm W1 40mm W2 110mm connection length 50mm tube ø 6.3mm windings 3 cable length 700mm dry heating element | | |
| For models: | 433, 434, 436, 437, 438, 439, G33, G34, G37, G38, G39 | | |

contact heaters

1

| | | | |
|--------------------|---|-----------------|------------------|
| GEV No. | 416237 | Ref. No. | 230104 999206 |
| description | contact heater 1400W 230V heating circuits 1 L 133mm W 120mm H 10mm dishwasher connection soldering connection connection distance 76mm connection length 37mm heat-conducting paste included hole ø 7mm dry heating element | | |
| For models: | 2312-007, 2312-009-CRP, 914100, 914101, 914339, 914342, 914343, 914624, 914625, 914626, 914627, 914628, 914850, 914851, 914854, 914944, PS-60, RIVER-48, RIVER-50, RIVER-50-CRP, RIVER-50-CRP-SP, RIVER-54, RIVER-54CRP, River-54-CRP-s.p., RIVER-54-CRP-SP, RIVER-61 | | |

quartz heating elements

1

| | | | |
|--------------------|---|-----------------|--------|
| GEV No. | 416494 | Ref. No. | 230031 |
| description | heating coil 500W 115V for quartz tube L1 240mm L2 185mm ø 6mm connection eye | | |
| For models: | 406 | | |

1

| | | | |
|--------------------|---|-----------------|--------|
| GEV No. | 415311 | Ref. No. | 923003 |
| description | quartz heating element L 410mm ø 11mm 1000W 230V W 130mm connection eye double inner length 390mm | | |
| For models: | 412 | | |

1

| | | | |
|--------------------|---|-----------------|--------|
| GEV No. | 416493 | Ref. No. | 484001 |
| description | quartz tube WV L 390mm ID ø 8.5mm ED ø 11mm | | |
| For models: | 406 | | |

1 electric components

**coil heating elements**

| | | | |
|--------------------|--|-----------------|----------------|
| GEV No. | 420330 | Ref. No. | 927132 DRE2 |
| description | heating element 2000W 240V L 454mm W 210mm ø 27.5mm thread M14x1 connection M4 for drying warewashing heating circuits 1 2 hole fixing | | |
| For models: | 161, 221, 271, 272, 362, A3EBDAKRKYK, A3EBSAKRK, A4EBDAKEYK, A4EBDAKRK, A4EBDAKWK, A4EBDAKZK, A4EBDBKRK, A4EBSAK, A4EBSAKCK, A4EBSAKEKYK, A4EBSAKRKP, A4EBTSAK, A5EBDAKYK, A5EBSAKRK, A5EBSAKRKYK, A5EBSAKWK, A5EBSAKWKYK, A5EBSBKRKPK, A5EBSBKWK, CLEAN-161, CLEAN-221, CLEAN-271, CLEAN-272, CLEAN-361, CLEAN-361P, CLEAN-362, CLEAN-471, CLEAN-471P, GL280EB23DAR, GL280EBDARY, GL280EBDAW, GL280EBDAY, GL280EBDB, GL280EBDBR, GL280EBSA, GL280EBSAE, GL280EBSAEW, GL280EBSAEWY, GL280EBSAR, GL280EBSARY, GL280EBSAW, GL280EBSAWY, GL280EBSAY, GL280EBSB, GL282EB93DA...(Other models you can see in the webshop) | | |



| | | | |
|--------------------|--|-----------------|--------|
| GEV No. | 417640 | Ref. No. | 927245 |
| description | heating element 3000W 230V L 455mm W 212mm ø 28mm thread M15x1 heating circuits 1 screw | | |
| For models: | CLEAN-160, CLEAN-220, CLEAN-270, CLEAN-271, CLEAN-361, CLEAN-361P, CLEAN-471, CLEAN-471P | | |



| | | | |
|--------------------|--|-----------------|------|
| GEV No. | 417526 | Ref. No. | DRE1 |
| description | heating element 4000W 220V L 475mm W 350mm ø 28mm thread M15x1 connection M4 connection length 33mm dry heating element heating circuits 1 2 hole fixing | | |

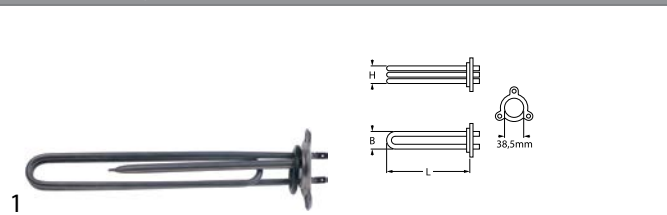



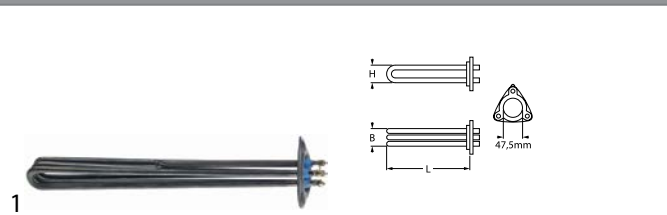

immersion heating elements**3 hole flange ø38.5mm**

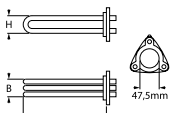

| | | | |
|------------------------|--|-----------------|--------|
| GEV No. | 418642 | Ref. No. | 230113 |
| description | heating element 2600W 230V mounting ø 38.5mm heating circuits 1 L 260mm W 33mm H 24mm number of thermostat sleeves 1 thermostat sleeves ø 7mm length thermostat sleeves 175mm thermostat sleeve eccentric, non clinging tube ø 6.5mm hole distance 57mm 3 hole flange connection male faston 6.3mm immersion heater | | |
| For models: | 913289, 913290, 913291, 913292, 913356, 913357, 913363, 913364, 913372, 913373, 913374, 913375, 913376, 913377, 913416, 913418, 913435, 913544, 913545, 913665, 913666, 913667, 913668, 913685, 913771, 913772, 913773, 913774, 913832, 913837, 913911, 913912, 913948, 913950, 913977, 913984, 913990, 914165, 914166, 914167, 914168, 914206, 914214, 914316, 914317, 914355, 914386, 914387, 914388, 914389...(Other models you can see in the webshop) | | |
| accessories for | 418642 | | |
| GEV No. | 532577 | Ref. No. | — |
| | O-ring EPDM thickness 5.34mm ID ø 40.65mm Qty 1 pcs | | |

3 hole flange ø47.5mm



| | | | |
|--------------------|---|-----------------|-------|
| GEV No. | 420545 | Ref. No. | 80397 |
| description | heating element 10500W 230V heating circuits 3 L 354mm W 35mm H 75mm number of thermostat sleeves 1 length thermostat sleeves 180mm thermostat sleeve right tube ø 8.5mm hole ø 60mm threaded | | |
| For models: | FAST-60, FAST-73, PV280FAST, PV280FASTCH | | |

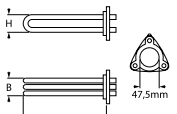

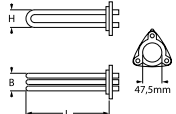

| | | | |
|---|---|-----------------|--------------------------------------|
|   | | | |
| 1 | | | |
| GEV No. | 415001 | Ref. No. | 230013 230014 230034 230081 |
| description | heating element 4500W 230V mounting \varnothing 47.5mm heating circuits 3 L 316mm W 35mm H 34mm number of thermostat sleeves 1 thermostat sleeves \varnothing 7mm length thermostat sleeves 180mm thermostat sleeve eccentric, non clinging tube \varnothing 6.3mm hole distance 62mm hole \varnothing 8mm connection M4 3 hole flange immersion heater | | |
| For models: | 10, 12, 14, 22F, 22R, 40F, 44F, 510F, 510FD, 66, 913297, 913298, 913299, 913300, 913360, 913361, 913391, 913392, 913546, 913547, 913578, 913611, 913684, 913932, 913933, 914318, 914319, 914326, 914331, 914338, 914406, 914431, 914517, 914545, 914688, 914979, 915140, 915248, CLEAN-100, CLEAN-120, CLEAN-3, E.50, E.51, E.52, E.55, E1, E10, E100, E110...(Other models you can see in the webshop) | | |
| spare parts for | 415001 | | |
|  | GEV No. | 510408 | Ref. No. 456002 456079 |
| | O-ring EPDM thickness 5.34mm ID \varnothing 47mm Qty 1 pcs | | |
| accessories for | 415001 | | |
|  | GEV No. | 510562 | Ref. No. — |
| | O-ring silicone thickness 5.34mm ID \varnothing 47mm Qty 1 pcs | | |
|  | GEV No. | 521103 | Ref. No. — |
| | nut thread M4 H 3mm WS 7 brass Qty 20 pcs | | |
|  | GEV No. | 521104 | Ref. No. — |
| | washer ID \varnothing 4.3mm ED \varnothing 8mm thickness 0.5mm brass Qty 20 pcs for thread M4 | | |
|  | GEV No. | 560111 | Ref. No. — |
| | plain washer ID \varnothing 4.3mm ED \varnothing 9mm thickness 0.8mm SS Qty 20 pcs DIN 125A for thread M4 | | |
|  | GEV No. | 560131 | Ref. No. — |
| | hexagonal nut thread M4 H 3.2mm WS 7 SS DIN/ISO DIN 934 / ISO 4032/8673 Qty 20 pcs | | |

| | | | |
|---|--|-----------------|----------------------------------|
|   | | | |
| 1 | | | |
| GEV No. | 417440 | Ref. No. | 230111 |
| description | heating element 4900W 230V mounting \varnothing 47.5mm heating circuits 3 L 330mm W 32mm H 34mm number of thermostat sleeves 1 thermostat sleeves \varnothing 7mm length thermostat sleeves 177mm thermostat sleeve not clinging tube \varnothing 6.5mm hole distance 62mm hole \varnothing 8mm connection M4 3 hole flange immersion heater | | |
| For models: | 913913, 913914, 914284, 914356, 914400, 914401, 914402, 914403, 914404, 914405, 914449, 914642, 914909, 915136, 915137, 915150, 915151, 915152, 915154, 915155, 915160, 915161, 915162, 915166, 915167, 915168, 915175, 915176, 915177, 915319, 915338, 915341, 915348, 915418, 915419, 915420, 915421, 915479, 915483, 915484, 915492, 915493, 915528, 915537, 915538, 915539, 915540, 915547, 915558, 915635...(Other models you can see in the webshop) | | |
| accessories for | 417440 | | |
|  | GEV No. | 510408 | Ref. No. 456002 456079 |
| | O-ring EPDM thickness 5.34mm ID \varnothing 47mm Qty 1 pcs | | |

| | | | |
|---|--|--------|-------------------|
| accessories for | 417440 | | |
|  | GEV No. | 510562 | Ref. No. — |
| | O-ring silicone thickness 5.34mm ID \varnothing 47mm Qty 1 pcs | | |

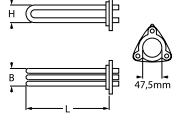
| | | | |
|--|---|-----------------|----------------------------------|
|   | | | |
| 1 | | | |
| GEV No. | 416240 | Ref. No. | 230083 230083C |
| description | heating element 6545W 230/400V mounting \varnothing 48mm heating circuits 3 L 355mm W 31mm H 37mm number of thermostat sleeves 1 thermostat sleeves \varnothing 7mm length thermostat sleeves 175mm thermostat sleeve upper centre not clinging tube \varnothing 6.5mm hole distance 63mm hole \varnothing 10mm connection M4 3 hole flange immersion heater | | |
| For models: | 80, 914380, 914436, 915747, 915817, 916045, A3EB, A3EBD, A3EBDA-KRKYK, A3EBDAKWK, A3EBDBKWK, A3EBDRKYK, A3EBDWK, A3EBDYK, A3EBSAK, A3EBSAKRK, A3EBSAKWK, A3EBSBKWKYK, A3EBSEKWK, A3EBSWK, A4EBT, A4EBTSAK, CE78HZ23, E.60, E78, E78HP, F85, F85P, FAST-161+PA-220-60-1, Fast161+PA-220-60-1, GL280EB, GL280EB23, GL280EB23DAR, GL280EB23HZ, GL280EB23HZDY, GL280EBD, GL280EBDA, GL280EBDAE, GL280EBDAR, GL280EBDARY, GL280EBDAW, GL280EBDAWY, GL280EBDAY, GL280EBDB, GL280EBDBR, GL280EBDBW, GL280EBDWY, GL280EBDY, GL280EBS, GL280EBSA...(Other models you can see in the webshop) | | |
| accessories for | 416240 | | |
|  | GEV No. | 510408 | Ref. No. 456002 456079 |
| | O-ring EPDM thickness 5.34mm ID \varnothing 47mm Qty 1 pcs | | |
|  | GEV No. | 510562 | Ref. No. — |
| | O-ring silicone thickness 5.34mm ID \varnothing 47mm Qty 1 pcs | | |

| | | | |
|--|--|-----------------|----------------------------------|
|   | | | |
| 1 | | | |
| GEV No. | 419043 | Ref. No. | 230117 |
| description | heating element 7600W 400V mounting \varnothing 47.5mm heating circuits 3 L 330mm W 40mm H 35mm number of thermostat sleeves 1 thermostat sleeves \varnothing 7.5mm length thermostat sleeves 180mm thermostat sleeve eccentric, non clinging tube \varnothing 8.5mm hole distance 63mm hole \varnothing 10mm connection length 25mm connection M4 3 hole flange immersion heater | | |
| For models: | 915157, 915158, 915166, 915167, 915168, 915172, 915173, 915285, 915348, 915420, 915421, 915422, 915479, 915494, 915495, 915496, 915497, 915547, 915558, 915635, 915747, 916054, 916067, 916068, 916069, 916079, 916080, 916209, 916367, 916368, 916417, 916420, 916421, 916422, 916423, 916424, 916686, 916760, 916802, 916885, NG281, NG281CDD, NG281HZ23, NG281HZ23DD, NG38123, NG38123TERMO, NG381DDHZ23, NG381DDPSHZ23, Niagara-261, Niagara-271-2...(Other models you can see in the webshop) | | |
| accessories for | 419043 | | |
|  | GEV No. | 510408 | Ref. No. 456002 456079 |
| | O-ring EPDM thickness 5.34mm ID \varnothing 47mm Qty 1 pcs | | |









| | | | | |
|------------------------|--|-----------------|---|------------------|
| | | | | |
| 1 | | | | |
| GEV No. | 416241 | Ref. No. | 230020 230020C 230095 REB230020C | |
| description | heating element 8000W 230V mounting \varnothing 47.5mm heating circuits 3 L 355mm W 35mm H 35mm number of thermostat sleeves 1 thermostat sleeves \varnothing 7.5mm length thermostat sleeves 185mm thermostat sleeve not clinging tube \varnothing 6.3mm hole distance 64mm hole \varnothing 8mm connection M4 3 hole flange immersion heater | | | |
| For models: | 81, 914380, 914436, 915729, 915747, A3EB, A3EBD, A3EBDAKRKYK, A3EBDAKWK, A3EBDBKWK, A3EBDRKYK, A3EBDVK, A3EBDYK, A3EBSAK, A3EBSAKRK, A3EBSAKWK, A3EBSBKWKYK, A3EBSEKWK, A3EBSWK, A4EB, A4EBD, A4EBDAKEKYK, A4EBDAKRK, A4EBDAKWK, A4EBDAKZK, A4EBDBKRK, A4EBDPKWKYK, A4EBDRK, A4EBS, A4EBSAK, A4EBSAKCK, A4EBSAKEKYK, A4EBSAKRK, A4EBSAKRKP, A4EBSAKYK, A4EBSCK, A4EBT, A4EBTSAK, CLEAN-110, E.65, E110, E12, E120, E14, Fast180, Fast180-230V-3Ph-60Hz, Fast181, FAST-181, FAST-200, FAST-63...(Other models you can see in the webshop) | | | |
| spare parts for | 416241 | | | |
| | GEV No. | 510408 | Ref. No. | 456002 456079 |
| | O-ring EPDM thickness 5.34mm ID \varnothing 47mm Qty 1 pcs | | | |
| accessories for | 416241 | | | |
| | GEV No. | 510093 | Ref. No. | 467002 69870 |
| | protection cap | | | |
| | GEV No. | 510408 | Ref. No. | 456002 456079 |
| | O-ring EPDM thickness 5.34mm ID \varnothing 47mm Qty 1 pcs | | | |
| | GEV No. | 510562 | Ref. No. | — |
| | O-ring silicone thickness 5.34mm ID \varnothing 47mm Qty 1 pcs | | | |







| | | | | |
|------------------------|---|-----------------|-----------------|------------------|
| | | | | |
| 1 | | | | |
| GEV No. | 416242 | Ref. No. | 80398 80398C | |
| description | heating element 9500W 230V mounting \varnothing 47.5mm heating circuits 3 L 330mm W 35mm H 35mm number of thermostat sleeves 1 thermostat sleeves \varnothing 7mm length thermostat sleeves 175mm thermostat sleeve eccentric, non clinging tube \varnothing 8.5mm hole distance 72mm hole \varnothing 8/10mm connection M4 3 hole flange immersion heater | | | |
| For models: | 80, 82, 914380, 914436, 915747, A5EB, A5EBD, A5EBDAKPKWK, A5EBDAKWK, A5EBDAKYK, A5EBDRK, A5EBS, A5EBSAKPKWK, A5EBSAKRK, A5EBSAKRKYK, A5EBSAKWK, A5EBSAKWKYK, A5EBSBKRPK, A5EBSBKWK, A5EBSRK, A5EBSYK, CGL74CABT, CNT800CH, Fast200, FAST-200, Fast93, GL280EB, GL280EB23, GL280EB23DAR, GL280EB23HZ, GL280EB23HZDY, GL280EBD, GL280EBDA, GL280EBDAE, GL280EBDAR, GL280EBDARY, GL280EBDAW, GL280EBDAWY, GL280EBDAY, GL280EBDB, GL280EBDBR, GL280EBDBW, GL280EBDWY, GL280EBDY, GL280EBS, GL280EBSA, GL280EBSAE, GL280EBSAEW, GL280EBSAEWY, GL280EBSAR...(Other models you can see in the webshop) | | | |
| spare parts for | 416242 | | | |
| | GEV No. | 510408 | Ref. No. | 456002 456079 |
| | O-ring EPDM thickness 5.34mm ID \varnothing 47mm Qty 1 pcs | | | |

| | | | | |
|------------------------|---|-----------------|------------------|------------------|
| | | | | |
| 1 | | | | |
| GEV No. | 415668 | Ref. No. | 230023 230090 | |
| description | heating element 2625W 230V mounting \varnothing 47.5mm heating circuits 1 L 190mm W 41mm H 54mm number of thermostat sleeves 1 thermostat sleeves \varnothing 7mm length thermostat sleeves 170mm thermostat sleeve eccentric, non clinging tube \varnothing 6.3mm hole distance 62mm hole \varnothing 8mm connection M4 3 hole flange immersion heater | | | |
| For models: | 21F, 21FD, 21R, 21RD, 25F, 25FD, 25R, 25RD, 30F, 30FD, 30R, 30RD, 31F, 31FD, 31R, 31RD, RIVER-40, S621, S623, S624, S626, S631, S633, S634, S636 | | | |
| spare parts for | 415668 | | | |
| | GEV No. | 510408 | Ref. No. | 456002 456079 |
| | O-ring EPDM thickness 5.34mm ID \varnothing 47mm Qty 1 pcs | | | |
| accessories for | 415668 | | | |
| | GEV No. | 510562 | Ref. No. | — |
| | O-ring silicone thickness 5.34mm ID \varnothing 47mm Qty 1 pcs | | | |



| | | | | |
|------------------------|---|-----------------|-----------------|------------------|
| | | | | |
| 1 | | | | |
| GEV No. | 416280 | Ref. No. | 230091 | |
| description | heating element 2700W 230V heating circuits 1 number of thermostat sleeves 1 thermostat sleeve eccentric, non clinging 3 hole flange immersion heater | | | |
| For models: | 913992, 913993, 914592, 914612, 914613, CLEAN-3, River-40, RIVER-43, RIVER-44 | | | |
| accessories for | 416280 | | | |
| | GEV No. | 510408 | Ref. No. | 456002 456079 |
| | O-ring EPDM thickness 5.34mm ID \varnothing 47mm Qty 1 pcs | | | |
| | GEV No. | 510562 | Ref. No. | — |
| | O-ring silicone thickness 5.34mm ID \varnothing 47mm Qty 1 pcs | | | |





| | | | |
|---|--|-----------------|----------------------------------|
|  | | | |
| GEV No. | 415002 | Ref. No. | 230012 |
| description | heating element 3000W 230V mounting ø 47.5mm heating circuits 1 L 198mm W 35mm H 44mm number of thermostat sleeves 1 thermostat sleeves ø 7mm length thermostat sleeves 175mm thermostat sleeve not clinging tube ø 6.3mm hole distance 64mm hole ø 8mm connection M4 3 hole flange immersion heater | | |
| For models: | 21F, 21FD, 21R, 21RD, 22F, 22R, 25F, 25FD, 25R, 25RD, 30F, 30FD, 30R, 30RD, 31F, 31FD, 31R, 31RD, 40F, 44F, S621, S623, S624, S626, S631, S633, S634, S636 | | |
| accessories for | 415002 | | |
|  | GEV No. | 510408 | Ref. No. 456002 456079 |
| | O-ring EPDM thickness 5.34mm ID ø 47mm Qty 1 pcs | | |
|  | GEV No. | 510562 | Ref. No. — |
| | O-ring silicone thickness 5.34mm ID ø 47mm Qty 1 pcs | | |
|  | GEV No. | 521103 | Ref. No. — |
| | nut thread M4 H 3mm WS 7 brass Qty 20 pcs | | |
|  | GEV No. | 521104 | Ref. No. — |
| | washer ID ø 4.3mm ED ø 8mm thickness 0.5mm brass Qty 20 pcs for thread M4 | | |
|  | GEV No. | 560111 | Ref. No. — |
| | plain washer ID ø 4.3mm ED ø 9mm thickness 0.8mm SS Qty 20 pcs DIN 125A for thread M4 | | |
|  | GEV No. | 560131 | Ref. No. — |
| | hexagonal nut thread M4 H 3.2mm WS 7 SS DIN/ISO DIN 934 / ISO 4032/8673 Qty 20 pcs | | |

| | | | |
|---|---|-----------------|----------------------------|
|  | | | |
| GEV No. | 415039 | Ref. No. | 927066 927280 DRB81C |
| description | heating element 8000W 230V mounting ø 57.5mm heating circuits 3 L 375mm W 41mm H 42mm number of thermostat sleeves 1 thermostat sleeves ø 7mm length thermostat sleeves 230mm thermostat sleeve upper centre not clinging tube ø 6mm hole distance 73mm hole ø 10mm connection length 30mm connection M4 3 hole flange immersion heater | | |
| For models: | 161, 221, 271, 272, 362, CLEAN-160, CLEAN-161, CLEAN-220, CLEAN-221, CLEAN-270, CLEAN-271, CLEAN-272, CLEAN-362 | | |
| spare parts for | 415039 | | |
|  | GEV No. | 510409 | Ref. No. 929046 |
| | O-ring EPDM thickness 5.34mm ID ø 56.52mm Qty 1 pcs | | |
| accessories for | 415039 | | |
|  | GEV No. | 521103 | Ref. No. — |
| | nut thread M4 H 3mm WS 7 brass Qty 20 pcs | | |
|  | GEV No. | 521104 | Ref. No. — |
| | washer ID ø 4.3mm ED ø 8mm thickness 0.5mm brass Qty 20 pcs for thread M4 | | |
|  | GEV No. | 560111 | Ref. No. — |
| | plain washer ID ø 4.3mm ED ø 9mm thickness 0.8mm SS Qty 20 pcs DIN 125A for thread M4 | | |
|  | GEV No. | 560131 | Ref. No. — |
| | hexagonal nut thread M4 H 3.2mm WS 7 SS DIN/ISO DIN 934 / ISO 4032/8673 Qty 20 pcs | | |

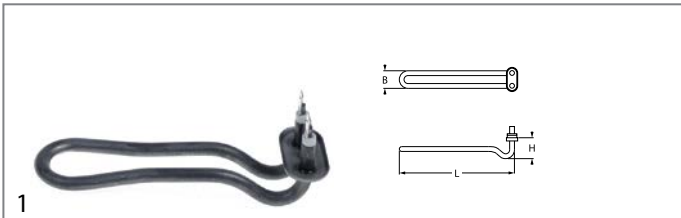

| | | | |
|---|--|-----------------|------------------------|
| 3 hole flange ø57.5mm | | | |
|  | | | |
| GEV No. | 418871 | Ref. No. | 927026 927276 |
| description | heating element 10000W 230V mounting ø 57.5mm heating circuits 3 L 375mm W 40mm H 33mm number of thermostat sleeves 1 thermostat sleeves ø 7mm length thermostat sleeves 225mm thermostat sleeve upper centre not clinging tube ø 6.3mm hole distance 73mm hole ø 8mm connection length 24mm | | |
| For models: | 161, 221, 271, 272, 362, CLEAN-160, CLEAN-161, CLEAN-220, CLEAN-221, CLEAN-270, CLEAN-271, CLEAN-272, CLEAN-361, CLEAN-361P, CLEAN-362, CLEAN-471, CLEAN-471P | | |
| accessories for | 418871 | | |
|  | GEV No. | 510409 | Ref. No. 929046 |
| | O-ring EPDM thickness 5.34mm ID ø 56.52mm Qty 1 pcs | | |

| | | | |
|--|---|-----------------|------------------------|
| with compression flange 50 x 26mm | | | |
|  | | | |
| GEV No. | 420332 | Ref. No. | 230107 |
| description | heating element 600W 230V heating circuits 1 flange 50x26mm L 125mm W 48mm H 70mm tube ø 8.4mm connection male faston 6.3mm immersion heater compression flange | | |
| For models: | 913992, 913993, 914583, 914592, 914612, 914613, 915143, RIVER-40, RIVER-40-CRP, RIVER-44, RIVER-44-CRP, RIVER-44-CRP-ST, RIVER-44CRP-ST | | |
| spare parts for | 420332 | | |
|  | GEV No. | 510387 | Ref. No. 437086 |
| | gasket L 46mm W 22mm ømm EPDM for heating element for flange 50x26mm | | |
|  | GEV No. | 510388 | Ref. No. — |
| | counterflange ømm hole distance mm perforation ømm L 43mm W 21mm SS for heating element for flange 50x26mm | | |

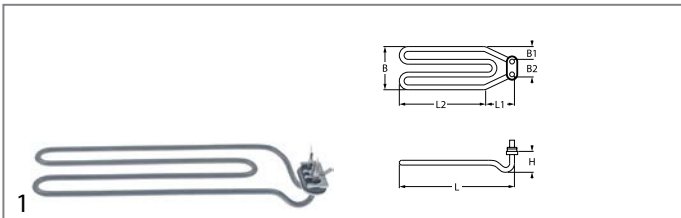

| | | | |
|--|--|-----------------|------------------------|
| GEV No. | 416234 | Ref. No. | 230098 |
| description | heating element 600W 230V heating circuits 1 flange 50x26mm L 160mm W 45mm H 27mm tube ø 8.8mm connection male faston 6.3mm connection length 40mm immersion heater compression flange | | |
| For models: | 913289, 913290, 913291, 913292, 913356, 913357, 913372, 913373, 913374, 913375, 913416, 913435, 913544, 913545, 913665, 913666, 913667, 913668, 913685, 913771, 913772, 913773, 913774, 913832, 913837, 913911, 913912, 913948, 913950, 913977, 913984, 913990, 914165, 914166, 914206, 914214, 914316, 914317, 914355, 914386, 914387, 914388, 914389, 914390, 914391, 914392, 914393, 914394, 914395, 914396...(Other models you can see in the webshop) | | |
| accessories for | 416234 | | |
|  | GEV No. | 510387 | Ref. No. 437086 |
| | gasket L 46mm W 22mm ømm EPDM for heating element for flange 50x26mm | | |
|  | GEV No. | 510388 | Ref. No. — |
| | counterflange ømm hole distancemm perforation ømm L 43mm W 21mm SS for heating element for flange 50x26mm | | |





| | | | |
|--|--|-----------------|------------------------|
| GEV No. | 420333 | Ref. No. | 230103 |
| description | heating element 2450W 220/240V heating circuits 1 compression flange flange 50x26mm L 295mm W 89mm H 27mm L1 35mm L2 260mm W1 59mm W2 30mm connection male faston 6.3mm tube ø 6.2mm immersion heater for tank | | |
| spare parts for | 420333 | | |
|  | GEV No. | 510387 | Ref. No. 437086 |
| | gasket L 46mm W 22mm ømm EPDM for heating element for flange 50x26mm | | |
|  | GEV No. | 510388 | Ref. No. — |
| | counterflange ømm hole distancemm perforation ømm L 43mm W 21mm SS for heating element for flange 50x26mm | | |



| | | | |
|---|---|-----------------|------------------------|
| GEV No. | 420464 | Ref. No. | 73069 |
| description | heating element 2500W 230V heating circuits 1 screw flange 50x26mm L 170mm W 120mm H 30mm L1 50mm L2 120mm tube ø 8.5mm warewashing | | |
| For models: | NG381, NG38123, NG38123TERMO, NG381C, NG381CDD, NG381CFUR, NG381DDHZ23, NG381DDPS, NG381DDPSHZ23, NG381HPDD, NG381TERMO, NG381TXCDD, Niagara-381, Niagara-381-230V-3Ph-50Hz, Niagara-381-230V-3Ph-60Hz, Niagara-381DP, Niagara-381HPD, River-282-2, River-282S-2TDE, River-285, River-382, River-382-230V-3Ph-50Hz, River-382H, River-382NRG, River-382NRG-230-3Ph-50Hz, River-382TDE, RV382, RV38223TERMO, RV382AHP, RV-382FUR, RV382R, RV382R23TERMO, RV382RFUR, RV382S, RV382SFUR, RV382TERMO, RV382TX, RV382TXR | | |
| spare parts for | 420464 | | |
|  | GEV No. | 510387 | Ref. No. 437086 |
| | gasket L 46mm W 22mm ømm EPDM for heating element for flange 50x26mm | | |



| | | | |
|---|---|-----------------|------------------------|
| GEV No. | 420331 | Ref. No. | 230112 |
| description | heating element 1400W 230V compression flange flange 50x26mm L 160mm heating circuits 1 H 29mm W 190mm connection male faston 6.3mm immersion heater tube ø 8.4mm | | |
| For models: | 915150, 915151, 915152, 915154, 915155, 915160, 915161, 915162, 915166, 915167, 915168, 915172, 915173, 915175, 915176, 915177, 915285, 915319, 915338, 915341, 915348, 915418, 915419, 915420, 915421, 915422, 915479, 915492, 915493, 915496, 915497, 915547, 915558, 915635, 915663, 915747, 916054, CNT800CH, FAST-73, NG281, NG281HP, NIAGARA-251, Niagara-261, NIAGARA-281, NIAGARA-281HP, PLUVIA-260, Pluvia-270, PLUVIA-280, Pluvia280-230V-3PH-60HZ, PV280...(Other models you can see in the webshop) | | |
| spare parts for | 420331 | | |
|  | GEV No. | 510387 | Ref. No. 437086 |
| | gasket L 46mm W 22mm ømm EPDM for heating element for flange 50x26mm | | |
|  | GEV No. | 510388 | Ref. No. — |
| | counterflange ømm hole distancemm perforation ømm L 43mm W 21mm SS for heating element for flange 50x26mm | | |



with compression flange 70 x 26mm

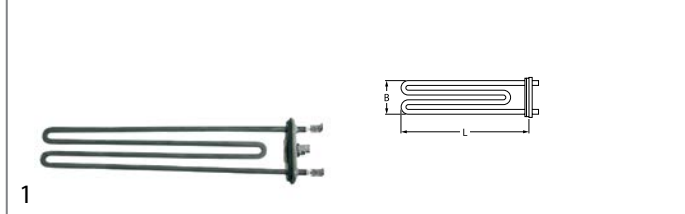

| | | | |
|------------------------|---|-----------------|----------------------------|
| GEV No. | 415009 | Ref. No. | 230057 230058 230087 |
| description | heating element 2500W 230V heating circuits 1 flange 70x26mm L 280mm W 51mm Hmm tube ø 6.3mm connection M4 immersion heater compression flange | | |
| For models: | 11F, 11FD, 11F-DVGW, 11R, 11RD, 350F, 350FD, 350R, 350RD, 35-ELECTRONIC, 35F, 35FD, 35R, 35RD, 400F, 400FD, 400R, 400RD, 40-ELECTRONIC, 40F, 40FD, 40R, 40RD, 45, 450, 67F, 67R, E.35, E.40, E.41, E.42, E.45 | | |
| accessories for | 415009 | | |
| | GEV No. | 521128 | Ref. No. 437048 |
| | gasket L 66mm W 21mm ømm for heating element suitable for ELETTROBAR, WOLK | | |

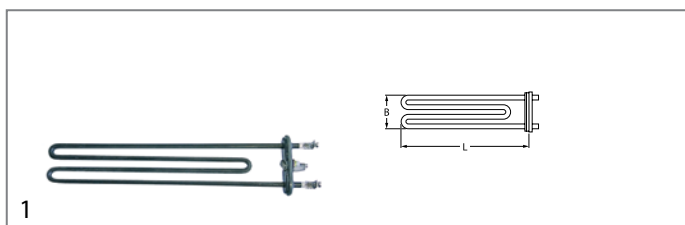

| | | | |
|------------------------|---|-----------------|----------------------------|
| GEV No. | 415000 | Ref. No. | 230075 230076 230088 |
| description | heating element 2900W 230V heating circuits 1 flange 70x26mm L 272mm W 51mm Hmm tube ø 6.3mm connection M4 immersion heater compression flange | | |
| For models: | 050F, 050FP, 46, 460, 500F, 500FD, 50-ELECTRONIC, 50F, 50FD, 510F, 510FD, 913297, 913298, 913299, 913300, 913360, 913361, 913391, 913392, 913546, 913547, 913578, 913611, 913684, 913932, 913933, 914331, 914517, 914545, 914688, 914979, 915140, 915248, E.46, E.50, E.51, GSP50, GSP50P, LF50, LF55, MCS01E, MCS01EP, MCS01S, MCS01SP, P500 | | |
| spare parts for | 415000 | | |
| | GEV No. | 521128 | Ref. No. 437048 |
| | gasket L 66mm W 21mm ømm for heating element suitable for ELETTROBAR, WOLK | | |
| accessories for | 415000 | | |
| | GEV No. | 521128 | Ref. No. 437048 |
| | gasket L 66mm W 21mm ømm for heating element suitable for ELETTROBAR, WOLK | | |

with expansion flange 70 x 18mm



| | | | |
|--------------------|--|-----------------|--------|
| GEV No. | 416239 | Ref. No. | 230100 |
| description | heating element 2600W 230V heating circuits 1 flange 70x18mm L 270mm W 65mm connection male faston 6.3mm tube ø 8.5mm immersion heater expansion flange | | |
| For models: | 913289, 913290, 913771, 913772, 913832, 914386, 914387, 914388, 914390, 914391, 914692, 914693, 914694, 914703, 914870, E.35, E.35H, E.40, E.40H, E.45, MC201CL, MINIBAR, MISTRAL-40, NIAGARA-35, NIAGARA-40, NIAGARA-45, S280 | | |

| | | | |
|--------------------|---|-----------------|--------|
| | 1 | | |
| GEV No. | 420550 | Ref. No. | 230109 |
| description | heating element 4600W 230V heating circuits 3 flange 70x18mm L 360mm W 60mm L1 45mm H 55mm L2 45mm connection F 6.3mm L3 290mm immersion heater expansion flange for dishwashers tube ø 6.5mm | | |
| For models: | 914583, 915143, RIVER-40-CRP, RIVER-44-CRP, River-44-CRP-ST, RIVER-44CRP-ST | | |

| | | | |
|--------------------|--|-----------------|--------|
| | 1 | | |
| GEV No. | 419042 | Ref. No. | 230108 |
| description | heating element 7000W 230V heating circuits 3 flange 70x18mm L 415mm W 64mm H 52mm L1 40mm L2 25mm L3 350mm tube ø 6.3mm connection male faston 6.3mm immersion heater expansion flange for dishwasher | | |
| For models: | 2312-009-CRP, 914628, 914944, RIVER-50-CRP, RIVER-50-CRP-SP, RIVER-54CRP, River-54-CRP-s.p., RIVER-54-CRP-SP | | |

| | | | |
|--------------------|--|-----------------|--------|
| | 1 | | |
| GEV No. | 416243 | Ref. No. | 230106 |
| description | heating element 7600W 230V heating circuits 3 flange 70x18mm L 390mm W 60mm H 13mm connection male faston 6.3mm tube ø 6.3mm immersion heater expansion flange INCOLOY-800 | | |
| For models: | 2312-007, 914100, 914101, 914339, 914342, 914343, 914624, 914625, 914626, 914627, 914850, 914851, 914854, RIVER-48, RIVER-50, RIVER-54, RIVER-61 | | |

with round flange ø47.5mm



| | | | |
|------------------------|---|-----------------|----------------------------------|
| GEV No. | 420057 | Ref. No. | 230116 |
| description | heating element 3000W 230V heating circuits 1 mounting ø 47.5mm L 330mm W 33mm H 19mm tube ø 8.4mm thermostat sleeves ø 7.4mm number of thermostat sleeves 1 length thermostat sleeves 170mm | | |
| For models: | 914400, 914401, 914402, 914403, 914404, 914405, 914449, 914568, 915483, 915484, 915537, 915538, 915539, 915540, 915664, 915697, 915698, 915699, 915700, 915701, 915702, 915756, 915799, 915800, 915809, 915830, 916020, 916024, 916026, 916030, 916247, 916248, 916249, 916382, 916452, 916584, 916654, 916670, 916688, 916763, 916812, 916813, E.50, E.50D.PA, E.51, Fast160, FAST-160, Fast160-2, FAST-160-230-50-1N, Fast160-230-50-1N...(Other models you can see in the webshop) | | |
| spare parts for | 420057 | | |
| | GEV No. | 510408 | Ref. No. 456002 456079 |
| | O-ring EPDM thickness 5.34mm ID ø 47mm Qty 1 pcs | | |



with round flange ø57.5mm



| | | | |
|------------------------|---|-----------------|-------------------|
| GEV No. | 415034 | Ref. No. | DRB23 |
| description | heating element 2600W 230V heating circuits 1 mounting ø 57.5mm L 180mm W 37mm H 27mm round flange connection male faston 6.3mm immersion heater tube ø 8.5mm | | |
| accessories for | 415034 | | |
| | GEV No. | 550002 | Ref. No. — |
| | tension strap H 10mm L 21mm W 10mm hole ø 6.5mm for heating element | | |



| | | | |
|------------------------|--|-----------------|------------------------|
| GEV No. | 415038 | Ref. No. | 929040 |
| description | heating element 5000W 230V heating circuits 3 mounting ø 57.5mm L 373mm W 44mm H 40mm round flange connection M4 immersion heater tube ø 6.3mm connection length 19mm thermostat sleeves ø 7mm number of thermostat sleeves 1 length thermostat sleeves 328mm thermostat sleeve not clinging | | |
| For models: | 55 | | |
| spare parts for | 415038 | | |
| | GEV No. | 510409 | Ref. No. 929046 |
| | O-ring EPDM thickness 5.34mm ID ø 56.52mm Qty 1 pcs | | |
| accessories for | 415038 | | |
| | GEV No. | 521103 | Ref. No. — |
| | nut thread M4 H 3mm WS 7 brass Qty 20 pcs | | |
| | GEV No. | 521104 | Ref. No. — |
| | washer ID ø 4.3mm ED ø 8mm thickness 0.5mm brass Qty 20 pcs for thread M4 | | |
| | GEV No. | 550002 | Ref. No. — |
| | tension strap H 10mm L 21mm W 10mm hole ø 6.5mm for heating element | | |
| | GEV No. | 560111 | Ref. No. — |
| | plain washer ID ø 4.3mm ED ø 9mm thickness 0.8mm SS Qty 20 pcs DIN 125A for thread M4 | | |
| | GEV No. | 560131 | Ref. No. — |
| | hexagonal nut thread M4 H 3.2mm WS 7 SS DIN/ISO DIN 934 / ISO 4032/8673 Qty 20 pcs | | |

miscellaneous



| | | | |
|--------------------|--|-----------------|--------|
| GEV No. | 417575 | Ref. No. | 230118 |
| description | heating element 2100W 230V W 165mm H 25mm L 270mm format angled | | |
| For models: | 915157, 915158, 915160, 915161, 915162, 915175, 915319, 915494, 915495, 915663, 916020, 916021, 916024, 916025, 916026, 916027, 916030, 916031, 916045, 916067, 916068, 916069, 916079, 916080, 916201, 916202, 916203, 916204, 916205, 916206, 916207, 916208, 916209, 916247, 916248, 916249, 916250, 916251, 916252, 916365, 916366, 916367, 916368, 916382, 916383, 916411, 916412, 916413, 916414, 916415...(Other models you can see in the webshop) | | |

1¼"



| | | | |
|------------------------|---|-----------------|------------------------|
| GEV No. | 415005 | Ref. No. | 230002 |
| description | heating element 2000W 230V heating circuits 1 thread 1¼" L 170mm W 32mm H 22mm tube ø 6.2mm connection M4 | | |
| For models: | R497, R499, R501, R503, R505, R507, S641, S643 | | |
| accessories for | 415005 | | |
| | GEV No. | 510405 | Ref. No. 437028 |
| | flat gasket fibre ED ø 56mm ID ø 42mm thickness 2mm for thread 1¼" Qty 1 pcs | | |
| | GEV No. | 520232 | Ref. No. — |
| | nut thread 1¼" H 5mm nickel-plated brass WS 47 Qty 1 pcs | | |
| | GEV No. | 521103 | Ref. No. — |
| | nut thread M4 H 3mm WS 7 brass Qty 20 pcs | | |
| | GEV No. | 521104 | Ref. No. — |
| | washer ID ø 4.3mm ED ø 8mm thickness 0.5mm brass Qty 20 pcs for thread M4 | | |
| | GEV No. | 528021 | Ref. No. — |
| | flat gasket PTFE ED ø 53mm ID ø 42.5mm thickness 3mm Qty 1 pcs equiv. no. 12001/02286 suitable for Astoria/Aurora/Brasilia/Wega | | |
| | GEV No. | 560111 | Ref. No. — |
| | plain washer ID ø 4.3mm ED ø 9mm thickness 0.8mm SS Qty 20 pcs DIN 125A for thread M4 | | |
| | GEV No. | 560131 | Ref. No. — |
| | hexagonal nut thread M4 H 3.2mm WS 7 SS DIN/ISO DIN 934 / ISO 4032/8673 Qty 20 pcs | | |







| | | | |
|------------------------|---|-----------------|------------------------|
| GEV No. | 415042 | Ref. No. | 230003 |
| description | heating element 2200W 230V heating circuits 1 thread 1¼" L 165mm W 35mm H 26mm tube ø 6.3mm connection M4 immersion heater flange with thread | | |
| spare parts for | 415042 | | |
| | GEV No. | 510405 | Ref. No. 437028 |
| | flat gasket fibre ED ø 56mm ID ø 42mm thickness 2mm for thread 1¼" Qty 1 pcs | | |
| accessories for | 415042 | | |
| | GEV No. | 520232 | Ref. No. — |
| | nut thread 1¼" H 5mm nickel-plated brass WS 47 Qty 1 pcs | | |
| | GEV No. | 521103 | Ref. No. — |
| | nut thread M4 H 3mm WS 7 brass Qty 20 pcs | | |
| | GEV No. | 521104 | Ref. No. — |
| | washer ID ø 4.3mm ED ø 8mm thickness 0.5mm brass Qty 20 pcs for thread M4 | | |
| | GEV No. | 528021 | Ref. No. — |
| | flat gasket PTFE ED ø 53mm ID ø 42.5mm thickness 3mm Qty 1 pcs equiv. no. 12001/02286 suitable for Astoria/Aurora/Brasilia/Wega | | |
| | GEV No. | 560111 | Ref. No. — |
| | plain washer ID ø 4.3mm ED ø 9mm thickness 0.8mm SS Qty 20 pcs DIN 125A for thread M4 | | |

Table continues overleaf

















| | | | |
|---|--|--------|------------|
| accessories for | 415042 | | |
|  | GEV No. | 560131 | Ref. No. — |
| | hexagonal nut thread M4 H 3.2mm WS 7 SS DIN/ISO DIN 934 / ISO 4032/8673 Qty 20 pcs | | |

| | | | |
|---|--|--------|------------|
| accessories for | 415004 | | |
|  | GEV No. | 560131 | Ref. No. — |
| | hexagonal nut thread M4 H 3.2mm WS 7 SS DIN/ISO DIN 934 / ISO 4032/8673 Qty 20 pcs | | |









| | | | |
|---|---|-----------------|------------------|
|  | | | |
| GEV No. | 415011 | Ref. No. | 230007 230021 |
| description | heating element 3000W 230V heating circuits 1 thread 1/4" L 285mm W 24mm H 20mm tube ø 6.5mm connection M4 immersion heater connection length 26mm flange with thread WS 54 | | |
| For models: | 35F, 35FD, 35R, 35RD, R509, R511, R704 | | |
| accessories for | 415011 | | |
|  | GEV No. | 510405 | Ref. No. 437028 |
| | flat gasket fibre ED ø 56mm ID ø 42mm thickness 2mm for thread 1/4" Qty 1 pcs | | |
|  | GEV No. | 520232 | Ref. No. — |
| | nut thread 1/4" H 5mm nickel-plated brass WS 47 Qty 1 pcs | | |
|  | GEV No. | 528021 | Ref. No. — |
| | flat gasket PTFE ED ø 53mm ID ø 42.5mm thickness 3mm Qty 1 pcs equiv. no. 12001/02286 suitable for Astoria/Aurora/Brasilia/Wega | | |





| | | | |
|--|--|-----------------|--------|
|  | | | |
| GEV No. | 415666 | Ref. No. | 230077 |
| description | heating element 1100W 230V heating circuits 1 L 151mm W 56mm Hmm thread 1/8" mounting distance 50mm tube ø 6.3mm 2 hole fixing immersion heater connection male faston 6.3mm | | |
| For models: | 350F, 350FD, 350R, 350RD, 400F, 400FD, 400R, 400RD, 40F, 40FD, 40R, 40RD | | |



| | | | |
|---|---|-----------------|------------------|
|  | | | |
| GEV No. | 415004 | Ref. No. | 230008 230026 |
| description | heating element 3000W 230/380V heating circuits 3 thread 1/2" L 300mm W 32mm H 34mm tube ø 6.3mm connection M4 immersion heater connection length 20mm flange with thread | | |
| For models: | R708, S870 | | |
| accessories for | 415004 | | |
|  | GEV No. | 510406 | Ref. No. — |
| | flat gasket fibre ED ø 60mm ID ø 48mm thickness 3mm for thread 1/2" Qty 1 pcs | | |
|  | GEV No. | 510424 | Ref. No. — |
| | gasket copper ED ø 55mm ID ø 48mm thickness 2.2mm Centellen for thread 1/2" | | |
|  | GEV No. | 520211 | Ref. No. — |
| | reducer thread 2" ET - 1/2" IT brass | | |
|  | GEV No. | 520212 | Ref. No. — |
| | hexagonal nut thread 1/2" brass WS 60 H 8mm | | |
|  | GEV No. | 521103 | Ref. No. — |
| | nut thread M4 H 3mm WS 7 brass Qty 20 pcs | | |
|  | GEV No. | 521104 | Ref. No. — |
| | washer ID ø 4.3mm ED ø 8mm thickness 0.5mm brass Qty 20 pcs for thread M4 | | |
|  | GEV No. | 550361 | Ref. No. — |
| | blind flange ø 58mm thread 1/2" | | |
|  | GEV No. | 560111 | Ref. No. — |
| | plain washer ID ø 4.3mm ED ø 9mm thickness 0.8mm SS Qty 20 pcs DIN 125A for thread M4 | | |

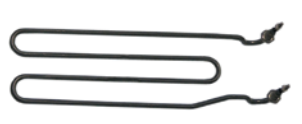









| | | | |
|---|---|-----------------|---------------------------|
|  | | | |
| GEV No. | 415008 | Ref. No. | 230016 |
| description | heating element 2000W 230V heating circuits 1 L 140mm W 173mm H 35mm thread M14x1.5 mounting distance 33mm tube ø 4.2mm 2 hole fixing connection length 15mm immersion heater L1 14mm L2 118mm W1 128mm W2 45mm | | |
| For models: | R495 | | |
| accessories for | 415008 | | |
|  | GEV No. | 510417 | Ref. No. 437002 437024 |
| | flat gasket fibre ED ø 20mm ID ø 14mm thickness 2mm Qty 1 pcs | | |
|  | GEV No. | 520228 | Ref. No. — |
| | tooth lock washer ID ø 15.3mm ED ø 24mm steel Qty 1 pcs for thread M14 | | |
|  | GEV No. | 520230 | Ref. No. — |
| | nut thread M14x1.5 H 5mm WS 19 zinc-coated steel Qty 1 pcs | | |
|  | GEV No. | 521101 | Ref. No. — |
| | nut thread M14x1.5 H 5mm WS 19 SS Qty 1 pcs | | |
|  | GEV No. | 550262 | Ref. No. — |
| | flat gasket copper ED ø 20mm ID ø 14mm thickness 2mm | | |









| | | | |
|---|--|-----------------|----------------------------|
|  | | | |
| 1 | | | |
| GEV No. | 415010 | Ref. No. | 230009 230017 230044 |
| description | heating element 2000W 230V heating circuits 1 L 260mm W 125mm H 20mm L1 110mm L2 150mm W1 42mm W2 83mm thread M10x1 mounting distance 70mm tube ø 6.5mm connection M4 immersion heater 2 hole fixing | | |
| For models: | 11F, 11FD, 11F-DVGW, 11R, 11RD, 21F, 21FD, 21R, 21RD, 22F, 22R, 25F, 25FD, 25R, 25RD, 30F, 30FD, 30R, 30RD, 31F, 31FD, 31R, 31RD, 40F, 440F, 44F, S621, S623, S624, S626, S631, S633, S634, S636 | | |
| accessories for | 415010 | | |
|  | GEV No. | 504306 | Ref. No. — |
| gasket fibre ED ø 16mm ID ø 10mm thickness 2mm Qty 1 pcs | | | |
|  | GEV No. | 510893 | Ref. No. 456015 |
| O-ring EPDM thickness 2.62mm ID ø 9.92mm Qty 1 pcs | | | |
|  | GEV No. | 520231 | Ref. No. — |
| nut thread M10x1 H 6mm WS 14 zinc-coated steel Qty 1 pcs | | | |
|  | GEV No. | 521103 | Ref. No. — |
| nut thread M4 H 3mm WS 7 brass Qty 20 pcs | | | |
|  | GEV No. | 521104 | Ref. No. — |
| washer ID ø 4.3mm ED ø 8mm thickness 0.5mm brass Qty 20 pcs for thread M4 | | | |
|  | GEV No. | 521129 | Ref. No. — |
| nut thread M10 H 6mm SS WS 17 Qty 1 pcs DIN/ISO DIN 439 | | | |
|  | GEV No. | 560111 | Ref. No. — |
| plain washer ID ø 4.3mm ED ø 9mm thickness 0.8mm SS Qty 20 pcs DIN 125A for thread M4 | | | |
|  | GEV No. | 560131 | Ref. No. — |
| hexagonal nut thread M4 H 3.2mm WS 7 SS DIN/ISO DIN 934 / ISO 4032/8673 Qty 20 pcs | | | |

| | | | |
|---|---|-----------------|------------------|
|  | | | |
| 1 | | | |
| GEV No. | 415664 | Ref. No. | 230006 230085 |
| description | heating element 2250W 230V heating circuits 1 L 300mm W 90mm H 25mm thread 1/8" mounting distance 64mm tube ø 6.3mm connection M4 immersion heater 2 hole fixing | | |
| For models: | 11F, 11FD, 11R, 11RD, 31F, 31FD, 31R, 31RD, 67F, 67R, 913363, 913364, 913376, 913377, 913418, 914167, 914168, 914398, 914399, 914443, 914943, 915695, 915696, 915819, E.41, E.42, E.45, E41, Fast145, FAST-145, Fast145D, FAST-145D, NIAGARA-45 | | |
| accessories for | 415664 | | |
|  | GEV No. | 510893 | Ref. No. 456015 |
| O-ring EPDM thickness 2.62mm ID ø 9.92mm Qty 1 pcs | | | |
|  | GEV No. | 521103 | Ref. No. — |
| nut thread M4 H 3mm WS 7 brass Qty 20 pcs | | | |
|  | GEV No. | 521104 | Ref. No. — |
| washer ID ø 4.3mm ED ø 8mm thickness 0.5mm brass Qty 20 pcs for thread M4 | | | |

| | | | |
|---|---------|--------|------------|
| accessories for | 415664 | | |
|  | GEV No. | 521129 | Ref. No. — |
| nut thread M10 H 6mm SS WS 17 Qty 1 pcs DIN/ISO DIN 439 | | | |
|  | GEV No. | 560111 | Ref. No. — |
| plain washer ID ø 4.3mm ED ø 9mm thickness 0.8mm SS Qty 20 pcs DIN 125A for thread M4 | | | |
|  | GEV No. | 560131 | Ref. No. — |
| hexagonal nut thread M4 H 3.2mm WS 7 SS DIN/ISO DIN 934 / ISO 4032/8673 Qty 20 pcs | | | |

| | | | |
|---|---|-----------------|----------------------------|
|  | | | |
| 1 | | | |
| GEV No. | 415665 | Ref. No. | 230060 230061 230086 |
| description | heating element 2750/3250W 220/240V heating circuits 1 L 380mm W 110mm H 30mm thread M10x1 mounting distance 75mm tube ø 6.5mm connection M4 immersion heater 2 hole fixing | | |
| For models: | 050F, 050FP, 10, 12, 14, 22F, 22R, 2312-001, 2312-002, 40F, 440F, 44F, 46, 460, 500F, 500FD, 50F, 50FD, 510F, 510FD, 913297, 913298, 913299, 913300, 913360, 913361, 913391, 913392, 913546, 913547, 913578, 913611, 913684, 913913, 913914, 913932, 913933, 914284, 914318, 914319, 914326, 914331, 914338, 914356, 914400, 914401, 914402, 914403, 914404, 914405...(Other models you can see in the webshop) | | |
| spare parts for | 415665 | | |
|  | GEV No. | 510893 | Ref. No. 456015 |
| O-ring EPDM thickness 2.62mm ID ø 9.92mm Qty 1 pcs | | | |
| accessories for | 415665 | | |
|  | GEV No. | 510416 | Ref. No. 437022 |
| flat gasket fibre ED ø 19mm ID ø 10.5mm thickness 1.5mm for thread M10 Qty 1 pcs | | | |
|  | GEV No. | 520231 | Ref. No. — |
| nut thread M10x1 H 6mm WS 14 zinc-coated steel Qty 1 pcs | | | |
|  | GEV No. | 520876 | Ref. No. 463007 |
| protection cap for heating element ø 11.5mm H 32mm W 25mm plastic | | | |
|  | GEV No. | 521103 | Ref. No. — |
| nut thread M4 H 3mm WS 7 brass Qty 20 pcs | | | |
|  | GEV No. | 521104 | Ref. No. — |
| washer ID ø 4.3mm ED ø 8mm thickness 0.5mm brass Qty 20 pcs for thread M4 | | | |
|  | GEV No. | 521129 | Ref. No. — |
| nut thread M10 H 6mm SS WS 17 Qty 1 pcs DIN/ISO DIN 439 | | | |
|  | GEV No. | 560111 | Ref. No. — |
| plain washer ID ø 4.3mm ED ø 9mm thickness 0.8mm SS Qty 20 pcs DIN 125A for thread M4 | | | |
|  | GEV No. | 560131 | Ref. No. — |
| hexagonal nut thread M4 H 3.2mm WS 7 SS DIN/ISO DIN 934 / ISO 4032/8673 Qty 20 pcs | | | |



| | | | |
|---|---|-----------------|-------------------------|
|  | | | |
| 1 | | | |
| GEV No. | 416235 | Ref. No. | 70562 80360 80677 |
| description | heating element 3000W 230V heating circuits 1 L 320mm W 50mm H 40mm thread M10x1 mounting distance 44mm tube ø 6.3mm connection male faston 6.3mm 2 hole fixing L1 32mm L2 288mm | | |
| For models: | 80, 81, 82, CE78HZ23, CGL74CABT, E78, E78HP, Fast181, Fast181-230V-3Ph-60Hz, Fast181-400V-3NPh-60Hz, HM1, KLP105EB, LP105DDDTEB, LP105DDDTEBN, LP105EB, LP60, NG292HZ, NG381L, NG381LC, NG381LCFUR, NG381LDDPS, NIAGARA-271, Niagara-283A, Niagara-283L-2, Niagara-292-400V-3Ph-60Hz, Niagara-381L, Niagara-381LC, RIVER-282, River-282L-2, River-282LS-2TDE, River-285, River-295P, River-296P, River-382L, River-382L-230V-3Ph-50Hz, River-382LNRG, River-382LTDE, River-482, RIVER-71, RIVER-78, RIVER-80, River-81, River-81CRP, RIVER-81-CRP, RIVER-82, River-82CRP, RIVER-82-CRP, RIVER-E78, RIVER-HL-81, RIVER-HL-82...(Other models you can see in the webshop) | | |
| spare parts for | 416235 | | |
| | GEV No. | 510893 | Ref. No. 456015 |
|  | O-ring EPDM thickness 2.62mm ID ø 9.92mm Qty 1 pcs | | |
| accessories for | 416235 | | |
| | GEV No. | 510416 | Ref. No. 437022 |
|  | flat gasket fibre ED ø 19mm ID ø 10.5mm thickness 1.5mm for thread M10 Qty 1 pcs | | |
| | GEV No. | 510893 | Ref. No. 456015 |
|  | O-ring EPDM thickness 2.62mm ID ø 9.92mm Qty 1 pcs | | |
| | GEV No. | 521129 | Ref. No. — |
|  | nut thread M10 H 6mm SS WS 17 Qty 1 pcs DIN/ISO DIN 439 | | |
| | GEV No. | 560192 | Ref. No. — |
|  | tooth lock washer ID ø 10.4mm ED ø 18mm SS DIN/ISO DIN 6798A Qty 1 pcs for thread M10 | | |

| | | | |
|---|---|-----------------|------------------|
|  | | | |
| 1 | | | |
| GEV No. | 420334 | Ref. No. | 41211 C.41211 |
| description | heating element 3000W 230V heating circuits 1 L 380mm W 87mm H 26mm thread M10x1 mounting distance 81mm tube ø 6.3mm connection M4 immersion heater 2 hole fixing | | |
| For models: | U61, U61E, U61H, U61HE | | |

foil heating elements

| | | | |
|--|--|-----------------|-----------|
|  | | | |
| 1 | | | |
| GEV No. | 416236 | Ref. No. | 230080.AG |
| description | foil heating element L 130mm W 84mm 130W 230V t.max. 175°C without temperature limiter silicone cable length 200mm thickness 1mm | | |
| For models: | CLEAN-3, RIVER-43 | | |

accessories

| | | | |
|--|--|-----------------|--------|
| various | | | |
|  | | | |
| Image not available | | | |
| 1 | | | |
| GEV No. | 550057 | Ref. No. | 999006 |
| description | screw connection set for heating element | | |
| For models: | 404, 406, 412 | | |

sealing washers

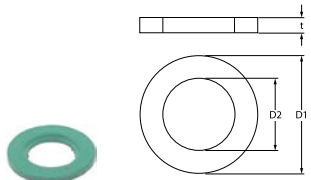
| | | | |
|--|--|-----------------|--------|
| fibre gaskets | | | |
|  | | | |
| 1 | | | |
| GEV No. | 510416 | Ref. No. | 437022 |
| description | flat gasket fibre ED ø 19mm ID ø 10.5mm thickness 1.5mm for thread M10 Qty 1 pcs | | |
| For models: | S621, S623, S624, S626, S631, S633, S634, S636 | | |

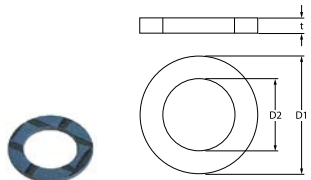
| | | | |
|--|--|-----------------|------------------|
|  | | | |
| 1 | | | |
| GEV No. | 510417 | Ref. No. | 437002 437024 |
| description | flat gasket fibre ED ø 20mm ID ø 14mm thickness 2mm Qty 1 pcs | | |
| For models: | 11F, 11FD, 11F-DVGW, 11R, 11RD, 12, 14, 21F, 21FD, 21R, 21RD, 22F, 22R, 25F, 25FD, 25R, 25RD, 30F, 30FD, 30R, 30RD, 31F, 31FD, 31R, 31RD, 40F, 440F, 44F, 450, 46, 460, 500F, 500FD, 50F, 50FD, 510F, 510FD, CLEAN-100, CLEAN-110, CLEAN-120, E.45, E.46, E.50, E.51, E.52, E1, E10, E100, E110, E12...(Other models you can see in the webshop) | | |

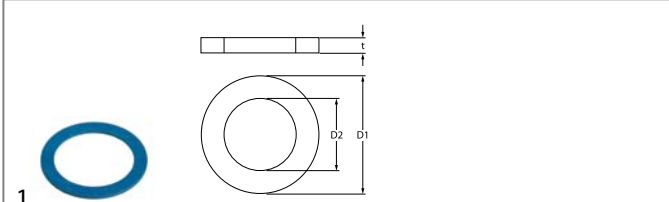

| | | | |
|--------------------|---|-----------------|--------|
| GEV No. | 510405 | Ref. No. | 437028 |
| description | flat gasket fibre ED ϕ 56mm ID ϕ 42mm thickness 2mm for thread 1 1/4" Qty 1 pcs | | |
| For models: | R497, R499, R501, R503, R505, R507, R509, R511, R704, S641, S643 | | |

O-rings

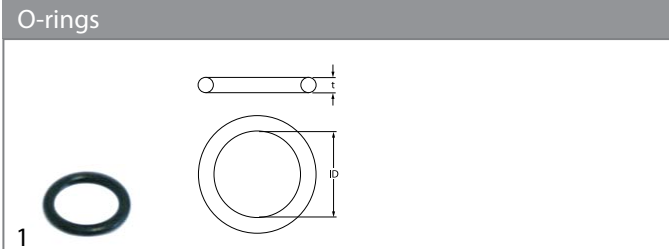

| | | | |
|--------------------|--|-----------------|--------|
| GEV No. | 510893 | Ref. No. | 456015 |
| description | O-ring EPDM thickness 2.62mm ID ϕ 9.92mm Qty 1 pcs | | |
| For models: | 050F, 050FP, 2312-001, 2312-002, 31F, 31FD, 31R, 31RD, 500F, 500FD, 50F, 50FD, 510F, 510FD, 67F, 67R, 913297, 913298, 913299, 913300, 913360, 913361, 913363, 913364, 913376, 913377, 913391, 913392, 913418, 913546, 913547, 913578, 913611, 913684, 913913, 913914, 913932, 913933, 914167, 914168, 914284, 914318, 914319, 914326, 914331, 914338, 914356, 914398, 914399, 914400...(Other models you can see in the webshop) | | |

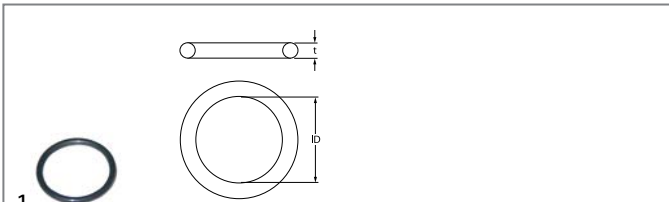

| | | | |
|--------------------|--|-----------------|--------|
| GEV No. | 510072 | Ref. No. | 456016 |
| description | O-ring EPDM thickness 3.53mm ID ϕ 32.93mm Qty 1 pcs | | |
| For models: | 050F, 050FP, 10, 11F, 11FD, 11F-DVGW, 11R, 11RD, 21F, 21FD, 21R, 21RD, 22F, 22R, 25F, 25FD, 25R, 25RD, 30F, 30FD, 30R, 30RD, 31F, 31FD, 31R, 31RD, 350F, 350FD, 350R, 350RD, 35-ELECTRONIC, 35F, 35FD, 35R, 35RD, 400F, 400FD, 400R, 400RD, 40-ELECTRONIC, 40F, 40FD, 40R, 40RD, 440F, 44F, 45, 450, 46, 460...(Other models you can see in the webshop) | | |

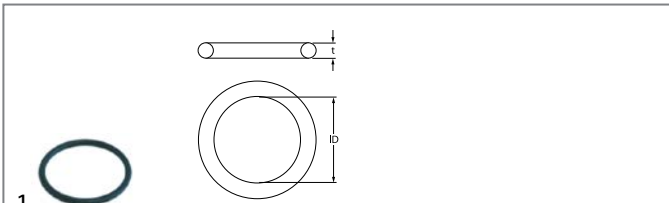

| | | | |
|--------------------|--|-----------------|--------|
| GEV No. | 521120 | Ref. No. | 456075 |
| description | O-ring EPDM thickness 5.34mm ID ϕ 37.47mm Qty 1 pcs | | |
| For models: | 913289, 913290, 913291, 913292, 913356, 913357, 913363, 913364, 913372, 913373, 913374, 913375, 913376, 913377, 913416, 913418, 913435, 913544, 913545, 913665, 913666, 913667, 913668, 913685, 913771, 913772, 913773, 913774, 913832, 913837, 913911, 913912, 913948, 913950, 913977, 913984, 913990, 914165, 914166, 914167, 914168, 914206, 914214, 914316, 914317, 914355, 914386, 914387, 914388, 914389...(Other models you can see in the webshop) | | |

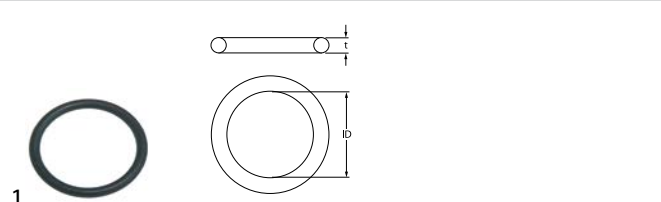

| | | | |
|--------------------|--|-----------------|------------------|
| GEV No. | 510408 | Ref. No. | 456002 456079 |
| description | O-ring EPDM thickness 5.34mm ID ϕ 47mm Qty 1 pcs | | |
| For models: | 10, 12, 14, 21F, 21FD, 21R, 21RD, 22F, 22R, 25F, 25FD, 25R, 25RD, 30F, 30FD, 30R, 30RD, 31F, 31FD, 31R, 31RD, 40F, 440F, 44F, 50F, 50FD, 510F, 510FD, 66, 80, 81, 82, 913297, 913298, 913299, 913300, 913360, 913361, 913391, 913392, 913546, 913547, 913578, 913611, 913684, 913913, 913914, 913932, 913933, 913992...(Other models you can see in the webshop) | | |

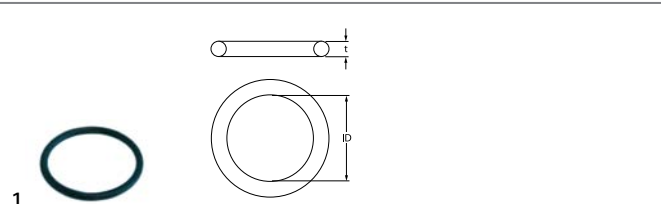

| | | | |
|--------------------|---|-----------------|--------|
| GEV No. | 510409 | Ref. No. | 929046 |
| description | O-ring EPDM thickness 5.34mm ID ϕ 56.52mm Qty 1 pcs | | |
| For models: | 161, 221, 271, 272, 362, 55, CLEAN-160, CLEAN-161, CLEAN-220, CLEAN-221, CLEAN-270, CLEAN-271, CLEAN-272, CLEAN-361, CLEAN-361P, CLEAN-362, CLEAN-471, CLEAN-471P | | |

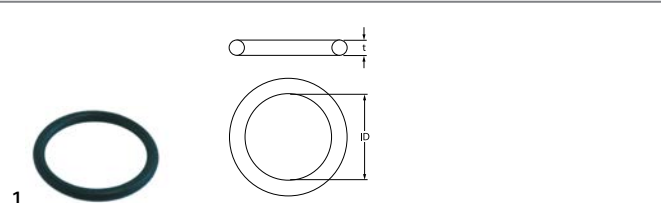

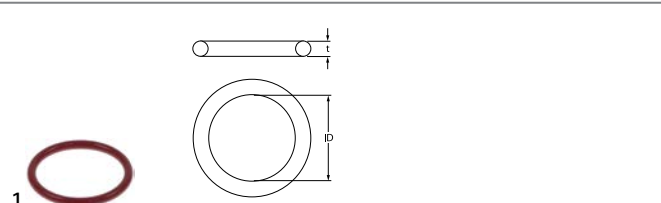

| | | | |
|--------------------|--|-----------------|--------|
| GEV No. | 510410 | Ref. No. | 456008 |
| description | O-ring EPDM thickness 5.34mm ID ϕ 75.57mm Qty 1 pcs | | |
| For models: | 66, S651, S651P, S653, S654, S655, S810, S815, S830, S835, S850, SR651 | | |





| | | | |
|--------------------|--|-----------------|--------|
| GEV No. | 514017 | Ref. No. | 927010 |
| description | O-ring silicone thickness 3.53mm ID ϕ 32.93mm Qty 1 pcs | | |
| For models: | CLEAN-160, CLEAN-220, CLEAN-270, CLEAN-271, CLEAN-361, CLEAN-361P, CLEAN-471, CLEAN-471P | | |





| flange gaskets | | | |
|---|--|-----------------|--------|
|  | | | |
| 1 | | | |
| GEV No. | 510387 | Ref. No. | 437086 |
| description | gasket L 46mm W 22mm ømm EPDM for heating element for flange 50x26mm | | |
| For models: | 913289, 913290, 913291, 913292, 913356, 913357, 913372, 913373, 913374, 913375, 913416, 913435, 913544, 913545, 913665, 913666, 913667, 913668, 913685, 913771, 913772, 913773, 913774, 913832, 913837, 913911, 913912, 913948, 913950, 913977, 913984, 913990, 913992, 913993, 914165, 914166, 914206, 914214, 914316, 914317, 914355, 914386, 914387, 914388, 914389, 914390, 914391, 914392, 914393, 914394...(Other models you can see in the webshop) | | |
| accessories for | 510387 | | |
| |  | GEV No. | 510388 |
| | | Ref. No. | — |
| | counterflange ømm hole distancemm perforation ømm L 43mm W 21mm SS for heating element for flange 50x26mm | | |

| | | | |
|---|--|-----------------|--------|
|  | | | |
| 1 | | | |
| GEV No. | 521128 | Ref. No. | 437048 |
| description | gasket L 66mm W 21mm ømm for heating element suitable for ELETTROBAR, WOLK | | |
| For models: | 050F, 050FP, 11F, 11FD, 11F-DVGW, 11R, 11RD, 2312-001, 2312-002, 350F, 350FD, 350R, 350RD, 35-ELECTRONIC, 35F, 35FD, 35R, 35RD, 400F, 400FD, 400R, 400RD, 40-ELECTRONIC, 40F, 40FD, 40R, 40RD, 46, 460, 500F, 500FD, 50-ELECTRONIC, 50F, 50FD, 510F, 510FD, 67F, 67R, 913297, 913298, 913299, 913300, 913360, 913361, 913391, 913392, 913546, 913547, 913578, 913611...(Other models you can see in the webshop) | | |

| protection caps | | | |
|---|--|-----------------|--------|
|  | | | |
| 1 | | | |
| GEV No. | 510084 | Ref. No. | 467001 |
| description | protection cap | | |
| For models: | 66, S651, S651P, S653, S654, S655, S810, S815, S830, S835, S850, SR651 | | |

| | | | |
|---|---|-----------------|-----------------|
|  | | | |
| 1 | | | |
| GEV No. | 510093 | Ref. No. | 467002 69870 |
| description | protection cap | | |
| For models: | 10, 12, 14, 21F, 21FD, 21R, 21RD, 22F, 22R, 25F, 25FD, 25R, 25RD, 30F, 30FD, 30R, 30RD, 31F, 31FD, 31R, 31RD, 40F, 440F, 44F, 510F, 510FD, 66, 913297, 913298, 913299, 913300, 913360, 913361, 913391, 913392, 913546, 913547, 913578, 913611, 913684, 913913, 913914, 913932, 913933, 913992, 913993, 914284, 914318, 914319, 914326...(Other models you can see in the webshop) | | |



| | | | |
|---|--|-----------------|--------|
|  | | | |
| 1 | | | |
| GEV No. | 510094 | Ref. No. | 415001 |
| description | protection cap | | |
| For models: | R509, R511, R704, R706, R708, S641, S643, S870 | | |

| | | | |
|---|---|-----------------|--------|
|  | | | |
| 1 | | | |
| GEV No. | 520876 | Ref. No. | 463007 |
| description | protection cap for heating element ø 11.5mm H 32mm W 25mm plastic | | |
| For models: | 050F, 050FP, 10, 11F, 11FD, 11F-DVGW, 11R, 11RD, 12, 14, 22F, 22R, 2312-001, 2312-002, 31F, 31FD, 31R, 31RD, 350F, 350FD, 350R, 350RD, 35-ELECTRONIC, 35F, 35FD, 35R, 35RD, 400F, 400FD, 400R, 400RD, 40-ELECTRONIC, 40F, 40FD, 40R, 40RD, 440F, 44F, 45, 450, 46, 460, 500F, 500FD, 50-ELECTRONIC, 50F, 50FD, 510F, 510FD, 67F...(Other models you can see in the webshop) | | |

thermostats

bi-metal thermostats

safety bi-metal thermostats

| | | | |
|--|--|-----------------|------------------|
|  | | | |
| 1 | | | |
| GEV No. | 390233 | Ref. No. | 236039 926189 |
| description | bi-metal safety thermostat hole distance 24mm switch-off temp. 110°C 1NC 1-pole 16A connection F6.3 2 hole fixing without holder | | |
| For models: | 050F, 050FP, 10, 11F, 11FD, 11R, 11RD, 12, 14, 22F, 2312-001, 2312-002, 2312-007, 31F, 31FD, 31R, 31RD, 350F, 350FD, 350R, 350RD, 35F, 35FD, 35R, 35RD, 400F, 400FD, 400R, 400RD, 40F, 40FD, 40R, 40RD, 440F, 44F, 45, 450, 46, 460, 500F, 500FD, 50F, 50FD, 510F, 510FD, 80, 81, 82, 913289, 913290...(Other models you can see in the webshop) | | |
| accessories for | 390233 | | |
| |  | GEV No. | 504736 |
| | | Ref. No. | — |
| | bracket for contact thermostat | | |
| |  | GEV No. | 550388 |
| | | Ref. No. | 431006 |
| | bracket for contact thermostat mounting distance 24.5mm mounting ø 3.8 | | |

| | | | |
|---|---|-----------------|--------|
|  | | | |
| 1 | | | |
| GEV No. | 390459 | Ref. No. | 236053 |
| description | bi-metal safety thermostat hole distancemm switch-off temp. 200°C 1NC 1-pole 16A connection F6.3 M4 | | |
| For models: | 2312-007, 2312-009-CRP, 67F, 67R, 914100, 914101, 914339, 914342, 914343, 914624, 914625, 914626, 914627, 914628, 914850, 914851, 914854, 914944, E.35, PS-60, RIVER-48, RIVER-50, RIVER-50-CRP, RIVER-50-CRP-SP, RIVER-54, RIVER-54CRP, River-54-CRP-s.p., RIVER-54-CRP-SP, RIVER-61 | | |





| | | | |
|---|--|-----------------|--------|
|  | | | |
| 1 | | | |
| GEV No. | 390318 | Ref. No. | 236047 |
| description | bi-metal safety thermostat switch-off temp. 95°C 1-pole 2 hole fixing | | |
| For models: | 2312-009-CRP, 913289, 913290, 913291, 913292, 913356, 913357, 913363, 913364, 913372, 913373, 913374, 913375, 913376, 913377, 913416, 913435, 913544, 913545, 913665, 913666, 913667, 913668, 913685, 913771, 913772, 913773, 913774, 913832, 913837, 913911, 913912, 913913, 913948, 913950, 913977, 913984, 913990, 913992, 913993, 914165, 914166, 914206, 914214, 914284, 914316, 914317, 914355, 914386, 914387...(Other models you can see in the webshop) | | |

bi-metal thermostats

| | | | |
|---|--|-----------------|--------|
|  | | | |
| 1 | | | |
| GEV No. | 390301 | Ref. No. | 236035 |
| description | bi-metal thermostat hole distance 23.8mm switch-off temp. 60°C 1NC 1-pole 16A connection F6.3 2 hole fixing | | |
| For models: | 350F, 350FD, 350R, 350RD, 400F, 400FD, 400R, 400RD, 913289, 913290, 913291, 913292, 913356, 913357, 913363, 913364, 913372, 913373, 913374, 913375, 913376, 913377, 913416, 913435, 913544, 913545, 913665, 913666, 913667, 913668, 913685, 913771, 913772, 913773, 913774, 913832, 913837, 913948, 914386, 914387, 914388, 914389, 914390, 914391, 914392, 914393, 914394, 914395, 914396, 914397...(Other models you can see in the webshop) | | |

| | | | |
|---|--|-----------------|--------|
|  | | | |
| 1 | | | |
| GEV No. | 390319 | Ref. No. | 236048 |
| description | bi-metal thermostat hole distance 23.8mm switch-off temp. 80°C 1NC 1-pole 16A connection F6.3 2 hole fixing | | |
| For models: | 913289, 913290, 913291, 913292, 913356, 913357, 913372, 913373, 913374, 913375, 913416, 913435, 913544, 913545, 913665, 913666, 913667, 913668, 913685, 913771, 913772, 913773, 913774, 913832, 913837, 913948, 914386, 914387, 914388, 914389, 914390, 914391, 914392, 914393, 914394, 914395, 914396, 914397, 914441, 914442, 914515, 914537, 914547, 914683, 914689, 914692, 914693, 914694, 914703, 914863...(Other models you can see in the webshop) | | |

| | | | |
|---|--|-----------------|--------|
|  | | | |
| 1 | | | |
| GEV No. | 390504 | Ref. No. | 236052 |
| description | bi-metal thermostat hole distance 23.8mm switch-off temp. 90°C 1NO 1-pole 16A 250V connection F6.3 2 hole fixing probe ø 16mm | | |
| For models: | 915150, 915151, 915152, 915154, 915155, 915160, 915161, 915162, 915166, 915167, 915168, 915172, 915173, 915175, 915319, 915348, 915418, 915419, 915420, 915421, 915422, 915479, 915492, 915493, 915496, 915497, 915547, 915558, 915635, 915663, 915747, 916020, 916021, 916024, 916025, 916026, 916027, 916030, 916031, 916045, 916054, 916068, 916069, 916080, 916201, 916202, 916203, 916204, 916205, 916206...(Other models you can see in the webshop) | | |

| | | | |
|---|---|-----------------|--------|
|  | | | |
| 1 | | | |
| GEV No. | 390129 | Ref. No. | 236056 |
| description | bi-metal thermostat hole distance mm switch-off temp. 125°C 1NC 1-pole 16A connection F6.3 M4 | | |
| For models: | 2312-007, 914100, 914101, 914339, 914342, 914343, 914624, 914625, 914626, 914627, 914628, 914850, 914851, 914854, 914944, PS-60, RIVER-48, RIVER-54, RIVER-54CRP, River-54-CRP-s.p. | | |

control and safety thermostats

EGO

control thermostats

51._ series

| | | | |
|--|---|-----------------|--------|
|  | | | |
| 1 | | | |
| GEV No. | 390306 | Ref. No. | 236022 |
| description | thermostat t.max. 85°C temperature range fixed 85°C 1-pole gland nut | | |
| For models: | 11F, 11FD, 11F-DVGW, 11R, 11RD, 21F, 21FD, 21R, 21RD, 22F, 22R, 25F, 25FD, 25R, 25RD, 30F, 30FD, 30R, 30RD, 31F, 31FD, 31R, 31RD, 350F, 350FD, 350R, 350RD, 500F, 500FD, 66 | | |

55.10/19_ series

| | | | |
|--|---|-----------------|----------------------------|
|  | | | |
| 1 | | | |
| GEV No. | 390003 | Ref. No. | 236002 236007 236008 |
| description | thermostat t.max. 90°C temperature range 30-90°C 1-pole 1CO 16A probe ø 15mm probe L 22.5mm capillary pipe 1700mm capillary pipe isolatedmm gland nut shaft ø 6x4.6mm shaft L 16mm shaft position upper° shaft position rotation 270° with knob probe | | |
| For models: | R495, R497, R499, R708, S641, S643 | | |
| accessories for | 390003 | | |
|  | GEV No. | 510165 | Ref. No. — |
| gasket for thermostat ED ø 27mm ID ø 11mm thickness 8.5mm | | | |



55.13_series



| | | | |
|--------------------|--|-----------------|--------------------------------------|
| GEV No. | 375006 | Ref. No. | 236004 236027 236041 236046 |
| description | thermostat t.max. 85°C temperature range 30-85°C 1-pole 1CO 16A probe ø 6mm probe L 92mm capillary pipe 3150mm capillary pipe isolated 300mm gland nut shaft L 23mm shaft position upper rotation 270° probe material SS | | |
| For models: | 10, 11F, 11FD, 11R, 11RD, 12, 14, 350F, 350FD, 350R, 350RD, 400F, 400FD, 400R, 400RD, 500F, 500FD, CLEAN-3, S621, S623, S624, S626, S631, S633, S634, S636, S651, S651P, S653, S654, S655, S810, S815, S830, S835, S850, S870, S950, SR651 | | |

55.14_series



| | | | |
|--------------------|--|-----------------|--------|
| GEV No. | 390316 | Ref. No. | 236024 |
| description | thermostat t.max. 53°C temperature range fixed 53°C 1-pole 1NC 16A probe ø 6mm probe L 116mm capillary pipe 600mm capillary pipe isolated 600mm gland nut shaft Lmm shaft position° shaft position | | |
| For models: | 350F, 350FD, 350R, 350RD, 400F, 400FD, 400R, 400RD, 66 | | |

55.17_series



| | | | |
|--------------------|---|-----------------|--------|
| GEV No. | 375672 | Ref. No. | 927312 |
| description | thermostat t.max. 320°C temperature range 50-320°C 1-pole 1NO 16A probe ø 3.03mm probe L 178mm capillary pipe 840mm capillary pipe isolatedmm gland nut shaft ø 6x4.6mm shaft L 23mm shaft position upper rotation 270° | | |

safety thermostats

55.10/19_series



| | | | |
|--------------------|---|-----------------|--------|
| GEV No. | 375200 | Ref. No. | 236029 |
| description | safety thermostat capillary pipe 900mm probe ø 6mm 1-pole probe L 130mm 0.5A capillary pipe isolatedmm gland nut switch-off temp. 235°C probe | | |

55.32_series



| | | | |
|--------------------|---|-----------------|--------|
| GEV No. | 375139 | Ref. No. | 236032 |
| description | safety thermostat switch-off temp. 108°C 3-pole 20A probe ø 3mm probe L 190mm capillary pipe 600mm capillary pipe isolated 600mm gland nut probe SS | | |
| For models: | 40F | | |

56._series



| | | | |
|--------------------|---|-----------------|--------|
| GEV No. | 390851 | Ref. No. | 236015 |
| description | safety thermostat set switch-off temp. 225°C 1-pole NC 0.5A probe ø 6mm probe L 80mm capillary pipe 900mm capillary pipe isolated 450mm gland nut M10x1 | | |



IMIT / TEMPOMATIC / ARTHERMO

control thermostats



| | | | |
|--------------------|---|-----------------|--------|
| GEV No. | 390314 | Ref. No. | 929106 |
| description | thermostat t.max. 60°C temperature range fixed 60°C-pole 1CO 15A probe ø 6.5mm probe L 95mm capillary pipe 2000mm capillary pipe isolated 1950mm gland nut shaft ømm shaft Lmm shaft position rotation° probe material copper | | |
| For models: | 55, CLEAN-161, CLEAN-221, CLEAN-271, CLEAN-272, CLEAN-362, U132, U70 | | |



| | | | |
|--------------------|--|-----------------|--------|
| GEV No. | 390421 | Ref. No. | 929107 |
| description | thermostat t.max. 85°C temperature range 0-90°C 1-pole 1CO 16A probe ø 6.5mm probe L 95mm capillary pipe 1500mm capillary pipe isolated 1450mm gland nut shaft ømm shaft Lmm shaft position rotation 270° probe material copper | | |
| For models: | 161, 221, 271, 272, 362, 55, CE78HZ23, CLEAN-160, CLEAN-161, CLEAN-220, CLEAN-221, CLEAN-270, CLEAN-271, CLEAN-272, CLEAN-361, CLEAN-361P, CLEAN-362, CLEAN-471, CLEAN-471P, E.60, E.65, E1, E10, E100, E110, E12, E120, E14, E140, E78, E78HP, GL280EB-23DAR, GL280EBDARY, GL280EBDAW, GL280EBDAY, GL280EBDB, GL280EBDBR, GL280EBSA, GL280EBSAE, GL280EBSAEW, GL280EBSAEWY, GL280EBSAR, GL280EBSARY, GL280EBSAW, GL280EBSAWY, GL280EBSAY, GL280EBSB, GL282EB93DA, GL282EBDA, GL282EB-DARW...(Other models you can see in the webshop) | | |



| | | | |
|------------------------|---|-----------------|----------------------------------|
| GEV No. | 390005 | Ref. No. | 236003 236014 926196 |
| description | thermostat t.max. 85°C temperature range 25-85°C 1-pole 1CO 15A probe ø 11mm probe L 35mm capillary pipe 600mm capillary pipe isolated 600mm gland nut shaft ø 6x4.6mm shaft L 8mm shaft position upper° rotation 270° screw-in probe | | |
| For models: | 11F, 11FD, 11R, 11RD, E.60, E.65, E1, E10, E100, E110, E12, E120, E14, E140, E78, RIVER-78, RIVER-E78, S621, S623, S624, S626, S631, S633, S634, S636, U61, U61H | | |
| accessories for | 390005 | | |
| | GEV No. | 510417 | Ref. No. 437002 437024 |
| | flat gasket fibre ED ø 20mm ID ø 14mm thickness 2mm Qty 1 pcs | | |
| | GEV No. | 550261 | Ref. No. — |
| | nut thread M14x1 H 4mm WS 19 SS Qty 1 pcs | | |

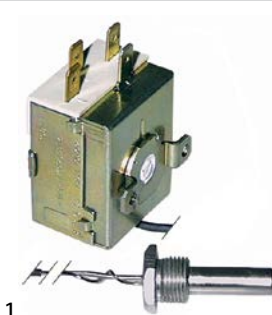

| | | | |
|------------------------|--|-----------------|------------------------|
| GEV No. | 390310 | Ref. No. | 236028 |
| description | thermostat t.max. 85°C temperature range fixed 55°C 1-pole 1CO 16A probe ø 9.5mm probe L 37mm capillary pipe 600mm capillary pipe isolated 540mm gland nut shaft ømm shaft Lmm shaft position rotation° screw-in probe probe thread 3/8" probe material SS | | |
| For models: | 500F, 500FD | | |
| accessories for | 390310 | | |
| | GEV No. | 506024 | Ref. No. — |
| | nut thread 3/8" H 6mm SS WS 22 Qty 1 pcs | | |
| | GEV No. | 529349 | Ref. No. 437030 |
| | flat gasket FIBER ED ø 22mm ID ø 16.5mm thickness 2mm for thread 3/8" Qty 1 pcs | | |



| | | | |
|------------------------|---|-----------------|----------------------------------|
| GEV No. | 390425 | Ref. No. | 926259 DRT141C |
| description | thermostat t.max. 85°C temperature range fixed 60°C 1-pole 1CO 16A probe ø 9.5mm probe L 37mm capillary pipe 600mm capillary pipe isolated 600mm gland nut shaft ømm shaft Lmm shaft position rotation° screw-in probe probe thread M14x1 probe material SS | | |
| For models: | E78 | | |
| accessories for | 390425 | | |
| | GEV No. | 510417 | Ref. No. 437002 437024 |
| | flat gasket fibre ED ø 20mm ID ø 14mm thickness 2mm Qty 1 pcs | | |
| | GEV No. | 511472 | Ref. No. — |
| | nut thread 3/8" H 4mm brass WS 21 Qty 1 pcs | | |

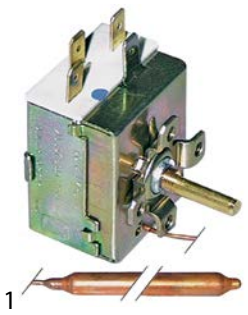

| | | | |
|---|--|-----------------|------------------------|
|  | | | |
| GEV No. | 390006 | Ref. No. | 929044 DRT13L |
| description | thermostat t.max. 86°C temperature range 0-86°C 1-pole 1CO 16A probe ø 6.5mm probe L 95mm capillary pipe 1500mm capillary pipe isolatedmm gland nut shaft ø 6x4.6mm shaft L 19mm rotation 270° | | |
| For models: | 161, 221, 271, 272, 362, CLEAN-160, CLEAN-161, CLEAN-220, CLEAN-221, CLEAN-270, CLEAN-271, CLEAN-272, CLEAN-361, CLEAN-361P, CLEAN-362, CLEAN-471, CLEAN-471P, RIVER-150 | | |
| accessories for | 390006 | | |
|  | GEV No. | 110100 | Ref. No. 929042 |
| | knob thermostat t.max. 90°C 0-90°C ø 42mm shaft ø 6x4.6mm shaft flat -135° black | | |
|  | GEV No. | 110105 | Ref. No. — |
| | rosette knob ø 42mm ø 56mm zero mark | | |

control thermostats with operation switch

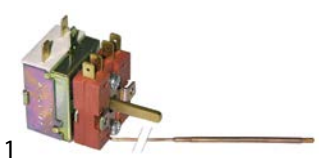

| | | | |
|--|--|-----------------|------------------|
|  | | | |
| GEV No. | 390139 | Ref. No. | 921014 921046 |
| description | thermostat t.max. 270°C temperature range 63-270°C 1-pole 1CO 15A probe ø 3.5mm probe L 195mm capillary pipe 1000mm capillary pipe isolatedmm gland nut shaft ø 6x4.6mm shaft L 17mm shaft position upper° rotation 270° | | |
| For models: | 433, 434, 436, 437, 438, 439, G33, G34, G35, G36, G37, G38, G39, GV45L, GV45R, GV62L, GV62R | | |

safety thermostats

| | | | |
|---|--|-----------------|--------|
|  | | | |
| GEV No. | 390770 | Ref. No. | 927057 |
| description | safety thermostat switch-off temp. 90-110°C 1-pole 1CO 16/0.5A probe ø 6.5mm probe L 90mm capillary pipe 2000mm capillary pipe isolated 1950mm gland nut probe | | |
| For models: | 161, 221, 271, 272, 362, 914380, 914436, A3EB, A3EBD, A3EBDAKRYK, A3EBDAKWK, A3EBDBKWK, A3EBDRKYK, A3EBDWK, A3EBDYK, A3EBS-AK, A3EBSAKRK, A3EBSAKWK, A3EBSBKWKYK, A3EBSEKWK, A3EBS-WK, A4EB, A4EBD, A4EBDAKEYK, A4EBDAKWK, A4EBDAKWK, A4EB-DKZK, A4EBDBKWK, A4EBDPKWKYK, A4EBDRK, A4EBS, A4EBSAK, A4EBSAKCK, A4EBSAKKEYK, A4EBSAKRK, A4EBSAKRKP, A4EBSAKYK, A4EBSCK, A4EBT, A4EBTSAK, A5EB, A5EBD, A5EBDAKPKWK, A5EBDAK-WK, A5EBDAKYK, A5EBDRK, A5EBS, A5EBSAKPKWK, A5EBSAKRK, A5EBSAKRKYK...(Other models you can see in the webshop) | | |

CAEM

control thermostats

| | | | |
|---|---|-----------------|----------------------------------|
|  | | | |
| GEV No. | 390672 | Ref. No. | 236023 236042 |
| description | thermostat t.max. 53°C temperature range fixed 53°C 1-pole 1CO 16A probe ø 9.5mm probe L 30mm capillary pipe 600mm capillary pipe isolated 540mm gland nut shaft Lmm screw-in probe probe thread M14x1 | | |
| For models: | 2312-001, 2312-002, 31F, 31FD, 31R, 31RD, 440F, 450, 460, 500F, 500FD, 50F, 50FD, 510F, 510FD, 67F, 67R, 913297, 913298, 913299, 913300, 913360, 913361, 913391, 913392, 913418, 913546, 913547, 913578, 913611, 913684, 913932, 913933, 914326, 914331, 914398, 914399, 914400, 914401, 914402, 914403, 914404, 914405, 914406, 914443, 914449, 914517, 914545, 914568, 914688...(Other models you can see in the webshop) | | |
| spare parts for | 390672 | | |
|  | GEV No. | 510417 | Ref. No. 437002 437024 |
| | flat gasket fibre ED ø 20mm ID ø 14mm thickness 2mm Qty 1 pcs | | |
|  | GEV No. | 550261 | Ref. No. — |
| | nut thread M14x1 H 4mm WS 19 SS Qty 1 pcs | | |

| | | | |
|--|--|-----------------|--------|
|  | | | |
| GEV No. | 390686 | Ref. No. | 236043 |
| description | thermostat t.max. 83°C temperature range°C 1-pole 1CO 20A probe ø 6mm probe L 90mm capillary pipe 630mm capillary pipe isolated 550mm gland nut shaft ømm shaft Lmm shaft position rotation 270° probe material copper | | |
| For models: | 2312-001, 2312-002, 31F, 31FD, 31R, 31RD, 350F, 350FD, 350R, 350RD, 400F, 400FD, 400R, 400RD, 440F, 450, 460, 50F, 50FD, 510F, 510FD, 67F, 67R, 913297, 913298, 913299, 913300, 913360, 913361, 913363, 913364, 913376, 913377, 913391, 913392, 913418, 913546, 913547, 913578, 913611, 913684, 913932, 913933, 914326, 914331, 914398, 914399, 914400, 914401, 914402...(Other models you can see in the webshop) | | |

TECASA

safety thermostats



| | | | |
|--------------------|---|-----------------|------------------|
| GEV No. | 390028 | Ref. No. | 236034 236045 |
| description | safety thermostat switch-off temp. 230°C 1-pole 16A probe ø 3mm probe L 155mm capillary pipe 890mm capillary pipe isolated 600mm gland nut probe SS | | |
| For models: | FRI12, FRI12+12, FRI15, FRI15M, FRI6, FRI6+6, FRI9, FRI9+9, ME15, ME20, ME30, ME40 | | |

PRODIGY / FIRT

safety thermostats



| | | | |
|--------------------|---|-----------------|-----------------|
| GEV No. | 375478 | Ref. No. | 927106 DRT25 |
| description | safety thermostat switch-off temp. 200°C temperature range°C 1-pole 1CO 20A probe ø 3.3mm probe L 190mm capillary pipe 2150mm capillary pipe isolatedmm gland nut probe SS | | |
| For models: | 161, 221, 271, 272, 362, A3EBDAKRKYK, A3EBSAKRK, A4EBDAKEKYK, A4EBDAKRK, A4EBDAKWK, A4EBDAKZK, A4EBDBKRK, A4EBSAK, A4EBSAKCK, A4EBSAKEKYK, A4EBSAKRKP, A4EBTSAK, A5EBDAKYK, A5EBSAKRK, A5EBSAKRKYK, A5EBSAKWK, A5EBSAKWKYK, A5EBSBKRKPK, A5EBSBKWK, CLEAN-160, CLEAN-161, CLEAN-220, CLEAN-221, CLEAN-270, CLEAN-271, CLEAN-272, CLEAN-361, CLEAN-361P, CLEAN-362, CLEAN-471, CLEAN-471P, GL280EB23DAR, GL280EBDARY, GL280EBDAW, GL280EBDAY, GL280EBDB, GL280EBDBR, GL280EB-SA, GL280EBSAE, GL280EBSAEW, GL280EBSAEWY, GL280EBSAR, GL280EBSARY, GL280EBSAW, GL280EBSAWY...(Other models you can see in the webshop) | | |

accessories

fitting parts



| | | | |
|--------------------|---|-----------------|--------|
| GEV No. | 550388 | Ref. No. | 431006 |
| description | bracket for contact thermostat mounting distance 24.5mm mounting ø 3.8 | | |
| For models: | 10, 11F, 11FD, 11R, 11RD, 12, 14, 22F, 31F, 31FD, 31R, 31RD, 350F, 350FD, 350R, 350RD, 35F, 35FD, 35R, 35RD, 400F, 400FD, 400R, 400RD, 40F, 40FD, 40R, 40RD, 440F, 44F, 45, 450, 46, 460, 500F, 500FD, 50F, 50FD, 510F, 510FD, CLEAN-100, CLEAN-110, CLEAN-120, CLEAN-3, E.35, E.40, E.41, E.42, E.45, E.46...(Other models you can see in the webshop) | | |

plunger sockets



| | | | |
|--------------------|--|-----------------|-----------------|
| GEV No. | 513031 | Ref. No. | 929038 DZP22 |
| description | thermowell L 125mm SS single | | |
| For models: | 55, A3EB, A3EBD, A3EBDAKRKYK, A3EBDAKWK, A3EBDBKWK, A3EBDRKYK, A3EBDVK, A3EBDYK, A3EBSAK, A3EBSAKRK, A3EBSAKWK, A3EBSBKWKYK, A3EBSEKWK, A3EBSWK, A4EB, A4EBD, A4EBDAKEKYK, A4EBDAKRK, A4EBDAKWK, A4EBDAKZK, A4EBDBKRK, A4EBDPKWKYK, A4EBDRK, A4EBS, A4EBSAK, A4EBSAKCK, A4EBSAKEKYK, A4EBSAKRK, A4EBSAKRKP, A4EBSAKYK, A4EBSCK, A4EBT, A4EBTSAK, A5EB, A5EBD, A5EBDAKPKWK, A5EBDAKWK, A5EBDAKYK, A5EBDRK, A5EBS, A5EBSAKPKWK, A5EBSAKRK, A5EBSAKRKYK, A5EBSAKWK, A5EBSAKWKYK, A5EBSBKRKPK, A5EBSBKWK, A5EBSRK, A5EBSYK...(Other models you can see in the webshop) | | |



| | | | |
|--------------------|---|-----------------|--------|
| GEV No. | 550995 | Ref. No. | 999160 |
| description | thermowell thread M14x1 ID ø 5mm L 40mm SS ø 9mm | | |
| For models: | 050F, 050FP, 913913, 913914, 914167, 914168, 914284, 914318, 914319, 914338, 914356, 914431, 914642, 914909, 914943, 915136, 915137, F85, F85P, Mistral51, MISTRAL-51, NIAGARA-45, Niagara-51 | | |

switches and momentary switches

rocker/momentary rocker switches

27.8x25mm



| | | | |
|--------------------|---|-----------------|--------|
| GEV No. | 345002 | Ref. No. | 208009 |
| description | rocker switch mounting measurements 27.8x25mm black 2CO 250V 16A connection male faston 6.3mm ambient temperature max. 85°C protection IP40 | | |



| | | | |
|--------------------|---|-----------------|--------|
| GEV No. | 345003 ¹ | Ref. No. | 213007 |
| description | rocker switch mounting measurements 27.8x25mm green 2NO 250V 16A illuminated connection male faston 6.3mm ambient temperature max. 85°C protection IP40 | | |

¹illuminated



push/momentary push switches

28.5x77.5mm



1

| | | | |
|--------------------|---|-----------------|-----------------|
| GEV No. | 345625 | Ref. No. | 926190 DEP61 |
| description | switch combination latching mounting measurements 28.5x77.5mm black 2CO/2NO/2NO 250V 16A connection male faston 6.3mm ambient temperature max. 85°C protection IP40 | | |

30x22mm



1

| | | | |
|--------------------|--|-----------------|--------|
| GEV No. | 301047 ¹ | Ref. No. | 226059 |
| description | push switch mounting measurements 30x22mm green 2NO 250V 16A illuminated connection male faston 6.3mm ambient temperature max. 85°C protection IP40 latching | | |
| For models: | 11F, 11FD, 11F-DVGW, 11R, 11RD | | |

¹illuminated

ø25mm





1

| | | | |
|--------------------|--|-----------------|--------|
| GEV No. | 345961 | Ref. No. | 999107 |
| description | momentary push switch mounting ø 25mm orange 1NO/indicator light 250V 16A connection male faston 6.3mm ambient temperature max. 85°C protection IP40 | | |
| For models: | CLEAN-3 | | |



1

| | | | | |
|---|--|-----------------|-----------------|--------|
| GEV No. | 345001 | Ref. No. | 999070 | |
| description | momentary push switch mounting ø 25mm yellow 1NO/indicator light 250V 16A cover connection male faston 6.3mm ambient temperature max. 85°C protection IP65 | | | |
| For models: | 11F, 11FD, 11R, 11RD | | | |
| accessories for | 345001 | | | |
|  | GEV No. | 345039 | Ref. No. | 410005 |
| | protective cover round ED ø 33mm external size 23mm internal size 21mm H 12mm clear mounting ø 25mm | | | |



1

| | | | | |
|---|--|-----------------|-----------------|--------|
| GEV No. | 345039 | Ref. No. | 410005 | |
| description | protective cover round ED ø 33mm external size 23mm internal size 21mm H 12mm clear mounting ø 25mm | | | |
| For models: | 11F, 11FD, 11F-DVGW, 11R, 11RD, 14 | | | |
| accessories for | 345039 | | | |
|  | GEV No. | 345001 | Ref. No. | 999070 |
| | momentary push switch mounting ø 25mm yellow 1NO/indicator light 250V 16A cover connection male faston 6.3mm ambient temperature max. 85°C protection IP65 | | | |

ø30mm



1

| | | | |
|--------------------|--|-----------------|--------|
| GEV No. | 345956 | Ref. No. | 226004 |
| description | momentary push switch mounting ø 30mm multicolour 1NO 300V incl. several button connection screw ambient temperature max. 85°C protection IP40 | | |
| For models: | S850, S870, S950 | | |

accessories

element holders



1

| | | | |
|--------------------|---|-----------------|--------|
| GEV No. | 348215 | Ref. No. | 226126 |
| description | element holder dimensions 25x25mm ID ø 21.4mm grey | | |
| For models: | 917042, 917043, 917044, 917049, Clean140, Clean140S, Clean161 | | |



microswitches

universal



1

| | | | |
|------------------------|--|-----------------|-------------------|
| GEV No. | 345042 | Ref. No. | 218009 |
| description | microswitch with plunger 250V 16A 1CO connection male faston 6.3mm L 28mm ambient temperature max. 125°C mounting distance 22mm type EF83161.3 actuating force: 75g blue/black | | |
| For models: | 11F, 11FD, 11R, 11RD, R495, R497, R499, R501, R503, R505, R507, R509, R511, R704, R706, R708, S621, S623, S624, S626, S631, S633, S634, S636, S641, S643, S651, S651P, S653, S654, S655, S810, S815, S830, S835, S850, S870, S950, SR651 | | |
| accessories for | 345042 | | |
| | GEV No. | 345043 | Ref. No. — |
| lever set 5-piece | | | |

lever actuated



1

| | | | |
|--------------------|---|-----------------|--------|
| GEV No. | 345257 | Ref. No. | 218002 |
| description | microswitch with lever 250V 16A 1CO connection male faston 6.3mm L 29mm L1 33mm ambient temperature max. 120°C mounting distance 22mm actuating force: 130g lever length 31.5mm | | |



1

| | | | |
|--------------------|---|-----------------|--------|
| GEV No. | 345125 | Ref. No. | 927246 |
| description | microswitch with lever 250V 16A 1CO connection male faston 6.3mm ambient temperature max. 85°C mounting distance 25mm type C99ZP3 actuating force: 25g lever length 63.5mm | | |
| For models: | 161, 221, 271, 272, 362, 914380, 914436, 915773, A3EB, A3EBD, A3EBDAKRKYK, A3EBDAKWK, A3EBDBKWK, A3EBDRKYK, A3EBDWK, A3EBDYK, A3EBSAK, A3EBSAKRK, A3EBSAKWK, A3EBSBKWKYK, A3EBSEKWK, A3EBSWK, A4EB, A4EBD, A4EBDAKEKYK, A4EBDAKRK, A4EBDAKWK, A4EBDAKZK, A4EBDBKWK, A4EBDPKWKYK, A4EBDRK, A4EBS, A4EBSAK, A4EBSAKCK, A4EBSAKEKYK, A4EBSAKRK, A4EBSAKRKP, A4EBSAKYK, A4EBSCK, A4EBT, A4EBTSAK, A5EB, A5EBD, A5EBDAKPWK, A5EBDAKWK, A5EBDAKYK, A5EBDRK, A5EBS, A5EBSAKPKWK, A5EBSAKRK...(Other models you can see in the webshop) | | |



1

| | | | |
|--------------------|--|-----------------|-------|
| GEV No. | 345311 | Ref. No. | DEM14 |
| description | microswitch with lever 250V 16A 1NO connection male faston 6.3mm ambient temperature max. 85°C type TYFE22 lever length 41mm | | |

pin-plunger actuated



1

| | | | |
|------------------------|--|-----------------|-------------------|
| GEV No. | 345042 | Ref. No. | 218009 |
| description | microswitch with plunger 250V 16A 1CO connection male faston 6.3mm L 28mm ambient temperature max. 125°C mounting distance 22mm type EF83161.3 actuating force: 75g blue/black | | |
| For models: | 11F, 11FD, 11R, 11RD, R495, R497, R499, R501, R503, R505, R507, R509, R511, R704, R706, R708, S621, S623, S624, S626, S631, S633, S634, S636, S641, S643, S651, S651P, S653, S654, S655, S810, S815, S830, S835, S850, S870, S950, SR651 | | |
| accessories for | 345042 | | |
| | GEV No. | 345043 | Ref. No. — |
| lever set 5-piece | | | |

accessories



1

| | | | |
|--------------------|---|-----------------|--------|
| GEV No. | 518000 | Ref. No. | 486160 |
| description | adjusting screw for pressure pin | | |
| For models: | 21F, 21FD, 21R, 21RD, 25F, 25FD, 25R, 25RD, 30F, 30FD, 30R, 30RD, 31F, 31FD, 31R, 31RD, 440F, 44F | | |



1

| | | | |
|--------------------|---|-----------------|--------|
| GEV No. | 518041 | Ref. No. | 462005 |
| description | pressure pin for microswitch L 25.4mm ø 4.7mm | | |
| For models: | 21F, 21FD, 21R, 21RD, 25F, 25FD, 25R, 25RD, 30F, 30FD, 30R, 30RD, 31F, 31FD, 31R, 31RD, 440F, 44F | | |

position switches

HIGHLY



1

| | | | |
|--------------------|--|-----------------|--------|
| GEV No. | 347877 | Ref. No. | 927304 |
| description | position switch 2NC 250V L 56mm W 21mm H 25mm 5A | | |



system switches (ROLD)



1

| | | | |
|--------------------|---|-----------------|--------|
| GEV No. | 345612 | Ref. No. | 480059 |
| description | blank size 23x23mm black | | |
| For models: | 350F, 350FD, 350R, 350RD, 35-ELECTRONIC, 35F, 35FD, 35R, 35RD, 400F, 400FD, 400R, 400RD, 40-ELECTRONIC, 40F, 40FD, 40R, 40RD, 45, 450, 46, 500F, 500FD, 50-ELECTRONIC, 50F, 50FD, 510F, 510FD, P500 | | |



2

| | | | |
|--------------------|--|-----------------|--------|
| GEV No. | 345721 | Ref. No. | 226102 |
| description | blank cap holder | | |
| For models: | Fast180, Fast180-230V-3Ph-60Hz, FAST-60, FAST-73, PLUVIA-280, Pluvia280-230V-3Ph-60Hz, PV280, PV280FAST, PV280FAST2, PV280FAST-2BIO, PV280FAST2HZ23, PV280FASTCH, PV280FASTHB, PV280HZ23 | | |



1

| | | | |
|--------------------|--|-----------------|--------|
| GEV No. | 346848 | Ref. No. | 226111 |
| description | element holder dimensions 25x25mm ID ø 21.4mm grey | | |





1

| | | | |
|--------------------|--|-----------------|--------|
| GEV No. | 345602 | Ref. No. | 226073 |
| description | element holder double mounting measurements 28.5x52.6mm black for push buttons 23x23mm | | |
| For models: | 350F, 350FD, 350R, 350RD, 35-ELECTRONIC, 35F, 35FD, 35R, 35RD, 400F, 400FD, 400R, 400RD, 40-ELECTRONIC, 40F, 40FD, 40R, 40RD | | |



1

| | | | | |
|---|--|-----------------|-----------------|--------|
| GEV No. | 345577 | Ref. No. | 226122 | |
| description | element holder mounting measurements 19.3x12.9mm black arched for push buttons 11x15.8 | | | |
| For models: | GLS40H, GLS40HP, GSP50, GSP50P, HM1 | | | |
| accessories for | 345577 | | | |
|  | GEV No. | 345578 | Ref. No. | 227078 |
| | push button mounting measurements 11x15.8mm orange for Element carrier | | | |



1

| | | | |
|--------------------|--|-----------------|--------|
| GEV No. | 345627 | Ref. No. | 226101 |
| description | element holder mounting measurements 20.6x16.4mm black arched for push buttons 13x17mm | | |



1

| | | | |
|--------------------|---|-----------------|--------|
| GEV No. | 346846 | Ref. No. | 226112 |
| description | element holder mounting measurements 20.6x16.4mm blue arched for push buttons 13x17mm | | |
| For models: | 2312-001, 2312-002 | | |



1

| | | | |
|--------------------|---|-----------------|--------|
| GEV No. | 345537 | Ref. No. | 226114 |
| description | element holder mounting measurements 20.6x16.4mm grey arched for push buttons 13x17mm | | |
| For models: | Fast181, ST70FASTHZ23 | | |



1

| | | | |
|--------------------|--|-----------------|--------|
| GEV No. | 347150 | Ref. No. | 226113 |
| description | element holder mounting measurements 23.6x14.6mm grey arched for push buttons 11x21mm | | |
| For models: | 913289, 913290, 913291, 913292, 913297, 913298, 913299, 913300, 913356, 913357, 913360, 913361, 913363, 913364, 913372, 913373, 913374, 913375, 913376, 913377, 913391, 913392, 913416, 913418, 913435, 913544, 913545, 913546, 913547, 913578, 913611, 913665, 913666, 913667, 913668, 913684, 913685, 913771, 913772, 913773, 913774, 913832, 913837, 913932, 913933, 913948, 914326, 914331, 914386, 914387...(Other models you can see in the webshop) | | |



1

| | | | |
|--------------------|--|-----------------|--------|
| GEV No. | 347151 | Ref. No. | 226121 |
| description | element holder mounting measurements 23.6x14.6mm white arched for push buttons 11x21mm | | |
| For models: | 915160, 915161, 915162, 915175, 915176, 915177, 915319, 915338, 915341, 915418, 915419, 915611, 915612, 915613, 915663, 915670, 915686, 915687, 915688, 915689, 915690, 915691, 915692, 915693, 915694, 915695, 915696, 915697, 915698, 915699, 915700, 915701, 915702, 915729, 915756, 915799, 915800, 915816, 915817, 915818, 915819, 915830, 915842, 916162, FAST-135, Fast135CT, FAST-135CT, Fast135D, FAST-135D, Fast135H...(Other models you can see in the webshop) | | |



1

| | | | |
|--------------------|---|-----------------|--------|
| GEV No. | 346201 | Ref. No. | 226080 |
| description | element holder mounting measurements 28.5x77.5mm grey three-fold element holder | | |
| For models: | LF50, LF55, PS-60 | | |



1

| | | | |
|--------------------|---|-----------------|--------|
| GEV No. | 345536 | Ref. No. | 226096 |
| description | element holder mounting ø 16mm flat black | | |
| For models: | MC201CL, MC501E, MC501EP, MC501S, MC501SP | | |



1

| | | | |
|--------------------|--|-----------------|--------|
| GEV No. | 345603 | Ref. No. | 226074 |
| description | element holder triple mounting measurements 28.5x77.5mm black for push buttons 23x23mm | | |
| For models: | 35-ELECTRONIC, 35F, 35FD, 35R, 35RD, 40-ELECTRONIC, 40F, 40FD, 40R, 40RD, 45, 450, 46, 460, 500F, 500FD, 50-ELECTRONIC, 50F, 50FD, 510F, 510FD, P500 | | |



1

| | | | |
|--------------------|--|-----------------|--------|
| GEV No. | 345601 | Ref. No. | 299035 |
| description | indicator lamp holder V ø 11mm | | |
| For models: | 350F, 350FD, 350R, 350RD, 35-ELECTRONIC, 35F, 35FD, 35R, 35RD, 400F, 400FD, 400R, 400RD, 40-ELECTRONIC, 40F, 40FD, 40R, 40RD, 45, 450, 46, 460, 500F, 500FD, 50-ELECTRONIC, 50F, 50FD, 510F, 510FD, 67F, 67R, 915695, 915696, 915819, Fast145, FAST-145, Fast145D, FAST-145D, LF50, LF55, P500 | | |



1

| | | | |
|--------------------|--------------------------------------|-----------------|--------|
| GEV No. | 346241 | Ref. No. | 207011 |
| description | indicator light lens ø 23.3mm yellow | | |
| For models: | LF50, LF55 | | |



1

| | | | |
|--------------------|--|-----------------|--------|
| GEV No. | 345606 | Ref. No. | 226071 |
| description | momentary switch unit 2CO 250V 16A connection male faston 6.3mm | | |
| For models: | 350F, 350FD, 350R, 350RD, 35-ELECTRONIC, 35F, 35FD, 35R, 35RD, 400F, 400FD, 400R, 400RD, 40-ELECTRONIC, 40F, 40FD, 40R, 40RD, 45, 450, 46, 460, 500F, 500FD, 50-ELECTRONIC, 50F, 50FD, 510F, 510FD, 67F, 67R, 915160, 915161, 915162, 915175, 915176, 915177, 915319, 915338, 915341, 915418, 915419, 915611, 915612, 915613, 915663, 915670, 915686, 915687, 915688...(Other models you can see in the webshop) | | |





1

| | | | |
|--------------------|--|-----------------|------------------|
| GEV No. | 345650 | Ref. No. | 226093 226095 |
| description | momentary switch unit 2CO 250V 16A connection male faston 6.3mm | | |
| For models: | 2312-001, 2312-002, 913289, 913290, 913291, 913292, 913297, 913298, 913299, 913300, 913356, 913357, 913360, 913361, 913363, 913364, 913372, 913373, 913374, 913375, 913376, 913377, 913391, 913392, 913416, 913418, 913435, 913544, 913545, 913546, 913547, 913578, 913611, 913665, 913666, 913667, 913668, 913684, 913685, 913771, 913772, 913773, 913774, 913832, 913837, 913932, 913933, 913948, 914326, 914331...(Other models you can see in the webshop) | | |



1

| | | | | |
|---|--|-----------------|-----------------|--------|
| GEV No. | 345578 | Ref. No. | 227078 | |
| description | push button mounting measurements 11x15.8mm orange for Element carrier | | | |
| For models: | GLS40H, GLS40HP, GSP50, GSP50P, HM1 | | | |
| accessories for | 345578 | | | |
|  | GEV No. | 345577 | Ref. No. | 226122 |
| | element holder mounting measurements 19.3x12.9mm black arched for push buttons 11x15.8 | | | |





1

| | | | |
|--------------------|--------------------------|-----------------|--------|
| GEV No. | 346816 | Ref. No. | 227035 |
| description | push button ø 23mm black | | |
| For models: | PS-60 | | |





| | | | |
|---|--|-----------------|--------|
|  | | | |
| 1 | | | |
| GEV No. | 347152 | Ref. No. | 227067 |
| description | push button size 11x21mm blue | | |
| For models: | 913289, 913290, 913291, 913292, 913297, 913298, 913299, 913300, 913356, 913357, 913360, 913361, 913363, 913364, 913372, 913373, 913374, 913375, 913376, 913377, 913391, 913392, 913416, 913418, 913435, 913544, 913545, 913546, 913547, 913578, 913611, 913665, 913666, 913667, 913668, 913684, 913685, 913771, 913772, 913773, 913774, 913832, 913837, 913932, 913933, 913948, 914326, 914331, 914386, 914387...(Other models you can see in the webshop) | | |

| | | | |
|---|---------------------------------|-----------------|--------|
|  | | | |
| 1 | | | |
| GEV No. | 347922 | Ref. No. | 227077 |
| description | push button size 11x21mm silver | | |

| | | | |
|---|--------------------------------|-----------------|--------|
|  | | | |
| 1 | | | |
| GEV No. | 345621 | Ref. No. | 227056 |
| description | push button size 17x13mm black | | |

| | | | |
|--|-------------------------------|-----------------|--------|
|  | | | |
| 1 | | | |
| GEV No. | 345539 | Ref. No. | 227068 |
| description | push button size 17x13mm grey | | |
| For models: | 2312-001, 2312-002 | | |

| | | | |
|---|---------------------------------|-----------------|--------|
|  | | | |
| 1 | | | |
| GEV No. | 346035 | Ref. No. | 227062 |
| description | push button size 17x13mm silver | | |

| | | | |
|---|--|-----------------|--------|
|  | | | |
| 1 | | | |
| GEV No. | 345613 | Ref. No. | 227030 |
| description | push button size 23x23mm black drain pump | | |
| For models: | 45, 450, 46, 460, 500F, 500FD, 50-ELECTRONIC, 50F, 50FD, 510F, 510FD, P500 | | |

| | | | |
|---|--|-----------------|--------|
|  | | | |
| 1 | | | |
| GEV No. | 345660 | Ref. No. | 227031 |
| description | push button size 23x23mm black flash with lens | | |
| For models: | P500 | | |

| | | | |
|---|--|-----------------|------------------|
|  | | | |
| 1 | | | |
| GEV No. | 345607 | Ref. No. | 207025 227025 |
| description | push button size 23x23mm black main switch with lens | | |
| For models: | 350F, 350FD, 350R, 350RD, 35-ELECTRONIC, 35F, 35FD, 35R, 35RD, 400F, 400FD, 400R, 400RD, 40-ELECTRONIC, 40F, 40FD, 40R, 40RD, 45, 450, 46, 460, 500F, 500FD, 50-ELECTRONIC, 50F, 50FD, 510F, 510FD | | |

| | | | |
|---|---|-----------------|--------|
|  | | | |
| 1 | | | |
| GEV No. | 345615 | Ref. No. | 227033 |
| description | push button size 23x23mm black programme | | |
| For models: | 46, 460, 500F, 500FD, 50-ELECTRONIC, 50F, 50FD, 510F, 510FD, P500 | | |

| | | | |
|---|---|-----------------|--------|
|  | | | |
| 1 | | | |
| GEV No. | 345611 | Ref. No. | 227029 |
| description | push button size 23x23mm black rinsing | | |
| For models: | 350F, 350FD, 350R, 350RD, 35-ELECTRONIC, 35F, 35FD, 35R, 35RD, 400F, 400FD, 400R, 400RD, 40-ELECTRONIC, 40F, 40FD, 40R, 40RD, 45, 450, 46, 460, 500F, 500FD, 50F, 50FD, 510F, 510FD | | |

| | | | |
|---|--|-----------------|--------|
|  | | | |
| 1 | | | |
| GEV No. | 345609 | Ref. No. | 227027 |
| description | push button size 23x23mm black START | | |
| For models: | 350F, 350FD, 350R, 350RD, 35-ELECTRONIC, 35F, 35FD, 35R, 35RD, 400F, 400FD, 400R, 400RD, 40-ELECTRONIC, 40F, 40FD, 40R, 40RD, 45, 450, 46, 460, 500F, 500FD, 50-ELECTRONIC, 50F, 50FD, 510F, 510FD | | |



1

| | | | |
|--------------------|--------------------------------------|-----------------|--------|
| GEV No. | 345661 | Ref. No. | 227032 |
| description | push button size 23x23mm black timer | | |
| For models: | P500 | | |



1

| | | | |
|--------------------|---|-----------------|--------|
| GEV No. | 347878 | Ref. No. | 227072 |
| description | push button size 23x23mm grey with lens | | |



1

| | | | |
|--------------------|---------------------------------------|-----------------|--------|
| GEV No. | 346847 | Ref. No. | 409003 |
| description | rotary disc green/black disc ø 18.7mm | | |



1

| | | | |
|--------------------|--|-----------------|--------|
| GEV No. | 345608 | Ref. No. | 409001 |
| description | rotary disc green/black disc ø 20.6mm | | |
| For models: | 350F, 350FD, 350R, 350RD, 35-ELECTRONIC, 35F, 35FD, 35R, 35RD, 400F, 400FD, 400R, 400RD, 40-ELECTRONIC, 40F, 40FD, 40R, 40RD, 45, 450, 46, 460, 500F, 500FD, 50-ELECTRONIC, 50F, 50FD, 510F, 510FD, 67F, 67R, LF50, LF55, P500 | | |



1

| | | | |
|--------------------|--|-----------------|--------|
| GEV No. | 345605 | Ref. No. | 208010 |
| description | switch 2CO 250V 16A connection male faston 6.3mm | | |
| For models: | 350F, 350FD, 350R, 350RD, 35-ELECTRONIC, 35F, 35FD, 35R, 35RD, 400F, 400FD, 400R, 400RD, 40-ELECTRONIC, 40F, 40FD, 40R, 40RD, 45, 450, 46, 460, 500F, 500FD, 50-ELECTRONIC, 50F, 50FD, 510F, 510FD, 67F, 67R, 915160, 915161, 915162, 915175, 915176, 915177, 915319, 915338, 915341, 915418, 915419, 915611, 915612, 915613, 915663, 915670, 915686, 915687, 915688...(Other models you can see in the webshop) | | |



1

| | | | |
|--------------------|--|-----------------|--------|
| GEV No. | 345651 | Ref. No. | 208011 |
| description | switch 2CO 250V 16A connection male faston 6.3mm | | |
| For models: | 2312-001, 2312-002, 913289, 913290, 913291, 913292, 913297, 913298, 913299, 913300, 913356, 913357, 913360, 913361, 913363, 913364, 913372, 913373, 913374, 913375, 913376, 913377, 913391, 913392, 913416, 913418, 913435, 913544, 913545, 913546, 913547, 913578, 913611, 913665, 913666, 913667, 913668, 913684, 913685, 913771, 913772, 913773, 913774, 913832, 913837, 913932, 913933, 913948, 914326, 914331...(Other models you can see in the webshop) | | |



1

| | | | |
|--------------------|---|-----------------|-------|
| GEV No. | 346851 | Ref. No. | 80804 |
| description | switch 2CO 250V 16A connection male faston 6.3mm | | |
| For models: | CE78HZ23, E78, E78HP, Fast181, FAST-181, Fast181-230V-3Ph-60Hz, Fast181-400V-3NPh-60Hz, FAST-60, FAST-73, HM1, PLUVIA-280, Pluvia280-230V-3PH-60HZ, PS-60, PV280, PV280FAST, PV280FASTCH, PV280FASTHB, PV280HZ23, RIVER-78, RIVER-E78, ST70FAST, ST-70FASTHB, ST70FASTHB400, ST70FASTHZ23 | | |

system switches

ELETTROBAR

fascias



1

| | | | |
|--------------------|--|-----------------|--------|
| GEV No. | 345655 | Ref. No. | 480096 |
| description | blank grey format rectangular mounting measurements 24x34mm | | |
| For models: | E.35, E.35H, E.40, E.40H, E.41, E.42, E.45, E.46, E.50, E.51, E.52 | | |





1

| | | | |
|--------------------|---|-----------------|--------|
| GEV No. | 345652 | Ref. No. | 480095 |
| description | blank grey format square mounting measurements 25x25mm | | |
| For models: | E.35, E.35H, E.40, E.41, E.42, E.45, E.46, E.50, E.51, E.52 | | |





push buttons

| | | | |
|--|---|-----------------|--------|
|  <p>1</p> | | | |
| GEV No. | 345658 | Ref. No. | 227052 |
| description | push button | | |
| For models: | E.35, E.35H, E.40, E.40H, E.41, E.42, E.45, E.46, E.50, E.51, E.52, E.60, E.65, E1, E10, E100, E110, E12, E120, E14, E140 | | |

| | | | |
|--|---|-----------------|--------|
|  <p>1</p> | | | |
| GEV No. | 345659 | Ref. No. | 227051 |
| description | push button | | |
| For models: | E.35, E.35H, E.40, E.40H, E.41, E.42, E.45, E.46, E.50, E.51, E.52, E.60, E.65, E1, E10, E100, E110, E12, E120, E14, E140, RIVER-78, U132, U61, U61H, U70 | | |

| | | | |
|--|---|-----------------|--------|
|  <p>1</p> | | | |
| GEV No. | 347523 | Ref. No. | 227050 |
| description | push button black ø 12mm H 7mm | | |
| For models: | MC201CL, MC501E, MC501EP, MC501S, MC501SP, TF-503 | | |

| | | | |
|--|---------------------------------|-----------------|--------|
|  <p>1</p> | | | |
| GEV No. | 347522 | Ref. No. | 226092 |
| description | push button green ø 20mm H 11mm | | |
| For models: | CLEAN-3 | | |

| | | | |
|--|---------------------------------|-----------------|--------|
|  <p>1</p> | | | |
| GEV No. | 347922 | Ref. No. | 227077 |
| description | push button size 11x21mm silver | | |

element holders

| | | | |
|--|---|-----------------|--------|
|  <p>1</p> | | | |
| GEV No. | 345653 | Ref. No. | 226098 |
| description | element holder grey format square illuminable L.26 suitable for E35/4 E46/E50/E51 | | |
| For models: | E.35, E.35H, E.40, E.40H, E.41, E.42, E.45, E.46, E.50, E.51, E.52 | | |

cam switches

3 operating positions

| | | | |
|---|---|-----------------|--------|
|  <p>1</p> | | | |
| GEV No. | 345670 | Ref. No. | 923011 |
| description | cam switch 3 operating positions 1CO sequence 1-0-2 16A shaft ø 6x4.6mm shaft L 23mm connection male faston 6.3mm | | |
| For models: | 412 | | |

rotary switches

BREMAS

A1200 series

| | | | |
|---|---|-----------------|--------|
|  <p>1</p> | | | |
| GEV No. | 345547 | Ref. No. | 213001 |
| description | rotary switch sets of contacts 1 2 0-1 type CA0120001 380V 12A shaft ø 5x5mm shaft L 23mm shaft square connection screw | | |
| For models: | 337, 338, 343, 344, 404, 406, ME15, ME20, ME30, ME40 | | |

| | | | |
|---|---|-----------------|--------|
|  <p>1</p> | | | |
| GEV No. | 345274 | Ref. No. | 213003 |
| description | rotary switch sets of contacts 4 2 0-1 type CA0120004 380V 12A shaft ø 5x5mm shaft L 23mm shaft square connection screw | | |
| For models: | 22F, 22R, 40F, R708 | | |



| | | | |
|---|---|-----------------|--------|
|  | | | |
| 1 | | | |
| GEV No. | 300326 | Ref. No. | 927034 |
| description | rotary switch sets of contacts 6 0-1-2-3 type CS012015B 400V 12A shaft \varnothing 5x5mm shaft L 18mm | | |
| For models: | 161, 221, 271, 272, 362, CLEAN-160, CLEAN-161, CLEAN-220, CLEAN-221, CLEAN-270, CLEAN-271, CLEAN-272, CLEAN-362 | | |

| | | | |
|---|---|-----------------|--------|
|  | | | |
| 1 | | | |
| GEV No. | 345916 | Ref. No. | 926182 |
| description | rotary switch sets of contacts 6 6 1-2-3-4-5-6 type CS0128618 600V 12A shaft \varnothing 5x5mm shaft L 15mm shaft square connection screw | | |
| For models: | E.60, E.65, E1, E10, E100, E110, E12, E120, E14, E140 | | |

| | | | |
|---|---|-----------------|--------|
| A1600 series | | | |
|  | | | |
| 1 | | | |
| GEV No. | 347401 | Ref. No. | 205004 |
| description | rotary switch 4 momentary switch-0-1-momentary switch sets of contacts 8 type CS0077762 600V 16A shaft \varnothing 5x5mm shaft L 22mm shaft square connection screw | | |
| For models: | 22F, 22R, 40F, PS-60 | | |

| | | | |
|---|--|-----------------|--------|
| VM | | | |
|  | | | |
| 1 | | | |
| GEV No. | 345619 | Ref. No. | 205010 |
| description | rotary switch 5 1-2-3-4-5 sets of contacts 15 type P302255 400V 16A shaft \varnothing 4x5mm shaft L 15mm shaft square connection screw | | |
| For models: | CLEAN-3 | | |

| | | | |
|---|--|-----------------|--------|
| miscellaneous | | | |
|  | | | |
| 1 | | | |
| GEV No. | 347689 | Ref. No. | 213002 |
| description | rotary switch sets of contacts 2 2 0-1 type CS20-00063 690V 25A shaft \varnothing 5x5mm shaft L 22mm shaft square connection male faston 6.3mm | | |
| For models: | 10, 12, 66, CLEAN-100, CLEAN-110, CLEAN-120, R495, R499, R501, R503, R505, R507, R509, R511, R704, R706, S641, S643, S870 | | |

magnetic switches

36x13mm

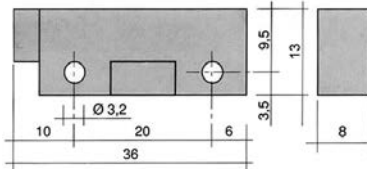
| | | | |
|--|--|--|--|
|  | | | |
| 1 | | | |
|  | | | |

| | | | |
|---|--|-----------------|--------------------------------|
| GEV No. | 345118 ¹ | Ref. No. | 211002 211002AG 80871 |
| description | magnetic switch L 36mm W 13mm 1NO 250V 1A P max. 50W connection cable cable length 980mm | | |
| For models: | 050F, 050FP, 21F, 21FD, 21R, 21RD, 2312-001, 2312-002, 2312-007, 2312-009-CRP, 25F, 25FD, 25R, 25RD, 30F, 30FD, 30R, 30RD, 31F, 31FD, 31R, 31RD, 350F, 350FD, 350R, 350RD, 35-ELECTRONIC, 35F, 35FD, 35R, 35RD, 400F, 400FD, 400R, 400RD, 40-ELECTRONIC, 40F, 40FD, 40R, 40RD, 440F, 44F, 45, 450, 46, 460, 500F, 500FD, 50-ELECTRONIC, 50F... | | |
| accessories for | 345118 | | |
|  | GEV No. | 345399 | Ref. No. 927088 CWM7 |
| magnet \varnothing 3.3mm L 40mm H 8mm W 13mm hole distance 30mm M3 | | | |

¹with coded connector

65x20mm

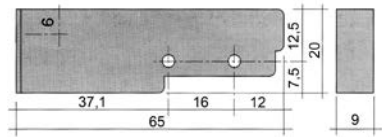
| | | | |
|---|--|--|--|
|  | | | |
| 1 | | | |
|  | | | |

| | | | |
|--------------------|---|-----------------|--------|
| GEV No. | 347876 | Ref. No. | 927056 |
| description | magnetic switch L 65mm W 20mm 1NC 24V 4A P max. 100W connection cable cable length 1940mm | | |
| For models: | 161, 221, 271, 272, 362, CLEAN-160, CLEAN-161, CLEAN-220, CLEAN-221, CLEAN-270, CLEAN-271, CLEAN-272, CLEAN-362 | | |

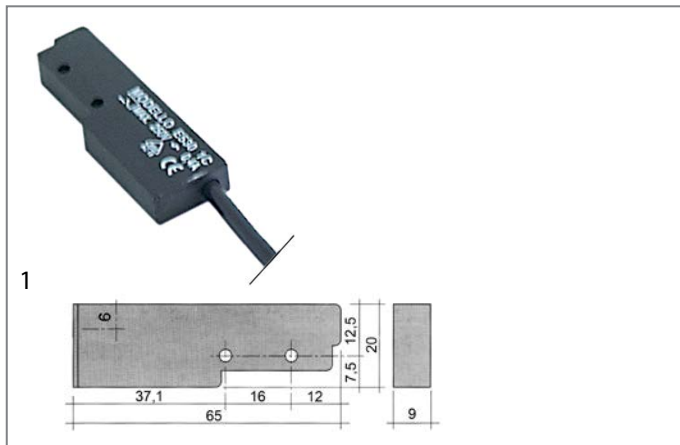

| | | | |
|---|---|-----------------|--------------------------------|
| GEV No. | 345116 | Ref. No. | 927017 |
| description | magnetic switch L 65mm W 20mm 1NO 250V 0.4A P max. 100W connection cable length 3000mm | | |
| For models: | 161, 221, 271, 272, 362, CLEAN-160, CLEAN-161, CLEAN-220, CLEAN-221, CLEAN-270, CLEAN-271, CLEAN-272, CLEAN-361, CLEAN-361P, CLEAN-362, CLEAN-471, CLEAN-471P, RIVER-150, RV150, U132, U132E, U61, U61E, U61H, U61HE, U70, U70E | | |
| accessories for | 345116 | | |
|  | GEV No. | 345399 | Ref. No. 927088 CWM7 |
| magnet \varnothing 3.3mm L 40mm H 8mm W 13mm hole distance 30mm M3 | | | |



| | | | |
|--------------------|--|-----------------|---------|
| GEV No. | 345202 | Ref. No. | DEM2038 |
| description | magnetic switch 250V 0.04A P max. 10W probe L 29mm 1NO connection plug cable length 1400mm | | |



| | | | |
|---|---|-----------------|------------------------|
| GEV No. | 345630 | Ref. No. | 926195 |
| description | magnetic switch 250V 0.04A P max. 10W probe L 29mm 1NO connection plug cable length 350mm | | |
| For models: | E.60, E.65, E100, E110, E120, E140 | | |
| accessories for | 345630 | | |
|  | GEV No. | 345336 | Ref. No. 926014 |
| magnet \varnothing 4.8mm L 63mm H 11mm W 18.8mm hole distance 51mm M4 | | | |



| | | | |
|--------------------|---|-----------------|--------|
| GEV No. | 345146 | Ref. No. | 211001 |
| description | magnetic switch 250V 1A P max. 50W probe L 29mm 1NO connection plug cable length 980mm | | |
| For models: | 10, 11F, 11FD, 11F-DVGW, 11R, 11RD, 12, 14, 22F, 22R, 2312-007, 2312-009-CRP, 40F, 914100, 914101, 914339, 914342, 914343, 914624, 914625, 914626, 914627, 914628, 914850, 914851, 914854, 914944, CLEAN-100, CLEAN-110, CLEAN-120, E1, E10, E100, E110, E12, E120, E14, E140, RIVER-48, RIVER-50, RIVER-50-CRP, RIVER-50-CRP-SP, River-54, RIVER-54CRP, River-54-CRP-s.p., RIVER-54-CRP-SP, RIVER-61 | | |

accessories

magnets

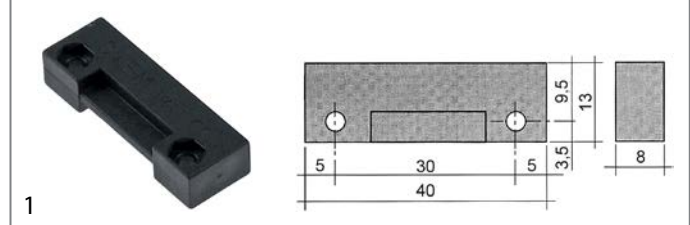

| | | | |
|--------------------|--|-----------------|----------------|
| GEV No. | 345399 | Ref. No. | 927088 CWM7 |
| description | magnet \varnothing 3.3mm L 40mm H 8mm W 13mm hole distance 30mm M3 | | |
| For models: | 161, 221, 271, 272, 362, 80, 81, 82, 914380, 914436, A3EB, A3EBD, A3EBDAKRKYK, A3EBDAKWK, A3EBDBKWK, A3EBDRKYK, A3EBDWK, A3EBDYK, A3EBSAK, A3EBSAKRK, A3EBSAKWK, A3EBSBKWKYK, A3EBSEKWK, A3EBSWK, A4EB, A4EBD, A4EBDAKEKYK, A4EBDAKRK, A4EBDAKWK, A4EBDAKZK, A4EBDBKRK, A4EBDPKWKYK, A4EBDRK, A4EBS, A4EBSAK, A4EBSAKCK, A4EBSAKEKYK, A4EBSAKRK, A4EBSAKRKP, A4EBSAKYK, A4EBSCK, A4EBT, A4EBTSAK, A5EB, A5EBD, A5EBDAKPKWK, A5EBDAKWK, A5EBDAKYK, A5EBDRK, A5EBS...(Other models you can see in the webshop) | | |

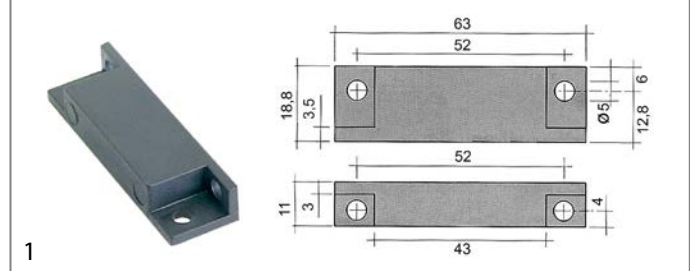

| | | | |
|--------------------|---|-----------------|--------|
| GEV No. | 345336 | Ref. No. | 926014 |
| description | magnet \varnothing 4.8mm L 63mm H 11mm W 18.8mm hole distance 51mm M4 | | |
| For models: | 10, 12, 161, 221, 271, 272, 362, 914380, 914436, A3EB, A3EBD, A3EBDAKRKYK, A3EBDAKWK, A3EBDBKWK, A3EBDRKYK, A3EBDWK, A3EBDYK, A3EBSAK, A3EBSAKRK, A3EBSAKWK, A3EBSBKWKYK, A3EBSEKWK, A3EBSWK, A4EB, A4EBD, A4EBDAKEKYK, A4EBDAKRK, A4EBDAKWK, A4EBDAKZK, A4EBDBKRK, A4EBDPKWKYK, A4EBDRK, A4EBS, A4EBSAK, A4EBSAKCK, A4EBSAKEKYK, A4EBSAKRK, A4EBSAKRKP, A4EBSAKYK, A4EBSCK, A4EBT, A4EBTSAK, A5EB, A5EBD, A5EBDAKPKWK, A5EBDAKWK, A5EBDAKYK, A5EBDRK, A5EBS, A5EBSAKPKWK...(Other models you can see in the webshop) | | |



| | | | |
|---|---|-----------------|--------|
|  | | | |
| 1 | | | |
| GEV No. | 346953 | Ref. No. | 999108 |
| description | magnet ømm L 23mm H 17mm W 18mm M6 hole ø 6.5mm | | |
| For models: | 050F, 050FP, 11F, 11FD, 11R, 11RD, 2312-001, 2312-002, 45, 450, 46, 460, 500F, 500FD, 510F, 510FD, 913297, 913298, 913299, 913300, 913360, 913361, 913391, 913392, 913418, 913546, 913547, 913578, 913611, 913684, 913913, 913914, 913932, 913933, 914167, 914168, 914284, 914318, 914319, 914326, 914331, 914338, 914356, 914398, 914399, 914400, 914401, 914402, 914403, 914404...(Other models you can see in the webshop) | | |

| | | | |
|---|--|-----------------|--------|
|  | | | |
| 1 | | | |
| GEV No. | 345398 | Ref. No. | 217003 |
| description | magnet ømm L 36mm H 8mm W 13mm hole distance 20mm M3 hole ø 3mm | | |
| For models: | 2312-007, 2312-009-CRP, 914100, 914101, 914214, 914316, 914317, 914339, 914342, 914343, 914624, 914625, 914626, 914627, 914628, 914850, 914851, 914854, 914874, 914944, Mistral40, MISTRAL-40, PS-60, RIVER-48, RIVER-50, RIVER-50-CRP, RIVER-50-CRP-SP, River-54, RIVER-54CRP, River-54-CRP-s.p., RIVER-54-CRP-SP, RIVER-61 | | |

control equipment

GENERAL ELECTRIC (AEG)

push buttons

| | | | |
|---|---|-----------------|--------|
|  | | | |
| 1 | | | |
| GEV No. | 347486 | Ref. No. | 927308 |
| description | push button mounting measurements ø22mm round red | | |
| For models: | CLEAN-161, CLEAN-221, CLEAN-271, CLEAN-272, CLEAN-362 | | |

| | | | |
|---|--|-----------------|------------------|
|  | | | |
| 1 | | | |
| GEV No. | 345779 | Ref. No. | 927035 927036 |
| description | contact block GENERAL ELECTRIC P9B10VN 1NO max 400V 10A brown | | |
| For models: | 161, 221, 271, 272, 362, CLEAN-160, CLEAN-161, CLEAN-220, CLEAN-221, CLEAN-270, CLEAN-271, CLEAN-272, CLEAN-361, CLEAN-361P, CLEAN-362, CLEAN-471, CLEAN-471P, RIVER-HL-82 | | |

lamps

indicator lights

indicator lights 2-piece (lens and indicator lamp)

indicator light lenses

ø12mm (type SDY-3)

| | | | |
|---|--|-----------------|--------|
|  | | | |
| 1 | | | |
| GEV No. | 359262 | Ref. No. | 926114 |
| description | indicator light housings mounting measurements ø12mm green round Qty 1 pcs | | |

| | | | |
|---|---|-----------------|--------|
|  | | | |
| 1 | | | |
| GEV No. | 359260 | Ref. No. | 926115 |
| description | indicator light housings mounting measurements ø12mm yellow round Qty 1 pcs | | |
| For models: | 161, 221, 271, 272, 362, CLEAN-161, CLEAN-221, CLEAN-271, CLEAN-272, CLEAN-362, E.60, E.65, E1, E10, E100, E110, E12, E120, E14, E140 | | |

indicator lamps for socket type SRZ / SDK / SDY / SFK

| | | | |
|--|--|-----------------|------------------|
|  | | | |
| 1 | | | |
| GEV No. | 359130 | Ref. No. | 216006 926113 |
| description | indicator lamp 230V clear connection male faston 6.3mm ø 8mm | | |
| For models: | 350F, 350FD, 350R, 350RD, 35-ELECTRONIC, 35F, 35FD, 35R, 35RD, 400F, 400FD, 400R, 400RD, 40-ELECTRONIC, 40F, 40FD, 40R, 40RD, 45, 450, 46, 460, 500F, 500FD, 50-ELECTRONIC, 50F, 50FD, 510F, 510FD, 67F, 67R, LF50, LF55, P500 | | |

| | | | |
|---|--|-----------------|--------|
|  | | | |
| 1 | | | |
| GEV No. | 359129 | Ref. No. | 927334 |
| description | indicator lamp 24V clear connection male faston 6.3mm | | |
| For models: | 161, 221, 271, 272, 362, CLEAN-161, CLEAN-221, CLEAN-271, CLEAN-272, CLEAN-362 | | |

indicator lights 3-piece (housing, lens and bulb)

lamps

neon light bulbs

| | | | |
|---|--|-----------------|--------|
|  | | | |
| 1 | | | |
| GEV No. | 345958 | Ref. No. | 216011 |
| description | neon light bulb socket Ba9s 230V ø 10mm L 28mm | | |
| For models: | S850, S870, S950 | | |

indicator lights (complete)

ø 6mm

| | | | |
|---|--|-----------------|------------------|
|  | | | |
| 1 | | | |
| GEV No. | 359005 | Ref. No. | 216003 216025 |
| description | indicator light ø 6mm 230V yellow cable length 400mm | | |
| For models: | 11F, 11FD, 11F-DVGW, 11R, 11RD, 2312-001, 2312-002, 913289, 913290, 913291, 913292, 913297, 913298, 913299, 913300, 913356, 913357, 913360, 913361, 913363, 913364, 913372, 913373, 913374, 913375, 913376, 913377, 913391, 913392, 913416, 913418, 913435, 913544, 913545, 913546, 913547, 913578, 913611, 913665, 913666, 913667, 913668, 913684, 913685, 913771, 913772, 913773, 913774, 913832, 913837...(Other models you can see in the webshop) | | |

| | | | |
|---|---|-----------------|--------|
|  | | | |
| 1 | | | |
| GEV No. | 360735 | Ref. No. | 216032 |
| description | indicator light ø 6mm yellow 12V cable length 280mm | | |
| For models: | 915160, 915161, 915162, 915175, 915319, 915611, 915612, 915613, 915663, 915670, 916247, 916248, 916249, 916250, 916251, 916252, 916365, 916366, 916382, 916383, 916452, 916504, 916584, 916670, 916688, 916763, 917044, 917049, Clean161, Fast160-2, Fast161-2, Fast170, Fast170S, Pluvia-240, Pluvia-260, Pluvia-270 | | |

| | | | |
|---|----------------------------------|-----------------|--------|
|  | | | |
| 1 | | | |
| GEV No. | 345960 | Ref. No. | 216022 |
| description | indicator light ø 6mm 230V green | | |
| For models: | CLEAN-3 | | |

| | | | |
|---|---|-----------------|-----------------|
|  | | | |
| 1 | | | |
| GEV No. | 359031 | Ref. No. | 926286 DEL15 |
| description | indicator light ø 6mm 230V green | | |
| For models: | CE78HZ23, E78, E78HP, RIVER-78, RIVER-E78 | | |

| | | | |
|---|-----------------------------------|-----------------|-------|
|  | | | |
| 1 | | | |
| GEV No. | 359032 | Ref. No. | DEL13 |
| description | indicator light ø 6mm 230V yellow | | |

ø10mm

with plug-in socket

| | | | |
|---|---|-----------------|--------|
|  | | | |
| 1 | | | |
| GEV No. | 359140 | Ref. No. | 216018 |
| description | indicator light ø 10mm yellow 230V connection male faston 6.3mm Qty 1 pcs | | |
| For models: | 10, 12, 14, 22F, 22R, 40F, 66, CLEAN-100, CLEAN-110, CLEAN-120 | | |

ø12mm

with plug-in socket

| | | | |
|---|--|-----------------|--------|
|  | | | |
| 1 | | | |
| GEV No. | 359044 | Ref. No. | 216020 |
| description | indicator light ø 12mm clear 230V connection male faston 6.3mm temp.-resist. 120°C Qty 1 pcs | | |
| For models: | 22F, 22R, 40F, 66 | | |

| | | | |
|---|--|-----------------|--------|
|  | | | |
| 1 | | | |
| GEV No. | 359041 | Ref. No. | 216019 |
| description | indicator light ø 12mm green 230V connection male faston 6.3mm temp.-resist. 120°C Qty 1 pcs | | |
| For models: | 22F, 22R, 40F, 66 | | |

| | | | |
|---|---|-----------------|------------------|
|  | | | |
| 1 | | | |
| GEV No. | 359042 | Ref. No. | 216012 216016 |
| description | indicator light ø 12mm yellow 230V connection male faston 6.3mm temp.-resist. 120°C Qty 1 pcs | | |
| For models: | 305, 305S, 306, 306S, 307, 307S, 308, 308S, 313, 313S, 314, 314S, 319, 319S, 320, 320S, 337, 338, 343, 344, 433, 434, 436, 437, 438, 439, FRI12, FRI12+12, FRI15, FRI15M, FRI6, FRI6+6, FRI9, FRI9+9, G33, G34, G37, G38, G39, ME15, ME20, ME30, ME40 | | |

28.5x28.5mm

| | | | |
|---|--|-----------------|--------|
|  | | | |
| 1 | | | |
| GEV No. | 345610 | Ref. No. | 207007 |
| description | indicator light lens 23x23 orange operating | | |
| For models: | 350F, 350FD, 350R, 350RD, 35-ELECTRONIC, 35F, 35FD, 35R, 35RD, 400F, 400FD, 400R, 400RD, 40-ELECTRONIC, 40F, 40FD, 40R, 40RD, 45, 450, 46, 460, 500F, 500FD, 50-ELECTRONIC, 50F, 50FD, 510F, 510FD, P500 | | |

| | | | |
|---|---|-----------------|--------|
|  | | | |
| 1 | | | |
| GEV No. | 345616 | Ref. No. | 207010 |
| description | indicator light lens 23x23 orange Sinus | | |

| | | | |
|---|---|-----------------|--------|
|  | | | |
| 1 | | | |
| GEV No. | 345614 | Ref. No. | 410008 |
| description | indicator light lens orange heating | | |
| For models: | 450, 46, 460, 500F, 500FD, 50F, 50FD, 510F, 510FD | | |



1

| | | | |
|--------------------|---|-----------------|--------|
| GEV No. | 345617 | Ref. No. | 207009 |
| description | indicator light lens orange thermometer | | |
| For models: | P500 | | |

miscellaneous



1

| | | | |
|--------------------|---|-----------------|--------|
| GEV No. | 359006 | Ref. No. | 226006 |
| description | indicator light white 230V | | |
| For models: | 31F, 31FD, 31R, 31RD, 440F, 44F, S621, S623, S624, S626, S631, S633, S634, S636, S641, S643, S651, S651P, S653, S654, S655, S810, S815, S830, S835, S850, S870, S950, SR651 | | |

LED

indicator lamps

mounting diameter 6mm



1

| | | | |
|--------------------|--|-----------------|--------|
| GEV No. | 359404 | Ref. No. | 216028 |
| description | indicator light LED mounting \varnothing 6mm 5VDC green connection cable 200mm 2mA | | |
| For models: | CE78HZ23, E.35H, E.40H, E78, E78HP, Fast181, FAST-181, Fast181-230V-3Ph-60Hz, Fast181-400V-3NPh-60Hz, HM1, PS-60, RIVER-E78, ST70FAST, ST70FASTHB, ST70FASTHB400, ST70FASTHZ23 | | |



1

| | | | |
|--------------------|---|-----------------|--------|
| GEV No. | 358098 | Ref. No. | 216029 |
| description | indicator light LED mounting \varnothing 6mm 5VDC yellow connection cable 200mm 2mA | | |
| For models: | CE78HZ23, E.35H, E.40H, E78, E78HP, Fast180, Fast180-230V-3Ph-60Hz, Fast181, FAST-181, Fast181-230V-3Ph-60Hz, Fast181-400V-3NPh-60Hz, FAST-60, FAST-73, HM1, PLUVIA-280, Pluvia280-230V-3PH-60HZ, PS-60, PV280, PV280FAST, PV280FAST2, PV280FAST2BIO, PV280FAST2HZ23, PV280FASTCH, PV280FASTHB, PV280HZ23, RIVER-E78, ST70FAST, ST70FASTHB, ST70FASTHB400, ST70FASTHZ23 | | |

screw-on/push-on fit

neon light bulbs



1

| | | | |
|--------------------|--|-----------------|--------|
| GEV No. | 345958 | Ref. No. | 216011 |
| description | neon light bulb socket Ba9s 230V \varnothing 10mm L 28mm | | |
| For models: | S850, S870, S950 | | |

timers

programme timers

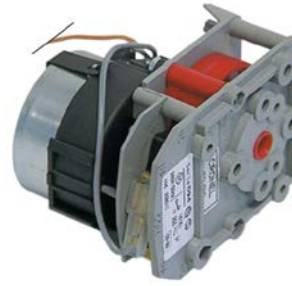

1

| | | | |
|--------------------|---|-----------------|------------------|
| GEV No. | 360005 | Ref. No. | 238011 238052 |
| description | timer BIGATTI D94 engines 1 chambers 1 operation time 20min 230V shaft \varnothing mm shaft Lmm manif. no. WE006 motor type 82354021L | | |
| For models: | 11F, 11FD, 11R, 11RD, 21F, 21FD, 21R, 21RD, 25F, 25FD, 25R, 25RD, 30F, 30FD, 30R, 30RD, 31F, 31FD, 31R, 31RD, 350F, 350FD, 350R, 350RD, 35-ELECTRONIC, 35F, 35FD, 35R, 35RD, 400F, 400FD, 400R, 400RD, 40-ELECTRONIC, 40F, 40FD, 40R, 40RD, 45, 450, 50-ELECTRONIC, 50F, 50FD, 67F, 67R, 913289, 913290, 913291, 913292, 913356...(Other models you can see in the webshop) | | |

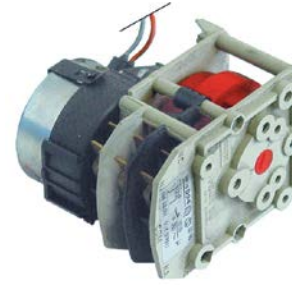

1

| | | | |
|--------------------|---|-----------------|-------|
| GEV No. | 360260 | Ref. No. | DTP31 |
| description | timer BIGATTI D94 engines 1 chambers 3 operation time 18min 230V shaft \varnothing mm shaft Lmm manif. no. COL001 motor type 82394831 | | |



1

| | | | |
|--------------------|---|-----------------|--------|
| GEV No. | 360004 | Ref. No. | 238003 |
| description | timer BIGATTI D94 engines 2 chambers 4 operation time 108s/168s 220-240V shaft \varnothing mm shaft Lmm manif. no. SER009 / 238003 motor type 82354018R / 82354017L | | |
| For models: | S651P, S810, S815, S830, S835 | | |

1

| | | | |
|--------------------|--|-----------------|--------|
| GEV No. | 360298 | Ref. No. | 238030 |
| description | timer BIGATTI D94 engines 2 chambers 4 operation time 3min/6min/9min 230V shaft ømm shaft Lmm manuf. no. WE004 motor type UDS40NE1LK operation time 3/6/9min | | |
| For models: | S950 | | |



1

| | | | |
|---|---|-----------------|---|
| GEV No. | 360349 | Ref. No. | 238046 238046.AG 238053 REB238046 REB238053 |
| description | timer CDC 11803 engines 1 chambers 3 operation time 150s 230V shaft ømm shaft Lmm manuf. no. 11803F1BEE000.0010 motor type M48R ATS type 11803F1 / 238046 | | |
| For models: | 11F, 11FD, 11R, 11RD, 21F, 21FD, 21R, 21RD, 25F, 25FD, 25R, 25RD, 30F, 30FD, 30R, 30RD, 31F, 31FD, 31R, 31RD, 350F, 350FD, 350R, 350RD, 400F, 400FD, 400R, 400RD, 450, 913289, 913290, 913291, 913292, 913356, 913357, 913363, 913364, 913372, 913373, 913374, 913375, 913376, 913377, 913416, 913418, 913435, 913544, 913545, 913665, 913666...(Other models you can see in the webshop) | | |
| spare parts for | 360349 | | |
|  | GEV No. | 360673 | Ref. No. — |
| | motor kit pinion ø 6.8mm teeth 15 230V voltage AC 50/60Hz turn direction clockwise motor ø 48mm H 18.5mm motor type UDS-40NE1RNZ165 cable length 150mm with holder | | |







1

| | | | |
|--------------------|---|-----------------|------------|
| GEV No. | 360723 | Ref. No. | RTFOC00030 |
| description | timer CDC 11903F3 engines 1 chambers 3 operation time 80min 230V shaft ø 6x4.6mm shaft L 18mm manuf. no. 11903F3EVE000.0000 | | |



1



| | | | |
|---|---|-----------------|-------------------------------|
| GEV No. | 360025 | Ref. No. | 238049 238050 238050.AG |
| description | timer CDC 7003F engines 1 chambers 3 operation time 360s 230V 50Hz shaft ø 6x7mm shaft L 26mm manuf. no. 7003F3 / 360025 motor type M37LN | | |
| For models: | 10, 12, 22F, 22R, 40F, 66, CLEAN-100, CLEAN-110, CLEAN-120 | | |
| spare parts for | 360025 | | |
|  | GEV No. | 360131 | Ref. No. — |
| | motor CDC pinion ø 5.4mm teeth 12 230V turn direction left motor ø 37mm motor type M37LN for timer | | |
| accessories for | 360025 | | |
|  | GEV No. | 110085 | Ref. No. 226051 |
| | push button t.max.°C°C ø 36mm shaft ømm shaft flat grey for knob | | |
|  | GEV No. | 110086 | Ref. No. 447089 |
| | knob switch zero mark t.max.°C°C ø 45mm shaft ømm shaft flat special black | | |
|  | GEV No. | 110087 | Ref. No. 499066 |
| | retaining ring shaft ø 8mm DIN 471 | | |





1

| | | | |
|---|---|-----------------|-------------------|
| GEV No. | 360132 | Ref. No. | 238060 |
| description | timer CDC 7801 engines 1 chambers 1 operation time 20min 230V shaft ømm shaft Lmm manuf. no. 7801F1 / 360132 motor type M37RN | | |
| For models: | 46, 500F, 500FD, 50F, 50FD, 510F, 510FD | | |
| spare parts for | 360132 | | |
|  | GEV No. | 360119 | Ref. No. — |
| | motor CDC pinion ø 5.4mm teeth 12 230V turn direction right motor ø 37mm motor type M37RN for timer | | |



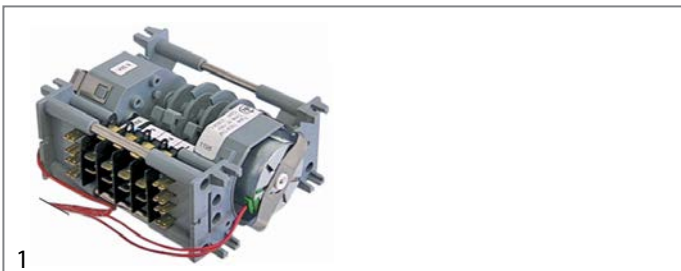

| | | | |
|---|---|-----------------|-------------------|
| GEV No. | 360133 | Ref. No. | 238066 |
| description | timer CDC 7804DV engines 2 chambers 4 operation time 60s / 20min 230V shaft ømm shaft Lmm manif. no. 7804DV / 360133 motor type M37RN/M37LN | | |
| For models: | 2312-001, 2312-002, 460, 500F, 500FD, 510F, 510FD, 913297, 913298, 913299, 913300, 913360, 913361, 913391, 913392, 913546, 913547, 913578, 913611, 913684, 913932, 913933, 914331, 914400, 914401, 914402, 914403, 914404, 914405, 914449, 914517, 914545, 914568, 914688, 914979, 915140, 915248, E.46, E.50, E.50D.PA, E.51, E.52, GSP50, GSP50P, GSP51, GSP51P, LF50, LF55, MC501E, MC501EP... (Other models you can see in the webshop) | | |
| spare parts for | 360133 | | |
|  | GEV No. | 360119 | Ref. No. — |
| | motor CDC pinion ø 5.4mm teeth 12 230V turn direction right motor ø 37mm motor type M37RN for timer | | |
|  | GEV No. | 360131 | Ref. No. — |
| | motor CDC pinion ø 5.4mm teeth 12 230V turn direction left motor ø 37mm motor type M37LN for timer | | |



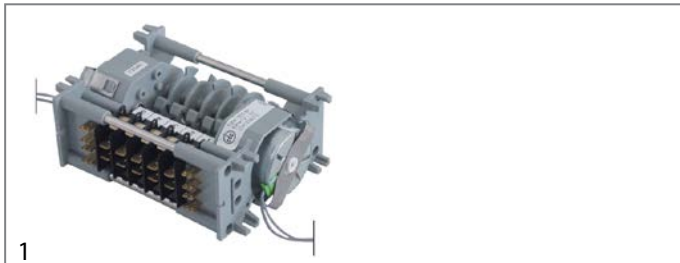

| | | | |
|---|---|-----------------|-------------------|
| GEV No. | 360134 | Ref. No. | 238061 |
| description | timer CDC 7804DV engines 2 chambers 4 operation time 6s / 3min 230V shaft ømm shaft Lmm manif. no. 7804DV / 360134 motor type M37RN/M37LN | | |
| For models: | 500F, 500FD, 50F, 50FD, 510F, 510FD | | |
| spare parts for | 360134 | | |
|  | GEV No. | 360119 | Ref. No. — |
| | motor CDC pinion ø 5.4mm teeth 12 230V turn direction right motor ø 37mm motor type M37RN for timer | | |
|  | GEV No. | 360131 | Ref. No. — |
| | motor CDC pinion ø 5.4mm teeth 12 230V turn direction left motor ø 37mm motor type M37LN for timer | | |



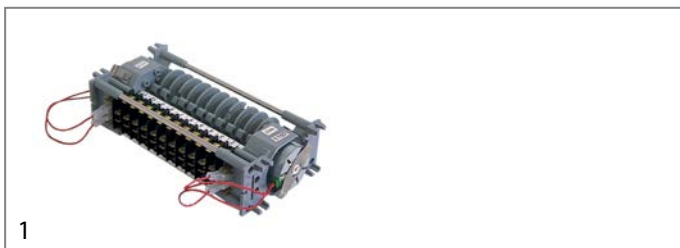

| | | | |
|---|---|-----------------|-------------------|
| GEV No. | 360264 | Ref. No. | 238073 |
| description | timer CDC 7805DV engines 2 chambers 5 operation time 72s/20min 230V shaft ømm shaft Lmm manif. no. 7805DV / 238073 motor type M37RN/M37LN | | |
| For models: | 914326, 914406, E.55 | | |
| spare parts for | 360264 | | |
|  | GEV No. | 360119 | Ref. No. — |
| | motor CDC pinion ø 5.4mm teeth 12 230V turn direction right motor ø 37mm motor type M37RN for timer | | |
|  | GEV No. | 360131 | Ref. No. — |
| | motor CDC pinion ø 5.4mm teeth 12 230V turn direction left motor ø 37mm motor type M37LN for timer | | |

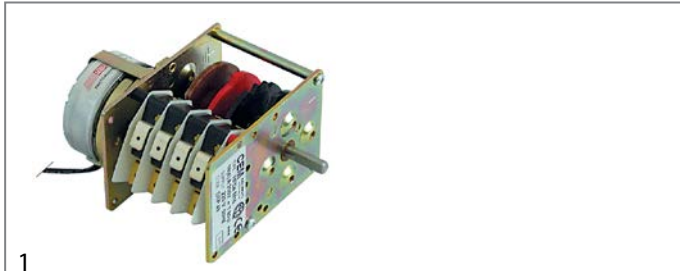

| | | | |
|---|--|-----------------|-------------------|
| GEV No. | 360124 | Ref. No. | 238067 |
| description | timer CDC 7811DV engines 2 chambers 11 operation time 90s / 20min 230V shaft ømm shaft Lmm manif. no. 7811DV / 238067 motor type M37RN/M37LN | | |
| For models: | CLEAN-3 | | |
| spare parts for | 360124 | | |
|  | GEV No. | 360119 | Ref. No. — |
| | motor CDC pinion ø 5.4mm teeth 12 230V turn direction right motor ø 37mm motor type M37RN for timer | | |
|  | GEV No. | 360131 | Ref. No. — |
| | motor CDC pinion ø 5.4mm teeth 12 230V turn direction left motor ø 37mm motor type M37LN for timer | | |



| | | | |
|---|---|-----------------|-------------------|
| GEV No. | 360089 | Ref. No. | 926122 DTP49 |
| description | timer CEM HFD4M16 engines 1 chambers 4 operation time 180s 230V shaft ø 6x4.6mm shaft L 17mm manif. no. HFD4M16 / DTP49 motor type UDS11NE1RH | | |
| spare parts for | 360089 | | |
|  | GEV No. | 360112 | Ref. No. — |
| | motor SAIA pinion ø 4mm teeth 12 230V turn direction right motor ø 48mm motor type UDS11NE1RHZ for timer | | |





1

| | | | |
|---|---|-----------------|-------------------|
| GEV No. | 360019 | Ref. No. | DTP14 |
| description | timer CEM HFD4M16 engines 1 chambers 4 operation time 255s 230V shaft ø 6x4.6mm shaft L 17mm manif. no. HFD4M16 / DTP14 motor type UDS11NE1RH | | |
| spare parts for | 360019 | | |
|  | GEV No. | 360112 | Ref. No. — |
| | motor SAIA pinion ø 4mm teeth 12 230V turn direction right motor ø 48mm motor type UDS11NE1RHZ for timer | | |





1

| | | | |
|---|---|-----------------|-------------------|
| GEV No. | 360028 | Ref. No. | DTP15 |
| description | timer CEM HFD4M16 engines 1 chambers 4 operation time 270s 230V shaft ø 6x4.6mm shaft L 17mm manif. no. HFD4M16 / DTP15 motor type UDS11NE1RH | | |
| spare parts for | 360028 | | |
|  | GEV No. | 360112 | Ref. No. — |
| | motor SAIA pinion ø 4mm teeth 12 230V turn direction right motor ø 48mm motor type UDS11NE1RHZ for timer | | |



1

| | | | |
|---|---|-----------------|-------------------|
| GEV No. | 360030 | Ref. No. | DTP21 |
| description | timer CEM HL6M16 engines 2 chambers 6 operation time 60s/120s 230V shaft ømm shaft Lmm manif. no. HL6M16 / DTP21 motor type UDS11NE1RH / UDS11NE1LH | | |
| spare parts for | 360030 | | |
|  | GEV No. | 360112 | Ref. No. — |
| | motor SAIA pinion ø 4mm teeth 12 230V turn direction right motor ø 48mm motor type UDS11NE1RHZ for timer | | |
|  | GEV No. | 360113 | Ref. No. — |
| | motor SAIA pinion ø 4mm teeth 12 230V turn direction left motor ø 48mm motor type UDS40NE1RNZ165 for timer | | |





1

| | | | |
|---|--|-----------------|-------------------|
| GEV No. | 360125 | Ref. No. | 238069 |
| description | timer FIBER P25 engines 1 chambers 1 operation time 15s-14.4min 230V shaft ømm shaft Lmm manif. no. P255JC11JK7 motor type M51BJOR6400 | | |
| For models: | CLEAN-3 | | |
| spare parts for | 360125 | | |
|  | GEV No. | 360673 | Ref. No. — |
| | motor kit pinion ø 6.8mm teeth 15 230V voltage AC 50/60Hz turn direction clockwise motor ø 48mm H 18.5mm motor type UDS-40NE1RNZ165 cable length 150mm with holder | | |

mechanical timers



1

| | | | |
|---|--|-----------------|-------------------|
| GEV No. | 350028 | Ref. No. | 222001 923012 |
| description | timer G 2-pole operation time 15min impulse mechanical 2NO at 250V 16A permanent position no shaft ø 3.5 x 3.5mm shaft 3.5x3.5mm shaft L 17mm mounting distance 28mm mounting thread M8 connection lateral | | |
| For models: | 404, 406, 412 | | |
| accessories for | 350028 | | |
|  | GEV No. | 110365 | Ref. No. — |
| | knob switch zero mark t.max.°C ø 44mm shaft ø 3.5x3.5mm shaft flat black | | |
|  | GEV No. | 110371 | Ref. No. — |
| | dial plate graduation 15min permanent position no rotation 30-330° ø 60mm timers knob ø 45mm | | |



contactors

LS Industrial Systems

power contactors



1

| | | | |
|--------------------|--|-----------------|------------------------|
| GEV No. | 381167 | Ref. No. | 229042 H.775599-001 |
| description | power contactor resistive load 20A 230VAC (AC3/400V) 9A/4kW main contacts 4NO auxiliary contacts connection screw connection type GMC-9M/4 | | |
| For models: | 913913, 913914, 914284, 914318, 914319, 914338, 914356, 914431, 914642, 914909, 915136, 915137, 915150, 915151, 915152, 915154, 915155, 915157, 915158, 915160, 915161, 915162, 915166, 915167, 915168, 915172, 915173, 915175, 915285, 915319, 915348, 915420, 915421, 915422, 915479, 915492, 915493, 915494, 915495, 915496, 915497, 915547, 915558, 915635, 915663, 915729, 915747, 916021, 916025, 916027...(Other models you can see in the webshop) | | |

GENERAL ELECTRIC (AEG)

power contactors



1

| | | | |
|--------------------|---|-----------------|--------|
| GEV No. | 380231 | Ref. No. | 926147 |
| description | power contactor resistive load 16A 230VAC (AC3/400V) 6A/3kW main contacts 3NO auxiliary contacts 1NC connection screw connection type AEG LS0701A | | |
| For models: | CLEAN-110, CLEAN-120, E.65, E110, E12, E120, E14, E140, River-285, RV282R, U132, U61, U61H, U70 | | |



1

| | | | |
|--------------------|--|-----------------|--------|
| GEV No. | 380239 | Ref. No. | 926040 |
| description | power contactor resistive load 20A 230VAC (AC3/400V) 8.4A/4kW main contacts 3NO auxiliary contacts 1NC connection screw connection type LS05 01A type AEG LS05 01A type GE MC1A 301A | | |
| For models: | 12, 14 | | |



1

| | | | |
|--------------------|--|-----------------|--------|
| GEV No. | 380238 | Ref. No. | 229032 |
| description | power contactor resistive load 20A 230VAC (AC3/400V) 8.4A/4kW main contacts 3NO auxiliary contacts 1NO connection screw connection type LS0510A type AEG LS0510A type GE MC1A 310A | | |
| For models: | 050F, 050FP, 12, 22F, 440F, 44F, F85, F85P, FRI12, FRI12+12, FRI15, FRI15M, FRI6, FRI6+6, FRI9, FRI9+9, MISTRAL-51, NIAGARA-51, S950, U132, U61, U61H, U70 | | |



1

| | | | |
|--------------------|---|-----------------|--------------------------------------|
| GEV No. | 380245 | Ref. No. | 229010 229011 229019 929122 |
| description | power contactor resistive load 25A 230VAC (AC3/400V) 9A/4kW main contacts 3NO auxiliary contacts 1NC connection screw connection type AEG LS4K 01A type GE CL00A 301 H 85mm | | |
| For models: | 500F, 500FD, 66, E.65, E110, E12, E120, E14, E140, FRI12, FRI12+12, FRI15, FRI15M, FRI6, FRI6+6, FRI9, FRI9+9, S651, S651P, S653, S654, S655, S810, S815, S830, S835, S850, S870, S950, SR651 | | |



1

| | | | |
|--------------------|--|-----------------|--------------------|
| GEV No. | 381191 | Ref. No. | 926282 DTC112NO |
| description | power contactor resistive load 25A 400VAC (AC3/400V) 12A/5.5kW main contacts 3NO auxiliary contacts 1NO connection screw connection type AEG type GE CL01A310T6 | | |
| For models: | 80, 81, 82, CGL74CABT, KLP105EB, KLP201DDDDTEB, KLP201EB, KLP301, KLP301DDDDTEB, LP105DDDDTEB, LP105DDDDTEBN, LP105EB, LP201DDDDTEB, LP201EB, LP301, LP301EB, Niagara-283A, River-285, River-81CRP, RIVER-81-CRP, RIVER-82, River-82CRP, RIVER-82-CRP, RIVER-HL-82, RV282R, RV81CCRP, RV81CRP, RV82, RV8223, RV82C, RV82CCRP, RV82CRP, SevenL, SV72AEB, U132e, U61E, U61HE, U70e | | |



ISKRA (FANAL)

power contactors



1

| | | | |
|--------------------|--|-----------------|--------|
| GEV No. | 380423 | Ref. No. | 229016 |
| description | power contactor resistive load 35A 230VAC (AC3/400V) 25A/11kW main contacts 3NO auxiliary contacts connection screw connection type Fanal DSL22 type ISKRA KNL22 | | |
| For models: | 337, 338, 343, 344, 440F, 44F, ME15, ME20, ME30, ME40, S950 | | |

SIEMENS

power contactors



1

| | | | |
|--------------------|---|-----------------|-------|
| GEV No. | 381387 | Ref. No. | 73350 |
| description | power contactor resistive load 22A 230VAC (AC3/400V) 4kW main contacts 3NO auxiliary contacts 1NO connection screw connection type 3RT2016-1AP01 | | |
| For models: | CNT800CH, Fast180, Fast180-230V-3Ph-60Hz, Fast181, Fast200, Fast93, GL280EB, GL280EB23, GL280EB23DAR, GL280EB23HZ, GL280EB23HZDY, GL280EBDARY, GL280EBDAW, GL280EBDAY, GL280EBDB, GL280EBDBR, GL280EBDWY, GL280EBSA, GL280EBSAE, GL280EBSAEW, GL280EBSAEWY, GL280EBSAR, GL280EBSARY, GL280EBSAW, GL280EBSAWY, GL280EBSAY, GL280EBSB, GL280EBSR, GL280EBSWY, GL282EB, GL282EB93, GL282EB93DA, GL282EB-93HZ23, GL282EBCH, GL282EBDA, GL282EBDARW, GL282EBDAWY, GL282EBDBW, GL282EBDCWY, GL282EBHZ23, GL282EBHZ23DY, GL282EBHZ23SY, GL282EBSA, GL282EBSAEW, GL282EBSAEWY, GL282EBSAP, GL282EBSAR, GL282EBSAW, GL282EBSBR, GL282EBSY... (Other models you can see in the webshop) | | |



1

| | | | |
|--------------------|---|-----------------|-----------------|
| GEV No. | 380389 | Ref. No. | 229037 80350 |
| description | power contactor resistive load 22A 230VAC (AC3/400V) 9A/4kW main contacts 3NO auxiliary contacts 1NO connection screw connection type 3RT10-16-1AP01 | | |
| For models: | 2312-007, 2312-009-CRP, 80, 81, 82, 914100, 914101, 914339, 914342, 914343, 914624, 914625, 914626, 914627, 914628, 914850, 914851, 914854, 914944, CE78HZ23, CGL74CABT, E78, E78HP, HM1, KLP105EB, KLP201DDDTTEB, KLP201EB, KLP301, KLP301DDDTTEB, LP105DDDTTEB, LP105DDDTTEBN, LP105EB, LP201DDDTTEB, LP201EB, LP301, LP301EB, LP60, NIAGARA-271, RIVER-150, RIVER-48, RIVER-50, RIVER-50-CRP, RIVER-50-CRP-SP, RIVER-54, RIVER-54CRP, River-54-CRP-s.p., RIVER-54-CRP-SP, RIVER-61, RIVER-71, RIVER-78...(Other models you can see in the webshop) | | |



1

| | | | |
|--------------------|--|-----------------|------------------|
| GEV No. | 380957 | Ref. No. | 927051 927160 |
| description | power contactor resistive load 22A 24VAC (AC3/400V) 12A/5.5kW main contacts 3NO auxiliary contacts 1NO connection screw connection type 3RT10-17-1AB01 50/60Hz | | |
| For models: | A3EBD, A3EBDAKWK, A3EBDBKWK, A3EBDWK, A3EBDYK, A3EBSAK, A3EBSAKWK, A3EBSBKWKYK, A3EBSWK, A4EBD, A4EBS, A4EBSAKRK, A4EBSAKYK, A4EBSCK, A5EBD, A5EBDAKPKWK, A5EBDAKWK, A5EBS, A5EBSAKPKWK, A5EBSYK, CLEAN-361, CLEAN-361P, CLEAN-471, CLEAN-471P, RIVER-MULTI-2252, RIVER-MULTI-2256, RIVER-MULTI-2258 | | |



1

| | | | |
|--------------------|--|-----------------|-------|
| GEV No. | 381393 | Ref. No. | 73351 |
| description | power contactor resistive load 40A 230VAC (AC3/400V) 12A/5.5kW main contacts 3NO auxiliary contacts 1NC/1NO connection screw type 3RT2024-1AL20 | | |
| For models: | Fast200, Fast93, GL280EB, GL280EB23, GL280EB23DAR, GL280EB-23HZ, GL280EB23HZDY, GL280EBDARY, GL280EBDAW, GL280EBDAY, GL280EBDB, GL280EBDBR, GL280EBDWY, GL280EBSA, GL280EBSAE, GL280EBSAEW, GL280EBSAEWY, GL280EBSAR, GL280EBSARY, GL280EBSAW, GL280EBSAWY, GL280EBSAY, GL280EBSB, GL280EBSR, GL280EBSWY, GL282EB, GL282EB93, GL282EB93DA, GL282EB-93HZ23, GL282EBCH, GL282EBDA, GL282EBDARW, GL282EBDAWY, GL282EBDBW, GL282EBDCWY, GL282EBHZ23, GL282EBHZ23DY, GL282EBHZ23SY, GL282EBSA, GL282EBSAEW, GL282EBSAEWY, GL282EBSAP, GL282EBSAR, GL282EBSAW, GL282EBSBR, GL282EBSY, GL284EB, GL284EBDA, GL284EBDAEW, GL284EBDPWY...(Other models you can see in the webshop) | | |



| | | | |
|--------------------|--|-----------------|-------|
| 1 | | | |
| GEV No. | 380390 | Ref. No. | 80351 |
| description | power contactor resistive load 40A 230VAC (AC3/400V) 12A/5.5kW main contacts 3NO auxiliary contacts connection screw connection type 3RT10-24-1AL20 50/60Hz | | |
| For models: | 914380, 914436, FAST-181, Fast181-230V-3Ph-60Hz, Fast181-400V-3NPh-60Hz, FAST-200, GL280EB, GL280EBD, GL280EBDA, GL280EBDAE, GL280EBDAR, GL280EBDAWY, GL280EBDBW, GL280EBDY, GL280EBS, GL280EBSY, GL282EB, GL282EBCH, GL282EBCHD, GL282EBD, GL282EBDAE, GL282EBDAR, GL284EBD, GL284EBDAWY, GL284EBS, GL284EBSAR, GL286EBD, GL286EBDARY, GL286EBS, GL286EBSAW, NIAGARA-2150, NIAGARA-2152, NIAGARA-2154, NIAGARA-2156, RIVER-150, RIVER-152, RIVER-154, RIVER-298, RIVER-80, RIVER-81, RIVER-82, RV150, RV15023, RV15023DA, RV150D, RV150DA, RV150DAR, RV150DARY, RV150DAW, RV150DAWY...(Other models you can see in the webshop) | | |

auxiliary contacts



| | | | |
|--------------------|--|-----------------|------|
| 1 | | | |
| GEV No. | 381389 | Ref. No. | DEI4 |
| description | auxiliary contact contacts 1NO/1NC AC15 6A for contactors 3RT1 connection screw AC1 10A type 3RH1921-1DA11 | | |
| For models: | FAST-181, Fast181-230V-3Ph-60Hz, Fast181-400V-3NPh-60Hz, RIVER-282L-2, RIVER-282LS-2TDE, RIVER-298, RIVER-382L, RIVER-382L-230V-3Ph-50Hz, RIVER-382LNRG, RIVER-382LTDE, RIVER-482, RV298, RV298HZ, RV382L, RV382L23TERMO, RV382LFUR, RV382LR, RV382LS, RV382LSFUR, RV382LTX, RV382LTXR, RV482, ST70FASTHB, ST70FASTHB400 | | |

motor protection circuit breakers



| | | | |
|--------------------|---|-----------------|-----------------|
| 1 | | | |
| GEV No. | 380541 | Ref. No. | 927368 DEI35 |
| description | motor protection circuit breaker type 3RV1011-0JA10 setting range 0.7-1A (AC3/400V) 0.25kW | | |
| For models: | 914380, 914436, 915819, A3EBD, A3EBDAKRKYK, A3EBDAKW, A3EBDBKWK, A3EBDRKYK, A3EBDWK, A3EBDYK, A3EBSAK, A3EBSAKRK, A3EBSAKWK, A3EBSBKWKYK, A3EBSKWK, A3EBSWK, A4EBD, A4EBDAKEYK, A4EBDAKRK, A4EBDBKRK, A4EBDRK, A4EBS, A4EBSAKCK, A4EBSAKEKYK, A4EBSAKRK, A4EBSAKRKPK, A4EBSAKYK, A4EBSCK, A5EBD, A5EBDAKPKWK, A5EBDAKW, A5EBDRK, A5EBS, A5EBSAKPKWK, A5EBSAKRK, A5EBSAKRKYK, A5EBSBKRPK, A5EBSBKWK, A5EBSRK, A5EBSYK, CLEAN-161, CLEAN-221, CLEAN-271, CLEAN-272, CLEAN-362, FAST-200, GL280EB, GL280EB23DAR, GL280EBD, GL280EBDA...(Other models you can see in the webshop) | | |



| | | | |
|--------------------|--|-----------------|--------|
| 1 | | | |
| GEV No. | 381190 | Ref. No. | DEI395 |
| description | motor protection circuit breaker type 3RV1021-4AA10 setting range 11-16A contacts 3NO connection screw | | |

relays

power relays

with DIN rail mounting

lateral



| | | | |
|--------------------|--|-----------------|--------|
| 1 | | | |
| GEV No. | 380313 | Ref. No. | 229036 |
| description | power relays FINDER 230VAC 16A 3CO connection male faston DIN rail manuf. no. 62.83.8.230.0008 | | |
| For models: | 050F, 050FP, CE78HZ23, E.51, E.55, E78, E78HP, F85, F85P, LF55, MC501E, MC501EP, MISTRAL-51, NIAGARA-51, PS-60, RIVER-152, RIVER-43, RIVER-78, RIVER-E78 | | |

with flange mounting



| | | | |
|--------------------|---|-----------------|---------|
| 1 | | | |
| GEV No. | 380131 | Ref. No. | 2290009 |
| description | power relays Italiana Relè 230VAC 16A 3CO connection male faston 6.3mm screw mounting manuf. no. B2-3-230AC | | |

1

| | | | |
|--------------------|---|-----------------|--------|
| GEV No. | 380130 | Ref. No. | 229008 |
| description | power relays Italiana Relè 230VAC 16A 3NO connection male faston 6.3mm screw mounting manuf. no. B1-3-230AC | | |



1

| | | | |
|--------------------|--|-----------------|------------------|
| GEV No. | 380702 | Ref. No. | 229039 229040 |
| description | power relays FINDER 230VAC 16A 3NO connection male faston 6.3mm flange dimensions 36x38x68mm manuf. no. 62.83.8.230.0300 230V | | |
| For models: | 913297, 913298, 913299, 913300, 913360, 913361, 913391, 913392, 913418, 913546, 913547, 913578, 913611, 913684, 913911, 913912, 913913, 913914, 913932, 913933, 913950, 913977, 913984, 913990, 913992, 913993, 914165, 914166, 914167, 914168, 914206, 914214, 914284, 914316, 914317, 914318, 914319, 914326, 914331, 914338, 914355, 914356, 914398, 914399, 914400, 914401, 914402, 914403, 914404, 914405...(Other models you can see in the webshop) | | |

with bracket mounting



1

| | | | |
|--------------------|--|-----------------|------------------|
| GEV No. | 380312 | Ref. No. | 229023 229024 |
| description | power relays FINDER 230VAC 10A 3CO connection male faston 4.8mm bracket mounting dimensions 52x32.2x36.5mm manuf. no. 60.63.8.230.0000 | | |
| For models: | 10, 12, 14, 21F, 21FD, 21R, 21RD, 22F, 22R, 2312-001, 2312-002, 25F, 25FD, 25R, 25RD, 30F, 30FD, 30R, 30RD, 31F, 31FD, 31R, 31RD, 40F, 440F, 460, 500F, 500FD, 510F, 510FD, 66, 913289, 913290, 913291, 913292, 913297, 913298, 913299, 913300, 913356, 913357, 913360, 913361, 913363, 913364, 913372, 913373, 913374, 913375, 913376...(Other models you can see in the webshop) | | |



1

| | | | |
|--------------------|--|-----------------|--------|
| GEV No. | 380311 | Ref. No. | 229030 |
| description | power relays Italiana Relè 230VAC 20A 1NC/1NO connection F6.3 bracket mounting manuf. no. A1B-230AC-FA | | |
| For models: | 11F, 11FD, 11F-DVGW, 11R, 11RD, 21F, 21FD, 21R, 21RD, 22F, 25F, 25FD, 25R, 25RD, 30F, 30FD, 30R, 30RD, 31F, 31FD, 31R, 31RD, 350F, 350FD, 350R, 350RD, 400F, 400FD, 400R, 400RD, 440F, 44F, 450, 460, 500F, 500FD, 50F, 50FD, 510F, 510FD, CLEAN-3, E.45, E.46, E.50, E.51, E.52, TF-503, TF-513, TF-515 | | |



1

| | | | |
|--------------------|--|-----------------|------------------|
| GEV No. | 380139 | Ref. No. | 926021 929115 |
| description | power relays FINDER 230VAC 16A 2CO connection F6.3 bracket mounting dimensions 68x38.2x35.8mm manuf. no. 62.82.8.230.0000 | | |
| For models: | 10, 2312-001, 2312-002, 80, 81, 82, 914380, 914436, 915747, CE78HZ23, CGL74CABT, CLEAN-100, E.50, E.51, E.60, E.65, E1, E10, E100, E110, E12, E120, E14, E140, E78, E78HP, Fast181, FAST-181, Fast181-230V-3Ph-60Hz, Fast181-400V-3NPh-60Hz, Fast200, FAST-200, Fast93, GL280EB, GL280EB23, GL280EB23DAR, GL280EB23HZ, GL280EB23HZDY, GL280EBD, GL280EBDA, GL280EBDAE, GL280EBDAR, GL280EBDARY, GL280EBDAW, GL280EBDAWY, GL280EBDAY, GL280EBDB, GL280EBDBR, GL280EBDBW, GL280EBDWY...(Other models you can see in the webshop) | | |



1

| | | | |
|--------------------|--|-----------------|----------------------------|
| GEV No. | 380185 | Ref. No. | 229025 229029 DER111 |
| description | power relays Italiana Relè 230VAC 30A 1NO connection F6.3 bracket mounting dimensions 36.5x32.2x51.8mm manuf. no. A10-230AC-FA | | |
| For models: | 050F, 050FP, 10, 22F, 22R, 2312-007, 2312-009-CRP, 440F, 44F, 46, 500F, 500FD, 50-ELECTRONIC, 50F, 50FD, 510F, 510FD, 80, 81, 913297, 913298, 913299, 913300, 913360, 913361, 913391, 913392, 913546, 913547, 913578, 913611, 913684, 913913, 913914, 913932, 913933, 914100, 914101, 914284, 914318, 914319, 914326, 914331, 914338, 914339, 914342, 914343, 914356, 914400, 914401...(Other models you can see in the webshop) | | |



with male contacts

bullet connectors, 8 contacts



| | | | | |
|------------------------|---|-----------------|-----------------|--------|
| 1 | | | | |
| GEV No. | 380135 | Ref. No. | 927044 | |
| description | power relays FINDER 24VAC 10A 2CO connection plug-in connection round 8-pole manif. no. 60.12.8.024.0040 90.26/ZVE8 250V 8-pole | | | |
| For models: | 161, 221, 271, 272, 362, CLEAN-160, CLEAN-161, CLEAN-220, CLEAN-221, CLEAN-270, CLEAN-271, CLEAN-272, CLEAN-361, CLEAN-361P, CLEAN-362, CLEAN-471, CLEAN-471P | | | |
| accessories for | 380135 | | | |
| | GEV No. | 380137 | Ref. No. | 927045 |
| | relay socket 8-pole connection plug-in connection round 8-pole dimensions 65x28x40mm 380V voltage AC 10A Italiana Relè manuf. no. ZVE8 | | | |
| | GEV No. | 380638 | Ref. No. | — |
| | relay socket 8-pole dimensions 51x41x23mm 250V 10A FINDER manuf. no. 90.26 | | | |

relay sockets



| | | | | |
|------------------------|---|-----------------|-----------------|---|
| 1 | | | | |
| GEV No. | 380137 | Ref. No. | 927045 | |
| description | relay socket 8-pole connection plug-in connection round 8-pole dimensions 65x28x40mm 380V voltage AC 10A Italiana Relè manuf. no. ZVE8 | | | |
| For models: | 161, 221, 271, 272, 362, CLEAN-160, CLEAN-161, CLEAN-220, CLEAN-221, CLEAN-270, CLEAN-271, CLEAN-272, CLEAN-361, CLEAN-361P, CLEAN-362, CLEAN-471, CLEAN-471P | | | |
| accessories for | 380137 | | | |
| | GEV No. | 380805 | Ref. No. | — |
| | support bracket | | | |

time relays

time relays



| | | | | |
|--------------------|---|-----------------|--------|--|
| 1 | | | | |
| GEV No. | 380611 | Ref. No. | 929113 | |
| description | time relay FINDER 81.01.0.230 time range 0.1s-10h 12-230V AC/DC 16A mounting measurements DIN railmm 1CO connection grip connection | | | |
| For models: | 161, 221, 271, 272, 362, CLEAN-161, CLEAN-221, CLEAN-271, CLEAN-272, CLEAN-362, E.60, E.65, E1, E10, E100, E110, E12, E120, E14, E140 | | | |



| | | | | |
|--------------------|---|-----------------|----------|--|
| 1 | | | | |
| GEV No. | 380612 | Ref. No. | DET237BT | |
| description | time relay FINDER 81.11.0.024.0000 12-240V AC/DC 16A 1CO connection grip connection | | | |
| For models: | River-285, RV282R | | | |

transformers

open transformers

with clamp terminal



| | | | | |
|--------------------|--|-----------------|--------|--|
| 1 | | | | |
| GEV No. | 401604 | Ref. No. | DET313 | |
| description | transformer primary 230/400VAC secondary 12VAC 160VA | | | |



electronic controllers

LAE

universal controllers

built-in version



1

| | | | |
|--------------------|--|-----------------|--------|
| GEV No. | 378340 | Ref. No. | 927289 |
| description | electronic controller LAE type AC1-5PS1RD mounting measurements 71x29mm 12V voltage AC/DC Pt100 relay outputs 1 CO-12A(4) Pt100 built-in depth 70mm protection IP54 built-in version defr. funct. -100 up to +850°C display 3 digits | | |

miscellaneous

electronic thermometers



1

| | | | |
|--------------------|--|-----------------|--------|
| GEV No. | 402047 | Ref. No. | DET164 |
| description | thermometer 14V voltage AC/DC display 2 digit PTC temperature restriction 0-60°C incl. probe | | |



1

| | | | |
|--------------------|---|-----------------|--------|
| GEV No. | 403327 | Ref. No. | 927333 |
| description | thermometer ARTERMO type ROF-DIG/12 mounting measurements 58x26mm 12V voltage AC -30 jusqu'à +110°C measuring input NTC display 3 digits front measurements 64x31mm | | |
| For models: | 161, 221, 271, 272, 362, CLEAN-161, CLEAN-221, CLEAN-271, CLEAN-272, CLEAN-362 | | |

probes

universal probes

temperature probes



1

| | | | |
|--------------------|--|-----------------|--------|
| GEV No. | 379142 | Ref. No. | 927335 |
| description | temperature probe PTC 1kOhm cable PVC probe -50 up to +150°C cable -10 up to 100°C probe ø6x30mm cable length 1.5m without screw connection 2-wire | | |
| For models: | 161, 221, 271, 272, 362, CLEAN-161, CLEAN-221, CLEAN-271, CLEAN-272, CLEAN-362 | | |

producer-specific probes

probes



1

| | | | |
|--------------------|--|-----------------|--------|
| GEV No. | 403942 | Ref. No. | 231016 |
| description | temperature probe | | |
| For models: | 913911, 913912, 913913, 913914, 913950, 913977, 913990, 914167, 914168, 914284, 914516, 914543, 914612, 915138, 915143, 915150, 915151, 915152, 915154, 915155, 915157, 915158, 915160, 915161, 915162, 915166, 915167, 915168, 915172, 915173, 915175, 915319, 915348, 915420, 915421, 915422, 915479, 915492, 915493, 915494, 915495, 915496, 915497, 915547, 915558, 915611, 915612, 915613, 915614, 915615...(Other models you can see in the webshop) | | |



1

| | | | |
|--------------------|---|-----------------|--------|
| GEV No. | 379101 | Ref. No. | 231006 |
| description | temperature probe NTC 10kOhm cable PVC probe -40 up to +110°C cable -10 up to 100°C connection plug thread probe ø4.5x30mm cable length 0.35m | | |
| For models: | 35-ELECTRONIC, 35F, 35FD, 35R, 35RD, 40-ELECTRONIC, 40F, 40FD, 40R, 40RD, 44F, 45, 46, 50-ELECTRONIC, 50F, 50FD | | |



1

| | | | |
|--------------------|---|-----------------|--------|
| GEV No. | 400910 | Ref. No. | 231014 |
| description | temperature probe NTC 10kOhm cable silicone probe -40 up to +110°C cable -50 up to +180°C connection coded plug thread probe ø4.5x30mm cable length 0.35m | | |
| For models: | 050F, 050FP, 2312-007, 2312-009-CRP, 80, 81, 82, 913977, 913984, 913992, 913993, 914100, 914101, 914165, 914166, 914206, 914214, 914316, 914317, 914318, 914319, 914338, 914339, 914342, 914343, 914355, 914356, 914380, 914431, 914436, 914516, 914543, 914583, 914592, 914613, 914624, 914625, 914626, 914627, 914628, 914642, 914684, 914850, 914851, 914854, 914874, 914909, 914943, 914944, 915136...(Other models you can see in the webshop) | | |



1

| | | | |
|--------------------|--|-----------------|--------|
| GEV No. | 403103 | Ref. No. | 927172 |
| description | temperature probe Pt100 cable PTFE probe -100 up to 450°C cable -40 up to +250°C connection 3-wire thread probe ø6x70mm cable length 10m | | |

accessories

miscellaneous



1

| | | | |
|--------------------|------------------------------|-----------------|--------|
| GEV No. | 379905 | Ref. No. | 231008 |
| description | extension | | |
| For models: | 46, 50-ELECTRONIC, 50F, 50FD | | |

electric components



electronics

electronics accessories



| | | | |
|--------------------|---|-----------------|--------|
| 1 | | | |
| GEV No. | 699373 | Ref. No. | 419040 |
| description | spacer piece for PCB thread M3 L 19.5mm H 10mm plastic black | | |
| For models: | 915160, 915161, 915162, 915175, 915319, 915611, 915612, 915613, 915663, 915670, 916247, 916248, 916249, 916250, 916251, 916252, 916365, 916366, 916382, 916383, 916452, 916504, 916584, 916670, 916688, 916763, 917044, 917049, Clean161, Fast160-2, Fast161-2, Fast170, Fast170S, Pluvia-240, Pluvia-260, Pluvia-270 | | |

EPROMS



| | | | |
|--------------------|--|-----------------|--------|
| 1 | | | |
| GEV No. | 400900 | Ref. No. | 225029 |
| description | EPROM CODE 225029-3 | | |
| For models: | MISTRAL-40, MISTRAL-51, NIAGARA-35, NIAGARA-40, NIAGARA-51, RIVER-40, RIVER-50, RIVER-61 | | |



| | | | |
|--------------------|--|-----------------|--------|
| 1 | | | |
| GEV No. | 401917 | Ref. No. | 225034 |
| description | EPROM CODE 225034 | | |
| For models: | 2312-009-CRP, RIVER-40-CRP, RIVER-50-CRP | | |



| | | | |
|--------------------|--|-----------------|----------------|
| 1 | | | |
| GEV No. | 401558 | Ref. No. | 81000 81010 |
| description | EPROM CODE 81000-1 | | |
| For models: | 80, 81, CGL74CABT, LP60, RIVER-71, RIVER-80, River-81, RIVER-82, RV71, RV80, RV8023, RV8023HZ, RV80C, RV80HZ, RV81, RV8123, RV81A, RV81C, RV81HZ, RV81HZ23, RV81PAP, RV82, RV8223, RV82C, SevenL, U60E | | |

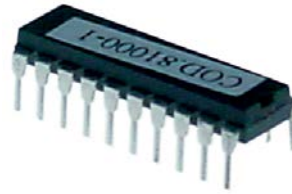

| | | | |
|--------------------|--|-----------------|-------|
| 1 | | | |
| GEV No. | 401559 | Ref. No. | 81021 |
| description | EPROM CODE 81000-1 | | |
| For models: | CE78HZ23, E78, E78HP, FAST-181, HM1, RIVER-E78, ST70FAST | | |

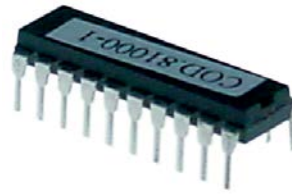

| | | | |
|--------------------|------------------------------------|-----------------|----------|
| 1 | | | |
| GEV No. | 401557 | Ref. No. | 225028-4 |
| description | EPROM for dishwasher CODE 225028-4 | | |



| | | | |
|--------------------|---|-----------------|--------|
| 1 | | | |
| GEV No. | 403247 | Ref. No. | 225031 |
| description | EPROM for dishwasher CODE 225031-5 | | |
| For models: | 050F, 050FP, 913911, 913912, 913913, 913914, 913950, 913977, 913984, 913990, 914165, 914166, 914206, 914214, 914284, 914316, 914317, 914318, 914319, 914338, 914355, 914356, 914431, 914516, 914543, 914642, 914684, 914874, 914909, 915136, 915137, 915138, F85, F85P, MINIBAR, Mistral40, MISTRAL-40, Mistral51, MISTRAL-51, NIAGARA-35, Niagara-40, NIAGARA-51, River-39, S280 | | |



| | | | |
|--------------------|------------------------------------|-----------------|--------|
| 1 | | | |
| GEV No. | 403245 | Ref. No. | 225032 |
| description | EPROM for dishwasher CODE 225032-2 | | |
| For models: | 914167, 914168, 914943, NIAGARA-45 | | |

1

| | | | |
|--------------------|---|-----------------|--------|
| GEV No. | 403248 | Ref. No. | 225033 |
| description | EPROM for dishwasher CODE 225033-1 unsuitable for Maidaid | | |
| For models: | NIAGARA-45 | | |



1

| | | | |
|--------------------|--|-----------------|-------|
| GEV No. | 403241 | Ref. No. | 81001 |
| description | EPROM type U61E for dishwasher CODE 81001-3 | | |
| For models: | KLP105EB, KLP201DDDTEB, KLP201EB, KLP301, KLP301DDDTEB, LP105DDDTEB, LP105DDDTEBN, LP105EB, LP201DDDTEB, LP201EB, LP301, LP301EB, River-81CRP, RIVER-81-CRP, River-82CRP, RIVER-82-CRP, RV81CCRP, RV81CRP, RV82CCRP, RV82CRP, U132E, U61E, U61HE, U70e | | |



1

| | | | |
|--------------------|--|-----------------|--------|
| GEV No. | 403249 | Ref. No. | 225044 |
| description | EPROM for dishwasher CODE 225044-2 | | |
| For models: | 2312-007, 914624, 914625, 914627, 914850, 914851, 914854 | | |

PCBs



1

| | | | |
|--------------------|--|-----------------|----------|
| GEV No. | 404015 | Ref. No. | 215034-1 |
| description | control PCB dishwasher 230V 50Hz | | |
| For models: | 916020, 916021, 916024, 916025, 916026, 916027, 916030, 916031, 916181, 916183, 916184, 916185, 916196, 916197, 916198, 916199, 916200, 916201, 916202, 916203, 916204, 916205, 916206, 916207, 916208, 916209, 916367, 916409, 916410, 916411, 916412, 916413, 916414, 916415, 916416, 916417, 916591, 916592, 916593, 916684, 916685, 916751, 916761, 916762, 916802, 916812, 916813, 916877, 916878, 916885...(Other models you can see in the webshop) | | |



1

| | | | |
|--------------------|-----------------------------------|-----------------|-------|
| GEV No. | 403246 | Ref. No. | 81006 |
| description | EPROM for dishwasher CODE 81006-5 | | |
| For models: | PS-60 | | |



1

| | | | |
|--------------------|--|-----------------|-------|
| GEV No. | 404017 | Ref. No. | 80944 |
| description | control PCB dishwasher Niagara 381 suitable for ELETTROBAR | | |
| For models: | 916020, 916021, 916024, 916025, 916026, 916027, 916030, 916031, 916045, 916181, 916183, 916184, 916185, 916196, 916197, 916198, 916199, 916200, 916201, 916202, 916203, 916204, 916205, 916206, 916207, 916208, 916209, 916367, 916409, 916410, 916411, 916412, 916413, 916414, 916415, 916416, 916417, 916591, 916592, 916593, 916654, 916684, 916685, 916751, 916761, 916762, 916802, 916812, 916813, 916877...(Other models you can see in the webshop) | | |





1

| | | | |
|--------------------|--|-----------------|-------|
| GEV No. | 403244 | Ref. No. | 81008 |
| description | EPROM for dishwasher CODE 81008 | | |
| For models: | RIVER-152, River-154, RV152, RV152D, RV152DA, RV152DARY, RV152DAY, RV152DW, RV152S, RV152SA, RV152SAW, RV152SE, RV152SW, RV152SY, RV154, RV154BT, RV154BTSAE, RV154D, RV154DA, RV154DARY, RV154DAW, RV154DAY, RV154DY, RV154S, RV154SA, RV154SAW, RV154SAY, RV154SC, RV154SY | | |



1

| | | | |
|------------------------|--|-----------------|----------|
| GEV No. | 404016 | Ref. No. | 215032-4 |
| description | control PCB warewashing Toptech 24-20GT 230V 50Hz | | |
| For models: | 916045, 916066, 916067, 916068, 916069, 916077, 916078, 916079, 916080, 916368, 916418, 916419, 916420, 916421, 916422, 916423, 916424, 916594, 916595, 916654, 916686, 916760, Fast160C, Ocean360-UK, River-242-2, River-242-2T, River-252-2, River-252-2T, River-262-2, River-262-2T, River-272, River-282-2, River-282L-2, River-282LS-2TDE, River-282S-2TDE, River-285, River-342C, River-342T, River-352C, River-352T, River-362C, River-362C-230V-3Ph-50Hz, River-362T, River-362T-230V-3Ph-50Hz, River-372, River-382, River-382-230V-3Ph-50Hz, River-382H, River-382L, River-382L-230V-3Ph-50Hz... (Other models you can see in the webshop) | | |
| accessories for | 404016 | | |
| | GEV No. | Ref. No. | — |
| |  programmer KIT BOOT-LOADER suitable for EUROTEC GROUP | | |



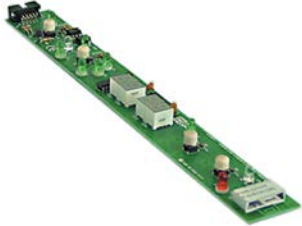

1

| | | | |
|--------------------|--|-----------------|-------|
| GEV No. | 404018 | Ref. No. | 80943 |
| description | control PCB warewashing Toptech 24-20GT suitable for ELETTRORBAR 50Hz 230V | | |
| For models: | 916066, 916067, 916068, 916069, 916077, 916078, 916079, 916080, 916368, 916418, 916419, 916420, 916421, 916422, 916423, 916424, 916594, 916595, 916686, 916760, River-242-2, River-242-2T, River-252-2, River-252-2T, River-262-2, River-262-2T, River-272, River-282-2, River-282L-2, River-282LS-2TDE, River-282S-2TDE, River-285, River-342C, River-342T, River-352C, River-352T, River-362C, River-362C-230V-3Ph-50Hz, River-362T, River-362T-230V-3Ph-50Hz, River-372, River-382, River-382-230V-3Ph-50Hz, River-382H, River-382L, River-382L-230V-3Ph-50Hz, River-382LNRG, River-382LTDE, River-382NRG, River-382NRG-230-3Ph-50Hz... (Other models you can see in the webshop) | | |



1

| | | | |
|------------------------|--|-----------------|------------------|
| GEV No. | 400897 | Ref. No. | 227059 227084 |
| description | display PCB dishwasher GS 60 | | |
| For models: | 050F, 050FP, 2312-007, 2312-009-CRP, 80, 81, 82, 913911, 913912, 913913, 913914, 913950, 913977, 913984, 913990, 913992, 913993, 914100, 914101, 914165, 914166, 914167, 914168, 914206, 914214, 914284, 914316, 914317, 914318, 914319, 914338, 914339, 914342, 914343, 914355, 914356, 914431, 914516, 914543, 914583, 914592, 914612, 914613, 914624, 914625, 914626, 914627, 914628, 914642, 914684... (Other models you can see in the webshop) | | |
| accessories for | 400897 | | |
| | GEV No. | Ref. No. | 80933 926272 |
| |  ribbon cable 10-pole L 3000mm plug type coded 2 row plug: number of poles 10 | | |



1

| | | | |
|--------------------|--|-----------------|--------|
| GEV No. | 403102 | Ref. No. | 227074 |
| description | keypad PCB dishwasher L 170mm W 35mm with display buttons 3 | | |
| For models: | 915150, 915151, 915152, 915166, 915167, 915168, 915348, 915420, 915421, 915479, 915547, 915558, 915614, 915615, 915616, 915635, 915671, 915747, 915959, NG271, NG281, NG281CDD, NG281HP, NG281HPDD, NG281HZ23, NG281HZ23DD, NG291, NG292, NG292HZ, NG293, NIAGARA-241, Niagara-251, NIAGARA-261, NIAGARA-271, NIAGARA-281, Niagara-281HP, NIAGARA-291, NIAGARA-292, Niagara-292-400V-3Ph-60Hz, NIAGARA-293 | | |



1

| | | | |
|--------------------|--|-----------------|-------|
| GEV No. | 402319 | Ref. No. | 41600 |
| description | keypad PCB dishwasher LP10/20/30 | | |
| For models: | 914380, 914436, KLP105EB, KLP201DDDTEB, KLP201EB, KLP301DDDTEB, LP105DDDTEB, LP105DDDTEBN, LP105EB, LP201DDDTEB, LP201EB, LP301EB, RIVER-150, River-152, RIVER-154, RV150, RV15023, RV15023DA, RV150D, RV150DA, RV150DAR, RV150DARY, RV150DAW, RV150DAWY, RV150DAY, RV150DE, RV150DRW, RV150DW, RV150DWY, RV150DY, RV150HZ23, RV150S, RV150SA, RV150SAC, RV150SAEW, RV150SAR, RV150SAW, RV150SAWY, RV150SAY, RV150SB, RV150SE, RV150SW, RV150SWY, RV150SY, RV152, RV152D, RV152DA, RV152DARY, RV152DAY, RV152DW... (Other models you can see in the webshop) | | |





1

| | | | |
|------------------------|--|-----------------|-------------------------|
| GEV No. | 400898 | Ref. No. | 80889 80899 80900 |
| description | keypad PCB dishwasher LP10/20/30 with display | | |
| For models: | CGL74CABT, CNT800CH, KLP301, LP301, River-295P, River-296P, RIVER-HL-82, RV295PS, RV296PS, SevenE, SevenL | | |
| accessories for | 400898 | | |
| | GEV No. | Ref. No. | 41523 |
| |  ribbon cable 10-pole L 1200mm plug type 2 row coded Qty 1m | | |

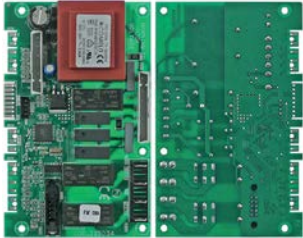

| | | | |
|--|--|-----------------|-----------------|
|  <p>1</p> | | | |
| GEV No. | 403270 | Ref. No. | 227083 80929 |
| description | keypad PCB for dishwasher River 252/262 L 220mm W 40mm with display buttons 3 | | |
| For models: | 915154, 915155, 915157, 915158, 915172, 915173, 915285, 915422, 915492, 915493, 915494, 915495, 915496, 915497, 915617, 915618, 915672, 915747, 915773, 915774, 916054, Fast200, FAST-200, Fast93, GL280EB, GL280EB23, GL280EB23DAR, GL280EB23HZ, GL280EB23HZDY, GL280EBD, GL280EBDA, GL280EBDAE, GL280EB-DAR, GL280EBDARY, GL280EBDAW, GL280EBDAWY, GL280EBDAY, GL280EBDB, GL280EBDBR, GL280EBDBW, GL280EBDWY, GL280EBDY, GL280EBS, GL280EBSA, GL280EBSAE, GL280EBSAEW, GL280EBSAEWY, GL280EBSAR, GL280EBSARY, GL280EBSAW...(Other models you can see in the webshop) | | |

| | | | |
|--|---|-----------------|----------|
|  <p>2</p> | | | |
| GEV No. | 403780 | Ref. No. | 215034-6 |
| description | main PCB dishwasher ELETTOBAR / COLGED L 136mm W 85mm | | |
| For models: | 916237, 916238, 916239, 916240, 916241, 916242, 916243, 916244, 916245, 916246, 916401, 916402, 916403, 916404, 916405, 916406, 916407, 916408, 916451, 916583, 916687, 916787, 916921, 916922, 916991, 916992, 916993, 917042, 917043, Clean140, Clean140S, Fast130, Fast135-2, Fast135-2S, Fast135H-2, Fast135H-2S, Fast139-2, Fast139-2S, Fast139H-2, Fast139H-2S, Fast140, Fast145-2, Fast150 | | |

| | | | |
|---|--------|-----------------|------------------|
|  <p>Image not available</p> <p>1</p> | | | |
| GEV No. | 400290 | Ref. No. | 215011 215998 |
| description | PCB | | |

| | | | |
|--|--------------|-----------------|--------|
|  <p>1</p> | | | |
| GEV No. | 400949 | Ref. No. | 215018 |
| description | PCB | | |
| For models: | E.35H, E.40H | | |

| | | | |
|---|--|-----------------|--------|
|  <p>1</p> | | | |
| GEV No. | 361366 | Ref. No. | 215001 |
| description | PCB dishwasher 11F suitable for DB2 type DB2/EV1/EKP-M | | |
| For models: | 10, 11F, 11FD, 11F-DVGW, 11R, 11RD, 12, 14, 21F, 21FD, 21R, 21RD, 22F, 22R, 25F, 25FD, 25R, 25RD, 30F, 30FD, 30R, 30RD, 31F, 31FD, 31R, 31RD, 40F, 440F, 46, 460, 66, CLEAN-100, CLEAN-110, CLEAN-120, CLEAN-3, E.45, E.46 | | |

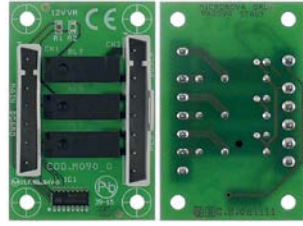
| | | | |
|---|--|-----------------|--------|
|  <p>1</p> | | | |
| GEV No. | 403621 | Ref. No. | 215036 |
| description | PCB dishwasher 25/26/27-05 26/27-20 L 60mm W 40mm | | |
| For models: | 915160, 915161, 915162, 915175, 915319, 915611, 915612, 915613, 915663, 915670, 916020, 916021, 916024, 916025, 916026, 916027, 916030, 916031, 916181, 916183, 916184, 916185, 916196, 916197, 916198, 916199, 916200, 916201, 916202, 916203, 916204, 916205, 916206, 916207, 916208, 916209, 916237, 916238, 916239, 916240, 916241, 916242, 916243, 916244, 916245, 916246, 916247, 916248, 916249, 916250...(Other models you can see in the webshop) | | |

| | | | |
|---|---|-----------------|--------|
|  <p>1</p> | | | |
| GEV No. | 403622 | Ref. No. | 215039 |
| description | PCB dishwasher 25/26/27-05 26/27-20 L 90mm W 50mm starting relay | | |
| For models: | 915160, 915161, 915162, 915175, 915319, 915496, 915663, 916067, 916068, 916069, 916079, 916080, 916201, 916202, 916203, 916204, 916205, 916206, 916207, 916208, 916209, 916365, 916366, 916367, 916368, 916411, 916412, 916413, 916414, 916415, 916416, 916417, 916420, 916421, 916422, 916423, 916424, 916684, 916685, 916686, 916760, 916761, 916762, 916802, 916812, 916813, 916878, 916885, Fast170, Fast170S...(Other models you can see in the webshop) | | |

1

| | | | |
|--------------------|--|-----------------|------------------|
| GEV No. | 400157 | Ref. No. | 215009 215013 |
| description | PCB dishwasher 35/40/50/350 | | |
| For models: | 35-ELECTRONIC, 35F, 35FD, 35R, 35RD, 40-ELECTRONIC, 40F, 40FD, 40R, 40RD, 45, 46, 50-ELECTRONIC, 50F, 50FD | | |

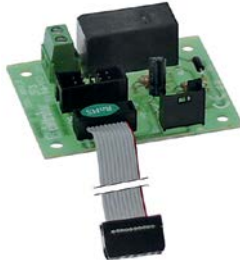

1

| | | | |
|--------------------|--|-----------------|--------|
| GEV No. | 401049 | Ref. No. | 215022 |
| description | PCB dishwasher LP10/20/30 | | |
| For models: | 2312-009-CRP, 914380, 914436, 914583, 914628, 914944, 915143, KLP105EB, KLP201DDDTTEB, KLP201EB, KLP301, KLP301DDDTTEB, LP105DDDTTEB, LP105DDDTTEBN, LP105EB, LP201DDDTTEB, LP201EB, LP301, LP301EB, RIVER-150, River-152, RIVER-154, RIVER-40-CRP, RIVER-44-CRP, RIVER-44-CRP-ST, RIVER-44CRP-ST, RIVER-50-CRP, RIVER-50-CRP-SP, RIVER-54CRP, River-54-CRP-s.p., RIVER-54-CRP-SP, River-81CRP, RIVER-81-CRP, River-82CRP, RIVER-82-CRP, RIVER-HL-81, RIVER-HL-82, RV150, RV15023, RV15023DA, RV150D, RV150DA, RV-150DAR, RV150DARY, RV150DAW, RV150DAWY, RV150DAY, RV150DE, RV150DRW, RV150DW...(Other models you can see in the webshop) | | |



1

| | | | |
|--------------------|---|-----------------|----------|
| GEV No. | 403734 | Ref. No. | 215034-3 |
| description | PCB dishwasher COLGED L 135mm W 85mm | | |
| For models: | 915160, 915161, 915162, 915175, 915319, 915611, 915612, 915613, 915663, 915670, 916247, 916248, 916249, 916250, 916251, 916252, 916365, 916366, 916382, 916383, 916452, 916504, 916584, 916670, 916688, 916763, 917044, 917049, Clean161, Fast160-2, Fast161-2, Fast170, Fast170S, Pluvia-240, Pluvia-260, Pluvia-270 | | |



1

| | | | |
|--------------------|---|-----------------|----------|
| GEV No. | 403572 | Ref. No. | 215032-1 |
| description | PCB dishwasher Protech 1113/611 TR10 L 178mm W 125mm | | |
| For models: | 915157, 915158, 915494, 915495, 915617, 915618, 915672, 915773, 915774, Fast200, Fast93, GL280EB, GL280EB23, GL280EB23DAR, GL280EB23HZ, GL280EB23HZDY, GL280EBDARY, GL280EBDAW, GL280EBDAY, GL280EBDB, GL280EBDBR, GL280EBDWY, GL280EB-SA, GL280ESAE, GL280ESAEW, GL280ESAEWY, GL280ES-AR, GL280ESARY, GL280ESAW, GL280ESAWY, GL280ESAY, GL280ESB, GL280ESR, GL280ESWY, GL282EB, GL282EB93, GL282EB93DA, GL282EB93HZ23, GL282EBCH, GL282EBDA, GL282EB-DARW, GL282EBDAWY, GL282EBDBW, GL282EBDCWY, GL282EBHZ23, GL282EBHZ23DY, GL282EBHZ23SY, GL282EBSA, GL282ESAEW, GL282ESAEWY...(Other models you can see in the webshop) | | |

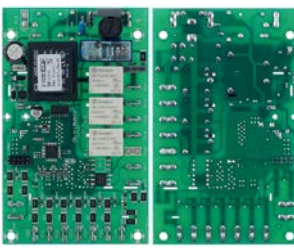

1

| | | | |
|--------------------|--|-----------------|------------------|
| GEV No. | 403093 | Ref. No. | 215033 215038 |
| description | PCB dishwasher L 135mm W 82mm | | |
| For models: | 913363, 913364, 915611, 915612, 915613, 915670, 915686, 915687, 915689, 915690, 915691, 915692, 915693, 915694, 915695, 915696, 915819, 916162, 916788, E.41, Fast135CT, Fast135D, Fast135H, Fast135HCT, Fast135HD, Fast139, Fast139CT, Fast139D, Fast140, Fast145, Fast145D, PLUVIA-240 | | |



1

| | | | |
|--------------------|---|-----------------|----------|
| GEV No. | 403518 | Ref. No. | 215034-5 |
| description | PCB dishwasher R4258E1120T7S L 136mm W 85.5mm 230V | | |
| For models: | Fast180, Fast180-230V-3Ph-60Hz, Fast181, PV280FAST2, PV280FAST-2BIO, PV280FAST2HZ23, ST70FASTHZ23 | | |



1

| | | | |
|--------------------|--|-----------------|--------|
| GEV No. | 402880 | Ref. No. | 215027 |
| description | PCB dishwasher L 152mm W 80mm | | |
| For models: | 915150, 915151, 915152, 915166, 915167, 915168, 915348, 915420, 915421, 915479, 915547, 915558, 915614, 915615, 915616, 915635, 915671, 915747, 915959, NG271, NG281, NG281CDD, NG281HP, NG281HPDD, NG281HZ23, NG281HZ23DD, NG291, NG292, NG292HZ, NG293, NIAGARA-241, Niagara-251, NIAGARA-261, NIAGARA-271, NIAGARA-281, Niagara-281HP, NIAGARA-291, NIAGARA-292, Niagara-292-400V-3Ph-60Hz, NIAGARA-293 | | |

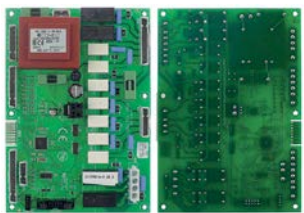

1

| | | | |
|--------------------|--|-----------------|----------|
| GEV No. | 404027 | Ref. No. | 215032-5 |
| description | PCB dishwasher TOPTECH 921-924 L 178mm W 130mm | | |
| For models: | River-295P, River-296P, RV295PS, RV296PS | | |

1

| | | | |
|--------------------|--|-----------------|--------|
| GEV No. | 401900 | Ref. No. | 215029 |
| description | PCB L 120mm W 80mm | | |
| For models: | 915160, 915161, 915162, 915175, 915176, 915177, 915319, 915338, 915341, 915418, 915419, 915483, 915484, 915527, 915528, 915537, 915538, 915539, 915540, 915663, 915664, 915686, 915687, 915688, 915689, 915690, 915691, 915692, 915693, 915694, 915695, 915696, 915697, 915698, 915699, 915700, 915701, 915702, 915729, 915756, 915799, 915800, 915809, 915816, 915817, 915818, 915819, 915830, 915842, FAST-135...(Other models you can see in the webshop) | | |



1

| | | | |
|--------------------|--|-----------------|--------|
| GEV No. | 403045 | Ref. No. | 215032 |
| description | PCB suitable for ELETTROBAR | | |
| For models: | 915154, 915155, 915172, 915173, 915285, 915422, 915492, 915493, 915496, 915497, 915617, 915618, 915672, 915773, 915774, 916054, FAST-200, GL280EB, GL280EBD, GL280EBDA, GL280EBDAE, GL280EBDAR, GL280EBDAWY, GL280EBDBW, GL280EBDY, GL280EBS, GL280EBSY, GL282EB, GL282EBCH, GL282EBCHD, GL282EBD, GL282EBDAE, GL282EBDAR, GL284EBD, GL284EBDAWY, GL284EBS, GL284EBSAR, GL286EBD, GL286EBDARY, GL286EBS, GL286EBSAW, NIAGARA-2150, NIAGARA-2152, NIAGARA-2154, NIAGARA-2156, RIVER-242, RIVER-252, River-262, RIVER-282, RIVER-294...(Other models you can see in the webshop) | | |



1

| | | | |
|--------------------|---|-----------------|--------|
| GEV No. | 403784 | Ref. No. | 215037 |
| description | PCB warewashing ELETTROBAR / COLGED L 60mm W 30mm | | |
| For models: | 915160, 915161, 915162, 915175, 915319, 915611, 915612, 915613, 915663, 915670, 916247, 916248, 916249, 916250, 916251, 916252, 916365, 916366, 916382, 916383, 916452, 916504, 916584, 916670, 916688, 916763, 917044, 917049, Clean161, Fast160-2, Fast161-2, Fast170, Fast170S, Fast180, Fast180-230V-3Ph-60Hz, Fast181, Pluvia-240, Pluvia-260, Pluvia-270, PV280FAST2, PV280FAST2BIO, PV280FAST2HZ23, ST70FASTHZ23 | | |





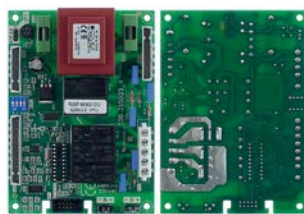

1

| | | | |
|--------------------|--|-----------------|--------|
| GEV No. | 403509 | Ref. No. | 999298 |
| description | PCB warewashing NIAGARA/SILVER | | |
| For models: | CNT800CH, NIAGARA-283, Niagara-283A, SevenE, SV72AEB, SV72EB | | |



1

| | | | |
|---|---|-----------------|--------------------------------|
| GEV No. | 400899 | Ref. No. | 215023 |
| description | power PCB dishwasher LP10/20/30 without EPROM | | |
| For models: | 050F, 050FP, 2312-007, 2312-009-CRP, 80, 81, 82, 913911, 913912, 913913, 913914, 913950, 913977, 913984, 913990, 913992, 913993, 914100, 914101, 914165, 914166, 914167, 914168, 914206, 914214, 914284, 914316, 914317, 914318, 914319, 914338, 914339, 914342, 914343, 914355, 914356, 914380, 914431, 914436, 914516, 914543, 914583, 914592, 914612, 914613, 914624, 914625, 914626, 914627, 914628...(Other models you can see in the webshop) | | |
| accessories for | 400899 | | |
|  | GEV No. | 400761 | Ref. No. CN5 |
| description | plug connector 5-pole | | |
|  | GEV No. | 400900 | Ref. No. 225029 |
| description | EPROM CODE 225029-3 | | |
|  | GEV No. | 401558 | Ref. No. 81000 81010 |
| description | EPROM CODE 81000-1 | | |
|  | GEV No. | 403241 | Ref. No. 81001 |
| description | EPROM type U61E for dishwasher CODE 81001-3 | | |
|  | GEV No. | 550048 | Ref. No. — |
| description | female bullet | | |

keypads

front foils



1

| | | | |
|--------------------|--|-----------------|--------|
| GEV No. | 402166 | Ref. No. | 025635 |
| description | front foil dishwasher E.50-51 L 420mm W 35mm | | |
| For models: | 913297, 913298, 913299, 913300, 913360, 913361, 913391, 913392, 913546, 913547, 913578, 913611, 913684, 913932, 913933, 914331, 914400, 914401, 914402, 914403, 914404, 914405, 914449, 914517, 914545, 914568, 914688, 914979, 915140, 915248, E.50, E.50D.PA, E.51 | | |



1

| | | | |
|--------------------|---|-----------------|----------------|
| GEV No. | 403782 | Ref. No. | 70704 70727 |
| description | front foil dishwasher ELETTROBAR / NIAGARA L 258mm W 36mm | | |
| For models: | 916196, 916197, 916198, 916199, 916200, 916201, 916202, 916203, 916204, 916205, 916206, 916207, 916208, 916209, 916367, 916409, 916410, 916411, 916412, 916413, 916414, 916415, 916416, 916417, 916591, 916592, 916593, 916684, 916685, 916761, 916762, 916802, 916812, 916813, 916877, 916878, 916885, NG381, NG38123, NG-38123TERMO, NG381C, NG381CDD, NG381CFUR, NG381DDHZ23, NG381DDPS, NG381DDPSHZ23, NG381HPDD, NG381L, NG381LC, NG381LCFUR...(Other models you can see in the webshop) | | |



electric components

| | | | |
|--------------------|----------------------------|-----------------|--------|
| | | | |
| 1 | | | |
| GEV No. | 401948 | Ref. No. | 025982 |
| description | front foil dishwasher GS40 | | |
| For models: | GLS40H, GLS40HP | | |

| | | | |
|--------------------|---------------------------------|-----------------|--------|
| | | | |
| 1 | | | |
| GEV No. | 401947 | Ref. No. | 025983 |
| description | front foil dishwasher GS50/GS51 | | |
| For models: | GSP50, GSP50P | | |

| | | | |
|--------------------|--------------------------|-----------------|-------|
| | | | |
| 1 | | | |
| GEV No. | 401963 | Ref. No. | 80856 |
| description | front foil dishwasher HM | | |
| For models: | HM1 | | |

| | | | |
|--------------------|---|-----------------|--------|
| | | | |
| 1 | | | |
| GEV No. | 403243 | Ref. No. | 025898 |
| description | front foil dishwasher Niagara 261 blue L 448mm W 53mm | | |
| For models: | 915166, 915167, 915168, 915348, 915420, 915421, 915479, 915547, 915558, 915635, 915747, NIAGARA-261 | | |

| | | | |
|--------------------|-------------|-----------------|--------|
| | | | |
| 1 | | | |
| GEV No. | 518568 | Ref. No. | 025473 |
| description | keypad foil | | |
| For models: | F85, F85P | | |

| | | | |
|--------------------|------------------------------|-----------------|--------|
| | | | |
| 1 | | | |
| GEV No. | 518566 | Ref. No. | 025471 |
| description | keypad foil dishwasher 050FP | | |
| For models: | 050F, 050FP | | |

| | | | |
|--------------------|----------------------------|-----------------|-------|
| | | | |
| 1 | | | |
| GEV No. | 401596 | Ref. No. | 36782 |
| description | keypad foil dishwasher L20 | | |

| | | | |
|--------------------|---|-----------------|-------|
| | | | |
| 1 | | | |
| GEV No. | 505276 | Ref. No. | 36784 |
| description | keypad foil dishwasher L25 L 494mm W 84mm buttons 4 | | |

| | | | |
|--------------------|-----------------------------|-----------------|--------|
| | | | |
| 1 | | | |
| GEV No. | 518567 | Ref. No. | 025472 |
| description | keypad foil warewashing F85 | | |
| For models: | F85 | | |

membrane keypads

| | | | |
|--------------------|---|-----------------|-------|
| | | | |
| 1 | | | |
| GEV No. | 403631 | Ref. No. | 75948 |
| description | membrane keypad for dishwasher L 230mm W 65mm | | |
| For models: | 915747 | | |

accessories

| | | | |
|--------------------|---------------------------------|-----------------|-------|
| | | | |
| 1 | | | |
| GEV No. | 346850 | Ref. No. | 80883 |
| description | push button no lens blue ø 21mm | | |

| | | | |
|--------------------|-----------------------------------|-----------------|-------|
| | | | |
| 1 | | | |
| GEV No. | 346849 | Ref. No. | 80884 |
| description | push button with lens blue ø 21mm | | |



solenoid valves

solenoid valves (water)

ELBI

straight



| | | | |
|--------------------|---|-----------------|------------------|
| GEV No. | 373017 | Ref. No. | 240016 240021 |
| description | solenoid valve single straight 230VAC inlet 3/4" outlet 11.5mm DN10 ELBI | | |
| For models: | 80, 81, 82, 915150, 915151, 915152, 915154, 915155, 915157, 915158, 915160, 915161, 915162, 915166, 915167, 915168, 915172, 915173, 915175, 915176, 915177, 915319, 915338, 915341, 915348, 915418, 915419, 915420, 915421, 915422, 915479, 915483, 915484, 915492, 915493, 915494, 915495, 915496, 915497, 915537, 915538, 915539, 915540, 915547, 915558, 915611, 915612, 915613, 915614, 915615... (Other models you can see in the webshop) | | |



| | | | |
|--------------------|--|-----------------|--------|
| GEV No. | 370243 | Ref. No. | 240012 |
| description | solenoid valve single straight 230VAC inlet 3/4" outlet 11.5mm input 5.5l/min t.max. 90°C ELBI plastic flow regulating valve inlet black | | |
| For models: | CLEAN-3, RIVER-43 | | |



| | | | |
|--------------------|--|-----------------|--------|
| GEV No. | 370315 | Ref. No. | 929172 |
| description | solenoid valve double straight 230VAC inlet 3/4" outlet 11.5mm input 16l/min t.max. 90°C ELBI plastic flow regulating valve inlet black | | |
| For models: | 914380, 914436, Fast200, FAST-200, Fast93, GL280EB, GL280EB23, GL280EB23DAR, GL280EB23HZ, GL280EB23HZDY, GL280EBD, GL280EBDA, GL280EBDAE, GL280EBDAR, GL280EBDARY, GL280EBDAW, GL280EBDAWY, GL280EBDAY, GL280EBDB, GL280EBDBR, GL280EBDBW, GL280EBDWY, GL280EBDY, GL280EBS, GL280EBSA, GL280EBSAE, GL280EBSAEW, GL280EBSAEWY, GL280EBSAR, GL280EBSARY, GL280EBSAW, GL280EBSAWY, GL280EBSAY, GL280EBSB, GL280EBSR, GL280EBSWY, GL280EBSY, GL282EB, GL282EB93, GL282EB93DA, GL282EB93HZ23, GL282EBCH, GL282EBCHD, GL282EBD, GL282EBDA, GL282EBDAE, GL282EBDAR, GL282EBDARW, GL282EBDAWY, GL282EBDBW... (Other models you can see in the webshop) | | |



| | | | |
|--------------------|---|-----------------|--------|
| GEV No. | 370246 | Ref. No. | 240010 |
| description | solenoid valve double straight 230VAC inlet 3/4" outlet 11.5mm t.max. 90°C ELBI plastic output B 0.5l/min flow regulating valve outlet B red | | |
| For models: | 050F, 050FP, 11F, 11FD, 11R, 11RD, 2312-001, 2312-002, 2312-007, 31F, 31FD, 31R, 31RD, 350F, 350FD, 350R, 350RD, 35-ELECTRONIC, 35F, 35FD, 35R, 35RD, 400F, 400FD, 400R, 400RD, 40-ELECTRONIC, 40F, 40FD, 40R, 40RD, 46, 460, 500F, 500FD, 50-ELECTRONIC, 50F, 50FD, 510F, 510FD, 913289, 913290, 913291, 913292, 913297, 913298, 913299, 913300, 913356, 913357... (Other models you can see in the webshop) | | |



| | | | |
|--------------------|---|-----------------|--------|
| GEV No. | 370247 | Ref. No. | 240002 |
| description | solenoid valve triple straight 230VAC inlet 3/4" outlet 11.5mm t.max. 90°C ELBI plastic flow regulating valve inlet orange output B 0.5l/min flow regulating valve outlet B red | | |
| For models: | 11F, 11FD, 11F-DVGW, 11R, 11RD, 21F, 21FD, 21R, 21RD, 25F, 25FD, 25R, 25RD, 30F, 30FD, 30R, 30RD, 31F, 31FD, 31R, 31RD, 350F, 350FD, 350R, 350RD, 35-ELECTRONIC, 35F, 35FD, 35R, 35RD, 400F, 400FD, 400R, 400RD, 40-ELECTRONIC, 40F, 40FD, 40R, 40RD, 45, 450, 46, 460, 50F, 50FD, 510F, 510FD, 55, 67F, 67R... (Other models you can see in the webshop) | | |

spare parts and accessories

reducers

inlet side



| | | | |
|--------------------|---------------------------|-----------------|-------|
| GEV No. | 371326 | Ref. No. | 75976 |
| description | reducer ELBI ø 16mm white | | |
| For models: | 915747 | | |

RPE







| | | | |
|--------------------|---|-----------------|---------|
| GEV No. | 374063 | Ref. No. | 5200152 |
| description | solenoid valve single straight 230VAC inlet 3/8" IT outlet 3/8" IT input/output/min DN11 t.max. 25/60/90°C duty cycle 100% RPE R Mini 410 plastic | | |

1 electric components



| TP | | | |
|---|---|-----------------|-------------------|
|  | | | |
| 1 | | | |
| GEV No. | 370021 | Ref. No. | 240003 |
| description | solenoid valve double straight 230VAC inlet 3/4" outlet 11.5mm DN10 TP flow regulating valve inlet white | | |
| For models: | 11F, 11FD, 11F-DVGW, 11R, 11RD, 21F, 21FD, 21R, 21RD, 22F, 22R, 25F, 25FD, 25R, 25RD, 30F, 30FD, 30R, 30RD, 31F, 31FD, 31R, 31RD, 350F, 350FD, 350R, 350RD, 400F, 400FD, 400R, 400RD, 40-ELECTRONIC, 40F, 40FD, 40R, 40RD, 44F, 46, 460, 50F, 50FD, 510F, 510FD, 55, 66, 67F, 67R, 913363, 913364, 913376...(Other models you can see in the webshop) | | |
| spare parts for | 370021 | | |
|  | GEV No. | 371013 | Ref. No. — |
| | solenoid coil TP 230VAC 50/60Hz | | |
| accessories for | 370021 | | |
|  | GEV No. | 371220 | Ref. No. — |
| | reducer TP flow rate 3l/min red tolerance ±15% | | |
|  | GEV No. | 371221 | Ref. No. — |
| | reducer TP flow rate 5.5l/min yellow tolerance ±15% | | |
|  | GEV No. | 371222 | Ref. No. — |
| | reducer TP flow rate 6l/min grey tolerance ±15% | | |
|  | GEV No. | 371223 | Ref. No. — |
| | reducer TP flow rate 10l/min white tolerance ±15% | | |
|  | GEV No. | 371224 | Ref. No. — |
| | reducer TP flow rate 12l/min bronze tolerance ±15% | | |
|  | GEV No. | 371225 | Ref. No. — |
| | reducer TP flow rate 16l/min light brown tolerance ±15% | | |
|  | GEV No. | 371226 | Ref. No. — |
| | reducer TP flow rate 20l/min red tolerance ±15% | | |
|  | GEV No. | 371230 | Ref. No. — |
| | reducer TP flow rate 0.25l/min red tolerance ±25% | | |
|  | GEV No. | 371231 | Ref. No. — |
| | reducer TP flow rate 0.35l/min violet tolerance ±25% | | |
|  | GEV No. | 371232 | Ref. No. — |
| | reducer TP flow rate 0.5l/min orange tolerance ±25% | | |
|  | GEV No. | 371233 | Ref. No. — |
| | reducer TP flow rate 0.8l/min white tolerance ±25% | | |
|  | GEV No. | 371234 | Ref. No. — |
| | reducer TP flow rate 1l/min light blue tolerance ±25% | | |
|  | GEV No. | 371235 | Ref. No. — |
| | reducer TP flow rate 1.2l/min brown tolerance ±25% | | |

| accessories for 370021 | | | |
|---|--|--------|-------------------|
|  | GEV No. | 371236 | Ref. No. — |
| | reducer TP flow rate 1.5l/min light brown tolerance ±25% | | |
|  | GEV No. | 371237 | Ref. No. — |
| | reducer TP flow rate 2.5l/min yellow tolerance ±25% | | |
|  | GEV No. | 371238 | Ref. No. — |
| | reducer TP flow rate 3.4l/min dark green tolerance ±25% | | |
|  | GEV No. | 371239 | Ref. No. — |
| | reducer TP flow rate 5l/min black tolerance ±25% | | |
|  | GEV No. | 371240 | Ref. No. — |
| | reducer TP flow rate 8l/min blue tolerance ±20% | | |













| | | | |
|---|---|-----------------|-------------------|
|  | | | |
| 1 | | | |
| GEV No. | 370111 | Ref. No. | 927001 |
| description | solenoid valve double straight 24VAC inlet 3/4" outlet 11.5mm DN10 TP | | |
| For models: | 161, 221, 271, 272, 362, CLEAN-160, CLEAN-161, CLEAN-220, CLEAN-221, CLEAN-270, CLEAN-271, CLEAN-272, CLEAN-362 | | |
| spare parts for | 370111 | | |
|  | GEV No. | 371035 | Ref. No. — |
| | solenoid coil 24VAC | | |
| accessories for | 370111 | | |
|  | GEV No. | 371220 | Ref. No. — |
| | reducer TP flow rate 3l/min red tolerance ±15% | | |
|  | GEV No. | 371221 | Ref. No. — |
| | reducer TP flow rate 5.5l/min yellow tolerance ±15% | | |
|  | GEV No. | 371222 | Ref. No. — |
| | reducer TP flow rate 6l/min grey tolerance ±15% | | |
|  | GEV No. | 371223 | Ref. No. — |
| | reducer TP flow rate 10l/min white tolerance ±15% | | |
|  | GEV No. | 371224 | Ref. No. — |
| | reducer TP flow rate 12l/min bronze tolerance ±15% | | |
|  | GEV No. | 371225 | Ref. No. — |
| | reducer TP flow rate 16l/min light brown tolerance ±15% | | |
|  | GEV No. | 371226 | Ref. No. — |
| | reducer TP flow rate 20l/min red tolerance ±15% | | |
|  | GEV No. | 371230 | Ref. No. — |
| | reducer TP flow rate 0.25l/min red tolerance ±25% | | |
|  | GEV No. | 371231 | Ref. No. — |
| | reducer TP flow rate 0.35l/min violet tolerance ±25% | | |

Table continues overleaf



| accessories for | | 370111 | | |
|-----------------|----------|----------|----------|--|
| GEV No. | Ref. No. | Ref. No. | Ref. No. | — |
| | 371232 | Ref. No. | — | reducer TP flow rate 0.5l/min orange tolerance ±25% |
| | 371233 | Ref. No. | — | reducer TP flow rate 0.8l/min white tolerance ±25% |
| | 371234 | Ref. No. | — | reducer TP flow rate 1l/min light blue tolerance ±25% |
| | 371235 | Ref. No. | — | reducer TP flow rate 1.2l/min brown tolerance ±25% |
| | 371236 | Ref. No. | — | reducer TP flow rate 1.5l/min light brown tolerance ±25% |
| | 371237 | Ref. No. | — | reducer TP flow rate 2.5l/min yellow tolerance ±25% |
| | 371238 | Ref. No. | — | reducer TP flow rate 3.4l/min dark green tolerance ±25% |
| | 371239 | Ref. No. | — | reducer TP flow rate 5l/min black tolerance ±25% |
| | 371240 | Ref. No. | — | reducer TP flow rate 8l/min blue tolerance ±20% |

|   <p>1</p> | | | | |
|--|---|----------|----------------------------|---|
| GEV No. | 370017 | Ref. No. | 240005 240011 240018 | |
| description | solenoid valve single straight 230VAC inlet 3/4" outlet 11.5mm DN10 TP p max 10bar | | | |
| For models: | 050F, 050FP, 10, 11F, 11FD, 11F-DVGW, 11R, 11RD, 12, 14, 21F, 21FD, 21R, 21RD, 22F, 2312-001, 2312-002, 2312-007, 2312-009-CRP, 25F, 25FD, 25R, 25RD, 30F, 30FD, 30R, 30RD, 31F, 31FD, 31R, 31RD, 350F, 350FD, 350R, 350RD, 35-ELECTRONIC, 35F, 35FD, 35R, 35RD, 400F, 400FD, 400R, 400RD, 40-ELECTRONIC, 40F, 40FD, 40R, 40RD, 440F... (Other models you can see in the webshop) | | | |
| spare parts for | 370017 | | | |
| | GEV No. | 371013 | Ref. No. | — |
| solenoid coil TP 230VAC 50/60Hz | | | | |
| accessories for | 370017 | | | |
| | GEV No. | 371220 | Ref. No. | — |
| reducer TP flow rate 3l/min red tolerance ±15% | | | | |
| | GEV No. | 371221 | Ref. No. | — |
| reducer TP flow rate 5.5l/min yellow tolerance ±15% | | | | |
| | GEV No. | 371222 | Ref. No. | — |
| reducer TP flow rate 6l/min grey tolerance ±15% | | | | |
| | GEV No. | 371223 | Ref. No. | — |
| reducer TP flow rate 10l/min white tolerance ±15% | | | | |

| accessories for | | 370017 | | |
|-----------------|----------|----------|----------|--|
| GEV No. | Ref. No. | Ref. No. | Ref. No. | — |
| | 371224 | Ref. No. | — | reducer TP flow rate 12l/min bronze tolerance ±15% |
| | 371225 | Ref. No. | — | reducer TP flow rate 16l/min light brown tolerance ±15% |
| | 371226 | Ref. No. | — | reducer TP flow rate 20l/min red tolerance ±15% |
| | 371230 | Ref. No. | — | reducer TP flow rate 0.25l/min red tolerance ±25% |
| | 371231 | Ref. No. | — | reducer TP flow rate 0.35l/min violet tolerance ±25% |
| | 371232 | Ref. No. | — | reducer TP flow rate 0.5l/min orange tolerance ±25% |
| | 371233 | Ref. No. | — | reducer TP flow rate 0.8l/min white tolerance ±25% |
| | 371234 | Ref. No. | — | reducer TP flow rate 1l/min light blue tolerance ±25% |
| | 371235 | Ref. No. | — | reducer TP flow rate 1.2l/min brown tolerance ±25% |
| | 371236 | Ref. No. | — | reducer TP flow rate 1.5l/min light brown tolerance ±25% |
| | 371237 | Ref. No. | — | reducer TP flow rate 2.5l/min yellow tolerance ±25% |
| | 371238 | Ref. No. | — | reducer TP flow rate 3.4l/min dark green tolerance ±25% |
| | 371239 | Ref. No. | — | reducer TP flow rate 5l/min black tolerance ±25% |
| | 371240 | Ref. No. | — | reducer TP flow rate 8l/min blue tolerance ±20% |



|   <p>1</p> | | | | |
|---|--|----------|----------|---|
| GEV No. | 370015 | Ref. No. | 240006 | |
| description | solenoid valve single angled 230VAC inlet 3/4" outlet 11.5mm DN10 TP | | | |
| accessories for | 370015 | | | |
| | GEV No. | 371220 | Ref. No. | — |
| reducer TP flow rate 3l/min red tolerance ±15% | | | | |

Table continues overleaf



| accessories for | | 370015 | |
|-----------------|--|----------|---|
| GEV No. | 371221 | Ref. No. | — |
| | reducer TP flow rate 5.5l/min yellow tolerance ±15% | | |
| | reducer TP flow rate 6l/min grey tolerance ±15% | | |
| | reducer TP flow rate 10l/min white tolerance ±15% | | |
| | reducer TP flow rate 12l/min bronze tolerance ±15% | | |
| | reducer TP flow rate 16l/min light brown tolerance ±15% | | |
| | reducer TP flow rate 20l/min red tolerance ±15% | | |
| | reducer TP flow rate 0.25l/min red tolerance ±25% | | |
| | reducer TP flow rate 0.35l/min violet tolerance ±25% | | |
| | reducer TP flow rate 0.5l/min orange tolerance ±25% | | |
| | reducer TP flow rate 0.8l/min white tolerance ±25% | | |
| | reducer TP flow rate 1l/min light blue tolerance ±25% | | |
| | reducer TP flow rate 1.2l/min brown tolerance ±25% | | |
| | reducer TP flow rate 1.5l/min light brown tolerance ±25% | | |
| | reducer TP flow rate 2.5l/min yellow tolerance ±25% | | |
| | reducer TP flow rate 3.4l/min dark green tolerance ±25% | | |
| | reducer TP flow rate 5l/min black tolerance ±25% | | |
| | reducer TP flow rate 8l/min blue tolerance ±20% | | |

solenoid valves with reducers

| | | | |
|--------------------|--|-----------------|----------------------------------|
| | | | |
| 1 | | | |
| GEV No. | 370245 | Ref. No. | 927242 DEV34516 LF-3120530 |
| description | solenoid valve single straight 24VAC inlet 3/4" outlet 11.5mm input 16l/min t.max. 90°C TP plastic flow regulating valve inlet light brown | | |
| For models: | 161, 221, 271, 272, 362, A4EBSAKCK, CLEAN-160, CLEAN-161, CLEAN-220, CLEAN-221, CLEAN-270, CLEAN-271, CLEAN-272, CLEAN-361, CLEAN-361P, CLEAN-362, CLEAN-471, CLEAN-471P | | |

various

| | | | |
|--------------------|--|-----------------|--------|
| | | | |
| 1 | | | |
| GEV No. | 370726 | Ref. No. | 999288 |
| description | solenoid valve double straight 220-240VAC inlet 11mm outlet 11mm MILANO plastic output B red | | |
| For models: | 913364, 915150, 915151, 915152, 915154, 915155, 915157, 915158, 915160, 915161, 915162, 915166, 915167, 915168, 915172, 915173, 915175, 915285, 915319, 915348, 915418, 915419, 915420, 915421, 915422, 915479, 915483, 915484, 915492, 915493, 915494, 915495, 915496, 915497, 915537, 915538, 915539, 915540, 915547, 915558, 915611, 915612, 915613, 915614, 915615, 915616, 915617, 915618, 915635, 915663...(Other models you can see in the webshop) | | |

| | | | |
|------------------------|--|-----------------|-----------------|
| | | | |
| 1 | | | |
| GEV No. | 370636 | Ref. No. | 240020 |
| description | solenoid valve single CO 230VAC outlet 10.5mm MILANO 00168401 plastic 3-ways inlet 10.5mm 50/60Hz male faston 6.3mm | | |
| For models: | 915154, 915155, 915157, 915158, 915166, 915167, 915168, 915172, 915173, 915175, 915176, 915177, 915285, 915338, 915341, 915348, 915420, 915421, 915422, 915492, 915493, 915494, 915495, 915496, 915497, 915547, 915558, 915617, 915618, 915663, 915672, 915747, 915773, 915774, 916054, 916066, 916067, 916068, 916069, 916077, 916078, 916079, 916080, 916368, 916418, 916419, 916420, 916421, 916422, 916423...(Other models you can see in the webshop) | | |
| accessories for | 370636 | | |
| | GEV No. | 371142 | Ref. No. |
| | | | 133009 |
| | reducer for solenoid valve ø 8.2mm | | |



metal

ASCO

solenoid valves steam (water)

2-way



1

| | | | |
|--------------------|--|-----------------|--------|
| GEV No. | 370728 | Ref. No. | 927148 |
| description | solenoid valve 2-ways 24VAC inlet 1/2" IT outlet 1/2" IT connection 1/2" L 62mm DN 12mm t.max. 85°C slide-on receptacle DIN -10 up to +85°C Asco type series E238C coil type 43005421 membranes NBR p max 10bar p min 0.3bar 50/60Hz brass | | |
| For models: | CLEAN-361, CLEAN-361P, CLEAN-471, CLEAN-471P | | |

PARKER

2-way

VE-123 series



1

| | | | |
|--------------------|--|-----------------|--------|
| GEV No. | 370727 | Ref. No. | 927142 |
| description | solenoid valve brass 2-ways 24VAC inlet 1/2" IT outlet 1/2" IT connection 1/2" L 72mm DN 13mm t.max. 140°C -10 up to 140°C PARKER type series VE123 coil type ZB09 membranes Viton p max 5bar 50/60Hz 24V voltage AC | | |
| For models: | 272, 362, CLEAN-161, CLEAN-221, CLEAN-271, CLEAN-272, CLEAN-361, CLEAN-361P, CLEAN-362, CLEAN-471, CLEAN-471P | | |

Solenoid valve - accessories



1

| | | | |
|--------------------|--|-----------------|--------|
| GEV No. | 371142 | Ref. No. | 133009 |
| description | reducer for solenoid valve ø 8.2mm | | |
| For models: | 915166, 915167, 915168, 915175, 915176, 915177, 915338, 915341, 915348, 915420, 915421, 915547, 915558, 915663, 915747, NIAGARA-251, NIAGARA-261, PLUVIA-260, Pluvia-270 | | |

pressure switches

for warewashing

ø 58mm with male faston 6.3mm

with connection horizontal



1

| | | | |
|--------------------|---|-----------------|--------|
| GEV No. | 541002 | Ref. No. | 224002 |
| description | pressure control pressure range 110/60mbar connection 6mm ø 58mm pressure connection horizontal warewashing pressure connection ø 6mm | | |
| For models: | 66, 80, 81, 82, CE78HZ23, E78, E78HP, HM1, LP60, NG381L, NG381LC, NG381LCFUR, NG381LDDPS, Niagara-283L-2, Niagara-381L, Niagara-381LC, R495, R499, R501, R503, R505, R507, R509, R511, R704, R706, R708, RIVER-282, River-282-2, River-282L-2, River-282LS-2TDE, River-282S-2TDE, River-285, RIVER-294, RIVER-295, River-295P, RIVER-296, River-296P, RIVER-297, RIVER-298, River-382, River-382-230V-3Ph-50Hz, River-382H, River-382L, River-382L-230V-3Ph-50Hz, River-382LNRG, River-382LTDE, River-382NRG, River-382NRG-230-3Ph-50Hz, River-382TDE...(Other models you can see in the webshop) | | |



1

| | | | |
|--------------------|--|-----------------|--------|
| GEV No. | 541011 | Ref. No. | 224010 |
| description | pressure control pressure range 110/70mbar connection 6mm ø 58mm pressure connection horizontal warewashing | | |
| For models: | 2312-002, 913297, 913298, 913299, 913300, 913360, 913361, 913391, 913392, 913546, 913547, 913578, 913611, 913684, 913913, 913914, 913932, 913933, 914284, 914318, 914319, 914331, 914338, 914356, 914400, 914401, 914402, 914403, 914404, 914405, 914431, 914449, 914517, 914545, 914568, 914642, 914688, 914909, 914979, 915136, 915137, 915140, 915248, 915483, 915484, 915528, 915537, 915538, 915539, 915540...(Other models you can see in the webshop) | | |



1

| | | | |
|--------------------|---|-----------------|--------|
| GEV No. | 541102 | Ref. No. | 224006 |
| description | pressure control pressure range 115/15mbar connection 6mm ø 58mm pressure connection horizontal warewashing | | |
| For models: | 915747, A4EBT, A4EBTSAK, CLEAN-3, River-multi-2256 | | |



1

| | | | |
|--------------------|--|-----------------|--------|
| GEV No. | 541647 | Ref. No. | 224011 |
| description | pressure control pressure range 115/85mbar connection 6mm ø 58mm pressure connection ø 6mm | | |
| For models: | 914326, 914406, 915729, E.55, FAST-63, RIVER-43 | | |



1

| | | | |
|--------------------|---|-----------------|--------|
| GEV No. | 543025 | Ref. No. | 224027 |
| description | pressure control pressure range 155/130mbar connection F6.3 ø 5.5mm | | |
| For models: | 915611, 915612, 915613, 915614, 915615, 915616, 915670, 915671, 915959, 916196, 916197, 916198, 916199, 916200, 916409, 916410, 916591, 916592, 916593, 916877, Niagara-241, Niagara-241-2, Niagara-341, Pluvia-240 | | |



1

| | | | |
|--------------------|---|-----------------|--------|
| GEV No. | 543024 | Ref. No. | 224026 |
| description | pressure control pressure range 120/95mbar connection F6.3 ø 5.5mm | | |
| For models: | 915611, 915612, 915613, 915614, 915615, 915616, 915670, 915671, 915959, 916196, 916197, 916198, 916199, 916200, 916409, 916410, 916591, 916592, 916593, 916877, NIAGARA-241, Niagara-241-2, Niagara-341, Pluvia-240 | | |



1

| | | | |
|--------------------|---|-----------------|--------|
| GEV No. | 541644 | Ref. No. | 224014 |
| description | pressure control pressure range 160/125mbar connection 6mm ø 58mm pressure connection ø 6mm | | |
| For models: | RIVER-43 | | |



1

| | | | |
|--------------------|--|-----------------|------------------|
| GEV No. | 541899 | Ref. No. | 224022 224025 |
| description | pressure control pressure range 125/105mbar connection 6mm ø 58mm pressure connection horizontal warewashing pressure connection ø 6mm | | |
| For models: | 915150, 915151, 915152, 915154, 915155, 915157, 915158, 915160, 915161, 915162, 915166, 915167, 915168, 915175, 915176, 915177, 915319, 915338, 915341, 915348, 915418, 915419, 915420, 915421, 915479, 915492, 915493, 915494, 915495, 915547, 915558, 915635, 915663, 915747, 916201, 916202, 916203, 916204, 916205, 916206, 916207, 916208, 916209, 916365, 916366, 916367, 916411, 916412, 916413, 916414...(Other models you can see in the webshop) | | |



1

| | | | |
|--------------------|--|-----------------|--------|
| GEV No. | 541898 | Ref. No. | 224023 |
| description | pressure control pressure range 165/140mbar connection 6mm ø 58mm pressure connection horizontal warewashing pressure connection ø 6mm | | |
| For models: | 915150, 915151, 915152, 915154, 915155, 915160, 915161, 915162, 915166, 915167, 915168, 915175, 915176, 915177, 915319, 915338, 915341, 915348, 915418, 915419, 915420, 915421, 915479, 915492, 915493, 915547, 915558, 915635, 915663, 915747, 916201, 916202, 916203, 916204, 916205, 916206, 916207, 916208, 916209, 916365, 916366, 916367, 916411, 916412, 916413, 916414, 916415, 916416, 916417, 916684...(Other models you can see in the webshop) | | |



1

| | | | |
|--------------------|--|-----------------|--------|
| GEV No. | 541166 | Ref. No. | 224008 |
| description | pressure control pressure range 140/110mbar connection 6mm ø 58mm pressure connection horizontal warewashing | | |
| For models: | 2312-009-CRP, PS-60, RIVER-40, RIVER-44, RIVER-44-CRP, RIVER-48, RIVER-50, RIVER-50-CRP, RIVER-61 | | |



1

| | | | |
|--------------------|--|-----------------|--------|
| GEV No. | 541103 | Ref. No. | 224007 |
| description | pressure control pressure range 170/140mbar connection 6mm ø 58mm pressure connection horizontal warewashing | | |
| For models: | CLEAN-3 | | |





| | | | |
|---|---|-----------------|--------|
|  | | | |
| 1 | | | |
| GEV No. | 541105 | Ref. No. | 926049 |
| description | pressure control pressure range 180/70mbar connection 6mm ø 58mm pressure connection horizontal warewashing | | |
| For models: | 12, 14, 161, 221, 271, 272, 362, 80, 81, 82, 914380, 914436, 915747, 915773, A3EB, A3EBD, A3EBDAKRKYK, A3EBDAKWK, A3EBDBKWK, A3EBDRKYK, A3EBDWK, A3EBDYK, A3EBSAK, A3EBSAKRK, A3EBSAKWK, A3EBSBKWKYK, A3EBSEKWK, A3EBSWK, A4EB, A4EBD, A4EBDAKEYK, A4EBDAKRK, A4EBDAKWK, A4EBDAKZK, A4EBDBKRRK, A4EBDPKWYK, A4EBDRK, A4EBS, A4EBSAK, A4EBSAKCK, A4EBSAKEKYK, A4EBSAKRK, A4EBSAKRKP, A4EBSAKYK, A4EBSCK, A4EBT, A4EBTSAK, A5EB, A5EBD, A5EBDAKPKWK...(Other models you can see in the webshop) | | |

| | | | |
|---|--|-----------------|--------|
|  | | | |
| 1 | | | |
| GEV No. | 541778 | Ref. No. | 224009 |
| description | pressure control pressure range 208/178mbar connection 6mm ø 58mm pressure connection horizontal warewashing pressure connection ø 6mm | | |
| For models: | 2312-009-CRP, RIVER-48, RIVER-50, RIVER-50-CRP, RIVER-61 | | |

| | | | |
|---|---|-----------------|--------|
|  | | | |
| 1 | | | |
| GEV No. | 541001 | Ref. No. | 224004 |
| description | pressure control pressure range 35/17mbar connection 6mm ø 58mm pressure connection horizontal warewashing | | |
| For models: | 11F, 11FD, 11F-DVGW, 11R, 11RD, 2312-009-CRP, 350F, 350FD, 350R, 350RD, 35-ELECTRONIC, 35F, 35FD, 35R, 35RD, 400F, 400FD, 400R, 400RD, 40-ELECTRONIC, 40F, 40FD, 40R, 40RD, 440F, 44F, 67F, 67R, 913289, 913290, 913291, 913292, 913356, 913357, 913363, 913364, 913372, 913373, 913374, 913375, 913376, 913377, 913416, 913435, 913544, 913545, 913665, 913666, 913667, 913668...(Other models you can see in the webshop) | | |

| | | | |
|---|--|-----------------|--------|
|  | | | |
| 1 | | | |
| GEV No. | 543014 | Ref. No. | 224024 |
| description | pressure control pressure range 35/22mbar connection 6mm suitable for COLGED | | |
| For models: | 915154, 915155, 915157, 915158, 915172, 915173, 915285, 915422, 915492, 915493, 915494, 915495, 915496, 915497, 916045, 916054, 916067, 916068, 916069, 916079, 916080, 916368, 916420, 916421, 916422, 916423, 916424, 916654, 916686, 916760, Fast160C, Ocean360-UK, River-252, River-252-2, River-252-2T, River-253, RIVER-262, River-262-2, River-262-2T, River-272, River-352C, River-352T, River-362C, River-362C-230V-3Ph-50Hz, River-362T, River-362T-230V-3Ph-50Hz, River-372 | | |

| | | | |
|--|---|-----------------|--------|
|  | | | |
| 1 | | | |
| GEV No. | 541132 | Ref. No. | 224015 |
| description | pressure control pressure range 40/18mbar connection 6mm ø 58mm pressure connection horizontal warewashing | | |
| For models: | 2312-007, 914100, 914101, 914339, 914342, 914343, 914624, 914625, 914626, 914627, 914850, 914851, 914854, PS-60, RIVER-48, River-54 | | |

| | | | |
|--|--|-----------------|--------|
|  | | | |
| 1 | | | |
| GEV No. | 541010 | Ref. No. | 224028 |
| description | pressure control pressure range 50/30mbar connection 6mm ø 58mm pressure connection horizontal warewashing | | |
| For models: | 915617, 915618, 915672, 915773, 915774, 916066, 916077, 916078, 916418, 916419, 916594, 916595, RIVER-242, River-242-2, River-242-2T, River-342C, River-342T | | |

| | | | |
|---|--|-----------------|--------|
|  | | | |
| 1 | | | |
| GEV No. | 541013 | Ref. No. | 929039 |
| description | pressure control pressure range 55/25mbar connection 6mm ø 58mm pressure connection horizontal warewashing | | |
| For models: | 10, 55, CLEAN-100, CLEAN-110, E.60, E.65, E1, E10, E100, E110 | | |

| | | | |
|--|---|-----------------|--------|
|  | | | |
| 1 | | | |
| GEV No. | 541003 | Ref. No. | 224003 |
| description | pressure control pressure range 55/35mbar connection 6mm ø 58mm pressure connection horizontal warewashing pressure connection ø 6mm | | |
| For models: | 050F, 050FP, 21F, 21FD, 21R, 21RD, 22F, 22R, 2312-001, 2312-002, 25F, 25FD, 25R, 25RD, 30F, 30FD, 30R, 30RD, 31F, 31FD, 31R, 31RD, 40F, 440F, 44F, 45, 450, 46, 460, 500F, 500FD, 50-ELECTRONIC, 50F, 50FD, 510F, 510FD, 913297, 913298, 913299, 913300, 913360, 913361, 913391, 913392, 913418, 913546, 913547, 913578, 913611, 913684...(Other models you can see in the webshop) | | |





| | | | |
|---|---|-----------------|--------|
|  | | | |
| GEV No. | 541106 | Ref. No. | 224005 |
| description | pressure control pressure range 90/56mbar connection 6mm ø 58mm pressure connection horizontal warewashing pressure connection ø 6mm | | |
| For models: | 050F, 050FP, 22F, 22R, 40F, 440F, 45, 450, 460, 500F, 500FD, 510F, 510FD, E.46, E.50, E.51, E.52, F85, F85P, LF50, LF55, MC501E, MC501EP, MC501S, MC501SP, NIAGARA-51, RIVER-40, RIVER-40-CRP, RIVER-44, RIVER-44-CRP, TF-503 | | |

| | | | |
|---|--|-----------------|--------|
|  | | | |
| GEV No. | 541951 | Ref. No. | 224029 |
| description | pressure control pressure range 90/60mbar connection 6mm ø 58mm pressure connection horizontal warewashing pressure connection ø 6mm | | |
| For models: | 916020, 916021, 916024, 916025, 916026, 916027, 916030, 916031, 916045, 916247, 916248, 916249, 916250, 916251, 916252, 916382, 916383, 916452, 916504, 916584, 916654, 916670, 916688, 916763, 916921, 916922, 916992, 916993, 917044, 917049, Clean161, Fast145-2, Fast150, Fast160-2, Fast160C, Fast161-2, Ocean360, Ocean360M, Ocean360-UK | | |

| | | | |
|---|---|-----------------|--------|
|  | | | |
| GEV No. | 541866 | Ref. No. | 224016 |
| description | pressure control pressure range 90/75mbar connection 6mm ø 58mm pressure connection horizontal warewashing pressure connection ø 6mm | | |
| For models: | 2312-007, 913992, 913993, 914100, 914101, 914339, 914342, 914343, 914583, 914592, 914612, 914613, 914624, 914625, 914626, 914627, 914850, 914851, 914854, 915143, RIVER-44, RIVER-44-CRP-ST, RIVER-44CRP-ST, RIVER-48, RIVER-54 | | |

| | | | |
|---|---|-----------------|-------|
|  | | | |
| GEV No. | 541017 | Ref. No. | 69850 |
| description | pressure control with mounting strap pressure range 40/20mbar connection 6mm ø 58mm pressure connection horizontal warewashing | | |
| For models: | Fast181, FAST-181, Fast181-230V-3Ph-60Hz, Fast181-400V-3NPh-60Hz, NG271, NG291, NG381, NG38123, NG38123TERMO, NG381C, NG381CDD, NG381CFUR, NG381DDHZ23, NG381DDPS, NG381D-DPSHZ23, NG381HPDD, NG381TERMO, NG381TXCDD, NIAGARA-271, NIAGARA-283, Niagara-283A, NIAGARA-291, Niagara-381, Niagara-381-230V-3Ph-50Hz, Niagara-381-230V-3Ph-60Hz, Niagara-381DP, Niagara-381HPD, RIVER-294, RV294, ST70FAST, ST70FASTHB, ST70FASTHB400, ST70FASTHZ23, SV72AEB, SV72EB | | |

| | | | |
|--|---|-----------------|------------------|
| miscellaneous | | | |
|  | | | |
| GEV No. | 541950 | Ref. No. | 224018 999328 |
| description | pressure control kit pressure range 0-30mbar connection 6mm warewashing | | |
| For models: | 915172, 915173, 915285, 915422, 915496, 915497, 915617, 915618, 915672, 915773, 915774, 916054, RIVER-242, RIVER-262, RIVER-282, RV282, RV282DD | | |

| | | | |
|--|---|-----------------|-------|
|  | | | |
| GEV No. | 543015 | Ref. No. | 70561 |
| description | pressure control pressure range 0-30mbar connection 6mm rectangular pressure monitoring | | |
| For models: | 915496, 915617, 915618, 915672, 915773, 915774, 916066, 916067, 916068, 916069, 916077, 916078, 916079, 916080, 916368, 916418, 916419, 916420, 916421, 916422, 916423, 916424, 916594, 916595, 916686, 916760, RIVER-242, RIVER-242-2, RIVER-242-2T, RIVER-252-2, RIVER-252-2T, RIVER-262, RIVER-262-2, RIVER-262-2T, RIVER-272, RIVER-282-2, RIVER-282L-2, RIVER-282LS-2TDE, RIVER-282S-2TDE, RIVER-285, RIVER-342C, RIVER-342T, RIVER-352C, RIVER-352T, RIVER-362C, RIVER-362C-230V-3Ph-50Hz, RIVER-362T, RIVER-362T-230V-3Ph-50Hz, RIVER-372, RIVER-382...(Other models you can see in the webshop) | | |

| | | | |
|--|---|-----------------|--------|
| accessories | | | |
|  | | | |
| GEV No. | 518367 | Ref. No. | 468098 |
| description | screw connection | | |
| For models: | 11F, 11FD, 11R, 11RD, 350F, 350FD, 350R, 350RD, 400F, 400FD, 400R, 400RD, 500F, 500FD | | |

1

| | | | |
|--------------------|--|-----------------|--------|
| GEV No. | 541109 | Ref. No. | 035031 |
| description | Y-piece plastic hose ø 8-6-8mm for pressure switch | | |
| For models: | 050F, 050FP, 22F, 22R, 2312-002, 2312-007, 2312-009-CRP, 40F, 440F, 45, 450, 460, 500F, 500FD, 510F, 510FD, 913297, 913298, 913299, 913300, 913360, 913361, 913391, 913392, 913546, 913547, 913578, 913611, 913684, 913913, 913914, 913932, 913933, 913992, 913993, 914100, 914101, 914284, 914318, 914319, 914326, 914331, 914338, 914339, 914342, 914343, 914356, 914400, 914401, 914402...(Other models you can see in the webshop) | | |

flow meters and flow sensors

flow meters

miscellaneous



1

| | | | |
|--------------------|--|-----------------|------------------|
| GEV No. | 402680 | Ref. No. | 240017 240998 |
| description | flow meter pressure range 0.2-10bar connection 10mm L 69mm | | |
| For models: | 80, 81, 82, MISTRAL-40, MISTRAL-51, NIAGARA-35, NIAGARA-40, NIAGARA-45, NIAGARA-51, RIVER-40, RIVER-43, RIVER-44, RIVER-48, RIVER-50, RIVER-54, RIVER-61, RIVER-80, RIVER-81, RIVER-82 | | |

motors

gear motors

for dishwashers



1

| | | | |
|--------------------|--|-----------------|--------|
| GEV No. | 601861 | Ref. No. | 927105 |
| description | gear motor FIR type 71-B5 180W 400V voltage AC 50/60Hz 3 phase 900/1100rpm shaft ø 14mm L 227mm for transport system without gearbox | | |
| For models: | 221, 271, 272, 362, A3EB, A3EBD, A3EBDAKRKYK, A3EBDAKWK, A3EBDBKWK, A3EBDRKYK, A3EBDVK, A3EBDYK, A3EBSAK, A3EBSAKRK, A3EBSAKWK, A3EBSBKWKYK, A3EBSEKWK, A3EBSWK, A4EB, A4EBD, A4EBDAKEKYK, A4EBDAKRK, A4EBDAKWK, A4EBDAKZK, A4EBDBKRK, A4EBDPKWKYK, A4EBDRK, A4EBS, A4EBSAK, A4EBSAKCK, A4EBSAKEKYK, A4EBSAKRK, A4EBSAKRKP, A4EBSAKYK, A4EBSCK, A4EBT, A4EBTSAK, A5EB, A5EBD, A5EBDAKPKWK, A5EBDAKWK, A5EBDAKYK, A5EBDRK, A5EBS, A5EBSAKPKWK, A5EBSAKRK, A5EBSAKRKYK, A5EBSAKWK, A5EBSAKWKYK, A5EBSBKRKP...(Other models you can see in the webshop) | | |

accessories

fan wheels



1

| | | | |
|--------------------|--|-----------------|--------|
| GEV No. | 601677 | Ref. No. | 927108 |
| description | fan wheel motor type 63B14 ø 220mm shaft intake ø 11mm H 65mm | | |
| For models: | 161, 221, 271, 272, 362, A3EBDAKRKYK, A3EBDRKYK, A3EBSAKRK, A3EBSEKWK, A4EBDAKEKYK, A4EBDAKRK, A4EBDBKRK, A4EBDRK, A4EBSAKCK, A4EBSAKEKYK, A4EBSAKRKP, A5EBDRK, A5EBSAKRK, A5EBSAKRKYK, A5EBSBKRPK, A5EBSRK, CLEAN-161, CLEAN-221, CLEAN-271, CLEAN-272, CLEAN-362, GL280EB23DAR, GL280EBDARY, GL280EBDBR, GL280EBSAE, GL280EBSAEW, GL280EBSAEWY, GL280EBSAR, GL280EBSARY, GL280EBSR, GL282EBDARW, GL282EBDCWY, GL282EBSAEW, GL282EBSAEWY, GL282EBSAR, GL282EBSBR, GL284EBDAEW, GL284EBDR, GL284EBSAE, GL286EBDAR, GL286EBSAPE, RV150DAR, RV150DRW, RV150SAC, RV150SAR...(Other models you can see in the webshop) | | |



pumps

wash and rinse pumps

FIR

pumps



| | | | |
|--------------------|--|-----------------|--------|
| GEV No. | 500541 | Ref. No. | 130107 |
| description | pump | | |
| For models: | 350F, 350FD, 350R, 350RD, 35F, 35FD, 35R, 35RD | | |



2

| | | | |
|--------------------|---|-----------------|------------------|
| GEV No. | 500545 | Ref. No. | 926079 926148 |
| description | pump | | |
| For models: | 12, 14, CLEAN-120, E12, E120, E14, E140 | | |

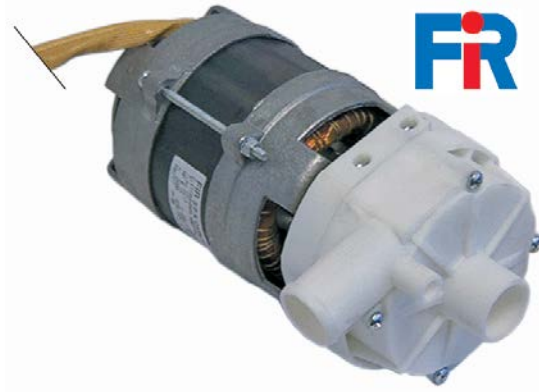

1

| | | | |
|--------------------|--|-----------------|--------|
| GEV No. | 500037 | Ref. No. | 929167 |
| description | pump inlet ø 28mm outlet ø 26mm type 2211.1410 230V 50Hz 1 phase 0.074kW 0.1HP L 190mm rotation direction left capacitor 5µF FIR | | |
| For models: | 915747, KLP105EB, KLP301, KLP301DDDTBE, LP105DDDTBE, LP105DDDTBE, LP105EB, LP301, LP301EB, LP60, River-81CRP, RIVER-81-CRP, River-82CRP, RIVER-82-CRP, RV81CCRP, RV81CRP, RV82CCRP, RV82CRP, U132E, U60E, U61, U61E, U61H, U61He | | |

spare parts for 500037

| | | | | |
|--|--|--------|-----------------|------------------|
| | GEV No. | 365017 | Ref. No. | 206008 206010 |
| | operating capacitor capacity 5µF 450V tolerance 5% 50/60Hz ambient temperature max. -25 to +85°C ø 28mm L 54mm M8 plastic connection male faston 6.3mm 16.10.08 protection | | | |
| | GEV No. | 510384 | Ref. No. | 116020 929182 |
| | pump cover inlet ø 28mm outlet ø 26mm ø 100mm ID ø 76mm | | | |
| | GEV No. | 510695 | Ref. No. | 927190 RAT123 |
| | mechanical shaft seal height counter ring 5.5mm ID ø 11mm | | | |
| | GEV No. | 521203 | Ref. No. | 124034 929173 |
| | impellor ø 72mm H 18mm thread M7 shaft ø 11mm shaft length 32mm blades 3 | | | |







1

| | | | | |
|------------------------|--|-----------------|-----------------|--------|
| GEV No. | 499227 | Ref. No. | 130108 | |
| description | pump inlet ø 28mm outlet ø 26mm type B236.1400 220-240V 50Hz 1 phase 0.14kW 0.2HP L 200mm rotation direction left capacitor 6.3µF FIR | | | |
| For models: | 400F, 400FD, 400R, 400RD, 40F, 40FD, 40R, 40RD, TF-503 | | | |
| spare parts for | 499227 | | | |
| | GEV No. | 365012 | Ref. No. | 206009 |
| | operating capacitor capacity 6.3µF 450V tolerance 5% 50Hz ambient temperature max. -25 to +85°C ø 30mm L 61mm M8 plastic connection male faston 6.3mm protection | | | |

Table continues overleaf



| | | | | |
|---|---------|--------|----------|------------------|
| spare parts for 499227 | | | | |
|  | GEV No. | 510384 | Ref. No. | 116020 929182 |
| pump cover inlet ø 28mm outlet ø 26mm ø 100mm ID ø 76mm | | | | |
|  | GEV No. | 510695 | Ref. No. | 927190 RAT123 |
| mechanical shaft seal height counter ring 5.5mm ID ø 11mm | | | | |
|  | GEV No. | 521203 | Ref. No. | 124034 929173 |
| impellor ø 72mm H 18mm thread M7 shaft ø 11mm shaft length 32mm blades 3 | | | | |
|  | GEV No. | 521703 | Ref. No. | 456038 456063 |
| pump cover gasket EPDM thickness 2.5mm ID ø 75mm Qty 1 pcs | | | | |

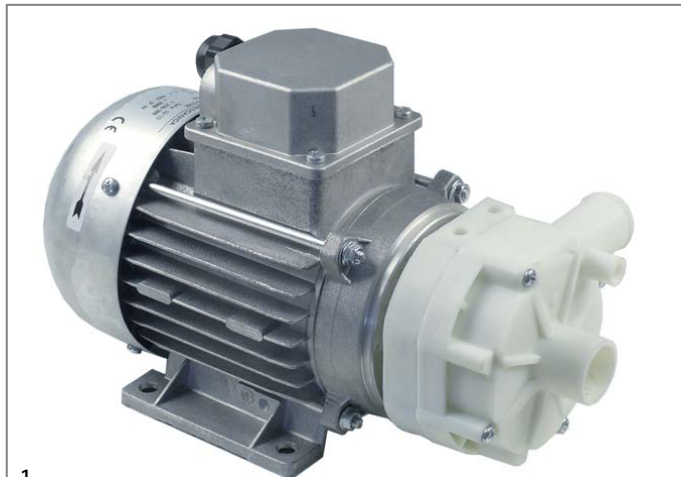

| | | | | |
|---|---|-----------------|----------|------------------|
| 1 | | | | |
| GEV No. | 499279 | Ref. No. | 927137 | |
| description | pump inlet ø 28mm outlet ø 26mm type B246.2520 230/400V 50Hz 3 phase 0.18kW 0.25HP L 265mm rotation direction right FIR | | | |
| For models: | 272, 362, CLEAN-161, CLEAN-221, CLEAN-271, CLEAN-272, CLEAN-361, CLEAN-361P, CLEAN-362, CLEAN-471, CLEAN-471P | | | |
| spare parts for 499279 | | | | |
|  | GEV No. | 510510 | Ref. No. | — |
| pump cover pump type 2212/2228/2229/2211 | | | | |
|  | GEV No. | 510532 | Ref. No. | 80813 |
| impellor ø 72mm H 22mm shaft ø 11mm shaft length 32mm blades 3 | | | | |
|  | GEV No. | 510695 | Ref. No. | 927190 RAT123 |
| mechanical shaft seal height counter ring 5.5mm ID ø 11mm | | | | |
|  | GEV No. | 521703 | Ref. No. | 456038 456063 |
| pump cover gasket EPDM thickness 2.5mm ID ø 75mm Qty 1 pcs | | | | |



| | | | | |
|--|--|-----------------|----------|-------|
| 1 | | | | |
| GEV No. | 502287 | Ref. No. | 77047 | |
| description | pump inlet ø 30mm outlet ø 26mm type 5213.4050 230/400V 50Hz 3 phase 0.11kW 0.15HP L 200mm rotation direction left | | | |
| For models: | A3EB, A3EBD, A3EBDAKRKYK, A3EBDAKWK, A3EBDBKWK, A3EBDRKYK, A3EBDVK, A3EBDYK, A3EBSAK, A3EBSAKRK, A3EBSAKWK, A3EBSBKWKYK, A3EBSEKWK, A3EBSWK, A4EB, A4EBD, A4EBDAKEYK, A4EBDAKRK, A4EBDAKWK, A4EBDAKZK, A4EBDBKRK, A4EBDPKWKYK, A4EBDRK, A4EBS, A4EBSAK, A4EBSAKCK, A4EBSAKEKYK, A4EBSAKRK, A4EBSAKRKP, A4EBSAKYK, A4EBSCK, A4EBT, A4EBTSAK, A5EB, A5EBD, A5EBDAKPKWK, A5EBDAKWK, A5EBDAKYK, A5EBDRK, A5EBS, A5EBSAKPKWK, A5EBSAKRK, A5EBSAKRKYK, A5EBSAKWK, A5EBSAKWKYK, A5EBSBKRPK, A5EBSBKWK, A5EBSRK, A5EBSYK, RIVER-MULTI-2252...(Other models you can see in the webshop) | | | |
| spare parts for 502287 | | | | |
|  | GEV No. | 699372 | Ref. No. | 80814 |
| flange for pump with cover type 5213 L 103mm W 103mm H 69mm | | | | |











| | | | | |
|--|---|-----------------|----------|-----------------------------------|
| 1 | | | | |
| GEV No. | 500544 | Ref. No. | 926151 | |
| description | pump inlet ø 60mm outlet ø 50mm type 4223.1900 230V 50Hz 1 phase 0.73kW 1HP L 225mm rotation direction right capacitor 16µF FIR | | | |
| For models: | CLEAN-100, E.60, E100 | | | |
| spare parts for 500544 | | | | |
|  | GEV No. | 365021 | Ref. No. | 206004 |
| operating capacitor capacity 16µF 425V tolerance 5% 50/60Hz ambient temperature max. -25 to +85°C ø 35mm L 73mm single M8 plastic connection male faston 6.3mm 416.10.99 protection | | | | |
|  | GEV No. | 510552 | Ref. No. | 437049 |
| pump cover gasket pump type 1292-2/3942/3981/3911/3983 | | | | |
|  | GEV No. | 510693 | Ref. No. | 141002 70942 80121 RAT72 |
| mechanical shaft seal for shaft ø 12mm slide ring ext. ø 24mm slide ring H 15.5mm slide ring int. ø 11mm counter ring mounting ø 24mm height counter ring 8mm counter ring int. ø 13.5mm | | | | |

Table continues overleaf





| | | | |
|---|---------|--------|-----------------|
| spare parts for 500544 | | | |
|  | GEV No. | 518067 | Ref. No. 926152 |
| impellor ø 103mm H 29mm M7L | | | |
|  | GEV No. | 521512 | Ref. No. 116015 |
| pump cover FIR inlet ø 60mm outlet ø 50mm | | | |



| | | | |
|--|--|-----------------|----------------------|
| 1 | | | |
| GEV No. | 499281 | Ref. No. | 80134 |
| description | pump inlet ø 60mm outlet ø 50mm type 4298.1404 230V 50Hz 1 phase 1.1kW L 210mm rotation direction right capacitor 12.5µF FIR | | |
| For models: | Niagara-283A, RIVER-282, River-285, RV282DD, RV282R, SV72AEB | | |
| spare parts for | 499281 | | |
|  | GEV No. | 365014 | Ref. No. 80191 |
| operating capacitor capacity 12.5µF 450V tolerance 5%Hz ambient temperature max. -25 to +85°C ø 35mm L 70mm M8 plastic connection male faston 6.3mm 455.C3DS.12.5 protection | | | |
|  | GEV No. | 510600 | Ref. No. 80197 |
| impellor ø 102mm H 29mm shaft intake ø 9/8mm rotation direction right blades 6 | | | |
|  | GEV No. | 510692 | Ref. No. 80193 RAT19 |
| mechanical shaft seal for shaft ø 11mm slide ring ext. ø 24mm slide ring H 13mm counter ring mounting ø 26mm height counter ring 8mm counter ring int. ø 14mm | | | |
|  | GEV No. | 521702 | Ref. No. — |
| pump cover gasket thickness 3.5x4.5mm Qty 1 pcs | | | |



| | | | |
|---|--|-----------------|-----------------|
| 1 | | | |
| GEV No. | 499336 | Ref. No. | 929175 |
| description | pump inlet ø 62 outlet ø 62 type 2250.2732 230/400V 50Hz 2.95kW 4HP | | |
| For models: | KLP301, KLP301DDDTEB, LP301, LP301EB, RIVER-298, RV298, U132, U132e, U70, U70E | | |
| spare parts for | 499336 | | |
|  | GEV No. | 510687 | Ref. No. 929179 |
| mechanical shaft seal for shaft ø 18mm height counter ring 8mm ID ø 17mm ED ø 39mm H 15mm mounting ø 42mm int. ø 1 21mm | | | |
|  | GEV No. | 521026 | Ref. No. — |
| pump cover gasket ID ø 182.5mm thickness 5x4.5mm | | | |
|  | GEV No. | 521028 | Ref. No. — |
| pump cover FIR inlet ø 62mm outlet ø 62mm turn direction right ø 215mm ID ø 175mm inner height 40mm | | | |











| | | | |
|---|--|-----------------|-----------------|
| 1 | | | |
| GEV No. | 499334 | Ref. No. | 929174 |
| description | pump inlet ø 62mm outlet ø 62mm type 2250.2731 230/400V 50Hz 1 phase 3kW FIR | | |
| For models: | KLP201DDDTEB, KLP201EB, KLP301, KLP301DDDTEB, LP201DDDTEB, LP201EB, LP301, LP301EB, RIVER-297, RIVER-298, RV297, RV298, U132, U132e, U70, U70e | | |
| spare parts for | 499334 | | |
|  | GEV No. | 510687 | Ref. No. 929179 |
| mechanical shaft seal for shaft ø 18mm height counter ring 8mm ID ø 17mm ED ø 39mm H 15mm mounting ø 42mm int. ø 1 21mm | | | |
|  | GEV No. | 512455 | Ref. No. 929189 |
| fan wheel ø 155mm H 18mm shaft intake ø 18mm plastic blades 12 | | | |





Table continues overleaf

| | | | | |
|---|---------|--------|----------|--------|
| spare parts for 499334 | | | | |
|  | GEV No. | 521026 | Ref. No. | — |
| pump cover gasket ID ø 182.5mm thickness 5x4.5mm | | | | |
|  | GEV No. | 521028 | Ref. No. | — |
| pump cover FIR inlet ø 62mm outlet ø 62mm turn direction right ø 215mm ID ø 175mm inner height 40mm | | | | |
|  | GEV No. | 521277 | Ref. No. | 929181 |
| impellor ø 135mm H 39mm pump type Fir 2275 - 3.6HP thread M14L | | | | |







| | | | |
|--|---|-----------------|-----------------------------------|
| GEV No. | 501487 | Ref. No. | 70100 |
| description | pump inlet ø 63mm outlet ø 40mm type 4267.5050 230/400V 50Hz 3 phase 1.5kW L 300mm rotation direction right FIR | | |
| For models: | NG381L, NG381LC, NG381LCFUR, NG381LDDPS, Niagara-283L-2, Niagara-381L, Niagara-381LC, River-282L-2, River-282LS-2TDE, River-382L, River-382L-230V-3Ph-50Hz, River-382LNRG, River-382LTDE, River-482, RV382L, RV382L23TERMO, RV382LFUR, RV382LR, RV382LS, RV382LSFUR, RV382LTX, RV382LTXR, RV482 | | |
| spare parts for | 501487 | | |
|  | GEV No. | 502273 | Ref. No. 70945 |
| pump cover FIR inlet ø 63mm outlet ø 2x40mm pump type 4267.5050 turn direction right | | | |
|  | GEV No. | 510602 | Ref. No. 124002 927186 |
| impellor ø 110mm H 34mm rotation direction right thread M8L shaft ø 28mm seat ø 12.2mm blades 6 | | | |
|  | GEV No. | 510693 | Ref. No. 141002 70942 80121 RAT72 |
| mechanical shaft seal for shaft ø 12mm slide ring ext. ø 24mm slide ring H 15.5mm slide ring int. ø 11mm counter ring mounting ø 24mm height counter ring 8mm counter ring int. ø 13.5mm | | | |
|  | GEV No. | 524416 | Ref. No. 70943 80120 |
| pump cover gasket thickness 4x4mm Qty 1 pcs | | | |

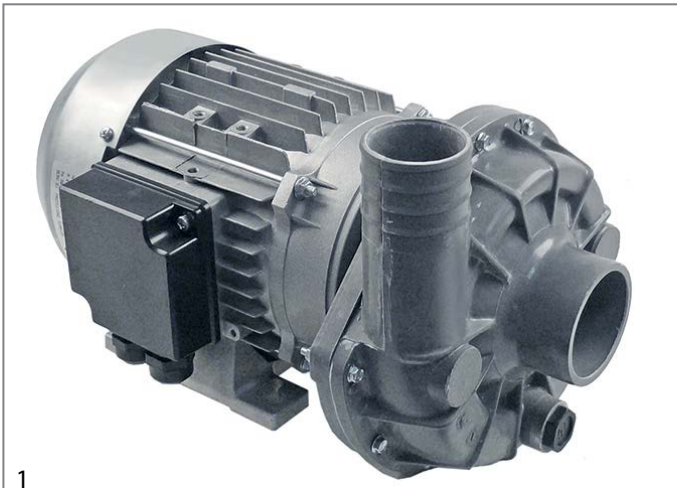

| | | | |
|--|---|-----------------|-----------------------------------|
| GEV No. | 500155 | Ref. No. | 130039 |
| description | pump inlet ø 63mm outlet ø 47mm type 1225 230V 50Hz 1 phase 1.1kW 1.5HP L 335mm rotation direction right capacitor 31.5µF FIR | | |
| For models: | 66, S850 | | |
| spare parts for | 500155 | | |
|  | GEV No. | 365016 | Ref. No. 206006 |
| operating capacitor capacity 31.5µF 400V tolerance 5%Hz ambient temperature max. -25 to +85°C ø 45mm L 95mm M8 plastic connection male faston 6.3mm protection | | | |
|  | GEV No. | 510602 | Ref. No. 124002 927186 |
| impellor ø 110mm H 34mm rotation direction right thread M8L shaft ø 28mm seat ø 12.2mm blades 6 | | | |
|  | GEV No. | 510693 | Ref. No. 141002 70942 80121 RAT72 |
| mechanical shaft seal for shaft ø 12mm slide ring ext. ø 24mm slide ring H 15.5mm slide ring int. ø 11mm counter ring mounting ø 24mm height counter ring 8mm counter ring int. ø 13.5mm | | | |
|  | GEV No. | 521513 | Ref. No. 116002 80118 |
| pump cover FIR inlet ø 63mm outlet ø 47mm turn direction right ID ø 150mm inner height 32mm | | | |
|  | GEV No. | 524416 | Ref. No. 70943 80120 |
| pump cover gasket thickness 4x4mm Qty 1 pcs | | | |







1

| | | | |
|---|--|-----------------|---|
| GEV No. | 500023 | Ref. No. | 130025 |
| description | pump inlet ø 63mm outlet ø 47mm type 1225.2725 230/400V 50Hz 3 phase 1.1kW 1.5HP L 335mm rotation direction right FIR | | |
| For models: | 66, S850 | | |
| spare parts for | 500023 | | |
|  | GEV No. | 510602 | Ref. No. 124002 927186 |
| | impellor ø 110mm H 34mm rotation direction right thread M8L shaft ø 28mm seat ø 12.2mm blades 6 | | |
|  | GEV No. | 510693 | Ref. No. 141002 70942 80121 RAT72 |
| | mechanical shaft seal for shaft ø 12mm slide ring ext. ø 24mm slide ring H 15.5mm slide ring int. ø 11mm counter ring mounting ø 24mm height counter ring 8mm counter ring int. ø 13.5mm | | |
|  | GEV No. | 521513 | Ref. No. 116002 80118 |
| | pump cover FIR inlet ø 63mm outlet ø 47mm turn direction right ID ø 150mm inner height 32mm | | |
|  | GEV No. | 524416 | Ref. No. 70943 80120 |
| | pump cover gasket thickness 4x4mm Qty 1 pcs | | |







1

| | | | |
|---|--|-----------------|---|
| GEV No. | 501513 | Ref. No. | 41990 |
| description | pump inlet ø 63mm outlet ø 47mm type 1227.2711M10 230/400V 50Hz 3 phase 1.7kW L 340mm rotation direction right FIR | | |
| For models: | NG293, NIAGARA-293, RIVER-296, River-296P, RV296, RV296PS | | |
| spare parts for | 501513 | | |
|  | GEV No. | 510693 | Ref. No. 141002 70942 80121 RAT72 |
| | mechanical shaft seal for shaft ø 12mm slide ring ext. ø 24mm slide ring H 15.5mm slide ring int. ø 11mm counter ring mounting ø 24mm height counter ring 8mm counter ring int. ø 13.5mm | | |
|  | GEV No. | 511667 | Ref. No. 70939 |
| | fan wheel ø 123mm H 17mm shaft intake ø 15mm | | |
|  | GEV No. | 521513 | Ref. No. 116002 80118 |
| | pump cover FIR inlet ø 63mm outlet ø 47mm turn direction right ID ø 150mm inner height 32mm | | |
|  | GEV No. | 524416 | Ref. No. 70943 80120 |
| | pump cover gasket thickness 4x4mm Qty 1 pcs | | |
|  | GEV No. | 698772 | Ref. No. 41991 |
| | impellor ø 113mm H 34mm M10L pump type 1227.2711M10 rotation direction right suitable for FIR blades 6 | | |







1

| | | | |
|---|--|-----------------|---|
| GEV No. | 500117 | Ref. No. | 919223 926150 929201 |
| description | pump inlet ø 63mm outlet ø 47mm type 4225.22725 230/400V 50Hz 3 phase 1.4kW 2HP L 280mm rotation direction right FIR | | |
| For models: | A3EB, A3EBD, A3EBDAKRKYK, A3EBDAKWK, A3EBDBKWK, A3EB-DRKYK, A3EBDWK, A3EBDYK, A3EBSAK, A3EBSAKRK, A3EBSAKWK, A3EBSBKWKYK, A3EBSEKWK, A3EBSWK, A4EB, A4EBD, A4EBDAKEKYK, A4EBDAKRK, A4EBDAKWK, A4EBDAKZK, A4EBDBKRK, A4EBDPKWKYK, A4EBDRK, A4EBS, A4EBSAK, A4EBSAKCK, A4EBSAKEKYK, A4EBSA-KRK, A4EBSAKRKP, A4EBSAKYK, A4EBSCK, E.65, E14, E140, Fast200, FAST-200, Fast93, GL282EB93, GL282EB93DA, GL282EB93HZ23, GL282EBCH, GL282EBCHD, GL286EB, GL286EBD, GL286EBDA, GL286EBDAR, GL286EBDARY, GL286EBDAW, GL286EBDAY, GL286EBD-WY...(Other models you can see in the webshop) | | |
| spare parts for | 500117 | | |
|  | GEV No. | 510602 | Ref. No. 124002 927186 |
| | impellor ø 110mm H 34mm rotation direction right thread M8L shaft ø 28mm seat ø 12.2mm blades 6 | | |
|  | GEV No. | 510693 | Ref. No. 141002 70942 80121 RAT72 |
| | mechanical shaft seal for shaft ø 12mm slide ring ext. ø 24mm slide ring H 15.5mm slide ring int. ø 11mm counter ring mounting ø 24mm height counter ring 8mm counter ring int. ø 13.5mm | | |
|  | GEV No. | 521513 | Ref. No. 116002 80118 |
| | pump cover FIR inlet ø 63mm outlet ø 47mm turn direction right ID ø 150mm inner height 32mm | | |
|  | GEV No. | 524416 | Ref. No. 70943 80120 |
| | pump cover gasket thickness 4x4mm Qty 1 pcs | | |





1

| | | | |
|---|--|-----------------|---|
| GEV No. | 500570 | Ref. No. | 75175 |
| description | pump inlet ø 63mm outlet ø 47mm type 422512725 230/400V 50Hz 3 phase 1.1kW 1.5HP L 285mm rotation direction right FIR | | |
| For models: | 914380, 914436, 915747, GL280EB, GL280EB23, GL280EB23DAR, GL280EBD, GL280EBDA, GL280EBDAE, GL280EBDAR, GL280EBDARY, GL280EBDAW, GL280EBDAWY, GL280EBDAY, GL280EBDB, GL280EBD-BR, GL280EBDBW, GL280EBDWY, GL280EBDY, GL280EBS, GL280EB-SA, GL280EBSAE, GL280EBSAEW, GL280EBSAEWY, GL280EBSAR, GL280EBSARY, GL280EBSAW, GL280EBSAWY, GL280EBSAY, GL280EBSB, GL280EBSR, GL280EBSWY, GL280EBSY, GL282EB, GL282EBD, GL282EBDA, GL282EBDAE, GL282EBDAR, GL282EB-DARW, GL282EBDAWY, GL282EBDBW, GL282EBDCWY, GL282EB-SA, GL282EBSAEW, GL282EBSAEWY, GL282EBSAP, GL282EBSAR, GL282EBSAW, GL282EBSBR, GL282EBSY...(Other models you can see in the webshop) | | |
| spare parts for | 500570 | | |
|  | GEV No. | 510693 | Ref. No. 141002 70942 80121 RAT72 |
| | mechanical shaft seal for shaft ø 12mm slide ring ext. ø 24mm slide ring H 15.5mm slide ring int. ø 11mm counter ring mounting ø 24mm height counter ring 8mm counter ring int. ø 13.5mm | | |
|  | GEV No. | 521082 | Ref. No. 80881 |
| | impellor ø 96mm H 32mm rotation direction right thread M8L | | |
|  | GEV No. | 521513 | Ref. No. 116002 80118 |
| | pump cover FIR inlet ø 63mm outlet ø 47mm turn direction right ID ø 150mm inner height 32mm | | |
|  | GEV No. | 524416 | Ref. No. 70943 80120 |
| | pump cover gasket thickness 4x4mm Qty 1 pcs | | |



| | | | |
|--------------------|---|-----------------|---------|
| 1 | | | |
| GEV No. | 499283 | Ref. No. | 75175HZ |
| description | pump inlet ø 63mm outlet ø 47mm type 422512760 230/400V 60Hz 3 phase 1.1kW L 290mm rotation direction right FIR | | |
| For models: | GL280EB23HZ, GL280EB23HZDY, GL282EBHZ23, GL282EBHZ23DY, GL282EBHZ23SY, GL284EBHZ23, GL284EBHZ23DBHZY, GL284EBHZ23DBWY, GL284EBHZ23DBY, GL284EBHZ23DY, GL284EBHZ23SAP, Niagara-2150-230V-3Ph-60hz, Niagara-2154-230-3Ph-60Hz | | |



| | | | |
|---|--|-----------------|---|
| 1 | | | |
| GEV No. | 501540 | Ref. No. | 929123 |
| description | pump inlet ø 63mm outlet ø 47mm type 422522726 230/400V 50Hz 3 phase 1.4kW 2HP L 280mm rotation direction right FIR | | |
| For models: | E.65, U61, U61E, U61HE | | |
| spare parts for | 501540 | | |
|  | GEV No. | 510602 | Ref. No. 124002 927186 |
| | impellor ø 110mm H 34mm rotation direction right thread M8L shaft ø 28mm seat ø 12.2mm blades 6 | | |
|  | GEV No. | 510693 | Ref. No. 141002 70942 80121 RAT72 |
| | mechanical shaft seal for shaft ø 12mm slide ring ext. ø 24mm slide ring H 15.5mm slide ring int. ø 11mm counter ring mounting ø 24mm height counter ring 8mm counter ring int. ø 13.5mm | | |
|  | GEV No. | 521513 | Ref. No. 116002 80118 |
| | pump cover FIR inlet ø 63mm outlet ø 47mm turn direction right ID ø 150mm inner height 32mm | | |

| | | | |
|---|---|--------|--------------------------------|
| spare parts for | 501540 | | |
|  | GEV No. | 524416 | Ref. No. 70943 80120 |
| | pump cover gasket thickness 4x4mm Qty 1 pcs | | |







| | | | |
|--------------------|--|-----------------|-------|
| 1 | | | |
| GEV No. | 499280 | Ref. No. | 80115 |
| description | pump inlet ø 63mm outlet ø 47mm type 5295.5050 230/400V 50Hz 3 phase 1.5kW L 300mm rotation direction right FIR | | |
| For models: | 80, 82, CGL74CABT, NG292, NIAGARA-292, RIVER-295, River-295P, River-81CRP, RIVER-81-CRP, RIVER-82, River-82CRP, RIVER-82-CRP, RIVER-HL-82, RV295, RV295PS, RV81CCRP, RV81CRP, RV82, RV8223, RV82C, RV82CCRP, RV82CRP, SevenL | | |

| | | | |
|---|--|--------|---|
| spare parts for | 499280 | | |
|  | GEV No. | 502277 | Ref. No. 70944 80119 |
| | impellor ø 111mm H 31mm thread M8L | | |
|  | GEV No. | 510693 | Ref. No. 141002 70942 80121 RAT72 |
| | mechanical shaft seal for shaft ø 12mm slide ring ext. ø 24mm slide ring H 15.5mm slide ring int. ø 11mm counter ring mounting ø 24mm height counter ring 8mm counter ring int. ø 13.5mm | | |
|  | GEV No. | 521022 | Ref. No. — |
| | fanwheel cover ID ø 137mm ED ø 142mm H 70mm for wash pump | | |
|  | GEV No. | 524416 | Ref. No. 70943 80120 |
| | pump cover gasket thickness 4x4mm Qty 1 pcs | | |
|  | GEV No. | 698773 | Ref. No. — |
| | pump cover inlet ø 63mm outlet ø 47mm turn direction right ø 194mm ID ø 158mm | | |





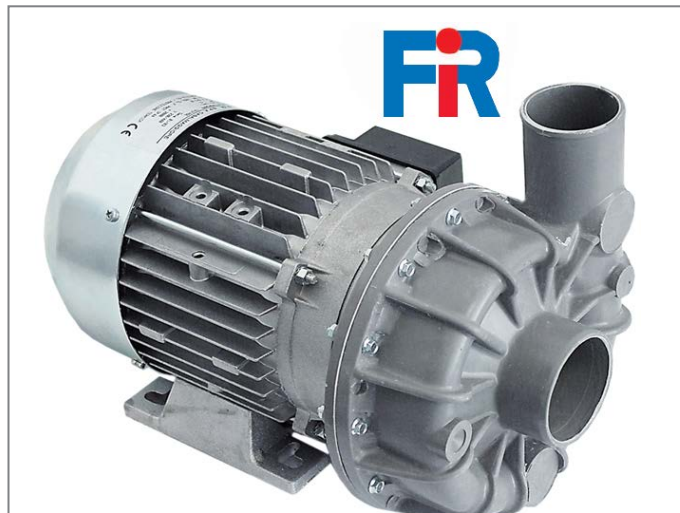

1

| | | | |
|---|--|-----------------|--|
| GEV No. | 500119 | Ref. No. | 130038 |
| description | pump inlet ø 63mm outlet ø 53mm type 1241.1402 230V 50Hz 1 phase 1.1kW 1.5HP L 330mm rotation direction left capacitor 31.5µF FIR | | |
| For models: | S870 | | |
| spare parts for | 500119 | | |
|  | GEV No. | 365016 | Ref. No. 206006 |
| | operating capacitor capacity 31.5µF 400V tolerance 5%Hz ambient temperature max. -25 to +85°C ø 45mm L 95mm M8 plastic connection male faston 6.3mm protection | | |
|  | GEV No. | 510531 | Ref. No. 1165005 |
| | pump cover FIR inlet ø 63mm outlet ø 53mm auxiliary pressure connection M16x1.5mm supporting pressure open turn direction left ø 185mm ID ø 150mm inner high 37mm | | |
|  | GEV No. | 510612 | Ref. No. 927227 RAG19 |
| | impellor ø 110mm H 34mm M8R | | |
|  | GEV No. | 510693 | Ref. No. 141002 70942 80121 RAT72 |
| | mechanical shaft seal for shaft ø 12mm slide ring ext. ø 24mm slide ring H 15.5mm slide ring int. ø 11mm counter ring mounting ø 24mm height counter ring 8mm counter ring int. ø 13.5mm | | |
|  | GEV No. | 524416 | Ref. No. 70943 80120 |
| | pump cover gasket thickness 4x4mm Qty 1 pcs | | |



1

| | | | |
|---|--|-----------------|--|
| GEV No. | 500111 | Ref. No. | 130002 |
| description | pump inlet ø 63mm outlet ø 53mm type 1241.2500 230/400V 50Hz 3 phase 1.1kW 1.5HP L 330mm rotation direction left FIR | | |
| For models: | 55, S870 | | |
| spare parts for | 500111 | | |
|  | GEV No. | 510531 | Ref. No. 1165005 |
| | pump cover FIR inlet ø 63mm outlet ø 53mm auxiliary pressure connection M16x1.5mm supporting pressure open turn direction left ø 185mm ID ø 150mm inner high 37mm | | |
|  | GEV No. | 510612 | Ref. No. 927227 RAG19 |
| | impellor ø 110mm H 34mm M8R | | |
|  | GEV No. | 510693 | Ref. No. 141002 70942 80121 RAT72 |
| | mechanical shaft seal for shaft ø 12mm slide ring ext. ø 24mm slide ring H 15.5mm slide ring int. ø 11mm counter ring mounting ø 24mm height counter ring 8mm counter ring int. ø 13.5mm | | |
|  | GEV No. | 524416 | Ref. No. 70943 80120 |
| | pump cover gasket thickness 4x4mm Qty 1 pcs | | |



1









| | | | |
|---|---|-----------------|------------------------|
| GEV No. | 500324 | Ref. No. | 130005 |
| description | pump inlet ø 63mm outlet ø 53mm type 1243.2591 230/400V 50Hz 3 phase 2.35kW 3.2HP L 365mm rotation direction left FIR | | |
| For models: | S950 | | |
| spare parts for | 500324 | | |
|  | GEV No. | 510357 | Ref. No. 124014 |
| | impellor ø 124mm H 34/16mm thread M8R blades 6 | | |



Table continues overleaf







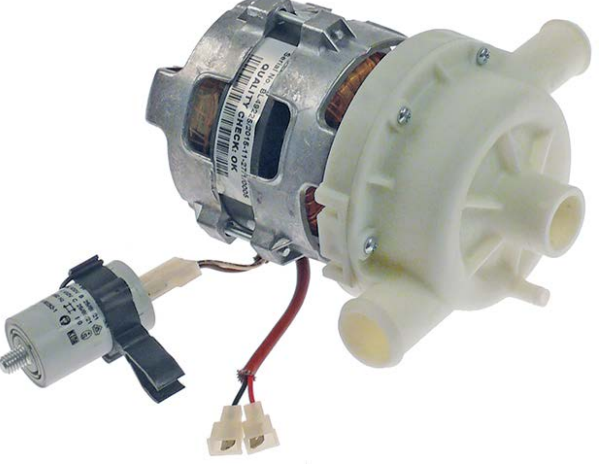

| spare parts for 500324 | | | | | |
|---|---|----------|-----------------------------------|----------|-----------------------------------|
|  | <table border="1"> <tr> <th>GEV No.</th> <th>510531</th> <th>Ref. No.</th> <th>1165005</th> </tr> </table> <p>pump cover FIR inlet ø 63mm outlet ø 53mm auxiliary pressure connection M16x1.5mm supporting pressure open turn direction left ø 185mm ID ø 150mm inner height 37mm</p> | GEV No. | 510531 | Ref. No. | 1165005 |
| GEV No. | 510531 | Ref. No. | 1165005 | | |
|  | <table border="1"> <tr> <th>GEV No.</th> <th>510693</th> <th>Ref. No.</th> <th>141002 70942 80121 RAT72</th> </tr> </table> <p>mechanical shaft seal for shaft ø 12mm slide ring ext. ø 24mm slide ring H 15.5mm slide ring int. ø 11mm counter ring mounting ø 24mm height counter ring 8mm counter ring int. ø 13.5mm</p> | GEV No. | 510693 | Ref. No. | 141002 70942 80121 RAT72 |
| GEV No. | 510693 | Ref. No. | 141002 70942 80121 RAT72 | | |
|  | <table border="1"> <tr> <th>GEV No.</th> <th>524416</th> <th>Ref. No.</th> <th>70943 80120</th> </tr> </table> <p>pump cover gasket thickness 4x4mm Qty 1 pcs</p> | GEV No. | 524416 | Ref. No. | 70943 80120 |
| GEV No. | 524416 | Ref. No. | 70943 80120 | | |

| LGB | | | | | |
|--|---|-----------------|--------|----------|--------|
|  | 1 | | | | |
| GEV No. | 500154 | Ref. No. | 130135 | | |
| description | pump 230V 50Hz 1 phase 0.18kW LGB | | | | |
| For models: | E.35 | | | | |
| spare parts for 500154 | | | | | |
|  | <table border="1"> <tr> <th>GEV No.</th> <th>521221</th> <th>Ref. No.</th> <th>124048</th> </tr> </table> <p>impellor ø 67mm H 16mm rotation direction right thread M7L shaft ø 13mm shaft length 12mm blades 8</p> | GEV No. | 521221 | Ref. No. | 124048 |
| GEV No. | 521221 | Ref. No. | 124048 | | |





|  | 1 | | | | |
|---|---|-----------------|------------------|----------|------------------|
| GEV No. | 501503 | Ref. No. | 130166 | | |
| description | pump inlet ø 28mm outlet ø 22/27mm type CF 2745 230V 50Hz 1 phase 0.19kW L 175mm rotation direction right capacitor 4µF LGB with capacitor | | | | |
| For models: | 915611, 915612, 915613, 915614, 915615, 915616, 915617, 915618, 915670, 915671, 915672, 915773, 915774, 915959, 916066, 916077, 916078, 916196, 916197, 916198, 916199, 916200, 916409, 916410, 916418, 916419, 916591, 916592, 916593, 916594, 916595, 916877, 916921, 916922, 916992, 916993, Fast145-2, Fast150, Niagara-241, Niagara-241-2, Niagara-341, Pluvia-240, RIVER-242, River-242-2, River-242-2T, River-342C, River-342T | | | | |
| spare parts for 501503 | | | | | |
|  | <table border="1"> <tr> <th>GEV No.</th> <th>365031</th> <th>Ref. No.</th> <th>206013</th> </tr> </table> <p>operating capacitor capacity 4µF 450V tolerance 5% 50/60Hz ambient temperature max. -25 to +85°C ø 31mm L 58mm M8 plastic connection male faston 6.3mm protection</p> | GEV No. | 365031 | Ref. No. | 206013 |
| GEV No. | 365031 | Ref. No. | 206013 | | |
|  | <table border="1"> <tr> <th>GEV No.</th> <th>509002</th> <th>Ref. No.</th> <th>456083 456084</th> </tr> </table> <p>O-ring EPDM thickness 2.62mm ID ø 82.22mm Qty 1 pcs</p> | GEV No. | 509002 | Ref. No. | 456083 456084 |
| GEV No. | 509002 | Ref. No. | 456083 456084 | | |

| spare parts for 501503 | | | | | |
|---|--|----------|-----------------|----------|-----------------|
|  | <table border="1"> <tr> <th>GEV No.</th> <th>510703</th> <th>Ref. No.</th> <th>141007 80843</th> </tr> </table> <p>mechanical shaft seal for shaft ø 13mm slide ring H 13mm height counter ring 5.5mm ED ø 26mm</p> | GEV No. | 510703 | Ref. No. | 141007 80843 |
| GEV No. | 510703 | Ref. No. | 141007 80843 | | |
|  | <table border="1"> <tr> <th>GEV No.</th> <th>698765</th> <th>Ref. No.</th> <th>124063</th> </tr> </table> <p>impellor ø 70mm H 21mm rotation direction right thread M7L suitable for LGB shaft ø 13mm shaft length 20mm blades 4</p> | GEV No. | 698765 | Ref. No. | 124063 |
| GEV No. | 698765 | Ref. No. | 124063 | | |
|  | <table border="1"> <tr> <th>GEV No.</th> <th>698770</th> <th>Ref. No.</th> <th>116035</th> </tr> </table> <p>pump cover LGB inlet ø 28mm outlet ø 22/28mm ø 108mm ID ø 84mm</p> | GEV No. | 698770 | Ref. No. | 116035 |
| GEV No. | 698770 | Ref. No. | 116035 | | |

|  | 1 | | | | |
|---|---|-----------------|------------------|----------|------------------|
| GEV No. | 501525 | Ref. No. | 130168 | | |
| description | pump inlet ø 28mm outlet ø 22/27mm type CF 3091 230V 60Hz 1 phase 0.2kW L 175mm rotation direction right capacitor 4µF LGB with capacitor | | | | |
| For models: | 915611, 915612, 915613, 915614, 915615, 915616, 915617, 915618, 915670, 915671, 915672, 915773, 915774, 915959, 916066, 916077, 916078, 916196, 916197, 916198, 916199, 916200, 916409, 916410, 916418, 916419, 916591, 916592, 916593, 916594, 916595, 916877, Niagara-241, Niagara-241-2, Niagara-341, Pluvia-240, River-242, River-242-2, River-242-2T, River-342C, River-342T | | | | |
| spare parts for 501525 | | | | | |
|  | <table border="1"> <tr> <th>GEV No.</th> <th>365031</th> <th>Ref. No.</th> <th>206013</th> </tr> </table> <p>operating capacitor capacity 4µF 450V tolerance 5% 50/60Hz ambient temperature max. -25 to +85°C ø 31mm L 58mm M8 plastic connection male faston 6.3mm protection</p> | GEV No. | 365031 | Ref. No. | 206013 |
| GEV No. | 365031 | Ref. No. | 206013 | | |
|  | <table border="1"> <tr> <th>GEV No.</th> <th>509002</th> <th>Ref. No.</th> <th>456083 456084</th> </tr> </table> <p>O-ring EPDM thickness 2.62mm ID ø 82.22mm Qty 1 pcs</p> | GEV No. | 509002 | Ref. No. | 456083 456084 |
| GEV No. | 509002 | Ref. No. | 456083 456084 | | |
|  | <table border="1"> <tr> <th>GEV No.</th> <th>510703</th> <th>Ref. No.</th> <th>141007 80843</th> </tr> </table> <p>mechanical shaft seal for shaft ø 13mm slide ring H 13mm height counter ring 5.5mm ED ø 26mm</p> | GEV No. | 510703 | Ref. No. | 141007 80843 |
| GEV No. | 510703 | Ref. No. | 141007 80843 | | |
|  | <table border="1"> <tr> <th>GEV No.</th> <th>698765</th> <th>Ref. No.</th> <th>124063</th> </tr> </table> <p>impellor ø 70mm H 21mm rotation direction right thread M7L suitable for LGB shaft ø 13mm shaft length 20mm blades 4</p> | GEV No. | 698765 | Ref. No. | 124063 |
| GEV No. | 698765 | Ref. No. | 124063 | | |
|  | <table border="1"> <tr> <th>GEV No.</th> <th>698770</th> <th>Ref. No.</th> <th>116035</th> </tr> </table> <p>pump cover LGB inlet ø 28mm outlet ø 22/28mm ø 108mm ID ø 84mm</p> | GEV No. | 698770 | Ref. No. | 116035 |
| GEV No. | 698770 | Ref. No. | 116035 | | |



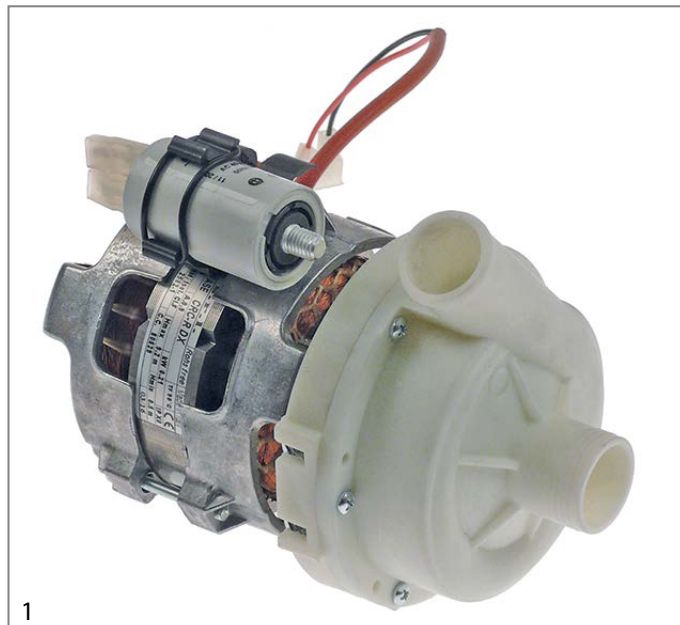

1

| | | | |
|---|---|-----------------|----------------------------------|
| GEV No. | 499099 | Ref. No. | 130163 80627 |
| description | pump inlet ø 28mm outlet ø 26mm type CRC-R DX 230V 50Hz 1 phase 0.2kW L 175mm rotation direction left capacitor 4µF LGB | | |
| For models: | 915154, 915155, 915157, 915158, 915172, 915173, 915285, 915422, 915492, 915493, 915494, 915495, 915496, 915497, 915617, 915618, 915672, 915773, 915774, 916045, 916054, 916066, 916067, 916068, 916069, 916077, 916078, 916079, 916080, 916368, 916418, 916419, 916420, 916421, 916422, 916423, 916424, 916594, 916595, 916654, 916686, 916760, Fast160C, Ocean360-UK, River-242, River-242-2, River-242-2T, RIVER-252, River-252-2, River-252-2T...(Other models you can see in the webshop) | | |
| spare parts for | 499099 | | |
|  | GEV No. | 365031 | Ref. No. 206013 |
| | operating capacitor capacity 4µF 450V tolerance 5% 50/60Hz ambient temperature max. -25 to +85°C ø 31mm L 58mm M8 plastic connection male faston 6.3mm protection | | |
|  | GEV No. | 509002 | Ref. No. 456083 456084 |
| | O-ring EPDM thickness 2.62mm ID ø 82.22mm Qty 1 pcs | | |
|  | GEV No. | 510703 | Ref. No. 141007 80843 |
| | mechanical shaft seal for shaft ø 13mm slide ring H 13mm height counter ring 5.5mm ED ø 26mm | | |
|  | GEV No. | 521091 | Ref. No. 116040 |
| | pump cover LGB inlet ø 28mm outlet ø 26mm pump type CRC-R DX | | |
|  | GEV No. | 521092 | Ref. No. 124070 |
| | impellor ø 80mm H 25mm pump type CRC-R DX thread M6R shaft ø 13mm shaft length 20mm | | |



1

| | | | |
|---|---|-----------------|----------------------------------|
| GEV No. | 501526 | Ref. No. | 80629 |
| description | pump inlet ø 28mm outlet ø 26mm type CRC-R DX 230V 60Hz 1 phase 0.21kW L 175mm rotation direction left capacitor 4µF LGB | | |
| For models: | 915154, 915155, 915157, 915158, 915172, 915173, 915285, 915422, 915492, 915493, 915494, 915495, 915496, 915497, 915617, 915618, 915672, 915773, 915774, 916045, 916054, 916066, 916067, 916068, 916069, 916077, 916078, 916079, 916080, 916368, 916418, 916419, 916420, 916421, 916422, 916423, 916424, 916594, 916595, 916654, 916686, 916760, Fast160C, Ocean360-UK, River-242, River-242-2, River-242-2T, RIVER-252, River-252-2, River-252-2T...(Other models you can see in the webshop) | | |
| spare parts for | 501526 | | |
|  | GEV No. | 365031 | Ref. No. 206013 |
| | operating capacitor capacity 4µF 450V tolerance 5% 50/60Hz ambient temperature max. -25 to +85°C ø 31mm L 58mm M8 plastic connection male faston 6.3mm protection | | |
|  | GEV No. | 509002 | Ref. No. 456083 456084 |
| | O-ring EPDM thickness 2.62mm ID ø 82.22mm Qty 1 pcs | | |
|  | GEV No. | 510703 | Ref. No. 141007 80843 |
| | mechanical shaft seal for shaft ø 13mm slide ring H 13mm height counter ring 5.5mm ED ø 26mm | | |
|  | GEV No. | 521091 | Ref. No. 116040 |
| | pump cover LGB inlet ø 28mm outlet ø 26mm pump type CRC-R DX | | |
|  | GEV No. | 521092 | Ref. No. 124070 |
| | impellor ø 80mm H 25mm pump type CRC-R DX thread M6R shaft ø 13mm shaft length 20mm | | |



1



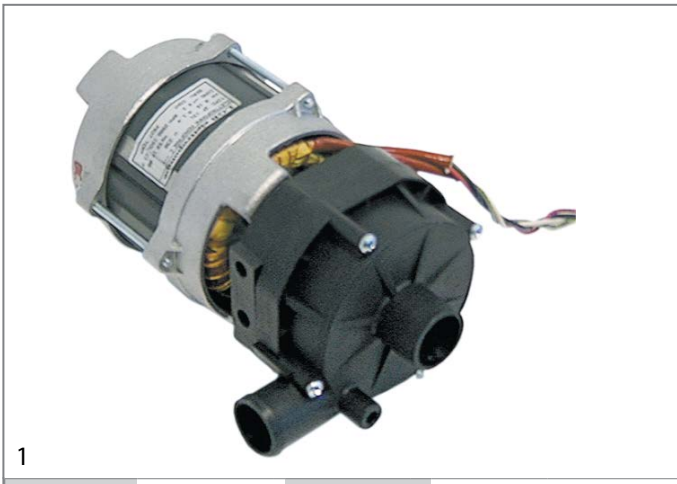

| | | | |
|---|--|-----------------|-----------------------|
| GEV No. | 500542 | Ref. No. | 130097 |
| description | pump inlet ø 28mm outlet ø 26mm type ZF130DX 230V 50Hz 1 phase 0.3kW 0.41HP L 190mm rotation direction left capacitor 6.3µF LGB | | |
| For models: | 400F, 400FD, 400R, 400RD, 40-ELECTRONIC, 40F, 40FD, 40R, 40RD | | |
| spare parts for | 500542 | | |
|  | GEV No. | 365012 | Ref. No. 206009 |
| | operating capacitor capacity 6.3µF 450V tolerance 5% 50Hz ambient temperature max. -25 to +85°C ø 30mm L 61mm M8 plastic connection male faston 6.3mm protection | | |
|  | GEV No. | 510703 | Ref. No. 141007 80843 |
| | mechanical shaft seal for shaft ø 13mm slide ring H 13mm height counter ring 5.5mm ED ø 26mm | | |
|  | GEV No. | 521107 | Ref. No. — |
| | pump cover LGB inlet ø 28mm outlet ø 26mm auxiliary pressure connection 12mm ID ø 77mm | | |
|  | GEV No. | 521228 | Ref. No. 124032 |
| | impellor ø 72mm H 17mm rotation direction left thread M7R shaft ø 13mm shaft length 12mm blades 3 | | |
|  | GEV No. | 528800 | Ref. No. — |
| | O-ring EPDM thickness 2.62mm ID ø 75.87mm Qty 1 pcs | | |



1

| | | | |
|---|--|-----------------|-----------------|
| GEV No. | 500094 | Ref. No. | 130099 |
| description | pump inlet ø 28mm outlet ø 26mm type ZF131SX 230V 50Hz 1 phase 0.2kW 0.15HP L 195mm rotation direction left capacitor 6.3µF LGB | | |
| For models: | 350F, 350FD, 350R, 350RD, 35-ELECTRONIC | | |
| spare parts for | 500094 | | |
|  | GEV No. | 365012 | Ref. No. 206009 |
| | operating capacitor capacity 6.3µF 450V tolerance 5% 50Hz ambient temperature max. -25 to +85°C ø 30mm L 61mm M8 plastic connection male faston 6.3mm protection | | |

spare parts for 500094

| | | | | |
|---|--|--------|----------|--------------|
|  | GEV No. | 502266 | Ref. No. | — |
| | pump cover inlet ø 28mm outlet ø 26mm | | | |
|  | GEV No. | 510703 | Ref. No. | 141007 80843 |
| | mechanical shaft seal for shaft ø 13mm slide ring H 13mm height counter ring 5.5mm ED ø 26mm | | | |
|  | GEV No. | 521085 | Ref. No. | — |
| | impellor ø 72mm H 17mm thread M7L shaft ø 13mm shaft length 12mm blades 3 | | | |
|  | GEV No. | 528800 | Ref. No. | — |
| | O-ring EPDM thickness 2.62mm ID ø 75.87mm Qty 1 pcs | | | |



1

| | | | |
|---|--|-----------------|-----------------------|
| GEV No. | 500979 | Ref. No. | 130148 |
| description | pump inlet ø 28mm outlet ø 26mm type ZFC1121DX 230V 50Hz 1 phase 0.25kW L 198mm rotation direction left capacitor 6.3µF LGB | | |
| For models: | 2312-009-CRP, 914628, 914944, RIVER-40-CRP, RIVER-44-CRP, RIVER-44-CRP-ST, RIVER-50-CRP, RIVER-50-CRP-SP, RIVER-54CRP, RIVER-54-CRP-s.p., RIVER-54-CRP-SP | | |
| spare parts for | 500979 | | |
|  | GEV No. | 365012 | Ref. No. 206009 |
| | operating capacitor capacity 6.3µF 450V tolerance 5% 50Hz ambient temperature max. -25 to +85°C ø 30mm L 61mm M8 plastic connection male faston 6.3mm protection | | |
|  | GEV No. | 510703 | Ref. No. 141007 80843 |
| | mechanical shaft seal for shaft ø 13mm slide ring H 13mm height counter ring 5.5mm ED ø 26mm | | |
|  | GEV No. | 521098 | Ref. No. — |
| | pump cover LGB inlet ø 28mm outlet ø 26mm auxiliary pressure connection 12mm ID ø 77mm | | |
|  | GEV No. | 521099 | Ref. No. — |
| | impellor ø 72mm H 17mm thread M7R shaft ø 13mm shaft length 12mm | | |
|  | GEV No. | 528800 | Ref. No. — |
| | O-ring EPDM thickness 2.62mm ID ø 75.87mm Qty 1 pcs | | |



1

| | | | |
|---|---|-----------------|------------------------------|
| GEV No. | 500351 | Ref. No. | 130994 |
| description | pump inlet \varnothing 29mm outlet \varnothing 39mm type X5SX 230V 50Hz 1 phase 0.8kW 1.09HP L 210mm rotation direction right capacitor 16 μ F LGB | | |
| For models: | 2312-009-CRP, RIVER-48, RIVER-50, RIVER-50-CRP, RIVER-50-CRP-SP, RIVER-54, RIVER-54-CRP-SP, RIVER-61 | | |
| spare parts for | 500351 | | |
|  | GEV No. | 365021 | Ref. No. 206004 |
| | operating capacitor capacity 16 μ F 425V tolerance 5% 50/60Hz ambient temperature max. -25 to +85°C \varnothing 35mm L 73mm single M8 plastic connection male faston 6.3mm 416.10.99 protection | | |
|  | GEV No. | 510703 | Ref. No. 141007 80843 |
| | mechanical shaft seal for shaft \varnothing 13mm slide ring H 13mm height counter ring 5.5mm ED \varnothing 26mm | | |
|  | GEV No. | 518294 | Ref. No. 437087 |
| | flat gasket rubber ED \varnothing 85mm ID \varnothing 71mm thickness 2mm Qty 1 pcs | | |
|  | GEV No. | 521234 | Ref. No. 124052 |
| | impellor thread M8L ED \varnothing 93mm W 16mm | | |
|  | GEV No. | 523509 | Ref. No. 314001 |
| | deep-groove ball bearing type 6201-2RS shaft \varnothing 12mm ED \varnothing 32mm W 10mm with sealing discs deep-groove ball bearing DIN 625-1 | | |
|  | GEV No. | 532537 | Ref. No. 456067 |
| | O-ring EPDM thickness 3.53mm ID \varnothing 113.9mm Qty 1 pcs | | |



1

| | | | |
|---|--|-----------------|-------------------------------|
| GEV No. | 499138 | Ref. No. | 130993 999241 |
| description | pump inlet \varnothing 33mm outlet \varnothing 26mm type X3SX 230V 50Hz 1 phase 0.26kW L 300mm rotation direction right capacitor 6.3 μ F LGB | | |
| For models: | 913992, 913993, 914583, 914592, 914612, 914613, 915143, RIVER-40, RIVER-40-CRP, RIVER-44, RIVER-44-CRP, RIVER-44-CRP-ST, RIVER-44CRP-ST | | |
| spare parts for | 499138 | | |
|  | GEV No. | 365012 | Ref. No. 206009 |
| | operating capacitor capacity 6.3 μ F 450V tolerance 5% 50Hz ambient temperature max. -25 to +85°C \varnothing 30mm L 61mm M8 plastic connection male faston 6.3mm protection | | |
|  | GEV No. | 509004 | Ref. No. 124049 |
| | impellor \varnothing 71mm H 16mm M7L rotation direction right shaft \varnothing 13mm shaft length 13mm blades 8 | | |
|  | GEV No. | 510703 | Ref. No. 141007 80843 |
| | mechanical shaft seal for shaft \varnothing 13mm slide ring H 13mm height counter ring 5.5mm ED \varnothing 26mm | | |
|  | GEV No. | 521088 | Ref. No. 116030 |
| | pump cover LGB inlet \varnothing 33mm outlet \varnothing 26mm | | |
|  | GEV No. | 521147 | Ref. No. 315024 |
| | flange | | |
|  | GEV No. | 521703 | Ref. No. 456038 456063 |
| | pump cover gasket EPDM thickness 2.5mm ID \varnothing 75mm Qty 1 pcs | | |
|  | GEV No. | 523501 | Ref. No. 314009 |
| | deep-groove ball bearing type 608-2RS shaft \varnothing 8mm ED \varnothing 22mm W 7mm with sealing discs deep-groove ball bearing DIN 625-1 | | |











1

| | | | |
|---|---|-----------------|------------------|
| GEV No. | 499100 | Ref. No. | 130161 130982 |
| description | pump inlet ø 42mm outlet ø 24/37mm type LA50 230V 50Hz 1 phase 0.47kW L 220mm rotation direction right capacitor 10µF LGB with flange and hoses | | |
| For models: | 915150, 915151, 915152, 915154, 915155, 915157, 915158, 915160, 915161, 915162, 915166, 915167, 915168, 915172, 915173, 915175, 915176, 915177, 915285, 915319, 915338, 915341, 915348, 915418, 915419, 915420, 915421, 915422, 915479, 915492, 915493, 915494, 915495, 915496, 915497, 915547, 915558, 915635, 915663, 915747, 916054, Niagara-251, NIAGARA-261, Pluvia-260, PLUVIA-270, River-252, RIVER-253, River-262 | | |
| spare parts for | 499100 | | |
|  | GEV No. | Ref. No. | 206002 |
| | operating capacitor capacity 10µF 400V tolerance 5%Hz ambient temperature max. -25 to +85°C ø 35.5mm L 59mm M8 plastic connection male faston 6.3mm protection | | |
|  | GEV No. | Ref. No. | — |
| | mechanical shaft seal height counter ring 5.5mm ID ø 12mm | | |
|  | GEV No. | Ref. No. | 124057 73053 |
| | impeller ø 88mm H 30mm rotation direction right thread M7L shaft ø 12mm blades 6 | | |
|  | GEV No. | Ref. No. | 335015 |
| | fan blade ø 110mm H 18mm shaft intake ø 12mm plastic blades 6 | | |
|  | GEV No. | Ref. No. | 480148 |
| | pump cover LGB inlet ø 42mm pump type LA50 AP ø 115mm ID ø 36mm | | |
|  | GEV No. | Ref. No. | 456078 |
| | O-ring EPDM thickness 3.56mm ID ø 112mm Qty 1 pcs | | |
|  | GEV No. | Ref. No. | 429074 |
| | threaded ring LGB pump type LA50 ø 120mm ID ø 70mm | | |



1



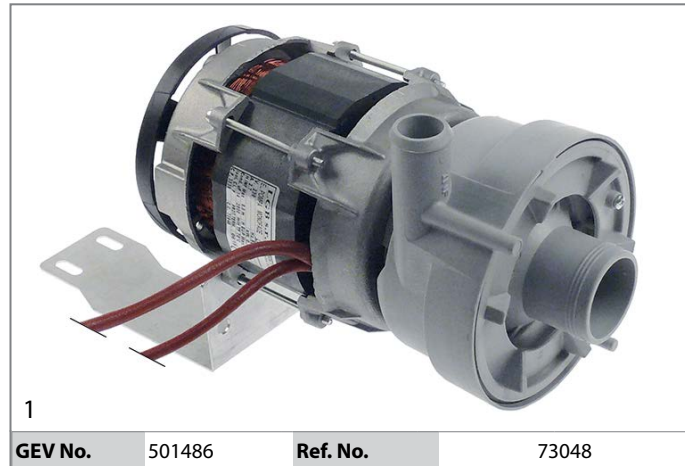

| | | | |
|---|--|-----------------|-----------------|
| GEV No. | 499190 | Ref. No. | 69120 |
| description | pump inlet ø 42mm outlet ø 24/37mm type LA50 230V 50Hz 1 phase 0.47kW L 225mm rotation direction right capacitor 10µF LGB | | |
| For models: | FAST-60, FAST-73, NG281, NG281HP, NIAGARA-281, NIAGARA-281HP, PLUVIA-280, PV280, PV280FAST, PV280FASTCH | | |
| spare parts for | 499190 | | |
|  | GEV No. | Ref. No. | 206002 |
| | operating capacitor capacity 10µF 400V tolerance 5%Hz ambient temperature max. -25 to +85°C ø 35.5mm L 59mm M8 plastic connection male faston 6.3mm protection | | |
|  | GEV No. | Ref. No. | — |
| | mechanical shaft seal height counter ring 5.5mm ID ø 12mm | | |
|  | GEV No. | Ref. No. | 124057 73053 |
| | impeller ø 88mm H 30mm rotation direction right thread M7L shaft ø 12mm blades 6 | | |
|  | GEV No. | Ref. No. | 335015 |
| | fan blade ø 110mm H 18mm shaft intake ø 12mm plastic blades 6 | | |
|  | GEV No. | Ref. No. | 480148 |
| | pump cover LGB inlet ø 42mm pump type LA50 AP ø 115mm ID ø 36mm | | |
|  | GEV No. | Ref. No. | 73052 |
| | pump cover outlet ø 24/36mm pump type LGB | | |
|  | GEV No. | Ref. No. | 456078 |
| | O-ring EPDM thickness 3.56mm ID ø 112mm Qty 1 pcs | | |
|  | GEV No. | Ref. No. | 429074 |
| | threaded ring LGB pump type LA50 ø 120mm ID ø 70mm | | |



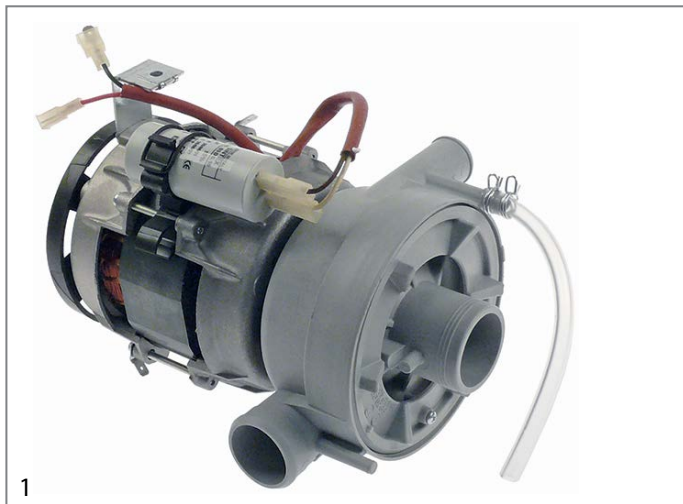



| | | | | |
|------------------------|---|-----------------|-----------------|-----------------|
| 1 | | | | |
| GEV No. | 501484 | Ref. No. | 69122 | |
| description | pump inlet ø 42mm outlet ø 37/24mm type LA50 230V 50Hz 1 phase 0.47kW L 220mm rotation direction right capacitor 10µF auxiliary pressure connection 8mm LGB | | | |
| For models: | CNT800CH, Fast180, NG281CDD, NG281HPDD, NG281HZ23, NG281HZ23DD, Niagara-281, Niagara-281-2, Niagara-281HP, OC380, OC380FUR, Ocean380, PV280FAST2, PV280FAST2BIO, SevenE | | | |
| spare parts for | 501484 | | | |
| | GEV No. | 365015 | Ref. No. | 206002 |
| | operating capacitor capacity 10µF 400V tolerance 5%Hz ambient temperature max. -25 to +85°C ø 35.5mm L 59mm M8 plastic connection male faston 6.3mm protection | | | |
| | GEV No. | 510702 | Ref. No. | — |
| | mechanical shaft seal height counter ring 5.5mm ID ø 12mm | | | |
| | GEV No. | 521024 | Ref. No. | 124057 73053 |
| | impellor ø 88mm H 30mm rotation direction right thread M7L shaft ø 12mm blades 6 | | | |
| | GEV No. | 698767 | Ref. No. | 335015 |
| | fan blade ø 110mm H 18mm shaft intake ø 12mm plastic blades 6 | | | |
| | GEV No. | 698768 | Ref. No. | 480148 |
| | pump cover LGB inlet ø 42mm pump type LA50 AP ø 115mm ID ø 36mm | | | |
| | GEV No. | 698769 | Ref. No. | 116032 |
| | pump casing ø 125mm outlet ø 24/37mm | | | |
| | GEV No. | 698810 | Ref. No. | 456078 |
| | O-ring EPDM thickness 3.56mm ID ø 112mm Qty 1 pcs | | | |
| | GEV No. | 698827 | Ref. No. | 429074 |
| | threaded ring LGB pump type LA50 ø 120mm ID ø 70mm | | | |

| | | | | |
|------------------------|--|-----------------|-----------------|-----------------|
| 1 | | | | |
| GEV No. | 501486 | Ref. No. | 73048 | |
| description | pump inlet ø 42mm outlet ø 37mm type LA50 AP 230V 50Hz 1 phase 0.7kW L 220mm rotation direction right capacitor 14µF auxiliary pressure connection 8mm LGB | | | |
| For models: | NG381, NG38123, NG38123TERMO, NG381C, NG381CDD, NG381C-FUR, NG381DDPS, NG381HPDD, NG381TERMO, NG381TXCDD, Niagara-381, Niagara-381-230V-3Ph-50Hz, Niagara-381DP, Niagara-381HPD, River-282-2, River-282S-2TDE, River-285, River-382, River-382-230V-3Ph-50Hz, River-382H, River-382NRG, River-382NRG-230-3Ph-50Hz, River-382TDE, RV382, RV38223TERMO, RV382AHP, RV382FUR, RV382R, RV382R23TERMO, RV382RFUR, RV382S, RV382SFUR, RV382TERMO, RV382TX, RV382TXR | | | |
| spare parts for | 501486 | | | |
| | GEV No. | 365020 | Ref. No. | 73055 |
| | operating capacitor capacity 14µF 400V tolerance 5%Hz ambient temperature max. -25 to +85°C ø 35mm L 70mm M8 plastic connection male faston 6.3mm protection | | | |
| | GEV No. | 510702 | Ref. No. | — |
| | mechanical shaft seal height counter ring 5.5mm ID ø 12mm | | | |
| | GEV No. | 521024 | Ref. No. | 124057 73053 |
| | impellor ø 88mm H 30mm rotation direction right thread M7L shaft ø 12mm blades 6 | | | |
| | GEV No. | 698767 | Ref. No. | 335015 |
| | fan blade ø 110mm H 18mm shaft intake ø 12mm plastic blades 6 | | | |
| | GEV No. | 698768 | Ref. No. | 480148 |
| | pump cover LGB inlet ø 42mm pump type LA50 AP ø 115mm ID ø 36mm | | | |
| | GEV No. | 698793 | Ref. No. | 73052 |
| | pump cover outlet ø 24/36mm pump type LGB | | | |
| | GEV No. | 698810 | Ref. No. | 456078 |
| | O-ring EPDM thickness 3.56mm ID ø 112mm Qty 1 pcs | | | |
| | GEV No. | 698827 | Ref. No. | 429074 |
| | threaded ring LGB pump type LA50 ø 120mm ID ø 70mm | | | |











| | | | |
|---|--|-----------------|---------------------------------|
| GEV No. | 501485 | Ref. No. | 130977 |
| description | pump inlet ø 42mm outlet ø 37mm type LA500 230V 50Hz 1 phase 0.47kW L 220mm rotation direction right capacitor 10µF auxiliary pressure connection 8mm LGB | | |
| For models: | 915160, 915161, 915162, 915175, 915319, 915496, 915663, 916020, 916021, 916024, 916025, 916026, 916027, 916030, 916031, 916045, 916067, 916068, 916069, 916079, 916080, 916201, 916202, 916203, 916204, 916205, 916206, 916207, 916208, 916209, 916247, 916248, 916249, 916250, 916251, 916252, 916365, 916366, 916367, 916368, 916382, 916383, 916411, 916412, 916413, 916414, 916415, 916416, 916417, 916420...(Other models you can see in the webshop) | | |
| spare parts for | 501485 | | |
|  | GEV No. | 365015 | Ref. No. 206002 |
| | operating capacitor capacity 10µF 400V tolerance 5%Hz ambient temperature max. -25 to +85°C ø 35.5mm L 59mm M8 plastic connection male faston 6.3mm protection | | |
|  | GEV No. | 510702 | Ref. No. — |
| | mechanical shaft seal height counter ring 5.5mm ID ø 12mm | | |
|  | GEV No. | 521024 | Ref. No. 124057 73053 |
| | impellor ø 88mm H 30mm rotation direction right thread M7L shaft ø 12mm blades 6 | | |
|  | GEV No. | 698767 | Ref. No. 335015 |
| | fan blade ø 110mm H 18mm shaft intake ø 12mm plastic blades 6 | | |
|  | GEV No. | 698768 | Ref. No. 480148 |
| | pump cover LGB inlet ø 42mm pump type LA50 AP ø 115mm ID ø 36mm | | |
|  | GEV No. | 698769 | Ref. No. 116032 |
| | pump casing ø 125mm outlet ø 24/37mm | | |
|  | GEV No. | 698810 | Ref. No. 456078 |
| | O-ring EPDM thickness 3.56mm ID ø 112mm Qty 1 pcs | | |
|  | GEV No. | 698827 | Ref. No. 429074 |
| | threaded ring LGB pump type LA50 ø 120mm ID ø 70mm | | |



| | | | |
|---|--|-----------------|---------------------------------|
| GEV No. | 501528 | Ref. No. | 130976 |
| description | pump inlet ø 42mm outlet ø 37mm type LA500 230V 60Hz 1 phase 0.46kW L 220mm rotation direction right capacitor 10µF auxiliary pressure connection 8mm LGB | | |
| For models: | 915160, 915161, 915162, 915175, 915319, 915496, 915663, 916020, 916021, 916024, 916025, 916026, 916027, 916030, 916031, 916067, 916068, 916069, 916079, 916080, 916201, 916202, 916203, 916204, 916205, 916206, 916207, 916208, 916209, 916247, 916248, 916249, 916250, 916251, 916252, 916365, 916366, 916367, 916368, 916382, 916383, 916411, 916412, 916413, 916414, 916415, 916416, 916417, 916420, 916421...(Other models you can see in the webshop) | | |
| spare parts for | 501528 | | |
|  | GEV No. | 365015 | Ref. No. 206002 |
| | operating capacitor capacity 10µF 400V tolerance 5%Hz ambient temperature max. -25 to +85°C ø 35.5mm L 59mm M8 plastic connection male faston 6.3mm protection | | |
|  | GEV No. | 510702 | Ref. No. — |
| | mechanical shaft seal height counter ring 5.5mm ID ø 12mm | | |
|  | GEV No. | 521024 | Ref. No. 124057 73053 |
| | impellor ø 88mm H 30mm rotation direction right thread M7L shaft ø 12mm blades 6 | | |
|  | GEV No. | 698767 | Ref. No. 335015 |
| | fan blade ø 110mm H 18mm shaft intake ø 12mm plastic blades 6 | | |
|  | GEV No. | 698768 | Ref. No. 480148 |
| | pump cover LGB inlet ø 42mm pump type LA50 AP ø 115mm ID ø 36mm | | |
|  | GEV No. | 698769 | Ref. No. 116032 |
| | pump casing ø 125mm outlet ø 24/37mm | | |
|  | GEV No. | 698810 | Ref. No. 456078 |
| | O-ring EPDM thickness 3.56mm ID ø 112mm Qty 1 pcs | | |
|  | GEV No. | 698827 | Ref. No. 429074 |
| | threaded ring LGB pump type LA50 ø 120mm ID ø 70mm | | |



1







| | | | |
|---|---|-----------------|---------------------------------|
| GEV No. | 500156 | Ref. No. | 130098 130109 |
| description | pump inlet ø 50mm outlet ø 50mm type ZF400SX 230V 50Hz 1 phase 0.6kW 0.8HP L 210mm rotation direction right capacitor 16µF LGB | | |
| For models: | 050F, 050FP, 2312-001, 2312-002, 46, 460, 500F, 500FD, 50-ELECTRONIC, 50F, 50FD, 913297, 913298, 913299, 913300, 913360, 913361, 913391, 913392, 913546, 913547, 913578, 913611, 913684, 913913, 913914, 913932, 913933, 914284, 914331, 914356, 914400, 914401, 914402, 914403, 914404, 914405, 914449, 914517, 914545, 914568, 914642, 914688, 914909, 914979, 915136, 915137, 915140, 915248, 915483...(Other models you can see in the webshop) | | |
| spare parts for | 500156 | | |
|  | GEV No. | 509020 | Ref. No. 124031 |
| | impellor ø 104mm H 25mm M8L | | |
|  | GEV No. | 510703 | Ref. No. 141007 80843 |
| | mechanical shaft seal for shaft ø 13mm slide ring H 13mm height counter ring 5.5mm ED ø 26mm | | |
|  | GEV No. | 513713 | Ref. No. 315017 |
| | pump cover bottom part | | |
|  | GEV No. | 521548 | Ref. No. 116019 |
| | pump cover LGB inlet ø 50mm outlet ø 50mm | | |
|  | GEV No. | 521562 | Ref. No. 116021 |
| | pump cover | | |
|  | GEV No. | 521734 | Ref. No. 315022 |
| | pump cover bottom part | | |
|  | GEV No. | 523509 | Ref. No. 314001 |
| | deep-groove ball bearing type 6201-2RS shaft ø 12mm ED ø 32mm W 10mm with sealing discs deep-groove ball bearing DIN 625-1 | | |
|  | GEV No. | 532623 | Ref. No. 80844 |
| | O-ring EPDM thickness 2.62mm ID ø 120.32mm Qty 1 pcs | | |
| accessories for | 500156 | | |
|  | GEV No. | 365021 | Ref. No. 206004 |
| | operating capacitor capacity 16µF 425V tolerance 5% 50/60Hz ambient temperature max. -25 to +85°C ø 35mm L 73mm single M8 plastic connection male faston 6.3mm 416.10.99 protection | | |







1

| | | | |
|---|---|-----------------|---------------------------------|
| GEV No. | 500543 | Ref. No. | 130126 |
| description | pump inlet ø 50mm outlet ø 50mm type ZF400VSX 230V 50Hz 1 phase 0.85kW 1.2HP L 245mm rotation direction right capacitor 16µF LGB | | |
| For models: | 510F, 510FD, 913297, 913298, 913299, 913300, 913360, 913361, 913391, 913392, 913546, 913547, 913578, 913611, 913684, 913932, 913933, 914318, 914319, 914331, 914338, 914431, 914517, 914545, 914688, 914979, 915140, 915248, E.50, E.51, F85, F85P, GSP51, GSP51P, LF55, MC501E, MC501EP, Mistral51, MISTRAL-51, NIAGARA-51, TF-513, TF-515 | | |
| spare parts for | 500543 | | |
|  | GEV No. | 365021 | Ref. No. 206004 |
| | operating capacitor capacity 16µF 425V tolerance 5% 50/60Hz ambient temperature max. -25 to +85°C ø 35mm L 73mm single M8 plastic connection male faston 6.3mm 416.10.99 protection | | |
|  | GEV No. | 509020 | Ref. No. 124031 |
| | impellor ø 104mm H 25mm M8L | | |
|  | GEV No. | 510703 | Ref. No. 141007 80843 |
| | mechanical shaft seal for shaft ø 13mm slide ring H 13mm height counter ring 5.5mm ED ø 26mm | | |
|  | GEV No. | 521548 | Ref. No. 116019 |
| | pump cover LGB inlet ø 50mm outlet ø 50mm | | |
|  | GEV No. | 521734 | Ref. No. 315022 |
| | pump cover bottom part | | |
|  | GEV No. | 532623 | Ref. No. 80844 |
| | O-ring EPDM thickness 2.62mm ID ø 120.32mm Qty 1 pcs | | |



| | | | |
|---|--|-----------------|--------------------------|
| 1 | | | |
| GEV No. | 500361 | Ref. No. | 80112 926078 |
| description | pump inlet ø 60mm outlet ø 49mm type ZF400SX 230V 50Hz 1 phase 0.8kW 1HP L 210mm rotation direction right capacitor 16µF LGB | | |
| For models: | 10, 80, 81, CE78HZ23, CLEAN-100, E100, E78, E78HP, FAST-181, HM1, NG271, NG291, NIAGARA-271, NIAGARA-291, RIVER-294, RIVER-78, RIVER-80, RIVER-81, RIVER-E78, RV294, RV80, RV8023, RV8023HZ, RV80C, RV80HZ, ST70FAST | | |
| spare parts for | 500361 | | |
| | GEV No. | 365021 | Ref. No. 206004 |
|  | operating capacitor capacity 16µF 425V tolerance 5% 50/60Hz ambient temperature max. -25 to +85°C ø 35mm L 73mm single M8 plastic connection male faston 6.3mm 416.10.99 protection | | |
|  | GEV No. | 509020 | Ref. No. 124031 |
| | impellor ø 104mm H 25mm M8L | | |
|  | GEV No. | 510703 | Ref. No. 141007 80843 |
| | mechanical shaft seal for shaft ø 13mm slide ring H 13mm height counter ring 5.5mm ED ø 26mm | | |
|  | GEV No. | 521547 | Ref. No. 116013 |
| | pump cover LGB inlet ø 60mm outlet ø 50mm supporting pressure M8 turn direction right ø 160mm ID ø 127mm inner height 36mm | | |
|  | GEV No. | 521736 | Ref. No. 315011 |
| | pump cover bottom part bottom part | | |
|  | GEV No. | 532623 | Ref. No. 80844 |
| | O-ring EPDM thickness 2.62mm ID ø 120.32mm Qty 1 pcs | | |
| accessories for | 500361 | | |
|  | GEV No. | 513264 | Ref. No. 80545 |
| | fastening angle for wash pump | | |



| | | | |
|---|---|-----------------|--------------------------|
| 1 | | | |
| GEV No. | 501527 | Ref. No. | 80113HZ |
| description | pump inlet ø 60mm outlet ø 49mm type ZF400SX 230V 60Hz 1 phase 0.77kW 1HP L 210mm rotation direction right capacitor 16µF LGB | | |
| For models: | Fast181, Fast181-230V-3Ph-60Hz, Fast181-400V-3NPh-60Hz, NIAGARA-283, RIVER-282, RV282, ST70FASTHB400, ST70FASTHZ23, SV72EB | | |
| spare parts for | 501527 | | |
| | GEV No. | 365021 | Ref. No. 206004 |
|  | operating capacitor capacity 16µF 425V tolerance 5% 50/60Hz ambient temperature max. -25 to +85°C ø 35mm L 73mm single M8 plastic connection male faston 6.3mm 416.10.99 protection | | |
|  | GEV No. | 509020 | Ref. No. 124031 |
| | impellor ø 104mm H 25mm M8L | | |
|  | GEV No. | 510703 | Ref. No. 141007 80843 |
| | mechanical shaft seal for shaft ø 13mm slide ring H 13mm height counter ring 5.5mm ED ø 26mm | | |
|  | GEV No. | 521547 | Ref. No. 116013 |
| | pump cover LGB inlet ø 60mm outlet ø 50mm supporting pressure M8 turn direction right ø 160mm ID ø 127mm inner height 36mm | | |
|  | GEV No. | 532623 | Ref. No. 80844 |
| | O-ring EPDM thickness 2.62mm ID ø 120.32mm Qty 1 pcs | | |







1

| | | | |
|---|--|-----------------|------------------------|
| GEV No. | 499282 | Ref. No. | 77553 |
| description | pump inlet ø 60mm outlet ø 49mm type ZF400VSX 220-230/380-400V 50Hz 3 phase 0.7kW L 270mm rotation direction right LGB | | |
| For models: | 915747, A4EB, A4EBD, A4EBDAKEKYK, A4EBDAKRK, A4EBDAKWK, A4EBDAKZK, A4EBDBKRK, A4EBDPKWYK, A4EBDRK, A4EBS, A4EBSAK, A4EBSAKCK, A4EBSAKEKYK, A4EBSAKRK, A4EBSAKRKP, A4EBSAKYK, A4EBSCK, A4EBT, A4EBTSAK, A5EB, A5EBD, A5EBDAKPKWK, A5EBDAKWK, A5EBDAKYK, A5EBDRK, A5EBS, A5EBSAKPKWK, A5EBSAKRK, A5EBSAKRKYK, A5EBSAKWK, A5EBSAKWKYK, A5EBSBKRPK, A5EBSBKWK, A5EBSRK, A5EBSYK, GL284EB, GL284EBD, GL284EBDA, GL284EBDAEW, GL284EBDAWY, GL284EBDPWY, GL284EBDR, GL284EBDY, GL284EBS, GL284EBSA, GL284EBSAE, GL284EBSAP, GL284EBSAR, GL284EBSAWY...(Other models you can see in the webshop) | | |
| spare parts for | 499282 | | |
|  | GEV No. | 502279 | Ref. No. — |
| | impellor H 31mm ED ø 100mm blades 6 | | |
|  | GEV No. | 510702 | Ref. No. — |
| | mechanical shaft seal height counter ring 5.5mm ID ø 12mm | | |
|  | GEV No. | 510709 | Ref. No. 926255 |
| | mechanical shaft seal | | |
|  | GEV No. | 521058 | Ref. No. — |
| | fanwheel cover suitable for LGB ID ø 138mm ED ø 142mm H 59mm plastic | | |
|  | GEV No. | 521547 | Ref. No. 116013 |
| | pump cover LGB inlet ø 60mm outlet ø 50mm supporting pressure M8 turn direction right ø 160mm ID ø 127mm inner height 36mm | | |







1

| | | | |
|---|--|-----------------|------------------------------|
| GEV No. | 500001 | Ref. No. | 130020 |
| description | pump inlet ø 60mm outlet ø 50mm type T150SX 230/400V 50Hz 3 phase 0.9kW 1.2HP L 290mm rotation direction right LGB | | |
| For models: | S651, S651P, S653, S654, S655, S830, S835, SR651 | | |
| spare parts for | 500001 | | |
|  | GEV No. | 509020 | Ref. No. 124031 |
| | impellor ø 104mm H 25mm M8L | | |
|  | GEV No. | 510703 | Ref. No. 141007 80843 |
| | mechanical shaft seal for shaft ø 13mm slide ring H 13mm height counter ring 5.5mm ED ø 26mm | | |
|  | GEV No. | 521547 | Ref. No. 116013 |
| | pump cover LGB inlet ø 60mm outlet ø 50mm supporting pressure M8 turn direction right ø 160mm ID ø 127mm inner height 36mm | | |
|  | GEV No. | 532623 | Ref. No. 80844 |
| | O-ring EPDM thickness 2.62mm ID ø 120.32mm Qty 1 pcs | | |







1

| | | | |
|---|--|-----------------|---------------------------------|
| GEV No. | 500148 | Ref. No. | 130042 130045 130059 |
| description | pump inlet ø 60mm outlet ø 50mm type ZA160SX 230V 50Hz 1 phase 1.1kW 1.5HP L 310mm rotation direction right capacitor 25µF LGB | | |
| For models: | S651, S654, S810, S815, S830, S835 | | |
| spare parts for | 500148 | | |
|  | GEV No. | 365109 | Ref. No. — |
| | operating capacitor capacity 25µF 400V tolerance 5%Hz ambient temperature max. -25 to +85°C ø 44mm L 70mm M8 plastic connection male faston 6.3mm protection | | |
|  | GEV No. | 510616 | Ref. No. 124012 |
| | impellor ø 104mm H 25mm shaft intake ø 10mm | | |
|  | GEV No. | 510703 | Ref. No. 141007 80843 |
| | mechanical shaft seal for shaft ø 13mm slide ring H 13mm height counter ring 5.5mm ED ø 26mm | | |
|  | GEV No. | 521547 | Ref. No. 116013 |
| | pump cover LGB inlet ø 60mm outlet ø 50mm supporting pressure M8 turn direction right ø 160mm ID ø 127mm inner height 36mm | | |
|  | GEV No. | 532623 | Ref. No. 80844 |
| | O-ring EPDM thickness 2.62mm ID ø 120.32mm Qty 1 pcs | | |



1

| | | | |
|---|--|-----------------|--|
| GEV No. | 500002 | Ref. No. | 130017 130018 130068 130069 130079 130080 |
| description | pump inlet ø 60mm outlet ø 50mm type ZA400SX 230V 50Hz 1 phase 0.9kW 1.2HP L 300mm rotation direction right capacitor 20µF LGB | | |
| For models: | 22F, 40F, 440F, 44F, E.52, S651, S651P, S653, S654, S655, S830, S835, SR651 | | |
| spare parts for | 500002 | | |
|  | GEV No. | 365019 | Ref. No. 206005 |
| | operating capacitor capacity 20µF 400V tolerance 5% 50/60Hz ambient temperature max. -25 to +85°C ø 39.5mm L 70mm M8 plastic connection male faston 6.3mm 16.10.25. protection | | |
|  | GEV No. | 509020 | Ref. No. 124031 |
| | impellor ø 104mm H 25mm M8L | | |
|  | GEV No. | 510703 | Ref. No. 141007 80843 |
| | mechanical shaft seal for shaft ø 13mm slide ring H 13mm height counter ring 5.5mm ED ø 26mm | | |
|  | GEV No. | 521547 | Ref. No. 116013 |
| | pump cover LGB inlet ø 60mm outlet ø 50mm supporting pressure M8 turn direction right ø 160mm ID ø 127mm inner height 36mm | | |
|  | GEV No. | 532623 | Ref. No. 80844 |
| | O-ring EPDM thickness 2.62mm ID ø 120.32mm Qty 1 pcs | | |







1

| | | | |
|---|--|-----------------|-----------------|
| GEV No. | 499126 | Ref. No. | 80113 |
| description | pump inlet ø 60mm outlet ø 50mm type ZF400SX 230V 50Hz 1 phase 1.1kW L 215mm rotation direction right capacitor 16µF LGB | | |
| For models: | NIAGARA-283, RIVER-282, RIVER-81, River-81CRP, RIVER-81-CRP, River-82CRP, RIVER-82-CRP, RV282, RV81, RV8123, RV81A, RV81C, RV81CCRP, RV81CRP, RV81HZ, RV81HZ23, RV81PAP, RV82CCRP, RV82CRP, SV72EB | | |
| spare parts for | 499126 | | |
|  | GEV No. | Ref. No. | 206004 |
| | 365021 | | |
| | operating capacitor capacity 16µF 425V tolerance 5% 50/60Hz ambient temperature max. -25 to +85°C ø 35mm L 73mm single M8 plastic connection male faston 6.3mm 416.10.99 protection | | |
|  | GEV No. | Ref. No. | 141007 80843 |
| | 510703 | | |
| | mechanical shaft seal for shaft ø 13mm slide ring H 13mm height counter ring 5.5mm ED ø 26mm | | |
|  | GEV No. | Ref. No. | 80845 |
| | 521090 | | |
| | impellor ø 101mm H 32mm thread M8L shaft ø 13mm shaft length 12mm | | |
|  | GEV No. | Ref. No. | 116013 |
| | 521547 | | |
| | pump cover LGB inlet ø 60mm outlet ø 50mm supporting pressure M8 turn direction right ø 160mm ID ø 127mm inner height 36mm | | |
|  | GEV No. | Ref. No. | 80844 |
| | 532623 | | |
| | O-ring EPDM thickness 2.62mm ID ø 120.32mm Qty 1 pcs | | |







1

| | | | |
|---|---|-----------------|------------------|
| GEV No. | 500362 | Ref. No. | 926146 |
| description | pump inlet ø 62mm outlet ø 50mm type CE150SX 230/400V 50Hz 3 phase 1.1kW 1.5HP L 280mm rotation direction right LGB | | |
| For models: | CLEAN-110, E1, E110 | | |
| spare parts for | 500362 | | |
|  | GEV No. | Ref. No. | 456023 926084 |
| | 510551 | | |
| | pump cover gasket ID ø 158.3mm pump type 1214/1293/1225/2243/1226/1204/3473/1241 thickness 3.53mm EPDM Qty 1 pcs | | |

| | | | |
|---|--|-----------------|-----------------------------------|
| spare parts for | 500362 | | |
|  | GEV No. | Ref. No. | 141002 70942 80121 RAT72 |
| | 510693 | | |
| | mechanical shaft seal for shaft ø 12mm slide ring ext. ø 24mm slide ring H 15.5mm slide ring int. ø 11mm counter ring mounting ø 24mm height counter ring 8mm counter ring int. ø 13.5mm | | |
|  | GEV No. | Ref. No. | 926085 |
| | 521240 | | |
| | impellor ø 110mm H 32mm rotation direction left thread M8L shaft ø 20mm shaft length 10mm seat ø 8.2mm blades 6 | | |
|  | GEV No. | Ref. No. | 926086 |
| | 521536 | | |
| | pump cover ALBA / LGB inlet ø 62mm outlet ø 50mm auxiliary pressure connection 12mm supporting pressure closed turn direction right ø 180mm ID ø 150mm inner height 38mm | | |
|  | GEV No. | Ref. No. | — |
| | 602013 | | |
| | fan wheel ø 100mm H 28mm shaft intake ø 17.5mm plastic | | |





1

| | | | |
|---|--|-----------------|-----------------------------------|
| GEV No. | 500360 | Ref. No. | 80114 |
| description | pump inlet ø 62mm outlet ø 50mm type ZF522SX 230V 50Hz 1 phase 1.1kW 1.5HP L 220mm rotation direction right capacitor 16µF LGB | | |
| For models: | 80, 81, LP60, RIVER-71, RIVER-80, RIVER-81, RIVER-81-CRP, RIVER-HL-81, RV71, RV81, RV8123, RV81A, RV81C, RV81HZ, RV81HZ23, RV81PAP, U60E | | |
| spare parts for | 500360 | | |
|  | GEV No. | Ref. No. | 206004 |
| | 365021 | | |
| | operating capacitor capacity 16µF 425V tolerance 5% 50/60Hz ambient temperature max. -25 to +85°C ø 35mm L 73mm single M8 plastic connection male faston 6.3mm 416.10.99 protection | | |
|  | GEV No. | Ref. No. | 456023 926084 |
| | 510551 | | |
| | pump cover gasket ID ø 158.3mm pump type 1214/1293/1225/2243/1226/1204/3473/1241 thickness 3.53mm EPDM Qty 1 pcs | | |
|  | GEV No. | Ref. No. | 141002 70942 80121 RAT72 |
| | 510693 | | |
| | mechanical shaft seal for shaft ø 12mm slide ring ext. ø 24mm slide ring H 15.5mm slide ring int. ø 11mm counter ring mounting ø 24mm height counter ring 8mm counter ring int. ø 13.5mm | | |
|  | GEV No. | Ref. No. | — |
| | 521280 | | |
| | impellor ø 107mm H 26mm thread M8L shaft ø 20mm shaft length 15mm seat ø 8.2mm blades 6 | | |
|  | GEV No. | Ref. No. | 926086 |
| | 521536 | | |
| | pump cover ALBA / LGB inlet ø 62mm outlet ø 50mm auxiliary pressure connection 12mm supporting pressure closed turn direction right ø 180mm ID ø 150mm inner height 38mm | | |





1



| | | | |
|---|--|-----------------|----------------------------------|
| GEV No. | 501363 | Ref. No. | 927022 |
| description | pump inlet ø 62mm outlet ø 52mm type AM5226 230/400V 50Hz 0.65kW L 295mm rotation direction left LGB | | |
| For models: | 161, 221, 271, 362, CLEAN-160, CLEAN-161, CLEAN-220, CLEAN-221, CLEAN-270, CLEAN-271, CLEAN-272, CLEAN-361, CLEAN-361P, CLEAN-362, CLEAN-471, CLEAN-471P | | |
| spare parts for | 501363 | | |
|  | GEV No. | 510551 | Ref. No. 456023 926084 |
| | pump cover gasket ID ø 158.3mm pump type 1214/1293/1225/2243/1226/1204/3473/1241 thickness 3.53mm EPDM Qty 1 pcs | | |
|  | GEV No. | 510694 | Ref. No. 926274 |
| | mechanical shaft seal for shaft ø 13mm height counter ring 8mm ID ø 11.5mm H 16mm mounting ø 24/26mm int. ø 1 14mm | | |
|  | GEV No. | 521141 | Ref. No. — |
| | impeller ø 70mm H 32mm thread M8R shaft ø 20mm shaft length 9mm | | |
|  | GEV No. | 521516 | Ref. No. — |
| | pump cover LGB inlet ø 62mm outlet ø 52mm auxiliary pressure connection 12mm supporting pressure closed turn direction left ø 190mm ID ø 150mm inner height 40mm | | |



1

| | | | |
|---|--|-----------------|----------------------------------|
| GEV No. | 499299 | Ref. No. | DPE1906 |
| description | pump inlet ø 62mm outlet ø 52mm type AM5226DX 220-240/380-415V 60Hz 3 phase 0.55kW L 293mm rotation direction left LGB | | |
| spare parts for | 499299 | | |
|  | GEV No. | 510551 | Ref. No. 456023 926084 |
| | pump cover gasket ID ø 158.3mm pump type 1214/1293/1225/2243/1226/1204/3473/1241 thickness 3.53mm EPDM Qty 1 pcs | | |
|  | GEV No. | 510694 | Ref. No. 926274 |
| | mechanical shaft seal for shaft ø 13mm height counter ring 8mm ID ø 11.5mm H 16mm mounting ø 24/26mm int. ø 1 14mm | | |

spare parts for 499299

| | | | | |
|---|--|--------|-----------------|---|
|  | GEV No. | 521141 | Ref. No. | — |
| | impeller ø 70mm H 32mm thread M8R shaft ø 20mm shaft length 9mm | | | |
|  | GEV No. | 521516 | Ref. No. | — |
| | pump cover LGB inlet ø 62mm outlet ø 52mm auxiliary pressure connection 12mm supporting pressure closed turn direction left ø 190mm ID ø 150mm inner height 40mm | | | |



1

| | | | |
|--------------------|---|-----------------|-------|
| GEV No. | 501584 | Ref. No. | 65600 |
| description | pump inlet ø 63mm outlet ø 44mm type PSA 230/400V 50Hz 3 phase 2.5kW L 340mm rotation direction right LGB | | |









1

| | | | |
|--------------------|--|-----------------|-------|
| GEV No. | 500733 | Ref. No. | 80116 |
| description | pump inlet ø 63mm outlet ø 48mm type AM5225SX 230/400V 50Hz 3 phase 0.9kW 1.2HP L 300mm rotation direction right LGB | | |
| For models: | 80, 81, 82, RIVER-82, RIVER-82-CRP, RIVER-HL-82 | | |



1

| | | | |
|---|---|-----------------|------------------------------|
| GEV No. | 499101 | Ref. No. | 79056 |
| description | pump inlet ø outlet ø 38mm type C600 230V 50Hz 1 phase 0.8kW L 220mm rotation direction right capacitor 16µF LGB with drain and flange | | |
| For models: | PS-60 | | |
| spare parts for | 499101 | | |
|  | GEV No. | 365021 | Ref. No. 206004 |
| | operating capacitor capacity 16µF 425V tolerance 5% 50/60Hz ambient temperature max. -25 to +85°C ø 35mm L 73mm single M8 plastic connection male faston 6.3mm 416.10.99 protection | | |
|  | GEV No. | 502280 | Ref. No. 111034 |
| | pump sump LGB auxiliary pressure connection 7mm supporting pressure closed pump type RV54 | | |
|  | GEV No. | 510703 | Ref. No. 141007 80843 |
| | mechanical shaft seal for shaft ø 13mm slide ring H 13mm height counter ring 5.5mm ED ø 26mm | | |
|  | GEV No. | 521234 | Ref. No. 124052 |
| | impellor thread M8L ED ø 93mm W 16mm | | |
|  | GEV No. | 523509 | Ref. No. 314001 |
| | deep-groove ball bearing type 6201-2RS shaft ø 12mm ED ø 32mm W 10mm with sealing discs deep-groove ball bearing DIN 625-1 | | |
|  | GEV No. | 532537 | Ref. No. 456067 |
| | O-ring EPDM thickness 3.53mm ID ø 113.9mm Qty 1 pcs | | |



1

| | | | |
|---|---|-----------------|------------------------------|
| GEV No. | 499119 | Ref. No. | 130987 |
| description | pump inlet ø outlet ø 38mm type RV54 230V 50Hz 1 phase 0.8kW L 380mm rotation direction right capacitor 16µF LGB with holder | | |
| For models: | 2312-007, 914100, 914101, 914339, 914342, 914343, 914624, 914625, 914626, 914627, 914628, 914850, 914851, 914854, 914944, RIVER-48, RIVER-54, RIVER-54CRP, River-54-CRP-s.p. | | |
| spare parts for | 499119 | | |
|  | GEV No. | 365021 | Ref. No. 206004 |
| | operating capacitor capacity 16µF 425V tolerance 5% 50/60Hz ambient temperature max. -25 to +85°C ø 35mm L 73mm single M8 plastic connection male faston 6.3mm 416.10.99 protection | | |
|  | GEV No. | 502280 | Ref. No. 111034 |
| | pump sump LGB auxiliary pressure connection 7mm supporting pressure closed pump type RV54 | | |
|  | GEV No. | 510703 | Ref. No. 141007 80843 |
| | mechanical shaft seal for shaft ø 13mm slide ring H 13mm height counter ring 5.5mm ED ø 26mm | | |
|  | GEV No. | 521234 | Ref. No. 124052 |
| | impellor thread M8L ED ø 93mm W 16mm | | |
|  | GEV No. | 523509 | Ref. No. 314001 |
| | deep-groove ball bearing type 6201-2RS shaft ø 12mm ED ø 32mm W 10mm with sealing discs deep-groove ball bearing DIN 625-1 | | |
|  | GEV No. | 532537 | Ref. No. 456067 |
| | O-ring EPDM thickness 3.53mm ID ø 113.9mm Qty 1 pcs | | |











1

| | | | |
|---|--|-----------------|--|
| GEV No. | 500153 | Ref. No. | 130139 999134 |
| description | pump inlet ø outlet ø type W180SX 230V 50Hz 1 phase 0.19kW 0.26HP L 220mm rotation direction right capacitor 5µF LGB | | |
| For models: | 913289, 913290, 913356, 913372, 913373, 913544, 913665, 913667, 913771, 913772, 913832, 913837, 914165, 914166, 914206, 914355, 914386, 914387, 914388, 914389, 914390, 914391, 914692, 914693, 914694, 914703, 914870, 915686, 915687, 915688, 915689, 915690, 915691, 916237, 916238, 916239, 916240, 916241, 916401, 916402, 916403, 916404, 916787, E.35, E.35-Elettrobar, E.35H, E.35H-Elettrobar, Fast130, FAST-135, Fast135-2...(Other models you can see in the webshop) | | |
| spare parts for | 500153 | | |
|  | GEV No. | 365017 | Ref. No. 206008 206010 |
| | operating capacitor capacity 5µF 450V tolerance 5% 50/60Hz ambient temperature max. -25 to +85°C ø 28mm L 54mm M8 plastic connection male faston 6.3mm 16.10.08 protection | | |
|  | GEV No. | 510703 | Ref. No. 141007 80843 |
| | mechanical shaft seal for shaft ø 13mm slide ring H 13mm height counter ring 5.5mm ED ø 26mm | | |
|  | GEV No. | 513267 | Ref. No. 480054 |
| | end cap for wash pump suitable for pump casing | | |
|  | GEV No. | 513283 | Ref. No. 437082 |
| | gasket | | |
|  | GEV No. | 518177 | Ref. No. 111023 116023 |
| | drain unit thread 3/4" ID ø 35mm hose ø 24mm | | |
|  | GEV No. | 518204 | Ref. No. 429065 |
| | screw connection for filter ø 67mm | | |
|  | GEV No. | 518205 | Ref. No. 437079 80182 reb437079 |
| | flat gasket rubber ED ø 61mm ID ø 47mm thickness 2mm Qty 1 pcs | | |
|  | GEV No. | 521147 | Ref. No. 315024 |
| | flange | | |
|  | GEV No. | 521221 | Ref. No. 124048 |
| | impellor ø 67mm H 16mm rotation direction right thread M7L shaft ø 13mm shaft length 12mm blades 8 | | |
|  | GEV No. | 528800 | Ref. No. — |
| | O-ring EPDM thickness 2.62mm ID ø 75.87mm Qty 1 pcs | | |



1

| | | | |
|---|--|-----------------|--|
| GEV No. | 500150 | Ref. No. | 130136 999135 |
| description | pump inlet ø outlet ø type W210SX 230V 50Hz 1 phase 0.24kW 0.33HP L 230mm rotation direction right capacitor 6.3µF LGB | | |
| For models: | 913291, 913292, 913357, 913374, 913375, 913416, 913435, 913545, 913666, 913668, 913685, 913773, 913774, 913911, 913912, 913948, 913950, 913977, 913984, 913990, 914214, 914316, 914317, 914392, 914393, 914394, 914395, 914396, 914397, 914441, 914442, 914515, 914516, 914537, 914543, 914547, 914683, 914684, 914689, 914863, 914874, 915138, 915139, 915527, 915692, 915693, 915694, 916162, 916181, 916183...(Other models you can see in the webshop) | | |
| spare parts for | 500150 | | |
|  | GEV No. | 365012 | Ref. No. 206009 |
| | operating capacitor capacity 6.3µF 450V tolerance 5% 50Hz ambient temperature max. -25 to +85°C ø 30mm L 61mm M8 plastic connection male faston 6.3mm protection | | |
|  | GEV No. | 509004 | Ref. No. 124049 |
| | impellor ø 71mm H 16mm M7L rotation direction right shaft ø 13mm shaft length 13mm blades 8 | | |
|  | GEV No. | 510703 | Ref. No. 141007 80843 |
| | mechanical shaft seal for shaft ø 13mm slide ring H 13mm height counter ring 5.5mm ED ø 26mm | | |
|  | GEV No. | 513267 | Ref. No. 480054 |
| | end cap for wash pump suitable for pump casing | | |
|  | GEV No. | 513275 | Ref. No. 456074 |
| | O-ring EPDM thickness 1.78mm ID ø 82.27mm Qty 1 pcs | | |
|  | GEV No. | 518177 | Ref. No. 111023 116023 |
| | drain unit thread 3/4" ID ø 35mm hose ø 24mm | | |
|  | GEV No. | 518204 | Ref. No. 429065 |
| | screw connection for filter ø 67mm | | |
|  | GEV No. | 518205 | Ref. No. 437079 80182 reb437079 |
| | flat gasket rubber ED ø 61mm ID ø 47mm thickness 2mm Qty 1 pcs | | |
|  | GEV No. | 521147 | Ref. No. 315024 |
| | flange | | |



OLYMPIA

pumps

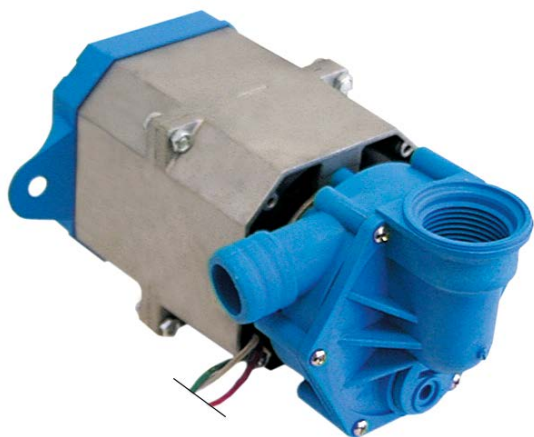

1





| | | | |
|---|--|-----------------|---|
| GEV No. | 500005 | Ref. No. | 130050 130085 130086 130087 |
| description | pump inlet \varnothing 1" IT outlet \varnothing 28mm type T60 230V 50Hz 1 phase 0.19kW 0.26HP L 210mm rotation direction left capacitor 5 μ F OLYMPIA | | |
| For models: | 11F, 11FD, 11F-DVGW, 11R, 11RD, 913363, 913364, 913376, 913377, E.41, E.42, E41 | | |
| spare parts for | 500005 | | |
|  | GEV No. | 365017 | Ref. No. 206008 206010 |
| | operating capacitor capacity 5 μ F 450V tolerance 5% 50/60Hz ambient temperature max. -25 to +85°C \varnothing 28mm L 54mm M8 plastic connection male faston 6.3mm 16.10.08 protection | | |
|  | GEV No. | 509001 | Ref. No. 124028 |
| | impellor \varnothing 75mm H 15mm pump type type C rotation direction left thread M6R shaft \varnothing 11/12mm shaft length 25mm blades 4 | | |
|  | GEV No. | 509003 | Ref. No. 315013 999175 |
| | pump cover OLYMPIA inlet 1" outlet \varnothing 28mm pump type T60 | | |
|  | GEV No. | 510693 | Ref. No. 141002 70942 80121 RAT72 |
| | mechanical shaft seal for shaft \varnothing 12mm slide ring ext. \varnothing 24mm slide ring H 15.5mm slide ring int. \varnothing 11mm counter ring mounting \varnothing 24mm height counter ring 8mm counter ring int. \varnothing 13.5mm | | |
|  | GEV No. | 528800 | Ref. No. — |
| | O-ring EPDM thickness 2.62mm ID \varnothing 75.87mm Qty 1 pcs | | |





1

| | | | |
|---|--|-----------------|---|
| GEV No. | 500199 | Ref. No. | 130115 130116 |
| description | pump inlet \varnothing 32mm outlet \varnothing 30/24mm type T80 230V 50Hz 1 phase 0.25kW 0.34HP L 205mm rotation direction left capacitor 5 μ F OLYMPIA | | |
| For models: | 67F, 67R | | |
| spare parts for | 500199 | | |
|  | GEV No. | 365017 | Ref. No. 206008 206010 |
| | operating capacitor capacity 5 μ F 450V tolerance 5% 50/60Hz ambient temperature max. -25 to +85°C \varnothing 28mm L 54mm M8 plastic connection male faston 6.3mm 16.10.08 protection | | |
|  | GEV No. | 510693 | Ref. No. 141002 70942 80121 RAT72 |
| | mechanical shaft seal for shaft \varnothing 12mm slide ring ext. \varnothing 24mm slide ring H 15.5mm slide ring int. \varnothing 11mm counter ring mounting \varnothing 24mm height counter ring 8mm counter ring int. \varnothing 13.5mm | | |
|  | GEV No. | 521151 | Ref. No. 124040 |
| | impellor \varnothing 71mm H 19mm pump type OLYMPIA thread M10R shaft \varnothing 12mm shaft length 8mm | | |
|  | GEV No. | 521178 | Ref. No. 315018 |
| | pump casing OLYMPIA outlet \varnothing 30/24mm pump type T80 | | |
|  | GEV No. | 521552 | Ref. No. 116022 |
| | pump cover OLYMPIA inlet \varnothing 32mm outlet \varnothing 30/24mm \varnothing 103mm ID \varnothing 93mm | | |
|  | GEV No. | 521703 | Ref. No. 456038 456063 |
| | pump cover gasket EPDM thickness 2.5mm ID \varnothing 75mm Qty 1 pcs | | |



| | | | | |
|---|--|-----------------|-----------------|-----------------------------------|
| 1 | | | | |
| GEV No. | 500152 | Ref. No. | 130122 | |
| description | pump inlet \varnothing 44mm outlet \varnothing 30mm type T90 230V 50Hz 1 phase 0.33kW 0.45HP L 220mm rotation direction left capacitor 8 μ F OLYMPIA | | | |
| For models: | 45, 450, 913418, 914167, 914168, 914398, 914399, 914443, 914943, 915695, 915696, 915819, E.45, Fast145, FAST-145, Fast145D, FAST-145D, Niagara-45 | | | |
| spare parts for | 500152 | | | |
|  | GEV No. | 365013 | Ref. No. | 206001 |
| | operating capacitor capacity 8 μ F 400V tolerance 5%Hz ambient temperature max. -25 to +85°C \varnothing 31.5mm L 55mm M8 plastic connection male faston 6.3mm protection | | | |
|  | GEV No. | 509007 | Ref. No. | 124043 |
| | impellor \varnothing 85mm H 20mm rotation direction left thread M10R shaft \varnothing 12mm shaft length 7.5mm blades 12 | | | |
|  | GEV No. | 510693 | Ref. No. | 141002 70942 80121 RAT72 |
| | mechanical shaft seal for shaft \varnothing 12mm slide ring ext. \varnothing 24mm slide ring H 15.5mm slide ring int. \varnothing 11mm counter ring mounting \varnothing 24mm height counter ring 8mm counter ring int. \varnothing 13.5mm | | | |
|  | GEV No. | 521703 | Ref. No. | 456038 456063 |
| | pump cover gasket EPDM thickness 2.5mm ID \varnothing 75mm Qty 1 pcs | | | |



| | | | | |
|---|--|-----------------|-----------------|-----------------------------------|
| 1 | | | | |
| GEV No. | 500003 | Ref. No. | 130008 | |
| description | pump inlet \varnothing 45mm outlet \varnothing 32mm type T30 230V 50Hz 1 phase 0.29kW 0.39HP L 190mm rotation direction right capacitor 8 μ F OLYMPIA | | | |
| For models: | S621, S623, S624, S626, S631, S633, S634, S636 | | | |
| spare parts for | 500003 | | | |
|  | GEV No. | 365013 | Ref. No. | 206001 |
| | operating capacitor capacity 8 μ F 400V tolerance 5%Hz ambient temperature max. -25 to +85°C \varnothing 31.5mm L 55mm M8 plastic connection male faston 6.3mm protection | | | |
|  | GEV No. | 510512 | Ref. No. | 116008 |
| | pump cover OLYMPIA inlet \varnothing 45mm outlet \varnothing 31mm outlet 2 \varnothing 24 turn direction right \varnothing 130mm ID \varnothing 124mm inner height 20mm | | | |
|  | GEV No. | 510554 | Ref. No. | 456024 |
| | O-ring EPDM thickness 2mm ID \varnothing 120mm Qty 1 pcs | | | |
|  | GEV No. | 510615 | Ref. No. | 124006 REB124006 |
| | impellor \varnothing 90mm H 22mm rotation direction right thread M10L blades 4 | | | |
|  | GEV No. | 510693 | Ref. No. | 141002 70942 80121 RAT72 |
| | mechanical shaft seal for shaft \varnothing 12mm slide ring ext. \varnothing 24mm slide ring H 15.5mm slide ring int. \varnothing 11mm counter ring mounting \varnothing 24mm height counter ring 8mm counter ring int. \varnothing 13.5mm | | | |



1

| | | | |
|---|--|-----------------|---|
| GEV No. | 500535 | Ref. No. | 130117 |
| description | pump inlet \varnothing outlet \varnothing 27mm type T70 230V 50Hz 1 phase 0.3kW 0.4HP L 130mm rotation direction right capacitor 6.3 μ F OLYMPIA | | |
| For models: | CLEAN-3, RIVER-43 | | |
| spare parts for | 500535 | | |
|  | GEV No. | 365012 | Ref. No. 206009 |
| | operating capacitor capacity 6.3 μ F 450V tolerance 5% 50Hz ambient temperature max. -25 to +85°C \varnothing 30mm L 61mm M8 plastic connection male faston 6.3mm protection | | |
|  | GEV No. | 510556 | Ref. No. 456022 |
| | O-ring EPDM thickness 1.78mm ID \varnothing 94.97mm Qty 1 pcs pump type T110 | | |
|  | GEV No. | 510693 | Ref. No. 141002 70942 80121 RAT72 |
| | mechanical shaft seal for shaft \varnothing 12mm slide ring ext. \varnothing 24mm slide ring H 15.5mm slide ring int. \varnothing 11mm counter ring mounting \varnothing 24mm height counter ring 8mm counter ring int. \varnothing 13.5mm | | |
|  | GEV No. | 521254 | Ref. No. 124022 124042 |
| | impellor \varnothing 81mm H 11mm thread M8L shaft \varnothing 12mm shaft length 28mm blades 6 | | |

booster pumps I



1

| | | | |
|---|--|-----------------|----------------------------|
| GEV No. | 500060 | Ref. No. | 130013 130049 130052 |
| description | pump inlet \varnothing 1" outlet \varnothing 1" type PQM60 230V 50Hz 1 phase 0.37kW PEDRELLLO | | |
| For models: | R495, R497, R499, R501, R503, R505, R507, R509, R511, R704, R706, R708, S621, S623, S624, S626, S631, S633, S634, S636, S641, S643, S651, S651P, S653, S654, S655, S810, S815, S830, S835, S850, S870, S950, SR651 | | |
| accessories for | 500060 | | |
|  | GEV No. | 365015 | Ref. No. 206002 |
| | operating capacitor capacity 10 μ F 400V tolerance 5%Hz ambient temperature max. -25 to +85°C \varnothing 35.5mm L 59mm M8 plastic connection male faston 6.3mm protection | | |



1



| | | | |
|---|--|-----------------|------------------------|
| GEV No. | 500359 | Ref. No. | 130143 DPE127 |
| description | pump inlet \varnothing 12 outlet \varnothing 12 type PPL46DX 230V 50Hz 0.33kW capacitor 10 μ F LGB | | |
| For models: | 80, 81, 82, 914568, 915756, CE78HZ23, CGL74CABT, E.50D.PA, E78, E78HP, FAST-160D-PA, FAST-181, HM1, NIAGARA-283, Niagara-283A, RIVER-71, RIVER-78, RIVER-80, River-81, RIVER-82, RIVER-E78, RV71, RV80, RV8023, RV8023HZ, RV80C, RV80HZ, RV81, RV8123, RV81A, RV81C, RV81HZ, RV81HZ23, RV81PAP, RV82, RV8223, RV82C, SevenL, ST70FAST, SV72AEB, SV72EB | | |
| spare parts for | 500359 | | |
|  | GEV No. | 698663 | Ref. No. — |
| | impellor \varnothing 60mm H 12mm with flute shaft intake \varnothing 12mm W 60mm suitable for LGB | | |
| accessories for | 500359 | | |
|  | GEV No. | 365015 | Ref. No. 206002 |
| | operating capacitor capacity 10 μ F 400V tolerance 5%Hz ambient temperature max. -25 to +85°C \varnothing 35.5mm L 59mm M8 plastic connection male faston 6.3mm protection | | |



1

| | | | |
|---|--|-----------------|------------------------|
| GEV No. | 500358 | Ref. No. | 130102 130120 |
| description | pump inlet \varnothing 3/8" outlet \varnothing 3/8" type PS46 230V 50Hz 0.45kW \varnothing 100mm L 200mm capacitor 10 μ F LGB | | |
| For models: | 45, 450, 46, 460, 500F, 500FD, 50F, 50FD, 510F, 510FD, 913297, 913298, 913299, 913300, 913360, 913361, 913391, 913392, 913546, 913547, 913578, 913611, 913684, 913913, 913914, 913932, 913933, 914284, 914326, 914331, 914356, 914400, 914401, 914402, 914403, 914404, 914405, 914406, 914449, 914517, 914545, 914642, 914688, 914909, 914979, 915136, 915137, 915140, 915248, CLEAN-3...(Other models you can see in the webshop) | | |
| spare parts for | 500358 | | |
|  | GEV No. | 510713 | Ref. No. 141009 |
| | slide ring for shaft \varnothing 12mm ED \varnothing 24mm H 16mm | | |
|  | GEV No. | 510723 | Ref. No. — |
| | counter ring H 8mm ED \varnothing 26mm ID \varnothing 13.5mm for mechanical shaft seal | | |
|  | GEV No. | 698400 | Ref. No. — |
| | pump cover gasket pump type PS46 thickness 2mm ID \varnothing 66mm Qty 1 pcs | | |
| accessories for | 500358 | | |
|  | GEV No. | 365015 | Ref. No. 206002 |
| | operating capacitor capacity 10 μ F 400V tolerance 5%Hz ambient temperature max. -25 to +85°C \varnothing 35.5mm L 59mm M8 plastic connection male faston 6.3mm protection | | |
|  | GEV No. | 511279 | Ref. No. — |
| | hose connector brass straight thread 3/8" hose \varnothing 12mm Qty 1 pcs | | |

Table continues overleaf

| | | | |
|---|---|--------|------------------------|
| accessories for | 500358 | | |
|  | GEV No. | 520202 | Ref. No. 927015 |
| | hose connector nickel-plated brass straight thread 3/8" hose ø 12mm Qty 1 pcs | | |
|  | GEV No. | 520677 | Ref. No. — |
| | hose connector brass straight thread 3/8" hose ø 13mm Qty 1 pcs | | |

drain pumps

ASKOLL



| | | | |
|--------------------|---|-----------------|--------|
| GEV No. | 500210 | Ref. No. | 130123 |
| description | drain pump 230V 40W | | |
| For models: | 2312-007, 2312-009-CRP, 45, 450, 913289, 913290, 913291, 913292, 913356, 913357, 913363, 913364, 913372, 913373, 913374, 913375, 913376, 913377, 913416, 913418, 913435, 913544, 913545, 913665, 913666, 913667, 913668, 913685, 913771, 913772, 913773, 913774, 913832, 913837, 913911, 913912, 913948, 913950, 913977, 913984, 913990, 914100, 914101, 914165, 914166, 914167, 914168, 914206, 914214, 914316...(Other models you can see in the webshop) | | |



| | | | |
|--------------------|--|-----------------|--------|
| GEV No. | 499343 | Ref. No. | 130182 |
| description | drain pump 32W 220V 60Hz ASKOLL type R26 | | |
| For models: | 916452, 916688 | | |



| | | | |
|--------------------|--|-----------------|-------------------|
| GEV No. | 499333 | Ref. No. | 130181 80117UL |
| description | drain pump 32W 220V inlet ø 30mm outlet ø 22mm 60Hz ASKOLL type R26 complete | | |
| For models: | 915150, 915151, 915152, 915154, 915155, 915157, 915158, 915160, 915161, 915162, 915166, 915167, 915168, 915172, 915173, 915175, 915319, 915348, 915418, 915419, 915420, 915421, 915422, 915479, 915492, 915493, 915494, 915495, 915496, 915497, 915547, 915558, 915611, 915612, 915613, 915614, 915615, 915616, 915617, 915618, 915635, 915663, 915670, 915671, 915672, 915747, 915773, 915774, 915959, 916054...(Other models you can see in the webshop) | | |



| | | | |
|--------------------|--|-----------------|--------|
| GEV No. | 501514 | Ref. No. | 130175 |
| description | drain pump 40W 220-240V inlet ø 30mm outlet ø 22mm 50Hz ASKOLL type M231 XP | | |
| For models: | 916020, 916021, 916024, 916025, 916026, 916027, 916030, 916031, 916045, 916247, 916248, 916249, 916250, 916251, 916252, 916382, 916383, 916504, 916584, 916654, 916670, 916763, 916921, 916922, 916992, 916993, 917044, 917049, Clean161, Fast145-2, Fast150, Fast160-2, Fast160C, Fast161-2, Ocean360, Ocean360M, Ocean360-UK | | |



| | | | |
|--------------------|--|-----------------|--------|
| GEV No. | 501541 | Ref. No. | 130177 |
| description | drain pump 40W 220-240V inlet ø 30mm outlet ø 22mm 50Hz ASKOLL type M231 XP | | |
| For models: | 915150, 915151, 915152, 915154, 915155, 915157, 915158, 915160, 915161, 915162, 915166, 915167, 915168, 915172, 915173, 915175, 915319, 915348, 915418, 915419, 915420, 915421, 915422, 915479, 915492, 915493, 915494, 915495, 915496, 915497, 915547, 915558, 915611, 915612, 915613, 915617, 915618, 915635, 915663, 915670, 915672, 915747, 915773, 915774, 915959, 916054, 916066, 916067, 916068, 916069...(Other models you can see in the webshop) | | |



1

| | | | |
|--------------------|---|-----------------|--------|
| GEV No. | 499310 | Ref. No. | 130146 |
| description | drain pump 40W 220V inlet ø 24mm outlet ø 22mm 50Hz ASKOLL type M231 XP complete | | |
| For models: | 913992, 913993, 914583, 914592, 914612, 914613, 915143, RIVER-40, RIVER-40-CRP, RIVER-44, RIVER-44-CRP, RIVER-44-CRP-ST, RIVER-44CRP-ST | | |



1

| | | | |
|--------------------|---|-----------------|--------|
| GEV No. | 499102 | Ref. No. | 999161 |
| description | drain pump inlet ø 24mm outlet ø 22mm 230-240V 25W 50Hz ASKOLL type R113 retrofit kit | | |
| For models: | 913297, 913298, 913299, 913300, 913360, 913361, 913391, 913392, 913546, 913547, 913578, 913611, 913684, 913932, 913933, 914318, 914319, 914331, 914338, 914400, 914401, 914402, 914403, 914404, 914405, 914431, 914449, 914517, 914545, 914688, 914979, 915140, 915248, E.50, E.51, Mistral51, MISTRAL-51, NIAGARA-51 | | |



1

| | | | |
|--------------------|--|-----------------|--------|
| GEV No. | 499315 | Ref. No. | 130178 |
| description | drain pump inlet ø 24/30/35/39mm outlet ø 22/31mm 230V 40W 50Hz ASKOLL type M231 XP kit | | |
| For models: | 915686, 915687, 915689, 915690, 915691, 915692, 915693, 915694, 916162, 916181, 916183, 916184, 916185, 916237, 916238, 916239, 916240, 916241, 916242, 916243, 916244, 916245, 916246, 916401, 916402, 916403, 916404, 916405, 916406, 916407, 916408, 916583, 916751, 916787, 916788, 916991, 917042, 917043, Clean140, Clean140S, Fast130, Fast135-2, Fast135-2S, Fast135CT, Fast135D, Fast135H, Fast135H-2, Fast135H-2S, Fast135HCT, Fast135HD...(Other models you can see in the webshop) | | |



1

| | | | |
|---|---|-----------------|--------|
| GEV No. | 499244 | Ref. No. | 999150 |
| description | drain pump inlet ø 30mm outlet ø 22mm 220-240V 40W 50Hz ASKOLL type M231 XP kit | | |
| spare parts for | 499244 | | |
|  | GEV No. | Ref. No. | — |
| | drain pump inlet ømm outlet ømm 230V 40W 50Hz ASKOLL type M231 XP without lid | | |

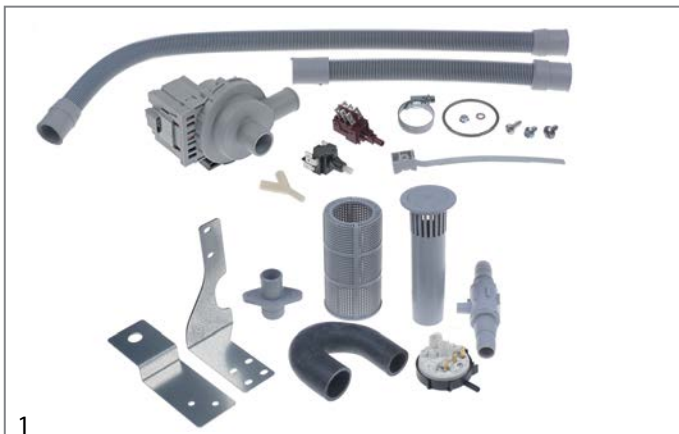

1

| | | | |
|---|---|-----------------|--------|
| GEV No. | 499245 | Ref. No. | 999162 |
| description | drain pump inlet ø 24mm outlet ø 22mm 220-240V 40W 50Hz ASKOLL type M231 XP kit | | |
| spare parts for | 499245 | | |
|  | GEV No. | Ref. No. | — |
| | drain pump inlet ømm outlet ømm 230V 40W 50Hz ASKOLL type M231 XP without lid | | |



1

| | | | |
|--------------------|---|-----------------|------------------|
| GEV No. | 500214 | Ref. No. | 130105 130176 |
| description | drain pump inlet ø 30mm outlet ø 22mm 230/240V 30W 50Hz ASKOLL type R113 | | |
| For models: | 050F, 050FP, 2312-001, 2312-002, 46, 460, 500F, 500FD, 50F, 50FD, 510F, 510FD, 913297, 913298, 913299, 913300, 913360, 913361, 913391, 913392, 913546, 913547, 913578, 913611, 913684, 913913, 913914, 913932, 913933, 914284, 914318, 914319, 914331, 914338, 914356, 914400, 914401, 914402, 914403, 914404, 914405, 914431, 914449, 914517, 914545, 914568, 914642, 914688, 914909, 914979...(Other models you can see in the webshop) | | |





| | | | |
|--|--|-----------------|------------------------|
| GEV No. | 501364 | Ref. No. | 999234 |
| description | drain pump inlet ø 30mm outlet ø 22mm 230V 25W 50Hz ASKOLL type R113 conversion kit | | |
| For models: | 914100, 914101, 914339, 914342, 914343, 914624, 914625, 914626, 914627, 914850, 914851, 914854, River-48, River-54 | | |
| spare parts for | 501364 | | |
|  | GEV No. | 517572 | Ref. No. 144992 |
| | backflow preventer for drain hose ø 31/21mm | | |



| | | | |
|--------------------|---|-----------------|--------|
| GEV No. | 500215 | Ref. No. | 130138 |
| description | drain pump inlet ø 30mm outlet ø 22mm 230V 40W 50Hz ASKOLL type M231 XP with holder | | |
| For models: | E.35, E.40 | | |



| | | | |
|--|---|-----------------|-------------------|
| GEV No. | 500209 | Ref. No. | 130156 |
| description | drain pump inlet ømm outlet ømm 230V 40W 50Hz ASKOLL type M231 XP with holder | | |
| For models: | 914326, 914406, E.55 | | |
| spare parts for | 500209 | | |
|  | GEV No. | 512175 | Ref. No. — |
| | O-ring EPDM thickness 2.62mm ID ø 53.65mm Qty 1 pcs | | |
| accessories for | 500209 | | |
|  | GEV No. | 500197 | Ref. No. — |
| | body drain pump | | |
|  | GEV No. | 500300 | Ref. No. — |
| | pump cover inlet ø 39mm outlet ø 31 mm | | |
|  | GEV No. | 500301 | Ref. No. — |
| | pump cover inlet ø 35mm outlet ø 31 mm | | |
|  | GEV No. | 500303 | Ref. No. — |
| | body inlet ø 24mm outlet ø 22mm suitable for drain pump | | |

| | | | |
|---|--|--------|-------------------|
| accessories for | 500209 | | |
|  | GEV No. | 500304 | Ref. No. — |
| | pump cover inlet ø 30mm outlet ø 22mm ø 78mm | | |
|  | GEV No. | 500305 | Ref. No. — |
| | pump cover inlet ø 30mm outlet ø 22mm | | |
|  | GEV No. | 560483 | Ref. No. — |
| | screw ø 3.7mm L 20mm SS Qty 1 pcs head ø 7mm | | |

GRE





| | | | |
|--------------------|--|-----------------|------------------|
| GEV No. | 500057 | Ref. No. | 130021 130022 |
| description | drain pump inlet ø 22/30mm outlet ø 22mm 100W 230V 50Hz GRE | | |
| For models: | R505, S621, S624, S631, S634, S651, S651P, S654, S655, S810, S815, S830, S835, SR651 | | |



| | | | |
|--------------------|--|-----------------|------------------|
| GEV No. | 500087 | Ref. No. | 130070 130083 |
| description | drain pump inlet ø 25mm outlet ø 21mm 100W 230V 50Hz GRE with temperature protection | | |
| For models: | 21F, 21FD, 21R, 21RD, 25F, 25FD, 25R, 25RD, 30F, 30FD, 30R, 30RD, 31F, 31FD, 31R, 31RD, S621, S623, S624, S626, S631, S633, S634, S636 | | |



| | | | |
|---|--|-----------------|------------------------|
| GEV No. | 500213 | Ref. No. | 130071 130084 |
| description | drain pump inlet ø 30mm outlet ø 22mm 100W 230V 50Hz GRE | | |
| For models: | 22F, 22R | | |
| spare parts for | 500213 | | |
|  | GEV No. | 500307 | Ref. No. 121053 |
| | filter | | |
|  | GEV No. | 500899 | Ref. No. — |
| | pump cover inlet ø 30mm outlet ø 22mm pump type 500.213 | | |

1

| | | | |
|--------------------|--|-----------------|--------|
| GEV No. | 500546 | Ref. No. | 130094 |
| description | drain pump inlet \varnothing 30mm outlet \varnothing 23mm 100W 230V 50Hz GRE | | |
| For models: | 22F, 40F, 440F, 44F, E.52 | | |



1

| | | | |
|--------------------|--|-----------------|--------|
| GEV No. | 500247 | Ref. No. | 926103 |
| description | drain pump inlet \varnothing 34mm outlet \varnothing 29mm 100W 230V 50Hz GRE | | |
| For models: | E1, E10, E100, E110 | | |



1

| | | | |
|--------------------|--|-----------------|--------|
| GEV No. | 500350 | Ref. No. | 929114 |
| description | drain pump inlet \varnothing 34mm outlet \varnothing 29mm 100W 230V 50Hz GRE | | |
| For models: | E.60, E.65, E120, E140 | | |



1

| | | | |
|--------------------|--|-----------------|--------|
| GEV No. | 500212 | Ref. No. | 130112 |
| description | drain pump inlet \varnothing mm outlet \varnothing mm 100W 230V 50Hz GRE without lid | | |
| For models: | CLEAN-3, RIVER-43 | | |

HANNING



1

| | | | |
|--------------------|---|-----------------|-------|
| GEV No. | 500363 | Ref. No. | 80117 |
| description | drain pump 40W 230V | | |
| For models: | 80, 81, 82, 915150, 915151, 915152, 915154, 915155, 915157, 915158, 915160, 915161, 915162, 915166, 915167, 915168, 915172, 915173, 915175, 915176, 915177, 915285, 915319, 915338, 915341, 915348, 915418, 915419, 915420, 915421, 915422, 915479, 915492, 915493, 915494, 915495, 915496, 915497, 915547, 915558, 915611, 915612, 915613, 915614, 915615, 915616, 915617, 915618, 915635, 915663... (Other models you can see in the webshop) | | |

accessories

holders



1

| | | | |
|---|---|-----------------|----------------------------|
| GEV No. | 513717 | Ref. No. | 035064 |
| description | fastening angle for drain pump | | |
| For models: | 050F, 050FP, 2312-002, 913297, 913298, 913299, 913300, 913360, 913361, 913391, 913392, 913546, 913547, 913578, 913611, 913684, 913913, 913914, 913932, 913933, 914284, 914318, 914319, 914331, 914338, 914356, 914400, 914401, 914402, 914403, 914404, 914405, 914431, 914449, 914517, 914545, 914568, 914642, 914688, 914909, 914979, 915136, 915137, 915140, 915248, 915483, 915484, 915528, 915537, 915538...(Other models you can see in the webshop) | | |
| accessories for | 513717 | | |
|  | GEV No. | Ref. No. | 111019 111030 111999 |
| opposite support mounting pos. lower for wash arm support | | | |



booster pumps II

accessories



| | | | |
|--------------------|---|-----------------|--------|
| 1 | | | |
| GEV No. | 365015 | Ref. No. | 206002 |
| description | operating capacitor capacity 10µF 400V tolerance 5%Hz ambient temperature max. -25 to +85°C ø 35.5mm L 59mm M8 plastic connection male faston 6.3mm protection | | |
| For models: | 500F, 500FD, 50F, 50FD, 510F, 510FD, 913297, 913298, 913299, 913300, 913360, 913361, 913391, 913392, 913546, 913547, 913578, 913611, 913684, 913913, 913914, 913932, 913933, 913992, 913993, 914100, 914101, 914284, 914326, 914331, 914339, 914342, 914343, 914356, 914400, 914401, 914402, 914403, 914404, 914405, 914406, 914449, 914517, 914545, 914568, 914624, 914625, 914626, 914627, 914642...(Other models you can see in the webshop) | | |



| | | | |
|--------------------|---|-----------------|------------------|
| 2 | | | |
| GEV No. | 365017 | Ref. No. | 206008 206010 |
| description | operating capacitor capacity 5µF 450V tolerance 5% 50/60Hz ambient temperature max. -25 to +85°C ø 28mm L 54mm M8 plastic connection male faston 6.3mm 16.10.08 protection | | |
| For models: | 11F, 11FD, 11F-DVGW, 11R, 11RD, 350F, 350FD, 350R, 350RD, 35-ELECTRONIC, 35F, 35FD, 35R, 35RD, 67F, 67R, 913289, 913290, 913356, 913363, 913364, 913372, 913373, 913376, 913377, 913544, 913665, 913667, 913771, 913772, 913832, 913837, 914165, 914166, 914206, 914355, 914386, 914387, 914388, 914389, 914390, 914391, 914692, 914693, 914694, 914703, 914870, 915686, 915687, 915688...(Other models you can see in the webshop) | | |



| | | | |
|--------------------|---|-----------------|--------|
| 1 | | | |
| GEV No. | 365012 | Ref. No. | 206009 |
| description | operating capacitor capacity 6.3µF 450V tolerance 5% 50Hz ambient temperature max. -25 to +85°C ø 30mm L 61mm M8 plastic connection male faston 6.3mm protection | | |
| For models: | 400F, 400FD, 400R, 400RD, 40-ELECTRONIC, 40F, 40FD, 40R, 40RD, 913291, 913292, 913357, 913374, 913375, 913416, 913435, 913545, 913666, 913668, 913685, 913773, 913774, 913911, 913912, 913948, 913950, 913977, 913984, 913990, 913992, 913993, 914214, 914316, 914317, 914392, 914393, 914394, 914395, 914396, 914397, 914441, 914442, 914515, 914516, 914537, 914543, 914547, 914583, 914592, 914612...(Other models you can see in the webshop) | | |

accessories

pump covers



| | | | |
|--------------------|---|-----------------|--------|
| 1 | | | |
| GEV No. | 521563 | Ref. No. | 929191 |
| description | pump cover | | |
| For models: | KLP201DDDTTEB, KLP201EB, KLP301, KLP301DDDTTEB, LP201DDDTTEB, LP201EB, LP301, LP301EB, U132, U132E, U70, U70e | | |



| | | | |
|--------------------|---------------------------|-----------------|--------|
| 1 | | | |
| GEV No. | 510516 | Ref. No. | 116004 |
| description | pump cover pump type 1295 | | |
| For models: | R706, R708 | | |



| | | | |
|--------------------|---------------------------|-----------------|--------|
| 1 | | | |
| GEV No. | 510514 | Ref. No. | 116009 |
| description | pump cover pump type T110 | | |

pump cover gaskets



| | | | |
|--------------------|--|-----------------|--------|
| 1 | | | |
| GEV No. | 513283 | Ref. No. | 437082 |
| description | gasket | | |
| For models: | 913289, 913290, 913356, 913372, 913373, 913544, 913665, 913667, 913771, 913772, 913832, 913837, 914165, 914166, 914206, 914355, 914386, 914387, 914388, 914389, 914390, 914391, 914692, 914693, 914694, 914703, 914870, 915686, 915687, 915688, 915689, 915690, 915691, 916237, 916238, 916239, 916240, 916241, 916401, 916402, 916403, 916404, 916787, E.35, E.35-Elettrobar, E.35H, E.35H-Elettrobar, Fast130, FAST-135, Fast135-2...(Other models you can see in the webshop) | | |



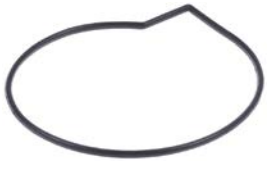

1

| | | | |
|--------------------|---|-----------------|--------|
| GEV No. | 524535 | Ref. No. | 929180 |
| description | pump cover gasket thickness 4.5x4.5mm ID ø 182mm Qty 1 pcs | | |
| For models: | KLP201DDDTEB, KLP201EB, KLP301, KLP301DDDTEB, LP201DDDTEB, LP201EB, LP301, LP301EB, RIVER-297, RIVER-298, RV297, RV298, RV298HZ, U132, U132E, U70, U70e | | |



1

| | | | |
|---|--|-----------------|-----------------------|
| GEV No. | 521081 | Ref. No. | 80199 |
| description | pump cover gasket thickness 4mm Qty 1 pcs | | |
| For models: | Niagara-283A, River-285, RV282R, SV72AEB | | |
| spare parts for | 521081 | | |
|  | GEV No. | 499281 | Ref. No. 80134 |
| | pump inlet ø 60mm outlet ø 50mm type 4298.1404 230V 50Hz 1 phase 1.1kW L 210mm rotation direction right capacitor 12.5µF FIR | | |



1

| | | | |
|--------------------|--|-----------------|-------|
| GEV No. | 365014 | Ref. No. | 80191 |
| description | operating capacitor capacity 12.5µF 450V tolerance 5%Hz ambient temperature max. -25 to +85°C ø 35mm L 70mm M8 plastic connection male faston 6.3mm 45S.C3DS.12.5 protection | | |
| For models: | Niagara-283A, RIVER-282, River-285, RV282DD, RV282R, SV72AEB | | |



1

| | | | |
|--------------------|---|-----------------|-------|
| GEV No. | 365020 | Ref. No. | 73055 |
| description | operating capacitor capacity 14µF 400V tolerance 5%Hz ambient temperature max. -25 to +85°C ø 35mm L 70mm M8 plastic connection male faston 6.3mm protection | | |
| For models: | NG381DDPS, NG381DDPSHZ23, Niagara-381-230V-3Ph-60Hz, Niagara-381DP, River-282-2, River-285, River-382, River-382-230V-3Ph-50Hz, River-382H, River-382NRG, River-382NRG-230-3Ph-50Hz, RV382, RV38223TERMO, RV382AHP, RV382FUR, RV382R, RV382R23TERMO, RV382RFUR, RV382TERMO, RV382TX, RV382TXR | | |

condensators & interference suppression filters

operating capacitors

plastic



1

| | | | |
|--------------------|---|-----------------|-------|
| GEV No. | 365209 | Ref. No. | 70536 |
| description | operating capacitor capacity 1.5µF 420V ø 25mm L 70mm M8 connection F6.3 | | |
| For models: | River-285, River-382LNRG, River-382NRG, River-382NRG-230-3Ph-50Hz, RV282R, RV382LR, RV382LTXR, RV382R, RV382R23TERMO, RV382RFUR, RV382TXR | | |



1

| | | | |
|--------------------|--|-----------------|--------|
| GEV No. | 365021 | Ref. No. | 206004 |
| description | operating capacitor capacity 16µF 425V tolerance 5% 50/60Hz ambient temperature max. -25 to +85°C ø 35mm L 73mm single M8 plastic connection male faston 6.3mm 416.10.99 protection | | |
| For models: | 050F, 050FP, 22F, 2312-001, 2312-002, 2312-007, 2312-009-CRP, 40F, 440F, 44F, 46, 460, 500F, 500FD, 50F, 50FD, 510F, 510FD, 913297, 913298, 913299, 913300, 913360, 913361, 913391, 913392, 913546, 913547, 913578, 913611, 913684, 913913, 913914, 913932, 913933, 914100, 914101, 914284, 914318, 914319, 914331, 914338, 914339, 914342, 914343, 914356, 914400, 914401, 914402, 914403...(Other models you can see in the webshop) | | |



1

| | | | |
|--------------------|---|-----------------|--------|
| GEV No. | 365015 | Ref. No. | 206002 |
| description | operating capacitor capacity 10µF 400V tolerance 5%Hz ambient temperature max. -25 to +85°C ø 35.5mm L 59mm M8 plastic connection male faston 6.3mm protection | | |
| For models: | 500F, 500FD, 50F, 50FD, 510F, 510FD, 913297, 913298, 913299, 913300, 913360, 913361, 913391, 913392, 913546, 913547, 913578, 913611, 913684, 913913, 913914, 913932, 913933, 913992, 913993, 914100, 914101, 914284, 914326, 914331, 914339, 914342, 914343, 914356, 914400, 914401, 914402, 914403, 914404, 914405, 914406, 914449, 914517, 914545, 914568, 914624, 914625, 914626, 914627, 914642...(Other models you can see in the webshop) | | |



1

| | | | |
|--------------------|---|-----------------|--------|
| GEV No. | 365019 | Ref. No. | 206005 |
| description | operating capacitor capacity 20µF 400V tolerance 5% 50/60Hz ambient temperature max. -25 to +85°C ø 39.5mm L 70mm M8 plastic connection male faston 6.3mm 16.10.25. protection | | |
| For models: | 10, 440F, 44F, 80, 81, 82, 914326, 914406, 915729, CE78HZ23, CLEAN-100, E.52, E.55, E100, E78, E78HP, Fast181, FAST-181, Fast181-230V-3Ph-60Hz, Fast181-400V-3NPh-60Hz, FAST-63, HM1, LP60, NG271, NG291, NIAGARA-271, NIAGARA-283, NIAGARA-291, R706, R708, RIVER-282, RIVER-294, RIVER-71, RIVER-78, RIVER-80, RIVER-81, RIVER-81-CRP, RIVER-82-CRP, RIVER-E78, RIVER-HL-81, RIVER-HL-82, RV282, RV294, RV71, RV80, RV8023, RV8023HZ, RV80C, RV80HZ, RV81...(Other models you can see in the webshop) | | |



| | | | |
|---|--|-----------------|--------|
|  | | | |
| 1 | | | |
| GEV No. | 365016 | Ref. No. | 206006 |
| description | operating capacitor capacity 31.5µF 400V tolerance 5%Hz ambient temperature max. -25 to +85°C ø 45mm L 95mm M8 plastic connection male faston 6.3mm protection | | |
| For models: | 66, S850, S870 | | |

| | | | |
|---|--|-----------------|--------|
|  | | | |
| 1 | | | |
| GEV No. | 365031 | Ref. No. | 206013 |
| description | operating capacitor capacity 4µF 450V tolerance 5% 50/60Hz ambient temperature max. -25 to +85°C ø 31mm L 58mm M8 plastic connection male faston 6.3mm protection | | |
| For models: | 915611, 915612, 915613, 915614, 915615, 915616, 915617, 915618, 915670, 915671, 915672, 915773, 915774, 915959, 916045, 916066, 916077, 916078, 916196, 916197, 916198, 916199, 916200, 916409, 916410, 916418, 916419, 916591, 916592, 916593, 916594, 916595, 916654, 916877, 916921, 916922, 916992, 916993, Fast145-2, Fast150, Fast160C, Niagara-241, Niagara-241-2, Niagara-341, Ocean360-UK, Pluvia-240, RIVER-242, River-242-2, River-242-2T, River-342C...(Other models you can see in the webshop) | | |

| | | | |
|--|---|-----------------|------------------|
|  | | | |
| 1 | | | |
| GEV No. | 365017 | Ref. No. | 206008 206010 |
| description | operating capacitor capacity 5µF 450V tolerance 5% 50/60Hz ambient temperature max. -25 to +85°C ø 28mm L 54mm M8 plastic connection male faston 6.3mm 16.10.08 protection | | |
| For models: | 11F, 11FD, 11F-DVGW, 11R, 11RD, 350F, 350FD, 350R, 350RD, 35-ELECTRONIC, 35F, 35FD, 35R, 35RD, 67F, 67R, 913289, 913290, 913356, 913363, 913364, 913372, 913373, 913376, 913377, 913544, 913665, 913667, 913771, 913772, 913832, 913837, 914165, 914166, 914206, 914355, 914386, 914387, 914388, 914389, 914390, 914391, 914692, 914693, 914694, 914703, 914870, 915686, 915687, 915688...(Other models you can see in the webshop) | | |

| | | | |
|---|---|-----------------|--------|
|  | | | |
| 1 | | | |
| GEV No. | 365012 | Ref. No. | 206009 |
| description | operating capacitor capacity 6.3µF 450V tolerance 5% 50Hz ambient temperature max. -25 to +85°C ø 30mm L 61mm M8 plastic connection male faston 6.3mm protection | | |
| For models: | 400F, 400FD, 400R, 400RD, 40-ELECTRONIC, 40F, 40FD, 40R, 40RD, 913291, 913292, 913357, 913374, 913375, 913416, 913435, 913545, 913666, 913668, 913685, 913773, 913774, 913911, 913912, 913948, 913950, 913977, 913984, 913990, 913992, 913993, 914214, 914316, 914317, 914392, 914393, 914394, 914395, 914396, 914397, 914441, 914442, 914515, 914516, 914537, 914543, 914547, 914583, 914592, 914612...(Other models you can see in the webshop) | | |

| | | | |
|--|--|-----------------|--------|
|  | | | |
| 1 | | | |
| GEV No. | 365013 | Ref. No. | 206001 |
| description | operating capacitor capacity 8µF 400V tolerance 5%Hz ambient temperature max. -25 to +85°C ø 31.5mm L 55mm M8 plastic connection male faston 6.3mm protection | | |
| For models: | 21F, 21FD, 21R, 21RD, 25F, 25FD, 25R, 25RD, 30F, 30FD, 30R, 30RD, 31F, 31FD, 31R, 31RD, 45, 450, 913418, 914167, 914168, 914398, 914399, 914443, 914943, 915695, 915696, 915819, CLEAN-3, E.45, Fast145, FAST-145, Fast145D, FAST-145D, NIAGARA-45, R495, R497, R499, R501, R503, R505, R507, R509, R511, R704, R706, R708, S621, S623, S624...(Other models you can see in the webshop) | | |

filters

interference suppression filters

| | | | |
|--|--|-----------------|--------|
|  | | | |
| 1 | | | |
| GEV No. | 365047 | Ref. No. | 926144 |
| description | interference suppression filter capacity 0.33µF(X2)+2x0.015µF | | |
| For models: | 913363, 913364, 913376, 913377, CLEAN-100, CLEAN-110, CLEAN-120, CLEAN-160, CLEAN-220, CLEAN-270, CLEAN-271, CLEAN-361, CLEAN-361P, CLEAN-471, CLEAN-471P, E.35, E.35H, E.40, E.40H, E.41, E.42, E.60, E.65, E1, E10, E100, E110, E12, E120, E14, E140, E41, MC-201CL, MINIBAR, NIAGARA-35, NIAGARA-40, RIVER-50, RIVER-61, S280, U132, U61, U61H, U70 | | |

| | | | |
|--|--|-----------------|--------|
|  | | | |
| 1 | | | |
| GEV No. | 365048 | Ref. No. | 212001 |
| description | interference suppression filter type KPB7028 275V 50/60Hz conductor 2 with E connection male faston 6.3mm L 50mm ø 38mm Hmm Wmm M8 aluminium Qty 1 pcs | | |
| For models: | 050F, 050FP, 11F, 11FD, 11F-DVGW, 11R, 11RD, 21F, 21FD, 21R, 21RD, 22F, 22R, 25F, 25FD, 25R, 25RD, 30F, 30FD, 30R, 30RD, 31F, 31FD, 31R, 31RD, 350F, 350FD, 350R, 350RD, 35-ELECTRONIC, 35F, 35FD, 35R, 35RD, 400F, 400FD, 400R, 400RD, 40-ELECTRONIC, 40F, 40FD, 40R, 40RD, 440F, 44F, 45, 450, 46, 460, 500F...(Other models you can see in the webshop) | | |



fuses

fine fuses



1

| | | | |
|--------------------|--|-----------------|--------|
| GEV No. | 358530 | Ref. No. | 926284 |
| description | fine fuse size \varnothing 5x20mm 0.8A fast-acting rated 250V Qty 10 pcs | | |
| For models: | 80, 81, 914380, 914436, CE78HZ23, CGL74CABT, E78, E78HP, FAST-181, HM1, KLP105EB, KLP201DDDTEB, KLP201EB, KLP301, KLP301DDDTEB, LP105DDDTEB, LP105DDDTEBN, LP105EB, LP201DDDTEB, LP201EB, LP301, LP301EB, LP60, PS-60, RIVER-150, River-152, RIVER-154, RIVER-71, RIVER-80, River-81, River-81CRP, RIVER-81-CRP, RIVER-82, River-82CRP, RIVER-82-CRP, RIVER-E78, RIVER-HL-81, RV150, RV15023, RV15023DA, RV150D, RV150DA, RV150DAR, RV150DARY, RV150DAW, RV150DAWY, RV150DAY, RV150DE, RV150DRW, RV150DW...(Other models you can see in the webshop) | | |



2

| | | | |
|--------------------|--|-----------------|------------------|
| GEV No. | 358677 | Ref. No. | 228004 228010 |
| description | fine fuse size \varnothing 5x20mm 4A fast-acting rated 250V Qty 10 pcs | | |
| For models: | 2312-007, 2312-009-CRP, 80, 81, 82, 913363, 913364, 913911, 913912, 913913, 913914, 913950, 913977, 913984, 913990, 913992, 913993, 914100, 914101, 914165, 914166, 914167, 914168, 914206, 914214, 914284, 914316, 914317, 914318, 914319, 914338, 914339, 914342, 914343, 914355, 914356, 914380, 914431, 914436, 914516, 914543, 914583, 914592, 914612, 914613, 914624, 914625, 914626, 914627, 914628...(Other models you can see in the webshop) | | |



1

| | | | |
|--------------------|---|-----------------|-------|
| GEV No. | 358693 | Ref. No. | 80874 |
| description | fine fuse size \varnothing 5x20mm 2A medium lag rated 250V Qty 10 pcs | | |
| For models: | RIVER-298, RV298, RV298HZ | | |



1

| | | | |
|--------------------|---|-----------------|--------|
| GEV No. | 358594 | Ref. No. | 228012 |
| description | fine fuse size \varnothing 5x20mm 0.16A slow-acting rated 250V Qty 10 pcs | | |
| For models: | 915154, 915155, 915157, 915158, 915172, 915173, 915285, 915422, 915492, 915493, 915494, 915495, 915496, 915497, 915747, 916045, 916054, 916067, 916068, 916069, 916079, 916080, 916368, 916420, 916421, 916422, 916423, 916424, 916654, 916686, 916760, Fast160C, Fast200, FAST-200, Fast93, GL280EB, GL280EB23, GL280EB23DAR, GL280EB23HZ, GL280EB23HZDY, GL280EBD, GL280EBDA, GL280EBDAE, GL280EBDAR, GL280EBDARY, GL280EBDAW, GL280EBDAWY, GL280EBDAY, GL280EBDB, GL280EBDBR...(Other models you can see in the webshop) | | |



1

| | | | |
|--------------------|---|-----------------|--------|
| GEV No. | 358603 | Ref. No. | 228011 |
| description | fine fuse size \varnothing 5x20mm 2A slow-acting rated 250V Qty 10 pcs | | |
| For models: | 915154, 915155, 915157, 915158, 915172, 915173, 915285, 915422, 915492, 915493, 915494, 915495, 915496, 915497, 915747, 916045, 916054, 916067, 916068, 916069, 916079, 916080, 916368, 916420, 916421, 916422, 916423, 916424, 916654, 916686, 916760, Fast160C, Fast200, FAST-200, Fast93, GL280EB, GL280EB23, GL280EB23DAR, GL280EB23HZ, GL280EB23HZDY, GL280EBD, GL280EBDA, GL280EBDAE, GL280EBDAR, GL280EBDARY, GL280EBDAW, GL280EBDAWY, GL280EBDAY, GL280EBDB, GL280EBDBR...(Other models you can see in the webshop) | | |



1

| | | | |
|--------------------|---|-----------------|--------|
| GEV No. | 358606 | Ref. No. | 228014 |
| description | fine fuse size \varnothing 5x20mm 4A slow-acting rated 250V Qty 10 pcs | | |
| For models: | 916237, 916238, 916239, 916240, 916241, 916242, 916243, 916244, 916245, 916246, 916401, 916402, 916403, 916404, 916405, 916406, 916407, 916408, 916451, 916583, 916687, 916787, 916991, 917042, 917043, Clean140, Clean140S, Fast130, Fast135-2, Fast135-2S, Fast135H-2, Fast135H-2S, Fast139-2, Fast139-2S, Fast139H-2, Fast139H-2S, Fast140 | | |



1

| | | | |
|--------------------|--|-----------------|--------|
| GEV No. | 358760 | Ref. No. | 926283 |
| description | fine fuse size \varnothing 6.3x32mm 0.315A medium lag rated 250V Qty 10 pcs | | |
| For models: | 80, 81, 914380, 914436, CE78HZ23, CGL74CABT, E78, E78HP, FAST-181, HM1, KLP105EB, KLP201DDDTEB, KLP201EB, KLP301, KLP301DDDTEB, LP105DDDTEB, LP105DDDTEBN, LP105EB, LP201DDDTEB, LP201EB, LP301, LP301EB, LP60, PS-60, RIVER-150, River-152, RIVER-154, RIVER-71, RIVER-80, River-81, River-81CRP, RIVER-81-CRP, RIVER-82, River-82CRP, RIVER-82-CRP, RIVER-E78, RIVER-HL-81, RV150, RV15023, RV15023DA, RV150D, RV150DA, RV150DAR, RV150DARY, RV150DAW, RV150DAWY, RV150DAY, RV150DE, RV150DRW, RV150DW...(Other models you can see in the webshop) | | |

fine fuse holders





1

| | | | |
|--------------------|--|-----------------|--------|
| GEV No. | 551234 | Ref. No. | 210010 |
| description | fuse holder suitable fuse \varnothing 5x20mm 1-pole 6.3A rated 600V L 52mm W 8mm H 51mm connection screw clamp cross section 4mm ² | | |
| For models: | 913913, 913914, 913992, 913993, 914100, 914101, 914167, 914168, 914284, 914318, 914319, 914338, 914356, 914431, 914583, 914592, 914612, 914613, 914624, 914625, 914627, 914628, 914642, 914850, 914851, 914854, 914909, 914943, 914944, 915136, 915137, 915143, 915150, 915151, 915152, 915160, 915161, 915162, 915166, 915167, 915168, 915175, 915176, 915177, 915319, 915338, 915341, 915348, 915418, 915419...(Other models you can see in the webshop) | | |

electric components

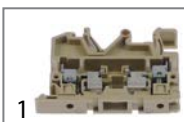



| | | | |
|--|--|-----------------|----------|
|  | | | |
| GEV No. | 550499 | Ref. No. | H.228047 |
| description | fuse holder suitable fuse ϕ 5x20mm 6.3A rated 500V | | |
| For models: | 2312-007, 2312-009-CRP, 80, 81, 82, 913911, 913912, 913950, 913977, 913984, 913990, 914165, 914166, 914206, 914214, 914316, 914317, 914339, 914342, 914343, 914355, 914380, 914436, 914516, 914543, 914626, 914684, 914874, 915138, A3EB, A3EBD, A3EBDAKRKYK, A3EB-DAKWK, A3EBDBKWK, A3EBDRKYK, A3EBDWK, A3EBDYK, A3EBSAK, A3EBSAKRK, A3EBSAKWK, A3EBSBKWKYK, A3EBSEKWK, A3EBSWK, A4EB, A4EBD, A4EBDAKEKYK, A4EBDAKRK, A4EBDAKWK, A4EBDAKZK, A4EBDBKRK...(Other models you can see in the webshop) | | |

| | | | |
|--|--|-----------------|----------|
|  | | | |
| GEV No. | 550519 | Ref. No. | H.228048 |
| description | cover plate suitable fuseA ratedV connection for fuse holder | | |
| For models: | 2312-007, 2312-009-CRP, 80, 81, 82, 913911, 913912, 913950, 913977, 913984, 913990, 914165, 914166, 914206, 914214, 914316, 914317, 914339, 914342, 914343, 914355, 914380, 914436, 914516, 914543, 914626, 914684, 914874, 915138, CE78HZ23, CGL74CABT, CNT800CH, E78, E78HP, Fast180, Fast180-230V-3Ph-60Hz, Fast181, FAST-181, Fast181-230V-3Ph-60Hz, Fast181-400V-3NPh-60Hz, Fast200, FAST-200, FAST-60, FAST-73, Fast93, GL280EB, GL280EB23, GL280EB23DAR, GL280EB23HZ, GL280EB23HZDY...(Other models you can see in the webshop) | | |

| | | | |
|--|---|-----------------|-----------------|
|  | | | |
| GEV No. | 403250 | Ref. No. | 80933 926272 |
| description | ribbon cable 10-pole L 3000mm plug type coded 2 row plug: number of poles 10 | | |
| For models: | 80, 81, 82, 914380, 914436, KLP105EB, KLP201DDDTTEB, KLP201EB, KLP301DDDTTEB, LP105DDDTTEB, LP105DDDTTEBN, LP105EB, LP201DDDTTEB, LP201EB, LP301EB, LP60, NG271, NG281, NG281CDD, NG281HP, NG281HPDD, NG281HZ23, NG281HZ23DD, NG291, NG381, NG38123, NG38123TERMO, NG381C, NG381CDD, NG381CFUR, NG381DDHZ23, NG381DDPS, NG381DDPSHZ23, NG381HPDD, NG381L, NG381LC, NG381LCFUR, NG381LDDPS, NG381TERMO, NG381TXCDD, NIAGARA-271, NIAGARA-281, Niagara-281-2, Niagara-281HP, NIAGARA-283, Niagara-283A, Niagara-283L-2, NIAGARA-291, Niagara-381, Niagara-381-230V-3Ph-50Hz...(Other models you can see in the webshop) | | |

| | | | |
|--|---|-----------------|--------|
|  | | | |
| GEV No. | 402927 | Ref. No. | 211011 |
| description | ribbon cable 10-pole L 500mm plug type FC-10P raster size 2.54mm | | |
| For models: | 913992, 913993, 914583, 914592, 914612, 914613, 915143, RIVER-40, RIVER-40-CRP, RIVER-43, RIVER-44, RIVER-44-CRP, River-44-CRP-ST, RIVER-44CRP-ST | | |

| | | | |
|--|---|-----------------|--------------------------|
|  | | | |
| GEV No. | 400902 | Ref. No. | 80934 926281 DWS90 |
| description | ribbon cable 10-pole L 750mm plug type FC-10P raster size 2.54mm | | |
| For models: | 915747, CNT800CH, Fast180, Fast180-230V-3Ph-60Hz, Fast181, Fast200, FAST-200, Fast93, GL280EB, GL280EB23, GL280EB23DAR, GL280EB23HZ, GL280EB23HZDY, GL280EBD, GL280EBDA, GL280EB-DAE, GL280EBDAR, GL280EBDARY, GL280EBDAW, GL280EBDAWY, GL280EBDAY, GL280EBDB, GL280EBDBR, GL280EBDBW, GL280EBDWY, GL280EBDY, GL280EBS, GL280EBSA, GL280EBSAE, GL280EBSAEW, GL280EBSAEWY, GL280EBSAR, GL280EBSARY, GL280EBSAW, GL280EBSAWY, GL280EBSAY, GL280EBSB, GL280EBSR, GL280EBSWY, GL280EBSY, GL282EB, GL282EB93, GL282EB93DA, GL282EB93HZ23, GL282EBCH, GL282EBCHD, GL282EBD, GL282EBDA, GL282EBDAE, GL282EBDAR...(Other models you can see in the webshop) | | |

| | | | |
|--|---|-----------------|--------|
|  | | | |
| GEV No. | 403451 | Ref. No. | 211017 |
| description | ribbon cable L 2100mm Qty 1m | | |
| For models: | 915611, 915612, 915613, 915614, 915615, 915616, 915617, 915618, 915670, 915671, 915672, 915773, 915774, 915959, 916066, 916077, 916078, 916181, 916183, 916184, 916185, 916196, 916197, 916198, 916199, 916200, 916409, 916410, 916418, 916419, 916591, 916592, 916593, 916594, 916595, 916751, 916877, NIAGARA-241, Niagara-241-2, Niagara-341, Ocean340, Pluvia-240, River-242, River-242-2, River-242-2T, River-342C, River-342T | | |

electric accessories

cables

ribbon cables

group 1

| | | | |
|--|--|-----------------|-------|
|  | | | |
| GEV No. | 402970 | Ref. No. | 41523 |
| description | ribbon cable 10-pole L 1200mm plug type 2 row coded Qty 1m | | |
| For models: | KLP301, LP301 | | |

| | | | |
|--|---|-----------------|--------|
|  | | | |
| GEV No. | 400903 | Ref. No. | 211009 |
| description | ribbon cable 10-pole L 2290mm plug type FC-10P raster size 2.54mm | | |
| For models: | 050F, 050FP, 2312-007, 2312-009-CRP, 913911, 913912, 913913, 913914, 913950, 913977, 913984, 913990, 914100, 914101, 914165, 914166, 914167, 914168, 914206, 914214, 914284, 914316, 914317, 914318, 914319, 914338, 914339, 914342, 914343, 914355, 914356, 914431, 914516, 914543, 914624, 914625, 914626, 914627, 914628, 914642, 914684, 914850, 914851, 914854, 914874, 914909, 914943, 914944, 915136, 915137...(Other models you can see in the webshop) | | |



| | | | |
|--|--|-----------------|--------|
|  | | | |
| GEV No. | 403450 | Ref. No. | 211013 |
| description | ribbon cable 10-pole L 2300mm warewashing Qty 1 pcs | | |
| For models: | 915150, 915151, 915152, 915154, 915155, 915158, 915160, 915161, 915162, 915166, 915167, 915168, 915172, 915173, 915175, 915285, 915319, 915348, 915420, 915421, 915422, 915479, 915492, 915493, 915496, 915497, 915547, 915558, 915635, 915663, 915747, 916020, 916021, 916024, 916025, 916026, 916027, 916030, 916031, 916045, 916054, 916068, 916069, 916080, 916201, 916202, 916203, 916204, 916205, 916206...(Other models you can see in the webshop) | | |







plug connectors



| | | | |
|---|--|-----------------|-----|
|  | | | |
| GEV No. | 551395 | Ref. No. | CN6 |
| description | female bullet ø 2.5mm CuZn gal Sn Qty 1 pcs suitable for CN2, CN3, CN4 | | |
| For models: | 2312-007, 913911, 913912, 913913, 913914, 913950, 913977, 913984, 913990, 913992, 913993, 914100, 914101, 914165, 914166, 914167, 914168, 914206, 914214, 914284, 914316, 914317, 914318, 914319, 914338, 914339, 914342, 914343, 914355, 914356, 914431, 914516, 914543, 914583, 914592, 914612, 914613, 914624, 914625, 914626, 914627, 914628, 914642, 914684, 914850, 914851, 914854, 914874, 914909, 914943...(Other models you can see in the webshop) | | |

| | | | |
|---|--|-----------------|-----|
|  | | | |
| GEV No. | 551394 | Ref. No. | CN7 |
| description | female bullet ø 2.8mm CuZn gal Sn Qty 1 pcs suitable for CN5 | | |
| For models: | 2312-007, 913911, 913912, 913913, 913914, 913950, 913977, 913984, 913990, 913992, 913993, 914100, 914101, 914165, 914166, 914167, 914168, 914206, 914214, 914284, 914316, 914317, 914318, 914319, 914338, 914339, 914342, 914343, 914355, 914356, 914431, 914516, 914543, 914583, 914592, 914612, 914613, 914624, 914625, 914626, 914627, 914628, 914642, 914684, 914850, 914851, 914854, 914874, 914909, 914943...(Other models you can see in the webshop) | | |

| | | | |
|---|--|--|-----------------|
|  | | | |
| GEV No. | 400761 | Ref. No. | CN5 |
| description | plug connector 5-pole | | |
| For models: | 2312-007, 913911, 913912, 913913, 913914, 913950, 913977, 913984, 913990, 913992, 913993, 914100, 914101, 914165, 914166, 914167, 914168, 914206, 914214, 914284, 914316, 914317, 914318, 914319, 914338, 914339, 914342, 914343, 914355, 914356, 914431, 914516, 914543, 914583, 914592, 914612, 914613, 914624, 914625, 914626, 914627, 914628, 914642, 914684, 914850, 914851, 914854, 914874, 914909, 914943...(Other models you can see in the webshop) | | |
| accessories for | 400761 | | |
| | GEV No. | 550048 | Ref. No. |
|  | | | — |
| | | female bullet | |
| | GEV No. | 551394 | Ref. No. |
|  | | | CN7 |
| | | female bullet ø 2.8mm CuZn gal Sn Qty 1 pcs suitable for CN5 | |

| | | | |
|---|--|--|-----------------|
|  | | | |
| GEV No. | 403854 | Ref. No. | CN3 |
| description | plug connector 5-pole raster size 5mm | | |
| For models: | 2312-007, 913911, 913912, 913913, 913914, 913950, 913977, 913984, 913990, 913992, 913993, 914100, 914101, 914165, 914166, 914167, 914168, 914206, 914214, 914284, 914316, 914317, 914318, 914319, 914338, 914339, 914342, 914343, 914355, 914356, 914431, 914516, 914543, 914583, 914592, 914612, 914613, 914624, 914625, 914626, 914627, 914628, 914642, 914684, 914850, 914851, 914854, 914874, 914909, 914943...(Other models you can see in the webshop) | | |
| accessories for | 403854 | | |
| | GEV No. | 551395 | Ref. No. |
|  | | | CN6 |
| | | female bullet ø 2.5mm CuZn gal Sn Qty 1 pcs suitable for CN2, CN3, CN4 | |

| | | | |
|---|--|--|-----------------|
|  | | | |
| GEV No. | 403853 | Ref. No. | CN4 |
| description | plug connector 6-pole raster size 5mm | | |
| For models: | 2312-007, 913911, 913912, 913913, 913914, 913950, 913977, 913984, 913990, 913992, 913993, 914100, 914101, 914165, 914166, 914167, 914168, 914206, 914214, 914284, 914316, 914317, 914318, 914319, 914338, 914339, 914342, 914343, 914355, 914356, 914431, 914516, 914543, 914583, 914592, 914612, 914613, 914624, 914625, 914626, 914627, 914628, 914642, 914684, 914850, 914851, 914854, 914874, 914909, 914943...(Other models you can see in the webshop) | | |
| accessories for | 403853 | | |
| | GEV No. | 551395 | Ref. No. |
|  | | | CN6 |
| | | female bullet ø 2.5mm CuZn gal Sn Qty 1 pcs suitable for CN2, CN3, CN4 | |

| | | | |
|--|--|--|-----------------|
|  | | | |
| GEV No. | 403852 | Ref. No. | CN2 |
| description | plug connector 8-pole raster size 5mm | | |
| For models: | 2312-007, 913911, 913912, 913913, 913914, 913950, 913977, 913984, 913990, 913992, 913993, 914100, 914101, 914165, 914166, 914167, 914168, 914206, 914214, 914284, 914316, 914317, 914318, 914319, 914338, 914339, 914342, 914343, 914355, 914356, 914431, 914516, 914543, 914583, 914592, 914612, 914613, 914624, 914625, 914626, 914627, 914628, 914642, 914684, 914850, 914851, 914854, 914874, 914909, 914943...(Other models you can see in the webshop) | | |
| accessories for | 403852 | | |
| | GEV No. | 551395 | Ref. No. |
|  | | | CN6 |
| | | female bullet ø 2.5mm CuZn gal Sn Qty 1 pcs suitable for CN2, CN3, CN4 | |

terminals

connection terminals with screw/faston connections

| | | | |
|--|--|-----------------|--------|
|  | | | |
| GEV No. | 550278 | Ref. No. | 921044 |
| description | power terminal block 3-pole max. 40A max 400V connection ø6mm ² / F6.3 temp.-resist. 150°C cross section 6mm ² | | |

| | | | |
|--|--|-----------------|--------|
|  | | | |
| GEV No. | 550349 | Ref. No. | 220010 |
| description | power terminal block 4-pole max. 40A max 400V connection ø6mm ² / F6.3 temp.-resist. 150°C cross section 6mm ² | | |
| For models: | 11F, 11FD, 11R, 11RD, 350F, 350FD, 350R, 350RD, 35F, 35FD, 35R, 35RD, 400F, 400FD, 400R, 400RD, 40F, 40FD, 40R, 40RD, 45, 450, 500F, 500FD, 50-ELECTRONIC, 50F, 50FD, 67F, 67R, 913418, 913992, 913993, 914167, 914168, 914398, 914399, 914443, 914583, 914592, 914612, 914613, 914943, 915143, 915611, 915612, 915613, 915614, 915615, 915616, 915617...(Other models you can see in the webshop) | | |



| | | | |
|---|--|-----------------|------------------|
|  | | | |
| 1 | | | |
| GEV No. | 550411 | Ref. No. | 220011 921057 |
| description | power terminal block 6-pole max. 40A max 450V connection $\phi 6\text{mm}^2$ / F6.3 temp.-resist. 150°C cross section 6mm^2 | | |
| For models: | 050F, 050FP, 10, 12, 14, 22F, 2312-001, 2312-002, 2312-007, 2312-009-CRP, 440F, 44F, 46, 460, 500F, 500FD, 50-ELECTRONIC, 50F, 50FD, 510F, 510FD, 80, 81, 82, 913297, 913298, 913299, 913300, 913360, 913361, 913391, 913392, 913546, 913547, 913578, 913611, 913684, 913913, 913914, 913932, 913933, 914100, 914101, 914284, 914318, 914319, 914326, 914331, 914338, 914339...(Other models you can see in the webshop) | | |

connection boxes

| | | | |
|---|--|-----------------|--------|
|  | | | |
| 1 | | | |
| GEV No. | 550300 | Ref. No. | 459018 |
| description | power terminal block 3-pole contacts P+N+E | | |
| For models: | 913289, 913290, 913291, 913292, 913356, 913357, 913363, 913364, 913372, 913373, 913374, 913375, 913376, 913377, 913416, 913435, 913544, 913545, 913665, 913666, 913667, 913668, 913685, 913771, 913772, 913773, 913774, 913832, 913837, 913911, 913912, 913948, 913950, 913977, 913984, 913990, 914165, 914166, 914206, 914214, 914316, 914317, 914355, 914386, 914387, 914388, 914389, 914390, 914391, 914392...(Other models you can see in the webshop) | | |

rail-mounted terminals

miscellaneous

| | | | |
|---|--|-----------------|--------|
|  | | | |
| 1 | | | |
| GEV No. | 551234 | Ref. No. | 210010 |
| description | fuse holder suitable fuse $\phi 5 \times 20\text{mm}$ 1-pole 6.3A rated 600V L 52mm W 8mm H 51mm connection screw clamp cross section 4mm^2 | | |
| For models: | 913913, 913914, 913992, 913993, 914100, 914101, 914167, 914168, 914284, 914318, 914319, 914338, 914356, 914431, 914583, 914592, 914612, 914613, 914624, 914625, 914627, 914628, 914642, 914850, 914851, 914854, 914909, 914943, 914944, 915136, 915137, 915143, 915150, 915151, 915152, 915160, 915161, 915162, 915166, 915167, 915168, 915175, 915176, 915177, 915319, 915338, 915341, 915348, 915418, 915419...(Other models you can see in the webshop) | | |

| | | | |
|---|--|-----------------|--------|
|  | | | |
| 1 | | | |
| GEV No. | 550996 | Ref. No. | 927115 |
| description | rail-mounted terminal 0.5-4mm ² green/yellow for TS 35 (plastic) | | |
| For models: | 161, 221, 271, 272, 362, A3EB, A3EBD, A3EBDAKRRKYK, A3EBDAKWK, A3EBDBKWK, A3EBDRKYK, A3EBDVK, A3EBDYK, A3EBSAK, A3EBSAKRK, A3EBSAKWK, A3EBSBKWKYK, A3EBSEKWK, A3EBSWK, A4EB, A4EBD, A4EBDAKEKYK, A4EBDAKRRK, A4EBDAKWK, A4EBDAKZK, A4EBDBKRRK, A4EBDPKWKYK, A4EBDRK, A4EBS, A4EBSAK, A4EBSAKCK, A4EBSAKEKYK, A4EBSAKRK, A4EBSAKRKP, A4EBSAKYK, A4EBSCK, A4EBT, A4EBTSAK, A5EB, A5EBD, A5EBDAKPKWK, A5EBDAKWK, A5EBDAKYK, A5EBDRK, A5EBS, A5EBSAKPKWK, A5EBSAKRK, A5EBSAKRKYK, A5EBSAKWK, A5EBSAKWKYK...(Other models you can see in the webshop) | | |

gas thermostats

SIT

710 Minisit series









| | | | |
|---|---|-----------------|--|
|  | | | |
| 1 | | | |
| GEV No. | 101131 | Ref. No. | 611001 |
| description | gas thermostat without cap, button and angle SIT type MINISIT 710 t.max. 190°C 50-190°C gas inlet 1/2" gas outlet 3/8" thermocouple connection M9x1 pilot connection M10x1 probe $\phi 5\text{mm}$ probe L 98mm capillary pipe 1200mm probe type type A2 pressure controller no pressure regulator mbar gland nut | | |
| For models: | 367, 368, 373, 374, MG15, MG20, MG30, MG40 | | |
| spare parts for | 101131 | | |
|  | GEV No. | 101053 | Ref. No. |
| | | | — |
| | | | magnet unit T1: M9x1 T2: M24x1 L 45mm $\phi 17\text{mm}$ suitable for Minisit |
|  | GEV No. | 102103 | Ref. No. |
| | | | — |
| | | | probe 60-200°C probe $\phi 5\text{mm}$ probe L 98mm capillary pipe 1050mm t.max. 200°C fryer probe type type A2 suitable for MINISIT 710 |
| accessories for | 101131 | | |
|  | GEV No. | 100809 | Ref. No. |
| | | | — |
| | | | O-ring EPDM thickness 2mm ID $\phi 21\text{mm}$ Qty 1 pcs |
|  | GEV No. | 100820 | Ref. No. |
| | | | — |
| | | | gland duct ET M14x1.5 IT M10x0.75 probe ϕ max. 6.5mm WS 22 |
|  | GEV No. | 100904 | Ref. No. |
| | | | — |
| | | | locking screw M10x1 for pipe $\phi 4\text{mm}$ Qty 1 pcs |
|  | GEV No. | 100905 | Ref. No. |
| | | | — |
| | | | locking screw M10x1 for pipe $\phi 6\text{mm}$ Qty 1 pcs |
|  | GEV No. | 101054 | Ref. No. |
| | | | — |
| | | | magnet unit T1: M10x1 T2: M24x1 L 45mm $\phi 17\text{mm}$ suitable for Minisit |



Table continues overleaf



| accessories for | | 101131 | |
|---|---------|--------|-----------------|
|  | GEV No. | 101136 | Ref. No. 611002 |
| piezoelectric igniter suitable for Minisit with cover cap ømm connection F6.3x0.8 | | | |
|  | GEV No. | 101137 | Ref. No. — |
| cover cap without piezoelectric igniter | | | |
|  | GEV No. | 101267 | Ref. No. — |
| reducer IT 3/8" ET 1/2" L 21mm | | | |
|  | GEV No. | 101268 | Ref. No. — |
| gas connection thread 3/8" angled with O-ring MINISIT 710 | | | |
|  | GEV No. | 101269 | Ref. No. — |
| gas connection thread 1/2" angled with O-ring MINISIT 710 | | | |
|  | GEV No. | 101270 | Ref. No. — |
| screw connection IT 3/8" ET 3/8" L 28mm | | | |
|  | GEV No. | 101272 | Ref. No. — |
| screw connection IT 1/2" ET 3/8" L 57mm | | | |
|  | GEV No. | 101273 | Ref. No. — |
| olive for pipe ø 12mm L 9.5mm brass Qty 1 pcs suitable for universal | | | |
|  | GEV No. | 101274 | Ref. No. — |
| olive for pipe ø 16mm Qty 1 pcs | | | |
|  | GEV No. | 101275 | Ref. No. — |
| union screw thread 1/2" for pipe ø 16mm Qty 1 pcs | | | |
|  | GEV No. | 101276 | Ref. No. — |
| union screw thread 3/8" tube ø 12mm Qty 1 pcs | | | |
|  | GEV No. | 110068 | Ref. No. 447060 |
| knob suitable for Minisit ø 37mm | | | |

accessories

probes

| | | | |
|--|---------|----------|------------|
|  | 1 | | |
| GEV No. | 102118 | Ref. No. | RIC0001008 |
| description probe 110-190°C probe ø 6mm probe L 102mm capillary pipe 1050mm t.max. 190°C fryer probe type type A3 suitable for MINISIT 710 | | | |
| For models: MG15, MG20 | | | |
| accessories for 102118 | | | |
|  | GEV No. | 100820 | Ref. No. — |
| gland duct ET M14x1.5 IT M10x0.75 probe ø max. 6.5mm WS 22 | | | |

ignition parts



pilot burners

producer-specific pilot burners

ELETTROBAR

| | | | |
|--|--------|----------|--------|
|  | 1 | | |
| GEV No. | 100192 | Ref. No. | 611003 |
| description pilot burner SIT type 160 series 2 flames nozzle ømm gas connectionmm without nozzle | | | |
| For models: 367, 368, 373, 374, MG15, MG20, MG30, MG40 | | | |

electrodes

| | | | |
|---|---------|----------|------------|
|  | 1 | | |
| GEV No. | 100701 | Ref. No. | 611006 |
| description ignition electrode connection M4 Qty 1 pcs | | | |
| For models: 367, 368, 373, 374, MG15, MG20, MG30, MG40 | | | |
| accessories for 100701 | | | |
|  | GEV No. | 100906 | Ref. No. — |
| screw connection thread M10x1 for ignition electrode brass Qty 1 pcs WS 10 | | | |

ignition cables

pre-assembled cables

| | | | |
|--|--------|----------|--------|
|  | 1 | | |
| GEV No. | 100026 | Ref. No. | 611007 |
| description ignition cable cable length 1000mm connection ø4mm / F6.3mm | | | |
| For models: 367, 368, 373, 374, MG15, MG20, MG30, MG40 | | | |

piezoelectric igniters

miscellaneous



| | | | |
|---|---|-----------------|-------------------|
| GEV No. | nla ¹ | Ref. No. | 611002 |
| description | piezoelectric igniter suitable for Minisit with cover cap ømm connection F6.3x0.8 | | |
| For models: | 367, 368, 373, 374, MG15, MG20, MG30, MG40 | | |
| spare parts for | 101136 | | |
|  | GEV No. | 100001 | Ref. No. — |
| | piezoelectric igniter suitable for Minisit connection F6.3x0.8 ømm | | |

¹no longer available

thermocouples

plug-in thermocouples

plug-in thermocouples with interruption

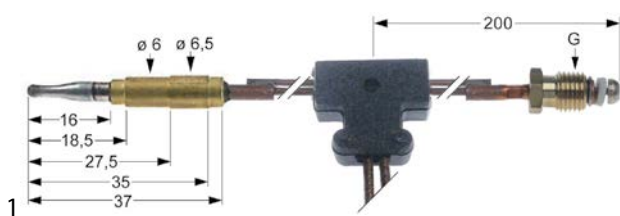

| | | | |
|--------------------|--|-----------------|--------|
| GEV No. | 102925 | Ref. No. | 611005 |
| description | thermocouple with interrupter M9x1 L 750mm plug connection ø6.0(6.5)mm F 6.3mm | | |
| For models: | 367, 368, 373, 374, MG15, MG20, MG30, MG40 | | |

accessories

interrupters



| | | | |
|--------------------|--|-----------------|--------|
| GEV No. | 101265 | Ref. No. | 468068 |
| description | interrupter thread M9x1 | | |
| For models: | 367, 368, 373, 374, MG15, MG20, MG30, MG40 | | |

gas nozzles

main nozzles

gas nozzles M10x0.75



| | | | |
|--------------------|--|-----------------|--------|
| GEV No. | 106796 | Ref. No. | 611026 |
| description | gas injector thread M10x0.75 WS 10 bore ø 1.75mm | | |
| For models: | 367, 368, 373, 374, MG15, MG20, MG30, MG40 | | |

pilot burner nozzles

pilot burner nozzles SIT

160 series



| | | | |
|--------------------|---|-----------------|--------|
| GEV No. | 107650 | Ref. No. | 611008 |
| description | pilot burner nozzle SIT LPG code 30 Qty 1 pcs | | |
| For models: | 367, 368, 373, 374, MG15, MG20, MG30, MG40 | | |



auxiliary gas parts

screw connections

olives



| | | | |
|--------------------|---------------------------------|-----------------|------------|
| GEV No. | 101278 | Ref. No. | RTCU900012 |
| description | olive for pipe ø 10mm Qty 1 pcs | | |
| For models: | MG15, MG20 | | |

| | | | |
|---|---------------------------------------|--------|----------------------------|
| accessories for | 101278 | | |
|  | GEV No. | 100943 | Ref. No. — |
| | union nut thread M17x1 tube ø 10mm | | |
|  | GEV No. | 101300 | Ref. No. — |
| | union nut thread M16x1.5 tube ø 10mm | | |
|  | GEV No. | 101478 | Ref. No. RTCU900013 |
| | union nut thread 3/8" for pipe ø 10mm | | |

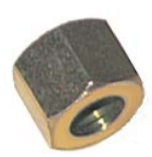

| union nuts | | | |
|---|---------------------------------------|-----------------|------------|
|  | | | |
| 1 | | | |
| GEV No. | 101478 | Ref. No. | RTCU900013 |
| description | union nut thread 3/8" for pipe ø 10mm | | |
| For models: | MG15, MG20 | | |

| pipes | | | |
|---|---------------------------------------|-----------------|------------|
| union nuts | | | |
|  | | | |
| 1 | | | |
| GEV No. | 101478 | Ref. No. | RTCU900013 |
| description | union nut thread 3/8" for pipe ø 10mm | | |
| For models: | MG15, MG20 | | |

equipment-specific units

for vegetable slicers

| miscellaneous | | | |
|---|---|-----------------|--------|
|  | | | |
| 1 | | | |
| GEV No. | 699128 | Ref. No. | 927095 |
| description | shaft sealing ED ø 40mm ID ø 30mm H 7mm plastic for vegetable slicer | | |
| For models: | 161, 221, 271, 272, 362, CLEAN-160, CLEAN-161, CLEAN-220, CLEAN-221, CLEAN-270, CLEAN-271, CLEAN-272, CLEAN-361, CLEAN-361P, CLEAN-362, CLEAN-471, CLEAN-471P | | |

for dishwashers

| containers | | | |
|---|---|-----------------|--------|
| container lids | | | |
|  | | | |
| 1 | | | |
| GEV No. | 518073 | Ref. No. | 480023 |
| description | container lid | | |
| For models: | 11F, 11FD, 11F-DVGW, 11R, 11RD, 22F, 22R, 40F, 440F, 44F, 913992, 913993, CLEAN-3, E.52, RIVER-40, RIVER-43, S651, S654, S810, S815, S830, S835 | | |

for espresso machines

| brewing units | | | |
|---|---|-----------------|--------|
| filter holder gaskets | | | |
| O-rings | | | |
|  | | | |
| 1 | | | |
| GEV No. | 510409 | Ref. No. | 929046 |
| description | O-ring EPDM thickness 5.34mm ID ø 56.52mm Qty 1 pcs | | |
| For models: | 161, 221, 271, 272, 362, 55, CLEAN-160, CLEAN-161, CLEAN-220, CLEAN-221, CLEAN-270, CLEAN-271, CLEAN-272, CLEAN-361, CLEAN-361P, CLEAN-362, CLEAN-471, CLEAN-471P | | |

| | | | |
|---|--|-----------------|--------|
|  | | | |
| 1 | | | |
| GEV No. | 510109 | Ref. No. | 480006 |
| description | lid for salt tank | | |
| For models: | 11F, 11FD, 11R, 11RD, 21F, 21FD, 21R, 21RD, 2312-007, 2312-009-CRP, 25F, 25FD, 25R, 25RD, 30F, 30FD, 30R, 30RD, 31F, 31FD, 31R, 31RD, 913363, 913364, 913376, 913377, 913992, 913993, 914100, 914101, 914339, 914342, 914343, 914583, 914592, 914612, 914613, 914624, 914625, 914626, 914627, 914628, 914850, 914851, 914854, 914944, 915143, E.41, E.42, E.41...(Other models you can see in the webshop) | | |

| steam/water taps | | | |
|---|--|-----------------|--------|
| steam/water pipes | | | |
| accessories | | | |
| gaskets | | | |
|  | | | |
| 1 | | | |
| GEV No. | 510893 | Ref. No. | 456015 |
| description | O-ring EPDM thickness 2.62mm ID ø 9.92mm Qty 1 pcs | | |
| For models: | 050F, 050FP, 2312-001, 2312-002, 31F, 31FD, 31R, 31RD, 500F, 500FD, 50F, 50FD, 510F, 510FD, 67F, 67R, 913297, 913298, 913299, 913300, 913360, 913361, 913363, 913364, 913376, 913377, 913391, 913392, 913418, 913546, 913547, 913578, 913611, 913684, 913913, 913914, 913932, 913933, 914167, 914168, 914284, 914318, 914319, 914326, 914331, 914338, 914356, 914398, 914399, 914400...(Other models you can see in the webshop) | | |

| | | | |
|--|---|-----------------|--------|
|  | | | |
| 1 | | | |
| GEV No. | 510110 | Ref. No. | 429012 |
| description | lid for salt tank | | |
| For models: | 11F, 11FD, 11R, 11RD, 21F, 21FD, 2312-007, 2312-009-CRP, 25F, 25FD, 30F, 30FD, 31F, 31FD, 31R, 31RD, 913363, 913364, 913376, 913377, 913992, 913993, 914100, 914101, 914339, 914342, 914343, 914583, 914592, 914612, 914613, 914624, 914625, 914626, 914627, 914628, 914850, 914851, 914854, 914944, 915143, E.41, E.42, E.41, R501, R503, R505, R507, R509, R511...(Other models you can see in the webshop) | | |

dosing containers



| | | | |
|---|--|-----------------|------------------------|
| GEV No. | 510019 | Ref. No. | 114997 |
| description | rinse aid container | | |
| For models: | 22F, 22R, 40F, 440F, 44F, E.52, S651, S654, S810, S815, S830, S835 | | |
| spare parts for | 510019 | | |
|  | GEV No. | 518073 | Ref. No. 480023 |
| | container lid | | |

salt tanks













| | | | |
|---|---|-----------------|-------------------|
| GEV No. | 524177 | Ref. No. | 480005 |
| description | lid ø 69mm H 20mm for salt tank ID ø 50mm | | |
| For models: | 050F, 050FP, 11F, 11FD, 11R, 11RD, 21F, 21FD, 21R, 21RD, 2312-001, 2312-002, 2312-007, 25F, 25FD, 25R, 25RD, 30F, 30FD, 30R, 30RD, 31F, 31FD, 31R, 31RD, 350R, 350RD, 35-ELECTRONIC, 35R, 35RD, 400F, 400FD, 400R, 400RD, 40-ELECTRONIC, 40F, 40FD, 40R, 40RD, 45, 450, 46, 460, 500F, 500FD, 50-ELECTRONIC, 50F, 50FD, 510F, 510FD...(Other models you can see in the webshop) | | |
| accessories for | 524177 | | |
|  | GEV No. | 524148 | Ref. No. — |
| | O-ring EPDM thickness 3.53mm ID ø 40.86mm Qty 1 pcs | | |



| | | | |
|--------------------|---|-----------------|--------|
| GEV No. | 510018 | Ref. No. | 429011 |
| description | nut ø 92mm H 10.5mm for salt tank ID ø 64mm | | |
| For models: | 050F, 050FP, 11F, 11FD, 21F, 21FD, 21R, 21RD, 2312-001, 2312-002, 2312-007, 25F, 25FD, 25R, 25RD, 30F, 30FD, 30R, 30RD, 31F, 31FD, 31R, 31RD, 350F, 350FD, 350R, 350RD, 35-ELECTRONIC, 35F, 35FD, 35R, 35RD, 400F, 400FD, 400R, 400RD, 40-ELECTRONIC, 40F, 40FD, 40R, 40RD, 45, 450, 46, 460, 500F, 500FD, 50-ELECTRONIC, 50F, 50FD...(Other models you can see in the webshop) | | |



| | | | |
|---|--|-----------------|------------------------|
| GEV No. | 510929 | Ref. No. | 406999 |
| description | salt tank ø 120mm H 117mm hose ø 10mm mounting ø 70mm overall height 157mm | | |
| For models: | R495, R497, R499, R501, R503, R505, R507, R509, R511, R704, R706, R708, S621, S623, S624, S626, S631, S633, S634, S636, S641, S643, S651, S651P, S653, S654, S655, S810, S815, S830, S835, S850, S870, S950, SR651 | | |
| spare parts for | 510929 | | |
|  | GEV No. | 506015 | Ref. No. 456052 |
| | O-ring EPDM thickness 3.53mm ID ø 39.69mm Qty 1 pcs | | |
|  | GEV No. | 510018 | Ref. No. 429011 |
| | nut ø 92mm H 10.5mm for salt tank ID ø 64mm | | |
|  | GEV No. | 524177 | Ref. No. 480005 |
| | lid ø 69mm H 20mm for salt tank ID ø 50mm | | |
| accessories for | 510929 | | |
|  | GEV No. | 510071 | Ref. No. 437034 |
| | flat gasket rubber ED ø 81mm ID ø 68mm thickness 3mm for salt tank Qty 1 pcs | | |
|  | GEV No. | 510654 | Ref. No. — |
| | gasket H 6mm D1 ø 82mm D2 ø 68mm | | |
|  | GEV No. | 510883 | Ref. No. — |
| | gasket rubber ED ø 86mm ID ø 66mm thickness 2mm for salt tank Qty 1 pcs | | |

| | | | |
|--|--|-----------------|--------|
|  <p>1</p> | | | |
| GEV No. | 510032 | Ref. No. | 406998 |
| description | salt tank without gasket new model | | |
| For models: | 050F, 050FP, 11F, 11FD, 11R, 11RD, 21F, 21FD, 2312-001, 2312-002, 2312-007, 25F, 25FD, 30F, 30FD, 31F, 31FD, 31R, 31RD, 350F, 350FD, 35-ELECTRONIC, 35F, 35FD, 400F, 400FD, 400R, 400RD, 40-ELECTRONIC, 40F, 40FD, 40R, 40RD, 45, 450, 46, 460, 500F, 500FD, 50-ELECTRONIC, 50F, 50FD, 510F, 510FD, 67F, 67R, 913289, 913290, 913291, 913292...(Other models you can see in the webshop) | | |
| spare parts for | 510032 | | |
| | GEV No. | Ref. No. | 456052 |
|  | 506015 | | |
| | O-ring EPDM thickness 3.53mm ID ø 39.69mm Qty 1 pcs | | |
| | GEV No. | Ref. No. | 429011 |
|  | 510018 | | |
| | nut ø 92mm H 10.5mm for salt tank ID ø 64mm | | |
| | GEV No. | Ref. No. | 437034 |
|  | 510071 | | |
| | flat gasket rubber ED ø 81mm ID ø 68mm thickness 3mm for salt tank Qty 1 pcs | | |

accessories

| | | | |
|--|--|-----------------|-------|
|  <p>1</p> | | | |
| GEV No. | 699250 | Ref. No. | 73337 |
| description | extension for salt tank ø 52mm Qty 1 pcs L 140mm | | |
| For models: | River-282S-2TDE, River-382TDE, RV382S, RV382SFUR | | |

| | | | |
|--|--|-----------------|--------|
|  <p>1</p> | | | |
| GEV No. | 517802 | Ref. No. | 466008 |
| description | extension for salt tank Qty 1 pcs L 78mm ID ø 38mm | | |
| For models: | 915617, 915618, 915672, 915773, 915774, 916066, 916077, 916078, 916418, 916419, 916594, 916595, River-242, River-242-2, River-242-2T, River-342C, River-342T | | |

| | | | |
|---|---|-----------------|--------|
|  <p>1</p> | | | |
| GEV No. | 504793 | Ref. No. | 466006 |
| description | extension for salt tank Qty 1 pcs L 94mm ID ø 38mm | | |
| For models: | 915154, 915155, 915157, 915158, 915172, 915173, 915285, 915422, 915492, 915493, 915494, 915495, 915496, 915497, 916054, 916067, 916068, 916069, 916079, 916080, 916368, 916420, 916421, 916422, 916423, 916424, 916686, 916760, RIVER-252, River-252-2, River-252-2T, River-253, RIVER-262, River-262-2, River-262-2T, River-272, River-282LS-2TDE, River-352C, River-352T, River-362C, River-362C-230V-3Ph-50Hz, River-362T, River-362T-230V-3Ph-50Hz, River-372, River-382LTDE, RV382LS, RV382LSFUR | | |

| | | | |
|---|---|-----------------|--------|
|  <p>1</p> | | | |
| GEV No. | 510071 | Ref. No. | 437034 |
| description | flat gasket rubber ED ø 81mm ID ø 68mm thickness 3mm for salt tank Qty 1 pcs | | |
| For models: | 050F, 050FP, 11F, 11FD, 11R, 11RD, 2312-001, 2312-002, 2312-007, 2312-009-CRP, 31F, 31FD, 31R, 31RD, 350F, 350FD, 35-ELECTRONIC, 35F, 35FD, 400F, 400FD, 400R, 400RD, 40-ELECTRONIC, 40F, 40FD, 40R, 40RD, 45, 450, 46, 460, 500F, 500FD, 50-ELECTRONIC, 50F, 50FD, 510F, 510FD, 67F, 67R, 913289, 913290, 913291, 913292, 913297, 913298, 913299, 913300, 913356...(Other models you can see in the webshop) | | |

| | | | |
|---|-----------------|-----------------|--------|
|  <p>1</p> | | | |
| GEV No. | 511457 | Ref. No. | 799002 |
| description | funnel for salt | | |



boilers

boilers for dishwashers



| | | | |
|--------------------|--------------------------------|-----------------|------------------|
| GEV No. | 510029 | Ref. No. | 104019 104023 |
| description | boiler | | |
| For models: | 11F, 11FD, 11F-DVGW, 11R, 11RD | | |



| | | | |
|--------------------|---|-----------------|--------|
| GEV No. | 513241 | Ref. No. | 926026 |
| description | boiler | | |
| For models: | 10, CLEAN-100, CLEAN-110, E.60, E1, E10, E100, E110, E140 | | |



| | | | |
|--------------------|---|-----------------|--------|
| GEV No. | 513242 | Ref. No. | 926055 |
| description | boiler | | |
| For models: | 12, 14, CLEAN-120, E.60, E.65, E12, E120, E14, E140 | | |



| | | | |
|--------------------|---|-----------------|-------|
| GEV No. | 513243 | Ref. No. | 80389 |
| description | boiler | | |
| For models: | 80, 81, 82, CE78HZ23, CGL74CABT, E78, E78HP, Fast181, FAST-181, Fast181-230V-3Ph-60Hz, Fast181-400V-3NPh-60Hz, HM1, NG292, NG293, NIAGARA-283, Niagara-283A, NIAGARA-292, NIAGARA-293, RIVER-71, RIVER-78, RIVER-80, River-81, RIVER-82, RIVER-E78, RIVER-HL-81, RIVER-HL-82, RV71, RV80, RV8023, RV8023HZ, RV80C, RV80HZ, RV81, RV8123, RV81A, RV81C, RV81HZ, RV81HZ23, RV81PAP, RV82, RV8223, RV82C, SevenL, ST70FAST, ST70FASTHB, ST70FASTHB400, ST70FASTHZ23, SV72AEB, SV72EB | | |



| | | | |
|--------------------|--|-----------------|------------------|
| GEV No. | 518373 | Ref. No. | 104025 104027 |
| description | boiler | | |
| For models: | 11R, 11RD, 350F, 350FD, 350R, 350RD, 35-ELECTRONIC, 35F, 35FD, 35R, 35RD, 400F, 400FD, 400R, 400RD, 40-ELECTRONIC, 40F, 40FD, 40R, 40RD, 45, 450, 67F, 67R, E.41, E.42, E.45 | | |



| | | | |
|--------------------|---|-----------------|--------|
| GEV No. | 518375 | Ref. No. | 104033 |
| description | boiler | | |
| For models: | 913992, 913993, 914592, 914612, 914613, CLEAN-3, E.35, RIVER-40, RIVER-43, RIVER-44 | | |



| | | | |
|--------------------|--------|-----------------|-----------|
| GEV No. | 518376 | Ref. No. | 104047.SO |
| description | boiler | | |
| For models: | E.45 | | |



| | | | |
|--------------------|--|-----------------|--------|
| GEV No. | 518378 | Ref. No. | 104030 |
| description | boiler | | |
| For models: | 22F, 500F, 500FD, 50F, 50FD, 510F, 510FD, 914326, 914406, E.50, E.51, E.52, E.55, TF-503, TF-513, TF-515 | | |



| | | | |
|--------------------|--------------------|-----------------|--------|
| GEV No. | 518574 | Ref. No. | 104020 |
| description | boiler | | |
| For models: | 22F, 22R, 40F, 44F | | |



| | | | |
|--------------------|--|-----------------|--------|
| GEV No. | 518576 | Ref. No. | 104050 |
| description | boiler | | |
| For models: | 913297, 913298, 913299, 913300, 913360, 913361, 913391, 913392, 913546, 913547, 913578, 913611, 913684, 913932, 913933, 914318, 914319, 914331, 914338, 914431, 914517, 914545, 914688, 914979, 915140, 915248, E.50, E.51, F85, F85P, GSP51, GSP51P, LF55, MC501E, MC501EP, Mistral51, MISTRAL-51, NIAGARA-271, NIAGARA-51, PS-60 | | |



| | | | |
|--------------------|--|-----------------|--------|
| GEV No. | 513709 | Ref. No. | 104056 |
| description | boiler ø 110mm L 295mm | | |
| For models: | 913291, 913292, 913357, 913374, 913375, 913416, 913435, 913545, 913666, 913668, 913685, 913773, 913774, 913911, 913912, 913948, 913950, 913977, 913984, 913990, 914165, 914166, 914206, 914214, 914316, 914317, 914355, 914392, 914393, 914394, 914395, 914396, 914397, 914441, 914442, 914515, 914516, 914537, 914543, 914547, 914683, 914684, 914689, 914863, 914874, 915138, 915139, 915527, 915611, 915612...(Other models you can see in the webshop) | | |



| | | | |
|---|--|-----------------|--------|
|  | | | |
| 1 | | | |
| GEV No. | 501512 | Ref. No. | 104063 |
| description | boiler ø 110mm L 300mm hose ø 6/11mm | | |
| For models: | 915617, 915618, 915672, 915773, 915774, 916066, 916077, 916078, 916418, 916419, 916594, 916595, River-242, River-242-2, River-242-2T, River-342C, River-342T | | |

| | | | |
|---|--|-----------------|--------|
|  | | | |
| 1 | | | |
| GEV No. | 518235 | Ref. No. | 104060 |
| description | boiler ø 145mm L 405mm flange 3 hole flange | | |
| For models: | 913913, 913914, 914284, 914356, 914400, 914401, 914402, 914403, 914404, 914405, 914449, 914568, 914642, 914909, 915136, 915137, 915150, 915151, 915152, 915160, 915161, 915162, 915166, 915167, 915168, 915175, 915176, 915177, 915319, 915338, 915341, 915348, 915418, 915419, 915420, 915421, 915479, 915483, 915484, 915528, 915537, 915538, 915539, 915540, 915547, 915558, 915635, 915663, 915664, 915697...(Other models you can see in the webshop) | | |

| | | | |
|--|--|-----------------|--------|
|  | | | |
| 1 | | | |
| GEV No. | 501511 | Ref. No. | 104061 |
| description | boiler ø 145mm L 420mm hose ø 18/27mm | | |
| For models: | 915154, 915155, 915157, 915158, 915172, 915173, 915285, 915422, 915492, 915493, 915494, 915495, 915496, 915497, 916045, 916054, 916067, 916068, 916069, 916079, 916080, 916368, 916420, 916421, 916422, 916423, 916424, 916654, 916686, 916760, Fast160C, Ocean360-UK, River-252, River-252-2, River-252-2T, River-253, RIVER-262, River-262-2, River-262-2T, River-272, RIVER-282, River-282-2, River-282L-2, River-282LS-2TDE, River-282S-2TDE, River-285, RIVER-294, RIVER-295, River-295P, RIVER-296...(Other models you can see in the webshop) | | |



| | | | |
|---|---|-----------------|--------|
|  | | | |
| 1 | | | |
| GEV No. | 518377 | Ref. No. | 104026 |
| description | boiler ø 150mm L 360mm | | |
| For models: | 050F, 050FP, 2312-001, 2312-002, 46, 460, 500F, 500FD, 50-ELECTRONIC, 50F, 50FD, 510F, 510FD, 913297, 913298, 913299, 913300, 913360, 913361, 913391, 913392, 913546, 913547, 913578, 913611, 913684, 913932, 913933, 914331, 914517, 914545, 914688, 914979, 915140, 915248, E.46, E.50, E.51, F85, F85P, GSP50, GSP50P, GSP51, GSP51P, LF50, LF55, MC501E, MC501EP, MC501S, MC501SP...(Other models you can see in the webshop) | | |





| | | | |
|--|--|-----------------|--------|
|  | | | |
| 1 | | | |
| GEV No. | 517447 | Ref. No. | 982019 |
| description | boiler ø 155mm L 405mm inlet ø 11 | | |
| For models: | 2312-009-CRP, 914628, 914944, RIVER-50-CRP, RIVER-50-CRP-SP, RIVER-54CRP, River-54-CRP-s.p., RIVER-54-CRP-SP | | |

| | | | |
|--|------------------------|-----------------|-------|
|  | | | |
| 1 | | | |
| GEV No. | 518111 | Ref. No. | 80582 |
| description | boiler ø 190mm L 425mm | | |



| | | | |
|---|------------------------|-----------------|-------|
|  | | | |
| 1 | | | |
| GEV No. | 517455 | Ref. No. | 41230 |
| description | boiler ø 210mm L 405mm | | |
| For models: | U132E, U70E | | |

| | | | |
|--|---------------------------|-----------------|-------|
|  | | | |
| 1 | | | |
| GEV No. | 698808 | Ref. No. | 43550 |
| description | boiler ø 210mm L 500mm | | |
| For models: | RIVER-298, RV298, RV298HZ | | |

| | | | |
|--|--|-----------------|------------------------|
|  | | | |
| 1 | | | |
| GEV No. | 518588 | Ref. No. | 104039 999244 |
| description | boiler with heating element 2600W 230V ø 110mm L 295mm | | |
| For models: | E.35, E.40 | | |
| spare parts for | 518588 | | |
|  | GEV No. | 513709 | Ref. No. 104056 |
| | boiler ø 110mm L 295mm | | |

| | | | |
|---|---|-----------------|----------------------------------|
|  | | | |
| 1 | | | |
| GEV No. | 518098 | Ref. No. | 104043.SO 104044.SO 104906 |
| description | boiler with safety thermostat 2600W 230V ø 110mm L 295mm W 110mm H 115mm connection 11mm hose ø 6mm with thermostat inlet ø 11mm | | |
| For models: | 913289, 913290, 913356, 913372, 913373, 913544, 913665, 913667, 913771, 913772, 913832, 913837, 914386, 914387, 914388, 914389, 914390, 914391, 914692, 914693, 914694, 914703, 914870, E.35, E.35-Elettrobar, E.35H, E.35H-Elettrobar, E.40, E.40H, MC201CL, MINIBAR, MISTRAL-40, NIAGARA-35, NIAGARA-40, S280 | | |
| spare parts for | 518098 | | |
|  | GEV No. | 390233 | Ref. No. 236039 926189 |
| | bi-metal safety thermostat hole distance 24mm switch-off temp. 110°C 1NC 1-pole 16A connection F6.3 2 hole fixing without holder | | |
|  | GEV No. | 390319 | Ref. No. 236048 |
| | bi-metal thermostat hole distance 23.8mm switch-off temp. 80°C 1NC 1-pole 16A connection F6.3 2 hole fixing | | |
|  | GEV No. | 418642 | Ref. No. 230113 |
| | heating element 2600W 230V mounting ø 38.5mm heating circuits 1 L 260mm W 33mm H 24mm number of thermostat sleeves 1 thermostat sleeves ø 7mm length thermostat sleeves 175mm thermostat sleeve eccentric, non clinging tube ø 6.5mm hole distance 57mm 3 hole flange connection male faston 6.3mm immersion heater | | |
|  | GEV No. | 521120 | Ref. No. 456075 |
| | O-ring EPDM thickness 5.34mm ID ø 37.47mm Qty 1 pcs | | |

accessories

| | | | |
|---|--|-----------------|------------------------|
|  | | | |
| 1 | | | |
| GEV No. | 511459 | Ref. No. | 468027 |
| description | connecting fitting for boiler | | |
| For models: | S621, S623, S624, S626, S631, S633, S634, S636 | | |
| accessories for | 511459 | | |
|  | GEV No. | 511460 | Ref. No. 468003 |
| | connecting fitting for boiler | | |

| | | | |
|---|-------------------------------|-----------------|--------|
|  | | | |
| 1 | | | |
| GEV No. | 511460 | Ref. No. | 468003 |
| description | connecting fitting for boiler | | |

| | | | |
|---|---|-----------------|--------|
|  | | | |
| 1 | | | |
| GEV No. | 518348 | Ref. No. | 468117 |
| description | hose connector | | |
| For models: | 050F, 050FP, 10, 12, 14, 21F, 21FD, 21R, 21RD, 22F, 22R, 25F, 25FD, 25R, 25RD, 30F, 30FD, 30R, 30RD, 31F, 31FD, 31R, 31RD, 40F, 44F, 46, 460, 500F, 500FD, 50-ELECTRONIC, 50F, 50FD, 510F, 510FD, 66, CLEAN-100, CLEAN-110, CLEAN-3, E.46, E.50, E.51, E.52, E.60, E.65, E1, E10, E100, E110, E12...(Other models you can see in the webshop) | | |

| | | | |
|--|---|-----------------|--------|
|  | | | |
| 1 | | | |
| GEV No. | 507451 | Ref. No. | 926027 |
| description | insulating mat for boiler L 455mm W 405mm thickness 6mm | | |
| For models: | 10, CLEAN-100, CLEAN-110, E.60, E1, E10, E100, E110 | | |

| | | | |
|--|--|-----------------|--------|
|  | | | |
| 1 | | | |
| GEV No. | 517799 | Ref. No. | 143228 |
| description | pipe for boiler ø 9mm L 245mm | | |
| For models: | 913289, 913290, 913291, 913292, 913356, 913357, 913363, 913364, 913372, 913373, 913374, 913375, 913376, 913377, 913416, 913418, 913435, 913544, 913545, 913665, 913666, 913667, 913668, 913685, 913771, 913772, 913773, 913774, 913832, 913837, 913911, 913912, 913948, 913950, 913977, 913984, 913990, 914165, 914166, 914167, 914168, 914206, 914214, 914316, 914317, 914355, 914386, 914387, 914388, 914389...(Other models you can see in the webshop) | | |

gaskets

| | | | |
|--|---|-----------------|-------|
|  | | | |
| 1 | | | |
| GEV No. | 698804 | Ref. No. | 70540 |
| description | gasket L 534mm W 108mm thickness 2.5mm | | |
| For models: | River-285, River-382LNRG, River-382NRG, River-382NRG-230-3Ph-50Hz, RV282R, RV382LR, RV382LTXR, RV382R, RV382R23TERMO, RV382RFUR, RV382TXR | | |

| | | | |
|--|--|-----------------|-------|
|  | | | |
| 1 | | | |
| GEV No. | 698802 | Ref. No. | 35510 |
| description | gasket L 65mm W 10mm H 4mm thickness 4mm | | |
| For models: | LP60, NG271, NG291, NIAGARA-271, NIAGARA-291, RIVER-294, RIVER-71, RV294, RV71, U60E | | |

rotation plates

rotation plates

| | | | |
|--|---|-----------------|--------|
|  | | | |
| 1 | | | |
| GEV No. | 516264 | Ref. No. | 319003 |
| description | rotation plate ø 350mm grey seat ø 21.7mm | | |
| For models: | 350R, 350RD, 35-ELECTRONIC, 35R, 35RD | | |



rotation plate bearings



Image not available

1

| | | | |
|--------------------|--|-----------------|--------|
| GEV No. | 519423 | Ref. No. | 322004 |
| description | spindle for rotation plate | | |
| For models: | 21R, 21RD, 25R, 25RD, 30R, 30RD, 31R, 31RD, S624, S626, S634, S636 | | |





Image not available

1

| | | | |
|--------------------|-----------------------------------|-----------------|--------|
| GEV No. | 519425 | Ref. No. | 322005 |
| description | spindle for rotation plate | | |
| For models: | 22R, S651, S654, S655, S815, S835 | | |



1

| | | | |
|--------------------|----------------------------|-----------------|--------|
| GEV No. | 519426 | Ref. No. | 322006 |
| description | spindle for rotation plate | | |
| For models: | 11R, 11RD | | |



1

| | | | |
|--------------------|---|-----------------|--------|
| GEV No. | 519427 | Ref. No. | 322007 |
| description | spindle for rotation plate | | |
| For models: | 350R, 350RD, 35-ELECTRONIC, 35R, 35RD, 400R, 400RD, 40-ELECTRONIC, 40R, 40RD, 67R, E.42 | | |

softener cartridges

softening columns



1

| | | | |
|--------------------|---------------------------------|-----------------|--------|
| GEV No. | 530000 | Ref. No. | 117001 |
| description | softener 4-fold L 380mm W 180mm | | |



1

| | | | |
|--------------------|--|-----------------|--------|
| GEV No. | 530395 | Ref. No. | 117007 |
| description | softener 4-fold L 380mm W 180mm | | |
| For models: | 915150, 915151, 915152, 915160, 915161, 915162, 915166, 915167, 915168, 915175, 915319, 915348, 915418, 915419, 915420, 915421, 915479, 915483, 915484, 915537, 915538, 915539, 915540, 915547, 915558, 915611, 915612, 915613, 915614, 915615, 915616, 915635, 915663, 915664, 915670, 915671, 915686, 915687, 915688, 915689, 915690, 915691, 915692, 915693, 915694, 915695, 915696, 915697, 915698, 915699...(Other models you can see in the webshop) | | |



1

| | | | |
|--------------------|--|-----------------|--------|
| GEV No. | 524534 | Ref. No. | 117006 |
| description | softener 6-fold L 380mm W 260mm | | |
| For models: | 915150, 915151, 915152, 915160, 915161, 915162, 915166, 915167, 915168, 915175, 915176, 915177, 915319, 915338, 915341, 915348, 915418, 915419, 915420, 915421, 915479, 915547, 915558, 915635, 915663, 915747, NIAGARA-251, NIAGARA-261, PLUVIA-260, Pluvia-270 | | |

complete



1

| | | | |
|--------------------|---|-----------------|--------|
| GEV No. | 518640 | Ref. No. | 117008 |
| description | softener type Eledro 425 | | |
| For models: | 915154, 915155, 915157, 915158, 915172, 915173, 915422, 915492, 915493, 915494, 915495, 915496, 915497, 915617, 915618, 916054, 916066, 916067, 916068, 916069, 916077, 916078, 916079, 916080, 916368, 916418, 916419, 916420, 916421, 916422, 916423, 916424, 916594, 916595, 916686, 916760, River-242, River-242-2, River-242-2T, River-252, River-252-2, River-252-2T, River-253, River-262, River-262-2, River-262-2T, River-272, River-282LS-2TDE, River-282S-2TDE, River-342C...(Other models you can see in the webshop) | | |

spare parts and accessories



1

| | | | |
|--------------------|--|-----------------|--------|
| GEV No. | 699348 | Ref. No. | 480084 |
| description | plug rubber D1 ø 35mm mounting ø 23.5mm | | |
| For models: | 913418, 914167, 914168, 914398, 914399, 914443, 914943, E.45, NIAGARA-45 | | |

housing and bezels

fascias



1

| | | | |
|--------------------|--|-----------------|--------|
| GEV No. | 518581 | Ref. No. | 480099 |
| description | end cap for control panel mounting pos. left | | |
| For models: | 2312-001, 2312-002, E.46, E.50, E.51, E.52, MISTRAL-51, NIAGARA-51 | | |



1

| | | | |
|--------------------|--|-----------------|--------|
| GEV No. | 518582 | Ref. No. | 480100 |
| description | end cap for control panel mounting pos. right | | |
| For models: | 2312-001, 2312-002, E.46, E.50, E.51, E.52, MISTRAL-51, NIAGARA-51 | | |

flanges



1

| | | | |
|--------------------|---|-----------------|-------|
| GEV No. | 699252 | Ref. No. | 75057 |
| description | flange H 40mm ø 130mm mounting pos. lower | | |
| For models: | 914380, 914436, A3EBD, A3EBDAKWK, A3EBDBKWK, A3EBDVK, A3EBDYK, A3EBSAK, A3EBSAKWK, A3EBSBKWKYK, A3EBSWK, A4EBD, A4EBS, A4EBSAKRK, A4EBSAKYK, A4EBSCK, A5EBD, A5EBDAKPKWK, A5EBDAKWK, A5EBS, A5EBSAKPKWK, A5EBSYK, FAST-200, GL280EB, GL280EBD, GL280EBDA, GL280EBDAE, GL280EBDAR, GL280EBDAWY, GL280EBDBW, GL280EBDY, GL280EBS, GL280EBSY, GL282EB, GL282EBCH, GL282EBCHD, GL282EBD, GL282EBDAE, GL282EBDAR, GL284EBD, GL284EBDAWY, GL284EBS, GL284EBSAR, GL286EBD, GL286EBDARY, GL286EBS, GL286EBSAW, NIAGARA-2150, NIAGARA-2152, NIAGARA-2154...(Other models you can see in the webshop) | | |



1

| | | | |
|--------------------|---|-----------------|-------|
| GEV No. | 699251 | Ref. No. | 75141 |
| description | flange H 65mm ø 130mm mounting pos. upper | | |
| For models: | 914380, 914436, A3EBD, A3EBDAKWK, A3EBDBKWK, A3EBDVK, A3EBDYK, A3EBSAK, A3EBSAKWK, A3EBSBKWKYK, A3EBSWK, A4EBD, A4EBS, A4EBSAKRK, A4EBSAKYK, A4EBSCK, A5EBD, A5EBDAKPKWK, A5EBDAKWK, A5EBS, A5EBSAKPKWK, A5EBSYK, FAST-200, GL280EB, GL280EBD, GL280EBDA, GL280EBDAE, GL280EBDAR, GL280EBDAWY, GL280EBDBW, GL280EBDY, GL280EBS, GL280EBSY, GL282EB, GL282EBCH, GL282EBCHD, GL282EBD, GL282EBDAE, GL282EBDAR, GL284EBD, GL284EBDAWY, GL284EBS, GL284EBSAR, GL286EBD, GL286EBDARY, GL286EBS, GL286EBSAW, NIAGARA-2150, NIAGARA-2152, NIAGARA-2154...(Other models you can see in the webshop) | | |



1

| | | | |
|--------------------|---|-----------------|--------|
| GEV No. | 699345 | Ref. No. | K75057 |
| description | flange with ring gasket H 35mm ø 130mm | | |
| For models: | A3EB, A3EBDAKRYK, A3EBDRKYK, A3EBSAKRK, A3EBSEKWK, A4EB, A4EBDAKEKYK, A4EBDAKWK, A4EBDAKZK, A4EBDBKWK, A4EBDPKWKYK, A4EBDRK, A4EBSAK, A4EBSAKCK, A4EBSAKEKYK, A4EBSAKRKPK, A4EBT, A4EBTSK, A5EB, A5EBDAKYK, A5EBDRK, A5EBSAKRK, A5EBSAKRYK, A5EBSAKWK, A5EBSAKWKYK, A5EBSBKRPK, A5EBSBKWK, A5EBSRK, Fast200, Fast93, GL280EB, GL280EB23, GL280EB23DAR, GL280EB23HZ, GL280EB23HZDY, GL280EBDARY, GL280EBDAW, GL280EBDAY, GL280EBDB, GL280EBDBR, GL280EBDWY, GL280EBSA, GL280EBSAE, GL280EBSAEW, GL280EBSAEWY, GL280EBSAR, GL280EBSARY, GL280EBSAW, GL280EBSAWY...(Other models you can see in the webshop) | | |



1

| | | | |
|--------------------|---|-----------------|--------|
| GEV No. | 699346 | Ref. No. | K75141 |
| description | flange with ring gasket H 35mm ø 130mm mounting pos. upper M6 | | |
| For models: | A3EB, A3EBDAKRYK, A3EBDRKYK, A3EBSAKRK, A3EBSEKWK, A4EB, A4EBDAKEKYK, A4EBDAKWK, A4EBDAKZK, A4EBDBKWK, A4EBDPKWKYK, A4EBDRK, A4EBSAK, A4EBSAKCK, A4EBSAKEKYK, A4EBSAKRKPK, A4EBT, A4EBTSK, A5EB, A5EBDAKYK, A5EBDRK, A5EBSAKRK, A5EBSAKRYK, A5EBSAKWK, A5EBSAKWKYK, A5EBSBKRPK, A5EBSBKWK, A5EBSRK, Fast200, Fast93, GL280EB, GL280EB23, GL280EB23DAR, GL280EB23HZ, GL280EB23HZDY, GL280EBDARY, GL280EBDAW, GL280EBDAY, GL280EBDB, GL280EBDBR, GL280EBDWY, GL280EBSA, GL280EBSAE, GL280EBSAEW, GL280EBSAEWY, GL280EBSAR, GL280EBSARY, GL280EBSAW, GL280EBSAWY...(Other models you can see in the webshop) | | |



trapdoors



| | | | |
|--------------------|--|-----------------|--------|
| 1 | | | |
| GEV No. | 518542 | Ref. No. | 029096 |
| description | door | | |
| For models: | 11F, 11FD, 11F-DVGW, 11R, 11RD, 913363, 913364, 913376, 913377, 913992, 913993, CLEAN-3, E.41, E.42, E41, RIVER-40, RIVER-43 | | |



| | | | |
|--------------------|--|-----------------|--------|
| 1 | | | |
| GEV No. | 518543 | Ref. No. | 029032 |
| description | door | | |
| For models: | 22F, 22R, 40F, 440F, 44F, E.52, S651, S654, S810, S815, S830, S835 | | |

miscellaneous



| | | | |
|--------------------|---|-----------------|-------|
| 1 | | | |
| GEV No. | 513304 | Ref. No. | 70549 |
| description | duct ID ø 17mm ED ø 24mm | | |
| For models: | River-285, River-382LNRG, River-382NRG, River-382NRG-230-3Ph-50Hz, RV282R, RV382LR, RV382LTXR, RV382R, RV382R23TERMO, RV382RFUR, RV382TXR | | |



| | | | |
|--------------------|--|-----------------|--------|
| 1 | | | |
| GEV No. | 513000 | Ref. No. | 480057 |
| description | lid rubber ED ø 27mm | | |
| For models: | 050F, 050FP, 11F, 11FD, 11R, 11RD, 12, 14, 22F, 22R, 2312-001, 2312-002, 350F, 350FD, 350R, 350RD, 35F, 35FD, 35R, 35RD, 400F, 400FD, 400R, 400RD, 40F, 40FD, 40R, 40RD, 440F, 44F, 500F, 500FD, 50F, 50FD, 510F, 510FD, 913297, 913298, 913299, 913300, 913360, 913361, 913391, 913392, 913418, 913546, 913547, 913578, 913611, 913684... (Other models you can see in the webshop) | | |



| | | | |
|--------------------|--|-----------------|--------|
| 1 | | | |
| GEV No. | 513708 | Ref. No. | 480058 |
| description | lid rubber ø 17mm mounting ø 17mm | | |
| For models: | 11F, 11FD, 11R, 11RD, 22F, 2312-001, 2312-002, 350F, 350FD, 350R, 350RD, 35F, 35FD, 35R, 35RD, 400F, 400FD, 400R, 400RD, 40F, 40FD, 40R, 40RD, 440F, 44F, 45, 450, 46, 460, 500F, 500FD, 50F, 50FD, 510F, 510FD, 66, 913297, 913298, 913299, 913300, 913360, 913361, 913391, 913392, 913546, 913547, 913578, 913611, 913684, 913913... (Other models you can see in the webshop) | | |

gearboxes



| | | | |
|--------------------|---|-----------------|--------|
| 1 | | | |
| GEV No. | 518634 | Ref. No. | 927102 |
| description | gearbox motor shaft ø 14mm flange ø 160mm drive shaft ø 25mm type VF49A60 | | |
| For models: | 161, 221, 271, 914380, 914436, CLEAN-160, CLEAN-161, CLEAN-220, CLEAN-221, GL280EB, GL280EB23, GL280EB23DAR, GL280EB23HZ, GL280EB23HZDY, GL280EBD, GL280EBDA, GL280EBDAE, GL280EBDAR, GL280EBDARY, GL280EBDAW, GL280EBDAWY, GL280EBDAY, GL280EBDB, GL280EBDBR, GL280EBDBW, GL280EBDWY, GL280EBDY, GL280EBS, GL280EBSA, GL280EBSAE, GL280EBSAEW, GL280EBSAEWY, GL280EBSAR, GL280EBSARY, GL280EBSAW, GL280EBSAWY, GL280EBSAY, GL280EBSB, GL280EBSR, GL280EBSWY, GL280EBSY, GL282EB, GL282EBD, GL282EBDA, GL282EBDAE, GL282EBDAR, GL282EBDARW, GL282EBDAWY, GL282EBDBW, GL282EBDCWY... (Other models you can see in the webshop) | | |



| | | | |
|--------------------|--|-----------------|-------|
| 1 | | | |
| GEV No. | 699357 | Ref. No. | 65921 |
| description | gearbox motor shaft ø 14mm flange ø 160mm transmission 1/30 drive shaft ø 25mm type SW 050 | | |

hood mechanics for dishwashers

bolts

| | | | |
|---|--|-----------------|-------|
|  | | | |
| 1 | | | |
| GEV No. | 513200 | Ref. No. | 80131 |
| description | screw bolt hood mechanics | | |
| For models: | 80, 81, 82, CGL74CABT, River-80, RIVER-81, River-81CRP, RIVER-81-CRP, RIVER-82, River-82CRP, RIVER-82-CRP, RIVER-HL-81, RIVER-HL-82, RV80, RV8023, RV8023HZ, RV80C, RV80HZ, RV81, RV8123, RV81A, RV81C, RV81CCRP, RV81CRP, RV81HZ, RV81HZ23, RV81PAP, RV82, RV8223, RV82C, RV82CCRP, RV82CRP, SevenL | | |

spring holders

| | | | |
|---|---------------|-----------------|-------|
|  | | | |
| 1 | | | |
| GEV No. | 513117 | Ref. No. | DAG31 |
| description | spring holder | | |

| | | | |
|--|--|-----------------|--------|
|  | | | |
| 1 | | | |
| GEV No. | 513205 | Ref. No. | 926004 |
| description | spring holder hood mechanics | | |
| For models: | 10, 12, 14, CLEAN-100, CLEAN-110, CLEAN-120, E1, E10, E100, E110, E12, E120, E14, E140 | | |

springs

| | | | |
|---|--------|-----------------|--------|
|  | | | |
| 1 | | | |
| GEV No. | 513118 | Ref. No. | CMT520 |
| description | spring | | |

| | | | |
|---|---|-----------------|--------|
|  | | | |
| 1 | | | |
| GEV No. | 517448 | Ref. No. | 926108 |
| description | tension spring ϕ 30mm total length 505mm wire gauge ϕ 5.5mm for hood mechanics Qty 1 pcs | | |
| For models: | 80, 81, 82, CGL74CABT, NG281, NG281CDD, NG281HP, NG281HPDD, NG281HZ23, NG281HZ23DD, NG381, NG38123, NG38123TERMO, NG381C, NG381CDD, NG381CFUR, NG381DDHZ23, NG381DDPS, NG381DDPSHZ23, NG381HPDD, NG381L, NG381LC, NG381LCFUR, NG381LDDPS, NG381TERMO, NG381TXCDD, NIAGARA-281, Niagara-281-2, Niagara-281HP, NIAGARA-283, Niagara-283L-2, Niagara-381, Niagara-381-230V-3Ph-50Hz, Niagara-381-230V-3Ph-60Hz, Niagara-381DP, Niagara-381HPD, Niagara-381L, Niagara-381LC, OC380, OC380FUR, OC380HZ23, Ocean380, RIVER-282, River-282-2, River-282L-2, River-282LS-2TDE, River-282S-2TDE, River-285, River-382, River-382-230V-3Ph-50Hz...(Other models you can see in the webshop) | | |

guide bars

| | | | |
|--|--|-----------------|----------------|
|  | | | |
| 1 | | | |
| GEV No. | 513724 | Ref. No. | 80068 80069 |
| description | guide bar L 590mm hood mechanics | | |
| For models: | 80, 81, 82, CE78HZ23, CGL74CABT, CNT800CH, E78, E78HP, Fast180, Fast180-230V-3Ph-60Hz, Fast181, FAST-181, Fast181-230V-3Ph-60Hz, Fast181-400V-3NPh-60Hz, FAST-60, FAST-73, HM1, NG281, NG281CDD, NG281HP, NG281HPDD, NG281HZ23, NG281HZ23DD, Niagara-281, Niagara-281-2, Niagara-281HP, NIAGARA-283, Niagara-283A, OC380, OC380FUR, OC380HZ23, Ocean380, PLUVIA-280, Pluvia280-230V-3Ph-60Hz, PS-60, PV280, PV280FAST, PV280FAST2, PV280FAST2BIO, PV280FAST2HZ23, PV280FASTCH, PV280FASTHB, PV280HZ23, RIVER-282, River-285, RIVER-78, RIVER-80, RIVER-81, River-81CRP, RIVER-81-CRP...(Other models you can see in the webshop) | | |

| | | | |
|--|--|-----------------|--------|
|  | | | |
| 1 | | | |
| GEV No. | 698740 | Ref. No. | K70365 |
| description | guide bar L 685mm W 28mm H 28mm with sealing strip | | |
| For models: | NG381, NG38123, NG38123TERMO, NG381C, NG381CDD, NG381CFUR, NG381DDHZ23, NG381DDPS, NG381DDPSHZ23, NG381HPDD, NG381L, NG381LC, NG381LCFUR, NG381LDDPS, NG381TERMO, NG381TXCDD, Niagara-283L-2, Niagara-381, Niagara-381-230V-3Ph-50Hz, Niagara-381-230V-3Ph-60Hz, Niagara-381DP, Niagara-381HPD, Niagara-381L, Niagara-381LC, River-282-2, River-282L-2, River-282LS-2TDE, River-282S-2TDE, River-285, River-382, River-382-230V-3Ph-50Hz, River-382H, River-382L, River-382L-230V-3Ph-50Hz, River-382LNRG, River-382LTDE, River-382NRG, River-382NRG-230-3Ph-50Hz, River-382TDE, RV382, RV38223TERMO, RV382AHP, RV382FUR, RV382L, RV382L23TERMO, RV382LFUR, RV382LR, RV382LS, RV382LSFUR, RV382LTX...(Other models you can see in the webshop) | | |

| | | | |
|--|--|-----------------|-------|
|  | | | |
| 1 | | | |
| GEV No. | 698739 | Ref. No. | 70065 |
| description | guide bar L 685mm W 28mm H 28mm without gasket | | |
| For models: | River-482, RV482 | | |

| | | | |
|--|---|-----------------|-------|
|  | | | |
| 1 | | | |
| GEV No. | 698803 | Ref. No. | 41038 |
| description | sliding rail L 458mm mounting pos. rear W 21mm H 20mm | | |
| For models: | KLP105EB, KLP201DDDTEB, KLP201EB, KLP301, KLP301DDDTEB, LP105DDDTEB, LP105DDDTEBN, LP105EB, LP201DDDTEB, LP201EB, LP301, LP301EB, NG292, NG292HZ, NG293, NIAGARA-292, Niagara-292-400V-3Ph-60Hz, NIAGARA-293, RIVER-295, River-295P, RV295, RV295PS, U132e, U61E, U61HE, U70e | | |



hood handles

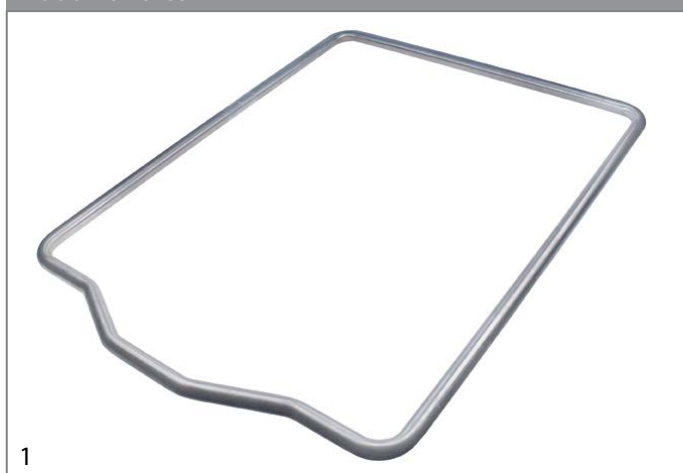

| | | | | |
|--------------------|--|-------------|-----------------|-------|
| 1 | GEV No. | 513719 | Ref. No. | 80027 |
| | description | hood handle | | |
| For models: | 80, 81, 82, CE78HZ23, CGL74CABT, CNT800CH, E78, E78HP, Fast180, Fast180-230V-3Ph-60Hz, Fast181, FAST-181, Fast181-230V-3Ph-60Hz, Fast181-400V-3NPh-60Hz, FAST-60, FAST-73, HM1, NG281, NG281HP, NG281HPDD, NG281HZ23, NG281HZ23DD, NIAGARA-281, Niagara-281-2, Niagara-281HP, Niagara-283A, OC380, OC380FUR, OC380HZ23, Ocean380, PLUVIA-280, Pluvia280-230V-3PH-60HZ, PS-60, PV280, PV280FAST, PV280FAST2, PV280FAST2BIO, PV-280FAST2HZ23, PV280FASTCH, PV280FASTHB, PV280HZ23, RIVER-78, RIVER-80, River-81, River-81CRP, RIVER-81-CRP, RIVER-82, River-82CRP, RIVER-82-CRP, RIVER-E78...(Other models you can see in the webshop) | | | |

hood handle supports



| | | | | |
|--------------------|--|---------------------------------|-----------------|-------|
| 1 | GEV No. | 513202 | Ref. No. | 80190 |
| | description | bearing for hood handle plastic | | |
| For models: | 80, 81, 82, CE78HZ23, CGL74CABT, CNT800CH, E78, E78HP, Fast180, Fast180-230V-3Ph-60Hz, Fast181, FAST-181, Fast181-230V-3Ph-60Hz, Fast181-400V-3NPh-60Hz, FAST-60, FAST-73, HM1, NG281, NG281CDD, NG281HP, NG281HPDD, NG281HZ23, NG281HZ23DD, Niagara-281, Niagara-281-2, Niagara-281HP, NIAGARA-283, Niagara-283A, OC380, OC380FUR, OC380HZ23, Ocean380, PLUVIA-280, Pluvia280-230V-3PH-60HZ, PS-60, PV280, PV280FAST, PV280FAST2, PV280FAST2BIO, PV280FAST2HZ23, PV280FASTCH, PV280FASTHB, PV280HZ23, RIVER-282, River-285, RIVER-78, RIVER-80, River-81, River-81CRP, RIVER-81-CRP...(Other models you can see in the webshop) | | | |



| | | | | |
|--------------------|---|--|-----------------|-------|
| 1 | GEV No. | 698795 | Ref. No. | 70192 |
| | description | guide for hood mechanics mounting pos. rear L 66mm W 38mm H 20mm | | |
| For models: | NG381, NG38123, NG38123TERMO, NG381C, NG381CDD, NG381CFUR, NG381DDHZ23, NG381DDPS, NG381DDPSHZ23, NG381HPDD, NG381L, NG381LC, NG381LCFUR, NG381LDDPS, NG381TERMO, NG381TXCDD, Niagara-283L-2, Niagara-381, Niagara-381-230V-3Ph-50Hz, Niagara-381-230V-3Ph-60Hz, Niagara-381DP, Niagara-381HPD, Niagara-381L, Niagara-381LC, River-282-2, River-282L-2, River-282LS-2TDE, River-282S-2TDE, River-285, River-382, River-382-230V-3Ph-50Hz, River-382H, River-382L, River-382L-230V-3Ph-50Hz, River-382LNRG, River-382LTDE, River-382NRG, River-382NRG-230-3Ph-50Hz, River-382TDE, River-482, RV382, RV38223TERMO, RV382AHP, RV382FUR, RV382L, RV382L23TERMO, RV382LFUR, RV382LR, RV382LS, RV382LSFUR...(Other models you can see in the webshop) | | | |



| | | | | |
|--------------------|---|-----------------------|-----------------|--------|
| 1 | GEV No. | 513192 | Ref. No. | 926243 |
| | description | guide for hood handle | | |
| For models: | CE78HZ23, E78, E78HP, HM1, PS-60, RIVER-78, RIVER-E78 | | | |



| | | | | |
|---|--------------------|---------------------------------|-----------------|-------|
| 1 | GEV No. | 513116 | Ref. No. | DWD2X |
| | description | connecting piece hood mechanics | | |

rollers

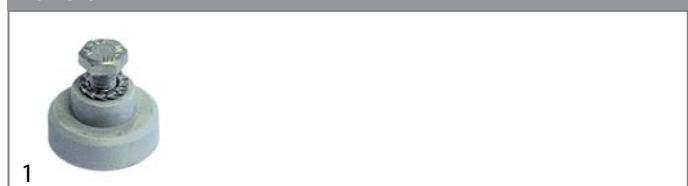

| | | | | |
|---|--------------------|--------|-----------------|--------|
| 1 | GEV No. | 510067 | Ref. No. | 999073 |
| | description | roller | | |



| | | | | |
|--------------------|--|--------------------------------|-----------------|--------|
| 1 | GEV No. | 518539 | Ref. No. | 926006 |
| | description | roller hood mechanics complete | | |
| For models: | 10, CLEAN-100, CLEAN-110, CLEAN-120, E1, E10, E100, E110, E12, E120, E14, E140 | | | |



| | | | | |
|--------------------|--|---------------------------------|-----------------|--------|
| 1 | GEV No. | 698741 | Ref. No. | 499098 |
| | description | roller ø 34.7mm H 5mm for cable | | |
| For models: | 915617, 915618, 915672, 915773, 915774, 916066, 916077, 916078, 916418, 916419, 916594, 916595, River-242, River-242-2, River-242-2T, River-342C, River-342T | | | |



| | | | | |
|--------------------|--------------------|---|-----------------|-------|
| 1 | GEV No. | 513201 | Ref. No. | 80132 |
| | description | roller ø 36/42mm H 34mm hood mechanics plastic grey hole ø 12mm | | |
| For models: | CGL74CABT, SevenL | | | |



1

| | | | |
|--------------------|---|-----------------|--------|
| GEV No. | 501335 | Ref. No. | 80132B |
| description | roller ϕ 42mm H 35mm for hood handle blue | | |
| For models: | 80, 81, 82, RIVER-80, River-81, RIVER-81-CRP, RIVER-82, RIVER-82-CRP, RIVER-HL-81, RIVER-HL-82, RV80, RV8023, RV8023HZ, RV80C, RV80HZ, RV81, RV8123, RV81A, RV81C, RV81HZ, RV81HZ23, RV81PAP, RV82, RV8223, RV82C | | |

screws for spring compressor



1

| | | | |
|--------------------|---|-----------------|--------|
| GEV No. | 518540 | Ref. No. | 927273 |
| description | screw for spring compressor hood mechanics | | |
| For models: | CLEAN-161, CLEAN-221, CLEAN-271, CLEAN-272, CLEAN-362, E100, E110, E120, E140 | | |

cable controls



1

| | | | |
|--------------------|--|-----------------|--------|
| GEV No. | 698742 | Ref. No. | 399020 |
| description | cable control L 60.5mm wire gauge ϕ 1.6mm for cover | | |
| For models: | 915617, 915618, 915672, 915773, 915774, 916066, 916077, 916078, 916418, 916419, 916594, 916595, River-242, River-242-2, River-242-2T, River-342C, River-342T | | |

miscellaneous



1

| | | | |
|--------------------|---|-----------------|--------|
| GEV No. | 501336 | Ref. No. | 80130B |
| description | base for hood rod blue | | |
| For models: | 80, 81, 82, RIVER-80, River-81, River-81CRP, RIVER-81-CRP, RIVER-82, River-82CRP, RIVER-82-CRP, RIVER-HL-81, RIVER-HL-82, RV80, RV8023, RV8023HZ, RV80C, RV80HZ, RV81, RV8123, RV81A, RV81C, RV81CCRP, RV81CRP, RV81HZ, RV81HZ23, RV81PAP, RV82, RV8223, RV82C, RV82CCRP, RV82CRP | | |



1

| | | | |
|--------------------|--|-----------------|-------|
| GEV No. | 513198 | Ref. No. | 80130 |
| description | base for roller ED ϕ 64mm ID ϕ 8.5mm hood mechanics grey | | |
| For models: | CGL74CABT, SevenL | | |



1

| | | | |
|--------------------|--|-----------------|-------|
| GEV No. | 698811 | Ref. No. | 41100 |
| description | door bumper ED ϕ 20mm H 20mm | | |
| For models: | NG292HZ, Niagara-292-400V-3Ph-60Hz, River-295P, River-296P, RV295PS, RV296PS | | |



1

| | | | |
|--------------------|---|-----------------|-------|
| GEV No. | 508375 | Ref. No. | 80105 |
| description | fixing support | | |
| For models: | 80, 81, 82, CE78HZ23, CGL74CABT, CNT800CH, E78, E78HP, Fast180, Fast180-230V-3Ph-60Hz, Fast181, FAST-181, Fast181-230V-3Ph-60Hz, Fast181-400V-3NPh-60Hz, FAST-60, FAST-73, HM1, LP60, NG271, NG281, NG281CDD, NG281HP, NG281HPDD, NG281HZ23, NG281HZ23DD, NG291, NIAGARA-271, NIAGARA-281, Niagara-281-2, Niagara-281HP, NIAGARA-283, Niagara-283A, NIAGARA-291, OC380, OC380FUR, OC380HZ23, Ocean380, PLUVIA-280, Pluvia280-230V-3PH-60Hz, PS-60, PV280, PV280FAST, PV280FAST2, PV280FAST2BIO, PV280FAST2HZ23, PV280FASTCH, PV280FASTHB, PV280HZ23, RIVER-282, River-285...(Other models you can see in the webshop) | | |



1

| | | | |
|--------------------|--|-----------------|--------|
| GEV No. | 518537 | Ref. No. | 926003 |
| description | handle holder hood mechanics | | |
| For models: | 10, 12, 14, CLEAN-100, CLEAN-110, CLEAN-120, E1, E10, E100, E110, E12, E120, E14, E140 | | |



| | | | |
|---|--|-----------------|-------|
|  | | | |
| 1 | | | |
| GEV No. | 513274 | Ref. No. | 80998 |
| description | hexagonal screw thread M4 plastic WS 7 thread L 6mm | | |
| For models: | 80, 81, 82, CE78HZ23, CGL74CABT, CNT800CH, E78, E78HP, Fast180, Fast180-230V-3Ph-60Hz, Fast181, FAST-181, Fast181-230V-3Ph-60Hz, Fast181-400V-3NPh-60Hz, FAST-60, FAST-73, HM1, NG281, NG281CDD, NG281HP, NG281HPDD, NG281HZ23, NG281HZ23DD, Niagara-281, Niagara-281-2, Niagara-281HP, NIAGARA-283, Niagara-283A, OC380, OC380FUR, OC380HZ23, Ocean380, PLUVIA-280, Pluvia280-230V-3PH-60HZ, PS-60, PV280, PV280FAST, PV280FAST2, PV280FAST2BIO, PV280FAST2HZ23, PV280FASTCH, PV280FASTHB, PV280HZ23, RIVER-282, River-285, RIVER-78, RIVER-80, River-81, River-81CRP, RIVER-81-CRP...(Other models you can see in the webshop) | | |

| | | | |
|---|--|-----------------|--------|
|  | | | |
| 1 | | | |
| GEV No. | 518538 | Ref. No. | 926002 |
| description | opposite support hood mechanics | | |
| For models: | 10, 12, 14, CLEAN-100, CLEAN-110, CLEAN-120, E1, E10, E100, E110, E12, E120, E14, E140 | | |

basket guides

guide bars

| | | | |
|---|--|-----------------|--------|
|  | | | |
| 1 | | | |
| GEV No. | 530558 | Ref. No. | 015039 |
| description | guide bar mounting pos. left L 422mm W 43mm H 39mm | | |
| For models: | 400F, 400FD, 400R, 400RD, 40F, 40FD, 40R, 40RD, 67F, 67R, 913291, 913292, 913357, 913374, 913375, 913416, 913435, 913545, 913666, 913668, 913685, 913773, 913774, 913911, 913912, 913948, 913950, 913977, 913984, 913990, 914214, 914316, 914317, 914392, 914393, 914394, 914395, 914396, 914397, 914441, 914442, 914515, 914516, 914537, 914543, 914547, 914683, 914684, 914689, 914863...(Other models you can see in the webshop) | | |

basket holders

| | | | |
|---|---|-----------------|-------|
|  | | | |
| 1 | | | |
| GEV No. | 699347 | Ref. No. | 75076 |
| description | buffer for basket transport L 25m ø 17.5mm | | |
| For models: | 914380, 914436, A3EB, A3EBD, A3EBDAKRKYK, A3EBDAKWK, A3EBDBKWK, A3EBDRKYK, A3EBDVK, A3EBDYK, A3EBSAK, A3EBSAKRK, A3EBSAKWK, A3EBSBKWKYK, A3EBSEKWK, A3EBSWK, A4EB, A4EBD, A4EBDAKEKYK, A4EBDAKRK, A4EBDAKWK, A4EBDAKZK, A4EBDBKWK, A4EBDPKWKYK, A4EBDRK, A4EBS, A4EBSAK, A4EBSAKCK, A4EBSAKKEKYK, A4EBSAKRK, A4EBSAKRKP, A4EBSAKYK, A4EBSCK, A4EBT, A4EBTSAK, A5EB, A5EBD, A5EBDAKPKWK, A5EBDAKWK, A5EBDAKYK, A5EBDRK, A5EBS, A5EBSAKPKWK, A5EBSAKRK, A5EBSAKRKYK, A5EBSAKWK, A5EBSAKWKYK, A5EBSBKRKP, A5EBSBKWK, A5EBSRK...(Other models you can see in the webshop) | | |





| | | | |
|--|---|-----------------|-------|
|  | | | |
| 1 | | | |
| GEV No. | 699344 | Ref. No. | 75058 |
| description | roller for basket H 35mm ø 45mm | | |
| For models: | 914380, 914436, A3EB, A3EBD, A3EBDAKRKYK, A3EBDAKWK, A3EBDBKWK, A3EBDRKYK, A3EBDVK, A3EBDYK, A3EBSAK, A3EBSAKRK, A3EBSAKWK, A3EBSBKWKYK, A3EBSEKWK, A3EBSWK, A4EB, A4EBD, A4EBDAKEKYK, A4EBDAKRK, A4EBDAKWK, A4EBDAKZK, A4EBDBKWK, A4EBDPKWKYK, A4EBDRK, A4EBS, A4EBSAK, A4EBSAKCK, A4EBSAKKEKYK, A4EBSAKRK, A4EBSAKRKP, A4EBSAKYK, A4EBSCK, A4EBT, A4EBTSAK, A5EB, A5EBD, A5EBDAKPKWK, A5EBDAKWK, A5EBDAKYK, A5EBDRK, A5EBS, A5EBSAKPKWK, A5EBSAKRK, A5EBSAKRKYK, A5EBSAKWK, A5EBSAKWKYK, A5EBSBKRKP, A5EBSBKWK, A5EBSRK...(Other models you can see in the webshop) | | |

air traps

air traps



| | | | |
|---|----------|-----------------|--------|
|  | | | |
| 1 | | | |
| GEV No. | 518229 | Ref. No. | 984006 |
| description | air trap | | |





| | | | |
|--|-------------------|-----------------|--------|
|  | | | |
| 1 | | | |
| GEV No. | 518232 | Ref. No. | 107006 |
| description | air trap | | |
| For models: | CLEAN-3, RIVER-43 | | |

| | | | |
|---|---|-----------------|------------------------|
|  | | | |
| 1 | | | |
| GEV No. | 518487 | Ref. No. | 107002 |
| description | air trap | | |
| For models: | 050F, 050FP, 31F, 31FD, 31R, 31RD, 500F, 500FD, 50F, 50FD, 510F, 510FD, E.52, F85, F85P | | |
| accessories for | 518487 | | |
|  | GEV No. | 505045 | Ref. No. 456009 |
| | O-ring EPDM thickness 1.78mm ID ø 5.28mm Qty 1 pcs | | |
|  | GEV No. | 510016 | Ref. No. 486002 |
| | eye bolt for rinse aid container connection | | |
|  | GEV No. | 510105 | Ref. No. 468053 |
| | hose connector for air trap | | |

| | | | |
|---|--|-----------------|------------------------|
|  | | | |
| 1 | | | |
| GEV No. | 518488 | Ref. No. | 107005 |
| description | air trap | | |
| For models: | 2312-001, 2312-002, 350F, 350FD, 350R, 350RD, 35F, 35FD, 35R, 35RD, 40F, 40FD, 40R, 40RD, 67F, 67R, 913289, 913290, 913291, 913292, 913297, 913298, 913299, 913300, 913356, 913357, 913360, 913361, 913363, 913364, 913372, 913373, 913374, 913375, 913376, 913377, 913391, 913392, 913416, 913418, 913435, 913544, 913545, 913546, 913547, 913578, 913611, 913665, 913666, 913667...(Other models you can see in the webshop) | | |
| accessories for | 518488 | | |
|  | GEV No. | 504618 | Ref. No. 456026 |
| | O-ring EPDM thickness 2.62mm ID ø 15.54mm Qty 1 pcs | | |
|  | GEV No. | 510075 | Ref. No. 437019 |
| | flat gasket rubber ED ø 22mm ID ø 13mm thickness 1.5mm Qty 1 pcs | | |
|  | GEV No. | 510106 | Ref. No. 468029 |
| | hose connector for air trap | | |

| | | | |
|---|--|-----------------|--------|
|  | | | |
| 1 | | | |
| GEV No. | 518641 | Ref. No. | 984007 |
| description | air trap complete ø 34mm H 70mm hose ø 6mm | | |
| For models: | 916020, 916021, 916024, 916025, 916026, 916027, 916030, 916031, 916045, 916247, 916248, 916249, 916250, 916251, 916252, 916382, 916383, 916452, 916504, 916584, 916654, 916670, 916688, 916763, 916921, 916922, 916992, 916993, 917044, 917049, Clean161, Fast145-2, Fast150, Fast160-2, Fast160C, Fast161-2, Ocean360, Ocean360M, Ocean360-UK | | |

| | | | |
|---|---|-----------------|------------------------|
|  | | | |
| 1 | | | |
| GEV No. | 519499 | Ref. No. | 107012 |
| description | air trap L 46mm W 35mm H 72mm thread 3/4" hose ø 5.5mm plastic | | |
| For models: | 2312-007, 913992, 913993, 914100, 914101, 914339, 914342, 914343, 914583, 914592, 914612, 914613, 914624, 914625, 914626, 914627, 914628, 914850, 914851, 914854, 914944, 915143, Fast181, FAST-181, Fast181-230V-3Ph-60Hz, Fast181-400V-3NPh-60Hz, NG271, NG291, NG292, NG292HZ, NG293, NG381, NG38123, NG38123TERMO, NG381C, NG381CDD, NG381CFUR, NG381DDHZ23, NG381DDPS, NG381DDPSHZ23, NG381HPDD, NG381L, NG381LC, NG381LCFUR, NG381LDDPS, NG381TERMO, NG381TXCDD, NIAGARA-271, NIAGARA-283, Niagara-283A...(Other models you can see in the webshop) | | |
| accessories for | 519499 | | |
|  | GEV No. | 516261 | Ref. No. 437098 |
| | flat gasket rubber ED ø 33mm ID ø 25mm thickness 2.5mm for air trap Qty 1 pcs | | |
|  | GEV No. | 519498 | Ref. No. 417120 |
| | nut thread 3/4" H 10mm WS 30 plastic Qty 1 pcs | | |

| | | | |
|---|---|-----------------|------------------------|
|  | | | |
| 1 | | | |
| GEV No. | 510103 | Ref. No. | 984001 |
| description | air trap L 85mm W 20mm H 80mm hose ø 6mm plastic | | |
| For models: | 050F, 050FP, 11F, 11FD, 11F-DVGW, 11R, 11RD, 21F, 21FD, 21R, 21RD, 22F, 22R, 25F, 25FD, 25R, 25RD, 30F, 30FD, 30R, 30RD, 31F, 31FD, 31R, 31RD, 40F, 440F, 44F, 500F, 500FD, 50-ELECTRONIC, 50F, 50FD, 510F, 510FD, 66, E.52, F85, F85P, S621, S623, S624, S626, S631, S633, S634, S636, S651, S651P, S653...(Other models you can see in the webshop) | | |
| spare parts for | 510103 | | |
|  | GEV No. | 505045 | Ref. No. 456009 |
| | O-ring EPDM thickness 1.78mm ID ø 5.28mm Qty 1 pcs | | |
|  | GEV No. | 505094 | Ref. No. — |
| | air trap | | |
|  | GEV No. | 510016 | Ref. No. 486002 |
| | eye bolt for rinse aid container connection | | |
|  | GEV No. | 510105 | Ref. No. 468053 |
| | hose connector for air trap | | |





| | | | |
|--|--|-----------------|------------------------|
|  | | | |
| 1 | | | |
| GEV No. | 510111 | Ref. No. | 984002 |
| description | air trap ø 34mm H 130mm hose ø 6mm plastic | | |
| For models: | R495, R499, R501, R503, R505, R507, R509, R511, R704, R706, R708, S641, S643, S870, S950 | | |
| spare parts for | 510111 | | |
|  | GEV No. | 504618 | Ref. No. 456026 |
| | O-ring EPDM thickness 2.62mm ID ø 15.54mm Qty 1 pcs | | |



Table continues overleaf



| | | | |
|---|----------------|--------|------------------------|
| spare parts for 510111 | | | |
|  | GEV No. | 510075 | Ref. No. 437019 |
| flat gasket rubber ED ø 22mm ID ø 13mm thickness 1.5mm Qty 1 pcs | | | |
|  | GEV No. | 510106 | Ref. No. 468029 |
| hose connector for air trap | | | |



| | | | |
|--------------------|---|-----------------|--------|
| GEV No. | 518200 | Ref. No. | 984005 |
| description | air trap ø 34mm H 78mm hose ø 6mm plastic | | |
| For models: | 10, 12, 14, 161, 221, 2312-001, 2312-002, 271, 272, 350F, 350FD, 350R, 350RD, 35-ELECTRONIC, 35F, 35FD, 35R, 35RD, 362, 400F, 400FD, 400R, 400RD, 40-ELECTRONIC, 40F, 40FD, 40R, 40RD, 45, 450, 46, 460, 67F, 67R, 80, 81, 82, 913289, 913290, 913291, 913292, 913297, 913298, 913299, 913300, 913356, 913357, 913360, 913361, 913363...(Other models you can see in the webshop) | | |

| | | | |
|--|----------------|--------|------------------------|
| spare parts for 518200 | | | |
|  | GEV No. | 504618 | Ref. No. 456026 |
| O-ring EPDM thickness 2.62mm ID ø 15.54mm Qty 1 pcs | | | |
|  | GEV No. | 510075 | Ref. No. 437019 |
| flat gasket rubber ED ø 22mm ID ø 13mm thickness 1.5mm Qty 1 pcs | | | |
|  | GEV No. | 510106 | Ref. No. 468029 |
| hose connector for air trap | | | |



| | | | |
|--------------------|--|-----------------|--------|
| GEV No. | 511959 | Ref. No. | 107014 |
| description | air trap ø 42mm hose ø 6mm plastic | | |
| For models: | 915150, 915151, 915152, 915154, 915155, 915160, 915161, 915162, 915166, 915167, 915168, 915175, 915176, 915177, 915319, 915338, 915341, 915348, 915418, 915419, 915420, 915421, 915479, 915492, 915493, 915547, 915558, 915611, 915612, 915613, 915614, 915615, 915616, 915635, 915663, 915670, 915671, 915747, 915959, 916196, 916197, 916198, 916199, 916200, 916201, 916202, 916203, 916204, 916205, 916206...(Other models you can see in the webshop) | | |



| | | | |
|--------------------|--|-----------------|--------|
| GEV No. | 511993 | Ref. No. | 107013 |
| description | air trap ø 43mm H 33mm hose ø 6mm plastic | | |
| For models: | 915150, 915151, 915152, 915154, 915155, 915157, 915158, 915160, 915161, 915162, 915166, 915167, 915168, 915172, 915173, 915175, 915176, 915177, 915285, 915319, 915338, 915341, 915348, 915418, 915419, 915420, 915421, 915422, 915479, 915492, 915493, 915494, 915495, 915496, 915497, 915547, 915558, 915611, 915612, 915613, 915614, 915615, 915616, 915617, 915618, 915635, 915663, 915670, 915671, 915672...(Other models you can see in the webshop) | | |



| | | | |
|--------------------|---|-----------------|------------------|
| GEV No. | 524810 | Ref. No. | 144027 144032 |
| description | air trap W 95mm H 150mm hose ø 6/8mm plastic | | |
| For models: | 915154, 915155, 915157, 915158, 915172, 915173, 915285, 915422, 915492, 915493, 915494, 915495, 915496, 915497, 915617, 915618, 915672, 915773, 915774, 916045, 916054, 916066, 916067, 916068, 916069, 916077, 916078, 916079, 916080, 916368, 916418, 916419, 916420, 916421, 916422, 916423, 916424, 916594, 916595, 916654, 916686, 916760, Fast160C, Ocean360-UK, River-242, River-242-2, River-242-2T, River-252, River-252-2, River-252-2T...(Other models you can see in the webshop) | | |

air trap accessories



| | | | |
|--------------------|---|-----------------|--------|
| GEV No. | 510075 | Ref. No. | 437019 |
| description | flat gasket rubber ED ø 22mm ID ø 13mm thickness 1.5mm Qty 1 pcs | | |
| For models: | 10, 12, 14, 22F, 22R, 2312-001, 2312-002, 350F, 350FD, 350R, 350RD, 35-ELECTRONIC, 35F, 35FD, 35R, 35RD, 400F, 400FD, 400R, 400RD, 40-ELECTRONIC, 40F, 40FD, 40R, 40RD, 44F, 45, 450, 46, 460, 67F, 67R, 913289, 913290, 913291, 913292, 913297, 913298, 913299, 913300, 913356, 913357, 913360, 913361, 913363, 913364, 913372, 913373, 913374, 913375...(Other models you can see in the webshop) | | |



| | | | |
|--------------------|---|-----------------|--------|
| GEV No. | 510105 | Ref. No. | 468053 |
| description | hose connector for air trap | | |
| For models: | 050F, 050FP, 11F, 11FD, 11F-DVGW, 21F, 21FD, 21R, 21RD, 22F, 22R, 25F, 25FD, 25R, 25RD, 30F, 30FD, 30R, 30RD, 31F, 31FD, 31R, 31RD, 40F, 440F, 44F, 500F, 500FD, 50-ELECTRONIC, 50F, 50FD, 510F, 510FD, 66, E.52, F85, F85P, S621, S623, S624, S626, S631, S633, S634, S636, S651, S654, S810, S815, S830...(Other models you can see in the webshop) | | |

| | | | |
|---|----------------|--------|------------------------|
| spare parts for 510105 | | | |
|  | GEV No. | 510017 | Ref. No. 468007 |
| union screw | | | |



| | | | |
|--------------------|--|-----------------|--------|
| GEV No. | 510106 | Ref. No. | 468029 |
| description | hose connector for air trap | | |
| For models: | 10, 12, 14, 22F, 22R, 2312-001, 2312-002, 350F, 350FD, 350R, 350RD, 40-ELECTRONIC, 40F, 40FD, 40R, 40RD, 44F, 913289, 913290, 913291, 913292, 913297, 913298, 913299, 913300, 913356, 913357, 913360, 913361, 913363, 913364, 913372, 913373, 913374, 913375, 913376, 913377, 913391, 913392, 913416, 913418, 913435, 913544, 913545, 913546, 913547, 913578, 913611, 913665, 913666...(Other models you can see in the webshop) | | |

mechanics for flight type dishwashers



| | | | |
|--------------------|--|-----------------|-----------------|
| GEV No. | 699351 | Ref. No. | 75231 K75649 |
| description | cover for eccentrics plastic D1 ø 147mm D2 ø 32.6mm | | |
| For models: | 914380, 914436, A3EB, A3EBD, A3EBDAKRKYK, A3EBDAKWK, A3EBDBKWK, A3EBDRKYK, A3EBDWK, A3EBDYK, A3EBSAK, A3EBSAKRK, A3EBSAKWK, A3EBSBKWKYK, A3EBSEKWK, A3EBSWK, A4EB, A4EBD, A4EBDAKEKYK, A4EBDAKRK, A4EBDAKWK, A4EBDAKZK, A4EBDBKRK, A4EBDPKWKYK, A4EBDRK, A4EBS, A4EBSAK, A4EBSAKCK, A4EBSAKKEYK, A4EBSAKRK, A4EBSAKRKP, A4EBSAKYK, A4EBSCK, A4EBT, A4EBTSAK, A5EB, A5EBD, A5EBDAKPKWK, A5EBDAKWK, A5EBDAKYK, A5EBDRK, A5EBS, A5EBSAKPKWK, A5EBSAKRK, A5EBSAKRKYK, A5EBSAKWK, A5EBSAKWKYK, A5EBSBKRPK, A5EBSBKWK, A5EBSRK...(Other models you can see in the webshop) | | |



| | | | |
|--------------------|---|-----------------|--------|
| GEV No. | 504423 | Ref. No. | 927048 |
| description | protector L 230mm W 95mm H 16mm hole ø 25x7mm thickness 4mm | | |
| For models: | 161, 221, 271, 272, 362, A3EB, A3EBD, A3EBDAKRKYK, A3EBDAKWK, A3EBDBKWK, A3EBDRKYK, A3EBDWK, A3EBDYK, A3EBSAK, A3EBSAKRK, A3EBSAKWK, A3EBSBKWKYK, A3EBSEKWK, A3EBSWK, A4EB, A4EBD, A4EBDAKEKYK, A4EBDAKRK, A4EBDAKWK, A4EBDAKZK, A4EBDBKRK, A4EBDPKWKYK, A4EBDRK, A4EBS, A4EBSAK, A4EBSAKCK, A4EBSAKKEYK, A4EBSAKRK, A4EBSAKRKP, A4EBSAKYK, A4EBSCK, A4EBT, A4EBTSAK, A5EB, A5EBD, A5EBDAKPKWK, A5EBDAKWK, A5EBDAKYK, A5EBDRK, A5EBS, A5EBSAKPKWK, A5EBSAKRK, A5EBSAKRKYK, A5EBSAKWK, A5EBSAKWKYK...(Other models you can see in the webshop) | | |



| | | | |
|--------------------|---|-----------------|--------|
| GEV No. | 504389 | Ref. No. | 927092 |
| description | roller for transport system L 30mm ID ø 16mm ED ø 30mm | | |
| For models: | 161, 221, 271, 272, 362, CLEAN-160, CLEAN-161, CLEAN-220, CLEAN-221, CLEAN-270, CLEAN-271, CLEAN-272, CLEAN-361, CLEAN-361P, CLEAN-362, CLEAN-471, CLEAN-471P | | |



| | | | |
|--------------------|---|-----------------|--------|
| GEV No. | 524511 | Ref. No. | 927082 |
| description | roller for transport system W 20mm ED ø 24.5mm hole ø 8mm | | |
| For models: | 161, 221, 271, 272, 362, CLEAN-160, CLEAN-161, CLEAN-220, CLEAN-221, CLEAN-270, CLEAN-271, CLEAN-272, CLEAN-361, CLEAN-361P, CLEAN-362, CLEAN-471, CLEAN-471P | | |



| | | | |
|--------------------|---|-----------------|-------|
| GEV No. | 505305 | Ref. No. | DND29 |
| description | spacer bush for transport system L 28.5mm ø 13.5mm ID ø 8mm | | |

EQUIPMENT-SPECIFIC UNITS ELETTROBAR



| | | | |
|--------------------|---|-----------------|-------|
| GEV No. | 504422 | Ref. No. | DNS18 |
| description | tappet for dishwasher L 84mm W 29.5mm H 26mm ø 14mm hole ø 9/10mm | | |



| | | | |
|--------------------|--|-----------------|--------|
| GEV No. | 511994 | Ref. No. | 927288 |
| description | tappet for dishwasher L 84mm W 30mm H 98mm | | |



| | | | |
|--------------------|---|-----------------|--------|
| GEV No. | 511996 | Ref. No. | 927083 |
| description | tappet for dishwasher right L 62mm W 52mm H 19mm hole ø 12mm | | |
| For models: | 161, 221, 271, 272, 362, CLEAN-160, CLEAN-161, CLEAN-220, CLEAN-221, CLEAN-270, CLEAN-271, CLEAN-272, CLEAN-361, CLEAN-361P, CLEAN-362, CLEAN-471, CLEAN-471P | | |

pipes



| | | | |
|--------------------|---|-----------------|-------|
| GEV No. | 698771 | Ref. No. | 42028 |
| description | aspiration tube tube ø 60.5mm L 87mm ID ø 57mm | | |
| For models: | 915747, A3EB, A3EBD, A3EBDAKRKYK, A3EBDAKWK, A3EBDBKWK, A3EBDRKYK, A3EBDWK, A3EBDYK, A3EBSAK, A3EBSAKRK, A3EBSAKWK, A3EBSBKWKYK, A3EBSEKWK, A3EBSWK, A4EB, A4EBD, A4EBDAKEKYK, A4EBDAKRK, A4EBDAKWK, A4EBDAKZK, A4EBDBKRK, A4EBDPKWKYK, A4EBDRK, A4EBS, A4EBSAK, A4EBSAKCK, A4EBSAKKEYK, A4EBSAKRK, A4EBSAKRKP, A4EBSAKYK, A4EBSCK, A4EBT, A4EBTSAK, A5EB, A5EBD, A5EBDAKPKWK, A5EBDAKWK, A5EBDAKYK, A5EBDRK, A5EBS, A5EBSAKPKWK, A5EBSAKRK, A5EBSAKRKYK, A5EBSAKWK, A5EBSAKWKYK, A5EBSBKRPK, A5EBSBKWK, A5EBSRK, A5EBSYK...(Other models you can see in the webshop) | | |

1

| | | | |
|--------------------|--|-----------------|-------|
| GEV No. | 698806 | Ref. No. | 70167 |
| description | connecting fitting tube ø 30/32mm L 50mm plastic | | |
| For models: | NG381, NG38123, NG38123TERMO, NG381C, NG381CDD, NG381CFUR, NG381DDHZ23, NG381DDPS, NG381DDPSHZ23, NG381HPDD, NG381L, NG381LC, NG381LCFUR, NG381LDDPS, NG381TERMO, NG381TXCDD, Niagara-283L-2, Niagara-381, Niagara-381-230V-3Ph-50Hz, Niagara-381-230V-3Ph-60Hz, Niagara-381DP, Niagara-381HPD, Niagara-381L, Niagara-381LC, River-282-2, River-282L-2, River-282LS-2TDE, River-282S-2TDE, River-285, River-295P, River-296P, River-382, River-382-230V-3Ph-50Hz, River-382H, River-382L, River-382L-230V-3Ph-50Hz, River-382LNRG, River-382LTDE, River-382NRG, River-382NRG-230-3Ph-50Hz, River-382TDE, River-482, RV295PS, RV296PS, RV382, RV38223TERMO, RV382AHP, RV382FUR, RV382L, RV382L23TERMO...(Other models you can see in the webshop) | | |



2

| | | | |
|--------------------|--|-----------------|-------|
| GEV No. | 698749 | Ref. No. | 70094 |
| description | pipe L 594mm tube ø 25mm | | |
| For models: | NG381, NG38123, NG38123TERMO, NG381C, NG381CDD, NG381CFUR, NG381DDHZ23, NG381DDPS, NG381DDPSHZ23, NG381HPDD, NG381L, NG381LC, NG381LCFUR, NG381LDDPS, NG381TERMO, NG381TXCDD, Niagara-283L-2, Niagara-381, Niagara-381-230V-3Ph-50Hz, Niagara-381-230V-3Ph-60Hz, Niagara-381DP, Niagara-381HPD, Niagara-381L, Niagara-381LC, River-282-2, River-282L-2, River-282LS-2TDE, River-282S-2TDE, River-285, River-382, River-382-230V-3Ph-50Hz, River-382H, River-382L, River-382L-230V-3Ph-50Hz, River-382LNRG, River-382LTDE, River-382NRG, River-382NRG-230-3Ph-50Hz, River-382TDE, River-482, RV382, RV38223TERMO, RV382AHP, RV382FUR, RV382L, RV382L23TERMO, RV382LRFUR, RV382LR, RV382LS, RV382LSFUR...(Other models you can see in the webshop) | | |



1

| | | | |
|--------------------|--|-----------------|-------|
| GEV No. | 698805 | Ref. No. | 43560 |
| description | T-piece for dishwasher tube ø 27mm L 115mm | | |
| For models: | RIVER-298, RV298, RV298HZ | | |

backflow preventers

backflow preventers



1

| | | | |
|--------------------|---|-----------------|--------|
| GEV No. | 698704 | Ref. No. | 144993 |
| description | air valve for drain hose D1 ø 21mm D2 ø 10.5mm | | |
| For models: | 915154, 915155, 915157, 915158, 915172, 915173, 915285, 915422, 915492, 915493, 915494, 915495, 915496, 915497, 915617, 915618, 915672, 915773, 915774, 916054, 916066, 916067, 916068, 916069, 916077, 916078, 916079, 916080, 916368, 916418, 916419, 916420, 916421, 916422, 916423, 916424, 916594, 916595, 916686, 916760, RIVER-242, River-242-2, River-242-2T, River-252, River-252-2, River-252-2T, River-253, RIVER-262, River-262-2, River-262-2T...(Other models you can see in the webshop) | | |



1

| | | | |
|--------------------|--|-----------------|--------|
| GEV No. | 698703 | Ref. No. | 144995 |
| description | air valve for drain hose D1 ø 21mm D2 ø 6mm ID ø 17mm | | |
| For models: | 915150, 915151, 915152, 915154, 915155, 915157, 915158, 915160, 915161, 915162, 915166, 915167, 915168, 915172, 915173, 915175, 915176, 915177, 915285, 915319, 915338, 915341, 915348, 915418, 915419, 915420, 915421, 915422, 915479, 915492, 915493, 915494, 915495, 915496, 915497, 915547, 915558, 915635, 915663, 915747, FAST-60, FAST-73, NG281, NG281HP, NIAGARA-251, NIAGARA-261, NIAGARA-281, NIAGARA-281HP, PLUVIA-260, Pluvia-270...(Other models you can see in the webshop) | | |



1

| | | | |
|--------------------|--|-----------------|---------|
| GEV No. | 698737 | Ref. No. | 144993B |
| description | air valve total length 78mm hose ø 11mm | | |
| For models: | River-282LS-2TDE, River-282S-2TDE, River-382LTDE, River-382TDE, RV382LS, RV382LSFUR, RV382S, RV382SFUR | | |



1

| | | | |
|--------------------|--|-----------------|--------|
| GEV No. | 512447 | Ref. No. | 144022 |
| description | backflow preventer | | |
| For models: | River-282-2, River-282L-2, River-285, River-382, River-382-230V-3Ph-50Hz, River-382H, River-382L, River-382L-230V-3Ph-50Hz, River-382LNRG, River-382NRG, River-382NRG-230-3Ph-50Hz, River-482, RV382, RV38223TERMO, RV382AHP, RV382FUR, RV382L, RV382L23TERMO, RV382LFUR, RV382LR, RV382LTX, RV382LTXR, RV382R, RV382R23TERMO, RV382RFUR, RV382TERMO, RV382TX, RV382TXR, RV482 | | |



1

| | | | |
|--------------------|---|-----------------|--------|
| GEV No. | 518237 | Ref. No. | 144004 |
| description | backflow preventer | | |
| For models: | 11F, 11FD, 11F-DVGW, 11R, 11RD, 22F, 350F, 350FD, 350R, 350RD, 35-ELECTRONIC, 35F, 35FD, 35R, 35RD, 400F, 400FD, 400R, 400RD, 40-ELECTRONIC, 40F, 40FD, 40R, 40RD, 440F, 44F, 45, 450, 46, 460, 500F, 500FD, 50-ELECTRONIC, 50F, 50FD, 510F, 510FD, CLEAN-3 | | |



1

| | | | |
|--------------------|---|-----------------|--------|
| GEV No. | 518297 | Ref. No. | 144011 |
| description | backflow preventer | | |
| For models: | 050F, 050FP, 2312-001, 2312-002, 913297, 913298, 913299, 913300, 913360, 913361, 913391, 913392, 913546, 913547, 913578, 913611, 913684, 913913, 913914, 913932, 913933, 913992, 913993, 914284, 914318, 914319, 914331, 914338, 914356, 914400, 914401, 914402, 914403, 914404, 914405, 914431, 914449, 914517, 914545, 914592, 914612, 914613, 914642, 914688, 914909, 914979, 915136, 915137, 915140, 915248...(Other models you can see in the webshop) | | |



1

| | | | |
|--------------------|---|-----------------|--------------------|
| GEV No. | 518486 | Ref. No. | 144010 144010NT |
| description | backflow preventer connection 1/2" dishwasher hose ø 12mm | | |
| For models: | 161, 221, 2312-007, 271, 272, 31F, 31FD, 31R, 31RD, 362, 80, 81, 82, 913289, 913290, 913291, 913292, 913356, 913357, 913372, 913373, 913374, 913375, 913416, 913418, 913435, 913544, 913545, 913665, 913666, 913667, 913668, 913685, 913771, 913772, 913773, 913774, 913832, 913837, 913911, 913912, 913948, 913950, 913977, 913984, 913990, 914100, 914101, 914165, 914166...(Other models you can see in the webshop) | | |



1

| | | | |
|--------------------|--|-----------------|--------|
| GEV No. | 517572 | Ref. No. | 144992 |
| description | backflow preventer for drain hose ø 31/21mm | | |
| For models: | 915611, 915612, 915613, 915614, 915615, 915616, 915617, 915618, 915670, 915671, 915672, 915773, 915774, 915959, 916020, 916021, 916024, 916025, 916026, 916027, 916030, 916031, 916045, 916066, 916077, 916078, 916196, 916197, 916198, 916199, 916200, 916247, 916248, 916249, 916250, 916251, 916252, 916382, 916383, 916409, 916410, 916418, 916419, 916452, 916504, 916584, 916591, 916592, 916593, 916594...(Other models you can see in the webshop) | | |



1

| | | | |
|--------------------|---|-----------------|---------|
| GEV No. | 512445 | Ref. No. | 144991B |
| description | backflow preventer hose ø 11mm | | |
| For models: | River-282-2, River-282L-2, River-282LS-2TDE, River-282S-2TDE, River-285, River-382, River-382-230V-3Ph-50Hz, River-382H, River-382L, River-382L-230V-3Ph-50Hz, River-382LNRG, River-382LTDE, River-382NRG, River-382NRG-230-3Ph-50Hz, River-382TDE, River-482, RV382, RV38223TERMO, RV382AHP, RV382FUR, RV382L, RV382L-23TERMO, RV382LFUR, RV382LR, RV382LS, RV382LSFUR, RV382LTX, RV382LTXR, RV382R, RV382R23TERMO, RV382RFUR, RV382S, RV382SFUR, RV382TERMO, RV382TX, RV382TXR, RV482 | | |



1

| | | | |
|--------------------|--|-----------------|--------|
| GEV No. | 512446 | Ref. No. | 144991 |
| description | backflow preventer hose ø 11mm | | |
| For models: | 915150, 915151, 915152, 915154, 915155, 915157, 915158, 915160, 915161, 915162, 915166, 915167, 915168, 915172, 915173, 915175, 915319, 915348, 915418, 915419, 915420, 915421, 915422, 915479, 915492, 915493, 915494, 915495, 915496, 915497, 915547, 915558, 915635, 915663, 915747, 916054, 916067, 916068, 916069, 916079, 916080, 916201, 916202, 916203, 916204, 916205, 916206, 916207, 916208, 916209...(Other models you can see in the webshop) | | |



| | | | |
|---|---|-----------------|----------|
|  | | | |
| 1 | | | |
| GEV No. | 524882 | Ref. No. | H.324091 |
| description | backflow preventer hose ø 12mm | | |
| For models: | 915150, 915151, 915152, 915154, 915155, 915157, 915158, 915160, 915161, 915162, 915166, 915167, 915168, 915172, 915173, 915175, 915176, 915177, 915285, 915319, 915338, 915341, 915348, 915418, 915419, 915420, 915421, 915422, 915479, 915492, 915493, 915494, 915495, 915496, 915497, 915547, 915558, 915635, 915663, 915747, NIAGARA-251, NIAGARA-261, PLUVIA-260, Pluvia-270, RIVER-252, RIVER-253, RIVER-262, River-282LS-2TDE, River-282S-2TDE, River-382LTDE...(Other models you can see in the webshop) | | |

| | | | |
|---|--|-----------------|--------|
|  | | | |
| 2 | | | |
| GEV No. | 514502 | Ref. No. | 144030 |
| description | backflow preventer plastic hose ø 11mm | | |
| For models: | 915150, 915151, 915152, 915154, 915155, 915157, 915158, 915160, 915161, 915162, 915166, 915167, 915168, 915172, 915173, 915175, 915319, 915348, 915418, 915419, 915420, 915421, 915422, 915479, 915492, 915493, 915494, 915495, 915496, 915497, 915547, 915558, 915611, 915612, 915613, 915614, 915615, 915616, 915617, 915618, 915635, 915663, 915670, 915671, 915672, 915686, 915694, 915695, 915696, 915747...(Other models you can see in the webshop) | | |

accessories

| | | | |
|---|--|-----------------|--------|
|  | | | |
| 1 | | | |
| GEV No. | 511997 | Ref. No. | 476008 |
| description | ball for back flow restrictor ø 8mm plastic | | |
| For models: | 913992, 913993, 914583, 914592, 914612, 914613, 914628, 914944, 915143, 915150, 915151, 915152, 915154, 915155, 915157, 915158, 915160, 915161, 915162, 915166, 915167, 915168, 915172, 915173, 915175, 915176, 915177, 915285, 915319, 915338, 915341, 915348, 915418, 915419, 915420, 915421, 915422, 915479, 915492, 915493, 915494, 915495, 915496, 915497, 915547, 915558, 915611, 915612, 915613, 915614...(Other models you can see in the webshop) | | |

miscellaneous

| | | | |
|---|---------------------|-----------------|-------|
|  | | | |
| 1 | Image not available | | |
| GEV No. | 513115 | Ref. No. | DWR15 |
| description | bush | | |

| | | | |
|---|--------------------|-----------------|--------|
|  | | | |
| 1 | | | |
| GEV No. | 513139 | Ref. No. | DWP725 |
| description | connecting fitting | | |

| | | | |
|--|--|-----------------|--------|
|  | | | |
| 1 | | | |
| GEV No. | 518241 | Ref. No. | 480087 |
| description | cover | | |
| For models: | 913291, 913292, 913357, 913374, 913375, 913416, 913435, 913545, 913666, 913668, 913685, 913773, 913774, 913911, 913912, 913948, 913950, 913977, 913984, 913990, 913992, 913993, 914214, 914316, 914317, 914392, 914393, 914394, 914395, 914396, 914397, 914441, 914442, 914515, 914516, 914537, 914543, 914547, 914583, 914592, 914612, 914613, 914683, 914684, 914689, 914863, 914874, 915138, 915139, 915143...(Other models you can see in the webshop) | | |

| | | | |
|--|--|-----------------|--------|
|  | | | |
| 1 | Image not available | | |
| GEV No. | 518184 | Ref. No. | 325047 |
| description | extension | | |
| For models: | 913992, 913993, 914583, 914592, 914612, 914613, 915143, CLEAN-3, RIVER-40, RIVER-40-CRP, RIVER-43, RIVER-44, RIVER-44-CRP, River-44-CRP-ST, RIVER-44CRP-ST | | |

| | | | |
|--|---|-----------------|--------|
|  | | | |
| 1 | | | |
| GEV No. | 519481 | Ref. No. | 927110 |
| description | heater battery L 440mm W 260mm H 195mm | | |
| For models: | 161, 221, 271, 272, 362, CLEAN-160, CLEAN-161, CLEAN-220, CLEAN-221, CLEAN-270, CLEAN-271, CLEAN-272, CLEAN-361, CLEAN-361P, CLEAN-362, CLEAN-471, CLEAN-471P, RIVER-150, RV150 | | |



| | | | |
|---|---|-----------------|--------|
|  | | | |
| 1 | | | |
| GEV No. | 698872 | Ref. No. | 480153 |
| description | lid for housing H 8mm D1 ø 27mm D2 ø 17mm | | |
| For models: | 915611, 915612, 915613, 915614, 915615, 915616, 915670, 915671, 915959, 916196, 916197, 916198, 916199, 916200, 916409, 916410, 916591, 916592, 916593, 916877, Niagara-241, Niagara-241-2, Niagara-341, Pluvia-240 | | |

| | | | |
|---|--|-----------------|------|
|  | | | |
| 1 | | | |
| GEV No. | 698716 | Ref. No. | CWP2 |
| description | PCB support L 34mm | | |
| For models: | CNT800CH, Fast180, Fast180-230V-3Ph-60Hz, Fast181, FAST-60, FAST-73, NG271, NG281, NG281CDD, NG281HP, NG281HPDD, NG281HZ23, NG281HZ23DD, NG291, NG292, NG292HZ, NG293, NG381, NG38123, NG38123TERMO, NG381C, NG381CDD, NG381CFUR, NG381DDHZ23, NG381DDPS, NG381DDPSHZ23, NG381HPDD, NG381L, NG381LC, NG381LCFUR, NG381LDDPS, NG381TERMO, NG381TXCDD, NIAGARA-271, NIAGARA-281, Niagara-281-2, Niagara-281HP, NIAGARA-283, Niagara-283A, Niagara-283L-2, NIAGARA-291, NIAGARA-292, Niagara-292-400V-3Ph-60Hz, NIAGARA-293, Niagara-381, Niagara-381-230V-3Ph-50Hz, Niagara-381-230V-3Ph-60Hz, Niagara-381DP, Niagara-381HPD, Niagara-381L...(Other models you can see in the webshop) | | |

| | | | |
|--|---|-----------------|--------|
|  | | | |
| 1 | | | |
| GEV No. | 343006 | Ref. No. | 214086 |
| description | protective film for dishwasher self-adhesive L 485mm W 360mm Qty 1 pcs | | |
| For models: | 2312-001, 2312-002, 2312-007, 2312-009-CRP, 46, 460, 913297, 913298, 913299, 913300, 913360, 913361, 913391, 913392, 913546, 913547, 913578, 913611, 913684, 913932, 913933, 913992, 913993, 914100, 914101, 914326, 914331, 914339, 914342, 914343, 914400, 914401, 914402, 914403, 914404, 914405, 914406, 914449, 914517, 914545, 914583, 914592, 914612, 914613, 914624, 914625, 914626, 914627, 914628, 914688...(Other models you can see in the webshop) | | |

| | | | |
|---|--|-----------------|--------|
|  | | | |
| 1 | | | |
| GEV No. | 698871 | Ref. No. | 419036 |
| description | spacer for PCB L 18mm W 6mm D1 ø 6mm D2 ø 3mm | | |
| For models: | 2312-007, 2312-009-CRP, 913911, 913912, 913913, 913914, 913950, 913977, 913984, 913990, 913992, 913993, 914100, 914101, 914165, 914166, 914167, 914168, 914206, 914214, 914284, 914316, 914317, 914318, 914319, 914338, 914339, 914342, 914343, 914355, 914356, 914431, 914516, 914543, 914583, 914592, 914612, 914613, 914624, 914625, 914626, 914627, 914628, 914642, 914684, 914850, 914851, 914854, 914874, 914909...(Other models you can see in the webshop) | | |

| | | | |
|---|--|-----------------|--------|
|  | | | |
| 1 | | | |
| GEV No. | 698875 | Ref. No. | 461028 |
| description | spacer for PCB L 19mm D1 ø 10mm | | |
| For models: | 915160, 915161, 915162, 915175, 915319, 915496, 915663, 916067, 916068, 916069, 916079, 916080, 916181, 916183, 916184, 916185, 916201, 916202, 916203, 916204, 916205, 916206, 916207, 916208, 916209, 916237, 916238, 916239, 916240, 916241, 916242, 916243, 916244, 916245, 916246, 916365, 916366, 916367, 916368, 916401, 916402, 916403, 916404, 916405, 916406, 916407, 916408, 916411, 916412, 916413...(Other models you can see in the webshop) | | |

| | | | |
|--|---|-----------------|--------|
|  | | | |
| 1 | | | |
| GEV No. | 511995 | Ref. No. | 927146 |
| description | water distributor for cold water brass L 170mm W 30mm H 30mm thread 1/2" IT | | |
| For models: | CLEAN-361, CLEAN-361P, CLEAN-471, CLEAN-471P, RIVER-150, RV150 | | |

door mechanics

spare parts and accessories

| | | | |
|---|--|-----------------|-------|
|  | | | |
| 1 | | | |
| GEV No. | 507579 | Ref. No. | 75064 |
| description | catch hook for door | | |
| For models: | A3EB, A3EBD, A3EBDAKRKYK, A3EBDAKWK, A3EBDBKWK, A3EBDRKYK, A3EBDVK, A3EBDYK, A3EBSAK, A3EBSAKRK, A3EBSAKWK, A3EBSBKWKYK, A3EBSEKWK, A3EBSWK, A4EB, A4EBD, A4EBDAKEKYK, A4EBDAKRK, A4EBDAKWK, A4EBDAKZK, A4EBDBKRK, A4EBDPKWKYK, A4EBDRK, A4EBS, A4EBSAK, A4EBSAKCK, A4EBSAKEKYK, A4EBSAKRK, A4EBSAKRKP, A4EBSAKYK, A4EBSCK, A4EBT, A4EBTSAK, A5EB, A5EBD, A5EBDAKPKWK, A5EBDAKWK, A5EBDAKYK, A5EBDRK, A5EBS, A5EBSAKPKWK, A5EBSAKRK, A5EBSAKRKYK, A5EBSAKWK, A5EBSAKWKYK, A5EBSBKRPK, A5EBSBKWK, A5EBSRK, A5EBSYK, GL284EB...(Other models you can see in the webshop) | | |



| | | | |
|---|---|-----------------|-------|
|  | | | |
| 1 | | | |
| GEV No. | 507580 | Ref. No. | 75226 |
| description | catch hook for door | | |
| For models: | 914380, 914436, A3EB, A3EBD, A3EBDAKRKYK, A3EBDAKWK, A3EBDBKWK, A3EBDRKYK, A3EBDVK, A3EBDYK, A3EBSAK, A3EBSAKRK, A3EBSAKWK, A3EBSBKWKYK, A3EBSEKWK, A3EBSWK, A4EB, A4EBD, A4EBDAKEKYK, A4EBDAKRK, A4EBDAKWK, A4EBDAKZK, A4EBDBKRK, A4EBDPKWKYK, A4EBDRK, A4EBS, A4EBSAK, A4EBSAKCK, A4EBSAKEYK, A4EBSAKRK, A4EBSAKRKP, A4EBSAKYK, A4EBSCK, A4EBT, A4EBTSAK, A5EB, A5EBD, A5EBDAKPKWK, A5EBDAKWK, A5EBDAKYK, A5EBDRK, A5EBS, A5EBSAKPKWK, A5EBSAKRK, A5EBSAKRKYK, A5EBSAKWK, A5EBSAKWKYK, A5EBSBKRPK, A5EBSBKWK, A5EBSRK...(Other models you can see in the webshop) | | |

spring holders

| | | | |
|---|--|-----------------|--------|
|  | | | |
| 1 | | | |
| GEV No. | 551324 | Ref. No. | 307014 |
| description | spring holder H 16mm L 17mm W 20mm | | |
| For models: | 915150, 915151, 915152, 915154, 915155, 915157, 915158, 915160, 915161, 915162, 915166, 915167, 915168, 915172, 915173, 915175, 915176, 915177, 915285, 915319, 915338, 915341, 915348, 915418, 915419, 915420, 915421, 915422, 915479, 915492, 915493, 915494, 915495, 915496, 915497, 915547, 915558, 915635, 915663, 915747, 916054, 916067, 916068, 916069, 916079, 916080, 916201, 916202, 916203, 916204...(Other models you can see in the webshop) | | |

springs

miscellaneous

| | | | |
|---|--|-----------------|--------|
|  | | | |
| 1 | | | |
| GEV No. | 698809 | Ref. No. | 449058 |
| description | spring L 170mm W 75mm | | |
| For models: | 915150, 915151, 915152, 915154, 915155, 915157, 915158, 915160, 915161, 915162, 915166, 915167, 915168, 915172, 915173, 915175, 915176, 915177, 915285, 915319, 915338, 915341, 915348, 915418, 915419, 915420, 915421, 915422, 915479, 915492, 915493, 915494, 915495, 915496, 915497, 915547, 915558, 915635, 915663, 915747, 916054, 916067, 916068, 916069, 916079, 916080, 916201, 916202, 916203, 916204...(Other models you can see in the webshop) | | |

tension springs

| | | | |
|---|--|-----------------|------------------|
|  | | | |
| 1 | | | |
| GEV No. | 701154 | Ref. No. | 449059 449063 |
| description | tension spring \varnothing 10.5mm total length 200mm wire gauge \varnothing 1.3mm for door mechanism | | |
| For models: | 915160, 915161, 915162, 915166, 915167, 915168, 915172, 915173, 915175, 915176, 915177, 915285, 915319, 915338, 915341, 915348, 915418, 915419, 915420, 915421, 915422, 915479, 915496, 915497, 915547, 915558, 915635, 915663, 915747, 916054, 916068, 916069, 916080, 916205, 916206, 916207, 916208, 916209, 916365, 916366, 916367, 916368, 916414, 916415, 916416, 916417, 916422, 916423, 916424, 916684...(Other models you can see in the webshop) | | |

| | | | |
|--|--|-----------------|--------------------------------|
|  | | | |
| 1 | | | |
| GEV No. | 701227 | Ref. No. | 449057 H.227855 H.231937 |
| description | tension spring \varnothing 10mm total length 155mm wire gauge \varnothing 1.1mm L1 60mm L2 11mm for door mechanism | | |
| For models: | 2312-007, 2312-009-CRP, 914100, 914101, 914339, 914342, 914343, 914624, 914625, 914626, 914627, 914628, 914850, 914851, 914854, 914944, RIVER-48, RIVER-50, RIVER-50-CRP, RIVER-50-CRP-SP, RIVER-54, RIVER-54CRP, RIVER-54-CRP-s.p., RIVER-54-CRP-SP, RIVER-61 | | |

| | | | |
|--|--|-----------------|--------|
|  | | | |
| 1 | | | |
| GEV No. | 519604 | Ref. No. | 449064 |
| description | tension spring \varnothing 21mm L1 58mm wire gauge \varnothing 2mm L2 13mm L3 13mm total length 84mm | | |
| For models: | 915617, 915618, 915672, 915773, 915774, 916066, 916077, 916078, 916418, 916419, 916594, 916595, RIVER-242, RIVER-242-2, RIVER-242-2T, RIVER-342C, RIVER-342T | | |

linkage

| | | | |
|--|--|-----------------|-------|
|  | | | |
| 1 | | | |
| GEV No. | 698800 | Ref. No. | 44593 |
| description | bar L 670mm thread M6/M10 \varnothing 10mm | | |
| For models: | NG293, NIAGARA-293, RIVER-296, RIVER-296P, RIVER-297, RIVER-298, RV296, RV296PS, RV297, RV298, RV298HZ | | |

| | | | |
|--|---|-----------------|---------------------------|
|  | | | |
| 1 | | | |
| GEV No. | 518558 | Ref. No. | 929016 999229 DAT43 |
| description | door pin complete with threaded shaft tie bar | | |
| For models: | 55, E.65 | | |

| | | | |
|--|--|-----------------|--------|
|  | | | |
| 1 | | | |
| GEV No. | 518362 | Ref. No. | 304024 |
| description | door pin door pin | | |
| For models: | 2312-007, 2312-009-CRP, 914100, 914101, 914339, 914342, 914343, 914624, 914625, 914626, 914627, 914628, 914850, 914851, 914854, 914944, RIVER-48, RIVER-50, RIVER-50-CRP, RIVER-50-CRP-SP, RIVER-54, RIVER-54CRP, RIVER-54-CRP-s.p., RIVER-54-CRP-SP, RIVER-61 | | |



| | | | |
|--|--|-----------------|--------|
|  | | | |
| 1 | | | |
| GEV No. | 518355 | Ref. No. | 304021 |
| description | door pin stop rod | | |
| For models: | 050F, 050FP, 2312-001, 2312-002, 45, 450, 46, 460, 500F, 500FD, 50F, 50FD, 510F, 510FD, 913297, 913298, 913299, 913300, 913360, 913361, 913391, 913392, 913418, 913546, 913547, 913578, 913611, 913684, 913913, 913914, 913932, 913933, 914167, 914168, 914284, 914318, 914319, 914326, 914331, 914338, 914356, 914398, 914399, 914400, 914401, 914402, 914403, 914404, 914405, 914406...(Other models you can see in the webshop) | | |





| | | | |
|--|--|-----------------|------------------|
|  <p>Image not available</p> | | | |
| GEV No. | 519418 | Ref. No. | 41093 C.41093 |
| description | tie bar L 560mm ø 10mm | | |
| For models: | KLP105EB, LP105DDDTBE, LP105DDDTBE, LP105EB, U132, U61, U61E, U61HE, U70 | | |

threaded shafts

| | | | |
|---|--|-----------------|--------|
|  | | | |
| GEV No. | 698798 | Ref. No. | 304028 |
| description | thread bolt ø 7mm L 30.2mm thread M5 | | |
| For models: | 915160, 915161, 915162, 915175, 915319, 915663, 916067, 916068, 916069, 916079, 916080, 916201, 916202, 916203, 916204, 916205, 916206, 916207, 916208, 916209, 916365, 916366, 916367, 916368, 916411, 916412, 916413, 916414, 916415, 916416, 916417, 916420, 916421, 916422, 916423, 916424, 916684, 916685, 916686, 916760, 916761, 916762, 916802, 916812, 916813, 916878, 916885, Fast170, Fast170S, Niagara-251-2...(Other models you can see in the webshop) | | |

| | | | |
|---|--|-----------------|------------------|
|  | | | |
| GEV No. | 518559 | Ref. No. | 929015 DWP380 |
| description | threaded shaft | | |
| For models: | 55, E.65 | | |
| accessories for | 518559 | | |
|  | | | |
| GEV No. | 518560 | Ref. No. | — |
| description | retaining ring E D1 ø 7mm D2 ø 14mm DIN 6799 | | |

sliding plates

| | | | |
|---|---|-----------------|--------|
|  | | | |
| GEV No. | 519407 | Ref. No. | 929210 |
| description | sliding plate dimensions 60x15mm | | |
| accessories for | 519407 | | |
|  | | | |
| GEV No. | 519406 | Ref. No. | 929209 |
| description | gasket for sliding plate dimensions 69x16mm | | |

| | | | |
|---|--|-----------------|--------|
|  | | | |
| GEV No. | 517801 | Ref. No. | 307012 |
| description | sliding plate L 75mm W 12mm H 10mm | | |
| For models: | 2312-007, 2312-009-CRP, 914100, 914101, 914339, 914342, 914343, 914624, 914625, 914626, 914627, 914628, 914850, 914851, 914854, 914944, LP60, NG271, NG291, NIAGARA-271, NIAGARA-291, RIVER-294, RIVER-48, RIVER-50, RIVER-50-CRP, RIVER-50-CRP-SP, RIVER-54, RIVER-54CRP, RIVER-54-CRP-s.p., RIVER-54-CRP-SP, RIVER-61, RIVER-71, RV294, RV71, U60E | | |

| | | | |
|--|--|-----------------|--------|
|  | | | |
| GEV No. | 518356 | Ref. No. | 307003 |
| description | sliding plate sliding plate | | |
| For models: | 050F, 050FP, 22F, 22R, 2312-001, 2312-002, 40F, 440F, 44F, 45, 450, 46, 460, 500F, 500FD, 50F, 50FD, 510F, 510FD, 913297, 913298, 913299, 913300, 913360, 913361, 913391, 913392, 913418, 913546, 913547, 913578, 913611, 913684, 913913, 913914, 913932, 913933, 914167, 914168, 914284, 914318, 914319, 914326, 914331, 914338, 914356, 914398, 914399, 914400, 914401...(Other models you can see in the webshop) | | |

| | | | |
|--|---|-----------------|--------|
|  | | | |
| GEV No. | 518353 | Ref. No. | 307005 |
| description | stop plastic for door L 60mm W 12.5mm H 10mm | | |
| For models: | 400F, 400FD, 400R, 400RD, 40-ELECTRONIC, 40F, 40FD, 40R, 40RD, 67F, 67R, 913291, 913292, 913357, 913374, 913375, 913416, 913435, 913545, 913666, 913668, 913685, 913773, 913774, 913911, 913912, 913948, 913950, 913977, 913984, 913990, 914214, 914316, 914317, 914392, 914393, 914394, 914395, 914396, 914397, 914441, 914442, 914515, 914516, 914537, 914543, 914547, 914683, 914684, 914689...(Other models you can see in the webshop) | | |

hinges

| | | | |
|---|-------------------------------------|-----------------|-----------|
|  | | | |
| GEV No. | 518547 | Ref. No. | 311002.CR |
| description | door hinge hinge mounting pos. left | | |
| For models: | 31F, 31FD, 31R, 31RD | | |

| | | | |
|--|---|-----------------|-----------|
|  | | | |
| GEV No. | 518551 | Ref. No. | 311005.CR |
| description | door hinge hinge mounting pos. left | | |
| For models: | 913363, 913364, 913376, 913377, E.41, E.42, E.52, E41 | | |





| | | | |
|---|--------------------------------------|-----------------|-----------|
|  | | | |
| 1 | | | |
| GEV No. | 518253 | Ref. No. | 311001.CR |
| description | door hinge hinge mounting pos. right | | |
| For models: | 31F, 31FD, 31R, 31RD | | |

| | | | |
|---|---|-----------------|-----------|
|  | | | |
| 1 | | | |
| GEV No. | 518550 | Ref. No. | 311006.CR |
| description | door hinge hinge mounting pos. right | | |
| For models: | 913363, 913364, 913376, 913377, E.41, E.42, E.52, E41 | | |

| | | | |
|---|--|-----------------|-------|
|  | | | |
| 1 | | | |
| GEV No. | 504797 | Ref. No. | 35060 |
| description | door hinge mounting pos. left ø 10mm L 70mm | | |
| For models: | LP60, NG271, NG291, NIAGARA-271, NIAGARA-291, RIVER-294, RIVER-71, RV294, RV71, U60E | | |

| | | | |
|---|--|-----------------|--------|
|  | | | |
| 1 | | | |
| GEV No. | 518301 | Ref. No. | 311019 |
| description | door hinge mounting pos. left/right | | |
| For models: | 913297, 913298, 913299, 913300, 913360, 913361, 913391, 913392, 913418, 913546, 913547, 913578, 913611, 913684, 913913, 913914, 913932, 913933, 914167, 914168, 914284, 914326, 914331, 914356, 914398, 914399, 914400, 914401, 914402, 914403, 914404, 914405, 914406, 914443, 914449, 914517, 914545, 914568, 914642, 914688, 914909, 914943, 914979, 915136, 915137, 915140, 915248, 915483, 915484, 915528...(Other models you can see in the webshop) | | |

| | | | |
|---|---------------------------------------|-----------------|--------|
|  | | | |
| 1 | | | |
| GEV No. | 518122 | Ref. No. | 030157 |
| description | hinge complete for dishwasher L 588mm | | |
| For models: | 2312-007, 2312-009-CRP | | |

| | | | |
|---|---|-----------------|--------|
|  <p>Image not available</p> | | | |
| 1 | | | |
| GEV No. | 518265 | Ref. No. | 311010 |
| description | hinge mounting pos. right | | |
| For models: | 45, 450, 46, 460, 500F, 500FD, 50F, 50FD, 510F, 510FD | | |

| | | | |
|---|--|-----------------|--------|
|  | | | |
| 1 | | | |
| GEV No. | 510090 | Ref. No. | 449036 |
| description | spring door lock spring mounting pos. door lock | | |
| For models: | 11F, 11FD, 11F-DVGW, 11R, 11RD, 350F, 350FD, 350R, 350RD, 35-ELECTRONIC, 35F, 35FD, 35R, 35RD, 400F, 400FD, 400R, 400RD, 40-ELECTRONIC, 40F, 40FD, 40R, 40RD, 46, 500F, 500FD, 50-ELECTRONIC, 50F, 50FD, 510F, 510FD, 67F, 67R, 913289, 913290, 913291, 913292, 913356, 913357, 913363, 913364, 913372, 913373, 913374, 913375, 913376, 913377, 913416, 913435, 913544...(Other models you can see in the webshop) | | |

| | | | |
|--|---|-----------------|---------------------|
| <h3>hinge camps</h3> | | | |
|  | | | |
| 1 | | | |
| GEV No. | 518257 | Ref. No. | 307002 307002.CR |
| description | hinge camp mounting pos. left | | |
| For models: | 21F, 21FD, 21R, 21RD, 25F, 25FD, 25R, 25RD, 30F, 30FD, 30R, 30RD, 31F, 31FD, 31R, 31RD, 440F, 44F, S621, S623, S624, S626, S631, S633, S634, S636, S651, S651P, S653, S654, S655, S810, S815, S830, S835, SR651 | | |

| | | | |
|---|--|-----------------|--------|
|  | | | |
| 1 | | | |
| GEV No. | 518262 | Ref. No. | 311009 |
| description | hinge camp mounting pos. left | | |
| For models: | 350F, 350FD, 350R, 350RD, 35-ELECTRONIC, 35F, 35FD, 35R, 35RD, 400F, 400FD, 400R, 400RD, 40-ELECTRONIC, 40F, 40FD, 40R, 40RD, 67F, 67R, 913289, 913290, 913291, 913292, 913356, 913357, 913372, 913373, 913374, 913375, 913416, 913435, 913544, 913545, 913665, 913666, 913667, 913668, 913685, 913771, 913772, 913773, 913774, 913832, 913837, 913911, 913912, 913948, 913950, 913977...(Other models you can see in the webshop) | | |

| | | | |
|--|--|-----------------|--------|
|  | | | |
| 1 | | | |
| GEV No. | 518553 | Ref. No. | 307008 |
| description | hinge camp mounting pos. left | | |
| For models: | 11F, 11FD, 11F-DVGW, 11R, 11RD, 22F, 22R, 40F, 913363, 913364, 913376, 913377, E.41, E.42, E.52, E41 | | |



| | | | |
|--------------------|--|-----------------|--------|
| GEV No. | 518261 | Ref. No. | 311008 |
| description | hinge camp mounting pos. right | | |
| For models: | 67F, 67R, 913289, 913290, 913291, 913292, 913356, 913357, 913372, 913373, 913374, 913375, 913416, 913435, 913544, 913545, 913665, 913666, 913667, 913668, 913685, 913771, 913772, 913773, 913774, 913832, 913837, 913911, 913912, 913948, 913950, 913977, 913984, 913990, 914165, 914166, 914206, 914214, 914316, 914317, 914355, 914386, 914387, 914388, 914389, 914390, 914391, 914392, 914393, 914394...(Other models you can see in the webshop) | | |



| | | | |
|--------------------|--|-----------------|--------|
| GEV No. | 518552 | Ref. No. | 307009 |
| description | hinge camp mounting pos. right | | |
| For models: | 11F, 11FD, 11F-DVGW, 11R, 11RD, 22F, 22R, 40F, 913363, 913364, 913376, 913377, E.41, E.42, E.52, E41 | | |

hinge pins



| | | | |
|--------------------|---|-----------------|--------|
| GEV No. | 518264 | Ref. No. | 325034 |
| description | hinge pin hinge pin | | |
| For models: | 400F, 400FD, 400R, 400RD, 40-ELECTRONIC, 40F, 40FD, 40R, 40RD, 67F, 67R, 913291, 913292, 913357, 913374, 913375, 913416, 913435, 913545, 913666, 913668, 913685, 913773, 913774, 913911, 913912, 913948, 913950, 913977, 913984, 913990, 914214, 914316, 914317, 914392, 914393, 914394, 914395, 914396, 914397, 914441, 914442, 914515, 914516, 914537, 914543, 914547, 914683, 914684, 914689...(Other models you can see in the webshop) | | |



| | | | |
|--------------------|---|-----------------|--------|
| GEV No. | 518267 | Ref. No. | 325036 |
| description | hinge pin hinge pin | | |
| For models: | 050F, 050FP, 2312-001, 2312-002, 45, 450, 46, 460, 500F, 500FD, 50-ELECTRONIC, 50F, 50FD, 510F, 510FD, 913297, 913298, 913299, 913300, 913360, 913361, 913391, 913392, 913418, 913546, 913547, 913578, 913611, 913684, 913913, 913914, 913932, 913933, 914167, 914168, 914284, 914318, 914319, 914326, 914331, 914338, 914356, 914398, 914399, 914400, 914401, 914402, 914403, 914404, 914405...(Other models you can see in the webshop) | | |



| | | | |
|--------------------|--|-----------------|--------|
| GEV No. | 518555 | Ref. No. | 325033 |
| description | hinge pin hinge pin | | |
| For models: | 11F, 11FD, 11F-DVGW, 11R, 11RD, 22F, 913363, 913364, 913376, 913377, E.41, E.42, E.52, E41 | | |

door seals

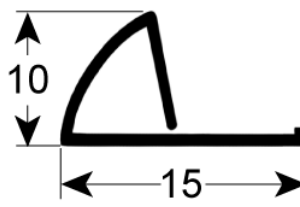

| | | | |
|--------------------|---|-----------------|--------|
| GEV No. | 512461 | Ref. No. | 437109 |
| description | door seal L 450mm W 17mm | | |
| For models: | 915611, 915612, 915613, 915614, 915615, 915616, 915670, 915671, 915959, 916196, 916197, 916198, 916199, 916200, 916409, 916410, 916591, 916592, 916593, 916877, Niagara-241, Niagara-241-2, Niagara-341, Pluvia-240 | | |

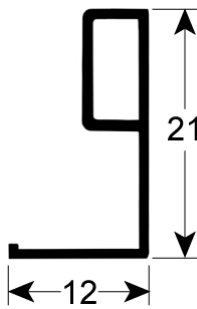

| | | | |
|--------------------|--|-----------------|--------|
| GEV No. | 512462 | Ref. No. | 437110 |
| description | door seal L 450mm W 21mm | | |
| For models: | 915617, 915618, 915672, 915773, 915774, 916066, 916077, 916078, 916418, 916419, 916594, 916595, River-242, River-242-2, River-242-2T, River-342C, River-342T | | |

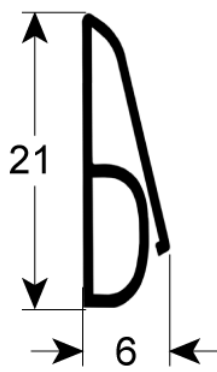

| | | | |
|--------------------|--|-----------------|-------|
| GEV No. | 512472 | Ref. No. | 35017 |
| description | door seal L 625mm W 21mm | | |
| For models: | NG271, NG291, NIAGARA-271, NIAGARA-291, RIVER-294, RV294 | | |



| | | | |
|--------------------|--|-----------------|-------|
| GEV No. | 512471 | Ref. No. | 41583 |
| description | door seal L 740mm W 21mm | | |
| For models: | NG292HZ, Niagara-292-400V-3Ph-60Hz, River-295P, River-296P, RV295PS, RV296PS | | |

door guides

| | | | |
|--------------------|--|-----------------|--------|
| GEV No. | 698744 | Ref. No. | 307015 |
| description | door guides L 109mm W 24.5mm H 18mm mounting pos. left/right | | |
| For models: | 915150, 915151, 915152, 915154, 915155, 915157, 915158, 915160, 915161, 915162, 915166, 915167, 915168, 915172, 915173, 915175, 915176, 915177, 915285, 915319, 915338, 915341, 915348, 915418, 915419, 915420, 915421, 915422, 915479, 915492, 915493, 915494, 915495, 915496, 915497, 915547, 915558, 915635, 915663, 915747, 916054, 916067, 916068, 916069, 916079, 916080, 916201, 916202, 916203, 916204...(Other models you can see in the webshop) | | |

| | | | |
|--------------------|---|-----------------|--------|
| GEV No. | 698743 | Ref. No. | 307016 |
| description | door guides L 88.5mm W 14mm H 6.3mm | | |
| For models: | 915611, 915612, 915613, 915614, 915615, 915616, 915617, 915618, 915670, 915671, 915672, 915773, 915774, 915959, 916066, 916077, 916078, 916196, 916197, 916198, 916199, 916200, 916409, 916410, 916418, 916419, 916591, 916592, 916593, 916594, 916595, 916877, NIAGARA-241, Niagara-241-2, Niagara-341, Pluvia-240, RIVER-242, River-242-2, River-242-2T, River-342C, River-342T | | |

| | | | |
|--------------------|--|-----------------|--------|
| GEV No. | 698797 | Ref. No. | 310013 |
| description | guide L 30mm W 17mm H 17mm mounting pos. right/left | | |
| For models: | 915150, 915151, 915152, 915154, 915155, 915157, 915158, 915160, 915161, 915162, 915166, 915167, 915168, 915172, 915173, 915175, 915176, 915177, 915285, 915319, 915338, 915341, 915348, 915418, 915419, 915420, 915421, 915422, 915479, 915492, 915493, 915494, 915495, 915496, 915497, 915547, 915558, 915635, 915663, 915747, 916054, 916067, 916068, 916069, 916079, 916080, 916201, 916202, 916203, 916204...(Other models you can see in the webshop) | | |

door frames

| | | | |
|--------------------|---|-----------------|-------|
| GEV No. | 901694 | Ref. No. | 41197 |
| description | frame for door mounting pos. upper W 34mm L 595mm SS mounting distance 225mm | | |
| For models: | KLP105EB, LP105DDDTEB, LP105DDDTEBN, LP105EB, NG292, NG293, NIAGARA-292, NIAGARA-293, RIVER-295, RIVER-296, RV295, RV296, U61E, U61HE | | |

door bumpers



| | | | |
|--------------------|--|-----------------|--------|
| GEV No. | 518066 | Ref. No. | 417041 |
| description | door bumper end stop | | |
| For models: | 050F, 050FP, 22F, 22R, 2312-001, 2312-002, 40F, 440F, 44F, 45, 450, 46, 460, 500F, 500FD, 50F, 50FD, 510F, 510FD, 913297, 913298, 913299, 913300, 913360, 913361, 913391, 913392, 913418, 913546, 913547, 913578, 913611, 913684, 913913, 913914, 913932, 913933, 914167, 914168, 914284, 914318, 914319, 914326, 914331, 914338, 914356, 914398, 914399, 914400, 914401...(Other models you can see in the webshop) | | |

| | | | |
|--------------------|---|-----------------|--------|
| GEV No. | 518354 | Ref. No. | 028078 |
| description | door bumper slotted hole disc | | |
| For models: | 400F, 400FD, 400R, 400RD, 40-ELECTRONIC, 40F, 40FD, 40R, 40RD, 67F, 67R, 913291, 913292, 913357, 913374, 913375, 913416, 913435, 913545, 913666, 913668, 913685, 913773, 913774, 913911, 913912, 913948, 913950, 913977, 913984, 913990, 914100, 914101, 914214, 914316, 914317, 914392, 914393, 914394, 914395, 914396, 914397, 914441, 914442, 914515, 914516, 914537, 914543, 914547, 914624...(Other models you can see in the webshop) | | |

door shafts

| | | | |
|--------------------|------------|-----------------|-------|
| GEV No. | 513106 | Ref. No. | DWP35 |
| description | door shaft | | |

| | | | |
|---|---|-----------------|--------|
| 1  | | | |
| GEV No. | 518263 | Ref. No. | 304017 |
| description | door shaft | | |
| For models: | 350F, 350FD, 350R, 350RD, 35-ELECTRONIC, 35F, 35FD, 35R, 35RD, 913289, 913290, 913356, 913372, 913373, 913544, 913665, 913667, 913771, 913772, 913832, 913837, 914165, 914166, 914206, 914355, 914386, 914387, 914388, 914389, 914390, 914391, 914692, 914693, 914694, 914703, 914870, 915686, 915687, 915688, 915689, 915690, 915691, 916237, 916238, 916239, 916240, 916241, 916401, 916402, 916403...(Other models you can see in the webshop) | | |

| | | | |
|---|----------------|-----------------|------------------------|
| 2  | | | |
| GEV No. | 518556 | Ref. No. | 929018 |
| description | door shaft | | |
| For models: | 55, E.65 | | |
| accessories for | 518556 | | |
|  | GEV No. | 518557 | Ref. No. 929017 |
| retaining ring E D1 ø 5mm D2 ø 11mm SS DIN 6799 thickness 0.7mm | | | |

| | | | |
|--|--|-----------------|--------|
| locks | | | |
| 1  | | | |
| GEV No. | 518242 | Ref. No. | 329012 |
| description | door catch | | |
| For models: | 11F, 11FD, 11F-DVGW, 11R, 11RD, 350F, 350FD, 350R, 350RD, 35-ELECTRONIC, 35F, 35FD, 35R, 35RD, 400F, 400FD, 400R, 400RD, 40-ELECTRONIC, 40F, 40FD, 40R, 40RD, 67F, 67R, 913289, 913290, 913291, 913292, 913356, 913357, 913363, 913364, 913372, 913373, 913374, 913375, 913376, 913377, 913416, 913435, 913544, 913545, 913665, 913666, 913667, 913668, 913685, 913771, 913772...(Other models you can see in the webshop) | | |

| | | | |
|---|--|-----------------|---------------------|
| 1  | | | |
| GEV No. | 518244 | Ref. No. | 994011 REB994011 |
| description | door catch catch | | |
| For models: | 050F, 050FP, 22F, 22R, 40F, 440F, 44F, 45, 450, 46, 460, 55, F85, F85P | | |

| | | | |
|---|----------------------|-----------------|--------|
| 1  | | | |
| GEV No. | 510091 | Ref. No. | 329009 |
| description | door catch tongue | | |
| For models: | 11F, 11FD, 11R, 11RD | | |

| | | | |
|--|---|-----------------|--------|
| 1  | | | |
| GEV No. | 513138 | Ref. No. | 994012 |
| description | door catch with nut door locking catch | | |
| For models: | 2312-001, 2312-002, 500F, 500FD, 50F, 50FD, 510F, 510FD, 913297, 913298, 913299, 913300, 913360, 913361, 913391, 913392, 913418, 913546, 913547, 913578, 913611, 913684, 913913, 913914, 913932, 913933, 914167, 914168, 914284, 914326, 914331, 914356, 914398, 914399, 914400, 914401, 914402, 914403, 914404, 914405, 914406, 914443, 914449, 914517, 914545, 914568, 914642, 914688, 914909, 914943...(Other models you can see in the webshop) | | |

| | | | |
|--|---|-----------------|--------|
| 1  | | | |
| GEV No. | 519575 | Ref. No. | 927278 |
| description | snap lock mounting pos. upper L 53mm W 14mm H 14mm thread M12 | | |

| | | | |
|---|---|-----------------|--------|
| 1  | | | |
| GEV No. | 518245 | Ref. No. | 325030 |
| description | spigot door catch | | |
| For models: | 22F, 22R, 2312-001, 2312-002, 40F, 440F, 44F, 45, 450, 46, 460, 500F, 500FD, 50F, 50FD, 510F, 510FD, 913297, 913298, 913299, 913300, 913360, 913361, 913391, 913392, 913418, 913546, 913547, 913578, 913611, 913684, 913913, 913914, 913932, 913933, 914167, 914168, 914284, 914326, 914331, 914356, 914398, 914399, 914400, 914401, 914402, 914403, 914404, 914405, 914406...(Other models you can see in the webshop) | | |

| | | | |
|---|---|-----------------|--------|
| 1  | | | |
| GEV No. | 518298 | Ref. No. | 325066 |
| description | spigot door catch | | |
| For models: | 050F, 050FP, 915729, 916020, 916021, 916024, 916025, 916026, 916027, 916030, 916031, 916045, 916247, 916248, 916249, 916250, 916251, 916252, 916382, 916383, 916452, 916504, 916584, 916654, 916670, 916688, 916763, 916921, 916922, 916992, 916993, 917044, 917049, Clean161, F85, F85P, Fast145-2, Fast150, Fast160-2, Fast160C, Fast161-2, FAST-63, GSP50, GSP50P, GSP51, GSP51P, Ocean360, Ocean360M, Ocean360-UK | | |



miscellaneous



1

| | | | |
|--------------------|---|-----------------|--------|
| GEV No. | 518527 | Ref. No. | 447116 |
| description | bracket door handle door handle support | | |
| For models: | 21F, 21FD, 21R, 21RD, 25F, 25FD, 25R, 25RD, 30F, 30FD, 30R, 30RD, 31F, 31FD, 31R, 31RD, 440F, 44F, 55, E.65, ME15, ME20, ME30, ME40, MG15, MG20, MG30, MG40 | | |



1

| | | | |
|--------------------|--|-----------------|--------|
| GEV No. | 518249 | Ref. No. | 033294 |
| description | fastening angle for door seal | | |
| For models: | 400F, 400FD, 400R, 400RD, 40-ELECTRONIC, 40F, 40FD, 40R, 40RD, 67F, 67R, 913291, 913292, 913357, 913374, 913375, 913416, 913435, 913545, 913666, 913668, 913685, 913773, 913774, 913911, 913912, 913948, 913950, 913977, 913984, 913990, 914392, 914393, 914394, 914395, 914396, 914397, 914441, 914442, 914515, 914516, 914537, 914543, 914547, 914683, 914684, 914689, 914863, 915138, 915139... (Other models you can see in the webshop) | | |



2

| | | | |
|--------------------|--|-----------------|-------|
| GEV No. | 513203 | Ref. No. | 80277 |
| description | bracket for lever | | |
| For models: | 80, 81, 82, CE78HZ23, CGL74CABT, CNT800CH, E78, E78HP, Fast180, Fast180-230V-3Ph-60Hz, Fast181, FAST-181, Fast181-230V-3Ph-60Hz, Fast181-400V-3NPh-60Hz, FAST-60, FAST-73, HM1, NG281, NG281CDD, NG281HP, NG281HPDD, NG281HZ23, NG281HZ23DD, Niagara-281, Niagara-281-2, Niagara-281HP, NIAGARA-283, Niagara-283A, OC380, OC380FUR, OC380HZ23, Ocean380, PLUVIA-280, Pluvia280-230V-3PH-60HZ, PS-60, PV280, PV280FAST, PV280FAST2, PV280FAST2BIO, PV280FAST2HZ23, PV280FASTCH, PV280FASTHB, PV280HZ23, RIVER-282, River-285, RIVER-78, RIVER-80, River-81, River-81CRP, RIVER-81-CRP...(Other models you can see in the webshop) | | |



1

| | | | |
|--------------------|---|-----------------|--------|
| GEV No. | 519406 | Ref. No. | 929209 |
| description | gasket for sliding plate dimensions 69x16mm | | |

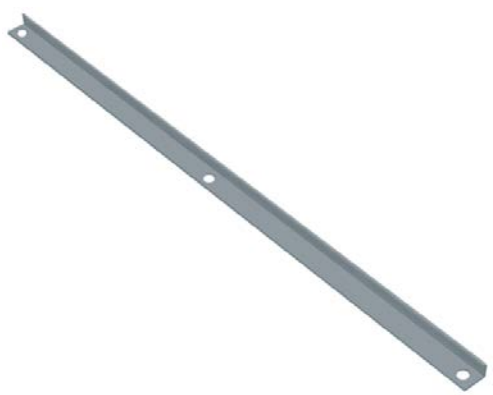

1

| | | | |
|--------------------|---|-----------------|--------|
| GEV No. | 518247 | Ref. No. | 033291 |
| description | fastening angle for door seal | | |
| For models: | 350F, 350FD, 350R, 350RD, 35-ELECTRONIC, 35F, 35FD, 35R, 35RD, 913289, 913290, 913356, 913372, 913373, 913544, 913665, 913667, 913771, 913772, 913832, 913837, 914165, 914166, 914206, 914355, 914386, 914387, 914388, 914389, 914390, 914391, 914692, 914693, 914694, 914703, 914870, 915686, 915687, 915688, 915689, 915690, 915691, 916237, 916238, 916239, 916240, 916241, 916401, 916402, 916403...(Other models you can see in the webshop) | | |



1

| | | | |
|--------------------|------------|-----------------|--------|
| GEV No. | 518526 | Ref. No. | 447137 |
| description | grip shell | | |
| For models: | CLEAN-3 | | |



1

| | | | |
|--------------------|--|-----------------|--------|
| GEV No. | 518522 | Ref. No. | 311013 |
| description | hinge hinge | | |
| For models: | 913992, 913993, 914583, 914592, 914612, 914613, 915143, CLEAN-3, RIVER-40, RIVER-40-CRP, RIVER-43, RIVER-44, RIVER-44-CRP, River-44-CRP-ST, RIVER-44CRP-ST | | |



1

| | | | |
|--------------------|--|-----------------|-------|
| GEV No. | 513204 | Ref. No. | 80275 |
| description | opposite support for spring \varnothing 28mm L 100mm | | |
| For models: | 80, 81, 82, CE78HZ23, CGL74CABT, CNT800CH, E78, E78HP, Fast180, Fast180-230V-3Ph-60Hz, Fast181, FAST-181, Fast181-230V-3Ph-60Hz, Fast181-400V-3NPh-60Hz, FAST-60, FAST-73, HM1, NG281, NG281CDD, NG281HP, NG281HPDD, NG281HZ23, NG281HZ23DD, Niagara-281, Niagara-281-2, Niagara-281HP, NIAGARA-283, Niagara-283A, OC380, OC380FUR, OC380HZ23, Ocean380, PLUVIA-280, Pluvia280-230V-3PH-60HZ, PS-60, PV280, PV280FAST, PV280FAST2, PV280FAST2BIO, PV280FAST2HZ23, PV280FASTCH, PV280FASTHB, PV280HZ23, RIVER-282, River-285, RIVER-78, RIVER-80, River-81, River-81CRP, RIVER-81-CRP...(Other models you can see in the webshop) | | |



1

| | | | |
|--------------------|--|-----------------|--------|
| GEV No. | 698708 | Ref. No. | 486224 |
| description | screw ED \varnothing 8.5mm ID \varnothing 4.8mm L 12mm thread M5 | | |
| For models: | 2312-007, 2312-009-CRP, 914100, 914101, 914624, 914625, 914627, 914628, 914850, 914851, 914854, 914944, RIVER-50, RIVER-50-CRP, RIVER-50-CRP-SP, RIVER-54, RIVER-54CRP, River-54-CRP-s.p., RIVER-54-CRP-SP, RIVER-61 | | |



1

| | | | |
|--------------------|--|-----------------|-------|
| GEV No. | 698748 | Ref. No. | 35013 |
| description | side panel for door L 235mm W 100mm thickness 2mm | | |
| For models: | LP60, NG271, NG291, NIAGARA-271, NIAGARA-291, RIVER-294, RIVER-71, RV294, RV71, U60E | | |



1

| | | | |
|--------------------|--|-----------------|--------|
| GEV No. | 513288 | Ref. No. | 307018 |
| description | spring holder for door spring | | |
| For models: | 915617, 915618, 915672, 915773, 915774, 916066, 916077, 916078, 916418, 916419, 916594, 916595, River-242, River-242-2, River-242-2T, River-342C, River-342T | | |

screw connections



1

| | | | |
|--------------------|---|-----------------|--------|
| GEV No. | 518508 | Ref. No. | 926222 |
| description | nut thread 1/4" H 7mm WS 50 brass Qty 1 pcs | | |
| For models: | E12, E120, E14, E140 | | |



1

| | | | |
|--------------------|---|-----------------|--------|
| GEV No. | 519498 | Ref. No. | 417120 |
| description | nut thread 3/4" H 10mm WS 30 plastic Qty 1 pcs | | |
| For models: | 2312-007, 913992, 913993, 914100, 914101, 914339, 914342, 914343, 914583, 914592, 914612, 914613, 914624, 914625, 914626, 914627, 914628, 914850, 914851, 914854, 914944, 915143, Fast181, FAST-181, Fast181-230V-3Ph-60Hz, Fast181-400V-3NPh-60Hz, NG271, NG291, NG292, NG292HZ, NG293, NG381, NG38123, NG38123TERMO, NG381C, NG381CDD, NG381CFUR, NG381DDHZ23, NG381DDPS, NG381DDPSHZ23, NG381HPDD, NG381L, NG381LC, NG381LCFUR, NG381LDDPS, NG381TERMO, NG381TXCDD, NIAGARA-271, NIAGARA-283, Niagara-283A...(Other models you can see in the webshop) | | |



1

| | | | |
|--------------------|--|-----------------|--------|
| GEV No. | 698874 | Ref. No. | 417119 |
| description | nut thread M3 H 3.5mm plastic Qty 1 pcs for PCB | | |
| For models: | 2312-007, 2312-009-CRP, 913911, 913912, 913913, 913914, 913950, 913977, 913984, 913990, 913992, 913993, 914100, 914101, 914165, 914166, 914167, 914168, 914206, 914214, 914284, 914316, 914317, 914318, 914319, 914338, 914339, 914342, 914343, 914355, 914356, 914431, 914516, 914543, 914583, 914592, 914612, 914613, 914624, 914625, 914626, 914627, 914628, 914642, 914684, 914850, 914851, 914854, 914874, 914909...(Other models you can see in the webshop) | | |



1

| | | | |
|--------------------|--|-----------------|--------|
| GEV No. | 698705 | Ref. No. | 429075 |
| description | screw H 14mm WS 22 Qty 1 pcs plastic for air valve | | |
| For models: | 915150, 915151, 915152, 915154, 915155, 915157, 915158, 915160, 915161, 915162, 915166, 915167, 915168, 915172, 915173, 915175, 915176, 915177, 915285, 915319, 915338, 915341, 915348, 915418, 915419, 915420, 915421, 915422, 915479, 915492, 915493, 915494, 915495, 915496, 915497, 915547, 915558, 915635, 915663, 915747, 916054, 916067, 916068, 916069, 916079, 916080, 916201, 916202, 916203, 916204...(Other models you can see in the webshop) | | |



1

| | | | |
|--------------------|---|-----------------|--------|
| GEV No. | 698876 | Ref. No. | 486078 |
| description | screw thread M6x30mm Qty 1 pcs SS | | |
| For models: | 914380, 914436, A3EB, A3EBD, A3EBDAKRYK, A3EBDAKWK, A3EBDBKWK, A3EBDRKYK, A3EBDVK, A3EBDYK, A3EBSAK, A3EBSAKRK, A3EBSAKWK, A3EBSBKWKYK, A3EBSEKWK, A3EBSWK, A4EB, A4EBD, A4EBDAKEKYK, A4EBDAKRK, A4EBDAKWK, A4EBDAKZK, A4EBDBKRR, A4EBDPKWKYK, A4EBDRK, A4EBS, A4EBSAK, A4EBSAKCK, A4EBSAKEKYK, A4EBSAKRK, A4EBSAKRKP, A4EBSAKYK, A4EBSCK, A4EBT, A4EBTSAK, A5EB, A5EBD, A5EBDAKPKWK, A5EBDAKWK, A5EBDAKYK, A5EBDRK, A5EBS, A5EBSAKPKWK, A5EBSAKRK, A5EBSAKRKYK, A5EBSAKWK, A5EBSAKWKYK, A5EBSBKRPK, A5EBSBKWK, A5EBSRK...(Other models you can see in the webshop) | | |



curtains

curtains

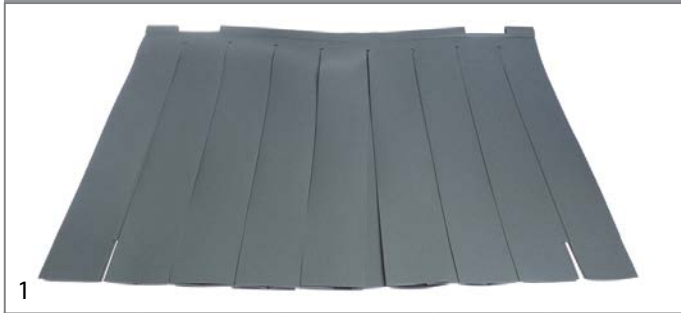

| | | | |
|------------------------|--|-----------------|-----------------------|
| GEV No. | 533008 | Ref. No. | 75120 |
| description | curtain W 540mm H 405mm plastic thickness 1.3mm | | |
| For models: | 914380, 914436, A3EB, A3EBD, A3EBDAKRKYK, A3EBDAKWK, A3EBDBKWK, A3EBDRKYK, A3EBDVK, A3EBDYK, A3EBSAK, A3EBSAKRK, A3EBSAKWK, A3EBSBKWKYK, A3EBSEKWK, A3EBSWK, A4EB, A4EBD, A4EBDAKEKYK, A4EBDAKRK, A4EBDAKWK, A4EBDAKZK, A4EBDBKRW, A4EBDPKWKYK, A4EBDRK, A4EBS, A4EBSAK, A4EBSAKCK, A4EBSAKKEYK, A4EBSAKRK, A4EBSAKRKP, A4EBSAKYK, A4EBSCK, A4EBT, A4EBTSAK, A5EB, A5EBD, A5EBDAKPKWK, A5EBDAKWK, A5EBDAKYK, A5EBDRK, A5EBS, A5EBSAKPKWK, A5EBSAKRK, A5EBSAKRKYK, A5EBSAKWK, A5EBSAKWKYK, A5EBSBKRKP, A5EBSBKWK, A5EBSRK...(Other models you can see in the webshop) | | |
| accessories for | 533008 | | |
| | GEV No. | 533009 | Ref. No. 75121 |
| | curtain rod L 545mm ø 8mm | | |



| | | | |
|--------------------|--|-----------------|-------|
| GEV No. | 533018 | Ref. No. | 77120 |
| description | curtain W 585mm H 400mm | | |
| For models: | A4EB, A4EBD, A4EBDAKEKYK, A4EBDAKRK, A4EBDAKWK, A4EBDAKZK, A4EBDBKRW, A4EBDPKWKYK, A4EBDRK, A4EBS, A4EBSAK, A4EBSAKCK, A4EBSAKKEYK, A4EBSAKRK, A4EBSAKRKP, A4EBSAKYK, A4EBSCK, A4EBT, A4EBTSAK, A5EB, A5EBD, A5EBDAKPKWK, A5EBDAKWK, A5EBDAKYK, A5EBDRK, A5EBS, A5EBSAKPKWK, A5EBSAKRK, A5EBSAKRKYK, A5EBSAKWK, A5EBSAKWKYK, A5EBSBKRKP, A5EBSBKWK, A5EBSRK, A5EBSYK, GL284EB, GL284EBD, GL284EBDA, GL284EBDAEW, GL284EBDAWY, GL284EBDPWY, GL284EBDR, GL284EBDY, GL284EBHZ23, GL284EBHZ23DBHZY, GL284EBHZ23DBWY, GL284EBHZ23DBY, GL284EBHZ23DY, GL284EBHZ23SAP, GL284EBS...(Other models you can see in the webshop) | | |



| | | | |
|--------------------|--|-----------------|-------|
| GEV No. | 533007 | Ref. No. | 75123 |
| description | curtain W 620mm H 250mm thickness 1.4mm | | |
| For models: | 914380, 914436, A3EB, A3EBD, A3EBDAKRKYK, A3EBDAKWK, A3EBDBKWK, A3EBDRKYK, A3EBDVK, A3EBDYK, A3EBSAK, A3EBSAKRK, A3EBSAKWK, A3EBSBKWKYK, A3EBSEKWK, A3EBSWK, A4EB, A4EBD, A4EBDAKEKYK, A4EBDAKRK, A4EBDAKWK, A4EBDAKZK, A4EBDBKRW, A4EBDPKWKYK, A4EBDRK, A4EBS, A4EBSAK, A4EBSAKCK, A4EBSAKKEYK, A4EBSAKRK, A4EBSAKRKP, A4EBSAKYK, A4EBSCK, A4EBT, A4EBTSAK, A5EB, A5EBD, A5EBDAKPKWK, A5EBDAKWK, A5EBDAKYK, A5EBDRK, A5EBS, A5EBSAKPKWK, A5EBSAKRK, A5EBSAKRKYK, A5EBSAKWK, A5EBSAKWKYK, A5EBSBKRKP, A5EBSBKWK, A5EBSRK...(Other models you can see in the webshop) | | |

curtain rods



| | | | |
|--------------------|--|-----------------|-------|
| GEV No. | 533009 | Ref. No. | 75121 |
| description | curtain rod L 545mm ø 8mm | | |
| For models: | 914380, 914436, A3EB, A3EBD, A3EBDAKRKYK, A3EBDAKWK, A3EBDBKWK, A3EBDRKYK, A3EBDVK, A3EBDYK, A3EBSAK, A3EBSAKRK, A3EBSAKWK, A3EBSBKWKYK, A3EBSEKWK, A3EBSWK, A4EB, A4EBD, A4EBDAKEKYK, A4EBDAKRK, A4EBDAKWK, A4EBDAKZK, A4EBDBKRW, A4EBDPKWKYK, A4EBDRK, A4EBS, A4EBSAK, A4EBSAKCK, A4EBSAKKEYK, A4EBSAKRK, A4EBSAKRKP, A4EBSAKYK, A4EBSCK, A4EBT, A4EBTSAK, A5EB, A5EBD, A5EBDAKPKWK, A5EBDAKWK, A5EBDAKYK, A5EBDRK, A5EBS, A5EBSAKPKWK, A5EBSAKRK, A5EBSAKRKYK, A5EBSAKWK, A5EBSAKWKYK, A5EBSBKRKP, A5EBSBKWK, A5EBSRK...(Other models you can see in the webshop) | | |







| | | | |
|--------------------|--|-----------------|-------|
| GEV No. | 533019 | Ref. No. | 75124 |
| description | curtain rod L 620mm ø 8mm | | |
| For models: | 914380, 914436, A3EB, A3EBD, A3EBDAKRKYK, A3EBDAKWK, A3EBDBKWK, A3EBDRKYK, A3EBDVK, A3EBDYK, A3EBSAK, A3EBSAKRK, A3EBSAKWK, A3EBSBKWKYK, A3EBSEKWK, A3EBSWK, A4EB, A4EBD, A4EBDAKEKYK, A4EBDAKRK, A4EBDAKWK, A4EBDAKZK, A4EBDBKRW, A4EBDPKWKYK, A4EBDRK, A4EBS, A4EBSAK, A4EBSAKCK, A4EBSAKKEYK, A4EBSAKRK, A4EBSAKRKP, A4EBSAKYK, A4EBSCK, A4EBT, A4EBTSAK, A5EB, A5EBD, A5EBDAKPKWK, A5EBDAKWK, A5EBDAKYK, A5EBDRK, A5EBS, A5EBSAKPKWK, A5EBSAKRK, A5EBSAKRKYK, A5EBSAKWK, A5EBSAKWKYK, A5EBSBKRKP, A5EBSBKWK, A5EBSRK...(Other models you can see in the webshop) | | |

washing and rinsing systems







| | | | |
|--------------------|--|-----------------|--------|
| GEV No. | 513271 | Ref. No. | 412028 |
| description | connector holder grey | | |
| For models: | 2312-001, 2312-002, E.35, E.35H, E.40, E.40H, E.50, E.51, GLS40H, GLS40HP, MC201CL, MISTRAL-40, MISTRAL-51, NIAGARA-35, NIAGARA-40, NIAGARA-51 | | |



| | | | |
|---|---|-----------------|------------------------|
| GEV No. | 517568 | Ref. No. | 41064 |
| description | counterflange for wash arm support ϕ 69mm ID ϕ 63mm H 35mm mounting distance 64mm hole ϕ 7mm | | |
| For models: | KLP105EB, KLP201DDDTEB, KLP201EB, KLP301, KLP301DDDTEB, LP105DDDTEB, LP105DDDTEBN, LP105EB, LP201DDDTEB, LP201EB, LP301, LP301EB, NG292, NG292HZ, NG293, NIAGARA-292, Niagara-292-400V-3Ph-60Hz, NIAGARA-293, RIVER-295, River-295P, RIVER-296, River-296P, RIVER-297, RIVER-298, RV295, RV295PS, RV296, RV296PS, RV297, RV298, RV298HZ, U132E, U61E, U61HE, U70e | | |
| accessories for | 517568 | | |
|  | GEV No. | 531605 | Ref. No. 42053 |
| | extension for rinsing shaft ϕ 16mm H 122mm thread L 12mm WS 19 | | |
|  | GEV No. | 532603 | Ref. No. 926252 |
| | O-ring EPDM thickness 3.53mm ID ϕ 69.85mm Qty 1 pcs | | |
|  | GEV No. | 698750 | Ref. No. 41185 |
| | throttle disc ϕ 71.5mm hole ϕ 17/22mm | | |



| | | | |
|---|---|-----------------|------------------------|
| GEV No. | 517441 | Ref. No. | 41064CP C.41064CP |
| description | counterflange for wash arm support with throttle disc ϕ 70mm ID ϕ 63mm L 110mm W 89mm H 35mm | | |
| For models: | KLP105EB, KLP201DDDTEB, KLP201EB, KLP301, KLP301DDDTEB, LP105DDDTEB, LP105DDDTEBN, LP105EB, LP201DDDTEB, LP201EB, LP301, LP301EB, NG292, NG292HZ, NG293, NIAGARA-292, Niagara-292-400V-3Ph-60Hz, NIAGARA-293, RIVER-295, River-295P, RIVER-296, River-296P, RIVER-297, RIVER-298, RV295, RV295PS, RV296, RV296PS, RV297, RV298, RV298HZ, U132, U132E, U61, U61E, U61H, U61HE, U70, U70e | | |
| spare parts for | 517441 | | |
|  | GEV No. | 698750 | Ref. No. 41185 |
| | throttle disc ϕ 71.5mm hole ϕ 17/22mm | | |
| accessories for | 517441 | | |
|  | GEV No. | 531605 | Ref. No. 42053 |
| | extension for rinsing shaft ϕ 16mm H 122mm thread L 12mm WS 19 | | |
|  | GEV No. | 532603 | Ref. No. 926252 |
| | O-ring EPDM thickness 3.53mm ID ϕ 69.85mm Qty 1 pcs | | |



| | | | |
|--------------------|---|-----------------|--------|
| GEV No. | 518473 | Ref. No. | 927084 |
| description | disc ID ϕ 12.2mm ED ϕ 19.3mm thickness 1.3mm | | |
| For models: | 161, 221, 271, 272, 362, CLEAN-160, CLEAN-161, CLEAN-220, CLEAN-221, CLEAN-270, CLEAN-271, CLEAN-272, CLEAN-361, CLEAN-361P, CLEAN-362, CLEAN-471, CLEAN-471P, E.60, E.65 | | |



| | | | |
|--------------------|---|-----------------|--------|
| GEV No. | 510016 | Ref. No. | 486002 |
| description | eye bolt for rinse aid container connection | | |
| For models: | 050F, 050FP, 11F, 11FD, 11F-DVGW, 11R, 11RD, 21F, 21FD, 21R, 21RD, 22F, 22R, 25F, 25FD, 25R, 25RD, 30F, 30FD, 30R, 30RD, 31F, 31FD, 31R, 31RD, 40F, 440F, 44F, 500F, 500FD, 50-ELECTRONIC, 50F, 50FD, 510F, 510FD, 66, E.52, F85, F85P, S621, S623, S624, S626, S631, S633, S634, S636, S651, S651P, S653...(Other models you can see in the webshop) | | |



| | | | |
|--------------------|---|-----------------|--------|
| GEV No. | 518461 | Ref. No. | 303029 |
| description | flange for wash arm support | | |
| For models: | 050F, 050FP, 2312-001, 2312-002, 913297, 913298, 913299, 913300, 913360, 913361, 913391, 913392, 913546, 913547, 913578, 913611, 913684, 913913, 913914, 913932, 913933, 914284, 914318, 914319, 914331, 914338, 914356, 914400, 914401, 914402, 914403, 914404, 914405, 914431, 914449, 914517, 914545, 914568, 914642, 914688, 914909, 914979, 915136, 915137, 915140, 915248, 915483, 915484, 915528, 915537...(Other models you can see in the webshop) | | |





| | | | |
|--------------------|---|-----------------|--------|
| GEV No. | 507545 | Ref. No. | 437091 |
| description | flat gasket PTFE ED ϕ 13mm ID ϕ 7mm thickness 0.65mm Qty 1 pcs | | |
| For models: | 2312-007, 2312-009-CRP, 913992, 913993, 914100, 914101, 914339, 914342, 914343, 914583, 914592, 914612, 914613, 914624, 914625, 914626, 914627, 914628, 914850, 914851, 914854, 914944, 915143, E.55, RIVER-40, RIVER-40-CRP, RIVER-43, RIVER-44, RIVER-44-CRP, RIVER-44-CRP-ST, RIVER-44CRP-ST, RIVER-48, RIVER-50, RIVER-50-CRP, RIVER-50-CRP-SP, RIVER-54, RIVER-54CRP, RIVER-54-CRP-s.p., RIVER-54-CRP-SP, RIVER-61 | | |





| | | | |
|--------------------|---|-----------------|--------|
| GEV No. | 518240 | Ref. No. | 437078 |
| description | flat gasket rubber ED ϕ 33mm ID ϕ 17mm thickness 1.5mm Qty 1 pcs | | |
| For models: | 2312-009-CRP, 67R, 913289, 913290, 913291, 913292, 913356, 913357, 913363, 913364, 913372, 913373, 913374, 913375, 913376, 913377, 913416, 913435, 913544, 913545, 913665, 913666, 913667, 913668, 913685, 913771, 913772, 913773, 913774, 913832, 913837, 913911, 913912, 913948, 913950, 913977, 913984, 913990, 913992, 913993, 914165, 914166, 914206, 914214, 914316, 914317, 914355, 914386, 914387, 914388...(Other models you can see in the webshop) | | |



| | | | |
|---|--|-----------------|--------|
|  | | | |
| 1 | | | |
| GEV No. | 507541 | Ref. No. | 437102 |
| description | flat gasket rubber ED ø 74mm ID ø 57mm thickness 2mm Qty 1 pcs | | |
| For models: | 915150, 915151, 915152, 915154, 915155, 915157, 915158, 915160, 915161, 915162, 915166, 915167, 915168, 915172, 915173, 915175, 915176, 915177, 915285, 915319, 915338, 915341, 915348, 915418, 915419, 915420, 915421, 915422, 915479, 915492, 915493, 915494, 915495, 915496, 915497, 915547, 915558, 915617, 915618, 915635, 915663, 915672, 915747, 915773, 915774, 916020, 916021, 916024, 916025, 916026...(Other models you can see in the webshop) | | |

| | | | |
|---|---|-----------------|------------------|
|  | | | |
| 1 | | | |
| GEV No. | 518444 | Ref. No. | 199051 480008 |
| description | flow control valve for wash arm ø 16mm H 20mm | | |
| For models: | 67R, 913291, 913292, 913357, 913374, 913375, 913416, 913435, 913545, 913666, 913668, 913685, 913773, 913774, 913911, 913912, 913948, 913950, 913977, 913984, 913990, 914214, 914316, 914317, 914392, 914393, 914394, 914395, 914396, 914397, 914441, 914442, 914515, 914516, 914537, 914543, 914547, 914683, 914684, 914689, 914863, 914874, 915138, 915139, 915527, 915692, 915693, 915694, 915816, 916162...(Other models you can see in the webshop) | | |

| | | | |
|---|--|-----------------|--------|
|  | | | |
| 1 | | | |
| GEV No. | 513228 | Ref. No. | 926035 |
| description | gasket | | |
| For models: | 10, 12, 14, CLEAN-100, CLEAN-110, CLEAN-120, E1, E10, E100, E110, E12, E120, E14, E140 | | |

| | | | |
|---|--|-----------------|--------|
|  | | | |
| 1 | | | |
| GEV No. | 513277 | Ref. No. | 437080 |
| description | gasket | | |
| For models: | 67F, 67R, 913291, 913292, 913357, 913363, 913364, 913374, 913375, 913376, 913377, 913416, 913435, 913545, 913666, 913668, 913685, 913773, 913774, 913911, 913912, 913948, 913950, 913977, 913984, 913990, 914214, 914316, 914317, 914392, 914393, 914394, 914395, 914396, 914397, 914441, 914442, 914515, 914516, 914537, 914543, 914547, 914683, 914689, 914863, 914874, 915138, 915139, 915150, 915151...(Other models you can see in the webshop) | | |

| | | | |
|---|---|-----------------|--------|
|  | | | |
| 1 | | | |
| GEV No. | 518594 | Ref. No. | 437037 |
| description | gasket for rinse connection | | |
| For models: | 21F, 21FD, 21R, 21RD, 25F, 25FD, 25R, 25RD, 30F, 30FD, 30R, 30RD, 31F, 31FD, 31R, 31RD, 45, 450, 913418, 914167, 914168, 914398, 914399, 914443, 914943, 915695, 915696, 915819, E.45, Fast145, FAST-145, Fast145D, FAST-145D, Niagara-45, S621, S623, S624, S626, S631, S633, S634, S636 | | |

| | | | |
|--|---|-----------------|-------|
|  | | | |
| 1 | | | |
| GEV No. | 518071 | Ref. No. | 80178 |
| description | gasket for wash arm support L 109mm W 68mm | | |
| For models: | 80, 81, 82, CE78HZ23, CGL74CABT, CNT800CH, E78, E78HP, Fast180, Fast180-230V-3Ph-60Hz, Fast181, FAST-181, Fast181-230V-3Ph-60Hz, Fast181-400V-3NPh-60Hz, FAST-60, FAST-73, HM1, NG281, NG281CDD, NG281HP, NG281HPDD, NG281HZ23, NG281HZ23DD, NG381, NG38123, NG38123TERMO, NG381C, NG381CDD, NG381CFUR, NG381DDHZ23, NG381DDPS, NG381DDPSHZ23, NG381HPDD, NG381L, NG381LC, NG381LCFUR, NG381LDDPS, NG381TERMO, NG381TXCDD, Niagara-281, Niagara-281-2, Niagara-281HP, NIAGARA-283, Niagara-283A, Niagara-283L-2, Niagara-381, Niagara-381-230V-3Ph-50Hz, Niagara-381-230V-3Ph-60Hz, Niagara-381DP, Niagara-381HPD...(Other models you can see in the webshop) | | |

| | | | |
|--|--|-----------------|------------|
|  | | | |
| 1 | | | |
| GEV No. | 518116 | Ref. No. | H.17298619 |
| description | gasket for wash arm support rubber ø 60mm ID ø 47mm thickness 1mm | | |
| For models: | 2312-007, 2312-009-CRP, 914326, E.55, NIAGARA-251, NIAGARA-261, PLUVIA-260, RIVER-48, RIVER-50, RIVER-50-CRP, RIVER-50-CRP-SP, RIVER-54, RIVER-54-CRP-SP, RIVER-61 | | |

| | | | |
|---|---|-----------------|--------|
|  | | | |
| 1 | | | |
| GEV No. | 518595 | Ref. No. | 111001 |
| description | hose connector double | | |
| For models: | 21F, 21FD, 21R, 21RD, 25F, 25FD, 25R, 25RD, 30F, 30FD, 30R, 30RD, 31F, 31FD, 31R, 31RD, 45, 450, 913418, 914167, 914168, 914398, 914399, 914443, 914943, 915695, 915696, 915819, E.45, Fast145, FAST-145, Fast145D, FAST-145D, Niagara-45, S621, S623, S624, S626, S631, S633, S634, S636 | | |

| | | | |
|--|---|-----------------|-------|
|  | | | |
| 1 | | | |
| GEV No. | 513158 | Ref. No. | 80365 |
| description | knurled nut | | |
| For models: | Fast181, FAST-181, KLP105EB, KLP201DDDTTEB, KLP201EB, KLP301, KLP301DDDTTEB, LP105DDDTTEB, LP105DDDTTEBN, LP105EB, LP201DDDTTEB, LP201EB, LP301, LP301EB, NG271, NG291, NG292, NG293, NG381, NG38123, NG38123TERMO, NG381C, NG381CDD, NG381CFUR, NG381DDHZ23, NG381DDPS, NG381DDPSHZ23, NG381HPDD, NG381TERMO, NG381TXCDD, NIAGARA-271, NIAGARA-283, Niagara-283A, NIAGARA-291, NIAGARA-292, NIAGARA-293, Niagara-381, Niagara-381-230V-3Ph-50Hz, Niagara-381-230V-3Ph-60Hz, Niagara-381DP, Niagara-381HPD, RIVER-282, RIVER-282-2, RIVER-2825-2TDE, RIVER-285, RIVER-294, RIVER-295, RIVER-296, RIVER-297, RIVER-298...(Other models you can see in the webshop) | | |

| | | | |
|---|--|-----------------|--------|
|  | | | |
| 1 | | | |
| GEV No. | 518286 | Ref. No. | 472068 |
| description | knurled nut | | |
| For models: | 2312-007, 2312-009-CRP, 914100, 914101, 914339, 914342, 914343, 914624, 914625, 914626, 914627, 914628, 914850, 914851, 914854, 914944, E.55, RIVER-48, RIVER-50, RIVER-50-CRP, RIVER-50-CRP-SP, River-54, RIVER-54CRP, River-54-CRP-s.p., RIVER-54-CRP-SP, RIVER-61 | | |

| | | | |
|---|--|-----------------|--------|
|  | | | |
| 1 | | | |
| GEV No. | 518665 | Ref. No. | 454006 |
| description | knurled nut mounting pos. upper/lateral ø 19.65mm H 4mm thread M5 | | |
| For models: | 913289, 913290, 913291, 913292, 913297, 913298, 913299, 913300, 913356, 913357, 913360, 913361, 913372, 913373, 913374, 913375, 913391, 913392, 913416, 913418, 913435, 913544, 913545, 913546, 913547, 913578, 913611, 913665, 913666, 913667, 913668, 913684, 913685, 913771, 913772, 913773, 913774, 913832, 913837, 913911, 913912, 913913, 913914, 913932, 913933, 913948, 913950, 913977, 913984, 913990...(Other models you can see in the webshop) | | |

| | | | |
|--|--|-----------------|-------|
|  | | | |
| 1 | | | |
| GEV No. | 517444 | Ref. No. | 80697 |
| description | knurled nut thread M10x1 ø 25mm H 4mm SS | | |
| For models: | 915830, Fast160DP | | |

| | | | |
|---|---|-----------------|------------------|
|  | | | |
| 1 | | | |
| GEV No. | 518238 | Ref. No. | 143173 143268 |
| description | manifold ø 12mm L 98mm | | |
| For models: | 050F, 050FP, 10, 12, 14, 2312-001, 2312-002, 2312-009-CRP, 31F, 31FD, 31R, 31RD, 350F, 350FD, 350R, 350RD, 35-ELECTRONIC, 35F, 35FD, 35R, 35RD, 400F, 400FD, 400R, 400RD, 40-ELECTRONIC, 40F, 40FD, 40R, 40RD, 45, 450, 46, 460, 500F, 500FD, 50-ELECTRONIC, 50F, 50FD, 510F, 510FD, 67F, 67R, 80, 81, 82, 913418, 913992, 913993, 914167...(Other models you can see in the webshop) | | |

| | | | |
|---|--|-----------------|--------|
|  | | | |
| 1 | | | |
| GEV No. | 510104 | Ref. No. | 991002 |
| description | mixer for rinse aid | | |
| For models: | R499, R501, R503, R505, R507, S641, S643, S950 | | |

| | | | |
|--|--|-----------------|--------|
|  | | | |
| 1 | | | |
| GEV No. | 518181 | Ref. No. | 429053 |
| description | nut | | |
| For models: | 913992, 913993, 914583, 914592, 914612, 914613, 915143, CLEAN-3, RIVER-40, RIVER-40-CRP, RIVER-43, RIVER-44, RIVER-44-CRP, River-44-CRP-ST, RIVER-44CRP-ST | | |

| | | | |
|--|---|-----------------|--------|
|  | | | |
| 1 | | | |
| GEV No. | 518593 | Ref. No. | 417039 |
| description | nut for rinse pipe | | |
| For models: | 21F, 21FD, 21R, 21RD, 25F, 25FD, 25R, 25RD, 30F, 30FD, 30R, 30RD, 31F, 31FD, 31R, 31RD, 45, 450, 913418, 914167, 914168, 914398, 914399, 914443, 914943, 915695, 915696, 915819, E.45, Fast145, FAST-145, Fast145D, FAST-145D, Niagara-45, S621, S623, S624, S626, S631, S633, S634, S636 | | |

| | | | |
|---|---|-----------------|--------|
|  | | | |
| 1 | | | |
| GEV No. | 517454 | Ref. No. | 308031 |
| description | nut for wash arm ED ø 35mm thickness 11mm plastic | | |
| For models: | 2312-007, 914100, 914101, 914339, 914342, 914343, 914568, 914624, 914625, 914626, 914627, 914628, 914850, 914851, 914854, 914944, 915830, E.50D.PA, Fast160DP, FAST-160DP, RIVER-48, RIVER-54, RIVER-54CRP, River-54-CRP-s.p. | | |

| | | | |
|--|--|-----------------|--------|
|  | | | |
| 1 | | | |
| GEV No. | 518637 | Ref. No. | 429073 |
| description | nut for wash arm support thread M56x2 | | |
| For models: | 915150, 915151, 915152, 915154, 915155, 915157, 915158, 915160, 915161, 915162, 915166, 915167, 915168, 915172, 915173, 915175, 915176, 915177, 915285, 915319, 915338, 915341, 915348, 915418, 915419, 915420, 915421, 915422, 915479, 915492, 915493, 915494, 915495, 915496, 915497, 915547, 915558, 915617, 915618, 915635, 915663, 915672, 915747, 915773, 915774, 916020, 916021, 916024, 916025, 916026...(Other models you can see in the webshop) | | |





| | | | |
|--|---|-----------------|--------|
|  <p>1</p> | | | |
| GEV No. | 518596 | Ref. No. | 417038 |
| description | nut wash pipe | | |
| For models: | 21F, 21FD, 21R, 21RD, 25F, 25FD, 25R, 25RD, 30F, 30FD, 30R, 30RD, 31F, 31FD, 31R, 31RD, 45, 450, 67F, 67R, 913291, 913292, 913357, 913363, 913364, 913374, 913375, 913376, 913377, 913416, 913418, 913435, 913545, 913666, 913668, 913685, 913773, 913774, 913911, 913912, 913948, 913950, 913977, 913984, 913990, 914167, 914168, 914214, 914316, 914317...(Other models you can see in the webshop) | | |

| | | | |
|--|---|-----------------|-------|
|  <p>2</p> | | | |
| GEV No. | 518086 | Ref. No. | 80174 |
| description | opposite support | | |
| For models: | CGL74CABT, CNT800CH, Fast180, Fast180-230V-3Ph-60Hz, FAST-60, FAST-73, NG281, NG281CDD, NG281HP, NG281HPDD, NG281HZ23, NG281HZ23DD, NG381, NG38123, NG38123TERMO, NG381C, NG381CDD, NG381CFUR, NG381DDHZ23, NG381DDPS, NG381D-DPSHZ23, NG381HPDD, NG381L, NG381LC, NG381LCFUR, NG381LD-DPS, NG381TERMO, NG381TXCDD, NIAGARA-281, Niagara-281-2, Niagara-281HP, NIAGARA-283, Niagara-283A, Niagara-283L-2, Niagara-381, Niagara-381-230V-3Ph-50Hz, Niagara-381-230V-3Ph-60Hz, Niagara-381DP, Niagara-381HPD, Niagara-381L, Niagara-381LC, OC380, OC380FUR, OC380HZ23, Ocean380, PLUVIA-280, Pluvia280-230V-3PH-60HZ, PS-60, PV280, PV280FAST...(Other models you can see in the webshop) | | |

| | | | |
|--|------------------|-----------------|-------|
|  <p>1</p> | | | |
| GEV No. | 518091 | Ref. No. | 80181 |
| description | opposite support | | |
| For models: | RIVER-71 | | |

| | | | |
|--|--|-----------------|-------|
|  <p>1</p> | | | |
| GEV No. | 518089 | Ref. No. | 80184 |
| description | retaining ring for wash arm ID ø 40mm ED ø 44mm thickness 3mm | | |
| For models: | Fast180, Fast180-230V-3Ph-60Hz, Fast181, FAST-181, Fast181-230V-3Ph-60Hz, Fast181-400V-3NPh-60Hz, LP60, NG291, NG381, NG38123, NG38123TERMO, NG381C, NG381CDD, NG381CFUR, NG381DDHZ23, NG381DDPS, NG381DDPSHZ23, NG381HPDD, NG381L, NG381LC, NG381LCFUR, NG381LDDPS, NG381TERMO, NG381TXCDD, Niagara-281-2, Niagara-283L-2, NIAGARA-291, Niagara-381, Niagara-381-230V-3Ph-50Hz, Niagara-381-230V-3Ph-60Hz, Niagara-381DP, Niagara-381HPD, Niagara-381L, Niagara-381LC, OC380, OC380FUR, OC380HZ23, Ocean380, PS-60, PV280FAST2, PV280FAST2BIO, PV280FAST2HZ23, River-282-2, River-282L-2, River-282LS-2TDE, River-282S-2TDE, River-285, RIVER-294, River-382, River-382-230V-3Ph-50Hz...(Other models you can see in the webshop) | | |

| | | | |
|---|--|-----------------|--------|
|  <p>1</p> | | | |
| GEV No. | 524811 | Ref. No. | 303037 |
| description | ring for wash arm ID ø 41mm ED ø 45mm thickness 3mm plastic | | |
| For models: | 914326, 914406, 915150, 915151, 915152, 915154, 915155, 915157, 915158, 915160, 915161, 915162, 915166, 915167, 915168, 915172, 915173, 915175, 915176, 915177, 915285, 915319, 915338, 915341, 915348, 915418, 915419, 915420, 915421, 915422, 915479, 915492, 915493, 915494, 915495, 915496, 915497, 915547, 915558, 915635, 915663, 915729, 915747, 916054, CE78HZ23, CNT800CH, E.55, E78, E78HP, FAST-181...(Other models you can see in the webshop) | | |

| | | | |
|---|--|-----------------|-------|
|  <p>1</p> | | | |
| GEV No. | 698715 | Ref. No. | 80622 |
| description | ring for wash arm ø 22mm ID ø 11.5mm thickness 1mm | | |

| | | | |
|--|-----------------|-----------------|--------|
|  <p>1</p> <p>Image not available</p> | | | |
| GEV No. | 518389 | Ref. No. | 325046 |
| description | rinse arm shaft | | |
| For models: | CLEAN-3 | | |

| | | | |
|---|--|-----------------|--------|
|  <p>1</p> | | | |
| GEV No. | 513259 | Ref. No. | 111026 |
| description | rinse arm support mounting pos. upper | | |
| For models: | 67F, 67R, 913291, 913292, 913357, 913363, 913364, 913374, 913375, 913376, 913377, 913416, 913435, 913545, 913666, 913668, 913685, 913773, 913774, 913911, 913912, 913948, 913950, 913977, 913984, 913990, 914214, 914316, 914317, 914392, 914393, 914394, 914395, 914396, 914397, 914441, 914442, 914515, 914516, 914537, 914543, 914547, 914683, 914684, 914689, 914863, 914874, 915138, 915139, 915527...(Other models you can see in the webshop) | | |

| | | | |
|---|--|-----------------|--------|
|  <p>1</p> | | | |
| GEV No. | 518434 | Ref. No. | 429050 |
| description | rinse arm support mounting pos. upper | | |
| For models: | 22F, 2312-009-CRP, 350F, 350FD, 350R, 350RD, 35-ELECTRONIC, 35F, 35FD, 35R, 35RD, 400F, 400FD, 400R, 400RD, 40-ELECTRONIC, 40F, 40FD, 40R, 40RD, 67R, 913289, 913290, 913291, 913292, 913356, 913357, 913363, 913364, 913372, 913373, 913374, 913375, 913376, 913377, 913416, 913435, 913544, 913545, 913665, 913666, 913667, 913668, 913685, 913771, 913772, 913773, 913774, 913832, 913837...(Other models you can see in the webshop) | | |



1

| | | | |
|--------------------|---|-----------------|--------|
| GEV No. | 518443 | Ref. No. | 468165 |
| description | rinse arm support mounting pos. upper | | |
| For models: | 2312-009-CRP, 67R, 913289, 913290, 913291, 913292, 913356, 913357, 913363, 913364, 913372, 913373, 913374, 913375, 913376, 913377, 913416, 913435, 913544, 913545, 913665, 913666, 913667, 913668, 913685, 913771, 913772, 913773, 913774, 913832, 913837, 913911, 913912, 913948, 913950, 913977, 913984, 913990, 914165, 914166, 914206, 914214, 914316, 914317, 914355, 914386, 914387, 914388, 914389, 914390...(Other models you can see in the webshop) | | |



1

| | | | |
|--------------------|--|-----------------|--------|
| GEV No. | 518125 | Ref. No. | 143240 |
| description | rinse hose ø 17.5mm | | |
| For models: | 913297, 913298, 913299, 913300, 913360, 913361, 913391, 913392, 913546, 913547, 913578, 913611, 913684, 913913, 913914, 913932, 913933, 914284, 914318, 914319, 914331, 914338, 914356, 914400, 914401, 914402, 914403, 914404, 914405, 914431, 914449, 914517, 914545, 914568, 914642, 914688, 914909, 914979, 915136, 915137, 915140, 915248, 915483, 915484, 915528, 915537, 915538, 915539, 915540, 915664...(Other models you can see in the webshop) | | |



1

| | | | |
|--------------------|---|-----------------|--------|
| GEV No. | 518471 | Ref. No. | 926065 |
| description | rinse pipe | | |
| For models: | 12, 14, CLEAN-120, E12, E120, E14, E140 | | |



1

| | | | |
|--------------------|---|-----------------|------------------|
| GEV No. | 518003 | Ref. No. | 447030 447128 |
| description | screw cap | | |
| For models: | 050F, 050FP, 11F, 11FD, 11F-DVGW, 21F, 21FD, 2312-001, 2312-002, 25F, 25FD, 30F, 30FD, 31F, 31FD, 400F, 400FD, 40-ELECTRONIC, 40F, 40FD, 45, 450, 46, 460, 500F, 500FD, 50F, 50FD, 510F, 510FD, 67R, 913363, 913364, 913376, 913377, 914568, 915830, E.41, E.42, E.45, E.46, E.50, E.50D.PA, E.51, E.41, F85, F85P, FAST-160DP, GSP50, GSP50P...(Other models you can see in the webshop) | | |



1

| | | | |
|--------------------|-----------------------|-----------------|-------|
| GEV No. | 513127 | Ref. No. | 80285 |
| description | screw connection | | |
| For models: | Fast181, ST70FASTHZ23 | | |



1

| | | | |
|--------------------|--|-----------------|-------|
| GEV No. | 513286 | Ref. No. | 80281 |
| description | screw connection | | |
| For models: | 80, 81, 82, CE78HZ23, CGL74CABT, E78, E78HP, FAST-181, Fast181-230V-3Ph-60Hz, Fast181-400V-3NPh-60Hz, HM1, NG271, NG291, NIAGARA-271, NIAGARA-283, Niagara-283A, NIAGARA-291, PS-60, RIVER-282, River-285, RIVER-294, RIVER-78, RIVER-80, River-81, River-81CRP, RIVER-81-CRP, RIVER-82, River-82CRP, RIVER-82-CRP, RIVER-E78, RIVER-HL-81, RIVER-HL-82, RV282, RV282DD, RV282R, RV294, RV71, RV80, RV8023, RV8023HZ, RV80C, RV80HZ, RV81, RV8123, RV81A, RV81C, RV81CCRP, RV81CRP, RV81HZ, RV81HZ23...(Other models you can see in the webshop) | | |



1

| | | | |
|--------------------|--|-----------------|--------|
| GEV No. | 518288 | Ref. No. | 429069 |
| description | screw connection | | |
| For models: | 2312-007, 2312-009-CRP, 80, 81, 82, 914100, 914101, 914326, 914339, 914342, 914343, 914406, 914624, 914625, 914626, 914627, 914628, 914850, 914851, 914854, 914944, 915150, 915151, 915152, 915154, 915155, 915157, 915158, 915160, 915161, 915162, 915166, 915167, 915168, 915172, 915173, 915175, 915176, 915177, 915285, 915319, 915338, 915341, 915348, 915418, 915419, 915420, 915421, 915422, 915479...(Other models you can see in the webshop) | | |



1

| | | | |
|--------------------|--|-----------------|--------|
| GEV No. | 510011 | Ref. No. | 429008 |
| description | screw connection plastic | | |
| For models: | 11F, 11FD, 11F-DVGW, 21F, 21FD, 25F, 25FD, 30F, 30FD, 31F, 31FD, 350F, 350FD, 35-ELECTRONIC, 35F, 35FD, 400F, 400FD, 40-ELECTRONIC, 40F, 40FD, 45, 450, 913289, 913290, 913291, 913292, 913356, 913357, 913363, 913364, 913372, 913373, 913374, 913375, 913376, 913377, 913416, 913418, 913435, 913544, 913545, 913665, 913666, 913667, 913668, 913685, 913771, 913772, 913773...(Other models you can see in the webshop) | | |





1

| | | | |
|--------------------|--|-----------------|--------|
| GEV No. | 518012 | Ref. No. | 308015 |
| description | slide ring ED ø 65mm ID ø 50mm thickness 1.8mm | | |
| For models: | S651, S654, S810, S815, S830, S835 | | |





| | | | |
|---|--|-----------------|-----------------|
|  | | | |
| 1 | | | |
| GEV No. | 517443 | Ref. No. | 437117 80623 |
| description | slide ring for rinse arm mounting pos. upper/lower PTFE ED ø 22mm ID ø 9.5mm thickness 1mm | | |
| For models: | 915160, 915161, 915162, 915175, 915319, 915611, 915612, 915613, 915663, 915670, 915830, 916020, 916021, 916024, 916025, 916026, 916027, 916030, 916031, 916045, 916066, 916067, 916068, 916069, 916077, 916078, 916079, 916080, 916181, 916183, 916184, 916185, 916196, 916197, 916198, 916199, 916200, 916201, 916202, 916203, 916204, 916205, 916206, 916207, 916208, 916209, 916237, 916238, 916239, 916240...(Other models you can see in the webshop) | | |

| | | | |
|---|---|-----------------|--------|
|  | | | |
| 1 | | | |
| GEV No. | 518485 | Ref. No. | 419030 |
| description | spacer rod | | |
| For models: | 45, 450, 913418, 914167, 914168, 914398, 914399, 914443, 914943, 915695, 915696, 915819, E.45, Fast145, FAST-145, Fast145D, FAST-145D, Niagara-45 | | |

| | | | |
|--|---|-----------------|--------|
|  | | | |
| 1 | | | |
| GEV No. | 510058 | Ref. No. | 199018 |
| description | throttle disc | | |
| For models: | 11F, 11FD, 11F-DVGW, 66, 67R, 913363, 913364, 913376, 913377, E.41, E.42, E41 | | |

| | | | |
|---|---|-----------------|-------|
|  | | | |
| 1 | | | |
| GEV No. | 513270 | Ref. No. | 80316 |
| description | throttle disc | | |
| For models: | 80, 81, 82, CE78HZ23, CGL74CABT, E78, E78HP, Fast181, FAST-181, Fast181-230V-3Ph-60Hz, Fast181-400V-3NPh-60Hz, HM1, LP60, NG271, NG291, NIAGARA-271, NIAGARA-283, Niagara-283A, NIAGARA-291, RIVER-282, River-285, RIVER-294, RIVER-71, RIVER-78, RIVER-80, River-81, River-81CRP, RIVER-81-CRP, RIVER-82, River-82CRP, RIVER-82-CRP, RIVER-E78, RIVER-HL-81, RIVER-HL-82, RV282, RV282DD, RV282R, RV294, RV71, RV80, RV8023, RV8023HZ, RV80C, RV80HZ, RV81, RV8123, RV81A, RV81C, RV81CCR, RV81CRP...(Other models you can see in the webshop) | | |

| | | | |
|--|------------------------------------|-----------------|--------|
|  | | | |
| 1 | | | |
| GEV No. | 518015 | Ref. No. | 199001 |
| description | throttle disc | | |
| For models: | S651, S654, S810, S815, S830, S835 | | |

| | | | |
|--|---|-----------------|--------|
|  | | | |
| 1 | | | |
| GEV No. | 518284 | Ref. No. | 199053 |
| description | throttle disc | | |
| For models: | 2312-007, 2312-009-CRP, 914100, 914101, 914339, 914342, 914343, 914624, 914625, 914626, 914627, 914628, 914850, 914851, 914854, 914944, PS-60, RIVER-48, RIVER-50, RIVER-50-CRP, RIVER-50-CRP-SP, River-54, RIVER-54CRP, River-54-CRP-s.p., RIVER-54-CRP-SP, RIVER-61 | | |

| | | | |
|--|---|-----------------|--------|
|  | | | |
| 1 | | | |
| GEV No. | 518337 | Ref. No. | 199039 |
| description | throttle disc | | |
| For models: | 46, 460, E.46, GSP50, GSP50P, GSP51, GSP51P, P500, TF-503, TF-513, TF-515 | | |

| | | | |
|--|---|-----------------|--------|
|  | | | |
| 1 | | | |
| GEV No. | 518458 | Ref. No. | 199045 |
| description | throttle disc | | |
| For models: | 2312-001, 2312-002, 500F, 500FD, 50F, 50FD, 510F, 510FD, E.50, E.51, E.52, E.60, E.65, E1, E110, LF50, LF55, MC501E, MC501EP, MC501S, MC501SP, MISTRAL-51, NIAGARA-51 | | |

| | | | |
|--|---|-----------------|-------------------|
|  | | | |
| 1 | | | |
| GEV No. | 518459 | Ref. No. | 199043 3243693 |
| description | throttle disc | | |
| For models: | 2312-001, 2312-002, 500F, 500FD, 50F, 50FD, 510F, 510FD, CLEAN-100, CLEAN-110, CLEAN-120, E.50, E.51, E.52, E.60, E.65, E1, E10, E100, E110, E12, E120, E14, E140, LF50, LF55, MC501E, MC501EP, MC501S, MC501SP, MISTRAL-51, NIAGARA-51 | | |

| | | | |
|---|--|-----------------|--------|
|  | | | |
| 1 | | | |
| GEV No. | 518032 | Ref. No. | 199027 |
| description | throttle disc ED ø 34mm ID ø 13.2mm thickness 1mm | | |
| For models: | 050F, 050FP, 22F, 40F, 440F, 44F, 500F, 500FD, 50F, 50FD, 510F, 510FD, F85, F85P | | |

| | | | |
|---|--|-----------------|--------|
|  | | | |
| 1 | | | |
| GEV No. | 510112 | Ref. No. | 454002 |
| description | Thumb screw thread M10 thread L 10mm ø 22mm H 4.5mm SS | | |
| For models: | 050F, 050FP, 11F, 11FD, 11F-DVGW, 21F, 21FD, 2312-001, 2312-002, 25F, 25FD, 30F, 30FD, 31F, 31FD, 400F, 400FD, 40-ELECTRONIC, 40F, 40FD, 45, 450, 46, 460, 500F, 500FD, 50F, 50FD, 510F, 510FD, 67R, 913363, 913364, 913376, 913377, 914568, 915830, E.41, E.42, E.45, E.46, E.50, E.50D.PA, E.51, E.41, F85, F85P, FAST-160DP, GSP50, GSP50P... (Other models you can see in the webshop) | | |

| | | | |
|--|---|-----------------|--------|
|  | | | |
| 1 | | | |
| GEV No. | 518484 | Ref. No. | 449045 |
| description | wash arm support for stationary arms mounting pos. upper | | |
| For models: | 21F, 21FD, 25F, 25FD, 30F, 30FD, 31F, 31FD, 31R, 31RD, 350R, 350RD, 35-ELECTRONIC, 35R, 35RD, 400F, 400FD, 400R, 400RD, 40-ELECTRONIC, 40F, 40FD, 40R, 40RD, 45, 450, 67R, 913291, 913292, 913357, 913363, 913364, 913374, 913375, 913376, 913377, 913416, 913418, 913435, 913545, 913666, 913668, 913685, 913773, 913774, 913911, 913912, 913948, 913950, 913977...(Other models you can see in the webshop) | | |

| | | | |
|---|--|-----------------|--------|
|  | | | |
| 1 | | | |
| GEV No. | 513229 | Ref. No. | 926036 |
| description | wash arm support mounting pos. upper | | |
| For models: | 10, 12, 14, CLEAN-100, CLEAN-110, CLEAN-120, E1, E10, E100, E110, E12, E120, E14, E140 | | |



| | | | |
|---|--------------------------------------|-----------------|--------|
|  | | | |
| 1 | | | |
| GEV No. | 518483 | Ref. No. | 449041 |
| description | wash arm support mounting pos. upper | | |
| For models: | 22F, 22R, 40F, 440F, 44F, E.52 | | |

| | | | |
|--|---------------------------------------|-----------------|--------|
|  | | | |
| 1 | | | |
| GEV No. | 518580 | Ref. No. | 115129 |
| description | wash arm support mounting pos. upper | | |
| For models: | 914326, 914406, 915729, E.55, FAST-63 | | |

| | | | |
|--|--|-----------------|--------|
|  | | | |
| 1 | | | |
| GEV No. | 518400 | Ref. No. | 127029 |
| description | wash arm support mounting pos. upper coupling left | | |
| For models: | 22F, 22R, 40F, 440F, 44F, E.52 | | |

| | | | |
|--|--|-----------------|--------|
|  | | | |
| 1 | | | |
| GEV No. | 518469 | Ref. No. | 127051 |
| description | wash arm support mounting pos. upper coupling left | | |
| For models: | E.52 | | |

| | | | |
|--|---|-----------------|---------------------|
|  | | | |
| 1 | | | |
| GEV No. | 518468 | Ref. No. | 127030 127030.FR |
| description | wash arm support mounting pos. upper coupling right | | |
| For models: | 22F, 40F, 440F, 44F, E.52, TF-503, TF-513, TF-515 | | |

| | | | |
|--|---|-----------------|-----------------------|
|  | | | |
| 1 | | | |
| GEV No. | 513714 | Ref. No. | 80237 |
| description | wash pipe | | |
| For models: | 80, 81, 82, CE78HZ23, CGL74CABT, E78, E78HP, Fast181, FAST-181, Fast181-230V-3Ph-60Hz, Fast181-400V-3NPh-60Hz, HM1, NIAGARA-283, Niagara-283A, RIVER-282, River-285, RIVER-78, RIVER-80, River-81, River-81CRP, RIVER-81-CRP, RIVER-82, River-82CRP, RIVER-82-CRP, RIVER-E78, RIVER-HL-81, RIVER-HL-82, RV282, RV282DD, RV282R, RV80, RV8023, RV8023HZ, RV80C, RV80HZ, RV81, RV8123, RV81A, RV81C, RV81CCRP, RV81CRP, RV81HZ, RV81HZ23, RV81PAP, RV82, RV8223, RV82C, RV82CCRP, RV82CRP, SevenL...(Other models you can see in the webshop) | | |
| spare parts for | 513714 | | |
|  | GEV No. | 518141 | Ref. No. 80179 |
| | wash arm support thread M46x2 ø 44mm ID ø 39mm L 112.5mm W 86mm hole ø 12mm | | |



| | | | |
|---|--|-----------------|------------------|
|  | | | |
| 1 | | | |
| GEV No. | 518633 | Ref. No. | 115128 115139 |
| description | wash pipe | | |
| For models: | 2312-007, 2312-009-CRP, 914100, 914101, 914339, 914342, 914343, 914624, 914625, 914626, 914627, 914628, 914850, 914851, 914854, 914944, RIVER-48, RIVER-50, RIVER-50-CRP, RIVER-50-CRP-SP, RIVER-54, RIVER-54CRP, River-54-CRP-s.p., RIVER-54-CRP-SP, RIVER-61 | | |

| | | | |
|---|--|-----------------|--------|
|  | | | |
| 1 | | | |
| GEV No. | 518645 | Ref. No. | 115140 |
| description | wash pipe L 690mm | | |
| For models: | 915160, 915161, 915162, 915166, 915167, 915168, 915172, 915173, 915175, 915176, 915177, 915285, 915319, 915338, 915341, 915348, 915418, 915419, 915420, 915421, 915422, 915479, 915496, 915497, 915547, 915558, 915635, 915663, 915747, 916054, 916068, 916069, 916080, 916205, 916206, 916207, 916208, 916209, 916365, 916366, 916367, 916368, 916414, 916415, 916416, 916417, 916422, 916423, 916424, 916684...(Other models you can see in the webshop) | | |

| | | | |
|--|--|-----------------|-------|
|  | | | |
| 1 | | | |
| GEV No. | 698718 | Ref. No. | 69017 |
| description | wash pipe mounting pos. upper ø 72x120mm L 310mm plastic thread M6 | | |
| For models: | Fast180, Fast180-230V-3Ph-60Hz, Fast181, NG381, NG38123, NG38123TERMO, NG381C, NG381CDD, NG381CFUR, NG381DDHZ23, NG381DDPS, NG381DDPSHZ23, NG381HPDD, NG381L, NG381LC, NG381LCFUR, NG381LDDPS, NG381TERMO, NG381TXCDD, Niagara-281-2, Niagara-283L-2, Niagara-381, Niagara-381-230V-3Ph-50Hz, Niagara-381-230V-3Ph-60Hz, Niagara-381DP, Niagara-381HPD, Niagara-381L, Niagara-381LC, OC380, OC380FUR, OC380HZ23, Ocean380, PV280FAST2, PV280FAST2BIO, PV280FAST2HZ23, River-282-2, River-282L-2, River-282LS-2TDE, River-282S-2TDE, River-285, River-382, River-382-230V-3Ph-50Hz, River-382H, River-382L, River-382L-230V-3Ph-50Hz, River-382LNRG, River-382LTDE, River-382NRG, River-382NRG-230-3Ph-50Hz, River-382TDE...(Other models you can see in the webshop) | | |

| | | | |
|---|---|-----------------|-------|
|  | | | |
| 1 | | | |
| GEV No. | 519493 | Ref. No. | 75165 |
| description | wash pipe ø 48mm L 617mm plastic | | |
| For models: | 914380, 914436, 915747, A4EB, A4EBD, A4EBDAKEYK, A4EBDAKRK, A4EBDAKWK, A4EBDAKZK, A4EBDBKRK, A4EBDPKWKYK, A4EBDRK, A4EBS, A4EBSAK, A4EBSACKK, A4EBSAKEKYK, A4EBSAKRK, A4EBSAKRKP, A4EBSAKYK, A4EBSCK, A4EBT, A4EBTSAK, A5EB, A5EBD, A5EBDAKPKWK, A5EBDAKWK, A5EBDAKYK, A5EBDRK, A5EBS, A5EBSAKPKWK, A5EBSAKRK, A5EBSAKRKYK, A5EBSAKWK, A5EBSAKWKYK, A5EBSBKRKP, A5EBSBKWK, A5EBSRK, A5EBSYK, Fast200, FAST-200, Fast93, GL280EB, GL280EB23, GL280EB23DAR, GL280EB23HZ, GL280EB23HZDY, GL280EBD, GL280EBDA, GL280EBDAE, GL280EBDAR...(Other models you can see in the webshop) | | |

washing and rinsing systems (sorted by producer)

ELETTROBAR



| | | | |
|---|---|-----------------|--|
|  | | | |
| 1 | | | |
| GEV No. | 518269 | Ref. No. | 990061 990108 |
| description | wash and rinse arm wash arm L 495mm rinse arm L 490mm w. jets 9 r. jets 5 mounting ø 16.5mm mounting pos. upper | | |
| For models: | 050F, 050FP, 2312-001, 2312-002, 914568, 915830, E.50, E.50D.PA, E.51, F85, F85P, FAST-160DP, GSP50, GSP50P, GSP51, GSP51P, LF50, LF55, MC501E, MC501EP, MC501S, MC501SP, MISTRAL-51, NIAGARA-51, P500, RIVER-E78 | | |
| spare parts for | 518269 | | |
|  | GEV No. | 510010 | Ref. No. 129003 129039 |
| | wash arm boss L1 64mm L2 60mm mounting ø 16.5mm | | |
|  | GEV No. | 510139 | Ref. No. 140007 |
| | rinse jet | | |
|  | GEV No. | 513262 | Ref. No. 499009 |
| | blank nozzle | | |
|  | GEV No. | 518004 | Ref. No. 140008 |
| | wash jet | | |
|  | GEV No. | 518053 | Ref. No. 429006.TN 429039 |
| | union nut for rinse jet | | |
|  | GEV No. | 518272 | Ref. No. 429040 |
| | union nut for wash jet | | |
|  | GEV No. | 518332 | Ref. No. 106008 |
| | wash arm mounting pos. right L 220mm mounting ø 24mm nozzles 5 | | |
|  | GEV No. | 518333 | Ref. No. 106006 |
| | wash arm mounting pos. left L 220mm mounting ø 24mm nozzles 4 | | |
|  | GEV No. | 518334 | Ref. No. 106007 |
| | rinse arm mounting pos. right L 220mm mounting ø 13mm nozzles 3 | | |
|  | GEV No. | 518335 | Ref. No. 106005 |
| | rinse arm mounting pos. left L 220mm mounting ø 13mm nozzles 3 | | |

| | | | |
|---|---|-----------------|-----------|
|  | | | |
| 1 | | | |
| GEV No. | 518465 | Ref. No. | 106072.CR |
| description | rinse arm mounting pos. left | | |
| For models: | 500F, 500FD, 50F, 50FD, 510F, 510FD, E.50, E.51 | | |

| | | | |
|---|---|-----------------|--------|
|  | | | |
| 1 | | | |
| GEV No. | 518335 | Ref. No. | 106005 |
| description | rinse arm mounting pos. left L 220mm mounting ø 13mm nozzles 3 | | |
| For models: | 050F, 050FP, 2312-001, 2312-002, 914568, 915830, E.50, E.50D.PA, E.51, F85, F85P, FAST-160DP, GSP50, GSP50P, GSP51, GSP51P, LF50, LF55, MC501E, MC501EP, MC501S, MC501SP, MISTRAL-51, NIAGARA-51, P500, PS-60, S651, S651P, S653, S654, S655, S830, S835, S850, SR651, TF-503, TF-513, TF-515 | | |

| | | | |
|--|---|-----------------|-----------|
|  <p>Image not available</p> | | | |
| 1 | | | |
| GEV No. | 518464 | Ref. No. | 106073.CR |
| description | rinse arm mounting pos. right | | |
| For models: | 500F, 500FD, 50F, 50FD, 510F, 510FD, E.50, E.51 | | |

| | | | |
|---|---|-----------------|--------|
|  | | | |
| 1 | | | |
| GEV No. | 518334 | Ref. No. | 106007 |
| description | rinse arm mounting pos. right L 220mm mounting ø 13mm nozzles 3 | | |
| For models: | 050F, 050FP, 2312-001, 2312-002, 914568, 915830, E.50, E.50D.PA, E.51, F85, F85P, FAST-160DP, GSP50, GSP50P, GSP51, GSP51P, LF50, LF55, MC501E, MC501EP, MC501S, MC501SP, MISTRAL-51, NIAGARA-51, P500, PS-60, S651, S651P, S653, S654, S655, S830, S835, S850, SR651 | | |

| | | | |
|---|--|-----------------|------------------------|
|  | | | |
| 1 | | | |
| GEV No. | 510139 | Ref. No. | 140007 |
| description | rinse jet | | |
| For models: | 050F, 050FP, 10, 11F, 11FD, 11F-DVGW, 11R, 11RD, 12, 21F, 21FD, 21R, 21RD, 22F, 2312-001, 2312-002, 25F, 25FD, 25R, 25RD, 30F, 30FD, 30R, 30RD, 31F, 31FD, 31R, 31RD, 350F, 350FD, 350R, 350RD, 35-ELECTRONIC, 35F, 35FD, 35R, 35RD, 400F, 400FD, 400R, 400RD, 40-ELECTRONIC, 40F, 40FD, 40R, 40RD, 440F, 44F, 45, 450...(Other models you can see in the webshop) | | |
| accessories for | 510139 | | |
|  | GEV No. | 510130 | Ref. No. 429006 |
| | union nut for rinse jet | | |

| | | | |
|---|---|-----------------|---------------------|
|  | | | |
| 1 | | | |
| GEV No. | 518053 | Ref. No. | 429006.TN 429039 |
| description | union nut for rinse jet | | |
| For models: | 050F, 050FP, 45, 450, 46, 460, 67R, 914684, E.50, E.51, F85, F85P, LF50, LF55, MC501E, MC501EP, MC501S, MC501SP, MISTRAL-51, NIAGARA-51, RIVER-39, TF-503, TF-513, TF-515 | | |

| | | | |
|---|---|-----------------|--------|
|  | | | |
| 1 | | | |
| GEV No. | 518272 | Ref. No. | 429040 |
| description | union nut for wash jet | | |
| For models: | 050F, 050FP, 45, 450, 46, 460, 67R, 914684, E.50, E.51, F85, F85P, LF50, LF55, MC501E, MC501EP, MC501S, MC501SP, MISTRAL-51, NIAGARA-51, RIVER-39, TF-503, TF-513, TF-515 | | |



| | | | |
|---|---|-----------------|------------------------|
|  | | | |
| 1 | | | |
| GEV No. | 518333 | Ref. No. | 106006 |
| description | wash arm mounting pos. left L 220mm mounting ø 24mm nozzles 4 | | |
| For models: | 050F, 050FP, 2312-001, 2312-002, 914568, 915830, E.50, E.50D.PA, E.51, F85, F85P, FAST-160DP, GSP50, GSP50P, GSP51, GSP51P, LF50, LF55, MC501E, MC501EP, MC501S, MC501SP, MISTRAL-51, NIAGARA-51, P500, PS-60, S651, S651P, S653, S654, S655, S830, S835, S850, SR651, TF-503, TF-513, TF-515 | | |
| accessories for | 518333 | | |
|  | GEV No. | 518004 | Ref. No. 140008 |
| | wash jet | | |
|  | GEV No. | 518272 | Ref. No. 429040 |
| | union nut for wash jet | | |

| | | | |
|---|---|-----------------|------------------------|
|  | | | |
| 1 | | | |
| GEV No. | 518332 | Ref. No. | 106008 |
| description | wash arm mounting pos. right L 220mm mounting ø 24mm nozzles 5 | | |
| For models: | 050F, 050FP, 2312-001, 2312-002, 914568, 915830, E.50, E.50D.PA, E.51, F85, F85P, FAST-160DP, GSP50, GSP50P, GSP51, GSP51P, LF50, LF55, MC501E, MC501EP, MC501S, MC501SP, MISTRAL-51, NIAGARA-51, P500, PS-60, S651, S651P, S653, S654, S655, S830, S835, S850, SR651 | | |
| accessories for | 518332 | | |
|  | GEV No. | 518004 | Ref. No. 140008 |
| | wash jet | | |
|  | GEV No. | 518272 | Ref. No. 429040 |
| | union nut for wash jet | | |

| | | | |
|---|---|-----------------|------------------|
|  | | | |
| 1 | | | |
| GEV No. | 510010 | Ref. No. | 129003 129039 |
| description | wash arm boss L1 64mm L2 60mm mounting ø 16.5mm | | |
| For models: | 050F, 050FP, 11F, 11FD, 11F-DVGW, 21F, 21FD, 2312-001, 2312-002, 25F, 25FD, 30F, 30FD, 31F, 31FD, 400F, 400FD, 40-ELECTRONIC, 40F, 40FD, 45, 450, 46, 460, 500F, 500FD, 50F, 50FD, 510F, 510FD, 67R, 913363, 913364, 913376, 913377, 914568, 915830, E.41, E.42, E.45, E.46, E.50, E.50D.PA, E.51, E.41, F85, F85P, FAST-160DP, GSP50, GSP50P...(Other models you can see in the webshop) | | |







| | | | |
|---|---|-----------------|--------|
|  | | | |
| 1 | | | |
| GEV No. | 518004 | Ref. No. | 140008 |
| description | wash jet | | |
| For models: | 050F, 050FP, 11R, 11RD, 21F, 21FD, 21R, 21RD, 2312-001, 2312-002, 25F, 25FD, 25R, 25RD, 30F, 30FD, 30R, 30RD, 31F, 31FD, 31R, 31RD, 500F, 500FD, 50F, 50FD, 510F, 510FD, 67R, 914568, 915830, E.42, E.50, E.50D.PA, E.51, F85, F85P, FAST-160DP, GSP50, GSP50P, GSP51, GSP51P, LF50, LF55, MC501E, MC501EP, MC501S, MC501SP, MISTRAL-51, NIAGARA-51...(Other models you can see in the webshop) | | |



| | | | |
|---|--|--------|------------------|
| accessories for | 510119 | | |
|  | GEV No. | 518003 | Ref. No. |
| | | | 447030 447128 |
| | screw cap | | |
|  | GEV No. | 518008 | Ref. No. |
| | | | 437016 |
| | gasket D1 ø 43mm D2 ø 78mm thickness 2mm with 6 holes wash arm support | | |
|  | GEV No. | 518036 | Ref. No. |
| | | | 127012 |
| | formed hose angled warewashing | | |



| | | | |
|---|---|-----------------|--------|
|  | | | |
| 1 | | | |
| GEV No. | 510119 | Ref. No. | 990008 |
| description | wash and rinse arm wash arm L 410mm rinse arm L 410mm w. jets 7 r. jets 5 mounting ø 16.5mm mounting pos. lower | | |
| For models: | 21F, 21FD, 25F, 25FD, 30F, 30FD, 31F, 31FD, S621, S623, S624, S626, S631, S633, S634, S636 | | |







| | | | |
|---|---|-----------------|--------|
|  | | | |
| 1 | | | |
| GEV No. | 518383 | Ref. No. | 106010 |
| description | rinse arm mounting pos. left L 175mm mounting ø 13mm nozzles 2 | | |
| For models: | 11F, 11FD, 11F-DVGW, 21F, 21FD, 25F, 25FD, 30F, 30FD, 31F, 31FD, 400F, 400FD, 40-ELECTRONIC, 40F, 40FD, 913363, 913364, 913376, 913377, E.41, E.42, E.46, E41, S621, S623, S624, S626, S631, S633, S634, S636 | | |



| | | | |
|---|---|--------|------------------|
| spare parts for | 510119 | | |
|  | GEV No. | 510010 | Ref. No. |
| | | | 129003 129039 |
| | wash arm boss L1 64mm L2 60mm mounting ø 16.5mm | | |
|  | GEV No. | 510130 | Ref. No. |
| | | | 429006 |
| | union nut for rinse jet | | |
|  | GEV No. | 510131 | Ref. No. |
| | | | 429007 |
| | union nut for wash jet | | |



| | | | |
|---|---|-----------------|--------|
|  | | | |
| 1 | | | |
| GEV No. | 518384 | Ref. No. | 106011 |
| description | rinse arm mounting pos. right L 175mm mounting ø 13mm nozzles 3 | | |
| For models: | 11F, 11FD, 11F-DVGW, 21F, 21FD, 25F, 25FD, 30F, 30FD, 31F, 31FD, 400F, 400FD, 40-ELECTRONIC, 40F, 40FD, 913363, 913364, 913376, 913377, E.41, E.42, E.46, E41, S621, S623, S624, S626, S631, S633, S634, S636 | | |

| | | | |
|---|----------------------|--------|----------------------------|
|  | GEV No. | 510138 | Ref. No. |
| | | | 114013 140013 140020 |
| | wash jet fine groove | | |
|  | GEV No. | 510139 | Ref. No. |
| | | | 140007 |
| | rinse jet | | |
|  | GEV No. | 518004 | Ref. No. |
| | | | 140008 |
| | wash jet | | |

| | | | |
|---|--|-----------------|-----------------|
|  | | | |
| 1 | | | |
| GEV No. | 510139 | Ref. No. | 140007 |
| description | rinse jet | | |
| For models: | 050F, 050FP, 10, 11F, 11FD, 11F-DVGW, 11R, 11RD, 12, 21F, 21FD, 21R, 21RD, 22F, 2312-001, 2312-002, 25F, 25FD, 25R, 25RD, 30F, 30FD, 30R, 30RD, 31F, 31FD, 31R, 31RD, 350F, 350FD, 350R, 350RD, 35-ELECTRONIC, 35F, 35FD, 35R, 35RD, 400F, 400FD, 400R, 400RD, 40-ELECTRONIC, 40F, 40FD, 40R, 40RD, 440F, 44F, 45, 450...(Other models you can see in the webshop) | | |
| accessories for | 510139 | | |
|  | GEV No. | 510130 | Ref. No. |
| | | | 429006 |
| | union nut for rinse jet | | |

| | | | |
|---|---|--------|-----------------|
|  | GEV No. | 518382 | Ref. No. |
| | | | 106009 |
| | wash arm mounting pos. right L 175mm mounting ø 24mm nozzles 4 | | |
|  | GEV No. | 518383 | Ref. No. |
| | | | 106010 |
| | rinse arm mounting pos. left L 175mm mounting ø 13mm nozzles 2 | | |
|  | GEV No. | 518384 | Ref. No. |
| | | | 106011 |
| | rinse arm mounting pos. right L 175mm mounting ø 13mm nozzles 3 | | |
|  | GEV No. | 518631 | Ref. No. |
| | | | 106012 |
| | wash arm mounting pos. left L 170mm nozzles mounting ø 24mm | | |
| accessories for | 510119 | | |
|  | GEV No. | 510108 | Ref. No. |
| | | | 327006 |
| | rinse arm shaft | | |
|  | GEV No. | 510112 | Ref. No. |
| | | | 454002 |
| | Thumb screw thread M10 thread L 10mm ø 22mm H 4.5mm SS | | |

| | | | |
|---|---|-----------------|-----------------|
|  | | | |
| 1 | | | |
| GEV No. | 510130 | Ref. No. | 429006 |
| description | union nut for rinse jet | | |
| For models: | 10, 11F, 11FD, 11F-DVGW, 11R, 11RD, 12, 21F, 21FD, 21R, 21RD, 22F, 2312-001, 2312-002, 25F, 25FD, 25R, 25RD, 30F, 30FD, 30R, 30RD, 31F, 31FD, 31R, 31RD, 350F, 350FD, 350R, 350RD, 35-ELECTRONIC, 35F, 35FD, 35R, 35RD, 400F, 400FD, 400R, 400RD, 40-ELECTRONIC, 40F, 40FD, 40R, 40RD, 440F, 44F, 500F, 500FD, 50-ELECTRONIC, 50F...(Other models you can see in the webshop) | | |
| accessories for | 510130 | | |
|  | GEV No. | 510139 | Ref. No. |
| | | | 140007 |
| | rinse jet | | |







| | | | |
|---|---|-----------------|----------------------------|
|  | | | |
| 1 | | | |
| GEV No. | 510131 | Ref. No. | 429007 |
| description | union nut for wash jet | | |
| For models: | 11F, 11FD, 11F-DVGW, 11R, 11RD, 21F, 21FD, 21R, 21RD, 2312-001, 2312-002, 25F, 25FD, 25R, 25RD, 30F, 30FD, 30R, 30RD, 31F, 31FD, 31R, 31RD, 350F, 350FD, 350R, 350RD, 35-ELECTRONIC, 35F, 35FD, 35R, 35RD, 400F, 400FD, 40-ELECTRONIC, 40F, 40FD, 500F, 500FD, 50F, 50FD, 510F, 510FD, 913363, 913364, 913376, 913377, 914568, 915830, E.35...(Other models you can see in the webshop) | | |
| accessories for | 510131 | | |
|  | GEV No. | 510138 | Ref. No. |
| | | | 114013 140013 140020 |
| | wash jet fine groove | | |

| | | | |
|---|--|-----------------|--------|
|  | | | |
| 1 | | | |
| GEV No. | 518631 | Ref. No. | 106012 |
| description | wash arm mounting pos. left L 170mm nozzles mounting ø 24mm | | |
| For models: | 11F, 11FD, 11F-DVGW, 21F, 21FD, 25F, 25FD, 30F, 30FD, 31F, 31FD, 400F, 400FD, 40-ELECTRONIC, 40F, 40FD, 913363, 913364, 913376, 913377, E.41, E.42, E.46, E.41, S621, S623, S624, S626, S631, S633, S634, S636 | | |

| | | | |
|--|--|-----------------|--------|
|  | | | |
| 1 | | | |
| GEV No. | 518382 | Ref. No. | 106009 |
| description | wash arm mounting pos. right L 175mm mounting ø 24mm nozzles 4 | | |
| For models: | 11F, 11FD, 11F-DVGW, 21F, 21FD, 25F, 25FD, 30F, 30FD, 31F, 31FD, 400F, 400FD, 40-ELECTRONIC, 40F, 40FD, 913363, 913364, 913376, 913377, E.41, E.42, E.45, E.46, E.41, NIAGARA-45, S621, S623, S624, S626, S631, S633, S634, S636 | | |

| | | | |
|---|--|-----------------|------------------|
|  | | | |
| 1 | | | |
| GEV No. | 510010 | Ref. No. | 129003 129039 |
| description | wash arm boss L1 64mm L2 60mm mounting ø 16.5mm | | |
| For models: | 050F, 050FP, 11F, 11FD, 11F-DVGW, 21F, 21FD, 2312-001, 2312-002, 25F, 25FD, 30F, 30FD, 31F, 31FD, 400F, 400FD, 40-ELECTRONIC, 40F, 40FD, 45, 450, 46, 460, 500F, 500FD, 50F, 50FD, 510F, 510FD, 67R, 913363, 913364, 913376, 913377, 914568, 915830, E.41, E.42, E.45, E.46, E.50, E.50D.PA, E.51, E.41, F85, F85P, FAST-160DP, GSP50, GSP50P... (Other models you can see in the webshop) | | |



| | | | |
|---|---|-----------------|--------|
|  | | | |
| 1 | | | |
| GEV No. | 518004 | Ref. No. | 140008 |
| description | wash jet | | |
| For models: | 050F, 050FP, 11R, 11RD, 21F, 21FD, 21R, 21RD, 2312-001, 2312-002, 25F, 25FD, 25R, 25RD, 30F, 30FD, 30R, 30RD, 31F, 31FD, 31R, 31RD, 500F, 500FD, 50F, 50FD, 510F, 510FD, 67R, 914568, 915830, E.42, E.50, E.50D.PA, E.51, F85, F85P, FAST-160DP, GSP50, GSP50P, GSP51, GSP51P, LF50, LF55, MC501E, MC501EP, MC501S, MC501SP, MISTRAL-51, NIAGARA-51...(Other models you can see in the webshop) | | |

| | | | |
|---|--|-----------------|----------------------------|
|  | | | |
| 1 | | | |
| GEV No. | 518411 | Ref. No. | 990077 |
| description | wash and rinse arm wash arm L 410mm rinse arm L 415mm w. jets 7 r. jets 5 mounting ø 17/52mm mounting pos. upper | | |
| For models: | 46, 460, TF-503, TF-513, TF-515 | | |
| spare parts for | 518411 | | |
|  | GEV No. | 510138 | Ref. No. |
| | | | 114013 140013 140020 |
| | wash jet fine groove | | |
|  | GEV No. | 510139 | Ref. No. |
| | | | 140007 |
| | rinse jet | | |
|  | GEV No. | 518053 | Ref. No. |
| | | | 429006.TN 429039 |
| | union nut for rinse jet | | |
|  | GEV No. | 518272 | Ref. No. |
| | | | 429040 |
| | union nut for wash jet | | |
| accessories for | 518411 | | |
|  | GEV No. | 510112 | Ref. No. |
| | | | 454002 |
| | Thumb screw thread M10 thread L 10mm ø 22mm H 4.5mm SS | | |
|  | GEV No. | 518003 | Ref. No. |
| | | | 447030 447128 |
| | screw cap | | |

| | | | |
|---|--|-----------------|--------|
|  | | | |
| 1 | | | |
| GEV No. | 518415 | Ref. No. | 106047 |
| description | rinse arm mounting pos. left mounting ø 19mm nozzles 2 | | |
| For models: | 46, 460, TF-503, TF-513, TF-515 | | |

| | | | |
|---|---|-----------------|--------|
|  | | | |
| 1 | | | |
| GEV No. | 518414 | Ref. No. | 106048 |
| description | rinse arm mounting pos. right mounting ø 19mm nozzles 3 | | |
| For models: | 46, 460, 67R, TF-503, TF-513, TF-515 | | |





| | | | |
|---|--|-----------------|--------|
|  | | | |
| GEV No. | 510139 | Ref. No. | 140007 |
| description | rinse jet | | |
| For models: | 050F, 050FP, 10, 11F, 11FD, 11F-DVGW, 11R, 11RD, 12, 21F, 21FD, 21R, 21RD, 22F, 2312-001, 2312-002, 25F, 25FD, 25R, 25RD, 30F, 30FD, 30R, 30RD, 31F, 31FD, 31R, 31RD, 350F, 350FD, 350R, 350RD, 35-ELECTRONIC, 35F, 35FD, 35R, 35RD, 400F, 400FD, 400R, 400RD, 40-ELECTRONIC, 40F, 40FD, 40R, 40RD, 440F, 44F, 45, 450...(Other models you can see in the webshop) | | |
| accessories for | 510139 | | |
|  | | | |
| GEV No. | 510130 | Ref. No. | 429006 |
| description | union nut for rinse jet | | |



| | | | |
|---|---|-----------------|---------------------|
|  | | | |
| GEV No. | 518053 | Ref. No. | 429006.TN 429039 |
| description | union nut for rinse jet | | |
| For models: | 050F, 050FP, 45, 450, 46, 460, 67R, 914684, E.50, E.51, F85, F85P, LF50, LF55, MC501E, MC501EP, MC501S, MC501SP, MISTRAL-51, NIAGARA-51, RIVER-39, TF-503, TF-513, TF-515 | | |

| | | | |
|---|---|-----------------|--------|
|  | | | |
| GEV No. | 518272 | Ref. No. | 429040 |
| description | union nut for wash jet | | |
| For models: | 050F, 050FP, 45, 450, 46, 460, 67R, 914684, E.50, E.51, F85, F85P, LF50, LF55, MC501E, MC501EP, MC501S, MC501SP, MISTRAL-51, NIAGARA-51, RIVER-39, TF-503, TF-513, TF-515 | | |

| | | | |
|---|---|-----------------|--------|
|  | | | |
| GEV No. | 518413 | Ref. No. | 106091 |
| description | wash arm mounting pos. left mounting ø 24mm nozzles 3 | | |
| For models: | 46, 460 | | |



| | | | |
|---|--|-----------------|--------|
|  | | | |
| GEV No. | 518412 | Ref. No. | 106090 |
| description | wash arm mounting pos. right mounting ø 24mm nozzles 4 | | |
| For models: | 46, 460 | | |

| | | | |
|---|--|-----------------|------------------|
|  | | | |
| GEV No. | 510010 | Ref. No. | 129003 129039 |
| description | wash arm boss L1 64mm L2 60mm mounting ø 16.5mm | | |
| For models: | 050F, 050FP, 11F, 11FD, 11F-DVGW, 21F, 21FD, 2312-001, 2312-002, 25F, 25FD, 30F, 30FD, 31F, 31FD, 400F, 400FD, 40-ELECTRONIC, 40F, 40FD, 45, 450, 46, 460, 500F, 500FD, 50F, 50FD, 510F, 510FD, 67R, 913363, 913364, 913376, 913377, 914568, 915830, E.41, E.42, E.45, E.46, E.50, E.50D.PA, E.51, E41, F85, F85P, FAST-160DP, GSP50, GSP50P...(Other models you can see in the webshop) | | |

| | | | |
|--|--|-----------------|----------------------------|
|  | | | |
| GEV No. | 510138 | Ref. No. | 114013 140013 140020 |
| description | wash jet fine groove | | |
| For models: | 11F, 11FD, 11F-DVGW, 350F, 350FD, 350R, 350RD, 35-ELECTRONIC, 35F, 35FD, 35R, 35RD, 400F, 400FD, 40-ELECTRONIC, 40F, 40FD, 45, 450, 46, 460, 67R, 913363, 913364, 913376, 913377, E.35, E.35H, E.40, E.40H, E.41, E.42, E.45, E.46, E41, GLS40H, GLS40HP, GSP50, GSP50P, GSP51, GSP51P, MC201CL, MISTRAL-40, NIAGARA-35, NIAGARA-40, NIAGARA-45, P500, PS-60, TF-503, TF-513...(Other models you can see in the webshop) | | |
| accessories for | 510138 | | |
|  | | | |
| GEV No. | 510131 | Ref. No. | 429007 |
| description | union nut for wash jet | | |



| | | | |
|--|---|-----------------|----------------------------|
|  | | | |
| GEV No. | 518449 | Ref. No. | 990078 990097 |
| description | wash and rinse arm wash arm L 435mm rinse arm L 445mm w. jets 8 r. jets 5 mounting ø 16.5mm mounting pos. lower | | |
| For models: | 45, 450, 46, 460, E.45, E.46, NIAGARA-45 | | |
| spare parts for | 518449 | | |
|  | | | |
| GEV No. | 510010 | Ref. No. | 129003 129039 |
| description | wash arm boss L1 64mm L2 60mm mounting ø 16.5mm | | |
|  | | | |
| GEV No. | 510130 | Ref. No. | 429006 |
| description | union nut for rinse jet | | |
|  | | | |
| GEV No. | 510131 | Ref. No. | 429007 |
| description | union nut for wash jet | | |
|  | | | |
| GEV No. | 510138 | Ref. No. | 114013 140013 140020 |
| description | wash jet fine groove | | |
|  | | | |
| GEV No. | 510139 | Ref. No. | 140007 |
| description | rinse jet | | |



Table continues overleaf



| | | | |
|---|---------|--------|-----------------|
| spare parts for 518449 | | | |
|  | GEV No. | 513262 | Ref. No. 499009 |
| blank nozzle | | | |
|  | GEV No. | 518382 | Ref. No. 106009 |
| wash arm mounting pos. right L 175mm mounting ø 24mm nozzles 4 | | | |
|  | GEV No. | 518451 | Ref. No. 106107 |
| rinse arm mounting pos. right L 200mm mounting ø 13mm nozzles 3 | | | |

| | | | |
|---|---------|--------|-----------------|
|  | | | |
| 1 | GEV No. | 518452 | Ref. No. 106108 |
| description rinse arm mounting pos. left L 185mm mounting ø 13mm nozzles 4 | | | |
| For models: E.45, E.46 | | | |

| | | | |
|--|---------|--------|-----------------|
|  | | | |
| 1 | GEV No. | 518451 | Ref. No. 106107 |
| description rinse arm mounting pos. right L 200mm mounting ø 13mm nozzles 3 | | | |
| For models: E.45, E.46, NIAGARA-45 | | | |

| | | | |
|---|---------|--------|-----------------|
|  | | | |
| 1 | GEV No. | 510139 | Ref. No. 140007 |
| description rinse jet | | | |
| For models: 050F, 050FP, 10, 11F, 11FD, 11F-DVGW, 11R, 11RD, 12, 21F, 21FD, 21R, 21RD, 22F, 2312-001, 2312-002, 25F, 25FD, 25R, 25RD, 30F, 30FD, 30R, 30RD, 31F, 31FD, 31R, 31RD, 350F, 350FD, 350R, 350RD, 35-ELECTRONIC, 35F, 35FD, 35R, 35RD, 400F, 400FD, 400R, 400RD, 40-ELECTRONIC, 40F, 40FD, 40R, 40RD, 440F, 44F, 45, 450...(Other models you can see in the webshop) | | | |
| accessories for 510139 | | | |
|  | GEV No. | 510130 | Ref. No. 429006 |
| union nut for rinse jet | | | |

| | | | |
|--|---------|--------|-----------------|
|  | | | |
| 1 | GEV No. | 510130 | Ref. No. 429006 |
| description union nut for rinse jet | | | |
| For models: 10, 11F, 11FD, 11F-DVGW, 11R, 11RD, 12, 21F, 21FD, 21R, 21RD, 22F, 2312-001, 2312-002, 25F, 25FD, 25R, 25RD, 30F, 30FD, 30R, 30RD, 31F, 31FD, 31R, 31RD, 350F, 350FD, 350R, 350RD, 35-ELECTRONIC, 35F, 35FD, 35R, 35RD, 400F, 400FD, 400R, 400RD, 40-ELECTRONIC, 40F, 40FD, 40R, 40RD, 440F, 44F, 500F, 500FD, 50-ELECTRONIC, 50F...(Other models you can see in the webshop) | | | |
| accessories for 510130 | | | |
|  | GEV No. | 510139 | Ref. No. 140007 |
| rinse jet | | | |



| | | | |
|--|---------|--------|-------------------------------------|
|  | | | |
| 1 | GEV No. | 510131 | Ref. No. 429007 |
| description union nut for wash jet | | | |
| For models: 11F, 11FD, 11F-DVGW, 11R, 11RD, 21F, 21FD, 21R, 21RD, 2312-001, 2312-002, 25F, 25FD, 25R, 25RD, 30F, 30FD, 30R, 30RD, 31F, 31FD, 31R, 31RD, 350F, 350FD, 350R, 350RD, 35-ELECTRONIC, 35F, 35FD, 35R, 35RD, 400F, 400FD, 40-ELECTRONIC, 40F, 40FD, 500F, 500FD, 50F, 50FD, 510F, 510FD, 913363, 913364, 913376, 913377, 914568, 915830, E.35...(Other models you can see in the webshop) | | | |
| accessories for 510131 | | | |
|  | GEV No. | 510138 | Ref. No. 114013 140013 140020 |
| wash jet fine groove | | | |

| | | | |
|---|---------|--------|-----------------|
|  | | | |
| 1 | GEV No. | 518450 | Ref. No. 106106 |
| description wash arm mounting pos. left L 175mm mounting ø 24mm nozzles 4 | | | |
| For models: E.45, E.46, NIAGARA-45 | | | |

| | | | |
|--|---------|--------|-----------------|
|  | | | |
| 1 | GEV No. | 518382 | Ref. No. 106009 |
| description wash arm mounting pos. right L 175mm mounting ø 24mm nozzles 4 | | | |
| For models: 11F, 11FD, 11F-DVGW, 21F, 21FD, 25F, 25FD, 30F, 30FD, 31F, 31FD, 400F, 400FD, 40-ELECTRONIC, 40F, 40FD, 913363, 913364, 913376, 913377, E.41, E.42, E.45, E.46, E41, NIAGARA-45, S621, S623, S624, S626, S631, S633, S634, S636 | | | |



| | | | |
|---|---------|--------|---------------------------|
|  | | | |
| 1 | GEV No. | 510010 | Ref. No. 129003 129039 |
| description wash arm boss L1 64mm L2 60mm mounting ø 16.5mm | | | |
| For models: 050F, 050FP, 11F, 11FD, 11F-DVGW, 21F, 21FD, 2312-001, 2312-002, 25F, 25FD, 30F, 30FD, 31F, 31FD, 400F, 400FD, 40-ELECTRONIC, 40F, 40FD, 45, 450, 46, 460, 500F, 500FD, 50F, 50FD, 510F, 510FD, 67R, 913363, 913364, 913376, 913377, 914568, 915830, E.41, E.42, E.45, E.46, E.50, E.50D.PA, E.51, E41, F85, F85P, FAST-160DP, GSP50, GSP50P...(Other models you can see in the webshop) | | | |





| | | | |
|---|--|-----------------|----------------------------|
|  | | | |
| GEV No. | 510138 | Ref. No. | 114013 140013 140020 |
| description | wash jet fine groove | | |
| For models: | 11F, 11FD, 11F-DVGW, 350F, 350FD, 350R, 350RD, 35-ELECTRONIC, 35F, 35FD, 35R, 35RD, 400F, 400FD, 40-ELECTRONIC, 40F, 40FD, 45, 450, 46, 460, 67R, 913363, 913364, 913376, 913377, E.35, E.35H, E.40, E.40H, E.41, E.42, E.45, E.46, E41, GLS40H, GLS40HP, GSP50, GSP50P, GSP51, GSP51P, MC201CL, MISTRAL-40, NIAGARA-35, NIAGARA-40, NIAGARA-45, P500, PS-60, TF-503, TF-513...(Other models you can see in the webshop) | | |
| accessories for | 510138 | | |
|  | | | |
| GEV No. | 510131 | Ref. No. | 429007 |
| union nut for wash jet | | | |



| | | | |
|---|---|-----------------|----------------------------|
|  | | | |
| GEV No. | 513711 | Ref. No. | 990075 |
| description | wash and rinse arm wash arm L 495mm rinse arm L 460mm w. jets 9 r. jets 5 mounting ø 16.5mm mounting pos. lower | | |
| For models: | GSP50, GSP50P, GSP51, GSP51P, P500, TF-503, TF-513, TF-515 | | |
| spare parts for | 513711 | | |
|  | | | |
| GEV No. | 510010 | Ref. No. | 129003 129039 |
| wash arm boss L1 64mm L2 60mm mounting ø 16.5mm | | | |
|  | | | |
| GEV No. | 510138 | Ref. No. | 114013 140013 140020 |
| wash jet fine groove | | | |
|  | | | |
| GEV No. | 510139 | Ref. No. | 140007 |
| rinse jet | | | |
|  | | | |
| GEV No. | 513262 | Ref. No. | 499009 |
| blank nozzle | | | |
|  | | | |
| GEV No. | 518053 | Ref. No. | 429006.TN 429039 |
| union nut for rinse jet | | | |
|  | | | |
| GEV No. | 518272 | Ref. No. | 429040 |
| union nut for wash jet | | | |
|  | | | |
| GEV No. | 518332 | Ref. No. | 106008 |
| wash arm mounting pos. right L 220mm mounting ø 24mm nozzles 5 | | | |
|  | | | |
| GEV No. | 518333 | Ref. No. | 106006 |
| wash arm mounting pos. left L 220mm mounting ø 24mm nozzles 4 | | | |
|  | | | |
| GEV No. | 518334 | Ref. No. | 106007 |
| rinse arm mounting pos. right L 220mm mounting ø 13mm nozzles 3 | | | |



| | | | |
|---|--|-----------------|--------|
|  | | | |
| GEV No. | 518409 | Ref. No. | 106094 |
| description | rinse arm mounting pos. left L 190mm mounting ø 19mm nozzles 3 | | |
| For models: | 45, 450, 46, 460, GSP50, GSP50P, GSP51, GSP51P, NIAGARA-45, P500 | | |

| | | | |
|--|---|-----------------|-----------|
|  | | | |
| Image not available | | | |
|  | | | |
| GEV No. | 518464 | Ref. No. | 106073.CR |
| description | rinse arm mounting pos. right | | |
| For models: | 500F, 500FD, 50F, 50FD, 510F, 510FD, E.50, E.51 | | |

| | | | |
|---|---|-----------------|--------|
|  | | | |
| GEV No. | 518334 | Ref. No. | 106007 |
| description | rinse arm mounting pos. right L 220mm mounting ø 13mm nozzles 3 | | |
| For models: | 050F, 050FP, 2312-001, 2312-002, 914568, 915830, E.50, E.50D.PA, E.51, F85, F85P, FAST-160DP, GSP50, GSP50P, GSP51, GSP51P, LF50, LF55, MC501E, MC501EP, MC501S, MC501SP, MISTRAL-51, NIAGARA-51, P500, PS-60, S651, S651P, S653, S654, S655, S830, S835, S850, SR651 | | |

| | | | |
|---|--|-----------------|--------|
|  | | | |
| GEV No. | 510139 | Ref. No. | 140007 |
| description | rinse jet | | |
| For models: | 050F, 050FP, 10, 11F, 11FD, 11F-DVGW, 11R, 11RD, 12, 21F, 21FD, 21R, 21RD, 22F, 2312-001, 2312-002, 25F, 25FD, 25R, 25RD, 30F, 30FD, 30R, 30RD, 31F, 31FD, 31R, 31RD, 350F, 350FD, 350R, 350RD, 35-ELECTRONIC, 35F, 35FD, 35R, 35RD, 400F, 400FD, 400R, 400RD, 40-ELECTRONIC, 40F, 40FD, 40R, 40RD, 440F, 44F, 45, 450...(Other models you can see in the webshop) | | |
| accessories for | 510139 | | |
|  | | | |
| GEV No. | 510130 | Ref. No. | 429006 |
| union nut for rinse jet | | | |



| | | | |
|---|---|-----------------|--------|
|  | | | |
| GEV No. | 510130 | Ref. No. | 429006 |
| description | union nut for rinse jet | | |
| For models: | 10, 11F, 11FD, 11F-DVGW, 11R, 11RD, 12, 21F, 21FD, 21R, 21RD, 22F, 2312-001, 2312-002, 25F, 25FD, 25R, 25RD, 30F, 30FD, 30R, 30RD, 31F, 31FD, 31R, 31RD, 350F, 350FD, 350R, 350RD, 35-ELECTRONIC, 35F, 35FD, 35R, 35RD, 400F, 400FD, 400R, 400RD, 40-ELECTRONIC, 40F, 40FD, 40R, 40RD, 440F, 44F, 500F, 500FD, 50-ELECTRONIC, 50F...(Other models you can see in the webshop) | | |
| accessories for | 510130 | | |
|  | | | |
| GEV No. | 510139 | Ref. No. | 140007 |
| rinse jet | | | |

| | | | |
|---|---|-----------------|----------------------------|
|  | | | |
| 1 | | | |
| GEV No. | 510131 | Ref. No. | 429007 |
| description | union nut for wash jet | | |
| For models: | 11F, 11FD, 11F-DVGW, 11R, 11RD, 21F, 21FD, 21R, 21RD, 2312-001, 2312-002, 25F, 25FD, 25R, 25RD, 30F, 30FD, 30R, 30RD, 31F, 31FD, 31R, 31RD, 350F, 350FD, 350R, 350RD, 35-ELECTRONIC, 35F, 35FD, 35R, 35RD, 400F, 400FD, 40-ELECTRONIC, 40F, 40FD, 500F, 500FD, 50F, 50FD, 510F, 510FD, 913363, 913364, 913376, 913377, 914568, 915830, E.35...(Other models you can see in the webshop) | | |
| accessories for | 510131 | | |
|  | GEV No. | 510138 | Ref. No. |
| | | | 114013 140013 140020 |
| | wash jet fine groove | | |

| | | | |
|---|---|-----------------|-----------------|
|  | | | |
| 1 | | | |
| GEV No. | 518333 | Ref. No. | 106006 |
| description | wash arm mounting pos. left L 220mm mounting ø 24mm nozzles 4 | | |
| For models: | 050F, 050FP, 2312-001, 2312-002, 914568, 915830, E.50, E.50D.PA, E.51, F85, F85P, FAST-160DP, GSP50, GSP50P, GSP51, GSP51P, LF50, LF55, MC501E, MC501EP, MC501S, MC501SP, MISTRAL-51, NIAGARA-51, P500, PS-60, S651, S651P, S653, S654, S655, S830, S835, S850, SR651, TF-503, TF-513, TF-515 | | |
| accessories for | 518333 | | |
|  | GEV No. | 518004 | Ref. No. |
| | | | 140008 |
| | wash jet | | |
|  | GEV No. | 518272 | Ref. No. |
| | | | 429040 |
| | union nut for wash jet | | |

| | | | |
|---|---|-----------------|-----------------|
|  | | | |
| 1 | | | |
| GEV No. | 518332 | Ref. No. | 106008 |
| description | wash arm mounting pos. right L 220mm mounting ø 24mm nozzles 5 | | |
| For models: | 050F, 050FP, 2312-001, 2312-002, 914568, 915830, E.50, E.50D.PA, E.51, F85, F85P, FAST-160DP, GSP50, GSP50P, GSP51, GSP51P, LF50, LF55, MC501E, MC501EP, MC501S, MC501SP, MISTRAL-51, NIAGARA-51, P500, PS-60, S651, S651P, S653, S654, S655, S830, S835, S850, SR651 | | |
| accessories for | 518332 | | |
|  | GEV No. | 518004 | Ref. No. |
| | | | 140008 |
| | wash jet | | |
|  | GEV No. | 518272 | Ref. No. |
| | | | 429040 |
| | union nut for wash jet | | |

| | | | |
|---|---|-----------------|------------------|
|  | | | |
| 1 | | | |
| GEV No. | 510010 | Ref. No. | 129003 129039 |
| description | wash arm boss L1 64mm L2 60mm mounting ø 16.5mm | | |
| For models: | 050F, 050FP, 11F, 11FD, 11F-DVGW, 21F, 21FD, 2312-001, 2312-002, 25F, 25FD, 30F, 30FD, 31F, 31FD, 400F, 400FD, 40-ELECTRONIC, 40F, 40FD, 45, 450, 46, 460, 500F, 500FD, 50F, 50FD, 510F, 510FD, 67R, 913363, 913364, 913376, 913377, 914568, 915830, E.41, E.42, E.45, E.46, E.50, E.50D.PA, E.51, E.41, F85, F85P, FAST-160DP, GSP50, GSP50P...(Other models you can see in the webshop) | | |

| | | | |
|--|---|-----------------|----------------------------|
|  | | | |
| 1 | | | |
| GEV No. | 510138 | Ref. No. | 114013 140013 140020 |
| description | wash jet fine groove | | |
| For models: | 11F, 11FD, 11F-DVGW, 350F, 350FD, 350R, 350RD, 35-ELECTRONIC, 35F, 35FD, 35R, 35RD, 400F, 400FD, 40-ELECTRONIC, 40F, 40FD, 45, 450, 46, 460, 67R, 913363, 913364, 913376, 913377, E.35, E.35H, E.40, E.40H, E.41, E.42, E.45, E.46, E.41, GLS40H, GLS40HP, GSP50, GSP50P, GSP51, GSP51P, MC201CL, MISTRAL-40, NIAGARA-35, NIAGARA-40, NIAGARA-45, P500, PS-60, TF-503, TF-513...(Other models you can see in the webshop) | | |
| accessories for | 510138 | | |
|  | GEV No. | 510131 | Ref. No. |
| | | | 429007 |
| | union nut for wash jet | | |









| | | | |
|--|--|-----------------|----------------------------|
|  | | | |
| 1 | | | |
| GEV No. | 518001 | Ref. No. | 990046 |
| description | wash and rinse arm wash arm L 410mm rinse arm L 410mm w. jets 7 r. jets 5 mounting ø 16.5mm mounting pos. lower | | |
| For models: | 11F, 11FD, 11F-DVGW, 400F, 400FD, 40-ELECTRONIC, 40F, 40FD, 913363, 913364, 913376, 913377, E.41, E.42, E.46, E.41 | | |
| spare parts for | 518001 | | |
|  | GEV No. | 510010 | Ref. No. |
| | | | 129003 129039 |
| | wash arm boss L1 64mm L2 60mm mounting ø 16.5mm | | |
|  | GEV No. | 510130 | Ref. No. |
| | | | 429006 |
| | union nut for rinse jet | | |
|  | GEV No. | 510131 | Ref. No. |
| | | | 429007 |
| | union nut for wash jet | | |
|  | GEV No. | 510138 | Ref. No. |
| | | | 114013 140013 140020 |
| | wash jet fine groove | | |
|  | GEV No. | 510139 | Ref. No. |
| | | | 140007 |
| | rinse jet | | |
|  | GEV No. | 518382 | Ref. No. |
| | | | 106009 |
| | wash arm mounting pos. right L 175mm mounting ø 24mm nozzles 4 | | |



Table continues overleaf







| spare parts for | | 518001 | |
|--|---------|--------|---------------------------|
|  | GEV No. | 518383 | Ref. No. 106010 |
| rinse arm mounting pos. left L 175mm mounting ø 13mm nozzles 2 | | | |
|  | GEV No. | 518384 | Ref. No. 106011 |
| rinse arm mounting pos. right L 175mm mounting ø 13mm nozzles 3 | | | |
|  | GEV No. | 518631 | Ref. No. 106012 |
| wash arm mounting pos. left L 170mm nozzles mounting ø 24mm | | | |
| accessories for | | 518001 | |
|  | GEV No. | 510037 | Ref. No. 115035 |
| wash arm support | | | |
|  | GEV No. | 510054 | Ref. No. 437046 |
| gasket D1 ø 65mm D2 ø 35.5mm thickness 2.5mm with 5 holes wash arm support | | | |
|  | GEV No. | 510056 | Ref. No. 325025 |
| rinse arm shaft | | | |
|  | GEV No. | 510057 | Ref. No. 111009 |
| opposite support for wash arm support mounting pos. lower Mod. 111009 suitable for 11R | | | |
|  | GEV No. | 510058 | Ref. No. 199018 |
| throttle disc | | | |
|  | GEV No. | 510108 | Ref. No. 327006 |
| rinse arm shaft | | | |
|  | GEV No. | 518003 | Ref. No. 447030 447128 |
| screw cap | | | |
|  | GEV No. | 518421 | Ref. No. 111015 |
| opposite support for wash arm support mounting pos. lower Mod. 111015 | | | |

| | | | |
|---|--------|----------|--------|
|  | 1 | | |
| GEV No. | 518383 | Ref. No. | 106010 |
| description | | | |
| rinse arm mounting pos. left L 175mm mounting ø 13mm nozzles 2 | | | |
| For models: | | | |
| 11F, 11FD, 11F-DVGW, 21F, 21FD, 25F, 25FD, 30F, 30FD, 31F, 31FD, 400F, 400FD, 40-ELECTRONIC, 40F, 40FD, 913363, 913364, 913376, 913377, E.41, E.42, E.46, E41, S621, S623, S624, S626, S631, S633, S634, S636 | | | |

| | | | |
|---|--------|----------|--------|
|  | 1 | | |
| GEV No. | 518384 | Ref. No. | 106011 |
| description | | | |
| rinse arm mounting pos. right L 175mm mounting ø 13mm nozzles 3 | | | |
| For models: | | | |
| 11F, 11FD, 11F-DVGW, 21F, 21FD, 25F, 25FD, 30F, 30FD, 31F, 31FD, 400F, 400FD, 40-ELECTRONIC, 40F, 40FD, 913363, 913364, 913376, 913377, E.41, E.42, E.46, E41, S621, S623, S624, S626, S631, S633, S634, S636 | | | |

| | | | |
|--|---------|----------|-----------------|
|  | 1 | | |
| GEV No. | 510139 | Ref. No. | 140007 |
| description | | | |
| rinse jet | | | |
| For models: | | | |
| 050F, 050FP, 10, 11F, 11FD, 11F-DVGW, 11R, 11RD, 12, 21F, 21FD, 21R, 21RD, 22F, 2312-001, 2312-002, 25F, 25FD, 25R, 25RD, 30F, 30FD, 30R, 30RD, 31F, 31FD, 31R, 31RD, 350F, 350FD, 350R, 350RD, 35-ELECTRONIC, 35F, 35FD, 35R, 35RD, 400F, 400FD, 400R, 400RD, 40-ELECTRONIC, 40F, 40FD, 40R, 40RD, 440F, 44F, 45, 450...(Other models you can see in the webshop) | | | |
| accessories for | | | |
|  | GEV No. | 510130 | Ref. No. 429006 |
| union nut for rinse jet | | | |



| | | | |
|---|---------|----------|-----------------|
|  | 1 | | |
| GEV No. | 510130 | Ref. No. | 429006 |
| description | | | |
| union nut for rinse jet | | | |
| For models: | | | |
| 10, 11F, 11FD, 11F-DVGW, 11R, 11RD, 12, 21F, 21FD, 21R, 21RD, 22F, 2312-001, 2312-002, 25F, 25FD, 25R, 25RD, 30F, 30FD, 30R, 30RD, 31F, 31FD, 31R, 31RD, 350F, 350FD, 350R, 350RD, 35-ELECTRONIC, 35F, 35FD, 35R, 35RD, 400F, 400FD, 400R, 400RD, 40-ELECTRONIC, 40F, 40FD, 40R, 40RD, 440F, 44F, 500F, 500FD, 50-ELECTRONIC, 50F...(Other models you can see in the webshop) | | | |
| accessories for | | | |
|  | GEV No. | 510139 | Ref. No. 140007 |
| rinse jet | | | |

| | | | |
|---|---------|----------|-------------------------------------|
|  | 1 | | |
| GEV No. | 510131 | Ref. No. | 429007 |
| description | | | |
| union nut for wash jet | | | |
| For models: | | | |
| 11F, 11FD, 11F-DVGW, 11R, 11RD, 21F, 21FD, 21R, 21RD, 2312-001, 2312-002, 25F, 25FD, 25R, 25RD, 30F, 30FD, 30R, 30RD, 31F, 31FD, 31R, 31RD, 350F, 350FD, 350R, 350RD, 35-ELECTRONIC, 35F, 35FD, 35R, 35RD, 400F, 400FD, 40-ELECTRONIC, 40F, 40FD, 500F, 500FD, 50F, 50FD, 510F, 510FD, 913363, 913364, 913376, 913377, 914568, 915830, E.35...(Other models you can see in the webshop) | | | |
| accessories for | | | |
|  | GEV No. | 510138 | Ref. No. 114013 140013 140020 |
| wash jet fine groove | | | |

| | | | |
|---|--------|----------|--------|
|  | 1 | | |
| GEV No. | 518631 | Ref. No. | 106012 |
| description | | | |
| wash arm mounting pos. left L 170mm nozzles mounting ø 24mm | | | |
| For models: | | | |
| 11F, 11FD, 11F-DVGW, 21F, 21FD, 25F, 25FD, 30F, 30FD, 31F, 31FD, 400F, 400FD, 40-ELECTRONIC, 40F, 40FD, 913363, 913364, 913376, 913377, E.41, E.42, E.46, E41, S621, S623, S624, S626, S631, S633, S634, S636 | | | |

| | | | |
|---|---|-----------------|--------|
|  | | | |
| 1 | | | |
| GEV No. | 518382 | Ref. No. | 106009 |
| description | wash arm mounting pos. right L 175mm mounting ø 24mm nozzles 4 | | |
| For models: | 11F, 11FD, 11F-DVGW, 21F, 21FD, 25F, 25FD, 30F, 30FD, 31F, 31FD, 400F, 400FD, 40-ELECTRONIC, 40F, 40FD, 913363, 913364, 913376, 913377, E.41, E.42, E.45, E.46, E41, NIAGARA-45, S621, S623, S624, S626, S631, S633, S634, S636 | | |

| | | | |
|---|---|-----------------|------------------|
|  | | | |
| 1 | | | |
| GEV No. | 510010 | Ref. No. | 129003 129039 |
| description | wash arm boss L1 64mm L2 60mm mounting ø 16.5mm | | |
| For models: | 050F, 050FP, 11F, 11FD, 11F-DVGW, 21F, 21FD, 2312-001, 2312-002, 25F, 25FD, 30F, 30FD, 31F, 31FD, 400F, 400FD, 40-ELECTRONIC, 40F, 40FD, 45, 450, 46, 460, 500F, 500FD, 50F, 50FD, 510F, 510FD, 67R, 913363, 913364, 913376, 913377, 914568, 915830, E.41, E.42, E.45, E.46, E.50, E.50D.PA, E.51, E41, F85, F85P, FAST-160DP, GSP50, GSP50P... (Other models you can see in the webshop) | | |

| | | | |
|---|--|-----------------|----------------------------|
|  | | | |
| 1 | | | |
| GEV No. | 510138 | Ref. No. | 114013 140013 140020 |
| description | wash jet fine groove | | |
| For models: | 11F, 11FD, 11F-DVGW, 350F, 350FD, 350R, 350RD, 35-ELECTRONIC, 35F, 35FD, 35R, 35RD, 400F, 400FD, 40-ELECTRONIC, 40F, 40FD, 45, 450, 46, 460, 67R, 913363, 913364, 913376, 913377, E.35, E.35H, E.40, E.40H, E.41, E.42, E.45, E.46, E41, GLS40H, GLS40HP, GSP50, GSP50P, GSP51, GSP51P, MC201CL, MISTRAL-40, NIAGARA-35, NIAGARA-40, NIAGARA-45, P500, PS-60, TF-503, TF-513...(Other models you can see in the webshop) | | |
| accessories for | 510138 | | |
|  | GEV No. | 510131 | Ref. No. 429007 |
| union nut for wash jet | | | |



| | | | |
|---|--|-----------------|--------|
|  | | | |
| 1 | | | |
| GEV No. | 518005 | Ref. No. | 990009 |
| description | wash and rinse arm 2 wash arms/ 2 rinse arms | | |
| For models: | S651, S651P, S653, S654, S655, S830, S835, S850, SR651 | | |

| | | | |
|---|---|-----------------|-----------|
|  | | | |
| 1 | | | |
| GEV No. | 518465 | Ref. No. | 106072.CR |
| description | rinse arm mounting pos. left | | |
| For models: | 500F, 500FD, 50F, 50FD, 510F, 510FD, E.50, E.51 | | |



| | | | |
|---|---|-----------------|--------|
|  | | | |
| 1 | | | |
| GEV No. | 518335 | Ref. No. | 106005 |
| description | rinse arm mounting pos. left L 220mm mounting ø 13mm nozzles 3 | | |
| For models: | 050F, 050FP, 2312-001, 2312-002, 914568, 915830, E.50, E.50D.PA, E.51, F85, F85P, FAST-160DP, GSP50, GSP50P, GSP51, GSP51P, LF50, LF55, MC501E, MC501EP, MC501S, MC501SP, MISTRAL-51, NIAGARA-51, P500, PS-60, S651, S651P, S653, S654, S655, S830, S835, S850, SR651, TF-503, TF-513, TF-515 | | |



| | | | |
|--|---|-----------------|-----------|
|  | | | |
| Image not available | | | |
| 1 | | | |
| GEV No. | 518464 | Ref. No. | 106073.CR |
| description | rinse arm mounting pos. right | | |
| For models: | 500F, 500FD, 50F, 50FD, 510F, 510FD, E.50, E.51 | | |

| | | | |
|---|---|-----------------|--------|
|  | | | |
| 1 | | | |
| GEV No. | 518334 | Ref. No. | 106007 |
| description | rinse arm mounting pos. right L 220mm mounting ø 13mm nozzles 3 | | |
| For models: | 050F, 050FP, 2312-001, 2312-002, 914568, 915830, E.50, E.50D.PA, E.51, F85, F85P, FAST-160DP, GSP50, GSP50P, GSP51, GSP51P, LF50, LF55, MC501E, MC501EP, MC501S, MC501SP, MISTRAL-51, NIAGARA-51, P500, PS-60, S651, S651P, S653, S654, S655, S830, S835, S850, SR651 | | |

| | | | |
|---|--|-----------------|------------------------|
|  | | | |
| 1 | | | |
| GEV No. | 510139 | Ref. No. | 140007 |
| description | rinse jet | | |
| For models: | 050F, 050FP, 10, 11F, 11FD, 11F-DVGW, 11R, 11RD, 12, 21F, 21FD, 21R, 21RD, 22F, 2312-001, 2312-002, 25F, 25FD, 25R, 25RD, 30F, 30FD, 30R, 30RD, 31F, 31FD, 31R, 31RD, 350F, 350FD, 350R, 350RD, 35-ELECTRONIC, 35F, 35FD, 35R, 35RD, 400F, 400FD, 400R, 400RD, 40-ELECTRONIC, 40F, 40FD, 40R, 40RD, 440F, 44F, 45, 450...(Other models you can see in the webshop) | | |
| accessories for | 510139 | | |
|  | GEV No. | 510130 | Ref. No. 429006 |
| union nut for rinse jet | | | |





| | | | |
|---|---|-----------------|--------|
|  | | | |
| 1 | | | |
| GEV No. | 510130 | Ref. No. | 429006 |
| description | union nut for rinse jet | | |
| For models: | 10, 11F, 11FD, 11F-DVGW, 11R, 11RD, 12, 21F, 21FD, 21R, 21RD, 22F, 2312-001, 2312-002, 25F, 25FD, 25R, 25RD, 30F, 30FD, 30R, 30RD, 31F, 31FD, 31R, 31RD, 350F, 350FD, 350R, 350RD, 35-ELECTRONIC, 35F, 35FD, 35R, 35RD, 400F, 400FD, 400R, 400RD, 40-ELECTRONIC, 40F, 40FD, 40R, 40RD, 440F, 44F, 500F, 500FD, 50-ELECTRONIC, 50F...(Other models you can see in the webshop) | | |
| accessories for | 510130 | | |
|  | | | |
| GEV No. | 510139 | Ref. No. | 140007 |
| description | rinse jet | | |

| | | | |
|--|---|-----------------|----------------------------|
|  | | | |
| 1 | | | |
| GEV No. | 510131 | Ref. No. | 429007 |
| description | union nut for wash jet | | |
| For models: | 11F, 11FD, 11F-DVGW, 11R, 11RD, 21F, 21FD, 21R, 21RD, 2312-001, 2312-002, 25F, 25FD, 25R, 25RD, 30F, 30FD, 30R, 30RD, 31F, 31FD, 31R, 31RD, 350F, 350FD, 350R, 350RD, 35-ELECTRONIC, 35F, 35FD, 35R, 35RD, 400F, 400FD, 40-ELECTRONIC, 40F, 40FD, 500F, 500FD, 50F, 50FD, 510F, 510FD, 913363, 913364, 913376, 913377, 914568, 915830, E.35...(Other models you can see in the webshop) | | |
| accessories for | 510131 | | |
|  | | | |
| GEV No. | 510138 | Ref. No. | 114013 140013 140020 |
| description | wash jet fine groove | | |

| | | | |
|---|---|-----------------|--------|
|  | | | |
| 1 | | | |
| GEV No. | 518333 | Ref. No. | 106006 |
| description | wash arm mounting pos. left L 220mm mounting ø 24mm nozzles 4 | | |
| For models: | 050F, 050FP, 2312-001, 2312-002, 914568, 915830, E.50, E.50D.PA, E.51, F85, F85P, FAST-160DP, GSP50, GSP50P, GSP51, GSP51P, LF50, LF55, MC501E, MC501EP, MC501S, MC501SP, MISTRAL-51, NIAGARA-51, P500, PS-60, S651, S651P, S653, S654, S655, S830, S835, S850, SR651, TF-503, TF-513, TF-515 | | |
| accessories for | 518333 | | |
|  | | | |
| GEV No. | 518004 | Ref. No. | 140008 |
| description | wash jet | | |
|  | | | |
| GEV No. | 518272 | Ref. No. | 429040 |
| description | union nut for wash jet | | |

| | | | |
|---|---|-----------------|--------|
|  | | | |
| 1 | | | |
| GEV No. | 518332 | Ref. No. | 106008 |
| description | wash arm mounting pos. right L 220mm mounting ø 24mm nozzles 5 | | |
| For models: | 050F, 050FP, 2312-001, 2312-002, 914568, 915830, E.50, E.50D.PA, E.51, F85, F85P, FAST-160DP, GSP50, GSP50P, GSP51, GSP51P, LF50, LF55, MC501E, MC501EP, MC501S, MC501SP, MISTRAL-51, NIAGARA-51, P500, PS-60, S651, S651P, S653, S654, S655, S830, S835, S850, SR651 | | |
| accessories for | 518332 | | |
|  | | | |
| GEV No. | 518004 | Ref. No. | 140008 |
| description | wash jet | | |
|  | | | |
| GEV No. | 518272 | Ref. No. | 429040 |
| description | union nut for wash jet | | |

| | | | |
|---|---|-----------------|------------------|
|  | | | |
| 1 | | | |
| GEV No. | 510010 | Ref. No. | 129003 129039 |
| description | wash arm boss L1 64mm L2 60mm mounting ø 16.5mm | | |
| For models: | 050F, 050FP, 11F, 11FD, 11F-DVGW, 21F, 21FD, 2312-001, 2312-002, 25F, 25FD, 30F, 30FD, 31F, 31FD, 400F, 400FD, 40-ELECTRONIC, 40F, 40FD, 45, 450, 46, 460, 500F, 500FD, 50F, 50FD, 510F, 510FD, 67R, 913363, 913364, 913376, 913377, 914568, 915830, E.41, E.42, E.45, E.46, E.50, E.50D.PA, E.51, E.41, F85, F85P, FAST-160DP, GSP50, GSP50P...(Other models you can see in the webshop) | | |

| | | | |
|---|---|-----------------|--------|
|  | | | |
| 1 | | | |
| GEV No. | 518004 | Ref. No. | 140008 |
| description | wash jet | | |
| For models: | 050F, 050FP, 11R, 11RD, 21F, 21FD, 21R, 21RD, 2312-001, 2312-002, 25F, 25FD, 25R, 25RD, 30F, 30FD, 30R, 30RD, 31F, 31FD, 31R, 31RD, 350F, 350FD, 350R, 350RD, 35-ELECTRONIC, 35F, 35FD, 35R, 35RD, 400F, 400FD, 40-ELECTRONIC, 40F, 40FD, 500F, 500FD, 50F, 50FD, 510F, 510FD, 67R, 914568, 915830, E.42, E.50, E.50D.PA, E.51, F85, F85P, FAST-160DP, GSP50, GSP50P, GSP51, GSP51P, LF50, LF55, MC501E, MC501EP, MC501S, MC501SP, MISTRAL-51, NIAGARA-51...(Other models you can see in the webshop) | | |







| | | | |
|--|---|-----------------|--------|
|  | | | |
| 1 | | | |
| GEV No. | 524077 | Ref. No. | 79040 |
| description | wash and rinse arm wash arm L 490mm rinse arm L 495mm w. jets 8 r. jets 6 mounting ø 16.5mm mounting pos. upper/lower | | |
| For models: | PS-60 | | |
| spare parts for | 524077 | | |
|  | | | |
| GEV No. | 510139 | Ref. No. | 140007 |
| description | rinse jet | | |
|  | | | |
| GEV No. | 518004 | Ref. No. | 140008 |
| description | wash jet | | |

Table continues overleaf



| | |
|---|--|
| spare parts for 524077 | |
|  | GEV No. 518053 Ref. No. 429006.TN 429039 |
| union nut for rinse jet | |
|  | GEV No. 518272 Ref. No. 429040 |
| union nut for wash jet | |
|  | GEV No. 518332 Ref. No. 106008 |
| wash arm mounting pos. right L 220mm mounting ø 24mm nozzles 5 | |
|  | GEV No. 518333 Ref. No. 106006 |
| wash arm mounting pos. left L 220mm mounting ø 24mm nozzles 4 | |
|  | GEV No. 518334 Ref. No. 106007 |
| rinse arm mounting pos. right L 220mm mounting ø 13mm nozzles 3 | |
|  | GEV No. 518335 Ref. No. 106005 |
| rinse arm mounting pos. left L 220mm mounting ø 13mm nozzles 3 | |



| | |
|---|---------------------------|
|  | 1 |
| GEV No. 518465 | Ref. No. 106072.CR |
| description rinse arm mounting pos. left | |
| For models: 500F, 500FD, 50F, 50FD, 510F, 510FD, E.50, E.51 | |



| | |
|--|------------------------|
|  | 1 |
| GEV No. 518335 | Ref. No. 106005 |
| description rinse arm mounting pos. left L 220mm mounting ø 13mm nozzles 3 | |
| For models: 050F, 050FP, 2312-001, 2312-002, 914568, 915830, E.50, E.50D.PA, E.51, F85, F85P, FAST-160DP, GSP50, GSP50P, GSP51, GSP51P, LF50, LF55, MC501E, MC501EP, MC501S, MC501SP, MISTRAL-51, NIAGARA-51, P500, PS-60, S651, S651P, S653, S654, S655, S830, S835, S850, SR651, TF-503, TF-513, TF-515 | |

| | |
|--|---------------------------|
|  Image not available | |
|  | 1 |
| GEV No. 518464 | Ref. No. 106073.CR |
| description rinse arm mounting pos. right | |
| For models: 500F, 500FD, 50F, 50FD, 510F, 510FD, E.50, E.51 | |

| | |
|--|------------------------|
|  | 1 |
| GEV No. 518334 | Ref. No. 106007 |
| description rinse arm mounting pos. right L 220mm mounting ø 13mm nozzles 3 | |
| For models: 050F, 050FP, 2312-001, 2312-002, 914568, 915830, E.50, E.50D.PA, E.51, F85, F85P, FAST-160DP, GSP50, GSP50P, GSP51, GSP51P, LF50, LF55, MC501E, MC501EP, MC501S, MC501SP, MISTRAL-51, NIAGARA-51, P500, PS-60, S651, S651P, S653, S654, S655, S830, S835, S850, SR651 | |

| | |
|---|--------------------------------|
|  | 1 |
| GEV No. 510139 | Ref. No. 140007 |
| description rinse jet | |
| For models: 050F, 050FP, 10, 11F, 11FD, 11F-DVGW, 11R, 11RD, 12, 21F, 21FD, 21R, 21RD, 22F, 2312-001, 2312-002, 25F, 25FD, 25R, 25RD, 30F, 30FD, 30R, 30RD, 31F, 31FD, 31R, 31RD, 350F, 350FD, 350R, 350RD, 35-ELECTRONIC, 35F, 35FD, 35R, 35RD, 400F, 400FD, 400R, 400RD, 40-ELECTRONIC, 40F, 40FD, 40R, 40RD, 440F, 44F, 45, 450...(Other models you can see in the webshop) | |
| accessories for 510139 | |
|  | GEV No. 510130 Ref. No. 429006 |
| union nut for rinse jet | |

| | |
|--|--------------------------------|
|  | 1 |
| GEV No. 510130 | Ref. No. 429006 |
| description union nut for rinse jet | |
| For models: 10, 11F, 11FD, 11F-DVGW, 11R, 11RD, 12, 21F, 21FD, 21R, 21RD, 22F, 2312-001, 2312-002, 25F, 25FD, 25R, 25RD, 30F, 30FD, 30R, 30RD, 31F, 31FD, 31R, 31RD, 350F, 350FD, 350R, 350RD, 35-ELECTRONIC, 35F, 35FD, 35R, 35RD, 400F, 400FD, 400R, 400RD, 40-ELECTRONIC, 40F, 40FD, 40R, 40RD, 440F, 44F, 500F, 500FD, 50-ELECTRONIC, 50F...(Other models you can see in the webshop) | |
| accessories for 510130 | |
|  | GEV No. 510139 Ref. No. 140007 |
| rinse jet | |

| | |
|--|--|
|  | 1 |
| GEV No. 510131 | Ref. No. 429007 |
| description union nut for wash jet | |
| For models: 11F, 11FD, 11F-DVGW, 11R, 11RD, 21F, 21FD, 21R, 21RD, 2312-001, 2312-002, 25F, 25FD, 25R, 25RD, 30F, 30FD, 30R, 30RD, 31F, 31FD, 31R, 31RD, 350F, 350FD, 350R, 350RD, 35-ELECTRONIC, 35F, 35FD, 35R, 35RD, 400F, 400FD, 40-ELECTRONIC, 40F, 40FD, 500F, 500FD, 50F, 50FD, 510F, 510FD, 913363, 913364, 913376, 913377, 914568, 915830, E.35...(Other models you can see in the webshop) | |
| accessories for 510131 | |
|  | GEV No. 510138 Ref. No. 114013 140013 140020 |
| wash jet fine groove | |





| | |
|--|--------------------------------|
|  | 1 |
| GEV No. 518333 | Ref. No. 106006 |
| description wash arm mounting pos. left L 220mm mounting ø 24mm nozzles 4 | |
| For models: 050F, 050FP, 2312-001, 2312-002, 914568, 915830, E.50, E.50D.PA, E.51, F85, F85P, FAST-160DP, GSP50, GSP50P, GSP51, GSP51P, LF50, LF55, MC501E, MC501EP, MC501S, MC501SP, MISTRAL-51, NIAGARA-51, P500, PS-60, S651, S651P, S653, S654, S655, S830, S835, S850, SR651, TF-503, TF-513, TF-515 | |
| accessories for 518333 | |
|  | GEV No. 518004 Ref. No. 140008 |
| wash jet | |

Table continues overleaf





| | | | |
|---|------------------------|--------|------------------------|
| accessories for | 518333 | | |
|  | GEV No. | 518272 | Ref. No. 429040 |
| | union nut for wash jet | | |

| | | | |
|---|---|-----------------|--------|
|  | 1 | | |
| GEV No. | 518332 | Ref. No. | 106008 |
| description | wash arm mounting pos. right L 220mm mounting ø 24mm nozzles 5 | | |
| For models: | 050F, 050FP, 2312-001, 2312-002, 914568, 915830, E.50, E.50D.PA, E.51, F85, F85P, FAST-160DP, GSP50, GSP50P, GSP51, GSP51P, LF50, LF55, MC501E, MC501EP, MC501S, MC501SP, MISTRAL-51, NIAGARA-51, P500, PS-60, S651, S651P, S653, S654, S655, S830, S835, S850, SR651 | | |

| | | | |
|---|------------------------|--------|------------------------|
| accessories for | 518332 | | |
|  | GEV No. | 518004 | Ref. No. 140008 |
| | wash jet | | |
|  | GEV No. | 518272 | Ref. No. 429040 |
| | union nut for wash jet | | |

| | | | |
|--|---|-----------------|------------------|
|  | 1 | | |
| GEV No. | 510010 | Ref. No. | 129003 129039 |
| description | wash arm boss L1 64mm L2 60mm mounting ø 16.5mm | | |
| For models: | 050F, 050FP, 11F, 11FD, 11F-DVGW, 21F, 21FD, 2312-001, 2312-002, 25F, 25FD, 30F, 30FD, 31F, 31FD, 400F, 400FD, 40-ELECTRONIC, 40F, 40FD, 45, 450, 46, 460, 500F, 500FD, 50F, 50FD, 510F, 510FD, 67R, 913363, 913364, 913376, 913377, 914568, 915830, E.41, E.42, E.45, E.46, E.50, E.50D.PA, E.51, E41, F85, F85P, FAST-160DP, GSP50, GSP50P... (Other models you can see in the webshop) | | |

| | | | |
|---|--|-----------------|-------|
|  | 1 | | |
| GEV No. | 517561 | Ref. No. | 79021 |
| description | wash arm boss mounting pos. upper/lower mounting ø 45mm L 84mm W 75mm H 50mm | | |
| For models: | PS-60 | | |

| | | | |
|---|--|-----------------|----------------------------|
|  | 1 | | |
| GEV No. | 510138 | Ref. No. | 114013 140013 140020 |
| description | wash jet fine groove | | |
| For models: | 11F, 11FD, 11F-DVGW, 350F, 350FD, 350R, 350RD, 35-ELECTRONIC, 35F, 35FD, 35R, 35RD, 400F, 400FD, 40-ELECTRONIC, 40F, 40FD, 45, 450, 46, 460, 67R, 913363, 913364, 913376, 913377, E.35, E.35H, E.40, E.40H, E.41, E.42, E.45, E.46, E41, GLS40H, GLS40HP, GSP50, GSP50P, GSP51, GSP51P, MC201CL, MISTRAL-40, NIAGARA-35, NIAGARA-40, NIAGARA-45, P500, PS-60, TF-503, TF-513...(Other models you can see in the webshop) | | |
| accessories for | 510138 | | |
|  | GEV No. | 510131 | Ref. No. 429007 |
| | union nut for wash jet | | |

| | | | |
|--|---|-----------------|------------------|
|  | 1 | | |
| GEV No. | 518040 | Ref. No. | 990064 990079 |
| description | wash and rinse arm 2 wash arms/ 2 rinse arms | | |
| For models: | 350F, 350FD, 350R, 350RD, 35-ELECTRONIC, 35F, 35FD, 35R, 35RD | | |

| | | | |
|--|--|-----------------|--------|
|  | 1 | | |
| GEV No. | 518426 | Ref. No. | 990096 |
| description | wash and rinse arm wash arm L 350mm rinse arm L 350mm w. jets 6 r. jets 4 mounting ø 14/37mm mounting pos. lower | | |
| For models: | E.35 | | |

| | | | |
|---|---|--------|--|
| spare parts for | 518426 | | |
|  | GEV No. | 510130 | Ref. No. 429006 |
| | union nut for rinse jet | | |
|  | GEV No. | 510131 | Ref. No. 429007 |
| | union nut for wash jet | | |
|  | GEV No. | 510138 | Ref. No. 114013 140013 140020 |
| | wash jet fine groove | | |
|  | GEV No. | 510139 | Ref. No. 140007 |
| | rinse jet | | |
|  | GEV No. | 513271 | Ref. No. 412028 |
| | connector holder grey | | |
|  | GEV No. | 518028 | Ref. No. 454004 |
| | knurled nut thread M5 ø 25mm H 4mm SS | | |
|  | GEV No. | 518428 | Ref. No. 106095 |
| | wash arm mounting pos. right L 160mm mounting ø 19mm nozzles 3 | | |
|  | GEV No. | 518429 | Ref. No. 106096 |
| | wash arm mounting pos. left L 155mm mounting ø 15mm nozzles 3 | | |
|  | GEV No. | 518430 | Ref. No. 106098 |
| | rinse arm mounting pos. right L 165mm mounting ø 14mm nozzles 2 | | |
|  | GEV No. | 518431 | Ref. No. 106097 |
| | rinse arm mounting pos. left L 165mm mounting ø 14mm nozzles 2 | | |



| | | | |
|--------------------|--|-----------------|--------|
| GEV No. | 513712 | Ref. No. | 990103 |
| description | wash and rinse arm wash arm L 350mm rinse arm L 350mm w. jets 6 r. jets 4 mounting ø 14/41mm mounting pos. lower | | |
| For models: | E.35, E.35H, MC201CL, NIAGARA-35 | | |

spare parts for 513712

| | | | | |
|--|--------------------|-------------------------|-----------------|--------|
| | GEV No. | 510130 | Ref. No. | 429006 |
| | description | union nut for rinse jet | | |

| | | | | |
|--|--------------------|------------------------|-----------------|--------|
| | GEV No. | 510131 | Ref. No. | 429007 |
| | description | union nut for wash jet | | |

| | | | | |
|--|--------------------|----------------------|-----------------|----------------------------|
| | GEV No. | 510138 | Ref. No. | 114013 140013 140020 |
| | description | wash jet fine groove | | |

| | | | | |
|--|--------------------|-----------|-----------------|--------|
| | GEV No. | 510139 | Ref. No. | 140007 |
| | description | rinse jet | | |

| | | | | |
|--|--------------------|---------------|-----------------|--------|
| | GEV No. | 513261 | Ref. No. | 129056 |
| | description | wash arm boss | | |

| | | | | |
|--|--------------------|-----------------------|-----------------|--------|
| | GEV No. | 513271 | Ref. No. | 412028 |
| | description | connector holder grey | | |

| | | | | |
|--|--------------------|---------------------------------------|-----------------|--------|
| | GEV No. | 518028 | Ref. No. | 454004 |
| | description | knurled nut thread M5 ø 25mm H 4mm SS | | |

| | | | | |
|--|--------------------|--|-----------------|--------|
| | GEV No. | 518428 | Ref. No. | 106095 |
| | description | wash arm mounting pos. right L 160mm mounting ø 19mm nozzles 3 | | |

| | | | | |
|--|--------------------|---|-----------------|--------|
| | GEV No. | 518429 | Ref. No. | 106096 |
| | description | wash arm mounting pos. left L 155mm mounting ø 15mm nozzles 3 | | |

| | | | | |
|--|--------------------|---|-----------------|--------|
| | GEV No. | 518430 | Ref. No. | 106098 |
| | description | rinse arm mounting pos. right L 165mm mounting ø 14mm nozzles 2 | | |

| | | | | |
|--|--------------------|--|-----------------|--------|
| | GEV No. | 518431 | Ref. No. | 106097 |
| | description | rinse arm mounting pos. left L 165mm mounting ø 14mm nozzles 2 | | |



| | | | |
|--------------------|---|-----------------|--------|
| GEV No. | 518431 | Ref. No. | 106097 |
| description | rinse arm mounting pos. left L 165mm mounting ø 14mm nozzles 2 | | |
| For models: | 350F, 350FD, 350R, 350RD, 35F, 35FD, 35R, 35RD, E.35, E.35H, MC-201CL, NIAGARA-35 | | |



| | | | |
|--------------------|---|-----------------|--------|
| GEV No. | 518430 | Ref. No. | 106098 |
| description | rinse arm mounting pos. right L 165mm mounting ø 14mm nozzles 2 | | |
| For models: | E.35, E.35H, MC201CL, NIAGARA-35 | | |



| | | | |
|--------------------|-----------|-----------------|--------|
| GEV No. | 510139 | Ref. No. | 140007 |
| description | rinse jet | | |

For models: 050F, 050FP, 10, 11F, 11FD, 11F-DVGW, 11R, 11RD, 12, 21F, 21FD, 21R, 21RD, 22F, 2312-001, 2312-002, 25F, 25FD, 25R, 25RD, 30F, 30FD, 30R, 30RD, 31F, 31FD, 31R, 31RD, 350F, 350FD, 350R, 350RD, 35-ELECTRONIC, 35F, 35FD, 35R, 35RD, 400F, 400FD, 400R, 400RD, 40-ELECTRONIC, 40F, 40FD, 40R, 40RD, 440F, 44F, 45, 450...(Other models you can see in the webshop)

accessories for 510139

| | | | | |
|--|--------------------|-------------------------|-----------------|--------|
| | GEV No. | 510130 | Ref. No. | 429006 |
| | description | union nut for rinse jet | | |



| | | | |
|--------------------|-------------------------|-----------------|--------|
| GEV No. | 510130 | Ref. No. | 429006 |
| description | union nut for rinse jet | | |

For models: 10, 11F, 11FD, 11F-DVGW, 11R, 11RD, 12, 21F, 21FD, 21R, 21RD, 22F, 2312-001, 2312-002, 25F, 25FD, 25R, 25RD, 30F, 30FD, 30R, 30RD, 31F, 31FD, 31R, 31RD, 350F, 350FD, 350R, 350RD, 35-ELECTRONIC, 35F, 35FD, 35R, 35RD, 400F, 400FD, 400R, 400RD, 40-ELECTRONIC, 40F, 40FD, 40R, 40RD, 440F, 44F, 500F, 500FD, 50-ELECTRONIC, 50F...(Other models you can see in the webshop)

accessories for 510130

| | | | | |
|--|--------------------|-----------|-----------------|--------|
| | GEV No. | 510139 | Ref. No. | 140007 |
| | description | rinse jet | | |



| | | | |
|--------------------|------------------------|-----------------|--------|
| GEV No. | 510131 | Ref. No. | 429007 |
| description | union nut for wash jet | | |

For models: 11F, 11FD, 11F-DVGW, 11R, 11RD, 21F, 21FD, 21R, 21RD, 2312-001, 2312-002, 25F, 25FD, 25R, 25RD, 30F, 30FD, 30R, 30RD, 31F, 31FD, 31R, 31RD, 350F, 350FD, 350R, 350RD, 35-ELECTRONIC, 35F, 35FD, 35R, 35RD, 400F, 400FD, 40-ELECTRONIC, 40F, 40FD, 500F, 500FD, 50F, 50FD, 510F, 510FD, 913363, 913364, 913376, 913377, 914568, 915830, E.35...(Other models you can see in the webshop)

accessories for 510131



| | | | | |
|--|--------------------|----------------------|-----------------|----------------------------|
| | GEV No. | 510138 | Ref. No. | 114013 140013 140020 |
| | description | wash jet fine groove | | |















| | | | |
|---|---|-----------------|--------|
|  | | | |
| 1 | | | |
| GEV No. | 518429 | Ref. No. | 106096 |
| description | wash arm mounting pos. left L 155mm mounting ø 15mm nozzles 3 | | |
| For models: | 350F, 350FD, 350R, 350RD, 35F, 35FD, 35R, 35RD, E.35, E.35H, MC-201CL, NIAGARA-35 | | |

| | | | |
|---|---|-----------------|--------|
|  | | | |
| 1 | | | |
| GEV No. | 518428 | Ref. No. | 106095 |
| description | wash arm mounting pos. right L 160mm mounting ø 19mm nozzles 3 | | |
| For models: | 350F, 350FD, 350R, 350RD, 35F, 35FD, 35R, 35RD, E.35, E.35H, MC-201CL, NIAGARA-35 | | |

| | | | |
|---|---|-----------------|--------|
|  | | | |
| 1 | | | |
| GEV No. | 518438 | Ref. No. | 129050 |
| description | wash arm boss L 64mm mounting ø 14/37mm H 38mm W 60mm | | |
| For models: | E.35, E.40 | | |



| | | | |
|---|--|-----------------|----------------------------|
|  | | | |
| 1 | | | |
| GEV No. | 510138 | Ref. No. | 114013 140013 140020 |
| description | wash jet fine groove | | |
| For models: | 11F, 11FD, 11F-DVGW, 350F, 350FD, 350R, 350RD, 35-ELECTRONIC, 35F, 35FD, 35R, 35RD, 400F, 400FD, 40-ELECTRONIC, 40F, 40FD, 45, 450, 46, 460, 67R, 913363, 913364, 913376, 913377, E.35, E.35H, E.40, E.40H, E.41, E.42, E.45, E.46, E41, GLS40H, GLS40HP, GSP50, GSP50P, GSP51, GSP51P, MC201CL, MISTRAL-40, NIAGARA-35, NIAGARA-40, NIAGARA-45, P500, PS-60, TF-503, TF-513...(Other models you can see in the webshop) | | |
| accessories for | 510138 | | |
|  | GEV No. | 510131 | Ref. No. 429007 |
| union nut for wash jet | | | |

| | | | |
|---|--|-----------------|------------------------|
|  | | | |
| 1 | | | |
| GEV No. | 518437 | Ref. No. | 990094 990104 |
| description | wash and rinse arm wash arm L 400mm rinse arm L 400mm w. jets 7 r. jets 5 mounting ø 14/41mm mounting pos. lower | | |
| For models: | E.40, E.40H, GLS40H, GLS40HP, MISTRAL-40, NIAGARA-40 | | |
| spare parts for | 518437 | | |
|  | GEV No. | 510130 | Ref. No. 429006 |
| union nut for rinse jet | | | |

| | | | |
|---|----------------|--------|--|
| spare parts for | 518437 | | |
|  | GEV No. | 510131 | Ref. No. 429007 |
| union nut for wash jet | | | |
|  | GEV No. | 510138 | Ref. No. 114013 140013 140020 |
| wash jet fine groove | | | |
|  | GEV No. | 510139 | Ref. No. 140007 |
| rinse jet | | | |
|  | GEV No. | 513261 | Ref. No. 129056 |
| wash arm boss | | | |
|  | GEV No. | 513271 | Ref. No. 412028 |
| connector holder grey | | | |
|  | GEV No. | 518028 | Ref. No. 454004 |
| knurled nut thread M5 ø 25mm H 4mm SS | | | |
|  | GEV No. | 518439 | Ref. No. 106111 |
| wash arm mounting pos. left L 180mm mounting ø 19mm nozzles 3 | | | |
|  | GEV No. | 518440 | Ref. No. 106112 |
| wash arm mounting pos. right L 180mm mounting ø 19mm nozzles 4 | | | |
|  | GEV No. | 518441 | Ref. No. 106113 |
| rinse arm mounting pos. left L 190mm mounting ø 14mm nozzles 3 type A | | | |
|  | GEV No. | 518442 | Ref. No. 106114 |
| rinse arm mounting pos. right L 190mm mounting ø 14mm nozzles 2 type B | | | |



| | | | |
|---|---|-----------------|--------|
|  | | | |
| 1 | | | |
| GEV No. | 518441 | Ref. No. | 106113 |
| description | rinse arm mounting pos. left L 190mm mounting ø 14mm nozzles 3 type A | | |
| For models: | E.40, E.40H, GLS40H, GLS40HP, MISTRAL-40, NIAGARA-40 | | |

| | | | |
|---|--|-----------------|--------|
|  | | | |
| 1 | | | |
| GEV No. | 518442 | Ref. No. | 106114 |
| description | rinse arm mounting pos. right L 190mm mounting ø 14mm nozzles 2 type B | | |
| For models: | E.40, E.40H, GLS40H, GLS40HP, MISTRAL-40, NIAGARA-40 | | |



| | | | |
|---|--|-----------------|------------------------|
|  | | | |
| 1 | | | |
| GEV No. | 510139 | Ref. No. | 140007 |
| description | rinse jet | | |
| For models: | 050F, 050FP, 10, 11F, 11FD, 11F-DVGW, 11R, 11RD, 12, 21F, 21FD, 21R, 21RD, 22F, 2312-001, 2312-002, 25F, 25FD, 25R, 25RD, 30F, 30FD, 30R, 30RD, 31F, 31FD, 31R, 31RD, 350F, 350FD, 350R, 350RD, 35-ELECTRONIC, 35F, 35FD, 35R, 35RD, 400F, 400FD, 400R, 400RD, 40-ELECTRONIC, 40F, 40FD, 40R, 40RD, 440F, 44F, 45, 450...(Other models you can see in the webshop) | | |
| accessories for | 510139 | | |
|  | GEV No. | 510130 | Ref. No. 429006 |
| union nut for rinse jet | | | |



| | | | |
|---|--|-----------------|--------|
|  | | | |
| 1 | | | |
| GEV No. | 518440 | Ref. No. | 106112 |
| description | wash arm mounting pos. right L 180mm mounting ø 19mm nozzles 4 | | |
| For models: | E.40, E.40H, GLS40H, GLS40HP, MISTRAL-40, NIAGARA-40 | | |

| | | | |
|---|--|-----------------|--------|
|  | | | |
| 1 | | | |
| GEV No. | 513261 | Ref. No. | 129056 |
| description | wash arm boss | | |
| For models: | E.35, E.35H, E.40, E.40H, GLS40H, GLS40HP, MC201CL, MISTRAL-40, NIAGARA-35, NIAGARA-40 | | |

| | | | |
|---|--|-----------------|----------------------------|
|  | | | |
| 1 | | | |
| GEV No. | 510138 | Ref. No. | 114013 140013 140020 |
| description | wash jet fine groove | | |
| For models: | 11F, 11FD, 11F-DVGW, 350F, 350FD, 350R, 350RD, 35-ELECTRONIC, 35F, 35FD, 35R, 35RD, 400F, 400FD, 40-ELECTRONIC, 40F, 40FD, 45, 450, 46, 460, 67R, 913363, 913364, 913376, 913377, E.35, E.35H, E.40, E.40H, E.41, E.42, E.45, E.46, E41, GLS40H, GLS40HP, GSP50, GSP50P, GSP51, GSP51P, MC201CL, MISTRAL-40, NIAGARA-35, NIAGARA-40, NIAGARA-45, P500, PS-60, TF-503, TF-513...(Other models you can see in the webshop) | | |
| accessories for | 510138 | | |
|  | GEV No. | 510131 | Ref. No. 429007 |
| union nut for wash jet | | | |









| | | | |
|--|---|-----------------|------------------|
|  | | | |
| 1 | | | |
| GEV No. | 518317 | Ref. No. | 993032 993036 |
| description | rinse arm L 245mm nozzles 4 mounting ø 17.2/M20mm mounting pos. upper | | |
| For models: | 45, 450, 67R, 914684, River-39 | | |

| | | | |
|--|---|-----------------|------------------------|
|  | | | |
| 1 | | | |
| GEV No. | 510130 | Ref. No. | 429006 |
| description | union nut for rinse jet | | |
| For models: | 10, 11F, 11FD, 11F-DVGW, 11R, 11RD, 12, 21F, 21FD, 21R, 21RD, 22F, 2312-001, 2312-002, 25F, 25FD, 25R, 25RD, 30F, 30FD, 30R, 30RD, 31F, 31FD, 31R, 31RD, 350F, 350FD, 350R, 350RD, 35-ELECTRONIC, 35F, 35FD, 35R, 35RD, 400F, 400FD, 400R, 400RD, 40-ELECTRONIC, 40F, 40FD, 40R, 40RD, 440F, 44F, 500F, 500FD, 50-ELECTRONIC, 50F...(Other models you can see in the webshop) | | |
| accessories for | 510130 | | |
|  | GEV No. | 510139 | Ref. No. 140007 |
| rinse jet | | | |

| | | | |
|---|---|-----------------|--|
|  | | | |
| 1 | | | |
| GEV No. | 510131 | Ref. No. | 429007 |
| description | union nut for wash jet | | |
| For models: | 11F, 11FD, 11F-DVGW, 11R, 11RD, 21F, 21FD, 21R, 21RD, 2312-001, 2312-002, 25F, 25FD, 25R, 25RD, 30F, 30FD, 30R, 30RD, 31F, 31FD, 31R, 31RD, 350F, 350FD, 350R, 350RD, 35-ELECTRONIC, 35F, 35FD, 35R, 35RD, 400F, 400FD, 40-ELECTRONIC, 40F, 40FD, 500F, 500FD, 50F, 50FD, 510F, 510FD, 913363, 913364, 913376, 913377, 914568, 915830, E.35...(Other models you can see in the webshop) | | |
| accessories for | 510131 | | |
|  | GEV No. | 510138 | Ref. No. 114013 140013 140020 |
| wash jet fine groove | | | |

| | | | |
|---|---|-----------------|--------|
|  | | | |
| 1 | | | |
| GEV No. | 518439 | Ref. No. | 106111 |
| description | wash arm mounting pos. left L 180mm mounting ø 19mm nozzles 3 | | |
| For models: | E.40, E.40H, GLS40H, GLS40HP, MISTRAL-40, NIAGARA-40 | | |





| | | | |
|---|--|-----------------|------------------------|
|  | | | |
| 1 | | | |
| GEV No. | 510118 | Ref. No. | 993031 |
| description | wash arm L 245mm nozzles 4 mounting ø 12mm mounting pos. upper | | |
| For models: | 11F, 11FD, 11F-DVGW, 21F, 21FD, 22F, 25F, 25FD, 30F, 30FD, 31F, 31FD, 350F, 350FD, 35-ELECTRONIC, 35F, 35FD, 400F, 400FD, 40-ELECTRONIC, 40F, 40FD, 913289, 913290, 913291, 913292, 913356, 913357, 913363, 913364, 913372, 913373, 913374, 913375, 913376, 913377, 913416, 913418, 913435, 913544, 913545, 913665, 913666, 913667, 913668, 913685, 913771, 913772, 913773, 913774...(Other models you can see in the webshop) | | |
| spare parts for | 510118 | | |
|  | GEV No. | 510011 | Ref. No. 429008 |
| | screw connection plastic | | |
|  | GEV No. | 510012 | Ref. No. 437008 |
| | flat gasket PTFE ED ø 16.5mm ID ø 12.5mm thickness 1.5mm Qty 1 pcs equiv. no. 437008 | | |
|  | GEV No. | 510013 | Ref. No. 325001 |
| | rinse arm shaft | | |
|  | GEV No. | 510130 | Ref. No. 429006 |
| | union nut for rinse jet | | |
|  | GEV No. | 510139 | Ref. No. 140007 |
| | rinse jet | | |
|  | GEV No. | 518326 | Ref. No. 129002 |
| | rinse arm boss | | |
|  | GEV No. | 518328 | Ref. No. 106036 |
| | rinse arm mounting pos. right L 110mm mounting ø 13mm nozzles 2 | | |
|  | GEV No. | 518329 | Ref. No. 106035 |
| | rinse arm mounting pos. left L 110mm mounting ø 13mm nozzles 2 | | |



| | | | |
|---|--|-----------------|--------|
|  | | | |
| 1 | | | |
| GEV No. | 518331 | Ref. No. | 106049 |
| description | rinse arm L 110mm nozzles 2 mounting ø 13mm mounting pos. left | | |
| For models: | 45, 450, 914684, RIVER-39 | | |



| | | | |
|---|--|-----------------|--------|
|  | | | |
| 1 | | | |
| GEV No. | 518329 | Ref. No. | 106035 |
| description | rinse arm mounting pos. left L 110mm mounting ø 13mm nozzles 2 | | |
| For models: | 11F, 11FD, 11F-DVGW, 21F, 21FD, 25F, 25FD, 30F, 30FD, 31F, 31FD, 400F, 400FD, 40-ELECTRONIC, 40F, 40FD, 913289, 913290, 913291, 913292, 913356, 913357, 913363, 913364, 913372, 913373, 913374, 913375, 913376, 913377, 913416, 913418, 913435, 913544, 913545, 913665, 913666, 913667, 913668, 913685, 913771, 913772, 913773, 913774, 913832, 913837, 913911, 913912, 913948, 913950...(Other models you can see in the webshop) | | |

| | | | |
|---|--------------------------------|-----------------|--------|
|  | | | |
| 1 | | | |
| GEV No. | 518330 | Ref. No. | 106050 |
| description | rinse arm mounting pos. right | | |
| For models: | 45, 450, 67R, 914684, RIVER-39 | | |

| | | | |
|---|---|-----------------|--------|
|  | | | |
| 1 | | | |
| GEV No. | 518328 | Ref. No. | 106036 |
| description | rinse arm mounting pos. right L 110mm mounting ø 13mm nozzles 2 | | |
| For models: | 11F, 11FD, 11F-DVGW, 21F, 21FD, 25F, 25FD, 30F, 30FD, 31F, 31FD, 350F, 350FD, 35-ELECTRONIC, 35F, 35FD, 400F, 400FD, 40-ELECTRONIC, 40F, 40FD, 913289, 913290, 913291, 913292, 913356, 913357, 913363, 913364, 913372, 913373, 913374, 913375, 913376, 913377, 913416, 913418, 913435, 913544, 913545, 913665, 913666, 913667, 913668, 913685, 913771, 913772, 913773, 913774, 913832...(Other models you can see in the webshop) | | |



| | | | |
|---|--|-----------------|--------|
|  | | | |
| 1 | | | |
| GEV No. | 518326 | Ref. No. | 129002 |
| description | rinse arm boss | | |
| For models: | 11F, 11FD, 11F-DVGW, 31F, 31FD, 350F, 350FD, 35-ELECTRONIC, 35F, 35FD, 400F, 400FD, 40-ELECTRONIC, 40F, 40FD, 45, 450, 67R, 913289, 913290, 913291, 913292, 913356, 913357, 913363, 913364, 913372, 913373, 913374, 913375, 913376, 913377, 913416, 913418, 913435, 913544, 913545, 913665, 913666, 913667, 913668, 913685, 913771, 913772, 913773, 913774, 913832, 913837, 913911, 913912...(Other models you can see in the webshop) | | |



| | | | |
|---|--|-----------------|------------------------|
|  | | | |
| 1 | | | |
| GEV No. | 510139 | Ref. No. | 140007 |
| description | rinse jet | | |
| For models: | 050F, 050FP, 10, 11F, 11FD, 11F-DVGW, 11R, 11RD, 12, 21F, 21FD, 21R, 21RD, 22F, 2312-001, 2312-002, 25F, 25FD, 25R, 25RD, 30F, 30FD, 30R, 30RD, 31F, 31FD, 31R, 31RD, 350F, 350FD, 350R, 350RD, 35-ELECTRONIC, 35F, 35FD, 35R, 35RD, 400F, 400FD, 400R, 400RD, 40-ELECTRONIC, 40F, 40FD, 40R, 40RD, 440F, 44F, 45, 450...(Other models you can see in the webshop) | | |
| accessories for | 510139 | | |
|  | GEV No. | 510130 | Ref. No. 429006 |
| | union nut for rinse jet | | |

| | | | |
|---|---|-----------------|------------------------|
|  | | | |
| 1 | | | |
| GEV No. | 510130 | Ref. No. | 429006 |
| description | union nut for rinse jet | | |
| For models: | 10, 11F, 11FD, 11F-DVGW, 11R, 11RD, 12, 21F, 21FD, 21R, 21RD, 22F, 2312-001, 2312-002, 25F, 25FD, 25R, 25RD, 30F, 30FD, 30R, 30RD, 31F, 31FD, 31R, 31RD, 350F, 350FD, 350R, 350RD, 35-ELECTRONIC, 35F, 35FD, 35R, 35RD, 400F, 400FD, 400R, 400RD, 40-ELECTRONIC, 40F, 40FD, 40R, 40RD, 440F, 44F, 500F, 500FD, 50-ELECTRONIC, 50F...(Other models you can see in the webshop) | | |
| accessories for | 510130 | | |
|  | GEV No. | 510139 | Ref. No. 140007 |
| | rinse jet | | |

| | | | |
|---|--|-----------------|--------|
|  | | | |
| 1 | | | |
| GEV No. | 532058 | Ref. No. | 456071 |
| description | O-ring EPDM thickness 2.62mm ID ø 23.81mm Qty 10 pcs | | |
| For models: | 913289, 913290, 913291, 913292, 913297, 913298, 913299, 913300, 913356, 913357, 913360, 913361, 913372, 913373, 913374, 913375, 913391, 913392, 913416, 913418, 913435, 913544, 913545, 913546, 913547, 913578, 913611, 913665, 913666, 913667, 913668, 913684, 913685, 913771, 913772, 913773, 913774, 913832, 913837, 913911, 913912, 913913, 913914, 913932, 913933, 913948, 913950, 913977, 913984, 913990...(Other models you can see in the webshop) | | |

| | | | |
|---|---|-----------------|---------------------|
|  | | | |
| 1 | | | |
| GEV No. | 518053 | Ref. No. | 429006.TN 429039 |
| description | union nut for rinse jet | | |
| For models: | 050F, 050FP, 45, 450, 46, 460, 67R, 914684, E.50, E.51, F85, F85P, LF50, LF55, MC501E, MC501EP, MC501S, MC501SP, MISTRAL-51, NIAGARA-51, RIVER-39, TF-503, TF-513, TF-515 | | |

| | | | |
|---|--|-----------------|------------------------|
|  | | | |
| 1 | | | |
| GEV No. | 517438 | Ref. No. | 106153 |
| description | wash arm mounting pos. upper left/bottom left wash arm L 230mm rinse arm L 230mm w. jets 5 r. jets 3 mounting ø 12/27mm | | |
| For models: | 913297, 913298, 913299, 913300, 913360, 913361, 913391, 913392, 913546, 913547, 913578, 913611, 913684, 913913, 913914, 913932, 913933, 914284, 914318, 914319, 914326, 914331, 914338, 914356, 914400, 914401, 914402, 914403, 914404, 914405, 914406, 914431, 914449, 914517, 914545, 914642, 914688, 914909, 914979, 915136, 915137, 915140, 915150, 915151, 915152, 915154, 915155, 915157, 915158, 915160...(Other models you can see in the webshop) | | |
| accessories for | 517438 | | |
|  | GEV No. | 517440 | Ref. No. 129068 |
| | wash arm boss mounting pos. upper/lower L 88mm W 63mm H 69mm | | |





| | | | |
|---|--|-----------------|------------------------|
|  | | | |
| 1 | | | |
| GEV No. | 518142 | Ref. No. | 990113 |
| description | wash arm wash arm L 490mm rinse arm L 490mm w. jets 10 r. jets 5 mounting ø 14/44mm mounting pos. upper/lower Mod. E50/503 & 91-series | | |
| For models: | 913297, 913298, 913299, 913300, 913360, 913361, 913391, 913392, 913546, 913547, 913578, 913611, 913684, 913913, 913914, 913932, 913933, 914284, 914318, 914319, 914326, 914331, 914338, 914356, 914400, 914401, 914402, 914403, 914404, 914405, 914406, 914431, 914449, 914517, 914545, 914642, 914688, 914909, 914979, 915136, 915137, 915140, 915150, 915151, 915152, 915154, 915155, 915157, 915158, 915160...(Other models you can see in the webshop) | | |
| spare parts for | 518142 | | |
|  | GEV No. | 511510 | Ref. No. 456070 |
| | O-ring EPDM thickness 2.62mm ID ø 15.54mm Qty 10 pcs | | |



| | | | |
|---|--|-----------------|-------|
|  | | | |
| 1 | | | |
| GEV No. | 517567 | Ref. No. | 69316 |
| description | wash arm mounting pos. upper/lower left wash arm L 210mm rinse arm L 210mm w. jets 5 r. jets 3 mounting ø 27/17mm | | |
| For models: | CNT800CH, Fast180, Fast180-230V-3Ph-60Hz, FAST-60, FAST-73, NG281, NG281CDD, NG281HP, NG281HPDD, NG281HZ23, NG281H-Z23DD, NIAGARA-281, Niagara-281-2, Niagara-281HP, OC380, OC380FUR, OC380HZ23, Ocean380, PLUVIA-280, Pluvia280-230V-3Ph-60Hz, PV280, PV280FAST, PV280FAST2, PV280FAST2BIO, PV280FAST2HZ23, PV280FASTCH, PV280FASTHB, PV280HZ23, SevenE | | |

| | | | |
|---|--|-----------------|--------|
|  | | | |
| 1 | | | |
| GEV No. | 511510 | Ref. No. | 456070 |
| description | O-ring EPDM thickness 2.62mm ID ø 15.54mm Qty 10 pcs | | |
| For models: | 913289, 913290, 913291, 913292, 913297, 913298, 913299, 913300, 913356, 913357, 913360, 913361, 913372, 913373, 913374, 913375, 913391, 913392, 913416, 913418, 913435, 913544, 913545, 913546, 913547, 913578, 913611, 913665, 913666, 913667, 913668, 913684, 913685, 913771, 913772, 913773, 913774, 913832, 913837, 913911, 913912, 913913, 913914, 913932, 913933, 913948, 913950, 913977, 913984, 913990...(Other models you can see in the webshop) | | |

| | | | |
|---|--|-----------------|-------|
|  | | | |
| 1 | | | |
| GEV No. | 517562 | Ref. No. | 69314 |
| description | wash arm mounting pos. upper/lower right wash arm L 210mm rinse arm L 210mm w. jets 4 r. jets 2 mounting ø 27/17mm | | |
| For models: | CNT800CH, Fast180, Fast180-230V-3Ph-60Hz, FAST-60, FAST-73, NG281, NG281CDD, NG281HP, NG281HPDD, NG281HZ23, NG281H-Z23DD, NIAGARA-281, Niagara-281-2, Niagara-281HP, OC380, OC380FUR, OC380HZ23, Ocean380, PLUVIA-280, Pluvia280-230V-3Ph-60Hz, PV280, PV280FAST, PV280FAST2, PV280FAST2BIO, PV280FAST2HZ23, PV280FASTCH, PV280FASTHB, PV280HZ23, SevenE | | |





| | | | |
|---|--|-----------------|------------------------|
|  | | | |
| GEV No. | 517563 | Ref. No. | 106152 |
| description | wash arm mounting pos. upper/lower right wash arm L 230mm rinse arm L 230mm w. jets 5 r. jets 2 mounting ø 27/17mm | | |
| For models: | 913297, 913298, 913299, 913300, 913360, 913361, 913391, 913392, 913546, 913547, 913578, 913611, 913684, 913913, 913914, 913932, 913933, 914284, 914318, 914319, 914326, 914331, 914338, 914356, 914400, 914401, 914402, 914403, 914404, 914405, 914406, 914431, 914449, 914517, 914545, 914642, 914688, 914909, 914979, 915136, 915137, 915140, 915150, 915151, 915152, 915154, 915155, 915157, 915158, 915160...(Other models you can see in the webshop) | | |
| accessories for | 517563 | | |
|  | GEV No. | 504618 | Ref. No. 456026 |
|  | GEV No. | 513725 | Ref. No. 437100 |
|  | GEV No. | 532058 | Ref. No. 456071 |

| | | | |
|---|--|-----------------|------------------------|
|  | | | |
| GEV No. | 517440 | Ref. No. | 129068 |
| description | wash arm boss mounting pos. upper/lower L 88mm W 63mm H 69mm | | |
| For models: | 913297, 913298, 913299, 913300, 913360, 913361, 913391, 913392, 913418, 913546, 913547, 913578, 913611, 913684, 913913, 913914, 913932, 913933, 914167, 914168, 914284, 914318, 914319, 914326, 914331, 914338, 914356, 914398, 914399, 914400, 914401, 914402, 914403, 914404, 914405, 914406, 914431, 914443, 914449, 914517, 914545, 914642, 914688, 914909, 914943, 914979, 915136, 915137, 915140, 915150...(Other models you can see in the webshop) | | |
| accessories for | 517440 | | |
|  | GEV No. | 517438 | Ref. No. 106153 |
|  | GEV No. | 517563 | Ref. No. 106152 |



| | | | |
|---|--|-----------------|--------|
|  | | | |
| GEV No. | 531272 | Ref. No. | 990110 |
| description | wash arm L 405mm rinse arm L 405mm w. jets 8 r. jets 5 mounting ø 14mm mounting pos. upper/lower complete HOBART/EUROTEC warewashing E40 | | |
| For models: | 913291, 913292, 913357, 913374, 913375, 913416, 913435, 913545, 913666, 913668, 913685, 913773, 913774, 913911, 913912, 913948, 913950, 913977, 913984, 913990, 914214, 914316, 914317, 914392, 914393, 914394, 914395, 914396, 914397, 914441, 914442, 914515, 914516, 914537, 914543, 914547, 914683, 914689, 914863, 914874, 915138, 915139, 915527, 915611, 915612, 915613, 915614, 915615, 915616, 915617...(Other models you can see in the webshop) | | |





| | | | |
|--|--|-----------------|--------|
|  | | | |
| GEV No. | 518666 | Ref. No. | 990118 |
| description | wash arm L 455mm w. jets 9 r. jets 5 | | |
| For models: | CE78HZ23, E78, E78HP, Fast181, FAST-181, NG271, NG381, NG38123, NG38123TERMO, NG381C, NG381CDD, NG381CFUR, NG381DDHZ23, NG381DDPS, NG381DDPSHZ23, NG381HPDD, NG381TERMO, NG381TXCDD, NIAGARA-271, NIAGARA-283, Niagara-283A, Niagara-381, Niagara-381-230V-3Ph-50Hz, Niagara-381-230V-3Ph-60Hz, Niagara-381DP, Niagara-381HPD, RIVER-282, River-282-2, River-282S-2TDE, River-285, River-382, River-382-230V-3Ph-50Hz, River-382H, River-382NRG, River-382NRG-230-3Ph-50Hz, River-382TDE, RIVER-E78, RV282, RV282DD, RV282R, RV382, RV38223TERMO, RV382AHP, RV-382FUR, RV382R, RV382R23TERMO, RV382RFUR, RV382S, RV382SFUR, RV382TERMO...(Other models you can see in the webshop) | | |

| | | | |
|---|--|-----------------|--------|
|  | | | |
| GEV No. | 511510 | Ref. No. | 456070 |
| description | O-ring EPDM thickness 2.62mm ID ø 15.54mm Qty 10 pcs | | |
| For models: | 913289, 913290, 913291, 913292, 913297, 913298, 913299, 913300, 913356, 913357, 913360, 913361, 913372, 913373, 913374, 913375, 913391, 913392, 913416, 913418, 913435, 913544, 913545, 913546, 913547, 913578, 913611, 913665, 913666, 913667, 913668, 913684, 913685, 913771, 913772, 913773, 913774, 913832, 913837, 913911, 913912, 913913, 913914, 913932, 913933, 913948, 913950, 913977, 913984, 913990...(Other models you can see in the webshop) | | |

| | | | |
|---|--|-----------------|--------|
|  | | | |
| GEV No. | 532058 | Ref. No. | 456071 |
| description | O-ring EPDM thickness 2.62mm ID ø 23.81mm Qty 10 pcs | | |
| For models: | 913289, 913290, 913291, 913292, 913297, 913298, 913299, 913300, 913356, 913357, 913360, 913361, 913372, 913373, 913374, 913375, 913391, 913392, 913416, 913418, 913435, 913544, 913545, 913546, 913547, 913578, 913611, 913665, 913666, 913667, 913668, 913684, 913685, 913771, 913772, 913773, 913774, 913832, 913837, 913911, 913912, 913913, 913914, 913932, 913933, 913948, 913950, 913977, 913984, 913990...(Other models you can see in the webshop) | | |

| | | | |
|---|--|-----------------|--------|
|  | | | |
| GEV No. | 517565 | Ref. No. | 106148 |
| description | wash arm L 185mm rinse arm L 185mm w. jets 4 r. jets 2 mounting ø 27/17mm | | |
| For models: | 913291, 913292, 913357, 913374, 913375, 913416, 913435, 913545, 913666, 913668, 913685, 913773, 913774, 913911, 913912, 913948, 913950, 913977, 913984, 913990, 914214, 914316, 914317, 914392, 914393, 914394, 914395, 914396, 914397, 914441, 914442, 914515, 914516, 914537, 914543, 914547, 914683, 914689, 914863, 914874, 915138, 915139, 915527, 915611, 915612, 915613, 915614, 915615, 915616, 915617...(Other models you can see in the webshop) | | |

| | | | |
|---|--|-----------------|------------------------|
|  | | | |
| GEV No. | 517564 | Ref. No. | 106149 |
| description | wash arm mounting pos. upper/lower right wash arm L 185mm rinse arm L 185mm w. jets 4 r. jets 3 mounting ø 27/17mm | | |
| For models: | 913291, 913292, 913357, 913374, 913375, 913416, 913435, 913545, 913666, 913668, 913685, 913773, 913774, 913911, 913912, 913948, 913950, 913977, 913984, 913990, 914214, 914316, 914317, 914392, 914393, 914394, 914395, 914396, 914397, 914441, 914442, 914515, 914516, 914537, 914543, 914547, 914683, 914689, 914863, 914874, 915138, 915139, 915527, 915611, 915612, 915613, 915614, 915615, 915616, 915617...(Other models you can see in the webshop) | | |
| accessories for | 517564 | | |
|  | GEV No. | 511510 | Ref. No. 456070 |
| | O-ring EPDM thickness 2.62mm ID ø 15.54mm Qty 10 pcs | | |
|  | GEV No. | 532058 | Ref. No. 456071 |
| | O-ring EPDM thickness 2.62mm ID ø 23.81mm Qty 10 pcs | | |

| | | | |
|---|---|-----------------|------------------------|
|  | | | |
| GEV No. | 524809 | Ref. No. | 990111 |
| description | wash and rinse arm wash arm L 340mm rinse arm L 340mm w. jets 7 r. jets 4 mounting ø 14/41mm mounting pos. lower | | |
| For models: | 913289, 913290, 913356, 913372, 913373, 913544, 913665, 913667, 913771, 913772, 913832, 913837, 914165, 914166, 914206, 914355, 914386, 914387, 914388, 914389, 914390, 914391, 914692, 914693, 914694, 914703, 914870, 915686, 915687, 915688, 915689, 915690, 915691, E.35, E.35-Elettrobar, E.35H, E.35H-Elettrobar, FAST-135, Fast135CT, FAST-135CT, Fast135D, FAST-135D, Fast135H, FAST-135H, Fast135HCT, FAST-135HCT, Fast135HD, FAST-135HD, NIAGARA-35 | | |
| spare parts for | 524809 | | |
|  | GEV No. | 511510 | Ref. No. 456070 |
| | O-ring EPDM thickness 2.62mm ID ø 15.54mm Qty 10 pcs | | |
|  | GEV No. | 517566 | Ref. No. 106146 |
| | wash arm mounting pos. bottom right wash arm L 155mm rinse arm L 155mm w. jets 3 r. jets 2 mounting ø 27/17mm | | |
|  | GEV No. | 517821 | Ref. No. 106147 |
| | wash and rinse arm wash arm L 155mm rinse arm L 155mm w. jets 4 r. jets 3 mounting ø 17/22mm | | |
|  | GEV No. | 532058 | Ref. No. 456071 |
| | O-ring EPDM thickness 2.62mm ID ø 23.81mm Qty 10 pcs | | |

| | | | |
|--|---|-----------------|-------|
|  | | | |
| GEV No. | 517822 | Ref. No. | 69312 |
| description | wash and rinse arm wash arm L 458mm rinse arm L 458mm w. jets 9 r. jets 5 mounting ø 14/44mm | | |
| For models: | CNT800CH, Fast180, Fast180-230V-3Ph-60Hz, FAST-60, FAST-73, NG281, NG281CDD, NG281HP, NG281HPDD, NG281HZ23, NG281HZ23DD, NIAGARA-281, Niagara-281-2, Niagara-281HP, OC380, OC380FUR, OC380HZ23, Ocean380, PLUVIA-280, Pluvia280-230V-3PH-60Hz, PV280, PV280FAST, PV280FAST2, PV280FAST2BIO, PV280FAST2HZ23, PV280FASTCH, PV280FASTHB, PV280HZ23, SevenE | | |

| | | | |
|---|--|-----------------|--------|
|  | | | |
| GEV No. | 511510 | Ref. No. | 456070 |
| description | O-ring EPDM thickness 2.62mm ID ø 15.54mm Qty 10 pcs | | |
| For models: | 913289, 913290, 913291, 913292, 913297, 913298, 913299, 913300, 913356, 913357, 913360, 913361, 913372, 913373, 913374, 913375, 913391, 913392, 913416, 913418, 913435, 913544, 913545, 913546, 913547, 913578, 913611, 913665, 913666, 913667, 913668, 913684, 913685, 913771, 913772, 913773, 913774, 913832, 913837, 913911, 913912, 913913, 913914, 913932, 913933, 913948, 913950, 913977, 913984, 913990...(Other models you can see in the webshop) | | |

| | | | |
|--|--|-----------------|--------|
|  | | | |
| GEV No. | 532058 | Ref. No. | 456071 |
| description | O-ring EPDM thickness 2.62mm ID ø 23.81mm Qty 10 pcs | | |
| For models: | 913289, 913290, 913291, 913292, 913297, 913298, 913299, 913300, 913356, 913357, 913360, 913361, 913372, 913373, 913374, 913375, 913391, 913392, 913416, 913418, 913435, 913544, 913545, 913546, 913547, 913578, 913611, 913665, 913666, 913667, 913668, 913684, 913685, 913771, 913772, 913773, 913774, 913832, 913837, 913911, 913912, 913913, 913914, 913932, 913933, 913948, 913950, 913977, 913984, 913990...(Other models you can see in the webshop) | | |

| | | | |
|---|---|-----------------|--------|
|  | | | |
| GEV No. | 517821 | Ref. No. | 106147 |
| description | wash and rinse arm wash arm L 155mm rinse arm L 155mm w. jets 4 r. jets 3 mounting ø 17/22mm | | |
| For models: | 913289, 913290, 913356, 913372, 913373, 913544, 913665, 913667, 913771, 913772, 913832, 913837, 914165, 914166, 914206, 914355, 914386, 914387, 914388, 914389, 914390, 914391, 914692, 914693, 914694, 914703, 914870, 915686, 915687, 915688, 915689, 915690, 915691, E.35, E.35-Elettrobar, E.35H, E.35H-Elettrobar, FAST-135, Fast135CT, FAST-135CT, Fast135D, FAST-135D, Fast135H, FAST-135H, Fast135HCT, FAST-135HCT, Fast135HD, FAST-135HD, NIAGARA-35 | | |





| | | | |
|---|---|-----------------|--------|
|  | | | |
| 1 | | | |
| GEV No. | 517566 | Ref. No. | 106146 |
| description | wash arm mounting pos. bottom right wash arm L 155mm rinse arm L 155mm w. jets 3 r. jets 2 mounting ø 27/17mm | | |
| For models: | 913289, 913290, 913356, 913372, 913373, 913544, 913665, 913667, 913771, 913772, 913832, 913837, 914165, 914166, 914206, 914355, 914386, 914387, 914388, 914389, 914390, 914391, 914692, 914693, 914694, 914703, 914870, 915686, 915687, 915688, 915689, 915690, 915691, E.35, E.35-Elettrobar, E.35H, E.35H-Elettrobar, FAST-135, Fast135CT, FAST-135CT, Fast135D, FAST-135D, Fast135H, FAST-135H, Fast135HCT, FAST-135HCT, Fast135HD, FAST-135HD, NIAGARA-35 | | |

| | | | |
|--|---|-----------------|--------|
|  | | | |
| 1 | | | |
| GEV No. | 518314 | Ref. No. | 990082 |
| description | wash arm H 470mm L 425mm nozzles 6 mounting pos. upper | | |
| For models: | 45, 450, 913418, 914167, 914168, 914398, 914399, 914443, 914943, 915695, 915696, 915819, E.45, Fast145, FAST-145, Fast145D, FAST-145D, NIAGARA-45 | | |

| | | | |
|---|--|-----------------|--------|
|  | | | |
| 1 | | | |
| GEV No. | 518626 | Ref. No. | 990015 |
| description | wash arm H 470mm L 325mm nozzles 6 mounting ø 25mm | | |
| For models: | R497, R499, R501, R503 | | |

| | | | |
|--|--|-----------------|--------|
|  | | | |
| 1 | | | |
| GEV No. | 518453 | Ref. No. | 990092 |
| description | wash arm H 470mm L 425mm nozzles 6 mounting pos. upper | | |
| For models: | E.45 | | |

| | | | |
|--|--|-----------------|--------|
|  | | | |
| 1 | | | |
| GEV No. | 510143 | Ref. No. | 140003 |
| description | wash jet | | |
| For models: | R495, R497, R499, R501, R503, R509, R511, R704, R706, R708, S651, S651P, S653, S654, S655, S830, S835, SR651 | | |

| | | | |
|---|------------------------------|-----------------|----------|
|  | | | |
| 1 | | | |
| GEV No. | 518312 | Ref. No. | 990095PL |
| description | wash arm mounting pos. lower | | |
| For models: | E.40H | | |

| | | | |
|---|---|-----------------|------------------|
|  | | | |
| 1 | | | |
| GEV No. | 518448 | Ref. No. | 129051 990099 |
| description | wash arm | | |
| For models: | 913363, 913364, 913376, 913377, E.41, E.42, E41 | | |

| | | | |
|---|--|-----------------|--------|
|  | | | |
| 1 | | | |
| GEV No. | 518410 | Ref. No. | 441010 |
| description | end cap | | |
| For models: | 21F, 21FD, 21R, 21RD, 25F, 25FD, 25R, 25RD, 30F, 30FD, 30R, 30RD, 31F, 31FD, 31R, 31RD, 45, 450, 67R, 913291, 913292, 913357, 913363, 913364, 913374, 913375, 913376, 913377, 913416, 913418, 913435, 913545, 913666, 913668, 913685, 913773, 913774, 913911, 913912, 913948, 913950, 913977, 913984, 913990, 914167, 914168, 914214, 914316, 914317, 914392...(Other models you can see in the webshop) | | |

| | | | |
|---|--|-----------------|--------|
|  | | | |
| 1 | | | |
| GEV No. | 518386 | Ref. No. | 990056 |
| description | wash arm H 395mm L 385mm nozzles 6 mounting pos. upper | | |
| For models: | 21F, 21FD, 25F, 25FD, 30F, 30FD, 31F, 31FD | | |



| | | | |
|---|---|-----------------|--------|
|  | | | |
| 1 | | | |
| GEV No. | 510135 | Ref. No. | 110001 |
| description | nozzle holder | | |
| For models: | 11F, 11FD, 11F-DVGW, 21F, 21FD, 25F, 25FD, 30F, 30FD, 31F, 31FD, 400F, 400FD, 40-ELECTRONIC, 40F, 40FD, E.40, E.40H, E.41, E.42, E.45, NIAGARA-40, S621, S623, S624, S626, S631, S633, S634, S636, S651, S655, S835 | | |

| | | | |
|---|--|-----------------|--------|
|  | | | |
| GEV No. | 510146 | Ref. No. | 119003 |
| description | swirl ø 18.5mm H 7mm hole ø 2mm | | |
| For models: | 11F, 11FD, 11F-DVGW, 21F, 21FD, 25F, 25FD, 30F, 30FD, 31F, 31FD, 400F, 400FD, 40-ELECTRONIC, 40F, 40FD, 45, 450, 67R, 913291, 913292, 913357, 913363, 913364, 913374, 913375, 913376, 913377, 913416, 913418, 913435, 913545, 913666, 913668, 913685, 913773, 913774, 913911, 913912, 913948, 913950, 913977, 913984, 913990, 914167, 914168, 914214, 914316, 914317, 914392...(Other models you can see in the webshop) | | |

| | | | |
|---|---|-----------------|--------|
|  | | | |
| GEV No. | 510144 | Ref. No. | 140010 |
| description | union nut for wash jet | | |
| For models: | 11F, 11FD, 11F-DVGW, 31F, 31FD, 400F, 400FD, 40-ELECTRONIC, 40F, 40FD, 45, 450, 67R, 913291, 913292, 913357, 913363, 913364, 913374, 913375, 913376, 913377, 913416, 913418, 913435, 913545, 913666, 913668, 913685, 913773, 913774, 913911, 913912, 913948, 913950, 913977, 913984, 913990, 914167, 914168, 914214, 914316, 914317, 914392, 914393, 914394, 914395, 914396, 914397, 914398...(Other models you can see in the webshop) | | |





| | | | |
|---|--|-----------------|--------|
|  | | | |
| GEV No. | 518159 | Ref. No. | 110010 |
| description | wash jet holder | | |
| For models: | 21F, 21FD, 25F, 25FD, 30F, 30FD, 31F, 31FD, 45, 450, 67R, 913418, 914167, 914168, 914398, 914399, 914443, 914943, 915695, 915696, 915819, E.45, Fast145, FAST-145, Fast145D, FAST-145D, NIAGARA-45 | | |

| | | | |
|---|---|-----------------|--------|
|  | | | |
| GEV No. | 518480 | Ref. No. | 929195 |
| description | wash arm | | |
| For models: | KLP105EB, LP105DDDTEB, LP105DDDEBN, LP105EB, NG292, NG292HZ, NG293, NIAGARA-292, Niagara-292-400V-3Ph-60Hz, NIAGARA-293, RIVER-295, River-295P, RIVER-296, River-296P, RV295, RV295PS, RV296, RV296PS, U61, U61E, U61H, U61HE | | |

| | | | |
|---|---|-----------------|------------------|
|  | | | |
| GEV No. | 518481 | Ref. No. | 929196 |
| description | wash arm L 335mm nozzles 12 mounting ø 16mm mounting pos. upper and bottom | | |
| For models: | KLP201DDDTEB, KLP201EB, KLP301, KLP301DDDTEB, LP201DDDEBN, LP201EB, LP301, LP301EB, RIVER-297, RIVER-298, RV297, RV298, RV298HZ, U132, U132E, U70, U70e | | |
| accessories for | 518481 | | |
|  | GEV No. | 513123 | Ref. No. |
| | | | 626129 926129 |
| | wash arm bearing mounting pos. upper/lower | | |
|  | GEV No. | 513124 | Ref. No. |
| | | | 80314 926128 |
| | nut M24x1.5 | | |

| | | | |
|--|--|-----------------|--------|
|  | | | |
| GEV No. | 518316 | Ref. No. | 129036 |
| description | wash arm L 385mm nozzles 4 mounting ø 20mm mounting pos. upper | | |
| For models: | 913992, 913993, 914583, 914592, 914612, 914613, 915143, CLEAN-3, RIVER-40, RIVER-40-CRP, RIVER-43, RIVER-44, RIVER-44-CRP, River-44-CRP-ST, RIVER-44CRP-ST | | |

| | | | |
|--|---|-----------------|--------|
|  | | | |
| GEV No. | 518455 | Ref. No. | 990087 |
| description | wash arm L 490mm nozzles 8 mounting ø 50mm mounting pos. lower | | |
| For models: | 2312-001, 2312-002, 500F, 500FD, 50F, 50FD, 510F, 510FD, CLEAN-100, CLEAN-110, CLEAN-120, E.50, E.51, E.52, E.60, E.65, E1, E10, E100, E110, E12, E120, E14, E140, LF50, LF55, MC501E, MC501EP, MC501S, MC501SP, MISTRAL-51, NIAGARA-51 | | |

| | | | |
|--|---|-----------------|-----------------|
|  | | | |
| GEV No. | 518019 | Ref. No. | 990055 |
| description | wash arm L 490mm nozzles 8 mounting ø 50mm mounting pos. upper and bottom | | |
| For models: | 10, 12, 14, 22F, 40F, 44F, 500F, 500FD, 50F, 50FD, 510F, 510FD, 55, 66, CLEAN-110, S651, S810, S830 | | |
| accessories for | 518019 | | |
|  | GEV No. | 511143 | Ref. No. |
| | | | 303009 |
| | bush for wash arm mounting pos. upper and bottom H 10mm D1 ø 65mm D2 ø 54mm ID ø 50mm type 22/66 | | |
|  | GEV No. | 518014 | Ref. No. |
| | | | 325011 |
| | rinse arm shaft | | |
|  | GEV No. | 518032 | Ref. No. |
| | | | 199027 |
| | throttle disc ED ø 34mm ID ø 13.2mm thickness 1mm | | |





| | | | |
|---|---|-----------------|------------------|
|  | | | |
| 1 | | | |
| GEV No. | 518270 | Ref. No. | 129046 DLL160 |
| description | wash arm L 510mm nozzles 10 mounting ø 16mm mounting pos. lower | | |
| For models: | 050F, 050FP, F85, F85P | | |

| | | | |
|---|--|-----------------|--------|
|  | | | |
| 1 | | | |
| GEV No. | 518273 | Ref. No. | 990107 |
| description | wash arm L 510mm nozzles 8 mounting ø 15mm mounting pos. upper and bottom | | |
| For models: | 2312-007, 2312-009-CRP, 914100, 914101, 914339, 914342, 914343, 914624, 914625, 914626, 914627, 914628, 914850, 914851, 914854, 914944, E.55, RIVER-48, RIVER-50, RIVER-50-CRP, RIVER-50-CRP-SP, River-54, RIVER-54CRP, River-54-CRP-s.p., RIVER-54-CRP-SP, RIVER-61 | | |

| | | | |
|---|---|-----------------|--------|
|  | | | |
| 1 | | | |
| GEV No. | 511143 | Ref. No. | 303009 |
| description | bush for wash arm mounting pos. upper and bottom H 10mm D1 ø 65mm D2 ø 54mm ID ø 50mm type 22/66 | | |
| For models: | 10, 12, 14, 22F, 2312-001, 2312-002, 40F, 440F, 44F, 500F, 500FD, 50-ELECTRONIC, 50F, 50FD, 510F, 510FD, 55, 66, CLEAN-100, CLEAN-110, CLEAN-120, E.50, E.51, E.52, E.60, E.65, E1, E10, E100, E110, E12, E120, E14, E140, LF50, LF55, MC501E, MC501EP, MC501S, MC501SP, MISTRAL-51, NIAGARA-51, S651, S810, S830 | | |

| | | | |
|---|--|-----------------|--------|
|  | | | |
| 1 | | | |
| GEV No. | 518236 | Ref. No. | 303040 |
| description | sealing ring for wash arm support ED ø 44mm ID ø 42mm plastic | | |
| For models: | 915154, 915155, 915160, 915161, 915162, 915168, 915175, 915319, 915479, 915492, 915493, 915496, 915663, 916020, 916021, 916024, 916025, 916026, 916027, 916030, 916031, 916045, 916067, 916068, 916069, 916079, 916080, 916201, 916202, 916203, 916204, 916205, 916206, 916207, 916208, 916209, 916247, 916248, 916249, 916250, 916251, 916252, 916365, 916366, 916367, 916368, 916382, 916383, 916411, 916412...(Other models you can see in the webshop) | | |

| | | | |
|---|--|-----------------|--------|
|  | | | |
| 1 | | | |
| GEV No. | 518282 | Ref. No. | 303032 |
| description | sealing ring for wash arm support stainless steel | | |
| For models: | 2312-007, 2312-009-CRP, 80, 81, 82, 914100, 914101, 914339, 914342, 914343, 914568, 914624, 914625, 914626, 914627, 914628, 914850, 914851, 914854, 914944, 915830, CE78HZ23, CGL74CABT, E.50D.PA, E.55, E78, E78HP, Fast160DP, FAST-160DP, Fast181, FAST-181, HM1, LP60, RIVER-48, RIVER-50, RIVER-50-CRP, RIVER-50-CRP-SP, RIVER-54, RIVER-54CRP, River-54-CRP-s.p., RIVER-54-CRP-SP, RIVER-61, RIVER-71, RIVER-78, RIVER-80, River-81, River-81CRP, RIVER-81-CRP, RIVER-82, River-82CRP...(Other models you can see in the webshop) | | |

| | | | |
|--|------------------------------------|-----------------|--------|
|  | | | |
| 1 | | | |
| GEV No. | 518007 | Ref. No. | 993030 |
| description | rinse arm | | |
| For models: | S651, S654, S810, S815, S830, S835 | | |

| | | | |
|---|---|-----------------|--------|
|  | | | |
| 1 | | | |
| GEV No. | 518392 | Ref. No. | 993041 |
| description | rinse arm L 325mm nozzles 3 mounting ø 14mm mounting pos. upper | | |
| For models: | 440F, 44F | | |

| | | | |
|---|--|-----------------|--------|
|  | | | |
| 1 | | | |
| GEV No. | 510159 | Ref. No. | 145003 |
| description | end cap | | |
| For models: | 10, 12, 22F, 2312-001, 2312-002, 40F, 440F, 44F, 500F, 500FD, 50-ELECTRONIC, 50F, 50FD, 510F, 510FD, 55, 66, CLEAN-100, CLEAN-110, CLEAN-120, E.50, E.51, E.52, E.60, E1, E10, E100, E110, E12, E120, LF50, LF55, MC501E, MC501EP, MC501S, MC501SP, MISTRAL-51, NIAGARA-51 | | |

| | | | |
|---|--|-----------------|--------|
|  | | | |
| 1 | | | |
| GEV No. | 518016 | Ref. No. | 145001 |
| description | end cap | | |
| For models: | 10, S651, S654, S810, S815, S830, S835, S950 | | |

| | | | |
|---|--|-----------------|--------|
|  | | | |
| 1 | | | |
| GEV No. | 518017 | Ref. No. | 145002 |
| description | end cap | | |
| For models: | S651, S654, S810, S815, S830, S835, S950 | | |

| | | | |
|---|--|-----------------|--------|
|  | | | |
| 1 | | | |
| GEV No. | 518035 | Ref. No. | 145004 |
| description | end cap without holder for rinse arm | | |
| For models: | 10, 12, 22F, 2312-001, 2312-002, 40F, 440F, 44F, 500F, 500FD, 50-ELECTRONIC, 50F, 50FD, 510F, 510FD, 55, 66, CLEAN-100, CLEAN-110, CLEAN-120, E.50, E.51, E.52, E.60, E1, E10, E100, E110, E12, E120, LF50, LF55, MC501E, MC501EP, MC501S, MC501SP, MISTRAL-51, NIAGARA-51 | | |

| | | | |
|---|--|-----------------|--------|
|  | | | |
| 1 | | | |
| GEV No. | 510134 | Ref. No. | 468055 |
| description | nozzle holder for rinse jet | | |
| For models: | S651, S654, S810, S815, S830, S835, S950 | | |

| | | | |
|---|--|-----------------|--------|
|  | | | |
| 1 | | | |
| GEV No. | 511150 | Ref. No. | 468125 |
| description | nozzle holder for rinse jet left | | |
| For models: | 10, 12, 22F, 2312-001, 2312-002, 40F, 440F, 44F, 500F, 500FD, 50-ELECTRONIC, 50F, 50FD, 510F, 510FD, 55, 66, CLEAN-100, CLEAN-110, CLEAN-120, E.50, E.51, E.52, E.60, E1, E10, E100, E110, E12, E120, LF50, LF55, MC501E, MC501EP, MC501S, MC501SP, MISTRAL-51, NIAGARA-51 | | |

| | | | |
|---|--|-----------------|--------|
|  | | | |
| 1 | | | |
| GEV No. | 511149 | Ref. No. | 468124 |
| description | nozzle holder for rinse jet right | | |
| For models: | 10, 12, 22F, 2312-001, 2312-002, 40F, 440F, 44F, 500F, 500FD, 50-ELECTRONIC, 50F, 50FD, 510F, 510FD, 55, 66, CLEAN-100, CLEAN-110, CLEAN-120, E.50, E.51, E.52, E.60, E1, E10, E100, E110, E12, E120, LF50, LF55, MC501E, MC501EP, MC501S, MC501SP, MISTRAL-51, NIAGARA-51 | | |

| | | | |
|---|--|-----------------|--------|
|  | | | |
| 1 | | | |
| GEV No. | 510113 | Ref. No. | 449029 |
| description | opposite support for rinse jet | | |
| For models: | 10, 12, 22F, 2312-001, 2312-002, 40F, 440F, 44F, 500F, 500FD, 50-ELECTRONIC, 50F, 50FD, 510F, 510FD, 55, 66, CLEAN-100, CLEAN-110, CLEAN-120, E.50, E.51, E.52, E.60, E1, E10, E100, E110, E12, E120, LF50, LF55, MC501E, MC501EP, MC501S, MC501SP, MISTRAL-51, NIAGARA-51, S651, S654, S810, S815, S830, S835, S950 | | |

| | | | |
|---|--|-----------------|-----------|
|  | | | |
| 1 | | | |
| GEV No. | 518425 | Ref. No. | 106054.CR |
| description | rinse arm mounting pos. bottom left L 200mm mounting ø 14mm nozzles 2 | | |
| For models: | 2312-001, 2312-002, 500F, 500FD, 50F, 50FD, 510F, 510FD, CLEAN-100, CLEAN-110, CLEAN-120, E.50, E.51, E.52, E1, E10, E100, E110, E12, E120, LF50, LF55, MC501E, MC501EP, MC501S, MC501SP, MISTRAL-51, NIAGARA-51 | | |



| | | | |
|---|--|-----------------|-----------|
|  | | | |
| 1 | | | |
| GEV No. | 518424 | Ref. No. | 106053.CR |
| description | rinse arm mounting pos. bottom right L 200mm mounting ø 14mm nozzles 1 | | |
| For models: | 2312-001, 2312-002, 500F, 500FD, 50F, 50FD, 510F, 510FD, CLEAN-100, CLEAN-110, CLEAN-120, E.50, E.51, E.52, E1, E10, E100, E110, E12, E120, LF50, LF55, MC501E, MC501EP, MC501S, MC501SP, MISTRAL-51, NIAGARA-51 | | |

| | | | |
|---|--|-----------------|-----------|
|  | | | |
| 1 | | | |
| GEV No. | 518423 | Ref. No. | 106056.CR |
| description | rinse arm mounting pos. upper left L 185mm mounting ø 14mm nozzles 1 | | |
| For models: | E.52 | | |

| | | | |
|---|---|-----------------|-----------|
|  | | | |
| 1 | | | |
| GEV No. | 518422 | Ref. No. | 106055.CR |
| description | rinse arm mounting pos. upper right L 185mm mounting ø 14mm nozzles 1 | | |
| For models: | E.52 | | |



| | | | |
|---|--|-----------------|------------------|
|  | | | |
| 1 | | | |
| GEV No. | 513219 | Ref. No. | 129019 DAS265 |
| description | rinse arm boss | | |
| For models: | 050F, 050FP, 10, 12, 14, 22F, 2312-001, 2312-002, 40F, 440F, 44F, 500F, 500FD, 50F, 50FD, 510F, 510FD, 55, 66, CLEAN-100, CLEAN-110, CLEAN-120, E.50, E.51, E.52, E.60, E.65, E1, E10, E100, E110, E12, E120, E14, E140, F85, F85P, LF50, LF55, MC501E, MC501EP, MC501S, MC501SP, MISTRAL-51, NIAGARA-51, S651, S654, S810, S815, S830...(Other models you can see in the webshop) | | |



| | | | |
|--|--|-----------------|--------|
|  <p>1</p> | | | |
| GEV No. | 510139 | Ref. No. | 140007 |
| description | rinse jet | | |
| For models: | 050F, 050FP, 10, 11F, 11FD, 11F-DVGW, 11R, 11RD, 12, 21F, 21FD, 21R, 21RD, 22F, 2312-001, 2312-002, 25F, 25FD, 25R, 25RD, 30F, 30FD, 30R, 30RD, 31F, 31FD, 31R, 31RD, 350F, 350FD, 350R, 350RD, 35-ELECTRONIC, 35F, 35FD, 35R, 35RD, 400F, 400FD, 400R, 400RD, 40-ELECTRONIC, 40F, 40FD, 40R, 40RD, 440F, 44F, 45, 450...(Other models you can see in the webshop) | | |
| accessories for | 510139 | | |
|  <p>GEV No. 510130 Ref. No. 429006</p> <p>union nut for rinse jet</p> | | | |



| | | | |
|--|---|-----------------|--------|
|  <p>1</p> | | | |
| GEV No. | 510140 | Ref. No. | 140006 |
| description | rinse jet | | |
| For models: | 22R, R495, R497, R499, R501, R503, R505, R507, R509, R511, R704, R706, R708, S651, S651P, S653, S654, S655, S810, S815, S830, S835, S870, S950, SR651 | | |



| | | | |
|--|---|-----------------|--------|
|  <p>1</p> | | | |
| GEV No. | 510137 | Ref. No. | 138001 |
| description | swirl | | |
| For models: | 22R, R495, R497, R499, R501, R503, R509, R511, R704, R706, R708, S651, S651P, S653, S654, S655, S810, S815, S830, S835, S870, SR651 | | |



| | | | |
|--|---|-----------------|--------|
|  <p>1</p> | | | |
| GEV No. | 510130 | Ref. No. | 429006 |
| description | union nut for rinse jet | | |
| For models: | 10, 11F, 11FD, 11F-DVGW, 11R, 11RD, 12, 21F, 21FD, 21R, 21RD, 22F, 2312-001, 2312-002, 25F, 25FD, 25R, 25RD, 30F, 30FD, 30R, 30RD, 31F, 31FD, 31R, 31RD, 350F, 350FD, 350R, 350RD, 35-ELECTRONIC, 35F, 35FD, 35R, 35RD, 400F, 400FD, 400R, 400RD, 40-ELECTRONIC, 40F, 40FD, 40R, 40RD, 440F, 44F, 500F, 500FD, 50-ELECTRONIC, 50F...(Other models you can see in the webshop) | | |
| accessories for | 510130 | | |
|  <p>GEV No. 510139 Ref. No. 140007</p> <p>rinse jet</p> | | | |

| | | | |
|--|--|-----------------|--------|
|  <p>1</p> | | | |
| GEV No. | 518470 | Ref. No. | 929126 |
| description | rinse arm L 500mm nozzles 7 mounting ø 14mm mounting pos. upper and bottom | | |
| For models: | E.65 | | |



| | | | |
|--|---|-----------------|--------|
|  <p>1</p> | | | |
| GEV No. | 518478 | Ref. No. | 422051 |
| description | rinse arm L 640mm nozzles 8 mounting ø 14mm mounting pos. upper and bottom complete | | |
| For models: | U132E, U70E | | |
| spare parts for | 518478 | | |
|  <p>GEV No. 510895 Ref. No. 456043</p> <p>O-ring EPDM thickness 3.53mm ID ø 34.52mm Qty 1 pcs</p> | | | |
|  <p>GEV No. 513055 Ref. No. 926133 CSP2502</p> <p>rinse jet</p> | | | |
|  <p>GEV No. 513271 Ref. No. 412028</p> <p>connector holder grey</p> | | | |
|  <p>GEV No. 518028 Ref. No. 454004</p> <p>knurled nut thread M5 ø 25mm H 4mm SS</p> | | | |
|  <p>GEV No. 518416 Ref. No. 926131</p> <p>opposite support for rinse jet</p> | | | |
|  <p>GEV No. 518419 Ref. No. 926132</p> <p>end cap for rinse arm</p> | | | |

| | | | |
|--|---------------------------------------|-----------------|--------|
|  <p>1</p> | | | |
| GEV No. | 518417 | Ref. No. | 926168 |
| description | blank nozzle for rinse arm | | |
| For models: | 050F, 050FP, F85, F85P, MINIBAR, S280 | | |
| accessories for | 518417 | | |
|  <p>GEV No. 560062 Ref. No. —</p> <p>flat-headed bolt thread M4 thread L 10mm SS DIN 7985/ISO 7045 Qty 20 pcs intake Phillips head ø 8mm head thickness 2mm</p> | | | |
|  <p>GEV No. 560131 Ref. No. —</p> <p>hexagonal nut thread M4 H 3.2mm WS 7 SS DIN/ISO DIN 934 / ISO 4032/8673 Qty 20 pcs</p> | | | |

| | | | |
|---|---|-----------------|------------------------|
|  | | | |
| GEV No. | 518419 | Ref. No. | 926132 |
| description | end cap for rinse arm | | |
| For models: | 050F, 050FP, 2312-007, 2312-009-CRP, 80, 81, 82, 913992, 913993, 914100, 914101, 914339, 914342, 914343, 914583, 914592, 914612, 914613, 914624, 914625, 914626, 914627, 914628, 914850, 914851, 914854, 914944, 915143, 915830, CGL74CABT, E.65, E78, F85, F85P, Fast160DP, FAST-181, Fast181-230V-3Ph-60Hz, Fast181-400V-3NPh-60Hz, HM1, KLP105EB, KLP201DDDTTEB, KLP201EB, KLP301, KLP301DDDTTEB, LP105DDDTTEB, LP105DDDTTEBN, LP105EB, LP201DDDTTEB, LP201EB, LP301...(Other models you can see in the webshop) | | |
| accessories for | 518419 | | |
|  | GEV No. | 528485 | Ref. No. 456060 |
| | O-ring EPDM thickness 1.78mm ID ø 6.07mm Qty 1 pcs | | |

| | | | |
|---|--|-----------------|-------------------|
|  | | | |
| GEV No. | 513055 | Ref. No. | 926133 CSP2502 |
| description | rinse jet | | |
| For models: | 050F, 050FP, E.65, F85, F85P, MINIBAR, S280, U132, U132E, U61, U61E, U61H, U61HE, U70, U70E | | |
| accessories for | 513055 | | |
|  | GEV No. | 560062 | Ref. No. — |
| | flat-headed bolt thread M4 thread L 10mm SS DIN 7985/ISO 7045 Qty 20 pcs intake Phillips head ø 8mm head thickness 2mm | | |
|  | GEV No. | 560131 | Ref. No. — |
| | hexagonal nut thread M4 H 3.2mm WS 7 SS DIN/ISO DIN 934 / ISO 4032/8673 Qty 20 pcs | | |

| | | | |
|---|--|-----------------|----------------------------------|
|  | | | |
| GEV No. | 518320 | Ref. No. | 993048 |
| description | rinse arm L 460mm nozzles 5 mounting ø 14mm mounting pos. lower | | |
| For models: | 914568, 915830, E.50D.PA, E.55, FAST-160DP, RIVER-50, RIVER-50-CRP, RIVER-61 | | |
| spare parts for | 518320 | | |
|  | GEV No. | 510303 | Ref. No. 456030 CGR106 |
| | O-ring EPDM thickness 1.78mm ID ø 6.75mm Qty 1 pcs | | |
|  | GEV No. | 518276 | Ref. No. 140025 80373 |
| | rinse jet | | |
|  | GEV No. | 518277 | Ref. No. 140026 |
| | rinse jet | | |
|  | GEV No. | 518278 | Ref. No. 480086 |
| | end cap | | |
|  | GEV No. | 518280 | Ref. No. 412029 |
| | connector holder for knurled nut | | |
|  | GEV No. | 518281 | Ref. No. 454005 |
| | knurled nut thread M6 SS ø 20mm H 4mm | | |
|  | GEV No. | 518327 | Ref. No. 129054 |
| | rinse arm boss | | |

| | | | |
|---|--|-----------------|-------------------|
|  | | | |
| GEV No. | 518416 | Ref. No. | 926131 |
| description | opposite support for rinse jet | | |
| For models: | 050F, 050FP, E.65, F85, F85P, MINIBAR, S280, U132, U132E, U61, U61E, U61H, U61HE, U70, U70E | | |
| accessories for | 518416 | | |
|  | GEV No. | 560062 | Ref. No. — |
| | flat-headed bolt thread M4 thread L 10mm SS DIN 7985/ISO 7045 Qty 20 pcs intake Phillips head ø 8mm head thickness 2mm | | |
|  | GEV No. | 560131 | Ref. No. — |
| | hexagonal nut thread M4 H 3.2mm WS 7 SS DIN/ISO DIN 934 / ISO 4032/8673 Qty 20 pcs | | |

| | | | |
|---|--|-----------------|------------------|
|  | | | |
| GEV No. | 510303 | Ref. No. | 456030 CGR106 |
| description | O-ring EPDM thickness 1.78mm ID ø 6.75mm Qty 1 pcs | | |
| For models: | 050F, 050FP, 914568, 915830, E.50D.PA, E.55, E.65, F85, F85P, FAST-160DP, Fast181-230V-3Ph-60Hz, Fast181-400V-3NPh-60Hz, MINIBAR, NG292HZ, Niagara-292-400V-3Ph-60Hz, River-295P, River-296P, RIVER-40, RIVER-43, RIVER-50, RIVER-50-CRP, RIVER-61, RIVER-80, RIVER-81, RIVER-82, RV295PS, RV296PS, S280, ST70FASTHB400, U132, U61, U61E, U61H, U61HE, U70 | | |

| | | | |
|---|--|-----------------|------------------|
|  | | | |
| GEV No. | 513219 | Ref. No. | 129019 DAS265 |
| description | rinse arm boss | | |
| For models: | 050F, 050FP, 10, 12, 14, 22F, 2312-001, 2312-002, 40F, 440F, 44F, 500F, 500FD, 50F, 50FD, 510F, 510FD, 55, 66, CLEAN-100, CLEAN-110, CLEAN-120, E.50, E.51, E.52, E.60, E.65, E1, E10, E100, E110, E12, E120, E14, E140, F85, F85P, LF50, LF55, MCS01E, MCS01EP, MCS01S, MCS01SP, MISTRAL-51, NIAGARA-51, S651, S654, S810, S815, S830...(Other models you can see in the webshop) | | |







| | | | |
|---|---|-----------------|--------|
|  | | | |
| 1 | | | |
| GEV No. | 518274 | Ref. No. | 993047 |
| description | rinse arm L 475mm nozzles 7 mounting ø 14mm mounting pos. upper | | |
| For models: | E.55, RIVER-50, RIVER-50-CRP, RIVER-61 | | |



| | | | |
|---|---|-----------------|--------|
|  | | | |
| 1 | | | |
| GEV No. | 518280 | Ref. No. | 412029 |
| description | connector holder for knurled nut | | |
| For models: | 2312-007, 2312-009-CRP, 913992, 913993, 914100, 914101, 914339, 914342, 914343, 914568, 914583, 914592, 914612, 914613, 914624, 914625, 914626, 914627, 914628, 914850, 914851, 914854, 914944, 915143, 915830, E.50D.PA, E.55, FAST-160DP, RIVER-40, RIVER-40-CRP, RIVER-43, RIVER-44, RIVER-44-CRP, RIVER-44-CRP-ST, RIVER-44CRP-ST, RIVER-48, RIVER-50, RIVER-50-CRP, RIVER-50-CRP-SP, RIVER-54, RIVER-54CRP, RIVER-54-CRP-s.p., RIVER-54-CRP-SP, RIVER-61 | | |



| | | | |
|---|--|-----------------|--------|
|  | | | |
| 1 | | | |
| GEV No. | 518278 | Ref. No. | 480086 |
| description | end cap | | |
| For models: | 914568, 915830, E.50D.PA, E.55, FAST-160DP, RIVER-40, RIVER-43, RIVER-50, RIVER-50-CRP, RIVER-61 | | |

| | | | |
|---|---|-----------------|--------|
|  | | | |
| 1 | | | |
| GEV No. | 518281 | Ref. No. | 454005 |
| description | knurled nut thread M6 SS ø 20mm H 4mm | | |
| For models: | 2312-007, 2312-009-CRP, 80, 81, 82, 913992, 913993, 914100, 914101, 914339, 914342, 914343, 914568, 914583, 914592, 914612, 914613, 914624, 914625, 914626, 914627, 914628, 914850, 914851, 914854, 914944, 915143, 915830, CE78HZ23, CGL74CABT, E.50D.PA, E.55, E78, E78HP, FAST-160DP, HM1, LP60, NIAGARA-271, RIVER-282, RIVER-40, RIVER-40-CRP, RIVER-43, RIVER-44, RIVER-44-CRP, RIVER-44-CRP-ST, RIVER-44CRP-ST, RIVER-48, RIVER-50, RIVER-50-CRP, RIVER-50-CRP-SP... (Other models you can see in the webshop) | | |



| | | | |
|---|--|-----------------|------------------|
|  | | | |
| 1 | | | |
| GEV No. | 510303 | Ref. No. | 456030 CGR106 |
| description | O-ring EPDM thickness 1.78mm ID ø 6.75mm Qty 1 pcs | | |
| For models: | 050F, 050FP, 914568, 915830, E.50D.PA, E.55, E.65, F85, F85P, FAST-160DP, Fast181-230V-3Ph-60Hz, Fast181-400V-3NPh-60Hz, MINIBAR, NG292HZ, Niagara-292-400V-3Ph-60Hz, River-295P, River-296P, RIVER-40, RIVER-43, RIVER-50, RIVER-50-CRP, RIVER-61, RIVER-80, RIVER-81, RIVER-82, RV295PS, RV296PS, S280, ST70FASTHB400, U132, U61, U61E, U61H, U61HE, U70 | | |

| | | | |
|---|---|-----------------|-----------------|
|  | | | |
| 1 | | | |
| GEV No. | 518327 | Ref. No. | 129054 |
| description | rinse arm boss | | |
| For models: | 2312-007, 2312-009-CRP, 913992, 913993, 914100, 914101, 914339, 914342, 914343, 914568, 914583, 914592, 914612, 914613, 914624, 914625, 914626, 914627, 914628, 914850, 914851, 914854, 914944, 915143, 915830, E.50D.PA, E.55, FAST-160DP, RIVER-40, RIVER-40-CRP, RIVER-43, RIVER-44, RIVER-44-CRP, RIVER-44-CRP-ST, RIVER-44CRP-ST, RIVER-48, RIVER-50, RIVER-50-CRP, RIVER-50-CRP-SP, RIVER-54, RIVER-54CRP, RIVER-54-CRP-s.p., RIVER-54-CRP-SP, RIVER-61 | | |
| accessories for | 518327 | | |
|  | | | |
| GEV No. | 513157 | Ref. No. | 412030 80374 |
| description connector holder | | | |
|  | | | |
| GEV No. | 518281 | Ref. No. | 454005 |
| description knurled nut thread M6 SS ø 20mm H 4mm | | | |

| | | | |
|---|--|-----------------|------------------|
|  | | | |
| 1 | | | |
| GEV No. | 518276 | Ref. No. | 140025 80373 |
| description | rinse jet | | |
| For models: | 914568, 915830, E.50D.PA, E.55, FAST-160DP, FAST-181, KLP105EB, KLP201DDDTBE, KLP201EB, KLP301, KLP301DDDTBE, LP105DDDTBE, LP105DDDTBE, LP105EB, LP201DDDTBE, LP201EB, LP301, LP301EB, NG291, NG292, NG293, NIAGARA-291, NIAGARA-292, NIAGARA-293, RIVER-294, RIVER-295, RIVER-296, RIVER-297, RIVER-298, RIVER-40, RIVER-43, RIVER-50, RIVER-50-CRP, RIVER-61, RV294, RV295, RV296, RV297, RV298, RV298HZ, ST70FASTHB, U132E, U61He, U70E | | |
| accessories for | 518276 | | |
|  | | | |
| GEV No. | 510303 | Ref. No. | 456030 CGR106 |
| description O-ring EPDM thickness 1.78mm ID ø 6.75mm Qty 1 pcs | | | |









| | | | |
|---|--|-----------------|--------|
|  | | | |
| 1 | | | |
| GEV No. | 518277 | Ref. No. | 140026 |
| description | rinse jet | | |
| For models: | E.55, RIVER-50, RIVER-50-CRP, RIVER-61 | | |
| accessories for | 518277 | | |
|  | | | |
| GEV No. | 528485 | Ref. No. | 456060 |
| description O-ring EPDM thickness 1.78mm ID ø 6.07mm Qty 1 pcs | | | |

| | | | |
|---|--------------------|-----------------|--------|
|  | | | |
| 1 | | | |
| GEV No. | 518388 | Ref. No. | 993043 |
| description | rinse arm complete | | |
| For models: | CLEAN-3 | | |

| | | | |
|---|--|-----------------|------------------------|
|  | | | |
| 1 | | | |
| GEV No. | 518162 | Ref. No. | 113992 |
| description | rinse arm L 370mm nozzles 4 mounting ø 13.5mm mounting pos. upper and bottom | | |
| For models: | CLEAN-3 | | |
| spare parts for | 518162 | | |
|  | GEV No. | 518164 | Ref. No. 140019 |
| | rinse jet | | |
|  | GEV No. | 518391 | Ref. No. 480065 |
| | end cap for rinse arm | | |

| | | | |
|---|-----------------------|-----------------|--------|
|  | | | |
| 1 | | | |
| GEV No. | 518391 | Ref. No. | 480065 |
| description | end cap for rinse arm | | |
| For models: | CLEAN-3 | | |

| | | | |
|---|--|-----------------|--------|
|  | | | |
| 1 | | | |
| GEV No. | 518164 | Ref. No. | 140019 |
| description | rinse jet | | |
| For models: | 2312-007, 2312-009-CRP, 913992, 913993, 914100, 914101, 914339, 914342, 914343, 914583, 914592, 914612, 914613, 914624, 914625, 914626, 914627, 914628, 914850, 914851, 914854, 914944, 915143, CLEAN-3, RIVER-40, RIVER-40-CRP, RIVER-43, RIVER-44, RIVER-44-CRP, RIVER-44-CRP-ST, RIVER-44CRP-ST, RIVER-48, RIVER-50, RIVER-50-CRP, RIVER-50-CRP-SP, RIVER-54, RIVER-54CRP, River-54-CRP-s.p., RIVER-54-CRP-SP, RIVER-61 | | |

| | | | |
|---|--|-----------------|-------------------------------|
|  | | | |
| 1 | | | |
| GEV No. | 513148 | Ref. No. | 926057 |
| description | rinse arm L 505mm nozzles 6 mounting ø 14mm mounting pos. upper and bottom | | |
| For models: | 14, E14, E140 | | |
| spare parts for | 513148 | | |
|  | GEV No. | 513152 | Ref. No. 926061 |
| | nozzle for rinse arm | | |
|  | GEV No. | 513219 | Ref. No. 129019 DAS265 |
| | rinse arm boss | | |
|  | GEV No. | 513220 | Ref. No. 926063 926093 |
| | bush for rinse arm | | |
|  | GEV No. | 513271 | Ref. No. 412028 |
| | connector holder grey | | |
|  | GEV No. | 518021 | Ref. No. 926059 |
| | rinse arm mounting pos. upper/lower nozzles 3 | | |
|  | GEV No. | 518028 | Ref. No. 454004 |
| | knurled nut thread M5 ø 25mm H 4mm SS | | |
|  | GEV No. | 518037 | Ref. No. 926062 |
| | end cap for rinse arm | | |

| | | | |
|---|---|-----------------|---------------|
|  | | | |
| 1 | | | |
| GEV No. | 513220 | Ref. No. | 926063 926093 |
| description | bush for rinse arm | | |
| For models: | 050F, 050FP, 14, E.65, E14, E140, F85, F85P, U132, U132E, U61, U61E, U61H, U61HE, U70, U70E | | |

| | | | |
|---|-----------------------|-----------------|--------|
|  | | | |
| 1 | | | |
| GEV No. | 518037 | Ref. No. | 926062 |
| description | end cap for rinse arm | | |
| For models: | 14, E14, E140 | | |

| | | | |
|---|--|-----------------|--------|
|  | | | |
| 1 | | | |
| GEV No. | 518038 | Ref. No. | 926058 |
| description | flat gasket rubber ED ø 12mm thickness 2mm Qty 1 pcs | | |
| For models: | 14, E14, E140 | | |





| | | | |
|---|----------------------|-----------------|--------|
|  | | | |
| 1 | | | |
| GEV No. | 513152 | Ref. No. | 926061 |
| description | nozzle for rinse arm | | |
| For models: | 14, E1, E14, E140 | | |

| | | | |
|---|---|-----------------|--------|
|  | | | |
| 1 | | | |
| GEV No. | 518021 | Ref. No. | 926059 |
| description | rinse arm mounting pos. upper/lower nozzles 3 | | |
| For models: | 14, E14, E140 | | |

| | | | |
|---|--|-----------------|---------------------|
|  | | | |
| 1 | | | |
| GEV No. | 518397 | Ref. No. | 106043 106043.FR |
| description | wash arm L 445mm nozzles 10 mounting pos. left | | |
| For models: | 22F, 40F, 440F, 44F, E.52 | | |

| | | | |
|---|---|-----------------|---------------------|
|  | | | |
| 1 | | | |
| GEV No. | 518396 | Ref. No. | 106044 106044.FR |
| description | wash arm L 445mm nozzles 10 mounting pos. right | | |
| For models: | 22F, 40F, 440F, 44F, E.52 | | |

| | | | |
|---|---|-----------------|--------|
|  | | | |
| 1 | | | |
| GEV No. | 518039 | Ref. No. | 480045 |
| description | end cap ø 22mm mounting pos. right for wash arm | | |
| For models: | 22F, 40F, 440F, 44F, E.52 | | |

| | | | |
|---|---|-----------------|--------|
|  | | | |
| 1 | | | |
| GEV No. | 510147 | Ref. No. | 119004 |
| description | swirl ø 27mm H 12mm | | |
| For models: | 22F, 22R, 400R, 400RD, 40-ELECTRONIC, 40F, 40R, 40RD, 440F, 44F, E.52, S651, S654, S810, S815, S830, S835 | | |

| | | | |
|---|---|-----------------|--------|
|  | | | |
| 1 | | | |
| GEV No. | 510007 | Ref. No. | 140014 |
| description | union nut for wash jet | | |
| For models: | 22F, 22R, 400R, 400RD, 40-ELECTRONIC, 40F, 40R, 40RD, 440F, 44F, E.52 | | |

| | | | |
|--|---|-----------------|--------|
|  | | | |
| 1 | | | |
| GEV No. | 517552 | Ref. No. | 927011 |
| description | wash arm mounting pos. upper/lower L 495mm nozzles 5 | | |
| For models: | 161, 221, 271, 272, 362, CLEAN-160, CLEAN-161, CLEAN-220, CLEAN-221, CLEAN-270, CLEAN-271, CLEAN-272, CLEAN-361, CLEAN-361P, CLEAN-362, CLEAN-471, CLEAN-471P | | |

| | | | |
|---|---|-----------------|--------|
|  | | | |
| 1 | | | |
| GEV No. | 524812 | Ref. No. | 927012 |
| description | end cap for wash arm mounting pos. upper/lower ø 45mm H 28mm | | |
| For models: | 161, 221, 271, 272, 362, CLEAN-160, CLEAN-161, CLEAN-220, CLEAN-221, CLEAN-270, CLEAN-271, CLEAN-272, CLEAN-361, CLEAN-361P, CLEAN-362, CLEAN-471, CLEAN-471P | | |

| | | | |
|---|---|-----------------|---------------------|
|  | | | |
| 1 | | | |
| GEV No. | 528155 | Ref. No. | 927337 CGR4131NT |
| description | O-ring Viton thickness 3.53mm ID ø 32.93mm Qty 1 pcs | | |
| For models: | 161, 221, 271, 272, 362, 915747, 915773, A3EB, A3EBDAKRKYK, A3EBDRKYK, A3EBSAKRK, A3EBSEKWK, A4EB, A4EBDAKEKYK, A4EBDAKRK, A4EBDAKWK, A4EBDAKZK, A4EBDBKRK, A4EBDPKWKYK, A4EBDRK, A4EBSAK, A4EBSAKCK, A4EBSAKEKYK, A4EBSAKRKP, A4EBT, A4EBTSAK, A5EB, A5EBDAKYK, A5EBDRK, A5EBSAKRK, A5EBSAKRKYK, A5EBSAKWK, A5EBSAKWKYK, A5EBSBKRKP, A5EBSBKWK, A5EBSRK, CLEAN-161, CLEAN-221, CLEAN-271, CLEAN-272, CLEAN-362, Fast181, FAST-181, Fast181-230V-3Ph-60Hz, Fast181-400V-3NPh-60Hz, Fast200, Fast93, GL280EB, GL280EB23, GL280EB23DAR... (Other models you can see in the webshop) | | |

| | | | |
|---|--|-----------------|-------|
|  | | | |
| 1 | | | |
| GEV No. | 517434 | Ref. No. | 75125 |
| description | rinse arm mounting pos. lower L 565mm W 20mm H 40mm nozzles 4 | | |
| For models: | 914380, 914436, 915747, A3EB, A3EBD, A3EBDAKRKYK, A3EBDAKWK, A3EBDBKWK, A3EBDRKYK, A3EBDVK, A3EBDYK, A3EBSAK, A3EBSAKRK, A3EBSAKWK, A3EBSBKWKYK, A3EBSEKWK, A3EBSWK, A4EB, A4EBD, A4EBDAKEKYK, A4EBDAKRK, A4EBDAKWK, A4EBDAKZK, A4EBDBKRK, A4EBDPKWKYK, A4EBDRK, A4EBS, A4EBSAK, A4EBSAKCK, A4EBSAKEKYK, A4EBSAKRK, A4EBSAKRKP, A4EBSAKYK, A4EBSCK, A4EBT, A4EBTSAK, A5EB, A5EBD, A5EBDAKPKWK, A5EBDAKWK, A5EBDAKYK, A5EBDRK, A5EBS, A5EBSAKPKWK, A5EBSAKRK, A5EBSAKRKYK, A5EBSAKWK, A5EBSAKWKYK, A5EBSBKRKP, A5EBSBKWK... (Other models you can see in the webshop) | | |

| | | | |
|---|---|-----------------|--------|
|  | | | |
| 2 | | | |
| GEV No. | 517436 | Ref. No. | 927069 |
| description | rinse arm mounting pos. upper/lower L 545mm W 20mm H 40mm nozzles 4 without nozzles | | |
| For models: | 161, 221, 271, 272, 362, CLEAN-160, CLEAN-161, CLEAN-220, CLEAN-221, CLEAN-270, CLEAN-271, CLEAN-272, CLEAN-361, CLEAN-361P, CLEAN-362, CLEAN-471, CLEAN-471P | | |

| | | | |
|---|--|-----------------|-------|
|  | | | |
| 1 | | | |
| GEV No. | 524536 | Ref. No. | 75133 |
| description | rinse jet thread M5 ø 8.5mm H 12mm WS 7 | | |
| For models: | 914380, 914436, 915747, A3EB, A3EBD, A3EBDAKRKYK, A3EBDAKWK, A3EBDBKWK, A3EBDRKYK, A3EBDVK, A3EBDYK, A3EBSAK, A3EBSAKRK, A3EBSAKWK, A3EBSBKWKYK, A3EBSEKWK, A3EBSWK, A4EB, A4EBD, A4EBDAKEKYK, A4EBDAKRK, A4EBDAKWK, A4EBDAKZK, A4EBDBKRK, A4EBDPKWKYK, A4EBDRK, A4EBS, A4EBSAK, A4EBSAKCK, A4EBSAKEKYK, A4EBSAKRK, A4EBSAKRKP, A4EBSAKYK, A4EBSCK, A4EBT, A4EBTSAK, A5EB, A5EBD, A5EBDAKPKWK, A5EBDAKWK, A5EBDAKYK, A5EBDRK, A5EBS, A5EBSAKPKWK, A5EBSAKRK, A5EBSAKRKYK, A5EBSAKWK, A5EBSAKWKYK, A5EBSBKRKP, A5EBSBKWK... (Other models you can see in the webshop) | | |

miscellaneous

| | | | |
|---|--|-----------------|--------|
|  | | | |
| 1 | | | |
| GEV No. | 518044 | Ref. No. | 110003 |
| description | nozzle holder | | |
| For models: | 11R, 11RD, 21R, 21RD, 25R, 25RD, 30R, 30RD, 31R, 31RD, 350F, 350FD, 35-ELECTRONIC, 35F, 35FD, E.42 | | |

| | | | |
|---|---|-----------------|-----------------|
|  | | | |
| 1 | | | |
| GEV No. | 510132 | Ref. No. | 110002 |
| description | nozzle holder for rinse jet | | |
| For models: | 22R, R495, R497, R499, R501, R503, R505, R507, R509, R511, R704, R706, R708, S651, S651P, S653, S654, S655, S815, S830, S835, S870, SR651 | | |
| accessories for | 510132 | | |
| | GEV No. | 510113 | Ref. No. |
| | | | 449029 |
| | opposite support for rinse jet | | |

| | | | |
|---|-----------|-----------------|--------|
|  | | | |
| 1 | | | |
| GEV No. | 513038 | Ref. No. | 929074 |
| description | rinse jet | | |
| For models: | 55 | | |

| | | | |
|---|-----------|-----------------|--------|
|  | | | |
| 1 | | | |
| GEV No. | 513255 | Ref. No. | 929075 |
| description | rinse jet | | |
| For models: | 55 | | |



| | | | |
|---|------------|-----------------|--------|
|  | | | |
| 1 | | | |
| GEV No. | 510141 | Ref. No. | 140004 |
| description | wash jet | | |
| For models: | R505, R507 | | |

| | | | |
|---|--|-----------------|--------|
|  | | | |
| 1 | | | |
| GEV No. | 518018 | Ref. No. | 110004 |
| description | wash jet holder | | |
| For models: | 22R, 400R, 400RD, 40-ELECTRONIC, 40R, 40RD, R497, R499, R501, R503, R505, R507, S651, S651P, S653, S654, S655, S810, S815, S830, S835, S870, S950, SR651 | | |

wash arm supports



| | | | |
|---|------------------|-----------------|--------|
|  | | | |
| 1 | | | |
| GEV No. | 518474 | Ref. No. | 929116 |
| description | opposite support | | |
| For models: | E.60, E.65 | | |





| | | | | | | | | | |
|---|---|-----------------|------------------------------|--|----------------|--------|-----------------|------------------------------|--|
|  <p>1</p> | | | | | | | | | |
| GEV No. | 518289 | Ref. No. | 115117 | | | | | | |
| description | opposite support for wash arm | | | | | | | | |
| For models: | 2312-007, 2312-009-CRP, 914339, 914342, 914343, 914626, PS-60, RIVER-48, RIVER-50, RIVER-50-CRP, RIVER-50-CRP-SP, RIVER-54, RIVER-54-CRP-SP, RIVER-61 | | | | | | | | |
| accessories for | 518289 | | | | | | | | |
|  <table border="1"> <tr> <td>GEV No.</td> <td>518205</td> <td>Ref. No.</td> <td colspan="2">437079 80182 reb437079</td> </tr> </table> <p>flat gasket rubber ED ø 61mm ID ø 47mm thickness 2mm Qty 1 pcs</p> | | | | | GEV No. | 518205 | Ref. No. | 437079 80182 reb437079 | |
| GEV No. | 518205 | Ref. No. | 437079 80182 reb437079 | | | | | | |

| | | | |
|--|--|-----------------|--------|
|  <p>1</p> | | | |
| GEV No. | 518183 | Ref. No. | 115088 |
| description | opposite support mounting pos. lower | | |
| For models: | 913992, 913993, 914583, 914592, 914612, 914613, 915143, CLEAN-3, RIVER-40, RIVER-40-CRP, RIVER-43, RIVER-44, RIVER-44-CRP, RIVER-44-CRP-ST, RIVER-44CRP-ST | | |

| | | | |
|--|---------------------------------------|-----------------|--------|
|  <p>1</p> | | | |
| GEV No. | 518108 | Ref. No. | 115102 |
| description | opposite support for wash arm support | | |
| For models: | 67R | | |

| | | | | | | | |
|--|--|-----------------|----------------------------|----------------|--------|-----------------|--------|
|  <p>1</p> | | | | | | | |
| GEV No. | 518171 | Ref. No. | 111019 111030 111999 | | | | |
| description | opposite support mounting pos. lower for wash arm support | | | | | | |
| For models: | 10, 22F, 46, 460, 500F, 500FD, 50-ELECTRONIC, 50F, 50FD, 510F, 510FD, 913297, 913298, 913299, 913300, 913360, 913361, 913391, 913392, 913546, 913547, 913578, 913611, 913684, 913913, 913914, 913932, 913933, 914284, 914318, 914319, 914326, 914331, 914338, 914356, 914400, 914401, 914402, 914403, 914404, 914405, 914406, 914431, 914449, 914517, 914545, 914568, 914642, 914688, 914909...(Other models you can see in the webshop) | | | | | | |
| accessories for | 518171 | | | | | | |
|  <table border="1"> <tr> <td>GEV No.</td> <td>513717</td> <td>Ref. No.</td> <td colspan="1">035064</td> </tr> </table> <p>fastening angle for drain pump</p> | | | | GEV No. | 513717 | Ref. No. | 035064 |
| GEV No. | 513717 | Ref. No. | 035064 | | | | |



| | | | |
|---|--|-----------------|--------|
|  <p>1</p> | | | |
| GEV No. | 510057 | Ref. No. | 111009 |
| description | opposite support for wash arm support mounting pos. lower Mod. 111009 suitable for 11R | | |
| For models: | 11F, 11FD, 11R, 11RD, 67F, 67R | | |

| | | | |
|--|--|-----------------|--------|
|  <p>1</p> | | | |
| GEV No. | 518343 | Ref. No. | 111031 |
| description | opposite support mounting pos. lower for wash arm support | | |
| For models: | 050F, 050FP, 2312-001, 2312-002, E.50, E.51, E.55, F85, F85P, LF50, LF55, MC501E, MC501EP, MC501S, MC501SP, MISTRAL-51, NIAGARA-51, P500 | | |



| | | | |
|--|---|-----------------|--------|
|  <p>1</p> | | | |
| GEV No. | 518421 | Ref. No. | 111015 |
| description | opposite support for wash arm support mounting pos. lower Mod. 111015 | | |
| For models: | 11F, 11FD, 11F-DVGW | | |

| | | | |
|--|--|-----------------|--------|
|  <p>1</p> | | | |
| GEV No. | 518427 | Ref. No. | 115087 |
| description | opposite support mounting pos. lower for wash arm support | | |
| For models: | 350F, 350FD, 350R, 350RD, 35-ELECTRONIC, 35F, 35FD, 35R, 35RD, 400F, 400FD, 400R, 400RD, 40-ELECTRONIC, 40F, 40FD, 40R, 40RD | | |



| | | | |
|--|---|-----------------|--------|
|  <p>1</p> | | | |
| GEV No. | 518447 | Ref. No. | 111025 |
| description | opposite support for wash arm support mounting pos. lower Mod. 111025 11NM suitable for E41 C | | |
| For models: | 913363, 913364, 913376, 913377, E.41, E.42, E41 | | |

| | | | |
|---|--|-----------------|------------------------|
|  | | | |
| 1 | | | |
| GEV No. | 513102 | Ref. No. | 926052 |
| description | opposite support mounting pos. upper | | |
| For models: | 12, 14, 45, 450, 915695, 915696, 915819, CLEAN-120, E.45, E12, E120, E14, E140, Fast145, Fast145D | | |
| accessories for | 513102 | | |
|  | GEV No. | 518025 | Ref. No. 437014 |
| | gasket D1 ø 50mm D2 ø 82mm thickness 2mm with 6 holes wash arm support equiv. no. 437014 suitable for COLGED | | |
|  | GEV No. | 518471 | Ref. No. 926065 |
| | rinse pipe | | |

| | | | |
|---|---------------------|-----------------|--------|
|  | | | |
| 1 | | | |
| GEV No. | 510037 | Ref. No. | 115035 |
| description | wash arm support | | |
| For models: | 11F, 11FD, 11F-DVGW | | |



| | | | |
|---|---|-----------------|-----------------------|
|  | | | |
| 1 | | | |
| GEV No. | 518069 | Ref. No. | 80177 |
| description | wash arm support | | |
| For models: | 80, 81, 82, CE78HZ23, CGL74CABT, CNT800CH, E78, E78HP, FAST-181, Fast181-230V-3Ph-60Hz, Fast181-400V-3NPh-60Hz, FAST-60, FAST-73, HM1, NG281, NG281CDD, NG281HP, NG281HPDD, NG281HZ23, NG281HZ23DD, NG291, NIAGARA-281, Niagara-281HP, NIAGARA-283, Niagara-283A, NIAGARA-291, PLUVIA-280, Pluvia280-230V-3PH-60HZ, PS-60, PV280, PV280FAST, PV280FASTCH, PV280FASTHB, PV280HZ23, RIVER-282, River-285, RIVER-294, River-482, RIVER-71, RIVER-78, RIVER-80, River-81, River-81CRP, RIVER-81-CRP, RIVER-82, River-82CRP, RIVER-82-CRP, RIVER-E78, RIVER-HL-81, RIVER-HL-82...(Other models you can see in the webshop) | | |
| accessories for | 518069 | | |
|  | GEV No. | 518071 | Ref. No. 80178 |
| | gasket for wash arm support L 109mm W 68mm | | |

| | | | |
|---|---|-----------------|---------|
|  | | | |
| 1 | | | |
| GEV No. | 518096 | Ref. No. | 4206301 |
| description | wash arm support mounting pos. lower | | |
| For models: | KLP105EB, KLP201DDDTEB, KLP201EB, KLP301, KLP301DDDTEB, LP105DDDTEB, LP105DDDTEBN, LP105EB, LP201DDDTEB, LP201EB, LP301, LP301EB, NG292, NG292HZ, NG293, NIAGARA-292, Niagara-292-400V-3Ph-60Hz, NIAGARA-293, RIVER-295, River-295P, RIVER-296, River-296P, RIVER-297, RIVER-298, RV295, RV295PS, RV296, RV296PS, RV297, RV298, RV298HZ, U132E, U61E, U61HE, U70e | | |

| | | | |
|---|--|-----------------|------------------------|
|  | | | |
| 1 | | | |
| GEV No. | 518168 | Ref. No. | 115094 |
| description | wash arm support mounting pos. lower | | |
| For models: | 45, 450, E.45, NIAGARA-45 | | |
| accessories for | 518168 | | |
|  | GEV No. | 518025 | Ref. No. 437014 |
| | gasket D1 ø 50mm D2 ø 82mm thickness 2mm with 6 holes wash arm support equiv. no. 437014 suitable for COLGED | | |

| | | | |
|---|--------------------------------------|-----------------|--------|
|  | | | |
| 1 | | | |
| GEV No. | 518173 | Ref. No. | 115106 |
| description | wash arm support mounting pos. lower | | |
| For models: | E.35, E.40 | | |

| | | | |
|--|---|-----------------|--------|
|  | | | |
| 1 | | | |
| GEV No. | 518445 | Ref. No. | 115107 |
| description | wash arm support mounting pos. lower | | |
| For models: | 913363, 913364, 913376, 913377, E.41, E.42, E41 | | |



| | | | |
|---|--|-----------------|------------------------|
|  | | | |
| 1 | | | |
| GEV No. | 518636 | Ref. No. | 115143 |
| description | wash arm support mounting pos. lower | | |
| For models: | 915150, 915151, 915152, 915154, 915155, 915157, 915158, 915160, 915161, 915162, 915166, 915167, 915168, 915172, 915173, 915175, 915176, 915177, 915285, 915319, 915338, 915341, 915348, 915418, 915419, 915420, 915421, 915422, 915479, 915492, 915493, 915494, 915495, 915496, 915497, 915547, 915558, 915635, 915663, 915747, 916020, 916021, 916024, 916025, 916026, 916027, 916030, 916031, 916045, 916054...(Other models you can see in the webshop) | | |
| accessories for | 518636 | | |
|  | GEV No. | 518637 | Ref. No. 429073 |
| | nut for wash arm support thread M56x2 | | |





| | | | |
|---|--|-----------------|--------|
|  | | | |
| 1 | | | |
| GEV No. | 518174 | Ref. No. | 115110 |
| description | wash arm support mounting pos. lower D1 ø 38mm D2 ø 59mm H 69mm ID ø 13mm | | |
| For models: | 913289, 913290, 913291, 913292, 913356, 913357, 913372, 913373, 913374, 913375, 913416, 913435, 913544, 913545, 913665, 913666, 913667, 913668, 913685, 913771, 913772, 913773, 913774, 913832, 913837, 913911, 913912, 913948, 913950, 913977, 913984, 913990, 914165, 914166, 914206, 914214, 914316, 914317, 914355, 914386, 914387, 914388, 914389, 914390, 914391, 914392, 914393, 914394, 914395, 914396...(Other models you can see in the webshop) | | |

| | | | |
|---|---|-----------------|-------|
|  | | | |
| 1 | | | |
| GEV No. | 517570 | Ref. No. | 75171 |
| description | wash arm support mounting pos. lower ø 40mm L1 62mm ID ø 28mm | | |
| For models: | 914380, 914436, A3EBD, A3EBDAKWK, A3EBDBKWK, A3EBDVK, A3EBDYK, A3EBSAK, A3EBSAKWK, A3EBSBKWKYK, A3EBSWK, A4EBD, A4EBS, A4EBSAKRK, A4EBSAKYK, A4EBSCK, A5EBD, A5EBDAKPKWK, A5EBDAKWK, A5EBS, A5EBSAKPKWK, A5EBSYK, FAST-200, GL280EB, GL280EBD, GL280EBDA, GL280EBDAE, GL280EBDAR, GL280EBDAWY, GL280EBDBW, GL280EBDY, GL280EBS, GL280EBSY, GL282EB, GL282EBCH, GL282EBCHD, GL282EBD, GL282EBDAE, GL282EBDAR, GL284EBD, GL284EBDAWY, GL284EBS, GL284EBSAR, GL286EBD, GL286EBDARY, GL286EBS, GL286EBSAW, NIAGARA-2150, NIAGARA-2152, NIAGARA-2154...(Other models you can see in the webshop) | | |

| | | | |
|---|--|-----------------|--------|
|  | | | |
| 1 | | | |
| GEV No. | 518031 | Ref. No. | 115075 |
| description | wash arm support mounting pos. lower H 108mm | | |
| For models: | 12, 14, 22F, 2312-001, 2312-002, 440F, 44F, 500F, 500FD, 50-ELECTRONIC, 50F, 50FD, 510F, 510FD, 913297, 913298, 913299, 913300, 913360, 913361, 913391, 913392, 913546, 913547, 913578, 913611, 913684, 913913, 913914, 913932, 913933, 914284, 914318, 914319, 914326, 914331, 914338, 914356, 914400, 914401, 914402, 914403, 914404, 914405, 914406, 914431, 914449, 914517, 914545, 914568...(Other models you can see in the webshop) | | |

| | | | |
|---|---|-----------------|-------------------------------------|
|  | | | |
| 1 | | | |
| GEV No. | 517793 | Ref. No. | 75648 |
| description | wash arm support mounting pos. lower ø 40mm L1 62mm ID ø 28mm | | |
| For models: | 915747, A3EB, A3EBDAKRKYK, A3EBDRKYK, A3EBSAKRK, A3EBSEKWK, A4EB, A4EBDAKEKYK, A4EBDAKRK, A4EBDAKWK, A4EBDAKZK, A4EBDBKRK, A4EBDPKWKYK, A4EBDRK, A4EBSAK, A4EBSAKCK, A4EBSAKEKYK, A4EBSAKRKP, A4EBT, A4EBTSAK, A5EB, A5EBDAKYK, A5EBDRK, A5EBSAKRK, A5EBSAKRKYK, A5EBSAKWK, A5EBSAKWKYK, A5EBSBKRPK, A5EBSBKWK, A5EBSRK, Fast200, Fast93, GL280EB, GL280EB23, GL280EB23DAR, GL280EB23HZ, GL280EB23HZDY, GL280EBDARY, GL280EBDAW, GL280EBDAY, GL280EBDB, GL280EBDBR, GL280EBDWY, GL280EBSA, GL280EBSAE, GL280EBSAEW, GL280EBSAEWY, GL280EBSAR, GL280EBSARY, GL280EBSAW...(Other models you can see in the webshop) | | |
| accessories for | 517793 | | |
|  | GEV No. | 528155 | Ref. No. 927337 CGR4131NT |

| | | | |
|---|--|-----------------|-------------------|
|  | | | |
| 1 | | | |
| GEV No. | 518024 | Ref. No. | 115076 DAS2596 |
| description | wash arm support mounting pos. lower H 126.5mm | | |
| For models: | 050F, 050FP, 10, 46, 460, CLEAN-100, CLEAN-110, CLEAN-120, E.46, E.60, E.65, E1, E10, E100, E110, E12, E120, F85, F85P, GSP50, GSP50P, GSP51, GSP51P, P500 | | |

| | | | |
|---|--------------------------------------|-----------------|--------|
|  | | | |
| 1 | | | |
| GEV No. | 518030 | Ref. No. | 926029 |
| description | wash arm support mounting pos. upper | | |
| For models: | 10, 12, 14, CLEAN-110 | | |

| | | | |
|---|---|-----------------|--------|
|  | | | |
| 1 | | | |
| GEV No. | 513167 | Ref. No. | 115144 |
| description | wash arm support mounting pos. lower H 145mm ID ø 24mm | | |
| For models: | 915611, 915612, 915613, 915614, 915615, 915616, 915617, 915618, 915670, 915671, 915672, 915773, 915774, 915959, 916066, 916077, 916078, 916196, 916197, 916198, 916199, 916200, 916409, 916410, 916418, 916419, 916591, 916592, 916593, 916594, 916595, 916877, 916921, 916922, 916992, 916993, Fast145-2, Fast150, Niagara-241, Niagara-241-2, Niagara-341, Pluvia-240, RIVER-242, River-242-2, River-242-2T, River-342C, River-342T | | |

| | | | |
|---|--|-----------------|--------|
|  | | | |
| 1 | | | |
| GEV No. | 518401 | Ref. No. | 108007 |
| description | wash arm support mounting pos. upper | | |
| For models: | 22F, 22R, 40F, 440F, 44F, E.52, TF-503, TF-513, TF-515 | | |



| | | | |
|--------------------|--------------------------------------|-----------------|--------|
| GEV No. | 518403 | Ref. No. | 127028 |
| description | wash arm support mounting pos. upper | | |
| For models: | 22F, 22R, 40F, 440F, 44F, E.52 | | |



| | | | |
|--------------------|---|-----------------|-------------------------|
| GEV No. | 517569 | Ref. No. | 75144 75169 75645 |
| description | wash arm support mounting pos. upper ø 40mm L1 62mm ID ø 28mm | | |
| For models: | 914380, 914436, 915747, A3EB, A3EBD, A3EBDAKRKYK, A3EBDAKWK, A3EBDBKWK, A3EBDRKYK, A3EBDWK, A3EBDYK, A3EBSAK, A3EBSAKRKR, A3EBSAKWK, A3EBSBKWKYK, A3EBSEKWK, A3EBSWK, A4EB, A4EBD, A4EBDAKEKYK, A4EBDAKRK, A4EBDAKWK, A4EBDAKZK, A4EBDBKRK, A4EBDPKWKYK, A4EBDRK, A4EBS, A4EBSAK, A4EBSAKCK, A4EBSAKEKYK, A4EBSAKRKR, A4EBSAKRKP, A4EBSAKYK, A4EBSCK, A4EBT, A4EBTSAK, A5EB, A5EBD, A5EBDAKPKWK, A5EBDAKWK, A5EBDAKYK, A5EBDRK, A5EBS, A5EBSAKPKWK, A5EBSAKRKR, A5EBSAKRKYK, A5EBSAKWK, A5EBSAKWKYK, A5EBSBKRPK, A5EBSBKWK... (Other models you can see in the webshop) | | |



| | | | |
|--------------------|---|-----------------|-----------------|
| GEV No. | 518338 | Ref. No. | 115074 41550 |
| description | wash arm support mounting pos. upper ø 49mm | | |
| For models: | 46, 460, 500F, 500FD, 50F, 50FD, 510F, 510FD, E.46, E.50, E.51, E.60, E.65, TF-503, TF-513, TF-515, U61, U61E | | |



| | | | |
|--------------------|--|-----------------|---------|
| GEV No. | 524079 | Ref. No. | 4205901 |
| description | wash arm support mounting pos. upper ø 69mm H 79mm | | |
| For models: | KLP105EB, KLP201DDTEB, KLP201EB, KLP301, KLP301DDTEB, LP105DDTEB, LP105DDTEBN, LP105EB, LP201DDTEB, LP201EB, LP301, LP301EB, RIVER-297, RIVER-298, RV297, RV298, RV298HZ, U132E, U61He, U70E | | |



| | | | |
|--------------------|---|-----------------|-------|
| GEV No. | 520646 | Ref. No. | 75155 |
| description | wash arm support ø 33mm hose ø 35mm | | |
| For models: | 914380, 914436, 915747, A3EB, A3EBD, A3EBDAKRKYK, A3EBDAKWK, A3EBDBKWK, A3EBDRKYK, A3EBDWK, A3EBDYK, A3EBSAK, A3EBSAKRKR, A3EBSAKWK, A3EBSBKWKYK, A3EBSEKWK, A3EBSWK, A4EB, A4EBD, A4EBDAKEKYK, A4EBDAKRK, A4EBDAKWK, A4EBDAKZK, A4EBDBKRK, A4EBDPKWKYK, A4EBDRK, A4EBS, A4EBSAK, A4EBSAKCK, A4EBSAKEKYK, A4EBSAKRKR, A4EBSAKRKP, A4EBSAKYK, A4EBSCK, A4EBT, A4EBTSAK, A5EB, A5EBD, A5EBDAKPKWK, A5EBDAKWK, A5EBDAKYK, A5EBDRK, A5EBS, A5EBSAKPKWK, A5EBSAKRKR, A5EBSAKRKYK, A5EBSAKWK, A5EBSAKWKYK, A5EBSBKRPK, A5EBSBKWK... (Other models you can see in the webshop) | | |



| | | | |
|--------------------|---|-----------------|--------|
| GEV No. | 501450 | Ref. No. | 111024 |
| description | wash arm support thread M12 L 100mm mounting ø 70mm ID ø 35mm | | |
| For models: | 913363, 913364, 913376, 913377, E.41, E.42, E41 | | |





| | | | |
|---|---|-----------------|--|
| GEV No. | 518141 | Ref. No. | 80179 |
| description | wash arm support thread M46x2 ø 44mm ID ø 39mm L 112.5mm W 86mm hole ø 12mm | | |
| For models: | CGL74CABT, NG271, NG291, NIAGARA-271, NIAGARA-283, Niagara-283A, NIAGARA-291, RIVER-282, River-285, RIVER-294, RIVER-80, River-81, RV282, RV282DD, RV282R, RV294, RV80, RV8023, RV8023HZ, RV80C, RV80HZ, RV81, RV8123, RV81A, RV81C, RV81HZ, RV81HZ23, RV81PAP, SevenL, SV72AEB, SV72EB | | |
| accessories for | 518141 | | |
|  | GEV No. | 513286 | Ref. No. 80281 |
|  | GEV No. | 518205 | Ref. No. 437079 80182 reb437079 |
| | flat gasket rubber ED ø 61mm ID ø 47mm thickness 2mm Qty 1 pcs | | |





| | | | |
|---|--|-----------------|----------------------------------|
| GEV No. | 513124 | Ref. No. | 80314 926128 |
| description | nut M24x1.5 | | |
| For models: | 2312-001, 2312-002, 2312-009-CRP, 80, 81, 82, 914583, 914628, 914944, 915143, CGL74CABT, E.50, E.51, E78, FAST-181, Fast181-230V-3Ph-60Hz, Fast181-400V-3NPh-60Hz, HM1, LP60, MISTRAL-51, NG291, NG292, NG292HZ, NG293, NIAGARA-291, NIAGARA-292, Niagara-292-400V-3Ph-60Hz, NIAGARA-293, NIAGARA-51, RIVER-294, RIVER-295, River-295P, RIVER-296, River-296P, RIVER-40-CRP, RIVER-44-CRP, RIVER-44-CRP-ST, RIVER-44CRP-ST, RIVER-50-CRP, RIVER-50-CRP-SP, RIVER-54CRP, River-54-CRP-s.p., RIVER-54-CRP-SP, RIVER-71, RIVER-78, RIVER-80, River-81, River-81CRP, RIVER-81-CRP, RIVER-82... (Other models you can see in the webshop) | | |
| accessories for | 513124 | | |
|  | GEV No. | 513123 | Ref. No. 626129 926129 |
| | wash arm bearing mounting pos. upper/lower | | |



| | | | |
|---|---|-----------------|--------|
|  | | | |
| 1 | | | |
| GEV No. | 518090 | Ref. No. | 417111 |
| description | wash arm bearing | | |
| For models: | 2312-007, 914100, 914101, 914339, 914342, 914343, 914568, 914624, 914625, 914626, 914627, 914628, 914850, 914851, 914854, 914944, 915830, E.50D.PA, Fast160DP, FAST-160DP, RIVER-48, RIVER-54, RIVER-54CRP, River-54-CRP-s.p. | | |

| | | | |
|---|--|-----------------|--------|
|  | | | |
| 1 | | | |
| GEV No. | 518178 | Ref. No. | 429052 |
| description | wash arm bearing mounting pos. lower | | |
| For models: | 913992, 913993, 914583, 914592, 914612, 914613, 915143, CLEAN-3, RIVER-40, RIVER-40-CRP, RIVER-43, RIVER-44, RIVER-44-CRP, River-44-CRP-ST, RIVER-44CRP-ST | | |

| | | | | | | | |
|---|---|---|-----------------|--------|-----------------|-----------------|-------------|
|  | | | | | | | |
| 1 | | | | | | | |
| GEV No. | 513161 | Ref. No. | 80310 | | | | |
| description | wash arm bearing mounting pos. upper | | | | | | |
| For models: | 80, 81, 82, CGL74CABT, E78, FAST-181, Fast181-230V-3Ph-60Hz, Fast181-400V-3NPh-60Hz, HM1, LP60, NG291, NG292, NG292HZ, NG293, NIAGARA-291, NIAGARA-292, Niagara-292-400V-3Ph-60Hz, NIAGARA-293, RIVER-294, RIVER-295, River-295P, RIVER-296, River-296P, RIVER-71, RIVER-78, RIVER-80, River-81, River-81CRP, RIVER-81-CRP, RIVER-82, River-82CRP, RIVER-82-CRP, RIVER-E78, RIVER-HL-81, RIVER-HL-82, RV294, RV295, RV295PS, RV296, RV296PS, RV71, RV80, RV8023, RV8023HZ, RV80C, RV80HZ, RV81, RV8123, RV81A, RV81C... (Other models you can see in the webshop) | | | | | | |
| accessories for | 513161 | | | | | | |
| |  | <table border="1"> <tr> <td>GEV No.</td> <td>513124</td> <td>Ref. No.</td> <td>80314 926128</td> </tr> </table> | GEV No. | 513124 | Ref. No. | 80314 926128 | nut M24x1.5 |
| GEV No. | 513124 | Ref. No. | 80314 926128 | | | | |

| | | | |
|---|--|-----------------|--------|
|  | | | |
| 1 | | | |
| GEV No. | 518179 | Ref. No. | 429055 |
| description | wash arm bearing mounting pos. upper | | |
| For models: | 913992, 913993, 914583, 914592, 914612, 914613, 915143, CLEAN-3, RIVER-40, RIVER-40-CRP, RIVER-43, RIVER-44, RIVER-44-CRP, River-44-CRP-ST, RIVER-44CRP-ST | | |

| | | | | | | | |
|---|---|---|------------------|--------|-----------------|-----------------|-------------|
|  | | | | | | | |
| 1 | | | | | | | |
| GEV No. | 513123 | Ref. No. | 626129 926129 | | | | |
| description | wash arm bearing mounting pos. upper/lower | | | | | | |
| For models: | 2312-001, 2312-002, 2312-009-CRP, 914583, 914628, 914944, 915143, E.50, E.51, LP60, MISTRAL-51, NG292HZ, Niagara-292-400V-3Ph-60Hz, NIAGARA-51, River-295P, River-296P, RIVER-40-CRP, RIVER-44-CRP, RIVER-44-CRP-ST, RIVER-44CRP-ST, RIVER-50-CRP, RIVER-50-CRP-SP, RIVER-54CRP, River-54-CRP-s.p., RIVER-54-CRP-SP, River-81CRP, RIVER-81-CRP, River-82CRP, RIVER-82-CRP, RV295PS, RV296PS, RV81CCRP, RV81CRP, RV82CCRP, RV82CRP, U132, U132E, U60E, U61, U61E, U61H, U61HE, U70, U70E | | | | | | |
| accessories for | 513123 | | | | | | |
| |  | <table border="1"> <tr> <td>GEV No.</td> <td>513124</td> <td>Ref. No.</td> <td>80314 926128</td> </tr> </table> | GEV No. | 513124 | Ref. No. | 80314 926128 | nut M24x1.5 |
| GEV No. | 513124 | Ref. No. | 80314 926128 | | | | |

rinse arm shafts

| | | | |
|---|---------------------------------------|-----------------|--------|
|  | | | |
| 1 | | | |
| GEV No. | 518048 | Ref. No. | 325039 |
| description | extension for rinse arm shaft | | |
| For models: | 400F, 400FD, 40-ELECTRONIC, 40F, 40FD | | |

| | | | |
|---|---|-----------------|--------|
|  | | | |
| 1 | | | |
| GEV No. | 518170 | Ref. No. | 143174 |
| description | extension for rinse arm shaft | | |
| For models: | 050F, 050FP, 22F, 2312-001, 2312-002, 440F, 44F, 46, 460, 500F, 500FD, 50F, 50FD, 510F, 510FD, 913297, 913298, 913299, 913300, 913360, 913361, 913391, 913392, 913546, 913547, 913578, 913611, 913684, 913913, 913914, 913932, 913933, 914284, 914318, 914319, 914326, 914331, 914338, 914356, 914400, 914401, 914402, 914403, 914404, 914405, 914406, 914431, 914449, 914517, 914545...(Other models you can see in the webshop) | | |

| | | | |
|---|---|-----------------|--------|
|  | | | |
| 1 | | | |
| GEV No. | 510013 | Ref. No. | 325001 |
| description | rinse arm shaft | | |
| For models: | 11F, 11FD, 11F-DVGW, 21F, 21FD, 25F, 25FD, 30F, 30FD, 31F, 31FD, 350F, 350FD, 35-ELECTRONIC, 35F, 35FD, 400F, 400FD, 40-ELECTRONIC, 40F, 40FD, 45, 450, 67R, 913289, 913290, 913291, 913292, 913356, 913357, 913363, 913364, 913372, 913373, 913374, 913375, 913376, 913377, 913416, 913418, 913435, 913544, 913545, 913665, 913666, 913667, 913668, 913685, 913771, 913772...(Other models you can see in the webshop) | | |

| | | | |
|---|--|-----------------|--------|
|  | | | |
| 1 | | | |
| GEV No. | 510056 | Ref. No. | 325025 |
| description | rinse arm shaft | | |
| For models: | 11F, 11FD, 11F-DVGW, 11R, 11RD, 67F, 67R, 913363, 913364, 913376, 913377, E.41, E.42, E.41 | | |

| | | | |
|---|--|-----------------|--------|
|  | | | |
| 1 | | | |
| GEV No. | 510108 | Ref. No. | 327006 |
| description | rinse arm shaft | | |
| For models: | 050F, 050FP, 11F, 11FD, 11F-DVGW, 21F, 21FD, 2312-001, 2312-002, 25F, 25FD, 30F, 30FD, 31F, 31FD, 400F, 400FD, 40-ELECTRONIC, 40F, 40FD, 45, 450, 46, 460, 500F, 500FD, 50-ELECTRONIC, 50F, 50FD, 510F, 510FD, 67R, 913363, 913364, 913376, 913377, 914568, 915830, E.41, E.42, E.45, E.46, E.50, E.50D.PA, E.51, E.41, F85, F85P, FAST-160DP, GSP50...(Other models you can see in the webshop) | | |

| | | | |
|---|-----------------|-----------------|--------|
|  | | | |
| 1 | | | |
| GEV No. | 511141 | Ref. No. | 926037 |
| description | rinse arm shaft | | |
| For models: | 10, 12, 14 | | |

| | | | |
|--|-----------------|-----------------|--------|
|  | | | |
| 1 | | | |
| GEV No. | 513101 | Ref. No. | DLP940 |
| description | rinse arm shaft | | |

| | | | |
|---|--|-----------------|-----------------|
|  | | | |
| 1 | | | |
| GEV No. | 513122 | Ref. No. | 926130 DLP52 |
| description | rinse arm shaft | | |
| For models: | 050F, 050FP, CLEAN-100, CLEAN-110, CLEAN-120, E.60, E.65, E1, E10, E100, E110, E12, E120, E14, E140, F85, F85P, U132, U132E, U61, U61E, U61H, U61HE, U70, U70E | | |

| | | | |
|---|---|-----------------|-------|
|  | | | |
| 1 | | | |
| GEV No. | 513159 | Ref. No. | 80380 |
| description | rinse arm shaft | | |
| For models: | 80, 81, 82, CGL74CABT, E78, FAST-181, HM1, KLP105EB, KL-P201DDDTBE, KLP201EB, KLP301, KLP301DDDTBE, LP105DDDTBE, LP105DDDTBE, LP105EB, LP201DDDTBE, LP201EB, LP301, LP301EB, LP60, NG291, NG292, NG293, NIAGARA-291, NIAGARA-292, NIAGARA-293, RIVER-294, RIVER-295, RIVER-296, RIVER-297, RIVER-298, RIVER-71, RIVER-78, RIVER-80, RIVER-81, RIVER-81CRP, RIVER-81-CRP, RIVER-82, RIVER-82CRP, RIVER-82-CRP, RIVER-E78, RIVER-HL-81, RIVER-HL-82, RV294, RV295, RV296, RV297, RV298, RV298HZ, RV71...(Other models you can see in the webshop) | | |

| | | | |
|---|--|-----------------|-------|
|  | | | |
| 1 | | | |
| GEV No. | 513160 | Ref. No. | 80282 |
| description | rinse arm shaft | | |
| For models: | 80, 81, 82, CE78HZ23, CGL74CABT, E78, E78HP, FAST-181, Fast181-230V-3Ph-60Hz, Fast181-400V-3NPh-60Hz, HM1, NG291, NG292, NG292HZ, NG293, NIAGARA-291, NIAGARA-292, Niagara-292-400V-3Ph-60Hz, NIAGARA-293, RIVER-294, RIVER-295, RIVER-295P, RIVER-296, RIVER-296P, RIVER-71, RIVER-78, RIVER-80, RIVER-81, RIVER-81CRP, RIVER-81-CRP, RIVER-82, RIVER-82CRP, RIVER-82-CRP, RIVER-E78, RIVER-HL-81, RIVER-HL-82, RV294, RV295, RV295PS, RV296, RV296PS, RV71, RV80, RV8023, RV8023HZ, RV80C, RV80HZ, RV81, RV8123, RV81A...(Other models you can see in the webshop) | | |

| | | | |
|---|---|-----------------|--------|
|  | | | |
| 1 | | | |
| GEV No. | 518014 | Ref. No. | 325011 |
| description | rinse arm shaft | | |
| For models: | 12, 14, 22F, 350R, 350RD, 35-ELECTRONIC, 35R, 35RD, 40F, 440F, 44F, 500F, 500FD, 50F, 50FD, 510F, 510FD, 66, S651, S654, S810, S815, S830, S835 | | |

| | | | |
|---|-----------------|-----------------|--------|
|  | | | |
| 1 | | | |
| GEV No. | 518023 | Ref. No. | 926038 |
| description | rinse arm shaft | | |
| For models: | 10, CLEAN-110 | | |

| | | | |
|---|---------------------|-----------------|--------|
|  | | | |
| 1 | | | |
| GEV No. | 518034 | Ref. No. | 325031 |
| description | rinse arm shaft | | |
| For models: | 22F, 40F, 44F, E.52 | | |

| | | | |
|---|---------------------------------------|-----------------|--------|
|  | | | |
| 1 | | | |
| GEV No. | 518042 | Ref. No. | 325043 |
| description | rinse arm shaft | | |
| For models: | 350F, 350FD, 35-ELECTRONIC, 35F, 35FD | | |

| | | | |
|---|---|-----------------|--------|
|  | | | |
| 1 | | | |
| GEV No. | 518172 | Ref. No. | 325064 |
| description | rinse arm shaft | | |
| For models: | 914684, E.35, E.35H, E.40, E.40H, GLS40H, GLS40HP, MC201CL, MINIBAR, MISTRAL-40, NIAGARA-35, NIAGARA-40, RIVER-39, S280 | | |

| | | | |
|---|--|-----------------|--------|
|  | | | |
| GEV No. | 518185 | Ref. No. | 325048 |
| description | rinse arm shaft | | |
| For models: | 913992, 913993, 914583, 914592, 914612, 914613, 915143, CLEAN-3, RIVER-40, RIVER-40-CRP, RIVER-43, RIVER-44, RIVER-44-CRP, RIVER-44-CRP-ST, RIVER-44CRP-ST | | |

| | | | |
|---|--|-----------------|--------|
|  | | | |
| GEV No. | 518283 | Ref. No. | 325069 |
| description | rinse arm shaft | | |
| For models: | 2312-007, 2312-009-CRP, 914100, 914101, 914339, 914342, 914343, 914624, 914625, 914626, 914627, 914628, 914850, 914851, 914854, 914944, RIVER-48, RIVER-50, RIVER-50-CRP, RIVER-50-CRP-SP, RIVER-54, RIVER-54CRP, RIVER-54-CRP-s.p., RIVER-54-CRP-SP, RIVER-61 | | |

| | | | |
|---|---|-----------------|--------|
|  | | | |
| GEV No. | 518285 | Ref. No. | 325071 |
| description | rinse arm shaft | | |
| For models: | 2312-007, 2312-009-CRP, 913992, 913993, 914100, 914101, 914339, 914342, 914343, 914583, 914592, 914612, 914613, 914624, 914625, 914626, 914627, 914628, 914850, 914851, 914854, 914944, 915143, E.55, RIVER-40, RIVER-40-CRP, RIVER-43, RIVER-44, RIVER-44-CRP, RIVER-44-CRP-ST, RIVER-44CRP-ST, RIVER-48, RIVER-50, RIVER-50-CRP, RIVER-50-CRP-SP, RIVER-54, RIVER-54CRP, RIVER-54-CRP-s.p., RIVER-54-CRP-SP, RIVER-61 | | |

| | | | |
|---|--|-----------------|--------|
|  | | | |
| GEV No. | 518287 | Ref. No. | 325070 |
| description | rinse arm shaft | | |
| For models: | 2312-007, 2312-009-CRP, 914100, 914101, 914339, 914342, 914343, 914624, 914625, 914626, 914627, 914628, 914850, 914851, 914854, 914944, E.55, RIVER-48, RIVER-50, RIVER-50-CRP, RIVER-50-CRP-SP, RIVER-54, RIVER-54CRP, RIVER-54-CRP-s.p., RIVER-54-CRP-SP, RIVER-61 | | |

| | | | |
|---|--|-----------------|--------|
|  | | | |
| GEV No. | 518420 | Ref. No. | 926154 |
| description | rinse arm shaft | | |
| For models: | 050F, 050FP, CLEAN-100, CLEAN-110, CLEAN-120, E.60, E.65, E1, E10, E100, E110, E12, E120, E14, E140, F85, F85P | | |

| | | | |
|---|---|-----------------|--------|
|  | | | |
| GEV No. | 518456 | Ref. No. | 325063 |
| description | rinse arm shaft | | |
| For models: | 2312-001, 2312-002, 500F, 500FD, 50F, 50FD, 510F, 510FD, E.50, E.51, E.52, LF50, LF55, MCS01E, MCS01EP, MCS01S, MCS01SP, MISTRAL-51, NIAGARA-51 | | |

| | | | |
|---|--|-----------------|--------|
|  | | | |
| GEV No. | 517571 | Ref. No. | 325078 |
| description | rinse arm shaft H 67mm thread M5 thread L 4.5mm | | |
| For models: | 913289, 913290, 913291, 913292, 913356, 913357, 913372, 913373, 913374, 913375, 913416, 913435, 913544, 913545, 913665, 913666, 913667, 913668, 913685, 913771, 913772, 913773, 913774, 913832, 913837, 913911, 913912, 913948, 913950, 913977, 913984, 913990, 914165, 914166, 914206, 914214, 914316, 914317, 914355, 914386, 914387, 914388, 914389, 914390, 914391, 914392, 914393, 914394, 914395, 914396...(Other models you can see in the webshop) | | |

| | | | |
|---|---|-----------------|--------|
|  | | | |
| GEV No. | 518405 | Ref. No. | 325045 |
| description | rinse arm shaft mounting pos. lower | | |
| For models: | 46, 460, E.46, GSP50, GSP50P, GSP51, GSP51P, P500, RIVER-40 | | |

| | | | |
|---|--|-----------------|-------|
|  | | | |
| GEV No. | 524096 | Ref. No. | 80283 |
| description | rinse arm shaft mounting pos. lower ø 16mm H 38mm thread M12x1.75 | | |
| For models: | 80, 81, 82, CE78HZ23, CGL74CABT, E78, E78HP, Fast181, FAST-181, Fast181-230V-3Ph-60Hz, Fast181-400V-3NPh-60Hz, HM1, NG291, NIAGARA-291, RIVER-294, RIVER-78, RIVER-80, RIVER-81, RIVER-81CRP, RIVER-81-CRP, RIVER-82, RIVER-82CRP, RIVER-82-CRP, RIVER-E78, RIVER-HL-81, RIVER-HL-82, RV294, RV71, RV80, RV8023, RV8023HZ, RV80C, RV80HZ, RV81, RV8123, RV81A, RV81C, RV81CCRP, RV81CRP, RV81HZ, RV81HZ23, RV81PAP, RV82, RV8223, RV82C, RV82CCRP, RV82CRP, SevenL, ST70FAST, ST70FASTHB...(Other models you can see in the webshop) | | |

| | | | |
|---|--|-----------------|--------|
|  | | | |
| GEV No. | 513224 | Ref. No. | 926127 |
| description | rinse arm shaft mounting pos. upper | | |
| For models: | CLEAN-100, CLEAN-110, CLEAN-120, E1, E10, E100, E110, E12, E120, E14, E140 | | |

| | | | |
|---|--|-----------------|-------|
|  | | | |
| GEV No. | 517445 | Ref. No. | 80700 |
| description | rinse arm shaft mounting pos. upper/lower H 36mm thread M10x1 thread L 9mm | | |
| For models: | 915830, Fast160DP | | |

| | | | |
|---|--|-----------------|--------|
|  | | | |
| GEV No. | 518151 | Ref. No. | 143199 |
| description | rinse pipe | | |
| For models: | 913418, 914167, 914168, 914398, 914399, 914443, 914943, 915695, 915696, 915819, E.45, Fast145, FAST-145, Fast145D, FAST-145D, NIAGARA-45 | | |

for toasters

pliers

pliers



1

| | | | |
|--------------------|--|-----------------|--------|
| GEV No. | 690010 | Ref. No. | 433004 |
| description | plier for toaster H 180mm total length 100mm | | |
| For models: | 404, 406, 412 | | |

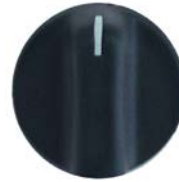

1

| | | | |
|--------------------|---|-----------------|------------------|
| GEV No. | 110339 | Ref. No. | 447059 447147 |
| description | knob switch zero mark ø 40mm shaft ø 6x4.6mm shaft flat lower black | | |
| For models: | 337, 338, 343, 344, FRI12, FRI12+12, FRI6, FRI6+6, FRI9, FRI9+9, ME15, ME20, ME30, ME40 | | |



1

| | | | |
|--------------------|--|-----------------|--------|
| GEV No. | 110354 | Ref. No. | 921002 |
| description | knob switch zero mark ø 47mm shaft ø 6x4.6mm shaft flat lower black | | |
| For models: | 305, 305S, 306, 306S, 307, 307S, 308, 308S, 313, 313S, 314, 314S, 319, 319S, 320, 320S, 337, 338, 343, 344, 433, 434, 436, 437, 438, 439, FRI12, FRI12+12, FRI15, FRI15M, FRI6, FRI6+6, FRI9, FRI9+9, ME15, ME20, ME30, ME40 | | |



1

| | | | |
|--------------------|--|-----------------|--------|
| GEV No. | 110285 | Ref. No. | 921039 |
| description | knob switch zero mark t.max.°C ø 40mm shaft ø 6x4.6mm shaft flat upper black | | |
| For models: | G33, G34, G37, G38, G39 | | |



1

| | | | |
|------------------------|--|-----------------|--------|
| GEV No. | 110086 | Ref. No. | 447089 |
| description | knob switch zero mark t.max.°C ø 45mm shaft ømm shaft flat special black | | |
| For models: | 10, 12, 22F, 22R, 40F, 66, CLEAN-100, CLEAN-110, CLEAN-120 | | |
| accessories for | 110086 | | |



| | | | |
|--------------------|--|-----------------|--------|
| GEV No. | 110085 | Ref. No. | 226051 |
| description | push button t.max.°C ø 36mm shaft ømm shaft flat grey for knob | | |

knobs

producer-specific knobs

ELETTROBAR



1

| | | | |
|--------------------|--|-----------------|--------|
| GEV No. | 510096 | Ref. No. | 447007 |
| description | knob | | |
| For models: | R495, R497, R499, R501, R503, R505, R507, R509, R511, R704, R706, R708, S641, S643, S870 | | |



1

| | | | |
|--------------------|--|-----------------|--------|
| GEV No. | 110004 | Ref. No. | 999044 |
| description | knob switch zero mark ø 38mm shaft ø 4x4mm black | | |
| For models: | 404, 406, 412 | | |





1

| | | | |
|--------------------|---|-----------------|--------|
| GEV No. | 110326 | Ref. No. | 999081 |
| description | knob switch zero mark ø 38mm shaft ø 6x4.6mm shaft flat lower brown | | |
| For models: | 412 | | |



| | | | |
|---|---|-----------------|------------------|
|  | | | |
| 1 | | | |
| GEV No. | 111434 | Ref. No. | 447148 999045 |
| description | knob switch zero mark t.max.°C ø 46mm shaft ø 5x5mm shaft flat horizontal black | | |
| For models: | 404, 406, ME15, ME20, ME30, ME40 | | |

| | | | |
|---|---|-----------------|--------|
|  | | | |
| 1 | | | |
| GEV No. | 110900 | Ref. No. | 999125 |
| description | knob zero mark ø 39mm shaft ø 6x4.6mm shaft flat left black | | |

| | | | |
|---|--|-----------------|--------|
|  | | | |
| 1 | | | |
| GEV No. | 110085 | Ref. No. | 226051 |
| description | push button t.max.°C ø 36mm shaft ømm shaft flat grey for knob | | |
| For models: | 10, 12, 22F, 22R, 40F, 66, CLEAN-100, CLEAN-110, CLEAN-120 | | |

| | | | |
|---|--|-----------------|------------------|
|  | | | |
| 1 | | | |
| GEV No. | 518532 | Ref. No. | 480091 480127 |
| description | end cap mounting pos. left | | |
| For models: | 913289, 913290, 913291, 913292, 913356, 913357, 913363, 913364, 913372, 913373, 913374, 913375, 913376, 913377, 913416, 913418, 913435, 913544, 913545, 913665, 913666, 913667, 913668, 913685, 913771, 913772, 913773, 913774, 913832, 913837, 913911, 913912, 913948, 913950, 913977, 913984, 913990, 913992, 913993, 914165, 914166, 914167, 914168, 914206, 914355, 914386, 914387, 914388, 914389, 914390...(Other models you can see in the webshop) | | |

| | | | |
|---|---|-----------------|--------|
|  | | | |
| 1 | | | |
| GEV No. | 518534 | Ref. No. | 480097 |
| description | end cap mounting pos. left | | |
| For models: | E.46, E.50, E.51, E.52, KLP105EB, KLP201DDDTEB, KLP201EB, KLP301DDDTEB, LP105DDDTEB, LP105DDDTEBN, LP105EB, LP201DDDTEB, LP201EB, LP301EB, NIAGARA-51, U132, U132e, U61, U61E, U61H, U61He, U70, U70e | | |

handles and hand wheels

handle rails

end caps

| | | | |
|---|---|-----------------|--------|
|  | | | |
| 1 | | | |
| GEV No. | 518530 | Ref. No. | 480043 |
| description | end cap mounting pos. left | | |
| For models: | 2312-001, 2312-002, 45, 450, 46, 460, 915695, 915696, 915819, FAST-145, Fast145D, FAST-145D | | |

| | | | |
|--|---|-----------------|--------|
|  | | | |
| 1 | | | |
| GEV No. | 518529 | Ref. No. | 480042 |
| description | end cap mounting pos. right | | |
| For models: | 2312-001, 2312-002, 45, 450, 46, 460, 915695, 915696, 915819, FAST-145, Fast145D, FAST-145D, TF-503, TF-513, TF-515 | | |

| | | | |
|---|--|-----------------|------------------|
|  | | | |
| 1 | | | |
| GEV No. | 518531 | Ref. No. | 480092 480128 |
| description | end cap mounting pos. right | | |
| For models: | 913289, 913290, 913291, 913292, 913356, 913357, 913363, 913364, 913372, 913373, 913374, 913375, 913376, 913377, 913416, 913418, 913435, 913544, 913545, 913665, 913666, 913667, 913668, 913685, 913771, 913772, 913773, 913774, 913832, 913837, 913911, 913912, 913948, 913950, 913977, 913984, 913990, 913992, 913993, 914165, 914166, 914167, 914168, 914206, 914355, 914386, 914387, 914388, 914389, 914390...(Other models you can see in the webshop) | | |



miscellaneous



Image not available

1

GEV No. 513094 **Ref. No.** DWM78

description door handle



Image not available

1

GEV No. 513095 **Ref. No.** DWM69

description door handle



Image not available

1

GEV No. 513108 **Ref. No.** DWM61

description handle

accessories

miscellaneous



Image not available

1

GEV No. 513098 **Ref. No.** DWP296

description screw for door handle

pullouts

rollers

rollers



1

GEV No. 518363 **Ref. No.** 499078

description roller rollers 36mm B1 10mm overall width 22mm A 36mm B 10mm C 22mm ø 20.5mm plastic tread plastic

For models: 2312-007, 2312-009-CRP, 913992, 913993, 914100, 914101, 914339, 914342, 914343, 914583, 914592, 914612, 914613, 914624, 914625, 914626, 914627, 914628, 914850, 914851, 914854, 914944, 915143, CLEAN-3, RIVER-40, RIVER-40-CRP, RIVER-43, RIVER-44, RIVER-44-CRP, RIVER-44-CRP-ST, RIVER-44CRP-ST, RIVER-48, RIVER-50, RIVER-50-CRP, RIVER-50-CRP-SP, RIVER-54, RIVER-54CRP, River-54-CRP-s.p., RIVER-54-CRP-SP, RIVER-61

fittings for catering equipment

outlet taps

universal



1

GEV No. 540699 **Ref. No.** 720008

description outlet tap W 35mm H 35mm thread 3/4" IT

For models: FRI12, FRI12+12, FRI6, FRI6+6, FRI9, FRI9+9



equipment feet and end caps

equipment feet

with screw mounting

universal



1

| | | | |
|--------------------|--|-----------------|-------|
| GEV No. | 700868 | Ref. No. | 73100 |
| description | equipment foot tube ø 64mm thread M12 thread L 25mm H 155-235mm SS size 2 1/2" Qty 1 pcs | | |
| For models: | A3EB, A3EBDAKRKYK, A3EBDRKYK, A3EBSAKRK, A3EBSEKWK, A4EB, A4EBDAKEKYK, A4EBDAKRK, A4EBDAKWK, A4EBDAKZK, A4EBDBKRK, A4EBDPKWYK, A4EBDRK, A4EBSAK, A4EBSAKCK, A4EBSAKEKYK, A4EBSAKRKP, A4EBT, A4EBTSAK, A5EB, A5EBDAKYK, A5EBDRK, A5EBSAKRK, A5EBSAKRKYK, A5EBSAKWK, A5EBSAKWKYK, A5EBSBKRPK, A5EBSBKWK, A5EBSRK, CNT800CH, Fast180, Fast180-230V-3Ph-60Hz, Fast181, Fast181-230V-3Ph-60Hz, Fast181-400V-3NPh-60Hz, Fast200, Fast93, GL280EB, GL280EB23, GL280EB23DAR, GL280EB23HZ, GL280EB23HZDY, GL280EBDARY, GL280EBDAW, GL280EBDAY, GL280EBDB, GL280EBDBR, GL280EBDWY, GL280EBSA, GL280EBSAE...(Other models you can see in the webshop) | | |



1

| | | | |
|--------------------|--|-----------------|-----------------|
| GEV No. | 513287 | Ref. No. | 79028 926117 |
| description | equipment foot tube ø 60mm thread M12 thread L 33mm H 155-235mm SS size 2" Qty 1 pcs | | |
| For models: | 80, 81, 82, 914100, 914101, 914326, 914380, 914406, 914436, 914624, 914625, 914627, 914628, 914850, 914851, 914854, 914944, 915175, 915176, 915177, 915663, 915729, A3EBD, A3EBDAKWK, A3EBDBKWK, A3EBDWK, A3EBDYK, A3EBSAK, A3EBSAKWK, A3EBSBKWKYK, A3EBSWK, A4EBD, A4EBS, A4EBSAKRK, A4EBSAKYK, A4EBSCK, A5EBD, A5EBDAKPKWK, A5EBDAKWK, A5EBS, A5EBSAKPKWK, A5EBSYK, CE78HZ23, CGL74CABT, E.55, E78, E78HP, FAST-181, FAST-200, FAST-60...(Other models you can see in the webshop) | | |

screw-in feet



1

| | | | |
|--------------------|---|-----------------|--------|
| GEV No. | 695601 | Ref. No. | 461010 |
| description | equipment foot thread M17 thread L 23mm ø 24mm H 11mm plastic WS 24 Qty 1 pcs | | |
| For models: | 11F, 11FD, 11F-DVGW, 11R, 11RD, 21F, 21FD, 21R, 21RD, 25F, 25FD, 25R, 25RD, 30F, 30FD, 30R, 30RD, 31F, 31FD, 31R, 31RD, 350F, 350FD, 350R, 350RD, 35-ELECTRONIC, 35F, 35FD, 35R, 35RD, 67F, 67R, 913289, 913290, 913291, 913292, 913356, 913357, 913363, 913364, 913372, 913373, 913374, 913375, 913376, 913377, 913416, 913435, 913544, 913545...(Other models you can see in the webshop) | | |



1

| | | | |
|--------------------|--|-----------------|--------|
| GEV No. | 513284 | Ref. No. | 461019 |
| description | equipment foot thread M8 thread L 20mm ø 30mm H 12mm Qty 1 pcs | | |
| For models: | 050F, 050FP, 2312-001, 2312-002, 2312-007, 2312-009-CRP, 45, 450, 46, 460, 500F, 500FD, 50F, 50FD, 510F, 510FD, 913297, 913298, 913299, 913300, 913360, 913361, 913391, 913392, 913418, 913546, 913547, 913578, 913611, 913684, 913913, 913914, 913932, 913933, 913992, 913993, 914100, 914101, 914167, 914168, 914284, 914318, 914319, 914331, 914338, 914339, 914342, 914343, 914356, 914398...(Other models you can see in the webshop) | | |

baskets

fryer baskets

ELETTROBAR



1

| | | | |
|--------------------|---|-----------------|--------|
| GEV No. | 970295 | Ref. No. | 706089 |
| description | fryer basket L1 295mm W1 200mm H1 110mm chrome-plated steel | | |
| For models: | FRI12, FRI12+12, FRI6, FRI6+6, FRI9, FRI9+9 | | |



1

| | | | |
|--------------------|--|-----------------|--------|
| GEV No. | 970298 | Ref. No. | 706092 |
| description | fryer basket L1 300mm W1 225mm H1 120mm | | |
| For models: | ME15, ME20, ME30, ME40, MG15, MG20, MG30, MG40 | | |



1

| | | | |
|--------------------|--|-----------------|--------|
| GEV No. | 970296 | Ref. No. | 706090 |
| description | fryer basket L1 325mm W1 220mm H1 110mm | | |
| For models: | FRI12, FRI12+12, FRI15, FRI15M, FRI6, FRI6+6, FRI9, FRI9+9 | | |



1

| | | | |
|--------------------|---|-----------------|--------|
| GEV No. | 970300 | Ref. No. | 706093 |
| description | fryer basket L1 390mm W1 235mm H1 120mm L2 560mm H3 300mm chrome-plated steel | | |

warewashing baskets

steel wire baskets round

mix baskets



1

| | | | |
|--------------------|--|-----------------|------------------|
| GEV No. | 970320 | Ref. No. | 983015 988015 |
| description | mix basket ED ø 370mm H 170mm seat ømm | | |



1

| | | | |
|--------------------|--|-----------------|--------|
| GEV No. | 970321 | Ref. No. | 983026 |
| description | mix basket ED ø 370mm H 195mm seat ømm | | |



1

| | | | |
|--------------------|--|-----------------|--------|
| GEV No. | 970322 | Ref. No. | 983025 |
| description | mix basket ED ø 400mm H 190mm seat ø 375mm | | |

steel wire baskets octagonal

mix baskets

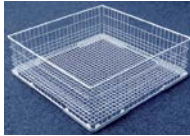

1

| | | | |
|--------------------|---|-----------------|--------|
| GEV No. | 971016 ¹ | Ref. No. | 983036 |
| description | mix basket L 382mm W 382mm H 130mm mesh type close-meshed | | |

¹fine-meshed



1

| | | | |
|--------------------|--|-----------------|--------|
| GEV No. | 971015 ¹ | Ref. No. | 983001 |
| description | mix basket L 382mm W 382mm H 200mm mesh type wide-meshed | | |

¹wide-meshed



1

| | | | |
|--------------------|---|-----------------|----------------------------|
| GEV No. | 971013 ¹ | Ref. No. | 938055 983039 983055 |
| description | mix basket L 382mm W 382mm H 90mm mesh type wide-meshed | | |

¹wide-meshed



1

| | | | |
|--------------------|--|-----------------|--------|
| GEV No. | 970072 ¹ | Ref. No. | 983032 |
| description | mix basket L 500mm W 500mm H 100mm mesh type wide-meshed | | |

¹wide-meshed



1

| | | | |
|--------------------|---|-----------------|--------|
| GEV No. | 970074 ¹ | Ref. No. | 983033 |
| description | mix basket L 500mm W 500mm H 130mm mesh type close-meshed | | |

¹fine-meshed





| | | | |
|--|------------------------------------|-----------------|-----------------|
|  <p>1</p> | | | |
| GEV No. | 971089 ¹ | Ref. No. | 41301 706125 |
| description | mix basket L 610mm W 550mm H 175mm | | |

¹wide-meshed

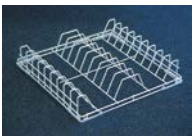

plate baskets

| | | | |
|--|--|-----------------|--------|
|  <p>1</p> | | | |
| GEV No. | 970071 | Ref. No. | 983031 |
| description | plate basket L 500mm W 500mm H 100mm plates 18 plate ø 250mm | | |

| | | | |
|--|--|-----------------|--------|
|  <p>1</p> | | | |
| GEV No. | 971127 | Ref. No. | 983027 |
| description | plate basket L 500mm W 500mm H 105mm plates 16 plate ø 240mm | | |

| | | | |
|---|--|-----------------|--------|
|  <p>1</p> | | | |
| GEV No. | 971053 | Ref. No. | 983030 |
| description | plate basket L 540mm W 540mm H 100mm plates 22 plate ø 270mm | | |

glass basket

| | | | |
|--|--|-----------------|-------------------|
|  <p>1</p> | | | |
| GEV No. | 971017 | Ref. No. | 983041 988041 |
| description | glass basket L 382mm W 382mm H 170mm number of rows 3 rows spacing 120mm | | |
| spare parts for | 971017 | | |
| | GEV No. | 970001 | Ref. No. — |
|  | sliding corner wire gauge ø 5mm L 120mm W 120mm H 12mm L-shape | | |

| | | | |
|---|---|-----------------|------------------|
|  <p>1</p> | | | |
| GEV No. | 971018 | Ref. No. | 938038 983038 |
| description | glass basket L 382mm W 382mm H 170mm number of rows 4 rows spacing 85mm inclined bottom | | |

plastic baskets octagonal

tray baskets

| | | | |
|---|--|-----------------|--------|
|  <p>1</p> | | | |
| GEV No. | 970829 | Ref. No. | 780106 |
| description | tray rack L 500mm W 500mm H 110mm mesh type wide-meshed for 8 trays for size 530x370 | | |

accessories

cutlery inserts

| | | | |
|---|--|-----------------|----------------------------|
|  <p>1</p> | | | |
| GEV No. | 976013 | Ref. No. | 712001 712003 712019 |
| description | cutlery insert L 105mm W 105mm ømm H 140mm | | |

| | | | |
|--|--|-----------------|--------|
|  <p>1</p> | | | |
| GEV No. | 976016 | Ref. No. | 780068 |
| description | cutlery insert L 110mm W 110mm ømm H 130mm | | |

section inserts for glasses

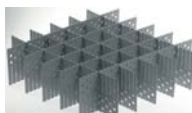
| | | | |
|---|---|-----------------|--------|
|  <p>1</p> | | | |
| GEV No. | 970302 | Ref. No. | 712006 |
| description | section insert for glasses L 400mm W 400mm H 105mm 10-piece | | |

sliding corners



| | | | |
|--------------------|---|-----------------|--------|
| GEV No. | 970830 | Ref. No. | 461003 |
| description | sliding corner L 120mm W 120mm L-shape for 970829 | | |
| For models: | S621, S623, S631, S633, S641, S643, S651, S651P, S653, S810, S830, S850, S870 | | |



| | | | |
|--------------------|---|-----------------|-------|
| GEV No. | 970820 | Ref. No. | 75075 |
| description | sliding corner L 44mm W 44mm H 17mm | | |
| For models: | 914380, 914436, A3EB, A3EBD, A3EBDAKRKYK, A3EBDAKWK, A3EBDBKWK, A3EBDRKYK, A3EBDWK, A3EBDYK, A3EBSAK, A3EBSAKRK, A3EBSAKWK, A3EBSBKWKYK, A3EBSEKWK, A3EBSWK, A4EB, A4EBD, A4EBDAKEKYK, A4EBDAKRK, A4EBDAKWK, A4EBDAKZK, A4EBDBKRK, A4EBDPKWKYK, A4EBDRK, A4EBS, A4EBSAK, A4EBSAKCK, A4EBSAKKEYK, A4EBSAKRK, A4EBSAKRKPK, A4EBSAKYK, A4EBSCK, A4EBT, A4EBTSAK, A5EB, A5EBD, A5EBDAKPKWK, A5EBDAKWK, A5EBDAKYK, A5EBDRK, A5EBS, A5EBSAKPKWK, A5EBSAKRK, A5EBSAKRKYK, A5EBSAKWK, A5EBSAKWKYK, A5EBSBKRPK, A5EBSBKWK, A5EBSRK...(Other models you can see in the webshop) | | |

plate inserts



| | | | |
|--------------------|---------------------------------------|-----------------|--------|
| GEV No. | 970517 | Ref. No. | 712004 |
| description | plate insert L 320mm W 80mm plates 12 | | |

gaskets

refrigeration gaskets

screw-in gaskets

profile 9663

We offer custom-made gaskets for this profile

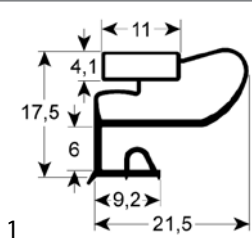

| | | | |
|--------------------|---|-----------------|------------|
| GEV No. | 901980 | Ref. No. | 025698-00R |
| description | refrigeration gasket profile 9663 W 302mm L 424mm external size | | |

O-rings

EPDM



| | | | |
|--------------------|---|-----------------|--------|
| GEV No. | 361304 | Ref. No. | 456042 |
| description | O-ring EPDM ID ϕ 11.11mm thickness 1.78mm Qty 1 pcs for type DIB3E/DIB5E | | |
| For models: | 350R, 350RD, 35-ELECTRONIC, 35R, 35RD, 67R, E.42, MINIBAR, S280 | | |

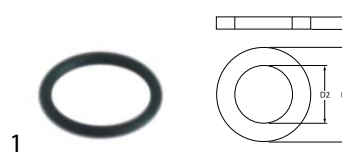

| | | | |
|--------------------|--|-----------------|--------|
| GEV No. | 529545 | Ref. No. | 456051 |
| description | O-ring EPDM thickness 1.78mm ID ϕ 10.82mm Qty 1 pcs | | |
| For models: | 67F, 67R, 913363, 913364, 913376, 913377, E.41, E.42, E.41 | | |

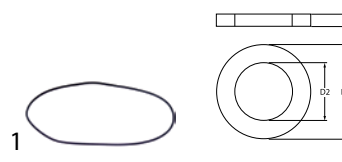

| | | | |
|--------------------|---|-----------------|--------|
| GEV No. | 521717 | Ref. No. | 456031 |
| description | O-ring EPDM thickness 1.78mm ID ϕ 120.37mm Qty 1 pcs | | |

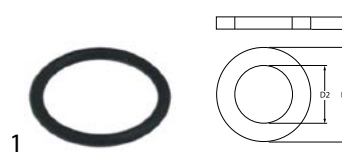

| | | | |
|--------------------|--|-----------------|--------|
| GEV No. | 504512 | Ref. No. | 456017 |
| description | O-ring EPDM thickness 1.78mm ID ϕ 14mm Qty 1 pcs | | |
| For models: | 66, R495, R497, R499, R501, R503, R505, R507, R509, R511, R704, R706, R708, S621, S623, S624, S626, S631, S633, S634, S636, S641, S643, S651, S651P, S653, S654, S655, S810, S815, S830, S835, S850, S870, S950, SR651 | | |

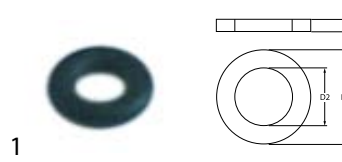

| | | | |
|--------------------|---|-----------------|--------|
| GEV No. | 511500 | Ref. No. | 456014 |
| description | O-ring EPDM thickness 1.78mm ID ϕ 2.9mm Qty 10 pcs | | |
| For models: | 21F, 21FD, 21R, 21RD, 25F, 25FD, 25R, 25RD, 30F, 30FD, 30R, 30RD, 31F, 31FD, 31R, 31RD, 44F | | |

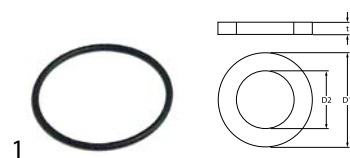

| | | | |
|---|---|-----------------|--------|
|  | | | |
| GEV No. | 513057 | Ref. No. | 927094 |
| description | O-ring EPDM thickness 1.78mm ID ϕ 28.3mm Qty 1 pcs | | |
| For models: | 161, 221, 271, 272, 362, CLEAN-160, CLEAN-161, CLEAN-220, CLEAN-221, CLEAN-270, CLEAN-271, CLEAN-272, CLEAN-361, CLEAN-361P, CLEAN-362, CLEAN-471, CLEAN-471P | | |

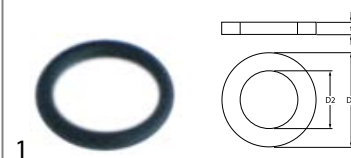
| | | | |
|--|--|-----------------|-------------------|
|  | | | |
| GEV No. | 510177 | Ref. No. | 456018 CGR2031 |
| description | O-ring EPDM thickness 1.78mm ID ϕ 7.66mm Qty 1 pcs | | |
| For models: | 10, 11F, 11FD, 11F-DVGW, 11R, 11RD, 12, 14, 161, 21F, 21FD, 21R, 21RD, 221, 22R, 25F, 25FD, 25R, 25RD, 271, 272, 30F, 30FD, 30R, 30RD, 31F, 31FD, 31R, 31RD, 362, 440F, 44F, 46, 460, 500F, 500FD, 50F, 50FD, 510F, 510FD, A4EBT, A4EBTSAK, C13, CLEAN-100, CLEAN-110, CLEAN-120, CLEAN-160, CLEAN-161, CLEAN-220, CLEAN-221...(Other models you can see in the webshop) | | |

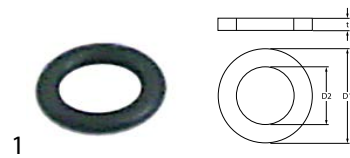
| | | | |
|---|--|-----------------|--------|
|  | | | |
| GEV No. | 505045 | Ref. No. | 456009 |
| description | O-ring EPDM thickness 1.78mm ID ϕ 5.28mm Qty 1 pcs | | |
| For models: | 11F, 11FD, 11F-DVGW, 11R, 11RD, 350F, 350FD, 350R, 350RD, 35-ELECTRONIC, 35F, 35FD, 35R, 35RD, 400F, 400FD, 400R, 400RD, 40-ELECTRONIC, 40F, 40FD, 40R, 40RD, 500F, 500FD, E.35, E.40, MC201CL | | |

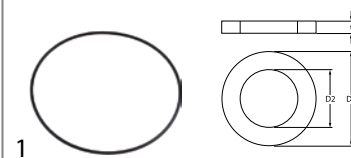
| | | | |
|--|--|-----------------|--------|
|  | | | |
| GEV No. | 513275 | Ref. No. | 456074 |
| description | O-ring EPDM thickness 1.78mm ID ϕ 82.27mm Qty 1 pcs | | |
| For models: | 913289, 913290, 913291, 913292, 913356, 913357, 913372, 913373, 913374, 913375, 913416, 913435, 913544, 913545, 913665, 913666, 913667, 913668, 913685, 913771, 913772, 913773, 913774, 913832, 913837, 913911, 913912, 913948, 913950, 913977, 913984, 913990, 914165, 914166, 914206, 914214, 914316, 914317, 914355, 914386, 914387, 914388, 914389, 914390, 914391, 914392, 914393, 914394, 914395, 914396...(Other models you can see in the webshop) | | |

| | | | |
|---|---|-----------------|--------|
|  | | | |
| GEV No. | 528485 | Ref. No. | 456060 |
| description | O-ring EPDM thickness 1.78mm ID ϕ 6.07mm Qty 1 pcs | | |
| For models: | 2312-007, 2312-009-CRP, 80, 81, 82, 913992, 913993, 914100, 914101, 914339, 914342, 914343, 914583, 914592, 914612, 914613, 914624, 914625, 914626, 914627, 914628, 914850, 914851, 914854, 914944, 915143, 915830, E78, Fast160DP, FAST-181, HM1, KLP105EB, KLP201DDDTTEB, KLP201EB, KLP301, KLP301DDDTTEB, LP105DDDTTEB, LP105DDDTTEBN, LP105EB, LP201DDDTTEB, LP201EB, LP301, LP301EB, NG291, NG292, NG293, NIAGARA-291, NIAGARA-292, NIAGARA-293, RIVER-294...(Other models you can see in the webshop) | | |

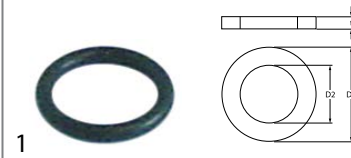
| | | | |
|--|---|-----------------|--------|
|  | | | |
| GEV No. | 504574 | Ref. No. | 456019 |
| description | O-ring EPDM thickness 1.78mm ID ϕ 9.25mm Qty 1 pcs | | |
| For models: | 11F, 11FD, 11F-DVGW, 11R, 11RD, 44F, 913289, 913290, 913291, 913292, 913356, 913357, 913372, 913373, 913374, 913375, 913416, 913435, 913544, 913545, 913665, 913666, 913667, 913668, 913685, 913771, 913772, 913773, 913774, 913832, 913837, 913911, 913912, 913948, 913950, 913977, 913984, 913990, 914165, 914166, 914206, 914214, 914316, 914317, 914355, 914386, 914387, 914388, 914389, 914390...(Other models you can see in the webshop) | | |

| | | | |
|---|--|-----------------|------------------|
|  | | | |
| GEV No. | 510303 | Ref. No. | 456030 CGR106 |
| description | O-ring EPDM thickness 1.78mm ID ϕ 6.75mm Qty 1 pcs | | |
| For models: | 050F, 050FP, 914568, 915830, E.50D.PA, E.55, E.65, F85, F85P, FAST-160DP, Fast181-230V-3Ph-60Hz, Fast181-400V-3NPh-60Hz, MINIBAR, NG292HZ, Niagara-292-400V-3Ph-60Hz, River-295P, River-296P, RIVER-40, RIVER-43, RIVER-50, RIVER-50-CRP, RIVER-61, RIVER-80, RIVER-81, RIVER-82, RV295PS, RV296PS, S280, ST70FASTHB400, U132, U61, U61E, U61H, U61HE, U70 | | |

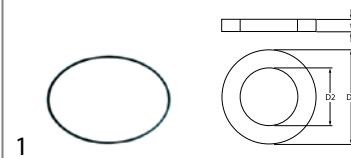
| | | | |
|--|---|-----------------|--------|
|  | | | |
| GEV No. | 510556 | Ref. No. | 456022 |
| description | O-ring EPDM thickness 1.78mm ID ϕ 94.97mm Qty 1 pcs pump type T110 | | |
| For models: | CLEAN-3, RIVER-43, S651, S651P, S653, S654, S655, S830, S835, SR651 | | |



| | | | |
|--------------------|---|-----------------|------------------|
| GEV No. | 529412 | Ref. No. | 456006 456048 |
| description | O-ring EPDM thickness 2.62mm ID ø 10.78mm Qty 1 pcs | | |
| For models: | 050F, 050FP, 11F, 11FD, 11F-DVGW, 11R, 11RD, 21F, 21FD, 21R, 21RD, 22F, 22R, 25F, 25FD, 25R, 25RD, 30F, 30FD, 30R, 30RD, 31F, 31FD, 31R, 31RD, 40F, 440F, 44F, 500F, 500FD, 50-ELECTRONIC, 50F, 50FD, 510F, 510FD, 55, 66, 913289, 913290, 913291, 913292, 913356, 913357, 913372, 913373, 913374, 913375, 913416, 913435, 913544...(Other models you can see in the webshop) | | |



| | | | |
|--------------------|--|-----------------|--------|
| GEV No. | 511510 | Ref. No. | 456070 |
| description | O-ring EPDM thickness 2.62mm ID ø 15.54mm Qty 10 pcs | | |
| For models: | 913289, 913290, 913291, 913292, 913297, 913298, 913299, 913300, 913356, 913357, 913360, 913361, 913372, 913373, 913374, 913375, 913391, 913392, 913416, 913418, 913435, 913544, 913545, 913546, 913547, 913578, 913611, 913665, 913666, 913667, 913668, 913684, 913685, 913771, 913772, 913773, 913774, 913832, 913837, 913911, 913912, 913913, 913914, 913932, 913933, 913948, 913950, 913977, 913984, 913990...(Other models you can see in the webshop) | | |



| | | | |
|--------------------|---|-----------------|--------|
| GEV No. | 518227 | Ref. No. | 456020 |
| description | O-ring EPDM thickness 2.62mm ID ø 12.37mm Qty 1 pcs | | |
| For models: | 10, 12, 14, 22F, 22R, 2312-001, 2312-002, 350F, 350FD, 350R, 350RD, 35-ELECTRONIC, 35F, 35FD, 35R, 35RD, 400F, 400FD, 400R, 400RD, 40-ELECTRONIC, 40F, 40FD, 40R, 40RD, 44F, 45, 450, 46, 460, 913289, 913290, 913291, 913292, 913297, 913298, 913299, 913300, 913356, 913357, 913360, 913361, 913363, 913364, 913372, 913373, 913374, 913375, 913376, 913377...(Other models you can see in the webshop) | | |



| | | | |
|--------------------|--|-----------------|--------|
| GEV No. | 528919 | Ref. No. | 456010 |
| description | O-ring EPDM thickness 2.62mm ID ø 20.24mm Qty 1 pcs | | |
| For models: | 11F, 11FD, 11R, 11RD, 21F, 21FD, 21R, 21RD, 25F, 25FD, 25R, 25RD, 30F, 30FD, 30R, 30RD, 31F, 31FD, 31R, 31RD, S621, S623, S624, S626, S631, S633, S634, S636, S870 | | |



| | | | |
|--------------------|---|-----------------|-------|
| GEV No. | 532623 | Ref. No. | 80844 |
| description | O-ring EPDM thickness 2.62mm ID ø 120.32mm Qty 1 pcs | | |
| For models: | Fast181, FAST-181, Fast181-230V-3Ph-60Hz, Fast181-400V-3NPh-60Hz, NG271, NG291, NIAGARA-271, NIAGARA-283, NIAGARA-291, RIVER-282, RIVER-294, RIVER-81, River-81CRP, RIVER-81-CRP, River-82CRP, RIVER-82-CRP, RV282, RV294, RV81, RV8123, RV81A, RV81C, RV81CCRP, RV81CRP, RV81HZ, RV81HZ23, RV81PAP, RV82CCRP, RV82CRP, ST70FAST, ST70FASTHB, ST70FASTHB400, ST70FASTHZ23, SV72EB | | |



| | | | |
|--------------------|--|-----------------|--------|
| GEV No. | 532058 | Ref. No. | 456071 |
| description | O-ring EPDM thickness 2.62mm ID ø 23.81mm Qty 10 pcs | | |
| For models: | 913289, 913290, 913291, 913292, 913297, 913298, 913299, 913300, 913356, 913357, 913360, 913361, 913372, 913373, 913374, 913375, 913391, 913392, 913416, 913418, 913435, 913544, 913545, 913546, 913547, 913578, 913611, 913665, 913666, 913667, 913668, 913684, 913685, 913771, 913772, 913773, 913774, 913832, 913837, 913911, 913912, 913913, 913914, 913932, 913933, 913948, 913950, 913977, 913984, 913990...(Other models you can see in the webshop) | | |



| | | | |
|--------------------|---|-----------------|--------|
| GEV No. | 504618 | Ref. No. | 456026 |
| description | O-ring EPDM thickness 2.62mm ID ø 15.54mm Qty 1 pcs | | |
| For models: | 10, 12, 14, C15, CLEAN-100, CLEAN-110, CLEAN-120 | | |

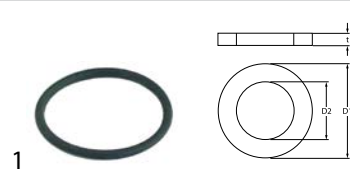

| | | | |
|--------------------|---|-----------------|--------|
| GEV No. | 510769 | Ref. No. | 456046 |
| description | O-ring EPDM thickness 2.62mm ID ø 25.07mm Qty 1 pcs | | |
| For models: | 10, 12, 14, 22F, 22R, 40F, 440F, 44F, 55, CLEAN-100, CLEAN-110, CLEAN-120, E.52 | | |

| | | | |
|--------------------|--|-----------------|--------|
| GEV No. | 504561 | Ref. No. | 456073 |
| description | O-ring EPDM thickness 2.62mm ID \varnothing 29.82mm Qty 1 pcs | | |
| For models: | 915150, 915151, 915152, 915154, 915155, 915157, 915158, 915160, 915161, 915162, 915166, 915167, 915168, 915172, 915173, 915175, 915176, 915177, 915285, 915319, 915338, 915341, 915348, 915418, 915419, 915420, 915421, 915422, 915479, 915492, 915493, 915494, 915495, 915496, 915497, 915547, 915558, 915611, 915612, 915613, 915614, 915615, 915616, 915617, 915618, 915635, 915663, 915670, 915671, 915672...(Other models you can see in the webshop) | | |

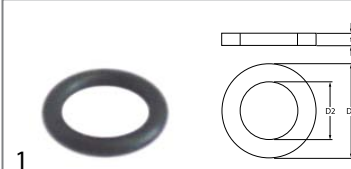

| | | | |
|--------------------|--|-----------------|---------|
| GEV No. | 528487 | Ref. No. | CGR3037 |
| description | O-ring EPDM thickness 2.62mm ID \varnothing 9.19mm Qty 1 pcs | | |
| For models: | NG381, NG38123, NG38123TERMO, NG381C, NG381CDD, NG381CFUR, NG381DDHZ23, NG381DDPS, NG381DDPSHZ23, NG381HPDD, NG381L, NG381LC, NG381LCFUR, NG381LDDPS, NG381TERMO, NG381TXCDD, Niagara-283L-2, Niagara-381, Niagara-381-230V-3Ph-50Hz, Niagara-381-230V-3Ph-60Hz, Niagara-381DP, Niagara-381HPD, Niagara-381L, Niagara-381LC, River-282-2, River-282L-2, River-282LS-2TDE, River-282S-2TDE, River-285, River-382, River-382-230V-3Ph-50Hz, River-382H, River-382L, River-382L-230V-3Ph-50Hz, River-382LNRG, River-382LTDE, River-382NRG, River-382NRG-230-3Ph-50Hz, River-382TDE, RV382, RV38223TERMO, RV382AHP, RV382FUR, RV382L, RV382L23TERMO, RV382LFUR, RV382LR, RV382LS, RV382LSFUR, RV382LTX...(Other models you can see in the webshop) | | |

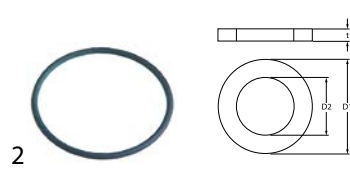

| | | | |
|--------------------|--|-----------------|--------|
| GEV No. | 512056 | Ref. No. | 929061 |
| description | O-ring EPDM thickness 2.62mm ID \varnothing 50.47mm Qty 1 pcs | | |
| For models: | 10, 12, 14, 55, CLEAN-100, CLEAN-110, CLEAN-120, E1, E10, E100, E110, E12, E120, E14, E140 | | |

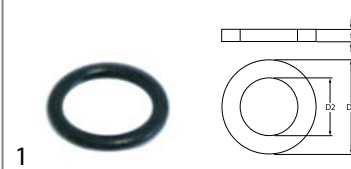

| | | | |
|--------------------|--|-----------------|--------|
| GEV No. | 510893 | Ref. No. | 456015 |
| description | O-ring EPDM thickness 2.62mm ID \varnothing 9.92mm Qty 1 pcs | | |
| For models: | 050F, 050FP, 2312-001, 2312-002, 31F, 31FD, 31R, 31RD, 500F, 500FD, 50F, 50FD, 510F, 510FD, 67F, 67R, 913297, 913298, 913299, 913300, 913360, 913361, 913363, 913364, 913376, 913377, 913391, 913392, 913418, 913546, 913547, 913578, 913611, 913684, 913913, 913914, 913932, 913933, 914167, 914168, 914284, 914318, 914319, 914326, 914331, 914338, 914356, 914398, 914399, 914400...(Other models you can see in the webshop) | | |

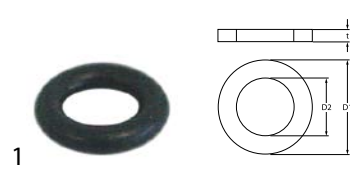

| | | | |
|--------------------|--|-----------------|--------|
| GEV No. | 518275 | Ref. No. | 456066 |
| description | O-ring EPDM thickness 2.62mm ID \varnothing 6.02mm Qty 1 pcs | | |

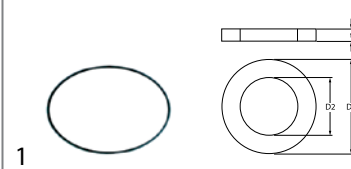

| | | | |
|--------------------|---|-----------------|--------|
| GEV No. | 510554 | Ref. No. | 456024 |
| description | O-ring EPDM thickness 2mm ID \varnothing 120mm Qty 1 pcs | | |
| For models: | 440F, 44F, 46, 460, 500F, 500FD, 50-ELECTRONIC, 50F, 50FD, E.46, E.50, E.52, R497, R499, R501, R503, R505, R507, R509, R511, R704, R706, R708, S641, S643 | | |

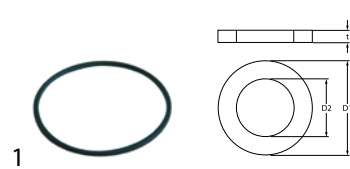

| | | | |
|--------------------|---|-----------------|------------------|
| GEV No. | 509002 | Ref. No. | 456083 456084 |
| description | O-ring EPDM thickness 2.62mm ID \varnothing 82.22mm Qty 1 pcs | | |
| For models: | 915611, 915612, 915613, 915614, 915615, 915616, 915617, 915618, 915670, 915671, 915672, 915773, 915774, 915959, 916066, 916077, 916078, 916196, 916197, 916198, 916199, 916200, 916409, 916410, 916418, 916419, 916591, 916592, 916593, 916594, 916595, 916877, 916921, 916922, 916992, 916993, Fast145-2, Fast150, NIAGARA-241, Niagara-241-2, Niagara-341, Pluvia-240, RIVER-242, River-242-2, River-242-2T, River-342C, River-342T | | |

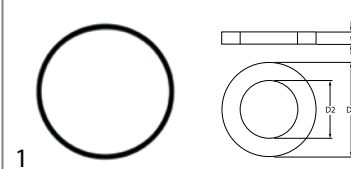

| | | | |
|--------------------|--|-----------------|--------|
| GEV No. | 510009 | Ref. No. | 456001 |
| description | O-ring EPDM thickness 3.53mm ID \varnothing 101.2mm Qty 1 pcs | | |
| For models: | 21F, 21FD, 21R, 21RD, 25F, 25FD, 25R, 25RD, 30F, 30FD, 30R, 30RD, 31F, 31FD, 31R, 31RD, 913418, 914398, 914399, 914443, E.45, S621, S623, S624, S626, S631, S633, S634, S636 | | |

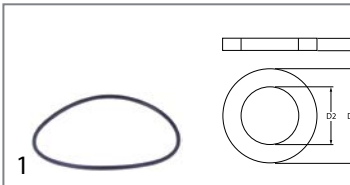

| | | | |
|--------------------|---|-----------------|--------|
| GEV No. | 532537 | Ref. No. | 456067 |
| description | O-ring EPDM thickness 3.53mm ID ø 113.9mm Qty 1 pcs | | |
| For models: | 2312-007, 2312-009-CRP, 914100, 914101, 914339, 914342, 914343, 914624, 914625, 914626, 914627, 914628, 914850, 914851, 914854, 914944, PS-60, RIVER-48, RIVER-50, RIVER-50-CRP, RIVER-50-CRP-SP, RIVER-54, RIVER-54CRP, River-54-CRP-s.p., RIVER-54-CRP-SP, RIVER-61 | | |

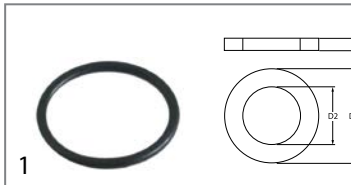

| | | | |
|--------------------|---|-----------------|--------|
| GEV No. | 506015 | Ref. No. | 456052 |
| description | O-ring EPDM thickness 3.53mm ID ø 39.69mm Qty 1 pcs | | |
| For models: | 2312-001, 2312-002, 2312-007, 350F, 350FD, 350R, 350RD, 35-ELECTRONIC, 35F, 35FD, 35R, 35RD, 400F, 400FD, 400R, 400RD, 40-ELECTRONIC, 40F, 40FD, 40R, 40RD, 55, 913289, 913290, 913291, 913292, 913297, 913298, 913299, 913300, 913356, 913357, 913360, 913361, 913363, 913364, 913372, 913373, 913374, 913375, 913376, 913377, 913391, 913392, 913416, 913418, 913435, 913544, 913545, 913546... (Other models you can see in the webshop) | | |

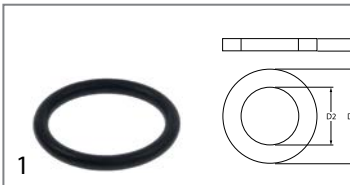

| | | | |
|--------------------|---|-----------------|--------|
| GEV No. | 513016 | Ref. No. | 929050 |
| description | O-ring EPDM thickness 3.53mm ID ø 26.58mm Qty 1 pcs | | |
| For models: | 55 | | |

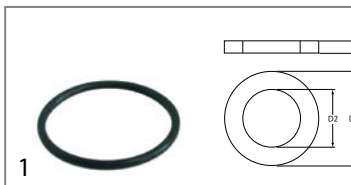

| | | | |
|--------------------|---|-----------------|--------|
| GEV No. | 528315 | Ref. No. | 456044 |
| description | O-ring EPDM thickness 3.53mm ID ø 47.63mm Qty 1 pcs | | |
| For models: | CLEAN-3, RIVER-43 | | |

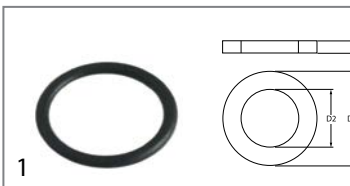

| | | | |
|--------------------|---|-----------------|-------|
| GEV No. | 505152 | Ref. No. | 70135 |
| description | O-ring EPDM thickness 3.53mm ID ø 29mm Qty 1 pcs | | |
| For models: | NG381, NG38123, NG38123TERMO, NG381C, NG381CDD, NG381CFUR, NG381DDHZ23, NG381DDPS, NG381DDPSHZ23, NG381HPDD, NG381L, NG381LC, NG381LCFUR, NG381LDDPS, NG381TERMO, NG381TXCDD, Niagara-283L-2, Niagara-381, Niagara-381-230V-3Ph-50Hz, Niagara-381-230V-3Ph-60Hz, Niagara-381DP, Niagara-381HPD, Niagara-381L, Niagara-381LC | | |

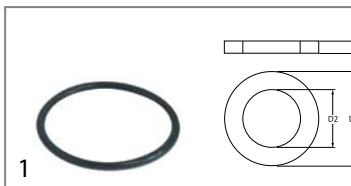

| | | | |
|--------------------|---|-----------------|---------------------|
| GEV No. | 518175 | Ref. No. | 456061 REB456061 |
| description | O-ring EPDM thickness 3.53mm ID ø 49.21mm Qty 1 pcs | | |
| For models: | 913289, 913290, 913291, 913292, 913356, 913357, 913372, 913373, 913374, 913375, 913416, 913418, 913435, 913544, 913545, 913665, 913666, 913667, 913668, 913685, 913771, 913772, 913773, 913774, 913832, 913837, 913911, 913912, 913948, 913950, 913977, 913984, 913990, 914165, 914166, 914206, 914214, 914316, 914317, 914355, 914386, 914387, 914388, 914389, 914390, 914391, 914392, 914393, 914394, 914395, 914396... (Other models you can see in the webshop) | | |

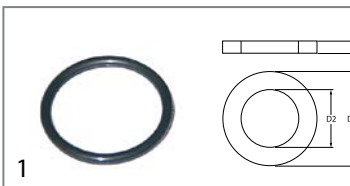

| | | | |
|--------------------|---|-----------------|--------|
| GEV No. | 510072 | Ref. No. | 456016 |
| description | O-ring EPDM thickness 3.53mm ID ø 32.93mm Qty 1 pcs | | |
| For models: | 050F, 050FP, 10, 11F, 11FD, 11F-DVGW, 11R, 11RD, 21F, 21FD, 21R, 21RD, 22F, 22R, 25F, 25FD, 25R, 25RD, 30F, 30FD, 30R, 30RD, 31F, 31FD, 31R, 31RD, 350F, 350FD, 350R, 350RD, 35-ELECTRONIC, 35F, 35FD, 35R, 35RD, 400F, 400FD, 400R, 400RD, 40-ELECTRONIC, 40F, 40FD, 40R, 40RD, 440F, 44F, 45, 450, 46, 460... (Other models you can see in the webshop) | | |

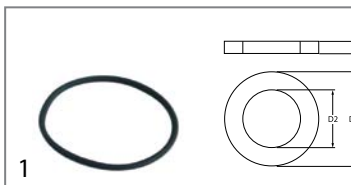

| | | | |
|--------------------|--|-----------------|--------|
| GEV No. | 532603 | Ref. No. | 926252 |
| description | O-ring EPDM thickness 3.53mm ID ø 69.85mm Qty 1 pcs | | |
| For models: | KLP105EB, KLP201DDTEB, KLP201EB, KLP301, KLP301DDTEB, LP105DDTEB, LP105DDTEBN, LP105EB, LP201DDTEB, LP201EB, LP301, LP301EB, NG292, NG292HZ, NG293, NIAGARA-292, Niagara-292-400V-3Ph-60Hz, NIAGARA-293, RIVER-295, River-295P, RIVER-296, River-296P, RIVER-297, RIVER-298, RV295, RV295PS, RV296, RV296PS, RV297, RV298, RV298HZ, U132E, U61E, U61HE, U70e | | |

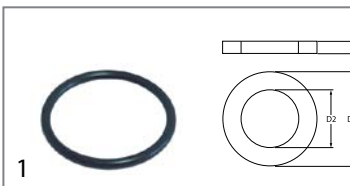

| | | | |
|--------------------|---|-----------------|--------|
| GEV No. | 510895 | Ref. No. | 456043 |
| description | O-ring EPDM thickness 3.53mm ID ø 34.52mm Qty 1 pcs | | |



| | | | |
|--------------------|--|-----------------|--------|
| | | | |
| GEV No. | 532498 | Ref. No. | 456047 |
| description | O-ring EPDM thickness 3.53mm ID ø 9.12mm Qty 1 pcs | | |
| For models: | 22F, 440F, 44F, 500F, 500FD, 50F, 50FD, 66, CLEAN-100, CLEAN-120, E.46, E100 | | |

| | | | |
|--------------------|--|-----------------|--------|
| | | | |
| GEV No. | 521120 | Ref. No. | 456075 |
| description | O-ring EPDM thickness 5.34mm ID ø 37.47mm Qty 1 pcs | | |
| For models: | 913289, 913290, 913291, 913292, 913356, 913357, 913363, 913364, 913372, 913373, 913374, 913375, 913376, 913377, 913416, 913418, 913435, 913544, 913545, 913665, 913666, 913667, 913668, 913685, 913771, 913772, 913773, 913774, 913832, 913837, 913911, 913912, 913948, 913950, 913977, 913984, 913990, 914165, 914166, 914167, 914168, 914206, 914214, 914316, 914317, 914355, 914386, 914387, 914388, 914389...(Other models you can see in the webshop) | | |

| | | | |
|--------------------|--|-----------------|--------|
| | | | |
| GEV No. | 698810 | Ref. No. | 456078 |
| description | O-ring EPDM thickness 3.56mm ID ø 112mm Qty 1 pcs | | |
| For models: | 915150, 915151, 915152, 915154, 915155, 915157, 915158, 915160, 915161, 915162, 915166, 915167, 915168, 915172, 915173, 915175, 915176, 915177, 915285, 915319, 915338, 915341, 915348, 915418, 915419, 915420, 915421, 915422, 915479, 915492, 915493, 915494, 915495, 915496, 915497, 915547, 915558, 915635, 915663, 915747, 916020, 916021, 916024, 916025, 916026, 916027, 916030, 916031, 916045, 916054...(Other models you can see in the webshop) | | |

| | | | |
|--------------------|--|-----------------|------------------|
| | | | |
| GEV No. | 510408 | Ref. No. | 456002 456079 |
| description | O-ring EPDM thickness 5.34mm ID ø 47mm Qty 1 pcs | | |
| For models: | 10, 12, 14, 21F, 21FD, 21R, 21RD, 22F, 22R, 25F, 25FD, 25R, 25RD, 30F, 30FD, 30R, 30RD, 31F, 31FD, 31R, 31RD, 40F, 440F, 44F, 50F, 50FD, 510F, 510FD, 66, 80, 81, 82, 913297, 913298, 913299, 913300, 913360, 913361, 913391, 913392, 913546, 913547, 913578, 913611, 913684, 913913, 913914, 913932, 913933, 913992...(Other models you can see in the webshop) | | |

| | | | |
|--------------------|--|-----------------|-------|
| | | | |
| GEV No. | 532718 | Ref. No. | 80816 |
| description | O-ring EPDM thickness 4mm ID ø 80mm Qty 1 pcs | | |
| For models: | A3EB, A3EBD, A3EBDAKRKYK, A3EBDAKWK, A3EBDBKWK, A3EBDRKYK, A3EBDVK, A3EBDYK, A3EBSAK, A3EBSAKRK, A3EBSAKWK, A3EBSBKWKYK, A3EBSKWK, A3EBSWK, A4EB, A4EBD, A4EBDAKEYK, A4EBDAKRK, A4EBDAKWK, A4EBDAKZK, A4EBDBKRK, A4EBDPKWKYK, A4EBDRK, A4EBS, A4EBSAK, A4EBSAKCK, A4EBSAKEKYK, A4EBSAKRK, A4EBSAKRKP, A4EBSAKYK, A4EBSCK, A4EBT, A4EBTSAK, A5EB, A5EBD, A5EBDAKPWK, A5EBDAKWK, A5EBDAKYK, A5EBDRK, A5EBS, A5EBSAKPKWK, A5EBSAKRK, A5EBSAKRKYK, A5EBSAKWK, A5EBSAKWKYK, A5EBSBKRPK, A5EBSBKWK, A5EBSRK, A5EBSYK, KLP105EB...(Other models you can see in the webshop) | | |

| | | | |
|--------------------|---|-----------------|--------|
| | | | |
| GEV No. | 510409 | Ref. No. | 929046 |
| description | O-ring EPDM thickness 5.34mm ID ø 56.52mm Qty 1 pcs | | |
| For models: | 161, 221, 271, 272, 362, 55, CLEAN-160, CLEAN-161, CLEAN-220, CLEAN-221, CLEAN-270, CLEAN-271, CLEAN-272, CLEAN-361, CLEAN-361P, CLEAN-362, CLEAN-471, CLEAN-471P | | |

| | | | |
|--------------------|--|-----------------|--------|
| | | | |
| GEV No. | 532543 | Ref. No. | 456076 |
| description | O-ring EPDM thickness 5.34mm ID ø 136.5mm Qty 1 pcs | | |
| For models: | 915150, 915151, 915152, 915154, 915155, 915157, 915158, 915160, 915161, 915162, 915166, 915167, 915168, 915172, 915173, 915175, 915176, 915177, 915285, 915319, 915338, 915341, 915348, 915418, 915419, 915420, 915421, 915422, 915479, 915492, 915493, 915494, 915495, 915496, 915497, 915547, 915558, 915635, 915663, 915747, 916020, 916021, 916024, 916025, 916026, 916027, 916030, 916031, 916045, 916054...(Other models you can see in the webshop) | | |

| | | | |
|--------------------|--|-----------------|--------|
| | | | |
| GEV No. | 510410 | Ref. No. | 456008 |
| description | O-ring EPDM thickness 5.34mm ID ø 75.57mm Qty 1 pcs | | |
| For models: | 66, S651, S651P, S653, S654, S655, S810, S815, S830, S835, S850, SR651 | | |

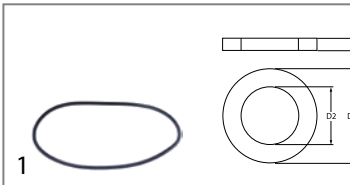

| | | | |
|--------------------|--|-----------------|------------------|
| GEV No. | 510551 | Ref. No. | 456023 926084 |
| description | pump cover gasket ID ø 158.3mm pump type 1214/1293/1225/2243/1226/1204/3473/1241 thickness 3.53mm EPDM Qty 1 pcs | | |
| For models: | 12, 14, 161, 221, 271, 272, 362, 55, 66, 80, 81, 82, 914380, 914436, 915747, A3EB, A3EBD, A3EBDAKRKYK, A3EBDAKWK, A3EBDBKWK, A3EBDRKYK, A3EBDWK, A3EBDYK, A3EBSAK, A3EBSAKRK, A3EBSAKWK, A3EBSBKWKYK, A3EBSEKWK, A3EBSWK, A4EB, A4EBD, A4EBDAKEKYK, A4EBDAKRK, A4EBDAKWK, A4EBDAKZK, A4EBDBKRK, A4EBDPKWYK, A4EBDRK, A4EBS, A4EBSAK, A4EBSAKCK, A4EBSAKEKYK, A4EBSAKRK, A4EBSAKRKP, A4EBSAKYK, A4EBSCK, A4EBT, A4EBTSAK, A5EB, A5EBD...(Other models you can see in the webshop) | | |

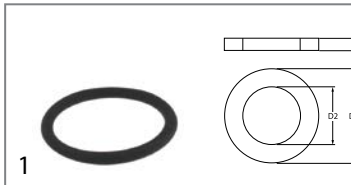

| | | | |
|--------------------|---|-----------------|---------------------|
| GEV No. | 528155 | Ref. No. | 927337 CGR4131NT |
| description | O-ring Viton thickness 3.53mm ID ø 32.93mm Qty 1 pcs | | |
| For models: | 161, 221, 271, 272, 362, 915747, 915773, A3EB, A3EBDAKRKYK, A3EBDRKYK, A3EBSAKRK, A3EBSEKWK, A4EB, A4EBDAKEKYK, A4EBDAKRK, A4EBDAKWK, A4EBDAKZK, A4EBDBKRK, A4EBDPKWYK, A4EBDRK, A4EBSAK, A4EBSAKCK, A4EBSAKEKYK, A4EBSAKRKP, A4EBT, A4EBTSAK, A5EB, A5EBDAKYK, A5EBDRK, A5EBSAKRK, A5EBSAKRKYK, A5EBSAKWK, A5EBSAKWKYK, A5EBSBKRKP, A5EBSBKWK, A5EBSRK, CLEAN-161, CLEAN-221, CLEAN-271, CLEAN-272, CLEAN-362, Fast181, FAST-181, Fast181-230V-3Ph-60Hz, Fast181-400V-3NPh-60Hz, Fast200, Fast93, GL280EB, GL280EB23, GL280EB23DAR...(Other models you can see in the webshop) | | |

silicone

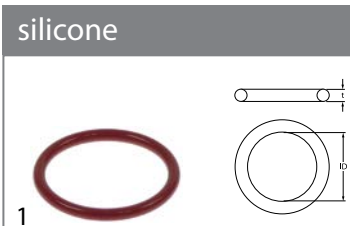

| | | | |
|--------------------|--|-----------------|--------|
| GEV No. | 514017 | Ref. No. | 927010 |
| description | O-ring silicone thickness 3.53mm ID ø 32.93mm Qty 1 pcs | | |
| For models: | CLEAN-160, CLEAN-220, CLEAN-270, CLEAN-271, CLEAN-361, CLEAN-361P, CLEAN-471, CLEAN-471P | | |

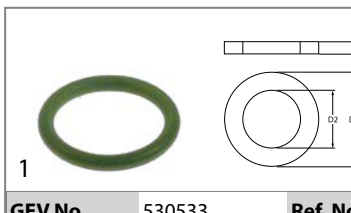

| | | | |
|--------------------|---|-----------------|--------|
| GEV No. | 530533 | Ref. No. | 456080 |
| description | O-ring Viton thickness 3mm ID ø 20mm Qty 1 pcs | | |
| For models: | 915611, 915612, 915613, 915614, 915615, 915616, 915670, 915671, 915959, 916196, 916197, 916198, 916199, 916200, 916409, 916410, 916591, 916592, 916593, 916877, 916921, 916922, 916992, 916993, Fast145-2, Fast150, Niagara-241, Niagara-241-2, Niagara-341, Pluvia-240 | | |

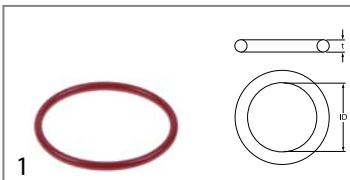

| | | | |
|--------------------|---|-----------------|--------|
| GEV No. | 532594 | Ref. No. | 927097 |
| description | O-ring silicone thickness 3.53mm ID ø 50.8mm Qty 1 pcs | | |
| For models: | 161, 221, 271, 272, 362, CLEAN-160, CLEAN-161, CLEAN-220, CLEAN-221, CLEAN-270, CLEAN-271, CLEAN-272, CLEAN-361, CLEAN-361P, CLEAN-362, CLEAN-471, CLEAN-471P | | |

miscellaneous

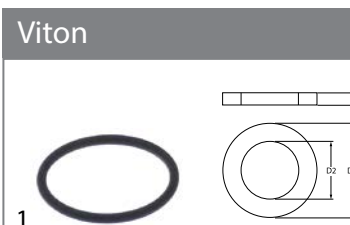

Image not available

| | | | |
|--------------------|--------|-----------------|--------|
| GEV No. | 513099 | Ref. No. | CGR108 |
| description | O-ring | | |

Viton



| | | | |
|--------------------|--|-----------------|-------------------|
| GEV No. | 532625 | Ref. No. | 456081 5037072 |
| description | O-ring Viton thickness 2.62mm ID ø 28.25mm Qty 1 pcs | | |
| For models: | 915150, 915151, 915152, 915154, 915155, 915160, 915161, 915162, 915166, 915167, 915168, 915175, 915176, 915177, 915319, 915338, 915341, 915348, 915418, 915419, 915420, 915421, 915479, 915492, 915493, 915547, 915558, 915635, 915663, 915747, 916020, 916021, 916024, 916025, 916026, 916027, 916030, 916031, 916045, 916201, 916202, 916203, 916204, 916205, 916206, 916207, 916208, 916209, 916247, 916248...(Other models you can see in the webshop) | | |

sealing washers

fibre gaskets





| | | | |
|--------------------|--|-----------------|--------|
| GEV No. | 518541 | Ref. No. | 437021 |
| description | flat gasket FIBER ED ø 12mm ID ø 8mm thickness 1.5mm Qty 1 pcs | | |
| For models: | 050F, 050FP, 11R, 11RD, 12, 14, 21F, 21FD, 21R, 21RD, 22F, 22R, 25F, 25FD, 25R, 25RD, 30F, 30FD, 30R, 30RD, 31F, 31FD, 31R, 31RD, 40F, 440F, 44F, 46, 460, 500F, 500FD, 50-ELECTRONIC, 50F, 50FD, 510F, 510FD, 66, CLEAN-100, CLEAN-110, CLEAN-120, CLEAN-3, E.46, E.50, E.51, E.52, E.60, E.65, E1, E10, E100...(Other models you can see in the webshop) | | |





| | | | |
|---|---|-----------------|--------|
|  | | | |
| 1 | | | |
| GEV No. | 529349 | Ref. No. | 437030 |
| description | flat gasket FIBER ED ø 22mm ID ø 16.5mm thickness 2mm for thread 3/8" Qty 1 pcs | | |
| For models: | 11F, 11FD, 11R, 11RD, 2312-001, 2312-002, 55, 67F, 67R, 913297, 913298, 913299, 913300, 913360, 913361, 913391, 913392, 913418, 913546, 913547, 913578, 913611, 913684, 913932, 913933, 914326, 914331, 914398, 914399, 914400, 914401, 914402, 914403, 914404, 914405, 914406, 914443, 914449, 914517, 914545, 914568, 914688, 914979, 915140, 915248, 915483, 915484, 915528, 915537, 915538... (Other models you can see in the webshop) | | |

| | | | |
|---|--|-----------------|-------|
|  | | | |
| 1 | | | |
| GEV No. | 506241 | Ref. No. | CGF17 |
| description | flat gasket FIBER ED ø 24mm ID ø 16mm thickness 2mm Qty 1 pcs | | |
| For models: | A3EB, A3EBD, A3EBDAKRKYK, A3EBDAKWK, A3EBDBKWK, A3EBDRKYK, A3EBDVK, A3EBDYK, A3EBSAK, A3EBSAKRK, A3EBSAKWK, A3EBSBKWKYK, A3EBSEKWK, A3EBSWK, A4EB, A4EBD, A4EBDAKEKYK, A4EBDAKRK, A4EBDAKWK, A4EBDAKZK, A4EBDBKRK, A4EBDPKWKYK, A4EBDRK, A4EBS, A4EBSAK, A4EBSAKCK, A4EBSAKEKYK, A4EBSAKRK, A4EBSAKRKP, A4EBSAKYK, A4EBSCK, A4EBT, A4EBTSAK, A5EB, A5EBD, A5EBDAKPKWK, A5EBDAKWK, A5EBDAKYK, A5EBDRK, A5EBS, A5EBSAKPKWK, A5EBSAKRK, A5EBSAKRKYK, A5EBSAKWK, A5EBSAKWKYK, A5EBSBKRPK, A5EBSBKWK, A5EBSRK, A5EBSYK, River-multi-2252... (Other models you can see in the webshop) | | |

| | | | |
|---|---|-----------------|--------|
|  | | | |
| 1 | | | |
| GEV No. | 518393 | Ref. No. | 437042 |
| description | flat gasket FIBER ED ø 24mm ID ø 17mm thickness 2mm Qty 1 pcs | | |
| For models: | 10, 11F, 11FD, 11R, 11RD, 12, 14, 21F, 21FD, 21R, 21RD, 22F, 22R, 25F, 25FD, 25R, 25RD, 30F, 30FD, 30R, 30RD, 31F, 31FD, 31R, 31RD, 40F, 440F, 44F, 500F, 500FD, 50-ELECTRONIC, 50F, 50FD, 510F, 510FD, 55, 913297, 913298, 913299, 913300, 913360, 913361, 913391, 913392, 913546, 913547, 913578, 913611, 913684, 913913... (Other models you can see in the webshop) | | |

| | | | |
|---|---|-----------------|--------|
|  | | | |
| 1 | | | |
| GEV No. | 510076 | Ref. No. | 437031 |
| description | flat gasket FIBER ED ø 33mm ID ø 21mm thickness 1.5mm Qty 1 pcs | | |
| For models: | 350R, 350RD, 35-ELECTRONIC, 35R, 35RD, 368, 374, 66, MG30, MG40, R495, R497, R499, R501, R503, R505, R507, R509, R511, R704, R706, R708, S641, S643, S870 | | |

| | | | |
|---|---|-----------------|--------|
|  | | | |
| 1 | | | |
| GEV No. | 510074 | Ref. No. | 437025 |
| description | flat gasket FIBER ED ø 35mm ID ø 27mm thickness 1.5mm Qty 1 pcs | | |
| For models: | 11F, 11FD, 11F-DVGW, 11R, 11RD, 2312-009-CRP, 350F, 350FD, 35-ELECTRONIC, 35F, 35FD, 400F, 400FD, 400R, 400RD, 40-ELECTRONIC, 40F, 40FD, 40R, 40RD, 67F, 67R, 913363, 913364, 913376, 913377, 913992, 913993, 914100, 914101, 914339, 914342, 914343, 914583, 914624, 914625, 914626, 914627, 914628, 914850, 914851, 914854, 914944, 915143, 915747, A4EBT, A4EBTSAK, CLEAN-3, E.41, E.42... (Other models you can see in the webshop) | | |

| | | | |
|---|--|-----------------|--------|
|  | | | |
| 1 | | | |
| GEV No. | 510416 | Ref. No. | 437022 |
| description | flat gasket fibre ED ø 19mm ID ø 10.5mm thickness 1.5mm for thread M10 Qty 1 pcs | | |
| For models: | S621, S623, S624, S626, S631, S633, S634, S636 | | |

| | | | |
|---|---|-----------------|------------------|
|  | | | |
| 1 | | | |
| GEV No. | 510417 | Ref. No. | 437002 437024 |
| description | flat gasket fibre ED ø 20mm ID ø 14mm thickness 2mm Qty 1 pcs | | |
| For models: | 11F, 11FD, 11F-DVGW, 11R, 11RD, 12, 14, 21F, 21FD, 21R, 21RD, 22F, 22R, 25F, 25FD, 25R, 25RD, 30F, 30FD, 30R, 30RD, 31F, 31FD, 31R, 31RD, 40F, 440F, 44F, 450, 46, 460, 500F, 500FD, 50F, 50FD, 510F, 510FD, CLEAN-100, CLEAN-110, CLEAN-120, E.45, E.46, E.50, E.51, E.52, E1, E10, E100, E110, E12... (Other models you can see in the webshop) | | |

| | | | |
|---|--|-----------------|--------|
|  | | | |
| 1 | | | |
| GEV No. | 510080 | Ref. No. | 437027 |
| description | flat gasket fibre ED ø 44.5mm ID ø 33mm thickness 2mm Qty 1 pcs | | |
| For models: | 11F, 11FD, 11F-DVGW, 11R, 11RD, 66, 67F, 67R, 913363, 913364, 913376, 913377, E.41, E.42, E.41, R495, R497, R499, R501, R503, R505, R507, R509, R511, R704, R706, R708, S651, S654, S810, S815, S830, S835, S870, S950 | | |

| | | | |
|---|---|-----------------|--------|
|  | | | |
| 1 | | | |
| GEV No. | 510405 | Ref. No. | 437028 |
| description | flat gasket fibre ED ø 56mm ID ø 42mm thickness 2mm for thread 1 1/4" Qty 1 pcs | | |
| For models: | R497, R499, R501, R503, R505, R507, R509, R511, R704, S641, S643 | | |

| | | | |
|---|--|-----------------|--------|
|  | | | |
| 1 | | | |
| GEV No. | 510081 | Ref. No. | 437029 |
| description | sealing ring fibre ED ø 60mm ID ø 48mm thickness 1.5mm Qty 1 pcs | | |
| For models: | R706, R708, S870 | | |

rubber gaskets

| | | | |
|---|---|-----------------|--------|
|  | | | |
| 1 | | | |
| GEV No. | 505396 | Ref. No. | 437107 |
| description | flat gasket rubber ED ø 109mm ID ø 86mm thickness 2.5mm Qty 1 pcs | | |
| For models: | 915611, 915612, 915613, 915614, 915615, 915616, 915617, 915618, 915670, 915671, 915672, 915773, 915774, 915959, 916066, 916077, 916078, 916196, 916197, 916198, 916199, 916200, 916409, 916410, 916418, 916419, 916591, 916592, 916593, 916594, 916595, 916877, 916921, 916922, 916992, 916993, Fast145-2, Fast150, Niagara-241, Niagara-241-2, Niagara-341, Pluvia-240, River-242, River-242-2, River-242-2T, River-342C, River-342T | | |

| | | | |
|---|---|-----------------|--------|
|  | | | |
| 2 | | | |
| GEV No. | 519547 | Ref. No. | 437041 |
| description | flat gasket rubber ED ø 14.4mm ID ø 15.5mm thickness 2mm Qty 1 pcs size 3/4" | | |
| For models: | 050F, 050FP, 10, 11F, 11FD, 11F-DVGW, 11R, 11RD, 12, 14, 21F, 21FD, 21R, 21RD, 22F, 22R, 2312-001, 2312-002, 2312-007, 2312-009-CRP, 25F, 25FD, 25R, 25RD, 30F, 30FD, 30R, 30RD, 31F, 31FD, 31R, 31RD, 350F, 350FD, 350R, 350RD, 35-ELECTRONIC, 35F, 35FD, 35R, 35RD, 400F, 400FD, 400R, 400RD... (Other models you can see in the webshop) | | |

| | | | |
|--|---|-----------------|--------|
|  | | | |
| 1 | | | |
| GEV No. | 510075 | Ref. No. | 437019 |
| description | flat gasket rubber ED ø 22mm ID ø 13mm thickness 1.5mm Qty 1 pcs | | |
| For models: | 10, 12, 14, 22F, 22R, 2312-001, 2312-002, 350F, 350FD, 350R, 350RD, 35-ELECTRONIC, 35F, 35FD, 35R, 35RD, 400F, 400FD, 400R, 400RD, 40-ELECTRONIC, 40F, 40FD, 40R, 40RD, 44F, 45, 450, 46, 460, 67F, 67R, 913289, 913290, 913291, 913292, 913297, 913298, 913299, 913300, 913356, 913357, 913360, 913361, 913363, 913364, 913372, 913373, 913374, 913375...(Other models you can see in the webshop) | | |

| | | | |
|---|--|-----------------|-------|
|  | | | |
| 1 | | | |
| GEV No. | 507544 | Ref. No. | 75402 |
| description | flat gasket rubber ED ø 29mm ID ø 17mm thickness 1mm Qty 1 pcs | | |
| For models: | RIVER-282, River-282-2, River-282L-2, River-282LS-2TDE, River-282S-2TDE, River-285, River-382, River-382-230V-3Ph-50Hz, River-382H, River-382L, River-382L-230V-3Ph-50Hz, River-382LNRG, River-382LTDE, River-382NRG, River-382NRG-230-3Ph-50Hz, River-382TDE, River-482, RV282DD, RV282R, RV382, RV38223TERMO, RV382AHP, RV382FUR, RV382L, RV382L23TERMO, RV382LFUR, RV382LR, RV382LS, RV382LSFUR, RV382LTX, RV382LTXR, RV382R, RV382R23TERMO, RV382RFUR, RV382S, RV382SFUR, RV382TERMO, RV382TX, RV382TXR, RV482 | | |

| | | | |
|---|--|-----------------|--------|
|  | | | |
| 1 | | | |
| GEV No. | 505397 | Ref. No. | 437083 |
| description | flat gasket rubber ED ø 32mm ID ø 19.5mm thickness 1.5mm Qty 1 pcs | | |
| For models: | 913992, 913993, 914583, 914592, 914612, 914613, 914628, 914944, 915143, 915150, 915151, 915152, 915154, 915155, 915157, 915158, 915160, 915161, 915162, 915166, 915167, 915168, 915172, 915173, 915175, 915176, 915177, 915285, 915319, 915338, 915341, 915348, 915418, 915419, 915420, 915421, 915422, 915479, 915492, 915493, 915494, 915495, 915496, 915497, 915547, 915558, 915611, 915612, 915613, 915614...(Other models you can see in the webshop) | | |

| | | | |
|---|---|-----------------|--------|
|  | | | |
| 1 | | | |
| GEV No. | 518240 | Ref. No. | 437078 |
| description | flat gasket rubber ED ø 33mm ID ø 17mm thickness 1.5mm Qty 1 pcs | | |
| For models: | 2312-009-CRP, 67R, 913289, 913290, 913291, 913292, 913356, 913357, 913363, 913364, 913372, 913373, 913374, 913375, 913376, 913377, 913416, 913435, 913544, 913545, 913665, 913666, 913667, 913668, 913685, 913771, 913772, 913773, 913774, 913832, 913837, 913911, 913912, 913948, 913950, 913977, 913984, 913990, 913992, 913993, 914165, 914166, 914206, 914214, 914316, 914317, 914355, 914386, 914387, 914388...(Other models you can see in the webshop) | | |

| | | | |
|--|---|-----------------|--------|
|  | | | |
| 1 | | | |
| GEV No. | 516261 | Ref. No. | 437098 |
| description | flat gasket rubber ED ø 33mm ID ø 25mm thickness 2.5mm for air trap Qty 1 pcs | | |
| For models: | 2312-007, 913992, 913993, 914100, 914101, 914339, 914342, 914343, 914583, 914592, 914612, 914613, 914624, 914625, 914626, 914627, 914628, 914850, 914851, 914854, 914944, 915143, Fast181, FAST-181, Fast181-230V-3Ph-60Hz, Fast181-400V-3NPh-60Hz, NG271, NG291, NG292, NG292HZ, NG293, NG381, NG38123, NG38123TERMO, NG381C, NG381CDD, NG381CFUR, NG381DDHZ23, NG381DDPS, NG381DDPSHZ23, NG381HPDD, NG381L, NG381LC, NG381LCFUR, NG381LDDPS, NG381TERMO, NG381TXCDD, NIAGARA-271, NIAGARA-283, Niagara-283A...(Other models you can see in the webshop) | | |

| | | | |
|---|---|-----------------|--------|
|  | | | |
| 1 | | | |
| GEV No. | 510876 | Ref. No. | 437104 |
| description | flat gasket rubber ED ø 45mm ID ø 33mm thickness 3mm Qty 1 pcs | | |
| For models: | 915154, 915155, 915157, 915158, 915172, 915173, 915285, 915422, 915492, 915493, 915494, 915495, 915496, 915497, 915617, 915618, 915672, 915773, 915774, 916045, 916054, 916066, 916067, 916068, 916069, 916077, 916078, 916079, 916080, 916368, 916418, 916419, 916420, 916421, 916422, 916423, 916424, 916594, 916595, 916654, 916686, 916760, Fast160C, Ocean360-UK, River-242, River-242-2, River-242-2T, River-252, River-252-2, River-252-2T...(Other models you can see in the webshop) | | |





| | | | |
|---|--|-----------------|--------|
|  | | | |
| GEV No. | 513059 | Ref. No. | 437063 |
| description | flat gasket rubber ED ø 52mm ID ø 40mm thickness 3mm Qty 1 pcs | | |
| For models: | 050F, 050FP, 12, 14, 161, 221, 2312-001, 2312-002, 271, 272, 362, 45, 450, 46, 460, 500F, 500FD, 50-ELECTRONIC, 50F, 50FD, 510F, 510FD, 55, 913297, 913298, 913299, 913300, 913360, 913361, 913391, 913392, 913418, 913546, 913547, 913578, 913611, 913684, 913913, 913914, 913932, 913933, 914167, 914168, 914284, 914318, 914319, 914331, 914338, 914356, 914398...(Other models you can see in the webshop) | | |

| | | | |
|---|--|-----------------|--------|
|  | | | |
| GEV No. | 510070 | Ref. No. | 437038 |
| description | flat gasket rubber ED ø 61mm ID ø 41.5mm thickness 3mm Qty 1 pcs | | |
| For models: | 350F, 350FD, 350R, 350RD, 35-ELECTRONIC, 35F, 35FD, 35R, 35RD, 400F, 400FD, 400R, 400RD, 40-ELECTRONIC, 40F, 40FD, 40R, 40RD, 66, R497, R499, R501, R503, R505, R507, R509, R511, R704, R706, R708, S641, S643, S651, S651P, S653, S654, S655, S810, S815, S830, S835, S850, S870, S950, SR651 | | |

| | | | |
|---|--|-----------------|------------------------------|
|  | | | |
| GEV No. | 518205 | Ref. No. | 437079 80182 reb437079 |
| description | flat gasket rubber ED ø 61mm ID ø 47mm thickness 2mm Qty 1 pcs | | |
| For models: | 2312-007, 2312-009-CRP, 80, 81, 82, 913289, 913290, 913291, 913292, 913356, 913357, 913372, 913373, 913374, 913375, 913416, 913435, 913544, 913545, 913665, 913666, 913667, 913668, 913685, 913771, 913772, 913773, 913774, 913832, 913837, 913911, 913912, 913948, 913950, 913977, 913984, 913990, 913992, 913993, 914100, 914101, 914165, 914166, 914206, 914214, 914316, 914317, 914339, 914342, 914343...(Other models you can see in the webshop) | | |

| | | | |
|---|--|-----------------|--------|
|  | | | |
| GEV No. | 518501 | Ref. No. | 437033 |
| description | flat gasket rubber ED ø 68mm ID ø 41.5mm thickness 8mm Qty 1 pcs | | |
| For models: | 66, R704, R706, R708, S651, S651P, S653, S654, S655, S810, S815, S830, S835, S850, S870, S950, SR651 | | |

| | | | |
|---|--|-----------------|--------|
|  | | | |
| GEV No. | 507541 | Ref. No. | 437102 |
| description | flat gasket rubber ED ø 74mm ID ø 57mm thickness 2mm Qty 1 pcs | | |
| For models: | 915150, 915151, 915152, 915154, 915155, 915157, 915158, 915160, 915161, 915162, 915166, 915167, 915168, 915172, 915173, 915175, 915176, 915177, 915285, 915319, 915338, 915341, 915348, 915418, 915419, 915420, 915421, 915422, 915479, 915492, 915493, 915494, 915495, 915496, 915497, 915547, 915558, 915617, 915618, 915635, 915663, 915672, 915747, 915773, 915774, 916020, 916021, 916024, 916025, 916026...(Other models you can see in the webshop) | | |

| | | | |
|---|---|-----------------|--------|
|  | | | |
| GEV No. | 510071 | Ref. No. | 437034 |
| description | flat gasket rubber ED ø 81mm ID ø 68mm thickness 3mm for salt tank Qty 1 pcs | | |
| For models: | 050F, 050FP, 11F, 11FD, 11R, 11RD, 2312-001, 2312-002, 2312-007, 2312-009-CRP, 31F, 31FD, 31R, 31RD, 350F, 350FD, 35-ELECTRONIC, 35F, 35FD, 400F, 400FD, 400R, 400RD, 40-ELECTRONIC, 40F, 40FD, 40R, 40RD, 45, 450, 46, 460, 500F, 500FD, 50-ELECTRONIC, 50F, 50FD, 510F, 510FD, 67F, 67R, 913289, 913290, 913291, 913292, 913297, 913298, 913299, 913300, 913356...(Other models you can see in the webshop) | | |

| | | | |
|---|---|-----------------|--------|
|  | | | |
| GEV No. | 518294 | Ref. No. | 437087 |
| description | flat gasket rubber ED ø 85mm ID ø 71mm thickness 2mm Qty 1 pcs | | |
| For models: | 2312-007, 2312-009-CRP, 914100, 914101, 914339, 914342, 914343, 914624, 914625, 914626, 914627, 914628, 914850, 914851, 914854, 914944, PS-60, RIVER-48, RIVER-50, RIVER-50-CRP, RIVER-50-CRP-SP, RIVER-54, RIVER-54CRP, River-54-CRP-s.p., RIVER-54-CRP-SP, RIVER-61 | | |

| | | | |
|---|---|-----------------|--------|
|  | | | |
| GEV No. | 518060 | Ref. No. | 456040 |
| description | gasket rubber ED ø 132mm ID ø 122mm thickness 5mm | | |
| For models: | 10, 22F, 22R, 40F, 44F, 80, 81, 82, 914326, 914406, 915729, CE78HZ23, CGL74CABT, CLEAN-100, CLEAN-110, E.52, E.55, E.60, E.65, E1, E10, E100, E110, E78, E78HP, Fast181, FAST-181, Fast181-230V-3Ph-60Hz, Fast181-400V-3NPh-60Hz, FAST-63, HM1, KLP105EB, LP105DDTEB, LP105DDTEBN, LP105EB, LP60, NG271, NG291, NG292, NG292HZ, NG293, NIAGARA-271, NIAGARA-283, Niagara-283A, NIAGARA-291, NIAGARA-292, Niagara-292-400V-3Ph-60Hz, NIAGARA-293, RIVER-282, River-285...(Other models you can see in the webshop) | | |

PTFE gaskets

| | | | |
|---|---|-----------------|--------|
|  | | | |
| GEV No. | 507545 | Ref. No. | 437091 |
| description | flat gasket PTFE ED ø 13mm ID ø 7mm thickness 0.65mm Qty 1 pcs | | |
| For models: | 2312-007, 2312-009-CRP, 913992, 913993, 914100, 914101, 914339, 914342, 914343, 914583, 914592, 914612, 914613, 914624, 914625, 914626, 914627, 914628, 914850, 914851, 914854, 914944, 915143, E.55, RIVER-40, RIVER-40-CRP, RIVER-43, RIVER-44, RIVER-44-CRP, RIVER-44-CRP-ST, RIVER-44CRP-ST, RIVER-48, RIVER-50, RIVER-50-CRP, RIVER-50-CRP-SP, RIVER-54, RIVER-54CRP, River-54-CRP-s.p., RIVER-54-CRP-SP, RIVER-61 | | |

| | | | |
|---|---|-----------------|--------|
|  | | | |
| 1 | | | |
| GEV No. | 510012 | Ref. No. | 437008 |
| description | flat gasket PTFE ED ø 16.5mm ID ø 12.5mm thickness 1.5mm Qty 1 pcs equiv. no. 437008 | | |
| For models: | 11F, 11FD, 11F-DVGW, 21F, 21FD, 25F, 25FD, 30F, 30FD, 31F, 31FD, 350F, 350FD, 35-ELECTRONIC, 35F, 35FD, 400F, 400FD, 40-ELECTRONIC, 40F, 40FD, 45, 450, 67R, 913289, 913290, 913291, 913292, 913356, 913357, 913363, 913364, 913372, 913373, 913374, 913375, 913376, 913377, 913416, 913418, 913435, 913544, 913545, 913665, 913666, 913667, 913668, 913685, 913771, 913772...(Other models you can see in the webshop) | | |

| | | | |
|---|--|-----------------|--------|
|  | | | |
| 2 | | | |
| GEV No. | 513725 | Ref. No. | 437100 |
| description | flat gasket PTFE ED ø 21.2mm ID ø 19mm thickness 0.5mm Qty 1 pcs | | |
| For models: | 913297, 913298, 913299, 913300, 913360, 913361, 913391, 913392, 913546, 913547, 913578, 913611, 913684, 913913, 913914, 913932, 913933, 914284, 914318, 914319, 914326, 914331, 914338, 914356, 914400, 914401, 914402, 914403, 914404, 914405, 914406, 914431, 914449, 914517, 914545, 914568, 914642, 914688, 914909, 914979, 915136, 915137, 915140, 915150, 915151, 915152, 915154, 915155, 915157, 915158...(Other models you can see in the webshop) | | |

| | | | |
|---|---|-----------------|--------|
|  | | | |
| 1 | | | |
| GEV No. | 518346 | Ref. No. | 437090 |
| description | flat gasket PTFE ED ø 22mm ID ø 9.2mm thickness 1mm Qty 1 pcs equiv. no. 437090 suitable for COLGED | | |
| For models: | 2312-007, 2312-009-CRP, 913992, 913993, 914100, 914101, 914339, 914342, 914343, 914583, 914592, 914612, 914613, 914624, 914625, 914626, 914627, 914628, 914850, 914851, 914854, 914944, 915143, E.55, RIVER-40, RIVER-40-CRP, RIVER-43, RIVER-44, RIVER-44-CRP, RIVER-44-CRP-ST, RIVER-44CRP-ST, RIVER-48, RIVER-50, RIVER-50-CRP, RIVER-50-CRP-SP, RIVER-54, RIVER-54CRP, RIVER-54-CRP-s.p., RIVER-54-CRP-SP, RIVER-61 | | |

| | | | |
|---|--|-----------------|--------|
|  | | | |
| 1 | | | |
| GEV No. | 518180 | Ref. No. | 303018 |
| description | flat gasket PTFE ED ø 40mm ID ø 35mm thickness 3mm Qty 1 pcs equiv. no. 303018/371450-166 suitable for COLGED, HOBART | | |
| For models: | 913289, 913290, 913291, 913292, 913356, 913357, 913372, 913373, 913374, 913375, 913416, 913435, 913544, 913545, 913665, 913666, 913667, 913668, 913685, 913771, 913772, 913773, 913774, 913832, 913837, 913911, 913912, 913948, 913950, 913977, 913984, 913990, 913992, 913993, 914165, 914166, 914206, 914214, 914316, 914317, 914355, 914386, 914387, 914388, 914389, 914390, 914391, 914392, 914393, 914394...(Other models you can see in the webshop) | | |



shaft gaskets

v-rings

| | | | |
|---|---|-----------------|--------|
|  | | | |
| 1 | | | |
| GEV No. | 696554 | Ref. No. | 499018 |
| description | V-ring for shaft ø 18mm ID ø 16.5mm ED ø 22mm thickness 7.5mm | | |
| For models: | 11R, 11RD, 21R, 21RD, 22R, 25R, 25RD, 30R, 30RD, 31R, 31RD, 67R, E.42, R495, R497, R499, R501, R503, R505, R507, S624, S626, S634, S636, S651, S654, S655, S815, S835 | | |

shaft gaskets

| | | | |
|---|---|-----------------|--------|
|  | | | |
| 1 | | | |
| GEV No. | 699128 | Ref. No. | 927095 |
| description | shaft sealing ED ø 40mm ID ø 30mm H 7mm plastic for vegetable slicer | | |
| For models: | 161, 221, 271, 272, 362, CLEAN-160, CLEAN-161, CLEAN-220, CLEAN-221, CLEAN-270, CLEAN-271, CLEAN-272, CLEAN-361, CLEAN-361P, CLEAN-362, CLEAN-471, CLEAN-471P | | |

| | | | |
|---|---|-----------------|-----------------|
|  | | | |
| 1 | | | |
| GEV No. | 698755 | Ref. No. | 314011 |
| description | shaft sealing ID ø 9mm ED ø 10mm for wash pump | | |
| For models: | 915611, 915612, 915613, 915614, 915615, 915616, 915617, 915618, 915670, 915671, 915672, 915773, 915774, 915959, 916066, 916077, 916078, 916196, 916197, 916198, 916199, 916200, 916409, 916410, 916418, 916419, 916591, 916592, 916593, 916594, 916595, 916877, 916921, 916922, 916992, 916993, Fast145-2, Fast150, Niagara-241, Niagara-241-2, Niagara-341, Pluvia-240, River-242, River-242-2, River-242-2T, River-342C, River-342T | | |
| spare parts for | 698755 | | |
|  | GEV No. | 501503 | Ref. No. |
| | | | 130166 |
| | pump inlet ø 28mm outlet ø 22/27mm type CF 2745 230V 50Hz 1 phase 0.19kW L 175mm rotation direction right capacitor 4µF LGB with capacitor | | |

special gaskets

door seals for dishwashers

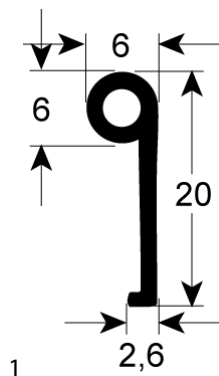

| | | | |
|--------------------|---|-----------------|-------|
| GEV No. | 518123 | Ref. No. | 41247 |
| description | door seal L 1050mm W 6mm H 20mm Qty 1 | | |
| For models: | KLP105EB, KLP201DDDTEB, KLP201EB, KLP301, KLP301DDDTEB, LP105DDDTEB, LP105DDDTEBN, LP105EB, LP201DDDTEB, LP201EB, LP301, LP301EB, NG292, NG293, NIAGARA-292, NIAGARA-293, RIVER-295, RIVER-296, RIVER-297, RIVER-298, RV295, RV296, RV297, RV298, RV298HZ, U132E, U61E, U61HE, U70e | | |

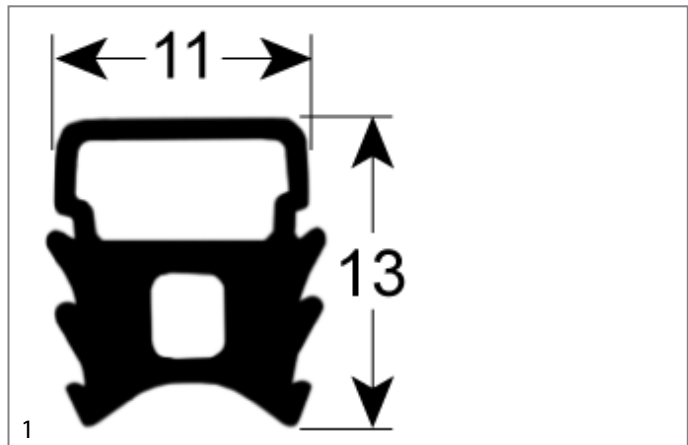

| | | | |
|--------------------|--|-----------------|------------------|
| GEV No. | 518088 | Ref. No. | 437088 437097 |
| description | door seal L 1370mm | | |
| For models: | 2312-007, 2312-009-CRP, 914100, 914101, 914339, 914342, 914343, 914624, 914625, 914626, 914627, 914628, 914850, 914851, 914854, 914944, RIVER-48, RIVER-50, RIVER-50-CRP, RIVER-50-CRP-SP, RIVER-54, RIVER-54CRP, RIVER-54-CRP-s.p., RIVER-54-CRP-SP, RIVER-61 | | |

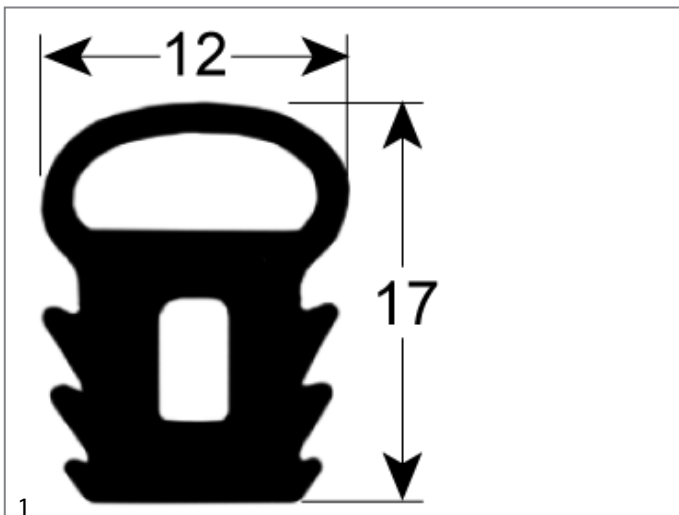

| | | | |
|--------------------|--|-----------------|--------|
| GEV No. | 518252 | Ref. No. | 437071 |
| description | door seal L 1165mm dishwasher | | |
| For models: | 913992, 913993, 914583, 914592, 914612, 914613, 915143, CLEAN-3, RIVER-40, RIVER-40-CRP, RIVER-43, RIVER-44, RIVER-44-CRP, RIVER-44-CRP-ST, RIVER-44CRP-ST | | |

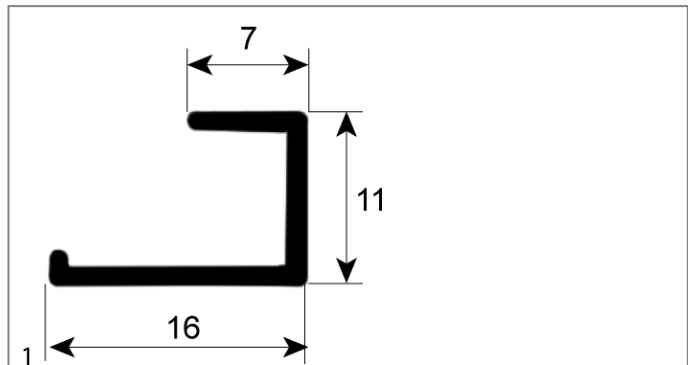

| | | | |
|--------------------|---|-----------------|--------|
| GEV No. | 518246 | Ref. No. | 437057 |
| description | door seal L 395mm dishwasher suitable for ELETTROBAR, WOLK equiv. no. 437057 | | |
| For models: | 350F, 350FD, 350R, 350RD, 35-ELECTRONIC, 35F, 35FD, 35R, 35RD, 913289, 913290, 913356, 913372, 913373, 913544, 913665, 913667, 913771, 913772, 913832, 913837, 914165, 914166, 914206, 914355, 914386, 914387, 914388, 914389, 914390, 914391, 914692, 914693, 914694, 914703, 914870, 915686, 915687, 915688, 915689, 915690, 915691, 916237, 916238, 916239, 916240, 916241, 916401, 916402, 916403...(Other models you can see in the webshop) | | |

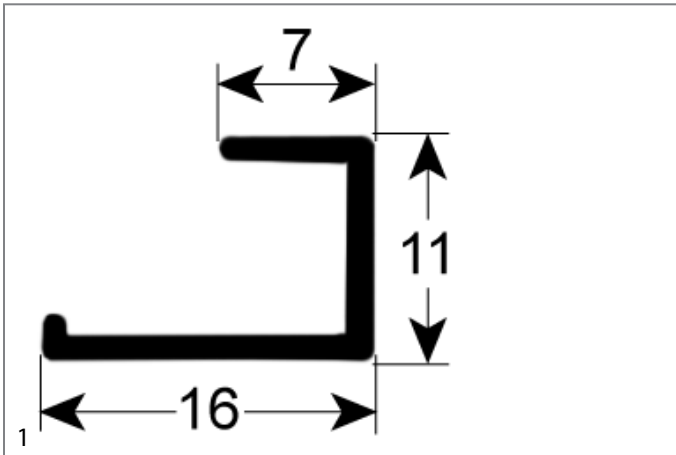

| | | | |
|--------------------|--|-----------------|--------|
| GEV No. | 518248 | Ref. No. | 437058 |
| description | door seal L 430mm dishwasher suitable for ELETTROBAR, WOLK equiv. no. 437058 | | |
| For models: | 400F, 400FD, 400R, 400RD, 40-ELECTRONIC, 40F, 40FD, 40R, 40RD, 67F, 67R, 913291, 913292, 913357, 913374, 913375, 913416, 913435, 913545, 913666, 913668, 913685, 913773, 913774, 913911, 913912, 913948, 913950, 913977, 913984, 913990, 914392, 914393, 914394, 914395, 914396, 914397, 914441, 914442, 914515, 914516, 914537, 914543, 914547, 914683, 914684, 914689, 914863, 915138, 915139... (Other models you can see in the webshop) | | |

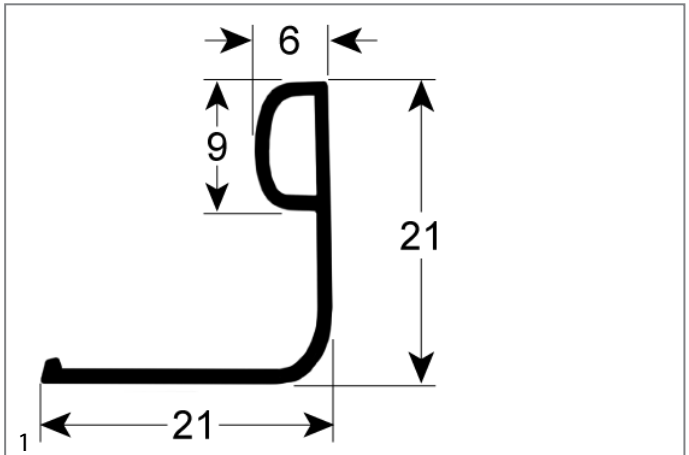

| | | | |
|--------------------|--|-----------------|--------|
| GEV No. | 518300 | Ref. No. | 437075 |
| description | door seal L 590mm dishwasher suitable for ELETTROBAR, WOLK equiv. no. 437075 | | |
| For models: | E.65 | | |

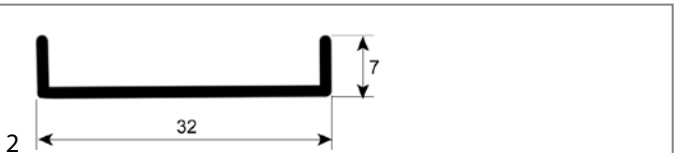

| | | | |
|--------------------|--|-----------------|--------|
| GEV No. | 518535 | Ref. No. | 437051 |
| description | door seal L 450mm dishwasher suitable for ELETTROBAR, WOLK equiv. no. 437051 | | |
| For models: | 11F, 11FD, 11F-DVGW, 11R, 11RD, 913363, 913364, 913376, 913377, E.41, E.42, E.41 | | |

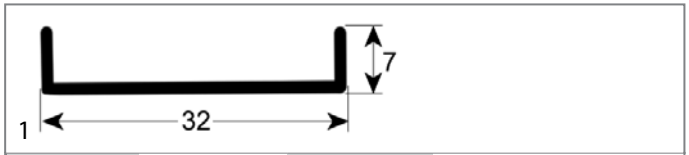

| | | | |
|--------------------|--|-----------------|------------------|
| GEV No. | 518536 | Ref. No. | 437052 437081 |
| description | door seal L 590mm W 32mm dishwasher suitable for ELETTROBAR, WOLK equiv. no. 437052 | | |
| For models: | 050F, 050FP, 22F, 22R, 2312-001, 2312-002, 40F, 913297, 913298, 913299, 913300, 913360, 913361, 913391, 913392, 913546, 913547, 913578, 913611, 913684, 913913, 913914, 913932, 913933, 914284, 914326, 914331, 914356, 914400, 914401, 914402, 914403, 914404, 914405, 914406, 914449, 914517, 914545, 914568, 914642, 914688, 914909, 914979, 915136, 915137, 915140, 915248, 915483, 915484, 915528...(Other models you can see in the webshop) | | |

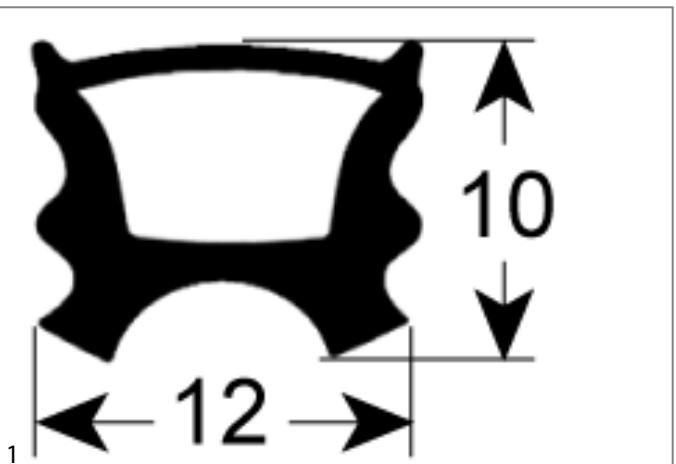

| | | | |
|--------------------|--|-----------------|--------|
| GEV No. | 518613 | Ref. No. | 437103 |
| description | door seal L 555mm W 395mm for dishwasher 3-sided | | |
| For models: | 915150, 915151, 915152, 915154, 915155, 915157, 915158, 915160, 915161, 915162, 915166, 915167, 915168, 915172, 915173, 915175, 915176, 915177, 915285, 915319, 915338, 915341, 915348, 915418, 915419, 915420, 915421, 915422, 915479, 915492, 915493, 915494, 915495, 915496, 915497, 915547, 915558, 915635, 915663, 915747, 916054, 916067, 916068, 916069, 916079, 916080, 916201, 916202, 916203, 916204...(Other models you can see in the webshop) | | |

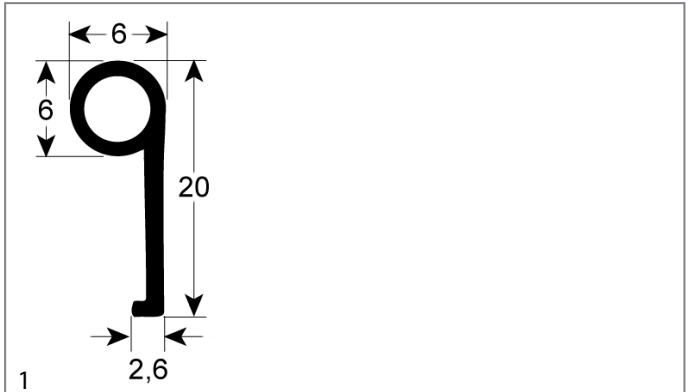

| | | | |
|--------------------|------------------------|-----------------|---------|
| GEV No. | 902025 | Ref. No. | 41247MT |
| description | door seal W 6mm H 20mm | | |



miscellaneous



| | | | |
|--------------------|--------------------------------|-----------------|--------|
| 1 | | | |
| GEV No. | 510066 | Ref. No. | 437053 |
| description | gasket for filter | | |
| For models: | 22F, 22R, 31F, 31FD, 31R, 31RD | | |



| | | | |
|--------------------|--|-----------------|-------|
| 1 | | | |
| GEV No. | 511999 | Ref. No. | 75168 |
| description | gasket for flange ED \varnothing 123mm ID \varnothing 46mm rubber thickness 3mm hole distance 53mm | | |
| For models: | 914380, 914436, A3EB, A3EBD, A3EBDAKRKYK, A3EBDAKWK, A3EBDBKWK, A3EBDRKYK, A3EBDVK, A3EBDYK, A3EBSAK, A3EBSAKRK, A3EBSAKWK, A3EBSBKWKYK, A3EBSEKWK, A3EBSWK, A4EB, A4EBD, A4EBDAKEKYK, A4EBDAKRK, A4EBDAKWK, A4EBDAKZK, A4EBDBKRK, A4EBDPKWKYK, A4EBDRK, A4EBS, A4EBSAK, A4EBSAKCK, A4EBSAKKEYK, A4EBSAKRK, A4EBSAKRKP, A4EBSAKYK, A4EBSCK, A4EBT, A4EBTSAK, A5EB, A5EBD, A5EBDAKPKWK, A5EBDAKWK, A5EBDAKYK, A5EBDRK, A5EBS, A5EBSAKPKWK, A5EBSAKRK, A5EBSAKRKYK, A5EBSAKWK, A5EBSAKWKYK, A5EBSBKRPK, A5EBSBKWK, A5EBSRK...(Other models you can see in the webshop) | | |



| | | | |
|--------------------|-------------------|-----------------|--------|
| 1 | | | |
| GEV No. | 518221 | Ref. No. | 437072 |
| description | gasket for lid | | |
| For models: | CLEAN-3, RIVER-43 | | |



| | | | |
|--------------------|---|-----------------|--------|
| 1 | | | |
| GEV No. | 519406 | Ref. No. | 929209 |
| description | gasket for sliding plate dimensions 69x16mm | | |



| | | | |
|--------------------|--|-----------------|--------|
| 1 | | | |
| GEV No. | 510014 | Ref. No. | 437036 |
| description | gasket suitable for HOBART equiv. no. 139321-155 L 84mm W 40mm thickness 2.5mm | | |
| For models: | 21F, 21FD, 21R, 21RD, 25F, 25FD, 25R, 25RD, 30F, 30FD, 30R, 30RD, 31F, 31FD, 31R, 31RD, S621, S623, S624, S626, S631, S633, S634, S636, S651, S651P, S653, S654, S655, S830, S835, SR651 | | |

gaskets for wash arm support



| | | | |
|--------------------|--|-----------------|--------|
| 1 | | | |
| GEV No. | 518008 | Ref. No. | 437016 |
| description | gasket D1 \varnothing 43mm D2 \varnothing 78mm thickness 2mm with 6 holes wash arm support | | |
| For models: | 66, S651, S651P, S653, S654, S655, S810, S815, S830, S835, S850, SR651 | | |



| | | | |
|--------------------|--|-----------------|--------|
| 1 | | | |
| GEV No. | 518025 | Ref. No. | 437014 |
| description | gasket D1 \varnothing 50mm D2 \varnothing 82mm thickness 2mm with 6 holes wash arm support equiv. no. 437014 suitable for COLGED | | |
| For models: | 050F, 050FP, 10, 12, 14, 22F, 22R, 2312-001, 2312-002, 40F, 440F, 44F, 45, 450, 46, 460, 500F, 500FD, 50F, 50FD, 510F, 510FD, 66, 913297, 913298, 913299, 913300, 913360, 913361, 913391, 913392, 913418, 913546, 913547, 913578, 913611, 913684, 913913, 913914, 913932, 913933, 914167, 914168, 914284, 914318, 914319, 914326, 914331, 914338, 914356...(Other models you can see in the webshop) | | |



| | | | |
|--------------------|---|-----------------|--------|
| 1 | | | |
| GEV No. | 518649 | Ref. No. | 437108 |
| description | gasket D1 \varnothing 64mm D2 \varnothing 49mm thickness 2mm wash arm support | | |
| For models: | 915611, 915612, 915613, 915614, 915615, 915616, 915617, 915618, 915670, 915671, 915672, 915773, 915774, 915959, 916066, 916077, 916078, 916196, 916197, 916198, 916199, 916200, 916409, 916410, 916418, 916419, 916591, 916592, 916593, 916594, 916595, 916877, 916921, 916922, 916992, 916993, Fast145-2, Fast150, Niagara-241, Niagara-241-2, Niagara-341, Pluvia-240, RIVER-242, River-242-2, River-242-2T, River-342C, River-342T | | |



| | | | |
|--------------------|--|-----------------|--------|
| 1 | | | |
| GEV No. | 510054 | Ref. No. | 437046 |
| description | gasket D1 \varnothing 65mm D2 \varnothing 35.5mm thickness 2.5mm with 5 holes wash arm support | | |
| For models: | 11F, 11FD, 11F-DVGW, 11R, 11RD, 67F, 67R, 913363, 913364, 913376, 913377, E.41, E.42, E41 | | |



1

| | | | |
|--------------------|---|-----------------|-------|
| GEV No. | 518656 | Ref. No. | 70476 |
| description | gasket D1 ø 90mm D2 ø 70mm thickness 1.5mm wash arm support | | |
| For models: | NG381L, NG381LC, NG381LCFUR, NG381LDDPS, Niagara-283L-2, Niagara-381L, Niagara-381LC, River-282L-2, River-282LS-2TDE, River-382L, River-382L-230V-3Ph-50Hz, River-382LNRG, River-382LTDE, River-482, RV382L, RV382L23TERMO, RV382LFUR, RV382LR, RV382LS, RV382LSFUR, RV382LTX, RV382LTXR, RV482 | | |



1

| | | | |
|--------------------|--|-----------------|--------|
| GEV No. | 518339 | Ref. No. | 437064 |
| description | gasket D2 ø 50mm thickness 2mm with 3 screw holes wash arm support equiv. no. 437064 suitable for COLGED hole ø 50mm hole distance 67mm | | |
| For models: | 050F, 050FP, 2312-001, 2312-002, 46, 460, 500F, 500FD, 50F, 50FD, 510F, 510FD, 913297, 913298, 913299, 913300, 913360, 913361, 913391, 913392, 913546, 913547, 913578, 913611, 913684, 913913, 913914, 913932, 913933, 914284, 914318, 914319, 914331, 914338, 914356, 914400, 914401, 914402, 914403, 914404, 914405, 914431, 914449, 914517, 914545, 914568, 914642, 914688, 914909, 914979... (Other models you can see in the webshop) | | |



1

| | | | |
|--------------------|--|-----------------|--------|
| GEV No. | 518402 | Ref. No. | 437050 |
| description | gasket with 3 screw holes wash arm support hole distance 61mm D2 ø 34mm thickness 2.5mm hole ø 34mm | | |
| For models: | 22F, 22R, 40F, 440F, 44F, 914380, 914436, 915747, A3EB, A3EBD, A3EBDAKRKYK, A3EBDAKWK, A3EBDBKWK, A3EBDRKYK, A3EBDWK, A3EBDYK, A3EBSAK, A3EBSAKRK, A3EBSAKWK, A3EBSBKWKYK, A3EBSEKWK, A3EBSWK, A4EB, A4EBD, A4EBDAKEYK, A4EBDAKRK, A4EBDAKWK, A4EBDAKZK, A4EBDBKRK, A4EBDPKWKYK, A4EBDRK, A4EBS, A4EBSAK, A4EBSAKCK, A4EBSAKEKYK, A4EBSAKRK, A4EBSAKRKP, A4EBSAKYK, A4EBSCK, A4EBT, A4EBTSAK, A5EB, A5EBD, A5EBDAKP-KWK, A5EBDAKWK, A5EBDAKYK, A5EBDRK, A5EBS, A5EBSAKPKWK, A5EBSAKRK... (Other models you can see in the webshop) | | |

transmission technology and ball bearings

ball bearings

deep-groove ball bearings 2RS



1

| | | | |
|--------------------|---|-----------------|--------|
| GEV No. | 523501 | Ref. No. | 314009 |
| description | deep-groove ball bearing type 608-2RS shaft ø 8mm ED ø 22mm W 7mm with sealing discs deep-groove ball bearing DIN 625-1 | | |
| For models: | 350F, 350FD, 350R, 350RD, 35-ELECTRONIC, 35F, 35FD, 35R, 35RD, 400F, 400FD, 400R, 400RD, 40-ELECTRONIC, 40F, 40FD, 40R, 40RD, 913289, 913290, 913291, 913292, 913356, 913357, 913372, 913373, 913374, 913375, 913416, 913435, 913544, 913545, 913665, 913666, 913667, 913668, 913685, 913771, 913772, 913773, 913774, 913832, 913837, 913911, 913912, 913948, 913950, 913977, 913984, 913990... (Other models you can see in the webshop) | | |



1

| | | | |
|--------------------|--|-----------------|--------|
| GEV No. | 523509 | Ref. No. | 314001 |
| description | deep-groove ball bearing type 6201-2RS shaft ø 12mm ED ø 32mm W 10mm with sealing discs deep-groove ball bearing DIN 625-1 | | |
| For models: | 050F, 050FP, 10, 11F, 11FD, 11F-DVGW, 11R, 11RD, 21F, 21FD, 21R, 21RD, 2312-001, 2312-002, 2312-007, 2312-009-CRP, 25F, 25FD, 25R, 25RD, 30F, 30FD, 30R, 30RD, 31F, 31FD, 31R, 31RD, 45, 450, 46, 460, 500F, 500FD, 50-ELECTRONIC, 50F, 50FD, 510F, 510FD, 67F, 67R, 913297, 913298, 913299, 913300, 913360, 913361, 913363, 913364, 913376... (Other models you can see in the webshop) | | |



1

| | | | |
|--------------------|--|-----------------|--------|
| GEV No. | 523511 | Ref. No. | 314003 |
| description | deep-groove ball bearing type 6203-2RS shaft ø 17mm ED ø 40mm W 12mm with sealing discs deep-groove ball bearing DIN 625-1 | | |
| For models: | 22F, 40F, 440F, 44F, 55, 66, CLEAN-120, E.52, E12, E120, E14, E140, S651, S654, S810, S815, S830, S835, S850, S870 | | |



deep-groove ball bearings 2Z



| | | | |
|--------------------|---|-----------------|--------|
| GEV No. | 523539 | Ref. No. | 314005 |
| description | deep-groove ball bearing shaft \varnothing 20mm ED \varnothing 47mm W 14mm type 6204-2Z DIN 625-1 | | |

springs

compression springs



| | | | |
|--------------------|--|-----------------|-----------------|
| GEV No. | 696750 | Ref. No. | 927244 CMT13 |
| description | compression spring \varnothing 20mm L 89.5mm wire gauge \varnothing 2mm windings 14 zinc-coated steel | | |
| For models: | 161, 221, 271, 272, 362, 914380, 914436, 915773, A3EB, A3EBD, A3EBDAKRKYK, A3EBDAKWK, A3EBDBKWK, A3EBDRKYK, A3EBDVK, A3EBDYK, A3EBSAK, A3EBSAKRK, A3EBSAKWK, A3EBSBKWKYK, A3EBSEKWK, A3EBSWK, A4EB, A4EBD, A4EBDAKEKYK, A4EBDAKRK, A4EBDAKWK, A4EBDAKZK, A4EBDBKRK, A4EBDPKWKYK, A4EBDRK, A4EBS, A4EBSAK, A4EBSAKCK, A4EBSAKEKYK, A4EBSAKRK, A4EBSAKRKP, A4EBSAKYK, A4EBSCK, A4EBT, A4EBTSAK, A5EB, A5EBD, A5EBDAKPKWK, A5EBDAKWK, A5EBDAKYK, A5EBDRK, A5EBS, A5EBSAKPKWK, A5EBSAKRK...(Other models you can see in the webshop) | | |

spring compressors



| | | | |
|--------------------|---|-----------------|--------|
| GEV No. | 513119 | Ref. No. | 926009 |
| description | spring compressor | | |
| For models: | 10, 12, 14, 80, 81, 82, CE78HZ23, CGL74CABT, CNT800CH, E100, E110, E120, E140, E78, E78HP, Fast180, Fast180-230V-3Ph-60Hz, Fast181, FAST-181, Fast181-230V-3Ph-60Hz, Fast181-400V-3NPh-60Hz, FAST-60, FAST-73, HM1, NG281, NG281CDD, NG281HP, NG281HPDD, NG281HZ23, NG281HZ23DD, NG381, NG38123, NG38123TERMO, NG381C, NG381CDD, NG381CFUR, NG381DDHZ23, NG381DDPS, NG381DDPSHZ23, NG381HPDD, NG381L, NG381LC, NG381LCFUR, NG381LDDPS, NG381TERMO, NG381TXCDD, Niagara-281, Niagara-281-2, Niagara-281HP, NIAGARA-283...(Other models you can see in the webshop) | | |

gas tension springs

gas tension springs



| | | | |
|--------------------|--|-----------------|-------|
| GEV No. | 701299 | Ref. No. | 35070 |
| description | gas tension spring 50N hub 150mm D1 \varnothing 15mm D2 \varnothing 6mm hole distance 365.5mm hole \varnothing 6.5mm L 380mm | | |
| For models: | 914214, 914316, 914317, 914318, 914319, 914338, 914431, 914874, LP60, Mistral40, MISTRAL-40, Mistral51, MISTRAL-51, NG271, NG291, NIAGARA-271, NIAGARA-291, RIVER-294, RIVER-71, RV294, RV71, U60E | | |

roller springs

roller springs



| | | | |
|--------------------|---|-----------------|--------|
| GEV No. | 511910 | Ref. No. | 927267 |
| description | roller spring complete incl. holder W 39mm ID \varnothing mm lug length 67mm | | |
| For models: | 161, 221, 271, 272, 362, CLEAN-160, CLEAN-161, CLEAN-220, CLEAN-221, CLEAN-270, CLEAN-271, CLEAN-272, CLEAN-361, CLEAN-361P, CLEAN-362, CLEAN-471, CLEAN-471P | | |



| | | | |
|--------------------|--|-----------------|------------------|
| GEV No. | 518029 | Ref. No. | 927268 927269 |
| description | roller spring complete incl. holder W 50mm ID \varnothing mm lug length 68mm | | |
| For models: | 271, 362, CLEAN-161, CLEAN-221, CLEAN-270, CLEAN-271, CLEAN-272, CLEAN-361, CLEAN-362, CLEAN-471 | | |



| | | | |
|--------------------|---|-----------------|-------|
| GEV No. | 517449 | Ref. No. | 75271 |
| description | roller spring L 95mm W 66mm | | |
| For models: | 914380, 914436, A3EB, A3EBD, A3EBDAKRKYK, A3EBDAKWK, A3EBDBKWK, A3EBDRKYK, A3EBDVK, A3EBDYK, A3EBSAK, A3EBSAKRK, A3EBSAKWK, A3EBSBKWKYK, A3EBSEKWK, A3EBSWK, A4EB, A4EBD, A4EBDAKEKYK, A4EBDAKRK, A4EBDAKWK, A4EBDAKZK, A4EBDBKRK, A4EBDPKWKYK, A4EBDRK, A4EBS, A4EBSAK, A4EBSAKCK, A4EBSAKEKYK, A4EBSAKRK, A4EBSAKRKP, A4EBSAKYK, A4EBSCK, A4EBT, A4EBTSAK, A5EB, A5EBD, A5EBDAKPKWK, A5EBDAKWK, A5EBDAKYK, A5EBDRK, A5EBS, A5EBSAKPKWK, A5EBSAKRK, A5EBSAKRKYK, A5EBSAKWK, A5EBSAKWKYK, A5EBSBKWK, A5EBSBKWKYK, A5EBSRK...(Other models you can see in the webshop) | | |





| | | | |
|--------------------|--|-----------------|--------|
| GEV No. | 517452 | Ref. No. | 927020 |
| description | roller spring W 38.5mm ID \varnothing 24mm lug lengthmm mounting distance 22mm | | |
| For models: | CLEAN-160, CLEAN-220, CLEAN-270, CLEAN-271, CLEAN-361, CLEAN-361P, CLEAN-471, CLEAN-471P | | |

| | | | |
|---|--|-----------------|--------|
|  | | | |
| 1 | | | |
| GEV No. | 517453 | Ref. No. | 927310 |
| description | roller spring W 51mm ID ø 28mm lug lengthmm mounting distance 22mm | | |

| | | | |
|---|---|-----------------|-------|
|  | | | |
| 1 | | | |
| GEV No. | 517450 | Ref. No. | 77560 |
| description | roller spring W 51mm ID ø 31mm lug length 90mm | | |
| For models: | A4EB, A4EBD, A4EBDAKEKYK, A4EBDAKRK, A4EBDAKWK, A4EBDAKZK, A4EBDBKRK, A4EBDPKWYK, A4EBDRK, A4EBS, A4EBSAK, A4EBSAKCK, A4EBSAKEKYK, A4EBSAKRK, A4EBSAKRKP, A4EBSAKYK, A4EBSCK, A4EBT, A4EBTSAK, A5EB, A5EBD, A5EBDAKPKWK, A5EBDAKWK, A5EBDAKYK, A5EBDRK, A5EBS, A5EBSAKPKWK, A5EBSAKRK, A5EBSAKRKYK, A5EBSAKWK, A5EBSAKWKYK, A5EBSBKRKP, A5EBSBKWK, A5EBSRK, A5EBSYK, GL284EB, GL284EBD, GL284EBDA, GL284EBDAEW, GL284EBDAWY, GL284EBDPWY, GL284EBDR, GL284EBDY, GL284EBHZ23, GL284EBHZ23DBHZY, GL284EBHZ23DBWY, GL284EBHZ23DBY, GL284EBHZ23DY, GL284EBHZ23SAP, GL284EBS...(Other models you can see in the webshop) | | |

tension springs

| | | | |
|---|--|-----------------|------------------|
|  | | | |
| 1 | | | |
| GEV No. | 701154 | Ref. No. | 449059 449063 |
| description | tension spring ø 10.5mm total length 200mm wire gauge ø 1.3mm for door mechanism | | |
| For models: | 915160, 915161, 915162, 915166, 915167, 915168, 915172, 915173, 915175, 915176, 915177, 915285, 915319, 915338, 915341, 915348, 915418, 915419, 915420, 915421, 915422, 915479, 915496, 915497, 915547, 915558, 915635, 915663, 915747, 916054, 916068, 916069, 916080, 916205, 916206, 916207, 916208, 916209, 916365, 916366, 916367, 916368, 916414, 916415, 916416, 916417, 916422, 916423, 916424, 916684...(Other models you can see in the webshop) | | |

| | | | |
|---|---|-----------------|--------|
|  | | | |
| 1 | | | |
| GEV No. | 518260 | Ref. No. | 449049 |
| description | tension spring ø 10mm total length 145mm wire gauge ø 1mm | | |
| For models: | 2312-007, 2312-009-CRP, 67R, 913992, 913993, 914100, 914101, 914214, 914316, 914317, 914318, 914319, 914338, 914339, 914342, 914343, 914431, 914583, 914592, 914612, 914613, 914624, 914625, 914626, 914627, 914628, 914850, 914851, 914854, 914874, 914944, 915143, 915150, 915151, 915152, 915154, 915155, 915157, 915158, 915492, 915493, 915494, 915495, 916067, 916079, 916201, 916202, 916203, 916204, 916411...(Other models you can see in the webshop) | | |

| | | | |
|--|--|-----------------|--------------------------------|
|  | | | |
| 1 | | | |
| GEV No. | 701227 | Ref. No. | 449057 H.227855 H.231937 |
| description | tension spring ø 10mm total length 155mm wire gauge ø 1.1mm L1 60mm L2 11mm for door mechanism | | |
| For models: | 2312-007, 2312-009-CRP, 914100, 914101, 914339, 914342, 914343, 914624, 914625, 914626, 914627, 914628, 914850, 914851, 914854, 914944, RIVER-48, RIVER-50, RIVER-50-CRP, RIVER-50-CRP-SP, River-54, RIVER-54CRP, River-54-CRP-s.p., RIVER-54-CRP-SP, RIVER-61 | | |

| | | | |
|--|---|-----------------|--------|
|  | | | |
| 1 | | | |
| GEV No. | 513206 | Ref. No. | 926007 |
| description | tension spring ø 29.8mm total length 513mm wire gauge ø 5.8mm | | |
| For models: | 10, 12, 14, 80, 81, 82, CE78HZ23, CGL74CABT, CLEAN-100, CLEAN-110, CLEAN-120, CNT800CH, E1, E10, E100, E110, E12, E120, E14, E140, E78, E78HP, Fast180, Fast180-230V-3Ph-60Hz, Fast181, FAST-181, Fast181-230V-3Ph-60Hz, Fast181-400V-3NPh-60Hz, FAST-60, FAST-73, HM1, Niagara-283A, PLUVIA-280, Pluvia280-230V-3PH-60HZ, PS-60, PV280, PV280FAST, PV280FAST2, PV280FAST2BIO, PV280FAST2HZ23, PV-280FASTCH, PV280FASTHB, PV280HZ23, RIVER-78, RIVER-80, River-81, River-81CRP, RIVER-81-CRP, RIVER-82, River-82CRP...(Other models you can see in the webshop) | | |

| | | | |
|--|--|-----------------|--------|
|  | | | |
| 1 | | | |
| GEV No. | 517448 | Ref. No. | 926108 |
| description | tension spring ø 30mm total length 505mm wire gauge ø 5.5mm for hood mechanics Qty 1 pcs | | |
| For models: | 80, 81, 82, CGL74CABT, NG281, NG281CDD, NG281HP, NG281HPDD, NG281HZ23, NG281HZ23DD, NG381, NG38123, NG38123TERMO, NG381C, NG381CDD, NG381CFUR, NG381DDHZ23, NG381DDPS, NG381DDPSHZ23, NG381HPDD, NG381L, NG381LC, NG381LCFUR, NG381LDDPS, NG381TERMO, NG381TXCDD, NIAGARA-281, Niagara-281-2, Niagara-281HP, NIAGARA-283, Niagara-283L-2, Niagara-381, Niagara-381-230V-3Ph-50Hz, Niagara-381-230V-3Ph-60Hz, Niagara-381DP, Niagara-381HPD, Niagara-381L, Niagara-381LC, OC380, OC-380FUR, OC380HZ23, Ocean380, RIVER-282, River-282-2, River-282L-2, River-282LS-2TDE, River-282S-2TDE, River-285, River-382, River-382-230V-3Ph-50Hz...(Other models you can see in the webshop) | | |

| | | | |
|--|--|-----------------|-------|
|  | | | |
| 1 | | | |
| GEV No. | 517451 | Ref. No. | 35020 |
| description | tension spring ø 8mm total length 150mm wire gauge ø 1mm Qty 1 pcs | | |
| For models: | LP60, NG271, NG291, NIAGARA-271, NIAGARA-291, RIVER-294, RIVER-71, RV294, RV71, U60E | | |



dosing pumps

peristaltic dosing pumps







BORES

built-in version

with flow control



1

| | | | |
|---|--|-----------------|--------|
| GEV No. | 361027 | Ref. No. | 209009 |
| description | dosing pump BORES flow control 0.72l/h 230VAC detergent hose ø 4x6mm hose type 361130 hose Santoprene type Perios CODE P1D | | |
| For models: | 45, 450, 46, 460 | | |
| spare parts for | 361027 | | |
| | GEV No. | Ref. No. | — |
|  | 361128 | | |
| | pump hose Perios detergent hose ø 4x7mm hose type Santoprene L 120mm | | |
| | GEV No. | Ref. No. | 143181 |
|  | 361130 | | |
| | pump hose Perios detergent hose ø 4x7mm hose type Santoprene | | |
| | GEV No. | Ref. No. | — |
|  | 361464 | | |
| | roller assembly rinse aid/detergent hose type Santoprene/silicone pump type Perios | | |
| accessories for | 361027 | | |
| | GEV No. | Ref. No. | — |
|  | 361142 | | |
| | mounting set detergent hose type 4x6mm hose length 2m PVC 2x hose/container filter/tank intake transparent | | |
| | GEV No. | Ref. No. | 143194 |
|  | 520090 | | |
| | PVC hose ID ø 4mm ED ø 6mm L 2m thickness 1mm t.max. 60°C transparent | | |
| | GEV No. | Ref. No. | — |
|  | 520091 | | |
| | nylon hose ID ø 4mm ED ø 6mm L 2m thickness 1mm operating p. 10bar burst p. 50bar t.max. 100°C transparent | | |

with time control



1

| | | | |
|--------------------|--|-----------------|-------|
| GEV No. | 361216 | Ref. No. | DWD11 |
| description | dosing pump time control rinse aid type PD2.0 230V voltage AC hose ø 4x6mm hose silicone | | |

GERMAC

built-in version

without control



1

| | | | |
|---|---|-----------------|--------|
| GEV No. | 361022 | Ref. No. | 209014 |
| description | dosing pump GERMAC without control 2l/h 230VAC detergent hose ø 4x6mm hose thermoplastic type G200 built-in version dimensions 55x70x88mm | | |
| spare parts for | 361022 | | |
| | GEV No. | Ref. No. | — |
|  | 361263 | | |
| | roller assembly GERMAC suitable for G80/82/150/152/200/202/250 /252/600 | | |
| | GEV No. | Ref. No. | — |
|  | 361554 | | |
| | pump hose GERMAC detergent hose type thermoplastic hose ø 5x8mm for model G200/G250/G252 | | |
| accessories for | 361022 | | |
| | GEV No. | Ref. No. | 143194 |
|  | 520090 | | |
| | PVC hose ID ø 4mm ED ø 6mm L 2m thickness 1mm t.max. 60°C transparent | | |
| | GEV No. | Ref. No. | — |
|  | 520091 | | |
| | nylon hose ID ø 4mm ED ø 6mm L 2m thickness 1mm operating p. 10bar burst p. 50bar t.max. 100°C transparent | | |

SEKO

built-in version







with frequency control







1



| | | | |
|---|--|-----------------|--------|
| GEV No. | 361767 ¹ | Ref. No. | 209021 |
| description | dosing pump SEKO 3l/h 230VAC detergent hose ø 4x6mm hose type K hose Santoprene suction level 1.5m type NBR 3 8W built-in version peristaltic pump | | |
| For models: | 913291, 913292, 913297, 913298, 913299, 913300, 913357, 913360, 913361, 913363, 913364, 913374, 913375, 913376, 913377, 913391, 913392, 913416, 913418, 913435, 913545, 913546, 913547, 913578, 913611, 913666, 913668, 913684, 913685, 913773, 913774, 913911, 913912, 913913, 913914, 913932, 913933, 913948, 913950, 913977, 913984, 913990, 913992, 913993, 914100, 914101, 914165, 914166, 914167, 914168...(Other models you can see in the webshop) | | |
| spare parts for | 361767 | | |
| | GEV No. | Ref. No. | — |
|  | 361815 | | |
| | pump hose detergent hose ø 6x10mm hose ø 4x6mm hose type K hose Santoprene type SEKO | | |

¹incl. inlet and conveyor hose



| | | | | | | | |
|---|--|---|---------|--------|----------|--------|--|
|  | | | | | | | |
| 1 | | | | | | | |
| GEV No. | 361215 | Ref. No. | 209016 | | | | |
| description | dosing pump SEKO frequency control 0.3-3.0l/h 230VAC detergent hose ø 4x6mm hose type K hose Santoprene suction level 1.5m type PBR protection IP55 dimensions 100x67x68mm power input 3.5W | | | | | | |
| For models: | 2312-001, 2312-002, 2312-007, 2312-009-CRP, 31F, 31FD, 31R, 31RD, 67F, 67R, 80, 81, 82, 913289, 913290, 913356, 913372, 913373, 913544, 913665, 913667, 913771, 913772, 913832, 913837, 914214, 914316, 914317, 914339, 914342, 914343, 914386, 914387, 914388, 914390, 914391, 914626, 914692, 914693, 914694, 914703, 914870, 914874, CGL74CABT, E.35, E.35-Elettrobar, E.35H, E.35H-Elettrobar, E.40, E.40H...(Other models you can see in the webshop) | | | | | | |
| spare parts for | 361215 | | | | | | |
| |  | <table border="1"> <tr> <td>GEV No.</td> <td>361136</td> <td>Ref. No.</td> <td>—</td> </tr> </table> | GEV No. | 361136 | Ref. No. | — | roller assembly for dosing pump hole ø 4.8x4mm |
| GEV No. | 361136 | Ref. No. | — | | | | |
| |  | <table border="1"> <tr> <td>GEV No.</td> <td>361226</td> <td>Ref. No.</td> <td>—</td> </tr> </table> | GEV No. | 361226 | Ref. No. | — | PCB L 59mm W 26mm electronic control |
| GEV No. | 361226 | Ref. No. | — | | | | |
| |  | <table border="1"> <tr> <td>GEV No.</td> <td>361815</td> <td>Ref. No.</td> <td>—</td> </tr> </table> | GEV No. | 361815 | Ref. No. | — | pump hose detergent hose ø 6x10mm hose ø 4x6mm hose type K hose Santoprene type SEKO |
| GEV No. | 361815 | Ref. No. | — | | | | |
| accessories for | 361215 | | | | | | |
| |  | <table border="1"> <tr> <td>GEV No.</td> <td>361142</td> <td>Ref. No.</td> <td>—</td> </tr> </table> | GEV No. | 361142 | Ref. No. | — | mounting set detergent hose type 4x6mm hose length 2m PVC 2x hose/container filter/tank intake transparent |
| GEV No. | 361142 | Ref. No. | — | | | | |
| |  | <table border="1"> <tr> <td>GEV No.</td> <td>520090</td> <td>Ref. No.</td> <td>143194</td> </tr> </table> | GEV No. | 520090 | Ref. No. | 143194 | PVC hose ID ø 4mm ED ø 6mm L 2m thickness 1mm t.max. 60°C transparent |
| GEV No. | 520090 | Ref. No. | 143194 | | | | |
| |  | <table border="1"> <tr> <td>GEV No.</td> <td>520091</td> <td>Ref. No.</td> <td>—</td> </tr> </table> | GEV No. | 520091 | Ref. No. | — | nylon hose ID ø 4mm ED ø 6mm L 2m thickness 1mm operating p. 10bar burst p. 50bar t.max. 100°C transparent |
| GEV No. | 520091 | Ref. No. | — | | | | |

| | | | | | | | |
|---|--|---|------------------|--------|----------|--------|--|
|  | | | | | | | |
| 1 | | | | | | | |
| GEV No. | 361949 | Ref. No. | 209034 209037 | | | | |
| description | dosing pump SEKO frequency control 0.4l/h 230VAC rinse aid hose ø 4x6mm hose type E hose Sekobril suction level 1.5m type NBR 0.4 | | | | | | |
| For models: | 913363, 913364, 915160, 915161, 915162, 915175, 915319, 915611, 915612, 915613, 915663, 915670, 915695, 915696, 916237, 916238, 916239, 916240, 916241, 916242, 916243, 916244, 916245, 916246, 916247, 916248, 916249, 916250, 916251, 916252, 916365, 916366, 916382, 916383, 916401, 916402, 916403, 916404, 916405, 916406, 916407, 916408, 916451, 916452, 916504, 916583, 916584, 916670, 916687, 916688...(Other models you can see in the webshop) | | | | | | |
| accessories for | 361949 | | | | | | |
| |  | <table border="1"> <tr> <td>GEV No.</td> <td>361925</td> <td>Ref. No.</td> <td>143266</td> </tr> </table> | GEV No. | 361925 | Ref. No. | 143266 | pump hose SEKO rinse aid hose ø 3x8mm with backflow preventer hose ø 6mm hose type E hose Sekobril |
| GEV No. | 361925 | Ref. No. | 143266 | | | | |

| | | | | | | | |
|--|--|---|------------------|--------|----------|--------|--|
|  | | | | | | | |
| 1 | | | | | | | |
| GEV No. | 361948 | Ref. No. | 209029 209038 | | | | |
| description | dosing pump SEKO frequency control 3l/h 230VAC detergent hose ø 4x6mm hose type L hose Santoprene suction level 1.5m type NBR 3 | | | | | | |
| For models: | 913363, 913364, 915160, 915161, 915162, 915175, 915319, 915479, 915611, 915612, 915613, 915614, 915615, 915616, 915635, 915663, 915670, 915671, 915686, 915687, 915688, 915689, 915690, 915691, 915692, 915693, 915694, 915695, 915696, 915697, 915698, 915699, 915700, 915701, 915702, 915747, 915756, 915799, 915800, 915819, 915830, 915959, 916162, 916237, 916238, 916239, 916240, 916241, 916242, 916243...(Other models you can see in the webshop) | | | | | | |
| spare parts for | 361948 | | | | | | |
| |  | <table border="1"> <tr> <td>GEV No.</td> <td>362004</td> <td>Ref. No.</td> <td>143267</td> </tr> </table> | GEV No. | 362004 | Ref. No. | 143267 | dosing hose SEKO detergent hose ø 6x9mm hose length 138mm hose ø 4x6mm hose type L hose Santoprene |
| GEV No. | 362004 | Ref. No. | 143267 | | | | |

| | | | | | | | |
|---|--|---|----------------------------|--------|----------|--------|--|
| without control | | | | | | | |
|  | | | | | | | |
| 1 | | | | | | | |
| GEV No. | 361902 | Ref. No. | 209028 209039 999296 | | | | |
| description | dosing pump SEKO 3l/h 230VAC detergent hose ø 4x6mm hose type L hose Santoprene suction level 1.5m type NPG 3 | | | | | | |
| For models: | 915154, 915155, 915157, 915158, 915172, 915173, 915285, 915422, 915492, 915493, 915494, 915495, 915496, 915497, 915617, 915618, 915672, 915773, 915774, 916020, 916021, 916024, 916025, 916026, 916027, 916030, 916031, 916045, 916054, 916066, 916067, 916068, 916069, 916077, 916078, 916079, 916080, 916181, 916183, 916184, 916185, 916196, 916197, 916198, 916199, 916200, 916201, 916202, 916203, 916204...(Other models you can see in the webshop) | | | | | | |
| spare parts for | 361902 | | | | | | |
| |  | <table border="1"> <tr> <td>GEV No.</td> <td>362004</td> <td>Ref. No.</td> <td>143267</td> </tr> </table> | GEV No. | 362004 | Ref. No. | 143267 | dosing hose SEKO detergent hose ø 6x9mm hose length 138mm hose ø 4x6mm hose type L hose Santoprene |
| GEV No. | 362004 | Ref. No. | 143267 | | | | |



| | | | |
|---|--|-----------------|--------------------------------------|
|  | | | |
| 1 | | | |
| GEV No. | 361929 ¹ | Ref. No. | 209024 209033 209036 999309 |
| description | dosing pump SEKO without control 0.4l/h 230VAC rinse aid hose ø 4x6mm hose type E hose Sekobril suction level 1.5m type NPG 0.4 8W cable length 45mm built-in version with backflow preventer | | |
| For models: | 915154, 915155, 915157, 915158, 915172, 915173, 915422, 915492, 915493, 915494, 915495, 915496, 915497, 915617, 915618, 915672, 915773, 915774, 916020, 916021, 916024, 916025, 916026, 916027, 916030, 916031, 916045, 916054, 916066, 916067, 916068, 916069, 916077, 916078, 916079, 916080, 916181, 916183, 916184, 916185, 916196, 916197, 916198, 916199, 916200, 916201, 916202, 916203, 916204, 916205...(Other models you can see in the webshop) | | |
| spare parts for | 361929 | | |
| | GEV No. | Ref. No. | 143266 |
| |  pump hose SEKO rinse aid hose ø 3x8mm with backflow preventer hose ø 6mm hose type E hose Sekobril | | |

¹with accessories



| | | | |
|---|--|-----------------|------------------|
| spare parts | | | |
|  | | | |
| 1 | | | |
| GEV No. | 698712 | Ref. No. | 143219 143258 |
| description | dosing hose SEKO detergent hose ø 4x8.6mm hose ø 4x6mm hose type H hose Santoprene | | |
| For models: | 2312-001, 2312-002, 2312-007, 2312-009-CRP, 913289, 913290, 913291, 913292, 913297, 913298, 913299, 913300, 913356, 913357, 913360, 913361, 913372, 913373, 913374, 913375, 913391, 913392, 913416, 913418, 913435, 913544, 913545, 913546, 913547, 913578, 913611, 913665, 913666, 913667, 913668, 913684, 913685, 913771, 913772, 913773, 913774, 913832, 913837, 913911, 913912, 913913, 913914, 913932, 913933, 913948...(Other models you can see in the webshop) | | |

| | | | |
|---|--|-----------------|--------|
|  | | | |
| 1 | | | |
| GEV No. | 362004 | Ref. No. | 143267 |
| description | dosing hose SEKO detergent hose ø 6x9mm hose length 138mm hose ø 4x6mm hose type L hose Santoprene | | |
| For models: | 915160, 915161, 915162, 915175, 915319, 915611, 915612, 915613, 915617, 915618, 915663, 915670, 916020, 916021, 916024, 916025, 916026, 916027, 916030, 916031, 916045, 916066, 916067, 916068, 916069, 916077, 916078, 916079, 916080, 916181, 916183, 916184, 916185, 916196, 916197, 916198, 916199, 916200, 916201, 916202, 916203, 916204, 916205, 916206, 916207, 916237, 916238, 916239...(Other models you can see in the webshop) | | |

| | | | |
|--|---|-----------------|--------|
|  | | | |
| 1 | | | |
| GEV No. | 698710 ¹ | Ref. No. | 143261 |
| description | dosing hose SEKO rinse aid hose ø 5x10mm hose length 116mm with backflow preventer hose ø 4x6mm hose type F hose Sekobril | | |
| For models: | 913363, 913364, 915154, 915155, 915157, 915158, 915172, 915173, 915422, 915492, 915493, 915494, 915495, 915496, 915497, 915617, 915618, 915672, 915773, 915774, 916054, 916788, E41, Fast140, NG381LCFUR, Niagara-283L-2, River-242, RIVER-252, River-253, RIVER-262, River-282L-2, RV382LFUR | | |

¹with backflow preventer

| | | | |
|--|---|-----------------|--------|
|  | | | |
| 1 | | | |
| GEV No. | 698711 | Ref. No. | 143259 |
| description | dosing hose SEKO rinse aid hose ø 6x10mm hose length 113mm hose ø 4x6mm hose type G hose Sekobril | | |
| For models: | 915285, RIVER-262 | | |

| | | | |
|--|---|-----------------|--------|
|  | | | |
| 1 | | | |
| GEV No. | 361135 | Ref. No. | 143251 |
| description | pump hose SEKO rinse aid hose ø 3x8mm hose ø 4x6mm hose type D hose Sekobril | | |
| For models: | A3EBDAKRKYK, A3EBDRKYK, A4EBDAKEKYK, A4EBDPKWKYK, A4EBSAKKYK, A5EBDAKYK, A5EBSAKRKYK, A5EBSAKWKYK | | |
| spare parts for | 361135 | | |
| | GEV No. | Ref. No. | — |
| |  union nut for hose connector ø 17mm | | |



| | | | |
|--|--|-----------------|--------|
|  | | | |
| 1 | | | |
| GEV No. | 361925 ¹ | Ref. No. | 143266 |
| description | pump hose SEKO rinse aid hose ø 3x8mm with backflow preventer hose ø 6mm hose type E hose Sekobril | | |
| For models: | 913363, 915160, 915161, 915162, 915175, 915319, 915611, 915612, 915613, 915617, 915618, 915663, 915670, 915695, 915696, 916020, 916021, 916024, 916025, 916026, 916027, 916030, 916031, 916045, 916066, 916067, 916068, 916069, 916077, 916078, 916079, 916080, 916181, 916183, 916184, 916185, 916196, 916197, 916198, 916199, 916200, 916201, 916202, 916203, 916204, 916205, 916206, 916207, 916208, 916209...(Other models you can see in the webshop) | | |

¹with backflow preventer

piston pumps

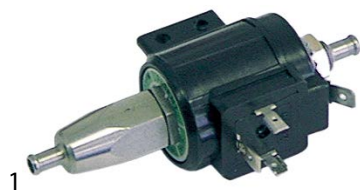
with solenoid coil



| | | | |
|---|--|-----------------|----------------------------------|
| GEV No. | 361026 | Ref. No. | 987017 |
| description | dosing pump inlet 5mm outlet 5mm 230V detergent duty cycle 30% type EV1 | | |
| For models: | 10, 11F, 11FD, 11F-DVGW, 11R, 11RD, 12, 14, 22F, 22R, 40F, 440F, 44F, 45, 450, 46, 460, 66, CLEAN-100, CLEAN-110, CLEAN-120, CLEAN-3, E.45, E.46, TF-503, TF-513, TF-515 | | |
| spare parts for | 361026 | | |
|  | GEV No. | 361365 | Ref. No. 201020 |
| | solenoid coil 230VAC for type EV1 | | |
|  | GEV No. | 510298 | Ref. No. 144012 144026 |
| | lip valve dosing pump suitable for DB2/DS5 | | |

spare parts



| | | | |
|--------------------|---|-----------------|--------|
| GEV No. | 361113 | Ref. No. | 201002 |
| description | solenoid coil 230VAC for type DB2 | | |
| For models: | 10, 11F, 11FD, 11F-DVGW, 11R, 11RD, 12, 21F, 21FD, 21R, 21RD, 22F, 22R, 25F, 25FD, 25R, 25RD, 30F, 30FD, 30R, 30RD, 31F, 31FD, 31R, 31RD, 350F, 350FD, 350R, 350RD, 35-ELECTRONIC, 35F, 35FD, 35R, 35RD, 400F, 400FD, 400R, 400RD, 40-ELECTRONIC, 40F, 40FD, 40R, 40RD, 440F, 44F, 45, 450, 46, 460, 500F...(Other models you can see in the webshop) | | |



| | | | |
|--------------------|---|-----------------|--------|
| GEV No. | 361365 | Ref. No. | 201020 |
| description | solenoid coil 230VAC for type EV1 | | |
| For models: | 10, 11F, 11FD, 11F-DVGW, 11R, 11RD, 12, 14, 21F, 21FD, 21R, 21RD, 22F, 22R, 25F, 25FD, 25R, 25RD, 30F, 30FD, 30R, 30RD, 31F, 31FD, 31R, 31RD, 40F, 440F, 44F, 46, 460, 66, CLEAN-100, CLEAN-110, CLEAN-120, CLEAN-3, E.45, E.46, TF-503, TF-513, TF-515 | | |



| | | | |
|--------------------|--|-----------------|------------------|
| GEV No. | 510298 | Ref. No. | 144012 144026 |
| description | lip valve dosing pump suitable for DB2/DS5 | | |
| For models: | 050F, 050FP, 2312-007, 913992, 913993, E.35, E.35H, E.40, E.40H, E.50, E.51, E.55, F85, F85P, LF50, LF55, MC201CL, MC501E, MC501EP, MC501S, MC501SP, MINIBAR, MISTRAL-51, NIAGARA-40, NIAGARA-51, RIVER-40, RIVER-50, RIVER-61, S280 | | |









| | | | |
|--------------------|--|-----------------|--------|
| GEV No. | 361366 | Ref. No. | 215001 |
| description | PCB dishwasher 11F suitable for DB2 type DB2/EV1/EKP-M | | |
| For models: | 10, 11F, 11FD, 11F-DVGW, 11R, 11RD, 12, 14, 21F, 21FD, 21R, 21RD, 22F, 22R, 25F, 25FD, 25R, 25RD, 30F, 30FD, 30R, 30RD, 31F, 31FD, 31R, 31RD, 40F, 440F, 46, 460, 66, CLEAN-100, CLEAN-110, CLEAN-120, CLEAN-3, E.45, E.46 | | |

membrane dosing pumps

self-priming



SEKO





| | | | |
|---|---|-----------------|--------------------------|
| GEV No. | 361364 ¹ | Ref. No. | 209025 926278 DWD3 |
| description | dosing pump type DIB5E self-sucking rinse aid pump rate 0-5cm ³ per stroke pressure connection ø 4x6mm suction connection ø 4x6mm SEKO supporting pressure closed | | |
| For models: | 80, 81, 82, 913291, 913292, 913297, 913298, 913299, 913300, 913357, 913360, 913361, 913374, 913375, 913391, 913392, 913416, 913418, 913435, 913545, 913546, 913547, 913578, 913611, 913666, 913668, 913684, 913685, 913773, 913774, 913911, 913912, 913913, 913914, 913932, 913933, 913948, 913950, 913977, 913984, 913990, 913992, 913993, 914100, 914101, 914167, 914168, 914214, 914284, 914316... (Other models you can see in the webshop) | | |
| spare parts for | 361364 | | |
|  | GEV No. | 361301 | Ref. No. — |
| | hose connector for type DIB3E/DIB5E | | |
|  | GEV No. | 361302 | Ref. No. — |
| | valve bush for type DIB3E/DIB5E | | |
|  | GEV No. | 361304 | Ref. No. 456042 |
| | O-ring EPDM ID ø 11.11mm thickness 1.78mm Qty 1 pcs for type DIB3E/DIB5E | | |
|  | GEV No. | 361305 | Ref. No. — |
| | valve disc for type DIB3E/DIB5E DIB3P/DIB5P | | |
|  | GEV No. | 361306 | Ref. No. — |
| | membrane for type DIB3E/DIB5E ø 49mm hole ø 5mm | | |
|  | GEV No. | 361307 | Ref. No. — |
| | membrane dosing pump ø 68mm hole ø 6mm for type DIB3P/DIB5P | | |
|  | GEV No. | 361459 | Ref. No. — |
| | hose connector ø 6mm for dosing pump | | |
|  | GEV No. | 361481 | Ref. No. — |
| | lip valve for type DIB3P/DIB5P DIB3E/DIB5E | | |



¹auxiliary pressure connection closed
Table continues overleaf





| | | | |
|---|--|--------|-------------------|
| accessories for | 361364 | | |
|  | GEV No. | 361240 | Ref. No. — |
| | hose connector 1-way hose ø 6mm plastic connection M10x1 | | |
|  | GEV No. | 361241 | Ref. No. — |
| | hose connector 1-way hose ø 9mm plastic connection M10x1 | | |

| | | | |
|---|---|-----------------|--------|
| spare parts | | | |
|  | | | |
| 1 | | | |
| GEV No. | 361304 | Ref. No. | 456042 |
| description | O-ring EPDM ID ø 11.1mm thickness 1.78mm Qty 1 pcs for type DIB3E/DIB5E | | |
| For models: | 350R, 350RD, 35-ELECTRONIC, 35R, 35RD, 67R, E.42, MINIBAR, S280 | | |

| | | | |
|---|--|-----------------|------------------|
| various | | | |
| spare parts | | | |
|  | | | |
| 1 | | | |
| GEV No. | 510298 | Ref. No. | 144012 144026 |
| description | lip valve dosing pump suitable for DB2/DS5 | | |
| For models: | 050F, 050FP, 2312-007, 913992, 913993, E.35, E.35H, E.40, E.40H, E.50, E.51, E.55, F85, F85P, LF50, LF55, MC201CL, MC501E, MC501EP, MC501S, MC501SP, MINIBAR, MISTRAL-51, NIAGARA-40, NIAGARA-51, River-40, RIVER-50, RIVER-61, S280 | | |

| | | | |
|---|---|-----------------|----------------------------------|
| self-priming with supporting pressure | | | |
| ELETTROBAR | | | |
|  | | | |
| 1 | | | |
| GEV No. | 361362 | Ref. No. | 209985 987023 |
| description | dosing pump rinse aid pressure connection ø 6mm pressure connection 6 | | |
| For models: | 050F, 050FP, 2312-001, 2312-002, 2312-007, 2312-009-CRP, 913289, 913290, 913356, 913372, 913373, 913544, 913665, 913667, 913771, 913772, 913832, 913837, 913992, 913993, 914165, 914166, 914206, 914339, 914342, 914343, 914355, 914386, 914387, 914388, 914389, 914390, 914391, 914626, 914692, 914693, 914694, 914703, 914870, 915686, 915687, 915688, 915689, 915690, 915691, E.35, E.35-Elettrobar, E.35H, E.35H-Elettrobar, E.40...(Other models you can see in the webshop) | | |
| spare parts for | 361362 | | |
|  | GEV No. | 361363 | Ref. No. 199012 |
| | membrane | | |
|  | GEV No. | 510298 | Ref. No. 144012 144026 |
| | lip valve dosing pump suitable for DB2/DS5 | | |

| | | | |
|---|--|-----------------|------------------|
|  | | | |
| 1 | | | |
| GEV No. | 510298 | Ref. No. | 144012 144026 |
| description | lip valve dosing pump suitable for DB2/DS5 | | |
| For models: | 050F, 050FP, 2312-007, 913992, 913993, E.35, E.35H, E.40, E.40H, E.50, E.51, E.55, F85, F85P, LF50, LF55, MC201CL, MC501E, MC501EP, MC501S, MC501SP, MINIBAR, MISTRAL-51, NIAGARA-40, NIAGARA-51, River-40, RIVER-50, RIVER-61, S280 | | |

| | | | |
|---|--|-----------------|--------|
|  | | | |
| 1 | | | |
| GEV No. | 361363 | Ref. No. | 199012 |
| description | membrane | | |
| For models: | 050F, 050FP, 2312-007, 913289, 913290, 913356, 913372, 913373, 913544, 913665, 913667, 913771, 913772, 913832, 913837, 913992, 913993, 914165, 914166, 914206, 914339, 914342, 914343, 914355, 914386, 914387, 914388, 914389, 914390, 914391, 914626, 914692, 914693, 914694, 914703, 914870, 915686, 915687, 915688, 915689, 915690, 915691, E.35, E.35-Elettrobar, E.35H, E.35H-Elettrobar, E.40, E.40H, E.50, E.51...(Other models you can see in the webshop) | | |

| | | | |
|---|--|-----------------|------------------|
| GERMAC | | | |
| spare parts | | | |
|  | | | |
| 1 | | | |
| GEV No. | 510298 | Ref. No. | 144012 144026 |
| description | lip valve dosing pump suitable for DB2/DS5 | | |
| For models: | 050F, 050FP, 2312-007, 913992, 913993, E.35, E.35H, E.40, E.40H, E.50, E.51, E.55, F85, F85P, LF50, LF55, MC201CL, MC501E, MC501EP, MC501S, MC501SP, MINIBAR, MISTRAL-51, NIAGARA-40, NIAGARA-51, River-40, RIVER-50, RIVER-61, S280 | | |



SEKO



1

| | | | |
|--------------------|---|-----------------|--------|
| GEV No. | 362013 | Ref. No. | 929198 |
| description | dosing pump type DIB P with auxiliary pressure connection for dishwashers pump rate 0-3cm ³ per stroke pressure connection ø 4x6mm suction connection ø 4x6mm auxiliary pressure connection 10mm SEKO | | |
| For models: | 914583, 914628, 914944, 915143, 915611, 915612, 915613, 915614, 915615, 915616, 915670, 915671, 915959, KLP105EB, KLP201DDDTEB, KLP201EB, LP105DDDTEB, LP105DDDTEBN, LP105EB, LP201DDDTEB, LP201EB, LP60, NIAGARA-241, PLUVIA-240, River-44-CRP-ST, RIVER-44CRP-ST, RIVER-54CRP, River-54-CRP-s.p., River-81CRP, RIVER-81-CRP, River-82CRP, RIVER-82-CRP, RV81CCRP, RV81CRP, RV82CCRP, RV82CRP, U132, U60E, U61, U61E, U61H, U61HE, U70, U70e | | |



2

| | | | |
|---|--|-----------------|------------------------|
| GEV No. | 361039 | Ref. No. | DWD4 |
| description | dosing pump type DIB5P with auxiliary pressure connection rinse aid 0-5cm ³ per stroke/h pressure connection ø 4x6mm suction connection ø 4x6mm auxiliary pressure connection 10mm SEKO | | |
| spare parts for | 361039 | | |
|  | GEV No. | 361301 | Ref. No. — |
| | hose connector for type DIB3E/DIB5E | | |
|  | GEV No. | 361302 | Ref. No. — |
| | valve bush for type DIB3E/DIB5E | | |
|  | GEV No. | 361304 | Ref. No. 456042 |
| | O-ring EPDM ID ø 11.11mm thickness 1.78mm Qty 1 pcs for type DIB3E/DIB5E | | |
|  | GEV No. | 361305 | Ref. No. — |
| | valve disc for type DIB3E/DIB5E DIB3P/DIB5P | | |
|  | GEV No. | 361307 | Ref. No. — |
| | membrane dosing pump ø 68mm hole ø 6mm for type DIB3P/DIB5P | | |
|  | GEV No. | 361481 | Ref. No. — |
| | lip valve for type DIB3P/DIB5P DIB3E/DIB5E | | |



1

| | | | |
|--------------------|--|-----------------|--------|
| GEV No. | 361304 | Ref. No. | 456042 |
| description | O-ring EPDM ID ø 11.11mm thickness 1.78mm Qty 1 pcs for type DIB3E/DIB5E | | |
| For models: | 350R, 350RD, 35-ELECTRONIC, 35R, 35RD, 67R, E.42, MINIBAR, S280 | | |

accessories

container filters



1

| | | | |
|--------------------|--|-----------------|--------|
| GEV No. | 513043 | Ref. No. | 121017 |
| description | container filter hose ø 4mm | | |
| For models: | 050F, 050FP, 10, 12, 14, 22F, 22R, 2312-001, 2312-002, 2312-007, 2312-009-CRP, 31F, 31FD, 31R, 31RD, 350F, 350FD, 350R, 350RD, 35-ELECTRONIC, 35F, 35FD, 35R, 35RD, 400F, 400FD, 400R, 400RD, 40-ELECTRONIC, 40F, 40FD, 40R, 40RD, 440F, 44F, 45, 450, 46, 460, 500F, 500FD, 50-ELECTRONIC, 50F, 50FD, 510F, 510FD, 55, 66, 67F, 67R...(Other models you can see in the webshop) | | |



1

| | | | |
|--------------------|--|-----------------|--------|
| GEV No. | 361141 | Ref. No. | 121075 |
| description | container filter with weight ceramic hose ø 4mm | | |
| For models: | 2312-001, 2312-002, 2312-007, 2312-009-CRP, 31F, 31FD, 31R, 31RD, 913289, 913290, 913291, 913292, 913297, 913298, 913299, 913300, 913356, 913357, 913360, 913361, 913363, 913364, 913372, 913373, 913374, 913375, 913376, 913377, 913391, 913392, 913416, 913418, 913435, 913544, 913545, 913546, 913547, 913578, 913611, 913665, 913666, 913667, 913668, 913684, 913685, 913771, 913772, 913773, 913774, 913832...(Other models you can see in the webshop) | | |



1

| | | | |
|--------------------|--|-----------------|--------|
| GEV No. | 361462 | Ref. No. | 121993 |
| description | container filter with weight SS hose ø 4x6mm | | |
| For models: | 913363, 913364, 915150, 915151, 915152, 915154, 915155, 915157, 915158, 915160, 915161, 915162, 915166, 915167, 915168, 915172, 915173, 915175, 915319, 915348, 915418, 915419, 915420, 915421, 915422, 915479, 915492, 915493, 915494, 915495, 915496, 915497, 915547, 915558, 915611, 915612, 915613, 915614, 915615, 915616, 915617, 915618, 915635, 915663, 915664, 915670, 915671, 915672, 915686, 915687...(Other models you can see in the webshop) | | |

intake lances



1

| | | | |
|--------------------|--|-----------------|--------|
| GEV No. | 698713 | Ref. No. | 999257 |
| description | intake lance plastic L 380mm with plug tube ø 9mm hose ø 5mm cable length 1500mm | | |



1

| | | | |
|--------------------|---------------------------------|-----------------|--------|
| GEV No. | 518544 | Ref. No. | 986006 |
| description | intake lance | | |
| For models: | CLEAN-3, TF-503, TF-513, TF-515 | | |

hoses

silicone hoses







1



| | | | |
|--------------------|--|-----------------|--------|
| GEV No. | 520242 | Ref. No. | 143235 |
| description | silicone hose for peristaltic pump ID ø 4mm ED ø 7mm L 5m thickness 1.5mm t.max. 200°C Shore A 55° transparent dosing Qty 5m | | |
| For models: | 2312-009-CRP, 914583, 914628, 914944, 915143, 915150, 915151, 915152, 915154, 915155, 915157, 915158, 915160, 915161, 915162, 915166, 915167, 915168, 915172, 915173, 915175, 915176, 915177, 915285, 915319, 915338, 915341, 915348, 915418, 915419, 915420, 915421, 915422, 915479, 915492, 915493, 915494, 915495, 915496, 915497, 915547, 915558, 915611, 915612, 915613, 915614, 915615, 915616, 915617, 915618...(Other models you can see in the webshop) | | |

PVC hoses



1

| | | | | |
|---|--|-----------------|-----------------|--------|
| GEV No. | 520090 | Ref. No. | 143194 | |
| description | PVC hose ID ø 4mm ED ø 6mm L 2m thickness 1mm t.max. 60°C transparent | | | |
| For models: | 2312-001, 2312-002, 2312-007, 2312-009-CRP, 31F, 31FD, 31R, 31RD, 67F, 67R, 913289, 913290, 913291, 913292, 913297, 913298, 913299, 913300, 913356, 913357, 913360, 913361, 913363, 913364, 913372, 913373, 913374, 913375, 913376, 913377, 913391, 913392, 913416, 913418, 913435, 913544, 913545, 913546, 913547, 913578, 913611, 913665, 913666, 913667, 913668, 913684, 913685, 913771, 913772, 913773...(Other models you can see in the webshop) | | | |
| accessories for | 520090 | | | |
|  | GEV No. | 361058 | Ref. No. | — |
| | container filter with non-return valve SS hose ø 4x6mm ø 20mm L 56mm | | | |
|  | GEV No. | 361066 | Ref. No. | — |
| | container filter straight SS hose ø 4x6mm L 37mm non return valve ball valve | | | |
|  | GEV No. | 361106 | Ref. No. | — |
| | container filter with weight and non-return valve SS hose ø 4x6mm ø 21mm L 51mm non return valve lip valve | | | |
|  | GEV No. | 361141 | Ref. No. | 121075 |
| | container filter with weight ceramic hose ø 4mm | | | |

| | | | | |
|---|--|--------|-----------------|--------|
| accessories for | 520090 | | | |
|  | GEV No. | 361230 | Ref. No. | — |
| | container filter with weight stainless steel hose ø 4x6mm | | | |
|  | GEV No. | 361462 | Ref. No. | 121993 |
| | container filter with weight SS hose ø 4x6mm | | | |
|  | GEV No. | 361728 | Ref. No. | — |
| | container filter with 4m 4x6 hose SS hose ø 4x6mm hose length 4000mm | | | |

tank inlets



1

| | | | |
|--------------------|---|-----------------|--------|
| GEV No. | 518489 | Ref. No. | 468024 |
| description | tank inlet | | |
| For models: | 21F, 21FD, 21R, 21RD, 25F, 25FD, 25R, 25RD, 30F, 30FD, 30R, 30RD, 31F, 31FD, 31R, 31RD, R495, R497, R499, R501, R503, R505, R507, R509, R511, R704, R706, R708, S621, S623, S624, S626, S631, S633, S634, S636, S641, S643, S651, S651P, S653, S654, S655, S810, S815, S830, S835, S850, S870, S950...(Other models you can see in the webshop) | | |



1

| | | | |
|--------------------|--|-----------------|------------------|
| GEV No. | 361270 | Ref. No. | 468151 999104 |
| description | tank inlet SS M12 hose ø 4mm | | |
| For models: | 10, 11F, 11FD, 11R, 11RD, 12, 14, 22F, 2312-001, 2312-002, 2312-007, 2312-009-CRP, 31F, 31FD, 31R, 31RD, 440F, 44F, 45, 450, 46, 460, 80, 81, 82, 913289, 913290, 913291, 913292, 913297, 913298, 913299, 913300, 913356, 913357, 913360, 913361, 913363, 913364, 913372, 913373, 913374, 913375, 913376, 913377, 913391, 913392, 913416, 913418, 913435...(Other models you can see in the webshop) | | |

miscellaneous



1

| | | | |
|--------------------|--|-----------------|--------|
| GEV No. | 521735 | Ref. No. | 466005 |
| description | spacer piece for rinse aid pump | | |
| For models: | 2312-007, 2312-009-CRP, 913289, 913290, 913356, 913372, 913373, 913544, 913665, 913667, 913771, 913772, 913832, 913837, 913992, 913993, 914165, 914166, 914206, 914339, 914342, 914343, 914355, 914386, 914387, 914388, 914389, 914390, 914391, 914626, 914692, 914693, 914694, 914703, 914870, 915686, 915687, 915688, 915689, 915690, 915691, E.35, E.35-Elettrobar, E.35H, E.35H-Elettrobar, E.40, E.40H, FAST-135, FAST-135CT, FAST-135D...(Other models you can see in the webshop) | | |





hoses

supply hoses

stainless steel flexi hoses

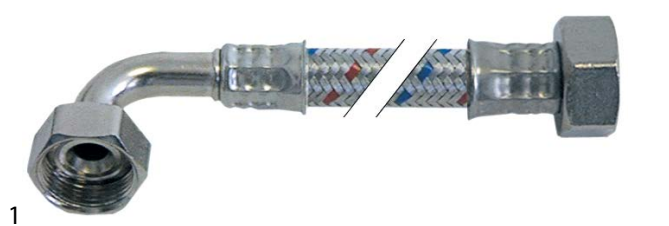

universal hoses

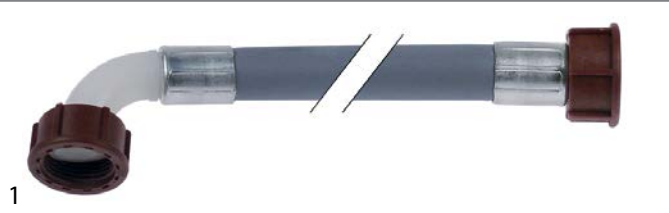

| | | | |
|---|--|-----------------|-------------------|
| GEV No. | 520008 | Ref. No. | 143016 143112 |
| description | flex hose SS braid straight-curved DN12 connection 1: 3/4" connection 2: 3/4" L 1500mm approval DVGW operating p. 10bar test pressure 32bar burst p. 95bar | | |
| For models: | 10, 12, 14, 22F, 22R, 40F, 440F, 44F, 66, 913363, 913364, 913992, 913993, 914592, 914612, 914613, 916045, CLEAN-100, CLEAN-110, CLEAN-120, E.52, E1, E10, E100, E110, E12, E120, E14, E140, E41, Ocean360-UK, River-40, River-44, S651, S654, S810, S815, S830, S835, S850, S870, S950, TF-503, TF-513, TF-515 | | |
| accessories for | 520008 | | |
|  | GEV No. | 520054 | Ref. No. — |
| | flat gasket rubber ED ø 23.5mm ID ø 14mm thickness 2.3mm Qty 10 pcs | | |

PVC supply hoses



| | | | |
|---|---|-----------------|-------------------|
| GEV No. | 520010 | Ref. No. | 143170 |
| description | supply hose PVC straight-curved DN13 connections 3/4" L 1500mm operating p. 10bar burst p. 32bar t.max. 90°C blue approval VDE flat seal | | |
| For models: | 050F, 050FP, 2312-001, 2312-002, 2312-007, 2312-009-CRP, 350F, 350FD, 350R, 350RD, 35-ELECTRONIC, 35F, 35FD, 35R, 35RD, 400F, 400FD, 400R, 400RD, 40-ELECTRONIC, 40F, 40FD, 40R, 40RD, 45, 450, 46, 460, 500F, 500FD, 50-ELECTRONIC, 50F, 50FD, 510F, 510FD, 67F, 67R, 913289, 913290, 913356, 913363, 913364, 913372, 913373, 913544, 913665, 913667, 913771, 913772, 913832...(Other models you can see in the webshop) | | |
| accessories for | 520010 | | |
|  | GEV No. | 520053 | Ref. No. — |
| | screen connection 3/4" D1 ø 26mm D2 ø 15mm Qty 10 pcs rubber thickness 8mm | | |
|  | GEV No. | 520054 | Ref. No. — |
| | flat gasket rubber ED ø 23.5mm ID ø 14mm thickness 2.3mm Qty 10 pcs | | |



| | | | |
|--------------------|--|-----------------|------------------|
| GEV No. | 520011 | Ref. No. | 143270 929169 |
| description | supply hose PVC straight-curved DN13 connections 3/4" L 2000mm operating p. 10bar burst p. 32bar t.max. 90°C approval VDE flat seal | | |
| For models: | 913291, 913292, 913297, 913298, 913299, 913300, 913357, 913360, 913361, 913374, 913375, 913391, 913392, 913416, 913418, 913435, 913545, 913546, 913547, 913578, 913611, 913666, 913668, 913684, 913685, 913773, 913774, 913911, 913912, 913913, 913914, 913932, 913933, 913948, 913950, 913977, 913984, 913990, 914167, 914168, 914214, 914284, 914316, 914317, 914318, 914319, 914326, 914331, 914338, 914356...(Other models you can see in the webshop) | | |

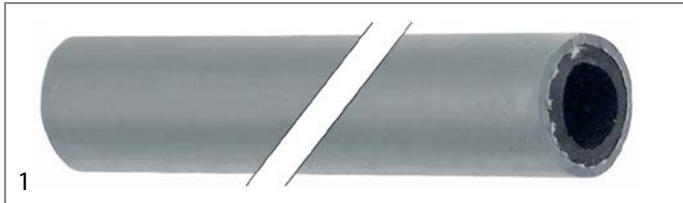

| | | | |
|---|---|-----------------|-------------------|
| GEV No. | 520015 | Ref. No. | 143004 |
| description | supply hose ID ø 10mm ED ø 17mm L 5m operating p. 20bar burst p. 60bar t.max. 95°C grey Qty 5m | | |
| For models: | 050F, 050FP, 10, 11F, 11FD, 11F-DVGW, 11R, 11RD, 12, 14, 21F, 21FD, 21R, 21RD, 22F, 22R, 2312-001, 2312-002, 2312-007, 2312-009-CRP, 25F, 25FD, 25R, 25RD, 30F, 30FD, 30R, 30RD, 31F, 31FD, 31R, 31RD, 350F, 350FD, 350R, 350RD, 35-ELECTRONIC, 35F, 35FD, 35R, 35RD, 400F, 400FD, 400R, 400RD, 40-ELECTRONIC, 40F, 40FD, 40R, 40RD...(Other models you can see in the webshop) | | |
| accessories for | 520015 | | |
|  | GEV No. | 504377 | Ref. No. — |
| | hose connector grommet ø 23mm grommet length 25mm total length 55mm for water filling | | |

drain hoses



| | | | |
|--------------------|--|-----------------|--------|
| GEV No. | 513718 | Ref. No. | 143120 |
| description | drain hose DN19 L 1500mm straight ø inside 24mm straight ext. ø 28mm outer hose ø 23mm | | |
| For models: | 11F, 11FD, 11F-DVGW, 11R, 11RD, 21F, 21FD, 21R, 21RD, 25F, 25FD, 25R, 25RD, 30F, 30FD, 30R, 30RD, 31F, 31FD, 31R, 31RD, 350F, 350FD, 350R, 350RD, 35-ELECTRONIC, 35F, 35FD, 35R, 35RD, 400F, 400FD, 400R, 400RD, 40-ELECTRONIC, 40F, 40FD, 40R, 40RD, 67F, 67R, 913289, 913290, 913291, 913292, 913356, 913357, 913363, 913364, 913372...(Other models you can see in the webshop) | | |

1

| | | | |
|--------------------|--|-----------------|------------------|
| GEV No. | 518068 | Ref. No. | 143136 929200 |
| description | drain hose DN34 L 2000mm elbow ø inside 50mm elbow ext. ø 59mm inner hose ø 35mm outer hose ø 42mm PVC | | |
| For models: | 10, 12, 14, 22F, 22R, 40F, 44F, 80, 81, 82, 914326, 914406, 915729, CE78HZ23, CGL74CABT, CLEAN-100, CLEAN-110, CLEAN-120, E.55, E.60, E.65, E1, E10, E100, E110, E12, E120, E14, E140, E78, E78HP, Fast181, FAST-181, Fast181-230V-3Ph-60Hz, Fast181-400V-3NPh-60Hz, FAST-63, HM1, KLP105EB, LP105DDDTEB, LP105DDDTEBN, LP105EB, LP60, NG271, NG291, NG292, NG292HZ, NG293, NIAGARA-271, NIAGARA-283, Niagara-283A...(Other models you can see in the webshop) | | |

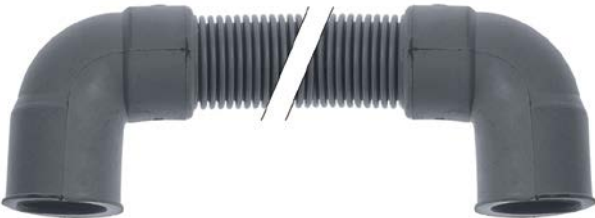

1

| | | | |
|--------------------|--|-----------------|--------|
| GEV No. | 530373 | Ref. No. | 127077 |
| description | drain hose L 680mm elbow ø inside 20mm outer hose ø 24mm | | |
| For models: | 914628, 914944, RIVER-50-CRP-SP, RIVER-54CRP, River-54-CRP-s.p., RIVER-54-CRP-SP | | |



1

| | | | |
|--------------------|--|-----------------|--------|
| GEV No. | 518518 | Ref. No. | 143178 |
| description | drain hose DN19 L 1500mm A int. ø 21mm A ext. ø 27mm B int. ø 29mm B ext. ø 35mm outer hose ø 25mm | | |

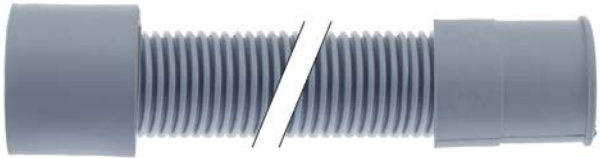

1

| | | | |
|--------------------|--|-----------------|--------|
| GEV No. | 511205 | Ref. No. | 143019 |
| description | drain hose DN19 L 1500mm A int. ø 23mm A ext. ø 29mm B int. ø 29mm outer hose ø 29mm B ext. ø 35mm | | |
| For models: | 11F, 11FD, 11R, 11RD, R495, R497, R499, R501, R503, R505, R507, R509, R511, S621, S623, S624, S626, S631, S633, S634, S636, S641, S643 | | |



1

| | | | |
|--------------------|--|-----------------|--------|
| GEV No. | 513258 | Ref. No. | 127044 |
| description | drain hose DN19 L 270mm A int. ø 22mm A ext. ø 28mm B int. ø 24mm B ext. ø 28mm outer hose ø 22mm | | |
| For models: | 2312-001, 2312-002, 913297, 913298, 913299, 913300, 913360, 913361, 913391, 913392, 913546, 913547, 913578, 913611, 913684, 913913, 913914, 913932, 913933, 914284, 914318, 914319, 914331, 914338, 914356, 914400, 914401, 914402, 914403, 914404, 914405, 914431, 914449, 914517, 914545, 914568, 914642, 914688, 914909, 914979, 915136, 915137, 915140, 915248, 915483, 915484, 915528, 915537, 915538, 915539...(Other models you can see in the webshop) | | |

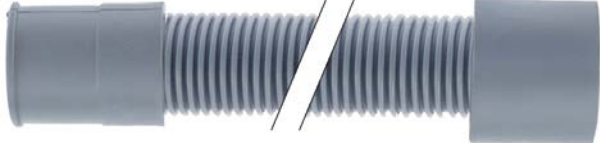

1

| | | | |
|--------------------|--|-----------------|--------|
| GEV No. | 518219 | Ref. No. | 127037 |
| description | drain hose DN19 L 630mm A int. ø 20mm A ext. ø 27mm B int. ø 21mm B ext. ø 28mm outer hose ø 24mm | | |
| For models: | 2312-001, 2312-002, 2312-007, 2312-009-CRP, 913297, 913298, 913299, 913300, 913360, 913361, 913391, 913392, 913546, 913547, 913578, 913611, 913684, 913913, 913914, 913932, 913933, 913992, 913993, 914100, 914101, 914284, 914318, 914319, 914326, 914331, 914338, 914339, 914342, 914343, 914356, 914400, 914401, 914402, 914403, 914404, 914405, 914406, 914431, 914449, 914517, 914545, 914568, 914624, 914625, 914626...(Other models you can see in the webshop) | | |



1

| | | | |
|--------------------|---|-----------------|-------|
| GEV No. | 530608 | Ref. No. | 70110 |
| description | drain hose DN24 L 1500mm A int. ø 24mm A ext. ø 28mm B int. ø 28mm B ext. ø 35mm outer hose ø 29mm temp.-resist. 90°C | | |
| For models: | NG381DDPS, NG381DDPSHZ23, NG381LDDPS, Niagara-381-230V-3Ph-60Hz, Niagara-381DP, Niagara-381L, Niagara-381LC, River-295P, River-296P, RV295PS, RV296PS | | |

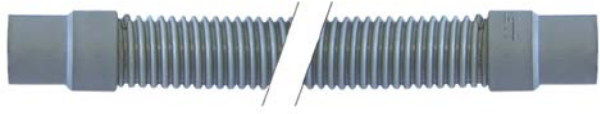

1

| | | | |
|--------------------|---|-----------------|--------|
| GEV No. | 530616 | Ref. No. | DZS151 |
| description | drain hose L 1500mm A int. ø 25mm B int. ø 25mm outer hose ø 32mm | | |
| For models: | CNT800CH, Fast180, Fast180-230V-3Ph-60Hz, NG271, NG281CDD, NG281HPDD, NG281HZ23, NG281HZ23DD, NG291, NIAGARA-271, Niagara-281, Niagara-281-2, Niagara-281HP, NIAGARA-291, OC380, OC380FUR, OC380HZ23, Ocean380, Pluvia280-230V-3PH-60HZ, PV280FAST2, PV280FAST2BIO, PV280FAST2HZ23, PV280HZ23, RIVER-294, RV294, SevenE | | |



1

| | | | |
|--------------------|--|-----------------|--------|
| GEV No. | 530374 | Ref. No. | 127086 |
| description | drain hose L 160mm DN19 A int. ø 28mm A ext. ø 34mm B int. ø 28mm B ext. ø 34mm outer hose ø 24mm | | |
| For models: | 2312-007, 914100, 914101, 914339, 914342, 914343, 914624, 914625, 914626, 914627, 914628, 914850, 914851, 914854, 914944, RIVER-48, RIVER-54, RIVER-54CRP, River-54-CRP-s.p. | | |



1

| | | | |
|--------------------|---|-----------------|-------|
| GEV No. | 530372 | Ref. No. | 80702 |
| description | drain hose DN19 L 1000mm straight \varnothing inside 21mm straight ext. \varnothing 27mm elbow \varnothing inside 21mm elbow ext. \varnothing 28mm outer hose \varnothing 24mm | | |
| For models: | RIVER-282, River-282-2, River-282L-2, River-282LS-2TDE, River-282S-2TDE, River-285, River-382, River-382-230V-3Ph-50Hz, River-382H, River-382L, River-382L-230V-3Ph-50Hz, River-382LNRG, River-382LTDE, River-382NRG, River-382NRG-230-3Ph-50Hz, River-382TDE, River-482, RV282, RV282DD, RV282R, RV382, RV38223TERMO, RV382AHP, RV382FUR, RV382L, RV382L23TERMO, RV382LFUR, RV382LR, RV382LS, RV382LSFUR, RV382LTX, RV382LTXR, RV382R, RV382R23TERMO, RV382RFUR, RV382S, RV382SFUR, RV382TERMO, RV382TX, RV382TXR, RV482 | | |

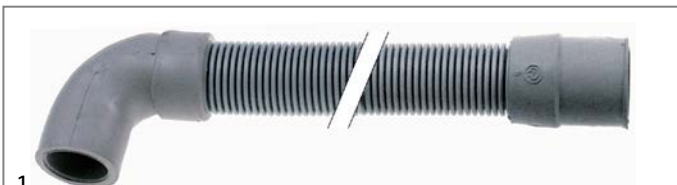

1

| | | | |
|--------------------|---|-----------------|--------|
| GEV No. | 530819 | Ref. No. | 143137 |
| description | drain hose DN20 L 2500mm straight \varnothing inside 19mm straight ext. \varnothing 24mm elbow \varnothing inside 22mm elbow ext. \varnothing 27mm outer hose \varnothing 24mm | | |
| For models: | 050F, 050FP, 21F, 21FD, 21R, 21RD, 22F, 22R, 25F, 25FD, 25R, 25RD, 30F, 30FD, 30R, 30RD, 31F, 31FD, 31R, 31RD, 40F, 440F, 44F, 45, 450, 46, 460, 500F, 500FD, 50-ELECTRONIC, 50F, 50FD, 510F, 510FD, 913289, 913290, 913291, 913292, 913356, 913357, 913363, 913364, 913372, 913373, 913374, 913375, 913376, 913377, 913416, 913418...(Other models you can see in the webshop) | | |



1

| | | | |
|--------------------|--|-----------------|--------|
| GEV No. | 518638 | Ref. No. | 143252 |
| description | drain hose DN24 L 1700mm straight \varnothing inside 28mm straight ext. \varnothing 34mm elbow \varnothing inside 28mm elbow ext. \varnothing 34mm outer hose \varnothing 30mm | | |
| For models: | 915150, 915151, 915152, 915154, 915155, 915160, 915161, 915162, 915166, 915167, 915168, 915175, 915176, 915177, 915319, 915338, 915341, 915348, 915418, 915419, 915420, 915421, 915479, 915492, 915493, 915547, 915558, 915635, 915663, 915747, 916020, 916021, 916024, 916025, 916026, 916027, 916030, 916031, 916045, 916201, 916202, 916203, 916204, 916205, 916206, 916207, 916208, 916209, 916247, 916248...(Other models you can see in the webshop) | | |



1

| | | | |
|--------------------|---|-----------------|-------|
| GEV No. | 518652 | Ref. No. | 70097 |
| description | drain hose DN24 L 600mm straight \varnothing inside 30mm straight ext. \varnothing 34mm elbow \varnothing inside 29mm elbow ext. \varnothing 33mm outer hose \varnothing 29mm | | |
| For models: | NG281HZ23, NG381DDPS, NG381DDPSHZ23, NG381LDDPS, Niagara-381-230V-3Ph-60Hz, Niagara-381DP, Niagara-381L, Niagara-381LC, River-282-2, River-282L-2, River-282LS-2TDE, River-282S-2TDE, River-285, River-382, River-382-230V-3Ph-50Hz, River-382H, River-382L, River-382L-230V-3Ph-50Hz, River-382LNRG, River-382LTDE, River-382NRG, River-382NRG-230-3Ph-50Hz, River-382TDE, River-482, RV382, RV38223TERMO, RV382AHP, RV382FUR, RV382L, RV382L-23TERMO, RV382LFUR, RV382LR, RV382LS, RV382LSFUR, RV382LTX, RV382LTXR, RV382R, RV382R23TERMO, RV382RFUR, RV382S, RV382SFUR, RV382TERMO, RV382TX, RV382TXR, RV482 | | |

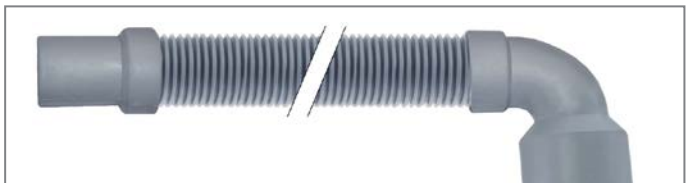

1

| | | | |
|--------------------|--|-----------------|--------|
| GEV No. | 506208 | Ref. No. | 143183 |
| description | drain hose DN25 L 1500mm straight \varnothing inside 25mm straight ext. \varnothing 30mm elbow \varnothing inside 40mm elbow ext. \varnothing 46mm outer hose \varnothing 32mm | | |
| For models: | 22F, 440F, 44F, E.52 | | |

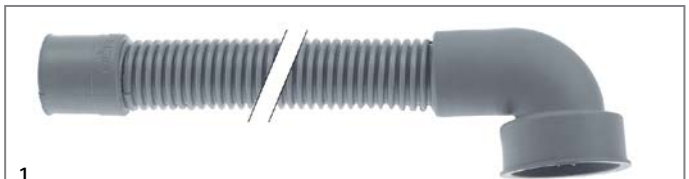

1

| | | | |
|--------------------|---|-----------------|--------|
| GEV No. | 518515 | Ref. No. | 127033 |
| description | drain hose DN28 L 260mm straight \varnothing inside 33mm straight ext. \varnothing 40mm elbow \varnothing inside 52mm elbow ext. \varnothing 58mm outer hose \varnothing 35mm | | |
| For models: | 22F, 22R, 40F, 440F, 44F, E.52, E.60, E.65 | | |



1

| | | | |
|--------------------|---|-----------------|--------|
| GEV No. | 518078 | Ref. No. | 127032 |
| description | drain hose DN34 L 500mm straight \varnothing inside 40mm straight ext. \varnothing 48mm elbow \varnothing inside 50mm elbow ext. \varnothing 58mm outer hose \varnothing 42mm | | |
| For models: | 22F, 440F, 44F, E.52, E1, E10, E100, E110, E12, E120, E14, E140 | | |



1

| | | | |
|--------------------|--|-----------------|--------|
| GEV No. | 518654 | Ref. No. | 127056 |
| description | drain hose DN34 L 600mm straight ϕ inside 30mm straight ext. ϕ 40mm elbow ϕ inside 51mm elbow ext. ϕ 61mm outer hose ϕ 34mm | | |
| For models: | NG271, NG291, NIAGARA-271, NIAGARA-291, RIVER-282, River-285, RIVER-294, River-295P, River-296P, RIVER-HL-81, RIVER-HL-82, RV282, RV282DD, RV282R, RV294, RV295PS, RV296PS | | |



1

| | | | |
|--------------------|--|-----------------|-------|
| GEV No. | 518653 | Ref. No. | 70116 |
| description | drain hose DN24 L 500mm elbow ϕ inside 29mm elbow ext. ϕ 34mm outer hose ϕ 29mm | | |
| For models: | NG381, NG38123, NG38123TERMO, NG381C, NG381CDD, NG381C-FUR, NG381DDHZ23, NG381HPDD, NG381L, NG381LC, NG381LC-FUR, NG381TERMO, NG381TXCDD, Niagara-283L-2, Niagara-381, Niagara-381-230V-3Ph-50Hz, Niagara-381-230V-3Ph-60Hz, Niagara-381HPD, Niagara-381L, Niagara-381LC | | |

industrial hoses

Niplaflex hoses



1

| | | | |
|--------------------|--|-----------------|--------|
| GEV No. | 570561 | Ref. No. | 143182 |
| description | pressure hose ID ϕ 10mm ED ϕ 17mm L 40m thickness 3.5mm operating p. 10bar burst p. 30bar t.max. 110°C | | |
| For models: | 11F, 11FD, 11R, 11RD, 2312-001, 2312-002, 2312-007, 31F, 31FD, 31R, 31RD, 350F, 350FD, 350R, 350RD, 35F, 35FD, 35R, 35RD, 400F, 400FD, 400R, 400RD, 40F, 40FD, 40R, 40RD, 440F, 44F, 45, 450, 46, 460, 500F, 500FD, 50F, 50FD, 510F, 510FD, 914100, 914101, 914339, 914342, 914343, 914624, 914625, 914626, 914627, 914850, 914851...(Other models you can see in the webshop) | | |



1

| | | | |
|--------------------|--|-----------------|--------|
| GEV No. | 530562 | Ref. No. | 143010 |
| description | pressure hose ID ϕ 13mm ED ϕ 21mm L 5m operating p. 10bar burst p. 30bar t.max. 110°C | | |
| For models: | 161, 221, 271, 272, 362, 80, 81, 82, 914380, 914436, 915747, A3EB, A3EBD, A3EBDAKRKYK, A3EBDAKWK, A3EBDBKWK, A3EBDRKYK, A3EBDWK, A3EBDYK, A3EBSAK, A3EBSAKRK, A3EBSAKWK, A3EBSB-KWKYK, A3EBSEKWK, A3EBSWK, A4EB, A4EBD, A4EBDAKEYK, A4EBDAKRK, A4EBDAKWK, A4EBDAKZK, A4EBDBKRK, A4EBDPKWKYK, A4EBDRK, A4EBS, A4EBSAK, A4EBSAKCK, A4EBSAKEKYK, A4EBSA-KRK, A4EBSAKRKP, A4EBSAKYK, A4EBSCK, A4EBT, A4EBTSAK, A5EB, A5EBD, A5EBDAKPKWK, A5EBDAKWK, A5EBDAKYK, A5EBDRK...(Other models you can see in the webshop) | | |

pressure control hoses



1

| | | | |
|--------------------|---|-----------------|------------------|
| GEV No. | 530560 | Ref. No. | 143005 143131 |
| description | pressure control hose ID ϕ 5mm ED ϕ 9mm L 5m operating p. 30bar burst p. 90bar temp.-resist. 60°C | | |
| For models: | 050F, 050FP, 10, 11F, 11FD, 11F-DVGW, 11R, 11RD, 12, 14, 161, 21F, 21FD, 21R, 21RD, 221, 22F, 22R, 2312-001, 2312-002, 2312-007, 2312-009-CRP, 25F, 25FD, 25R, 25RD, 271, 272, 30F, 30FD, 30R, 30RD, 31F, 31FD, 31R, 31RD, 350F, 350FD, 350R, 350RD, 35-ELECTRONIC, 35F, 35FD, 35R, 35RD, 362, 400F, 400FD, 400R, 400RD...(Other models you can see in the webshop) | | |

PVC hoses

PVC hoses without fabric



1









| | | | | |
|---|--|-----------------|-----------------|---|
| GEV No. | 520383 | Ref. No. | H.775601 | |
| description | PVC hose ID ϕ 4mm ED ϕ 6mm L 2m thickness 1mm t.max. 60°C blue | | | |
| For models: | 913291, 913292, 913297, 913298, 913299, 913300, 913357, 913360, 913361, 913363, 913364, 913374, 913375, 913391, 913392, 913416, 913418, 913435, 913545, 913546, 913547, 913578, 913611, 913666, 913668, 913684, 913685, 913773, 913774, 913911, 913912, 913913, 913914, 913932, 913933, 913948, 913950, 913977, 913984, 913990, 914214, 914284, 914316, 914317, 914318, 914319, 914326, 914331, 914338, 914356...(Other models you can see in the webshop) | | | |
| accessories for | 520383 | | | |
|  | GEV No. | 361058 | Ref. No. | — |
| | container filter with non-return valve SS hose ϕ 4x6mm ϕ 20mm L 56mm | | | |
|  | GEV No. | 361066 | Ref. No. | — |
| | container filter straight SS hose ϕ 4x6mm L 37mm non return valve ball valve | | | |
|  | GEV No. | 361106 | Ref. No. | — |
| | container filter with weight and non-return valve SS hose ϕ 4x6mm ϕ 21mm L 51mm non return valve lip valve | | | |

Table continues overleaf

| accessories for | | 520383 | |
|---|--|----------|--------|
| GEV No. | 361141 | Ref. No. | 121075 |
|  | container filter with weight ceramic hose ø 4mm | | |
| GEV No. | 361230 | Ref. No. | — |
|  | container filter with weight stainless steel hose ø 4x6mm | | |
| GEV No. | 361462 | Ref. No. | 121993 |
|  | container filter with weight SS hose ø 4x6mm | | |
| GEV No. | 361728 | Ref. No. | — |
|  | container filter with 4m 4x6 hose SS hose ø 4x6mm hose length 4000mm | | |

| accessories for | | 520090 | |
|---|--|----------|--------|
| GEV No. | 361058 | Ref. No. | — |
|  | container filter with non-return valve SS hose ø 4x6mm ø 20mm L 56mm | | |
| GEV No. | 361066 | Ref. No. | — |
|  | container filter straight SS hose ø 4x6mm L 37mm non return valve ball valve | | |
| GEV No. | 361106 | Ref. No. | — |
|  | container filter with weight and non-return valve SS hose ø 4x6mm ø 21mm L 51mm non return valve lip valve | | |
| GEV No. | 361141 | Ref. No. | 121075 |
|  | container filter with weight ceramic hose ø 4mm | | |
| GEV No. | 361230 | Ref. No. | — |
|  | container filter with weight stainless steel hose ø 4x6mm | | |
| GEV No. | 361462 | Ref. No. | 121993 |
|  | container filter with weight SS hose ø 4x6mm | | |
| GEV No. | 361728 | Ref. No. | — |
|  | container filter with 4m 4x6 hose SS hose ø 4x6mm hose length 4000mm | | |

| accessories for | | 520027 | |
|---|--|----------|------------------|
| GEV No. | 361058 | Ref. No. | 143013 143028 |
|  | PVC hose ID ø 4mm ED ø 7mm L 10m thickness 1.5mm t.max. 60°C transparent | | |
| For models: | 050F, 050FP, 10, 11F, 11FD, 11F-DVGW, 11R, 11RD, 12, 14, 21F, 21FD, 21R, 21RD, 22F, 22R, 2312-001, 2312-002, 2312-007, 2312-009-CRP, 25F, 25FD, 25R, 25RD, 30F, 30FD, 30R, 30RD, 31F, 31FD, 31R, 31RD, 350F, 350FD, 350R, 350RD, 35-ELECTRONIC, 35F, 35FD, 35R, 35RD, 400F, 400FD, 400R, 400RD, 40-ELECTRONIC, 40F, 40FD, 40R, 40RD... (Other models you can see in the webshop) | | |

| accessories for | | 520935 | |
|--|--|----------|----------|
| GEV No. | 361058 | Ref. No. | H.165168 |
|  | PVC hose ID ø 6mm ED ø 9mm L 1m transparent warewashing | | |
| For models: | 2312-007, 914100, 914101, 914339, 914342, 914343, 914624, 914625, 914626, 914627, 914628, 914850, 914851, 914854, 914944, 915154, 915155, 915157, 915158, 915172, 915173, 915285, 915422, 915492, 915493, 915494, 915495, 915496, 915497, 915611, 915612, 915613, 915614, 915615, 915616, 915617, 915618, 915670, 915671, 915672, 915773, 915774, 915959, 916020, 916021, 916024, 916025, 916026, 916027, 916030...(Other models you can see in the webshop) | | |

| accessories for | | 520242 | |
|--|--|----------|--------|
| GEV No. | 361058 | Ref. No. | 143235 |
|  | silicone hose for peristaltic pump ID ø 4mm ED ø 7mm L 5m thickness 1.5mm t.max. 200°C Shore A 55° transparent dosing Qty 5m | | |
| For models: | 2312-009-CRP, 914583, 914628, 914944, 915143, 915150, 915151, 915152, 915154, 915155, 915157, 915158, 915160, 915161, 915162, 915166, 915167, 915168, 915172, 915173, 915175, 915176, 915177, 915285, 915319, 915338, 915341, 915348, 915418, 915419, 915420, 915421, 915422, 915479, 915492, 915493, 915494, 915495, 915496, 915497, 915547, 915558, 915611, 915612, 915613, 915614, 915615, 915616, 915617, 915618...(Other models you can see in the webshop) | | |

| accessories for | | 520842 | |
|--|--|----------|--------|
| GEV No. | 361058 | Ref. No. | 143253 |
|  | silicone hose ID ø 3mm ED ø 6mm L 1m thickness 1.5mm t.max. 200°C brown | | |
| For models: | 915172, 915173, 915285, 915422, 915496, 915497, 915617, 915618, 915672, 915773, 915774, 916054, NG292, NG292HZ, NG293, NIAGARA-292, Niagara-292-400V-3Ph-60Hz, NIAGARA-293, RIVER-242, RIVER-262, RIVER-282, RIVER-295, River-295P, RIVER-296, River-296P, RIVER-297, RIVER-298, RV282, RV282DD, RV295, RV295PS, RV296, RV296PS, RV297, RV298, RV298HZ | | |

| accessories for | | 520242 | |
|--|--|----------|--------|
| GEV No. | 361058 | Ref. No. | 143235 |
|  | silicone hose for peristaltic pump ID ø 4mm ED ø 7mm L 5m thickness 1.5mm t.max. 200°C Shore A 55° transparent dosing Qty 5m | | |
| For models: | 2312-009-CRP, 914583, 914628, 914944, 915143, 915150, 915151, 915152, 915154, 915155, 915157, 915158, 915160, 915161, 915162, 915166, 915167, 915168, 915172, 915173, 915175, 915176, 915177, 915285, 915319, 915338, 915341, 915348, 915418, 915419, 915420, 915421, 915422, 915479, 915492, 915493, 915494, 915495, 915496, 915497, 915547, 915558, 915611, 915612, 915613, 915614, 915615, 915616, 915617, 915618...(Other models you can see in the webshop) | | |



formed hoses

straight



1

| | | | |
|--------------------|--|-----------------|--------|
| GEV No. | 518303 | Ref. No. | 127065 |
| description | formed hose | | |
| For models: | 2312-007, 2312-009-CRP, 914100, 914101, 914339, 914342, 914343, 914624, 914625, 914626, 914627, 914628, 914850, 914851, 914854, 914944, RIVER-48, RIVER-50, RIVER-50-CRP, RIVER-50-CRP-SP, River-54, RIVER-54CRP, River-54-CRP-s.p., RIVER-54-CRP-SP, RIVER-61 | | |





Image not available

1

| | | | |
|--------------------|-------------|-----------------|--------|
| GEV No. | 518514 | Ref. No. | 143133 |
| description | formed hose | | |
| For models: | 22F, 22R | | |



1

| | | | |
|--------------------|--|-----------------|--------|
| GEV No. | 518519 | Ref. No. | 127054 |
| description | formed hose dishwasher straight equiv. no. 127054 | | |
| For models: | 913289, 913290, 913291, 913292, 913356, 913357, 913372, 913373, 913374, 913375, 913416, 913435, 913544, 913545, 913665, 913666, 913667, 913668, 913685, 913771, 913772, 913773, 913774, 913832, 913837, 913911, 913912, 913948, 913950, 913977, 913984, 913990, 914165, 914166, 914206, 914214, 914316, 914317, 914355, 914386, 914387, 914388, 914389, 914390, 914391, 914392, 914393, 914394, 914395, 914396...(Other models you can see in the webshop) | | |



1

| | | | |
|--------------------|---|-----------------|--------|
| GEV No. | 518213 | Ref. No. | 143009 |
| description | formed hose dishwasher straight equiv. no. 143009 | | |
| For models: | 35OR, 35ORD, 35-ELECTRONIC, 35R, 35RD, 400F, 400FD, 400R, 400RD, 40-ELECTRONIC, 40F, 40FD, 40R, 40RD, 45, 450, 67F, 67R, 913418, 914167, 914168, 914398, 914399, 914443, 914943, 915695, 915696, 915819, E.45, Fast145, FAST-145, Fast145D, FAST-145D, NIAGARA-45, S641, S643 | | |



1

| | | | |
|--------------------|--|-----------------|--------|
| GEV No. | 518223 | Ref. No. | 127022 |
| description | formed hose dishwasher straight mounting pos. lower equiv. no. 127022 | | |
| For models: | 11F, 11FD, 11F-DVGW, 11R, 11RD, 45, 450, 913363, 913364, 913376, 913377, 913418, 914167, 914168, 914398, 914399, 914443, 914943, 915695, 915696, 915819, E.41, E.42, E.45, E41, Fast145, FAST-145, Fast145D, FAST-145D, NIAGARA-45 | | |



1

| | | | |
|--------------------|---|-----------------|--------|
| GEV No. | 518070 | Ref. No. | 127026 |
| description | formed hose dishwasher straight mounting pos. upper equiv. no. 127026 | | |
| For models: | 050F, 050FP, 22F, 22R, 2312-001, 2312-002, 40F, 440F, 44F, 46, 460, 500F, 500FD, 50F, 50FD, 510F, 510FD, 913297, 913298, 913299, 913300, 913360, 913361, 913391, 913392, 913546, 913547, 913578, 913611, 913684, 913913, 913914, 913932, 913933, 914284, 914318, 914319, 914326, 914331, 914338, 914356, 914400, 914401, 914402, 914403, 914404, 914405, 914406, 914431, 914449...(Other models you can see in the webshop) | | |



1

| | | | |
|--------------------|---|-----------------|--------|
| GEV No. | 518381 | Ref. No. | 127035 |
| description | formed hose dishwasher straight mounting pos. upper equiv. no. 127035 | | |
| For models: | 46, 460, 500F, 500FD, 50-ELECTRONIC, 50F, 50FD, 510F, 510FD, E.46, E.50, E.51, E.60, E.65, TF-503, TF-513, TF-515 | | |



1

| | | | |
|--------------------|---|-----------------|--------|
| GEV No. | 518513 | Ref. No. | 143158 |
| description | formed hose ext. ø 43.5 ID ø 35mm L 925mm dishwasher straight mounting pos. upper equiv. no. 143158 | | |
| For models: | 22F, 22R, 40F, 440F, 44F, E.52 | | |



1

| | | | |
|--------------------|---|-----------------|-----------------|
| GEV No. | 518380 | Ref. No. | 127036 80189 |
| description | formed hose ext. ø 53 ID ø 43mm L 65mm dishwasher straight mounting pos. upper equiv. no. 127036 | | |
| For models: | 22F, 2312-001, 2312-002, 440F, 44F, 46, 460, 500F, 500FD, 50-ELECTRONIC, 50F, 50FD, 510F, 510FD, 80, 81, 82, 913297, 913298, 913299, 913300, 913360, 913361, 913391, 913392, 913546, 913547, 913578, 913611, 913684, 913913, 913914, 913932, 913933, 914284, 914318, 914319, 914331, 914338, 914356, 914400, 914401, 914402, 914403, 914404, 914405, 914431, 914449, 914517, 914545...(Other models you can see in the webshop) | | |



| | | | |
|--------------------|---|-----------------|----------------|
| GEV No. | 513294 | Ref. No. | 41525 43149 |
| description | formed hose hose ext. ø 20mm ID ø 13mm hose int. ø 25mm L 1350mm | | |
| For models: | 915747, A3EB, A3EBD, A3EBDAKRKYK, A3EBDAKWK, A3EBDBKWK, A3EBDRKYK, A3EBDVK, A3EBDYK, A3EBSAK, A3EBSAKRK, A3EBSAKWK, A3EBSBKWKYK, A3EBSKWK, A3EBSWK, A4EB, A4EBD, A4EBDAKEYK, A4EBDAKRK, A4EBDAKWK, A4EBDAKZK, A4EBDBKRK, A4EBDPKWYK, A4EBDRK, A4EBS, A4EBSAK, A4EBSAKCK, A4EBSAKK, A4EBSAKRK, A4EBSAKRKP, A4EBSAKYK, A4EBSCK, A4EBT, A4EBTSAK, A5EB, A5EBD, A5EBDAKPKWK, A5EBDAKWK, A5EBDAKYK, A5EBDRK, A5EBS, A5EBSAKPKWK, A5EBSAKRK, A5EBSAKRKYK, A5EBSAKWK, A5EBSAKWKYK, A5EBSBKRKP, A5EBSBKWK, A5EBSRK, A5EBSYK...(Other models you can see in the webshop) | | |



| | | | |
|--------------------|--|-----------------|--------|
| GEV No. | 504795 | Ref. No. | 127096 |
| description | formed hose L 47mm warewashing | | |
| For models: | 915154, 915155, 915157, 915158, 915172, 915173, 915285, 915422, 915492, 915493, 915494, 915495, 915496, 915497, 916054, 916067, 916068, 916069, 916079, 916080, 916368, 916420, 916421, 916422, 916423, 916424, 916686, 916760, RIVER-252, RIVER-252-2, RIVER-252-2T, RIVER-253, RIVER-262, RIVER-262-2, RIVER-262-2T, RIVER-272, RIVER-282, RIVER-352C, RIVER-352T, RIVER-362C, RIVER-362C-230V-3Ph-50Hz, RIVER-362T, RIVER-362T-230V-3Ph-50Hz, RIVER-372, RV282, RV282DD | | |

form L



| | | | |
|--------------------|---|-----------------|--------|
| GEV No. | 518302 | Ref. No. | 127064 |
| description | formed hose | | |
| For models: | 2312-007, 2312-009-CRP, 914100, 914101, 914339, 914342, 914343, 914624, 914625, 914626, 914627, 914628, 914850, 914851, 914854, 914944, PS-60, RIVER-48, RIVER-50, RIVER-50-CRP, RIVER-50-CRP-SP, RIVER-54, RIVER-54CRP, RIVER-54-CRP-s.p., RIVER-54-CRP-SP, RIVER-61 | | |



| | | | |
|--------------------|---|-----------------|--------|
| GEV No. | 513311 | Ref. No. | 127128 |
| description | formed hose end piece A ext. ø 17mm end piece A int. ø 10mm AD2 ø 17mm ø end piece B 10mm L 112mm | | |
| For models: | 915611, 915612, 915613, 915614, 915615, 915616, 915670, 915671, 915959, 916196, 916197, 916198, 916199, 916200, 916409, 916410, 916591, 916592, 916593, 916877, Niagara-241, Niagara-241-2, Niagara-341, Pluvia-240 | | |



| | | | |
|--------------------|---|-----------------|-------|
| GEV No. | 513301 | Ref. No. | 70543 |
| description | formed hose end piece A ext. ø 18mm end piece A int. ø 10mm AD2 ø 18mm ø end piece B 10mm L 174mm | | |
| For models: | River-285, River-382LNRG, River-382NRG, River-382NRG-230-3Ph-50Hz, RV282R, RV382LR, RV382LTXR, RV382R, RV382R23TERMO, RV382RFUR, RV382TXR | | |



| | | | |
|--------------------|--|-----------------|--------|
| GEV No. | 513299 | Ref. No. | 127090 |
| description | formed hose end piece A ext. ø 18mm end piece A int. ø 10mm AD2 ø 18mm ø end piece B 10mm L 435mm | | |
| For models: | 915150, 915151, 915152, 915160, 915161, 915162, 915166, 915167, 915168, 915175, 915176, 915177, 915319, 915338, 915341, 915348, 915418, 915419, 915420, 915421, 915479, 915547, 915558, 915635, 915663, 915747, 916201, 916202, 916203, 916204, 916205, 916206, 916207, 916208, 916209, 916365, 916366, 916367, 916411, 916412, 916413, 916414, 916415, 916416, 916417, 916684, 916685, 916761, 916762, 916802...(Other models you can see in the webshop) | | |



| | | | |
|--------------------|---|-----------------|--------|
| GEV No. | 513302 | Ref. No. | 127107 |
| description | formed hose end piece A ext. ø 18mm end piece A int. ø 10mm AD2 ø 18mm ø end piece B 10mm L 450mm | | |
| For models: | 915611, 915612, 915613, 915614, 915615, 915616, 915670, 915671, 915959, 916196, 916197, 916198, 916199, 916200, 916409, 916410, 916591, 916592, 916593, 916877, Niagara-241, Niagara-241-2, Niagara-341, Pluvia-240 | | |



| | | | |
|--------------------|--|-----------------|--------|
| GEV No. | 518639 | Ref. No. | 143237 |
| description | formed hose end piece A ext. ø 18mm end piece A int. ø 11mm AD2 ø 18mm ø end piece B 11mm L 460mm | | |
| For models: | 913289, 913290, 913291, 913292, 913356, 913357, 913372, 913373, 913374, 913375, 913416, 913435, 913544, 913545, 913665, 913666, 913667, 913668, 913685, 913771, 913772, 913773, 913774, 913832, 913837, 913911, 913912, 913948, 913950, 913977, 913984, 913990, 914165, 914166, 914206, 914214, 914316, 914317, 914355, 914386, 914387, 914388, 914389, 914390, 914391, 914392, 914393, 914394, 914395, 914396...(Other models you can see in the webshop) | | |



| | | | |
|--------------------|--|-----------------|-------|
| GEV No. | 513296 | Ref. No. | 69388 |
| description | formed hose end piece A ext. ø 32mm end piece A int. ø 28mm AD2 ø 28mm ø end piece B 20mm L 590mm | | |
| For models: | River-282LS-2TDE, River-282S-2TDE, River-382LTDE, River-382TDE, RV382LS, RV382LSFUR, RV382S, RV382SFUR | | |



| | | | |
|---|---|-----------------|-------|
|  | | | |
| 1 | | | |
| GEV No. | 513305 | Ref. No. | 35603 |
| description | formed hose end piece A ext. ø 51mm end piece A int. ø 44mm AD2 ø 42mm ø end piece B 33mm L 300mm | | |
| For models: | LP60, NG271, NG291, NIAGARA-271, NIAGARA-291, RIVER-294, RIVER-71, RV294, RV71, U60E | | |

| | | | |
|---|---|-----------------|-------|
|  | | | |
| 1 | | | |
| GEV No. | 513313 | Ref. No. | 70020 |
| description | formed hose end piece A ext. ø 54mm end piece A int. ø 44mm AD2 ø 48mm ø end piece B 38mm L 900mm | | |
| For models: | NG381L, NG381LC, NG381LCFUR, NG381LDDPS, Niagara-283L-2, Niagara-381L, Niagara-381LC, River-282L-2, River-282LS-2TDE, River-382L, River-382L-230V-3Ph-50Hz, River-382LNRG, River-382LTDE, River-482, RV382L, RV382L23TERMO, RV382LFUR, RV382LR, RV382LS, RV382LSFUR, RV382LTX, RV382LTXR, RV482 | | |

| | | | |
|--|--|-----------------|-------|
|  | | | |
| 1 | | | |
| GEV No. | 513251 | Ref. No. | 80187 |
| description | formed hose end piece A ext. ø 59mm end piece A int. ø 47mm AD2 ø 58mm ø end piece B 46mm warewashing L-shape equiv. no. 80187 mounting pos. upper | | |
| For models: | 80, 81, 82, 915747, CGL74CABT, Fast200, FAST-200, Fast93, GL280EB, GL280EB23, GL280EB23DAR, GL280EB23HZ, GL280EB23HZDY, GL280EBD, GL280EBDA, GL280EBDAE, GL280EBDAR, GL280EBDARY, GL280EBDAW, GL280EBDAWY, GL280EBDAY, GL280EBDB, GL280EBDBR, GL280EBDBW, GL280EBDWY, GL280EBDY, GL280EBS, GL280EBSA, GL280EBSAE, GL280EBSAEW, GL280EBSAEWY, GL280EBSAR, GL280EBSARY, GL280EBSAW, GL280EBSAWY, GL280EBSAY, GL280EBSB, GL280EBSR, GL280EBSWY, GL280EBSY, GL282EB, GL282EB93, GL282EB93DA, GL282EB93HZ23, GL282EBCH, GL282EBCHD, GL282EBD, GL282EBDA, GL282EBDAE, GL282EBDAR...(Other models you can see in the webshop) | | |

| | | | |
|---|---|-----------------|-----------------|
|  | | | |
| 1 | | | |
| GEV No. | 518124 | Ref. No. | 927016 DZG52 |
| description | formed hose end piece A ext. ø 61mm end piece A int. ø 49mm AD2 ø 65mm ø end piece B 53mm L 290mm rubber Qty 1 for dishwasher L-shape outflow | | |
| For models: | 161, 221, 271, 272, 362, CLEAN-160, CLEAN-161, CLEAN-220, CLEAN-221, CLEAN-270, CLEAN-271, CLEAN-272, CLEAN-361, CLEAN-361P, CLEAN-362, CLEAN-471, CLEAN-471P | | |

| | | | |
|--|---|-----------------|--------|
|  | | | |
| 1 | | | |
| GEV No. | 503178 | Ref. No. | 127106 |
| description | formed hose for drain pump warewashing | | |
| For models: | 915611, 915612, 915613, 915614, 915615, 915616, 915617, 915618, 915670, 915671, 915672, 915773, 915774, 915959, 916066, 916077, 916078, 916196, 916197, 916198, 916199, 916200, 916409, 916410, 916418, 916419, 916591, 916592, 916593, 916594, 916595, 916877, 916921, 916922, 916992, 916993, Fast145-2, Fast150, Niagara-241, Niagara-241-2, Niagara-341, Pluvia-240, River-242, River-242-2, River-242-2T, River-342C, River-342T | | |

| | | | |
|--|---|-----------------|--------|
|  | | | |
| 1 | | | |
| GEV No. | 503179 | Ref. No. | 127120 |
| description | formed hose for drain pump warewashing | | |
| For models: | 915611, 915612, 915613, 915614, 915615, 915616, 915617, 915618, 915670, 915671, 915672, 915773, 915774, 915959, 916066, 916077, 916078, 916196, 916197, 916198, 916199, 916200, 916409, 916410, 916418, 916419, 916591, 916592, 916593, 916594, 916595, 916877, Niagara-241, Niagara-241-2, Niagara-341, Pluvia-240, River-242, River-242-2, River-242-2T, River-342C, River-342T | | |

| | | | |
|---|--|-----------------|-------|
|  | | | |
| 1 | | | |
| GEV No. | 503180 | Ref. No. | 41560 |
| description | formed hose for drain pump warewashing | | |
| For models: | NG292, NG292HZ, NG293, NIAGARA-292, Niagara-292-400V-3Ph-60Hz, NIAGARA-293, RIVER-295, River-295P, RIVER-296, River-296P, RV295, RV295PS, RV296, RV296PS | | |

| | | | |
|--|--|-----------------|--------|
|  | | | |
| 1 | | | |
| GEV No. | 503181 | Ref. No. | 127084 |
| description | formed hose for drain pump warewashing | | |
| For models: | 915150, 915151, 915152, 915154, 915155, 915157, 915158, 915160, 915161, 915162, 915166, 915167, 915168, 915172, 915173, 915175, 915176, 915177, 915285, 915319, 915338, 915341, 915348, 915418, 915419, 915420, 915421, 915422, 915479, 915492, 915493, 915494, 915495, 915496, 915497, 915547, 915558, 915635, 915663, 915747, 916054, 916067, 916068, 916069, 916079, 916080, 916201, 916202, 916203, 916204...(Other models you can see in the webshop) | | |

| | | | |
|---|--|-----------------|-------|
|  | | | |
| 1 | | | |
| GEV No. | 503182 | Ref. No. | 73024 |
| description | formed hose for drain pump warewashing | | |
| For models: | NG381, NG38123, NG38123TERMO, NG381C, NG381CDD, NG381CFUR, NG381DDHZ23, NG381DDPS, NG381DDPSHZ23, NG381HPDD, NG381TERMO, NG381TXCDD, Niagara-381, Niagara-381-230V-3Ph-50Hz, Niagara-381-230V-3Ph-60Hz, Niagara-381DP, Niagara-381HPD, River-282-2, River-282S-2TDE, River-285, River-382, River-382-230V-3Ph-50Hz, River-382H, River-382NRG, River-382NRG-230-3Ph-50Hz, River-382TDE, RV382, RV38223TERMO, RV382AHP, RV382FUR, RV382R, RV382R23TERMO, RV382RFUR, RV382S, RV382SFUR, RV382TERMO, RV382TX, RV382TXR | | |

| | | | |
|--|---|-----------------|-------|
|  | | | |
| 1 | | | |
| GEV No. | 513254 | Ref. No. | 80186 |
| description | formed hose L 340mm warewashing L-shape equiv. no. 80186 ID ø 60mm | | |
| For models: | 80, 81, 82, 915747, A4EB, A4EBD, A4EBDAKEKYK, A4EBDAKRK, A4EBDAKWK, A4EBDAKZK, A4EBDBKRK, A4EBDPKWKYK, A4EBDRK, A4EBS, A4EBSAK, A4EBSAKCK, A4EBSAKEKYK, A4EBSAKRK, A4EBSAKRKP, A4EBSAKYK, A4EBSCK, A4EBT, A4EBTSAK, A5EB, A5EBD, A5EBDAKPKWK, A5EBDAKWK, A5EBDAKYK, A5EBDRK, A5EBS, A5EBSAKPKWK, A5EBSAKRK, A5EBSAKRKYK, A5EBSAKWK, A5EBSAKWKYK, A5EBSBKRPK, A5EBSBKWK, A5EBSRK, A5EBSYK, CE78HZ23, CGL74CABT, E78, E78HP, Fast181, FAST-181, Fast181-230V-3Ph-60Hz, Fast181-400V-3NPh-60Hz, GL284EB, GL284EBD, GL284EBDA...(Other models you can see in the webshop) | | |

| | | | |
|---|--|-----------------|--------|
|  | | | |
| 2 | | | |
| GEV No. | 503175 | Ref. No. | 127134 |
| description | formed hose for intake body warewashing | | |
| For models: | 916020, 916021, 916024, 916025, 916026, 916027, 916030, 916031, 916045, 916247, 916248, 916249, 916250, 916251, 916252, 916382, 916383, 916452, 916504, 916584, 916654, 916670, 916688, 916763, 917044, 917049, Clean161, Fast160-2, Fast160C, Fast161-2, Ocean360, Ocean360M, Ocean360-UK | | |

| | | | |
|--|--|-----------------|--------|
|  | | | |
| 1 | | | |
| GEV No. | 503174 | Ref. No. | 127102 |
| description | formed hose warewashing | | |
| For models: | 915154, 915155, 915157, 915158, 915172, 915173, 915285, 915422, 915492, 915493, 915494, 915495, 915496, 915497, 915695, 915696, 915819, 916054, 916067, 916068, 916069, 916079, 916080, 916368, 916420, 916421, 916422, 916423, 916424, 916686, 916760, 916921, 916922, 916992, 916993, Fast145, FAST-145, Fast145-2, Fast145D, FAST-145D, Fast150, RIVER-252, River-252-2, River-252-2T, RIVER-253, RIVER-262, River-262-2, River-262-2T, River-272, River-282LS-2TDE...(Other models you can see in the webshop) | | |

| | | | |
|--|--|-----------------|-------|
|  | | | |
| 1 | | | |
| GEV No. | 513250 | Ref. No. | 80188 |
| description | formed hose ID ø 48mm ED ø 60mm thickness 6mm L1 235mm L2 140mm L-shape | | |
| For models: | 80, 81, 82, 914380, 914436, A3EB, A3EBD, A3EBDAKRKYK, A3EBDAKWK, A3EBDBKWK, A3EBDRKYK, A3EBDWK, A3EBDYK, A3EBSAK, A3EBSAKRK, A3EBSAKWK, A3EBSBKWKYK, A3EBSEKWK, A3EBSWK, A4EB, A4EBD, A4EBDAKEKYK, A4EBDAKRK, A4EBDAKWK, A4EBDAKZK, A4EBDBKRK, A4EBDPKWKYK, A4EBDRK, A4EBS, A4EBSAK, A4EBSAKCK, A4EBSAKEKYK, A4EBSAKRK, A4EBSAKRKP, A4EBSAKYK, A4EBSCK, A4EBT, A4EBTSAK, A5EB, A5EBD, A5EBDAKPKWK, A5EBDAKWK, A5EBDAKYK, A5EBDRK, A5EBS, A5EBSAKPKWK, A5EBSAKRK, A5EBSAKRKYK, A5EBSAKWK, A5EBSAKWKYK...(Other models you can see in the webshop) | | |

| | | | |
|--|--|-----------------|--------|
|  | | | |
| 1 | | | |
| GEV No. | 503176 | Ref. No. | 127098 |
| description | formed hose warewashing | | |
| For models: | 915150, 915151, 915152, 915154, 915155, 915157, 915158, 915160, 915161, 915162, 915166, 915167, 915168, 915172, 915173, 915175, 915176, 915177, 915285, 915319, 915338, 915341, 915348, 915418, 915419, 915420, 915421, 915422, 915479, 915492, 915493, 915494, 915495, 915496, 915497, 915547, 915558, 915635, 915663, 915695, 915696, 915747, 915819, 916054, 916067, 916068, 916069, 916079, 916080, 916201...(Other models you can see in the webshop) | | |

| | | | |
|--|--|-----------------|--------|
|  | | | |
| 1 | | | |
| GEV No. | 503177 | Ref. No. | 127111 |
| description | formed hose warewashing | | |
| For models: | 915617, 915618, 915672, 915773, 915774, 916066, 916077, 916078, 916418, 916419, 916594, 916595, River-242, River-242-2, River-242-2T, River-342C, River-342T | | |

1

| | | | |
|--------------------|--|-----------------|--------|
| GEV No. | 518216 | Ref. No. | 127001 |
| description | formed hose warewashing L-shape equiv. no. 127001 mounting pos. upper | | |
| For models: | 21F, 21FD, 21R, 21RD, 22F, 22R, 25F, 25FD, 25R, 25RD, 30F, 30FD, 30R, 30RD, 31F, 31FD, 31R, 31RD, 40F, 440F, 44F, 45, 450, 67F, 67R, 913418, 914167, 914168, 914398, 914399, 914443, 914943, 915695, 915696, 915819, E.45, E.52, Fast145, FAST-145, Fast145D, FAST-145D, Niagra-45, S621, S623, S624, S626, S631, S633, S634, S636 | | |



1

| | | | |
|--------------------|---|-----------------|--------|
| GEV No. | 518520 | Ref. No. | 127005 |
| description | formed hose warewashing L-shape equiv. no. 127005 | | |
| For models: | 11F, 11FD, 11R, 11RD, 21F, 21FD, 21R, 21RD, 25F, 25FD, 25R, 25RD, 30F, 30FD, 30R, 30RD, 31F, 31FD, 31R, 31RD, 913363, 913364, 913376, 913377, E.41, E.42, E41, S621, S623, S624, S626, S631, S633, S634, S636 | | |



1

| | | | |
|--------------------|--|-----------------|--------|
| GEV No. | 518225 | Ref. No. | 127041 |
| description | formed hose warewashing L-shape equiv. no. 127041 | | |
| For models: | 050F, 050FP, 2312-001, 2312-002, 46, 460, 500F, 500FD, 50F, 50FD, 510F, 510FD, 913297, 913298, 913299, 913300, 913360, 913361, 913391, 913392, 913546, 913547, 913578, 913611, 913684, 913913, 913914, 913932, 913933, 914284, 914318, 914319, 914331, 914338, 914356, 914400, 914401, 914402, 914403, 914404, 914405, 914431, 914449, 914517, 914545, 914568, 914642, 914688, 914909, 914979... (Other models you can see in the webshop) | | |



1

| | | | |
|--------------------|--|-----------------|--------|
| GEV No. | 518224 | Ref. No. | 127042 |
| description | formed hose warewashing L-shape equiv. no. 127042 | | |
| For models: | 45, 450, 913418, 914167, 914168, 914398, 914399, 914443, 914943, 915695, 915696, 915819, E.45, Fast145, FAST-145, Fast145D, FAST-145D, Niagra-45 | | |



1

| | | | |
|--------------------|--|-----------------|--------|
| GEV No. | 513245 | Ref. No. | 926032 |
| description | formed hose warewashing L-shape equiv. no. 926032, DZG441 | | |
| For models: | 10, 12, 14, CLEAN-100, CLEAN-110, CLEAN-120, E1, E10, E100, E110, E12, E120, E14, E140 | | |



1

| | | | |
|--------------------|--|-----------------|--------|
| GEV No. | 513134 | Ref. No. | 926034 |
| description | formed hose warewashing L-shape equiv. no. 926034, DZG47 | | |
| For models: | 10, 12, 14, 82, CLEAN-100, CLEAN-110, CLEAN-120, E.60, E.65, E1, E10, E100, E110 | | |



1

| | | | |
|--------------------|---|-----------------|--------|
| GEV No. | 513135 | Ref. No. | 926056 |
| description | formed hose warewashing L-shape equiv. no. 926056, DZG461 | | |
| For models: | 12, 14, 161, 221, 271, 272, 362, 914380, 914436, 915747, A3EB, A3EBD, A3EBDAKRKYK, A3EBDAKWK, A3EBDBKWK, A3EBDRKYK, A3EBDWWK, A3EBDYK, A3EBSAK, A3EBSAKRK, A3EBSAKWK, A3EBSBKWKYK, A3EBSEKWK, A3EBSWK, A4EB, A4EBD, A4EBDAKEYK, A4EBDAKRK, A4EBDAKWK, A4EBDAKZK, A4EBDBKRK, A4EBDPKWYK, A4EBDRK, A4EBS, A4EBSAK, A4EBSAKCK, A4EBSAKEKYK, A4EBSAKRK, A4EBSAKRKP, A4EBSAKYK, A4EBSCK, A4EBT, A4EBTSAK, A5EB, A5EBD, A5EBDAKPKWK, A5EBDAKWK, A5EBDAKYK, A5EBDRK, A5EBS...(Other models you can see in the webshop) | | |



1

| | | | |
|--------------------|--|-----------------|--------|
| GEV No. | 513246 | Ref. No. | 926157 |
| description | formed hose warewashing L-shape equiv. no. 926157, DZG6162 | | |
| For models: | CLEAN-100, CLEAN-110, E1, E10, E100, E110 | | |



1

| | | | |
|--------------------|--|-----------------|--------|
| GEV No. | 518578 | Ref. No. | 127010 |
| description | formed hose warewashing L-shape equiv. no. DZG30, 127010 | | |
| For models: | R509, R511, R704 | | |



1

| | | | |
|--------------------|---|-----------------|--------|
| GEV No. | 513075 | Ref. No. | 929164 |
| description | formed hose warewashing L-shape equiv. no. DZG60, 929164 | | |
| For models: | 914380, 914436, 915747, A3EB, A3EBD, A3EBDAKRKYK, A3EBDAKWK, A3EBDBKWK, A3EBDRKYK, A3EBDVK, A3EBDYK, A3EBSAK, A3EBSAKRK, A3EBSAKWK, A3EBSBKWKYK, A3EBSEKWK, A3EBSWK, A4EB, A4EBD, A4EBDAKEKYK, A4EBDAKRK, A4EBDAKWK, A4EBDAKZK, A4EBDBKRK, A4EBDPKWKYK, A4EBDRK, A4EBS, A4EBSAK, A4EBSAKCK, A4EBSAKEKYK, A4EBSAKRK, A4EBSAKRKP, A4EBSAKYK, A4EBSCK, A4EBT, A4EBTSAK, A5EB, A5EBD, A5EBDAKPKWK, A5EBDAKWK, A5EBDAKYK, A5EBDRK, A5EBS, A5EBSAKPKWK, A5EBSAKRK, A5EBSAKRKYK, A5EBSAKWK, A5EBSAKWKYK, A5EBSBKRKPK, A5EBSBKWK... (Other models you can see in the webshop) | | |

with branch



1

| | | | |
|--------------------|---|-----------------|--------|
| GEV No. | 511929 | Ref. No. | 143239 |
| description | formed hose ext. ø 17 L 430mm plastic black Qty 1 | | |
| For models: | 913289, 913290, 913291, 913292, 913356, 913357, 913363, 913364, 913372, 913373, 913374, 913375, 913376, 913377, 913416, 913435, 913544, 913545, 913665, 913666, 913667, 913668, 913685, 913771, 913772, 913773, 913774, 913832, 913837, 913911, 913912, 913948, 913950, 913977, 913984, 913990, 914165, 914166, 914206, 914214, 914316, 914317, 914355, 914386, 914387, 914388, 914389, 914390, 914391, 914392... (Other models you can see in the webshop) | | |



1

| | | | |
|--------------------|---|-----------------|--------|
| GEV No. | 513247 | Ref. No. | 926158 |
| description | formed hose warewashing equiv. no. 926158, DZG6364 mounting pos. upper with piggyback | | |
| For models: | E12, E120, E14, E140 | | |

form S



1

| | | | |
|--------------------|---|-----------------|--------|
| GEV No. | 512448 | Ref. No. | 127103 |
| description | formed hose ED ø 17mm hose int. ø 10mm warewashing | | |
| For models: | 915154, 915155, 915157, 915158, 915172, 915173, 915285, 915422, 915492, 915493, 915494, 915495, 915496, 915497, 916054, 916067, 916068, 916069, 916079, 916080, 916368, 916420, 916421, 916422, 916423, 916424, 916686, 916760, RIVER-252, River-252-2, River-252-2T, River-253, RIVER-262, River-262-2, River-262-2T, River-272, River-282LS-2TDE, River-282S-2TDE, River-352C, River-352T, River-362C, River-362C-230V-3Ph-50Hz, River-362T, River-362T-230V-3Ph-50Hz, River-372, River-382LTDE, River-382TDE, RV382LS, RV382LSFUR, RV382S... (Other models you can see in the webshop) | | |



1

| | | | |
|--------------------|--|-----------------|--------|
| GEV No. | 512450 | Ref. No. | 127116 |
| description | formed hose ED ø 29mm hose int. ø 21mm warewashing | | |
| For models: | 915617, 915618, 915672, 915773, 915774, 916066, 916077, 916078, 916418, 916419, 916594, 916595, River-242, River-242-2, River-242-2T, River-342C, River-342T | | |

1

| | | | |
|--------------------|---|-----------------|--------|
| GEV No. | 512454 | Ref. No. | 127105 |
| description | formed hose for drain pump warewashing | | |
| For models: | 915611, 915612, 915613, 915614, 915615, 915616, 915617, 915618, 915670, 915671, 915672, 915773, 915774, 915959, 916066, 916077, 916078, 916196, 916197, 916198, 916199, 916200, 916409, 916410, 916418, 916419, 916591, 916592, 916593, 916594, 916595, 916877, 916921, 916922, 916992, 916993, Fast145-2, Fast150, Niagara-241, Niagara-241-2, Niagara-341, Pluvia-240, River-242, River-242-2, River-242-2T, River-342C, River-342T | | |



1

| | | | |
|--------------------|---|-----------------|--------|
| GEV No. | 513237 | Ref. No. | 127121 |
| description | formed hose for drain pump warewashing | | |
| For models: | 915611, 915612, 915613, 915614, 915615, 915616, 915617, 915618, 915670, 915671, 915672, 915773, 915774, 915959, 916066, 916077, 916078, 916196, 916197, 916198, 916199, 916200, 916409, 916410, 916418, 916419, 916591, 916592, 916593, 916594, 916595, 916877, NIAGARA-241, NIAGARA-241-2, NIAGARA-341, PLUVIA-240, RIVER-242, RIVER-242-2, RIVER-242-2T, RIVER-342C, RIVER-342T | | |



1

| | | | |
|--------------------|--|-----------------|--------|
| GEV No. | 513312 | Ref. No. | 127114 |
| description | formed hose ID ø 10mm hose ext. ø 17mm ED ø 17mm hose int. ø 10mm L 115mm | | |
| For models: | 915617, 915618, 915672, 915773, 915774, 916066, 916077, 916078, 916418, 916419, 916594, 916595, River-242, River-242-2, River-242-2T, River-342C, River-342T | | |



1

| | | | |
|--------------------|--|-----------------|--------|
| GEV No. | 513300 | Ref. No. | 127093 |
| description | formed hose ID ø 30mm hose ext. ø 35mm ED ø 27mm hose int. ø 21mm L 460mm | | |
| For models: | 915150, 915151, 915152, 915154, 915155, 915157, 915158, 915160, 915161, 915162, 915166, 915167, 915168, 915172, 915173, 915175, 915176, 915177, 915285, 915319, 915338, 915341, 915348, 915418, 915419, 915420, 915421, 915422, 915479, 915492, 915493, 915494, 915495, 915496, 915497, 915547, 915558, 915635, 915663, 915747, 916054, 916067, 916068, 916069, 916079, 916080, 916201, 916202, 916203, 916204...(Other models you can see in the webshop) | | |



1

| | | | |
|--------------------|--|-----------------|--------|
| GEV No. | 513244 | Ref. No. | 926033 |
| description | formed hose S-shape warewashing equiv. no. 926033, DZG63 | | |
| For models: | 10, CLEAN-100, CLEAN-110, E1, E10, E100, E110 | | |



1

| | | | |
|--------------------|--|-----------------|--------|
| GEV No. | 512449 | Ref. No. | 127092 |
| description | formed hose warewashing | | |
| For models: | 915150, 915151, 915152, 915154, 915155, 915157, 915158, 915160, 915161, 915162, 915166, 915167, 915168, 915172, 915173, 915175, 915176, 915177, 915285, 915319, 915338, 915341, 915348, 915418, 915419, 915420, 915421, 915422, 915479, 915492, 915493, 915494, 915495, 915496, 915497, 915547, 915558, 915635, 915663, 915747, 916054, 916067, 916068, 916069, 916079, 916080, 916201, 916202, 916203, 916204...(Other models you can see in the webshop) | | |



1

| | | | |
|--------------------|--|-----------------|--------|
| GEV No. | 512451 | Ref. No. | 127101 |
| description | formed hose warewashing | | |
| For models: | 915154, 915155, 915157, 915158, 915172, 915173, 915285, 915422, 915492, 915493, 915494, 915495, 915496, 915497, 916054, 916067, 916068, 916069, 916079, 916080, 916368, 916420, 916421, 916422, 916423, 916424, 916686, 916760, RIVER-252, RIVER-252-2, RIVER-252-2T, RIVER-253, RIVER-262, RIVER-262-2, RIVER-262-2T, RIVER-272, RIVER-282LS-2TDE, RIVER-282S-2TDE, RIVER-352C, RIVER-352T, RIVER-362C, RIVER-362C-230V-3Ph-50Hz, RIVER-362T, RIVER-362T-230V-3Ph-50Hz, RIVER-372, RIVER-382LTDE, RIVER-382TDE, RV382LS, RV382LSFUR, RV382S...(Other models you can see in the webshop) | | |



1

| | | | |
|--------------------|---|-----------------|--------|
| GEV No. | 512452 | Ref. No. | 127122 |
| description | formed hose warewashing | | |
| For models: | 915611, 915612, 915613, 915614, 915615, 915616, 915617, 915618, 915670, 915671, 915672, 915773, 915774, 915959, 916066, 916077, 916078, 916196, 916197, 916198, 916199, 916200, 916409, 916410, 916418, 916419, 916591, 916592, 916593, 916594, 916595, 916877, NIAGARA-241, NIAGARA-241-2, NIAGARA-341, PLUVIA-240, RIVER-242, RIVER-242-2, RIVER-242-2T, RIVER-342C, RIVER-342T | | |



1

| | | | |
|--------------------|--|-----------------|--------|
| GEV No. | 512453 | Ref. No. | 127112 |
| description | formed hose warewashing | | |
| For models: | 915617, 915618, 915672, 915773, 915774, 916066, 916077, 916078, 916418, 916419, 916594, 916595, River-242, River-242-2, River-242-2T, River-342C, River-342T | | |

form U



1

| | | | |
|--------------------|-------------|-----------------|--------|
| GEV No. | 518516 | Ref. No. | 127045 |
| description | formed hose | | |
| For models: | 46, 460 | | |



1

| | | | |
|--------------------|--|-----------------|--------|
| GEV No. | 513233 | Ref. No. | 127087 |
| description | formed hose D1 ø 30mm D2 ø 30mm for drain pump rubber warewashing | | |
| For models: | 915150, 915151, 915152, 915154, 915155, 915157, 915158, 915160, 915161, 915162, 915166, 915167, 915168, 915172, 915173, 915175, 915176, 915177, 915285, 915319, 915338, 915341, 915348, 915418, 915419, 915420, 915421, 915422, 915479, 915492, 915493, 915494, 915495, 915496, 915497, 915547, 915558, 915635, 915663, 915747, 916054, 916067, 916068, 916069, 916079, 916080, 916201, 916202, 916203, 916204...(Other models you can see in the webshop) | | |



1

| | | | |
|--------------------|--|-----------------|--------|
| GEV No. | 513297 | Ref. No. | 127109 |
| description | formed hose ext. ø 30 D1 ø 25mm D2 ø 11mm L 860mm | | |
| For models: | 915617, 915618, 915672, 915773, 915774, 916066, 916077, 916078, 916418, 916419, 916594, 916595, River-242, River-242-2, River-242-2T, River-342C, River-342T | | |



1

| | | | |
|--------------------|--|-----------------|-------|
| GEV No. | 698840 | Ref. No. | 44354 |
| description | formed hose ext. ø 40.5 D1 ø 32.5mm D2 ø 42.5mm 1210 warewashing Qty 1 | | |
| For models: | NG293, NIAGARA-293, RIVER-296, River-296P, RV296, RV296PS | | |



1

| | | | |
|--------------------|--|-----------------|--------|
| GEV No. | 698842 | Ref. No. | 127133 |
| description | formed hose ext. ø 44 D1 ø 34mm D2 ø 34mm L 630mm warewashing Qty 1 | | |
| For models: | 916020, 916021, 916024, 916025, 916026, 916027, 916030, 916031, 916045, 916247, 916248, 916249, 916250, 916251, 916252, 916382, 916383, 916452, 916504, 916584, 916654, 916670, 916688, 916763, 917044, 917049, Clean161, Fast160-2, Fast160C, Fast161-2, Ocean360, Ocean360M, Ocean360-UK | | |



1

| | | | |
|--------------------|---|-----------------|-------|
| GEV No. | 513315 | Ref. No. | 43555 |
| description | formed hose ext. ø 52 D1 ø 44mm L 1200mm | | |
| For models: | RIVER-297, RIVER-298, RV297, RV298, RV298HZ | | |



1

| | | | |
|--------------------|---|-----------------|-------|
| GEV No. | 513314 | Ref. No. | 41554 |
| description | formed hose ext. ø 52 D1 ø 46mm D2 ø 42mm L 1000mm | | |
| For models: | NG292, NG292HZ, NIAGARA-292, Niagara-292-400V-3Ph-60Hz, RIVER-295, River-295P, RV295, RV295PS | | |



| | | | |
|---|---|-----------------|--------|
|  | | | |
| 1 | | | |
| GEV No. | 518517 | Ref. No. | 127050 |
| description | formed hose for drain pump D1 ø 28mm D2 ø 21mm warewashing U-shape | | |
| For models: | 050F, 050FP, 2312-001, 2312-002, 500F, 500FD, 50F, 50FD, 510F, 510FD, 913297, 913298, 913299, 913300, 913360, 913361, 913391, 913392, 913546, 913547, 913578, 913611, 913684, 913913, 913914, 913932, 913933, 914284, 914318, 914319, 914331, 914338, 914356, 914400, 914401, 914402, 914403, 914404, 914405, 914431, 914449, 914517, 914545, 914568, 914642, 914688, 914909, 914979, 915136, 915137... (Other models you can see in the webshop) | | |

| | | | |
|--|---|-----------------|--------|
|  | | | |
| 1 | | | |
| GEV No. | 513260 | Ref. No. | 143242 |
| description | formed hose warewashing | | |
| For models: | 913289, 913290, 913291, 913292, 913356, 913357, 913372, 913373, 913374, 913375, 913416, 913435, 913544, 913545, 913665, 913666, 913667, 913668, 913685, 913771, 913772, 913773, 913774, 913832, 913837, 913911, 913912, 913948, 913950, 913977, 913984, 913990, 914165, 914166, 914206, 914214, 914316, 914317, 914355, 914386, 914387, 914388, 914389, 914390, 914391, 914392, 914393, 914394, 914395, 914396... (Other models you can see in the webshop) | | |

| | | | |
|---|---|-----------------|-------|
|  | | | |
| 2 | | | |
| GEV No. | 513199 | Ref. No. | 69068 |
| description | formed hose for drain pump warewashing | | |
| For models: | 915154, 915155, 915157, 915158, 915172, 915173, 915285, 915422, 915492, 915493, 915494, 915495, 915496, 915497, 916045, 916054, 916067, 916068, 916069, 916079, 916080, 916368, 916420, 916421, 916422, 916423, 916424, 916654, 916686, 916760, Fast160C, Ocean360-UK, River-252, River-252-2, River-252-2T, River-253, RIVER-262, River-262-2, River-262-2T, River-272, RIVER-282, River-282-2, River-282L-2, River-282LS-2TDE, River-282S-2TDE, River-285, RIVER-294, RIVER-295, River-295P, RIVER-296... (Other models you can see in the webshop) | | |

| | | | |
|--|--|-----------------|--------|
|  | | | |
| 1 | | | |
| GEV No. | 513278 | Ref. No. | 127136 |
| description | formed hose warewashing | | |
| For models: | 916020, 916021, 916024, 916025, 916026, 916027, 916030, 916031, 916045, 916247, 916248, 916249, 916250, 916251, 916252, 916382, 916383, 916452, 916504, 916584, 916654, 916670, 916688, 916763, 916921, 916922, 916992, 916993, 917044, 917049, Clean161, Fast145-2, Fast150, Fast160-2, Fast160C, Fast161-2, Ocean360, Ocean360M, Ocean360-UK | | |

| | | | |
|---|---|-----------------|--------|
|  | | | |
| 1 | | | |
| GEV No. | 513232 | Ref. No. | 127115 |
| description | formed hose for drain pump warewashing | | |
| For models: | 915611, 915612, 915613, 915614, 915615, 915616, 915617, 915618, 915670, 915671, 915672, 915773, 915774, 915959, 916066, 916077, 916078, 916196, 916197, 916198, 916199, 916200, 916409, 916410, 916418, 916419, 916591, 916592, 916593, 916594, 916595, 916877, Niagara-241, Niagara-241-2, Niagara-341, Pluvia-240, River-242, River-242-2, River-242-2T, River-342C, River-342T | | |

| | | | |
|--|---|-----------------|--------|
| miscellaneous | | | |
|  | | | |
| 1 | | | |
| GEV No. | 518036 | Ref. No. | 127012 |
| description | formed hose angled warewashing | | |
| For models: | 21F, 21FD, 25F, 25FD, 30F, 30FD, 31F, 31FD, 31R, 31RD, S621, S623, S624, S626, S631, S633, S634, S636 | | |

| | | | |
|---|--|-----------------|--------|
|  | | | |
| 1 | | | |
| GEV No. | 513234 | Ref. No. | 127123 |
| description | formed hose for drain pump warewashing | | |
| For models: | 915617, 915618, 915672, 915773, 915774, 916066, 916077, 916078, 916418, 916419, 916594, 916595, RIVER-242, River-242-2, River-242-2T, River-342C, River-342T | | |

| | | | |
|--|--|-----------------|--------|
|  | | | |
| 1 | | | |
| GEV No. | 513303 | Ref. No. | 127135 |
| description | formed hose end piece A ext. ø 28mm end piece A int. ø 20mm AD2 ø 28mm ø end piece B 20mm L 410mm | | |
| For models: | 916020, 916021, 916024, 916025, 916026, 916027, 916030, 916031, 916045, 916247, 916248, 916249, 916250, 916251, 916252, 916382, 916383, 916452, 916504, 916584, 916654, 916670, 916688, 916763, 917044, 917049, Clean161, Fast160-2, Fast160C, Fast161-2, Ocean360, Ocean360M, Ocean360-UK | | |

1

| | | | |
|--------------------|--|-----------------|--------|
| GEV No. | 513293 | Ref. No. | 143236 |
| description | formed hose ext. ø 18 ID ø 11mm L 535mm dishwasher | | |
| For models: | 913289, 913290, 913291, 913292, 913356, 913357, 913372, 913373, 913374, 913375, 913416, 913435, 913544, 913545, 913665, 913666, 913667, 913668, 913685, 913771, 913772, 913773, 913774, 913832, 913837, 913911, 913912, 913948, 913950, 913977, 913984, 913990, 913992, 913993, 914165, 914166, 914206, 914214, 914316, 914317, 914355, 914386, 914387, 914388, 914389, 914390, 914391, 914392, 914393, 914394...(Other models you can see in the webshop) | | |



1

| | | | |
|--------------------|---|-----------------|--------|
| GEV No. | 513298 | Ref. No. | 127144 |
| description | formed hose ext. ø 19 ID ø 11mm L 360mm | | |
| For models: | 916045, 916654, Fast160C, Ocean360-UK | | |



1

| | | | |
|--------------------|---|-----------------|--------|
| GEV No. | 513295 | Ref. No. | 127143 |
| description | formed hose ext. ø 31 ID ø 24mm D1 ø 19mm D2 ø 11mm | | |
| For models: | 916045, 916654, Fast160C, Ocean360-UK | | |



1

| | | | |
|--------------------|--|-----------------|--------|
| GEV No. | 513306 | Ref. No. | 127085 |
| description | formed hose ext. ø 43 ID ø 34mm ED ø 23mm D1 ø 32mm L 140mm | | |
| For models: | 915150, 915151, 915152, 915154, 915155, 915157, 915158, 915160, 915161, 915162, 915166, 915167, 915168, 915172, 915173, 915175, 915176, 915177, 915285, 915319, 915338, 915341, 915348, 915418, 915419, 915420, 915421, 915422, 915479, 915492, 915493, 915494, 915495, 915496, 915497, 915547, 915558, 915635, 915663, 915747, 916020, 916021, 916024, 916025, 916026, 916027, 916030, 916031, 916045, 916054...(Other models you can see in the webshop) | | |



1

| | | | |
|--------------------|--|-----------------|-------|
| GEV No. | 698841 | Ref. No. | 69020 |
| description | formed hose ext. ø 44.5 ID ø 34.5mm ED ø 53mm D1 ø 43mm | | |
| For models: | CNT800CH, Fast180, Fast180-230V-3Ph-60Hz, FAST-60, FAST-73, NG281, NG281CDD, NG281HP, NG281HPDD, NG281HZ23, NG281H-Z23DD, NG381, NG38123, NG38123TERMO, NG381C, NG381CDD, NG381CFUR, NG381DDHZ23, NG381DDPS, NG381DDPSHZ23, NG381HPDD, NG381TERMO, NG381TXCDD, NIAGARA-281, Niagara-281-2, Niagara-281HP, Niagara-381, Niagara-381-230V-3Ph-50Hz, Niagara-381-230V-3Ph-60Hz, Niagara-381DP, Niagara-381HPD, OC380, OC380FUR, OC380HZ23, Ocean380, PLUVIA-280, Pluvia280-230V-3Ph-60Hz, PV280, PV280FAST, PV280FAST2, PV280FAST2BIO, PV280FAST2HZ23, PV280FASTCH, PV280FASTHB, PV280HZ23, River-282-2, River-2825-2TDE, River-285, River-382, River-382-230V-3Ph-50Hz...(Other models you can see in the webshop) | | |



1

| | | | |
|--------------------|--|-----------------|--------|
| GEV No. | 513307 | Ref. No. | 127082 |
| description | formed hose ext. ø 47 ID ø 39mm ED ø 47mm D1 ø 39mm L 82mm | | |
| For models: | 915150, 915151, 915152, 915154, 915155, 915157, 915158, 915160, 915161, 915162, 915166, 915167, 915168, 915172, 915173, 915175, 915176, 915177, 915285, 915319, 915338, 915341, 915348, 915418, 915419, 915420, 915421, 915422, 915479, 915492, 915493, 915494, 915495, 915496, 915497, 915547, 915558, 915635, 915663, 915747, 916020, 916021, 916024, 916025, 916026, 916027, 916030, 916031, 916045, 916054...(Other models you can see in the webshop) | | |



1

| | | | |
|--------------------|--|-----------------|-------|
| GEV No. | 513308 | Ref. No. | 73008 |
| description | formed hose ext. ø 65 ID ø 58mm ED ø 49.5mm D1 ø 58mm L 90mm | | |
| For models: | NG381, NG38123, NG38123TERMO, NG381C, NG381CDD, NG381CFUR, NG381DDHZ23, NG381DDPS, NG381DDPSHZ23, NG381HPDD, NG381TERMO, NG381TXCDD, Niagara-381, Niagara-381-230V-3Ph-50Hz, Niagara-381-230V-3Ph-60Hz, Niagara-381DP, Niagara-381HPD, River-282-2, River-2825-2TDE, River-285, River-382, River-382-230V-3Ph-50Hz, River-382H, River-382NRG, River-382NRG-230-3Ph-50Hz, River-382TDE, RV382, RV38223TERMO, RV382AHP, RV382FUR, RV382R, RV382R23TERMO, RV382RFUR, RV382S, RV382SFUR, RV382TERMO, RV382TX, RV382TXR | | |



| | | | |
|---|---|-----------------|--------|
|  | | | |
| GEV No. | 513235 | Ref. No. | 127108 |
| description | formed hose for boiler warewashing | | |
| For models: | 915611, 915612, 915613, 915614, 915615, 915616, 915670, 915671, 915959, 916196, 916197, 916198, 916199, 916200, 916409, 916410, 916591, 916592, 916593, 916877, 916921, 916922, 916992, 916993, Fast145-2, Fast150, Niagara-241, Niagara-241-2, Niagara-341, Pluvia-240 | | |

| | | | |
|---|---|-----------------|--------|
|  | | | |
| GEV No. | 517800 | Ref. No. | 127097 |
| description | formed hose ID ø 11/25mm ED ø 18/29mm warewashing | | |
| For models: | 915154, 915155, 915157, 915158, 915172, 915173, 915285, 915422, 915492, 915493, 915494, 915495, 915496, 915497, 916054, 916067, 916068, 916069, 916079, 916080, 916368, 916420, 916421, 916422, 916423, 916424, 916686, 916760, RIVER-252, River-252-2, River-252-2T, River-253, RIVER-262, River-262-2, River-262-2T, River-272, River-352C, River-352T, River-362C, River-362C-230V-3PH-50Hz, River-362T, River-362T-230V-3PH-50Hz, River-372 | | |

| | | | |
|--|--|-----------------|--------|
|  | | | |
| GEV No. | 513169 | Ref. No. | 127091 |
| description | formed hose warewashing | | |
| For models: | 915150, 915151, 915152, 915160, 915161, 915162, 915166, 915167, 915168, 915175, 915176, 915177, 915319, 915338, 915341, 915348, 915418, 915419, 915420, 915421, 915479, 915547, 915558, 915635, 915663, 915747, 916201, 916202, 916203, 916204, 916205, 916206, 916207, 916208, 916209, 916365, 916366, 916367, 916411, 916412, 916413, 916414, 916415, 916416, 916417, 916684, 916685, 916761, 916762, 916802...(Other models you can see in the webshop) | | |

| | | | |
|---|--|-----------------|--------|
|  | | | |
| GEV No. | 513236 | Ref. No. | 127118 |
| description | formed hose warewashing | | |
| For models: | 915617, 915618, 915672, 915773, 915774, 916066, 916077, 916078, 916418, 916419, 916594, 916595, River-242, River-242-2, River-242-2T, River-342C, River-342T | | |

| | | | |
|--|--|-----------------|--------|
|  | | | |
| GEV No. | 513239 | Ref. No. | 127099 |
| description | formed hose warewashing | | |
| For models: | 915150, 915151, 915152, 915154, 915155, 915157, 915158, 915160, 915161, 915162, 915166, 915167, 915168, 915172, 915173, 915175, 915176, 915177, 915285, 915319, 915338, 915341, 915348, 915418, 915419, 915420, 915421, 915422, 915479, 915492, 915493, 915494, 915495, 915496, 915497, 915547, 915558, 915635, 915663, 915747, 916054, 916067, 916068, 916069, 916079, 916080, 916201, 916202, 916203, 916204...(Other models you can see in the webshop) | | |

| | | | |
|--|---|-----------------|--------|
|  | | | |
| GEV No. | 513252 | Ref. No. | 127129 |
| description | formed hose warewashing | | |
| For models: | 915611, 915612, 915613, 915614, 915615, 915616, 915670, 915671, 915959, 916196, 916197, 916198, 916199, 916200, 916409, 916410, 916591, 916592, 916593, 916877, Niagara-241, Niagara-241-2, Niagara-341, Pluvia-240 | | |

| | | | |
|--|---|-----------------|--------|
|  | | | |
| GEV No. | 513263 | Ref. No. | 127124 |
| description | formed hose warewashing | | |
| For models: | 915611, 915612, 915613, 915614, 915615, 915616, 915617, 915618, 915670, 915671, 915672, 915773, 915774, 915959, 916066, 916077, 916078, 916196, 916197, 916198, 916199, 916200, 916409, 916410, 916418, 916419, 916591, 916592, 916593, 916594, 916595, 916877, 916921, 916922, 916992, 916993, Fast145-2, Fast150, Niagara-241, Niagara-241-2, Niagara-341, Pluvia-240, River-242, River-242-2, River-242-2T, River-342C, River-342T | | |

| | | | |
|--|---|-----------------|--------|
|  | | | |
| GEV No. | 513279 | Ref. No. | 127126 |
| description | formed hose warewashing | | |
| For models: | 915611, 915612, 915613, 915614, 915615, 915616, 915670, 915671, 915959, 916196, 916197, 916198, 916199, 916200, 916409, 916410, 916591, 916592, 916593, 916877, Niagara-241, Niagara-241-2, Niagara-341, Pluvia-240 | | |





1

| | | | |
|--------------------|--|-----------------|--------|
| GEV No. | 513280 | Ref. No. | 127113 |
| description | formed hose warewashing | | |
| For models: | 915617, 915618, 915672, 915773, 915774, 916066, 916077, 916078, 916418, 916419, 916594, 916595, River-242, River-242-2, River-242-2T, River-342C, River-342T | | |



1

| | | | |
|--------------------|---|-----------------|--------|
| GEV No. | 513281 | Ref. No. | 127100 |
| description | formed hose warewashing | | |
| For models: | 915154, 915155, 915157, 915158, 915172, 915173, 915285, 915422, 915492, 915493, 915494, 915495, 915496, 915497, 915695, 915696, 915819, 916054, 916067, 916068, 916069, 916079, 916080, 916368, 916420, 916421, 916422, 916423, 916424, 916686, 916760, Fast145, FAST-145, Fast145D, FAST-145D, RIVER-252, River-252-2, River-252-2T, RIVER-253, RIVER-262, River-262-2, River-262-2T, River-272, River-282LS-2TDE, River-282S-2TDE, River-352C, River-352T, River-362C, River-362C-230V-3Ph-50Hz, River-362T...(Other models you can see in the webshop) | | |



1

| | | | |
|--------------------|---------------------------------------|-----------------|--------|
| GEV No. | 513276 | Ref. No. | 127145 |
| description | formed hose warewashing for boiler | | |
| For models: | 916045, 916654, Fast160C, Ocean360-UK | | |



1

| | | | |
|--------------------|---|-----------------|-------|
| GEV No. | 513282 | Ref. No. | 70021 |
| description | formed hose warewashing for drain pump | | |
| For models: | NG381L, NG381LC, NG381LCFUR, NG381LDDPS, Niagara-283L-2, Niagara-381L, Niagara-381LC, River-282L-2, River-282LS-2TDE, River-382L, River-382L-230V-3Ph-50Hz, River-382LNRG, River-382LTDE, River-482, RV382L, RV382L23TERMO, RV382LFUR, RV382LR, RV382LS, RV382LSFUR, RV382LTX, RV382LTXR, RV482 | | |



1

| | | | |
|--------------------|--|-----------------|--------|
| GEV No. | 513716 | Ref. No. | 127053 |
| description | pressure hose warewashing | | |
| For models: | 913291, 913292, 913357, 913363, 913364, 913374, 913375, 913376, 913377, 913416, 913435, 913545, 913666, 913668, 913685, 913773, 913774, 913911, 913912, 913948, 913950, 913977, 913984, 913990, 914214, 914316, 914317, 914392, 914393, 914394, 914395, 914396, 914397, 914441, 914442, 914515, 914516, 914537, 914543, 914547, 914683, 914684, 914689, 914863, 914874, 915138, 915139, 915527, 915692, 915693...(Other models you can see in the webshop) | | |

for dishwashers

pressure hoses



1

| | | | |
|--------------------|---|-----------------|--------|
| GEV No. | 698807 | Ref. No. | 143263 |
| description | rinse hose ext. ø 18 ID ø 11mm | | |
| For models: | 916020, 916021, 916024, 916025, 916026, 916027, 916030, 916031, 916247, 916248, 916249, 916250, 916251, 916252, 916382, 916383, 916452, 916504, 916584, 916670, 916688, 916763, 917044, 917049, Clean161, Fast160-2, Fast161-2, Ocean360, Ocean360M | | |

ventilation hoses



1

| | | | |
|--------------------|--|-----------------|--------------|
| GEV No. | 698717 | Ref. No. | H.775611-001 |
| description | PVC hose ext. ø 14 L 1044mm PVC D1 ø 10mm | | |
| For models: | 915150, 915151, 915152, 915154, 915155, 915157, 915158, 915160, 915161, 915162, 915166, 915167, 915168, 915172, 915173, 915175, 915319, 915348, 915418, 915419, 915420, 915421, 915422, 915479, 915492, 915493, 915494, 915495, 915496, 915497, 915547, 915558, 915635, 915663, 915747, 916054, 916067, 916068, 916069, 916079, 916080, 916201, 916202, 916203, 916204, 916205, 916206, 916207, 916208, 916209...(Other models you can see in the webshop) | | |



| | | | |
|--------------------|--|-----------------|--------|
| | | | |
| 1 | | | |
| GEV No. | 513265 | Ref. No. | 143189 |
| description | ventilation hose ext. ø 17 ID ø 14mm L 75mm warewashing back-flow restrictor | | |
| For models: | 050F, 050FP, 2312-001, 2312-002, 350F, 350FD, 350R, 350RD, 35F, 35FD, 35R, 35RD, 400F, 400FD, 400R, 400RD, 40F, 40FD, 40R, 40RD, 45, 450, 46, 460, 500F, 500FD, 50F, 50FD, 510F, 510FD, 913297, 913298, 913299, 913300, 913360, 913361, 913391, 913392, 913546, 913547, 913578, 913611, 913684, 913913, 913914, 913932, 913933, 913992, 913993, 914284...(Other models you can see in the webshop) | | |

| | | | |
|--------------------|--------------------------|-----------------|--------|
| | | | |
| 1 | | | |
| GEV No. | 518220 | Ref. No. | 143193 |
| description | hose for pressure switch | | |
| For models: | CLEAN-3, RIVER-43 | | |

fittings, hose and pipe connectors

hose connectors

without screw connection

miscellaneous

| | | | |
|--------------------|----------------------|-----------------|--------|
| | | | |
| 1 | | | |
| GEV No. | 511633 | Ref. No. | 999231 |
| description | conversion kit | | |
| For models: | 914326, 914406, E.55 | | |

| | | | |
|--------------------|--|-----------------|-------|
| | | | |
| 1 | | | |
| GEV No. | 501524 | Ref. No. | 70996 |
| description | Y-piece plastic hose ø 4mm 3-way | | |
| For models: | 915747, A4EBT, A4EBTSAK, NG381DDPS, NG381DDPSHZ23, NG381LDDPS, Niagara-381-230V-3Ph-60Hz, Niagara-381DP, Niagara-381L, Niagara-381LC, River-multi-2256 | | |

| | | | |
|--------------------|---|-----------------|--------|
| | | | |
| 1 | | | |
| GEV No. | 530770 | Ref. No. | 929171 |
| description | hose ED ø 30mm ID ø 20mm L 1050mm rubber black Qty 1 | | |
| For models: | KLP105EB, KLP201DDDTEB, KLP201EB, KLP301, KLP301DDDTEB, LP105DDDTEB, LP105DDDTEBN, LP105EB, LP201DDDTEB, LP201EB, LP301, LP301EB, LP60, River-282-2, River-282L-2, River-282LS-2TDE, River-282S-2TDE, River-285, RIVER-294, RIVER-295, River-295P, RIVER-296, RIVER-296P, RIVER-297, RIVER-298, River-382, River-382-230V-3Ph-50Hz, River-382H, River-382L, River-382L-230V-3Ph-50Hz, River-382LNRG, River-382LTDE, River-382NRG, River-382NRG-230-3Ph-50Hz, River-382TDE, River-482, River-81CRP, RIVER-81-CRP, River-82CRP, RIVER-82-CRP, RV282R, RV294, RV295, RV295PS, RV296, RV296PS, RV297, RV298, RV298HZ, RV382...(Other models you can see in the webshop) | | |

| | | | |
|--------------------|--|-----------------|--------|
| | | | |
| 1 | | | |
| GEV No. | 541109 | Ref. No. | 035031 |
| description | Y-piece plastic hose ø 8-6-8mm for pressure switch | | |
| For models: | 050F, 050FP, 22F, 22R, 2312-002, 2312-007, 2312-009-CRP, 40F, 440F, 45, 450, 460, 500F, 500FD, 510F, 510FD, 913297, 913298, 913299, 913300, 913360, 913361, 913391, 913392, 913546, 913547, 913578, 913611, 913684, 913913, 913914, 913932, 913933, 913992, 913993, 914100, 914101, 914284, 914318, 914319, 914326, 914331, 914338, 914339, 914342, 914343, 914356, 914400, 914401, 914402...(Other models you can see in the webshop) | | |

| | | | |
|--------------------|---|-----------------|--------|
| | | | |
| 1 | | | |
| GEV No. | 698706 | Ref. No. | 127095 |
| description | hose ED ø 31mm ID ø 25mm L 34mm plastic for rinsing | | |
| For models: | 915154, 915155, 915157, 915158, 915172, 915173, 915285, 915422, 915492, 915493, 915494, 915495, 915496, 915497, 915617, 915618, 915672, 915773, 915774, 916045, 916054, 916066, 916067, 916068, 916069, 916077, 916078, 916079, 916080, 916368, 916418, 916419, 916420, 916421, 916422, 916423, 916424, 916594, 916595, 916654, 916686, 916760, Fast160C, Ocean360-UK, River-242, River-242-2, River-242-2T, River-252, River-252-2, River-252-2T...(Other models you can see in the webshop) | | |

| | | | |
|--------------------|---|-----------------|--------|
| | | | |
| 1 | | | |
| GEV No. | 518347 | Ref. No. | 468149 |
| description | T-piece plastic hose ø 10-10-10mm 3-way | | |
| For models: | 22F, 440F, 44F, 45, 450, 46, 460, CLEAN-3, E.45, E.46, E.50, E.51, E.52, RIVER-43 | | |

fittings

screw pipe fittings

angle pieces



1

| | | | |
|--------------------|---|-----------------|--------|
| GEV No. | 698714 | Ref. No. | 929077 |
| description | angle piece thread 1/2" tube ø 12mm brass | | |
| For models: | 55 | | |

hose connectors

brass



1

| | | | |
|--------------------|--|-----------------|--------|
| GEV No. | 513253 | Ref. No. | 108006 |
| description | hose connector brass angled thread 1/4" hose ø 12mm Qty 1 pcs | | |
| For models: | 10, 11F, 11FD, 11R, 11RD, 12, 14, 161, 21F, 21FD, 21R, 21RD, 221, 22F, 22R, 25F, 25FD, 25R, 25RD, 271, 272, 30F, 30FD, 30R, 30RD, 31F, 31FD, 31R, 31RD, 362, 40F, 440F, 44F, 500F, 500FD, 50F, 50FD, 510F, 510FD, 66, 913297, 913298, 913299, 913300, 913360, 913361, 913391, 913392, 913546, 913547...(Other models you can see in the webshop) | | |

nickel-plated brass



1

| | | | |
|--------------------|---|-----------------|--------|
| GEV No. | 520202 | Ref. No. | 927015 |
| description | hose connector nickel-plated brass straight thread 3/8" hose ø 12mm Qty 1 pcs | | |
| For models: | 161, 221, 271, 272, 362, 914380, 914436, A3EB, A3EBD, A3EBDAKRYK, A3EBDAKWK, A3EBDBKWK, A3EBDRKYK, A3EBDVK, A3EBDYK, A3EBSAK, A3EBSAKRK, A3EBSAKWK, A3EBSBKWKYK, A3EBSEKWK, A3EBSWK, A4EB, A4EBD, A4EBDAKEKYK, A4EBDAKRK, A4EBDAKWK, A4EBDAKZK, A4EBDBKRR, A4EBDPKWKYK, A4EBDRK, A4EBS, A4EBSAK, A4EBSAKCK, A4EBSAKEKYK, A4EBSAKRK, A4EBSAKRKP, A4EBSAKYK, A4EBSCK, A5EB, A5EBD, A5EBDAKPKWK, A5EBDAKWK, A5EBDAKYK, A5EBDRK, A5EBS, A5EBSAKPKWK, A5EBSAKRK, A5EBSAKRKYK, A5EBSAKWK, A5EBSAKWKYK...(Other models you can see in the webshop) | | |

producer-specific



1

| | | | |
|--------------------|--|-----------------|--------|
| GEV No. | 504388 | Ref. No. | 468205 |
| description | hose connector grommet ø 10.5mm grommet length 15mm total length 26mm plastic for drain hose | | |
| For models: | 915150, 915151, 915152, 915154, 915155, 915157, 915158, 915160, 915161, 915162, 915166, 915167, 915168, 915172, 915173, 915175, 915319, 915348, 915418, 915419, 915420, 915421, 915422, 915479, 915492, 915493, 915494, 915495, 915496, 915497, 915547, 915558, 915617, 915618, 915635, 915663, 915672, 915747, 915773, 915774, 916054, 916066, 916067, 916068, 916069, 916077, 916078, 916079, 916080, 916201...(Other models you can see in the webshop) | | |

push-in fittings

JOHN GUEST



1

| | | | |
|--------------------|--|-----------------|---------|
| GEV No. | 521179 | Ref. No. | 9300339 |
| description | push-in fitting John Guest straight thread 3/8" BSP stub ø 8mm | | |

valves and tank inlets

ball valves

universal

ball valves with butterfly handle



1

| | | | |
|--------------------|--|-----------------|--------|
| GEV No. | 540646 | Ref. No. | 720010 |
| description | ball valve connection 3/4" IT - 3/4" IT DN20 total length 56mm | | |
| For models: | FRI15, FRI15M, ME15, ME20, ME30, ME40, MG15, MG20, MG30, MG40 | | |

water softeners

manual softener



1

| | | | |
|--------------------|------------------------------|-----------------|--------|
| GEV No. | 530128 | Ref. No. | 922011 |
| description | base suitable for type LT/BP | | |
| For models: | LT12, LT16, LT8 | | |



water cycle components

pressure reduction valves

pressure reduction valves

universal



1

| | | | |
|--------------------|---|-----------------|--------|
| GEV No. | 520868 | Ref. No. | 927150 |
| description | pressure reduction valve OR series PN40 connection 1/2" setting range 1-7bar p max 40bar t.max. 80°C brass | | |
| For models: | 161, 221, 271, 272, 362, 914380, 914436, A3EB, A3EBD, A3EBDAKRYK, A3EBDAKWK, A3EBDBKWK, A3EBDRKYK, A3EBDWK, A3EBDYK, A3EBSAK, A3EBSAKRK, A3EBSAKWK, A3EBSBKWKYK, A3EBSEKWK, A3EBSWK, A4EB, A4EBD, A4EBDAKEKYK, A4EBDAKWK, A4EBDAKWK, A4EBDAKZK, A4EBDBKWK, A4EBDPKWKYK, A4EBDRK, A4EBS, A4EBSAK, A4EBSAKCK, A4EBSAKEKYK, A4EBSAKRK, A4EBSAKRKP, A4EBSAKYK, A4EBSCK, A5EB, A5EBD, A5EBDAKPKWK, A5EBDAKWK, A5EBDAKYK, A5EBDRK, A5EBS, A5EBSAKPKWK, A5EBSAKRK, A5EBSAKRKYK, A5EBSAKWK, A5EBSAKWKYK...(Other models you can see in the webshop) | | |

supply filters



1

| | | | |
|--------------------|---|-----------------|--------|
| GEV No. | 520261 | Ref. No. | 927078 |
| description | supply filter thread 1/2" IT - 1/2" IT total length 58mm red brass mesh opening 0.4mm | | |
| For models: | 161, 221, 271, 272, 362, CLEAN-160, CLEAN-161, CLEAN-220, CLEAN-221, CLEAN-270, CLEAN-271, CLEAN-272, CLEAN-361, CLEAN-361P, CLEAN-362, CLEAN-471, CLEAN-471P | | |

ancillary products

clamps

hose clamps

DIN 3017 - W2



1

| | | | |
|--------------------|---|-----------------|-------|
| GEV No. | 520117 | Ref. No. | CFS1A |
| description | hose clamp stainless steel ø 40-60mm width 9mm Qty 5 pcs DIN 3017 | | |
| For models: | CGL74CABT, CNT800CH, Fast180, Fast180-230V-3Ph-60Hz, FAST-60, FAST-73, NG271, NG281, NG281CDD, NG281HP, NG281HPDD, NG281HZ23, NG281HZ23DD, NG291, NG381, NG38123, NG38123TERMO, NG381C, NG381CDD, NG381CFUR, NG381DDHZ23, NG381DDPS, NG381DDPSHZ23, NG381HPDD, NG381L, NG381LC, NG381LCFUR, NG381LDDPS, NG381TERMO, NG381TXCDD, NIAGARA-271, NIAGARA-281, Niagara-281-2, Niagara-281HP, NIAGARA-283, Niagara-283A, Niagara-283L-2, NIAGARA-291, Niagara-381, Niagara-381-230V-3Ph-50Hz, Niagara-381-230V-3Ph-60Hz, Niagara-381DP, Niagara-381HPD, Niagara-381L, Niagara-381LC, OC380, OC380FUR, OC380HZ23, Ocean380, PLUVIA-280...(Other models you can see in the webshop) | | |

DIN 3017 - W4



1

| | | | |
|--------------------|---|-----------------|--------|
| GEV No. | 520120 | Ref. No. | 927322 |
| description | hose clamp SS W4 ø 12-20mm width 9mm Qty 1 pcs DIN 3017 | | |
| For models: | CLEAN-161, CLEAN-221, CLEAN-271, CLEAN-272, CLEAN-362, CNT800CH, Fast180, Fast180-230V-3Ph-60Hz, FAST-60, FAST-73, NG271, NG281, NG281CDD, NG281HP, NG281HPDD, NG281HZ23, NG281HZ23DD, NG291, NG292, NG292HZ, NG293, NG381, NG38123, NG38123TERMO, NG381C, NG381CDD, NG381CFUR, NG381DDHZ23, NG381DDPS, NG381DDPSHZ23, NG381HPDD, NG381L, NG381LC, NG381LCFUR, NG381LDDPS, NG381TERMO, NG381TXCDD, NIAGARA-271, NIAGARA-281, Niagara-281-2, Niagara-281HP, Niagara-283L-2, NIAGARA-291, NIAGARA-292, Niagara-292-400V-3Ph-60Hz, NIAGARA-293, Niagara-381, Niagara-381-230V-3Ph-50Hz, Niagara-381-230V-3Ph-60Hz, Niagara-381DP...(Other models you can see in the webshop) | | |

double wire clamps



1

| | | | |
|--------------------|--|-----------------|--------|
| GEV No. | 513268 | Ref. No. | 423011 |
| description | hose clamp ø 8-10mm wire gauge ø 1mm Qty 1 pcs | | |
| For models: | 050F, 050FP, 2312-001, 2312-002, 2312-007, 2312-009-CRP, 31F, 31FD, 31R, 31RD, 500F, 500FD, 50F, 50FD, 510F, 510FD, 67F, 67R, 913297, 913298, 913299, 913300, 913360, 913361, 913391, 913392, 913546, 913547, 913578, 913611, 913684, 913913, 913914, 913932, 913933, 914100, 914101, 914284, 914318, 914319, 914326, 914331, 914338, 914356, 914400, 914401, 914402, 914403, 914404, 914405...(Other models you can see in the webshop) | | |



| | | | |
|---|--|-----------------|----------|
|  | | | |
| 1 | | | |
| GEV No. | 560503 | Ref. No. | CFF10073 |
| description | hose clamp ø 8-10mm wire gauge ø 1mm Qty 1 pcs | | |
| For models: | NG292, NG292HZ, NG293, NIAGARA-292, Niagara-292-400V-3Ph-60Hz, NIAGARA-293, RIVER-282, RIVER-295, River-295P, RIVER-296, River-296P, RIVER-297, RIVER-298, RV282, RV282DD, RV295, RV295PS, RV296, RV296PS, RV297, RV298, RV298HZ | | |

| | | | |
|---|--|-----------------|--------|
| knurled screws | | | |
|  | | | |
| 1 | | | |
| GEV No. | 510112 | Ref. No. | 454002 |
| description | Thumb screw thread M10 thread L 10mm ø 22mm H 4.5mm SS | | |
| For models: | 050F, 050FP, 11F, 11FD, 11F-DVGW, 21F, 21FD, 2312-001, 2312-002, 25F, 25FD, 30F, 30FD, 31F, 31FD, 400F, 400FD, 40-ELECTRONIC, 40F, 40FD, 45, 450, 46, 460, 500F, 500FD, 50F, 50FD, 510F, 510FD, 67R, 913363, 913364, 913376, 913377, 914568, 915830, E.41, E.42, E.45, E.46, E.50, E.50D.PA, E.51, E.41, F85, F85P, FAST-160DP, GSP50, GSP50P... (Other models you can see in the webshop) | | |

measuring equipment

thermometers

built-in thermometers

| | | | |
|---|---|-----------------|--------|
|  | | | |
| 1 | | | |
| GEV No. | 541095 | Ref. No. | 926100 |
| description | thermometer mounting measurements 58x25.5mm 0 up to +120°C capillary pipe 3000mm probe ø 6.5mm probe L 20mm | | |
| For models: | CLEAN-160, CLEAN-220, CLEAN-270, CLEAN-271 | | |

miscellaneous



| | | | |
|--------------------|-----------------------|-----------------|--------|
| 1 | | | |
| GEV No. | 513098 | Ref. No. | DWP296 |
| description | screw for door handle | | |

ø60mm

| | | | |
|---|--|-----------------|-------|
|  | | | |
|  | | | |
| 1 | | | |
| GEV No. | 542106 | Ref. No. | DET1L |
| description | thermometer mounting ø 60mm t.max. 120°C 0-120°C probe ø 8.5mm probe L 35mm capillary pipe 5000mm connection M10x1 | | |

nuts

knurled nuts

| | | | |
|---|--|-----------------|-------|
|  | | | |
| 1 | | | |
| GEV No. | 517444 | Ref. No. | 80697 |
| description | knurled nut thread M10x1 ø 25mm H 4mm SS | | |
| For models: | 915830, Fast160DP | | |

fastening material

screws

hexagonal screws

| | | | |
|---|---|-----------------|--------|
|  | | | |
| 1 | | | |
| GEV No. | 506447 | Ref. No. | 486041 |
| description | hexagonal screw thread M8 thread L 16mm SS WS 13 Qty 1 pcs DIN 933 / ISO 4017 | | |

| | | | |
|---|--|-----------------|--------|
|  | | | |
| 1 | | | |
| GEV No. | 518028 | Ref. No. | 454004 |
| description | knurled nut thread M5 ø 25mm H 4mm SS | | |
| For models: | 050F, 050FP, 10, 12, 14, 22F, 2312-001, 2312-002, 350F, 350FD, 350R, 350RD, 35-ELECTRONIC, 35F, 35FD, 35R, 35RD, 40F, 440F, 44F, 500F, 500FD, 50-ELECTRONIC, 50F, 50FD, 510F, 510FD, 55, 66, 914684, CLEAN-100, CLEAN-110, CLEAN-120, E.35, E.35H, E.40, E.40H, E.50, E.51, E.52, E.60, E.65, E1, E10, E100, E110, E12, E120, E14, E140... (Other models you can see in the webshop) | | |



hexagonal nuts

DIN 934 / ISO 4032/8673

| | | | |
|---|---|-----------------|--------|
|  | | | |
| 1 | | | |
| GEV No. | 560340 | Ref. No. | CDI204 |
| description | hexagonal nut thread M4 H 3.2mm WS 7 SS DIN/ISO DIN 934 / ISO 4032/8673 Qty 1 pcs | | |

DIN 985

| | | | |
|---|---|-----------------|--------|
|  | | | |
| 1 | | | |
| GEV No. | 560518 | Ref. No. | 926087 |
| description | hexagonal nut thread M8 H 9.2mm SS WS 13 self-locking Qty 1 pcs | | |
| For models: | 12, 14, CLEAN-110, CLEAN-120, E1, E110 | | |

hexagonal nuts metric (without norm)

| | | | |
|---|---|-----------------|--------|
|  | | | |
| 1 | | | |
| GEV No. | 521134 | Ref. No. | 417017 |
| description | hexagonal nut thread M14x1 SS | | |
| For models: | 10, 11F, 11FD, 11F-DVGW, 11R, 11RD, 12, 14, 21F, 21FD, 21R, 21RD, 22F, 22R, 2312-001, 2312-002, 25F, 25FD, 25R, 25RD, 30F, 30FD, 30R, 30RD, 31F, 31FD, 31R, 31RD, 40F, 440F, 44F, 45, 450, 46, 460, 500F, 500FD, 50F, 50FD, 510F, 510FD, 67F, 67R, 913297, 913298, 913299, 913300, 913360, 913361, 913391...(Other models you can see in the webshop) | | |

| | | | |
|---|---|-----------------|--------|
|  | | | |
| 1 | | | |
| GEV No. | 560014 | Ref. No. | 417002 |
| description | hexagonal nut thread M8x1 H 4.7mm WS 12 chrome-plated brass Qty 1 pcs DIN/ISO DIN 934 / ISO 4032/8673 | | |
| For models: | 21F, 21FD, 21R, 21RD, 25F, 25FD, 25R, 25RD, 30F, 30FD, 30R, 30RD, 31F, 31FD, 31R, 31RD, 440F, 44F | | |

| | | | |
|---|--|-----------------|--------|
|  | | | |
| 1 | | | |
| GEV No. | 513266 | Ref. No. | 417104 |
| description | nut | | |
| For models: | 913289, 913290, 913291, 913292, 913356, 913357, 913372, 913373, 913374, 913375, 913416, 913435, 913544, 913545, 913665, 913666, 913667, 913668, 913685, 913771, 913772, 913773, 913774, 913832, 913837, 913911, 913912, 913948, 913950, 913977, 913984, 913990, 914165, 914166, 914206, 914214, 914316, 914317, 914355, 914386, 914387, 914388, 914389, 914390, 914391, 914392, 914393, 914394, 914395, 914396...(Other models you can see in the webshop) | | |

hexagonal nuts inch thread

| | | | |
|---|---|-----------------|--------|
|  | | | |
| 1 | | | |
| GEV No. | 513025 | Ref. No. | 929047 |
| description | nut thread 1/2" nickel-plated brass H 7.5mm WS 27 Qty 1 pcs | | |
| For models: | 161, 221, 271, 272, 362, 55, CLEAN-160, CLEAN-161, CLEAN-220, CLEAN-221, CLEAN-270, CLEAN-271, CLEAN-272, CLEAN-361, CLEAN-361P, CLEAN-362, CLEAN-471, CLEAN-471P | | |

| | | | |
|---|---|-----------------|--------|
|  | | | |
| 1 | | | |
| GEV No. | 518508 | Ref. No. | 926222 |
| description | nut thread 1 1/4" H 7mm WS 50 brass Qty 1 pcs | | |
| For models: | E12, E120, E14, E140 | | |

| | | | |
|---|---|-----------------|---------|
|  | | | |
| 1 | | | |
| GEV No. | 503042 | Ref. No. | CDO138C |
| description | nut thread 3/8" H 6mm brass WS 22 Qty 1 pcs | | |

miscellaneous

| | | | |
|--|-----------|-----------------|----------|
|  | | | |
| Image not available | | | |
| 1 | | | |
| GEV No. | 513197 | Ref. No. | CDI206AU |
| description | nut | | |
| For models: | RIVER-150 | | |

washers

washers

miscellaneous

| | | | |
|---|--------|-----------------|--------|
|  | | | |
| 1 | | | |
| GEV No. | 513223 | Ref. No. | 926249 |
| description | disc | | |

fasteners

clamps

hose clamps

DIN 3017 - W2



| | | | |
|--------------------|--|-----------------|-------|
| GEV No. | 520117 | Ref. No. | CFS1A |
| description | hose clamp stainless steel ø 40-60mm width 9mm Qty 5 pcs DIN 3017 | | |
| For models: | CGL74CABT, CNT800CH, Fast180, Fast180-230V-3Ph-60Hz, FAST-60, FAST-73, NG271, NG281, NG281CDD, NG281HP, NG281HPDD, NG281HZ23, NG281HZ23DD, NG291, NG381, NG38123, NG-38123TERMO, NG381C, NG381CDD, NG381CFUR, NG381DDHZ23, NG381DDPS, NG381DDPSHZ23, NG381HPDD, NG381L, NG381LC, NG381LCFUR, NG381LDDPS, NG381TERMO, NG381TXCDD, NIAGARA-271, NIAGARA-281, Niagara-281-2, Niagara-281HP, NIAGARA-283, Niagara-283A, Niagara-283L-2, NIAGARA-291, Niagara-381, Niagara-381-230V-3Ph-50Hz, Niagara-381-230V-3Ph-60Hz, Niagara-381DP, Niagara-381HPD, Niagara-381L, Niagara-381LC, OC380, OC380FUR, OC380HZ23, Ocean380, PLUVIA-280...(Other models you can see in the webshop) | | |

DIN 3017 - W4



| | | | |
|--------------------|---|-----------------|--------|
| GEV No. | 520120 | Ref. No. | 927322 |
| description | hose clamp SS W4 ø 12-20mm width 9mm Qty 1 pcs DIN 3017 | | |
| For models: | CLEAN-161, CLEAN-221, CLEAN-271, CLEAN-272, CLEAN-362, CNT800CH, Fast180, Fast180-230V-3Ph-60Hz, FAST-60, FAST-73, NG271, NG281, NG281CDD, NG281HP, NG281HPDD, NG281HZ23, NG281HZ23DD, NG291, NG292, NG292HZ, NG293, NG381, NG38123, NG38123TERMO, NG381C, NG381CDD, NG381CFUR, NG381DDHZ23, NG381DDPS, NG381DDPSHZ23, NG381HPDD, NG381L, NG381LC, NG381LCFUR, NG381LDDPS, NG381TERMO, NG381TXCDD, NIAGARA-271, NIAGARA-281, Niagara-281-2, Niagara-281HP, Niagara-283L-2, NIAGARA-291, NIAGARA-292, Niagara-292-400V-3Ph-60Hz, NIAGARA-293, Niagara-381, Niagara-381-230V-3Ph-50Hz, Niagara-381-230V-3Ph-60Hz, Niagara-381DP...(Other models you can see in the webshop) | | |

double wire clamps



| | | | |
|--------------------|--|-----------------|--------|
| GEV No. | 513268 | Ref. No. | 423011 |
| description | hose clamp ø 8-10mm wire gauge ø 1mm Qty 1 pcs | | |
| For models: | 050F, 050FP, 2312-001, 2312-002, 2312-007, 2312-009-CRP, 31F, 31FD, 31R, 31RD, 500F, 500FD, 50F, 50FD, 510F, 510FD, 67F, 67R, 913297, 913298, 913299, 913300, 913360, 913361, 913391, 913392, 913546, 913547, 913578, 913611, 913684, 913913, 913914, 913932, 913933, 914100, 914101, 914284, 914318, 914319, 914326, 914331, 914338, 914356, 914400, 914401, 914402, 914403, 914404, 914405...(Other models you can see in the webshop) | | |



| | | | |
|--------------------|---|-----------------|----------|
| GEV No. | 560503 | Ref. No. | CFF10073 |
| description | hose clamp ø 8-10mm wire gauge ø 1mm Qty 1 pcs | | |
| For models: | NG292, NG292HZ, NG293, NIAGARA-292, Niag-ara-292-400V-3Ph-60Hz, NIAGARA-293, RIVER-282, RIVER-295, River-295P, RIVER-296, River-296P, RIVER-297, RIVER-298, RV282, RV282DD, RV295, RV295PS, RV296, RV296PS, RV297, RV298, RV298HZ | | |

retaining rings

DIN 471



| | | | |
|--------------------|--|-----------------|--------|
| GEV No. | 110087 | Ref. No. | 499066 |
| description | retaining ring shaft ø 8mm DIN 471 | | |
| For models: | 10, 12, 22F, 22R, 40F, 66, CLEAN-100, CLEAN-110, CLEAN-120 | | |

DIN 6799



| | | | |
|--------------------|---|-----------------|--------|
| GEV No. | 518557 | Ref. No. | 929017 |
| description | retaining ring E D1 ø 5mm D2 ø 11mm SS DIN 6799 thickness 0.7mm | | |
| For models: | 55, E.65, RIVER-HL-81, RIVER-HL-82 | | |



| | | | |
|--------------------|--|-----------------|------------------|
| GEV No. | 507015 | Ref. No. | 929014 CWA5D7 |
| description | retaining ring E D1 ø 7mm D2 ø 14mm SS DIN 6799 thickness 0.9mm for shaft ø 8-11mm | | |
| For models: | 55, E.65 | | |

DIN 7993



| | | | |
|--------------------|--|-----------------|--------|
| GEV No. | 518308 | Ref. No. | 303019 |
| description | retaining ring DIN 7993 for drain assembly thickness 3mm ED ø 57mm | | |
| For models: | 050F, 050FP, 2312-001, 2312-002, 45, 450, 46, 460, 500F, 500FD, 50F, 50FD, 510F, 510FD, 913297, 913298, 913299, 913300, 913360, 913361, 913391, 913392, 913418, 913546, 913547, 913578, 913611, 913684, 913913, 913914, 913932, 913933, 914167, 914168, 914284, 914318, 914319, 914331, 914338, 914356, 914398, 914399, 914400, 914401, 914402, 914403, 914404, 914405, 914431, 914443...(Other models you can see in the webshop) | | |





consumables

fuses

fine fuses

| | | | |
|--|--|-----------------|--------|
|  <p>1</p> | | | |
| GEV No. | 358530 | Ref. No. | 926284 |
| description | fine fuse size ϕ 5x20mm 0.8A fast-acting rated 250V Qty 10 pcs | | |
| For models: | 80, 81, 914380, 914436, CE78HZ23, CGL74CABT, E78, E78HP, FAST-181, HM1, KLP105EB, KLP201DDDTEB, KLP201EB, KLP301, KLP301DDDTEB, LP105DDDTEB, LP105DDDTEBN, LP105EB, LP201DDDTEB, LP201EB, LP301, LP301EB, LP60, PS-60, RIVER-150, River-152, RIVER-154, RIVER-71, RIVER-80, River-81, River-81CRP, RIVER-81-CRP, RIVER-82, River-82CRP, RIVER-82-CRP, RIVER-E78, RIVER-HL-81, RV150, RV15023, RV15023DA, RV150D, RV150DA, RV150DAR, RV150DARY, RV150DAW, RV150DAWY, RV150DAY, RV150DE, RV150DRW, RV150DW...(Other models you can see in the webshop) | | |

| | | | |
|--|--|-----------------|------------------|
|  <p>1</p> | | | |
| GEV No. | 358677 | Ref. No. | 228004 228010 |
| description | fine fuse size ϕ 5x20mm 4A fast-acting rated 250V Qty 10 pcs | | |
| For models: | 2312-007, 2312-009-CRP, 80, 81, 82, 913363, 913364, 913911, 913912, 913913, 913914, 913950, 913977, 913984, 913990, 913992, 913993, 914100, 914101, 914165, 914166, 914167, 914168, 914206, 914214, 914284, 914316, 914317, 914318, 914319, 914338, 914339, 914342, 914343, 914355, 914356, 914380, 914431, 914436, 914516, 914543, 914583, 914592, 914612, 914613, 914624, 914625, 914626, 914627, 914628...(Other models you can see in the webshop) | | |

| | | | |
|--|--|-----------------|-------|
|  <p>1</p> | | | |
| GEV No. | 358693 | Ref. No. | 80874 |
| description | fine fuse size ϕ 5x20mm 2A medium lag rated 250V Qty 10 pcs | | |
| For models: | RIVER-298, RV298, RV298HZ | | |

| | | | |
|--|---|-----------------|--------|
|  <p>1</p> | | | |
| GEV No. | 358594 | Ref. No. | 228012 |
| description | fine fuse size ϕ 5x20mm 0.16A slow-acting rated 250V Qty 10 pcs | | |
| For models: | 915154, 915155, 915157, 915158, 915172, 915173, 915285, 915422, 915492, 915493, 915494, 915495, 915496, 915497, 915747, 916045, 916054, 916067, 916068, 916069, 916079, 916080, 916368, 916420, 916421, 916422, 916423, 916424, 916654, 916686, 916760, Fast160C, Fast200, FAST-200, Fast93, GL280EB, GL280EB23, GL280EB23DAR, GL280EB23HZ, GL280EB23HZDY, GL280EBD, GL280EBDA, GL280EBDAE, GL280EBDAR, GL280EBDARY, GL280EBDAW, GL280EBDAWY, GL280EBDAY, GL280EBDB, GL280EBDBR...(Other models you can see in the webshop) | | |

| | | | |
|---|---|-----------------|--------|
|  <p>1</p> | | | |
| GEV No. | 358603 | Ref. No. | 228011 |
| description | fine fuse size ϕ 5x20mm 2A slow-acting rated 250V Qty 10 pcs | | |
| For models: | 915154, 915155, 915157, 915158, 915172, 915173, 915285, 915422, 915492, 915493, 915494, 915495, 915496, 915497, 915747, 916045, 916054, 916067, 916068, 916069, 916079, 916080, 916368, 916420, 916421, 916422, 916423, 916424, 916654, 916686, 916760, Fast160C, Fast200, FAST-200, Fast93, GL280EB, GL280EB23, GL280EB23DAR, GL280EB23HZ, GL280EB23HZDY, GL280EBD, GL280EBDA, GL280EBDAE, GL280EBDAR, GL280EBDARY, GL280EBDAW, GL280EBDAWY, GL280EBDAY, GL280EBDB, GL280EBDBR...(Other models you can see in the webshop) | | |

| | | | |
|---|---|-----------------|--------|
|  <p>1</p> | | | |
| GEV No. | 358606 | Ref. No. | 228014 |
| description | fine fuse size ϕ 5x20mm 4A slow-acting rated 250V Qty 10 pcs | | |
| For models: | 916237, 916238, 916239, 916240, 916241, 916242, 916243, 916244, 916245, 916246, 916401, 916402, 916403, 916404, 916405, 916406, 916407, 916408, 916451, 916583, 916687, 916787, 916991, 917042, 917043, Clean140, Clean140S, Fast130, Fast135-2, Fast135-2S, Fast135H-2, Fast135H-2S, Fast139-2, Fast139-2S, Fast139H-2, Fast139H-2S, Fast140 | | |

ϕ 6.3x32mm 250V

| | | | |
|---|--|-----------------|--------|
|  <p>1</p> | | | |
| GEV No. | 358760 | Ref. No. | 926283 |
| description | fine fuse size ϕ 6.3x32mm 0.315A medium lag rated 250V Qty 10 pcs | | |
| For models: | 80, 81, 914380, 914436, CE78HZ23, CGL74CABT, E78, E78HP, FAST-181, HM1, KLP105EB, KLP201DDDTEB, KLP201EB, KLP301, KLP301DDDTEB, LP105DDDTEB, LP105DDDTEBN, LP105EB, LP201DDDTEB, LP201EB, LP301, LP301EB, LP60, PS-60, RIVER-150, River-152, RIVER-154, RIVER-71, RIVER-80, River-81, River-81CRP, RIVER-81-CRP, RIVER-82, River-82CRP, RIVER-82-CRP, RIVER-E78, RIVER-HL-81, RV150, RV15023, RV15023DA, RV150D, RV150DA, RV150DAR, RV150DARY, RV150DAW, RV150DAWY, RV150DAY, RV150DE, RV150DRW, RV150DW...(Other models you can see in the webshop) | | |

fine fuse holders

| | | | |
|--|--|-----------------|----------|
|  <p>1</p> | | | |
| GEV No. | 550519 | Ref. No. | H.228048 |
| description | cover plate suitable fuseA ratedV connection for fuse holder | | |
| For models: | 2312-007, 2312-009-CRP, 80, 81, 82, 913911, 913912, 913913, 913914, 913950, 913977, 913984, 913990, 914165, 914166, 914206, 914214, 914316, 914317, 914339, 914342, 914343, 914355, 914380, 914436, 914516, 914543, 914626, 914684, 914874, 915138, CE78HZ23, CGL74CABT, CNT800CH, E78, E78HP, Fast180, Fast180-230V-3Ph-60Hz, Fast181, FAST-181, Fast181-230V-3Ph-60Hz, Fast181-400V-3NPh-60Hz, Fast200, FAST-200, FAST-60, FAST-73, Fast93, GL280EB, GL280EB23, GL280EB23DAR, GL280EB23HZ, GL280EB23HZDY...(Other models you can see in the webshop) | | |

tools, fastening materials, consumables

| | | | |
|---|----------|--|--|
| B | | | |
| ball valves | 218 | | |
| bi-metal thermostats | 15, 16 | | |
| booster pumps I | 83 | | |
| booster pumps II | 88 | | |
| C | | | |
| cables | 92 | | |
| cam switches | 27 | | |
| clamps | 219, 222 | | |
| coil heating elements | 4 | | |
| condensators & interference suppression filters | 89 | | |
| consumables | 223 | | |
| contact heaters | 3 | | |
| contactors | 36 | | |
| container filters | 198 | | |
| control equipment | 30 | | |
| control thermostats | 16, 18 | | |
| D | | | |
| door seals for dishwashers | 187 | | |
| dosing pumps | 193 | | |
| double wire clamps | 219, 222 | | |
| drain hoses | 200 | | |
| drain pumps | 84 | | |
| E | | | |
| electric accessories | 92 | | |
| electronic controllers | 41 | | |
| F | | | |
| fasteners | 222 | | |
| fastening material | 220 | | |
| filters | 90 | | |
| fine fuses | 223 | | |
| fittings | 218 | | |
| flow meters | 57 | | |
| foil heating elements | 13 | | |
| formed hoses | 205 | | |
| fuses | 91, 223 | | |
| G | | | |
| gas nozzles | 96 | | |
| gas thermostats | 94 | | |
| gaskets for wash arm support | 189 | | |
| H | | | |
| heating elements | 3 | | |
| heating elements for contact grills | 3 | | |
| heating elements for fryers | 3 | | |
| hexagonal nuts | 221 | | |
| hexagonal screws | 220 | | |
| hose clamps | 219, 222 | | |
| hose connectors | 217, 218 | | |
| hoses | 200 | | |
| I | | | |
| ignition cables | 95 | | |
| immersion heating elements | 4 | | |
| indicator lights | 30 | | |
| indicator lights (complete) | 31 | | |
| industrial hoses | 203 | | |
| intake lances | 199 | | |
| K | | | |
| knurled nuts | 220 | | |
| knurled screws | 220 | | |
| L | | | |
| lamps | 30 | | |
| LED | 32 | | |
| M | | | |
| magnetic switches | 28 | | |
| manual softener | 218 | | |
| measuring equipment | 220 | | |
| mechanical timers | 35 | | |
| microswitches | 22 | | |
| motors | 57 | | |
| N | | | |
| neon light bulbs | 30, 32 | | |
| Niplaflex hoses | 203 | | |
| nuts | 220 | | |
| O | | | |
| operating capacitors | 89 | | |
| O-rings | 176 | | |
| P | | | |
| piezoelectric igniters | 96 | | |
| pilot burners | 95 | | |
| plug connectors | 93 | | |
| plunger sockets | 20 | | |
| position switches | 22 | | |
| pressure control hoses | 203 | | |
| pressure hoses | 216 | | |
| pressure reduction valves | 219, 219 | | |
| pressure switches | 53 | | |
| probes | 41 | | |
| programme timers | 32 | | |
| pump hoses | 199 | | |
| pumps | 58 | | |
| push/momentary push switches | 21 | | |
| push-in fittings | 218 | | |

| | | | |
|----------------------------------|----------|-----------------|-----|
| PVC hoses | 203 | water softeners | 218 |
| PVC supply hoses | 200 | | |
| Q | | | |
| quartz heating elements | 3 | | |
| R | | | |
| refrigeration gaskets | 176 | | |
| relays | 38 | | |
| retaining rings | 222 | | |
| ribbon cables | 92 | | |
| rocker/momentary rocker switches | 20 | | |
| rotary switches | 27 | | |
| S | | | |
| safety bi-metal thermostats | 15 | | |
| safety thermostats | 17, 19 | | |
| screw pipe fittings | 218 | | |
| screw-in gaskets | 176 | | |
| screws | 220 | | |
| sealing washers | 182 | | |
| shaft gaskets | 186 | | |
| silicone hoses | 199, 204 | | |
| solenoid valves | 49 | | |
| stainless steel flexi hoses | 200 | | |
| supply filters | 219, 219 | | |
| supply hoses | 200 | | |
| switches and momentary switches | 20 | | |
| system switches | 26 | | |
| system switches (ROLD) | 23 | | |
| T | | | |
| tank inlets | 199 | | |
| temperature probes | 41 | | |
| terminals | 93 | | |
| thermocouples | 96 | | |
| thermostats | 15 | | |
| time relays | 40 | | |
| timers | 32 | | |
| transformers | 40 | | |
| U | | | |
| universal hoses | 200 | | |
| universal probes | 41 | | |
| V | | | |
| valves and tank inlets | 218 | | |
| ventilation hoses | 216 | | |
| W | | | |
| wash and rinse pumps | 58 | | |
| washers | 221 | | |
| water cycle components | 219 | | |