



GAS COMPONENTS



ELECTRIC COMPONENTS



WATER TECHNOLOGY



MECHANICAL COMPONENTS



TOOLS

Spare parts suitable for

ELEKTRA

Find the complete and up-to-date range of products in our GEV Webshop



Manufacturer catalogue

The most important spare parts and accessories arranged clearly for every manufacturer

- ✓ Complete product range and all appliance data always up to date in the GEV Webshop
- ✓ Alphabetical Index at the end of the catalogue

GEV Webshop

www.gev-online.co.uk

www.gev-online.com



- 🔍 Add to Favourites
- 🔍 Sign In with email address and usual password
- 🔍 Easy-order – place several items in your basket at the same time
- 🔍 Quick Item search – no login needed



heating elements

heating elements for coffee machine



			
1			
GEV No.	417174	Ref. No.	01195035
description	heating element 2000W 230V heating circuits 3 mounting ϕ 42mm hole distance 74mm L 152mm W 35mm H 58mm L1 38mm L2 56mm L3 58mm H1 35mm hole ϕ 10mm tube ϕ 8mm thermost sleeves ϕ 4mm length thermost sleeves 150mm number of thermost sleeves 1 connection M3x0.6 immersion heater 2 hole flange		

			
1			
GEV No.	417215	Ref. No.	01197035
description	heating element 2500W 230V heating circuits 3 hole distance 74mm L 150mm W 31mm H 57mm L1 33mm L2 67mm L3 50mm H1 35mm H2 22mm tube ϕ 8mm thermost sleeves ϕ 5mm length thermost sleeves 135mm thermost sleeve eccentric, clinging connection M3 suitable for Verticale 2GR		
accessories for	417215		
	GEV No.	527169	Ref. No. —
	hexagonal nut thread M3 H 2.8mm WS 5.5 brass Qty 1 pcs		
	GEV No.	560110	Ref. No. —
	plain washer ID ϕ 3.2mm ED ϕ 7mm thickness 0.5mm SS Qty 20 pcs DIN 125A for thread M3		
	GEV No.	560130	Ref. No. —
	hexagonal nut thread M3 H 2.4mm WS 5.5 SS DIN/ISO DIN 934 / ISO 4032/8673 Qty 20 pcs		

			
1			
GEV No.	417155	Ref. No.	00127035
description	heating element 3000W 230V heating circuits 3 mounting ϕ 43mm hole distance 74mm L 315mm W 32mm H 45mm L1 35mm L2 60mm L3 220mm H1 33mm H2 12mm hole ϕ 10mm tube ϕ 8mm connection M3 immersion heater 2 hole flange		
accessories for	417155		
	GEV No.	527169	Ref. No. —
	hexagonal nut thread M3 H 2.8mm WS 5.5 brass Qty 1 pcs		
	GEV No.	560110	Ref. No. —
	plain washer ID ϕ 3.2mm ED ϕ 7mm thickness 0.5mm SS Qty 20 pcs DIN 125A for thread M3		
	GEV No.	560130	Ref. No. —
	hexagonal nut thread M3 H 2.4mm WS 5.5 SS DIN/ISO DIN 934 / ISO 4032/8673 Qty 20 pcs		

			
1			
GEV No.	417295	Ref. No.	02159035
description	heating element 3500W 230/400V heating circuits 3 mounting ϕ 42mm hole distance 74mm L 325mm W 35mm H 60mm L1 47mm L2 53mm L3 225mm H1 35mm H2 25mm hole ϕ 10mm tube ϕ 8mm thermost sleeves ϕ 5mm length thermost sleeves 198mm thermost sleeve eccentric, clinging number of thermost sleeves 1 connection M3 dry heating element 2 hole flange		

			
1			
GEV No.	417265	Ref. No.	01992035
description	heating element 5500W 230/400V heating circuits 3 mounting ϕ 42mm hole distance 74mm L 503mm W 35mm H 62mm L1 44mm L2 64mm L3 395mm H1 35mm H2 27mm hole ϕ 9.5mm tube ϕ 8mm thermost sleeves ϕ 5mm length thermost sleeves 190mm thermost sleeve eccentric, clinging number of thermost sleeves 1 connection 3 immersion heater 2 hole flange		

			
1			
GEV No.	417175	Ref. No.	01192035
description	heating element 800W 220V heating circuits 1 ϕ 50mm H 41mm W1 38mm H1 19mm H2 22mm mounting distance 32mm thread 1/4" stainless steel windings 2 tube ϕ 6.3mm immersion heater 2 hole fixing connection male faston 6.3mm		
spare parts for	417175		
	GEV No.	510417	Ref. No. —
	flat gasket fibre ED ϕ 20mm ID ϕ 14mm thickness 2mm Qty 1 pcs		
accessories for	417175		
	GEV No.	361182	Ref. No. —
	nut thread 1/4" H 5mm nickel-plated brass WS 17 Qty 1 pcs		
	GEV No.	520228	Ref. No. —
	tooth lock washer ID ϕ 15.3mm ED ϕ 24mm steel Qty 1 pcs for thread M14		
	GEV No.	550262	Ref. No. —
	flat gasket copper ED ϕ 20mm ID ϕ 14mm thickness 2mm		

accessories

sealing washers

fibre gaskets

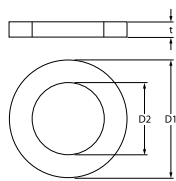
 			
1			
GEV No.	528171	Ref. No.	00499035
description	flat gasket fibre ED ϕ 55mm ID ϕ 42mm thickness 2mm Qty 1 pcs		



O-rings

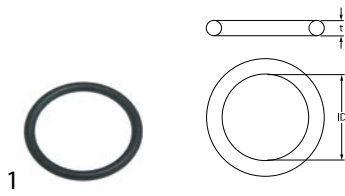

GEV No. 510408 **Ref. No.** 00174035

description O-ring EPDM thickness 5.34mm ID ø 47mm Qty 1 pcs

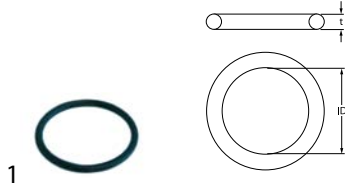

GEV No. 510409 **Ref. No.** 01917035

description O-ring EPDM thickness 5.34mm ID ø 56.52mm Qty 1 pcs

protection caps



GEV No. 520483 **Ref. No.** 00276014

description protection cap for heating element ø 48mm plastic L 50mm

thermostats

bi-metal thermostats

safety bi-metal thermostats



GEV No. 390312 **Ref. No.** 01194035

description bi-metal safety thermostat 1-pole connection F6.3 2 hole fixing

bi-metal thermostats



GEV No. 390129 **Ref. No.** 00700035

description bi-metal thermostat hole distancemm switch-off temp. 125°C 1NC 1-pole 16A connection F6.3 M4



GEV No. 390153 **Ref. No.** 00277035

description bi-metal thermostat hole distancemm switch-off temp. 135°C 1NC 1-pole 16A connection F6.3 M4



GEV No. 390327 **Ref. No.** 00702035

description bi-metal thermostat hole distancemm switch-off temp. 150°C 1NC 1-pole 16A connection F6.3 M4



GEV No. 390128 **Ref. No.** 00701035

description bi-metal thermostat hole distancemm switch-off temp. 95°C 1NC 1-pole 16A connection F6.3 M4

control and safety thermostats

EGO

safety thermostats

55.32_ series



GEV No. 390324 **Ref. No.** 02790035

description safety thermostat switch-off temp. 169°C 3-pole 3NC 20A probe ø 4mm probe L 128mm capillary pipe 890mm capillary pipe isolated 210/210mm gland nut probe SS

switches and momentary switches

rocker/momentary rocker switches



30x11 mm



GEV No. 301038 **Ref. No.** 00632034

description rocker switch mounting measurements 30x11mm green 1NO/indicator light 250V 16A connection male faston 6.3mm





30x22mm			
			
1			
GEV No.	301001	Ref. No.	00492035
description	rocker switch mounting measurements 30x22mm red 2NO 250V 16A illuminated 0-I connection male faston 6.3mm ambient temperature max. 125/55°C protection IP65		
accessories for	301001		
			
GEV No.	301036	Ref. No.	—
description	protective cover internal size 30x22mm for rocker switch mounting measurementsmm		

			
1			
GEV No.	301060	Ref. No.	01603035
description	rocker switch mounting measurements 30x22mm red 2NO 250V 16A illuminated connection male faston 6.3mm ambient temperature max. 125/55°C protection IP40		

push/momentary push switches

28.5x28.5mm			
			
1			
GEV No.	346019	Ref. No.	00746034
description	push switch mounting measurements 28.5x28.5mm green/black 2NO 250V 16A cup connection male faston 6.3mm ambient temperature max. 150/75°C protection IP40 with indicator		

30x22mm			
			
1			
GEV No.	301044	Ref. No.	01606034
description	momentary push switch mounting measurements 30x22mm green 2NO 250V 16A illuminated		

			
1			
GEV No.	301040 ¹	Ref. No.	00631034
description	push switch mounting measurements 30x22mm green 2NO 250V 16A illuminated connection male faston 6.3mm ambient temperature max. 85°C protection IP40		

¹illuminated

ø25mm			
			
1			
GEV No.	346044	Ref. No.	01606034
description	momentary push switch mounting ø 25mm black 2NO 250V 16A water connection male faston 6.3mm ambient temperature max. 85°C protection IP40		

			
1			
GEV No.	346040	Ref. No.	00631034
description	momentary push switch mounting ø 25mm red 2NO 250V 16A water connection male faston 6.3mm ambient temperature max. 85°C protection IP40		

			
1			
GEV No.	346039	Ref. No.	01607034
description	push switch mounting ø 25mm black 2NO 250V 16A coffee connection male faston 6.3mm ambient temperature max. 85°C protection IP40		

			
1			
GEV No.	346038	Ref. No.	00632034
description	push switch mounting ø 25mm red 2NO 250V 16A coffee connection male faston 6.3mm ambient temperature max. 85°C protection IP40		

microswitches

roller actuated

roller 0°

			
1			
GEV No.	346370	Ref. No.	01903035
description	microswitch with roller plunger 230V 16A 1CO connection screw L1 49mm ambient temperature max. 125°C thread L 14mm thread M10 mounting distance 25mm actuating force: 300g type MV15-2		



system switches (ROLD)



1

GEV No.	346498	Ref. No.	00740035
description	element holder mounting measurements 28.5x28.5mm black single element holder		



1

GEV No.	346032	Ref. No.	00743073
description	push button ø 23mm black flash with lens		



1

GEV No.	345722	Ref. No.	01221035
description	switch 1NO 250V 16A connection male faston 6.3mm		



1

GEV No.	345720	Ref. No.	01222035
description	switch 2NO 250V 16A connection male faston 6.3mm		

key lock switches



1

GEV No.	400298	Ref. No.	00388035 03196035
description	key lock switch		



1

GEV No.	400297	Ref. No.	00387035 03195035
description	key lock switch 1 group thread M12x1 1NO mounting ø 12mm cable length 300mm		



1

GEV No.	402219	Ref. No.	00391035
description	key lock switch 1 group thread M12x1 1NO mounting ø 12mm cable length 500mm		



1

GEV No.	400299	Ref. No.	03197035 0389035
description	key lock switch mounting ø 11.6mm 3-group		

rotary switches

BREMAS

A1700 series



1

GEV No.	347085	Ref. No.	00056035
description	rotary switch 2 0-1 sets of contacts 2 type CA0170002V 400V 20A shaft ø 5x5mm shaft L 18mm shaft square connection screw		



1

GEV No.	347198 ¹	Ref. No.	02019035
description	rotary switch 2 0-1 sets of contacts 4 type CA0200004V 400V 20A shaft ø 5x5mm shaft L 19mm shaft square connection screw		

¹incl. rubber protective sleeve

1

GEV No.	346004	Ref. No.	00056035
description	rotary switch 20A shaft L 23mm 2 operating positions 2-pole shaft 5x5mm screw		



1

GEV No.	347274	Ref. No.	02020035
description	rotary switch 3 0-1-2 sets of contacts 6 type CS0178623 400V 20A shaft ø 5x5mm shaft L 23mm shaft square connection screw		

accessories



1

GEV No.	111315	Ref. No.	01965058
description	knob ø 28/48mm shaft ø 5x5mm brown H 22mm L 40mm		



			
1			
GEV No.	527259	Ref. No.	01965057
description	knob push-in ø 34/60mm shaft ø 5x5mm black H 21.4mm L 49mm		

lamps

indicator lights

indicator lights 2-piece (lens and indicator lamp)

rings for socket type SC-1

			
1			
GEV No.	359242	Ref. No.	01311035
description	frame chrome-plated		

indicator lights (complete)

ø10mm

with screw socket

			
1			
GEV No.	359238	Ref. No.	01312035
description	indicator light ø 10mm 230V green connection male faston 6.3mm		

			
1			
GEV No.	359237	Ref. No.	00073035
description	indicator light ø 10mm 230V red connection male faston 6.3mm		

relays



power relays

with male contacts

bullet connectors, 8 contacts

				
1				
GEV No.	380134	Ref. No.	00681035	
description	power relays Italiana Relè 230VAC 10A 2CO connection plug-in connection round 8-pole manuf. no. C42-230VAC 90.26/ZVE8 250V			
accessories for	380134			
	GEV No.	380137	Ref. No.	—
	relay socket 8-pole connection plug-in connection round 8-pole dimensions 65x28x40mm 380V voltage AC 10A Italiana Relè manuf. no. ZVE8			
	GEV No.	380638	Ref. No.	—
	relay socket 8-pole dimensions 51x41x23mm 250V 10A FINDER manuf. no. 90.26			

plug-in/print relays

				
1				
GEV No.	380662	Ref. No.	02021035	
description	print relay 250VAC 1CO at 250V 10A connection pins raster size 3.5mm			
accessories for	380662			
	GEV No.	380663	Ref. No.	—
	relay socket 250V voltage AC 10A FINDER manuf. no. 95.83.3			

relay sockets

			
1			
GEV No.	380910	Ref. No.	02022035
description	relay socket 5-pole 250V 10A FINDER manuf. no. 95.63		

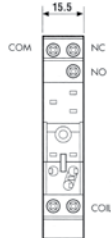

15.5

COM NC

 NO

 COIL

			
1			
GEV No.	380909	Ref. No.	00683035
description	relay socket 8-pole 250V 10A FINDER manuf. no. 90.22		

level relays

GICAR			
			
1			
GEV No.	402392	Ref. No.	00189035
description	level controller 230V voltage AC 50/60Hz 10A connection male faston 6.3mm type NRL30/1E-2C/F		

keypads
keypad units

			
1			
GEV No.	400361	Ref. No.	00384035 EL-384
description	keypad unit		

			
1			
GEV No.	400057	Ref. No.	03154034
description	keypad unit buttons 7 black		

			
1			
GEV No.	400357	Ref. No.	02901034
description	keypad unit buttons 7 blue type DOS TG 1GR+RL 230V		

			
1			
GEV No.	400059	Ref. No.	01955034
description	keypad unit buttons 7 brown type DOS TG 1GR+RL 230V		

solenoid valves

solenoid valves (water)

metal			
PARKER			
spare parts and accessories			
valve bodies			

			
1			
GEV No.	370568	Ref. No.	01847035
description	solenoid valve body PARKER 2-ways type VE-140 pressure range 0-10bar		

				
1				
GEV No.	370062	Ref. No.	EK02	
description	solenoid valve body PARKER 3-ways outer cone			
accessories for	370062			
	GEV No.	371029	Ref. No.	—
	solenoid coil PARKER 230VAC 9VA coil type ZB09 seat ø 14mm H 33mm W 34mm D 43mm			
	GEV No.	371030	Ref. No.	—
	solenoid coil 24VDC 12VA coil type ZB12 seat ø 14mm			
	GEV No.	371033	Ref. No.	—
	solenoid coil PARKER 230VAC 9VA coil type YB09 with cable seat ø 14mm			
	GEV No.	371036	Ref. No.	—
	solenoid coil 24VAC 9VA coil type ZB09 seat ø 14mm			
	GEV No.	371095	Ref. No.	—
	O-ring Viton thickness 1.78mm ID ø 6.07mm Qty 1 pcs			

Table continues overleaf



accessories for	370062		
	GEV No.	371100	Ref. No. —
	O-ring silicone thickness 1.78mm ID ø 6.07mm Qty 1 pcs		

pressure switches

for coffee machines

ø 38mm



1

GEV No.	541020	Ref. No.	01344035
description	pressure control ø 38mm pressure range 0.5-1.2bar coffee machine parts pressure connection vertical preset at 1bar 16A 250V connection 1/4" pressure connection 1/4" GAS		

miscellaneous



1

GEV No.	541021	Ref. No.	00049035
description	pressure control pressure range adjustable 0.5-1.4bar connection 1/4" 30A 3-pole type P302 coffee machine parts SIRAI		

accessories for 541021

	GEV No.	550262	Ref. No. —
	flat gasket copper ED ø 20mm ID ø 14mm thickness 2mm		

	GEV No.	890100	Ref. No. —
	PTFE tape reel L 12m W 12mm -200 up to +260°C approval DIN-DVGW, KTW temperature-resistant, elastic for fine thread thickness 0.1mm		

electrodes



1

GEV No.	400214	Ref. No.	00191035
description	level electrode 1/4" total length 140mm probe L 112mm insulated probe length 26mm connection male faston 6.3mm stainless steel ø 2.5mm		



1

GEV No.	400523	Ref. No.	01108034
description	level electrode total length 111mm probe L 81mm with housing ø 14mm		



1

GEV No.	400573	Ref. No.	01110034 01971034
description	level electrode total length 130mm probe L 102mm with housing ø 14mm		

pumps

booster pumps II

pump heads

FLUID-O-TECH



1

GEV No.	500177	Ref. No.	00046035
description	pump head PA204X FLUID-O-TECH L 82mm 200l/h connection 3/8" GAS with filter an bypass brass clip connection for coffee machine shaft ø 4.8x11mm		

equipment-specific units

for vegetable slicers

miscellaneous



1

GEV No.	110703	Ref. No.	00469035
description	cylindrical handle thread M10 ø 28mm L 87mm		

for cheese graters

miscellaneous



1

GEV No.	110703	Ref. No.	00469035
description	cylindrical handle thread M10 ø 28mm L 87mm		

for espresso machines

filter holders

filter holders standard

filter holder without spout



1

GEV No.	525991	Ref. No.	N/A
description	filter holder suitable for ELEKTRA without outlet mounting \varnothing 82.5mm outlet 3/8" ID \varnothing 61.8mm wedge height 8.5mm wedge position horizontal number of wedges 2 lever inclined		

filter holders short



1

GEV No.	529181	Ref. No.	00187021
description	filter holder chrome-plated		



1

GEV No.	529180	Ref. No.	00187019
description	filter holder mounting \varnothing 64mm hole \varnothing 4mm ID \varnothing 51mm handle M8x1.25 wedge height 8mm wedge position horizontal number of wedges 2 lever straight brass polished		



1

GEV No.	529198	Ref. No.	00061021 02152021
description	filter holder mounting \varnothing 82.5mm outlet 3/8" ID \varnothing 61.8mm handle M12x1.75 wedge height 9.5mm wedge position horizontal number of wedges 2 lever inclined chrome-plated brass		

handles

with external thread



1

GEV No.	529129	Ref. No.	02900014
description	handle for filter holder \varnothing 36.5mm thread M12x1.75 thread L 15mm L 110mm black		



1

GEV No.	529199	Ref. No.	01897035
description	handle for filter holder \varnothing 36.5mm thread M12x1.75 thread L 15mm L 110mm brown		

with bore



1

GEV No.	529793	Ref. No.	01899035
description	handle		



1

GEV No.	529185	Ref. No.	00177005 00177014
description	handle \varnothing 36mm aperture 10mm L 125mm brown wood		

screws



1

GEV No.	529182	Ref. No.	00186035
description	threaded rod		

spouts

with thread 3/8"



1

GEV No.	529003	Ref. No.	01308021
description	filter holder spout thread 3/8" 1-way curved/long outlet distance mm thread L 5mm		



1

GEV No.	529161	Ref. No.	00064021
description	filter holder spout thread 3/8" adjustable curved H 34mm outlet distance 45mm cups 2		

accessories



GEV No.	529200	Ref. No.	00526021
description	extension chrome-plated brass		

filters

for 1 cup



GEV No.	529178	Ref. No.	00164035
description	coffee filter ø 58mm mounting ø 51mm H 22mm cups 1 amount of coffee 6g		



GEV No.	526261	Ref. No.	01796035
description	coffee filter ø 70mm mounting ø 60.5mm H 20.5mm cups 1 amount of coffee 6.5g		



GEV No.	529196	Ref. No.	00065035
description	coffee filter ø 70mm mounting ø 60.6mm H 24.5mm cups 1 amount of coffee 7g		



GEV No.	527631	Ref. No.	N/A
description	coffee filter ø 70mm mounting ø 60.7mm H 17mm cups 1 amount of coffee 8g		

for 2 cups



GEV No.	529179	Ref. No.	00163035
description	coffee filter ø 58mm mounting ø 51mm H 26mm cups 2 amount of coffee 12g		



GEV No.	529197	Ref. No.	00066035
description	coffee filter ø 70mm mounting ø 60mm H 24.5mm cups 2 amount of coffee 14g		

filter holder springs



GEV No.	529079	Ref. No.	013040335 01304035
description	filter holder spring L 70mm W 60mm wire gauge ø 1.3mm for espresso filter holder		

miscellaneous

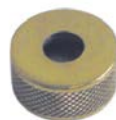

GEV No.	529184	Ref. No.	01367019
description	nut		

brewing units

shower screens

flat



GEV No.	529193	Ref. No.	01208035
description	shower screen ø 52.1mm hole ø 6.3mm		
accessories for	529193		
GEV No.	560300	Ref. No.	01206035
description	countersunk screw thread M5 L 16mm SS DIN 963/ISO 2009 Qty 1 pcs intake slotted head ø 9mm		

with upstand



1

GEV No.	529177	Ref. No.	00175035
description	shower screen ø 48mm H 14mm		

screws



1

GEV No.	560300	Ref. No.	01206035
description	countersunk screw thread M5 L 16mm SS DIN 963/ISO 2009 Qty 1 pcs intake slotted head ø 9mm		

filter holder gaskets

O-rings



1

GEV No.	510409	Ref. No.	01917035
description	O-ring EPDM thickness 5.34mm ID ø 56.52mm Qty 1 pcs		

shim gaskets



1

GEV No.	531251	Ref. No.	—
description	shim gasket D1 ø 66mm D2 ø 58mm thickness 0.8mm paper Qty 20 pcs		

brewing units with solenoid valve

nozzle holders



1

GEV No.	526420	Ref. No.	01335014
description	nozzle holder thread M5 IT M5 L 10.3mm brass WS 8		

filters

accessories



1

GEV No.	526419	Ref. No.	00110014
description	filter support for brewing unit D1 ø 11mm D2 ø 18mm D3 ø 16.5mm L 5.6mm		

brewing units manual

components

gaskets



1

GEV No.	529174	Ref. No.	00172035
description	gasket		



1

GEV No.	529795	Ref. No.	01245035 02862035
description	gasket D1 ø 13mm D2 ø 4mm thickness 4mm coffee machine		



1

GEV No.	529175	Ref. No.	00173035
description	gasket ED ø 41mm ID ø 28mm H 6mm		

brewing units with lever

complete



1

GEV No.	525005	Ref. No.	00131039
description	brewing unit complete suitable for ELEKTRA		

			
1			
GEV No.	525006	Ref. No.	00131038
description	brewing unit complete suitable for ELEKTRA		

components			
nozzles			
with thread			
			
1			
GEV No.	529188	Ref. No.	01336014
description	nozzle bore ø 0.9mm		

screw connections			
			
1			
GEV No.	526386	Ref. No.	00026014
description	screw cap thread M30x1.5 ID ø 15mm L 21mm brass WS 12		

			
1			
GEV No.	526385	Ref. No.	00921021
description	screw cap thread M30x1.5 ID ø 15mm L 30mm chrome-plated brass WS 17		

gaskets			
			
1			
GEV No.	529190	Ref. No.	01228035
description	O-ring Viton thickness 2.62mm ID ø 31.42mm Qty 1 pcs		

water dispersions			
water dispersions			
group 3			
			
1			
GEV No.	529194	Ref. No.	01252014
description	water distributor ø 57mm H 8.5mm 10 holes hole ø 1.2mm mounting ø 5mm brass		

safety valves			
safety valves			
3/8"			
			
1			
GEV No.	529312	Ref. No.	01618034
description	safety valve connection 3/8" triggering pressure 1.8bar		

expansion valves			
			
1			
GEV No.	529341	Ref. No.	00422034
description	expansion valve T1: 1/8" ET T2: 1/8" ET L 24mm		

drain pans			
drain pans			
			
1			
GEV No.	526373	Ref. No.	01262014
description	drain pan L 98mm W 70mm H 48mm		

aerators and air bleeders



GEV No. 529303 **Ref. No.** 00200034

description aerator and air bleeder connection 1/4" only steam

spare parts for 529303



GEV No. 528687 **Ref. No.** —

O-ring Viton thickness 1.78mm ID ø 3.69mm Qty 1 pcs

boilers

gaskets

O-rings

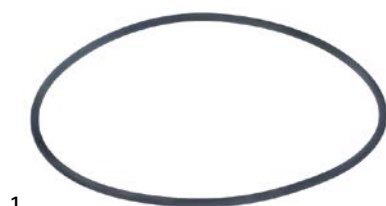

GEV No. 526394 **Ref. No.** 01994035

description boiler gasket Viton thickness 3.53mm ID ø 129.8mm Qty 1 pcs

steam/water taps

steam/water taps

steam/water taps



GEV No. 529811 **Ref. No.** 00690038

description steam/water tap brass

spare parts for 529811



GEV No. 526404 **Ref. No.** 01891019

tap body T1: M18x1 T2: M20x1 T3: TR20 left brass polished L 49mm



GEV No. 529813 **Ref. No.** 01898035

star handle shaft 7x7mm ø 58mm L 19mm brown thermoplastic



GEV No. 529814 **Ref. No.** 00953030

disc for knob ø 33.8mm ELEKTRA



GEV No. 529812 **Ref. No.** 00690039

description steam/water tap chrome-plated

spare parts for 529812



GEV No. 526399 **Ref. No.** 01891021

tap body T1: M18x1 T2: M20x1 T3: TR20 left chrome-plated L 49mm



GEV No. 529813 **Ref. No.** 01898035

star handle shaft 7x7mm ø 58mm L 19mm brown thermoplastic



GEV No. 529814 **Ref. No.** 00953030

disc for knob ø 33.8mm ELEKTRA

steam taps

steam taps (complete)



GEV No. 529790 **Ref. No.** 00958038

description steam tap brass

spare parts for 529790



GEV No. 526417 **Ref. No.** 00048014

shaft for steam-/water-tap ø 5mm D2 ø 4mm L 65mm thread M4 SS



GEV No. 526418 **Ref. No.** 01457015

lever L 36mm T1: M5 T2: M8 ø 13.5mm



GEV No. 526377 **Ref. No.** 02906039

description steam tap complete chrome-plated blue/black





1

GEV No.	526376	Ref. No.	01990039
description	steam tap complete chrome-plated white/brown		







1

GEV No.	526374	Ref. No.	00958034	
description	steam tap complete swing lever brass			
spare parts for	526374			
	GEV No.	526417	Ref. No.	00048014
	shaft for steam-/water-tap ø 5mm D2 ø 4mm L 65mm thread M4 SS			
	GEV No.	526418	Ref. No.	01457015
	lever L 36mm T1: M5 T2: M8 ø 13.5mm			





1

GEV No.	529808	Ref. No.	00945034	
description	steam tap complete swing lever brass			
spare parts for	529808			
	GEV No.	526384	Ref. No.	01891014
	tap body T1: M18x1 T2: M20x1 T3: TR20 left brass L 49mm			
	GEV No.	526417	Ref. No.	00048014
	shaft for steam-/water-tap ø 5mm D2 ø 4mm L 65mm thread M4 SS			
	GEV No.	526418	Ref. No.	01457015
	lever L 36mm T1: M5 T2: M8 ø 13.5mm			



1

GEV No.	529789	Ref. No.	00958039	
description	steam tap complete swing lever chrome-plated			
spare parts for	529789			
	GEV No.	526417	Ref. No.	00048014
	shaft for steam-/water-tap ø 5mm D2 ø 4mm L 65mm thread M4 SS			
	GEV No.	526418	Ref. No.	01457015
	lever L 36mm T1: M5 T2: M8 ø 13.5mm			

components

shafts



1

GEV No.	526417	Ref. No.	00048014
description	shaft for steam-/water-tap ø 5mm D2 ø 4mm L 65mm thread M4 SS		

bushes



1

GEV No.	529804	Ref. No.	01913014
description	bush		

gaskets



1

GEV No.	529796	Ref. No.	01178035
description	gasket D1 ø 12mm D2 ø 5mm thickness 5mm PTFE coffee machine		



1

GEV No.	529795	Ref. No.	01245035 02862035
description	gasket D1 ø 13mm D2 ø 4mm thickness 4mm coffee machine		

gasket supports



1

GEV No.	529794	Ref. No.	00042014
description	gasket support		



1

GEV No.	526391	Ref. No.	00047014
description	piston for steam-/water-tap ø 13mm L 11mm thread M4		

spring guides



1

GEV No.	529797	Ref. No.	00045014
description	spring guide		

springs



1

GEV No.	529803	Ref. No.	01912035
description	compression spring ø 10.9mm L 16mm wire gauge ø 1.8mm		



1

GEV No.	529798	Ref. No.	01189035
description	compression spring ø 12.4mm L 36mm wire gauge ø 1.8mm		

tap bodies



1

GEV No.	529780	Ref. No.	00150021
description	tap body		



1

GEV No.	529781	Ref. No.	00150019
description	tap body		



1

GEV No.	526384	Ref. No.	01891014
description	tap body T1: M18x1 T2: M20x1 T3: TR20 left brass L 49mm		



1

GEV No.	526404	Ref. No.	01891019
description	tap body T1: M18x1 T2: M20x1 T3: TR20 left brass polished L 49mm		



1

GEV No.	526399	Ref. No.	01891021
description	tap body T1: M18x1 T2: M20x1 T3: TR20 left chrome-plated L 49mm		

levers



1

GEV No.	526418	Ref. No.	01457015
description	lever L 36mm T1: M5 T2: M8 ø 13.5mm		

knob adaptors





1

GEV No.	526411	Ref. No.	00948021
description	knob adapter thread TR20 left shaft 7x7mm L 40mm handle M4 chrome-plated brass		





nuts			
			
1			
GEV No.	526498	Ref. No.	00950014
description	hexagonal nut thread TR20 left H 5mm WS 25 brass		

screws			
			
1			
GEV No.	526389	Ref. No.	00952015
description	screw for stop		

union nuts			
			
1			
GEV No.	529806	Ref. No.	00946021
description	union nut chrome-plated		

			
1			
GEV No.	529792	Ref. No.	00947019
description	union nut thread TR20 left ID ø 14mm L 24mm brass polished		

			
1			
GEV No.	529791	Ref. No.	00947021 03207015 03207021
description	union nut thread TR20 left ID ø 14mm L 24mm chrome-plated		

			
1			
GEV No.	526407	Ref. No.	00950021
description	union nut thread TR20 left L 21mm chrome-plated		

			
1			
GEV No.	526406	Ref. No.	00950019
description	union nut thread TR20 left L 21mm WS 24 brass polished		

washers			
			
1			
GEV No.	526393	Ref. No.	00955014
description	plain washer D1 ø 25mm D2 ø 20mm thickness 1.5mm aluminium for steam-/water-tap		

screw connections			
			
1			
GEV No.	526408	Ref. No.	00954019
description	screw connection for steam-/water-tap T1: M18x1 T2: 3/8" L 9mm ø 26mm ID ø 8.5mm WS 24 brass polished		

			
1			
GEV No.	526409	Ref. No.	00954014
description	screw connection for steam-/water-tap T1: M20x1 T2: 3/8" L 9mm ø 26mm ID ø 8mm WS 24 brass		

			
1			
GEV No.	526410	Ref. No.	00954021
description	screw connection for steam-/water-tap T1: M20x1 T2: 3/8" L 9mm ø 26mm ID ø 8mm WS 24 chrome-plated		

miscellaneous			
			
1			
GEV No.	526416	Ref. No.	01458014
description	ball for swing lever ø 16.4mm L 14mm thread M5		

water taps

water taps



1

GEV No.	526381	Ref. No.	02907039
----------------	--------	-----------------	----------

description	water tap complete brass polished blue/black		
--------------------	--	--	--



1

GEV No.	526378	Ref. No.	01991039
----------------	--------	-----------------	----------

description	water tap complete chrome-plated white/red		
--------------------	--	--	--



1

GEV No.	526382	Ref. No.	00957034
----------------	--------	-----------------	----------

description	water tap complete swing lever brass black		
--------------------	--	--	--



1

GEV No.	526380	Ref. No.	00959034
----------------	--------	-----------------	----------

description	water tap complete swing lever brass brown		
--------------------	--	--	--



1

GEV No.	526375	Ref. No.	00959038
----------------	--------	-----------------	----------

description	water tap complete swing lever brass polished		
--------------------	---	--	--



1

GEV No.	526379	Ref. No.	00959039
----------------	--------	-----------------	----------

description	water tap complete swing lever chrome-plated brown		
--------------------	--	--	--



steam/water pipes

steam pipes

1	
GEV No.	529785
Ref. No.	00151039
description	steam pipe chrome-plated

1	
GEV No.	529786
Ref. No.	00151038
description	steam pipe copper

1	
GEV No.	526398
Ref. No.	00444011
description	steam pipe H 155mm ø 14.5mm

1	
GEV No.	529799
Ref. No.	02202039
description	steam pipe SS

1	
GEV No.	529800
Ref. No.	00439011
description	steam pipe SS

nozzles for steam pipes

1	
GEV No.	529801
Ref. No.	00448014
description	steam nozzle

1	
GEV No.	529788
Ref. No.	00088019 01400019
description	steam nozzle brass

1	
GEV No.	529787
Ref. No.	00088021 01400021
description	steam nozzle chrome-plated

nozzles for water pipes

components

1	
GEV No.	526415
Ref. No.	00442014
description	screw connection for flow regulator thread M21x1 L 29.5mm ø 23.5mm SS ID ø 16.1mm

1	
GEV No.	526414
Ref. No.	00423014
description	screw connection for flow regulator thread M22x1 L 16mm ø 23.5mm SS ID ø 20mm

tap aerators

1	
GEV No.	527966
Ref. No.	00424014
description	tap aerator D1 ø 18.8mm D2 ø 20.8mm H 12mm

water pipes

1	
GEV No.	526396
Ref. No.	02208038
description	water pipe thread M20x1 ø 23.5mm L 195mm

1	
GEV No.	526397
Ref. No.	02206039
description	water pipe thread M20x1 ø 23.5mm L 80mm

1	
GEV No.	526383
Ref. No.	02205034
description	water pipe thread M20x1 ø 23mm L 80mm

accessories

gaskets



GEV No.	526392	Ref. No.	00409035
description	flat gasket Viton ED ϕ 21mm ID ϕ 15mm thickness 2mm Qty 1 pcs		



GEV No.	529805	Ref. No.	01893035 02265035 Viton
description	gasket PTFE D1 ϕ 20mm		

tube handles



GEV No.	529627	Ref. No.	01964035 EK1001
description	tube handle ϕ 8mm L 30mm plastic		

union nuts



GEV No.	529784	Ref. No.	01280019 01281019
description	union nut brass		



GEV No.	529783	Ref. No.	01280021 01281021
description	union nut chrome-plated		



GEV No.	526405	Ref. No.	00946014
description	union nut thread M20x1 ID ϕ 12.5mm L 21mm brass		



GEV No.	529807	Ref. No.	00946019
description	union nut thread M20x1 with gasket ID ϕ 12.5mm L 21mm brass polished		

fine filters

fine filters



GEV No.	529192	Ref. No.	00111035
description	fine filter fabric ID ϕ 12mm ϕ 18mm H 20mm		



GEV No.	526395	Ref. No.	01341035
description	fine filter flat fabric ϕ 8.5mm H 2mm		

level glasses

level glasses

gaskets



GEV No.	529449	Ref. No.	00119035
description	gasket D1 ϕ 15mm D2 ϕ 9mm H 8mm water level glass suitable for ELEKTRA equiv. no. 00119035		

pressure rings



GEV No.	529450	Ref. No.	01380035
description	press ring		



GEV No.	529453	Ref. No.	00142021
description	union screw chrome-plated		

housings





GEV No.	529459	Ref. No.	00536031 01025031
description	base part for level glass round		





			
1			
GEV No.	529462	Ref. No.	00899021
description	tap head for level glass round		

level glasses			
			
1			
GEV No.	529461	Ref. No.	00544035
description	glass panel Lmm Wmm thickness 8mm ø 72.5mm		

level glasses (complete)				
				
1				
GEV No.	529458	Ref. No.	00895039 01096039	
description	level glass complete			
spare parts for	529458			
	GEV No.	529459	Ref. No.	00536031 01025031
	base part for level glass round			
	GEV No.	529460	Ref. No.	00543035
	O-ring EPDM thickness 5.34mm ID ø 59.69mm Qty 1 pcs			
	GEV No.	529461	Ref. No.	00544035
	glass panel Lmm Wmm thickness 8mm ø 72.5mm			
	GEV No.	529462	Ref. No.	00899021
	tap head for level glass round			

level glass pipes			
			
1			
GEV No.	529448	Ref. No.	00141035
description	water level tube ø 9mm H 148mm		

protective plates			
			
1			
GEV No.	529455	Ref. No.	00043021
description	protector		

			
1			
GEV No.	529456	Ref. No.	00043019
description	protector		

screw connections			
			
1			
GEV No.	529451	Ref. No.	00041021
description	union screw chrome-plated		

			
1			
GEV No.	529452	Ref. No.	00041019
description	union screw varnished		

			
1			
GEV No.	529454	Ref. No.	00142019
description	union screw varnished		

non-return valves			
complete			
			
1			
GEV No.	529340	Ref. No.	00330034
description	non-return valve		

screw connections

double nipples



1

GEV No.	526413	Ref. No.	01506014
description	double nipple T1: 1/4" T2: 3/8" int. ø 1 8.3mm L 5mm brass Qty 1 pcs		



1

GEV No.	526412	Ref. No.	01288014
description	double nipple T1: 1/8" T2: 3/8" int. ø 1 8.5mm int. ø 2 5mm L 25.5mm brass Qty 1 pcs		

for coffee grinders

grinding burrs

grinding burrs straight

standard



1

GEV No.	527700	Ref. No.	C0004M122
description	grinding burrs pair turn direction right D1 ø 64.5mm ID ø 38mm H 8.5mm tooth spacing 3mm hole ø 5mm bore ø 8.5mm mounting ø 48		

coffee beans containers

coffee beans containers



1

GEV No.	527664	Ref. No.	C0007M113
description	coffee beans container ø 230mm H 265mm seat ø 67mm		

knobs

steam/water taps

steam/water taps



1

GEV No.	529782	Ref. No.	00154035
description	knob ø 25mm shaft ø 9x9mm shaft flat square black		

knob dial plates



1

GEV No.	111310	Ref. No.	01916030
description	bezel 0-1 yellow ELEKTRA		



1

GEV No.	111312	Ref. No.	02903030
description	bezel 0-1-2 blue ELEKTRA		





1

GEV No.	111311	Ref. No.	01908030
description	bezel 0-1-2 yellow ELEKTRA		



1			
GEV No.	526388	Ref. No.	02902030
description	disc for knob ø 33.8mm blue ELEKTRA		

1			
GEV No.	529814	Ref. No.	00953030
description	disc for knob ø 33.8mm ELEKTRA		

1			
GEV No.	531175	Ref. No.	03961030
description	disc steam ø 33.7mm ID ø 4.5mm thickness 1mm yellow for knob ELEKTRA		

1	 Image not available		
GEV No.	531176	Ref. No.	03962030
description	disc water ø 33.7mm ID ø 4.5mm thickness 1mm yellow for knob ELEKTRA		

miscellaneous

1			
GEV No.	110205	Ref. No.	01965057
description	knob ø 27mm shaft ø 5x5mm		

1			
GEV No.	111315	Ref. No.	01965058
description	knob ø 28/48mm shaft ø 5x5mm brown H 22mm L 40mm		

1			
GEV No.	527259	Ref. No.	01965057
description	knob push-in ø 34/60mm shaft ø 5x5mm black H 21.4mm L 49mm		

handles and hand wheels

cylindrical handles

fixed

1			
GEV No.	110703	Ref. No.	00469035
description	cylindrical handle thread M10 ø 28mm L 87mm		

1			
GEV No.	529183	Ref. No.	00469035
description	cylindrical handle thread M10 ø 29mm L 86mm		

cone handles

1			
GEV No.	529810	Ref. No.	01900035
description	cone handle thread M8 ø 20mm L 58.5mm plastic black		

1			
GEV No.	111092	Ref. No.	02898035
description	cone handle thread M8 ø 25mm L 41mm black		

1			
GEV No.	111313	Ref. No.	01901035
description	cone handle thread M8 ø 25mm L 41mm plastic brown marbled		

star handles



1

GEV No.	529813	Ref. No.	01898035
description	star handle shaft 7x7mm \varnothing 58mm L 19mm brown thermoplastic		



1

GEV No.	111309	Ref. No.	02899035
description	star handle shaft 7x7mm \varnothing 62mm L 19mm black plastic		

levers

with handle



1

GEV No.	111160	Ref. No.	00176039
description	lever		



1

GEV No.	111161	Ref. No.	00176038
description	lever		

lever handles



1

GEV No.	529810	Ref. No.	01900035
description	cone handle thread M8 \varnothing 20mm L 58.5mm plastic black		

accessories

miscellaneous



1

GEV No.	526421	Ref. No.	01902092
description	spring L 10mm \varnothing 10mm		

gaskets

O-rings

EPDM

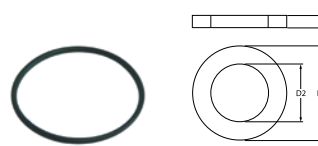

1

GEV No.	510824	Ref. No.	01888035
description	O-ring EPDM thickness 1.78mm ID \varnothing 20.35mm Qty 1 pcs		

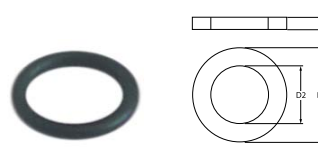

1

GEV No.	528333	Ref. No.	00113035
description	O-ring EPDM thickness 2.62mm ID \varnothing 13.1mm Qty 1 pcs		



1

GEV No.	510408	Ref. No.	00174035
description	O-ring EPDM thickness 5.34mm ID \varnothing 47mm Qty 1 pcs		



1

GEV No.	510409	Ref. No.	01917035
description	O-ring EPDM thickness 5.34mm ID \varnothing 56.52mm Qty 1 pcs		



GEV No.	529460	Ref. No.	00543035
description	O-ring EPDM thickness 5.34mm ID ø 59.69mm Qty 1 pcs		

GEV No.	529190	Ref. No.	01228035
description	O-ring Viton thickness 2.62mm ID ø 31.42mm Qty 1 pcs		

silicone

GEV No.	529187	Ref. No.	01386035
description	O-ring silicone thickness 2.62mm ID ø 13.1mm Qty 1 pcs		

GEV No.	529186	Ref. No.	01204035
description	O-ring Viton thickness 3.53mm ID ø 47.63mm Qty 1 pcs		

GEV No.	528182	Ref. No.	01168035
description	O-ring silicone thickness 3.53mm ID ø 66.27mm Qty 1 pcs		

sealing washers

fibre gaskets

GEV No.	529349	Ref. No.	01172035
description	flat gasket FIBER ED ø 22mm ID ø 16.5mm thickness 2mm for thread 3/8" Qty 1 pcs		

Viton

GEV No.	526394	Ref. No.	01994035
description	boiler gasket Viton thickness 3.53mm ID ø 129.8mm Qty 1 pcs		

GEV No.	528171	Ref. No.	00499035
description	flat gasket fibre ED ø 55mm ID ø 42mm thickness 2mm Qty 1 pcs		

GEV No.	532493	Ref. No.	00956035
description	O-ring Viton thickness 1.78mm ID ø 18.77mm Qty 1 pcs		

copper gaskets

DIN-7603-A

GEV No.	529361	Ref. No.	00102035
description	flat gasket copper ED ø 18mm ID ø 13.5mm thickness 1.5mm for thread 1/4"		

GEV No.	528647	Ref. No.	00144035
description	O-ring Viton thickness 2.62mm ID ø 15.08mm Qty 1 pcs		

DIN-7603-C

GEV No.	526387	Ref. No.	01172035
description	flat gasket copper ED ø 21mm ID ø 17mm thickness 2mm		



			
1			
GEV No.	526390	Ref. No.	00102035
description	gasket copper ED ø 18.7mm ID ø 13.2mm thickness 2.5mm Qty 1 pcs		

Viton gaskets

			
1			
GEV No.	526392	Ref. No.	00409035
description	flat gasket Viton ED ø 21mm ID ø 15mm thickness 2mm Qty 1 pcs		

special gaskets

group gaskets

			
1			
GEV No.	529170	Ref. No.	00098035
description	group gasket D1 ø 65mm thickness 2mm suitable for ELEKTRA equiv. no. 00098035		

			
1			
GEV No.	529174	Ref. No.	00172035
description	gasket		

			
1			
GEV No.	529175	Ref. No.	00173035
description	gasket ED ø 41mm ID ø 28mm H 6mm		

springs

compression springs

			
1			
GEV No.	529803	Ref. No.	01912035
description	compression spring ø 10.9mm L 16mm wire gauge ø 1.8mm		

			
1			
GEV No.	529798	Ref. No.	01189035
description	compression spring ø 12.4mm L 36mm wire gauge ø 1.8mm		

			
1			
GEV No.	529191	Ref. No.	01242035
description	compression spring ø 20.3mm L 18mm wire gauge ø 1.8mm		

			
1			
GEV No.	529173	Ref. No.	00819014
description	compression spring ø 37mm L 93mm wire gauge ø 4.7mm		

manometers

			
1			
GEV No.	541718	Ref. No.	02904014
description	manometer double scale ø 60mm pressure range 0-2/0-16bar connection on the backside thread 1/8" blue/chrome		

			
1			
GEV No.	541264	Ref. No.	02218035
description	manometer double scale ø 60mm pressure range 0-2/0-16bar connection on the backside thread 1/8" chrome/chrome		



1			
GEV No.	541719	Ref. No.	00985014
description	manometer double scale ø 60mm pressure range 0-2/0-16bar connection on the backside thread 1/8" white/chrome		

1			
GEV No.	541255	Ref. No.	00985026
description	manometer double scale ø 60mm pressure range 0-2/0-16bar connection on the backside thread 1/8" white/gold		

1			
GEV No.	541254	Ref. No.	00398035
description	manometer ø 41mm pressure range 0 up to 3bar connection pressure connection vertical marking 1.2-1.8 thread 1/8"		

1			
GEV No.	541253	Ref. No.	00143035
description	manometer ø 42.3mm pressure range 0 up to 3bar connection vertical marking 1.6-2 thread 1/8"		

hoses

industrial hoses

hoses wire reinforced

1			
GEV No.	520036	Ref. No.	00450035
description	drain hose ID ø 16mm ED ø 21mm L 30m wire reinforced		

1			
GEV No.	520072	Ref. No.	00450035
description	drain hose ID ø 16mm ED ø 21mm L 5m wire reinforced		

fastening material

screws

countersunk screws

1			
GEV No.	560300	Ref. No.	01206035
description	countersunk screw thread M5 L 16mm SS DIN 963/ISO 2009 Qty 1 pcs intake slotted head ø 9mm		

flat-headed bolts

1			
GEV No.	560403	Ref. No.	00114035
description	flat-headed bolt thread M4 thread L 12mm brass Qty 1 pcs intake slotted head ø 7mm head thickness 2.5mm		

1			
GEV No.	560406	Ref. No.	01983035
description	flat-headed bolt thread M4 thread L 16mm SS DIN 84 Qty 1 pcs intake slotted head ø 7mm head thickness 2.5mm WS 1.3		

oval head screws

1			
GEV No.	560404	Ref. No.	01952015
description	oval head screw thread M4 thread L 8mm L 10mm head ø 10mm intake slotted Qty 1 pcs		

hexagonal screws

1			
GEV No.	550682	Ref. No.	00126035
description	hexagonal screw thread M8 thread L 20mm SS WS 13 Qty 1 pcs DIN 933 / ISO 4017		

cylinder head bolts

DIN 912/ISO 4762



1

GEV No.	560402	Ref. No.	00122035
description	cylinder head bolt thread M5 thread L 10mm L 15.5mm WS 4 SS Qty 1 pcs intake hexagonal DIN 912/ISO 4762		

nuts

hexagonal nuts

hexagonal nuts inch thread



1

GEV No.	520484	Ref. No.	01290014
description	nut thread 3/8" H 5mm WS 21 brass Qty 1 pcs		

washers

washers

DIN 125A



1

GEV No.	560405	Ref. No.	01291035
description	plain washer ID ø 17.3mm ED ø 30mm thickness 3mm SS Qty 1 pcs DIN 125A		



1

GEV No.	511481	Ref. No.	01392035
description	plain washer ID ø 8.4mm ED ø 16mm thickness 1.6mm zinc-coated steel Qty 1 pcs DIN 125A for thread M8		

fasteners

retaining rings

DIN 471



1

GEV No.	504519	Ref. No.	00044035
description	retaining ring shaft ø 17mm thickness 1mm SS DIN 471		

B			
bi-metal thermostats	4, 4	retaining rings	28
booster pumps II	9	rocker/momentary rocker switches	4
		rotary switches	6
C		S	
countersunk screws	27	safety bi-metal thermostats	4
cylinder head bolts	28	safety thermostats	4
		screws	27
E		sealing washers	25
electrodes	9	solenoid valves	8
		switches and momentary switches	4
F		system switches (ROLD)	6
fasteners	28	T	
fastening material	27	thermostats	4
flat-headed bolts	27		
H		W	
heating elements	3	washers	28
heating elements for coffee machine	3		
hexagonal nuts	28		
hexagonal screws	27		
hoses	27		
hoses wire reinforced	27		
I			
indicator lights	7		
indicator lights (complete)	7		
industrial hoses	27		
K			
key lock switches	6		
L			
lamps	7		
M			
microswitches	5		
N			
nuts	28		
O			
O-rings	24		
oval head screws	27		
P			
pressure switches	9		
pumps	9		
push/momentary push switches	5		
R			
relays	7		