



GAS COMPONENTS



ELECTRIC COMPONENTS



WATER TECHNOLOGY



MECHANICAL COMPONENTS



TOOLS

Spare parts suitable for

EKU

Find the complete and up-to-date range of products in our GEV Webshop



Manufacturer catalogue

The most important spare parts and accessories arranged clearly for every manufacturer

- ✓ Complete product range and all appliance data always up to date in the GEV Webshop
- ✓ Alphabetical Index at the end of the catalogue

GEV Webshop

www.gev-online.co.uk

www.gev-online.com











- 🔍 Add to Favourites
- 🔍 Sign In with email address and usual password
- 🔍 Easy-order – place several items in your basket at the same time
- 🔍 Quick Item search – no login needed

heating elements

heating elements for bain maries







1





GEV No.	415091	Ref. No.	1W217
description	heating element 1000W 230V heating circuits 1 L 295mm W 85mm connection length 20mm connection M3 tube ø 6.5mm 2 hole fixing thread M14x1 immersion heater/dry heating element bain marie/ chip scuttle L1 145mm L2 150mm H 18mm mounting distance 79mm		
spare parts for	415091		
	GEV No.	510417	Ref. No. —
	flat gasket fibre ED ø 20mm ID ø 14mm thickness 2mm Qty 1 pcs		
accessories for	415091		
	GEV No.	520228	Ref. No. —
	tooth lock washer ID ø 15.3mm ED ø 24mm steel Qty 1 pcs for thread M14		
	GEV No.	521133	Ref. No. —
	nut thread M14x1.5 H 6mm WS 19 zinc-coated steel Qty 1 pcs		
	GEV No.	527169	Ref. No. —
	hexagonal nut thread M3 H 2.8mm WS 5.5 brass Qty 1 pcs		
	GEV No.	550261	Ref. No. —
	nut thread M14x1 H 4mm WS 19 SS Qty 1 pcs		
	GEV No.	550262	Ref. No. —
	flat gasket copper ED ø 20mm ID ø 14mm thickness 2mm		
	GEV No.	560110	Ref. No. —
	plain washer ID ø 3.2mm ED ø 7mm thickness 0.5mm SS Qty 20 pcs DIN 125A for thread M3		
	GEV No.	560130	Ref. No. —
	hexagonal nut thread M3 H 2.4mm WS 5.5 SS DIN/ISO DIN 934 / ISO 4032/8673 Qty 20 pcs		



1

GEV No.	415092	Ref. No.	4-06
description	heating element 1300W 230V L 290mm W 130mm connection M4 tube ø 6.3mm 2 hole fixing thread M14x1.5 immersion heater L1 140mm L2 150mm H 18mm mounting distance 127mm		
accessories for	415092		
	GEV No.	510417	Ref. No. —
	flat gasket fibre ED ø 20mm ID ø 14mm thickness 2mm Qty 1 pcs		
	GEV No.	520228	Ref. No. —
	tooth lock washer ID ø 15.3mm ED ø 24mm steel Qty 1 pcs for thread M14		
	GEV No.	520230	Ref. No. —
	nut thread M14x1.5 H 5mm WS 19 zinc-coated steel Qty 1 pcs		
	GEV No.	521101	Ref. No. —
	nut thread M14x1.5 H 5mm WS 19 SS Qty 1 pcs		









accessories for 415092

	GEV No.	521103	Ref. No.	—
	nut thread M4 H 3mm WS 7 brass Qty 20 pcs			
	GEV No.	521104	Ref. No.	—
	washer ID ø 4.3mm ED ø 8mm thickness 0.5mm brass Qty 20 pcs for thread M4			
	GEV No.	550262	Ref. No.	—
	flat gasket copper ED ø 20mm ID ø 14mm thickness 2mm			
	GEV No.	560111	Ref. No.	—
	plain washer ID ø 4.3mm ED ø 9mm thickness 0.8mm SS Qty 20 pcs DIN 125A for thread M4			
	GEV No.	560131	Ref. No.	—
	hexagonal nut thread M4 H 3.2mm WS 7 SS DIN/ISO DIN 934 / ISO 4032/8673 Qty 20 pcs			

heating elements for chip scuttles



1

GEV No.	415091	Ref. No.	1W217
description	heating element 1000W 230V heating circuits 1 L 295mm W 85mm connection length 20mm connection M3 tube ø 6.5mm 2 hole fixing thread M14x1 immersion heater/dry heating element bain marie/ chip scuttle L1 145mm L2 150mm H 18mm mounting distance 79mm		
spare parts for	415091		
	GEV No.	510417	Ref. No. —
	flat gasket fibre ED ø 20mm ID ø 14mm thickness 2mm Qty 1 pcs		
accessories for	415091		
	GEV No.	520228	Ref. No. —
	tooth lock washer ID ø 15.3mm ED ø 24mm steel Qty 1 pcs for thread M14		
	GEV No.	521133	Ref. No. —
	nut thread M14x1.5 H 6mm WS 19 zinc-coated steel Qty 1 pcs		
	GEV No.	527169	Ref. No. —
	hexagonal nut thread M3 H 2.8mm WS 5.5 brass Qty 1 pcs		
	GEV No.	550261	Ref. No. —
	nut thread M14x1 H 4mm WS 19 SS Qty 1 pcs		
	GEV No.	550262	Ref. No. —
	flat gasket copper ED ø 20mm ID ø 14mm thickness 2mm		
	GEV No.	560110	Ref. No. —
	plain washer ID ø 3.2mm ED ø 7mm thickness 0.5mm SS Qty 20 pcs DIN 125A for thread M3		
	GEV No.	560130	Ref. No. —
	hexagonal nut thread M3 H 2.4mm WS 5.5 SS DIN/ISO DIN 934 / ISO 4032/8673 Qty 20 pcs		



heating elements for fryers

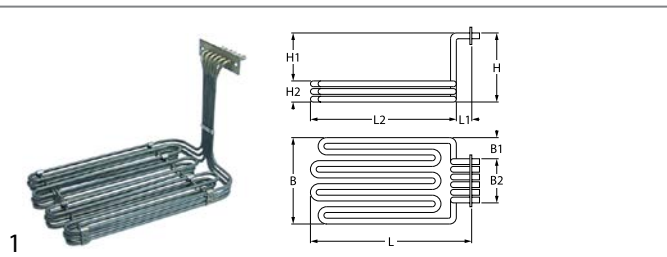

GEV No.	415090	Ref. No.	1-W-218 f.FQE-60-110,1-W-218
----------------	--------	-----------------	---------------------------------

description heating element 5500W 230/400V heating circuits 3 L 325mm W 200mm H 210mm L1 15mm L2 310mm W1 67mm W2 66mm H1 183mm H2 25mm windings 12 flange length 115mm flange width 30mm hole distance 95mm hole \varnothing 7mm connection M4 rectangular flange fryer heaters

accessories for 415090

	GEV No.	521103	Ref. No.	—
	nut thread M4 H 3mm WS 7 brass Qty 20 pcs			
	GEV No.	521104	Ref. No.	—
	washer ID \varnothing 4.3mm ED \varnothing 8mm thickness 0.5mm brass Qty 20 pcs for thread M4			
	GEV No.	560111	Ref. No.	—
	plain washer ID \varnothing 4.3mm ED \varnothing 9mm thickness 0.8mm SS Qty 20 pcs DIN 125A for thread M4			
	GEV No.	560131	Ref. No.	—
	hexagonal nut thread M4 H 3.2mm WS 7 SS DIN/ISO DIN 934 / ISO 4032/8673 Qty 20 pcs			

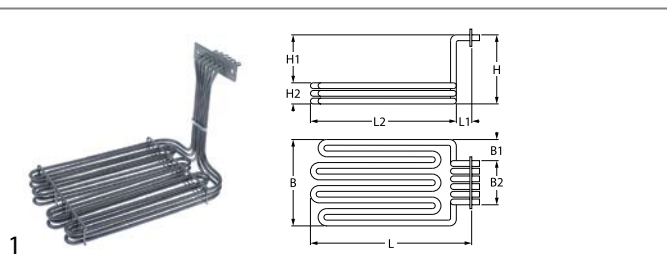

GEV No.	420289	Ref. No.	4-102
----------------	--------	-----------------	-------

description heating element 7500W 220V heating circuits 3 L 320mm W 196mm H 215mm L1 15mm L2 305mm W1 60mm W2 67mm H1 185mm H2 32mm windings 4 flange length 115mm flange width 30mm hole distance 95mm hole \varnothing 6.5mm connection screw tube \varnothing 6.2mm rectangular flange fryer

heating elements for griddles



GEV No.	415076	Ref. No.	373.007.0 1-W-237
----------------	--------	-----------------	-------------------

description heating element 1300W 230V heating circuits 1 L 490mm W 78mm H 70mm tube \varnothing 6.3mm W1 17mm W2 44mm connection M4 connection length 20mm dry heating element

accessories for 415076

	GEV No.	521103	Ref. No.	—
	nut thread M4 H 3mm WS 7 brass Qty 20 pcs			
	GEV No.	521104	Ref. No.	—
	washer ID \varnothing 4.3mm ED \varnothing 8mm thickness 0.5mm brass Qty 20 pcs for thread M4			
	GEV No.	560111	Ref. No.	—
	plain washer ID \varnothing 4.3mm ED \varnothing 9mm thickness 0.8mm SS Qty 20 pcs DIN 125A for thread M4			

accessories for 415076

	GEV No.	560131	Ref. No.	—
	hexagonal nut thread M4 H 3.2mm WS 7 SS DIN/ISO DIN 934 / ISO 4032/8673 Qty 20 pcs			

heating elements for large hobs



GEV No.	418707	Ref. No.	4-208
----------------	--------	-----------------	-------

description heating element 1500W 230V L 230mm W 265mm H 70mm tube \varnothing 6.5mm mounting pos. inner connection screw



GEV No.	418708	Ref. No.	4-207
----------------	--------	-----------------	-------

description heating element 1500W 230V L 255mm W 300mm H 70mm tube \varnothing 6.5mm mounting pos. centre connection screw

heating elements for tilting bratt pan



GEV No.	415076	Ref. No.	373.007.0 1-W-237
----------------	--------	-----------------	-------------------

description heating element 1300W 230V heating circuits 1 L 490mm W 78mm H 70mm tube \varnothing 6.3mm W1 17mm W2 44mm connection M4 connection length 20mm dry heating element

accessories for 415076

	GEV No.	521103	Ref. No.	—
	nut thread M4 H 3mm WS 7 brass Qty 20 pcs			
	GEV No.	521104	Ref. No.	—
	washer ID \varnothing 4.3mm ED \varnothing 8mm thickness 0.5mm brass Qty 20 pcs for thread M4			
	GEV No.	560111	Ref. No.	—
	plain washer ID \varnothing 4.3mm ED \varnothing 9mm thickness 0.8mm SS Qty 20 pcs DIN 125A for thread M4			
	GEV No.	560131	Ref. No.	—
	hexagonal nut thread M4 H 3.2mm WS 7 SS DIN/ISO DIN 934 / ISO 4032/8673 Qty 20 pcs			







GEV No.	415250	Ref. No.	4-FI-18
----------------	--------	-----------------	---------

description heating element grill 1650W 230V L 490mm W 42mm H 45mm connection M4 dry heating element heating circuits 1 tube \varnothing 8.5mm 2 hole fixing thread 1/4" mounting distance 37mm



			
1			
GEV No.	415077	Ref. No.	TYP 1-W-240
description	heating element stock pot 1300W 230V L 280mm W 150mm H 40mm connection male faston 6.3mm tilting bratt pan heating circuits 1 tube ø 8.5mm bracket mounting hole distance 142mm hole ø 5mm lug length 25mm lug width 15mm		

heating elements for chargrills

			
1			
GEV No.	415095	Ref. No.	1-W-236
description	heating element 1500W 220V L 465mm W 75mm H 55mm 2 hole fixing thread 1/4" mounting distance 70mm connection M4 L1 25mm L2 440mm tube ø 6.3mm dry heating element heating circuits 1		
accessories for	415095		
	GEV No.	521103	Ref. No. —
	nut thread M4 H 3mm WS 7 brass Qty 20 pcs		
	GEV No.	521104	Ref. No. —
	washer ID ø 4.3mm ED ø 8mm thickness 0.5mm brass Qty 20 pcs for thread M4		
	GEV No.	560111	Ref. No. —
	plain washer ID ø 4.3mm ED ø 9mm thickness 0.8mm SS Qty 20 pcs DIN 125A for thread M4		
	GEV No.	560131	Ref. No. —
	hexagonal nut thread M4 H 3.2mm WS 7 SS DIN/ISO DIN 934 / ISO 4032/8673 Qty 20 pcs		

			
1			
GEV No.	415250	Ref. No.	4-FI-18
description	heating element grill 1650W 230V L 490mm W 42mm H 45mm connection M4 dry heating element heating circuits 1 tube ø 8.5mm 2 hole fixing thread 1/4" mounting distance 37mm		

heating elements for salamanders/toast-

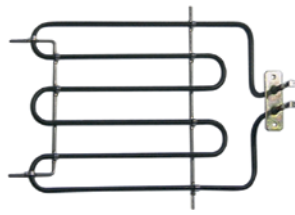
			
1			
GEV No.	415347	Ref. No.	HS 60 E, 15-B-001
description	heating element 1600W 230V heating circuits 1 L 295mm W 205mm H 45mm flange length 70mm flange width 22mm hole distance 56mm connection male faston 6.3mm tube ø 6.3mm mounting thread M5 rectangular flange dry heating element		

			
1			
GEV No.	415141	Ref. No.	SME-63
description	heating element 2900W 230V heating circuits 1 L 425mm W 165mm L1 25mm L2 50mm L3 350mm W1 52mm W2 60mm flange length 100mm flange width 22mm hole distance 88mm tube ø 8.5mm connection length 17mm dry heating element rectangular flange hole ø 5mm H 8.5mm		

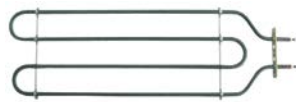
			
1			
GEV No.	415142	Ref. No.	370.423.0 SME70
description	heating element 3500W 230V heating circuits 1 L 525mm W 167mm L1 15mm L2 50mm L3 460mm W1 63mm W2 50mm flange length 100mm flange width 22mm hole distance 31mm tube ø 9mm connection length 54mm dry heating element connection male faston 6.3mm rectangular flange hole ø 10mm H 9mm		

heating elements for convection

			
1			
GEV No.	417586	Ref. No.	3-55
description	heating element 3200W 230V heating circuits 1 ID ø 178mm ED ø 192mm L 260mm H 34mm L1 64mm W1 30mm H1 10mm H2 24mm flange length 70mm flange width 22mm hole distance 56mm connection M4 connection length 34mm tube ø 6.25mm convection heating element mounting thread M4		

			
1			
GEV No.	418019	Ref. No.	14-N-124
description	heating element 3900W 230V heating circuits 3 ID ø 206mm ED ø 218mm L 275mm H 40mm L1 48mm W1 104mm H1 10mm H2 24mm flange length 142mm flange width 25mm hole distance 62.5mm connection M4 connection length 62mm tube ø 6mm convection heating element hole ø 6.5mm rectangular flange		



radiation heaters

square



1

GEV No.	490202	Ref. No.	3-09A
description	radiation heater L 300mm W 300mm 4000W 400V H 40mm connection type screw with pan detection		

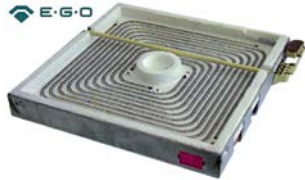

1

GEV No.	490008	Ref. No.	3-09
description	radiation heater L 300mm W 300mm 4000W 400V heating circuits 2 connections 3 square connection type male faston 6.3mm without pan detection EGO		
spare parts for	490008		
	GEV No.	499157	Ref. No.
			—
	protection pipe for temperature probe ceramic L 297mm ED ø 7mm ID ø 5mm		

accessories

sealing washers

O-rings

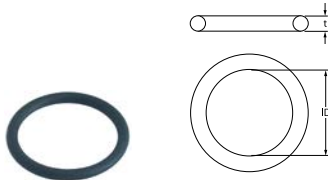

1

GEV No.	505092	Ref. No.	04-3090
description	O-ring EPDM thickness 5.34mm ID ø 43.82mm Qty 1 pcs		

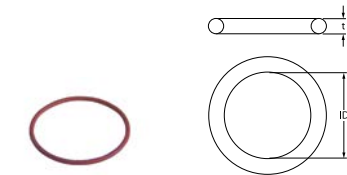

1

GEV No.	521116	Ref. No.	05-0790
description	O-ring Viton thickness 3.53mm ID ø 78.97mm Qty 1 pcs		

hot plates

square & rectangular

with radiused edge



1

GEV No.	490068 ¹	Ref. No.	3-06
description	hot plate dimensions 220x220mm 2600W 400V with spill ring connection 4 screw clamps protector yes square		

¹incl. protector

1

GEV No.	490074 ¹	Ref. No.	05-0600
description	hot plate dimensions 300x300mm 4000W 400V with spill ring connection 4 screw clamps protector yes square		

¹incl. protector

round

with radiused edge

for domestic and commercial kitchens



1

GEV No.	490016	Ref. No.	3-02
description	hot plate ø 180mm 2000W 230V connection 4 screw clamps with 8mm spill ring		



1

GEV No.	490021	Ref. No.	3-03A
description	hot plate ø 220mm 2600W 400V connection 4 screw clamps with 8mm spill ring		



thermostats

control and safety thermostats

EGO

control thermostats

55.10/19_ series



GEV No. 375363 **Ref. No.** 4-FI-004

description thermostat t.max. 161°C temperature range 73-161°C 1-pole 1NO 16A probe ø 3mm probe L 144mm capillary pipe 1600mm capillary pipe isolated 1600mm gland nut shaft ø 6x4.6mm shaft L 23mm shaft position upper rotation 270°

55.13_ series



GEV No. 375401 **Ref. No.** 230054
4-117

description thermostat t.max. 185°C temperature range 97-185°C 1-pole 1NO 16A probe ø 6mm probe L 87mm capillary pipe 1430mm capillary pipe isolated 1100mm gland nut M9x1 shaft ø 6x4.6mm shaft L 23mm shaft position upper rotation 270°



GEV No. 375505 **Ref. No.** 15-BA-18
3-36

description thermostat t.max. 320°C temperature range 50-320°C 1-pole 1NO 16A probe ø 3mm probe L 160mm capillary pipe 870mm capillary pipe isolatedmm gland nut shaft ø 6x4.6mm shaft L 23mm shaft position upper rotation 270°



GEV No. 375005 **Ref. No.** 10-44

description thermostat t.max. 85°C temperature range 30-85°C 1-pole 1NO 16A probe ø 6mm probe L 92mm capillary pipe 830mm capillary pipe isolatedmm gland nut shaft L 23mm shaft position upper rotation 270° probe material SS

accessories for 375005



GEV No. 110109 **Ref. No.** —
knob thermostat t.max. 85°C ø 60mm shaft ø 6x4.6mm shaft flat upper silver temperature range 30-85°C rotation 270°



GEV No. 110133 **Ref. No.** —
knob thermostat t.max. 85°C ø 50mm shaft ø 6x4.6mm shaft flat upper black temperature range 30-85°C rotation 270°



GEV No. 110240 **Ref. No.** —
knob thermostat t.max. 85°C ø 50mm shaft ø 6x4.6mm shaft flat upper black temperature range 30-85°C

55.34_ series



GEV No. 375410 **Ref. No.** 1-W-228
4-103

description thermostat t.max. 180°C temperature range 95-180°C 3-pole 3NO 16A probe ø 6mm probe L 133mm capillary pipe 1780mm capillary pipe isolated 1400mm gland nut M10x1 shaft ø 6x4.6mm shaft L 23mm shaft position upper rotation 270°

55.40_ series



GEV No. 375096 **Ref. No.** 4-116

description thermostat t.max. 450°C temperature range 100-450°C 4-pole 4NO 16A probe ø 3.9mm probe L 163mm capillary pipe 1180mm capillary pipe isolated 850mm gland nut shaft ø 6x4.6mm shaft L 23mm shaft position upper rotation 270°

→ electric components



safety thermostats

55.12_ series



GEV No.	375998	Ref. No.	10-45 230418
----------------	--------	-----------------	-----------------

description safety thermostat switch-off temp. 110°C 1-pole NC 10A probe ø 6mm probe L 95mm capillary pipe 880mm capillary pipe isolated 830mm gland nut probe screw connection M10x0.75 connection male faston 6.3mm

control thermostats with operation switch

55.34_ series

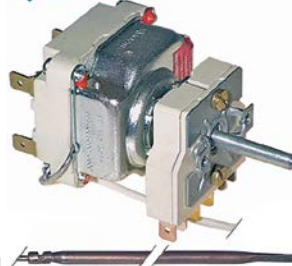

GEV No.	375246	Ref. No.	3-22
----------------	--------	-----------------	------

description thermostat t.max. 645°C temperature range 100-615/645°C 2-pole 2NO 16A probe ø 4mm probe L 230mm capillary pipe 1100mm capillary pipe isolated 600mm gland nut shaft ø 6x4.6mm shaft L 25mm shaft position lower rotation 270° outer switch 2NO probe material copper

55.31_ series



GEV No.	375104	Ref. No.	1-W-213 230057 4-104
----------------	--------	-----------------	----------------------------

description safety thermostat switch-off temp. 230°C 3-pole 20A probe ø 6mm probe L 167mm capillary pipe 830mm capillary pipe isolated 600mm gland nut M10x1 probe

accessories

connecting bows



GEV No.	550059	Ref. No.	3-47
----------------	--------	-----------------	------

description connecting bow short for switch Qty 1 pcs

switches and momentary switches

push/momentary push switches

30x22mm



GEV No.	301040 ¹	Ref. No.	10-2369
----------------	---------------------	-----------------	---------

description push switch mounting measurements 30x22mm green 2NO 250V 16A illuminated connection male faston 6.3mm ambient temperature max. 85°C protection IP40

¹illuminated

microswitches

lever actuated



GEV No.	345044	Ref. No.	4-FI-063
----------------	--------	-----------------	----------

description microswitch with lever 250V 16A 1CO connection male faston 6.3mm ambient temperature max. 85°C mounting distance 25mm type C99ZP3 actuating force: 25g lever length 71mm

56_ series



GEV No.	390809	Ref. No.	10-45old
----------------	--------	-----------------	----------

description safety thermostat switch-off temp. 110°C 1-pole 1NC probe ø 6mm probe L 78mm capillary pipe 900mm capillary pipe isolated 800mm gland nut front fixing M10x1



cam switches

operation switches

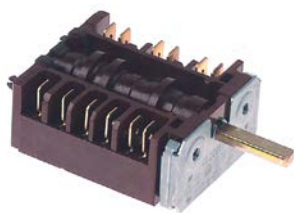

1			
GEV No.	301128	Ref. No.	3-35
description	operation switch 16A shaft ϕ 6x4.6mm		



1			
GEV No.	345321	Ref. No.	15-CB-86
description	operation switch 4 operating positions 5NO 16A sequence 0-1-2-3 shaft ϕ 6x4.6mm shaft L 23mm connection male faston 6.3mm plastic 3-pole ambient temperature max. 300°C		

magnetic switches

29x19mm

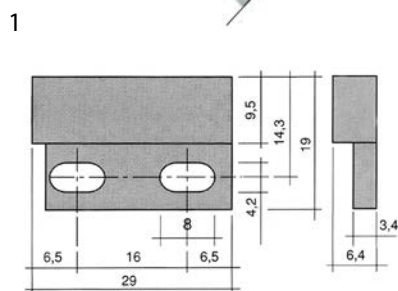

1			
GEV No.	345117	Ref. No.	F.400-G, 606
description	magnetic switch L 28.5mm W 19mm 1NO 250V 0.04A P max. 10W connection cable cable length 1000mm		

lamps

indicator lights

indicator lights (complete)

ϕ 6mm



1			
GEV No.	359284	Ref. No.	14-N-024
description	indicator light ϕ 6mm 24V green cable length 150mm		

22x10mm



1			
GEV No.	357081	Ref. No.	3-24
description	indicator light mounting measurements 22x10mm 230V yellow connection cable 250mm temp.-resist. 120°C		

timers

programme timers



1			
GEV No.	360349	Ref. No.	10-238053
description	timer CDC 11803 engines 1 chambers 3 operation time 150s 230V shaft ϕ mm shaft Lmm manuf. no. 11803F1BEE000.0010 motor type M48R ATS type 11803F1 / 238046		

spare parts for	360349		
	GEV No.	Ref. No.	—
	motor kit pinion ϕ 6.8mm teeth 15 230V voltage AC 50/60Hz turn direction clockwise motor ϕ 48mm H 18.5mm motor type UDS-40NE1RNZ165 cable length 150mm with holder		



1			
GEV No.	360515	Ref. No.	10-18A
description	timer CEM HFD4M16 engines 1 chambers 4 operation time 120s shaft ϕ 6x4.6mm shaft L 18mm motor type UDS11NE1RHZ235		



contactors

ABB

power contactors



1

GEV No.	380101	Ref. No.	14-N-057
description	power contactor resistive load 20A 230VAC (AC3/400V) 12A/5.5kW main contacts 3NO auxiliary contacts 1NC connection screw connection type B6-30-01 / B7-30-01		



1

GEV No.	380109	Ref. No.	ABB-02
description	power contactor resistive load 30A 230VAC (AC3/400V) 17A/7.5kW main contacts 3NO auxiliary contacts 1NC connection screw connection type A16-30-01		

electronic controllers

ELIWELL

universal controllers

built-in version



1

GEV No.	379605	Ref. No.	IC-N035A
description	electronic controller ELIWELL type ICPlus915 model ICP22J135000 mounting measurements 71x29mm 12V voltage AC/DC Pt100/TC (J,K) relay outputs 2 NO-8A(4) NO-8A(4) Pt100/TC (J,K) cooking front measurements 78x37mm built-in depth 59mm mode of operation cooking protection IPx0 accuracy 1% built-in version defr. funct. no dependend on probe°C display 3½ digits		
accessories for	379605		
	GEV No.	Ref. No.	—
	379050		
	temperature probe Pt100 cable Vetrotex probe -200 up to +600°C cable -50 up to +350°C probe ø6x100mm cable length 2.7m without screw connection 3-wire		
	GEV No.	Ref. No.	—
	379054		
	transformer primary 230VAC secondary 12VAC 3VA secondary 0.25A H 40mm L 45mm W 50mm connection screw 50/60Hz type 153/M		

accessories for	379605		
	GEV No.	Ref. No.	—
	379785		
	temperature probe Pt100 cable silicone probe -100 up to 450°C cable -50 up to +180°C probe ø6x100mm cable length 1.5m without screw connection 2-wire resistor 0.1kOhm		
	GEV No.	Ref. No.	—
	379786		
	temperature probe Pt100 cable silicone probe -100 up to 450°C cable -50 up to +180°C probe ø6x100mm cable length 3m without screw connection 2-wire resistor 0.1kOhm		
	GEV No.	Ref. No.	—
	379787		
	temperature probe Pt100 cable Vetrotex probe -200 up to +600°C cable -50 up to +350°C probe ø6x100mm cable length 1.4m without screw connection 2-wire resistor 0.1kOhm		

solenoid valves

solenoid valves (water)

TP



1

GEV No.	370029	Ref. No.	14-76
description	solenoid valve single straight 24VAC inlet 3/4" outlet 11.5mm DN10 TP flow regulating valve inlet white		
spare parts for	370029		
	GEV No.	Ref. No.	—
	371035		
	solenoid coil 24VAC		
accessories for	370029		
	GEV No.	Ref. No.	—
	371220		
	reducer TP flow rate 3l/min red tolerance ±15%		
	GEV No.	Ref. No.	—
	371221		
	reducer TP flow rate 5.5l/min yellow tolerance ±15%		
	GEV No.	Ref. No.	—
	371222		
	reducer TP flow rate 6l/min grey tolerance ±15%		
	GEV No.	Ref. No.	—
	371223		
	reducer TP flow rate 10l/min white tolerance ±15%		
	GEV No.	Ref. No.	—
	371224		
	reducer TP flow rate 12l/min bronze tolerance ±15%		
	GEV No.	Ref. No.	—
	371225		
	reducer TP flow rate 16l/min light brown tolerance ±15%		
	GEV No.	Ref. No.	—
	371226		
	reducer TP flow rate 20l/min red tolerance ±15%		
	GEV No.	Ref. No.	—
	371230		
	reducer TP flow rate 0.25l/min red tolerance ±25%		
	GEV No.	Ref. No.	—
	371231		
	reducer TP flow rate 0.35l/min violet tolerance ±25%		

Table continues overleaf



accessories for		370029		
GEV No.	Ref. No.	Ref. No.	Ref. No.	—
	371232	Ref. No.	Ref. No.	—
reducer TP flow rate 0.5l/min orange tolerance ±25%				
	371233	Ref. No.	Ref. No.	—
reducer TP flow rate 0.8l/min white tolerance ±25%				
	371234	Ref. No.	Ref. No.	—
reducer TP flow rate 1l/min light blue tolerance ±25%				
	371235	Ref. No.	Ref. No.	—
reducer TP flow rate 1.2l/min brown tolerance ±25%				
	371236	Ref. No.	Ref. No.	—
reducer TP flow rate 1.5l/min light brown tolerance ±25%				
	371237	Ref. No.	Ref. No.	—
reducer TP flow rate 2.5l/min yellow tolerance ±25%				
	371238	Ref. No.	Ref. No.	—
reducer TP flow rate 3.4l/min dark green tolerance ±25%				
	371239	Ref. No.	Ref. No.	—
reducer TP flow rate 5l/min black tolerance ±25%				
	371240	Ref. No.	Ref. No.	—
reducer TP flow rate 8l/min blue tolerance ±20%				

accessories for		101095		
GEV No.	Ref. No.	Ref. No.	Ref. No.	—
	100909	Ref. No.	Ref. No.	—
union screw thread M10x1 for pipe ø 6mm Qty 1 pcs				
	101246	Ref. No.	Ref. No.	—
olive for pipe ø 4mm Qty 1 pcs				
	101278	Ref. No.	Ref. No.	—
olive for pipe ø 10mm Qty 1 pcs				
	101286	Ref. No.	Ref. No.	—
olive ID ø 6mm Qty 1 pcs				
	101300	Ref. No.	Ref. No.	—
union nut thread M16x1.5 tube ø 10mm				
	101450	Ref. No.	Ref. No.	—
olive for pipe ø 8mm L 12.7mm Qty 1 pcs ED ø 10mm				
	101451	Ref. No.	Ref. No.	—
union nut thread M16x1.5 tube ø 8mm				
	110081	Ref. No.	Ref. No.	—
knob ø 70mm shaft ø 8x6.5mm shaft flat universal				
	112206	Ref. No.	Ref. No.	—
knob dial plate silver gas tap PEL21/22/23 t.max.°C ED ø 63mm ID ø 45.5mm				

gas taps

PEL

21S series

	1		
GEV No.	101095	Ref. No.	3-203
description	gas tap PEL type 21S gas inlet M16x1.5 (tube ø 10mm) bypass nozzle ø 0.35mm gas outlet M16x1.5 (tube ø 10/8mm) thermocouple connection M8x1 pilot connection M10x1 shaft ø 8x6.5mm shaft L 22/15mm shaft flat lower		
spare parts for	101095		
	GEV No.	100408	Ref. No.
bypass nozzle type PEL20/21 bore ø 0.35mm thread M5x0.5			
	GEV No.	101060	Ref. No.
magnet unit standard L 39mm D1 ø 15.4mm D2 ø 11mm suitable for PEL20-21/JUNKERS/EGA			
	GEV No.	101206	Ref. No.
gas tap front part shaft ø 8x6.5mm shaft L 22/15mm shaft flat upper/lower suitable for PEL21			
	GEV No.	101230	Ref. No.
thermocouple nut T1: M8x1 T2: M18x1 aluminium			
accessories for	101095		
	GEV No.	100908	Ref. No.
union screw thread M10x1 for pipe ø 4mm Qty 1 pcs			

	1		
GEV No.	106298	Ref. No.	06-101 A240067
description	gas tap PEL type 21S gas inlet M16x1.5 (tube ø 10mm) bypass nozzle ø 0.65mm gas outlet M16x1.5 (tube ø 10/8mm) thermocouple connection M8x1 pilot connection M10x1 shaft ø 8x6.5mm shaft L 22/15mm shaft flat lower		
spare parts for	106298		
	GEV No.	100548	Ref. No.
bypass nozzle type PEL20/21 bore ø 0.65mm thread M5x0.5			
	GEV No.	101060	Ref. No.
magnet unit standard L 39mm D1 ø 15.4mm D2 ø 11mm suitable for PEL20-21/JUNKERS/EGA			
	GEV No.	101206	Ref. No.
gas tap front part shaft ø 8x6.5mm shaft L 22/15mm shaft flat upper/lower suitable for PEL21			
	GEV No.	101230	Ref. No.
thermocouple nut T1: M8x1 T2: M18x1 aluminium			
accessories for	106298		
	GEV No.	100908	Ref. No.
union screw thread M10x1 for pipe ø 4mm Qty 1 pcs			
	GEV No.	100909	Ref. No.
union screw thread M10x1 for pipe ø 6mm Qty 1 pcs			





Table continues overleaf

accessories for		106298	
	GEV No.	101246	Ref. No. —
olive for pipe ø 4mm Qty 1 pcs			
	GEV No.	101278	Ref. No. —
olive for pipe ø 10mm Qty 1 pcs			
	GEV No.	101286	Ref. No. —
olive ID ø 6mm Qty 1 pcs			
	GEV No.	101300	Ref. No. —
union nut thread M16x1.5 tube ø 10mm			
	GEV No.	101450	Ref. No. —
olive for pipe ø 8mm L 12.7mm Qty 1 pcs ED ø 10mm			
	GEV No.	101451	Ref. No. —
union nut thread M16x1.5 tube ø 8mm			
	GEV No.	110081	Ref. No. —
knob ø 70mm shaft ø 6x6.5mm shaft flat universal			
	GEV No.	112206	Ref. No. —
knob dial plate silver gas tap PEL21/22/23 t.max.°C ED ø 63mm ID ø 45.5mm			

22S/V series

			
1			
GEV No.	106888	Ref. No.	06-102
description	gas tap PEL type 22S/V gas inlet M20x1.5 (tube ø 12mm) bypass nozzle ø 0.8mm gas outlet M20x1.5 (tube ø 12/10mm) thermocouple connection M8x1 pilot connection M10x1 shaft ø 10x8mm shaft L 25/17mm shaft flat right		

SKG







			
1			
GEV No.	101154	Ref. No.	650/750 132
description	gas tap SKG without ignition flame connection		
spare parts for	101154		
	GEV No.	101060	Ref. No. —
magnet unit standard L 39mm D1 ø 15.4mm D2 ø 11mm suitable for PEL20-21/JUNKERS/EGA			
accessories for	101154		
	GEV No.	101060	Ref. No. —
magnet unit standard L 39mm D1 ø 15.4mm D2 ø 11mm suitable for PEL20-21/JUNKERS/EGA			
	GEV No.	101351	Ref. No. —
mounting strap for gas tap			

accessories for		101154	
	GEV No.	101376	Ref. No. —
gasket ID ø 8mm ED ø 12mm H 3/5mm			

gas thermostats







SIT

630 Eurosit series

			
1			
GEV No.	101409	Ref. No.	4-FI-009
description	gas thermostat type 630 Eurosit series t.max. 280°C 40-280°C gas inlet 3/8" gas outlet 3/8" thermocouple connection M9x1 pilot connection M10x1 probe ø 4mm probe L 72mm capillary pipe 1050mm SIT		
spare parts for	101409		
	GEV No.	101333	Ref. No. —
plug thread 3/8" with O-ring			
accessories for	101409		
	GEV No.	100904	Ref. No. —
locking screw M10x1 for pipe ø 4mm Qty 1 pcs			
	GEV No.	100905	Ref. No. —
locking screw M10x1 for pipe ø 6mm Qty 1 pcs			
	GEV No.	101273	Ref. No. —
olive for pipe ø 12mm L 9.5mm brass Qty 1 pcs suitable for universal			
	GEV No.	101276	Ref. No. —
union screw thread 3/8" tube ø 12mm Qty 1 pcs			



710 Minisit series			
			
GEV No.	101437	Ref. No.	1-W-042 1-W-42
description	gas thermostat SIT type MINISIT 710 t.max. 190°C 110-190°C gas inlet 1/2" gas outlet 3/8" thermocouple connection M9x1 pilot connection M10x1 probe ø 6mm probe L 102mm capillary pipe 1050mm probe type type A3 pressure controller yes pressure regulator 3-18mbar gland nut		
spare parts for	101437		
	GEV No.	101053	Ref. No. —
	magnet unit T1: M9x1 T2: M24x1 L 45mm ø 17mm suitable for Minisit		
	GEV No.	102118	Ref. No. —
	probe 110-190°C probe ø 6mm probe L 102mm capillary pipe 1050mm t.max. 190°C fryer probe type type A3 suitable for MINISIT 710		
accessories for	101437		
	GEV No.	100809	Ref. No. —
	O-ring EPDM thickness 2mm ID ø 21mm Qty 1 pcs		
	GEV No.	100820	Ref. No. —
	gland duct ET M14x1.5 IT M10x0.75 probe ø max. 6.5mm WS 22		
	GEV No.	100904	Ref. No. —
	locking screw M10x1 for pipe ø 4mm Qty 1 pcs		
	GEV No.	100905	Ref. No. —
	locking screw M10x1 for pipe ø 6mm Qty 1 pcs		
	GEV No.	101054	Ref. No. —
	magnet unit T1: M10x1 T2: M24x1 L 45mm ø 17mm suitable for Minisit		
	GEV No.	101136	Ref. No. —
	piezoelectric igniter suitable for Minisit with cover cap ømm connection F6.3x0.8		
	GEV No.	101137	Ref. No. —
	cover cap without piezoelectric igniter		
	GEV No.	101267	Ref. No. —
	reducer IT 3/8" ET 1/2" L 21mm		
	GEV No.	101268	Ref. No. —
	gas connection thread 3/8" angled with O-ring MINISIT 710		
	GEV No.	101269	Ref. No. —
	gas connection thread 1/2" angled with O-ring MINISIT 710		
	GEV No.	101270	Ref. No. —
	screw connection IT 3/8" ET 3/8" L 28mm		

accessories for 101437			
	GEV No.	101272	Ref. No. —
	screw connection IT 1/2" ET 3/8" L 57mm		
	GEV No.	101273	Ref. No. —
	olive for pipe ø 12mm L 9.5mm brass Qty 1 pcs suitable for universal		
	GEV No.	101274	Ref. No. —
	olive for pipe ø 16mm Qty 1 pcs		
	GEV No.	101275	Ref. No. —
	union screw thread 1/2" for pipe ø 16mm Qty 1 pcs		
	GEV No.	101276	Ref. No. —
	union screw thread 3/8" tube ø 12mm Qty 1 pcs		
	GEV No.	110068	Ref. No. —
	knob suitable for Minisit ø 37mm		



			
GEV No.	101432	Ref. No.	1-W-048
description	gas thermostat with push button SIT type MINISIT 710 t.max. 90°C 30-90°C gas inlet 1/2" gas outlet 1/2" thermocouple connection M9x1 pilot connection M10x1 probe ø 8mm probe L 100mm capillary pipe 1050mm probe type type E2 pressure controller yes pressure regulator 3-18mbar gland nut		
For models:	BMG40, BMG60		
spare parts for	101432		
	GEV No.	100809	Ref. No. —
	O-ring EPDM thickness 2mm ID ø 21mm Qty 1 pcs		
	GEV No.	100905	Ref. No. —
	locking screw M10x1 for pipe ø 6mm Qty 1 pcs		
	GEV No.	101053	Ref. No. —
	magnet unit T1: M9x1 T2: M24x1 L 45mm ø 17mm suitable for Minisit		
	GEV No.	101269	Ref. No. —
	gas connection thread 1/2" angled with O-ring MINISIT 710		
	GEV No.	102117	Ref. No. —
	probe 30-90°C probe ø 8mm probe L 100mm capillary pipe 1050mm t.max. 90°C bain marie probe type type E2 suitable for MINISIT 710		
	GEV No.	110068	Ref. No. —
	knob suitable for Minisit ø 37mm		
accessories for	101432		
	GEV No.	100904	Ref. No. —
	locking screw M10x1 for pipe ø 4mm Qty 1 pcs		

Table continues overleaf

accessories for		101432	
	GEV No.	101054	Ref. No. —
magnet unit T1: M10x1 T2: M24x1 L 45mm ø 17mm suitable for Minisit			
	GEV No.	101136	Ref. No. —
piezoelectric igniter suitable for Minisit with cover cap ømm connection F6.3x0.8			
	GEV No.	101137	Ref. No. —
cover cap without piezoelectric igniter			
	GEV No.	101267	Ref. No. —
reducer IT 3/8" ET 1/2" L 21mm			
	GEV No.	101268	Ref. No. —
gas connection thread 3/8" angled with O-ring MINISIT 710			
	GEV No.	101270	Ref. No. —
screw connection IT 3/8" ET 3/8" L 28mm			
	GEV No.	101272	Ref. No. —
screw connection IT 1/2" ET 3/8" L 57mm			
	GEV No.	101273	Ref. No. —
olive for pipe ø 12mm L 9.5mm brass Qty 1 pcs suitable for universal			
	GEV No.	101274	Ref. No. —
olive for pipe ø 16mm Qty 1 pcs			
	GEV No.	101275	Ref. No. —
union screw thread 1/2" for pipe ø 16mm Qty 1 pcs			
	GEV No.	101276	Ref. No. —
union screw thread 3/8" tube ø 12mm Qty 1 pcs			

ignition parts

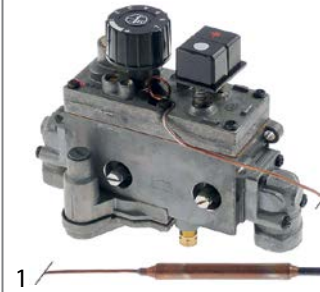
pilot burners

SIT

100 series

accessories

pilot burner brackets

producer-specific



1

GEV No.	100890	Ref. No.	1314915 Mareno
description	pilot burner bracket suitable for 100 series		

pilot burner nozzles



1

GEV No.	100245	Ref. No.	3-314 A230126
description	pilot burner nozzle LPG code 20 bore ø 0.2mm Qty 1 pcs thread M8x0.75		

PRO-GAS

140 - 145 -150 series

pilot burners



1

GEV No.	100859	Ref. No.	1-W-623
description	pilot burner type 140 series 1 flame		
spare parts for	100859		
	GEV No.	100205	Ref. No. —
pilot burner nozzle SIT LPG code 19 bore ø 0.23/0.26mm Qty 1 pcs suitable for SIT 150 series			
	GEV No.	100206	Ref. No. —
pilot burner nozzle SIT natural gas code 36 bore ø 0.60/0.55mm Qty 1 pcs suitable for SIT 150 series			
	GEV No.	100897	Ref. No. —
olive for pipe ø 4mm Qty 1 pcs for pilot burner			
	GEV No.	100898	Ref. No. —
olive for pipe ø 6mm Qty 1 pcs for pilot burner			
	GEV No.	100906	Ref. No. —
screw connection thread M10x1 for ignition electrode brass Qty 1 pcs WS 10			
	GEV No.	100907	Ref. No. —
screw connection thread M10x1 Qty 1 pcs type SEF 1 ømm for thermocouple			
	GEV No.	100908	Ref. No. —
union screw thread M10x1 for pipe ø 4mm Qty 1 pcs			
	GEV No.	100909	Ref. No. —
union screw thread M10x1 for pipe ø 6mm Qty 1 pcs			



producer-specific pilot burners

EKU

pilot burners



GEV No.	100082	Ref. No.	N/A
description	pilot burner		
accessories for	100078		
	GEV No. 100202	Ref. No.	—
pilot burner nozzle natural gas code 41 Qty 1 pcs nozzle ø 0.41mm			
	GEV No. 100203	Ref. No.	—
pilot burner nozzle LPG code 25 Qty 1 pcs nozzle ø 0.25mm			
	GEV No. 100834	Ref. No.	3-230 A240110
pilot burner cap			
	GEV No. 100908	Ref. No.	—
union screw thread M10x1 for pipe ø 4mm Qty 1 pcs			
	GEV No. 100909	Ref. No.	—
union screw thread M10x1 for pipe ø 6mm Qty 1 pcs			
	GEV No. 101282	Ref. No.	—
olive for pipe ø 4mm L 7.4mm Qty 1 pcs			
	GEV No. 101287	Ref. No.	—
olive for pipe ø 6mm Qty 1 pcs			
	GEV No. 101860	Ref. No.	—
nut thread M10x1 H 4mm WS 14 chrome-plated brass Qty 1 pcs			
	GEV No. 107650	Ref. No.	06-123 A230131-10
pilot burner nozzle SIT LPG code 30 Qty 1 pcs			



GEV No.	100078	Ref. No.	06-122
description	pilot burner for wok range		
accessories for	100078		
	GEV No. 100202	Ref. No.	—
pilot burner nozzle natural gas code 41 Qty 1 pcs nozzle ø 0.41mm			

accessories for	100078		
	GEV No. 100203	Ref. No.	—
pilot burner nozzle LPG code 25 Qty 1 pcs nozzle ø 0.25mm			
	GEV No. 100908	Ref. No.	—
union screw thread M10x1 for pipe ø 4mm Qty 1 pcs			
	GEV No. 100909	Ref. No.	—
union screw thread M10x1 for pipe ø 6mm Qty 1 pcs			
	GEV No. 101282	Ref. No.	—
olive for pipe ø 4mm L 7.4mm Qty 1 pcs			
	GEV No. 101287	Ref. No.	—
olive for pipe ø 6mm Qty 1 pcs			
	GEV No. 102067	Ref. No.	—
nut thread M8x1 H 3mm brass Qty 1 pcs type SEF 1			
	GEV No. 107650	Ref. No.	06-123 A230131-10
pilot burner nozzle SIT LPG code 30 Qty 1 pcs			



GEV No.	102979	Ref. No.	1-W-651 3-229 A240107
description	pilot burner suitable for MARENO		
accessories for	102979		
	GEV No. 101860	Ref. No.	—
nut thread M10x1 H 4mm WS 14 chrome-plated brass Qty 1 pcs			
	GEV No. 102980	Ref. No.	—
pilot burner mushroom cap with mounting thread			

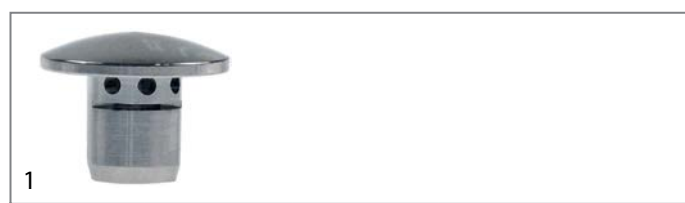

GEV No.	100834	Ref. No.	3-230 A240110
description	pilot burner cap		



electrodes

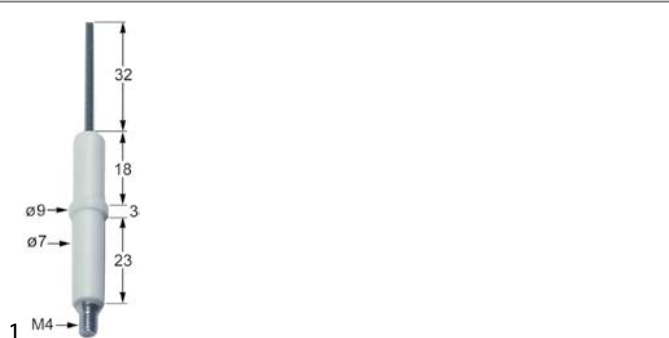

GEV No.	100701	Ref. No.	1-W-626
description	ignition electrode connection M4 Qty 1 pcs		
accessories for	100701		
	GEV No.	100906	Ref. No. —
	screw connection thread M10x1 for ignition electrode brass Qty 1 pcs WS 10		



GEV No.	100729	Ref. No.	1-W-396
description	ignition electrode L1 5mm D1 ø 8mm D2 ø 10mm BL1 41mm BL2 14mm connection F 2.8x0.8mm to clip with spring		

thermocouples

plug-in thermocouples

plug-in thermocouples standard

with barrel socket ø6(6.5)mm

thermocouples SIT

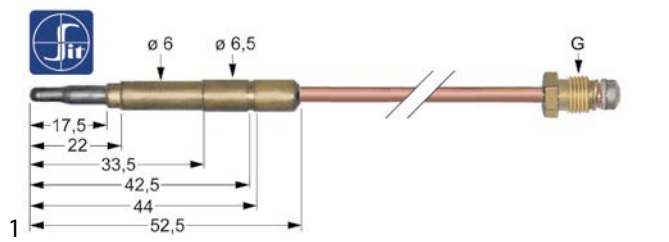

GEV No.	107600	Ref. No.	3-205
description	thermocouple SIT M8x1 L 320mm plug connection ø6.0(6.5)mm		
For models:	60GE4, 60GST4		

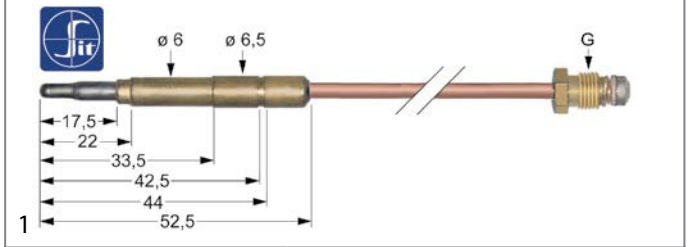

GEV No.	107601	Ref. No.	3-206 A230121
description	thermocouple SIT M8x1 L 600mm plug connection ø6.0(6.5)mm		

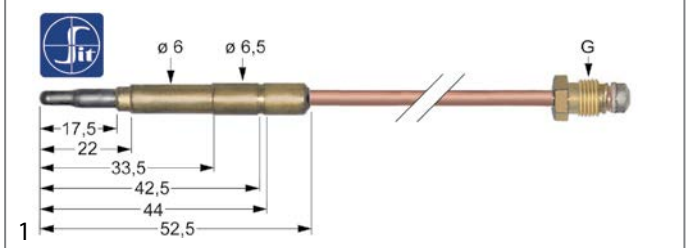

GEV No.	107612	Ref. No.	05-1250
description	thermocouple SIT M9x1 L 1000mm plug connection ø6.0(6.5)mm		

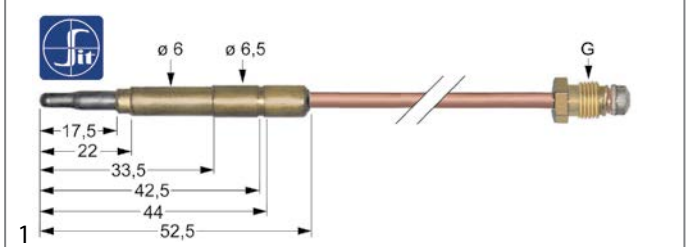

GEV No.	107611	Ref. No.	1-W-631
description	thermocouple SIT M9x1 L 850mm plug connection ø6.0(6.5)mm		

gas burners

hob burners

universal hob burners

GEV

	GEV No.	106379	Ref. No.	N/A
description	air mixing tube for burner cap ø 80mm L 23mm D1 ø 20mm D2 ø 15.6mm D3 ø 14mm			









	GEV No.	103068	Ref. No.	1-W-059
description	burner cap ø 100mm			
accessories for	103068			
	GEV No.	103067	Ref. No.	1-W-068
	burner ring for burner cap ø 100mm			
	GEV No.	104102	Ref. No.	1-W-066
	burner head for burner cap ø 100mm ext. ø 130			





Table continues overleaf







accessories for	103068		
	GEV No.	104103	Ref. No. —
	burner holder suitable for burner ø100mm with nozzle holder		





accessories for	104101		
	GEV No.	104100	Ref. No. 1-W-065
	burner head for burner cap ø 80mm		





1			
GEV No.	103066	Ref. No.	1-W-057
description	burner cap ø 80mm		
accessories for	103066		
	GEV No.	103065	Ref. No. 1-W-067
	burner ring for burner cap ø 80mm		
	GEV No.	104100	Ref. No. 1-W-065
	burner head for burner cap ø 80mm		
	GEV No.	104101	Ref. No. 1-W-064
	burner holder for burner cap ø 80mm with nozzle holder with mixing sleeve		

1			
GEV No.	103067	Ref. No.	1-W-068
description	burner ring for burner cap ø 100mm		
accessories for	103067		
	GEV No.	103068	Ref. No. 1-W-059
	burner cap ø 100mm		
	GEV No.	104102	Ref. No. 1-W-066
	burner head for burner cap ø 100mm ext. ø 130		
	GEV No.	104103	Ref. No. —
	burner holder suitable for burner ø100mm with nozzle holder		

1			
GEV No.	104102	Ref. No.	1-W-066
description	burner head for burner cap ø 100mm ext. ø 130		

1			
GEV No.	103065	Ref. No.	1-W-067
description	burner ring for burner cap ø 80mm		
accessories for	103065		
	GEV No.	103066	Ref. No. 1-W-057
	burner cap ø 80mm		
	GEV No.	104100	Ref. No. 1-W-065
	burner head for burner cap ø 80mm		
	GEV No.	104101	Ref. No. 1-W-064
	burner holder for burner cap ø 80mm with nozzle holder with mixing sleeve		

1			
GEV No.	104100	Ref. No.	1-W-065
description	burner head for burner cap ø 80mm		
accessories for	104100		
	GEV No.	103065	Ref. No. 1-W-067
	burner ring for burner cap ø 80mm		
	GEV No.	103066	Ref. No. 1-W-057
	burner cap ø 80mm		
	GEV No.	104103	Ref. No. —
	burner holder suitable for burner ø100mm with nozzle holder		

producer-specific hob burners			
EKU			
900 series			
1			
GEV No.	105051	Ref. No.	05-0463
description	air mixing sleeve L 45mm ED ø 45mm ID ø 42mm aluminium		
accessories for	105051		
	GEV No.	103150	Ref. No. 05-1240
	burner lower part for burner cap ø 110/120mm		
	GEV No.	104030	Ref. No. 05-0470
	burner head for burner cap ø 80mm		
	GEV No.	104031	Ref. No. 05-0047 05-0472
	burner head for burner cap ø 110mm		
	GEV No.	104032	Ref. No. 05-0479
	burner head for burner cap ø 120mm		

















1			
GEV No.	104101	Ref. No.	1-W-064
description	burner holder for burner cap ø 80mm with nozzle holder with mixing sleeve		
accessories for	104101		
	GEV No.	103065	Ref. No. 1-W-067
	burner ring for burner cap ø 80mm		
	GEV No.	103066	Ref. No. 1-W-057
	burner cap ø 80mm		

Table continues overleaf

accessories for 105051				
	GEV No.	104033	Ref. No.	05-0467
burner lower part for burner cap ø 80mm 1. generation				
	GEV No.	104034	Ref. No.	05-0469
burner lower part for burner cap ø 110mm				
	GEV No.	105052	Ref. No.	05-0403
nozzle holder ID ø 10mm nozzle mounting M10x1				
	GEV No.	105265	Ref. No.	—
burner head for burner cap ø 80mm				
	GEV No.	105266	Ref. No.	—
burner lower part for burner cap ø 80mm				
	GEV No.	105269	Ref. No.	—
burner head ø 158mm for burner cap ø 110mm				
	GEV No.	105272	Ref. No.	—
burner lower part for burner cap ø 110mm				
	GEV No.	105274	Ref. No.	—
burner head for burner cap ø 120mm				
	GEV No.	105275	Ref. No.	—
burner lower part for burner cap ø 120mm				

				
1				
GEV No.	103021	Ref. No.	05-0476	
description	burner cap ø 110mm			
accessories for	103021			
	GEV No.	103150	Ref. No.	05-1240
burner lower part for burner cap ø 110/120mm				
	GEV No.	103151	Ref. No.	05-1243
reducer suitable for burner head ø110mm				
	GEV No.	104031	Ref. No.	05-0047 05-0472
burner head for burner cap ø 110mm				
	GEV No.	104034	Ref. No.	05-0469
burner lower part for burner cap ø 110mm				
	GEV No.	105051	Ref. No.	05-0463
air mixing sleeve L 45mm ED ø 45mm ID ø 42mm aluminium				
	GEV No.	105052	Ref. No.	05-0403
nozzle holder ID ø 10mm nozzle mounting M10x1				

				
1				
GEV No.	103022	Ref. No.	05-0481	
description	burner cap ø 120mm with central hole			
accessories for	103022			
	GEV No.	103150	Ref. No.	05-1240
burner lower part for burner cap ø 110/120mm				
	GEV No.	104032	Ref. No.	05-0479
burner head for burner cap ø 120mm				
	GEV No.	104035	Ref. No.	—
burner lower part for burner cap ø 120mm				
	GEV No.	105051	Ref. No.	05-0463
air mixing sleeve L 45mm ED ø 45mm ID ø 42mm aluminium				
	GEV No.	105052	Ref. No.	05-0403
nozzle holder ID ø 10mm nozzle mounting M10x1				

				
1				
GEV No.	103020	Ref. No.	05-0474	
description	burner cap ø 80mm			
accessories for	103020			
	GEV No.	104030	Ref. No.	05-0470
burner head for burner cap ø 80mm				
	GEV No.	104033	Ref. No.	05-0467
burner lower part for burner cap ø 80mm 1. generation				
	GEV No.	105051	Ref. No.	05-0463
air mixing sleeve L 45mm ED ø 45mm ID ø 42mm aluminium				
	GEV No.	105052	Ref. No.	05-0403
nozzle holder ID ø 10mm nozzle mounting M10x1				







				
1				
GEV No.	104031	Ref. No.	05-0047 05-0472	
description	burner head for burner cap ø 110mm			
accessories for	104031			
	GEV No.	103021	Ref. No.	05-0476
burner cap ø 110mm				
	GEV No.	103150	Ref. No.	05-1240
burner lower part for burner cap ø 110/120mm				





Table continues overleaf



accessories for	104031		
	GEV No.	103151	Ref. No. 05-1243
	reducer suitable for burner head ø110mm		
	GEV No.	104034	Ref. No. 05-0469
	burner lower part for burner cap ø 110mm		
	GEV No.	105051	Ref. No. 05-0463
	air mixing sleeve L 45mm ED ø 45mm ID ø 42mm aluminium		
	GEV No.	105052	Ref. No. 05-0403
	nozzle holder ID ø 10mm nozzle mounting M10x1		

	1		
GEV No.	104032	Ref. No.	05-0479
description	burner head for burner cap ø 120mm		
accessories for	104032		
	GEV No.	103022	Ref. No. 05-0481
	burner cap ø 120mm with central hole		
	GEV No.	103150	Ref. No. 05-1240
	burner lower part for burner cap ø 110/120mm		
	GEV No.	105051	Ref. No. 05-0463
	air mixing sleeve L 45mm ED ø 45mm ID ø 42mm aluminium		
	GEV No.	105052	Ref. No. 05-0403
	nozzle holder ID ø 10mm nozzle mounting M10x1		

	1		
GEV No.	104030	Ref. No.	05-0470
description	burner head for burner cap ø 80mm		
accessories for	104030		
	GEV No.	103020	Ref. No. 05-0474
	burner cap ø 80mm		
	GEV No.	104033	Ref. No. 05-0467
	burner lower part for burner cap ø 80mm 1. generation		
	GEV No.	105051	Ref. No. 05-0463
	air mixing sleeve L 45mm ED ø 45mm ID ø 42mm aluminium		
	GEV No.	105052	Ref. No. 05-0403
	nozzle holder ID ø 10mm nozzle mounting M10x1		





	1		
GEV No.	103150	Ref. No.	05-1240
description	burner lower part for burner cap ø 110/120mm		
accessories for	103150		
	GEV No.	103021	Ref. No. 05-0476
	burner cap ø 110mm		
	GEV No.	103022	Ref. No. 05-0481
	burner cap ø 120mm with central hole		
	GEV No.	103151	Ref. No. 05-1243
	reducer suitable for burner head ø110mm		
	GEV No.	104031	Ref. No. 05-0047 05-0472
	burner head for burner cap ø 110mm		
	GEV No.	104032	Ref. No. 05-0479
	burner head for burner cap ø 120mm		
	GEV No.	105051	Ref. No. 05-0463
	air mixing sleeve L 45mm ED ø 45mm ID ø 42mm aluminium		
	GEV No.	105052	Ref. No. 05-0403
	nozzle holder ID ø 10mm nozzle mounting M10x1		

	1		
GEV No.	104034	Ref. No.	05-0469
description	burner lower part for burner cap ø 110mm		
accessories for	104034		
	GEV No.	103021	Ref. No. 05-0476
	burner cap ø 110mm		
	GEV No.	104031	Ref. No. 05-0047 05-0472
	burner head for burner cap ø 110mm		
	GEV No.	105051	Ref. No. 05-0463
	air mixing sleeve L 45mm ED ø 45mm ID ø 42mm aluminium		
	GEV No.	105052	Ref. No. 05-0403
	nozzle holder ID ø 10mm nozzle mounting M10x1		

			
1			
GEV No.	104033	Ref. No.	05-0467
description	burner lower part for burner cap ø 80mm 1. generation		

			
1			
GEV No.	105052	Ref. No.	05-0403
description	nozzle holder ID ø 10mm nozzle mounting M10x1		

accessories for 105052			
	GEV No.	100469	Ref. No. 3-309 A240156
gas injector thread M10x1 WS 12 bore ø 1.15mm			
	GEV No.	100478	Ref. No. —
gas injector thread M10x1 WS 12 bore ø 1.75mm			
	GEV No.	103150	Ref. No. 05-1240
burner lower part for burner cap ø 110/120mm			
	GEV No.	104030	Ref. No. 05-0470
burner head for burner cap ø 80mm			
	GEV No.	104031	Ref. No. 05-0047 05-0472
burner head for burner cap ø 110mm			
	GEV No.	104032	Ref. No. 05-0479
burner head for burner cap ø 120mm			
	GEV No.	104033	Ref. No. 05-0467
burner lower part for burner cap ø 80mm 1. generation			
	GEV No.	104034	Ref. No. 05-0469
burner lower part for burner cap ø 110mm			
	GEV No.	105051	Ref. No. 05-0463
air mixing sleeve L 45mm ED ø 45mm ID ø 42mm aluminium			

			
1			
GEV No.	103151	Ref. No.	05-1243
description	reducer suitable for burner head ø 110mm		
accessories for 103151			
	GEV No.	103021	Ref. No. 05-0476
burner cap ø 110mm			
	GEV No.	103150	Ref. No. 05-1240
burner lower part for burner cap ø 110/120mm			
	GEV No.	104031	Ref. No. 05-0047 05-0472
burner head for burner cap ø 110mm			
	GEV No.	105051	Ref. No. 05-0463
air mixing sleeve L 45mm ED ø 45mm ID ø 42mm aluminium			

accessories for 103151			
	GEV No.	105052	Ref. No. 05-0403
nozzle holder ID ø 10mm nozzle mounting M10x1			

old (2) series			
			
1			
GEV No.	103095	Ref. No.	3-211A A240109
description	burner cap ø 95mm 7kW		

			
1			
GEV No.	103105	Ref. No.	240012-00 3-212B
description	burner head for burner cap ø 95mm 7kW		

			
1			
GEV No.	104111	Ref. No.	240082-00 3-212A
description	burner head for burner cap ø 95mm 7kW		

			
1			
GEV No.	104114	Ref. No.	240041-00 3-207
description	burner lower part for burner cap ø 85mm 3.5kW		

			
1			
GEV No.	104115	Ref. No.	240010-00 3-210 N/A
description	burner lower part for burner cap ø 95mm 7kW		

			
1			
GEV No.	104112	Ref. No.	3-244 A240185
description	gasket for burner cap ø 85mm silicone suitable for burner 3.5kW		











			
1			
GEV No.	104113	Ref. No.	3-245 A240184
description	gasket for burner cap ø 95mm silicone for burner 7kW		

			
1			
GEV No.	520587	Ref. No.	10-109
description	hose clamp stainless steel ø 12-20mm width 25mm Qty 1 pcs		





			
1			
GEV No.	104119	Ref. No.	3-231 A240072
description	nozzle holder		





Snack 2001 series			
			
1			
GEV No.	106379	Ref. No.	N/A
description	air mixing tube for burner cap ø 80mm L 23mm D1 ø 20mm D2 ø 15.6mm D3 ø 14mm		





			
1			
GEV No.	103068	Ref. No.	1-W-059
description	burner cap ø 100mm		
accessories for	103068		
	GEV No.	Ref. No.	
	103067		1-W-068
	burner ring for burner cap ø 100mm		
	GEV No.	Ref. No.	
	104102		1-W-066
	burner head for burner cap ø 100mm ext. ø 130		
	GEV No.	Ref. No.	
	104103		—
	burner holder suitable for burner ø100mm with nozzle holder		

			
1			
GEV No.	103066	Ref. No.	1-W-057
description	burner cap ø 80mm		
accessories for	103066		
	GEV No.	Ref. No.	
	103065		1-W-067
	burner ring for burner cap ø 80mm		
	GEV No.	Ref. No.	
	104100		1-W-065
	burner head for burner cap ø 80mm		
	GEV No.	Ref. No.	
	104101		1-W-064
	burner holder for burner cap ø 80mm with nozzle holder with mixing sleeve		





			
1			
GEV No.	104102	Ref. No.	1-W-066
description	burner head for burner cap ø 100mm ext. ø 130		

			
1			
GEV No.	104100	Ref. No.	1-W-065
description	burner head for burner cap ø 80mm		
accessories for	104100		
	GEV No.	Ref. No.	
	103065		1-W-067
	burner ring for burner cap ø 80mm		
	GEV No.	Ref. No.	
	103066		1-W-057
	burner cap ø 80mm		
	GEV No.	Ref. No.	
	104103		—
	burner holder suitable for burner ø100mm with nozzle holder		



			
1			
GEV No.	104101	Ref. No.	1-W-064
description	burner holder for burner cap ø 80mm with nozzle holder with mixing sleeve		
accessories for	104101		
	GEV No.	Ref. No.	
	103065		1-W-067
	burner ring for burner cap ø 80mm		
	GEV No.	Ref. No.	
	103066		1-W-057
	burner cap ø 80mm		
	GEV No.	Ref. No.	
	104100		1-W-065
	burner head for burner cap ø 80mm		

			
1			
GEV No.	103067	Ref. No.	1-W-068
description	burner ring for burner cap ø 100mm		
accessories for	103067		
	GEV No.	Ref. No.	
	103068		1-W-059
	burner cap ø 100mm		
	GEV No.	Ref. No.	
	104102		1-W-066
	burner head for burner cap ø 100mm ext. ø 130		
	GEV No.	Ref. No.	
	104103		—
	burner holder suitable for burner ø100mm with nozzle holder		



				
GEV No.	103065	Ref. No.	1-W-067	
description	burner ring for burner cap ø 80mm			
accessories for	103065			
	GEV No.	103066	Ref. No.	1-W-057
burner cap ø 80mm				
	GEV No.	104100	Ref. No.	1-W-065
burner head for burner cap ø 80mm				
	GEV No.	104101	Ref. No.	1-W-064
burner holder for burner cap ø 80mm with nozzle holder with mixing sleeve				





Snack 2001-96, 60, 701, 702, 703 series

				
GEV No.	103143	Ref. No.	1-W-652 3-208 A240108	
description	burner cap ø 85mm 3.5kW			
accessories for	103143			
	GEV No.	103140	Ref. No.	240011-00 3-209
burner head seat ø 75mm for burner cap ø 85mm 3.5kW				

				
GEV No.	103144	Ref. No.	3-211	
description	burner cap ø 95mm 5.5kW			

				
GEV No.	103141	Ref. No.	3-212	
description	burner head ø 95mm suitable for burner 5.5kW			
accessories for	103141			
	GEV No.	103147	Ref. No.	—
burner lower part for burner cap ø 95mm 5.5/7kW				
	GEV No.	103149	Ref. No.	N/A
gasket L 55mm W 62mm for burner 5.5/7kW				
	GEV No.	105230	Ref. No.	—
nozzle holder				
	GEV No.	105259	Ref. No.	—
burner cap ø 95mm with central hole				

				
GEV No.	103140	Ref. No.	240011-00 3-209	
description	burner head seat ø 75mm for burner cap ø 85mm 3.5kW			
accessories for	103140			
	GEV No.	103146	Ref. No.	1-W-646
burner lower part for burner cap ø 85mm 3.5kW				
	GEV No.	103148	Ref. No.	1-W-690
gasket L 47mm W 53mm suitable for burner 3.5kW				
	GEV No.	105230	Ref. No.	—
nozzle holder				
	GEV No.	107203	Ref. No.	—
burner cap ø 85mm 3.5kW				

				
GEV No.	103146	Ref. No.	1-W-646	
description	burner lower part for burner cap ø 85mm 3.5kW			
accessories for	103146			
	GEV No.	103140	Ref. No.	240011-00 3-209
burner head seat ø 75mm for burner cap ø 85mm 3.5kW				
	GEV No.	103148	Ref. No.	1-W-690
gasket L 47mm W 53mm suitable for burner 3.5kW				
	GEV No.	105230	Ref. No.	—
nozzle holder				
	GEV No.	107203	Ref. No.	—
burner cap ø 85mm 3.5kW				















				
GEV No.	103148	Ref. No.	1-W-690	
description	gasket L 47mm W 53mm suitable for burner 3.5kW			
accessories for	103148			
	GEV No.	103140	Ref. No.	240011-00 3-209
burner head seat ø 75mm for burner cap ø 85mm 3.5kW				
	GEV No.	103146	Ref. No.	1-W-646
burner lower part for burner cap ø 85mm 3.5kW				
	GEV No.	105230	Ref. No.	—
nozzle holder				

Table continues overleaf









accessories for	103148		
	GEV No.	107203	Ref. No. —
	burner cap ø 85mm 3.5kW		

	1		
GEV No.	103149	Ref. No.	N/A
description	gasket L 55mm W 62mm for burner 5.5/7kW		
accessories for	103149		
	GEV No.	103141	Ref. No. 3-212
	burner head ø 95mm suitable for burner 5.5kW		
	GEV No.	103145	Ref. No. —
	burner cap ø 95mm 7kW with central hole		
	GEV No.	103147	Ref. No. —
	burner lower part for burner cap ø 95mm 5.5/7kW		
	GEV No.	105230	Ref. No. —
	nozzle holder		
	GEV No.	105259	Ref. No. —
	burner cap ø 95mm with central hole		
	GEV No.	107143	Ref. No. —
	burner head for burner cap ø 95mm 5.5kW		

solid tops			
	1		
GEV No.	105042	Ref. No.	05-0486
description	burner cap ø 175mm with central hole		
accessories for	105042		
	GEV No.	105041	Ref. No. 05-0485
	burner head ø 175mm for solid top suitable for 1000, BS series		
	GEV No.	105484	Ref. No. —
	burner head ø 175mm for solid top suitable for Protagonista series		

	1		
GEV No.	105041	Ref. No.	05-0485
description	burner head ø 175mm for solid top suitable for 1000, BS series		
accessories for	105041		
	GEV No.	105042	Ref. No. 05-0486
	burner cap ø 175mm with central hole		

wok burners			
	1		
GEV No.	104117	Ref. No.	06-107
description	air mixing sleeve for wok range		
accessories for	104117		
	GEV No.	103096	Ref. No. 06-106
	burner cap ø 120mm 9.5kW for wok range		
	GEV No.	104116	Ref. No. —
	burner head 9.5kW for wok range		

	1		
GEV No.	103096	Ref. No.	06-106
description	burner cap ø 120mm 9.5kW for wok range		
accessories for	103096		
	GEV No.	104116	Ref. No. —
	burner head 9.5kW for wok range		
	GEV No.	104117	Ref. No. 06-107
	air mixing sleeve for wok range		

	1		
GEV No.	104734	Ref. No.	06-105
description	burner head for wok range		



pan supports



1

GEV No.	210151	Ref. No.	1-W-645
description	pan support W 295mm L 545mm gas range		



1

GEV No.	210150	Ref. No.	1-W-644
description	pan support W 340mm L 545mm		

accessories

reducers for pan supports



1

GEV No.	210050	Ref. No.	RR
description	reducer for pan support L 260mm W 260mm chrome-plated steel suitable for universal		

pan supports



1

GEV No.	210035	Ref. No.	06-108
description	pan support ø 353mm H 70mm		
For models:	CHINAHERD		



1

GEV No.	210034	Ref. No.	06-109
description	pan support ø 356mm H 90mm		



1

GEV No.	210151	Ref. No.	1-W-645
description	pan support W 295mm L 545mm gas range		



1

GEV No.	210150	Ref. No.	1-W-644
description	pan support W 340mm L 545mm		

bar burners

bar burners



1

GEV No.	104156	Ref. No.	1-W-050
description	bar burner 2 row L 445mm W 200mm ømm H 50mm chargrill stainless steel		
For models:	SNACK2001		



1

GEV No.	105422	Ref. No.	4-PLX-02
description	bar burner 4 row L 480mm W 450mm ømm chargrill		











1

GEV No.	211029	Ref. No.	1-W-280
description	lava rock grid L 464mm W 310mm		



lava rock grids			
			
1			
GEV No.	211029	Ref. No.	1-W-280
description	lava rock grid L 464mm W 310mm		

accessories

nozzle holders			
			
1			
GEV No.	105052	Ref. No.	05-0403
description	nozzle holder ID ø 10mm nozzle mounting M10x1		
accessories for	105052		
	GEV No.	100469	Ref. No. 3-309 A240156
gas injector thread M10x1 WS 12 bore ø 1.15mm			
	GEV No.	100478	Ref. No. —
gas injector thread M10x1 WS 12 bore ø 1.75mm			
	GEV No.	103150	Ref. No. 05-1240
burner lower part for burner cap ø 110/120mm			
	GEV No.	104030	Ref. No. 05-0470
burner head for burner cap ø 80mm			
	GEV No.	104031	Ref. No. 05-0047 05-0472
burner head for burner cap ø 110mm			
	GEV No.	104032	Ref. No. 05-0479
burner head for burner cap ø 120mm			
	GEV No.	104033	Ref. No. 05-0467
burner lower part for burner cap ø 80mm 1. generation			
	GEV No.	104034	Ref. No. 05-0469
burner lower part for burner cap ø 110mm			
	GEV No.	105051	Ref. No. 05-0463
air mixing sleeve L 45mm ED ø 45mm ID ø 42mm aluminium			

miscellaneous			
			
1			
GEV No.	103151	Ref. No.	05-1243
description	reducer suitable for burner head ø110mm		
accessories for	103151		
	GEV No.	103021	Ref. No. 05-0476
burner cap ø 110mm			
	GEV No.	103150	Ref. No. 05-1240
burner lower part for burner cap ø 110/120mm			
	GEV No.	104031	Ref. No. 05-0047 05-0472
burner head for burner cap ø 110mm			
	GEV No.	105051	Ref. No. 05-0463
air mixing sleeve L 45mm ED ø 45mm ID ø 42mm aluminium			
	GEV No.	105052	Ref. No. 05-0403
nozzle holder ID ø 10mm nozzle mounting M10x1			

gas nozzles

main nozzles			
gas nozzles M6x0.75			
			
1			
GEV No.	100415	Ref. No.	3-237 A240128
description	gas injector thread M6x0.75 WS 7 bore ø 0.85mm		
For models:	60GE4, 60GST4		

gas nozzles M7x1			
			
1			
GEV No.	103129	Ref. No.	1-W-092
description	gas injector thread M7x1 WS 10 bore ø 0.75mm		

			
1			
GEV No.	100517	Ref. No.	1-W-093
description	gas injector thread M7x1 WS 10 bore ø 0.8mm		



gas nozzles M10x1



1

GEV No.	100464	Ref. No.	1-W-101
----------------	--------	-----------------	---------

description	gas injector thread M10x1 WS 12 bore \varnothing 0.75mm		
--------------------	-----------------------------------------------------------	--	--



1

GEV No.	100469	Ref. No.	3-309 A240156
----------------	--------	-----------------	------------------

description	gas injector thread M10x1 WS 12 bore \varnothing 1.15mm		
--------------------	-----------------------------------------------------------	--	--

gas nozzles M13x1



1

GEV No.	102790	Ref. No.	DIV Erdg 255 PLX-60
----------------	--------	-----------------	---------------------

description	gas injector thread M13x1 bore \varnothing 2.55mm WS 13		
--------------------	-----------------------------------------------------------	--	--

pilot burner nozzles

pilot burner nozzle AB



1

GEV No.	100869	Ref. No.	06-124
----------------	--------	-----------------	--------

description	pilot burner nozzle natural gas code 51 Qty 1 pcs suitable for 160 series nozzle \varnothing 0.51mm		
--------------------	-------------------------------------------------------------------------------------------------------	--	--

pilot burner nozzles JUNKERS

CB 5050_ series



1

GEV No.	100230	Ref. No.	1-W-119
----------------	--------	-----------------	---------

description	pilot burner nozzle LPG gas pressure 50mbar code 2 Qty 1 pcs suitable for JUNKERS CB5050_		
--------------------	-------------------------------------------------------------------------------------------	--	--

pilot burner nozzles SIT

100 series



1

GEV No.	100245	Ref. No.	3-314 A230126
----------------	--------	-----------------	------------------

description	pilot burner nozzle LPG code 20 bore \varnothing 0.2mm Qty 1 pcs thread M8x0.75		
--------------------	-----------------------------------------------------------------------------------	--	--

160 series



1

GEV No.	107649	Ref. No.	3-225 A230132
----------------	--------	-----------------	------------------

description	pilot burner nozzle SIT LPG code 20 Qty 1 pcs		
--------------------	-----------------------------------------------	--	--



1

GEV No.	107650	Ref. No.	06-123 A230131-10
----------------	--------	-----------------	----------------------

description	pilot burner nozzle SIT LPG code 30 Qty 1 pcs		
--------------------	-----------------------------------------------	--	--

equipment-specific units

for dishwashers

air traps

air traps



1

GEV No.	503337	Ref. No.	10-61
----------------	--------	-----------------	-------

description	air trap		
--------------------	----------	--	--

washing and rinsing systems



1

GEV No.	511161	Ref. No.	DZT71
----------------	--------	-----------------	-------

description	rinse arm shaft		
--------------------	-----------------	--	--

knobs

producer-specific knobs

EKU



1

GEV No.	112183	Ref. No.	06-135
description	knob gas tap with ignition flame ø 63mm shaft ø 8x6.5mm shaft flat upper black		

locks

edgemoount latches



handle latches

producer-specific

INOXTREND





1

GEV No.	690146	Ref. No.	14-N-081
description	handle latch L 172mm mounting distance 134mm non lockable heated units 6200 H 65mm type DUPLO total length 248mm		
accessories for	690146		
	GEV No.	690123	Ref. No. —
	door catch with roller		
	GEV No.	693777	Ref. No. —
	gasket H 6.6mm L 105mm W 45mm L1 78mm W1 25mm for handle		
	GEV No.	693778	Ref. No. —
	door catch		

MODULAR



1

GEV No.	690146	Ref. No.	14-N-081
description	handle latch L 172mm mounting distance 134mm non lockable heated units 6200 H 65mm type DUPLO total length 248mm		
accessories for	690146		
	GEV No.	690123	Ref. No. —
	door catch with roller		
	GEV No.	693777	Ref. No. —
	gasket H 6.6mm L 105mm W 45mm L1 78mm W1 25mm for handle		
	GEV No.	693778	Ref. No. —
	door catch		

door catches





1

GEV No.	700061	Ref. No.	14-123
description	door catch L 58mm W 20mm H 35mm mounting distance 42mm chrome-plated brass for headed units		
accessories for	700061		
	GEV No.	690414	Ref. No. —
	handle latch L 150mm mounting distance 133mm non lockable refrigeration units G 791		

hinges

oven hinges

GEV No.	700005	Ref. No.	3-52A A230084
description	oven hinge mounting distance 173mm mounting distance 2 105mm lug mounting 14mm lever length 118mm groove distance 7mm spring thickness 3.5mm mounting ear position left spring length 112mm W 25mm		
accessories for	700005		
	GEV No.	700001	Ref. No. —
	opposite support L 118mm W 17mm mounting distance 94mm		

GEV No.	700004	Ref. No.	3-52
description	oven hinge mounting distance 173mm mounting distance 2 105mm lug mounting 14mm lever length 119mm groove distance 7mm spring thickness 3.5mm mounting ear position right spring length 112mm L 206mm W 25mm		
accessories for	700004		
	GEV No.	700001	Ref. No. —
	opposite support L 118mm W 17mm mounting distance 94mm		

baskets

fryer baskets

EKU

GEV No.	970156	Ref. No.	1-W-02
description	fryer basket L1 280mm W1 200mm H1 105mm chrome-plated steel		

gaskets

refrigeration gaskets

plug-in gaskets

profile 9743

We offer custom-made gaskets for this profile

GEV No.	902304	Ref. No.	N/A
description	refrigeration gasket profile 9743 Wmm L 2500mm		

profile 9783

We offer custom-made gaskets for this profile

GEV No.	900024	Ref. No.	Mar.2500600
description	refrigeration gasket profile 9783 W 190mm L 357mm plug size drawer refrigeration size 1/3		

GEV No.	900025	Ref. No.	Mar.2500700
description	refrigeration gasket profile 9783 W 260mm L 355mm plug size drawer refrigeration size 1/2		

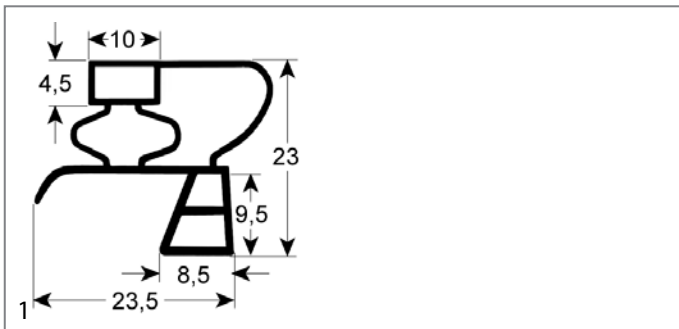

GEV No.	902306	Ref. No.	N/A
description	refrigeration gasket profile 9783 Wmm L 2500mm		

gaskets for heated units

door seals with fixing hook



GEV No.	901676	Ref. No.	3-75
description	door seal W 555mm 3-sided with hook H 285mm		

O-rings

EPDM

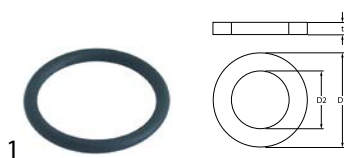

GEV No.	505092	Ref. No.	04-3090
description	O-ring EPDM thickness 5.34mm ID ø 43.82mm Qty 1 pcs		

Viton

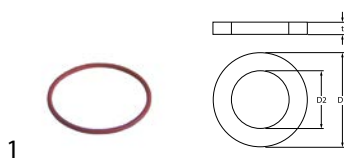

GEV No.	521116	Ref. No.	05-0790
description	O-ring Viton thickness 3.53mm ID ø 78.97mm Qty 1 pcs		

springs

torsion springs







GEV No.	514234	Ref. No.	8102-10
description	torsion spring ø 32.3mm L2 188mm wire gauge ø 5.7mm L1 15mm tilting bratt pan series 900		

dosing pumps

piston pumps

with solenoid coil



GEV No.	361013	Ref. No.	10-54	
description	dosing pump inlet 4x6mm outlet 5mm 230V rinse aid duty cycle 25% type EKP-M 50Hz impulse 3imp/s			
spare parts for	361013			
	GEV No.	361482	Ref. No.	—
	solenoid coil 230VAC for type EKP-M			
	GEV No.	361811	Ref. No.	—
	hose connector for dosing pump hose ø 6.3mm T1: M12x1.5 chrome-plated brass			
	GEV No.	371090	Ref. No.	—
	power socket plug type DIN 43650A screw			
accessories for	361013			
	GEV No.	361366	Ref. No.	—
	PCB dishwasher 11F suitable for DB2 type DB2/EV1/EKP-M			
	GEV No.	361505	Ref. No.	—
	screw pipe fitting straight nickel-plated brass thread 3/8" IT hose ø 6x8mm			

accessories

tank inlets



GEV No.	361856	Ref. No.	10-149 10-149a
description	tank inlet stainless steel M12 hose ø 4/5/6mm		

hoses

drain hoses

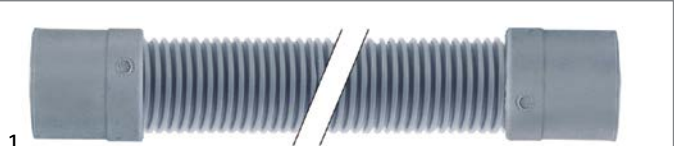



GEV No.	507211	Ref. No.	10-112
description	drain hose DN26 L 1500mm A int. ø 33mm A ext. ø 40mm B int. ø 32mm B ext. ø 40mm outer hose ø 35mm		

drain systems and wash basins

standpipes

3/4"



GEV No.	515049	Ref. No.	G367000
description	standpipe size 3/4" usable height 68mm overall height 94mm ED ø 20mm chrome-plated brass with O-ring		
spare parts for	515049		
	GEV No.	528813	Ref. No. —
	O-ring EPDM thickness 2mm ID ø 17mm Qty 1 pcs		
accessories for	515049		
	GEV No.	515041	Ref. No. —
	drain fitting size 3/4" usable heightmm overall height 30mm ED ø 38mm chrome-plated brass		

fastening material

fasteners

clamps

hose clamps

miscellaneous



GEV No.	520587	Ref. No.	10-109
description	hose clamp stainless steel ø 12-20mm width 25mm Qty 1 pcs		

ancillary products

clamps

hose clamps

miscellaneous



GEV No.	520587	Ref. No.	10-109
description	hose clamp stainless steel ø 12-20mm width 25mm Qty 1 pcs		

B			
bar burners		24	
C			
cam switches		9	
clamps		30, 30	
contactors		10	
control thermostats		7	
D			
door catches		27	
door seals with fixing hook		29	
dosing pumps		29	
drain hoses		29	
drain systems and wash basins		30	
E			
edgemount latches		27	
electronic controllers		10	
F			
fasteners		30	
fastening material		30	
G			
gas burners		16	
gas nozzles		25	
gas taps		11	
gas thermostats		12	
gaskets for heated units		29	
H			
handle latches		27	
heating elements		3	
heating elements for bain maries		3	
heating elements for chargrills		5	
heating elements for chip scuttles		3	
heating elements for convection		5	
heating elements for fryers		4	
heating elements for griddles		4	
heating elements for large hobs		4	
heating elements for salamanders/toasters		5	
heating elements for tilting bratt pan		4	
hob burners		16	
hose clamps		30, 30	
hoses		29	
hot plates		6	
I			
indicator lights		9	
indicator lights (complete)		9	
L			
lamps		9	
M			
magnetic switches		9	
microswitches		8	
O			
O-rings		29	
oven hinges		28	
P			
pilot burners		14	
plug-in gaskets		28	
programme timers		9	
push/momentary push switches		8	
R			
radiation heaters		6	
refrigeration gaskets		28	
S			
safety thermostats		8	
solenoid valves		10	
standpipes		30	
switches and momentary switches		8	
T			
tank inlets		29	
thermocouples		16	
thermostats		7	
timers		9	