



GAS COMPONENTS



ELECTRIC COMPONENTS



WATER TECHNOLOGY



MECHANICAL COMPONENTS



TOOLS

Spare parts suitable for

DYNAMIC

Find the complete and up-to-date range of products in our GEV Webshop



Manufacturer catalogue

The most important spare parts and accessories arranged clearly for every manufacturer

- ✓ Complete product range and all appliance data always up to date in the GEV Webshop
- ✓ Alphabetical Index at the end of the catalogue

GEV Webshop

www.gev-online.co.uk

www.gev-online.com



- 🔍 Add to Favourites
- 🔍 Sign In with email address and usual password
- 🔍 Easy-order – place several items in your basket at the same time
- 🔍 Quick Item search – no login needed



switches and momentary switches



miscellaneous

			
1			
GEV No.	348132	Ref. No.	0908
description	safety switch 250V H 48mm 5A with safety device		
For models:	FD98, FT86, FTP94, Junior-Fouet, Junior-Plus, Junior-Standard, MD95, MMX92, MMX98, MX85, MXP94, PMDH250, PMF250, PMX83, PMX98, SMX500, SMX502, SMX600		

electronics

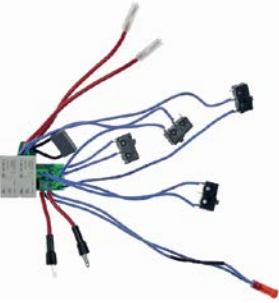

PCBs

			
1			
GEV No.	403778	Ref. No.	2003
description	control PCB hand blenders MX2000 / MDH2000 / MF2000 / MFAP2000 L 46mm W 40mm with microswitch		
For models:	Master, MDH2000, MF2000, MFAP2000, MX2000, MX2000-DSC		

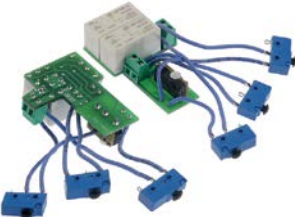
			
1			
GEV No.	403165	Ref. No.	2852
description	PCB GSM1000 speed control		
For models:	Dynamix		
spare parts for	403165		
	GEV No.	696506	Ref. No.
			2858
	 knob for PCB ø 26mm black Qty 1 pcs		

			
1			
GEV No.	403561	Ref. No.	45620
description	PCB hand blenders SMX600/800		
For models:	SMX600-DSC, SMX600-E, SMX800-DSC, SMX800-E		

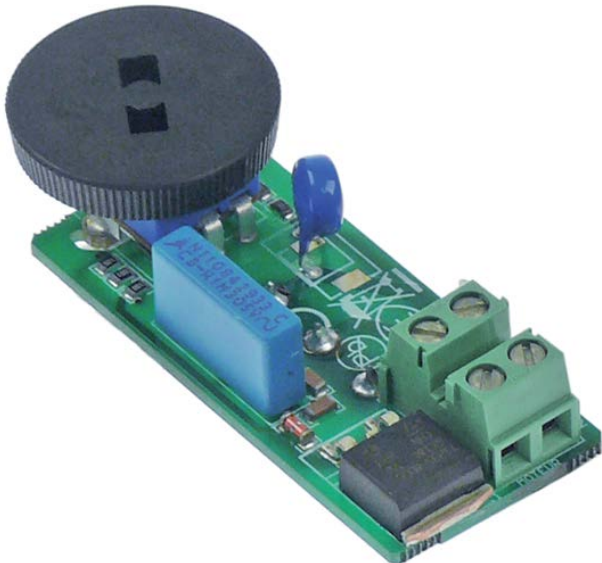
speed controllers

			
1			
GEV No.	403165	Ref. No.	2852
description	PCB GSM1000 speed control		
For models:	Dynamix		
spare parts for	403165		
	GEV No.	696506	Ref. No.
			2858
	 knob for PCB ø 26mm black Qty 1 pcs		

motors

motors

for hand blenders

motors

			
1			
GEV No.	698257	Ref. No.	9507
description	motor 230V 180W 50Hz shaft ø 6.3mm mounting distance 60mm H 86mm		
For models:	MD95		

			
1			
GEV No.	698378	Ref. No.	2847
description	motor for hand blender 230V 100W shaft ø 6.4mm GSM1000		
For models:	Dynamix		



accessories



1

GEV No.	698269	Ref. No.	0504
description	motor carbon brush set with spring L 22mm W 6mm H 8mm		
For models:	FT79, FT97, MDH2000, MDH460, MF2000, MF90, MFAP2000, MFAP90, MX2000, MX2000-DSC, MX79, MX91, PP84, PP97, PP97-Plus		



1

GEV No.	699133	Ref. No.	2843M
description	housing right blue GSM1000		
accessories for	699133		
	GEV No.	699134	Ref. No.
			2849M
	housing left blue GSM1000		

equipment-specific units

for hand blenders

housings



1

GEV No.	699708	Ref. No.	2840M
description	cover for handle blue GSM1000 L 80mm W 42mm		



1

GEV No.	698386	Ref. No.	2848M
description	sticker for hand blender silver L 125mm W 25mm thickness 1mm ON-OFF		



1

GEV No.	696503	Ref. No.	2851
description	handle for hand blender plastic grey		
For models:	Dynamix		



1

GEV No.	698387	Ref. No.	2853M
description	sticker for lid silver L 50mm W 27mm		



1

GEV No.	699134	Ref. No.	2849M
description	housing left blue GSM1000		
accessories for	699134		
	GEV No.	699133	Ref. No.
			2843M
	housing right blue GSM1000		

couplings



1

GEV No.	651038	Ref. No.	9508
description	coupling D1 ø 12.3mm D2 ø 8.6mm int. ø 1 6.5mm int. ø 2 4mm L 35.3mm		
For models:	MD95		



 <p>1</p>			
GEV No.	699709	Ref. No.	9051
description	coupling D1 ø 13.5mm D2 ø 22mm int. ø 1 8mm int. ø 2 17mm L1 22mm		
For models:	AP90, Coupe-Legume, Dynacutter, EM98, FM90, MDH2000, MDH460, MF2000, MF90, MFAP2000, MFAP90, PMDH250, PMF250, SMX600-DSC, SMX800-DSC, SMX800-E		

 <p>2</p>			
GEV No.	698308	Ref. No.	45122
description	coupling D1 ø 22.5mm L 15mm teeth 8		
For models:	SMX450, SMX500, SMX502, SMX600, SMX600-E		

 <p>1</p>			
GEV No.	696504	Ref. No.	2846
description	coupling for hand blender D1 ø 19mm int. ø 1 6.3mm L 29.5mm teeth 8 GSM1000		
For models:	Dynamix		

 <p>1</p>			
GEV No.	698307	Ref. No.	45123
description	coupling with roll pin for hand blender D1 ø 15mm D2 ø 19mm int. ø 1 8mm L 12mm teeth 8 SMX		
For models:	Junior-Plus, SMX450, SMX500, SMX502, SMX600, SMX600-E		

 <p>1</p>			
GEV No.	696505	Ref. No.	2860
description	coupling with roll pin for hand blender D1 ø 19mm int. ø 1 8mm teeth 8 GSM1000		

blender sticks

bearing blocks

 <p>1</p>			
GEV No.	698603	Ref. No.	45130
description	bearing for hand blender ø 50mm ID ø 8mm H 34mm SMX450/500/502/600/800		
For models:	SMX450, SMX500, SMX502, SMX600, SMX600-DSC, SMX600-E, SMX800-DSC, SMX800-E		

 <p>1</p>			
GEV No.	698270	Ref. No.	7916
description	bushing with gasket ø 22mm ID ø 8mm H 30mm MASTER/PMF250		
For models:	Master, MDH2000, MDH460, MF2000, MF90, MFAP2000, MFAP90, MMX98, MX2000, MX2000-DSC, MX79, MX85, MX91, PMDH250, PMF250, PMX98		

blades

blades with adaptor (complete)

 <p>1</p>			
GEV No.	698262	Ref. No.	0551 9415
description	knife ø 39mm hole ø 4mm H 12mm		
For models:	Dynamix, MD95, MXP94		

 <p>1</p>			
GEV No.	698261	Ref. No.	0550 9414
description	knife ø 39mm hole ø 4mm H 18mm		
For models:	Dynamix, MD95, MXP94		

 <p>1</p>			
GEV No.	698321	Ref. No.	4004
description	knife ø 45mm hole ø 4mm H 12mm JUNIOR		
For models:	Junior-Plus, Junior-Standard		

 <p>1</p>			
GEV No.	698604	Ref. No.	7917
description	knife ø 58mm hole ø 8mm H 22mm MDH/MF/MFA/MX		
For models:	MDH2000, MDH460, MF2000, MF90, MFAP2000, MFAP90, MX2000, MX2000-DSC, MX79, MX85, MX91		

 <p>1</p>			
GEV No.	698271	Ref. No.	45161
description	knife ø 68mm hole ø 8mm H 30mm SMX		
For models:	SMX450, SMX500, SMX502, SMX600, SMX600-DSC, SMX600-E, SMX800-DSC, SMX800-E		

			
1			
GEV No.	698381	Ref. No.	0552
description	mixer disc ø 36mm hole ø 4mm H 0.8mm GSM1000		
For models:	Dynamix		

			
1			
GEV No.	698382	Ref. No.	0553
description	mixer disc ø 36mm hole ø 4mm H 3.4mm GSM1000		
For models:	Dynamix		

blender sticks



			
1			
GEV No.	698379	Ref. No.	2845M
description	blender stick GSM1000 L 234mm flange ø 66mm		



			
1			
GEV No.	698260	Ref. No.	9510
description	blender stick MXP94 L 215mm flange ø 70mm mounting distance 60mm with shaft sealing		
For models:	MD95, MXP94		

spindles

			
1			
GEV No.	699707	Ref. No.	9131
description	drive shaft for hand blender D1 ø 8mm D2 ø 14mm L 408mm		
For models:	Master, MX2000, MX2000-DSC, MX91		

			
1			
GEV No.	699706	Ref. No.	45120
description	drive shaft for hand blender with ball bearing D1 ø 8mm D2 ø 18mm L 488mm		
For models:	SMX450, SMX500, SMX502, SMX600, SMX600-E		

			
1			
GEV No.	698380	Ref. No.	2844M
description	drive shaft for hand blender with coupling D1 ø 4mm D2 ø 8mm L 214mm SS		
spare parts for	698380		
	GEV No.	696505	Ref. No.
			2860
	coupling with roll pin for hand blender D1 ø 19mm int. ø 1 8mm teeth 8 GSM1000		

			
1			
GEV No.	698259	Ref. No.	089956
description	drive shaft with coupling D1 ø 4mm D2 ø 8mm L 180mm stainless steel		
For models:	MD95		
spare parts for	698259		
	GEV No.	651038	Ref. No.
			9508
	coupling D1 ø 12.3mm D2 ø 8.6mm int. ø 1 6.5mm int. ø 2 4mm L 35.3mm		

beaters

beaters

			
1			
GEV No.	698258	Ref. No.	9424
description	whisk 1 pair ø 60mm L 190mm hole ø 6mm JUNIOR		
For models:	FD98, FTP94, Junior-Fouet, Junior-Plus		

miscellaneous

			
1			
GEV No.	696439	Ref. No.	45138
description	bolt L 155mm M5 Qty 4 pcs		
For models:	SMX450, SMX500, SMX502, SMX600, SMX600-DSC, SMX600-E, SMX800-DSC, SMX800-E		

			
1			
GEV No.	698385	Ref. No.	2841
description	bracket for grab handle L 40mm W 37mm thickness 1.5mm		
For models:	Dynamix		





			
1			
GEV No.	696507	Ref. No.	2854
description	bracket for motor plastic black		
For models:	Dynamix		

			
1			
GEV No.	698605	Ref. No.	0529
description	carbon for hand blender L 28mm W 9mm H 6mm suitable for DYNAMIC for model SMX		
For models:	SMX450, SMX500, SMX502, SMX600, SMX600-DSC, SMX600-E, SMX800-DSC, SMX800-E		

			
1			
GEV No.	696506	Ref. No.	2858
description	knob for PCB ø 26mm black Qty 1 pcs		

			
1			
GEV No.	698607	Ref. No.	9028
description	mixer coupling for hand blender L 25mm ø 17mm suitable for DYNAMIC for model MDH/MF/MFAP/PMDH/PMF/SMX		
For models:	MDH2000, MDH460, MF2000, MF90, MFAP2000, MFAP90, PMDH250, PMF250, SMX600-DSC, SMX800-DSC, SMX800-E		

			
1			
GEV No.	532648	Ref. No.	2859
description	O-ring EPDM thickness 1.5mm ID ø 5mm Qty 1 pcs		



			
1			
GEV No.	698384	Ref. No.	45710
description	protection cap for grab handle plastic black		
For models:	Dynamix, Master, MDH2000, MF2000, MFAP2000, MX2000, MX2000-DSC, SMX600-DSC, SMX600-E, SMX800-DSC, SMX800-E		

			
1			
GEV No.	699710	Ref. No.	9025
description	ring for ball bearing L 15mm thickness 15.5mm ø 30mm		
For models:	MDH2000, MDH460, MF2000, MF90, MFAP2000, MFAP90, MMX98, MX2000, MX2000-DSC, MX91, PMDH250, PMF250, PMX98		



			
1			
GEV No.	698383	Ref. No.	0632
description	shaft sealing ID ø 4mm ED ø 12mm for hand blender H 6.3mm		
For models:	Junior-Plus, Junior-Standard, MD95, MXP94		

for salad washers

			
1			
GEV No.	698255	Ref. No.	2808
description	gear wheel ø 41mm shaft intake ø 14mm W 38mm teeth 12 plastic tooth width 19mm		
For models:	E10, E20		
accessories for	698255		
	GEV No.	Ref. No.	
	698256	2815.1	
	gear wheel pair set shaft intake ø 14mm teeth 12/30 plastic tooth width 14mm for salad spinner		

			
1			
GEV No.	698254	Ref. No.	2806
description	gear wheel with roll pin ø 95mm shaft intake ø 14mm W 21mm teeth 30 plastic tooth width 14mm		
For models:	E10, E20		
accessories for	698254		
	GEV No.	Ref. No.	
	698256	2815.1	
	gear wheel pair set shaft intake ø 14mm teeth 12/30 plastic tooth width 14mm for salad spinner		



 <p>1</p>			
GEV No.	698256	Ref. No.	2815.1
description	gear wheel pair set shaft intake \varnothing 14mm teeth 12/30 plastic tooth width 14mm for salad spinner		
For models:	E10, E20		
spare parts for	698256		
	GEV No.	698254	Ref. No. 2806
	gear wheel with roll pin \varnothing 95mm shaft intake \varnothing 14mm W 21mm teeth 30 plastic tooth width 14mm		
	GEV No.	698255	Ref. No. 2808
	gear wheel \varnothing 41mm shaft intake \varnothing 14mm W 38mm teeth 12 plastic tooth width 19mm		

knobs

miscellaneous

 <p>1</p>			
GEV No.	696506	Ref. No.	2858
description	knob for PCB \varnothing 26mm black Qty 1 pcs		

gaskets

O-rings

EPDM

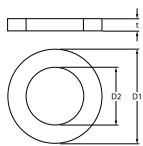
  <p>1</p>			
GEV No.	532648	Ref. No.	2859
description	O-ring EPDM thickness 1.5mm ID \varnothing 5mm Qty 1 pcs		

shaft gaskets

shaft gaskets

 <p>1</p>			
GEV No.	698383	Ref. No.	0632
description	shaft sealing ID \varnothing 4mm ED \varnothing 12mm for hand blender H 6.3mm		
For models:	Junior-Plus, Junior-Standard, MD95, MXP94		

transmission technology and ball bearings

ball bearings

deep-groove ball bearings 2RS

 <p>1</p>			
GEV No.	523501	Ref. No.	0601
description	deep-groove ball bearing type 608-2RS shaft \varnothing 8mm ED \varnothing 22mm W 7mm with sealing discs deep-groove ball bearing DIN 625-1		
For models:	Coupe-Legume, Dynacutter, FM90, FT79, FT86, FT97, Junior-Plus, MDH2000, MDH460, MF2000, MF90, MFAP2000, MFAP90, MMX92, MMX98, MX2000, MX2000-DSC, MX79, MX85, MX91, PMDH250, PMF250, PMX83, PMX98, PP84, PP97, PP97-Plus, SMX450, SMX500, SMX502, SMX600, SMX600-DSC, SMX600-E, SMX800-DSC, SMX800-E		

fastening material

fasteners

roll pins

 <p>1</p>			
GEV No.	691637	Ref. No.	0744
description	roll pin \varnothing 3mm L 20mm		
For models:	FT79, FT86, FT97, MDH2000, MDH460, MF2000, MF90, MFAP2000, MFAP90, PMF250		

F

fasteners	8
fastening material	8

M

motors	3
--------	---

O

O-rings	8
---------	---

R

roll pins	8
-----------	---

S

shaft gaskets	8
speed controllers	3
switches and momentary switches	3