



GAS COMPONENTS



ELECTRIC COMPONENTS



WATER TECHNOLOGY



MECHANICAL COMPONENTS



TOOLS

Spare parts suitable for

DUKERS

Find the complete and up-to-date range of products in our GEV Webshop



Manufacturer catalogue

The most important spare parts and accessories arranged clearly for every manufacturer

- ✓ Complete product range and all appliance data always up to date in the GEV Webshop
- ✓ Alphabetical Index at the end of the catalogue

GEV Webshop

www.gev-online.co.uk

www.gev-online.com



- 🔍 Add to Favourites
- 🔍 Sign In with email address and usual password
- 🔍 Easy-order – place several items in your basket at the same time
- 🔍 Quick Item search – no login needed



thermostats

refrigeration thermostats

miscellaneous producers



1

GEV No.	390997	Ref. No.	DQWA0002 HSC350-18
description	thermostat probe ø 3.4mm probe Lmm capillary pipe 770mm type WPF11-L for fridge 1NO 230V 50/60Hz		



1

GEV No.	390972	Ref. No.	DQWA0010 HSC360-37
description	thermostat temperature range°C probe ø 10mm probe L 24mm capillary pipe 660mm type WPF-45270 hole distance 55mm		

switches and momentary switches

rocker/momentary rocker switches

28x10mm



1

GEV No.	347804	Ref. No.	DQKC0000 GBC1001-21 GBC1002-22 GBC1003-22 HBC1002-22 HBC2003-22 HSC1002-22
description	rocker switch mounting measurements 28x10mm red 1NO 250V 15A 0-I connection male faston 6.3mm ambient temperature max. 85°C protection IP40		

ø20mm



1

GEV No.	347803	Ref. No.	DQKA0000 GSC1100-04 HSC800-37
description	rocker switch mounting measurements 20mm red 1NO 250V 15A 0-I connection male faston 4.8mm ambient temperature max. 85°C protection IP40		

GEV No.	347802	Ref. No.	GSC1336-05 GSC1336-5 GSC2336-05 GSC2336-5 HSC350-37 HSC360-31
description	rocker switch mounting ø 20mm red 1NO 250V 15A illuminated 0-I connection male faston 4.8mm ambient temperature max. 85°C protection IP40		

lamps

LED

LED bars



1

GEV No.	357257	Ref. No.	DQLED007 HSC350DD-23
description	LED bar L 1100mm W 14.4mm H 7.5mm 24VDC white number of lamps 36 cable length 120mm		



1

GEV No.	357256	Ref. No.	DQLED008 GSC1100G-27 HSC360G-21
description	LED bar L 1200mm W 14.4mm H 7.5mm 24VDC white number of lamps 42 cable length 120mm		



1

GEV No.	357251	Ref. No.	DQLED066 HBC1002-29
description	LED bar L 400mm W 12mm H 12mm 24V blue number of lamps 30 cable length 280mm		

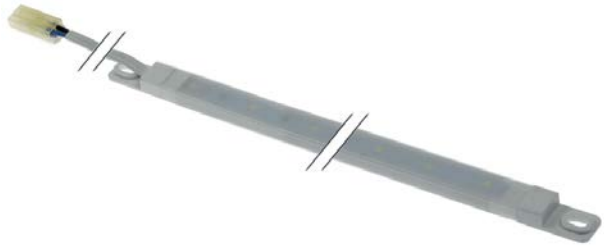
			
1			
GEV No.	357255	Ref. No.	DQLED011 HSC350DD-30
description	LED bar L 400mm W 14.4mm H 7.5mm 24VDC white number of lamps 18 cable length 380mm		

			
1			
GEV No.	357241	Ref. No.	DQLED067 HBC2003-29
description	LED bar L 600mm W 11.5mm H 12.5mm 24V number of lamps 42 cable length 285mm voltage DC		

			
1			
GEV No.	357258	Ref. No.	GSC1100G-29
description	LED bar L 900mm W 14.4mm H 7.5mm 24VDC white number of lamps 30 cable length 120mm		

fluorescent lamps

fluorescent lamps

G5

			
1			
GEV No.	357156	Ref. No.	DQDA0009 GBC1001-31
description	fluorescent lamp socket G5 L 285mm 8W ø 16mm 230V T5/865 Qty 1 pcs		

			
1			
GEV No.	357148	Ref. No.	DQDA0010 GBC1002-32 GBC1003-32
description	fluorescent lamp socket G5 L 547mm 14W ø 16mm 230V T5/865 Qty 1 pcs		

G13

			
1			
GEV No.	357145	Ref. No.	DQDA0012 GSC1336-22 GSC2336-22 HSC350-31
description	fluorescent lamp socket G13 L 438mm 15W ø 27mm 230V Qty 1 pcs light colour 865		

			
1			
GEV No.	357146	Ref. No.	DQDA0007 GSC1336-18 GSC2336-18 HSC350-24 HSC360-26 HSC800-26
description	fluorescent lamp socket G13 L 895mm 30W ø 26mm 230V T8/765 Qty 1 pcs		

			
1			
GEV No.	357147	Ref. No.	GSC1100-07
description	fluorescent lamp socket G13 L 895mm 30W ø 26mm 230V T8/765 Qty 1 pcs		

accessories

sockets

			
1			
GEV No.	381169	Ref. No.	GSC1100-42 GSC1336-43 GSC2336-43 HSC800-30 SLJY2010
description	lamp holder socket G13 L 26.5mm W 24.5mm Qty 1 pcs for fluorescent lamps		

			
1			
GEV No.	381447	Ref. No.	GBC1001-30 GBC1002-31 GBC1003-31 SLZA3000
description	lamp socket socket G13 L 33mm W 10mm H 28mm		



 <p>1</p>			
GEV No.	381413	Ref. No.	GSC1100-08 HSC350-28 HSC360-28 SLZA2000
description	lamp socket socket G13 L 37.5mm W 28.5mm Qty 1 pcs for fluorescent lamps		

starter holders

 <p>1</p>			
GEV No.	381170	Ref. No.	GBC1001-27 GBC1002-28 GBC1003-28 GSC1100-44 GSC1336-21 GSC2336-21 HSC350-34 HSC360-08 HSC800-35 SLZA1000
description	starter holder L 32mm W 24mm housing ø 23mm Qty 1 pcs		

starter

 <p>1</p>			
GEV No.	380464	Ref. No.	DQDF0000 GBC1001-26 GBC1002-27 GBC1003-27 GSC1100-45 GSC1336-20 GSC2336-20 HSC350-33 HSC360-09
description	starter 4-65W		

ballasts

 <p>1</p>			
GEV No.	403192	Ref. No.	DQZB0005 GBC1002-18 GBC1003-18
description	electrical ballast 15W 220-240V connection screw clamp for fluorescent lamps type JF-1595M Qty 1 pcs		

 <p>1</p>			
GEV No.	403190	Ref. No.	DQZA0027 GSC1100-35 GSC1336-35 HSC800-31
description	electrical ballast 30W 220-240V connection screw clamp for fluorescent lamps type JF-3095W Qty 1 pcs		

 <p>1</p>			
GEV No.	358134	Ref. No.	DQZA0024 GSC1336-23 GSC2336-23 HSC360-06
description	electrical ballast 76W 230V connection screw clamp for fluorescent lamps type JF-1595W Qty 1 pcs		

 <p>1</p>			
GEV No.	403191	Ref. No.	DQZB0029 GBC1001-17
description	electrical ballast 9W 220V connection screw clamp for fluorescent lamps type JF-995M Qty 1 pcs		

covers

 <p>1</p>			
GEV No.	699314	Ref. No.	GBC1001-32 SLZV0017
description	cover L 510mm W 30mm H 30mm		

 <p>1</p>			
GEV No.	694873	Ref. No.	HSC350-40 SLSE2008
description	cover L 590mm W 280mm H 1mm		

 <p>1</p>			
GEV No.	699312	Ref. No.	GBC1002-33 GBC1003-33 SLZV0018
description	cover L 810mm W 30mm H 30mm transparent		



			
1			
GEV No.	694874	Ref. No.	GSC1100-03 GSC1100-05 HSC350-38 SLZQ0037
description	cover set mounting pos. left/right W 82mm H 280mm D 34		
spare parts for	694874		
	GEV No.	Ref. No.	—
			bezel for cover mounting pos. right/left W 82mm H 280mm D 34mm plastic Qty 1 pcs
	GEV No.	Ref. No.	—
			bezel for cover mounting pos. left W 82mm H 280mm D 34mm plastic Qty 1 pcs

			
1			
GEV No.	694872	Ref. No.	HSC350-36 SLJV2040
description	cover support L 610mm W 20mm H 55mm mounting pos. lower		

			
1			
GEV No.	694871	Ref. No.	HSC350-41 SLJV2041
description	cover support L 610mm W 20mm H 55mm mounting pos. upper		

			
1			
GEV No.	699307	Ref. No.	HSC360-24 SLZE0061
description	end cap L 60mm W 40mm H 10mm for lamp		

			
1			
GEV No.	694870	Ref. No.	HSC350-23 SLJY2016
description	housing L 131.5mm W 45mm H 40mm		

relays

power relays

with bracket mounting

			
1			
GEV No.	380867	Ref. No.	DQWBZJ02 HSC800-22
description	relay SHANGFANG 12VDC 30A 1NO connection male faston 6.3mm screw mounting at 250V 30A manuf. no. 855AW-1A-C1		

transformers

encapsulated transformers

			
1			
GEV No.	379054	Ref. No.	HSC800-23
description	transformer primary 230VAC secondary 12VAC 3VA secondary 0.25A H 40mm L 45mm W 50mm connection screw 50/60Hz type 153/M		

miscellaneous

			
1			
GEV No.	403660	Ref. No.	DQLED069 HBC1002-18 HBC2003-18
description	transformer primary 100-240V secondary 24VDC 20VA secondary 0.84A		

			
1			
GEV No.	403867	Ref. No.	DQLED042 DQLED055 GSC1100G-31 GSC1100G-32 HSC350DD-32 HSC350DD-33 HSC360G-06
description	transformer primary 100-240V secondary 24VDC secondary 0.42A H 25mm L 95mm W 40mm		



electronic controllers

SHANGFANG

refrigeration controllers

built-in version



1

GEV No.	379799 ¹	Ref. No.	DQWBZX02 GSC1100-22 GSC1336-11 GSC2336-11 HSC800-52
description	electronic controller SHANGFANG type SF-104S-2 mounting measurements 71x29mm 12V voltage AC NTC relay outputs 2 12VDC 12VDC NTC front measurements 77x35mm built-in depth 40mm protection IP54 accuracy 1% built-in version alarm without accessories defr. funct. yes -45 up to +45°C display 3 digits		
spare parts for	379799		
	GEV No.	379054	Ref. No. HSC800-23
	transformer primary 230VAC secondary 12VAC 3VA secondary 0.25A H 40mm L 45mm W 50mm connection screw 50/60Hz type 153/M		
	GEV No.	380867	Ref. No. DQWBZJ02 HSC800-22
	relay SHANGFANG 12VDC 30A 1NO connection male faston 6.3mm screw mounting at 250V 30A manuf. no. 855AW-1A-C1		
	GEV No.	381318	Ref. No. —
	temperature probe NTC cable silicone cable colours white cable length 3m probe -40 up to +110°C cable -50 up to +180°C probe ø7x25mm coded plug		
	GEV No.	381319	Ref. No. —
	temperature probe NTC cable silicone cable colours black cable length 3m evaporator probe -40 up to +110°C cable -50 up to +180°C probe ø7x25mm coded plug		
accessories for	379799		
	GEV No.	379054	Ref. No. HSC800-23
	transformer primary 230VAC secondary 12VAC 3VA secondary 0.25A H 40mm L 45mm W 50mm connection screw 50/60Hz type 153/M		
	GEV No.	380867	Ref. No. DQWBZJ02 HSC800-22
	relay SHANGFANG 12VDC 30A 1NO connection male faston 6.3mm screw mounting at 250V 30A manuf. no. 855AW-1A-C1		
	GEV No.	381318	Ref. No. —
	temperature probe NTC cable silicone cable colours white cable length 3m probe -40 up to +110°C cable -50 up to +180°C probe ø7x25mm coded plug		
	GEV No.	381319	Ref. No. —
	temperature probe NTC cable silicone cable colours black cable length 3m evaporator probe -40 up to +110°C cable -50 up to +180°C probe ø7x25mm coded plug		

¹without relay, cable harness, probe and transformer

built-in version 2-piece









1

GEV No.	378531	Ref. No.	HBC1002-19 HBC2003-19
description	electronic controller SHANGFANG type SF-101S mounting measurements 71x29mm 230V voltage AC NTC relay outputs 1 NO-30A NTC Comp front measurements 77x35mm built-in depth 40mm protection IP54 accuracy 1% built-in version alarm incl. relay, cable harness, probe and transformer defr. funct. yes -45 up to +45°C display 3 digits		



71 x 29mm

1

GEV No.	379849 ¹	Ref. No.	DQWB0005 GBC1001-18 GBC1002-19 GBC1003-19
description	electronic controller SHANGFANG type SF-101S mounting measurements 71x29mm 230V voltage AC NTC relay outputs 1 NO-30A NTC Comp front measurements 77x35mm built-in depth 40mm protection IP54 accuracy 1% built-in version alarm incl. relay, cable harness, probe and transformer defr. funct. yes -45 up to +45°C display 3 digits		
spare parts for	379849		
	GEV No.	379054	Ref. No. HSC800-23
	transformer primary 230VAC secondary 12VAC 3VA secondary 0.25A H 40mm L 45mm W 50mm connection screw 50/60Hz type 153/M		
	GEV No.	380867	Ref. No. DQWBZJ02 HSC800-22
	relay SHANGFANG 12VDC 30A 1NO connection male faston 6.3mm screw mounting at 250V 30A manuf. no. 855AW-1A-C1		
	GEV No.	381318	Ref. No. —
	temperature probe NTC cable silicone cable colours white cable length 3m probe -40 up to +110°C cable -50 up to +180°C probe ø7x25mm coded plug		
	GEV No.	381319	Ref. No. —
	temperature probe NTC cable silicone cable colours black cable length 3m evaporator probe -40 up to +110°C cable -50 up to +180°C probe ø7x25mm coded plug		
accessories for	379849		
	GEV No.	379054	Ref. No. HSC800-23
	transformer primary 230VAC secondary 12VAC 3VA secondary 0.25A H 40mm L 45mm W 50mm connection screw 50/60Hz type 153/M		
	GEV No.	380867	Ref. No. DQWBZJ02 HSC800-22
	relay SHANGFANG 12VDC 30A 1NO connection male faston 6.3mm screw mounting at 250V 30A manuf. no. 855AW-1A-C1		
	GEV No.	381318	Ref. No. —
	temperature probe NTC cable silicone cable colours white cable length 3m probe -40 up to +110°C cable -50 up to +180°C probe ø7x25mm coded plug		

¹incl. relay, cable harness, probe and transformer

Table continues overleaf

accessories for 379849			
GEV No.	381319	Ref. No.	—
 temperature probe NTC cable silicone cable colours black cable length 3m evaporator probe -40 up to +110°C cable -50 up to +180°C probe ø7x25mm coded plug			



GEV No.	403074 ¹	Ref. No.	DQWB0002 GSC1100-25 GSC1336-12 GSC2336-12
----------------	---------------------	-----------------	--

description electronic controller SHANGFANG type SF-104S-2 mounting measurements 71x29mm 230V voltage AC NTC relay outputs 2 NO-30A NO-30A NTC NTC front measurements 77x35mm built-in depth 38mm protection IP54 accuracy 1% built-in version alarm incl. relay, cable harness, probe and transformer defr. funct. yes -45 up to +45°C display 2½ digit

spare parts for 403074

	GEV No.	379054	Ref. No.	HSC800-23
transformer primary 230VAC secondary 12VAC 3VA secondary 0.25A H 40mm L 45mm W 50mm connection screw 50/60Hz type 153/M				

	GEV No.	380867	Ref. No.	DQWBZJ02 HSC800-22
relay SHANGFANG 12VDC 30A 1NO connection male faston 6.3mm screw mounting at 250V 30A manuf. no. 855AW-1A-C1				

GEV No.	381318	Ref. No.	—
---------	--------	----------	---

 temperature probe NTC cable silicone cable colours white cable length 3m probe -40 up to +110°C cable -50 up to +180°C probe ø7x25mm coded plug

GEV No.	381319	Ref. No.	—
---------	--------	----------	---

 temperature probe NTC cable silicone cable colours black cable length 3m evaporator probe -40 up to +110°C cable -50 up to +180°C probe ø7x25mm coded plug

accessories for 403074

	GEV No.	379054	Ref. No.	HSC800-23
transformer primary 230VAC secondary 12VAC 3VA secondary 0.25A H 40mm L 45mm W 50mm connection screw 50/60Hz type 153/M				

	GEV No.	380867	Ref. No.	DQWBZJ02 HSC800-22
relay SHANGFANG 12VDC 30A 1NO connection male faston 6.3mm screw mounting at 250V 30A manuf. no. 855AW-1A-C1				

GEV No.	381318	Ref. No.	—
---------	--------	----------	---

 temperature probe NTC cable silicone cable colours white cable length 3m probe -40 up to +110°C cable -50 up to +180°C probe ø7x25mm coded plug

GEV No.	381319	Ref. No.	—
---------	--------	----------	---

 temperature probe NTC cable silicone cable colours black cable length 3m evaporator probe -40 up to +110°C cable -50 up to +180°C probe ø7x25mm coded plug

¹incl. relay, cable harness, probe and transformer

accessories

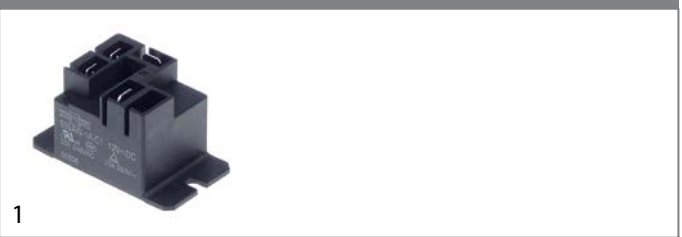

GEV No.	380867	Ref. No.	DQWBZJ02 HSC800-22
description	relay SHANGFANG 12VDC 30A 1NO connection male faston 6.3mm screw mounting at 250V 30A manuf. no. 855AW-1A-C1		



GEV No.	379054	Ref. No.	HSC800-23
description	transformer primary 230VAC secondary 12VAC 3VA secondary 0.25A H 40mm L 45mm W 50mm connection screw 50/60Hz type 153/M		

miscellaneous

refrigeration controllers



GEV No.	379848	Ref. No.	GBC1001-19 GBC1002-20 GBC1003-20
description	electronic controller ZHONGSHAN SHANGFANG INSTRUMENT type SF-101 mounting measurements 71x29mm 12V display 3 digits relay outputs 1		



compressors

ACC/ZEL

R600A

LBP monophase

Lower evaporation temperature below -20°C



1			DQYD0015 GBC1002-15 GBC1003-15 GSC2336-33 HBC1002-15
GEV No.	605141	Ref. No.	
description	compressor coolant R600a type HPY12AAa 220-240V 50Hz LBP 8.8kg 1/5HP cylinder capacity 12cm ³ RSIR H 200mmWWWWWWWWWW		



1			DQYD0014 GBC1001-14
GEV No.	605142	Ref. No.	
description	compressor coolant R600a type HVM86AA 220-240V 50Hz LBP fully hermetic 7.83kg 1/7HP cylinder capacity 8.6cm ³ RSIR H 174mmWWWW		

miscellaneous

R134A



1			
GEV No.	605240	Ref. No.	HSC800-07
description	compressor HuaGuang coolant R134a type AN150ML 220-240V 50Hz LBP 10.5kg 1/2HP cylinder capacity 15.1cm ³ CSIR H 180mmWWWWWWWWWW		



1			DQYA0009 HBC2003-15
GEV No.	605239	Ref. No.	
description	compressor HuaGuang coolant R134a type ANA90 220-240V 50Hz 10.5kgHP power input 255W cylinder capacitycm ³ H 180mmWWWWWWWWWW		



1			DQYA0014 HSC350-07 HSC350-7 HSC360-11
GEV No.	605245	Ref. No.	
description	compressor HuaGuang coolant R134a type ATA72XL 220-240V 50/60Hz 7.2kg 1/5HP cylinder capacity 7cm ³ H 160mmWWWWWWWWWW		

→ electric components



1

GEV No.	605140	Ref. No.	DQYA0087 GSC1100-28 GSC1336-33
description	compressor KONOR type GQR90AA coolant R134a 220-240V 50Hz 10.1kg 1/4HP cylinder capacity 9.1cm ³ RSIR H 186mm W W W W W W W W W W		

R290A



1

GEV No.	605271	Ref. No.	GSC1100G-08
description	compressor HuaGuang coolant R290 type FN90M 220-240V 50Hz LBP 11kg 1HP CSIR		

R600A



1

GEV No.	605272	Ref. No.	DQYD0009 HSC350DD-07 HSC360G-08
description	compressor HuaGuang coolant R600 type ETA110 220-240V 50Hz LBP 8kg 1/4HP RSIR		

fans

axial fans

import



1

GEV No.	601787 ¹	Ref. No.	DQFA1000 DQFD1000 DQFD1001 GBC1001-07 GBC1001-35 GBC1002-36 GBC1003-36 GSC1100-17 GSC1336-15 GSC2336-15 HBC1002-33 HSC350-42 HSC360-30 HSC800-44
description	axial fan L 119mm W 119mm H 38mm 230VAC 50/60Hz 22/38.4W bearing slide bearing manif. no. HT-A12038S220 connection plug cable length 300mm HUI TONG fan wheel ø 110mm input current 0.1/0.16A housing aluminium		

¹with slide bearings





1

GEV No.	602136	Ref. No.	DQFD2003 HBC2003-33
description	axial fan L 119mm W 119mm H 38mm 230VAC 50/60Hz 22/38.4W bearing slide bearing manif. no. HT-A12038S220 connection with cable 500mm cable length 300mm HUI TONG fan wheel ø 110mm input current 0.1/0.16A housing aluminium		





accessories			
fan guards			
			
1			
GEV No.	691104	Ref. No.	GBC1001-36 GBC1002-37 GBC1003-37 GSC1336-13 GSC2336-13 HBC1002-34 HBC2003-34 HSC350-43 WJFZ0007
description	guard ø 115mm mounting distance 105mm for axial fan 119mm		

			
1			
GEV No.	601835	Ref. No.	DQJB2013 GSC1100-26 HL-YJF10
description	fan 220V 35/5W 50/60Hz L 82mm W 82mm connection spate terminal M4 cable length 1100mm		
spare parts for	601835		
	GEV No.	602184	Ref. No. —
description	fixing plate suitable for fanwheel ED ø 33mm shaft ø 6 mounting distance 17mm		

refrigeration fans			
refrigeration motors universal			
miscellaneous			
			
1			
GEV No.	602164	Ref. No.	GSC1100G-07
description	fan motor 10W 220-240V 50-60Hz L2 65mm L3 81mm W 82mm cable length 1200mm 1300/1500rpm HL-YJF10		

accessories universal			
			
1			
GEV No.	699309	Ref. No.	HSC360-35 WJFZ0008
description	guard ø 194mm hole distance 208mm		

cooling motors (complete)			
			
1			
GEV No.	601836	Ref. No.	DQJB2004 GBC1002-07 GBC1003-07 HBC1002-07 HBC2003-07 HSC800-19
description	fan 220V 25/3W 50/60Hz fan wheel ø 172mm L 82mm W 82mm connection spate terminal M4 cable length 1000mm		

electric accessories			
cables			
power supply cables			
			
1			
GEV No.	551217	Ref. No.	DQXA6002 GBC1001-15 GBC1002-16 GBC1003-16 GSC1100-34 GSC1336-30 GSC2336-30 HBC1002-16 HBC2003-16 HSC350-05 HSC360-05
description	power lead CEE7/7 type E+F 3-pole contacts P+N+E 0.75mm ² max. 16A 2.2m with strain relief 16A Qty 1 pcs white		



connection cables

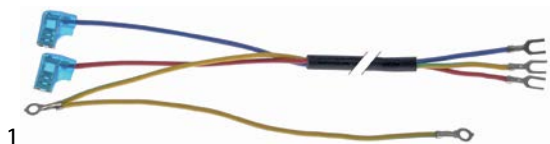

1

GEV No.	699304	Ref. No.	DQXB9019 GBC1001-20 GBC1002-21 GBC1003-21 HBC1002-21 HBC2003-21
description	connection cable L 360mm 3-pole		

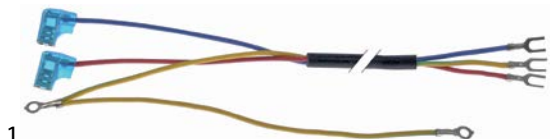

1

GEV No.	699305	Ref. No.	DQXB2003 GSC1336-31 GSC2336-31 HSC350-03 HSC360-03
description	connection cable L 650mm 3-pole		

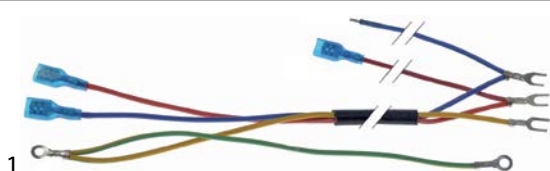

1

GEV No.	699306	Ref. No.	DQXB4003 HSC800-02
description	connection cable L 665mm 3-pole		

terminal boxes



1

GEV No.	551216	Ref. No.	GBC1001-16 GBC1002-17 GBC1003-17 GSC2336-35 HBC1002-17 HBC2003-17 HSC350-06 HSC360-10 HSC800-21 SLZB3001
description	terminal box 4-pole L 90mm W 52mm H 33mm with strain relief 250V 1mm ² Qty 1 pcs		

equipment-specific units

for fridges

drain systems

drain valves



1

GEV No.	692441	Ref. No.	GSC1100-48
description	drain fitting L 45mm plastic H 38mm W 28mm hose ø 10mm Qty 1 pcs		

spare parts and accessories



1

GEV No.	694868	Ref. No.	HSC350-11
description	bracket for dryer L 40mm W 30mm H 31mm Qty 1 pcs		



1

GEV No.	694869	Ref. No.	HSC350-17
description	cover L 153mm W 57mm H 110mm plastic Qty 1 pcs mounting distance 125mm		



1

GEV No.	694967	Ref. No.	HSC360G-22 SLCX0002
description	cover L 51mm W 44mm H 12mm plastic mounting distance 30mm		



			
1			
GEV No.	698878	Ref. No.	HBC1002-47 HBC2003-46 WJQZ9000 WJQZ9001
description	guide counterweight for sliding door L 248mm W 20mm H 10mm		

			
1			
GEV No.	694594	Ref. No.	GSC1336-03 GSC2336-03
description	cover for lighting W 615mm H 180mm plate thickness max. 1mm plexiglas white Qty 1 pcs		

			
1			
GEV No.	698890	Ref. No.	HBC2003-25 PTBP9N88
description	cover L 1350mm W 65mm H 52mm Qty 1 pcs		

housing and bezels

covers

			
1			
GEV No.	694596	Ref. No.	GSC1336-04 GSC1336-4 GSC2336-04 GSC2336-4
description	bezel for lighting L 185mm W 72mm H 15mm mounting pos. left Qty 1 pcs		

			
1			
GEV No.	694969	Ref. No.	GSC1100G-28
description	cover L 1420mm W 127mm H 30mm		

lids

			
1			
GEV No.	698886	Ref. No.	HSC800-16
description	cover for compressor white L 1005mm W 325mm H 45mm Qty 1 pcs		

			
1			
GEV No.	694595	Ref. No.	GSC1336-02 GSC2336-02
description	bezel for lighting L 185mm W 72mm H 15mm mounting pos. right Qty 1 pcs		

handles

			
1			
GEV No.	692390	Ref. No.	GSC1100-12 GSC1336-45 GSC2336-45 LCCG0005
description	handle rod for door L 380mm W 40mm aluminium Qty 1 pcs		

			
1			
GEV No.	698891	Ref. No.	HBC1002-25 PTBP9N76
description	cover for compressor L 900mm W 65mm H 52mm Qty 1 pcs		

miscellaneous

			
1			
GEV No.	698889	Ref. No.	HBC800-29
description	cover for lamp transparent L 1500mm W 56mm H 20mm plastic		

			
1			
GEV No.	694859	Ref. No.	HSC800-40
description	cover for lighting L 970mm W 280mm plexiglas thickness 1mm		

			
1			
GEV No.	692392	Ref. No.	GSC1100-02 SLSE4005
description	cover for lighting W 1170mm H 280mm thickness 1mm plastic Qty 1 pcs		



1

GEV No.	694875	Ref. No.	HSC350-19 SLZE0026
description	cover for thermostat		



1

GEV No.	692391	Ref. No.	GSC1336-24 GSC2336-24 HSC350-39 HSC800-39 SLZE0027
description	housing for bulb socket L 150mm W 40mm H 20mm plastic Qty 1 pcs		

doors

doors



1

GEV No.	698989	Ref. No.	BLGM2B12 HSC350-46
description	glass door L 1350mm W 620mm		



1

GEV No.	699381	Ref. No.	BLGM4010 GSC1100-15
description	glass door left W 600mm H 1330mm D 40mm		



1

GEV No.	699382	Ref. No.	BLGM4011 GSC1100-16
description	glass door right W 600mm H 1330mm D 40mm		



GEV No.	699375	Ref. No.	BLGM4160 HSC800-51
description	glass door W 460mm H 1230mm mounting pos. left D 30mm		



GEV No.	699377	Ref. No.	GSC1336-07 GSC2336-07
description	glass door W 620mm H 1380mm with handle D 40mm		



GEV No.	699376	Ref. No.	BLGM4161 HSC800-49
description	glass door W 460mm H 1230mm mounting pos. right D 30mm		



GEV No.	699374	Ref. No.	BLPM2033 HSC360-40
description	glass door W 620mm H 1600mm D 40mm		



GEV No.	699494	Ref. No.	BLGM4024 HSC350DD-47
description	glass door W 620mm H 680mm D 38mm mounting pos. upper		
spare parts for	699494		
	GEV No.	902465	Ref. No. HSC350DD-46 HSC350DD-49 SLJP2015
refrigeration gasket profile 9161 W 590mm L 650mm plug size			



GEV No.	699493	Ref. No.	BLGM4025 HSC350DD-51
description	glass door with lock W 620mm H 680mm D 38mm mounting pos. lower		
spare parts for	699493		
	GEV No.	902465	Ref. No. HSC350DD-46 HSC350DD-49 SLJP2015
refrigeration gasket profile 9161 W 590mm L 650mm plug size			

miscellaneous



GEV No.	701431	Ref. No.	HSC360-22 WJLD0000
description	bracket for glass door L 54mm W 42mm H 75mm hole \varnothing 7x12mm Qty 1 pcs		

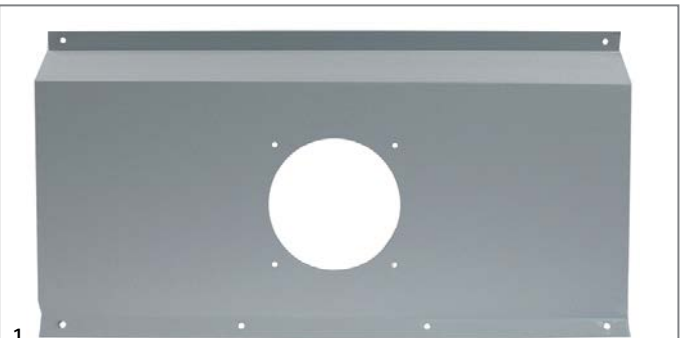

GEV No.	694867	Ref. No.	HSC350-29 PTBP2020
description	cover for evaporator L 525mm W 280mm H 53mm plate Qty 1 pcs		

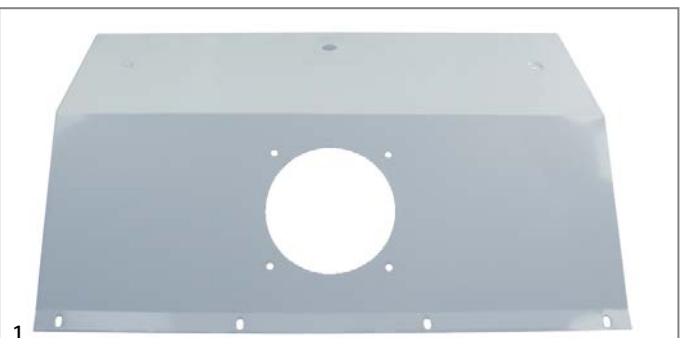



GEV No.	694597	Ref. No.	GSC1336-14 GSC2336-14
description	cover for evaporator L 525mm W 345mm H 115mm plate Qty 1 pcs		



GEV No.	692424	Ref. No.	GSC1336-19 GSC2336-19 HSC350-25 SLZV0007
description	cover for lighting mounting pos. inner L 1263mm W 56mm H 20mm plastic Qty 1 pcs		



			
1			
GEV No.	698888	Ref. No.	HBC1002-30 HBC2003-30 SLZV0019
description	cover transparent for lamp L 810mm W 40mm H 30mm Qty 1 pcs		

			
1			
GEV No.	692426	Ref. No.	GSC1336-38 GSC2336-38 HSC350-26 LCCJ2029
description	guide for fridge L 1145mm W 26mm H 4.5mm Qty 1 pcs		

			
1			
GEV No.	698877	Ref. No.	HSC800-28 LCCCK0001
description	shelf support L 26.5mm W 8.5mm H 40mm aluminium		

for display coolers

housing and bezels

fascias

			
1			
GEV No.	692733	Ref. No.	HSC360-27 SLJX2014
description	cover for lamp W 55mm H 20mm L 1040mm		

housings

			
1			
GEV No.	699298	Ref. No.	HSC800-38
description	side panel mounting pos. upper for lamp W 40mm H 80mm L 280mm plastic		

miscellaneous

			
1			
GEV No.	699310	Ref. No.	HSC800-47
description	cover L 500mm W 40mm thickness 0.5mm		

			
1			
GEV No.	699315	Ref. No.	HBC1002-39 HBC2003-39 SLZE0042
description	fixing plate for evaporator L 55mm W 27mm H 6mm		

doors

			
1			
GEV No.	699379	Ref. No.	GBC1002-49 GBC1003-49
description	glass door W 440mm H 770mm D 25mm		

			
1			
GEV No.	698973	Ref. No.	BLGM9S01 HBC1002-44
description	glass door W 440mm H 770mm mounting pos. right		



1

GEV No.	699378	Ref. No.	GBC1002-47 GBC1003-47
description	glass door W 440mm H 770mm with catch D 25mm		



1

GEV No.	698969	Ref. No.	BLGM9S57 HBC2003-48
description	glass door W 450mm H 770mm mounting pos. left		



1

GEV No.	698972	Ref. No.	BLGM9S00 HBC1002-45
description	glass door W 440mm H 770mm with lock mounting pos. left		
accessories for	698972		



GEV No.	902210	Ref. No.	HBC2003-52 JNMA0000
description	gasket L 930mm Qty 1 dimensions 5x6mm		



1

GEV No.	698970	Ref. No.	BLGM9S5M GBC1003-48 HBC2003-49
description	glass door W 450mm H 770mm with lock mounting pos. centre		



1

GEV No.	698971	Ref. No.	BLGM9S52 HBC2003-50
description	glass door W 440mm H 770mm with lock mounting pos. right		



1

GEV No.	699380	Ref. No.	GBC1001-44
description	glass door W 600mm H 800mm D 30mm		

door mechanics

miscellaneous



1

GEV No.	694928	Ref. No.	HBC1002-48 HBC2003-44 WJXC0000
description	door magnet L 46mm W 16mm H 14.5mm		



 <p>1</p>			
GEV No.	694929	Ref. No.	HBC1002-49 HBC2003-45 WJXG000
description	plate for magnet L 45mm W 12mm H 1.5mm mounting distance 32mm		

knobs

miscellaneous

 <p>1</p>			
GEV No.	692677	Ref. No.	HSC350-20 SLZI0001
description	knob ø 26mm grey zero mark for thermostat shaft diameter 6x4mm Qty 1		

handles and hand wheels

handle rails

handle rails

 <p>1</p>			
GEV No.	699449	Ref. No.	HSC350DD-48 HSC350DD-52 SLZB0020
description	handle rail for fridge L 220mm W 36mm H 23mm grey hole distance 120mm		

 <p>1</p>			
GEV No.	698869	Ref. No.	HSC800-50 SLZB0037
description	handle rail thread M4 L 300mm		

locks

locking devices

producer-specific

DUKERS

 <p>1</p>			
GEV No.	692395	Ref. No.	GSC1100-32
description	key cylinder ø 14mm rotation 90° cam length 43mm cam width 12mm Qty 1 pcs		

 <p>1</p>			
GEV No.	692423	Ref. No.	GSC1336-10 GSC2336-10 HSC360-41 WJSB0000
description	key cylinder with lever ø 18mm thread M18x1.25 rotation 90° cam length 53.5mm cam width 17mm Qty 1 pcs		

hinges

door bearing

 <p>1</p>			
GEV No.	692396	Ref. No.	GSC1100-11
description	bush L 25mm ø 12mm ID ø 9.4mm transparent for door hinge Qty 1 pcs		

 <p>1</p>			
GEV No.	701280	Ref. No.	GSC1100-10 WJMA4002
description	door hinge L 42mm W 33mm H 82mm mounting pos. bottom right/ left set Qty 1 pcs		

 <p>1</p>			
GEV No.	701281	Ref. No.	GSC1100-13 WJMA4005
description	door hinge L 43mm W 82mm H 71mm mounting pos. upper right/ left set Qty 1 pcs		

 <p>1</p>			
GEV No.	694927	Ref. No.	HSC360-29
description	hinge L 105mm W 52mm H 34mm bolt 17mm bolt ø 7mm		

 <p>1</p>			
GEV No.	701284	Ref. No.	GBC1001-43 GBC1002-46 GBC1003-46
description	hinge L 39mm W 39mm H 23mm Qty 1 pcs		

			
1			
GEV No.	694968	Ref. No.	HSC350DD-25 WJMA2020
description	hinge L 77mm W 19mm H 42mm mounting distance 27mm mounting distance 2 27mm mounting pos. centre thickness 3mm bolt 18/22mm bolt ø 7mm		

			
1			
GEV No.	694926	Ref. No.	HSC360-23 WJMA2012
description	hinge L 82mm W 42mm H 50mm mounting pos. lower bolt 19mm bolt ø 9mm		

			
1			
GEV No.	694592	Ref. No.	GSC1336-08 GSC1336-8 GSC2336-08 GSC2336-8
description	hinge L 82mm W 42mm H 50mm mounting pos. lower with bolt Qty 1 pcs		

			
1			
GEV No.	694866	Ref. No.	HSC350-22 WJMA2003
description	hinge mounting pos. lower L 82mm W 53mm H 43mm mounting distance 30mm mounting distance 2 56mm thickness 4mm bolt 20mm bolt ø 7mm		

			
1			
GEV No.	694865	Ref. No.	HSC350-32 WJMA0004
description	hinge mounting pos. upper L 50mm W 33mm H 42mm mounting distance 27mm thickness 3mm bolt 32.5mm bolt ø 9mm Qty 1kg		

			
1			
GEV No.	694593	Ref. No.	GSC1336-06 GSC1336-6 GSC2336-06 GSC2336-6
description	hinge mounting pos. upper with bolt Qty 1 pcs		

equipment feet and end caps

screw-in feet

			
1			
GEV No.	701279	Ref. No.	GBC1001-23 GBC1002-24 GBC1003-24 HSC350-14 HSC360-18 WJLB0008
description	equipment foot thread M8 thread L 22mm ø 35mm H 38mm Qty 1 pcs		

miscellaneous

with fixing plate

ø30mm

			
1			
GEV No.	701277 ¹	Ref. No.	GSC1336-42 GSC2336-42 HBC1002-24 HBC2003-24 WJLA1001 WJLA1009
description	swivel castor 2 with & 2 without brake ø 30mm plate fixing housing zinc-plated sheet steel plate size 61x51mm hole distancemm capacity 60kg bearing slide bearing wheel body PVC tread PVC H 44mm wheel width 23.5mm		

¹with swivel brake

			
1			
GEV No.	701523	Ref. No.	HSC350-13 HSC360-17 WJLA2001
description	swivel castor ø 31mm plate fixing H 45mm wheel width 22.5mm Qty 1 pcs		



ø75mm

1

GEV No.	701282	Ref. No.	GSC1100-30 HSC800-14 WJLA1002
description	swivel castor set 2 with & 2 without brake ø 75mm plates fixing 102x83mm housing zinc-plated sheet steel hole distance 55/75mm bearing slide bearing H 112mm wheel width 31mm Qty 4 pcs		

shelves and shelf rails

grates

universal

without upstand

1

GEV No.	970801	Ref. No.	GBC1003-43 HBC2003-40 WJGA9008
description	grate W 345mm D 400mm chrome-plated steel wire gauge frame 6mm lengthwise wires gauge 2.5mm crossing wires 4 Qty 1 pcs		

1

GEV No.	970800	Ref. No.	GBC1001-41 WJGA9002
description	grate W 345mm D 500mm chrome-plated steel wire gauge frame 6mm lengthwise wires gauge 2.5mm crossing wires 4 Qty 1 pcs		

1

GEV No.	970906	Ref. No.	GBC1002-43 GBC1003-43A GBC1003-43C HBC1002-40 WJGA9005
description	grate W 400mm D 345mm chrome-plated steel wire gauge frame 6mm crossing wires 4		

producer-specific

1

GEV No.	970921	Ref. No.	GSC1336-40 GSC2336-40 HSC350-44 WJGA2010
----------------	--------	-----------------	---

description	grate W 500mm D 425mm H 38mm plastic-coated steel wire gauge frame 6.5mm lengthwise wires gauge 2.5mm crossing wires 6 white Qty 1kg		
--------------------	--	--	--

1

GEV No.	970910	Ref. No.	HSC360-38
----------------	--------	-----------------	-----------

description	grate W 530mm D 380mm H 40mm plastic-coated steel wire gauge frame 6mm lengthwise wires gauge 3mm crossing wires 23		
--------------------	---	--	--

1

GEV No.	970799	Ref. No.	GSC1100-09 WJGA4078
----------------	--------	-----------------	------------------------

description	grate W 540mm D 505mm H 41mm plastic-coated steel wire gauge frame 6mm lengthwise wires gauge 3mm crossing wires 3 white Qty 1 pcs		
--------------------	--	--	--

accessories

1

GEV No.	699311	Ref. No.	HSC800-46
----------------	--------	-----------------	-----------

description	profile L 400mm W 28mm H 15mm for grate		
--------------------	---	--	--

shelf rails and supports

producer-specific

1

GEV No.	698870	Ref. No.	GBC1001-25 GBC1002-26 GBC1003-26 HBC1002-26 HBC2003-26 LCCJ2001
----------------	--------	-----------------	--

description	guide L 390mm W 25mm mounting pos. left/right inner height 4mm		
--------------------	--	--	--

gaskets

refrigeration gaskets

plug-in gaskets

profile 9161

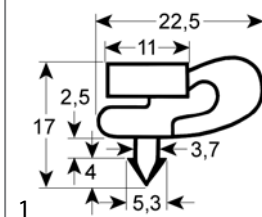

GEV No.	902208	Ref. No.	HSC360-39 SLJP2025
description	refrigeration gasket profile 9161 W 590mm L 1540mm plug size		

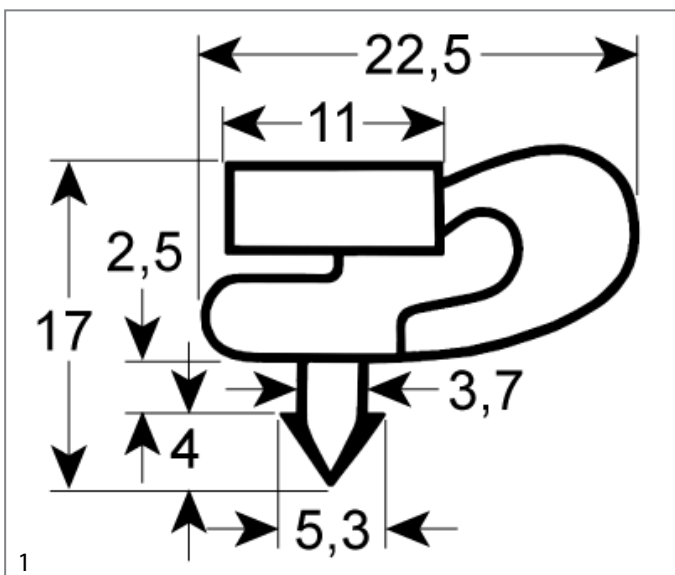

GEV No.	902465	Ref. No.	HSC350DD-46 HSC350DD-49 SLJP2015
description	refrigeration gasket profile 9161 W 590mm L 650mm plug size		

profile 9156

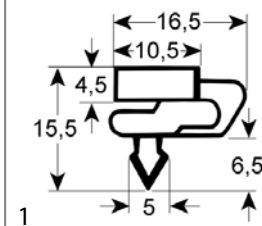

GEV No.	901662	Ref. No.	GSC1100-14 GSC1100-14 (569x1295) SLJP4007
description	door seal profile 9156 W 569mm L 1295mm plug size Qty 1 pcs		



GEV No.	701278	Ref. No.	GSC1100-37
description	rack L 1290mm W 26mm hole distance 22mm Qty 1 pcs aperture 10x10mm		



GEV No.	698887	Ref. No.	HSC800-27
description	rack L 1400mm W 25mm H 4.5mm hole distance 21mm Qty 1 pcs		



GEV No.	692399	Ref. No.	GSC1100-38
description	shelf support L 24mm W 7mm H 28mm aluminium for fridge Qty 1 pcs		



GEV No.	692398	Ref. No.	GBC1001-42 GBC1002-44 GBC1003-44 HBC1002-41 HBC1003-41 HBC2003-41 LCCK0002
description	shelf support L 24mm W 9mm H 29mm aluminium for fridge Qty 1 pcs		



GEV No.	694591	Ref. No.	GSC1336-39 GSC2336-39 HSC350-27 SLZE0028
description	shelf support L 33mm W 9mm H 27mm aluminium for fridge Qty 1 pcs		

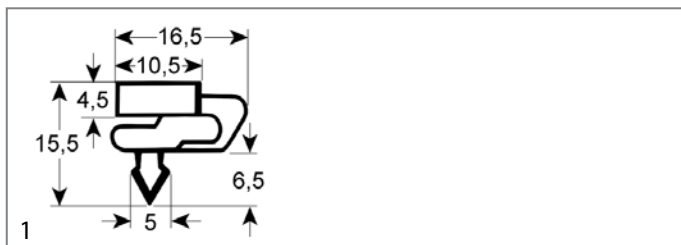

GEV No.	901674	Ref. No.	GBC1002-48
description	refrigeration gasket profile 9156 W 415mm L 775mm plug size Qty 1 pcs		

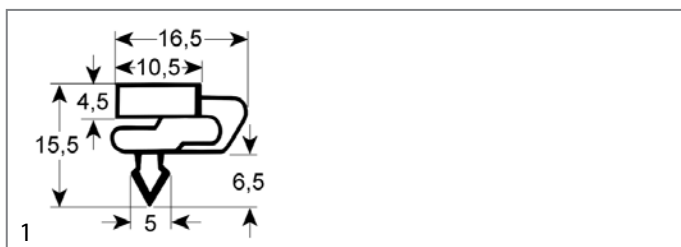

GEV No.	901660	Ref. No.	GBC1001-45
description	refrigeration gasket profile 9156 W 420mm L 785mm plug size Qty 1 pcs		

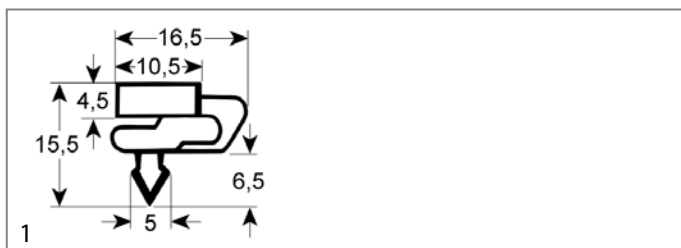

GEV No.	901999	Ref. No.	GSC1100-14 (570x1400)
description	refrigeration gasket profile 9156 W 570mm L 1400mm plug size until 2009		

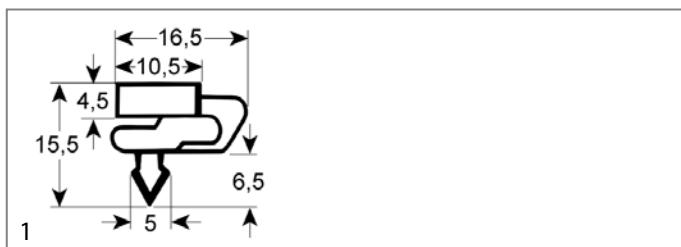

GEV No.	901648	Ref. No.	GSC1336-44 GSC2336-44 HSC350-45 SLJP2010
description	refrigeration gasket profile 9156 W 595mm L 1340mm plug size Qty 1 pcs		

profile 9314

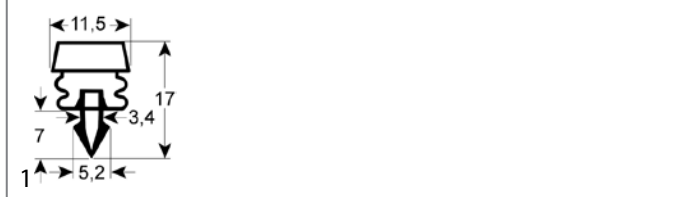

GEV No.	902158	Ref. No.	HSC800-53
description	refrigeration gasket profile 9314 Wmm L 1200mm		

miscellaneous



GEV No.	902210	Ref. No.	HBC2003-52 JNMA0000
description	gasket L 930mm Qty 1 dimensions 5x6mm		

refrigeration cycle components

filter driers

accessories

holders

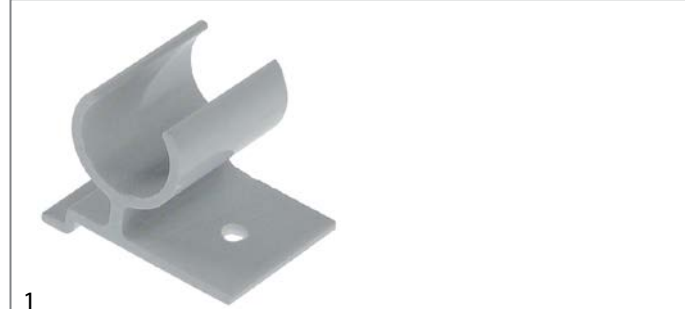

GEV No.	699297	Ref. No.	GBC1001-10 GBC1002-10 GBC1003-10 HBC1002-10 HBC2003-10 HSC360-15 HSC800-11 SLJAC008
description	bracket L 40mm W 30mm H 31mm ID ø 18mm ED ø 22mm for dryer		

miscellaneous



GEV No.	750381	Ref. No.	GBC1001-09 GBC1002-09 GBC1003-09 GSC1336-32 GSC2336-32 HBC1002-09 HBC2003-09 HSC360-14 TCGV0002
description	dryer ø 18.5mm L 115.5mm connection 2,4/5,2mm Qty 1 pcs		

			
1			
GEV No.	750382	Ref. No.	GSC1100-31 HSC350-10 HSC800-10 TCGV0002 HSC350-10 TCGV0009
description	dryer ø 18.5mm L 120mm connection 4/7mm Qty 1 pcs		
accessories for	750382		
	GEV No.	694868	Ref. No. HSC350-11
bracket for dryer L 40mm W 30mm H 31mm Qty 1 pcs			

refrigeration pipes

copper pipes uninsulated

			
1			
GEV No.	692730	Ref. No.	HBC1002-12 HBC2003-12 TCGO3004
description	copper pipe ID ø 4mm ED ø 6mm L 0.095m		

heating tubes

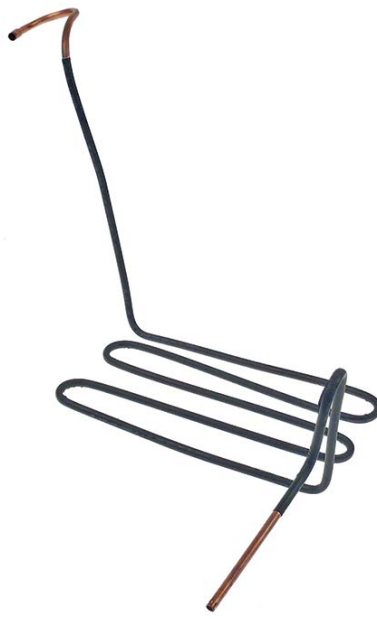
			
1			
GEV No.	701495	Ref. No.	HSC800-08 TCGD4010
description	heater ED ø 6mm ID ø 5mm Qty 1m for evaporator connection ø 6mm		

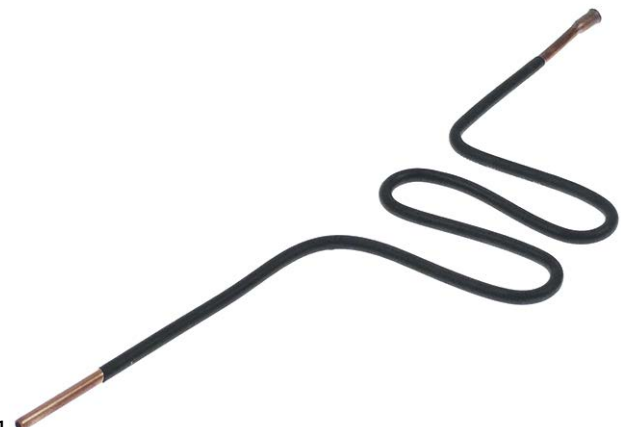
			
1			
GEV No.	701432	Ref. No.	HSC350-08 HSC360-12
description	heater pipe ED ø 5mm ID ø 3mm L 350mm copper Qty 1		

GEV No.	701432	Ref. No.	HSC350-08 HSC360-12
description	heater pipe ED ø 5mm ID ø 3mm L 350mm copper Qty 1		

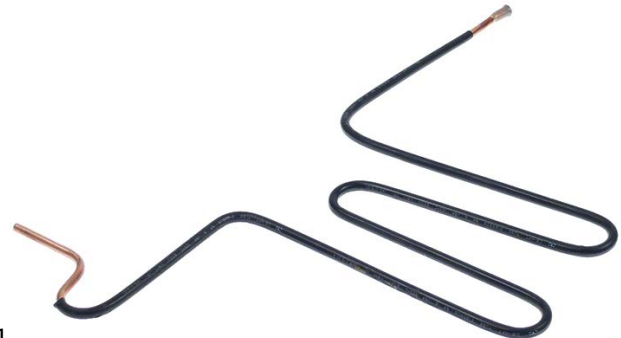
			
1			
GEV No.	701582	Ref. No.	GBC1001-13 GBC1002-11 GBC1003-11 HBC1002-11 HBC2003-11 TCGD2001
description	heater pipe ED ø 5mm ID ø 3mm L 355mm H 250mm		

GEV No.	701582	Ref. No.	GBC1001-13 GBC1002-11 GBC1003-11 HBC1002-11 HBC2003-11 TCGD2001
description	heater pipe ED ø 5mm ID ø 3mm L 355mm H 250mm		

evaporators

for fridges

producer-specific

			
1			
GEV No.	750387	Ref. No.	GBC1001-39 TLZA9000
description	evaporator for fridge GBC1001 L 430mm W 500mm		



			
1			
GEV No.	750376	Ref. No.	GBC1002-41 HBC1002-38 TLZD9001
description	evaporator for fridge GBC1002 L 760mm W 500mm		

			
1			
GEV No.	750456	Ref. No.	HSC360-21
description	evaporator for fridge HSC360 L 780mm W 495mm		

			
1			
GEV No.	750377	Ref. No.	GBC1003-41 TLZD9002
description	evaporator for fridge L 1000mm W 500mm		

			
1			
GEV No.	750634	Ref. No.	HBC2003-38
description	evaporator L 1000mm W 510mm		

			
1			
GEV No.	750345	Ref. No.	GSC1336-16 GSC2336-16
description	evaporator L 520mm W 180mm H 160mm		

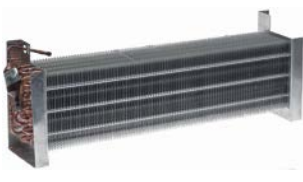
			
1			
GEV No.	750728	Ref. No.	GSC1100G-39
description	evaporator L 610mm W 120mm H 215mm		

			
1			
GEV No.	750660	Ref. No.	HSC800-42 TLZA4003
description	evaporator L 620mm W 225mm H 160mm		

			
1			
GEV No.	750375	Ref. No.	GSC1100-19 TLZA4004
description	evaporator L 760mm W 140mm H 225mm		

accessories

miscellaneous

			
1			
GEV No.	692425	Ref. No.	GSC1336-28 GSC2336-28
description	bush for evaporator plastic ø 24mm L 34mm Qty 1 pcs		

condensors

condensors

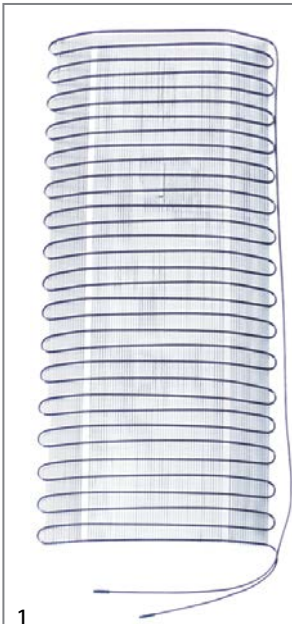

1				DTLB2004 GSC1336-27 GSC2336-27 HSC350-02 HSC350DD-02 HSC360-02
GEV No.	750346	Ref. No.		
description	condenser L 1430mm W 520mm			



1				DTLA9002 GBC1002-06 HBC2003-06
GEV No.	750373	Ref. No.		
description	condenser W 190mm D 160mm H 205mm Qty 1 pcs			



1				DTLA9000 GBC1001-06
GEV No.	750372	Ref. No.		
description	condenser W 195mm D 80mm H 205mm Qty 1 pcs			



1				GBC1003-06 HBC1002-06
GEV No.	750385	Ref. No.		
description	condenser W 255mm D 180mm H 205mm Qty 1 pcs			



GEV No.	750659	Ref. No.	HSC800-06
description	condenser W 290mm D 180mm H 215mm Qty 1 pcs		



GEV No.	750729	Ref. No.	GSC1100G-17
description	condenser W 395mm D 235mm H 275mm		



GEV No.	750374	Ref. No.	DTLA4008 GSC1100-29
description	condenser W 555mm D 100mm H 275mm Qty 1 pcs		

evaporation and condensing trays

evaporation trays



GEV No.	699308	Ref. No.	GBC1002-14 GBC1003-14
description	evaporation tray L 120mm W 74mm H 58mm Qty 1 pcs		



GEV No.	699302	Ref. No.	GBC1001-12 SLZJ0021
description	evaporation tray L 185mm W 130mm H 75mm		



GEV No.	699299	Ref. No.	GSC1336-47 HSC350-09 HSC360-13 SLZJ0014
description	evaporation tray L 210mm W 105mm H 80mm		

unheated condensing trays



GEV No.	750632	Ref. No.	HBC1002-14 HBC2003-14 SLZJ0022
description	drip tray L 187mm W 128mm H 70mm plastic		



GEV No.	750631	Ref. No.	GSC1100-27 HSC800-09 SLZJ0015
description	drip tray L 302mm W 204mm H 85mm plastic		

A

axial fans 10

B

ballasts 5

C

cables 11

castors and bumper angles 20

compressors 9

connection cables 12

copper pipes uninsulated 24

E

electric accessories 11

electronic controllers 7

evaporators 24

F

fans 10

filter driers 23

fluorescent lamps 4, 4

G

grates 21

L

lamps 3

LED 3

P

plug-in gaskets 22

power supply cables 11

R

refrigeration cycle components 23

refrigeration fans 11

refrigeration gaskets 22

refrigeration motors universal 11

refrigeration pipes 24

refrigeration thermostats 3

relays 6

rocker/momentary rocker switches 3

S

shelves and shelf rails 21

starter 5

switches and momentary switches 3

T

terminal boxes 12

thermostats 3