



GAS COMPONENTS



ELECTRIC COMPONENTS



WATER TECHNOLOGY



MECHANICAL COMPONENTS



TOOLS

Spare parts suitable for

CUPPONE

Find the complete and up-to-date range of products in our GEV Webshop



Manufacturer catalogue

The most important spare parts and accessories arranged clearly for every manufacturer

- ✓ Complete product range and all appliance data always up to date in the GEV Webshop
- ✓ Alphabetical Index at the end of the catalogue

GEV Webshop

www.gev-online.co.uk

www.gev-online.com



- 🔍 Add to Favourites
- 🔍 Sign In with email address and usual password
- 🔍 Easy-order – place several items in your basket at the same time
- 🔍 Quick Item search – no login needed



heating elements

heating elements for pizza ovens



GEV No.	415678	Ref. No.	91711901 ME0000002
description	heating element 1000W 230V L 575mm W 160mm flange length 220mm flange width 31mm hole distance 201mm connection length 133mm connection M5 L1 30mm L2 25mm L3 520mm W1 25mm W2 112mm tube ø 10mm heating circuits 1 rectangular flange hole ø 4mm dry heating element		
For models:	EXPRESS P 6, EXPRESS P66, PAOLO 6, PAOLO12		

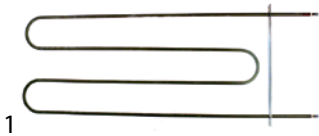

GEV No.	418679	Ref. No.	91711013
description	heating element 1000W 230V L 675mm W 280mm flange length 324mm flange width 25mm hole distance 310mm connection length 135mm connection M4 tube ø 8.5mm heating circuits 1 rectangular flange hole ø 4mm dry heating element		

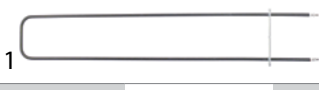

GEV No.	417630	Ref. No.	9171185
description	heating element 1080W 230V L 715mm W 130mm flange length 160mm flange width 24mm hole distance 143mm tube ø 9mm heating circuits 1 mounting pos. upper for pizza oven		

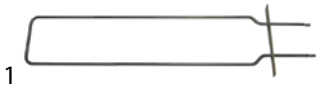

GEV No.	415917	Ref. No.	91711911 ME0000003
description	heating element 1400W 230V L 572mm W 159mm flange length 220mm flange width 32mm hole distance 199mm connection length 134mm connection M5 L1 30mm L2 27mm L3 515mm W1 25mm W2 110mm tube ø 10.2mm heating circuits 1 rectangular flange hole ø 4mm dry heating element		
For models:	EXPRESS P 6, EXPRESS P66, PAOLO 6, PAOLO12		



GEV No.	415918	Ref. No.	91711902 ME0000004
description	heating element 1500W 230V L 875mm W 164mm flange length 220mm flange width 30mm hole distance 202mm connection length 132mm connection M5 L3 815mm W1 25mm W2 110mm tube ø 10mm heating circuits 1 rectangular flange hole ø 4mm dry heating element		
For models:	EXPRESS P 9, EXPRESS P99, PAOLO 9, PAOLO18		

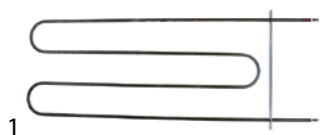

GEV No.	418680	Ref. No.	91711018
description	heating element 1600W 230V L 675mm W 280mm flange length 324mm flange width 25mm hole distance 310mm connection length 135mm connection M4 tube ø 8.5mm heating circuits 1 mounting thread rectangular flange hole ø 4mm dry heating element		



GEV No.	415959	Ref. No.	N/A
description	heating element 1750W 230V L 860mm W 160mm flange length 220mm flange width 30mm hole distance 200mm connection length 112mm connection M5 L3 810mm W1 25mm W2 110mm tube ø 10mm heating circuits 1 rectangular flange hole ø 4mm dry heating element		



GEV No.	415919	Ref. No.	91711912 ME0000005
description	heating element 2000W 230V L 870mm W 160mm flange length 220mm flange width 31mm hole distance 200mm connection length 130mm connection 5 L3 820mm W1 110mm W2 160mm tube ø 10mm heating circuits 1 rectangular flange hole ø 4mm dry heating element		
For models:	EXPRESS P 9, EXPRESS P99, PAOLO 9, PAOLO18		



GEV No.	415677	Ref. No.	N/A
description	heating element 600W 230V L 567mm W 130mm flange length 160mm flange width 22mm hole distance 144mm connection length 132mm connection M5 tube ø 8.5mm heating circuits 1 rectangular flange hole ø 6mm dry heating element		



GEV No.	418853	Ref. No.	91711900
description	heating element 600W 230V L 570mm W 130mm flange length 160mm flange width 22mm hole distance 145mm connection length 27mm heating circuits 1		

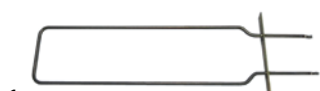

GEV No.	415939	Ref. No.	ME0000000
description	heating element 600W 230V L 570mm W 160mm flange length 220mm flange width 30mm hole distance 200mm connection length 131mm connection M5 L3 520mm W2 113mm tube ø 10mm heating circuits 1 rectangular flange hole ø 4mm dry heating element		
For models:	EXPRESS P 4, EXPRESS P44, PAOLO 4, PAOLO 8		

1 electric components

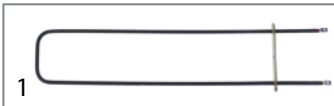

GEV No.	418854	Ref. No.	91711910
description	heating element 800W 230V L 560mm W 130mm flange length 160mm flange width 22mm hole distance 145mm connection length 133mm connection M5 IT tube ø 8.5mm heating circuits 1 rectangular flange hole ø 6mm		



GEV No.	415916	Ref. No.	N/A
description	heating element 800W 230V L 567mm W 128mm flange length 160mm flange width 22mm hole distance 144mm connection length 132mm connection M5 tube ø 8.5mm heating circuits 1 rectangular flange hole ø 6mm dry heating element		

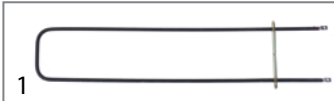

GEV No.	415940	Ref. No.	ME0000001
description	heating element 800W 230V L 570mm W 156mm flange length 220mm flange width 30mm hole distance 202mm connection length 132mm connection M5 tube ø 10mm heating circuits 1 rectangular flange hole ø 4mm dry heating element W1 110mm W2 23mm		
For models:	EXPRESS P 4, EXPRESS P44, PAOLO 4, PAOLO 8		





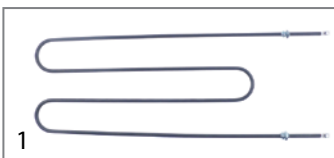

GEV No.	418057	Ref. No.	91711041 ME0000062
description	heating element 1000W 230V L 1060mm W 205mm thread 1/4" mounting distance 196mm connection length 109mm connection M5 tube ø 8.6mm heating circuits 1 dry heating element 2 hole fixing		
For models:	MAX 6/35, MAX 6/35X, MAX 8/35, MAX12/35		
accessories for	418057		
	GEV No.	361182	Ref. No. —
	nut thread 1/4" H 5mm nickel-plated brass WS 17 Qty 1 pcs		
	GEV No.	510417	Ref. No. —
	flat gasket fibre ED ø 20mm ID ø 14mm thickness 2mm Qty 1 pcs		
	GEV No.	520228	Ref. No. —
	tooth lock washer ID ø 15.3mm ED ø 24mm steel Qty 1 pcs for thread M14		
	GEV No.	550262	Ref. No. —
	flat gasket copper ED ø 20mm ID ø 14mm thickness 2mm		

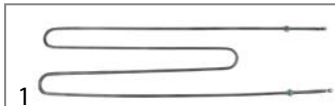

GEV No.	418880	Ref. No.	91711022
description	heating element 1000W 230V L 580mm W 235mm thread 1/4" mounting distance 227mm connection length 110mm connection M5 tube ø 8.5mm heating circuits 1 for pizza oven		





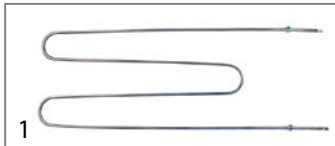

GEV No.	418054	Ref. No.	91711050 ME0000061
description	heating element 1000W 230V L 708mm W 198mm thread 1/4" mounting distance 178mm connection length 108mm connection M5 tube ø 8.5mm heating circuits 1 dry heating element 2 hole fixing		
For models:	MAX 4/35, MAX 4/35X, MAX 6/35, MAX 8/35		
accessories for	418054		
	GEV No.	361182	Ref. No. —
	nut thread 1/4" H 5mm nickel-plated brass WS 17 Qty 1 pcs		
	GEV No.	510417	Ref. No. —
	flat gasket fibre ED ø 20mm ID ø 14mm thickness 2mm Qty 1 pcs		
	GEV No.	520228	Ref. No. —
	tooth lock washer ID ø 15.3mm ED ø 24mm steel Qty 1 pcs for thread M14		
	GEV No.	550262	Ref. No. —
	flat gasket copper ED ø 20mm ID ø 14mm thickness 2mm		



GEV No.	418059	Ref. No.	91711042 ME0000066
description	heating element 1000W 230V L 710mm W 300mm thread 1/4" mounting distance 290mm connection M5 tube ø 8.5mm heating circuits 1 dry heating element 2 hole fixing		
For models:	MAX 6/35L, MAX 6/35LX, MAX12/35L		





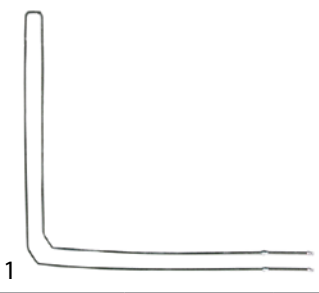

GEV No.	416437	Ref. No.	91711021 ME0000012
description	heating element 1000W 230V L 895mm W 132mm thread 1/4" mounting distance 122mm connection length 110mm connection M4 tube ø 8.5mm heating circuits 1 dry heating element 2 hole fixing		
For models:	EXCELSIOR MAXI PROFI		
accessories for	416437		
	GEV No.	361182	Ref. No. —
	nut thread 1/4" H 5mm nickel-plated brass WS 17 Qty 1 pcs		
	GEV No.	510417	Ref. No. —
	flat gasket fibre ED ø 20mm ID ø 14mm thickness 2mm Qty 1 pcs		
	GEV No.	520228	Ref. No. —
	tooth lock washer ID ø 15.3mm ED ø 24mm steel Qty 1 pcs for thread M14		
	GEV No.	550262	Ref. No. —
	flat gasket copper ED ø 20mm ID ø 14mm thickness 2mm		







GEV No.	418221	Ref. No.	91711062 ME0000107
description	heating element 1400W 230V L 1144mm W 1090mm thread 1/4" mounting distance 100mm connection length 160mm connection M5 tube ø 8.5mm dry heating element mounting pos. bottom at the back 2 hole fixing		
For models:	EVOLUTION DIGITAL, EVOLUTION MECHANICAL		

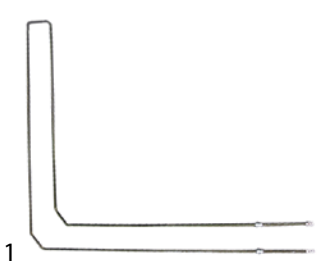





GEV No.	416438	Ref. No.	91711031 ME0000013
description	heating element 1400W 230V L 898mm W 132mm thread 1/4" mounting distance 123mm connection length 98mm connection M5 tube ø 8.5mm heating circuits 1 dry heating element 2 hole fixing		
For models:	EXCELSIOR MAXI PROFI		
spare parts for	416438		
	GEV No.	510417	Ref. No. —
	flat gasket fibre ED ø 20mm ID ø 14mm thickness 2mm Qty 1 pcs		
accessories for	416438		
	GEV No.	361182	Ref. No. —
	nut thread 1/4" H 5mm nickel-plated brass WS 17 Qty 1 pcs		
	GEV No.	520228	Ref. No. —
	tooth lock washer ID ø 15.3mm ED ø 24mm steel Qty 1 pcs for thread M14		
	GEV No.	550262	Ref. No. —
	flat gasket copper ED ø 20mm ID ø 14mm thickness 2mm		



GEV No.	418220	Ref. No.	91711061 ME0000106
description	heating element 1400W 230V L 938mm W 880mm thread 1/4" mounting distance 97mm connection length 24mm connection M5 tube ø 8.7mm dry heating element mounting pos. bottom/centre 2 hole fixing		
For models:	EVOLUTION MECHANICAL		
accessories for	418220		
	GEV No.	361182	Ref. No. —
	nut thread 1/4" H 5mm nickel-plated brass WS 17 Qty 1 pcs		
	GEV No.	510417	Ref. No. —
	flat gasket fibre ED ø 20mm ID ø 14mm thickness 2mm Qty 1 pcs		

accessories for	418220		
	GEV No.	520228	Ref. No. —
	tooth lock washer ID ø 15.3mm ED ø 24mm steel Qty 1 pcs for thread M14		
	GEV No.	550262	Ref. No. —
	flat gasket copper ED ø 20mm ID ø 14mm thickness 2mm		



GEV No.	418061	Ref. No.	91711043 ME0000064
description	heating element 1500W 230V L 1055mm W 280mm thread 1/4" mounting distance 272mm connection length 108mm connection M5 tube ø 8.5mm heating circuits 1 dry heating element 2 hole fixing		
For models:	MAX 9/35, MAX 9/35X, MAX18/35		
accessories for	418061		
	GEV No.	361182	Ref. No. —
	nut thread 1/4" H 5mm nickel-plated brass WS 17 Qty 1 pcs		
	GEV No.	510417	Ref. No. —
	flat gasket fibre ED ø 20mm ID ø 14mm thickness 2mm Qty 1 pcs		
	GEV No.	520228	Ref. No. —
	tooth lock washer ID ø 15.3mm ED ø 24mm steel Qty 1 pcs for thread M14		
	GEV No.	550262	Ref. No. —
	flat gasket copper ED ø 20mm ID ø 14mm thickness 2mm		







GEV No.	420501	Ref. No.	91711343
description	heating element 1500W 230V L 1060mm W 320mm thread 1/4" mounting distance 1060mm connection M5 tube ø 8.5mm heating circuits 1 mounting pos. lower threaded		

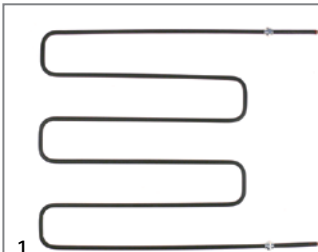





GEV No.	418053	Ref. No.	91711005 ME0000026
description	heating element 1500W 230V L 365mm W 400mm L1 20mm L2 60mm L3 285mm W1 32mm W2 335mm thread M10x1 mounting distance 331mm connection length 85mm connection M5 windings 4 tube ø 6.3mm heating circuits 1 dry heating element mounting pos. upper 2 hole fixing pizza oven		
For models:	MICRO		







GEV No.	418673	Ref. No.	91711010 91715001
description	heating element 1500W 230V L 475mm W 445mm thread 1/4" mounting distance 436.5mm connection length 116mm connection male faston 6.3mm tube ø 8.5mm heating circuits 1 dry heating element 2 hole fixing		
accessories for	418673		
	GEV No.	361182	Ref. No. —
	nut thread 1/4" H 5mm nickel-plated brass WS 17 Qty 1 pcs		
	GEV No.	510417	Ref. No. —
	flat gasket fibre ED ø 20mm ID ø 14mm thickness 2mm Qty 1 pcs		
	GEV No.	520228	Ref. No. —
	tooth lock washer ID ø 15.3mm ED ø 24mm steel Qty 1 pcs for thread M14		
	GEV No.	550262	Ref. No. —
	flat gasket copper ED ø 20mm ID ø 14mm thickness 2mm		







GEV No.	416439	Ref. No.	91711023 ME0000014
description	heating element 1500W 230V L 900mm W 245mm thread 1/4" mounting distance 237mm connection length 110mm connection M5 tube ø 8.5mm heating circuits 1 dry heating element 2 hole fixing		
For models:	EXCELSIOR EXTRAPROFI		
accessories for	416439		
	GEV No.	361182	Ref. No. —
	nut thread 1/4" H 5mm nickel-plated brass WS 17 Qty 1 pcs		
	GEV No.	510417	Ref. No. —
	flat gasket fibre ED ø 20mm ID ø 14mm thickness 2mm Qty 1 pcs		
	GEV No.	520228	Ref. No. —
	tooth lock washer ID ø 15.3mm ED ø 24mm steel Qty 1 pcs for thread M14		
	GEV No.	550262	Ref. No. —
	flat gasket copper ED ø 20mm ID ø 14mm thickness 2mm		

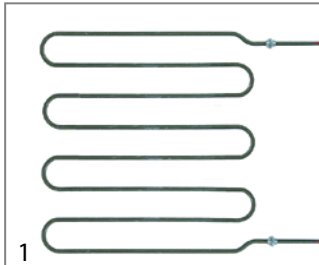

GEV No.	418056	Ref. No.	91711051 ME0000063
description	heating element 1600W 230V L 1060mm W 230mm thread 1/4" mounting distance 221mm connection length 110mm connection M5 tube ø 8.5mm heating circuits 1 dry heating element 2 hole fixing		
For models:	MAX 6/35, MAX 6/35X, MAX 8/35, MAX12/35, MAX18/35		
accessories for	418056		
	GEV No.	361182	Ref. No. —
	nut thread 1/4" H 5mm nickel-plated brass WS 17 Qty 1 pcs		

accessories for	418056		
	GEV No.	510417	Ref. No. —
	flat gasket fibre ED ø 20mm ID ø 14mm thickness 2mm Qty 1 pcs		
	GEV No.	520228	Ref. No. —
	tooth lock washer ID ø 15.3mm ED ø 24mm steel Qty 1 pcs for thread M14		
	GEV No.	550262	Ref. No. —
	flat gasket copper ED ø 20mm ID ø 14mm thickness 2mm		



GEV No.	416434	Ref. No.	91711930 ME0000020
description	heating element 1600W 230V L 480mm W 500mm L1 40mm L2 30mm L3 410mm W1 20mm W2 460mm thread 1/4" mounting distance 452mm connection length 130mm connection grip connection windings 4 tube ø 8.5mm heating circuits 1 dry heating element 2 hole fixing		
For models:	BABY		
accessories for	416434		
	GEV No.	361182	Ref. No. —
	nut thread 1/4" H 5mm nickel-plated brass WS 17 Qty 1 pcs		
	GEV No.	510417	Ref. No. —
	flat gasket fibre ED ø 20mm ID ø 14mm thickness 2mm Qty 1 pcs		
	GEV No.	520228	Ref. No. —
	tooth lock washer ID ø 15.3mm ED ø 24mm steel Qty 1 pcs for thread M14		
	GEV No.	550262	Ref. No. —
	flat gasket copper ED ø 20mm ID ø 14mm thickness 2mm		

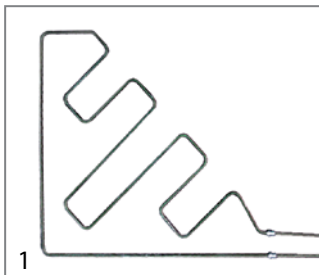





GEV No.	418219	Ref. No.	91711060 ME0000105
description	heating element 1600W 230V L 710mm W 665mm thread 1/4" mounting distance 96mm connection length 148mm connection M5 tube ø 8.5mm heating circuits 1 dry heating element mounting pos. bottom in the front 2 hole fixing		
For models:	EVOLUTION DIGITAL, EVOLUTION MECHANICAL		
accessories for	418219		
	GEV No.	361182	Ref. No. —
	nut thread 1/4" H 5mm nickel-plated brass WS 17 Qty 1 pcs		

Table continues overleaf



accessories for	418219		
	GEV No.	510417	Ref. No. —
	flat gasket fibre ED ø 20mm ID ø 14mm thickness 2mm Qty 1 pcs		
	GEV No.	520228	Ref. No. —
	tooth lock washer ID ø 15.3mm ED ø 24mm steel Qty 1 pcs for thread M14		
	GEV No.	550262	Ref. No. —
	flat gasket copper ED ø 20mm ID ø 14mm thickness 2mm		



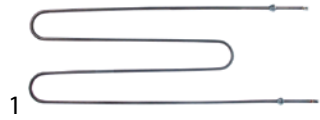

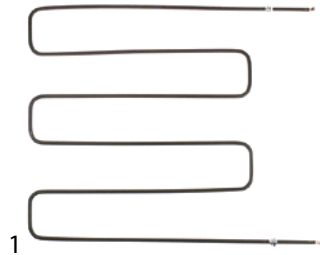

1

GEV No.	418058	Ref. No.	91711052 ME0000067
description	heating element 1600W 230V L 715mm W 275mm thread 1/4" mounting distance 275mm connection M4 tube ø 8.5mm heating circuits 1 dry heating element 2 hole fixing		
For models:	MAX 6/35L, MAX 6/35LX, MAX12/35L		





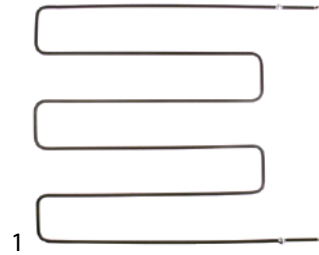

1

GEV No.	418675	Ref. No.	91711011
description	heating element 1800W 230V L 575mm W 550mm thread 1/4" mounting distance 541mm connection length 116mm connection male faston 6.3mm tube ø 8.5mm heating circuits 1 dry heating element 2 hole fixing		
spare parts for	418675		
	GEV No.	510417	Ref. No. —
	flat gasket fibre ED ø 20mm ID ø 14mm thickness 2mm Qty 1 pcs		
accessories for	418675		
	GEV No.	361182	Ref. No. —
	nut thread 1/4" H 5mm nickel-plated brass WS 17 Qty 1 pcs		
	GEV No.	520228	Ref. No. —
	tooth lock washer ID ø 15.3mm ED ø 24mm steel Qty 1 pcs for thread M14		
	GEV No.	550262	Ref. No. —
	flat gasket copper ED ø 20mm ID ø 14mm thickness 2mm		





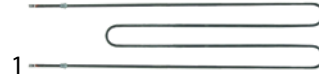

1





GEV No.	418677	Ref. No.	91711012
description	heating element 2000W 230V L 675mm W 650mm thread 1/4" mounting distance 651.5mm connection length 120mm connection male faston 6.3mm tube ø 8.5mm heating circuits 1 dry heating element 2 hole fixing		
accessories for	418677		
	GEV No.	361182	Ref. No. —
	nut thread 1/4" H 5mm nickel-plated brass WS 17 Qty 1 pcs		
	GEV No.	510417	Ref. No. —
	flat gasket fibre ED ø 20mm ID ø 14mm thickness 2mm Qty 1 pcs		
	GEV No.	520228	Ref. No. —
	tooth lock washer ID ø 15.3mm ED ø 24mm steel Qty 1 pcs for thread M14		
	GEV No.	550262	Ref. No. —
	flat gasket copper ED ø 20mm ID ø 14mm thickness 2mm		



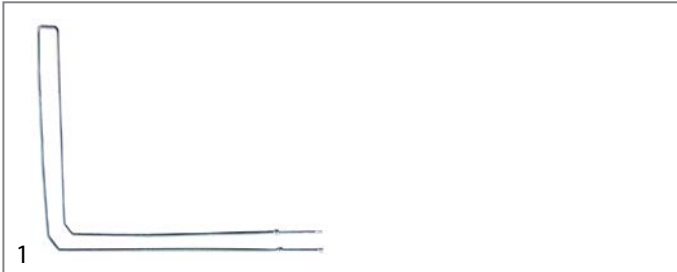



1

GEV No.	416440	Ref. No.	91711033 ME0000015
description	heating element 2000W 230V L 892mm W 245mm thread 1/4" mounting distance 237mm connection length 97mm connection M5 tube ø 8.5mm heating circuits 1 dry heating element 2 hole fixing		
For models:	EXCELSIOR EXTRAPROFI		
spare parts for	416440		
	GEV No.	510417	Ref. No. —
	flat gasket fibre ED ø 20mm ID ø 14mm thickness 2mm Qty 1 pcs		
accessories for	416440		
	GEV No.	361182	Ref. No. —
	nut thread 1/4" H 5mm nickel-plated brass WS 17 Qty 1 pcs		
	GEV No.	520228	Ref. No. —
	tooth lock washer ID ø 15.3mm ED ø 24mm steel Qty 1 pcs for thread M14		
	GEV No.	550262	Ref. No. —
	flat gasket copper ED ø 20mm ID ø 14mm thickness 2mm		

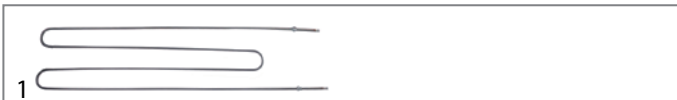





GEV No.	418212	Ref. No.	91711072 ME0000102
description	heating element 2400W 230V L 1043mm W 1090mm thread 1/4" mounting distance 100mm connection length 160mm connection M5 tube ø 8.5mm dry heating element mounting pos. upper/lower 2 hole fixing pizza oven		
For models:	EVOLUTION DIGITAL, EVOLUTION MECHANICAL		
accessories for	418212		
	GEV No.	361182	Ref. No. —
	nut thread 1/4" H 5mm nickel-plated brass WS 17 Qty 1 pcs		
	GEV No.	510417	Ref. No. —
	flat gasket fibre ED ø 20mm ID ø 14mm thickness 2mm Qty 1 pcs		
	GEV No.	520228	Ref. No. —
	tooth lock washer ID ø 15.3mm ED ø 24mm steel Qty 1 pcs for thread M14		
	GEV No.	550262	Ref. No. —
	flat gasket copper ED ø 20mm ID ø 14mm thickness 2mm		

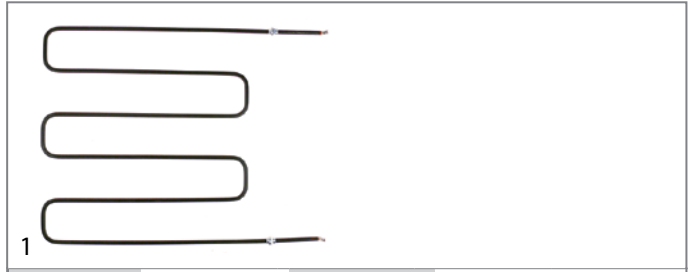





GEV No.	418060	Ref. No.	91711053 ME0000065
description	heating element 2400W 230V L 1060mm W 265mm thread 1/4" mounting distance 257mm connection length 108mm connection M5 tube ø 8.5mm heating circuits 1 dry heating element 2 hole fixing		
For models:	MAX 9/35, MAX 9/35X, MAX18/35		
accessories for	418060		
	GEV No.	361182	Ref. No. —
	nut thread 1/4" H 5mm nickel-plated brass WS 17 Qty 1 pcs		
	GEV No.	510417	Ref. No. —
	flat gasket fibre ED ø 20mm ID ø 14mm thickness 2mm Qty 1 pcs		
	GEV No.	520228	Ref. No. —
	tooth lock washer ID ø 15.3mm ED ø 24mm steel Qty 1 pcs for thread M14		
	GEV No.	550262	Ref. No. —
	flat gasket copper ED ø 20mm ID ø 14mm thickness 2mm		

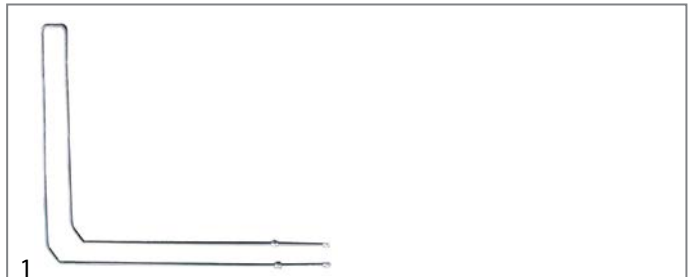





GEV No.	418674	Ref. No.	91711015 91715021
description	heating element 2400W 230V L 475mm W 445mm thread 1/4" mounting distance 436.5mm connection length 116mm connection male faston 6.3mm tube ø 8.5mm dry heating element 2 hole fixing		
accessories for	418674		
	GEV No.	361182	Ref. No. —
	nut thread 1/4" H 5mm nickel-plated brass WS 17 Qty 1 pcs		
	GEV No.	510417	Ref. No. —
	flat gasket fibre ED ø 20mm ID ø 14mm thickness 2mm Qty 1 pcs		
	GEV No.	520228	Ref. No. —
	tooth lock washer ID ø 15.3mm ED ø 24mm steel Qty 1 pcs for thread M14		
	GEV No.	550262	Ref. No. —
	flat gasket copper ED ø 20mm ID ø 14mm thickness 2mm		

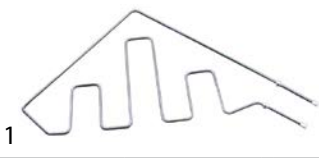

GEV No.	418213	Ref. No.	91711071 ME0000101
description	heating element 2400W 230V L 930mm W 883mm thread 1/4" mounting distance 109mm connection length 159mm connection M5 tube ø 8.5mm dry heating element 2 hole fixing		
For models:	EVOLUTION DIGITAL, EVOLUTION MECHANICAL		
accessories for	418213		
	GEV No.	361182	Ref. No. —
	nut thread 1/4" H 5mm nickel-plated brass WS 17 Qty 1 pcs		
	GEV No.	510417	Ref. No. —
	flat gasket fibre ED ø 20mm ID ø 14mm thickness 2mm Qty 1 pcs		
	GEV No.	520228	Ref. No. —
	tooth lock washer ID ø 15.3mm ED ø 24mm steel Qty 1 pcs for thread M14		
	GEV No.	550262	Ref. No. —
	flat gasket copper ED ø 20mm ID ø 14mm thickness 2mm		

GEV No.	418214	Ref. No.	91711070 ME0000100
description	heating element 2600W 230V L 710mm W 665mm thread 1/4" mounting distance 93mm connection length 151mm connection M5 tube ø 8.5mm heating circuits 1 dry heating element 2 hole fixing W1 101mm W2 564mm		
For models:	EVOLUTION DIGITAL, EVOLUTION MECHANICAL		
accessories for	418214		
	GEV No.	361182	Ref. No. —
	nut thread 1/4" H 5mm nickel-plated brass WS 17 Qty 1 pcs		
	GEV No.	510417	Ref. No. —
	flat gasket fibre ED ø 20mm ID ø 14mm thickness 2mm Qty 1 pcs		
	GEV No.	520228	Ref. No. —
	tooth lock washer ID ø 15.3mm ED ø 24mm steel Qty 1 pcs for thread M14		
	GEV No.	550262	Ref. No. —
	flat gasket copper ED ø 20mm ID ø 14mm thickness 2mm		





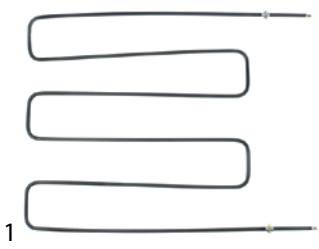

GEV No.	420502	Ref. No.	91711353 91711353-1
description	heating element 2690W 230V L 1060mm W 320mm thread 1/4" mounting distance 106mm connection M5 tube ø 8.5mm heating circuits 1 mounting pos. upper threaded		

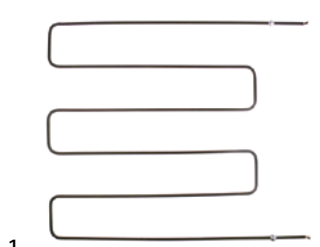





GEV No.	418676	Ref. No.	91711016
description	heating element 2800W 230V L 570mm W 520mm thread 1/4" mounting distance 511mm connection length 118mm connection male faston 6.3mm tube ø 8.5mm heating circuits 1		



GEV No.	418678	Ref. No.	91711017
description	heating element 3200W 230V L 675mm W 650mm thread 1/4" mounting distance 641mm connection length 120mm connection male faston 6.3mm tube ø 8.5mm heating circuits 1 dry heating element 2 hole fixing		
spare parts for	418678		
	GEV No.	510417	Ref. No. —
	flat gasket fibre ED ø 20mm ID ø 14mm thickness 2mm Qty 1 pcs		
accessories for	418678		
	GEV No.	361182	Ref. No. —
	nut thread 1/4" H 5mm nickel-plated brass WS 17 Qty 1 pcs		
	GEV No.	520228	Ref. No. —
	tooth lock washer ID ø 15.3mm ED ø 24mm steel Qty 1 pcs for thread M14		
	GEV No.	550262	Ref. No. —
	flat gasket copper ED ø 20mm ID ø 14mm thickness 2mm		



GEV No.	416435	Ref. No.	91711020 ME0000010
description	heating element 600W 230V L 605mm W 130mm thread 1/4" mounting distance 120mm connection length 110mm connection M4 tube ø 8.5mm heating circuits 1 dry heating element 2 hole fixing pizza oven		
For models:	EXCELSIOR MINI PROFI		
accessories for	416435		
	GEV No.	361182	Ref. No. —
	nut thread 1/4" H 5mm nickel-plated brass WS 17 Qty 1 pcs		
	GEV No.	510417	Ref. No. —
	flat gasket fibre ED ø 20mm ID ø 14mm thickness 2mm Qty 1 pcs		
	GEV No.	520228	Ref. No. —
	tooth lock washer ID ø 15.3mm ED ø 24mm steel Qty 1 pcs for thread M14		
	GEV No.	550262	Ref. No. —
	flat gasket copper ED ø 20mm ID ø 14mm thickness 2mm		

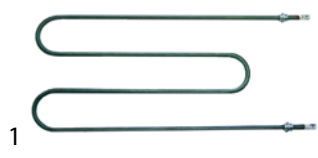



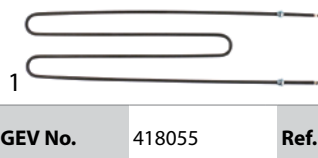

GEV No.	415825	Ref. No.	N/A
description	heating element 600W 400V L 470mm W 200mm thread 1/4" mounting distance 191mm connection length 54mm connection M4 tube ø 8.5mm heating circuits 1 dry heating element mounting pos. upper 2 hole fixing pizza oven		



GEV No.	418055	Ref. No.	91711040 ME0000060
description	heating element 700W 230V L 711mm W 194mm thread 1/4" mounting distance 185mm connection length 121mm connection M5 tube ø 8.8mm heating circuits 1 dry heating element 2 hole fixing		
For models:	MAX 4/35, MAX 4/35X, MAX 6/35, MAX 8/35		

accessories for 418055

	GEV No.	361182	Ref. No.	—
nut thread 1/4" H 5mm nickel-plated brass WS 17 Qty 1 pcs				
	GEV No.	510417	Ref. No.	—
flat gasket fibre ED ø 20mm ID ø 14mm thickness 2mm Qty 1 pcs				
	GEV No.	520228	Ref. No.	—
tooth lock washer ID ø 15.3mm ED ø 24mm steel Qty 1 pcs for thread M14				
	GEV No.	550262	Ref. No.	—
flat gasket copper ED ø 20mm ID ø 14mm thickness 2mm				





GEV No.	418052	Ref. No.	91711000 ME0000025
description	heating element 800W 230V L 370mm W 390mm L1 30mm L2 55mm L3 285mm W1 30mm W2 330mm thread M10x1 mounting distance 310mm connection length 87mm connection M4 windings 4 tube ø 6.3mm dry heating element mounting pos. lower 2 hole fixing pizza oven		
For models:	MICRO		



GEV No.	416436	Ref. No.	91711030 ME0000011	
description	heating element 800W 230V L 605mm W 130mm thread 1/4" mounting distance 122mm connection length 110mm connection M4 tube ø 8.5mm heating circuits 1 dry heating element 2 hole fixing			
For models:	EXCELSIOR MINI PROFI			
spare parts for	416436			
	GEV No.	510417	Ref. No.	—
flat gasket fibre ED ø 20mm ID ø 14mm thickness 2mm Qty 1 pcs				

accessories for 416436

	GEV No.	361182	Ref. No.	—
nut thread 1/4" H 5mm nickel-plated brass WS 17 Qty 1 pcs				
	GEV No.	520228	Ref. No.	—
tooth lock washer ID ø 15.3mm ED ø 24mm steel Qty 1 pcs for thread M14				
	GEV No.	550262	Ref. No.	—
flat gasket copper ED ø 20mm ID ø 14mm thickness 2mm				

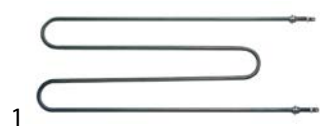

GEV No.	415588	Ref. No.	N/A
description	heating element 800W 415V L 575mm W 200mm thread 1/4" mounting distance 191mm connection length 52mm connection M4 tube ø 8.5mm heating circuits 1 dry heating element mounting pos. lower 2 hole fixing		

heating elements for pizza presses



GEV No.	416441	Ref. No.	91711940 ME0000035
description	heating element 1500W 230V L 355mm W 245mm heating circuits 1 connection M5 connection length 16mm L1 120mm L2 235mm dry heating element tube ø 8.5mm connection distance 11mm		
For models:	P33		



GEV No.	418047	Ref. No.	91711080 ME0000040
description	heating element 1600W 230V L 300mm Wmm heating circuits 1 cable length 1450mm connection length 30mm dry heating element tube ø 6.3mm ext. ø 300		
For models:	P/30		

1

GEV No.	418048	Ref. No.	91711081 91711086 ME0000041
description	heating element 1790W 208V heating circuits 1 cable length 1350mm tube ø 6.3mm ext. ø 300 connection distance 50mm		
For models:	P/35		



1

GEV No.	418050	Ref. No.	ME0000043
description	heating element 2600W 220V heating circuits 1 cable length 1480mm dry heating element tube ø 6.3mm ext. ø 435 connection distance 47mm		
For models:	P/45		

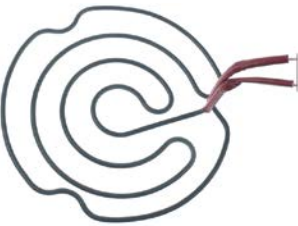

1

GEV No.	419186	Ref. No.	91711280
description	heating element 1790W 220V L 29mm Wmm heating circuits 1 cable length 900mm dry heating element tube ø 6.3mm ext. ø 29		

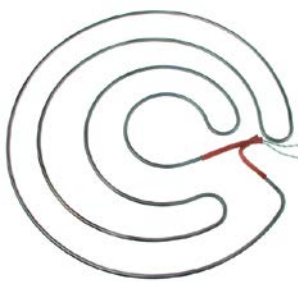

1

GEV No.	418051	Ref. No.	91711084 ME0000044
description	heating element 2900/3200W 208/230V cable length 1400mm dry heating element tube ø 6.3mm ext. ø 475		
For models:	P/50		

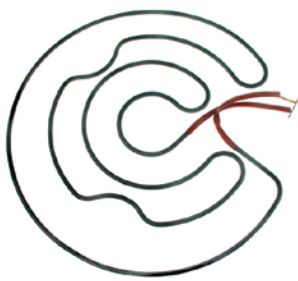

1

GEV No.	418049	Ref. No.	91711082 ME0000042
description	heating element 2200W 220V heating circuits 1 cable length 1480mm dry heating element tube ø 6.3mm ext. ø 385 connection distance 38mm		
For models:	P/40		

thermostats

control and safety thermostats

EGO

control thermostats

55.10/19_ series



GEV No.	375273	Ref. No.	ME0000303 ME0000304
description	thermostat t.max. 200°C temperature range 60-200°C 1-pole 1NO 16A probe ø 6mm probe L 74mm capillary pipe 1500mm capillary pipe isolatedmm gland nut shaft L 23mm shaft position upper rotation 270°		
For models:	P/45, P33		

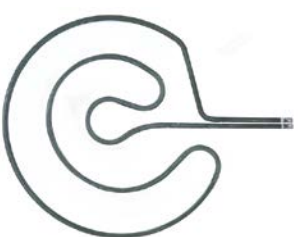

1

GEV No.	416442	Ref. No.	91711941 ME0000036
description	heating element 2500W 230V L 460mm W 355mm connection M5 connection length 16mm L1 130mm L2 330mm dry heating element tube ø 8.5mm connection distance 12mm		
For models:	P/45		



electric components



GEV No.	375253	Ref. No.	91310003
description	thermostat t.max. 455°C temperature range 85-455°C 1-pole 1NO 16A probe ø 3.9mm probe L 228mm capillary pipe 870mm capillary pipe isolated 660mm gland nut shaft ø 6x4.6mm shaft L 23mm shaft position upper rotation 270°		



GEV No.	375247	Ref. No.	57100 ME0000300
description	thermostat t.max. 500°C temperature range 75-500°C 1-pole 1NO 16A probe ø 4mm probe L 228mm capillary pipe 900mm capillary pipe isolatedmm gland nut shaft ø 6x4.6mm shaft L 23mm shaft position upper rotation 270°		
For models:	BABY, EXPRESS P 4, EXPRESS P 6, EXPRESS P 9, EXPRESS P44, EXPRESS P66, EXPRESS P99, MICRO, MINI PROFI 90, PAOLO 4, PAOLO 6, PAOLO 8, PAOLO 9, PAOLO12, PAOLO18		

safety thermostats

55.10/19_ series



GEV No.	375191	Ref. No.	91310050 ME0000305
description	safety thermostat switch-off temp. 500°C 1-pole 16A probe ø 3.9mm probe L 230mm capillary pipe 870mm capillary pipe isolated 660mm gland nut probe		
For models:	EVOLUTION DIGITAL, G433, G633, G933, GAS-EXCELSIOR G433, GAS-EXCELSIOR G633, GAS-EXCELSIOR G933, MAX 4/35, MAX 6/35, MAX 6/35L, MAX 8/35, MAX 9/35, MAX12/35, MAX12/35L, MAX18/35		

55.32_ series



GEV No.	375190	Ref. No.	91310051 ME0000306
description	safety thermostat switch-off temp. 560°C 3-pole 20A probe ø 3.9mm probe L 228mm capillary pipe 870mm capillary pipe isolated 700mm gland nut probe		
For models:	BABY, EVOLUTION MECHANICAL, EXCELSIOR EXTRAPROFI, EXCELSIOR MAXI PROFI, EXCELSIOR MINI PROFI, EXPRESS P 4, EXPRESS P 6, EXPRESS P 9, EXPRESS P44, EXPRESS P66, EXPRESS P99, MAX 4/35X, MAX 6/35LX, MAX 6/35X, MAX 8/35X, MAX 9/35X, MAX12/35LX, MAX12/35X, MAX18/35X, PAOLO 4, PAOLO 6, PAOLO 8, PAOLO 9, PAOLO12, PAOLO18		

JUMO

safety thermostats



GEV No.	376069	Ref. No.	91310057
description	safety thermostat switch-off temp. adjustable 30-500°C 1-pole 1CO 16A probe ø 4mm probe L 183mm capillary pipe 1470mm capillary pipe isolatedmm shaft ø 5.4mm		

switches and momentary switches

rocker/momentary rocker switches



30x11 mm



GEV No.	301012	Ref. No.	ME0000330
description	rocker switch mounting measurements 30x11mm green 1NO/ indicator light 250V 16A 0-I connection male faston 6.3mm ambient temperature max. 85/125°C protection IP40		
For models:	EXPRESS P 4, EXPRESS P 6, EXPRESS P 9, EXPRESS P44, EXPRESS P66, EXPRESS P99		



30x22mm			
			
1			
GEV No.	301020	Ref. No.	91310090 ME0000332
description	momentary rocker switch mounting measurements 30x22mm red 2NO 250V 16A illuminated 0-1 connection male faston 6.3mm ambient temperature max. 100/55°C protection IP65		
For models:	EVOLUTION MECHANICAL, G433, G633, G933, GAS-EXCELSIOR G433, GAS-EXCELSIOR G633, GAS-EXCELSIOR G933, MAX 4/35X, MAX 6/35LX, MAX 6/35X, MAX 8/35X, MAX 9/35X, MAX12/35LX, MAX12/35X, MAX18/35X		

			
1			
GEV No.	301003	Ref. No.	91310085 ME0000331
description	rocker switch mounting measurements 30x22mm green 2NO 250V 16A illuminated 0-1 connection male faston 6.3mm ambient temperature max. 125/55°C protection IP65		
For models:	EVOLUTION MECHANICAL, EXCELSIOR EXTRAPROFI, EXCELSIOR MAXI PROFI, EXCELSIOR MINI PROFI, EXPRESS P 4, EXPRESS P 6, EXPRESS P 9, EXPRESS P44, EXPRESS P66, EXPRESS P99, G433, G633, G933, GAS-EXCELSIOR G433, GAS-EXCELSIOR G633, GAS-EXCELSIOR G933, MAX 4/35X, MAX 6/35LX, MAX 6/35X, MAX 8/35X, MAX 9/35X, MAX12/35LX, MAX12/35X, MAX18/35X, MICRO, PAOLO 4, PAOLO 6, PAOLO 8, PAOLO 9, PAOLO12, PAOLO18		
accessories for	301003		
	GEV No.	301036	Ref. No. —
	protective cover internal size 30x22mm for rocker switch mounting measurementsmm		

microswitches

lever actuated

			
1			
GEV No.	345125	Ref. No.	ME0000491
description	microswitch with lever 250V 16A 1CO connection male faston 6.3mm ambient temperature max. 85°C mounting distance 25mm type C99ZP3 actuating force: 25g lever length 63.5mm		
For models:	P/30, P/35, P/40, P/45, P/50, P33		

roller actuated

roller 0°

			
1			
GEV No.	348145	Ref. No.	91310430
description	microswitch 250V 16A 1CO connection screw thread L 15mm thread M12x1 mounting distance 25.4mm actuating force: 500g type MK V11D15		

			
1			
GEV No.	345639	Ref. No.	ME0000490
description	microswitch with roller plunger 230V 16A 1CO connection solder/ screw connection L1 49mm ambient temperature max. 125°C thread L 14mm thread M10 mounting distance 25mm actuating force: 300g type MS15-1		
For models:	P/30, P/35, P/40, P/45, P/50, P33		

cam switches

operation switches

			
1			
GEV No.	301214	Ref. No.	91310095
description	cam switch 2 operating positions operation switch 16A sequence 0-1 shaft ø 6x4.6mm shaft L 33mm connection male faston 6.3mm plastic ambient temperature max. 150°C		

rotary switches

BREMAS

A1600 series

			
1			
GEV No.	345315 ¹	Ref. No.	ME0000310
description	rotary switch 3 1-0-2 sets of contacts 6 type CA160007 400V 16A shaft ø 5x5mm shaft L 23mm shaft square with knob connection screw		
For models:	EXCELSIOR EXTRAPROFI, EXCELSIOR MAXI PROFI, EXCELSIOR MINI PROFI, PAOLO 4, PAOLO 6, PAOLO 8, PAOLO 9, PAOLO12, PAOLO18		

¹incl. knob

A2500 series

			
1			
GEV No.	345026 ¹	Ref. No.	91310061 ME0000311
description	rotary switch 3 1-0-2 sets of contacts 6 type CS0257088 600V 32A shaft ø 5x5mm shaft L 23mm shaft square connection screw		
For models:	EVOLUTION MECHANICAL, MAX 4/35X, MAX 6/35LX, MAX 6/35X, MAX 8/35X, MAX 9/35X, MAX12/35LX, MAX12/35X, MAX18/35X		

¹incl. knob and dial plate

accessories



1			
GEV No.	111420	Ref. No.	91510090
description	knob switch zero mark ø 34/60mm shaft ø 5x5mm red H 22mm L 50mm		



1			
GEV No.	345780	Ref. No.	ME0000621
description	contact block GENERAL ELECTRIC P9B01VN 1NC max 660V 10A		
For models:	P/30, P/35, P/40, P/45, P/50		

control equipment

BRETER

push buttons



1			
GEV No.	345638	Ref. No.	91310380 ME0000501
description	momentary push switch mounting measurements ø30mm black		
For models:	P/45, P33		



1			
GEV No.	345779	Ref. No.	ME0000620
description	contact block GENERAL ELECTRIC P9B10VN 1NO max 400V 10A brown		
For models:	P/30, P/35, P/40, P/45, P/50		

momentary mushroom switches



1			
GEV No.	346326	Ref. No.	ME0000616
description	mushroom momentary switch mounting measurements ø22mm black		



1			
GEV No.	345640	Ref. No.	91310400 ME0000520
description	contact block BRETER 1NO		
For models:	P/45, P33		



1			
GEV No.	346325	Ref. No.	ME0000615
description	mushroom momentary switch mounting measurements ø22mm red		
For models:	P/30, P/35, P/40, P/45, P/50		

GENERAL ELECTRIC (AEG)

push buttons



1			
GEV No.	346327	Ref. No.	ME0000610
description	push button mounting measurements ø22mm black		
For models:	P/30, P/35, P/40, P/45, P/50		

TELEMECANIQUE (EFA)

ZB2 series

push buttons



1			
GEV No.	348177	Ref. No.	91310374
description	push button mounting measurements ø22mm black OFF		



			
1			
GEV No.	348178	Ref. No.	91310373
description	push button mounting measurements ø22mm green on		

lamps

indicator lights

indicator lights (complete)

ø 6mm

			
1			
GEV No.	359038	Ref. No.	91310116
description	indicator light ø 6mm 230V red		

			
1			
GEV No.	359336	Ref. No.	91310115 ME0000322
description	indicator light ø 6mm 230V green		
For models:	MICRO		

ø10mm

with plug-in socket

			
1			
GEV No.	359036	Ref. No.	ME0000320
description	indicator light ø 10mm clear 230V connection male faston 6.3mm Qty 1 pcs		
For models:	BABY, EXCELSIOR EXTRAPROFI, EXCELSIOR MAXI PROFI, EXCELSIOR MINI PROFI, EXPRESS P 4, EXPRESS P 6, EXPRESS P 9, EXPRESS P44, EXPRESS P66, EXPRESS P99, P/45, P33		

			
1			
GEV No.	359035	Ref. No.	ME0000321
description	indicator light ø 10mm clear 400V connection male faston 6.3mm Qty 1 pcs		
For models:	EVOLUTION MECHANICAL, MAX 4/35X, MAX 6/35LX, MAX 6/35X, MAX 8/35X, MAX 9/35X, MAX12/35LX, MAX12/35X, MAX18/35X, MINI PROFI 90, PAOLO 4, PAOLO 6, PAOLO 8, PAOLO 9, PAOLO12, PAOLO18		

screw-on/push-on fit

light bulbs

for ovens

			
1			
GEV No.	359610	Ref. No.	91310190 ME0000375
description	light bulb t.max. 300°C socket E14 15W 230V ø 22mm L 47mm lens L 20mm for oven lamp type Philips		
For models:	MICRO		

			
1			
GEV No.	359612	Ref. No.	57153
description	light bulb t.max. 300°C socket E14 25W 230V ø 25mm L 56mm lens L 30mm for oven lamp type Philips		
For models:	G18/335		

			
1			
GEV No.	359448	Ref. No.	91310195 ME0000372
description	light bulb t.max. 500°C socket E14 25W 240V ø 24mm L 54mm lens L 21mm for pizza oven not shock-resistant type		

			
1			
GEV No.	359615	Ref. No.	91310191 ME0000370
description	light bulb t.max. 300°C socket E14 25W 230V ø 45mm L 76mm lens L 50mm for oven lamp IMPORT		
For models:	EXCELSIOR EXTRAPROFI, EXCELSIOR MAXI PROFI, EXCELSIOR MINI PROFI, EXPRESS P 4, EXPRESS P 6, EXPRESS P 9, EXPRESS P44, EXPRESS P66, EXPRESS P99, G433, G633, G933, GAS-EXCELSIOR G433, GAS-EXCELSIOR G633, GAS-EXCELSIOR G933, PAOLO 4, PAOLO 6, PAOLO 8, PAOLO 9, PAOLO12, PAOLO18		

halogen lamp

for socket E14 / E27



GEV No.	359728	Ref. No.	91310205
description	halogen lamp socket E14 230V 40W ø 25mm lens L 54mm L 80mm temp.-resist. 300°C Qty 1		

for socket G4 / G6.35 / G9



GEV No.	359599	Ref. No.	91310196
description	halogen lamp socket G4 12V 20W temp.-resist. 500°C		



GEV No.	359946	Ref. No.	91310206 91310207
description	halogen lamp socket G9 230V 40W temp.-resist. 300°C		

for socket GU5.3 / GU10 / GZ5.3



GEV No.	357054	Ref. No.	91310208
description	halogen lamp socket GU5.3 12V 20W ø 50mm H 38mm temp.-resist. 300°C AC/DC		

oven lamps

universal oven lamps

mounting diameter 35.5mm



GEV No.	359701	Ref. No.	91310185 ME0000363
description	lamp socket socket E14 220-230V mounting ø 35.5mm connection male faston 6.3mm 15W		
For models:	MICRO		

accessories for	359701			
	GEV No.	359705	Ref. No.	—
	oven lamp glass thr.ø 33.5mm ø 52mm hard glas temp.-resist. 350°C			

accessories for	359701			
	GEV No.	359709	Ref. No.	91610020 ADNM00005
	oven lamp glass thr.ø 33.5mm ø 42mm hard glas temp.-resist. 350°C			
	GEV No.	359721	Ref. No.	—
	gasket silicone ED ø 48mm ID ø 39.5mm thickness 5mm Qty 1 pcs			
	GEV No.	359942	Ref. No.	—
	oven lamp glass thr.ø 33.5mm ø 41mm hard glas temp.-resist. 350°C			

	GEV No.	359709	Ref. No.	91610020 ADNM00005
description	oven lamp glass thr.ø 33.5mm ø 42mm hard glas temp.-resist. 350°C			
For models:	MICRO			

mounting diameter 65.5mm

	GEV No.	359022	Ref. No.	91310180 91310186 ME0000360
description	lamp socket socket E14 mounting ø 65.5mm connection male faston 6.3mm			
For models:	EVOLUTION DIGITAL, EVOLUTION MECHANICAL, EXCELSIOR EXTRA-PROFI, EXCELSIOR MAXI PROFI, EXCELSIOR MINI PROFI, EXPRESS P 4, EXPRESS P 6, EXPRESS P 9, EXPRESS P44, EXPRESS P66, EXPRESS P99, G433, G633, G933, GAS-EXCELSIOR G433, GAS-EXCELSIOR G633, GAS-EXCELSIOR G933, MAX 4/35, MAX 4/35X, MAX 6/35, MAX 6/35L, MAX 6/35LX, MAX 6/35X, MAX 8/35, MAX 8/35X, MAX 9/35, MAX 9/35X, MAX12/35, MAX12/35L, MAX12/35LX, MAX12/35X, MAX18/35, MAX18/35X, PAOLO 4, PAOLO 6, PAOLO 8, PAOLO 9, PAOLO12, PAOLO18			

	GEV No.	357002	Ref. No.	91310187
description	lamp socket socket G9 mounting ø 65.5mm connection male faston 6.3mm			



 <p>1</p>			
GEV No.	359724	Ref. No.	61004 91610021 ADNM00003
description	oven lamp glass thread \varnothing 62mm H 46mm \varnothing 74mm hard glas temp.-resist. 350°C		
For models:	EVOLUTION DIGITAL, EVOLUTION MECHANICAL, EXCELSIOR EXTRA-PROFI, EXCELSIOR MAXI PROFI, EXCELSIOR MINI PROFI, EXPRESS P 4, EXPRESS P 6, EXPRESS P 9, EXPRESS P44, EXPRESS P66, EXPRESS P99, G433, G633, G933, GAS-EXCELSIOR G433, GAS-EXCELSIOR G633, GAS-EXCELSIOR G933, MAX 4/35, MAX 4/35X, MAX 6/35, MAX 6/35L, MAX 6/35LX, MAX 6/35X, MAX 8/35, MAX 8/35X, MAX 9/35, MAX 9/35X, MAX12/35, MAX12/35L, MAX12/35LX, MAX12/35X, MAX18/35, MAX18/35X, PAOLO 4, PAOLO 6, PAOLO 8, PAOLO 9, PAOLO12, PAOLO18		

 <p>1</p>			
GEV No.	358148	Ref. No.	91310183 91810185
description	lamp socket socket G4 12-250V mounting measurements 55x70mm connection cable 135mm		

 <p>1</p>			
GEV No.	359937	Ref. No.	91610025
description	lamp glass L 80mm W 65mm mounting measurements 52x67mm		

 <p>1</p>			
GEV No.	359729	Ref. No.	91410000
description	gasket glass fibre ID \varnothing 57mm ED \varnothing 67mm thickness 5mm \varnothing 67mm		

 <p>1</p>			
GEV No.	359937	Ref. No.	91610025
description	lamp glass L 80mm W 65mm mounting measurements 52x67mm		

55x70mm			
 <p>1</p>			
GEV No.	358111	Ref. No.	xlo
description	oven lamp complete 12V 20W socket G4 L 70mm W 55mm mounting measurements 55x70mm cable length 300mm		
spare parts for	358111		
	GEV No.	359295	Ref. No. —
	lamp socket for halogen lamp 12V 20W socket G4 mounting measurements 55 x 70mm cable length 135mm		
	GEV No.	359599	Ref. No. 91310196
	halogen lamp socket G4 12V 20W temp.-resist. 500°C		
	GEV No.	359937	Ref. No. 91610025
	lamp glass L 80mm W 65mm mounting measurements 52x67mm		
accessories for	358111		
	GEV No.	358112	Ref. No. —
	gasket L 83mm W 69mm thickness 1mm silicone		

lamps			
light bulbs			
 <p>1</p>			
GEV No.	359610	Ref. No.	91310190 ME0000375
description	light bulb t.max. 300°C socket E14 15W 230V \varnothing 22mm L 47mm lens L 20mm for oven lamp type Philips		
For models:	MICRO		

 <p>1</p>			
GEV No.	359612	Ref. No.	57153
description	light bulb t.max. 300°C socket E14 25W 230V \varnothing 25mm L 56mm lens L 30mm for oven lamp type Philips		
For models:	G18/335		

 <p>1 500°C</p>			
GEV No.	359448	Ref. No.	91310195 ME0000372
description	light bulb t.max. 500°C socket E14 25W 240V \varnothing 24mm L 54mm lens L 21mm for pizza oven not shock-resistant type		

 <p>1</p>			
GEV No.	359615	Ref. No.	91310191 ME0000370
description	light bulb t.max. 300°C socket E14 25W 230V ø 45mm L 76mm lens L 50mm for oven lamp IMPORT		
For models:	EXCELSIOR EXTRAPROFI, EXCELSIOR MAXI PROFI, EXCELSIOR MINI PROFI, EXPRESS P 4, EXPRESS P 6, EXPRESS P 9, EXPRESS P44, EXPRESS P66, EXPRESS P99, G433, G633, G933, GAS-EXCELSIOR G433, GAS-EXCELSIOR G633, GAS-EXCELSIOR G933, PAOLO 4, PAOLO 6, PAOLO 8, PAOLO 9, PAOLO12, PAOLO18		

halogen lamps

for socket E14 / E27

 <p>1</p>			
GEV No.	359728	Ref. No.	91310205
description	halogen lamp socket E14 230V 40W ø 25mm lens L 54mm L 80mm temp.-resist. 300°C Qty 1		

for socket G4 / G6.35 / G9

 <p>1 500°C</p>			
GEV No.	359599	Ref. No.	91310196
description	halogen lamp socket G4 12V 20W temp.-resist. 500°C		

 <p>1</p>			
GEV No.	359946	Ref. No.	91310206 91310207
description	halogen lamp socket G9 230V 40W temp.-resist. 300°C		

for socket GU5,3 / GU10

 <p>1</p>			
GEV No.	357054	Ref. No.	91310208
description	halogen lamp socket GU5.3 12V 20W ø 50mm H 38mm temp.-resist. 300°C AC/DC		

lamp accessories

lenses

glass panels

 <p>1</p>			
GEV No.	357250	Ref. No.	91610013
description	lamp glass L 180mm W 84mm thickness 9.5mm for pizza oven		



contactors

LS Industrial Systems

power contactors

 <p>1</p>			
GEV No.	381167	Ref. No.	91310154
description	power contactor resistive load 20A 230VAC (AC3/400V) 9A/4kW main contacts 4NO auxiliary contacts connection screw connection type GMC-9M/4		

overload switches

 <p>1</p>				
GEV No.	381118	Ref. No.	91310476	
description	overload switch setting range 2.5-4A type GTK-12M LS Industrial Systems			
accessories for	381118			
	GEV No.	380238	Ref. No.	ME0000590
	power contactor resistive load 20A 230VAC (AC3/400V) 8.4A/4kW main contacts 3NO auxiliary contacts 1NO connection screw connection type LS0510A type AEG LS0510A type GE MC1A 310A			



GENERAL ELECTRIC (AEG)

power contactors



1

GEV No.	380238	Ref. No.	ME0000590
description	power contactor resistive load 20A 230VAC (AC3/400V) 8.4A/4kW main contacts 3NO auxiliary contacts 1NO connection screw connection type LS0510A type AEG LS0510A type GE MC1A 310A		
For models:	BABY, EXCELSIOR EXTRAPROFI, EXCELSIOR MAXI PROFI, EXCELSIOR MINI PROFI, EXPRESS P 4, EXPRESS P 6, EXPRESS P 9, EXPRESS P44, EXPRESS P66, EXPRESS P99, PAOLO 4, PAOLO 6, PAOLO 8, PAOLO 9, PAOLO12, PAOLO18		



1

GEV No.	380245	Ref. No.	ME0000597
description	power contactor resistive load 25A 230VAC (AC3/400V) 9A/4kW main contacts 3NO auxiliary contacts 1NC connection screw connection type AEG LS4K 01A type GE CL00A 301 H 85mm		



1

GEV No.	380203	Ref. No.	57142 ME0000595
description	power contactor resistive load 25A 230VAC (AC3/400V) 9A/4kW main contacts 3NO auxiliary contacts 1NC connection screw connection type Fanal DSL9 01 type ISKRA KNL9 01 230V		
For models:	EVOLUTION DIGITAL, EVOLUTION MECHANICAL, EXCELSIOR EXTRA-PROFI, EXCELSIOR MAXI PROFI, EXCELSIOR MINI PROFI, G18/335, MAX 4/35, MAX 4/35X, MAX 6/35, MAX 6/35L, MAX 6/35LX, MAX 6/35X, MAX 8/35, MAX 8/35X, MAX 9/35, MAX 9/35X, MAX12/35, MAX12/35L, MAX12/35LX, MAX12/35X, MAX18/35, MAX18/35X, PAOLO 4, PAOLO 6, PAOLO 8, PAOLO 9, PAOLO12, PAOLO18		



1

GEV No.	380204	Ref. No.	ME0000354
description	power contactor resistive load 25A 230VAC (AC3/400V) 9A/4kW main contacts 3NO auxiliary contacts 1NO connection screw connection type Fanal DSL9 10 type ISKRA KNL9 10		
For models:	MINI PROFI 90, P/30, P/35, P/40, P/45, P/50		

ISKRA (FANAL)

power contactors



1

GEV No.	380212	Ref. No.	ME0000351
description	power contactor resistive load 20A 230VAC (AC3/400V) 8.5A/5.5kW main contacts 3NO auxiliary contacts 1NC connection screw connection type Fanal K07M 01 type ISKRA DSL7 01		
For models:	P/30, P/33, P/35, P/40, P/45, P/50		

LOVATO

power contactors



1

GEV No.	380714	Ref. No.	91310136
description	power contactor resistive load 25A 230VAC (AC3/400V) 9A/4.2kW main contacts 3NO auxiliary contacts 1NO connection screw connection type BF0910A230		



relays

power relays

with bracket mounting

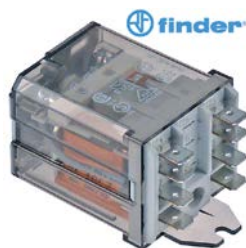

1

GEV No.	380139	Ref. No.	ME0000345
description	power relays FINDER 230VAC 16A 2CO connection F6.3 bracket mounting dimensions 68x38.2x35.8mm manuf. no. 62.82.8.230.0000		
For models:	P/40, P/45, P/50		

time relays

time relays



1

GEV No.	360104	Ref. No.	ME0000571	
description	time relay FINDER 88.12.0.230.0002 time range 0.05s-100h 24-230V AC/DC 2x5A mounting measurements 45x45mm 2CO connection plug-in connection round 8-pole			
For models:	P/30, P/35, P/40, P/45, P/50, P33			
accessories for	360104			
	GEV No.	380638	Ref. No.	—
	relay socket 8-pole dimensions 51x41x23mm 250V 10A FINDER manuf. no. 90.26			

transformers

encapsulated transformers

PMA



1

GEV No.	379054	Ref. No.	91310350 ME0000410
description	transformer primary 230VAC secondary 12VAC 3VA secondary 0.25A H 40mm L 45mm W 50mm connection screw 50/60Hz type 153/M		
For models:	EXCELSIOR EXTRAPROFI, EXCELSIOR MAXI PROFI, EXCELSIOR MINI PROFI, G433, G633, G933, GAS-EXCELSIOR G433, GAS-EXCELSIOR G633, GAS-EXCELSIOR G933, MAX 4/35X, MAX 6/35LX, MAX 6/35X, MAX 8/35X, MAX 9/35X, MAX12/35LX, MAX12/35X, MAX18/35X		

electronic controllers

ELIWELL

universal controllers

built-in version







1



GEV No.	379566	Ref. No.	ME0000309
description	electronic controller ELIWELL type IC912 mounting measurements 71x29mm 12V Pt100/TC-J defr. funct. no		
For models:	MICRO		



1

GEV No.	379605	Ref. No.	91310030	
description	electronic controller ELIWELL type ICPPlus915 model ICP22JI35000 mounting measurements 71x29mm 12V voltage AC/DC Pt100/TC (J,K) relay outputs 2 NO-8A(4) NO-8A(4) Pt100/TC (J,K) cooking front measurements 78x37mm built-in depth 59mm mode of operation cooking protection IPx0 accuracy 1% built-in version defr. funct. no depend on probe°C display 3½ digits			
accessories for	379605			
	GEV No.	379050	Ref. No.	—
	temperature probe Pt100 cable Vetrotex probe -200 up to +600°C cable -50 up to +350°C probe ø6x100mm cable length 2.7m without screw connection 3-wire			
	GEV No.	379054	Ref. No.	91310350 ME0000410
	transformer primary 230VAC secondary 12VAC 3VA secondary 0.25A H 40mm L 45mm W 50mm connection screw 50/60Hz type 153/M			
	GEV No.	379785	Ref. No.	—
	temperature probe Pt100 cable silicone probe -100 up to 450°C cable -50 up to +180°C probe ø6x100mm cable length 1.5m without screw connection 2-wire resistor 0.1kOhm			
	GEV No.	379786	Ref. No.	—
	temperature probe Pt100 cable silicone probe -100 up to 450°C cable -50 up to +180°C probe ø6x100mm cable length 3m without screw connection 2-wire resistor 0.1kOhm			
	GEV No.	379787	Ref. No.	—
	temperature probe Pt100 cable Vetrotex probe -200 up to +600°C cable -50 up to +350°C probe ø6x100mm cable length 1.4m without screw connection 2-wire resistor 0.1kOhm			



			
1			
GEV No.	379568	Ref. No.	ME0000299
description	electronic controller ELIWELL type ICP22JI750000 mounting measurements 71x29mm 230V voltage AC Pt100/TC (J,K) relay outputs 2 CO-8A(4) CO-8A(4) Pt100/TC (J,K,S) DI front measurements 78x37mm built-in depth 60mm mode of operation cooking protection IPx0 accuracy 1% built-in version defr. funct. no -150 to 1350°C display 3½ digits		
For models:	EVOLUTION MECHANICAL, P/30, P/35, P/40, P/45, P/50		
accessories for	379568		
	GEV No.	378065	Ref. No.
	description	alarm device AKO type AKO-520641 mounting measurements 214x214mm 230V voltage AC relay outputs 1 CO-8A(4) up to 4 front measurements 222x222mm yes yes	
	GEV No.	378074	Ref. No.
	description	temperature probe thermocouple J (Fe-CuNi) cable Vetrotex probe -50 up to +750°C cable -50 up to +350°C probe ø3x100mm cable length 3m without screw connection 2-wire	
	GEV No.	378075	Ref. No.
	description	temperature probe thermocouple K (NiCr-Ni) cable Vetrotex probe -50 up to 1150°C cable -50 up to +350°C probe ø4.5x150mm cable length 3m without screw connection 2-wire	
	GEV No.	379050	Ref. No.
	description	temperature probe Pt100 cable Vetrotex probe -200 up to +600°C cable -50 up to +350°C probe ø6x100mm cable length 2.7m without screw connection 3-wire	
GEV No.	379062	Ref. No.	ME0000402
description	temperature probe thermocouple J (Fe-CuNi) cable Vetrotex probe -50 up to +750°C cable -50 up to +350°C probe ø6x50mm cable length 3m without screw connection 2-wire		

refrigeration controllers

built-in version

			
1			
GEV No.	379018	Ref. No.	ME0000307
description	electronic controller ELIWELL type EWPC902T thermocouple J		

PIXSYS

universal controllers

built-in version

			
1			
GEV No.	379888	Ref. No.	91310031
description	electronic controller PIXSYS type ATR111-B mounting measurements 71x29mm 230V voltage AC NTC/PTC/Pt100/Pt1000/TC(J,K)/mV/mA relay outputs 2 CO-8A(3) 8VDC/20mA NTC/PTC/Pt100/Pt1000/TC(J,K)/mV/mA front measurements 35x77mm built-in depth 54mm protection IP64 accuracy 1% built-in version defr. funct. dependent on probe°C display 3 digits		

			
1			
GEV No.	381309	Ref. No.	ATR121-B
description	electronic controller PIXSYS type ATR121-B mounting measurements 71x29mm 230V voltage AC NTC/PTC/Pt100/Pt1000/TC(J,K)/mV/mA relay outputs 3 CO-8A(3) NO-5A(3) 8VDC/20mA NTC/PTC/Pt100/Pt1000/TC(J,K)/mV/mA front measurements 35x77mm built-in depth 54mm protection IP64 accuracy 1% built-in version defr. funct. no dependent on probe°C display 3 digits		

SHANGFANG

accessories



			
1			
GEV No.	379054	Ref. No.	91310350 ME0000410
description	transformer primary 230VAC secondary 12VAC 3VA secondary 0.25A H 40mm L 45mm W 50mm connection screw 50/60Hz type 153/M		
For models:	EXCELSIOR EXTRAPROFI, EXCELSIOR MAXI PROFI, EXCELSIOR MINI PROFI, G433, G633, G933, GAS-EXCELSIOR G433, GAS-EXCELSIOR G633, GAS-EXCELSIOR G933, MAX 4/35X, MAX 6/35LX, MAX 6/35X, MAX 8/35X, MAX 9/35X, MAX12/35LX, MAX12/35X, MAX18/35X		



probes

universal probes

temperature probes

1 			
GEV No.	379051	Ref. No.	57210 91310211 ME0000400
description	temperature probe thermocouple J (Fe-CuNi) cable Vetrotex probe -50 up to +750°C cable -50 up to +350°C probe ø6x100mm cable length 3m without screw connection cable colours red/blue 2-wire		
For models:	EVOLUTION MECHANICAL, EXCELSIOR EXTRAPROFI, EXCELSIOR MAXI PROFI, EXCELSIOR MINI PROFI, G433, G633, G933, GAS-EXCELSIOR G433, GAS-EXCELSIOR G633, GAS-EXCELSIOR G933, MAX 4/35X, MAX 6/35LX, MAX 6/35X, MAX 8/35X, MAX 9/35X, MAX12/35LX, MAX12/35X, MAX18/35X		
accessories for	379051		
	GEV No.	379877	Ref. No. —
	electronic controller HONEYWELL type DC10N-400 mounting measurements 92x92mm 24/230V voltage AC TC (J) relay outputs 1 CO-10A(6) TC (J) universal built-in depth 55mm protection IP54 accuracy 1% built-in version defr. funct. no 0 up to +400°C display 3 digits		

1 			
GEV No.	379062	Ref. No.	ME0000402
description	temperature probe thermocouple J (Fe-CuNi) cable Vetrotex probe -50 up to +750°C cable -50 up to +350°C probe ø6x50mm cable length 3m without screw connection 2-wire		
For models:	P/30, P/35, P/40, P/45, P/50		

producer-specific probes

probes

1 			
GEV No.	403694	Ref. No.	91310212
description	temperature probe thermocouple J (Fe-CuNi) cable Vetrotex probe -50 up to +750°C cable -50 up to +350°C connection 2-wire thread probe ø6x100mm cable length 0.45m		

1 			
GEV No.	379598	Ref. No.	91310215 ME0000401
description	temperature probe thermocouple K (NiCr-Ni) cable Vetrotex probe -50 up to 1150°C cable -50 up to +350°C connection 2-wire thread probe ø3x200mm cable length 1.5m		
For models:	EVOLUTION DIGITAL, MAX 4/35, MAX 6/35, MAX 6/35L, MAX 8/35, MAX 9/35, MAX12/35, MAX12/35L, MAX18/35		

electronics

PCBs

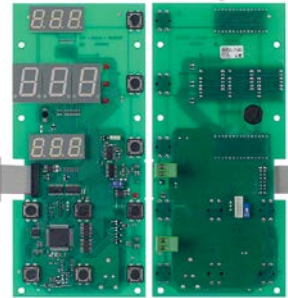
1 			
GEV No.	401149	Ref. No.	3990298082 91310255 ME0000482
description	control PCB		
For models:	EVOLUTION DIGITAL, MAX 4/35, MAX 6/35, MAX 6/35L, MAX 8/35, MAX 9/35, MAX12/35, MAX12/35L, MAX18/35		

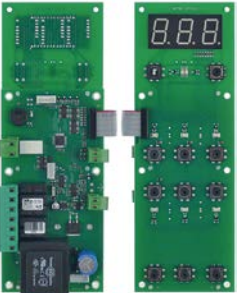
1 			
GEV No.	403693	Ref. No.	91310258
description	control PCB for pizza oven Michelangelo L 230mm W 80mm connection screw clamps		

1 			
GEV No.	400859	Ref. No.	91310250 ME0000480
description	control PCB pizza oven TH4351DC		

1 			
GEV No.	403692	Ref. No.	91310259
description	PCB for pizza oven Michelangelo L 80mm W 32mm connection coded plug for flues		

1

GEV No.	401150	Ref. No.	91310305 91310306 ME0000487
description	PCB pizza oven MAX 4/35		
For models:	EVOLUTION DIGITAL, MAX 4/35, MAX 6/35, MAX 6/35L, MAX 8/35, MAX 9/35, MAX12/35, MAX12/35L, MAX18/35		



1

GEV No.	400814	Ref. No.	60022 91310301 ME0000486
description	PCB pizza oven TH4351DC 2kW		



1

GEV No.	361978	Ref. No.	91310260 91310261
description	PCB pizza oven/pizza press L 125mm W 108mm with display buttons 6		



1

GEV No.	401965	Ref. No.	91310270 ME0000488
description	PCB suitable for EV385		

keypads

front foils



1

GEV No.	401144	Ref. No.	ADNM00220
description	front foil		
For models:	P/30, P/35, P/40, P/45, P/50		



1

GEV No.	401147	Ref. No.	ADNM00155
description	front foil		
For models:	EVOLUTION MECHANICAL		

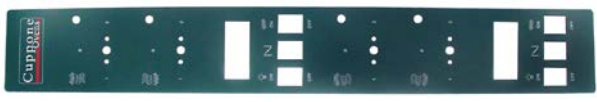

1

GEV No.	401148	Ref. No.	ADNM00156
description	front foil		

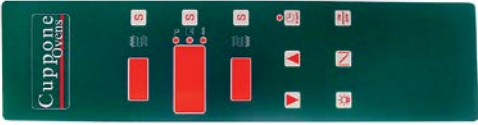

1

GEV No.	401145	Ref. No.	91611080 ADNM00150
description	keypad foil		
For models:	EVOLUTION DIGITAL, MAX 4/35, MAX 6/35, MAX 6/35L, MAX 9/35		



1

GEV No.	401146	Ref. No.	91611090 ADNM00151
description	keypad foil		
For models:	EVOLUTION DIGITAL, MAX 8/35, MAX12/35, MAX12/35L, MAX18/35		



fans

axial fans

import



GEV No.	601131 ¹	Ref. No.	ME0000631
description	axial fan L 119mm W 119mm H 25mm 230VAC 50/60Hz 19/18W bearing ball bearing connection male faston 2.8mm metal ADDA fan wheel ø 110mm temp.-resist. 70°C		
For models:	EVOLUTION DIGITAL, EVOLUTION MECHANICAL		
accessories for	601131		
	GEV No.	550898	Ref. No. —
connecting cable cable length 2000mm connection F 2.8 connection distance 7.9mm for axial flow fan			

¹with ball bearings



GEV No.	601080 ¹	Ref. No.	91310320
description	axial fan L 119mm W 119mm H 38mm 230VAC 50/60Hz 23/20W bearing ball bearing connection male faston 2.8mm metal ADDA fan wheel ø 110mm temp.-resist. 70°C		
accessories for	601080		
	GEV No.	550898	Ref. No. —
connecting cable cable length 2000mm connection F 2.8 connection distance 7.9mm for axial flow fan			
	GEV No.	692519	Ref. No. —
guard L 120mm W 120mm plastic			

¹with ball bearings

motors

gear motors

for ovens

for flues



GEV No.	601247	Ref. No.	91310530+91310540old vers. ME0000630
description	gear motor FIBER type G0655CABN00 230V 50Hz 7.5rpm shaft ø 6mm L 66mm W 50mm H 47mm for air fan		
For models:	EVOLUTION DIGITAL, EVOLUTION MECHANICAL, MAX 4/35, MAX 6/35, MAX 6/35L, MAX 8/35, MAX 9/35, MAX12/35, MAX12/35L, MAX18/35		



GEV No.	602083	Ref. No.	91310530 91310530+91310540
description	gear motor MOTEC type 04BUA1 230V 50Hz 500rpm shaft ø 6mm L 46mm W 48mm H 65mm		

motors

universal



GEV No.	500633	Ref. No.	91411040 MM0000030
description	motor 370W 230V 50Hz 1 phase shaft ø 14mm flange ø 105mm 1400rpm type LME71L4R3 ø 140mm H 200mm L 220mm Lafert 0.37kW		
For models:	P33		



 Image not available 1			
GEV No.	500635	Ref. No.	MM0000071
description	motor 400V 3 phase		
For models:	P/45		

 Image not available 2			
GEV No.	500636	Ref. No.	MM0000075
description	motor 400V 3 phase		
For models:	P/30, P/35		

 Image not available 1			
GEV No.	500637	Ref. No.	MM0000076
description	motor 400V 3 phase		
For models:	P/40, P/45, P/50		

fuses

fine fuses

 1			
GEV No.	358074	Ref. No.	91310504
description	fine fuse size ø5x20mm 5A fast-acting rated 250V Qty 10 pcs		

fine fuse holders

 1			
GEV No.	551332	Ref. No.	91310511
description	fuse holder suitable fuse 5x20 10A rated 250V L 42mm W 16mm max. 10A		

gas valves and ignition boxes

gas control valves

SIT

TANDEM

 1			
GEV No.	101684	Ref. No.	91310340 ME0000431
description	gas valve 230V 50Hz gas inlet 1/2" gas outlet 1/2" pilot connection level slow ignition standard ignition time 3-7s pressure range 3-50mbar power supply for modulator type SIT equiv. no. 0.830.034		
spare parts for	101684		
	GEV No.	101379	Ref. No. —
	solenoid coil 230V 50Hz suitable for Tandem		
accessories for	101684		
	GEV No.	101274	Ref. No. —
	olive for pipe ø 16mm Qty 1 pcs		
	GEV No.	101275	Ref. No. —
	union screw thread 1/2" for pipe ø 16mm Qty 1 pcs		
	GEV No.	102845	Ref. No. —
	gas connection angled 1/2" flange 32x32mm hole distance 24x24mm Tandem		
	GEV No.	102846	Ref. No. —
	gas connection straight 1/2" flange 32x32mm hole distance 24x24mm suitable for Tandem		
	GEV No.	102847	Ref. No. —
	O-ring		



GEV No.	101189	Ref. No.	058011
description	gas valve 230V 50Hz gas inlet 1/2" gas outlet 1/2" pilot connection M10x1 level slow ignition ignition times pressure range 3-50mbar power supply for modulator equiv. no. 0.830.040 suitable for Tandem		
For models:	G433, G633, G933, GAS-EXCELSIOR G433, GAS-EXCELSIOR G633, GAS-EXCELSIOR G933		
spare parts for	101189		
	GEV No.	101379	Ref. No. —
	solenoid coil 230V 50Hz suitable for Tandem		
accessories for	101189		
	GEV No.	100904	Ref. No. —
	locking screw M10x1 for pipe ø 4mm Qty 1 pcs		
	GEV No.	100905	Ref. No. —
	locking screw M10x1 for pipe ø 6mm Qty 1 pcs		
	GEV No.	101274	Ref. No. —
	olive for pipe ø 16mm Qty 1 pcs		
	GEV No.	101275	Ref. No. —
	union screw thread 1/2" for pipe ø 16mm Qty 1 pcs		
	GEV No.	101925	Ref. No. —
	plug with O-ring thread M10x1 for pilot burner suitable for NOVASIT		
	GEV No.	102845	Ref. No. —
	gas connection angled 1/2" flange 32x32mm hole distance 24x24mm Tandem		
	GEV No.	102846	Ref. No. —
	gas connection straight 1/2" flange 32x32mm hole distance 24x24mm suitable for Tandem		
	GEV No.	102847	Ref. No. —
	O-ring		

ignition boxes

SIT



GEV No.	101685	Ref. No.	91310280 ME0000420
description	ignition box SIT type 503EFD electrodes 2 waiting time 1.5s safety time 10s 220/240V 10VA 50-60Hz protection IP40		
For models:	G433, G633, G933, GAS-EXCELSIOR G433, GAS-EXCELSIOR G633, GAS-EXCELSIOR G933		

ignition parts
electrodes

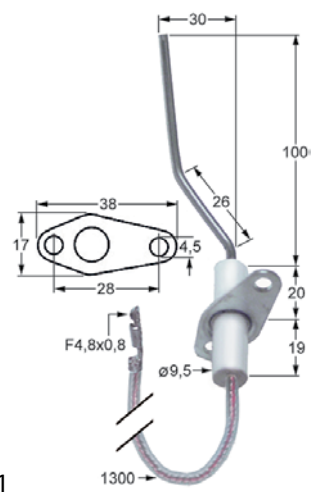

GEV No.	100780	Ref. No.	91310490 ME0000471
description	ignition electrode flange length 38mm flange width 17mm D1 ø 9.5mm L1 100mm L2 30mm L3 26mm BL1 20mm BL2 19mm connection F 4.8x0.8mm cable length 1300mm fixing dimensions ø4.5mm mounting distance 28mm with flange		
For models:	G433, G633, G933, GAS-EXCELSIOR G433, GAS-EXCELSIOR G633, GAS-EXCELSIOR G933		

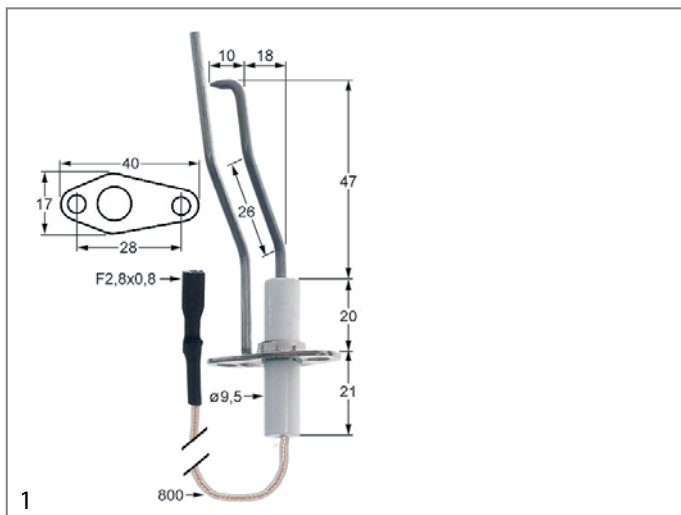



GEV No.	100769	Ref. No.	91310480 ME0000470
description	ignition electrode flange length 40mm flange width 17mm D1 ø 9.5mm L1 47mm L2 18mm L4 10mm L3 26mm BL1 20mm BL2 21mm connection F 2.8x0.8mm cable length 800mm fixing dimensions ø4.5mm mounting distance 28mm with flange with earthing contact		
For models:	G433, G633, G933, GAS-EXCELSIOR G433, GAS-EXCELSIOR G633, GAS-EXCELSIOR G933		

gas nozzles

main nozzles

gas nozzles M13x1

	1		
GEV No.	100108	Ref. No.	92210370
description	gas injector thread M13x1 bore ø 1.6mm WS 13		

	1		
GEV No.	102783	Ref. No.	92210371
description	gas injector thread M13x1 bore ø 1.8mm WS 13		

	1		
GEV No.	100389	Ref. No.	92210372
description	gas injector thread M13x1 bore ø 1.9mm WS 13		

	1		
GEV No.	100417	Ref. No.	92210373
description	gas injector thread M13x1 bore ø 2.15mm WS 13		

	1		
GEV No.	102789	Ref. No.	92210374
description	gas injector thread M13x1 bore ø 2.45mm WS 13		

	1		
GEV No.	100710	Ref. No.	92210375
description	gas injector thread M13x1 bore ø 2.85mm WS 13		

	1		
GEV No.	100722	Ref. No.	92210376
description	gas injector thread M13x1 bore ø 2.95mm WS 13		

	1		
GEV No.	100866	Ref. No.	92210377
description	gas injector thread M13x1 bore ø 3.1mm WS 13		

	1		
GEV No.	100923	Ref. No.	92210378
description	gas injector thread M13x1 bore ø 3.4mm WS 13		

	1		
GEV No.	106272	Ref. No.	92210379
description	gas injector thread M13x1 bore ø 3.55mm WS 13		



1

GEV No.	106274	Ref. No.	92210381
description	gas injector thread M13x1 bore ø 3.75mm WS 13		



1

GEV No.	106273	Ref. No.	92210380
description	gas injector thread M13x1 bore ø 3.7mm WS 13		



1

GEV No.	106275	Ref. No.	92210382
description	gas injector thread M13x1 bore ø 3.8mm WS 13		



1

GEV No.	106276	Ref. No.	92210383
description	gas injector thread M13x1 bore ø 4.1mm WS 13		

equipment-specific units

for dough mixers

chains

roller chains 08B-1 single



1

GEV No.	697128	Ref. No.	92410817
description	roller chain DIN/ISO 08 B-1 splitting 1/2" / 12.7mm links 37 internal width 7.75mm rollerø 8.51mm single		

connectors



1

GEV No.	693276	Ref. No.	91410640
description	connector single DIN/ISO 08 B-1 splitting 1/2" links 1 L 23mm internal width 11.8mm rollerø 4.3mm metal		

for pizza press

gearboxes



1

GEV No.	693336	Ref. No.	MM0000112
description	gearbox		
For models:	P/45		



1

GEV No.	693337	Ref. No.	MM0000115
description	gearbox		
For models:	P/30, P/35		



1

GEV No.	693338	Ref. No.	MM0000116
description	gearbox		
For models:	P/40, P/45, P/50		

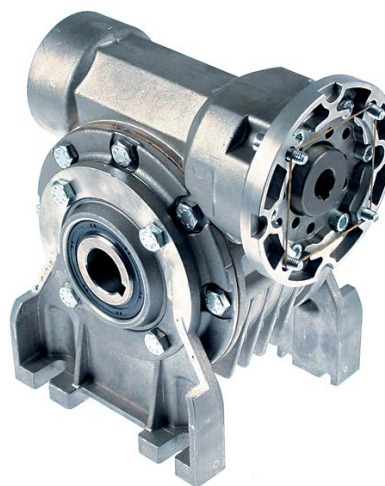

1

GEV No.	601182	Ref. No.	91411510 MM0000111
description	gearbox motor shaft ø 14mm flange ø 105mm transmission 1/80 drive shaft ø 25mm fixing dimensions 86-110mm type MV 63A		
For models:	P33		



for pizza ovens

glass panels



GEV No.	698992	Ref. No.	91610038
description	ceramic washer W 1120mm H 93mm thickness 4mm for pizza oven Qty 1 pcs		

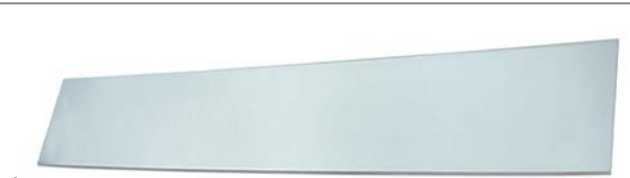

GEV No.	693331	Ref. No.	91610005 ADNM00007
description	glass panel L 1063mm W 93mm rectangular		
For models:	MAX 4/35X, MAX 6/35L, MAX 6/35LX, MAX 6/35X, MAX 8/35X, MAX 9/35, MAX 9/35X, MAX12/35L, MAX12/35LX, MAX12/35X, MAX18/35, MAX18/35X		

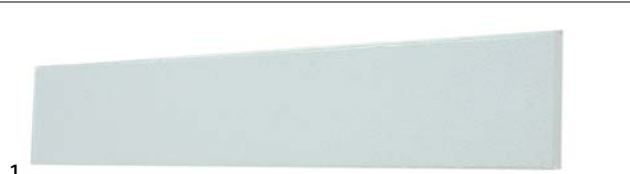

GEV No.	700205	Ref. No.	91610010 ADNM00000
description	glass panel L 320mm W 100mm thickness 5mm rectangular		
For models:	EXCELSIOR EXTRAPROFI, EXCELSIOR MAXI PROFI, EXCELSIOR MINI PROFI, EXPRESS P 4, EXPRESS P 6, EXPRESS P 9, EXPRESS P44, EXPRESS P66, EXPRESS P99, G433, G633, G933, GAS-EXCELSIOR G433, GAS-EXCELSIOR G633, GAS-EXCELSIOR G933, MICRO, MINI PROFI 90, PAOLO 4, PAOLO 6, PAOLO 8, PAOLO 9, PAOLO12, PAOLO18		

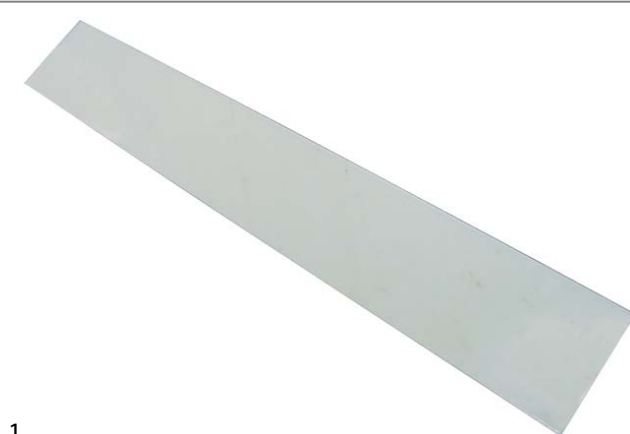

GEV No.	700697	Ref. No.	91610001
description	glass panel L 626mm W 93mm thickness 4mm		
For models:	G035		



GEV No.	693330	Ref. No.	91610002 ADNM00006
description	glass panel L 713mm W 93mm rectangular		
For models:	EVOLUTION DIGITAL, EVOLUTION MECHANICAL, MAX 4/35, MAX 4/35X, MAX 6/35, MAX 6/35LX, MAX 6/35X, MAX 8/35, MAX 8/35X, MAX 9/35X, MAX12/35, MAX12/35LX, MAX12/35X, MAX18/35X		



GEV No.	700703	Ref. No.	91610003
description	glass panel L 726mm W 93mm		



GEV No.	691228	Ref. No.	91610004
description	glass panel L 926mm W 93mm rectangular		

firebricks



GEV No.	850103	Ref. No.	91610056 ADNM00018
description	firebrick L 1050mm W 350mm H 19mm delivery freight forwarding company only		
For models:	MAX 4/35X, MAX 6/35L, MAX 6/35LX, MAX 6/35X, MAX 8/35X, MAX 9/35, MAX 9/35X, MAX12/35L, MAX12/35LX, MAX12/35X, MAX18/35, MAX18/35X		



GEV No.	850128	Ref. No.	91610141
description	firebrick L 1074mm W 358mm H 16mm delivery freight forwarding company only		



1

GEV No.	850056	Ref. No.	91610072 ADNM00011
description	firebrick L 330mm W 330mm H 30mm delivery freight forwarding company only		
For models:	G433, G633, G933, GAS-EXCELSIOR G433, GAS-EXCELSIOR G633, GAS-EXCELSIOR G933, MINI PROFI 90		



1

GEV No.	850065	Ref. No.	91610060 ADNM00015
description	firebrick L 400mm W 400mm H 19mm delivery freight forwarding company only		
For models:	MICRO		



1

GEV No.	850079	Ref. No.	91610062 ADNM00021
description	firebrick L 585mm W 585mm H 19mm delivery freight forwarding company only		
For models:	EVOLUTION DIGITAL, EVOLUTION MECHANICAL		



1

GEV No.	850110	Ref. No.	91610110
description	firebrick L 588mm W 294mm H 19mm		



1

GEV No.	850080	Ref. No.	ADNM00022
description	firebrick L 590mm W 590mm H 19mm triangular delivery freight forwarding company only		
For models:	EVOLUTION DIGITAL, EVOLUTION MECHANICAL		



1

GEV No.	850101	Ref. No.	91610050
description	firebrick L 600mm W 300mm H 20mm grooved delivery freight forwarding company only		



1

GEV No.	850018	Ref. No.	91610101 91610130
description	firebrick L 616mm W 308mm H 19mm delivery freight forwarding company only		



1

GEV No.	850102	Ref. No.	91610055 ADNM00017
description	firebrick L 700mm W 350mm H 19mm delivery freight forwarding company only		
For models:	MAX 4/35, MAX 4/35X, MAX 6/35, MAX 6/35LX, MAX 6/35X, MAX 8/35, MAX 8/35X, MAX 9/35X, MAX12/35, MAX12/35LX, MAX12/35X, MAX18/35X		





1

GEV No.	850112	Ref. No.	91610102 91610140
description	firebrick L 715mm W 357mm H 20mm delivery freight forwarding company only		



1

GEV No.	850105	Ref. No.	91610051
description	firebrick L 900mm W 300mm H 18mm delivery freight forwarding company only		



1

GEV No.	110618	Ref. No.	91510071 MP0000000
description	knob switch zero mark t.max.°C ø 45mm shaft ø 6x4.6mm shaft flat upper black		
For models:	BABY, EXPRESS P 4, EXPRESS P 6, EXPRESS P 9, EXPRESS P44, EXPRESS P66, EXPRESS P99, MINI PROFI 90		



1

GEV No.	110619	Ref. No.	91510096 MP0000013
description	knob switch zero mark t.max.°C ø 48mm shaft ø 5x5mm shaft flat black		
For models:	EVOLUTION MECHANICAL, EXCELSIOR EXTRAPROFI, EXCELSIOR MAXI PROFI, EXCELSIOR MINI PROFI, MAX 4/35X, MAX 6/35LX, MAX 6/35X, MAX 8/35X, MAX 9/35X, MAX12/35LX, MAX12/35X, MAX18/35X		

knobs

universal knobs



1

GEV No.	110243	Ref. No.	MP0000003
description	knob thermostat t.max. 200°C ø 50mm shaft ø 6x4.6mm shaft flat upper black temperature range 60-200°C		
For models:	P/45, P33		



1

GEV No.	110243	Ref. No.	MP0000003
description	knob thermostat t.max. 200°C ø 50mm shaft ø 6x4.6mm shaft flat upper black temperature range 60-200°C		
For models:	P/45, P33		

producer-specific knobs

CUPPONE



1

GEV No.	111420	Ref. No.	91510090
description	knob switch zero mark ø 34/60mm shaft ø 5x5mm red H 22mm L 50mm		

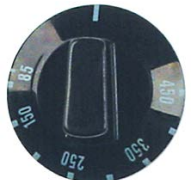

1

GEV No.	111740	Ref. No.	91510083
description	knob thermostat t.max. 450°C ø 49mm shaft ø 6x4.6mm shaft flat upper black temperature range 85-450°C rotation 270°		

handles and hand wheels

hand wheels

spare parts and accessories



1			
GEV No.	693332	Ref. No.	91510020 MP0000022
description	cylindrical handle thread M8 ø 23mm L 62mm rotary		
For models:	MICRO		

cylindrical handles

rotary



1			
GEV No.	693332	Ref. No.	91510020 MP0000022
description	cylindrical handle thread M8 ø 23mm L 62mm rotary		
For models:	MICRO		

fixed



1			
GEV No.	110804	Ref. No.	91510011 MP0000021
description	cylindrical handle thread M12 ø 29mm L 111mm		
For models:	BABY, EXCELSIOR EXTRAPROFI, EXCELSIOR MAXI PROFI, EXCELSIOR MINI PROFI, G433, G633, G933, GAS-EXCELSIOR G433, GAS-EXCELSIOR G633, GAS-EXCELSIOR G933		



1			
GEV No.	110803	Ref. No.	91510010 MP0000020
description	cylindrical handle thread M12 ø 29mm L 87mm		
For models:	EXPRESS P 4, EXPRESS P 6, EXPRESS P 9, EXPRESS P44, EXPRESS P66, EXPRESS P99, PAOLO 4, PAOLO 6, PAOLO 8, PAOLO 9, PAOLO12, PAOLO18		

miscellaneous

1			
GEV No.	693333	Ref. No.	91510000 MP0000026
description	handle		
For models:	EVOLUTION DIGITAL, EVOLUTION MECHANICAL, MAX 4/35, MAX 4/35X, MAX 6/35, MAX 6/35L, MAX 6/35LX, MAX 6/35X, MAX 8/35, MAX 8/35X, MAX 9/35, MAX 9/35X, MAX12/35, MAX12/35L, MAX12/35LX, MAX12/35X, MAX18/35, MAX18/35X		

accessories

1			
GEV No.	693334	Ref. No.	91510050 MP0000031
description	hand protection for door handle		
For models:	EVOLUTION DIGITAL, EVOLUTION MECHANICAL, MAX 4/35, MAX 4/35X, MAX 6/35, MAX 6/35L, MAX 6/35LX, MAX 6/35X, MAX 8/35, MAX 8/35X, MAX 9/35, MAX 9/35X, MAX12/35, MAX12/35L, MAX12/35LX, MAX12/35X, MAX18/35, MAX18/35X		

1			
GEV No.	690026	Ref. No.	91510060 MP0000030
description	hand protection for door handle ED ø 36mm ID ø 12.3mm D1 ø 22.6-23.5mm		
For models:	EXCELSIOR EXTRAPROFI, EXCELSIOR MAXI PROFI, EXCELSIOR MINI PROFI, G433, G633, G933, GAS-EXCELSIOR G433, GAS-EXCELSIOR G633, GAS-EXCELSIOR G933, PAOLO 4, PAOLO 6, PAOLO 8, PAOLO 9, PAOLO12, PAOLO18		



gaskets

sealing cords

flat



1

GEV No.	698994	Ref. No.	95311031
description	sealing cord flat size 20x2mm self-adhesive L 1124m t.max.°C for discs		

square



1

GEV No.	698993	Ref. No.	95311021
description	sealing cord square size 16x16mm braided L 1560mm t.max. 550°C for door		



1

GEV No.	900505	Ref. No.	92013500 SLMX01050
description	sealing cord square size 16x16mm t.max. 550°C braided L 0.69m for door		
For models:	EVOLUTION DIGITAL, EVOLUTION MECHANICAL, MAX 4/35, MAX 4/35X, MAX 6/35, MAX 6/35LX, MAX 6/35X, MAX 8/35, MAX 8/35X, MAX 9/35X, MAX12/35, MAX12/35LX, MAX12/35X, MAX18/35X		



1

GEV No.	901176	Ref. No.	92013501 92210561
description	sealing cord square size 16x16mm t.max. 550°C braided L 1.2m for door		

transmission technology and ball bearings

ball bearings

deep-groove ball bearings 2RS



1

GEV No.	523513	Ref. No.	91410102
description	deep-groove ball bearing type 6205-2RS shaft ø 25mm ED ø 52mm W 15mm with sealing discs deep-groove ball bearing DIN 625-1		

chains

roller chains 08B-1 single



1

GEV No.	697128	Ref. No.	92410817
description	roller chain DIN/ISO 08 B-1 splitting 1/2" / 12.7mm links 37 internal width 7.75mm rollerø 8.51mm single		



1

GEV No.	698990	Ref. No.	92410822
description	roller chain DIN/ISO 08 B-1 splitting 1/2" / 12.7mm links 61 internal width 7.75mm rollerø 8.51mm single		

connectors



1

GEV No.	694876 ¹	Ref. No.	91410641
description	connector single DIN/ISO 08 B-1 splitting 1/2" links 1 L 23mm internal width 11.8mm rollerø 4.3mm hardend		



1

GEV No.	693276	Ref. No.	91410640
description	connector single DIN/ISO 08 B-1 splitting 1/2" links 1 L 23mm internal width 11.8mm rollerø 4.3mm metal		

half links



1

GEV No.	697841	Ref. No.	91410620
description	half link single DIN/ISO 08 B-1 splitting 1/2"		

springs

tension springs



1

GEV No.	698991	Ref. No.	92410560
description	tension spring ø 15.5mm total length 100mm wire gauge ø 1.5mm L1 15mm L2 70mm L3 15mm for dough mixer Qty 1 pcs		



1

GEV No.	514073	Ref. No.	92012240 ADME01203
description	tension spring with thread \varnothing 29.8mm total length 125 extendable max. 280mm wire gauge \varnothing 5.2mm		
For models:	EVOLUTION MECHANICAL		

measuring equipment

thermometers

built-in thermometers

\varnothing 60mm



1

GEV No.	541054	Ref. No.	91410020 MM0000000
description	thermometer mounting \varnothing 60mm t.max. 500°C 0 up to +500°C probe \varnothing 10mm probe L 80mm capillary pipe 700mm		
For models:	BABY, EXPRESS P 4, EXPRESS P 6, EXPRESS P 9, EXPRESS P44, EXPRESS P66, EXPRESS P99, PAOLO 4, PAOLO 6, PAOLO 8, PAOLO 9, PAOLO12, PAOLO18		

consumables

fuses

fine fuses



1

GEV No.	358074	Ref. No.	91310504
description	fine fuse size \varnothing 5x20mm 5A fast-acting rated 250V Qty 10 pcs		

A			
axial fans	24		
C			
cam switches	13		
consumables	34		
contactors	18		
control equipment	14		
control thermostats	11		
E			
electronic controllers	20		
F			
fans	24		
fine fuses	34		
fuses	25, 34		
G			
gas control valves	25		
gas nozzles	27		
H			
halogen lamp	16		
heating elements	3		
heating elements for pizza ovens	3		
heating elements for pizza presses	10		
I			
ignition boxes	26		
indicator lights	15		
indicator lights (complete)	15		
L			
lamp accessories	18		
lamps	15		
light bulbs	15		
M			
measuring equipment	34		
microswitches	13		
motors	24		
O			
oven lamps	16		
P			
probes	22		
R			
relays	20		
rocker/momentary rocker switches	12		
		rotary switches	13
S			
		safety thermostats	12, 12
		sealing cords	33
		switches and momentary switches	12
T			
		temperature probes	22
		thermostats	11
		time relays	20
		transformers	20
U			
		universal probes	22