



**GAS COMPONENTS**



**ELECTRIC COMPONENTS**



**WATER TECHNOLOGY**



**MECHANICAL COMPONENTS**



**TOOLS**

Spare parts suitable for

**COOKMAX**

Find the complete and up-to-date range of products in our GEV Webshop



# Manufacturer catalogue

The most important spare parts and accessories arranged clearly for every manufacturer

- ✓ Complete product range and all appliance data always up to date in the GEV Webshop
- ✓ Alphabetical Index at the end of the catalogue

## GEV Webshop

[www.gev-online.co.uk](http://www.gev-online.co.uk)

[www.gev-online.com](http://www.gev-online.com)



- 🔍 Add to Favourites
- 🔍 Sign In with email address and usual password
- 🔍 Easy-order – place several items in your basket at the same time
- 🔍 Quick Item search – no login needed



# heating elements

## heating elements for ovens

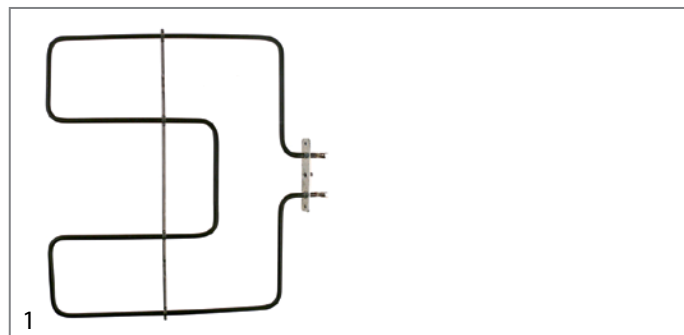

<b>GEV No.</b>	418696	<b>Ref. No.</b>	CR0410150
<b>description</b>	heating element 1300W 230V heating circuits 1 L 350mm W 380mm L1 35mm L2 315mm W1 160mm W2 60mm flange length 100mm flange width 22mm hole distance 86mm bridge length 400mm hole ø 3.2mm tube ø 6mm connection male faston 6.3mm connection length 10mm windings 2		

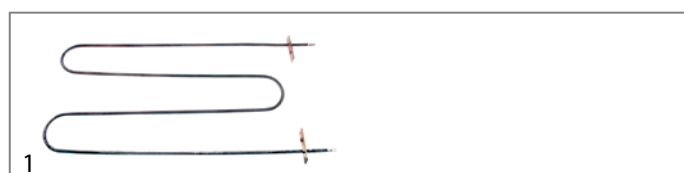

<b>GEV No.</b>	418025	<b>Ref. No.</b>	41826620041 BN826620041
<b>description</b>	heating element 1500W 230V L 525mm W 240mm lug length 70mm lug width 22mm hole distance 56mm hole ø 5mm tube ø 6.3mm connection male faston 6.3mm heating circuits 1 dry heating element rectangular flange oven		
<b>For models:</b>	131003, 131004, 131005, 131006, 131007, 131008, 131009, 131201, 131202, 131203, 131204, 131205, 131206, 131207, 131208, 131209, 131210, 132003, 132004, 132201, 132202, 132203, 132204, 133024, 133203, 133209, 133210, 133211, 133212, 133213, 133214, 133215, 141005, 141007, 141013, 141016, 141021		

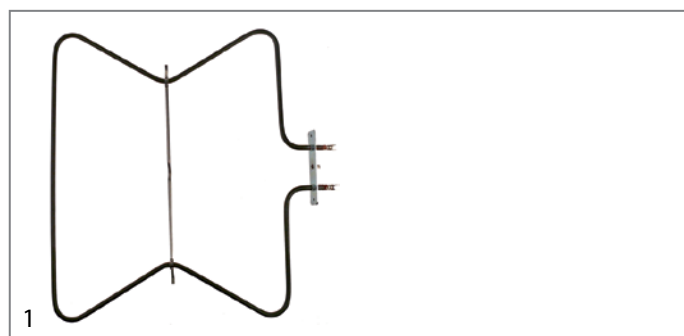

<b>GEV No.</b>	418695	<b>Ref. No.</b>	CR0410140
<b>description</b>	heating element 900W 230V heating circuits 1 L 350mm W 390mm L1 40mm L2 310mm W1 165mm W2 60mm flange length 100mm flange width 22mm hole distance 86mm bridge length 300mm hole ø 3.2mm tube ø 6mm connection male faston 6.3mm connection length 10mm windings 4 oven		

## heating elements for bain maries



<b>GEV No.</b>	415091	<b>Ref. No.</b>	1037039513 MA1037039513
<b>description</b>	heating element 1000W 230V heating circuits 1 L 295mm W 85mm connection length 20mm connection M3 tube ø 6.5mm 2 hole fixing thread M14x1 immersion heater/dry heating element bain marie/ chip scuttle L1 145mm L2 150mm H 18mm mounting distance 79mm		
<b>For models:</b>	124105, 144001		
<b>spare parts for</b>	415091		
	<b>GEV No.</b>	510417	<b>Ref. No.</b> —
	flat gasket fibre ED ø 20mm ID ø 14mm thickness 2mm Qty 1 pcs		
<b>accessories for</b>	415091		
	<b>GEV No.</b>	520228	<b>Ref. No.</b> —
	tooth lock washer ID ø 15.3mm ED ø 24mm steel Qty 1 pcs for thread M14		
	<b>GEV No.</b>	521133	<b>Ref. No.</b> 1325313
	nut thread M14x1.5 H 6mm WS 19 zinc-coated steel Qty 1 pcs		
	<b>GEV No.</b>	527169	<b>Ref. No.</b> WY23050
	hexagonal nut thread M3 H 2.8mm WS 5.5 brass Qty 1 pcs		
	<b>GEV No.</b>	550261	<b>Ref. No.</b> —
	nut thread M14x1 H 4mm WS 19 SS Qty 1 pcs		
	<b>GEV No.</b>	550262	<b>Ref. No.</b> —
	flat gasket copper ED ø 20mm ID ø 14mm thickness 2mm		
	<b>GEV No.</b>	560110	<b>Ref. No.</b> —
	plain washer ID ø 3.2mm ED ø 7mm thickness 0.5mm SS Qty 20 pcs DIN 125A for thread M3		
	<b>GEV No.</b>	560130	<b>Ref. No.</b> —
	hexagonal nut thread M3 H 2.4mm WS 5.5 SS DIN/ISO DIN 934 / ISO 4032/8673 Qty 20 pcs		

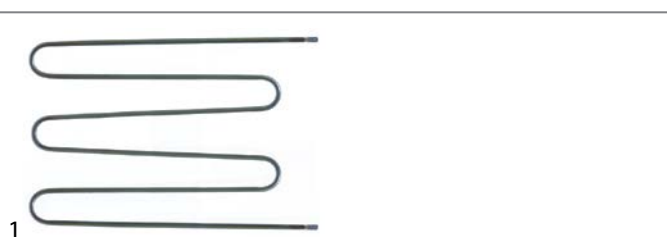

<b>GEV No.</b>	416195	<b>Ref. No.</b>	401023000
<b>description</b>	heating element 1500W 230V heating circuits 1 L 368mm L1 23mm W 268mm connection male faston 6.3mm connection distance 263mm tube ø 6.3mm dry heating element bain marie L2 345mm H 19mm		
<b>For models:</b>	115001, 115002, 245001, 245002, 245004, 245005, 245007, 245008		

electric components

<b>GEV No.</b>	418036	<b>Ref. No.</b>	41826620101
<b>description</b>	heating element 2200W 230V L 458mm W 186mm tube ø 8.5mm lug length 23mm lug width 13mm hole ø 5mm dry heating element 2 hole fixing bain marie mounting distance 177mm		
<b>For models:</b>	135001, 135002, 135003, 135004, 135201, 135202, 135203, 135204		

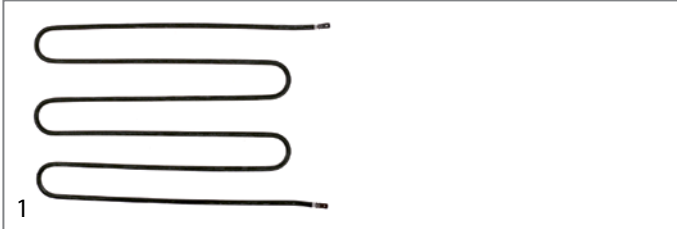

<b>GEV No.</b>	418668	<b>Ref. No.</b>	401021700 40121700
<b>description</b>	heating element 700W 230V heating circuits 1 L 370mm L1 35mm W 230mm connection 6.3 connection distance 224mm tube ø 6.3mm bain marie L2 335mm H 15mm		
<b>For models:</b>	245003, 955001, 955002, 955003, 955004		



<b>GEV No.</b>	418694	<b>Ref. No.</b>	CR0502320
<b>description</b>	heating element 750W 230V heating circuits 1 L 410mm W 63mm flange length 100mm flange width 22mm hole distance 86mm connection length 27mm connection male faston 6.3mm tube ø 8.5mm rectangular flange hole ø 5.5mm dry heating element		

### heating elements for frying pans



<b>GEV No.</b>	416698	<b>Ref. No.</b>	MA1037317700
<b>description</b>	heating element 1350W 230V L 460mm W 95mm connection M4 tube ø 6.3mm dry heating element multi purpose roasting pan H 40mm connection distance 89mm		
<b>For models:</b>	127102, 127103		

### heating elements for crepes makers

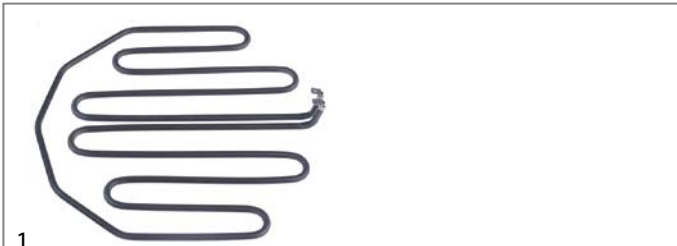

<b>GEV No.</b>	418646	<b>Ref. No.</b>	IGS703103
<b>description</b>	heating element 2000W 230V L 270mm W 235mm H 45mm tube ø 6.3mm W2 20mm connection male faston 6.3mm connection distance 229mm crepes maker		

### heating elements for chip scuttles



<b>GEV No.</b>	418037	<b>Ref. No.</b>	41826620031
<b>description</b>	heating element 700W 230V heating circuits 1 L 425mm W 220mm flange length 70mm flange width 22mm hole distance 56mm connection length 41mm connection male faston 6.3mm tube ø 6.5mm rectangular flange hole ø 5mm dry heating element W2 30mm		
<b>For models:</b>	131004, 131006, 131007, 131008, 131009, 131201, 131202, 131203, 131204, 131205, 131206, 131207, 131208, 131209, 131210, 132003, 132004, 132201, 132202, 132203, 132204, 134207		



<b>GEV No.</b>	415091	<b>Ref. No.</b>	1037039513 MA1037039513
<b>description</b>	heating element 1000W 230V heating circuits 1 L 295mm W 85mm connection length 20mm connection M3 tube ø 6.5mm 2 hole fixing thread M14x1 immersion heater/dry heating element bain marie/ chip scuttle L1 145mm L2 150mm H 18mm mounting distance 79mm		
<b>For models:</b>	124105, 144001		

<b>spare parts for</b>	415091		
	<b>GEV No.</b>	510417	<b>Ref. No.</b> —
	flat gasket fibre ED ø 20mm ID ø 14mm thickness 2mm Qty 1 pcs		
<b>accessories for</b>	415091		
	<b>GEV No.</b>	520228	<b>Ref. No.</b> —
	tooth lock washer ID ø 15.3mm ED ø 24mm steel Qty 1 pcs for thread M14		
	<b>GEV No.</b>	521133	<b>Ref. No.</b> 1325313
	nut thread M14x1.5 H 6mm WS 19 zinc-coated steel Qty 1 pcs		
	<b>GEV No.</b>	527169	<b>Ref. No.</b> WY23050
	hexagonal nut thread M3 H 2.8mm WS 5.5 brass Qty 1 pcs		
	<b>GEV No.</b>	550261	<b>Ref. No.</b> —
	nut thread M14x1 H 4mm WS 19 SS Qty 1 pcs		
	<b>GEV No.</b>	550262	<b>Ref. No.</b> —
	flat gasket copper ED ø 20mm ID ø 14mm thickness 2mm		
	<b>GEV No.</b>	560110	<b>Ref. No.</b> —
	plain washer ID ø 3.2mm ED ø 7mm thickness 0.5mm SS Qty 20 pcs DIN 125A for thread M3		
	<b>GEV No.</b>	560130	<b>Ref. No.</b> —
	hexagonal nut thread M3 H 2.4mm WS 5.5 SS DIN/ISO DIN 934 / ISO 4032/8673 Qty 20 pcs		



<b>GEV No.</b>	418659	<b>Ref. No.</b>	401021000
<b>description</b>	heating element 350W 230V heating circuits 1 L 175mm W 180mm connection 6.3 tube ø 6.5mm dry heating element hot dog machine L1 30mm L2 145mm H 17mm connection distance 174mm		
<b>For models:</b>	114003, 244010		

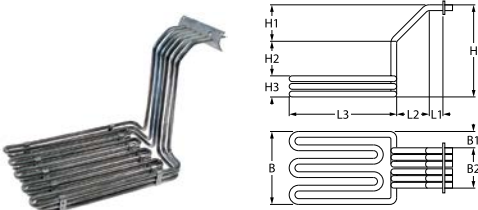

<b>GEV No.</b>	418710	<b>Ref. No.</b>	9000483 BN9000483
<b>description</b>	heating element 13000W 230/400V heating circuits 3 L 385mm W 200mm H 270mm L1 40mm L2 30mm L3 315mm W1 54mm W2 92mm H1 30mm H2 200mm H3 35mm hole distance 122mm hole ø 6mm flange length 132mm flange width 38mm tube ø 8.5mm		
<b>For models:</b>	134001, 134005, 134201, 134205, 144008, 144009		

heating elements for fryers

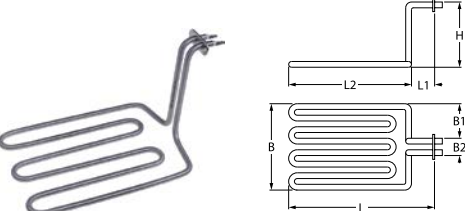

<b>GEV No.</b>	418643	<b>Ref. No.</b>	172-5016
<b>description</b>	heating element 3200W 230V heating circuits 1 L 290mm W 185mm H 165mm L1 35mm L2 255mm W1 78mm W2 29mm flange length 50mm flange width 22mm hole distance 40mm windings 3 tube ø 8.5mm connection length 35mm connection F 6.3 hole ø 4mm rectangular flange immersion heater		
<b>For models:</b>	244012		

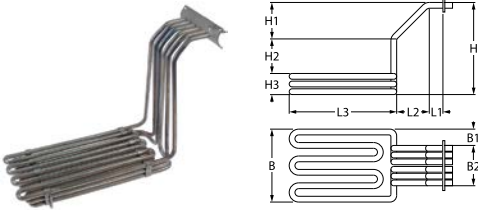

<b>GEV No.</b>	418713	<b>Ref. No.</b>	9000482 BN9000482
<b>description</b>	heating element 9000W 230/400V heating circuits 3 L 395mm W 135mm H 267mm L1 35mm L2 40mm L3 320mm W1 22mm W2 90mm H1 40mm H2 195mm H3 32mm hole distance 121mm hole ø 6mm flange length 132mm flange width 38mm tube ø 8.5mm connection length 18mm		
<b>For models:</b>	134003, 134203, 144010		

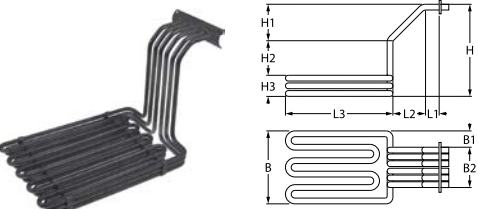

<b>GEV No.</b>	420063	<b>Ref. No.</b>	9000481	
<b>description</b>	heating element 13000W 230/400V heating circuits 3 L 385mm W 200mm H 245mm L1 40mm L2 30mm L3 315mm W1 53mm W2 94mm H1 40mm H2 170mm H3 35mm rectangular flange hole distance 122mm hole ø 6mm flange length 132mm immersion heater flange width 38mm tube ø 8.5mm			
<b>accessories for</b>	420063			
	<b>GEV No.</b>	551114	<b>Ref. No.</b>	—
	gasket L 131mm W 42mm silicone thickness 1mm for heating element			

2 hole fixing

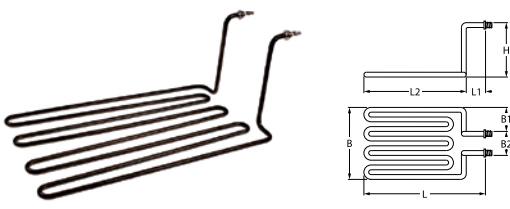











<b>GEV No.</b>	418665	<b>Ref. No.</b>	401003000	
<b>description</b>	heating element 5000W 230V heating circuits 1 L 473mm W 250mm H 190mm connection M6 L1 23mm L2 450mm W1 53mm W2 145mm tube ø 8.5mm thread 1/4" windings 4 fryer			
<b>For models:</b>	244009, 244021			
<b>accessories for</b>	418665			
	<b>GEV No.</b>	361182	<b>Ref. No.</b>	—
	nut thread 1/4" H 5mm nickel-plated brass WS 17 Qty 1 pcs			
	<b>GEV No.</b>	510417	<b>Ref. No.</b>	—
	flat gasket fibre ED ø 20mm ID ø 14mm thickness 2mm Qty 1 pcs			
	<b>GEV No.</b>	520228	<b>Ref. No.</b>	—
	tooth lock washer ID ø 15.3mm ED ø 24mm steel Qty 1 pcs for thread M14			
	<b>GEV No.</b>	550262	<b>Ref. No.</b>	—
	flat gasket copper ED ø 20mm ID ø 14mm thickness 2mm			
	<b>GEV No.</b>	560113	<b>Ref. No.</b>	260504 AMA238 RG04064
	plain washer ID ø 6.4mm ED ø 12mm thickness 1.6mm SS Qty 20 pcs DIN 125A for thread M6			

Table continues overleaf



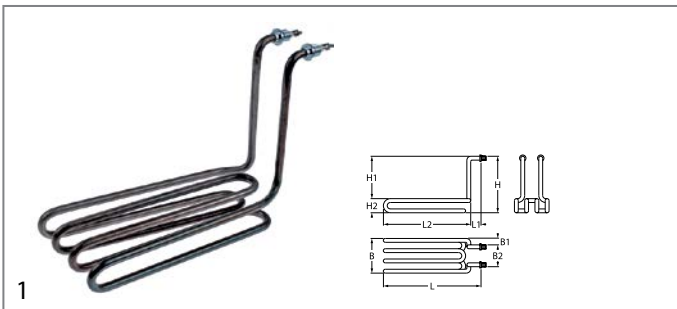



<b>accessories for</b>	418665		
	GEV No.	560133	Ref. No. 260404
	hexagonal nut thread M6 H 5mm WS 10 SS DIN/ISO DIN 934 / ISO 4032/8673 Qty 20 pcs		

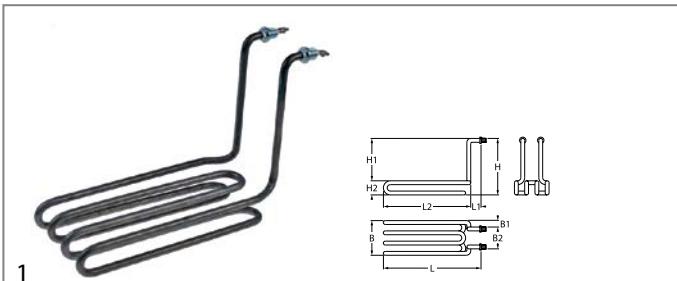



<b>GEV No.</b>	418654	<b>Ref. No.</b>	401001000
<b>description</b>	heating element 2100W 230V heating circuits 1 L 270mm W 120mm H 200mm L1 15mm L2 255mm H1 155mm H2 45mm thread 1/4" tube ø 8.5mm connection M4 fryer windings 4		
<b>For models:</b>	244001, 244004, 244007		
<b>accessories for</b>	418654		
	GEV No.	521103	Ref. No. —
	nut thread M4 H 3mm WS 7 brass Qty 20 pcs		
	GEV No.	521104	Ref. No. —
	washer ID ø 4.3mm ED ø 8mm thickness 0.5mm brass Qty 20 pcs for thread M4		
	GEV No.	560111	Ref. No. —
	plain washer ID ø 4.3mm ED ø 9mm thickness 0.8mm SS Qty 20 pcs DIN 125A for thread M4		
	GEV No.	560131	Ref. No. —
	hexagonal nut thread M4 H 3.2mm WS 7 SS DIN/ISO DIN 934 / ISO 4032/8673 Qty 20 pcs		

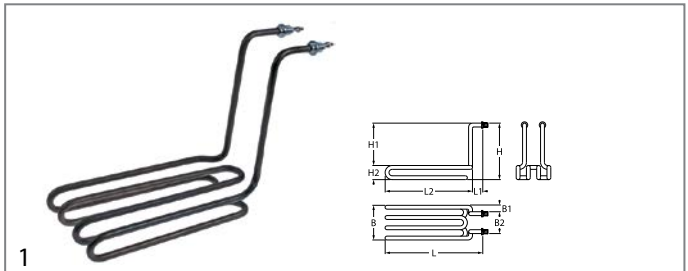

<b>GEV No.</b>	418669	<b>Ref. No.</b>	401002000
<b>description</b>	heating element 3000W 230V heating circuits 1 L 270mm W 110mm H 200mm L1 15mm L2 255mm H1 160mm H2 40mm thread 1/4" tube ø 8.5mm connection M4 fryer windings 4		
<b>For models:</b>	244002, 244003, 244004, 244006, 244007, 244008		
<b>accessories for</b>	418669		
	GEV No.	521103	Ref. No. —
	nut thread M4 H 3mm WS 7 brass Qty 20 pcs		
	GEV No.	521104	Ref. No. —
	washer ID ø 4.3mm ED ø 8mm thickness 0.5mm brass Qty 20 pcs for thread M4		
	GEV No.	560111	Ref. No. —
	plain washer ID ø 4.3mm ED ø 9mm thickness 0.8mm SS Qty 20 pcs DIN 125A for thread M4		
	GEV No.	560131	Ref. No. —
	hexagonal nut thread M4 H 3.2mm WS 7 SS DIN/ISO DIN 934 / ISO 4032/8673 Qty 20 pcs		



<b>GEV No.</b>	418671	<b>Ref. No.</b>	401002520
<b>description</b>	heating element 3000W 230V heating circuits 1 L 300mm W 120mm H 215mm L1 50mm L2 250mm H1 180mm H2 35mm thread 1/4" tube ø 8.5mm connection M4 immersion heater fryer windings 4		
<b>For models:</b>	114001, 114002		
<b>spare parts for</b>	418671		
	GEV No.	510417	Ref. No. —
	flat gasket fibre ED ø 20mm ID ø 14mm thickness 2mm Qty 1 pcs		
<b>accessories for</b>	418671		
	GEV No.	361182	Ref. No. —
	nut thread 1/4" H 5mm nickel-plated brass WS 17 Qty 1 pcs		
	GEV No.	520228	Ref. No. —
	tooth lock washer ID ø 15.3mm ED ø 24mm steel Qty 1 pcs for thread M14		
	GEV No.	521103	Ref. No. —
	nut thread M4 H 3mm WS 7 brass Qty 20 pcs		
	GEV No.	521104	Ref. No. —
	washer ID ø 4.3mm ED ø 8mm thickness 0.5mm brass Qty 20 pcs for thread M4		
	GEV No.	550262	Ref. No. —
	flat gasket copper ED ø 20mm ID ø 14mm thickness 2mm		
	GEV No.	560111	Ref. No. —
	plain washer ID ø 4.3mm ED ø 9mm thickness 0.8mm SS Qty 20 pcs DIN 125A for thread M4		
	GEV No.	560131	Ref. No. —
	hexagonal nut thread M4 H 3.2mm WS 7 SS DIN/ISO DIN 934 / ISO 4032/8673 Qty 20 pcs		

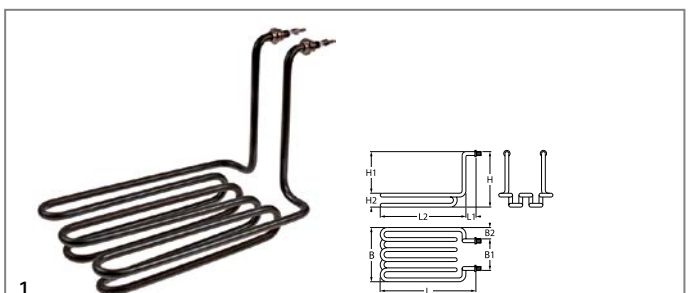

<b>GEV No.</b>	418655	<b>Ref. No.</b>	401002500
<b>description</b>	heating element 3000W 230V heating circuits 1 L 275mm W 175mm H 200mm L1 15mm L2 260mm H1 160mm H2 40mm thread 1/4" tube ø 8.5mm connection M4 windings 5 W1 50mm W2 75mm		
<b>For models:</b>	244002, 244005		
<b>spare parts for</b>	418655		
	GEV No.	510417	Ref. No. —
	flat gasket fibre ED ø 20mm ID ø 14mm thickness 2mm Qty 1 pcs		

Table continues overleaf



<b>accessories for</b> 418655	
	GEV No. 361182 Ref. No. — nut thread 1/4" H 5mm nickel-plated brass WS 17 Qty 1 pcs
	GEV No. 520228 Ref. No. — tooth lock washer ID ø 15.3mm ED ø 24mm steel Qty 1 pcs for thread M14
	GEV No. 521103 Ref. No. — nut thread M4 H 3mm WS 7 brass Qty 20 pcs
	GEV No. 521104 Ref. No. — washer ID ø 4.3mm ED ø 8mm thickness 0.5mm brass Qty 20 pcs for thread M4
	GEV No. 550262 Ref. No. — flat gasket copper ED ø 20mm ID ø 14mm thickness 2mm
	GEV No. 560111 Ref. No. — plain washer ID ø 4.3mm ED ø 9mm thickness 0.8mm SS Qty 20 pcs DIN 125A for thread M4
	GEV No. 560131 Ref. No. — hexagonal nut thread M4 H 3.2mm WS 7 SS DIN/ISO DIN 934 / ISO 4032/8673 Qty 20 pcs



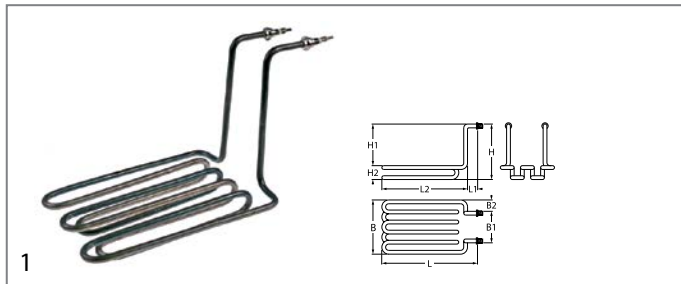

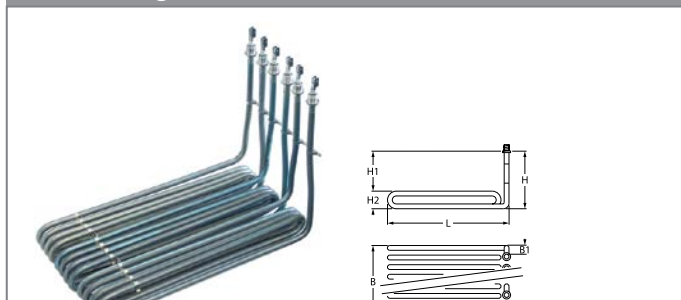

<b>GEV No.</b>	418670	<b>Ref. No.</b>	401002510
<b>description</b>	heating element 3000W 230V heating circuits 1 L 310mm W 175mm H 220mm L1 50mm L2 260mm H1 180mm H2 40mm thread 1/4" tube ø 8.5mm connection M4 windings 5 W1 50mm W2 75mm		

6 hole fixing

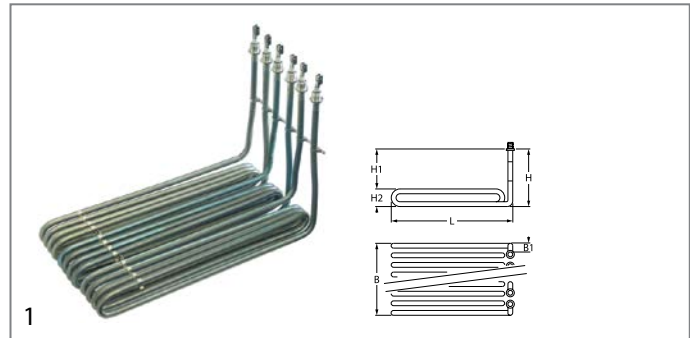

<b>GEV No.</b>	416810	<b>Ref. No.</b>	1037317100 MA1037317100
<b>description</b>	heating element 6000W 230/400V heating circuits 3 L 320mm W 175mm H 205mm W1 5mm H1 165mm H2 40mm thread M12x1 tube ø 8.5mm connection male faston 6.3mm immersion heater 6 hole fixing		
<b>For models:</b>	124102		



<b>GEV No.</b>	416811	<b>Ref. No.</b>	1037317200 MA1037317200
<b>description</b>	heating element 9000W 230V heating circuits 3 L 320mm W 175mm H 205mm W1 5mm H1 165mm H2 40mm thread M12x1 tube ø 8.5mm connection male faston 6.3mm immersion heater 6 hole fixing		
<b>For models:</b>	124101		
<b>spare parts for</b>	416811		
	GEV No. 521110	Ref. No.	460527
	flat gasket fibre ED ø 20mm ID ø 13mm thickness 2mm Qty 1 pcs		
<b>accessories for</b>	416811		
	GEV No. 520229	Ref. No.	—
	nut thread M12x1 H 4mm WS 16 zinc-coated steel Qty 1 pcs		
	GEV No. 521131	Ref. No.	—
	nut thread M12x1 H 3.5mm WS 17 SS Qty 1 pcs		
	GEV No. 528110	Ref. No.	095624
	O-ring EPDM thickness 2.62mm ID ø 12.37mm Qty 1 pcs		





heating elements for griddles

<b>GEV No.</b>	418498	<b>Ref. No.</b>	PD411K
<b>description</b>	heating element 1000W 230V heating circuits 1 L 472mm W 76mm H 38mm tube ø 8.5mm connection M4 connection length 27mm dry heating element		
<b>For models:</b>	234001, 234002, 234005		





<b>GEV No.</b>	418027	<b>Ref. No.</b>	41826620070
<b>description</b>	heating element 1250W 230V heating circuits 1 L 407mm W 88mm H 20mm tube ø 8.5mm bracket mounting connection male faston 6.3mm hole distance 60mm hole ø 5mm griddle dry heating element lug length 25mm lug width 15mm		
<b>For models:</b>	133004, 133005, 133006, 133016, 133017, 133018, 133019, 133020, 133021, 133106, 133119, 133204, 133205, 133206, 133216, 133217, 133218, 133219, 133220, 133221, 133227, 133228		



			
<b>GEV No.</b>	415076	<b>Ref. No.</b>	1037300713 MA1037300713
<b>description</b>	heating element 1300W 230V heating circuits 1 L 490mm W 78mm H 70mm tube ø 6.3mm W1 17mm W2 44mm connection M4 connection length 20mm dry heating element		
<b>For models:</b>	123110, 123111, 123112, 123113, 123114, 123115, 123120		
<b>accessories for</b>	415076		
	<b>GEV No.</b>	521103	<b>Ref. No.</b> —
	nut thread M4 H 3mm WS 7 brass Qty 20 pcs		
	<b>GEV No.</b>	521104	<b>Ref. No.</b> —
	washer ID ø 4.3mm ED ø 8mm thickness 0.5mm brass Qty 20 pcs for thread M4		
	<b>GEV No.</b>	560111	<b>Ref. No.</b> —
	plain washer ID ø 4.3mm ED ø 9mm thickness 0.8mm SS Qty 20 pcs DIN 125A for thread M4		
	<b>GEV No.</b>	560131	<b>Ref. No.</b> —
	hexagonal nut thread M4 H 3.2mm WS 7 SS DIN/ISO DIN 934 / ISO 4032/8673 Qty 20 pcs		





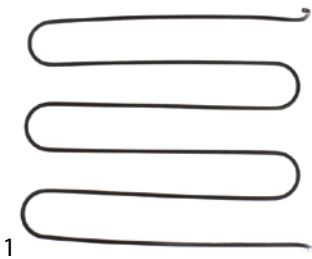

			
<b>GEV No.</b>	420109	<b>Ref. No.</b>	CR0582840
<b>description</b>	heating element 2500W 230V heating circuits 1 L 635mm W 90mm H 80mm L1 30mm connection M5 connection distance 81.5mm tube ø 8.5mm connection length 18mm dry heating element for griddle		
<b>For models:</b>	143017, 143018, 143019, 143020, 143027, 143028, 143029, 143030, 143031, 143032		

			
<b>GEV No.</b>	419009	<b>Ref. No.</b>	401025000
<b>description</b>	heating element 3000W 230V heating circuits 1 L 430mm W 270mm H 35mm tube ø 8.5mm W1 20mm W2 230mm connection male faston 6.3mm griddle connection distance 200mm dry heating element		
<b>For models:</b>	113003, 113004, 113005, 113006, 113011, 113012, 113013, 113014, 243001, 243002, 243005		

			
<b>GEV No.</b>	420110	<b>Ref. No.</b>	CR0685730
<b>description</b>	heating element 3500W 230V heating circuits 1 L 635mm W 140mm H 80mm tube ø 8.5mm L1 35mm connection M5 connection length 18mm for griddle connection distance 131.5mm dry heating element		
<b>For models:</b>	143021, 143022, 143023, 143024, 143025, 143026		

			
<b>GEV No.</b>	418644	<b>Ref. No.</b>	IV5253500
<b>description</b>	heating element 450W 230V heating circuits 1 L 440mm W 350mm H 45mm tube ø 6.3mm warming plate connection distance 344mm		
<b>For models:</b>	541004		

## heating elements for gyros grills

			
<b>GEV No.</b>	415562	<b>Ref. No.</b>	PT0094
<b>description</b>	heating element 1300W 230V L 270mm W 92mm H 80mm connection M4 thread M14x1.5 tube ø 8.5mm connection length 13mm 2 hole fixing dry heating element mounting distance 85mm		
<b>spare parts for</b>	415562		
	<b>GEV No.</b>	510417	<b>Ref. No.</b> —
	flat gasket fibre ED ø 20mm ID ø 14mm thickness 2mm Qty 1 pcs		
<b>accessories for</b>	415562		
	<b>GEV No.</b>	520228	<b>Ref. No.</b> —
	tooth lock washer ID ø 15.3mm ED ø 24mm steel Qty 1 pcs for thread M14		
	<b>GEV No.</b>	520230	<b>Ref. No.</b> —
	nut thread M14x1.5 H 5mm WS 19 zinc-coated steel Qty 1 pcs		
	<b>GEV No.</b>	521101	<b>Ref. No.</b> —
	nut thread M14x1.5 H 5mm WS 19 SS Qty 1 pcs		
	<b>GEV No.</b>	550262	<b>Ref. No.</b> —
	flat gasket copper ED ø 20mm ID ø 14mm thickness 2mm		







			
<b>GEV No.</b>	415563	<b>Ref. No.</b>	PT0095
<b>description</b>	heating element 1500W 230V L 265mm W 93mm H 80mm connection M4 thread M14x1.5 tube ø 8.5mm 2 hole fixing dry heating element mounting distance 84mm		
<b>spare parts for</b>	415563		
	<b>GEV No.</b>	510417	<b>Ref. No.</b> —
	flat gasket fibre ED ø 20mm ID ø 14mm thickness 2mm Qty 1 pcs		
<b>accessories for</b>	415563		
	<b>GEV No.</b>	520228	<b>Ref. No.</b> —
	tooth lock washer ID ø 15.3mm ED ø 24mm steel Qty 1 pcs for thread M14		

Table continues overleaf









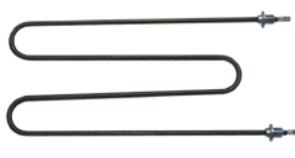

<b>accessories for</b>	415563			
	GEV No.	520230	Ref. No.	—
	nut thread M14x1.5 H 5mm WS 19 zinc-coated steel Qty 1 pcs			
	GEV No.	521101	Ref. No.	—
	nut thread M14x1.5 H 5mm WS 19 SS Qty 1 pcs			
	GEV No.	550262	Ref. No.	—
	flat gasket copper ED ø 20mm ID ø 14mm thickness 2mm			

heating elements for hot counters

	1		
<b>GEV No.</b>	418720	<b>Ref. No.</b>	X02.05.619.00
<b>description</b>	heating element 350W 220V heating circuits 1 L 133mm W 116mm H 113mm W1 41mm W2 34mm tube ø 8mm connection male faston 6.3mm L1 17mm L2 116mm rectangular flange hole distance 56mm flange length 70mm flange width 16mm hole ø 3mm		
<b>For models:</b>	541003		

	1		
<b>GEV No.</b>	415699	<b>Ref. No.</b>	401021200
<b>description</b>	heating element 400W 230V heating circuits 1 L 298mm W 138mm tube ø 6.3mm connection male faston 6.3mm dry heating element for vitrine 2 hole fixing thread M12x1.25 mounting distance 132mm		
<b>For models:</b>	272001, 272002		





	1			
<b>GEV No.</b>	418666	<b>Ref. No.</b>	401021701	
<b>description</b>	heating element 700W 230V heating circuits 1 L 630mm W 160mm tube ø 6.3mm connection male faston 6.3mm for vitrine thread M12 mounting distance 154mm			
<b>spare parts for</b>	418666			
	GEV No.	521110	Ref. No.	460527
	flat gasket fibre ED ø 20mm ID ø 13mm thickness 2mm Qty 1 pcs			
<b>accessories for</b>	418666			
	GEV No.	520229	Ref. No.	—
	nut thread M12x1 H 4mm WS 16 zinc-coated steel Qty 1 pcs			
	GEV No.	521131	Ref. No.	—
	nut thread M12x1 H 3.5mm WS 17 SS Qty 1 pcs			
	GEV No.	528110	Ref. No.	095624
	O-ring EPDM thickness 2.62mm ID ø 12.37mm Qty 1 pcs			



heating elements for hot dog machines



	1		
<b>GEV No.</b>	418661	<b>Ref. No.</b>	401022500
<b>description</b>	heating element 1000W 230V L 180mm W 187mm H 18mm tube ø 6.2mm L1 30mm L2 150mm connection 6.3 connection distance 181mm heating circuits 1 hot dog machine		
<b>For models:</b>	261001, 261002, 262002, 262003, HD3NK		

	1		
<b>GEV No.</b>	418656	<b>Ref. No.</b>	401020500
<b>description</b>	heating element 110W 230V L 131mm W 140mm H 6mm tube ø 6.5mm connection cable with thermal fuse cable length 160/300mm dry heating element heating circuits 1		
<b>For models:</b>	261001, HD3NK		

heating elements for coffee machine

	1			
<b>GEV No.</b>	417453	<b>Ref. No.</b>	098645	
<b>description</b>	heating element 1000W 220V heating circuits 1 ø 55mm H 62mm W1 44mm H1 32mm H2 30mm mounting distance 40mm thread M10x1 stainless steel windings 4 tube ø 6mm coffee machine screw			
<b>For models:</b>	743001			
<b>accessories for</b>	417453			
	GEV No.	510416	Ref. No.	—
	flat gasket fibre ED ø 19mm ID ø 10.5mm thickness 1.5mm for thread M10 Qty 1 pcs			
	GEV No.	510893	Ref. No.	200810 456015
	O-ring EPDM thickness 2.62mm ID ø 9.92mm Qty 1 pcs			
	GEV No.	520231	Ref. No.	—
	nut thread M10x1 H 6mm WS 14 zinc-coated steel Qty 1 pcs			
	GEV No.	521129	Ref. No.	—
	nut thread M10 H 6mm SS WS 17 Qty 1 pcs DIN/ISO DIN 439			

			
<b>GEV No.</b>	417459	<b>Ref. No.</b>	WY17202
<b>description</b>	heating element 1300W 230V heating circuits 1 thread 1¼" L 107mm W 26mm H 26mm connection male faston 6.3mm immersion heater flange with thread coffee machine		
<b>For models:</b>	742005		
<b>accessories for</b>	417459		
	<b>GEV No.</b>	510405	<b>Ref. No.</b> —
	flat gasket fibre ED ø 56mm ID ø 42mm thickness 2mm for thread 1¼" Qty 1 pcs		
	<b>GEV No.</b>	528021	<b>Ref. No.</b> —
	flat gasket PTFE ED ø 53mm ID ø 42.5mm thickness 3mm Qty 1 pcs equiv. no. 12001/02286 suitable for Astoria/Aurora/Brasilia/Wega		





			
<b>GEV No.</b>	417006	<b>Ref. No.</b>	WY17201
<b>description</b>	heating element 1300W 230V heating circuits 1 thread 1¼" L 110mm W 27mm H 30mm tube ø 6.4mm connection male faston 6.3mm immersion heater connection length 30mm flange with thread WS 37 with thread for safety thermostat		
<b>For models:</b>	742005		
<b>accessories for</b>	417006		
	<b>GEV No.</b>	510405	<b>Ref. No.</b> —
	flat gasket fibre ED ø 56mm ID ø 42mm thickness 2mm for thread 1¼" Qty 1 pcs		
	<b>GEV No.</b>	528021	<b>Ref. No.</b> —
	flat gasket PTFE ED ø 53mm ID ø 42.5mm thickness 3mm Qty 1 pcs equiv. no. 12001/02286 suitable for Astoria/Aurora/Brasilia/Wega		

			
<b>GEV No.</b>	417454	<b>Ref. No.</b>	15633
<b>description</b>	heating element 2000W 230V heating circuits 1 ø 93mm flange 50x26mm H 63mm H1 29mm H2 34mm connection male faston 6.3mm compression flange tube ø 8.5mm immersion heater		
<b>For models:</b>	741003		

			
<b>GEV No.</b>	417458	<b>Ref. No.</b>	WY17022
<b>description</b>	heating element 200W 230V L 500mm W 160mm tube ø 6.4mm cable length 600mm H 15mm		
<b>For models:</b>	742001, 742002, 742003, 742004, 742018, 742020		

			
<b>GEV No.</b>	417107	<b>Ref. No.</b>	WY17051
<b>description</b>	heating element 2600W 230V heating circuits 2 mounting ø 42mm hole distance 74mm L 295mm W 36mm H 41mm L1 22mm L2 38mm L3 235mm H1 30mm H2 11mm hole ø 10mm tube ø 8.5mm thermostat sleeves ø 6mm length thermostat sleeves 186mm thermostat sleeve not clinging number of thermostat sleeves 1 connection M6x1 immersion heater 2 hole flange		
<b>For models:</b>	742001, 742002, 742003, 742004, 742018, 742020		

			
<b>GEV No.</b>	417294	<b>Ref. No.</b>	WY17012
<b>description</b>	heating element 2700/2950W 230/240V heating circuits 3 mounting ø 42mm hole distance 74mm L 180mm W 34mm H 47mm L1 35mm L2 50mm L3 85mm H1 31mm H2 16mm hole ø 10mm tube ø 8mm thermostat sleeves ø 6mm length thermostat sleeves 158mm thermostat sleeve centre not clinging number of thermostat sleeves 1 connection M3 immersion heater 2 hole flange		
<b>For models:</b>	742017, 742019		

			
<b>GEV No.</b>	417000	<b>Ref. No.</b>	WY17059
<b>description</b>	heating element 3400W 230V heating circuits 3 mounting ø 43mm hole distance 74mm L 315mm W 35mm H 38mm L1 35mm L2 65mm L3 205mm H1 31mm H2 7mm hole ø 9.2mm tube ø 8.3mm thermostat sleeves ø 6mm length thermostat sleeves 155mm thermostat sleeve centre number of thermostat sleeves 1 connection M3 immersion heater 2 hole flange		
<b>For models:</b>	742001, 742002, 742003, 742004, 742018, 742020		
<b>accessories for</b>	417000		
	<b>GEV No.</b>	527156	<b>Ref. No.</b> WY12001
	flat gasket PTFE ED ø 57.8mm ID ø 43.3mm thickness 2mm Qty 1 pcs		
	<b>GEV No.</b>	527169	<b>Ref. No.</b> WY23050
	hexagonal nut thread M3 H 2.8mm WS 5.5 brass Qty 1 pcs		
	<b>GEV No.</b>	560110	<b>Ref. No.</b> —
	plain washer ID ø 3.2mm ED ø 7mm thickness 0.5mm SS Qty 20 pcs DIN 125A for thread M3		
	<b>GEV No.</b>	560130	<b>Ref. No.</b> —
	hexagonal nut thread M3 H 2.4mm WS 5.5 SS DIN/ISO DIN 934 / ISO 4032/8673 Qty 20 pcs		

			
<b>GEV No.</b>	417456	<b>Ref. No.</b>	11624
<b>description</b>	hot plate 70W 230V coffee machine connection male faston 6.3mm heating circuits 1 cable length 350mm H 2mm L 128mm W 38mm		
<b>For models:</b>	741001		





			
1			
<b>GEV No.</b>	417501	<b>Ref. No.</b>	308397
<b>description</b>	hot plate 90W 230V heating circuits 1 ø 120mm connection Faston 6.3mm cable length 450mm H 2mm suitable for MELITTA		
<b>For models:</b>	741001		

			
1			
<b>GEV No.</b>	417455	<b>Ref. No.</b>	11533
<b>description</b>	hot plate 90W 240V ø 99mm H 12mm hole ø 11mm connection male faston 6.3mm		
<b>For models:</b>	741001, 741003		

heating elements for refrigeration

heating elements for defrosting

			
1			
<b>GEV No.</b>	418752	<b>Ref. No.</b>	1666355
<b>description</b>	heating element 350W 230V L 395mm W 450mm L1 45mm L2 360mm W1 360mm W2 95mm cable length 1000mm tube ø 6mm defrosting connection with cable		
<b>For models:</b>	201780, 621007, 622005		



			
1			
<b>GEV No.</b>	420150	<b>Ref. No.</b>	GN650BT.01
<b>description</b>	heating element 400W 230V L 290mm W 75mm H 90mm L1 60mm L2 230mm W1 16mm W2 43mm connection spate terminal M4 cable length 1200mm tube ø 10mm refrigeration for evaporator		
<b>For models:</b>	621019		

heating elements for condensate evaporation

			
1			
<b>GEV No.</b>	418732	<b>Ref. No.</b>	877107800
<b>description</b>	heating element 650W 230V L 280mm W 95mm H 87mm L1 65mm L2 215mm cable length 1500mm connection distance 86mm tube ø 8.5mm heating circuits 1 immersion heater		
<b>For models:</b>	644008, 644009, 644010		

			
1			
<b>GEV No.</b>	418733	<b>Ref. No.</b>	877107900
<b>description</b>	heating element 750W 230V L 430mm W 95mm H 98mm L1 85mm L2 345mm cable length 1500mm connection cable connection distance 86mm tube ø 8.5mm heating circuits 1 immersion heater		
<b>For models:</b>	644006, 644011, 644012		

condensing trays heated

										
1										
<b>GEV No.</b>	750005	<b>Ref. No.</b>	222312100							
<b>description</b>	condensing tray heated L 240mm W 240mm H 250mm									
<b>For models:</b>	644010									
<b>spare parts for</b>	750005									
		<table border="1"> <tr> <td><b>GEV No.</b></td> <td>418732</td> <td><b>Ref. No.</b></td> <td>877107800</td> </tr> <tr> <td><b>description</b></td> <td colspan="3">heating element 650W 230V L 280mm W 95mm H 87mm L1 65mm L2 215mm cable length 1500mm connection distance 86mm tube ø 8.5mm heating circuits 1 immersion heater</td> </tr> </table>	<b>GEV No.</b>	418732	<b>Ref. No.</b>	877107800	<b>description</b>	heating element 650W 230V L 280mm W 95mm H 87mm L1 65mm L2 215mm cable length 1500mm connection distance 86mm tube ø 8.5mm heating circuits 1 immersion heater		
<b>GEV No.</b>	418732	<b>Ref. No.</b>	877107800							
<b>description</b>	heating element 650W 230V L 280mm W 95mm H 87mm L1 65mm L2 215mm cable length 1500mm connection distance 86mm tube ø 8.5mm heating circuits 1 immersion heater									









										
1										
<b>GEV No.</b>	750003	<b>Ref. No.</b>	226303600							
<b>description</b>	condensing tray heated L 240mm W 240mm H 75mm 230V 650W connect with power contactor									
<b>For models:</b>	644008, 644009									
<b>spare parts for</b>	750003									
		<table border="1"> <tr> <td><b>GEV No.</b></td> <td>348139</td> <td><b>Ref. No.</b></td> <td>—</td> </tr> <tr> <td><b>description</b></td> <td colspan="3">float switch 250V 1A 1NO or 1NC thread M16x1.5 ø 17.4mm L 100.5mm mounting ø 28mm cable cable length 1500mm temp.-resist. -20 up to +90°C</td> </tr> </table>	<b>GEV No.</b>	348139	<b>Ref. No.</b>	—	<b>description</b>	float switch 250V 1A 1NO or 1NC thread M16x1.5 ø 17.4mm L 100.5mm mounting ø 28mm cable cable length 1500mm temp.-resist. -20 up to +90°C		
<b>GEV No.</b>	348139	<b>Ref. No.</b>	—							
<b>description</b>	float switch 250V 1A 1NO or 1NC thread M16x1.5 ø 17.4mm L 100.5mm mounting ø 28mm cable cable length 1500mm temp.-resist. -20 up to +90°C									





Table continues overleaf





<b>spare parts for</b> 750003			
	GEV No.	418732	Ref. No. 877107800
heating element 650W 230V L 280mm W 95mm H 87mm L1 65mm L2 215mm cable length 1500mm connection distance 86mm tube ø 8.5mm heating circuits 1 immersion heater			
<b>accessories for</b> 750003			
	GEV No.	380185	Ref. No. 229029 880302100
power relays Italiana Relè 230VAC 30A 1NO connection F6.3 bracket mounting dimensions 36.5x32.2x51.8mm manuf. no. A10-230AC-FA			

			
1			
<b>GEV No.</b>	750006	<b>Ref. No.</b>	222312200
<b>description</b>	condensing tray heated L 380mm W 240mm H 250mm		
<b>For models:</b>	644011, 644012		

			
1			
<b>GEV No.</b>	750004	<b>Ref. No.</b>	227206000
<b>description</b>	condensing tray heated L 380mm W 240mm H 75mm 230V 750W with float switch		
<b>For models:</b>	644006		
<b>spare parts for</b> 750004			
	GEV No.	348139	Ref. No. —
float switch 250V 1A 1NO or 1NC thread M16x1.5 ø 17.4mm L 100.5mm mounting ø 28mm cable length 1500mm temp.-resist. -20 up to +90°C			
	GEV No.	418733	Ref. No. 877107900
heating element 750W 230V L 430mm W 95mm H 98mm L1 85mm L2 345mm cable length 1500mm connection distance 86mm tube ø 8.5mm heating circuits 1 immersion heater			
<b>accessories for</b> 750004			
	GEV No.	380185	Ref. No. 229029 880302100
power relays Italiana Relè 230VAC 30A 1NO connection F6.3 bracket mounting dimensions 36.5x32.2x51.8mm manuf. no. A10-230AC-FA			



heating elements for tilting bratt pan

			
1			
<b>GEV No.</b>	415076	<b>Ref. No.</b>	1037300713 MA1037300713
<b>description</b>	heating element 1300W 230V heating circuits 1 L 490mm W 78mm H 70mm tube ø 6.3mm W1 17mm W2 44mm connection M4 connection length 20mm dry heating element		
<b>For models:</b>	123110, 123111, 123112, 123113, 123114, 123115, 123120		
<b>accessories for</b> 415076			
	GEV No.	521103	Ref. No. —
nut thread M4 H 3mm WS 7 brass Qty 20 pcs			
	GEV No.	521104	Ref. No. —
washer ID ø 4.3mm ED ø 8mm thickness 0.5mm brass Qty 20 pcs for thread M4			
	GEV No.	560111	Ref. No. —
plain washer ID ø 4.3mm ED ø 9mm thickness 0.8mm SS Qty 20 pcs DIN 125A for thread M4			
	GEV No.	560131	Ref. No. —
hexagonal nut thread M4 H 3.2mm WS 7 SS DIN/ISO DIN 934 / ISO 4032/8673 Qty 20 pcs			

			
1			
<b>GEV No.</b>	418039	<b>Ref. No.</b>	826620090
<b>description</b>	heating element for tilting bratt pan 1200W 230V L 292mm W 86mm H 20mm connection male faston 6.3mm dry heating element tube ø 8.5mm 2 hole fixing thread 1/4" mounting distance 78mm connection length 90mm		
<b>For models:</b>	137001, 137003, 137004, 137201		
<b>accessories for</b> 418039			
	GEV No.	361182	Ref. No. —
nut thread 1/4" H 5mm nickel-plated brass WS 17 Qty 1 pcs			
	GEV No.	510417	Ref. No. —
flat gasket fibre ED ø 20mm ID ø 14mm thickness 2mm Qty 1 pcs			
	GEV No.	520228	Ref. No. —
tooth lock washer ID ø 15.3mm ED ø 24mm steel Qty 1 pcs for thread M14			
	GEV No.	550262	Ref. No. —
flat gasket copper ED ø 20mm ID ø 14mm thickness 2mm			

1

<b>GEV No.</b>	416805	<b>Ref. No.</b>	6A050210
<b>description</b>	heating element for tilting bratt pan 2350W 230V L 400mm W 160mm H 55mm connection M5 dry heating element tube ø 8.5mm L1 210mm L2 190mm 2 hole fixing thread 1/4" mounting distance 152mm		
<b>For models:</b>	137001, 137201		
<b>accessories for</b>	416805		
	<b>GEV No.</b>	361182	<b>Ref. No.</b> —
	nut thread 1/4" H 5mm nickel-plated brass WS 17 Qty 1 pcs		
	<b>GEV No.</b>	510417	<b>Ref. No.</b> —
	flat gasket fibre ED ø 20mm ID ø 14mm thickness 2mm Qty 1 pcs		
	<b>GEV No.</b>	520228	<b>Ref. No.</b> —
	tooth lock washer ID ø 15.3mm ED ø 24mm steel Qty 1 pcs for thread M14		



1

<b>GEV No.</b>	420266	<b>Ref. No.</b>	KO-B113 WFB108
<b>description</b>	heating element 1000W 220V heating circuits 1 L 200mm W 220mm H 34mm connection distance 34mm tube ø 8.5mm windings 1 connection M4 mounting pos. lower dry heating element for contact grill/waffle iron		
<b>For models:</b>	225009, 255013		



1

<b>GEV No.</b>	415077	<b>Ref. No.</b>	1037301713
<b>description</b>	heating element stock pot 1300W 230V L 280mm W 150mm H 40mm connection male faston 6.3mm tilting bratt pan heating circuits 1 tube ø 8.5mm bracket mounting hole distance 142mm hole ø 5mm lug length 25mm lug width 15mm		



1

<b>GEV No.</b>	418660	<b>Ref. No.</b>	401031200
<b>description</b>	heating element 1200W 230V L 177mm W 215mm H 20mm W1 35mm W2 145mm tube ø 6.3mm windings 4 connection M4		
<b>For models:</b>	255001, 255002, 255003, 255004, 255006, 255007		

heating elements for contact grills



1

<b>GEV No.</b>	420254	<b>Ref. No.</b>	KOB108
<b>description</b>	heating element 1000W 220V heating circuits 1 L 194mm W 274mm H 37mm connection distance 40mm tube ø 8.5mm windings 4 connection M4 mounting pos. upper dry heating element for contact grill		
<b>For models:</b>	255009		



1

<b>GEV No.</b>	420252	<b>Ref. No.</b>	KO-B109
<b>description</b>	heating element 1250W 220V heating circuits 1 L 185mm W 395mm H 28mm connection distance 37mm tube ø 8.3mm windings 4 connection M4 mounting pos. upper dry heating element for contact grill		
<b>For models:</b>	255012, 255014		



<b>GEV No.</b>	420253	<b>Ref. No.</b>	KG2735DEG-09 KOB111
<b>description</b>	heating element 1500W 220V heating circuits 1 L 225mm W 278mm H 37mm connection distance 32mm tube ø 8.5mm windings 4 connection M4 mounting pos. lower dry heating element for contact grill		
<b>For models:</b>	255009, 255017		







<b>GEV No.</b>	420265	<b>Ref. No.</b>	KO-B110 WFB106
<b>description</b>	heating element 650W 220V heating circuits 1 L 160mm W 210mm H 28mm connection distance 38mm tube ø 8.5mm windings 1 connection M4 mounting pos. upper dry heating element for contact grill/waffle iron		
<b>For models:</b>	225009, 255013		



<b>GEV No.</b>	418664	<b>Ref. No.</b>	401031800
<b>description</b>	heating element 1800W 230V L 185mm W 205mm H 20mm W1 40mm W2 125mm tube ø 6.3mm windings 4 connection M4		
<b>For models:</b>	255001, 255002, 255003, 255004, 255006, 255007		

heating elements for pasta cookers













<b>GEV No.</b>	418663	<b>Ref. No.</b>	401002600	
<b>description</b>	heating element 3000W 230V L 245mm W 225mm H 27mm connection 6.3 thread M10x1 tube ø 6.3mm L1 120mm L2 125mm mounting distance 220mm			
<b>For models:</b>	116001, 116002			
<b>spare parts for</b>	418663			
	<b>GEV No.</b>	510893	<b>Ref. No.</b>	200810 456015
	O-ring EPDM thickness 2.62mm ID ø 9.92mm Qty 1 pcs			
<b>accessories for</b>	418663			
	<b>GEV No.</b>	510416	<b>Ref. No.</b>	—
	flat gasket fibre ED ø 19mm ID ø 10.5mm thickness 1.5mm for thread M10 Qty 1 pcs			
	<b>GEV No.</b>	520231	<b>Ref. No.</b>	—
	nut thread M10x1 H 6mm WS 14 zinc-coated steel Qty 1 pcs			
	<b>GEV No.</b>	521129	<b>Ref. No.</b>	—
	nut thread M10 H 6mm SS WS 17 Qty 1 pcs DIN/ISO DIN 439			



<b>GEV No.</b>	420248	<b>Ref. No.</b>	KO-B112
<b>description</b>	heating element 2000W 220V heating circuits 2 L 240mm W 383mm H 33mm connection distance 32mm tube ø 8.5mm windings 6 connection M4 mounting pos. lower dry heating element for contact grill		
<b>For models:</b>	255012, 255014		



				
1				
<b>GEV No.</b>	415977	<b>Ref. No.</b>	MA1870000	
<b>description</b>	heating element 5670W 230V heating circuits 3 L 292mm W 225mm H 26mm rotation flange tube ø 6.3mm thermostat sleeves ø 9mm length thermostat sleeves 185mm L1 42mm L2 250mm W1 197mm W2 28mm cable length 460mm number of thermostat sleeves 1 connection length 50mm flange length 1 9mm flange length 2 15.5mm flange length 24.5mm flange ø1 43.8mm flange ø2 39.7mm thermostat sleeve centred, adjacent pasta cooker sensor screw connection M10x1			
<b>For models:</b>	126103			
<b>accessories for</b>	415977			
	<b>GEV No.</b>	514016	<b>Ref. No.</b>	1814500 MA1814500
	flat gasket PTFE ED ø 45mm ID ø 40mm thickness 4mm Qty 1 pcs equiv. no. 1036500400/1814500 suitable for MARENO			
	<b>GEV No.</b>	514017	<b>Ref. No.</b>	1814400 MA1814400
	O-ring silicone thickness 3.53mm ID ø 32.93mm Qty 1 pcs			
	<b>GEV No.</b>	514018	<b>Ref. No.</b>	1814600 MA1814600
	bush			
	<b>GEV No.</b>	514020	<b>Ref. No.</b>	1815014 MA1815014
	bush			
	<b>GEV No.</b>	514021	<b>Ref. No.</b>	1814700 MA1814700
	O-ring silicone thickness 3.53mm ID ø 49.21mm Qty 1 pcs			
	<b>GEV No.</b>	514022	<b>Ref. No.</b>	14044599 MA14044599
	nut thread 1½" H 12mm SS WS 59 Qty 1 pcs			
	<b>GEV No.</b>	540435	<b>Ref. No.</b>	MA1869600
	threaded rod thread M10 hollow			
	<b>GEV No.</b>	540436	<b>Ref. No.</b>	1033514900 MA1033514900
	hexagonal nut thread M10x1.25 H 4mm WS 13 brass Qty 1 pcs			
	<b>GEV No.</b>	540438	<b>Ref. No.</b>	1868700 MA1868700
	long nut thread M10 L 25mm WS 13 brass Qty 1 pcs			
	<b>GEV No.</b>	540439	<b>Ref. No.</b>	1869500 MA1869500
	distance washer			

				
1				
<b>GEV No.</b>	416795	<b>Ref. No.</b>	8218100	
<b>description</b>	heating element 7500W 230V heating circuits 3 L 300mm W 237mm Hmm 6 hole fixing connection M5 thread M14x1 tube ø 8.9mm complete auxiliary equipment			
<b>For models:</b>	136003, 136004, 136203, 136204			
<b>spare parts for</b>	416795			
	<b>GEV No.</b>	507309	<b>Ref. No.</b>	41824710280 824710280
	O-ring EPDM thickness 2.62mm ID ø 17.13mm Qty 1 pcs			
	<b>GEV No.</b>	550261	<b>Ref. No.</b>	—
	nut thread M14x1 H 4mm WS 19 SS Qty 1 pcs			
<b>accessories for</b>	416795			
	<b>GEV No.</b>	510417	<b>Ref. No.</b>	—
	flat gasket fibre ED ø 20mm ID ø 14mm thickness 2mm Qty 1 pcs			
	<b>GEV No.</b>	520228	<b>Ref. No.</b>	—
	tooth lock washer ID ø 15.3mm ED ø 24mm steel Qty 1 pcs for thread M14			
	<b>GEV No.</b>	521133	<b>Ref. No.</b>	1325313
	nut thread M14x1.5 H 6mm WS 19 zinc-coated steel Qty 1 pcs			
	<b>GEV No.</b>	550262	<b>Ref. No.</b>	—
	flat gasket copper ED ø 20mm ID ø 14mm thickness 2mm			



				
1				
<b>GEV No.</b>	415971	<b>Ref. No.</b>	MA1870100	
<b>description</b>	heating element 9000W 230/415V heating circuits 3 L 245mm W 320mm H 25mm rotation flange tube ø 6.3mm thermostat sleeves ø 7mm length thermostat sleeves 210mm L1 55mm L2 190mm W1 28mm W2 292mm cable length 600mm number of thermostat sleeves 1 connection length 35mm flange length 1 9mm flange length 2 15.5mm flange length 24.5mm flange ø1 43.8mm flange ø2 39.7mm mounting pos. left suitable for 600 series thermostat sleeve centred, adjacent pasta cooker sensor screw connection M10x1			
<b>For models:</b>	126101			
<b>accessories for</b>	415971			
	<b>GEV No.</b>	514016	<b>Ref. No.</b>	1814500 MA1814500
	flat gasket PTFE ED ø 45mm ID ø 40mm thickness 4mm Qty 1 pcs equiv. no. 1036500400/1814500 suitable for MARENO			
	<b>GEV No.</b>	514017	<b>Ref. No.</b>	1814400 MA1814400
	O-ring silicone thickness 3.53mm ID ø 32.93mm Qty 1 pcs			

Table continues overleaf



<b>accessories for</b> 415971				
	GEV No.	514018	Ref. No.	1814600 MA1814600
bush				
	GEV No.	514019	Ref. No.	—
threaded rod thread M8 L 45mm brass				
	GEV No.	514020	Ref. No.	1815014 MA1815014
bush				
	GEV No.	514021	Ref. No.	1814700 MA1814700
O-ring silicone thickness 3.53mm ID ø 49.21mm Qty 1 pcs				
	GEV No.	514022	Ref. No.	14044599 MA14044599
nut thread 1½" H 12mm SS WS 59 Qty 1 pcs				
	GEV No.	540435	Ref. No.	MA1869600
threaded rod thread M10 hollow				
	GEV No.	540436	Ref. No.	1033514900 MA1033514900
hexagonal nut thread M10x1.25 H 4mm WS 13 brass Qty 1 pcs				
	GEV No.	540438	Ref. No.	1868700 MA1868700
long nut thread M10 L 25mm WS 13 brass Qty 1 pcs				
	GEV No.	540439	Ref. No.	1869500 MA1869500
distance washer				

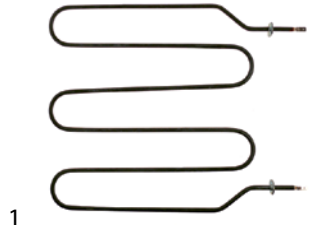

## heating elements for pizza ovens

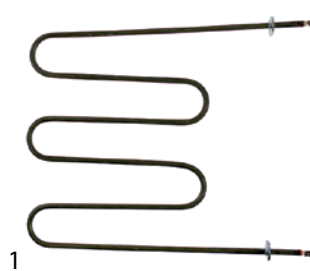
				
1				
GEV No.	418672	Ref. No.	401031000	
description	heating element 1000W 230V heating circuits 1 L 330mm W 300mm L1 30mm L2 60mm L3 240mm W1 35mm W2 230mm lug length 27mm lug width 22mm connection length 55mm connection male faston 6.3mm tube ø 6.3mm 2 hole fixing hole ø 3mm dry heating element pizza oven			
For models:	535001, 535002, 535004			

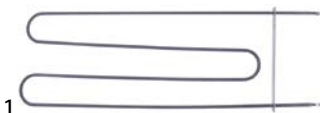
				
1				
GEV No.	418667	Ref. No.	401021750	
description	heating element 750W 230V heating circuits 1 L 310mm W 250mm lug length 30mm lug width 20.4mm connection male faston 6.3mm pizza oven			
For models:	535004			

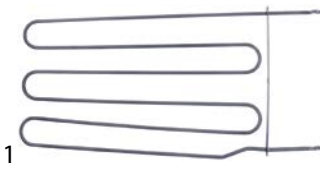
				
1				
GEV No.	420250	Ref. No.	PI-B114	
description	heating element 1250W 220V L 613mm W 218mm flange length 245mm flange width 25mm hole distance 120mm connection M4 tube ø 8.3mm heating circuits 1 flange connection hole ø 4.5mm dry heating element for pizza oven			
For models:	531039			

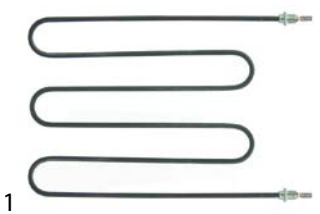
				
1				
GEV No.	420251	Ref. No.	PI-B115 PIB117	
description	heating element 1500W 220V heating circuits 1 L 610mm W 350mm flange length 355mm flange width 25mm hole distance 173mm tube ø 8.5mm connection M4 flange connection hole ø 5mm dry heating element for pizza oven			
For models:	531034, 531040			



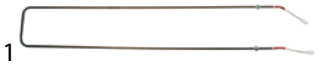

				
1				
GEV No.	416488	Ref. No.	IB5256400	
description	heating element 1000W 230V L 320mm W 240mm thread M12x1.5 mounting distance 233mm connection length 33mm connection male faston 6.3mm tube ø 6.3mm heating circuits 1 dry heating element 2 hole fixing			
For models:	541001, 541002			
accessories for	416488			
	GEV No.	560502	Ref. No.	—
hexagonal nut thread M12x1.5 H 6mm WS 19 SS Qty 1 pcs zinc-plated				

				
1				
GEV No.	420435	Ref. No.	EE24700	
description	heating element 1300W 230V L 568mm W 158mm mounting distance 148mm connection F6.3 tube ø 8.5mm heating circuits 1			
For models:	531014, 531015			

				
1				
GEV No.	418726	Ref. No.	74400260	
description	heating element 1456W 230V heating circuits 1 dry heating element			
For models:	531007, 531008			







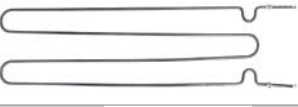

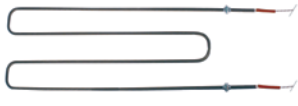

			
<b>GEV No.</b>	416837	<b>Ref. No.</b>	RESIS009
<b>description</b>	heating element 1500W 230V L 700mm W 270mm L1 30mm L2 70mm L3 600mm W1 174mm W2 148mm thread 1/4" mounting distance 40mm connection length 108mm connection M5 windings 2 tube ø 8.5mm heating circuits 1 dry heating element 2 hole fixing		
<b>For models:</b>	530010, 530012, 531022, 531023		
<b>spare parts for</b>	416837		
			
<b>GEV No.</b>	510417	<b>Ref. No.</b>	—
<b>description</b>	flat gasket fibre ED ø 20mm ID ø 14mm thickness 2mm Qty 1 pcs		
<b>accessories for</b>	416837		
			
<b>GEV No.</b>	361182	<b>Ref. No.</b>	—
<b>description</b>	nut thread 1/4" H 5mm nickel-plated brass WS 17 Qty 1 pcs		
			
<b>GEV No.</b>	520228	<b>Ref. No.</b>	—
<b>description</b>	tooth lock washer ID ø 15.3mm ED ø 24mm steel Qty 1 pcs for thread M14		
			
<b>GEV No.</b>	550262	<b>Ref. No.</b>	—
<b>description</b>	flat gasket copper ED ø 20mm ID ø 14mm thickness 2mm		

			
<b>GEV No.</b>	419122	<b>Ref. No.</b>	101013
<b>description</b>	heating element 1500W 230V L 890mm W 280mm thread M12x1.5 mounting distance 270mm connection length 110mm connection M4 tube ø 8mm heating circuits 1 dry heating element pizza oven		
<b>For models:</b>	531028, 531029, 531030, 531031		

			
<b>GEV No.</b>	418728	<b>Ref. No.</b>	74400180
<b>description</b>	heating element 1650W 230V L 1070mm W 130mm thread 1/4" mounting distance 121mm connection length 100mm heating circuits 1 dry heating element		
<b>For models:</b>	531003, 531004		

			
<b>GEV No.</b>	418729	<b>Ref. No.</b>	74400250
<b>description</b>	heating element 1750W 230V L 680mm W 260mm thread 1/4" mounting distance 251mm connection length 101mm tube ø 8.5mm heating circuits 1 dry heating element		
<b>For models:</b>	531005, 531006		

			
<b>GEV No.</b>	416464	<b>Ref. No.</b>	EE28200
<b>description</b>	heating element 2000W 230V L 600mm W 572mm thread 1/4" mounting distance 563mm connection length 45mm tube ø 8.6mm cable length 643mm heating circuits 1 dry heating element 2 hole fixing		
<b>For models:</b>	531010, 531011		
<b>accessories for</b>	416464		
			
<b>GEV No.</b>	361182	<b>Ref. No.</b>	—
<b>description</b>	nut thread 1/4" H 5mm nickel-plated brass WS 17 Qty 1 pcs		
			
<b>GEV No.</b>	510417	<b>Ref. No.</b>	—
<b>description</b>	flat gasket fibre ED ø 20mm ID ø 14mm thickness 2mm Qty 1 pcs		
			
<b>GEV No.</b>	520228	<b>Ref. No.</b>	—
<b>description</b>	tooth lock washer ID ø 15.3mm ED ø 24mm steel Qty 1 pcs for thread M14		
			
<b>GEV No.</b>	550262	<b>Ref. No.</b>	—
<b>description</b>	flat gasket copper ED ø 20mm ID ø 14mm thickness 2mm		

			
<b>GEV No.</b>	418889	<b>Ref. No.</b>	EE24800
<b>description</b>	heating element 2000W 230V L 880mm W 160mm thread 3/8" mounting distance 150mm connection length 105mm connection male faston 6.3mm tube ø 10mm heating circuits 1 dry heating element pizza oven		
<b>For models:</b>	531016, 531017		

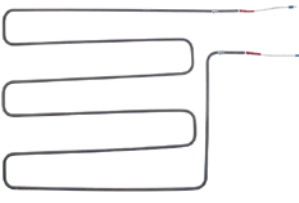
			
<b>GEV No.</b>	418157	<b>Ref. No.</b>	74400150
<b>description</b>	heating element 2100W 230V L 675mm W 550mm L1 35mm L2 640mm W1 415mm W2 135mm thread 1/4" mounting distance 127mm connection length 90mm connection male faston 6.3mm tube ø 8.5mm cable length 140mm heating circuits 1 dry heating element 2 hole fixing pizza oven		
<b>For models:</b>	531001, 531002		

			
<b>GEV No.</b>	418730	<b>Ref. No.</b>	74400280
<b>description</b>	heating element 2400W 230V L 1200mm W 290mm heating circuits 1 dry heating element pizza oven		
<b>For models:</b>	531007, 531008		



heating elements for rolling grills

<b>GEV No.</b>	416189	<b>Ref. No.</b>	637108200
<b>description</b>	heating element 220W 240V heating circuits 1 L 359mm connection distance 359mm tube ø 8.5mm dry heating element roller grill		
<b>For models:</b>	262001		

heating elements for salamanders/toast-

<b>GEV No.</b>	418723	<b>Ref. No.</b>	X02.09.260.00
<b>description</b>	heating element 1000W 220V L 290mm W 90mm H 40mm tube ø 7mm connection male faston 6.3mm with strap hole ø 5mm hole distance 66mm mounting distance 83mm heating circuits 1 lug length 25mm lug width 12.5mm dry heating element connection length 17mm mounting pos. upper		
<b>For models:</b>	222004, 222005		

<b>GEV No.</b>	418722	<b>Ref. No.</b>	02.05.682.00 HAT02.05.682.00 X02.09.259.00
<b>description</b>	heating element 600W 220V L 210mm W 90mm H 40mm tube ø 7mm connection male faston 6.3mm with strap hole ø 5mm hole distance 66mm mounting distance 83mm heating circuits 1 lug length 25mm lug width 12.5mm dry heating element connection length 17mm mounting pos. lower		
<b>For models:</b>	222004, 222005		

<b>GEV No.</b>	418721	<b>Ref. No.</b>	02.05.679.00 X02.09.258.00
<b>description</b>	heating element 700W 220V L 210mm W 85mm H 40mm tube ø 7mm connection male faston 6.3mm bracket mounting hole ø 5mm hole distance 66mm mounting distance 78mm heating circuits 1 lug length 25mm lug width 12.5mm dry heating element connection length 17mm mounting pos. upper		
<b>For models:</b>	222004, 222005		

<b>GEV No.</b>	418724	<b>Ref. No.</b>	X02.09.261.00
<b>description</b>	heating element 900W 220V L 290mm W 110mm H 40mm tube ø 7mm connection male faston 6.3mm with strap hole ø 5mm mounting thread 103 hole distance 66mm heating circuits 1 lug length 25mm lug width 12.5mm dry heating element connection length 17mm mounting pos. lower		
<b>For models:</b>	222004, 222005		

<b>GEV No.</b>	420041	<b>Ref. No.</b>	RESIS013
<b>description</b>	heating element 3000W 230V L 690mm W 460mm thread 1/4" mounting distance 452mm connection M5 tube ø 8.5mm heating circuits 1 for pizza oven mounting pos. upper/lower		
<b>For models:</b>	530009, 530011, 531020, 531021		

<b>GEV No.</b>	418727	<b>Ref. No.</b>	74400160
<b>description</b>	heating element 920W 230V L 1040mm W 120mm thread 1/4" mounting distance 111mm connection length 100mm tube ø 9mm heating circuits 1 dry heating element		
<b>For models:</b>	531003, 531004		

<b>GEV No.</b>	418725	<b>Ref. No.</b>	74400210
<b>description</b>	heating element 972W 230V L 645mm W 195mm thread 1/4" mounting distance 186mm connection length 102mm tube ø 8.5mm heating circuits 1 dry heating element		
<b>For models:</b>	531005, 531006		

heating elements for pizza presses





<b>GEV No.</b>	416309	<b>Ref. No.</b>	5590710
<b>description</b>	heating element 2000W 230V L 260mm W 260mm heating circuits 1 cable length 290mm connection length 10mm tube ø 6.2mm windings 8 connection distance 59mm		

<b>GEV No.</b>	416316	<b>Ref. No.</b>	5590760
<b>description</b>	heating element 2500W 230V L 360mm W 360mm heating circuits 1 cable length 250mm connection length 10mm tube ø 6.3mm windings 12 connection distance 49mm		

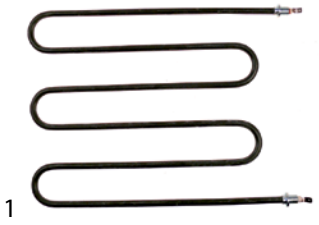

			
<b>GEV No.</b>	418740	<b>Ref. No.</b>	OAT93607 A0AT93607
<b>description</b>	heating element 2000W 230V heating circuits 1 L 400mm W 200mm L1 27mm L2 373mm W1 85mm W2 30mm flange length 70mm flange width 22mm hole distance 56mm tube ø 6.5mm rectangular flange hole ø 5mm H 6.5mm		
<b>For models:</b>	221007		

			
<b>GEV No.</b>	418645	<b>Ref. No.</b>	IB52565010
<b>description</b>	heating element 1700W 230V L 235mm W 211mm thread M12x1 mounting distance 205mm connection M4 tube ø 6.3mm heating circuits 1 dry heating element 2 hole fixing salamander grill H 6.3mm		
<b>For models:</b>	221006		

			
<b>GEV No.</b>	418653	<b>Ref. No.</b>	401024000
<b>description</b>	heating element 2200W 230V L 350mm W 260mm thread M12 mounting distance 245mm connection 6.3 air tube ø 8.5mm heating circuits 1 H 8.5mm		
<b>For models:</b>	221001, 221002, 221003, 221004		
<b>spare parts for</b>	418653		
	<b>GEV No.</b>	521110	<b>Ref. No.</b> 460527
	flat gasket fibre ED ø 20mm ID ø 13mm thickness 2mm Qty 1 pcs		
<b>accessories for</b>	418653		
	<b>GEV No.</b>	520229	<b>Ref. No.</b> —
	nut thread M12x1 H 4mm WS 16 zinc-coated steel Qty 1 pcs		
	<b>GEV No.</b>	521131	<b>Ref. No.</b> —
	nut thread M12x1 H 3.5mm WS 17 SS Qty 1 pcs		
	<b>GEV No.</b>	528110	<b>Ref. No.</b> 095624
	O-ring EPDM thickness 2.62mm ID ø 12.37mm Qty 1 pcs		

			
<b>GEV No.</b>	420301	<b>Ref. No.</b>	2010000
<b>description</b>	heating element 500W 240V L 250mm W 55mm thread 3/8" mounting distance 45mm tube ø 10mm heating circuits 1 M4 Hmm		
<b>For models:</b>	221019, 221020		

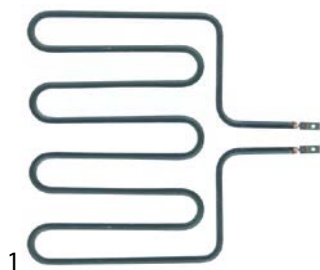
			
<b>GEV No.</b>	416579	<b>Ref. No.</b>	417522300
<b>description</b>	heating element 1900W 220V heating circuits 1 L 245mm W 240mm L1 63mm L2 182mm W1 98mm W2 45mm connection distance 16mm connection M4 dry heating element tube ø 6.3mm H 6.3mm		
<b>For models:</b>	221017		

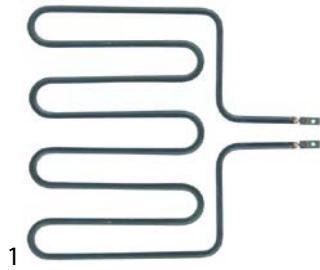
			
<b>GEV No.</b>	420288	<b>Ref. No.</b>	417522400
<b>description</b>	heating element 1900W 400V heating circuits 1 L 245mm W 230mm L1 60mm L2 185mm W1 100mm W2 30mm connection distance 25mm windings 4 connection M4 dry heating element tube ø 6.25mm H 6.25mm		
<b>For models:</b>	221017		

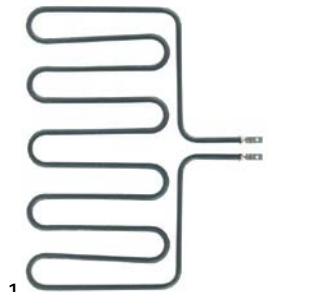
			
<b>GEV No.</b>	416580	<b>Ref. No.</b>	417522200
<b>description</b>	heating element 2000W 220V heating circuits 1 L 240mm W 333mm L1 60mm L2 180mm W1 149mm W2 35mm connection distance 29mm connection M4 dry heating element tube ø 6.3mm H 6.3mm		
<b>For models:</b>	221018		





### heating elements for heating bridges

			
<b>GEV No.</b>	418207	<b>Ref. No.</b>	R02.08.142E.00 R020811200
<b>description</b>	heating element 1100W 220V heating circuits 1 L 1095mm Wmm lug length 40mm lug width 18mm connection length 27mm connection M5 tube ø 6.3mm bracket mounting hole ø 5mm dry heating element		

			
<b>GEV No.</b>	418208	<b>Ref. No.</b>	R02.08.143E.00 R020813100
<b>description</b>	heating element 1250W 220V heating circuits 1 L 1245mm Wmm lug length 39mm lug width 25mm connection length 27mm connection M5 tube ø 6.5mm bracket mounting hole ø M4mm dry heating element		

			
<b>GEV No.</b>	418209	<b>Ref. No.</b>	R02.08.144E.00 R020811500
<b>description</b>	heating element 1400W 220V heating circuits 1 L 1400mm Wmm lug length 39mm lug width 25mm connection length 28mm connection M5 tube ø 6.5mm bracket mounting hole ø M4mm dry heating element		

			
<b>GEV No.</b>	418210	<b>Ref. No.</b>	R02.08.145E.00 R020813400
<b>description</b>	heating element 1560W 220V heating circuits 1 L 1565mm Wmm lug length 39mm lug width 25mm connection length 26mm connection M5 tube ø 6.5mm bracket mounting hole ø M4mm dry heating element		

			
<b>GEV No.</b>	418211	<b>Ref. No.</b>	R02.08.148E.00 R020811800
<b>description</b>	heating element 1725W 220V heating circuits 1 L 1715mm Wmm lug length 39mm lug width 25mm connection length 27mm connection M5 tube ø 6.8mm bracket mounting hole ø M4mm dry heating element		

			
<b>GEV No.</b>	418203	<b>Ref. No.</b>	R02.08.138E.00 R020813500
<b>description</b>	heating element 350W 220V heating circuits 1 L 335mm Wmm lug length 40mm lug width 18mm connection M5 tube ø 6.3mm rectangular flange mounting pos. dry heating element hole ø 5mm		

			
<b>GEV No.</b>	418202	<b>Ref. No.</b>	R02.08.103.00 R02.08.136E.00
<b>description</b>	heating element 500W 220V heating circuits 1 L 485mm Wmm lug length 40mm lug width 18mm connection M5 tube ø 6.3mm rectangular flange hole ø M4mm dry heating element		

			
<b>GEV No.</b>	418657	<b>Ref. No.</b>	401021500
<b>description</b>	heating element 500W 230V heating circuits 1 L 165mm W 125mm connection 6.3 tube ø 8.5mm dry heating element heated bridge L1 30mm L2 135mm H 16mm		
<b>For models:</b>	114003, 276001, 279001		

			
<b>GEV No.</b>	418204	<b>Ref. No.</b>	R02.08.139E.00 R020812900
<b>description</b>	heating element 660W 220V heating circuits 1 L 634mm Wmm lug length 40mm lug width 18mm connection male faston tube ø 6.5mm rectangular flange hole ø 4mm dry heating element		

			
<b>GEV No.</b>	418205	<b>Ref. No.</b>	R02.08.140E.00 R020810600
<b>description</b>	heating element 800W 220V heating circuits 1 L 790mm Wmm lug length 40mm lug width 18mm connection length 26mm connection M5 tube ø 6.3mm rectangular flange hole ø 5mm dry heating element flange length 40mm flange width 18mm		

			
<b>GEV No.</b>	418206	<b>Ref. No.</b>	R02.08.141E.00 R020810900
<b>description</b>	heating element 950W 220V L 940mm Wmm lug length 40mm lug width 18mm tube ø 6.3mm dry heating element flange length 40mm flange width 18mm		

### heating elements for heated cabinets

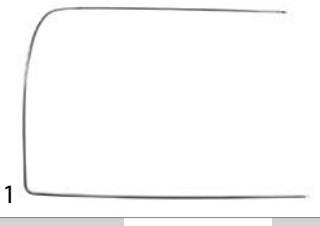
			
<b>GEV No.</b>	418743	<b>Ref. No.</b>	040576
<b>description</b>	heating element 1200W 230V L 220mm W 680mm H 700mm heated cabinet		
<b>For models:</b>	271003		

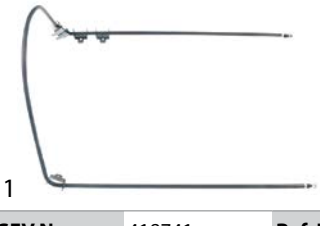
			
<b>GEV No.</b>	418741	<b>Ref. No.</b>	040827
<b>description</b>	heating element 400W 230V L 220mm W 350mm H 440mm heated cabinet		
<b>For models:</b>	271001		





			
GEV No.	418742	Ref. No.	040577
description	heating element 750W 230V L 220mm W 360mm H 690mm heated cabinet		
For models:	271002		

			
GEV No.	418737	Ref. No.	224820400
description	drain heating cable 62W 230V ø 6mm L 2680mm L1 (unheated) 130mm L2 (heated) 2550mm silicone 25W/m connection cable		
For models:	641017		

## heating cables

### drain heating cables

			
GEV No.	418570	Ref. No.	BN1666009
description	drain heating cable 12W 230V ø 4mm L 3190mm L1 (unheated) 1650mm L2 (heated) 1540mm defrost drain metal connection male faston		
For models:	622020		

			
GEV No.	418735	Ref. No.	224820200
description	drain heating cable 37W 230V L 1980mm L1 (unheated) 190mm L2 (heated) 1790mm silicone 25W/m connection cable		
For models:	641015		

			
GEV No.	418734	Ref. No.	224820100
description	drain heating cable 37W 230V ø 6mm L 1670mm L1 (unheated) 130mm L2 (heated) 1650mm cable length 110mm silicone 25W/m connection cable		
For models:	641014		

			
GEV No.	418736	Ref. No.	224820300
description	drain heating cable 50W 230V ø 6mm L 2120mm L1 (unheated) 130mm L2 (heated) 2010mm cable length 110mm silicone 25W/m connection cable		
For models:	641016		

### connection on both sides (metal braided)

			
GEV No.	417602	Ref. No.	73632024
description	heating cable 52W 230V L1 (unheated) 200mm L2 (heated) 6500mm door frame heating L 6700mm connection cable		
For models:	622031		

### miscellaneous

			
GEV No.	418499	Ref. No.	R35-0002
description	heating cable L 7000mm door frame heating 2050hm/m		
For models:	622004		

## heating plates

			
GEV No.	417569	Ref. No.	S160P022
description	hot plate 58W 230V L 62mm W 43mm		
For models:	236004		

			
GEV No.	417456	Ref. No.	11624
description	hot plate 70W 230V coffee machine connection male faston 6.3mm heating circuits 1 cable length 350mm H 2mm L 128mm W 38mm		
For models:	741001		



### ceramic heaters

245x60mm



<b>1</b>			
<b>GEV No.</b>	415104	<b>Ref. No.</b>	MA1037317601 PT0212
<b>description</b>	ceramic emitter 1000W 230V cable beaded cord L 245mm W 60mm H 35mm		
<b>For models:</b>	124105, 144001		
<b>spare parts for</b>	415104		
	<b>GEV No.</b>	415109	<b>Ref. No.</b> —
	spring clip		
<b>accessories for</b>	415104		
	<b>GEV No.</b>	415110	<b>Ref. No.</b> —
	reflector L 245mm W 95mm H 31mm thickness 0.75mm hole ø 15x40mm		

### quartz heating elements



<b>1</b>			
<b>GEV No.</b>	359630	<b>Ref. No.</b>	0661301000
<b>description</b>	infrared lamp 230V 500W L 490mm connection M4 ø 12mm		
<b>For models:</b>	910005, 910006, 910007		



<b>1</b>			
<b>GEV No.</b>	693058	<b>Ref. No.</b>	637000200
<b>description</b>	insulator female L 7mm hole ø 5.5mm ø 13mm		
<b>For models:</b>	262001		



<b>1</b>			
<b>GEV No.</b>	416187	<b>Ref. No.</b>	401023400
<b>description</b>	quartz heating element 400W 115V L 260mm ø 12mm connection male faston 6.3mm mounting distance 24.8mm		



<b>1</b>			
<b>GEV No.</b>	418625	<b>Ref. No.</b>	401023500
<b>description</b>	quartz heating element 500W 115V L 365mm ø 10mm connection male faston 6.3mm		
<b>For models:</b>	222002, 222003		

### coil heating elements



<b>1</b>			
<b>GEV No.</b>	418719	<b>Ref. No.</b>	X02.05.620.00
<b>description</b>	heating element 1000W 230V L 180mm W 80mm H 84mm tube ø 22mm connection male faston 6.3mm connection length 36mm dry heating element heating circuits 1 bracket mounting		
<b>For models:</b>	541003		

### immersion heating elements

3 hole flange ø38.5mm



<b>1</b>			
<b>GEV No.</b>	418642	<b>Ref. No.</b>	230113
<b>description</b>	heating element 2600W 230V mounting ø 38.5mm heating circuits 1 L 260mm W 33mm H 24mm number of thermostat sleeves 1 thermostat sleeves ø 7mm length thermostat sleeves 175mm thermostat sleeve eccentric, non clinging tube ø 6.5mm hole distance 57mm 3 hole flange connection male faston 6.3mm immersion heater		
<b>For models:</b>	811001, 811002, 811003		
<b>accessories for</b>	418642		
	<b>GEV No.</b>	532577	<b>Ref. No.</b> —
	O-ring EPDM thickness 5.34mm ID ø 40.65mm Qty 1 pcs		



3 hole flange ø47.5mm





<b>1</b>			
<b>GEV No.</b>	415001	<b>Ref. No.</b>	230081
<b>description</b>	heating element 4500W 230V mounting ø 47.5mm heating circuits 3 L 316mm W 35mm H 34mm number of thermostat sleeves 1 thermostat sleeves ø 7mm length thermostat sleeves 180mm thermostat sleeve eccentric, non clinging tube ø 6.3mm hole distance 62mm hole ø 8mm connection M4 3 hole flange immersion heater		
<b>spare parts for</b>	415001		
	<b>GEV No.</b>	510408	<b>Ref. No.</b> 200820 456002
	O-ring EPDM thickness 5.34mm ID ø 47mm Qty 1 pcs		
<b>accessories for</b>	415001		
	<b>GEV No.</b>	510562	<b>Ref. No.</b> —
	O-ring silicone thickness 5.34mm ID ø 47mm Qty 1 pcs		
	<b>GEV No.</b>	521103	<b>Ref. No.</b> —
	nut thread M4 H 3mm WS 7 brass Qty 20 pcs		

Table continues overleaf

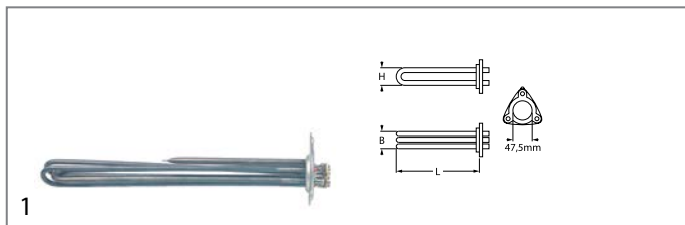

<b>accessories for</b>	415001		
	<b>GEV No.</b>	521104	<b>Ref. No.</b> —
	washer ID ø 4.3mm ED ø 8mm thickness 0.5mm brass Qty 20 pcs for thread M4		
	<b>GEV No.</b>	560111	<b>Ref. No.</b> —
	plain washer ID ø 4.3mm ED ø 9mm thickness 0.8mm SS Qty 20 pcs DIN 125A for thread M4		
	<b>GEV No.</b>	560131	<b>Ref. No.</b> —
	hexagonal nut thread M4 H 3.2mm WS 7 SS DIN/ISO DIN 934 / ISO 4032/8673 Qty 20 pcs		



<b>GEV No.</b>	417440	<b>Ref. No.</b>	230111
<b>description</b>	heating element 4900W 230V mounting ø 47.5mm heating circuits 3 L 330mm W 32mm H 34mm number of thermostat sleeves 1 thermostat sleeves ø 7mm length thermostat sleeves 177mm thermostat sleeve not clinging tube ø 6.5mm hole distance 62mm hole ø 8mm connection M4 3 hole flange immersion heater		
<b>For models:</b>	812003, 812004, 812006, 812008, 812010, 915236, 915237, 915461, 915462, 915463, 915464, 915465		
<b>accessories for</b>	417440		
	<b>GEV No.</b>	510408	<b>Ref. No.</b> 200820 456002
	O-ring EPDM thickness 5.34mm ID ø 47mm Qty 1 pcs		
	<b>GEV No.</b>	510562	<b>Ref. No.</b> —
	O-ring silicone thickness 5.34mm ID ø 47mm Qty 1 pcs		

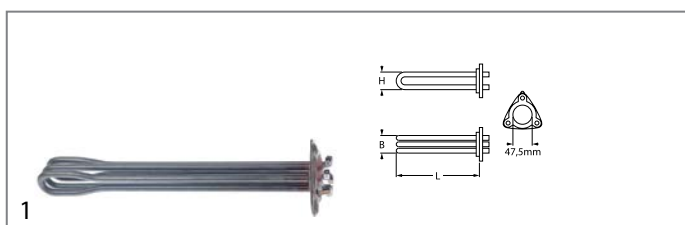



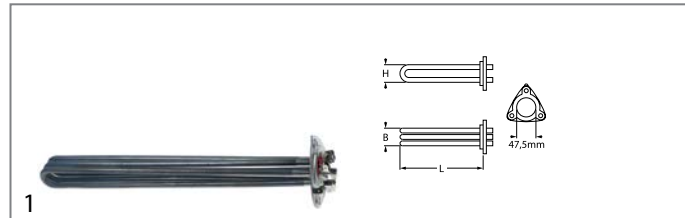

<b>GEV No.</b>	420302	<b>Ref. No.</b>	01-240761-001 01-240761-002
<b>description</b>	heating element 6000W 240V mounting ø 47.5mm heating circuits 3 L 325mm W 33mm H 37mm number of thermostat sleeves 1 thermostat sleeves ø 5mm length thermostat sleeves 140mm thermostat sleeve centre not clinging tube ø 8.3mm hole distance 62mm hole ø 10mm connection male faston 6.3mm 3 hole flange immersion heater		
<b>For models:</b>	811011, 811012, 811013, 811014, 811015, 812011, 812012, 812013, 812014, 812015, 813002, 813004		
<b>accessories for</b>	420302		
	<b>GEV No.</b>	521030	<b>Ref. No.</b> 01-240135-011
	O-ring Viton thickness 5.34mm ID ø 47mm Qty 1 pcs		

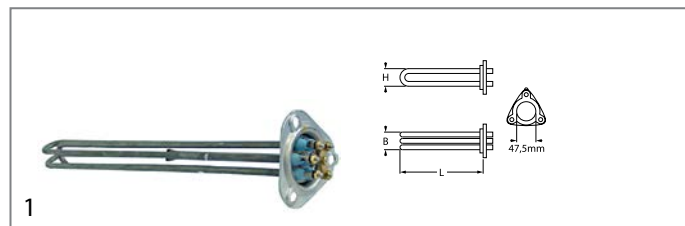



<b>GEV No.</b>	419005	<b>Ref. No.</b>	01-240135-002
<b>description</b>	heating element 7260W 250V mounting ø 47.5mm heating circuits 3 L 375mm W 31mm H 35mm number of thermostat sleeves 1 thermostat sleeves ø 5mm length thermostat sleeves 220mm thermostat sleeve centre not clinging tube ø 8.5mm connection male faston 6.3mm 3 hole flange immersion heater		
<b>For models:</b>	813003, 813004		
<b>accessories for</b>	419005		
	<b>GEV No.</b>	510408	<b>Ref. No.</b> 200820 456002
	O-ring EPDM thickness 5.34mm ID ø 47mm Qty 1 pcs		



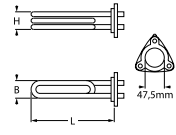

<b>GEV No.</b>	416241	<b>Ref. No.</b>	230020 230020C
<b>description</b>	heating element 8000W 230V mounting ø 47.5mm heating circuits 3 L 355mm W 35mm H 35mm number of thermostat sleeves 1 thermostat sleeves ø 7.5mm length thermostat sleeves 185mm thermostat sleeve not clinging tube ø 6.3mm hole distance 64mm hole ø 8mm connection M4 3 hole flange immersion heater		
<b>For models:</b>	813001		
<b>spare parts for</b>	416241		
	<b>GEV No.</b>	510408	<b>Ref. No.</b> 200820 456002
	O-ring EPDM thickness 5.34mm ID ø 47mm Qty 1 pcs		
<b>accessories for</b>	416241		
	<b>GEV No.</b>	510093	<b>Ref. No.</b> 467002 69870
	protection cap		
	<b>GEV No.</b>	510408	<b>Ref. No.</b> 200820 456002
	O-ring EPDM thickness 5.34mm ID ø 47mm Qty 1 pcs		
	<b>GEV No.</b>	510562	<b>Ref. No.</b> —
	O-ring silicone thickness 5.34mm ID ø 47mm Qty 1 pcs		





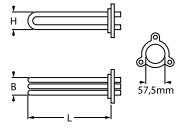

<b>GEV No.</b>	415013	<b>Ref. No.</b>	110396
<b>description</b>	heating element 2400W 230V mounting ø 47.5mm heating circuits 1 L 215mm W 40mm H 35mm number of thermostat sleeves 1 thermostat sleeves ø 6.5mm length thermostat sleeves 190mm thermostat sleeve eccentric, non clinging tube ø 6.5mm hole distance 64mm hole ø 8x10mm connection male faston 6.3mm 3 hole flange immersion heater		
<b>For models:</b>	SP1		
<b>accessories for</b>	415013		
	<b>GEV No.</b>	510408	<b>Ref. No.</b> 200820 456002
	O-ring EPDM thickness 5.34mm ID ø 47mm Qty 1 pcs		
	<b>GEV No.</b>	510562	<b>Ref. No.</b> —
	O-ring silicone thickness 5.34mm ID ø 47mm Qty 1 pcs		

### 3 hole flange ø57.5mm

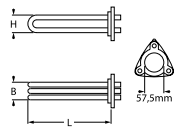



<b>GEV No.</b>	418714	<b>Ref. No.</b>	6A037190
<b>description</b>	heating element 6000W 230V heating circuits 3 L 385mm W 37mm H 60mm tube ø 8.5mm thermostat sleeves ø 7.5mm length thermostat sleeves 210mm number of thermostat sleeves 1 thermostat sleeve eccentric, clinging connection male faston 6.3mm immersion heater 3 hole flange hole distance 75mm mounting ø 57.5mm hole ø 8x10mm		
<b>spare parts for</b>	418714		
	<b>GEV No.</b>	510409	<b>Ref. No.</b> 200815
	O-ring EPDM thickness 5.34mm ID ø 56.52mm Qty 1 pcs		

<b>GEV No.</b>	418895	<b>Ref. No.</b>	110332
<b>description</b>	heating element 5000W 230V mounting ø 57.5mm heating circuits 3 L 350mm W 35mm H 40mm number of thermostat sleeves 1 thermostat sleeves ø 7mm length thermostat sleeves 290mm thermostat sleeve eccentric, non clinging tube ø 8.5mm connection male faston 6.3mm		
<b>For models:</b>	SP2-12, SP2-S12		
<b>accessories for</b>	418895		
	<b>GEV No.</b>	510409	<b>Ref. No.</b> 200815
	O-ring EPDM thickness 5.34mm ID ø 56.52mm Qty 1 pcs		
	<b>GEV No.</b>	510490	<b>Ref. No.</b> 161102
	protection cap for heating element ø 62mm H 54mm mounting distance 70mm		

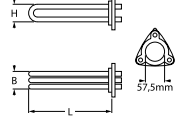



<b>GEV No.</b>	415670	<b>Ref. No.</b>	110343
<b>description</b>	heating element 8000W 230V mounting ø 57.5mm heating circuits 3 L 480mm W 40mm H 50mm number of thermostat sleeves 1 thermostat sleeves ø 7mm length thermostat sleeves 295mm thermostat sleeve not clinging tube ø 10mm hole distance 72mm hole ø 8mm connection M5 3 hole flange immersion heater		
<b>For models:</b>	SP3		
<b>spare parts for</b>	415670		
	<b>GEV No.</b>	510409	<b>Ref. No.</b> 200815
	O-ring EPDM thickness 5.34mm ID ø 56.52mm Qty 1 pcs		

### with compression flange 50 x 26mm

#### group 1



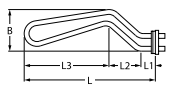

<b>GEV No.</b>	420071	<b>Ref. No.</b>	01-240766-001
<b>description</b>	heating element 2000W 240V heating circuits 1 flange 50x26mm L 320mm W 36mm H mm compression flange connection male faston 6.3mm tube ø 8.6mm immersion heater		
<b>For models:</b>	811011, 811012, 811013, 811014, 811015, 812011, 812012, 812013, 812014, 812015		
<b>accessories for</b>	420071		
	<b>GEV No.</b>	510387	<b>Ref. No.</b> 437086
	gasket L 46mm W 22mm ømm EPDM for heating element for flange 50x26mm		

<b>GEV No.</b>	417517	<b>Ref. No.</b>	00-883423-001
<b>description</b>	heating element 3000W 254V heating circuits 1 flange 50x26mm L 420mm W 70mm L1 58mm L2 70mm L3 320mm compression flange connection male faston 6.3mm horizontal tube ø 8.5mm immersion heater		
<b>For models:</b>	813002, 813003, 813004		



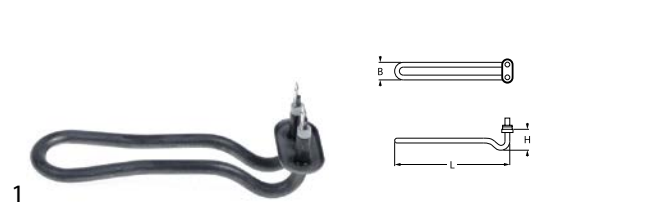

<b>GEV No.</b>	416234	<b>Ref. No.</b>	230098
<b>description</b>	heating element 600W 230V heating circuits 1 flange 50x26mm L 160mm W 45mm H 27mm tube ø 8.8mm connection male faston 6.3mm connection length 40mm immersion heater compression flange		
<b>For models:</b>	811001, 811002, 811003		
<b>accessories for</b>	416234		
	<b>GEV No.</b>	510387	<b>Ref. No.</b> 437086
	gasket L 46mm W 22mm ømm EPDM for heating element for flange 50x26mm		
	<b>GEV No.</b>	510388	<b>Ref. No.</b> —
	counterflange ømm hole distancemm perforation ømm L 43mm W 21mm SS for heating element for flange 50x26mm		

with compression flange 70 x 26mm

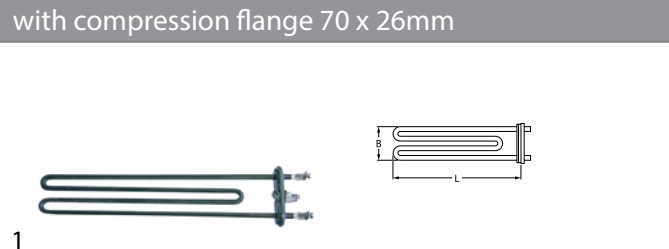

<b>GEV No.</b>	415000	<b>Ref. No.</b>	230088
<b>description</b>	heating element 2900W 230V heating circuits 1 flange 70x26mm L 272mm W 51mm Hmm tube ø 6.3mm connection M4 immersion heater compression flange		
<b>For models:</b>	915234, 915235, 915236, 915237		
<b>spare parts for</b>	415000		
	<b>GEV No.</b>	521128	<b>Ref. No.</b> 437048
	gasket L 66mm W 21mm ømm for heating element suitable for ELETTOBAR, WOLK		
<b>accessories for</b>	415000		
	<b>GEV No.</b>	521128	<b>Ref. No.</b> 437048
	gasket L 66mm W 21mm ømm for heating element suitable for ELETTOBAR, WOLK		

with round flange ø47.5mm





<b>GEV No.</b>	420057	<b>Ref. No.</b>	230116
<b>description</b>	heating element 3000W 230V heating circuits 1 mounting ø 47.5mm L 330mm W 33mm H 19mm tube ø 8.4mm thermostat sleeves ø 7.4mm number of thermostat sleeves 1 length thermostat sleeves 170mm		
<b>For models:</b>	812001, 812002, 812005, 812007, 812009, 915234, 915235, 915460		
<b>spare parts for</b>	420057		
	<b>GEV No.</b>	510408	<b>Ref. No.</b> 200820 456002
	O-ring EPDM thickness 5.34mm ID ø 47mm Qty 1 pcs		

with round flange ø57.5mm





<b>GEV No.</b>	415019	<b>Ref. No.</b>	110226
<b>description</b>	heating element 3000W 230V heating circuits 3 mounting ø 57.5mm L 338mm W 37mm H 41mm round flange connection male faston 6.3mm immersion heater tube ø 8.5mm connection length 27mm thermostat sleeves ø 7mm number of thermostat sleeves 1 length thermostat sleeves 300mm thermostat sleeve not clinging with 3 hole flange & O-ring		
<b>For models:</b>	SP3		
<b>accessories for</b>	415019		
	<b>GEV No.</b>	520357	<b>Ref. No.</b> 161123
	protection cap for flange ø 57.5mm ø 62mm H 42mm		
	<b>GEV No.</b>	550002	<b>Ref. No.</b> —
	tension strap H 10mm L 21mm W 10mm hole ø 6.5mm for heating element		



<b>GEV No.</b>	418040	<b>Ref. No.</b>	853310062
<b>description</b>	heating element 6000W 230V heating circuits 3 L 385mm W 32mm H 42mm tube ø 6.3mm thermostat sleeves ø 7mm length thermostat sleeves 275mm number of thermostat sleeves 1 thermostat sleeve clinging connection male faston 6.3mm connection length 27mm immersion heater round flange mounting ø 57.5mm		
<b>For models:</b>	136002, 136202		
<b>accessories for</b>	418040		
	<b>GEV No.</b>	550002	<b>Ref. No.</b> —
	tension strap H 10mm L 21mm W 10mm hole ø 6.5mm for heating element		

1"





<b>GEV No.</b>	420074	<b>Ref. No.</b>	CR0682160
<b>description</b>	heating element 260W 230V heating circuits 1 L 242mm W 18mm H 6.25mm tube ø 6.25mm thermostat sleeves ø 5mm length thermostat sleeves 230mm number of thermostat sleeves 1 thermostat sleeve centred, adjacent connection male faston 6.3mm connection length 35mm immersion heater flange with thread WS 32 thread 1"		
<b>For models:</b>	146002, 146007		
<b>spare parts for</b>	420074		
	<b>GEV No.</b>	503158	<b>Ref. No.</b> —
	flat gasket FIBER ED ø 44mm ID ø 33mm thickness 2mm Qty 1 pcs		
<b>accessories for</b>	420074		
	<b>GEV No.</b>	507532	<b>Ref. No.</b> —
	nut thread 1" H 10mm WS 40 brass Qty 1 pcs		











<b>GEV No.</b>	418902	<b>Ref. No.</b>	110269
<b>description</b>	heating element 2000W 230V heating circuits 1 L 300mm W 140mm H 28mm thread M12x1 mounting distance 70mm tube ø 6.3mm connection male faston 6.3mm 2 hole fixing connection length 35mm immersion heater		
<b>For models:</b>	SP1		









<b>GEV No.</b>	415198	<b>Ref. No.</b>	110273	
<b>description</b>	heating element 2000W 230V heating circuits 1 L 318mm W 85mm H 26mm thread M12x1 mounting distance 77mm tube ø 8.3mm connection male faston 6.3mm 2 hole fixing immersion heater			
<b>For models:</b>	SP2-12, SP2-S12			
<b>accessories for</b>	415198			
	<b>GEV No.</b>	520229	<b>Ref. No.</b>	—
	nut thread M12x1 H 4mm WS 16 zinc-coated steel Qty 1 pcs			
	<b>GEV No.</b>	521110	<b>Ref. No.</b>	460527
	flat gasket fibre ED ø 20mm ID ø 13mm thickness 2mm Qty 1 pcs			



<b>GEV No.</b>	415665	<b>Ref. No.</b>	230086	
<b>description</b>	heating element 2750/3250W 220/240V heating circuits 1 L 380mm W 110mm H 30mm thread M10x1 mounting distance 75mm tube ø 6.5mm connection M4 immersion heater 2 hole fixing			
<b>For models:</b>	812001, 812002, 812003, 812004, 812005, 812006, 812007, 812008, 812009, 812010, 915234, 915235, 915236, 915237, 915460, 915461, 915462, 915463, 915464, 915465			
<b>spare parts for</b>	415665			
	<b>GEV No.</b>	510893	<b>Ref. No.</b>	200810 456015
	O-ring EPDM thickness 2.62mm ID ø 9.92mm Qty 1 pcs			
<b>accessories for</b>	415665			
	<b>GEV No.</b>	510416	<b>Ref. No.</b>	—
	flat gasket fibre ED ø 19mm ID ø 10.5mm thickness 1.5mm for thread M10 Qty 1 pcs			
	<b>GEV No.</b>	520231	<b>Ref. No.</b>	—
	nut thread M10x1 H 6mm WS 14 zinc-coated steel Qty 1 pcs			
	<b>GEV No.</b>	520876	<b>Ref. No.</b>	463007
	protection cap for heating element ø 11.5mm H 32mm W 25mm plastic			
	<b>GEV No.</b>	521103	<b>Ref. No.</b>	—
	nut thread M4 H 3mm WS 7 brass Qty 20 pcs			
	<b>GEV No.</b>	521104	<b>Ref. No.</b>	—
	washer ID ø 4.3mm ED ø 8mm thickness 0.5mm brass Qty 20 pcs for thread M4			
	<b>GEV No.</b>	521129	<b>Ref. No.</b>	—
	nut thread M10 H 6mm SS WS 17 Qty 1 pcs DIN/ISO DIN 439			

<b>accessories for</b>	415665			
	<b>GEV No.</b>	560111	<b>Ref. No.</b>	—
	plain washer ID ø 4.3mm ED ø 9mm thickness 0.8mm SS Qty 20 pcs DIN 125A for thread M4			
	<b>GEV No.</b>	560131	<b>Ref. No.</b>	—
	hexagonal nut thread M4 H 3.2mm WS 7 SS DIN/ISO DIN 934 / ISO 4032/8673 Qty 20 pcs			



<b>GEV No.</b>	416235	<b>Ref. No.</b>	80360	
<b>description</b>	heating element 3000W 230V heating circuits 1 L 320mm W 50mm H 40mm thread M10x1 mounting distance 44mm tube ø 6.3mm connection male faston 6.3mm 2 hole fixing L1 32mm L2 288mm			
<b>For models:</b>	813001			
<b>spare parts for</b>	416235			
	<b>GEV No.</b>	510893	<b>Ref. No.</b>	200810 456015
	O-ring EPDM thickness 2.62mm ID ø 9.92mm Qty 1 pcs			
<b>accessories for</b>	416235			
	<b>GEV No.</b>	510416	<b>Ref. No.</b>	—
	flat gasket fibre ED ø 19mm ID ø 10.5mm thickness 1.5mm for thread M10 Qty 1 pcs			
	<b>GEV No.</b>	510893	<b>Ref. No.</b>	200810 456015
	O-ring EPDM thickness 2.62mm ID ø 9.92mm Qty 1 pcs			
	<b>GEV No.</b>	521129	<b>Ref. No.</b>	—
	nut thread M10 H 6mm SS WS 17 Qty 1 pcs DIN/ISO DIN 439			
	<b>GEV No.</b>	560192	<b>Ref. No.</b>	—
	tooth lock washer ID ø 10.4mm ED ø 18mm SS DIN/ISO DIN 6798A Qty 1 pcs for thread M10			



heating elements for convection



<b>GEV No.</b>	415828	<b>Ref. No.</b>	R65011310
<b>description</b>	heating element 15000W 230V heating circuits 3 ID ø 388mm ED ø 408mm L 428mm H 132mm L1 20mm W1 105mm H1 114mm H2 18mm flange length 140mm flange width 25mm hole distance 126mm connection M4 connection length 65mm tube ø 8.5mm convection heating element hole ø 6.3mm rectangular flange		
<b>For models:</b>	212003		





			
1			
<b>GEV No.</b>	418887	<b>Ref. No.</b>	0617301601
<b>description</b>	heating element 2400W 240V heating circuits 1 ID ø 180mm ED ø 192mm L 208mm H 33mm L1 10mm W1 30mm H1 5mm H2 27mm flange length 100mm flange width 22mm hole distance 86mm connection male faston 6.3mm connection length 36mm tube ø 6.3mm convection heating element mounting thread M4 rectangular flange heated cabinet		
<b>For models:</b>	913013, 913014, 913015, 913016, 913017, 913018, 913019, 913020, 913021, 913022, 913023, 913024, 914003, 914004, 914005, 914006, 914009, 914010, 914011, 914012, 914015, 914016, 914017, 914018, 914021, 914022, 914023, 914024		



			
1			
<b>GEV No.</b>	416852	<b>Ref. No.</b>	195TL100
<b>description</b>	heating element 2500W 220V heating circuits 1 ID ø 183mm ED ø 195mm L 240mm H 26mm L1 45mm W1 31mm H1 6mm H2 20mm flange length 70mm flange width 22mm hole distance 56mm connection male faston 6.3mm tube ø 6.5mm convection heating element hole ø 5mm rectangular flange		
<b>For models:</b>	913114, 913115, 913116, 913117, 913246, 913247, 913248, 913249, 913250, 913251, 913252, 913253, 913254, 913255, 913256, 913257, 913258, 913259, 913260, 913261, 913262, 913263, 913264, 913265, 913266, 914103, 914105, 914107, 914109, 914114, 914116, 914118, 914120, 914121, 914122, 914123, 914124, 914201, 914202, 914203, 914204, 914205, 914206, 914207, 914208, 914209, 914210, 914211, 914212, 914213...(Other models you can see in the webshop)		
<b>spare parts for</b>	416852		
	<b>GEV No.</b>	510368	<b>Ref. No.</b> —
	gasket L 70mm W 23.5mm hole ø 5mm hole distance 56mm FIBER thickness 2mm for heating element		



			
1			
<b>GEV No.</b>	418267	<b>Ref. No.</b>	RES30003 RES30019
<b>description</b>	heating element 2500W 230V heating circuits 1 ID ø 181mm ED ø 193mm L 208mm H 30mm L1 10mm W1 30mm H1 6mm H2 24mm flange length 70mm flange width 22mm hole distance 56mm connection male faston 6.3mm tube ø 6.3mm convection heating element hole ø 5mm rectangular flange		
<b>For models:</b>	211004, 211017, 211018, 211028		
<b>spare parts for</b>	418267		
	<b>GEV No.</b>	510368	<b>Ref. No.</b> —
	gasket L 70mm W 23.5mm hole ø 5mm hole distance 56mm FIBER thickness 2mm for heating element		

			
1			
<b>GEV No.</b>	420507	<b>Ref. No.</b>	01203220
<b>description</b>	heating element 2700W 230V heating circuits 1 ID ø 180mm ED ø 192mm L 240mm H 250mm L1 54mm W1 30mm H1 30mm H2 24mm flange length 70mm flange width 22mm hole distance 56mm connection F6.3 tube ø 6.5mm hole ø 4.5mm mounting pos. rear		
<b>For models:</b>	211038, 211039		

			
1			
<b>GEV No.</b>	418746	<b>Ref. No.</b>	KRS020 KRS1130A RS1130A0
<b>description</b>	heating element 2900W 230V heating circuits 1 ID ø 220mm ED ø 235mm L 268mm H 40mm L1 35mm W1 30mm H1 11mm H2 32mm flange length 99mm flange width 21mm hole distance 86mm connection male faston 6.3mm connection length 60mm tube ø 6.3mm convection heating element hole ø 5mm rectangular flange		
<b>For models:</b>	211001, 211002		



			
1			
<b>GEV No.</b>	418745	<b>Ref. No.</b>	KRS016 KRS1090A RS1090A1
<b>description</b>	heating element 2900W 230V heating circuits 1 ID ø 220mm ED ø 235mm L 268mm H 75mm L1 35mm W1 30mm H1 11mm H2 32mm flange length 99mm flange width 21mm hole distance 86mm connection male faston 6.3mm connection length 60mm tube ø 6.3mm convection heating element hole ø 5mm rectangular flange		
<b>For models:</b>	211003		
<b>accessories for</b>	418745		
	<b>GEV No.</b>	550986	<b>Ref. No.</b> GN224
	gasket L 100mm W 22mm 7 holes graphite thickness 1mm for heating element		

			
1			
<b>GEV No.</b>	417224	<b>Ref. No.</b>	RES30005
<b>description</b>	heating element 3000W 230V heating circuits 1 ID ø 180mm ED ø 194mm L 205mm H 32mm L1 11mm W1 30mm H1 10mm H2 24mm flange length 70mm flange width 22mm hole distance 56mm connection male faston 6.3mm tube ø 6.1mm convection heating element hole ø 5mm rectangular flange		
<b>For models:</b>	211005, 211006, 211010, 211011, 211012, 211014, 211015, 211016, 211023, 211027		
<b>accessories for</b>	417224		
		<b>GEV No.</b>	510368
		<b>Ref. No.</b>	—
	gasket L 70mm W 23.5mm hole ø 5mm hole distance 56mm FIBER thickness 2mm for heating element		

			
1			
<b>GEV No.</b>	418662	<b>Ref. No.</b>	401033000
<b>description</b>	heating element 3000W 230V heating circuits 1 ID ø 186mm ED ø 200mm L 217mm H 31mm L1 17mm W1 31mm H1 6mm H2 25mm flange length 70mm flange width 22mm hole distance 56mm connection male faston 6.3mm connection length 30mm tube ø 6.3mm convection heating element hole ø 5.5mm rectangular flange		
<b>For models:</b>	111001, 111002, 111003		
<b>spare parts for</b>	418662		
		<b>GEV No.</b>	510368
		<b>Ref. No.</b>	—
	gasket L 70mm W 23.5mm hole ø 5mm hole distance 56mm FIBER thickness 2mm for heating element		

			
1			
<b>GEV No.</b>	420508	<b>Ref. No.</b>	01202671
<b>description</b>	heating element 3000W 230V heating circuits 1 ID ø 215mm ED ø 226mm L 261mm H 40mm L1 15mm H1 10mm H2 27mm flange length 70mm flange width 22mm hole distance 57mm connection F6.3 tube ø 6.5mm		
<b>For models:</b>	211042, 211043, 211046, 212034, 212035, 212036, 212037		



			
1			
<b>GEV No.</b>	420506	<b>Ref. No.</b>	01201300
<b>description</b>	heating element 3500W 230V heating circuits 1 ID ø 218mm ED ø 232mm H 46mm L1 264mm W1 32mm H1 8mm H2 38mm hole distance 57mm connection F6.3 tube ø 8.5mm hole ø 5mm mounting pos. rear		
<b>For models:</b>	211044, 211045		

			
1			
<b>GEV No.</b>	419024	<b>Ref. No.</b>	RES30006
<b>description</b>	heating element 4000W 230V heating circuits 1 ID ø 217mm ED ø 233mm L 265mm H 50mm L1 25mm W1 33mm H1 5mm H2 45mm flange length 70mm flange width 22mm hole distance 56mm connection male faston 6.3mm connection length 29mm tube ø 8.5mm convection heating element hole ø 5mm rectangular flange oven		
<b>For models:</b>	212014, 212015, 212016		
<b>accessories for</b>	419024		
		<b>GEV No.</b>	510368
		<b>Ref. No.</b>	—
	gasket L 70mm W 23.5mm hole ø 5mm hole distance 56mm FIBER thickness 2mm for heating element		

			
1			
<b>GEV No.</b>	419215	<b>Ref. No.</b>	01203130
<b>description</b>	heating element 4000W 230V heating circuits 2 ID ø 220mm ED ø 230mm L 262mm H 60mm L1 20mm W1 92mm H1 10mm H2 50mm flange length 100mm flange width 22mm hole distance 86mm connection F6.3 tube ø 6.5mm hole ø 5mm threaded		
<b>For models:</b>	212038, 212039		



			
1			
<b>GEV No.</b>	420509	<b>Ref. No.</b>	01202660
<b>description</b>	heating element 5000W 230V heating circuits 2 ID ø 225mm ED ø 235mm L 248mm H 60mm L1 18mm W1 90mm H1 18mm H2 50mm flange length 100mm flange width 22mm hole distance 85mm connection F6.3 tube ø 6.5mm hole ø 4mm		
<b>For models:</b>	212040, 212041		

			
1			
<b>GEV No.</b>	415829	<b>Ref. No.</b>	R65011540
<b>description</b>	heating element 7500W 230V heating circuits 3 ID ø 248mm ED ø 260mm L 287mm H 88mm L1 20mm W1 105mm H1 23mm H2 65mm flange length 142mm flange width 25mm hole distance 64mm connection M4 connection length 78mm convection heating element hole ø 5mm rectangular flange		
<b>For models:</b>	212002		
<b>accessories for</b>	415829		
		<b>GEV No.</b>	531270
		<b>Ref. No.</b>	—
	gasket L 141mm W 22mm D1 ø 10mm D2 ø 9mm 9 holes graphite thickness 1mm suitable for UNOX		

			
1			
<b>GEV No.</b>	418196	<b>Ref. No.</b>	R65011530
<b>description</b>	heating element 6000W 230V heating circuits 3 ID ø 215mm ED ø 228mm L 266mm H 78mm L1 38mm W1 102mm H1 10mm H2 68mm flange length 142mm flange width 25mm hole distance 57mm connection M4 connection length 66mm tube ø 6.3mm convection heating element hole ø 6mm rectangular flange		
<b>For models:</b>	212004, 212005, 212006, 212007, 212008, 212009, 212017, 212018		

			
1			
<b>GEV No.</b>	419110	<b>Ref. No.</b>	R65011900
<b>description</b>	heating element 9000W 230V heating circuits 3 ID ø 250mm ED ø 266mm L 290mm H 93mm L1 24mm W1 105mm H1 11mm H2 82mm flange length 142mm flange width 25mm hole distance 63mm connection M4 tube ø 8.5mm hole ø 6.1mm		
<b>For models:</b>	212002, 212010, 212011, 212012, 212013		

			
1			
<b>GEV No.</b>	415871	<b>Ref. No.</b>	R65011520
<b>description</b>	heating element 6000W 230V heating circuits 3 ID ø 217mm ED ø 230mm L 267mm H 75mm L1 38mm W1 103mm H1 65mm H2 10mm flange length 140mm flange width 23mm hole distance 67mm connection M4 connection length 25mm tube ø 6.5mm convection heating element hole ø 5mm rectangular flange		
<b>For models:</b>	212001		

radiation heaters

			
1			
<b>GEV No.</b>	490153	<b>Ref. No.</b>	853400030
<b>description</b>	radiation heater octagonal 3400W 230V L 300mm W 300mm heating circuits 2 H 30mm with heating coil energy regulation with temperature signalization connections 4+2 connection type cable cable length 900mm AD		
<b>For models:</b>	131012, 132005, 132006, 132206		

			
1			
<b>GEV No.</b>	420525	<b>Ref. No.</b>	R65011730
<b>description</b>	heating element 7000W 230V heating circuits 3 ID ø 248mm ED ø 260mm L 298mm H 87mm L1 10mm W1 102mm H1 15mm H2 66mm flange length 142mm flange width 25mm hole distance 127mm connection M4 tube ø 6.5mm		
<b>For models:</b>	212019, 212020		



1

<b>GEV No.</b>	416656	<b>Ref. No.</b>	PD2454
<b>description</b>	radiation heater rectangular 4000W 230V L 490mm W 245mm heating circuits 2 connections 2+2 IRCA		
<b>For models:</b>	221005		
<b>spare parts for</b>	416656		
	<b>GEV No.</b>	<b>Ref. No.</b>	—
	417727		
	terminal L 20m W 8.2mm		



1

<b>GEV No.</b>	490172	<b>Ref. No.</b>	826620241
<b>description</b>	radiation heater rectangular 4500W 400V L 280mm W 400mm heating circuits 2 connections 2x2 connection type cable cable length 800mm IRCA		
<b>For models:</b>	137003, 137004, 137203, 137204		

1-circuit



Image not available

1

<b>GEV No.</b>	490138	<b>Ref. No.</b>	853400060
<b>description</b>	heating element 1200W 230V heating circuits 1		
<b>For models:</b>	131012, 132005, 132006, 132206		



1

<b>GEV No.</b>	490113	<b>Ref. No.</b>	853400050
<b>description</b>	radiation heater ø 200mm 1800W 230V heating circuits 1 energy regulation with temperature signalization with ribbon heater connections 2+2 connection type male faston 6.3mm CERAMASPEED		
<b>For models:</b>	131011, 131012, 132005, 132006, 132205, 132206		



1

<b>GEV No.</b>	490150	<b>Ref. No.</b>	CR0791310
<b>description</b>	radiation heater ø 250mm 2500W 230V heating circuits 1 energy regulation with temperature signalization with heating coil connections 2+2 connection type male faston 6.3mm EGO		
<b>For models:</b>	122105, 122106, 122110		

2-circuit









1

<b>GEV No.</b>	490139	<b>Ref. No.</b>	6A001401 853400040
<b>description</b>	radiation heater ø 250mm 2500W 230V heating circuits 2 energy regulation with temperature signalization partial power 1000W with ribbon heater connections 3+2 connection type male faston 6.3mm EGO		
<b>For models:</b>	131011, 131012, 132005, 132006, 132205, 132206		

flow heaters





1

<b>GEV No.</b>	417214	<b>Ref. No.</b>	0V2506
<b>description</b>	flow heater 1000W 220V ø 88mm L 110mm Wmm complete coffee machine suitable for KORO ES/Tank C252X02		
<b>For models:</b>	743001		
<b>spare parts for</b>	417214		
	<b>GEV No.</b>	<b>Ref. No.</b>	098761
	370477		
	solenoid valve brass 230VAC outlet 1/8" 5-way body outer cone slide-on receptacle DIN ODE coil type BDA/LBA p max 15bar coffee machine		
	<b>GEV No.</b>	<b>Ref. No.</b>	0V1318
	390624		
	bi-metal safety thermostat hole distance 40mm switch-off temp. 125°C 2NC 2-pole 16A connection F6.3 2 hole fixing		
	<b>GEV No.</b>	<b>Ref. No.</b>	094872
	402078		
	temperature probe NTC 10kOhm cable probe -40 up to +110°C cable°C connection male faston 6.3mm thread 1/4" probe ø10x25mm cable lengthm		
	<b>GEV No.</b>	<b>Ref. No.</b>	098645
	417453		
	heating element 1000W 220V heating circuits 1 ø 55mm H 62mm W1 44mm H1 32mm H2 30mm mounting distance 40mm thread M10x1 stainless steel windings 4 tube ø 6mm coffee machine screw		
	<b>GEV No.</b>	<b>Ref. No.</b>	095624
	528110		
	O-ring EPDM thickness 2.62mm ID ø 12.37mm Qty 1 pcs		
	<b>GEV No.</b>	<b>Ref. No.</b>	098701
	528500		
	O-ring EPDM thickness 3.53mm ID ø 72.62mm Qty 1 pcs		

1

<b>GEV No.</b>	417457	<b>Ref. No.</b>	10820
<b>description</b>	flow heater 1300W 230V ø 56mm L 155mm Wmm connection male faston 6.3mm suitable for 190/193W		
<b>For models:</b>	741003		
<b>spare parts for</b>	417457		
	<b>GEV No.</b>	358854	<b>Ref. No.</b> 10915
	thermal fuse switch-off temp. 167°C nominal A cable length 830mm		
	<b>GEV No.</b>	390627	<b>Ref. No.</b> 17779
	bi-metal thermostat hole distance mm switch-off temp. 110°C INCA connection F6.3 M4		

foil heating elements



1

<b>GEV No.</b>	416371	<b>Ref. No.</b>	70259058
<b>description</b>	foil heating element L 400mm W 290mm 1000W 230V t.max. 140°C with temperature limiter silicone cable length 2000mm thickness 1mm		
<b>For models:</b>	651010		

accessories

hexagonal nuts



1

<b>GEV No.</b>	540436	<b>Ref. No.</b>	1033514900 MA1033514900
<b>description</b>	hexagonal nut thread M10x1.25 H 4mm WS 13 brass Qty 1 pcs		
<b>For models:</b>	126101, 126103		



1

<b>GEV No.</b>	527169	<b>Ref. No.</b>	WY23050
<b>description</b>	hexagonal nut thread M3 H 2.8mm WS 5.5 brass Qty 1 pcs		
<b>For models:</b>	742001, 742002, 742003, 742004, 742005		



1

<b>GEV No.</b>	560132	<b>Ref. No.</b>	886003500
<b>description</b>	hexagonal nut thread M5 H 4mm WS 8 SS DIN/ISO DIN 934 / ISO 4032/8673 Qty 20 pcs		
<b>For models:</b>	631001, 631002, 631003, 631004, 631005, 631006, 641001, 641002, 641003, 641004, 641005, 641006, 641007, 641008, 641010, 641011, 641012, 641013, 641014, 641015, 641016, 641017		



1

<b>GEV No.</b>	514022	<b>Ref. No.</b>	14044599 MA14044599
<b>description</b>	nut thread 1½" H 12mm SS WS 59 Qty 1 pcs		
<b>For models:</b>	126101, 126103		



1

<b>GEV No.</b>	521133	<b>Ref. No.</b>	1325313
<b>description</b>	nut thread M14x1.5 H 6mm WS 19 zinc-coated steel Qty 1 pcs		

washers



1

<b>GEV No.</b>	560112	<b>Ref. No.</b>	260503
<b>description</b>	plain washer ID ø 5.3mm ED ø 10mm thickness 1mm SS Qty 20 pcs DIN 125A for thread M5		
<b>For models:</b>	SP1, SP2-12, SP2-S12		



1

<b>GEV No.</b>	560113	<b>Ref. No.</b>	260504 AMA238 RG04064
<b>description</b>	plain washer ID ø 6.4mm ED ø 12mm thickness 1.6mm SS Qty 20 pcs DIN 125A for thread M6		
<b>For models:</b>	411001, 451001, SP1, SP3		



## sealing washers

## fibre gaskets

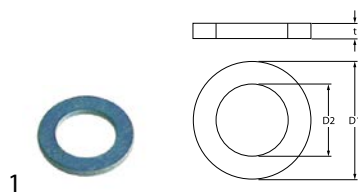

<b>GEV No.</b>	521110	<b>Ref. No.</b>	460527
<b>description</b>	flat gasket fibre ED $\varnothing$ 20mm ID $\varnothing$ 13mm thickness 2mm Qty 1 pcs		
<b>For models:</b>	SP1		

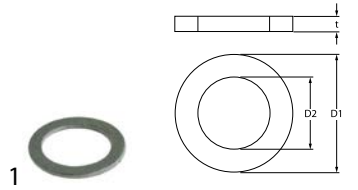

<b>GEV No.</b>	510404	<b>Ref. No.</b>	6A022280
<b>description</b>	flat gasket fibre ED $\varnothing$ 44mm ID $\varnothing$ 34mm thickness 2mm Qty 1 pcs		

## PTFE gaskets

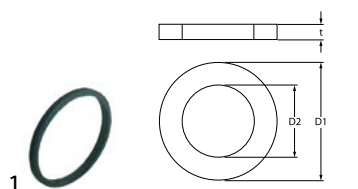

<b>GEV No.</b>	514016	<b>Ref. No.</b>	1814500 MA1814500
<b>description</b>	flat gasket PTFE ED $\varnothing$ 45mm ID $\varnothing$ 40mm thickness 4mm Qty 1 pcs equiv. no. 1036500400/1814500 suitable for MARENO		
<b>For models:</b>	126101, 126103		

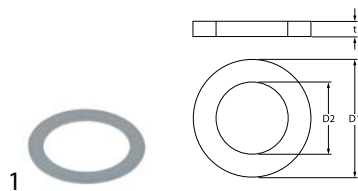

<b>GEV No.</b>	527156	<b>Ref. No.</b>	WY12001
<b>description</b>	flat gasket PTFE ED $\varnothing$ 57.8mm ID $\varnothing$ 43.3mm thickness 2mm Qty 1 pcs		
<b>For models:</b>	742001, 742002, 742003, 742004, 742005, 742017, 742018, 742019, 742020		

## O-rings

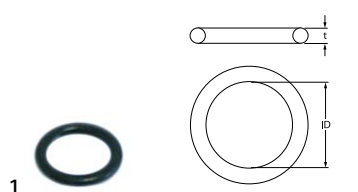

<b>GEV No.</b>	510893	<b>Ref. No.</b>	200810 456015
<b>description</b>	O-ring EPDM thickness 2.62mm ID $\varnothing$ 9.92mm Qty 1 pcs		
<b>For models:</b>	812001, 812002, 812003, 812004, 812005, 812006, 812007, 812008, 812009, 812010, 915234, 915235, 915236, 915237, 915460, 915461, 915462, 915463, 915464, 915465, SP2-12, SP2-S12		

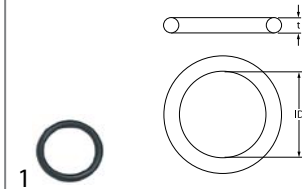

<b>GEV No.</b>	510901	<b>Ref. No.</b>	200843
<b>description</b>	O-ring EPDM thickness 2mm ID $\varnothing$ 13mm Qty 1 pcs		
<b>For models:</b>	SP1, SP2-12, SP2-S12		

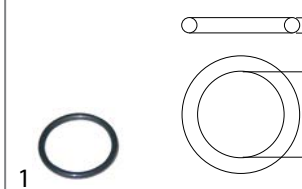

<b>GEV No.</b>	510072	<b>Ref. No.</b>	456016
<b>description</b>	O-ring EPDM thickness 3.53mm ID $\varnothing$ 32.93mm Qty 1 pcs		
<b>For models:</b>	813001		

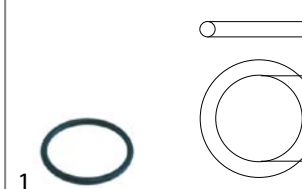

<b>GEV No.</b>	521120	<b>Ref. No.</b>	456075
<b>description</b>	O-ring EPDM thickness 5.34mm ID $\varnothing$ 37.47mm Qty 1 pcs		
<b>For models:</b>	811001, 811002, 811003		



<b>GEV No.</b>	510408	<b>Ref. No.</b>	200820 456002
<b>description</b>	O-ring EPDM thickness 5.34mm ID $\varnothing$ 47mm Qty 1 pcs		
<b>For models:</b>	812001, 812002, 812003, 812004, 812005, 812006, 812007, 812008, 812009, 812010, 813001, 915234, 915235, 915236, 915237, 915460, 915461, 915462, 915463, 915464, 915465, SP1, SP2-12, SP2-S12		

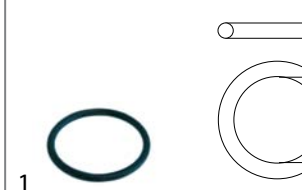

<b>GEV No.</b>	510409	<b>Ref. No.</b>	200815
<b>description</b>	O-ring EPDM thickness 5.34mm ID $\varnothing$ 56.52mm Qty 1 pcs		
<b>For models:</b>	SP2-12, SP2-S12, SP3		

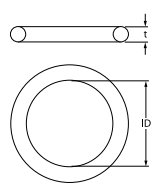

1

<b>GEV No.</b>	514017	<b>Ref. No.</b>	1814400 MA1814400
<b>description</b>	O-ring silicone thickness 3.53mm ID ø 32.93mm Qty 1 pcs		
<b>For models:</b>	126101, 126103		

1

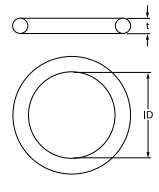
<b>GEV No.</b>	514021	<b>Ref. No.</b>	1814700 MA1814700
<b>description</b>	O-ring silicone thickness 3.53mm ID ø 49.21mm Qty 1 pcs		
<b>For models:</b>	126101, 126103		

**flange gaskets**



1

<b>GEV No.</b>	550937	<b>Ref. No.</b>	01000140 01960368000
<b>description</b>	gasket L 71mm W 21mm hole ø 5mm hole distance 57mm fibre thickness 1mm for heating element		
<b>For models:</b>	211038		





1

<b>GEV No.</b>	550986	<b>Ref. No.</b>	GN224
<b>description</b>	gasket L 100mm W 22mm 7 holes graphite thickness 1mm for heating element		
<b>For models:</b>	211001, 211002		



1

<b>GEV No.</b>	510387	<b>Ref. No.</b>	437086	
<b>description</b>	gasket L 46mm W 22mm ømm EPDM for heating element for flange 50x26mm			
<b>For models:</b>	811001, 811002, 811003			
<b>accessories for</b>	510387			
	<b>GEV No.</b>	510388	<b>Ref. No.</b>	—
	counterflange ømm hole distancemm perforation ømm L 43mm W 21mm SS for heating element for flange 50x26mm			



1

<b>GEV No.</b>	521128	<b>Ref. No.</b>	437048
<b>description</b>	gasket L 66mm W 21mm ømm for heating element suitable for ELETTRORBAR, WOLK		
<b>For models:</b>	915234, 915235, 915236, 915237		

**capillary tube clips**



1

<b>GEV No.</b>	550970	<b>Ref. No.</b>	1033709500 MA1033709500
<b>description</b>	capillary tube clip for pipe ø 8.5mm		
<b>For models:</b>	124101, 124102		



1

<b>GEV No.</b>	550980	<b>Ref. No.</b>	8208270
<b>description</b>	capillary tube clip for pipe ø 8.5mm Qty 1 pcs		



1

<b>GEV No.</b>	551046	<b>Ref. No.</b>	770125
<b>description</b>	capillary tube clip for pipe ø 8mm for thermostat		
<b>For models:</b>	741003		

**spring clips**



1

<b>GEV No.</b>	550041	<b>Ref. No.</b>	8208250
<b>description</b>	probe clip for pipe ø 7mm for probe ø 6mm		



1

<b>GEV No.</b>	550417	<b>Ref. No.</b>	1033515200 MA1033515200
<b>description</b>	probe clip for pipe ø 2x8.5mm for probe ø 6mm for heating elements spacing 15-19mm Qty 1 pcs		
<b>For models:</b>	124101, 124102		





			
1			
<b>GEV No.</b>	550795	<b>Ref. No.</b>	PIA30014
<b>description</b>	probe clip for pipe ø 6mm for probe ø 3.5mm Qty 1 pcs for oven		
<b>For models:</b>	211004, 211005, 211006, 211010, 211011, 211012, 211013, 211014, 211015, 211016, 211017, 211018, 211023, 211024, 211028, 211029, 212014, 212015, 212016, 212024, 212025		

			
2			
<b>GEV No.</b>	550981	<b>Ref. No.</b>	8208260
<b>description</b>	probe clip for pipe ø 8.5mm for probe ø 6mm for heating elements spacing 0.4mm Qty 1 pcs		

### protection caps

			
1			
<b>GEV No.</b>	510093	<b>Ref. No.</b>	467002 69870
<b>description</b>	protection cap		
<b>For models:</b>	812001, 812002, 812003, 812004, 812005, 812006, 812007, 812008, 812009, 812010, 915234, 915235, 915236, 915237, 915460, 915461, 915462, 915463, 915464, 915465		

			
1			
<b>GEV No.</b>	520357	<b>Ref. No.</b>	161123
<b>description</b>	protection cap for flange ø 57.5mm ø 62mm H 42mm		
<b>For models:</b>	SP3		

			
1			
<b>GEV No.</b>	520876	<b>Ref. No.</b>	463007
<b>description</b>	protection cap for heating element ø 11.5mm H 32mm W 25mm plastic		
<b>For models:</b>	812001, 812002, 812003, 812004, 812005, 812006, 812007, 812008, 812009, 812010, 915234, 915235, 915236, 915237, 915460, 915461, 915462, 915463, 915464, 915465		

			
1			
<b>GEV No.</b>	510490	<b>Ref. No.</b>	161102
<b>description</b>	protection cap for heating element ø 62mm H 54mm mounting distance 70mm		
<b>For models:</b>	SP2-12, SP2-S12, SP3		

			
1			
<b>GEV No.</b>	850030	<b>Ref. No.</b>	PT0106
<b>description</b>	ceramic plate curved		

			
1			
<b>GEV No.</b>	514018	<b>Ref. No.</b>	1814600 MA1814600
<b>description</b>	bush		
<b>For models:</b>	126101, 126103		

			
1			
<b>GEV No.</b>	514020	<b>Ref. No.</b>	1815014 MA1815014
<b>description</b>	bush		
<b>For models:</b>	126101, 126103		

			
1			
<b>GEV No.</b>	693058	<b>Ref. No.</b>	637000200
<b>description</b>	insulator female L 7mm hole ø 5.5mm ø 13mm		
<b>For models:</b>	262001		

			
1			
<b>GEV No.</b>	693057	<b>Ref. No.</b>	637000100
<b>description</b>	insulator male L 10mm hole ø 8.4mm ø 13mm		
<b>For models:</b>	262001		

			
1			
<b>GEV No.</b>	691335	<b>Ref. No.</b>	1033715314 MA1033715314
<b>description</b>	lever for tilting element		
<b>For models:</b>	124101, 124102		

			
1			
<b>GEV No.</b>	691354	<b>Ref. No.</b>	1041304334 MA1041304334
<b>description</b>	lever for tilting element		
<b>For models:</b>	124101, 124102		



## hot plates

### square & rectangular

#### with radiused edge



1

<b>GEV No.</b>	490066 <sup>1</sup>	<b>Ref. No.</b>	6A036720
<b>description</b>	hot plate dimensions 220x220mm 2600W 230V with spill ring connection 4 screw clamps protector yes square		

<sup>1</sup>incl. protector



1

<b>GEV No.</b>	490074 <sup>1</sup>	<b>Ref. No.</b>	MA1937400
<b>description</b>	hot plate dimensions 300x300mm 4000W 400V with spill ring connection 4 screw clamps protector yes square		
<b>For models:</b>	141011, 141012, 141013		

<sup>1</sup>incl. protector

### round

#### with radiused edge

#### for domestic kitchens



1

<b>GEV No.</b>	490006	<b>Ref. No.</b>	401051820
<b>description</b>	hot plate ø 180mm 2000W 230V with protector connection 4 screw clamps with 4mm spill ring		
<b>For models:</b>	111001, 112001, 112002		

#### for domestic and commercial kitchens



1

<b>GEV No.</b>	490129	<b>Ref. No.</b>	1839813
<b>description</b>	hot plate ø 180mm 1500W 230V connection 4 screw clamps with 8mm spill ring		



1

<b>GEV No.</b>	490130	<b>Ref. No.</b>	1647013
<b>description</b>	hot plate ø 220mm 2000W 230V connection 4 screw clamps with 8mm spill ring		



1

<b>GEV No.</b>	490020	<b>Ref. No.</b>	1832313 MA1832313	
<b>description</b>	hot plate ø 220mm 2600W 230V connection 4 screw clamps with 8mm spill ring			
<b>For models:</b>	121104, 122103, 122104			
<b>accessories for</b>	490020			
	<b>GEV No.</b>	550796	<b>Ref. No.</b>	—
	fixing plate for hot plate ø220mm			



1

<b>GEV No.</b>	490021	<b>Ref. No.</b>	41826620010
<b>description</b>	hot plate ø 220mm 2600W 400V connection 4 screw clamps with 8mm spill ring		
<b>For models:</b>	131007, 131008, 131009, 131207, 131208, 131209, 132003, 132004, 132203, 132204		



## energy regulators

### EGO

#### 1-circuit





1

<b>GEV No.</b>	380666	<b>Ref. No.</b>	R02.19.019.00	
<b>description</b>	energy regulator			
<b>For models:</b>	276003, 276004, 276005, 276006, 276007, 276008, 276009, 276010			
<b>accessories for</b>	380666			
	<b>GEV No.</b>	111825	<b>Ref. No.</b>	05.30.043.00
	knob switch zero mark ø 30mm shaft ø 6x4.6mm shaft flat right silver			
	<b>GEV No.</b>	112946	<b>Ref. No.</b>	07.01.034.00
	bezel 0-7 dimensions 51x60mm			



			
1			
<b>GEV No.</b>	380015	<b>Ref. No.</b>	01201450 05057021010 402520000 637060100 699801001 6A049320 800400 A0AT93616 LA65080250
<b>description</b>	energy regulator 230V 13A single-circuit turn direction right shaft ø 6x4.6mm shaft L 23mm mounting thread M4 power release 6-100% no. 50.57021.010		
<b>For models:</b>	122105, 122106, 122110, 123118, 123119, 126101, 126103, 132207, 132208, 132209, 132210, 211045, 211046, 212034, 212036, 212038, 212040, 221001, 221002, 221003, 221004, 221017, 221018, 248001, 248002, 248003, 262001		

			
1			
<b>GEV No.</b>	380013	<b>Ref. No.</b>	699800500
<b>description</b>	energy regulator 400V 7A single-circuit turn direction right shaft ø 6x4.6mm mounting thread M4 no. 50.57031.010		
<b>For models:</b>	221017		

2-circuit			
			
1			
<b>GEV No.</b>	380024	<b>Ref. No.</b>	853400010
<b>description</b>	energy regulator 240V 13A turn direction right shaft ø 6x4.6mm shaft L 36mm mounting thread M4 no. 50.67079.601 with operation switch 1-pole		
<b>For models:</b>	131011, 131012, 132005, 132006, 132205, 132206		

			
1			
<b>GEV No.</b>	380027	<b>Ref. No.</b>	6A001402 853400020 CM293900 MACM293900
<b>description</b>	energy regulator EGO 230V 13A dual circuit turn direction right shaft ø 6x4.6mm shaft L 23mm mounting thread M4 power release 6-70% no. 50.55021.100		
<b>For models:</b>	131011, 131012, 132005, 132006, 132205, 132206, 146006, 146007		

## DIAMOND

			
1			
<b>GEV No.</b>	380032	<b>Ref. No.</b>	IB5256500
<b>description</b>	energy regulator 230V 13.5A turn direction right shaft ø 6x4.6mm shaft L 23mm mounting thread M4 equiv. no. 45ER104C1		
<b>For models:</b>	221006		

## ROBERTSHAW

## MSA series

			
1			
<b>GEV No.</b>	380858	<b>Ref. No.</b>	TER30004
<b>description</b>	energy regulator ROBERTSHAW 240V 15A turn direction right shaft ø 6x4.6mm shaft L 23mm mounting thread 8"-32UNC		
<b>For models:</b>	212014, 212015, 212016		

## accessories

## knobs

			
1			
<b>GEV No.</b>	110235	<b>Ref. No.</b>	548810000
<b>description</b>	knob energy regulator 1-3 t.max.°C ø 50mm shaft ø 6x4.6mm shaft flat upper black		
<b>For models:</b>	221017, 221018		



## thermostats

## bi-metal thermostats

## safety bi-metal thermostats

			
1			
<b>GEV No.</b>	390222	<b>Ref. No.</b>	90.16.26 95.16.25
<b>description</b>	bi-metal safety thermostat hole distance 23.8mm switch-off temp. 112°C 1NCA connection F6.3 2 hole fixing		
<b>For models:</b>	745001, 745002		





			
1			
<b>GEV No.</b>	390233	<b>Ref. No.</b>	236039 926189
<b>description</b>	bi-metal safety thermostat hole distance 24mm switch-off temp. 110°C 1NC 1-pole 16A connection F6.3 2 hole fixing without holder		
<b>For models:</b>	811001, 811002, 811003, 812003, 812004, 812006, 812008, 812010, 813001, 915234, 915235, 915236, 915237, 915461, 915462, 915463, 915464, 915465		
<b>accessories for</b>	390233		
	<b>GEV No.</b>	504736	<b>Ref. No.</b> —
bracket for contact thermostat			
	<b>GEV No.</b>	550388	<b>Ref. No.</b> —
bracket for contact thermostat mounting distance 24.5mm mounting ø 3.8			

			
1			
<b>GEV No.</b>	390590	<b>Ref. No.</b>	C23114
<b>description</b>	bi-metal safety thermostat hole distance 24mm switch-off temp. °C 1NC 1-poleAV connection plug 2 hole fixing		
<b>For models:</b>	711002, 711003, 711004, 711005, 711006, 711007, 711008, 711009, 711010, 711011, 711012, 711013, 711014, 711015, 711016, 711017, 711018, 711019		

			
1			
<b>GEV No.</b>	390624	<b>Ref. No.</b>	0V1318
<b>description</b>	bi-metal safety thermostat hole distance 40mm switch-off temp. 125°C 2NC 2-pole 16A connection F6.3 2 hole fixing		
<b>For models:</b>	743001		

			
1			
<b>GEV No.</b>	390370	<b>Ref. No.</b>	WY20304
<b>description</b>	bi-metal safety thermostat hole distance 40mm switch-off temp. 145°C 1NC 1-pole 16A connection F6.3 M4		
<b>For models:</b>	742005		

			
1			
<b>GEV No.</b>	390432	<b>Ref. No.</b>	WY20300008
<b>description</b>	bi-metal safety thermostat switch-off temp. 120°C 3NC 3-pole 25A connection M5		

			
1			
<b>GEV No.</b>	390318	<b>Ref. No.</b>	236047
<b>description</b>	bi-metal safety thermostat switch-off temp. 95°C 1-pole 2 hole fixing		
<b>For models:</b>	811001, 811002, 811003, 812001, 812002, 812005, 812007, 812009, 915234, 915235, 915460		

bi-metal thermostats

			
1			
<b>GEV No.</b>	390632	<b>Ref. No.</b>	RTHM-A122WRZZ
<b>description</b>	bi-metal thermostat hole distance 23.5mm switch-off temp. 125°C 1NC 1-poleAV connection F6.3 2 hole fixing		

			
1			
<b>GEV No.</b>	390447	<b>Ref. No.</b>	X02.16.138.00
<b>description</b>	bi-metal thermostat hole distance 23.5mm switch-off temp. 130°C NC 1-pole 10A 250V connection F6.3		
<b>For models:</b>	541003		

			
1			
<b>GEV No.</b>	390634	<b>Ref. No.</b>	RTHM-A120WRE0 TER30002
<b>description</b>	bi-metal thermostat hole distance 23.5mm switch-off temp. 145°C 1NC 1-pole 16A 250V connection F6.3 2 hole fixing		
<b>For models:</b>	211004, 211005, 211006, 211010, 211011, 211012, 211013, 211014, 211015, 211016, 211017, 211027, 211028, 213001		



			
1			
<b>GEV No.</b>	390613	<b>Ref. No.</b>	6A035210
<b>description</b>	bi-metal thermostat hole distance 23.5mm switch-off temp. 150°C 1NCA connection F6.3		

			
1			
<b>GEV No.</b>	390301	<b>Ref. No.</b>	236035
<b>description</b>	bi-metal thermostat hole distance 23.8mm switch-off temp. 60°C 1NC 1-pole 16A connection F6.3 2 hole fixing		
<b>For models:</b>	811001, 811002, 811003		

			
1			
<b>GEV No.</b>	390319	<b>Ref. No.</b>	236048
<b>description</b>	bi-metal thermostat hole distance 23.8mm switch-off temp. 80°C 1NC 1-pole 16A connection F6.3 2 hole fixing		
<b>For models:</b>	811001, 811002, 811003		

			
1			
<b>GEV No.</b>	390612	<b>Ref. No.</b>	6A035200
<b>description</b>	bi-metal thermostat hole distance 24mm switch-off temp. 110°C		

			
1			
<b>GEV No.</b>	390635	<b>Ref. No.</b>	QFS-TA014WRE0
<b>description</b>	bi-metal thermostat hole distance 24mm switch-off temp. 150°C NC 1-pole 15A connection F6.3 2 hole fixing		
<b>For models:</b>	213002, 213003		

			
1			
<b>GEV No.</b>	390025	<b>Ref. No.</b>	120524
<b>description</b>	bi-metal thermostat hole distance 40mm switch-off temp. 55/42°C NC/NO 2-pole 16A 250V connection F6.3 2 hole fixing		
<b>For models:</b>	SP1		
<b>accessories for</b>	390025		
	<b>GEV No.</b>	512154	<b>Ref. No.</b>
			200494
	gasket for thermostat ID ø 20mm equiv. no. 200494/H200494 hole distance 41mm suitable for COMENDA, HOONVED		

			
1			
<b>GEV No.</b>	390627	<b>Ref. No.</b>	17779
<b>description</b>	bi-metal thermostat hole distance 24mm switch-off temp. 110°C 1NCA connection F6.3 M4		
<b>For models:</b>	741001, 741002		

			
1			
<b>GEV No.</b>	375905	<b>Ref. No.</b>	11074
<b>description</b>	bi-metal thermostat switch-off temp. 140°C 1NC 1-pole connection F6.3 M4		
<b>For models:</b>	741001		

control and safety thermostats

EGO

control thermostats

55.10/19\_ series

			
1			
<b>GEV No.</b>	375548	<b>Ref. No.</b>	CR0682740
<b>description</b>	thermostat t.max. 142°C temperature range fixed 142°C 1-pole 1CO 16A probe ø 4mm probe L 157mm capillary pipe 870mm capillary pipe isolated 870mm gland nut shaft ø 6x4.6mm shaft Lmm shaft position		
<b>For models:</b>	146002, 146006, 146007		

			
1			
<b>GEV No.</b>	375777	<b>Ref. No.</b>	122-2002
<b>description</b>	thermostat t.max. 180°C temperature range 70-180°C 1-pole 1NO 16A probe ø 6mm probe L 87mm capillary pipe 600mm capillary pipe isolated 350mm gland nut shaft ø 6x4.6mm shaft L 23mm shaft position upper rotation 270°		
<b>For models:</b>	244012		





<b>GEV No.</b>	375463	<b>Ref. No.</b>	01201310 09953137000
<b>description</b>	thermostat t.max. 277°C 1-pole 1NO 16A probe ø 3.03mm probe L 139mm capillary pipe 870mm capillary pipe isolatedmm gland nut shaft ø 6x4.6mm shaft L 23mm		
<b>For models:</b>	212036, 212038, 212040		



<b>GEV No.</b>	375184	<b>Ref. No.</b>	1037102300
<b>description</b>	thermostat t.max. 298°C temperature range 55-294°C 1-pole 1NO 16A probe ø 3.1mm probe L 226mm capillary pipe 870mm capillary pipe isolated 350mm gland nut shaft L 23mm shaft position upper probe material SS		



<b>GEV No.</b>	375894	<b>Ref. No.</b>	KTR009 KTR012 TR006
<b>description</b>	thermostat t.max. 293°C temperature range 55-293°C 1-pole 1NO 16A probe ø 3.1mm probe L 226mm capillary pipe 870mm capillary pipe isolated 350mm gland nut shaft ø 4.0-6.0mm shaft L 23mm rotation 270°		
<b>For models:</b>	211001, 211002, 211003		



<b>GEV No.</b>	375667	<b>Ref. No.</b>	R65070360
<b>description</b>	thermostat t.max. 300°C temperature range 68-300°C 1-pole 1NO 16A probe ø 3.1mm probe L 226mm capillary pipe 980mm capillary pipe isolated 980mm gland nut shaft ø 6x4.6mm shaft L 23mm shaft position upper rotation 318°		
<b>For models:</b>	212002, 212003		



<b>GEV No.</b>	375382	<b>Ref. No.</b>	A049200
<b>description</b>	thermostat t.max. 295°C temperature range 45-295°C 1-pole 1NO 16A probe ø 3mm probe L 219mm capillary pipe 1300mm capillary pipe isolated 350mm gland nut shaft ø 6x4.6mm shaft L 23mm rotation 270°		



<b>GEV No.</b>	375595	<b>Ref. No.</b>	01201550
<b>description</b>	thermostat t.max. 303°C temperature range 71-303°C 1-pole 1NO 16A probe ø 3mm probe L 114mm capillary pipe 1230mm capillary pipe isolatedmm gland nut shaft ø 6x4.6mm shaft L 23mm shaft position upper rotation 270° with 2 probes		
<b>For models:</b>	211046, 212034		



<b>GEV No.</b>	375594	<b>Ref. No.</b>	01200370
<b>description</b>	thermostat t.max. 318°C temperature range 60-318°C 1-pole 1NO 16A probe ø 3.03mm probe L 139mm capillary pipe 870mm capillary pipe isolatedmm gland nut shaft ø 6x4.6mm shaft L 23mm shaft position upper rotation 270°		
<b>For models:</b>	211038, 211039, 211045		



<b>GEV No.</b>	375604	<b>Ref. No.</b>	41826630191
<b>description</b>	thermostat t.max. 320°C temperature range 64-320°C 1-pole 1NO 0.5A probe ø 4mm probe L 124mm capillary pipe 1470mm capillary pipe isolatedmm gland nut shaft ø 6x4.6mm shaft L 23mm shaft position upper rotation 270°		
<b>For models:</b>	137001, 137002, 137003, 137004, 137201, 137202, 137204		



<b>GEV No.</b>	375313	<b>Ref. No.</b>	ED00700
<b>description</b>	thermostat t.max. 358°C temperature range 60-358°C 1-pole 1NO 16A probe ø 3.03mm probe L 178mm capillary pipe 870mm capillary pipe isolated 870mm gland nut shaft L 23mm shaft position upper rotation 270°		
<b>For models:</b>	531010, 531011, 531012, 531013, 531014, 531015, 531016, 531017		



<b>GEV No.</b>	375253	<b>Ref. No.</b>	74300110 PF5050DE4-21 PI-B148 PIB148
<b>description</b>	thermostat t.max. 455°C temperature range 85-455°C 1-pole 1NO 16A probe ø 3.9mm probe L 228mm capillary pipe 870mm capillary pipe isolated 660mm gland nut shaft ø 6x4.6mm shaft L 23mm shaft position upper rotation 270°		
<b>For models:</b>	531001, 531002, 531003, 531004, 531005, 531006, 531007, 531008, 531034, 531039, 531040, 531047		



<b>GEV No.</b>	375945	<b>Ref. No.</b>	CR0734520
<b>description</b>	thermostat t.max. 470°C temperature range 90-470°C 1-pole 1NO 16A probe ø 3.9mm probe L 163mm capillary pipe 870mm capillary pipe isolated 600mm shaft ø 4.5x6mm shaft L 23mm shaft position upper rotation 270°		
<b>For models:</b>	141020		

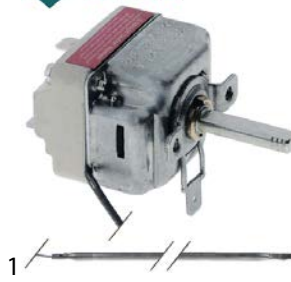

<b>GEV No.</b>	375247	<b>Ref. No.</b>	101001 TERMO001
<b>description</b>	thermostat t.max. 500°C temperature range 75-500°C 1-pole 1NO 16A probe ø 4mm probe L 228mm capillary pipe 900mm capillary pipe isolatedmm gland nut shaft ø 6x4.6mm shaft L 23mm shaft position upper rotation 270°		
<b>For models:</b>	530009, 530011, 531020, 531021, 531028, 531029, 531030, 531031		





<b>GEV No.</b>	375215	<b>Ref. No.</b>	R65070165
<b>description</b>	thermostat t.max. 65°C temperature range fixed 65°C 1-pole 1CO 16A probe ø 6mm probe L 130mm capillary pipe 900mm capillary pipe isolated 900mm gland nut shaft Lmm shaft position		
<b>For models:</b>	212002, 212003, 212004, 212006, 212008, 212017, 212019		



<b>GEV No.</b>	375006	<b>Ref. No.</b>	040575
<b>description</b>	thermostat t.max. 85°C temperature range 30-85°C 1-pole 1CO 16A probe ø 6mm probe L 92mm capillary pipe 3150mm capillary pipe isolated 300mm gland nut shaft L 23mm shaft position upper rotation 270° probe material SS		
<b>For models:</b>	271001, 271002, 271003		



<b>GEV No.</b>	375217	<b>Ref. No.</b>	R65070240
<b>description</b>	thermostat t.max. 70°C temperature range fixed 70°C 1-pole 1CO 16A probe ø 6mm probe L 130mm capillary pipe 900mm capillary pipe isolated 900mm gland nut shaft Lmm shaft position probe material SS		
<b>For models:</b>	212002, 212003		

55.14\_series



<b>GEV No.</b>	375874	<b>Ref. No.</b>	1037117700 MA1037117700
<b>description</b>	thermostat t.max. 90°C temperature range 30-90°C 1-pole 1NO 16A probe ø 6mm probe L 74mm capillary pipe 900mm capillary pipe isolated 800mm gland nut M10x1 shaft ø 6x4.6mm shaft L 23mm shaft position 180° shaft position rotation 270°		
<b>For models:</b>	124105, 125101, 125102, 125103, 144001		

55.13\_series

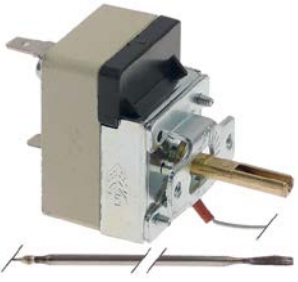

<b>GEV No.</b>	376065	<b>Ref. No.</b>	R65070400
<b>description</b>	thermostat t.max. 320°C temperature range 50-320°C 1-pole 1NO 15A probe ø 3mm probe L 155mm capillary pipe 1030mm capillary pipe isolated 100mm gland nut shaft ø 6x4.6mm shaft L 23mm rotation 270° 250V		
<b>For models:</b>	212004, 212006, 212008, 212017, 212019		

55.17\_series



<b>GEV No.</b>	390821	<b>Ref. No.</b>	CR-B118 KG2735DEG-24 KO-B118 KOB118 WFB112
<b>description</b>	thermostat t.max. 310°C temperature range 50-310°C 1-pole 1NO 16A probe ø 4mm probe L 111mm capillary pipe 1000mm capillary pipe isolatedmm gland nut shaft ø 6x4.6mm shaft L 16mm shaft position° shaft position rotation 270°		
<b>For models:</b>	223007, 223008, 225009, 255009, 255012, 255013, 255014, 255017		



55.34\_series



<b>GEV No.</b>	375887	<b>Ref. No.</b>	6A044650 BN6A044650
<b>description</b>	thermostat t.max. 125°C temperature range 65-125°C 3-pole 3NO 16A probe ø 6mm probe L 77mm capillary pipe 880mm capillary pipe isolated 880mm gland nut shaft L 23mm shaft position upper°		
<b>For models:</b>	136003, 136004, 136203, 136204, 146010		

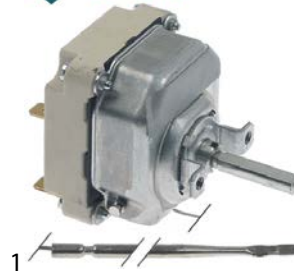

<b>GEV No.</b>	375192	<b>Ref. No.</b>	1309115 MA1309115
<b>description</b>	thermostat t.max. 300°C temperature range 50-300°C 3-pole 3NO 16A probe ø 3mm probe L 219mm capillary pipe 900mm capillary pipe isolatedmm gland nut shaft ø 6x4.6mm shaft L 23mm shaft position upper rotation 270°		
<b>For models:</b>	121101, 121104, 121106, 122110, 123110, 123111, 123112, 123113, 123114, 123115, 123120, 127102, 127103		



<b>GEV No.</b>	375385	<b>Ref. No.</b>	8219601 BN8219601
<b>description</b>	thermostat t.max. 180°C temperature range 100-180°C 3-pole 3NO 16A probe ø 6mm probe L 131mm capillary pipe 2000mm capillary pipe isolated 1800mm gland nut shaft ø 6x4.6mm shaft L 23mm shaft position upper rotation 270°		
<b>For models:</b>	134001, 134003, 134005, 134201, 134203, 134205, 144008, 144009, 144010, 144012		



<b>GEV No.</b>	375944	<b>Ref. No.</b>	CR0582770
<b>description</b>	thermostat t.max. 350°C temperature range 100-350°C 3-pole 3NOA probe ø 3mm probe L 147mm capillary pipe 900mm capillary pipe isolatedmm gland nut shaft ø 6x4.6mm shaft L 26mm shaft position upper rotation 270° probe material SS		
<b>For models:</b>	143017, 143018, 143019, 143020, 143021, 143022, 143023, 143024, 143025, 143026, 143027, 143028, 143029, 143030, 143031, 143032		

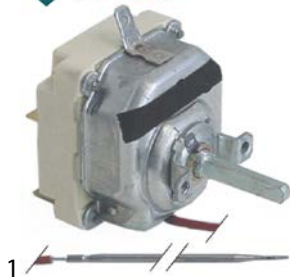

<b>GEV No.</b>	375603	<b>Ref. No.</b>	41826630123 BN826630123
<b>description</b>	thermostat t.max. 300°C temperature range 50-300°C 3-pole 3NO 16A probe ø 3mm probe L 219mm capillary pipe 900mm capillary pipe isolated 900mm gland nut shaft ø 6x4.6mm shaft L 23mm shaft position upper rotation 270°		
<b>For models:</b>	131004, 131006, 131007, 131008, 131009, 131201, 131202, 131203, 131204, 131205, 131206, 131207, 131208, 131209, 131210, 132003, 132004, 132201, 132202, 132203, 132204, 133004, 133005, 133006, 133016, 133017, 133018, 133019, 133020, 133021, 133106, 133119, 133204, 133205, 133206, 133216, 133217, 133218, 133219, 133220, 133221, 133227, 133228, 137003, 137203, 141005, 141007, 141013, 141016, 141021		

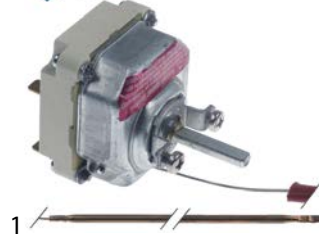

<b>GEV No.</b>	375498	<b>Ref. No.</b>	TERMO002
<b>description</b>	thermostat t.max. 512°C temperature range 60-512°C 3-pole 3NO 16A probe ø 3.8mm probe L 225mm capillary pipe 1150mm capillary pipe isolated 1110mm gland nut shaft ø 6x4.6mm shaft L 32mm shaft position upper rotation 270°		
<b>For models:</b>	530010, 530012, 531022, 531023		



safety thermostats

55.10/19\_series



<b>GEV No.</b>	375886	<b>Ref. No.</b>	826630240
<b>description</b>	safety thermostat switch-off temp. 140°C 1-pole 1NC 0.5A probe ø 3mm probe L 226mm capillary pipe 900mm capillary pipe isolated 840mm gland nut probe probe material SS		
<b>For models:</b>	135001, 135002, 135003, 135004, 135201, 135202, 135203, 135204		

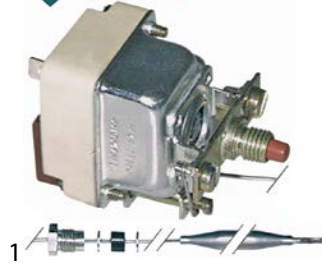

<b>GEV No.</b>	390061	<b>Ref. No.</b>	6A049401
<b>description</b>	safety thermostat switch-off temp. 220°C 1-pole 0.5A probe ø 6mm probe L 140mm capillary pipe 900mm capillary pipe isolatedmm gland nut probe M9x1		



<b>GEV No.</b>	375191	<b>Ref. No.</b>	ED02300
<b>description</b>	safety thermostat switch-off temp. 500°C 1-pole 16A probe ø 3.9mm probe L 230mm capillary pipe 870mm capillary pipe isolated 660mm gland nut probe		
<b>For models:</b>	531010, 531011, 531012, 531013, 531014, 531015, 531016, 531017		

55.11\_series

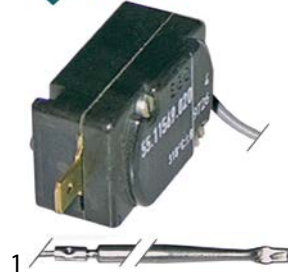

<b>GEV No.</b>	375109	<b>Ref. No.</b>	34-1370
<b>description</b>	safety thermostat switch-off temp. 240°C 1-pole 16A probe ø 4mm probe L 91mm capillary pipe 530mm capillary pipe isolated 350mm gland nut probe SS		
<b>For models:</b>	244012		



<b>GEV No.</b>	390878	<b>Ref. No.</b>	700107
<b>description</b>	safety thermostat switch-off temp. 80°C 1-pole 1NC 16A probe ø 4mm probe L 89mm capillary pipe 195mm capillary pipe isolatedmm gland nut probe		
<b>For models:</b>	122009		

55.32\_series



<b>GEV No.</b>	375199	<b>Ref. No.</b>	1878900 MA1878900
<b>description</b>	safety thermostat switch-off temp. 132°C 3-pole 2x20/1x0.5A probe ø 6mm probe L 77mm capillary pipe 890mm capillary pipe isolated-mm gland nut M10x1 probe SS		
<b>For models:</b>	126101, 126103		



<b>GEV No.</b>	375888	<b>Ref. No.</b>	6A049407
<b>description</b>	safety thermostat switch-off temp. 132°C 3-pole 3NC 20A probe ø 6mm probe L 87mm capillary pipe 890mm capillary pipe isolated 850mm gland nut starting temperature 118°C probe SS probe material SS		
<b>For models:</b>	136003, 136004, 136203, 136204		

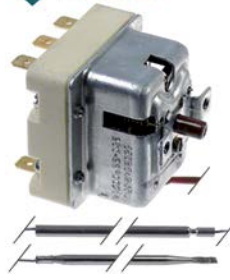

<b>GEV No.</b>	375445	<b>Ref. No.</b>	MACM097701
<b>description</b>	safety thermostat switch-off temp. 230°C 3-pole 2x20/1x0.5A probe ø 4mm probe L 120mm capillary pipe 900mm capillary pipe isolated 700mm gland nut probe		
<b>For models:</b>	124103		



<b>GEV No.</b>	375622	<b>Ref. No.</b>	853310064
<b>description</b>	safety thermostat switch-off temp. 147°C 1-pole 20A probe ø 6mm probe L 89mm capillary pipe 900mm capillary pipe isolated 800mm gland nut probe		
<b>For models:</b>	136002, 136202		



<b>GEV No.</b>	375359	<b>Ref. No.</b>	CMN097700
<b>description</b>	safety thermostat switch-off temp. 230°C 3-pole 2x20/1x0.5A probe ø 4mm probe L 120mm capillary pipe 900mm capillary pipe isolated 900mm gland nut probe kettle		



<b>GEV No.</b>	375380	<b>Ref. No.</b>	6A049405
<b>description</b>	safety thermostat switch-off temp. 160°C 3-pole 20A probe ø 6mm probe L 89mm capillary pipe 900mm capillary pipe isolated 900mm gland nut probe SS		



<b>GEV No.</b>	375873	<b>Ref. No.</b>	1878600 MA1878600	
<b>description</b>	safety thermostat switch-off temp. 236°C 3-pole 20A probe ø 6mm probe L 77mm capillary pipe 1190mm capillary pipe isolated 990mm gland nut starting temperature 218°C probe			
<b>For models:</b>	124101, 124102			
<b>accessories for</b>	375873			
	<b>GEV No.</b>	550148	<b>Ref. No.</b>	—
	gland duct ET M12x0.75 IT M9x1 probe ø max. 6.5mm WS 17 silicone			



1 

<b>GEV No.</b>	375312	<b>Ref. No.</b>	8219602 BN8219602
<b>description</b>	safety thermostat switch-off temp. 245°C 3-pole 3NC 20A probe ø 4mm probe L 120mm capillary pipe 1800mm capillary pipe isolated 1800mm gland nut probe SS		
<b>For models:</b>	134001, 134003, 134005, 134201, 134203, 134205, 144008, 144009, 144010, 144012		
<b>accessories for</b>	375312		
	<b>GEV No.</b>	550981	<b>Ref. No.</b> 8208260
	probe clip for pipe ø 8.5mm for probe ø 6mm for heating elements spacing 0.4mm Qty 1 pcs		



1 

<b>GEV No.</b>	375599	<b>Ref. No.</b>	41826630010
<b>description</b>	safety thermostat switch-off temp. 360°C 1-pole 0.5A probe ø 6mm probe L 79mm capillary pipe 890mm capillary pipe isolatedmm gland nut probe SS		
<b>For models:</b>	133001, 133002, 133003, 133009, 133010, 133011, 133012, 133013, 133014, 133015, 133024, 133201, 133202, 133203, 133209, 133210, 133211, 133212, 133213, 133214, 133215, 133224, 137002, 137202		



1 

<b>GEV No.</b>	375357	<b>Ref. No.</b>	MA1942900
<b>description</b>	safety thermostat switch-off temp. 325°C 1-pole 0.5A probe ø 3mm probe L 188mm capillary pipe 900mm capillary pipe isolatedmm gland nut probe		
<b>For models:</b>	123104, 123107, 123109		



1 

<b>GEV No.</b>	375684	<b>Ref. No.</b>	R65070350
<b>description</b>	safety thermostat switch-off temp. 360°C 1-pole 20A probe ø 11mm probe L 16mm capillary pipe 900mm capillary pipe isolated 900mm gland nut probe screw-in probe probe thread M14x1		
<b>For models:</b>	212001, 212002, 212003, 212010, 212011, 212012, 212013		



1 

<b>GEV No.</b>	390999	<b>Ref. No.</b>	01202690 TER30008 TER30011
<b>description</b>	safety thermostat switch-off temp. 350°C temperature range°C 2-pole NC 20A probe ø 3mm probe L 187mm capillary pipe 690mm capillary pipe isolated 680mm gland nut shaft ømm probe SS		
<b>For models:</b>	211029, 211039, 211042, 212015, 212016, 212024, 212025, 212036, 212037		



1 

<b>GEV No.</b>	375562	<b>Ref. No.</b>	41826630130 BN826630130
<b>description</b>	safety thermostat switch-off temp. 360°C 3-pole 20A probe ø 4mm probe L 120mm capillary pipe 900mm capillary pipe isolated 900mm gland nut probe SS		
<b>For models:</b>	131004, 131006, 131007, 131008, 131009, 131201, 131202, 131203, 131204, 131205, 131206, 131207, 131208, 131209, 131210, 132003, 132004, 132201, 132202, 132203, 132204, 133004, 133005, 133006, 133016, 133017, 133018, 133019, 133020, 133021, 133106, 133119, 133204, 133205, 133206, 133216, 133217, 133218, 133219, 133220, 133221, 133227, 133228, 137001, 137003, 137004, 137201, 137203, 137204, 141005...(Other models you can see in the webshop)		



<b>GEV No.</b>	375187	<b>Ref. No.</b>	1878500 MA1878500
<b>description</b>	safety thermostat switch-off temp. 360°C 3-pole 3NC 2x20/1x0.5A probe ø 6mm probe L 79mm capillary pipe 890mm capillary pipe isolated gland nut probe SS		
<b>For models:</b>	121101, 121104, 121106, 122110, 123110, 123111, 123112, 123113, 123114, 123115, 123120, 127102, 127103, 143001, 143002, 143003, 143004, 143005, 143006, 143007, 143008, 143009, 143010, 143011, 143012, 143013, 143014, 143015, 143016, 143017, 143018, 143019, 143020, 143021, 143022, 143023, 143024, 143025, 143026, 143027, 143028, 143029, 143030, 143031, 143032, 147003, 147005, 147006, 147007		



<b>GEV No.</b>	390610	<b>Ref. No.</b>	402511000
<b>description</b>	safety thermostat switch-off temp. 235°C 1-pole 16A probe ø 3mm probe L 190mm capillary pipe 1000mm capillary pipe isolated 640mm gland nut probe SS		
<b>For models:</b>	114001, 114002, 244001, 244002, 244003, 244004, 244005, 244006, 244007, 244008, 244009, 244021		

55.33\_ series



<b>GEV No.</b>	390883	<b>Ref. No.</b>	WY20300019
<b>description</b>	safety thermostat switch-off temp. 160°C 3-pole 20A probe ø 4mm probe L 155mm capillary pipe 880mm capillary pipe isolated 350mm gland nut probe SS		

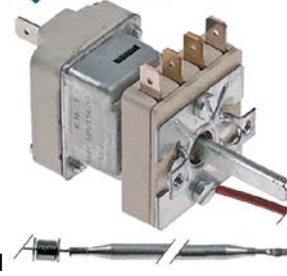



<b>GEV No.</b>	375875	<b>Ref. No.</b>	1037317300 MA1037317300
<b>description</b>	thermostat t.max. 180°C temperature range 53-180°C 1-pole 1NO 16A probe ø 6mm probe L 133mm capillary pipe 1170mm capillary pipe isolated 1000mm gland nut shaft ø 6x4.6mm shaft L 23mm rotation 270° outer switch 2NO		
<b>For models:</b>	124101, 124102		

56.\_ series

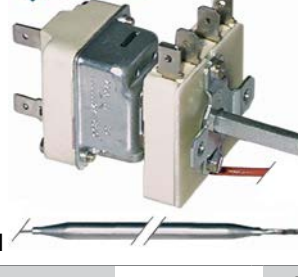

<b>GEV No.</b>	375895	<b>Ref. No.</b>	17764	
<b>description</b>	safety thermostat switch-off temp. 132°C 1-pole 16A probe ø 3.1mm probe L 200mm capillary pipe 860mm capillary pipe isolated 400mm gland nut M9x1 probe with gland nut adapter front fixing M10			
<b>For models:</b>	741003			
<b>accessories for</b>	375895			
	<b>GEV No.</b>	695621	<b>Ref. No.</b>	16529
	duct ET M8x1 IT M10x1 probe ø max. 5mm WS 13			



<b>GEV No.</b>	390039	<b>Ref. No.</b>	41826630230	
<b>description</b>	thermostat t.max. 90°C temperature range 30-90°C 1-pole 1CO 16A probe ø 6mm probe L 173mm capillary pipe 980mm capillary pipe isolated 980mm gland nut shaft ø 6x4.6mm shaft L 23mm shaft position upper rotation 270° outer switch 2NO			
<b>For models:</b>	131004, 131006, 131007, 131008, 131009, 131201, 131202, 131203, 131204, 131205, 131206, 131207, 131208, 131209, 131210, 132003, 132004, 132201, 132202, 132203, 132204, 134207, 135001, 135002, 135003, 135004, 135201, 135202, 135203, 135204			
<b>accessories for</b>	390039			
	<b>GEV No.</b>	111934	<b>Ref. No.</b>	—
	knob thermostat t.max. 90°C ø 50mm shaft ø 6x4.6mm shaft flat upper black temperature range 30-90°C rotation 270°			



55.13\_series

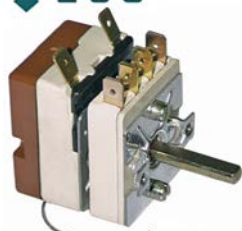

<b>GEV No.</b>	375408	<b>Ref. No.</b>	PD412C
<b>description</b>	thermostat t.max. 320°C temperature range 50-320°C 1-pole 1NO 16A probe ø 3.03mm probe L 160mm capillary pipe 1150mm capillary pipe isolatedmm gland nut shaft ø 6x4.6mm shaft L 23mm shaft position upper rotation 270° outer switch 2NO		
<b>For models:</b>	234001, 234002, 234005		



<b>GEV No.</b>	390812	<b>Ref. No.</b>	120530
<b>description</b>	thermostat t.max. 87°C temperature range fixes 87°C 1-pole 1CO 16A probe ø 6.5mm probe L 97mm capillary pipe 1500mm capillary pipe isolatedmm gland nut shaft Lmm rotation 270° 250V contacts male faston 6.3mm		
<b>For models:</b>	SP3		

55.34\_series



<b>GEV No.</b>	375140	<b>Ref. No.</b>	CR0688650
<b>description</b>	thermostat t.max. 650°C temperature range 50°C/50-600°C/70-650°C 3-pole 3NO 16A probe ø 4mm probe L 228mm capillary pipe 1200mm capillary pipe isolated 1200mm gland nut shaft ø 6x4.6mm shaft L 23mm shaft position left rotation 318° outer switch 2NO		
<b>For models:</b>	141014, 141015, 141016		



<b>GEV No.</b>	375847	<b>Ref. No.</b>	IV5863500
<b>description</b>	thermostat t.max. 90°C temperature range 0-90°C 1-pole 1CO 15A probe ø 6.5mm probe L 100mm capillary pipe 1500mm capillary pipe isolatedmm gland nut shaft ø 6x4.6mm shaft L 18mm shaft position +135° rotation 270° 250V		
<b>For models:</b>	541004		

IMIT / TEMPOMATIC / ARTHERMO

control thermostats



<b>GEV No.</b>	375891	<b>Ref. No.</b>	X02.16.136.00
<b>description</b>	thermostat t.max. 85°C temperature range 0-85°C 1-pole 1CO 15A probe ø 6mm probe L 78mm capillary pipe 1000mm capillary pipe isolatedmm gland nut shaft ø 6x4.6mm shaft L 15mm probe material SS		
<b>For models:</b>	541003		



<b>GEV No.</b>	390022	<b>Ref. No.</b>	120522
<b>description</b>	thermostat t.max. 90°C temperature range 30-90°C 1-pole 1CO 16A probe ø 9.5mm probe L 50mm capillary pipe 1000mm capillary pipe isolated 1000mm gland nut shaft L 19mm rotation 270°		
<b>For models:</b>	SP2-12, SP2-S12		



<b>GEV No.</b>	390014	<b>Ref. No.</b>	120525
<b>description</b>	thermostat t.max. 85°C temperature range 40-78 / 47-85°C 2-pole 2CO 16A probe ø 6.5mm probe L 95mm capillary pipe 1500mm capillary pipe isolated 1450mm gland nut shaft ø 6x4.6mm shaft L 15mm shaft position right rotation 270°		
<b>For models:</b>	SP1, SP2-12, SP2-S12, SP3		

safety thermostats



<b>GEV No.</b>	390773	<b>Ref. No.</b>	120519
<b>description</b>	safety thermostat switch-off temp. 135°C temperature range 95-135°C 1-pole 1CO 16A probe ø 5mm probe L 130mm capillary pipe 1000mm capillary pipe isolated 900mm gland nut probe		
<b>For models:</b>	SP3		

CAEM

control thermostats



<b>GEV No.</b>	390082	<b>Ref. No.</b>	40250110
<b>description</b>	thermostat t.max. 100°C temperature range 30-90°C 1-pole 1CO 16A probe ø 6mm probe L 94mm capillary pipe 1600mm capillary pipe isolatedmm gland nut shaft ø 6x4.6mm shaft L 22mm shaft position upper rotation 270° probe material copper		



<b>GEV No.</b>	390604	<b>Ref. No.</b>	402501500
<b>description</b>	thermostat t.max. 110°C temperature range 30-110°C 1-pole 1NO 16A probe ø 5mm probe L 90mm capillary pipe 970mm capillary pipe isolated 28mm gland nut shaft ø 6x4.6mm shaft L 17mm rotation 270°		
<b>For models:</b>	116001, 116002		



<b>GEV No.</b>	390882	<b>Ref. No.</b>	402501501
<b>description</b>	thermostat t.max. 120°C temperature range 30-120°C 1-pole 1NO 16A probe ø 5mm probe L 80mm capillary pipe 980mm capillary pipe isolated 28mm gland nut shaft ø 6x4.6mm shaft L 17mm rotation 270° 250V		



<b>GEV No.</b>	390611	<b>Ref. No.</b>	402502000
<b>description</b>	thermostat t.max. 190°C temperature range 50-190°C 1-pole 1NO 16A probe ø 3mm probe L 185mm capillary pipe 980mm capillary pipe isolated 640mm gland nut shaft ø 6x4.6mm shaft L 23mm shaft position upper rotation 270° probe material SS		
<b>For models:</b>	114002, 244001, 244002, 244003, 244004, 244005, 244006, 244007, 244008, 244009, 244021, 261001, 261002, HD3NK		





<b>GEV No.</b>	390606	<b>Ref. No.</b>	402503150
<b>description</b>	thermostat t.max. 300°C temperature range 50-300°C 1-pole 1NO 16A probe ø 3mm probe L 175mm capillary pipe 1500mm capillary pipe isolated 650mm gland nut shaft ø 6x4.6mm shaft L 18mm rotation 270°		
<b>For models:</b>	111001, 111002, 111003		



<b>GEV No.</b>	390602	<b>Ref. No.</b>	402503000 402503500
<b>description</b>	thermostat t.max. 300°C temperature range 50-300°C 1-pole 1NO 16A probe ø 5mm probe L 70mm capillary pipe 900mm capillary pipe isolated 700mm gland nut shaft L 18mm rotation 270°		
<b>For models:</b>	113003, 113004, 113005, 113006, 113011, 113012, 113013, 113014, 243001, 243002, 243005, 255001, 255002, 255003, 255004, 255006, 255007, 535001, 535002, 535004		



<b>GEV No.</b>	390672	<b>Ref. No.</b>	236042
<b>description</b>	thermostat t.max. 53°C temperature range fixed 53°C 1-pole 1CO 16A probe ø 9.5mm probe L 30mm capillary pipe 600mm capillary pipe isolated 540mm gland nut shaft Lmm screw-in probe probe thread M14x1		
<b>For models:</b>	812001, 812002, 812005, 812007, 812009, 915234, 915235, 915236, 915237, 915460		

<b>spare parts for</b>	390672			
	<b>GEV No.</b>	510417	<b>Ref. No.</b>	—
	flat gasket fibre ED ø 20mm ID ø 14mm thickness 2mm Qty 1 pcs			
	<b>GEV No.</b>	550261	<b>Ref. No.</b>	—
	nut thread M14x1 H 4mm WS 19 SS Qty 1 pcs			





<b>GEV No.</b>	390686	<b>Ref. No.</b>	236043
<b>description</b>	thermostat t.max. 83°C temperature range°C 1-pole 1CO 20A probe ø 6mm probe L 90mm capillary pipe 630mm capillary pipe isolated 550mm gland nut shaft ømm shaft Lmm shaft position rotation 270° probe material copper		
<b>For models:</b>	812001, 812002, 812005, 812007, 812009, 915234, 915235, 915236, 915237, 915460		



<b>GEV No.</b>	391038	<b>Ref. No.</b>	R65070460
<b>description</b>	thermostat switch-off temp. 360°C temperature range°C 1-pole 1NC 10A probe ø 3mm probe L 150mm capillary pipe 1050mm capillary pipe isolatedmm gland nut shaft ømm SS		
<b>For models:</b>	212004, 212005, 212006, 212007, 212008, 212009, 212017, 212018, 212019, 212020		

safety thermostats



<b>GEV No.</b>	390603	<b>Ref. No.</b>	402511130
<b>description</b>	safety thermostat switch-off temp. 130°C 1-pole 16A probe ø 5mm probe L 120mm capillary pipe 900mm capillary pipe isolatedmm gland nut probe SS		
<b>For models:</b>	116001, 116002		

TECASA

control thermostats



<b>GEV No.</b>	375986	<b>Ref. No.</b>	IGS704203
<b>description</b>	thermostat t.max. 310°C temperature range 50-310°C 1-pole 1NO 16A probe ø 3.5mm probe L 195mm capillary pipe 900mm capillary pipe isolated 20mm gland nut shaft ø 6x4.6mm shaft L 18mm shaft position upper rotation 270° 230V suitable for IMIT		



<b>GEV No.</b>	375456	<b>Ref. No.</b>	01200400 TR254
<b>description</b>	safety thermostat switch-off temp. 335°C 2-pole 20A probe ø 3mm probe L 200mm capillary pipe 1050mm capillary pipe isolated 650mm gland nut probe SS at 250V 20A at 400V 10A		
<b>For models:</b>	211001, 211002, 211038		

CAMPINI

safety thermostats

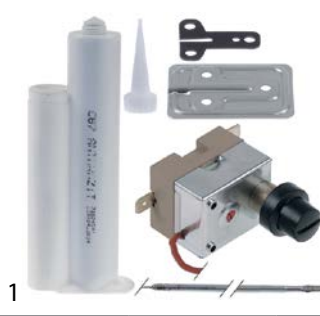

<b>GEV No.</b>	376080	<b>Ref. No.</b>	TR255B
<b>description</b>	safety thermostat kit switch-off temp. 318°C 1-pole 16A probe ø 3mm probe L 137mm capillary pipe 1260mm capillary pipe isolated 710mm gland nut probe SS type Ty 95-H		
<b>For models:</b>	211003		



<b>GEV No.</b>	375892	<b>Ref. No.</b>	01202780
<b>description</b>	safety thermostat switch-off temp. 318°C 1-pole 16A probe ø 3mm probe L 137mm capillary pipe 1260mm capillary pipe isolated 710mm gland nut probe SS type Ty 95-H		
<b>For models:</b>	211043, 211044, 211045, 211046, 212034, 212035, 212038, 212039, 212040, 212041		

**PRODIGY / FIRT**  
control thermostats



<b>GEV No.</b>	390822	<b>Ref. No.</b>	MC2869300
<b>description</b>	thermostat temperature range 30-90°C 1-pole 1CO 16A probe ø 6.5mm probe L 67mm capillary pipe 1450mm capillary pipe isolated 70mm shaft ø 6x4.6mm shaft L 16mm shaft position lower rotation 270°		
<b>For models:</b>	913114, 913115, 913116, 913117, 913246, 913247, 913248, 913249, 913250, 913251, 913252, 913253, 913254, 913255, 913256, 913257, 913258, 913259, 913260, 913261, 913262, 913263, 913264, 913265, 913266, 914103, 914105, 914107, 914109, 914114, 914116, 914118, 914120, 914121, 914122, 914123, 914124, 914201, 914202, 914203, 914204, 914205, 914206, 914207, 914208, 914209, 914210, 914211, 914212, 914213...(Other models you can see in the webshop)		

safety thermostats



<b>GEV No.</b>	390823	<b>Ref. No.</b>	MC2869400
<b>description</b>	safety thermostat switch-off temp. 235°C 1-pole 1CO 20A probe ø 6mm probe L 62mm capillary pipe 1600mm capillary pipe isolated 85mm gland nut probe copper connection male faston 6.3mm		
<b>For models:</b>	913114, 913115, 913116, 913117, 913246, 913247, 913248, 913249, 913250, 913251, 913252, 913253, 913254, 913255, 913256, 913257, 913258, 913259, 913260, 913261, 913262, 913263, 913264, 913265, 913266, 914103, 914105, 914107, 914109, 914114, 914116, 914118, 914120, 914121, 914122, 914123, 914124, 914201, 914202, 914203, 914204, 914205, 914206, 914207, 914208, 914209, 914210, 914211, 914212, 914213...(Other models you can see in the webshop)		

**RANCO**

safety thermostats

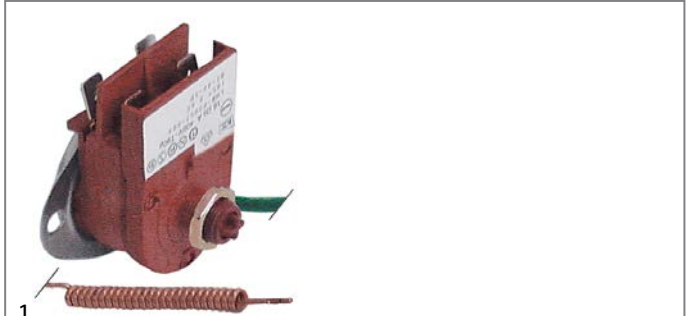

<b>GEV No.</b>	390469	<b>Ref. No.</b>	120526
<b>description</b>	safety thermostat t.max. 110°C temperature range°C 2-pole 2NC 16A probe ø 6mm probe L 50mm capillary pipe 1540mm capillary pipe isolated 160mm gland nut shaft ømm shaft Lmm shaft position rotation° probe material copper screw connection M10x0.75 switch-off temp. 110°C		
<b>For models:</b>	SP1, SP2-12, SP2-S12		

various

control thermostats



<b>GEV No.</b>	390623	<b>Ref. No.</b>	A02011002
<b>description</b>	thermostat for pizza oven		



<b>GEV No.</b>	375914	<b>Ref. No.</b>	TER30003
<b>description</b>	thermostat t.max. 290°C temperature range 50-290°C 1-pole 1NOA probe ø 3mm probe L 165mm capillary pipe 1040mm capillary pipe isolated 600mm gland nut shaft ø 6x4.6mm shaft L 23mm shaft position upper rotation 270° probe material SS		
<b>For models:</b>	211004, 211005, 211006, 211010, 211011, 211012, 211013, 211014, 211015, 211016, 211017, 211018, 211023, 211024, 211028, 212014, 212015, 212016		





<b>GEV No.</b>	375904	<b>Ref. No.</b>	IB5866000
<b>description</b>	thermostat t.max. 90°C temperature range 0-90°C 1-pole 1NO 16A probe ø 6.5mm probe L 85mm capillary pipe 970mm capillary pipe isolatedmm gland nut shaft L 15mm shaft position upper° rotation 270° probe material copper ambient temperature max. 150°C		
<b>For models:</b>	541001, 541002		



<b>GEV No.</b>	390622	<b>Ref. No.</b>	01143566
<b>description</b>	thermostat t.max.°C temperature range°C 1-pole 1NC 10A probe ømm probe Lmm capillary pipemm capillary pipe isolatedmm gland nut shaft ø 6x4.6mm shaft L 30mm shaft position upper rotation 315° for heated cabinet		
<b>For models:</b>	273001		

**safety thermostats**



<b>GEV No.</b>	390607	<b>Ref. No.</b>	402511200
<b>description</b>	safety thermostat switch-off temp. 360°C 1-pole 20A probe ø 3mm probe L 150mm capillary pipe 920mm capillary pipe isolated 240mm gland nut probe SS		
<b>For models:</b>	111001, 111002, 111003		

rod thermostats

safety rod thermostats



<b>GEV No.</b>	390433	<b>Ref. No.</b>	WY20302
<b>description</b>	safety rod thermostat switch-off temp. 145°C temperature range 0-145°C 2-pole 2NC 20A probe ø 8mm probe L 187mm capillary pipemm capillary pipe isolatedmm gland nut shaft ømm thermostat sleeves ø 16mm length thermostat sleeves 200mm		

refrigeration thermostats

RANCO

K22 series



<b>GEV No.</b>	390524	<b>Ref. No.</b>	23591 R23591
<b>description</b>	thermostat RANCO type K22L1082 probe ømm probe Lmm capillary pipe 2000mm temperature range -22 up to -3°C		
<b>For models:</b>	711001, 711002, 711003, 711004, 711005, 711006, 711007, 711008, 711009, 711010, 711011, 711012, 711013, 711014, 711015, 711016, 711017, 711018, 711019		

K50 series



<b>GEV No.</b>	390286	<b>Ref. No.</b>	23005 R23005
<b>description</b>	thermostat RANCO type K50L3383 probe ømm probe Lmm capillary pipe 1500mm temperature range +1 up to +3°C		
<b>For models:</b>	711001, 711002, 711003, 711004, 711005, 711006, 711007, 711008, 711009, 711010, 711011, 711012, 711013, 711014, 711015, 711016, 711017, 711018, 711019		

RANCO



<b>GEV No.</b>	390619	<b>Ref. No.</b>	6151995
<b>description</b>	thermostat RANCO type K50P6073/001 probe ømm probe Lmm capillary pipe 2000mm		
<b>For models:</b>	625010		
<b>accessories for</b>	390619		
	<b>GEV No.</b>	112945	<b>Ref. No.</b> 7422505
knob ø 22mm shaft ø 6x4.6mm shaft flat vertical white			

K57 series

RANCO



<b>GEV No.</b>	390618	<b>Ref. No.</b>	6151761
<b>description</b>	thermostat RANCO type K57L2865 capillary pipe 1950mm temperature range -40 up to +40°C probe ø9.5x107mm		
<b>For models:</b>	621015, 622019		
<b>accessories for</b>	390618		
	<b>GEV No.</b>	112945	<b>Ref. No.</b> 7422505
knob ø 22mm shaft ø 6x4.6mm shaft flat vertical white			

RANCO



<b>GEV No.</b>	390617	<b>Ref. No.</b>	6151753
<b>description</b>	thermostat RANCO type K57-L2866 probe ø 2mm probe Lmm capillary pipe 2000mm temperature range -40 up to +40°C		
<b>For models:</b>	629001		

accessories

fitting parts



<b>GEV No.</b>	699163	<b>Ref. No.</b>	30307040
<b>description</b>	mounting flange L 50mm W 30mm bore ø 5/12mm		
<b>For models:</b>	211039, 211045, 211046, 212036, 212038, 212040		

probe clips

spring clips

for thermostat



<b>GEV No.</b>	550041	<b>Ref. No.</b>	8208250
<b>description</b>	probe clip for pipe ø 7mm for probe ø 6mm		

for safety thermostat



<b>GEV No.</b>	550417	<b>Ref. No.</b>	1033515200 MA1033515200
<b>description</b>	probe clip for pipe ø 2x8.5mm for probe ø 6mm for heating elements spacing 15-19mm Qty 1 pcs		
<b>For models:</b>	124101, 124102		



<b>GEV No.</b>	550795	<b>Ref. No.</b>	PIA30014
<b>description</b>	probe clip for pipe ø 6mm for probe ø 3.5mm Qty 1 pcs for oven		
<b>For models:</b>	211004, 211005, 211006, 211010, 211011, 211012, 211013, 211014, 211015, 211016, 211017, 211018, 211023, 211024, 211028, 211029, 212014, 212015, 212016, 212024, 212025		



<b>GEV No.</b>	550981	<b>Ref. No.</b>	8208260
<b>description</b>	probe clip for pipe ø 8.5mm for probe ø 6mm for heating elements spacing 0.4mm Qty 1 pcs		

capillary tube clips



<b>GEV No.</b>	550970	<b>Ref. No.</b>	1033709500 MA1033709500
<b>description</b>	capillary tube clip for pipe ø 8.5mm		
<b>For models:</b>	124101, 124102		



<b>GEV No.</b>	550980	<b>Ref. No.</b>	8208270
<b>description</b>	capillary tube clip for pipe ø 8.5mm Qty 1 pcs		



			
1			
<b>GEV No.</b>	551046	<b>Ref. No.</b>	770125
<b>description</b>	capillary tube clip for pipe ø 8mm for thermostat		
<b>For models:</b>	741003		

gland nut accessories

ducts

			
1			
<b>GEV No.</b>	695621	<b>Ref. No.</b>	16529
<b>description</b>	duct ET M8x1 IT M10x1 probe ø max. 5mm WS 13		
<b>For models:</b>	741003		

			
1			
<b>GEV No.</b>	550271	<b>Ref. No.</b>	741415
<b>description</b>	gland duct ET M12x0.75 IT M9x1 with gasket and nut		
<b>For models:</b>	741003		



washers with slot

			
1			
<b>GEV No.</b>	510241	<b>Ref. No.</b>	6A038803
<b>description</b>	washer with slot ED ø 7.8mm slit width 1.3mm Qty 10		

gaskets

			
1			
<b>GEV No.</b>	550982	<b>Ref. No.</b>	6A038804
<b>description</b>	gasket graphite ø 7.5mm L 7mm Qty 1 pcs for gland nut		
<b>For models:</b>	134002, 134004, 134006, 134202, 134204, 134206		



bolts with slot



			
1			
<b>GEV No.</b>	520243	<b>Ref. No.</b>	6A038801
<b>description</b>	bolt with slot thread M9x1 Qty 10 pcs nickel-plated brass		
<b>accessories for</b>	520243		
	<b>GEV No.</b>	510591	<b>Ref. No.</b>
			—
	washer with slot ED ø 8.8mm slit width 1.2mm Qty 10		
	<b>GEV No.</b>	510592	<b>Ref. No.</b>
			—
	gasket ø 8x8.7mm Qty 10 pcs slotted silicone		

locking screws

			
1			
<b>GEV No.</b>	106605	<b>Ref. No.</b>	CM012401 MACM012401
<b>description</b>	union screw thread M10x1 probe ø max. 4.5mm		
<b>For models:</b>	124103		

plunger sockets

			
1			
<b>GEV No.</b>	510986	<b>Ref. No.</b>	450516
<b>description</b>	thermowell thread 1/2" L 120mm SS double ø 6.5mm		
<b>For models:</b>	SP3		
<b>accessories for</b>	510986		
	<b>GEV No.</b>	361184	<b>Ref. No.</b>
			—
	nut thread 1/2" H 6mm nickel-plated brass WS 24 Qty 1 pcs		
	<b>GEV No.</b>	521122	<b>Ref. No.</b>
			—
	flat gasket fibre ED ø 31mm ID ø 21.5mm thickness 2mm for thread 1/2" Qty 1 pcs		

			
1			
<b>GEV No.</b>	510987	<b>Ref. No.</b>	450519
<b>description</b>	thermowell thread 1/2" L 44mm SS single ø 10mm		
<b>For models:</b>	SP2-12, SP2-S12		
<b>accessories for</b>	510987		
	<b>GEV No.</b>	361184	<b>Ref. No.</b>
			—
	nut thread 1/2" H 6mm nickel-plated brass WS 24 Qty 1 pcs		
	<b>GEV No.</b>	521122	<b>Ref. No.</b>
			—
	flat gasket fibre ED ø 31mm ID ø 21.5mm thickness 2mm for thread 1/2" Qty 1 pcs		

connecting bows

			
1			
<b>GEV No.</b>	550060	<b>Ref. No.</b>	402503201 6A045900 821550060 MA1988500 MA921200
<b>description</b>	connecting bow long for thermostat Qty 1 pcs		
<b>For models:</b>	111001, 111002, 111003, 123110, 123111, 123112, 123113, 123114, 123115, 123120, 124105, 125101, 125102, 125103, 127102, 127103, 134005, 134205, 137001, 137002, 137003, 137004, 137201, 137202, 141020, 144001, 144007		





			
1			
<b>GEV No.</b>	550059	<b>Ref. No.</b>	6A045000
<b>description</b>	connecting bow short for switch Qty 1 pcs		

## switches and momentary switches

## rocker/momentary rocker switches

27.8x25mm			
			
1			
<b>GEV No.</b>	347715	<b>Ref. No.</b>	130498
<b>description</b>	momentary rocker switch mounting measurements 27.8x25mm white 2NO 250V 16A START connection male faston 6.3mm ambient temperature max. 85°C protection IP40		
<b>For models:</b>	SP3		

			
1			
<b>GEV No.</b>	347263	<b>Ref. No.</b>	130499
<b>description</b>	rocker switch mounting measurements 25x25mm white 2CO 250V 16A cycle connection male faston 6.3mm protection IP40		
<b>For models:</b>	SP3		

			
1			
<b>GEV No.</b>	348221	<b>Ref. No.</b>	1635110 BN1635110
<b>description</b>	rocker switch mounting measurements 27.8x25mm black/green 1NO/indicator light 250V 16A ON-OFF connection F6.3x0.8 ambient temperature max. 100/55°C protection IP40		
<b>For models:</b>	551010, 551011, 551012, 551013, 554016, 554017, 554018, 554019, 611017		



			
1			
<b>GEV No.</b>	510281	<b>Ref. No.</b>	160733
<b>description</b>	blank black mounting measurements 27.8x25mm		
<b>For models:</b>	SP1, SP2-12, SP2-S12, SP3		

28x13.5mm			
			
1			
<b>GEV No.</b>	346957	<b>Ref. No.</b>	KODK005
<b>description</b>	rocker switch mounting measurements 28x13.5mm green 1NO 250V 6A illuminated ON-OFF connection male faston 6.3mm ambient temperature max. 85°C protection IP40		

30x11mm			
			
1			
<b>GEV No.</b>	347350	<b>Ref. No.</b>	PI-B100 PIB100
<b>description</b>	rocker switch mounting measurements 30x11mm black 1CO 250V 16A I O connection male faston 6.3mm ambient temperature max. 90°C protection IP40		
<b>For models:</b>	531034, 531039, 531040		

			
1			
<b>GEV No.</b>	345575	<b>Ref. No.</b>	PT0176
<b>description</b>	rocker switch mounting measurements 30x11mm black 1CO 250V 16A I O connection male faston 6.3mm ambient temperature max. 90°C protection IP40 with neutral position		
<b>For models:</b>	254001, 254002, 254003, 254004, 254005, 254006, 254007, 254008, 254009, 254010, 254011, 254012		

			
1			
<b>GEV No.</b>	345382	<b>Ref. No.</b>	INTER001
<b>description</b>	rocker switch mounting measurements 30x11mm green 1NO/indicator light 250V 16A 0-I connection male faston 6.3mm ambient temperature max. 85°C protection IP40		
<b>For models:</b>	530009, 530010, 530011, 530012, 531020, 531021, 531022, 531023		

			
1			
<b>GEV No.</b>	301010	<b>Ref. No.</b>	X02.19.180.00
<b>description</b>	rocker switch mounting measurements 30x11mm red 1NO/indicator light 250V 16A 0-I connection male faston 6.3mm ambient temperature max. 85/125°C protection IP40		
<b>For models:</b>	541003		
<b>accessories for</b>	301010		
	<b>GEV No.</b>	301035	<b>Ref. No.</b> —
protective cover mounting measurements 30x11mm			

			
1			
<b>GEV No.</b>	301053	<b>Ref. No.</b>	16986
<b>description</b>	rocker switch mounting measurements 30x11mm white 1NO/indicator light 250V 16A 0-I connection male faston 6.3mm		
<b>For models:</b>	741001, 741002		





			
1			
<b>GEV No.</b>	301038	<b>Ref. No.</b>	01143568
<b>description</b>	rocker switch mounting measurements 30x11mm green 1NO/indicator light 250V 16A connection male faston 6.3mm		
<b>For models:</b>	273001		



			
1			
<b>GEV No.</b>	301039	<b>Ref. No.</b>	101004
<b>description</b>	rocker switch mounting measurements 30x11mm red 1NO/indicator light 250V 16A connection male faston 6.3mm		
<b>For models:</b>	531028, 531029, 531030, 531031		



<b>30x22mm</b>			
			
1			
<b>GEV No.</b>	346896 <sup>1</sup>	<b>Ref. No.</b>	637086000
<b>description</b>	rocker switch mounting measurements 30x22mm black 2NO 250V 16A 0-I connection male faston 6.3mm ambient temperature max. 125/55°C protection IP65		
<b>For models:</b>	262001		

<sup>1</sup>non-illuminated



			
1			
<b>GEV No.</b>	347791	<b>Ref. No.</b>	CO1038 S900.01 SL0621
<b>description</b>	rocker switch mounting measurements 30x22mm green 2NO 230V 20A illuminated 0-I connection male faston 6.3mm ambient temperature max. 125/55°C protection IP65 with rubber collar		
<b>For models:</b>	272006, 272007, 273002, 273003, 273004, 279004, 421005, 611007, 611008, 611009, 611010, 611011, 611013, 611014, 611023, 613016, 613017, 621018, 621019, 625002, 625003, 625017, 625018, 633001, 633002		

			
1			
<b>GEV No.</b>	301020	<b>Ref. No.</b>	WY18268
<b>description</b>	momentary rocker switch mounting measurements 30x22mm red 2NO 250V 16A illuminated 0-I connection male faston 6.3mm ambient temperature max. 100/55°C protection IP65		
<b>For models:</b>	742005, 742017, 742018, 742019, 742020		

			
1			
<b>GEV No.</b>	301003	<b>Ref. No.</b>	0641303900 401500550 74500120 877124300
<b>description</b>	rocker switch mounting measurements 30x22mm green 2NO 250V 16A illuminated 0-I connection male faston 6.3mm ambient temperature max. 125/55°C protection IP65		
<b>For models:</b>	113003, 113004, 113005, 113006, 113011, 113012, 113013, 113014, 114003, 115001, 115002, 116001, 116002, 245003, 271004, 271005, 271006, 531003, 531004, 531005, 531006, 531007, 531008, 535005, 535006, 644006, 644007, 644008, 644009, 644010, 644011, 644012, 913013, 913014, 913015, 913016, 913017, 913018, 914003, 914004, 914005, 914006, 914015, 914016, 914017, 914018, 955001, 955002, 955003, 955004		
<b>accessories for</b>	301003		
	<b>GEV No.</b>	301036	<b>Ref. No.</b> 401509000 WY19049
	protective cover internal size 30x22mm for rocker switch mounting measurementsmm		

			
1			
<b>GEV No.</b>	301002	<b>Ref. No.</b>	IB5806000
<b>description</b>	rocker switch mounting measurements 30x22mm orange 2NO 250V 16A illuminated 0-I connection male faston 6.3mm ambient temperature max. 85/125°C protection IP65		
<b>For models:</b>	541001, 541002		
<b>accessories for</b>	301002		
	<b>GEV No.</b>	301036	<b>Ref. No.</b> 401509000 WY19049
	protective cover internal size 30x22mm for rocker switch mounting measurementsmm		

			
1			
<b>GEV No.</b>	345512	<b>Ref. No.</b>	EF00400
<b>description</b>	rocker switch mounting measurements 30x22mm orange 2NO 400V 16A illuminated 0-I connection male faston 6.3mm ambient temperature max. 85/125°C protection IP40		
<b>For models:</b>	531010, 531011, 531012, 531013, 531014, 531015, 531016, 531017		

			
1			
<b>GEV No.</b>	301017	<b>Ref. No.</b>	74500130
<b>description</b>	rocker switch mounting measurements 30x22mm green 2CO 250V 16A illuminated connection male faston 6.3mm ambient temperature max. 125/55°C protection IP40		
<b>For models:</b>	531001, 531002		
<b>accessories for</b>	301017		
	<b>GEV No.</b>	301036	<b>Ref. No.</b> 401509000 WY19049
	protective cover internal size 30x22mm for rocker switch mounting measurementsmm		





			
<b>1</b>			
<b>GEV No.</b>	301060	<b>Ref. No.</b>	WY18263
<b>description</b>	rocker switch mounting measurements 30x22mm red 2NO 250V 16A illuminated connection male faston 6.3mm ambient temperature max. 125/55°C protection IP40		
<b>For models:</b>	742001, 742002, 742003, 742004, 742017, 742018, 742019, 742020		

			
<b>1</b>			
<b>GEV No.</b>	301036	<b>Ref. No.</b>	401509000 WY19049
<b>description</b>	protective cover internal size 30x22mm for rocker switch mounting measurementsmm		
<b>For models:</b>	113003, 113004, 113005, 113006, 113011, 113012, 113013, 113014, 115001, 115002, 116001, 116002, 243001, 243002, 243005, 244001, 244002, 244006, 245001, 245002, 245003, 245004, 245005, 245007, 245008, 255001, 255002, 255003, 255004, 255006, 255007, 742001, 742002, 742003, 742004, 742005, 742017, 742018, 742019, 742020, 955001, 955002, 955003, 955004		

			
<b>1</b>			
<b>GEV No.</b>	346474	<b>Ref. No.</b>	WY15486002
<b>description</b>	dummy element external size 30x22mm suitable for rocker switch		
<b>For models:</b>	742001, 742002, 742003, 742004, 742017, 742018, 742019, 742020		

			
<b>1</b>			
<b>GEV No.</b>	301718	<b>Ref. No.</b>	18316
<b>description</b>	momentary rocker switch mounting measurements 30x22mm white 1NO/indicator light 250V 16A connection male faston 6.3mm ambient temperature max. male faston 6.3mm°C protection IP40		
<b>For models:</b>	741003		

			
<b>1</b>			
<b>GEV No.</b>	301717	<b>Ref. No.</b>	16988
<b>description</b>	momentary rocker switch mounting measurements 30x22mm white 1NO 250V 16A START connection male faston 6.3mm ambient temperature max. 125/55°C protection IP40		
<b>For models:</b>	741003		

			
<b>1</b>			
<b>GEV No.</b>	346377	<b>Ref. No.</b>	251858 401500500
<b>description</b>	rocker switch mounting measurements 30x22mm black 2CO 230V 16A 0-I connection male faston 6.3mm ambient temperature max. 125/55°C protection IP40		
<b>For models:</b>	243001, 243002, 243005, 244001, 244002, 244006, 244010, 245001, 245002, 245004, 245005, 245007, 245008, 255001, 255002, 255003, 255004, 255006, 255007, 261001, 261002, 262002, 262003, 272001, 272002, 276001, 279001, 743001, HD3NK		
<b>accessories for</b>	346377		
	<b>GEV No.</b>	301036	<b>Ref. No.</b>
			401509000 WY19049
	protective cover internal size 30x22mm for rocker switch mounting measurementsmm		

			
<b>1</b>			
<b>GEV No.</b>	301249	<b>Ref. No.</b>	WY18135
<b>description</b>	rocker switch mounting measurements 30x22mm red 2CO 250V 16A I O connection male faston 6.3mm ambient temperature max. 125/55°C protection IP40		
<b>For models:</b>	742005		



			
<b>1</b>			
<b>GEV No.</b>	348090	<b>Ref. No.</b>	29410101
<b>description</b>	rocker switch mounting measurements 30x22mm white 2CO 250V 16A for mincer arrow connection male faston 6.3mm ambient temperature max. 100/55°C protection IP40		
<b>For models:</b>	421002		



			
<b>1</b>			
<b>GEV No.</b>	301716	<b>Ref. No.</b>	16987
<b>description</b>	rocker switch mounting measurements 30x22mm white 2NO 250V 16A illuminated 0-I connection male faston 6.3mm ambient temperature max. 125/55°C protection IP40		
<b>For models:</b>	741003		

			
<b>1</b>			
<b>GEV No.</b>	346378	<b>Ref. No.</b>	74500220 74500400
<b>description</b>	rocker switch mounting measurements 30x22mm green 2NO 250V 16A illuminated lighting connection male faston 6.3mm ambient temperature max. 100/55°C protection IP40		
<b>For models:</b>	531001, 531002, 531003, 531004, 531005, 531006, 531007, 531008		





 <p>1</p>			
<b>GEV No.</b>	347112	<b>Ref. No.</b>	74742008
<b>description</b>	rocker switch mounting measurements 30x22mm green 2NO 250V 16A illuminated ON-OFF connection male faston 6.3mm ambient temperature max. 85°C protection IP40		
<b>For models:</b>	621038, 621039, 622031, 651015, 651016, 651017, 651018, 651019, 651020, 651021, 651022, 651023, 651024, 651025, 651026, 651027, 651028, 651032, 651033, 651034, 651035, 651036, 651037, 651038, 651039, 651040, 651041, 651042, 651043, 651044, 651045, 651046, 651047, 651048, 651049, 651050, 651058, 651060, 651061, 651062, 651063, 651072, 651073, 651074, 651075, 651076, 651077, 651078, 651079, 651080...(Other models you can see in the webshop)		
<b>accessories for</b>	347112		
	<b>GEV No.</b>	301036	<b>Ref. No.</b> 401509000 WY19049
protective cover internal size 30x22mm for rocker switch mounting measurementsmm			

 <p>1</p>			
<b>GEV No.</b>	346868	<b>Ref. No.</b>	19410101 19410102
<b>description</b>	rocker switch mounting measurements 30x22mm white 2NO 250V 16A illuminated 0-I connection male faston 6.3mm ambient temperature max. 125/55°C protection IP65 with cover cap		
<b>For models:</b>	411001, 541004		
<b>accessories for</b>	346868		
	<b>GEV No.</b>	301036	<b>Ref. No.</b> 401509000 WY19049
protective cover internal size 30x22mm for rocker switch mounting measurementsmm			

 <p>1</p>			
<b>GEV No.</b>	347019	<b>Ref. No.</b>	877124200
<b>description</b>	rocker switch mounting measurements 30x22mm orange 2NO 250V 16A illuminated lamp connection male faston 6.3mm ambient temperature max. 100/55°C protection IP40		
<b>For models:</b>	641010, 641011, 641012, 641013, 641014, 641015, 641016, 641017, 644006, 644010, 644011, 644012		

 <p>1</p>			
<b>GEV No.</b>	346985	<b>Ref. No.</b>	401500600
<b>description</b>	rocker switch mounting measurements 30x22mm black 1NO/1CO 250V 16A 0-I/II connection male faston 6.3mm ambient temperature max. 85°C protection IP40		
<b>For models:</b>	261001, HD3NK		



push/momentary push switches

19x13mm

 <p>1</p>			
<b>GEV No.</b>	345056	<b>Ref. No.</b>	WY28165003
<b>description</b>	rocker switch mounting measurements 30x22mm orange 2NO 250V 8A illuminated cup connection male faston 6.3mm ambient temperature max. 85°C protection IP40		
<b>For models:</b>	744001, 744002		

 <p>1</p>			
<b>GEV No.</b>	347627	<b>Ref. No.</b>	00010300
<b>description</b>	momentary push switch mounting measurements 19x13mm black 2NO 250V 16A connection male faston 6.3mm ambient temperature max. 85°C protection IP65 with cover cap		
<b>For models:</b>	211039		

labelled

 <p>1</p>			
<b>GEV No.</b>	300125	<b>Ref. No.</b>	0660800901 23327 MC2869600 R25-0010
<b>description</b>	rocker switch mounting measurements 30x22mm green 2NO 230V 16A 0-I connection male faston 6.3mm ambient temperature max. 125/55°C protection IP65 with cover cap		
<b>For models:</b>	621004, 621005, 622004, 711004, 711005, 711006, 711007, 711008, 711009, 711010, 711011, 711012, 711013, 711014, 711015, 711016, 711017, 711018, 711019, 910005, 910006, 910007, 913114, 913115, 913116, 913117, 913246, 913247, 913248, 913249, 913250, 913251, 913252, 913253, 913254, 913255, 913256, 913257, 913258, 913259, 913260, 913261, 913262, 913263, 913264, 913265, 913266, 914103, 914105, 914107...(Other models you can see in the webshop)		
<b>accessories for</b>	300125		
	<b>GEV No.</b>	301036	<b>Ref. No.</b> 401509000 WY19049
protective cover internal size 30x22mm for rocker switch mounting measurementsmm			

27.2x22.2mm

 <p>1</p>			
<b>GEV No.</b>	345033 <sup>1</sup>	<b>Ref. No.</b>	10.16.00
<b>description</b>	push switch mounting measurements 27.2x22.2mm red 2NO 250V 16A illuminated connection male faston 6.3mm ambient temperature max. 85°C protection IP40		
<b>For models:</b>	745001, 745002		

<sup>1</sup>illuminated



## 30x22mm



<b>GEV No.</b>	301086	<b>Ref. No.</b>	401500530
<b>description</b>	push switch mounting measurements 30x22mm black 2NO 250V 12A 0-1 connection male faston 6.3mm ambient temperature max. 85/55°C protection IP54 with protective collar		
<b>For models:</b>	114001, 114002, 244001, 244002, 244003, 244004, 244005, 244007, 244008, 244009, 244021		



<b>GEV No.</b>	345712	<b>Ref. No.</b>	I3735
<b>description</b>	push switch mounting measurements 30x22mm red/green 2CO 250V 16A Stop / I connection male faston 6.3mm ambient temperature max. 85°C protection IP40 with indicator		
<b>For models:</b>	411011, 411012		
<b>accessories for</b>	345712		
	<b>GEV No.</b>	301127	<b>Ref. No.</b> —
	protective cover internal size 30x55mm transparent		



<b>GEV No.</b>	301036	<b>Ref. No.</b>	401509000 WY19049
<b>description</b>	protective cover internal size 30x22mm for rocker switch mounting measurementsmm		
<b>For models:</b>	113003, 113004, 113005, 113006, 113011, 113012, 113013, 113014, 115001, 115002, 116001, 116002, 243001, 243002, 243005, 244001, 244002, 244006, 245001, 245002, 245003, 245004, 245005, 245007, 245008, 255001, 255002, 255003, 255004, 255006, 255007, 742001, 742002, 742003, 742004, 742005, 742017, 742018, 742019, 742020, 955001, 955002, 955003, 955004		

## ø 9mm



<b>GEV No.</b>	346053	<b>Ref. No.</b>	90.40.00
<b>description</b>	momentary push switch mounting ø 9mm red 1NC connection cable 280mm with plug protection IP40		
<b>For models:</b>	745002		

## ø11mm



<b>GEV No.</b>	347060	<b>Ref. No.</b>	IV5820010
<b>description</b>	push button mounting ø M11x1mm black 1NO 250V 16A connection male faston 6.3mm ambient temperature max. 125°C with plunger actuating force: 200g type CM thread L 14mm		
<b>For models:</b>	481001		

## ø16mm



<b>GEV No.</b>	301172	<b>Ref. No.</b>	R65260610
<b>description</b>	momentary push switch mounting ø 16mm black 1NO 250V 16A connection male faston 6.3mm protection IP40 ambient temperature max. 150°C		
<b>For models:</b>	212002, 212003		



<b>GEV No.</b>	301227	<b>Ref. No.</b>	R65260600
<b>description</b>	push switch mounting ø 16mm black 1NO 250V 16A connection male faston 6.3mm protection IP40 ambient temperature max. 150°C		
<b>For models:</b>	212002, 212003		



<b>GEV No.</b>	301310	<b>Ref. No.</b>	CO4687
<b>description</b>	push switch mounting ø 16mm chrome 1NO 250V 16A connection male faston 6.3mm protection IP40 ambient temperature max. 150°C		
<b>For models:</b>	721008		
<b>spare parts for</b>	301310		
	<b>GEV No.</b>	347676	<b>Ref. No.</b> —
	switch 1NO 250V 16A connection male faston 6.3mm		

## ø22mm







<b>GEV No.</b>	401357	<b>Ref. No.</b>	MF2138
<b>description</b>	momentary push switch mounting measurements ø22mm 1NO/1NC/indicator light 400V 4A indicator lamp 24V 0-1 connection screw ambient temperature max. 125/55°C protection IP40		
<b>For models:</b>	422001, 433001, 433002		
<b>spare parts for</b>	401357		
	<b>GEV No.</b>	346181	<b>Ref. No.</b> —
	push button mounting ø 21mm external size 30x55mm oval		

Table continues overleaf





<b>accessories for</b>	401357		
	<b>GEV No.</b>	401709	<b>Ref. No.</b> —
	protective cover external size 57x32mm internal size 47x22mm matt finish rubber H 27.5mm		



	1		
<b>GEV No.</b>	699002	<b>Ref. No.</b>	SL0891
<b>description</b>	momentary push switch mounting ø 22mm black/white 1NO/1NC/indicator light 230V 6A 0-1 connection screw ambient temperature max. 70°C protection IP40		
<b>For models:</b>	421006, 421007, 421008, 422005, 422006, 431002, 433003, 433004, 433005, 513004, 513005, 513006, 513008, 513009, 513010, 516001, 516002		

<b>ø25mm</b>			
	1		
<b>GEV No.</b>	347355	<b>Ref. No.</b>	PUL30003
<b>description</b>	momentary push switch mounting ø 25mm red 2NO 250V 16A connection male faston 6.3mm ambient temperature max. 85°C protection IP40		
<b>For models:</b>	211005, 211006, 211010, 211012, 211013, 211014, 211015, 211016, 211018		

	1		
<b>GEV No.</b>	345162 <sup>1</sup>	<b>Ref. No.</b>	41826630200
<b>description</b>	push switch mounting ø 25mm yellow 2NO 250V 16A illuminated connection male faston 6.3mm ambient temperature max. 85°C protection IP40		
<b>For models:</b>	134207, 135001, 135002, 135003, 135004, 135201, 135202, 135203, 135204		

<sup>1</sup>illuminated

	1		
<b>GEV No.</b>	346318	<b>Ref. No.</b>	41826630050 BN826630050
<b>description</b>	momentary push switch mounting ø 25mm red 1NO 250V 16A with cover cap ignition connection male faston 6.3mm ambient temperature max. 85°C protection IP65		
<b>For models:</b>	131001, 131002, 131003, 131004, 131005, 131006, 131010, 131201, 131202, 131203, 131204, 131205, 131206, 131210, 132001, 132002, 132201, 132202		
<b>accessories for</b>	346318		
	<b>GEV No.</b>	345039	<b>Ref. No.</b> 41826630420 41826630460 826630060 826630420 826630460 BN826630420 CR0410310
	protective cover round ED ø 33mm external size 23mm internal size 21mm H 12mm clear mounting ø 25mm		

	1		
<b>GEV No.</b>	345039	<b>Ref. No.</b>	41826630420 41826630460 826630060 BN826630420 CR0410310
<b>description</b>	protective cover round ED ø 33mm external size 23mm internal size 21mm H 12mm clear mounting ø 25mm		
<b>For models:</b>	131001, 131002, 131003, 131004, 131005, 131006, 131010, 131201, 131202, 131203, 131204, 131205, 131206, 131210, 132001, 132002, 132201, 132202, 133001, 133002, 133003, 133007, 133008, 133009, 133010, 133011, 133012, 133013, 133014, 133015, 133022, 133023, 133024, 133201, 133202, 133203, 133207, 133208, 133209, 133210, 133211, 133212, 133213, 133214, 133215, 133222, 133223, 133224, 134002, 134004...(Other models you can see in the webshop)		
<b>accessories for</b>	345039		
	<b>GEV No.</b>	345001	<b>Ref. No.</b> —
	momentary push switch mounting ø 25mm yellow 1NO/indicator light 250V 16A cover connection male faston 6.3mm ambient temperature max. 85°C protection IP65		

<b>overload switches</b>			
	1		
<b>GEV No.</b>	348137	<b>Ref. No.</b>	8308560
<b>description</b>	momentary push switch KLD-28A mounting measurements 45x22mm green/red 2NO/A1 250V 16A I O connection male faston 2.8mm/6.3mm ambient temperature max. 85°C protection IP55 with cover cap		
<b>For models:</b>	421002, 512001, 715001		

	1		
<b>GEV No.</b>	347067	<b>Ref. No.</b>	19410152 SL2919
<b>description</b>	push switch KJD17 mounting measurements 45x22mm black/white 2NO/A1 250V 10A I O connection male faston 4.8mm/6.3mm ambient temperature max. 85°C protection IP54 with cover cap		
<b>For models:</b>	421005, 511001		



## 2 hole fixing

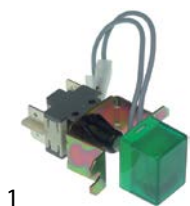

1

<b>GEV No.</b>	346879	<b>Ref. No.</b>	23078
<b>description</b>	push switch green 2NO/indicator light 250V 16A illuminated connection male faston 6.3mm ambient temperature max. 125/55°C protection IP40		
<b>For models:</b>	711001, 711002, 711003		



1

<b>GEV No.</b>	348122	<b>Ref. No.</b>	P9501
<b>description</b>	push switch green/red 230V connection cable 1800mm		
<b>For models:</b>	411013, 411014, 411015, 411016, 411017, 411019		

## miscellaneous



1

<b>GEV No.</b>	346955	<b>Ref. No.</b>	IB5804402
<b>description</b>	momentary push switch mounting measurements 29x29mm black 1NO 250V 6A connection screw VORTEX		
<b>accessories for</b>	346955		
	<b>GEV No.</b>	346960	<b>Ref. No.</b> IB4104002
	protection cap for push-button L 45mm W 21mm		



1

<b>GEV No.</b>	697414	<b>Ref. No.</b>	SL0757
<b>description</b>	momentary push switch mounting measurements 29x29mm black 2NO 250V 16A connection screw ambient temperature max. 85°C protection IP40 FM3		
<b>For models:</b>	473006, 473007, 473008		



1



<b>GEV No.</b>	346959	<b>Ref. No.</b>	IB5804403
<b>description</b>	momentary push switch mounting measurements 29x29mm red 1NO 250V 6A connection screw CICLONE		
<b>For models:</b>	473001, 473002		
<b>accessories for</b>	346959		
	<b>GEV No.</b>	346958	<b>Ref. No.</b> IB4104102
	protection cap L 45mm W 21mm		

## accessories

## push buttons



1

<b>GEV No.</b>	527289	<b>Ref. No.</b>	251787
<b>description</b>	button grey		
<b>For models:</b>	743001		
<b>accessories for</b>	527289		
	<b>GEV No.</b>	402089	<b>Ref. No.</b> 251865
	keypad PCB for coffee machine		
	<b>GEV No.</b>	402110	<b>Ref. No.</b> 251785
	push button set 8-piece transparent		

## frame



1

<b>GEV No.</b>	346252	<b>Ref. No.</b>	19563171
<b>description</b>	frame external size 36x65mm internal size 30x22mm black plastic mounting distance 54mm		
<b>For models:</b>	411001		

## protective covers



1

<b>GEV No.</b>	346960	<b>Ref. No.</b>	IB4104002
<b>description</b>	protection cap for push-button L 45mm W 21mm		
<b>accessories for</b>	346960		
	<b>GEV No.</b>	346955	<b>Ref. No.</b> IB5804402
	momentary push switch mounting measurements 29x29mm black 1NO 250V 6A connection screw VORTEX		



1

<b>GEV No.</b>	346958	<b>Ref. No.</b>	IB4104102
<b>description</b>	protection cap L 45mm W 21mm		
<b>For models:</b>	473001, 473002		
<b>accessories for</b>	346958		
	<b>GEV No.</b>	346959	<b>Ref. No.</b> IB5804403
	momentary push switch mounting measurements 29x29mm red 1NO 250V 6A connection screw CICLONE		



toggle switches

M12x0.75



<b>GEV No.</b>	301230	<b>Ref. No.</b>	R02.19.008A.00
<b>description</b>	toggle switch thread M12x0.75 2NO 250V 15A ON-OFF screw		
<b>For models:</b>	276003, 276004, 276005, 276006, 276007, 276008, 276009, 276010		
<b>accessories for</b>	301230		



<b>GEV No.</b>	112947	<b>Ref. No.</b>	07.01.035.00
<b>description</b>	bezel L 60mm W 51mm		



<b>GEV No.</b>	691506	<b>Ref. No.</b>	07.01.214.00
<b>description</b>	plate for toggle switch		



<b>GEV No.</b>	691507	<b>Ref. No.</b>	04.08.240.00
<b>description</b>	cover for toggle switch		

accessories

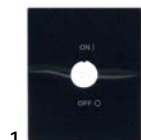

<b>GEV No.</b>	112947	<b>Ref. No.</b>	07.01.035.00
<b>description</b>	bezel L 60mm W 51mm		
<b>For models:</b>	276003, 276004, 276005, 276006, 276007, 276008, 276009, 276010		



<b>GEV No.</b>	691507	<b>Ref. No.</b>	04.08.240.00
<b>description</b>	cover for toggle switch		
<b>For models:</b>	276003, 276004, 276005, 276006, 276007, 276008, 276009, 276010		



<b>GEV No.</b>	691506	<b>Ref. No.</b>	07.01.214.00
<b>description</b>	plate for toggle switch		
<b>For models:</b>	276003, 276004, 276005, 276006, 276007, 276008, 276009, 276010		

microswitches

universal



<b>GEV No.</b>	345042	<b>Ref. No.</b>	IB5820800
----------------	--------	-----------------	-----------

<b>description</b>	microswitch with plunger 250V 16A 1CO connection male faston 6.3mm L 28mm ambient temperature max. 125°C mounting distance 22mm type EF83161.3 actuating force: 75g blue/black		
<b>For models:</b>	721003		

<b>accessories for</b>	345042		
------------------------	--------	--	--

<b>GEV No.</b>	345043	<b>Ref. No.</b>	—
<b>description</b>	lever set 5-piece		

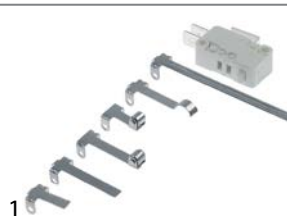

<b>GEV No.</b>	348043	<b>Ref. No.</b>	MSC04N262
----------------	--------	-----------------	-----------

<b>description</b>	microswitch with plunger 250V 16A 1CO connection male faston 6.3mm Lmm L1 27.8mm ambient temperature max. 125°C mounting distance 22mm with lever set type MS1-16 actuating force: 100g white		
<b>For models:</b>	471001		

lever actuated



<b>GEV No.</b>	347033	<b>Ref. No.</b>	0900461
----------------	--------	-----------------	---------

<b>description</b>	microswitch with lever 250V 10A 1CO connection with cable L 38mm ambient temperature max. 85°C mounting distance 16mm actuating force: 60g lever length 40mm		
--------------------	--	--	--





<b>GEV No.</b>	347032	<b>Ref. No.</b>	0900460
----------------	--------	-----------------	---------

<b>description</b>	microswitch with lever 250V 10A 1NO connection with cable L 40mm ambient temperature max. 85°C actuating force: 10g		
<b>For models:</b>	442006, 442008		



			
1			
<b>GEV No.</b>	347021	<b>Ref. No.</b>	X02.19.186.00
<b>description</b>	microswitch with lever 250V 5A 1CO connection soldering connection L 15mm ambient temperature max. 85°C mounting distance 10mm actuating force: 13g lever length 17mm		
<b>For models:</b>	541003		

			
1			
<b>GEV No.</b>	347035	<b>Ref. No.</b>	0900466
<b>description</b>	microswitch with lever 30V 1A 1CO connection with cable L 25mm ambient temperature max. 85°C type D2FW-G 271M actuating force: 80g lever length 21mm		

			
1			
<b>GEV No.</b>	347034	<b>Ref. No.</b>	0900465
<b>description</b>	microswitch with lever 30V 1A 1NO connection with cable L 18mm ambient temperature max. 85°C type D2FW-G 271M actuating force: 100g lever length 25mm		
<b>For models:</b>	442003, 442004, 442005, 442007, 442008		

			
1			
<b>GEV No.</b>	347010	<b>Ref. No.</b>	IB5820700
<b>description</b>	microswitch with lever 250V 16A 1CO connection male faston 4.8mm L 36mm ambient temperature max. 105°C mounting distance 22mm type D3V-16G443-1C25-K actuating force: 50g lever length 28mm		
<b>For models:</b>	723001		

			
1			
<b>GEV No.</b>	345255	<b>Ref. No.</b>	826630310
<b>description</b>	microswitch with lever 250V 16A 1CO connection male faston 6.3mm L 35mm L1 28mm ambient temperature max. 125°C mounting distance 22mm actuating force: 136g lever length 27mm		
<b>For models:</b>	137001, 137003, 137004, 137201		

## roller-lever actuated

## microswitches

			
1			
<b>GEV No.</b>	347028	<b>Ref. No.</b>	251861
<b>description</b>	microswitch with handle with a switch 250V 10A 1NO connection male faston 6.3mm L 28mm ambient temperature max. 125°C black/green lever length 26mm		
<b>For models:</b>	743001		

			
1			
<b>GEV No.</b>	346893	<b>Ref. No.</b>	MSC04N292
<b>description</b>	microswitch with handle with a switch 250V 16A 1CO connection male faston 6.3mm ambient temperature max. 125°C mounting distance 22mm white		
<b>For models:</b>	471001		

			
1			
<b>GEV No.</b>	345041	<b>Ref. No.</b>	SL0885
<b>description</b>	microswitch with handle with a switch 250V 16A 1CO connection male faston 6.3mm ambient temperature max. 85°C black lever length 20.5mm		
<b>For models:</b>	431002, 433003, 433004, 433005, 481004, 512010, 512011, 512012, 512013, 512014, 512015, 512016, 512017, 512018, 512019, 512020, 512021, 512022, 513008, 513009, 513010, 516004		

## heavy duty version

			
1			
<b>GEV No.</b>	345485	<b>Ref. No.</b>	8300990
<b>description</b>	microswitch with handle with a switch 250V 20A 1CO connection screw L 50mm L1 49mm ambient temperature max. 85°C mounting distance 22mm type Z15G1703 actuating force: 75g lever length 47mm		
<b>For models:</b>	512001, 512002, 512003, 512004		

## non-standard

			
1			
<b>GEV No.</b>	347026	<b>Ref. No.</b>	096355
<b>description</b>	microswitch with handle with a switch 250V 5A 1CO connection soldering connection L 12.5mm L1 20mm ambient temperature max. 85°C mounting distance 10mm actuating force: 55g lever length 16.6mm		
<b>For models:</b>	743001		



pin-plunger actuated



1

<b>GEV No.</b>	345326	<b>Ref. No.</b>	1037312900 MA1037312900
<b>description</b>	microswitch with plunger 250V 16A 1NO connection male faston 6.3mm ambient temperature max. 85°C mounting distance 22mm type XP52Z11 actuating force: 350g red stroke 15mm		
<b>For models:</b>	124101, 124102		



1

<b>GEV No.</b>	300092	<b>Ref. No.</b>	097796
<b>description</b>	microswitch with plunger 400V 16A 2NO connection male faston 6.3mm ambient temperature max. 85°C mounting distance 22mm type XTD22A21 actuating force: 150g fryer black		
<b>For models:</b>	743001		



1

<b>GEV No.</b>	345759	<b>Ref. No.</b>	WY28165001
<b>description</b>	microswitch 250V 16A 1CO connection male faston 6.3mm ambient temperature max. 125°C mounting distance 22mm type B actuating force: 280g black		
<b>For models:</b>	744001, 744002		



1

<b>GEV No.</b>	345042	<b>Ref. No.</b>	IB5820800
<b>description</b>	microswitch with plunger 250V 16A 1CO connection male faston 6.3mm L 28mm ambient temperature max. 125°C mounting distance 22mm type EF83161.3 actuating force: 75g blue/black		
<b>For models:</b>	721003		
<b>accessories for</b>	345042		
	<b>GEV No.</b>	345043	<b>Ref. No.</b> —
	lever set 5-piece		



1

<b>GEV No.</b>	347043	<b>Ref. No.</b>	QSW-MA086WRE0 QSW-MA111WRE0
<b>description</b>	microswitch with plunger 250V 16A 1NC connection male faston 4.8mm ambient temperature max. 105°C mounting distance 22mm type V-16G-2C25 actuating force: 140g black		
<b>For models:</b>	213001, 213002, 213003		

M10



1

<b>GEV No.</b>	347603	<b>Ref. No.</b>	01200890
<b>description</b>	microswitch with plunger thread M10x0.75 thread L 10mm 250V 16A 1CO connection male faston 6.3mm stroke 5mm mounting distance 22mm L 29mm ambient temperature max. 125°C type VRSR01DZ2 actuating force: 170g		
<b>For models:</b>	211039, 211042, 211043, 211044, 211045, 211046		



1

<b>GEV No.</b>	347945 <sup>1</sup>	<b>Ref. No.</b>	VE086B
<b>description</b>	microswitch with plunger thread M10x0.75 thread L 13mm 250V 5A 1CO connection male faston 6.3mm stroke 6mm mounting distance 25mm L 49mm L1 13mm ambient temperature max. 85°C IP65 type MKH12D09 actuating force: 340g		
<b>For models:</b>	211003		

<sup>1</sup>protection class IP65



1

<b>GEV No.</b>	345678	<b>Ref. No.</b>	19410201
<b>description</b>	microswitch with plunger thread M10x0.75 thread L 16mm 250V 16A 1NO connection male faston 6.3mm stroke 2.5mm mounting distance 22mm ambient temperature max. 125°C actuating force: 290g		
<b>For models:</b>	411001		
<b>accessories for</b>	345678		
	<b>GEV No.</b>	100779	<b>Ref. No.</b> —
	nut thread M10x0.75 H 3mm WS 14 SS Qty 2 pcs		





1

<b>GEV No.</b>	345032	<b>Ref. No.</b>	401520000 6A039800 BN6A039800 MSC04N276 R65260540
<b>description</b>	microswitch with plunger thread M10x1 thread L 12mm 250V 16A 1CO connection male faston 6.3mm stroke 7mm mounting distance 22mm L 28mm ambient temperature max. 125°C type SP9603 actuating force: 180g		
<b>For models:</b>	114001, 114002, 134001, 134003, 134005, 134201, 134203, 134205, 137001, 137002, 137201, 137202, 144008, 144009, 144010, 144012, 212001, 212002, 212003, 212004, 212005, 212006, 212007, 212008, 212009, 212010, 212011, 212012, 212013, 212017, 212018, 212019, 212020, 244001, 244002, 244003, 244004, 244005, 244006, 244007, 244008, 244009, 244021, 471001		





			
<b>GEV No.</b>	345156	<b>Ref. No.</b>	VE1295A0
<b>description</b>	microswitch with plunger thread M10x1 thread L 13mm 250V 16A 1CO connection male faston 6.3mm stroke 6mm mounting distance 25mm L 46mm L1 13mm ambient temperature max. 85°C type C4A-ZN3 actuating force: 340g		

<b>M12</b>			
			
<b>GEV No.</b>	345138	<b>Ref. No.</b>	SL1401
<b>description</b>	microswitch with plunger mounting distance 25mm thread M12x1 thread L 12mm 250V 20A 1CO connection screw stroke 7mm L1 13mm ambient temperature max. 85°C type Z15G1307 actuating force: 250g		
<b>For models:</b>	512014, 512015, 512016, 512017, 512018, 512019, 512020, 512021, 512022		

<b>with push button</b>			
<b>switches with snap-fit</b>			
			
<b>GEV No.</b>	347027	<b>Ref. No.</b>	OV2378
<b>description</b>	microswitch with push button 250V 1A 1CO connection male faston 2.8mm L 26x12mm ambient temperature max. 85°C type XKA-304B1AAJ11 actuating force: 50g		
<b>For models:</b>	743001		

			
<b>GEV No.</b>	347018	<b>Ref. No.</b>	6060995
<b>description</b>	microswitch with push button 250V 1A 1CO connection male faston 2.8mm L 28x12mm ambient temperature max. 85°C actuating force: 60g		
<b>For models:</b>	621015, 622019		

			
<b>GEV No.</b>	347057	<b>Ref. No.</b>	164608 BN164608
<b>description</b>	microswitch with push button 250V 2.5A 1CO connection male faston 4.8mm L 27x21mm ambient temperature max. 85°C type built-in version actuating force: 300g		
<b>For models:</b>	201780, 621007, 621020, 621021, 622005, 622020, 622021		

			
<b>GEV No.</b>	348008	<b>Ref. No.</b>	78010438
<b>description</b>	microswitch with push button 250V 2.5A 1NO/1NC connection male faston 2.8mm/6.3mm L 27mm L1 22mm ambient temperature max. 104°C actuating force: 180g		
<b>For models:</b>	621038, 621039, 622031		

			
<b>GEV No.</b>	346772	<b>Ref. No.</b>	GN650TN.48 R25-0086
<b>description</b>	microswitch with push button 250V 5A 1CO connection male faston 4.8mm L 24x27mm ambient temperature max. 85°C actuating force: 160g		
<b>For models:</b>	621004, 621005, 621018, 621019, 622004		

<b>roller actuated</b>			
<b>roller 0°</b>			
			
<b>GEV No.</b>	345639	<b>Ref. No.</b>	5400100
<b>description</b>	microswitch with roller plunger 230V 16A 1CO connection solder/screw connection L1 49mm ambient temperature max. 125°C thread L 14mm thread M10 mounting distance 25mm actuating force: 300g type MS15-1		

<b>accessories</b>			
			
<b>GEV No.</b>	698204	<b>Ref. No.</b>	MSC04N264
<b>description</b>	bracket for microswitch C4-C6		
<b>For models:</b>	471001		



			
<b>GEV No.</b>	347031	<b>Ref. No.</b>	090681
<b>description</b>	insulating mat for microswitch L 42mm W 28mm		
<b>For models:</b>	743001		







			
1			
<b>GEV No.</b>	347061	<b>Ref. No.</b>	MSC04N274
<b>description</b>	spacer ring for microswitch ID ø 10mm ED ø 14mm thickness 4mm		
<b>For models:</b>	471001		

system switches (ROLD)



			
1			
<b>GEV No.</b>	345577	<b>Ref. No.</b>	226122
<b>description</b>	element holder mounting measurements 19.3x12.9mm black arched for push buttons 11x15.8		
<b>For models:</b>	811001, 811002, 811003, 812001, 812002, 812003, 812004, 812005, 812006, 812007, 812008, 812009, 812010, 813001, 915234, 915235, 915236, 915237, 915460, 915461, 915462, 915463, 915464, 915465		
<b>accessories for</b>	345577		
		<b>GEV No.</b>	345578
		<b>Ref. No.</b>	227078
	push button mounting measurements 11x15.8mm orange		

			
1			
<b>GEV No.</b>	345627	<b>Ref. No.</b>	VE1170A0
<b>description</b>	element holder mounting measurements 20.6x16.4mm black arched for push buttons 13x17mm		
<b>For models:</b>	211002, 211003		

			
1			
<b>GEV No.</b>	345131	<b>Ref. No.</b>	190140
<b>description</b>	element holder mounting measurements 28.5x28.5mm grey single element holder		
<b>For models:</b>	SP1, SP2-12, SP2-S12		

			
1			
<b>GEV No.</b>	345601	<b>Ref. No.</b>	VE162
<b>description</b>	indicator lamp holder V ø 11mm		
<b>For models:</b>	211002, 211003		

			
1			
<b>GEV No.</b>	357012	<b>Ref. No.</b>	KVE007
<b>description</b>	indicator lamps set mounting measurements 20.6x16.4mm green 230V connection male faston 6.3mm ø 20.6x16.4mm socket male faston 6.3mm		

			
1			
<b>GEV No.</b>	360598	<b>Ref. No.</b>	VE177
<b>description</b>	indicator light LED white connection male faston 6.3mm 250V ø 11mm voltage AC		
<b>For models:</b>	211002, 211003		
<b>accessories for</b>	360598		
		<b>GEV No.</b>	345601
		<b>Ref. No.</b>	VE162
	indicator lamp holder V ø 11mm		

			
1			
<b>GEV No.</b>	347746	<b>Ref. No.</b>	VE164
<b>description</b>	indicator light lens size 17x13mm green thermometer gold		
<b>For models:</b>	211002, 211003		

			
1			
<b>GEV No.</b>	347193	<b>Ref. No.</b>	130449
<b>description</b>	momentary switch unit 1NO 250V 16A connection male faston 6.3mm		
<b>For models:</b>	SP1, SP2-12, SP2-S12		

			
1			
<b>GEV No.</b>	345606	<b>Ref. No.</b>	226071
<b>description</b>	momentary switch unit 2CO 250V 16A connection male faston 6.3mm		
<b>For models:</b>	811001, 811002, 811003, 812002, 812004, 812007, 812008, 812009, 812010, 915234, 915235, 915236, 915237, 915460, 915461, 915462, 915463, 915464, 915465		



1

<b>GEV No.</b>	345578	<b>Ref. No.</b>	227078
<b>description</b>	push button mounting measurements 11x15.8mm orange		
<b>For models:</b>	811001, 811002, 811003, 812001, 812002, 812003, 812004, 812005, 812006, 812007, 812008, 812009, 812010, 813001, 915234, 915235, 915236, 915237, 915460, 915461, 915462, 915463, 915464, 915465		
<b>accessories for</b>	345578		
	<b>GEV No.</b>	345577	<b>Ref. No.</b> 226122
	element holder mounting measurements 19.3x12.9mm black arched for push buttons 11x15.8		



1

<b>GEV No.</b>	347475	<b>Ref. No.</b>	450357
<b>description</b>	push button ø 23mm white main switch		
<b>For models:</b>	SP1, SP2-12, SP2-S12		



1

<b>GEV No.</b>	347929	<b>Ref. No.</b>	450358
<b>description</b>	push button ø 23mm white programme		
<b>For models:</b>	SP2-12, SP2-S12		



1

<b>GEV No.</b>	346035	<b>Ref. No.</b>	227062
<b>description</b>	push button size 17x13mm silver		
<b>For models:</b>	811001, 811002		



1

<b>GEV No.</b>	345605	<b>Ref. No.</b>	208010
<b>description</b>	switch 2CO 250V 16A connection male faston 6.3mm		
<b>For models:</b>	811001, 811002, 811003, 812001, 812002, 812003, 812004, 812005, 812006, 812007, 812008, 812009, 812010, 915234, 915235, 915236, 915237, 915460, 915461, 915462, 915463, 915464, 915465		



1

<b>GEV No.</b>	346851	<b>Ref. No.</b>	80804
<b>description</b>	switch 2CO 250V 16A connection male faston 6.3mm		
<b>For models:</b>	813001		



1

<b>GEV No.</b>	347098	<b>Ref. No.</b>	130487
<b>description</b>	switch 2CO 250V 16A connection male faston 6.3mm		
<b>For models:</b>	SP1, SP2-12, SP2-S12		

## float switches



1

<b>GEV No.</b>	348087	<b>Ref. No.</b>	0220114
<b>description</b>	float switch length external size 110mm thread 1/8" 1NC/Temp ø 30mm L 110mm mounting ø 10mm 300V 0.5A cable, 4-wire cable length 1600mm with temperature probe		



1

<b>GEV No.</b>	401986	<b>Ref. No.</b>	6A021950
<b>description</b>	float switch thread 1/8" 1NO ø 28mm L 116mm mounting ø 10mm 220V 0.5A cable cable length 330mm		



1

<b>GEV No.</b>	402061	<b>Ref. No.</b>	X02.01.249.00
<b>description</b>	float switch thread 9.7 1NO ø 26mm L 130mm mounting ø 10mm 230V 0.5A cable cable length 500mm		
<b>For models:</b>	541003		

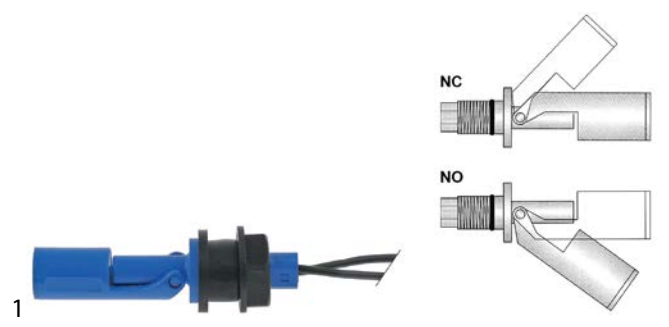



<b>GEV No.</b>	347020	<b>Ref. No.</b>	877121600
<b>description</b>	float switch thread M16x2 1NO or 1NC ø 16mm L 88.5mm mounting ø 16mm 250V 1A cable cable length 800mm		
<b>For models:</b>	644006, 644008, 644009		

### floats



<b>GEV No.</b>	527288	<b>Ref. No.</b>	251851
<b>description</b>	float for drip pan		
<b>For models:</b>	743001		



<b>GEV No.</b>	527287	<b>Ref. No.</b>	251876
<b>description</b>	float with magnet ømm L 23.5mm W 16mm H 17mm plastic		
<b>For models:</b>	743001		

### key lock switches



<b>GEV No.</b>	346029	<b>Ref. No.</b>	Anfrage l?uft
<b>description</b>	key lock switch 2NO 240V 3A mounting ø 22.5mm connection screw		



<b>GEV No.</b>	346062	<b>Ref. No.</b>	WY22715820
<b>description</b>	key lock switch set		

### cam switches

#### on/off



<b>GEV No.</b>	300021	<b>Ref. No.</b>	1230100 6A046700 826630290 MA1230100
<b>description</b>	cam switch 4 operating positions 4NO sequence 0-1-0-1 16A shaft ø 6x4.6mm shaft L 23mm connection screw ceramic		
<b>For models:</b>	124105, 137001, 137003, 137004, 137201, 144001, 145002		

#### 4-position



<b>GEV No.</b>	300022	<b>Ref. No.</b>	X02.19.174.00
<b>description</b>	cam switch 4 operating positions 2CO sequence 0-1-2-3 16A shaft ø 6x4.6mm shaft L 23mm connection screw		
<b>For models:</b>	222004, 222005		

#### 7-position

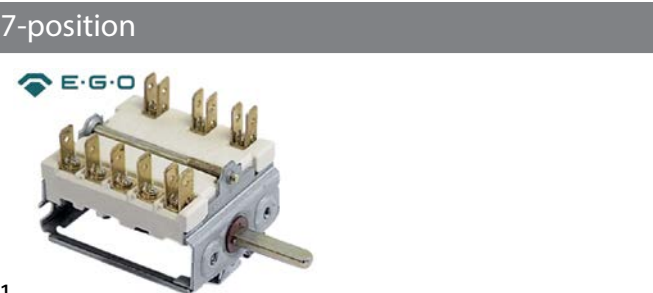



<b>GEV No.</b>	300004	<b>Ref. No.</b>	PT0178
<b>description</b>	cam switch 7 operating positions 1NO/2CO sequence 0-1-2-3-4-5-6 16A shaft ø 6x4.6mm shaft L 23mm connection male faston 6.3mm 7-position ceramic		





			
			
1			
<b>GEV No.</b>	300025	<b>Ref. No.</b>	1616100 6A045500 826630070 MA1616100 PT0177
<b>description</b>	cam switch 7 operating positions 1NO/2CO sequence 0-1-2-3-4-5-6 16A shaft $\varnothing$ 6x4.6mm shaft L 23mm connection screw 7-position ceramic		
<b>For models:</b>	121004, 121104, 122103, 122104, 131007, 131008, 131009, 132003, 132004		
<b>accessories for</b>	300025		
	<b>GEV No.</b>	112172	<b>Ref. No.</b> —
	knob universal $\varnothing$ 70mm black without adaptor/dial plate		
	<b>GEV No.</b>	112213	<b>Ref. No.</b> —
	knob dial plate silver switch 7-position t.max.°C ED $\varnothing$ 63mm ID $\varnothing$ 45.5mm		
	<b>GEV No.</b>	112311	<b>Ref. No.</b> —
	knob adapter shaft $\varnothing$ 6x4.6mm L 0mm with spring		

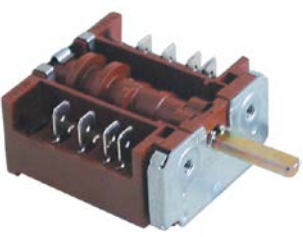

## 2 operating positions

			
			
1			
<b>GEV No.</b>	300112	<b>Ref. No.</b>	CR-B105 KO-B102 KOB102 WFB103
<b>description</b>	cam switch 1NO sequence 0-1 10A shaft $\varnothing$ 6x4.6mm shaft L 23mm connection screw ON-OFF		
<b>For models:</b>	223007, 223008, 225009, 255009, 255012, 255013, 255014		

			
1			
<b>GEV No.</b>	301715	<b>Ref. No.</b>	401505000
<b>description</b>	cam switch 2 operating positions sequence 0-1 16A shaft $\varnothing$ 6x4.6mm shaft L 23mm connection male faston 6.3mm plastic		
<b>For models:</b>	222002, 222003		

## 4 operating positions

			
			
1			
<b>GEV No.</b>	300081	<b>Ref. No.</b>	MA1309000
<b>description</b>	cam switch 4 operating positions 3NO/2CO sequence 0-1-2-3 16A shaft $\varnothing$ 6x4.6mm shaft L 23mm connection screw		
<b>For models:</b>	121101, 121104, 121106, 122110, 141005, 141007, 141013, 141016, 141021		

			
			
1			
<b>GEV No.</b>	300229	<b>Ref. No.</b>	COM30001
<b>description</b>	cam switch 4 operating positions 4NO sequence 0-1-0-2 16A shaft $\varnothing$ 6x4.6mm shaft L 23mm connection male faston 6.3mm plastic		
<b>For models:</b>	211005, 211006, 211014, 211015, 211016, 212015, 212016		

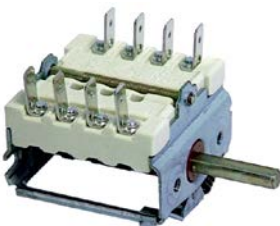
			
1			
<b>GEV No.</b>	300184	<b>Ref. No.</b>	6A046750
<b>description</b>	cam switch 4 operating positions sequence 0-3-2-1 shaft $\varnothing$ 6x4.6mm connection male faston 4-pole		
<b>For models:</b>	131004, 131006, 131007, 131008, 131009, 131201, 131202, 131203, 131204, 131205, 131206, 131207, 131208, 131209, 131210, 132003, 132004, 132201, 132202, 132203, 132204		

			
1			
<b>GEV No.</b>	300239	<b>Ref. No.</b>	CR0581810
<b>description</b>	operation switch 4 operating positions 4NO sequence 0-1-2-3 16A shaft $\varnothing$ 6x4.6mm shaft L 23mm connection male faston 6.3mm plastic		
<b>For models:</b>	146002, 146006		

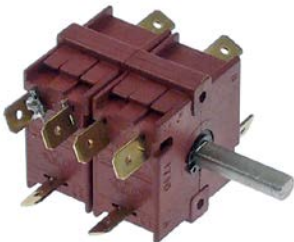
1

<b>GEV No.</b>	347778	<b>Ref. No.</b>	3000001
<b>description</b>	rotary switch 4 operating positions sequence 0-1-2-3 13A shaft $\varnothing$ 6x4.6mm shaft L 23mm connection male faston 6.3mm 250V plastic open A+1, B+3 A+1, B+4 A+2, B+4 shaft round ambient temperature max. 150°C		
<b>For models:</b>	221011, 221012, 221019, 221020		

### 5 operating positions

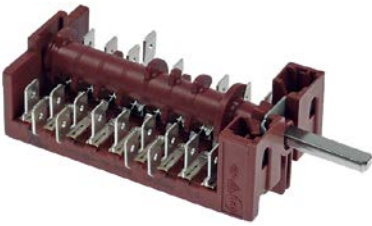

1

<b>GEV No.</b>	347191	<b>Ref. No.</b>	R65080020
<b>description</b>	cam switch 5 operating positions 9NO sequence 1-0-2-3-4 16A shaft $\varnothing$ 6x4.6mm shaft L 23mm connection male faston 6.3mm plastic		
<b>For models:</b>	212002, 212003, 212004, 212006, 212008, 212017, 212019		

### 6 operating positions

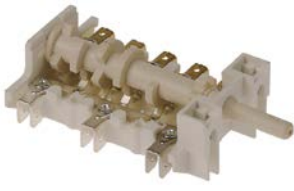

1

<b>GEV No.</b>	301714	<b>Ref. No.</b>	401505100
<b>description</b>	cam switch 6 operating positions 3-pole		
<b>For models:</b>	111001, 112001, 112002		

### with potentiometer

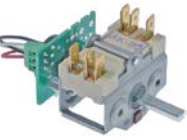

1

<b>GEV No.</b>	300249	<b>Ref. No.</b>	100133
<b>description</b>	cam switch 2 operating positions 2NO sequence 0-1 16A shaft $\varnothing$ 6x4.6mm shaft L 23mm connection screw 10K/J cable lengthmm 10kOhm ceramic		
<b>For models:</b>	131216, 131217, 131218, 246009, 246010, 246011, 246012, 246013, 246014		



1

<b>GEV No.</b>	300199	<b>Ref. No.</b>	100108
<b>description</b>	operation switch 0-1 16A shaft $\varnothing$ 6x4.6mm shaft L 23mm connection male faston 6.3mm 10K/J 2-pole with potentiometer		
<b>For models:</b>	131216, 131217, 131218, 246009, 246010, 246011, 246012, 246013, 246014		



1

<b>GEV No.</b>	300252	<b>Ref. No.</b>	CR0737320
<b>description</b>	potentiometer 2 operating positions 2NO sequence 0-1 16A shaft $\varnothing$ 6x4.6mm shaft L 23mm connection coded plug cable length 1420mm 10kOhm 12V with cable and indicator light		
<b>For models:</b>	141017, 141018, 141019		

### operation switches



1

<b>GEV No.</b>	300002	<b>Ref. No.</b>	6A046001 826630150 BN6A046001
<b>description</b>	cam switch 2 operating positions 4NO 16A sequence 0-1 shaft $\varnothing$ 6x4.6mm shaft L 23mm connection male faston 6.3mm ceramic		
<b>For models:</b>	133004, 133005, 133006, 133016, 133017, 133018, 133019, 133020, 133021, 141005, 141007, 141013, 141016, 141021, 144010		



1

<b>GEV No.</b>	300080	<b>Ref. No.</b>	710300 MA710300
<b>description</b>	cam switch 2 operating positions 4NO 16A sequence 0-1 shaft $\varnothing$ 6x4.6mm shaft L 23mm connection screw operation switch ceramic ambient temperature max. 150°C		
<b>For models:</b>	123110, 123111, 123112, 123113, 123114, 123115, 123118, 123119, 123120, 127102, 127103		
<b>accessories for</b>	300080		
	<b>GEV No.</b>	<b>Ref. No.</b>	—
	gasket for switch ED $\varnothing$ 14mm ID $\varnothing$ 2.5mm thickness 3.5mm white		

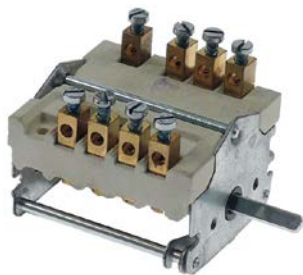

1

<b>GEV No.</b>	300180	<b>Ref. No.</b>	CR0686110
<b>description</b>	cam switch 2 operating positions operation switch 32A sequence 0-1 shaft $\varnothing$ 6x4.6mm shaft L 23mm connection screw ceramic		
<b>For models:</b>	143017, 143018, 143019, 143020, 143027, 143028, 143029, 143030, 143031, 143032		



1

<b>GEV No.</b>	301095	<b>Ref. No.</b>	PD2455
<b>description</b>	cam switch 4 operating positions operation switch sequence 0-1-2-3 shaft $\varnothing$ 6x4.6mm connection male faston 3-pole ambient temperature max. 270°C		
<b>For models:</b>	221005		



1

<b>GEV No.</b>	300200	<b>Ref. No.</b>	6A046000 MA1037313200
<b>description</b>	operation switch 2 operating positions 2NO 16A sequence 0-1 shaft $\varnothing$ 6x4.6mm shaft L 23mm connection male faston 6.3mm operation switch ceramic		
<b>For models:</b>	124105, 125101, 125102, 125103, 141020, 144001, 144008, 144009, 144012		



1

<b>GEV No.</b>	300091	<b>Ref. No.</b>	401506000
<b>description</b>	operation switch EGO 2 operating positions 2NO 16A sequence 0-1 shaft $\varnothing$ 6x4.6mm shaft L 23mm connection screw ceramic		
<b>For models:</b>	111001, 111002, 111003		

## rotary switches

### BREMAS

#### A1600 series



1

<b>GEV No.</b>	347097	<b>Ref. No.</b>	120751
<b>description</b>	rotary switch 5 0-1-2-3-4 sets of contacts 4 type CS0169615V 400V 16A shaft $\varnothing$ 5x5mm shaft L 25mm shaft square connection screw		
<b>For models:</b>	SP3		

#### A1700 series



1

<b>GEV No.</b>	346100	<b>Ref. No.</b>	WY18104
<b>description</b>	rotary switch 3 1-0-2 sets of contacts 8 type CS0177412 400V 20A shaft $\varnothing$ 5x5mm shaft L 21mm shaft square connection screw		
<b>For models:</b>	742001, 742002, 742003, 742004, 742017, 742018, 742019, 742020		

#### A2500 series



1

<b>GEV No.</b>	346101	<b>Ref. No.</b>	WY18103
<b>description</b>	rotary switch 3 1-0-2 sets of contacts 8 type CS0257412 600V 32A shaft $\varnothing$ 5x5mm shaft L 21mm shaft square connection screw		
<b>For models:</b>	742001, 742002, 742003, 742004		

#### CA040V series



1

<b>GEV No.</b>	348052 <sup>1</sup>	<b>Ref. No.</b>	WY18105
<b>description</b>	rotary switch sets of contacts 8 3 1-0-2 type CA0407412V 600V 40A shaft $\varnothing$ 5x5mm shaft L 21mm shaft square incl. rubber protection and knob connection screw		
<b>For models:</b>	742001, 742002, 742003, 742004, 742017, 742018, 742019, 742020		

<sup>1</sup>incl. rubber protection and knob



accessories



1			
<b>GEV No.</b>	527259	<b>Ref. No.</b>	WY15271
<b>description</b>	knob push-in ø 34/60mm shaft ø 5x5mm black H 21.4mm L 49mm		
<b>For models:</b>	742001, 742002, 742003, 742004, 742017, 742018, 742019, 742020		

GIOVENZANA

rotary switches



1			
<b>GEV No.</b>	347634	<b>Ref. No.</b>	5320080
<b>description</b>	rotary switch 2 0-1 sets of contacts 4 type A87AZ69004 690V 20A shaft ø 8x8mm shaft L 15mm shaft star-shaped connection screw		
<b>spare parts for</b>	347634		
	<b>GEV No.</b>	347651	<b>Ref. No.</b>
			—
	knob with bezel dimensions 48x48mm display 0-1 ømm shaftmm shaft diametermm for rotary switch		

KRAUS & NAIMER

rotary switches



1			
<b>GEV No.</b>	345431	<b>Ref. No.</b>	8301310
<b>description</b>	rotary switch 2 0-1 sets of contacts 4 type 9A003PL-2V 400V 2A shaft ø 6mm shaft L 17mm shaft star-shaped connection screw		
<b>For models:</b>	512002, 512003, 512004		

LEGRAND



1			
<b>GEV No.</b>	347597	<b>Ref. No.</b>	101005
<b>description</b>			
<b>For models:</b>	531028, 531029, 531030, 531031		

MOELLER/EATON



1			
<b>GEV No.</b>	346588	<b>Ref. No.</b>	SL2743
<b>description</b>	rotary switch 2 1-2 sets of contacts 8 type T0-4-969/E 400V 16A shaft ø 5.8x6.9mm shaft L 26.8mm shaft star-shaped connection screw		
<b>For models:</b>	512010, 512011, 512012, 512013, 512014, 512015, 512016, 512017, 512018, 512019, 512020, 512021, 512022		

TECNOMATIC



1			
<b>GEV No.</b>	348152	<b>Ref. No.</b>	MF2365
<b>description</b>	rotary switch 1-0-2 momentary 3 type HD1237R922 600V 12A shaft ø 5x5mm shaft L 22mm		
<b>For models:</b>	421001		



1			
<b>GEV No.</b>	346239	<b>Ref. No.</b>	MF2365 (old version)
<b>description</b>	rotary switch 3 1-0-2 momentary sets of contacts 5 type HD1237R921-L5 600V 12A shaft ø 6mm shaft L 22mm shaft round connection male faston 6.3mm		



1			
<b>GEV No.</b>	346238	<b>Ref. No.</b>	MF2364
<b>description</b>	rotary switch 3 1-0-2 momentary sets of contacts 6 type HD1249R922 600V 12A shaft ø 5x5mm shaft L 23mm shaft square connection screw		
<b>For models:</b>	421001		

producer-specific rotary switches

DIHR / KROMO



1			
<b>GEV No.</b>	345896	<b>Ref. No.</b>	0065736 0065788
<b>description</b>	O-ring EPDM thickness 1.5mm ID ø 37mm Qty 1 pcs		



## miscellaneous



<b>GEV No.</b>	347734	<b>Ref. No.</b>	PF7070E-21A PI-B101 PIB101
<b>description</b>	rotary switch sets of contacts 2 2 0-1 type CA20A201 690V 25A shaft ø 5.8mm shaft L 27mm shaft star-shaped complete connection screw		
<b>For models:</b>	531034, 531039, 531040, 531046		



<b>GEV No.</b>	347040	<b>Ref. No.</b>	0220060
<b>description</b>	rotary switch sets of contacts 3 2 0-1 momentary type 400V 32A shaft ø 5x5mm shaft Lmm connection screw		
<b>For models:</b>	442006, 442008		

## accessories

## levers



<b>GEV No.</b>	347041	<b>Ref. No.</b>	0220065
<b>description</b>	knob 2 0-1 typeVA shaft ømm shaft Lmm connection for rotary switch		
<b>For models:</b>	442006, 442008		

## symbol labels

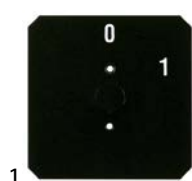

<b>GEV No.</b>	345793	<b>Ref. No.</b>	WY29068
<b>description</b>	symbol label 0 up to 1 L 58.5mm W 58.5mm bore ø 10mm mounting distance 20mm		
<b>For models:</b>	742001, 742002, 742003, 742004		

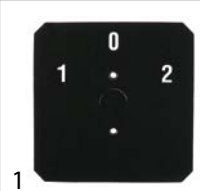

<b>GEV No.</b>	345794	<b>Ref. No.</b>	WY29067
<b>description</b>	symbol label 1-0-2 L 58.5mm W 58.5mm bore ø 10mm mounting distance 20mm		
<b>For models:</b>	742001, 742002, 742003, 742004, 742017, 742018, 742019, 742020		

## foot switches

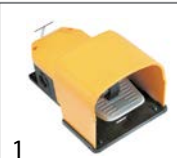

<b>GEV No.</b>	347735	<b>Ref. No.</b>	510002
<b>description</b>	foot switch		



<b>GEV No.</b>	346841	<b>Ref. No.</b>	510001
<b>description</b>	foot switch 1CO		

## touch sensitive light switches



<b>GEV No.</b>	346388	<b>Ref. No.</b>	R65260750
<b>description</b>	touch sensitive light switch 1NOVA for combi-steamer L 47mm W 20mm H 30mm		
<b>For models:</b>	212002, 212003, 212010, 212011, 212012, 212013		

## magnetic switches

## 23x14mm

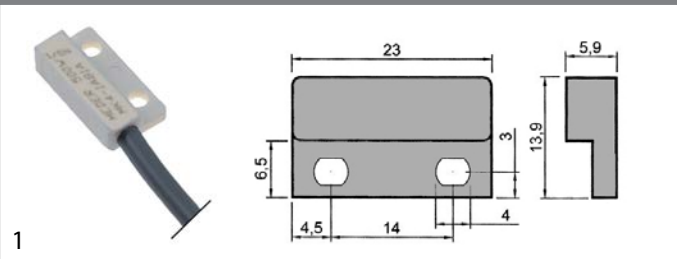

<b>GEV No.</b>	346106	<b>Ref. No.</b>	WY18255000
<b>description</b>	magnetic switch L 23mm W 13.9mm 1NO 90V 0.5A P max. 10W cable length 500mm mounting distance 14mm		
<b>For models:</b>	742005		





29x19mm

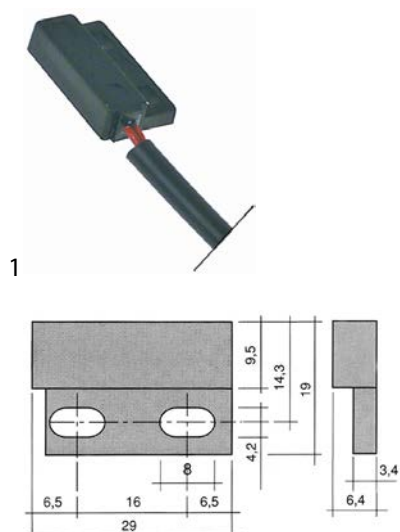

<b>GEV No.</b>	347030 <sup>1</sup>	<b>Ref. No.</b>	251860
<b>description</b>	magnetic switch L 29mm W 19mm 1NO 250V cable length 360mm		
<b>For models:</b>	743001		

<sup>1</sup>with coded connector

36x13mm

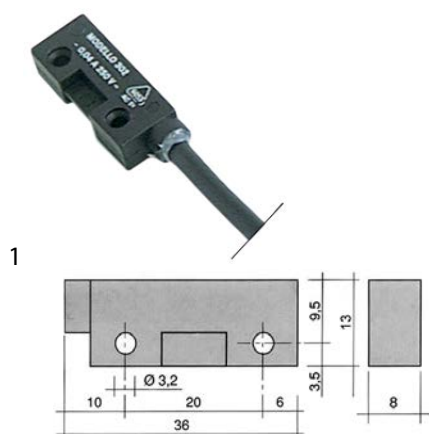

<b>GEV No.</b>	345335	<b>Ref. No.</b>	995405 IV5820000 MF2362
<b>description</b>	magnetic switch L 36mm W 13mm 1NO 250V 0.04A P max. 10W connection cable cable length 960mm		
<b>For models:</b>	433001, 433002, 481001, 671004, 671005, 671007, 671008		
<b>accessories for</b>	345335		
	<b>GEV No.</b>	519049	<b>Ref. No.</b> —
	magnet ømm L 63mm H 10.7mm W 18.8mm hole distance 52mm M2 hole ø 2mm		

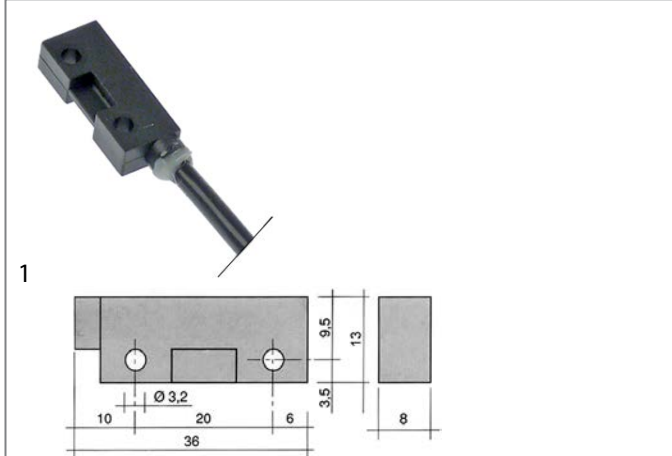

<b>GEV No.</b>	345118 <sup>1</sup>	<b>Ref. No.</b>	211002
<b>description</b>	magnetic switch L 36mm W 13mm 1NO 250V 1A P max. 50W connection cable cable length 980mm		
<b>For models:</b>	811001, 811002, 811003, 812001, 812002, 812003, 812004, 812005, 812006, 812007, 812008, 812009, 812010, 813001, 915234, 915235, 915236, 915237, 915460, 915461, 915462, 915463, 915464, 915465		
<b>accessories for</b>	345118		
	<b>GEV No.</b>	345399	<b>Ref. No.</b> 927088
	magnet ø 3.3mm L 40mm H 8mm W 13mm hole distance 30mm M3		

<sup>1</sup>with coded connector

40x13mm

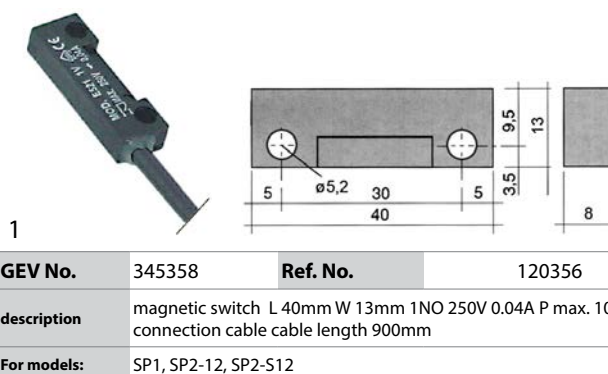

<b>GEV No.</b>	345358	<b>Ref. No.</b>	120356
<b>description</b>	magnetic switch L 40mm W 13mm 1NO 250V 0.04A P max. 10W connection cable cable length 900mm		
<b>For models:</b>	SP1, SP2-12, SP2-S12		

	<b>GEV No.</b>	300273	<b>Ref. No.</b> LF1010005
	<b>description</b>	magnetic switch L 40mm W 13mm 1NO 250V 1A P max. 50W connection cable cable length 1180mm	
	<b>For models:</b>	431001	



65x20mm



1

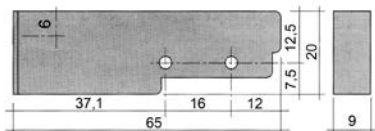

<b>GEV No.</b>	345116	<b>Ref. No.</b>	120348
<b>description</b>	magnetic switch L 65mm W 20mm 1NO 250V 0.4A P max. 100W connection cable cable length 3000mm		
<b>For models:</b>	SP3		
<b>accessories for</b>	345116		
	<b>GEV No.</b>	345399	<b>Ref. No.</b> 927088
	magnet $\varnothing$ 3.3mm L 40mm H 8mm W 13mm hole distance 30mm M3		

 $\varnothing$  4mm

1

<b>GEV No.</b>	347049	<b>Ref. No.</b>	I3647
<b>description</b>	magnetic switch 24V 0.5A P max. 12W probe L 20mm 1NO		
<b>For models:</b>	411018		

 $\varnothing$  6mm

1

<b>GEV No.</b>	347044 <sup>1</sup>	<b>Ref. No.</b>	95.16.26
<b>description</b>	magnetic switch 200V 0.1A P max. 10W probe L 26mm 1NO connection coded plug cable length 490mm		
<b>For models:</b>	745002		

<sup>1</sup>with coded connector

1

<b>GEV No.</b>	345967	<b>Ref. No.</b>	RG04094
<b>description</b>	magnetic switch 250V 1A P max. 50W probe L 29mm 1NO connection cable cable length 3000mm		
<b>For models:</b>	451001		



1

<b>GEV No.</b>	347461	<b>Ref. No.</b>	01-240288-001
<b>description</b>	magnetic switch 28V 0.5A P max. 15W probe L 26mm 1NO connection coded plug cable length 280mm		
<b>For models:</b>	811011, 811012, 811013, 811014, 811015, 812011, 812012, 812013, 812014, 812015, 813002, 813003, 813004		
<b>accessories for</b>	347461		
	<b>GEV No.</b>	524661	<b>Ref. No.</b> 00-883838-001
	bracket for magnetic switch L 34.5mm W 26mm H 9mm		

M8x0.75



1

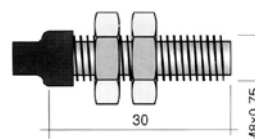

<b>GEV No.</b>	345631	<b>Ref. No.</b>	RG04224
<b>description</b>	magnetic switch thread M8x0.75 1NO 250V 1A P max. 50W connection cable cable length 2000mm		
<b>For models:</b>	451001		

M10x0.75



1

<b>GEV No.</b>	348182	<b>Ref. No.</b>	00005771 00010510
<b>description</b>	magnetic switch thread M10x0.75 1NO 250V 0.04A cable length 570mm L 40mm		
<b>For models:</b>	212034, 212035, 212036, 212037, 212038, 212039, 212040, 212041		

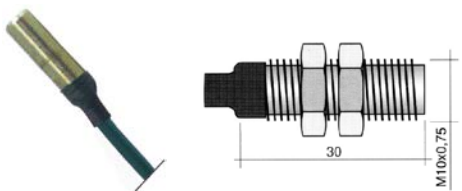
1

<b>GEV No.</b>	345632	<b>Ref. No.</b>	32W3240 IV5820510
<b>description</b>	magnetic switch thread M10x0.75 1NO 250V 0.5A P max. 50W connection cable cable length 2000mm type 102		
<b>For models:</b>	421003, 451003, 451004, 471003, 471004, 481004		
<b>accessories for</b>	345632		
	<b>GEV No.</b>	100779	<b>Ref. No.</b>
			—
	nut thread M10x0.75 H 3mm WS 14 SS Qty 2 pcs		

**miscellaneous**



1

<b>GEV No.</b>	401961	<b>Ref. No.</b>	R66110300
<b>description</b>	magnetic switch door contact		
<b>For models:</b>	212002, 212003		

**accessories**

**magnets**





1

<b>GEV No.</b>	691503	<b>Ref. No.</b>	X05.30.099.00
<b>description</b>	magnet for door		
<b>For models:</b>	541003		



1

<b>GEV No.</b>	510257	<b>Ref. No.</b>	411002
<b>description</b>	magnet L 24mm with hole W 12mm		
<b>For models:</b>	SP3		
<b>accessories for</b>	510257		
	<b>GEV No.</b>	346075	<b>Ref. No.</b>
			190806
	magnet holder		



1

<b>GEV No.</b>	691178	<b>Ref. No.</b>	IB5823050
<b>description</b>	magnet ø 22mm Lmm H 7mm Wmm ED ø 22mm M5		
<b>For models:</b>	451001		

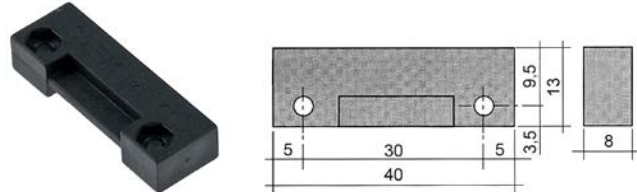

1

<b>GEV No.</b>	345399	<b>Ref. No.</b>	927088
<b>description</b>	magnet ø 3.3mm L 40mm H 8mm W 13mm hole distance 30mm M3		
<b>For models:</b>	813001		

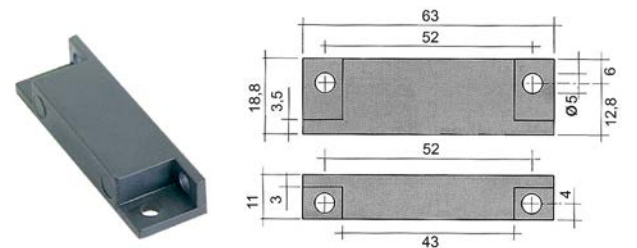

1

<b>GEV No.</b>	345336	<b>Ref. No.</b>	IV5820050
<b>description</b>	magnet ø 4.8mm L 63mm H 11mm W 18.8mm hole distance 51mm M4		
<b>For models:</b>	431001, 481001		



1

<b>GEV No.</b>	346953	<b>Ref. No.</b>	999108
<b>description</b>	magnet ømm L 23mm H 17mm W 18mm M6 hole ø 6.5mm		
<b>For models:</b>	812001, 812002, 812003, 812004, 812005, 812006, 812007, 812008, 812009, 812010, 915234, 915235, 915236, 915237, 915461, 915462, 915464, 915465		



1



<b>GEV No.</b>	691490	<b>Ref. No.</b>	7424266
<b>description</b>	magnet ømm L 29.5mm H 7mm W 28.5mm hole distance 13mm		
<b>For models:</b>	621014, 622009, 622012, 622014		

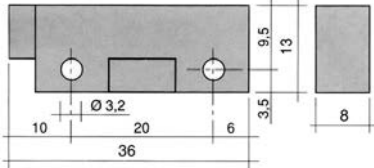

			
1			
<b>GEV No.</b>	347881	<b>Ref. No.</b>	411004
<b>description</b>	magnet ømm L 35mm H 6mm W 11mm		
<b>For models:</b>	SP2-12, SP2-S12		

			
1			
			
<b>GEV No.</b>	345398	<b>Ref. No.</b>	RG04146
<b>description</b>	magnet ømm L 36mm H 8mm W 13mm hole distance 20mm M3 hole ø 3mm		
<b>For models:</b>	451001		

## magnetic holders

			
1			
<b>GEV No.</b>	346075	<b>Ref. No.</b>	190806
<b>description</b>	magnet holder		
<b>For models:</b>	SP3		
<b>accessories for</b>	346075		
	<b>GEV No.</b>	510257	<b>Ref. No.</b>
			411002
	magnet L 24mm with hole W 12mm		

## miscellaneous

			
1			
<b>GEV No.</b>	524661	<b>Ref. No.</b>	00-883838-001
<b>description</b>	bracket for magnetic switch L 34.5mm W 26mm H 9mm		
<b>For models:</b>	811011, 811012, 811013, 811014, 811015, 812011, 812012, 812013, 812014, 812015, 813002, 813003, 813004		

## control equipment

## MOELLER/EATON

## switch blocks

			
1			
<b>GEV No.</b>	346292	<b>Ref. No.</b>	50MAA78015
<b>description</b>	contact block screw 1NO		
<b>For models:</b>	481003		

			
1			
<b>GEV No.</b>	346293	<b>Ref. No.</b>	50MAA78014
<b>description</b>	contact block holder triple		
<b>For models:</b>	481003		

## switches (complete)

## push/momentary push switches

			
1			
<b>GEV No.</b>	346587	<b>Ref. No.</b>	SL0807
<b>description</b>	momentary push switch mounting measurements ø22mm black 1NC OFF momentary		
<b>For models:</b>	512010, 512011, 512012, 512013, 512014, 512015, 512016, 512017, 512018, 512019, 512020, 512021, 512022		

			
1			
<b>GEV No.</b>	347643	<b>Ref. No.</b>	SA1088
<b>description</b>	momentary push switch mounting measurements ø22mm black 1NO/1CO tipping momentary		
<b>For models:</b>	451003, 451004		

			
1			
<b>GEV No.</b>	346585	<b>Ref. No.</b>	SL1049
<b>description</b>	momentary push switch mounting measurements ø22mm white 1NO I momentary		
<b>For models:</b>	512010, 512011, 512012, 512013, 512014, 512015, 512016, 512017, 512018, 512019, 512020, 512021, 512022		





ABB

ø22mm

switches (complete)



<b>GEV No.</b>	347153	<b>Ref. No.</b>	0220006
<b>description</b>	push switch mounting measurements ø22mm black 2NO 300V 5A connection screw ambient temperature max. 85°C protection IP40		
<b>For models:</b>	442010		

<b>GEV No.</b>	401357	<b>Ref. No.</b>	MF2138	
<b>description</b>	momentary push switch mounting measurements ø22mm 1NO/1NC/indicator light 400V 4A indicator lamp 24V 0-1 connection screw ambient temperature max. 125/55°C protection IP40			
<b>For models:</b>	422001, 433001, 433002			
<b>spare parts for</b>	401357			
	<b>GEV No.</b>	346181	<b>Ref. No.</b>	—
	push button mounting ø 21mm external size 30x55mm oval			
<b>accessories for</b>	401357			
	<b>GEV No.</b>	401709	<b>Ref. No.</b>	—
	protective cover external size 57x32mm internal size 47x22mm matt finish rubber H 27.5mm			

GEV special

ø22mm

switches (complete)



<b>GEV No.</b>	347036	<b>Ref. No.</b>	0220017	
<b>description</b>	push switch mounting measurements ø22mm 2NO 230V main switch clear connection screw 6A protection IP40 ambient temperature max. 55°C			
<b>accessories for</b>	347036			
	<b>GEV No.</b>	347038	<b>Ref. No.</b>	0220042
	protection cap for pressure switch			

<b>GEV No.</b>	346545	<b>Ref. No.</b>	RG04356
<b>description</b>	push button mounting measurements ø22mm green 1NO complete with protecting cover		
<b>For models:</b>	451001		

button plates



<b>GEV No.</b>	347038	<b>Ref. No.</b>	0220042
<b>description</b>	protection cap for pressure switch		

<b>GEV No.</b>	346513	<b>Ref. No.</b>	LF1010705 RG04354
<b>description</b>	push button mounting measurements ø22mm red 1NC complete with protecting cover		
<b>For models:</b>	451001		

GIOVENZANA

switches (complete)



<b>GEV No.</b>	346490	<b>Ref. No.</b>	RG04300 RG04300+RG04328
<b>description</b>	emergency stop switch mounting measurements ø22mm red 1NC complete		
<b>For models:</b>	451001		

TELEMECANIQUE (EFA)





XA2 series

switches (complete)



<b>GEV No.</b>	345435	<b>Ref. No.</b>	8301060
<b>description</b>	momentary push switch mounting measurements ø22mm 1NO		
<b>For models:</b>	512002, 512003, 512004		





			
1			
<b>GEV No.</b>	345461	<b>Ref. No.</b>	8301050
<b>description</b>	mushroom switch mounting measurements ø22mm 1NC EMERGENCY SHUT-DOWN		
<b>For models:</b>	512002, 512003, 512004		
<b>spare parts for</b>	345461		
	<b>GEV No.</b>	345221	<b>Ref. No.</b> —
	contact block EFA ZB2BE102 1NC max 230V 10(6)A black		
	<b>GEV No.</b>	346660	<b>Ref. No.</b> —
	contact block holder		
<b>accessories for</b>	345461		
	<b>GEV No.</b>	345220	<b>Ref. No.</b> —
	contact block EFA ZB2BE101 1NO max 230V 10(6)A black		

## miscellaneous

			
1			
<b>GEV No.</b>	347037	<b>Ref. No.</b>	0220005
<b>description</b>	push switch mounting measurements ø22mm black 2NO 10A		
<b>For models:</b>	442003, 442004, 442005, 442006, 442008		

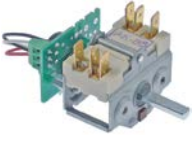
## encoders and potentiometers

			
1			
<b>GEV No.</b>	300249	<b>Ref. No.</b>	100133
<b>description</b>	cam switch 2 operating positions 2NO sequence 0-1 16A shaft ø 6x4.6mm shaft L 23mm connection screw 10K/J cable lengthmm 10kOhm ceramic		
<b>For models:</b>	131216, 131217, 131218, 246009, 246010, 246011, 246012, 246013, 246014		

			
1			
<b>GEV No.</b>	401338	<b>Ref. No.</b>	R65301450
<b>description</b>	encoder		
<b>For models:</b>	212001, 212002, 212003		

			
1			
<b>GEV No.</b>	403843	<b>Ref. No.</b>	SCH30006
<b>description</b>	encoder complete auxiliary equipment		
<b>For models:</b>	212024, 212025		

			
1			
<b>GEV No.</b>	401677	<b>Ref. No.</b>	DPWBFC373WRKZ
<b>description</b>	encoder for microwaves		
<b>For models:</b>	213002, 213003		

			
1			
<b>GEV No.</b>	401678	<b>Ref. No.</b>	RVR-BA018WRE0
<b>description</b>	encoder for microwaves		
<b>For models:</b>	213003		

			
1			
<b>GEV No.</b>	403084	<b>Ref. No.</b>	R65301940
<b>description</b>	encoder shaft L 18mm cable length 200mm shaft 6x4.6mm		
<b>For models:</b>	212005, 212007, 212009, 212010, 212011, 212012, 212013, 212018, 212020		



			
1			
<b>GEV No.</b>	300199	<b>Ref. No.</b>	100108
<b>description</b>	operation switch 0-1 16A shaft ø 6x4.6mm shaft L 23mm connection male faston 6.3mm 10K/J 2-pole with potentiometer		
<b>For models:</b>	131216, 131217, 131218, 246009, 246010, 246011, 246012, 246013, 246014		

			
1			
<b>GEV No.</b>	401953	<b>Ref. No.</b>	IB5944010
<b>description</b>	PCB hand blenders VORTEX with potentiometer 230V		



 <p>1</p>			
<b>GEV No.</b>	300362	<b>Ref. No.</b>	19414060N IB5940920
<b>description</b>	potentiometer 0.1KOhm rotation 270° shaft ø 6mm confectioned shaft L 42mm thread M10 cable length 28mm Orione		
<b>For models:</b>	471001, 721004		

 <p>1</p>			
<b>GEV No.</b>	300227	<b>Ref. No.</b>	IB5940011
<b>description</b>	potentiometer 0.1KOhm rotation 270° shaft ø 6mm shaft L 42mm thread M10 cable length 600mm		

 <p>1</p>			
<b>GEV No.</b>	402057	<b>Ref. No.</b>	02.13.338.00 02.13.340.00 X02.13.330.00
<b>description</b>	potentiometer 0.5KOhm rotation 320° shaft ø 6mm shaft L 12.8mm 25W 230V type FVR25W cable length 150mm		
<b>For models:</b>	222004, 222005		
<b>accessories for</b>	402057		
 <p>GEV No. 112939 Ref. No. X05.30.093.00 X05.30.098.00</p> <p>knob switch zero mark ø 45mm shaft ø 6mm</p>			

 <p>1</p>			
<b>GEV No.</b>	300225	<b>Ref. No.</b>	FT08060
<b>description</b>	potentiometer 10KOhm		

 <p>1</p>			
<b>GEV No.</b>	300252	<b>Ref. No.</b>	CR0737320
<b>description</b>	potentiometer 2 operating positions 2NO sequence 0-1 16A shaft ø 6x4.6mm shaft L 23mm connection coded plug cable length 1420mm 10kOhm 12V with cable and indicator light		
<b>For models:</b>	141017, 141018, 141019		

## lamps

### indicator lights

#### indicator lights 2-piece (lens and indicator lamp)

#### indicator light lenses

#### ø 6mm (type SQ-20)

 <p>1</p>			
<b>GEV No.</b>	359806	<b>Ref. No.</b>	130707
<b>description</b>	indicator light lens clear Qty 1 pcs ø 6mm		
<b>For models:</b>	SP1, SP2-12, SP2-S12, SP3		

 <p>1</p>			
<b>GEV No.</b>	359803	<b>Ref. No.</b>	660801201
<b>description</b>	indicator light lens green Qty 1 pcs ø 6mm		
<b>For models:</b>	221017, 221018		

#### ø 8mm (type RL-2)

 <p>1</p>			
<b>GEV No.</b>	359819	<b>Ref. No.</b>	00002360
<b>description</b>	indicator light lens green Qty 1 pcs ø 8mm		
<b>For models:</b>	211038, 211039, 211045, 211046, 212034, 212036, 212038, 212040		

 <p>1</p>			
<b>GEV No.</b>	359820	<b>Ref. No.</b>	00002350
<b>description</b>	indicator light lens yellow Qty 1 pcs ø 8mm		
<b>For models:</b>	211038, 211039, 211045, 211046, 212034, 212036, 212038, 212040		

#### ø10mm (type SRZ-2)

 <p>1</p>			
<b>GEV No.</b>	359358	<b>Ref. No.</b>	EL00200
<b>description</b>	indicator light housings mounting measurements ø10mm orange square		
<b>For models:</b>	531010, 531011, 531012, 531013, 531014, 531015, 531016, 531017		



## ø10mm (type SRZ-3)



1

<b>GEV No.</b>	359228	<b>Ref. No.</b>	6A039207 bis 2009
<b>description</b>	indicator light housings mounting measurements ø10mm clear round Qty 1 pcs		



1

<b>GEV No.</b>	359123	<b>Ref. No.</b>	6A038507 bis 2009
<b>description</b>	indicator light housings mounting measurements ø10mm green round Qty 1 pcs		

<b>accessories for</b>	359123		
	<b>GEV No.</b>	359132	<b>Ref. No.</b> EL00300
	indicator lamp green 250V connection male faston 6.3mm protection IP54 ambient temperature max. 85°C		



1

<b>GEV No.</b>	359125	<b>Ref. No.</b>	6A038907 bis 2009
<b>description</b>	indicator light housings mounting measurements ø10mm red round Qty 1 pcs		

## indicator lamps for socket type SQ



1

<b>GEV No.</b>	359801	<b>Ref. No.</b>	130182
<b>description</b>	indicator lamp 12V white connection male faston 6.3mm no lens ø 6mm		
<b>For models:</b>	SP1, SP2-12, SP2-S12		



1

<b>GEV No.</b>	359109	<b>Ref. No.</b>	130188 660801101
<b>description</b>	indicator lamp 230V green connection male faston 6.3mm no lens ø 6mm		
<b>For models:</b>	221017, 221018, SP1, SP2-12, SP2-S12		

<b>accessories for</b>	359109		
	<b>GEV No.</b>	359806	<b>Ref. No.</b> 130707
	indicator light lens clear Qty 1 pcs ø 6mm		



1

<b>GEV No.</b>	347476	<b>Ref. No.</b>	130196
<b>description</b>	indicator light 5V green connection cable 170mm		
<b>For models:</b>	SP3		

<b>accessories for</b>	347476		
	<b>GEV No.</b>	359806	<b>Ref. No.</b> 130707
	indicator light lens clear Qty 1 pcs ø 6mm		

## indicator lamps for socket type RL



1

<b>GEV No.</b>	359818	<b>Ref. No.</b>	01200330
<b>description</b>	indicator light 230V clear connection male faston 6.3mm		
<b>For models:</b>	211038, 211039, 211045, 211046, 212034, 212036, 212038, 212040		

<b>accessories for</b>	359818		
	<b>GEV No.</b>	359820	<b>Ref. No.</b> 00002350
	indicator light lens yellow Qty 1 pcs ø 8mm		

	<b>GEV No.</b>	359833	<b>Ref. No.</b> —
	indicator light lens red Qty 1 pcs ø 8mm		

	<b>GEV No.</b>	359948	<b>Ref. No.</b> —
	indicator light lens clear Qty 1 pcs ø 8mm		



1

<b>GEV No.</b>	359817	<b>Ref. No.</b>	01200340
<b>description</b>	indicator light 230V green connection male faston 6.3mm		
<b>For models:</b>	211038, 211039, 211045, 211046, 212034, 212036, 212038, 212040		

<b>accessories for</b>	359817		
	<b>GEV No.</b>	359819	<b>Ref. No.</b> 00002360
	indicator light lens green Qty 1 pcs ø 8mm		

## indicator lamps for socket type SA / SC / SD / SF / SR



1

<b>GEV No.</b>	359520	<b>Ref. No.</b>	LAMPA002
<b>description</b>	indicator lamp 400V green connection cable 400mm cable material silicone Qty 1 pcs		
<b>For models:</b>	530009, 530010, 530011, 530012, 531020, 531021, 531022, 531023		





1

<b>GEV No.</b>	359522	<b>Ref. No.</b>	41826650050
<b>description</b>	indicator lamp 400V green connection male faston 6.3mm Qty 1 pcs		
<b>For models:</b>	131001, 131002, 131003, 131004, 131005, 131006, 131007, 131008, 131009, 131010, 131201, 131202, 131203, 131204, 131205, 131206, 131207, 131208, 131209, 131210, 132001, 132002, 132003, 132004, 132201, 132202, 132203, 132204, 132205, 132206, 133004, 133005, 133006, 133016, 133017, 133018, 133019, 133020, 133021, 133024, 133106, 133119, 133203, 133204, 133205, 133206, 133209, 133210, 133211, 133212...(Other models you can see in the webshop)		





indicator lamps for socket type SRZ / SDK / SDY / SFK

			
1			
<b>GEV No.</b>	359430	<b>Ref. No.</b>	PT0118
<b>description</b>	indicator lamp 230V clear connection cable 400mm		
<b>accessories for</b>	359430		
	<b>GEV No.</b>	359260	<b>Ref. No.</b> —
	 indicator light housings mounting measurements ø12mm yellow round Qty 1 pcs		

			
1			
<b>GEV No.</b>	359131	<b>Ref. No.</b>	6A038506
<b>description</b>	indicator lamp 400V clear connection male faston 6.3mm		
<b>For models:</b>	131003, 131004, 131005, 131006, 131007, 131008, 131009, 131201, 131202, 131203, 131204, 131205, 131206, 131207, 131208, 131209, 131210, 132003, 132004, 132201, 132202, 132203, 132204, 132205, 132206, 133004, 133005, 133006, 133016, 133017, 133018, 133019, 133020, 133021, 133024, 133106, 133119, 133203, 133204, 133205, 133206, 133209, 133210, 133211, 133212, 133213, 133214, 133215, 133216, 133217...(Other models you can see in the webshop)		

			
1			
<b>GEV No.</b>	359132	<b>Ref. No.</b>	EL00300
<b>description</b>	indicator lamp green 250V connection male faston 6.3mm protection IP54 ambient temperature max. 85°C		
<b>For models:</b>	531010, 531011, 531012, 531013, 531014, 531015, 531016, 531017		

indicator lights (complete)

ø 6mm

			
1			
<b>GEV No.</b>	359005	<b>Ref. No.</b>	216003 216025
<b>description</b>	indicator light ø 6mm 230V yellow cable length 400mm		
<b>For models:</b>	811001, 811002, 811003, 812001, 812002, 812003, 812004, 812005, 812006, 812007, 812008, 812009, 812010, 813001, 915234, 915235, 915236, 915237, 915460, 915461, 915462, 915463, 915464, 915465		

			
1			
<b>GEV No.</b>	359031	<b>Ref. No.</b>	130157 IND30001
<b>description</b>	indicator light ø 6mm 230V green		
<b>For models:</b>	211005, 211006, 211010, 211014, 211015, 211016, 211018, 212015, 212016, SP3		

			
1			
<b>GEV No.</b>	359032	<b>Ref. No.</b>	IND30002
<b>description</b>	indicator light ø 6mm 230V yellow		
<b>For models:</b>	211004, 211005, 211006, 211010, 211011, 211012, 211013, 211014, 211015, 211016, 211017, 211018, 211023, 211024, 211028, 212014, 212015, 212016, 215001, 215002, 215003, 215004, 215005, 215006		

ø 8mm

			
1			
<b>GEV No.</b>	359906	<b>Ref. No.</b>	100128
<b>description</b>	indicator light ø 8mm 230V clear cable length 600mm		
<b>For models:</b>	131216, 131217, 131218, 246009, 246010, 246011, 246012, 246013, 246014		

ø 10mm  
with screw socket

			
1			
<b>GEV No.</b>	359872	<b>Ref. No.</b>	01143569
<b>description</b>	indicator light ø 10mm 230V red connection male faston 4.8mm socket screw base		

			
1			
<b>GEV No.</b>	359380	<b>Ref. No.</b>	CR0682520
<b>description</b>	indicator light ø 10mm 230V red connection male faston 6.3mm socket screw base		
<b>For models:</b>	141014, 141015, 141016, 146006, 146007		

			
1			
<b>GEV No.</b>	359379	<b>Ref. No.</b>	CR0587500
<b>description</b>	indicator light ø 10mm 230V yellow connection male faston 6.3mm socket screw base		
<b>For models:</b>	121101, 121104, 121106, 122103, 122104, 122105, 122106, 122110, 123110, 123111, 123112, 123113, 123114, 123115, 123118, 123119, 123120, 124101, 124102, 124105, 125101, 125102, 125103, 126101, 126103, 127102, 127103, 141005, 141007, 141013, 141014, 141015, 141016, 141021, 143017, 143018, 143019, 143020, 143021, 143022, 143023, 143024, 143025, 143026, 143027, 143028, 143029, 143030, 143031, 143032...(Other models you can see in the webshop)		

			
1			
<b>GEV No.</b>	357001	<b>Ref. No.</b>	IGS716033
<b>description</b>	indicator light ø 10mm 230V yellow/red temp.-resist. 120°C with protecting cover		

			
1			
<b>GEV No.</b>	359986	<b>Ref. No.</b>	IGS716023
<b>description</b>	indicator light ø 10mm 250V yellow connection male faston 6.3mm		

			
1			
<b>GEV No.</b>	359400	<b>Ref. No.</b>	CR-B117 KO-B119 KOB119 PI-B118 PIB118 WFB113 WY21011 WY83210010R
<b>description</b>	indicator light ø 10mm 230V green		
<b>For models:</b>	223007, 223008, 225009, 255009, 255012, 255013, 255014, 531034, 531039, 531040, 742001, 742002, 742003, 742004, 742017, 742018, 742019, 742020		

			
1			
<b>GEV No.</b>	359401	<b>Ref. No.</b>	CR-B101 CR-B104 KO-B101 KOB101 WFB101
<b>description</b>	indicator light ø 10mm 230V red		
<b>For models:</b>	223007, 223008, 225009, 255009, 255012, 255013, 255014		

			
1			
<b>GEV No.</b>	360481	<b>Ref. No.</b>	101003
<b>description</b>	indicator light ø 10mm 250V green cable length 300mm socket screw base		
<b>For models:</b>	531028, 531029, 531030, 531031		

with plug-in socket			
			
1			
<b>GEV No.</b>	359036	<b>Ref. No.</b>	1037300810
<b>description</b>	indicator light ø 10mm clear 230V connection male faston 6.3mm Qty 1 pcs		

			
1			
<b>GEV No.</b>	359422	<b>Ref. No.</b>	671002
<b>description</b>	indicator light ø 10mm green 12V connection male faston 2.8mm Qty 1 pcs		
<b>For models:</b>	741003		

			
1			
<b>GEV No.</b>	359139	<b>Ref. No.</b>	401515100 401515150
<b>description</b>	indicator light ø 10mm green 230V connection male faston 6.3mm Qty 1 pcs		
<b>For models:</b>	111001, 111002, 111003, 112001, 112002, 222002, 222003, 261001, 261002, 276001, 279001, 535001, 535002, 535004, HD3NK		

			
1			
<b>GEV No.</b>	359138	<b>Ref. No.</b>	MF2192
<b>description</b>	indicator light ø 10mm red 230V connection male faston 6.3mm Qty 1 pcs		
<b>For models:</b>	421001, 422001, 433001, 433002		

			
1			
<b>GEV No.</b>	359140	<b>Ref. No.</b>	1037300910 401515200 401515250 671026 IB5846400 MC2854000
<b>description</b>	indicator light ø 10mm yellow 230V connection male faston 6.3mm Qty 1 pcs		
<b>For models:</b>	111001, 111002, 111003, 113003, 113004, 113005, 113006, 113011, 113012, 113013, 113014, 114003, 115001, 115002, 116001, 116002, 221006, 222002, 222003, 245003, 535001, 535002, 535004, 541001, 541002, 741001, 741002, 741003, 913114, 913115, 913116, 913117, 914103, 914105, 914107, 914109, 914114, 914116, 914118, 914120, 914121, 914122, 914123, 914124, 955001, 955002, 955003, 955004		

ø12mm  
with screw socket

			
1			
<b>GEV No.</b>	359994	<b>Ref. No.</b>	6A039207
<b>description</b>	indicator light ø 12mm 400V clear connection male faston 6.3mm		
<b>For models:</b>	131001, 131002, 131003, 131004, 131005, 131006, 131007, 131008, 131009, 131010, 131201, 131202, 131203, 131204, 131205, 131206, 131207, 131208, 131209, 131210, 132001, 132002, 132003, 132004, 132201, 132202, 132203, 132204, 133004, 133005, 133006, 133016, 133017, 133018, 133019, 133020, 133021, 133024, 133106, 133119, 133203, 133204, 133205, 133206, 133209, 133210, 133211, 133212, 133213, 133214...(Other models you can see in the webshop)		



with plug-in socket



			
1			
<b>GEV No.</b>	359041	<b>Ref. No.</b>	X02.19.175.00 X02.19.182.00
<b>description</b>	indicator light ø 12mm green 230V connection male faston 6.3mm temp.-resist. 120°C Qty 1 pcs		
<b>For models:</b>	222004, 222005, 541003		





 <p>1</p>			
<b>GEV No.</b>	359043	<b>Ref. No.</b>	X02.19.176.00 X02.19.181.00
<b>description</b>	indicator light ø 12mm red 230V connection male faston 6.3mm temp.-resist. 120°C Qty 1 pcs		
<b>For models:</b>	222004, 222005, 541003		



<p>ø12.5mm</p>  <p>1</p>			
<b>GEV No.</b>	357009	<b>Ref. No.</b>	02.19.150.00
<b>description</b>	indicator light ø 12.5mm 230V green connection male faston 4.8mm		
<b>For models:</b>	276003, 276004, 276005, 276006, 276007, 276008, 276009, 276010		



<p>ø13mm</p> <p>with screw socket</p>  <p>1</p>			
<b>GEV No.</b>	359145	<b>Ref. No.</b>	826650020
<b>description</b>	indicator light ø 13mm 230V green t.max. 120°C		
<b>For models:</b>	131007, 131008, 131009, 131011, 131012, 132003, 132004, 132005, 132006, 132205, 132206, 133004, 133005, 133006, 133016, 133017, 133018, 133019, 133020, 133021, 135001, 135002, 135003, 135004, 136002, 136202, 137001, 137003, 137004, 137201		
<b>accessories for</b>	359145		
	<b>GEV No.</b>	<b>Ref. No.</b>	<b>510302</b> 0PP077.00.00
	O-ring EPDM ID ø 12.42mm thickness 1.78mm Qty 1 pcs		
	<b>GEV No.</b>	<b>Ref. No.</b>	<b>511505</b> —
	O-ring EPDM thickness 1.78mm ID ø 12.42mm Qty 10 pcs		

 <p>1</p>			
<b>GEV No.</b>	359146	<b>Ref. No.</b>	826650030
<b>description</b>	indicator light ø 13mm 230V yellow		
<b>For models:</b>	133004, 133005, 133006, 133016, 133017, 133018, 133019, 133020, 133021, 135001, 135002, 135003, 135004, 137001, 137003, 137004, 137201		
<b>accessories for</b>	359146		
	<b>GEV No.</b>	<b>Ref. No.</b>	<b>510302</b> 0PP077.00.00
	O-ring EPDM ID ø 12.42mm thickness 1.78mm Qty 1 pcs		
	<b>GEV No.</b>	<b>Ref. No.</b>	<b>511505</b> —
	O-ring EPDM thickness 1.78mm ID ø 12.42mm Qty 10 pcs		

<p>with plug-in socket</p>  <p>1</p>			
<b>GEV No.</b>	359143	<b>Ref. No.</b>	122-2004 74420520
<b>description</b>	indicator light ø 13mm yellow 230V connection male faston 6.3mm temp.-resist. 120°C Qty 1 pcs		
<b>For models:</b>	244012, 531001, 531002, 531003, 531004, 531005, 531006, 531007, 531008		

 <p>1</p>			
<b>GEV No.</b>	357010	<b>Ref. No.</b>	0AT93615 A0AT93615
<b>description</b>	indicator light ø 13mm green clock		
<b>For models:</b>	221007		

<p>ø16mm</p> <p>with screw socket</p>  <p>1</p>			
<b>GEV No.</b>	359835	<b>Ref. No.</b>	PD414K
<b>description</b>	indicator light ø 16mm 230V green connection male faston 6.3mm		
<b>For models:</b>	221005, 234001, 234002, 234005		
<b>accessories for</b>	359835		
	<b>GEV No.</b>	<b>Ref. No.</b>	<b>550559</b> —
	nut thread M16x1 H 5.5mm WS 19		

 <p>1</p>			
<b>GEV No.</b>	359834	<b>Ref. No.</b>	PD414J
<b>description</b>	indicator light ø 16mm 230V yellow connection male faston 6.3mm temp.-resist. 120°C		
<b>For models:</b>	221005, 234001, 234002, 234005		
<b>accessories for</b>	359834		
	<b>GEV No.</b>	<b>Ref. No.</b>	<b>550559</b> —
	nut thread M16x1 H 5.5mm WS 19		

<p>with plug-in socket</p>  <p>1</p>			
<b>GEV No.</b>	359788	<b>Ref. No.</b>	R65270160
<b>description</b>	indicator light ø 16mm 230V green connection male faston 6.3mm		
<b>For models:</b>	212002, 212003		





			
1			
<b>GEV No.</b>	359789	<b>Ref. No.</b>	R65270150
<b>description</b>	indicator light ø 16mm 230V yellow connection male faston 6.3mm		
<b>For models:</b>	212002, 212003		

30x11mm			
			
1			
<b>GEV No.</b>	359160	<b>Ref. No.</b>	1029727
<b>description</b>	indicator light mounting measurements 30x11mm 230V green connection male faston 6.3mm rectangular temp.-resist. 125°C		
<b>For models:</b>	741001		

30x22mm			
			
1			
<b>GEV No.</b>	359164	<b>Ref. No.</b>	637082100
<b>description</b>	indicator light mounting measurements 30x22mm 230V green/white connection male faston 6.3mm temp.-resist. 125°C		
<b>For models:</b>	223002, 262001		

			
1			
<b>GEV No.</b>	301138	<b>Ref. No.</b>	401510000
<b>description</b>	indicator light mounting measurements 30x22mm 230V red/green connection male faston 6.3mm temp.-resist. 125/55°C type RL2		
<b>For models:</b>	114001, 114002, 221001, 221002, 221003, 221004, 243001, 243002, 243005, 244001, 244002, 244003, 244004, 244005, 244006, 244007, 244008, 244009, 244010, 244021, 245001, 245002, 245004, 245005, 245007, 245008, 255001, 255002, 255003, 255004, 255006, 255007, 262002, 262003, 272001, 272002		

miscellaneous			
			
1			
<b>GEV No.</b>	357012	<b>Ref. No.</b>	KVE007
<b>description</b>	indicator lamps set mounting measurements 20.6x16.4mm green 230V connection male faston 6.3mm ø 20.6x16.4mm socket male faston 6.3mm		

			
1			
<b>GEV No.</b>	359851	<b>Ref. No.</b>	KODK006
<b>description</b>	indicator light mounting measurements 32.5x8.5mm white 230V		

LED			
indicator lamps			
mounting diameter 6mm			
			
1			
<b>GEV No.</b>	359404	<b>Ref. No.</b>	216028
<b>description</b>	indicator light LED mounting ø 6mm 5VDC green connection cable 200mm 2mA		
<b>For models:</b>	813001		

			
1			
<b>GEV No.</b>	358098	<b>Ref. No.</b>	216029
<b>description</b>	indicator light LED mounting ø 6mm 5VDC yellow connection cable 200mm 2mA		
<b>For models:</b>	813001		

miscellaneous			
			
1			
<b>GEV No.</b>	400538	<b>Ref. No.</b>	WY21024 WY22625
<b>description</b>	indicator light LED red mounting thread M8x0.75 ø 5mm		
<b>For models:</b>	742001, 742002, 742003, 742004		

screw-on/push-on fit			
light bulbs			
for ovens			
			
1			
<b>GEV No.</b>	359610	<b>Ref. No.</b>	IB5946010
<b>description</b>	light bulb t.max. 300°C socket E14 15W 230V ø 22mm L 47mm lens L 20mm for oven lamp type Philips		
<b>For models:</b>	541001, 541002		





 <p>1</p>			
<b>GEV No.</b>	359612	<b>Ref. No.</b>	101010 74420260 PF7070E-15 PI-B102 PIB102
<b>description</b>	light bulb t.max. 300°C socket E14 25W 230V ø 25mm L 56mm lens L 30mm for oven lamp type Philips		
<b>For models:</b>	531001, 531002, 531003, 531004, 531005, 531006, 531007, 531008, 531028, 531029, 531030, 531031, 531034, 531039, 531040, 531046		

**halogen lamp**  
for socket E14 / E27

 <p>1</p>			
<b>GEV No.</b>	359728	<b>Ref. No.</b>	EL06600
<b>description</b>	halogen lamp socket E14 230V 40W ø 25mm lens L 54mm L 80mm temp.-resist. 300°C Qty 1		
<b>For models:</b>	531010, 531011, 531012, 531013, 531014, 531015, 531016, 531017		

for socket G4 / G6.35 / G9

 <p>1 <b>500°C</b></p>			
<b>GEV No.</b>	359599	<b>Ref. No.</b>	R65270020
<b>description</b>	halogen lamp socket G4 12V 20W temp.-resist. 500°C		
<b>For models:</b>	212002, 212003, 212010, 212011, 212012, 212013		

 <p>1 <b>500°C</b></p>			
<b>GEV No.</b>	359074	<b>Ref. No.</b>	01201470
<b>description</b>	halogen lamp socket G6.35 12V 35W temp.-resist. 500°C		
<b>For models:</b>	212038, 212039, 212040, 212041		

 <p>1</p>			
<b>GEV No.</b>	359946	<b>Ref. No.</b>	VE1005A1
<b>description</b>	halogen lamp socket G9 230V 40W temp.-resist. 300°C		
<b>For models:</b>	211003		

**linear lamps**

**infrared lamps**  
with base type R7s

 <p>1</p>			
<b>GEV No.</b>	357019	<b>Ref. No.</b>	74751020
<b>description</b>	infrared lamp socket R7s L 254mm 235V 500W IMPORT		
<b>For models:</b>	651010		

 <p>1</p>			
<b>GEV No.</b>	360507 <sup>1</sup>	<b>Ref. No.</b>	2001000
<b>description</b>	infrared lamp socket R7s L 255mm 240V 1300W ø 10mm gold-plated IMPORT		
<b>For models:</b>	221011, 221012, 221014		

<sup>1</sup>with gold-plating

**sockets for linear lamps**

R7s

 <p>1</p>			
<b>GEV No.</b>	359735	<b>Ref. No.</b>	74741636
<b>description</b>	lamp socket socket R7s 250V ømm L 16mm W 25mm H 40mm connection cable 230mm mounting distancemm		
<b>For models:</b>	651027, 651028, 651039, 651040, 651041, 651042, 651043, 651044, 651045, 651058, 651060, 651061, 651062, 651063, 651070, 651071, 651082, 651083, 651084, 651085, 651092, 651093, 651094, 651095, 651096, 651130, 651131		

 <p>1</p>			
<b>GEV No.</b>	357234	<b>Ref. No.</b>	74741632
<b>description</b>	lamp socket socket R7s ø 18mm H 27mm connection cable 2000mm mounting distancemm mounting thread M14x1 cable material PTFE Qty 1 pcs		
<b>For models:</b>	651020, 651021, 651022, 651023, 651024		

**hard-glass infrared lamps**

 <p>1</p>			
<b>GEV No.</b>	358097	<b>Ref. No.</b>	71.40.06
<b>description</b>	infrared lamp socket E27 240V 250W ø 125mm L 173mm type BR125 clear hard glas		
<b>For models:</b>	274003, 274004, 274005, 274006, 274007		





			
1			
<b>GEV No.</b>	359463	<b>Ref. No.</b>	71.40.05 SL0681
<b>description</b>	infrared lamp socket E27 240V 250W ø 125mm L 173mm type BR125 red hard glas		
<b>For models:</b>	274003, 274004, 274006, 274007, 279003, 279004		

## fluorescent lamps

### fluorescent lamps

#### G13

1			
<b>GEV No.</b>	357008	<b>Ref. No.</b>	877016000
<b>description</b>	fluorescent lamp socket G13 L 1198mm 36W 230V Qty 1 pcs		
<b>For models:</b>	644011, 644012		



1			
<b>GEV No.</b>	359386	<b>Ref. No.</b>	877010700
<b>description</b>	fluorescent lamp socket G13 L 1198mm 36W 230V Qty 1 pcs		
<b>For models:</b>	641003, 641005, 641007, 641011, 641015, 644010, 644011, 644012		



1			
<b>GEV No.</b>	359390	<b>Ref. No.</b>	877016600
<b>description</b>	fluorescent lamp socket G13 L 1500mm 58W 230V Qty 1 pcs		
<b>For models:</b>	641006, 641008, 641012, 641016		

1			
<b>GEV No.</b>	359383	<b>Ref. No.</b>	877010200
<b>description</b>	fluorescent lamp socket G13 L 438mm 15W 230V Qty 1 pcs light colour 640		

1			
<b>GEV No.</b>	359371	<b>Ref. No.</b>	877010400
<b>description</b>	fluorescent lamp socket G13 L 590mm 18W 230V Qty 1 pcs		
<b>For models:</b>	641001		

1			
<b>GEV No.</b>	359372	<b>Ref. No.</b>	877010500
<b>description</b>	fluorescent lamp socket G13 L 895mm 30W 230V Qty 1 pcs		
<b>For models:</b>	644006		

1				
<b>GEV No.</b>	357007	<b>Ref. No.</b>	877016300	
<b>description</b>	fluorescent lamp socket G13 L 895mm 30W ø 27mm 230V Qty 1 pcs			
<b>For models:</b>	644010			
<b>accessories for</b>	357007			
	<b>GEV No.</b>	380464	<b>Ref. No.</b>	877003100
	starter 4-65W			

<b>accessories for</b>	357007			
	<b>GEV No.</b>	401505	<b>Ref. No.</b>	877000500
	electrical ballast 36W 230V Qty 1 pcs			
	<b>GEV No.</b>	402065	<b>Ref. No.</b>	877000400
	electrical ballast 30W 230V for fluorescent lamps Qty 1 pcs			

1			
<b>GEV No.</b>	359738	<b>Ref. No.</b>	877016700
<b>description</b>	fluorescent lamp socket G13 L 970mm 23W 230V Qty 1 pcs		
<b>For models:</b>	641002, 641004, 641009, 641010, 641013, 641014, 641017		

### accessories

#### starter

1			
<b>GEV No.</b>	380464	<b>Ref. No.</b>	877003100
<b>description</b>	starter 4-65W		
<b>For models:</b>	641001, 641002, 641003, 641004, 641005, 641006, 641007, 641008, 641009, 641010, 641011, 641012, 641013, 641014, 641015, 641016, 641017, 644010, 644011, 644012		

#### ballasts

1			
<b>GEV No.</b>	402063	<b>Ref. No.</b>	877000100
<b>description</b>	electrical ballast 15W 230V for fluorescent lamps Qty 1 pcs		

1			
<b>GEV No.</b>	401504	<b>Ref. No.</b>	877000200
<b>description</b>	electrical ballast 18W 230V Qty 1 pcs		
<b>For models:</b>	641001		

1			
<b>GEV No.</b>	402064	<b>Ref. No.</b>	877000300
<b>description</b>	electrical ballast 25W 230V Qty 1 pcs		
<b>For models:</b>	641002, 641004, 641009, 641010, 641013, 641014, 641017		





			
1			
<b>GEV No.</b>	402065	<b>Ref. No.</b>	877000400
<b>description</b>	electrical ballast 30W 230V for fluorescent lamps Qty 1 pcs		
<b>For models:</b>	644006, 644010		

			
1			
<b>GEV No.</b>	401505	<b>Ref. No.</b>	877000500
<b>description</b>	electrical ballast 36W 230V Qty 1 pcs		
<b>For models:</b>	641003, 641005, 641007, 641011, 641015, 644011, 644012		

			
1			
<b>GEV No.</b>	402066	<b>Ref. No.</b>	877000800
<b>description</b>	electrical ballast 58W 230V for fluorescent lamps Qty 1 pcs		
<b>For models:</b>	641006, 641008, 641012, 641016		

covers			
			
1			
<b>GEV No.</b>	551020	<b>Ref. No.</b>	877030500
<b>description</b>	protection cap for fluorescent lamps ø 30mm		
<b>For models:</b>	644010, 644011, 644012		

protective tube			
			
1			
<b>GEV No.</b>	550614	<b>Ref. No.</b>	127113400
<b>description</b>	protection pipe for fluorescent lamps L 1195mm ømm		
<b>For models:</b>	644010, 644011, 644012		

			
1			
<b>GEV No.</b>	550613	<b>Ref. No.</b>	870736300
<b>description</b>	protection pipe for fluorescent lamps ø 28.7mm L 1180mm Qty 1 pcs		
<b>For models:</b>	641003, 641005, 641007, 641011, 641015, 644011, 644012		

			
1			
<b>GEV No.</b>	550612	<b>Ref. No.</b>	870736100
<b>description</b>	protection pipe for fluorescent lamps ø 28.7mm L 875mm Qty 1 pcs		
<b>For models:</b>	644010		

### fridge lamps

			
1			
<b>GEV No.</b>	359595	<b>Ref. No.</b>	1640403 BN1640403
<b>description</b>	light bulb socket E14 15W 230-240V ø 25mm L 56mm lens L 30mm Qty 1 pcs		
<b>For models:</b>	201780, 621007, 621020, 621021, 622005, 622020, 622021		

### producer-specific fridge lamps

#### POLARIS

			
1			
<b>GEV No.</b>	550070	<b>Ref. No.</b>	165705
<b>description</b>	lamp socket socket E14		
<b>For models:</b>	201780, 621007, 622005		

### microwave lamps

#### light bulbs

			
1			
<b>GEV No.</b>	359549	<b>Ref. No.</b>	RLMPTA028WRE0 RLMPTA078WRE0
<b>description</b>	light bulb socket E14 220-240V 25W ø 25mm L 60mm Qty 1 pcs for microwave		
<b>For models:</b>	213001, 213002, 213003		





### oven lamps

#### universal oven lamps

mounting diameter 35.5mm



1

<b>GEV No.</b>	359718	<b>Ref. No.</b>	00002330 1037317000 IB5846000
<b>description</b>	oven lamp mounting ø 35.5mm 230V 15W socket E14 temp.-resist. 300°C connection male faston 6.3mm hard glas		
<b>For models:</b>	211038, 541001, 541002		
<b>spare parts for</b>	359718		
	<b>GEV No.</b>	359701	<b>Ref. No.</b> —
	lamp socket socket E14 220-230V mounting ø 35.5mm connection male faston 6.3mm 15W		
	<b>GEV No.</b>	359740	<b>Ref. No.</b> —
	light bulb t.max. 300°C socket E14 15W 230V ø 22mm L 48mm lens L 20mm for oven lamp IMPORT		



1

<b>GEV No.</b>	359660	<b>Ref. No.</b>	LAMPA010
<b>description</b>	oven lamp mounting ø 35.5mm 230V 25W socket E14 temp.-resist. 300°C connection male faston 6.3mm hard glas		
<b>For models:</b>	530009, 530010, 530011, 530012, 531020, 531021, 531022, 531023		



1



<b>GEV No.</b>	359934	<b>Ref. No.</b>	PF5050DE3-15A PI-B102B PIB102B
<b>description</b>	oven lamp mounting ø 35.5mm 230V 25W socket E14 temp.-resist. 300°C connection male faston 6.3mm hard glas		
<b>For models:</b>	531034, 531039, 531040, 531043		



1

<b>GEV No.</b>	359259	<b>Ref. No.</b>	00002720 00002730
<b>description</b>	oven lamp mounting ø 35.5mm 230V 25W socket G9 temp.-resist. 300°C connection cable 380mm hard glas		
<b>For models:</b>	211039, 211042, 211043, 211044, 211045, 211046, 212034, 212035, 212036, 212037		
<b>spare parts for</b>	359259		
	<b>GEV No.</b>	357161	<b>Ref. No.</b> —
	lamp socket socket G9 220-230V mounting ø 35.5mm connection cable 380mm		

**spare parts for** 359259

	<b>GEV No.</b>	358128	<b>Ref. No.</b>	—
	gasket for oven lamp silicone ID ø 30mm ED ø 38mm thickness 2mm			
	<b>GEV No.</b>	359942	<b>Ref. No.</b>	PF9262DE-15C PI-B102A PIB102A
	oven lamp glass thr.ø 33.5mm ø 41mm hard glas temp.-resist. 350°C			
	<b>GEV No.</b>	359946	<b>Ref. No.</b>	VE1005A1
	halogen lamp socket G9 230V 40W temp.-resist. 300°C			



1

<b>GEV No.</b>	357158	<b>Ref. No.</b>	LAM30003-A	
<b>description</b>	oven lamp mounting ø 35.5mm 230V 40W socket G9 cable length 100mm connection male faston 6.3mm with gasket			
<b>For models:</b>	211029, 212014, 212015, 212016, 212024, 212025			
<b>spare parts for</b>	357158			
	<b>GEV No.</b>	357160	<b>Ref. No.</b>	VE1015A0
	lamp socket socket G9 220-230V mounting ø 35.5mm connection cable 100mm			
	<b>GEV No.</b>	358135	<b>Ref. No.</b>	—
	gasket for oven lamp PTFE ID ø 44mm ED ø 53mm thickness 3mm with silicone O-ring			
	<b>GEV No.</b>	359705	<b>Ref. No.</b>	—
	oven lamp glass thr.ø 33.5mm ø 52mm hard glas temp.-resist. 350°C			
	<b>GEV No.</b>	359946	<b>Ref. No.</b>	VE1005A1
	halogen lamp socket G9 230V 40W temp.-resist. 300°C			



1

<b>GEV No.</b>	357176	<b>Ref. No.</b>	LAM30006
<b>description</b>	oven lamp mounting ø 35.5mm 230V 40W socket G9 temp.-resist. 300°C connection cable 100mm hard glas		
<b>For models:</b>	211028		



1



<b>GEV No.</b>	357160	<b>Ref. No.</b>	VE1015A0
<b>description</b>	lamp socket socket G9 220-230V mounting ø 35.5mm connection cable 100mm		
<b>For models:</b>	211003		





			
1			
<b>GEV No.</b>	359942	<b>Ref. No.</b>	PF9262DE-15C PI-B102A PIB102A
<b>description</b>	oven lamp glass thr.ø 33.5mm ø 41mm hard glas temp.-resist. 350°C		
<b>For models:</b>	531034, 531039, 531040, 531044		

			
1			
<b>GEV No.</b>	359709	<b>Ref. No.</b>	VE036
<b>description</b>	oven lamp glass thr.ø 33.5mm ø 42mm hard glas temp.-resist. 350°C		
<b>For models:</b>	211003		

			
1			
<b>GEV No.</b>	359661	<b>Ref. No.</b>	AL20100 VETRO002
<b>description</b>	oven lamp glass thread 32.1 ø 58mm hard glas temp.-resist. 350°C		
<b>For models:</b>	530009, 530010, 530011, 530012, 531010, 531011, 531012, 531013, 531014, 531015, 531016, 531017, 531020, 531021, 531022, 531023		
<b>accessories for</b>	359661		
	<b>GEV No.</b>	<b>Ref. No.</b>	AL26600
	 gasket for pizza oven fibre glass ID ø 32.5mm ED ø 55mm thickness 5mm		

			
1			
<b>GEV No.</b>	359700	<b>Ref. No.</b>	AL26600
<b>description</b>	gasket for pizza oven fibre glass ID ø 32.5mm ED ø 55mm thickness 5mm		
<b>For models:</b>	531010, 531011, 531012, 531013, 531014, 531015, 531016, 531017		

mounting diameter 47.8mm			
			
1			
<b>GEV No.</b>	359499	<b>Ref. No.</b>	74700070
<b>description</b>	lamp socket socket E14 mounting ø 47.8mm connection male faston 6.3mm		
<b>For models:</b>	531001, 531002, 531003, 531004, 531005, 531006, 531007, 531008		
<b>accessories for</b>	359499		
	<b>GEV No.</b>	<b>Ref. No.</b>	—
	 oven lamp glass thread ø 44mm H 43mm ø 54mm hard glas temp.-resist. 350°C		

mounting diameter 65.5mm			
			
1			
<b>GEV No.</b>	359724	<b>Ref. No.</b>	73700690
<b>description</b>	oven lamp glass thread ø 62mm H 46mm ø 74mm hard glas temp.-resist. 350°C		
<b>For models:</b>	531001, 531002, 531003, 531004, 531005, 531006, 531007, 531008		

55x70mm			
			
1			
<b>GEV No.</b>	359659	<b>Ref. No.</b>	6111400005 LAM30002
<b>description</b>	oven lamp complete 230V 25W socket E14 L 70mm W 55mm mounting measurements 55x70mm temp.-resist. 300°C connection male faston 6.3mm		
<b>For models:</b>	211004, 211005, 211006, 211010, 211011, 211012, 211013, 211014, 211015, 211016, 211027		

producer-specific oven lamps			
COOKMAX			
			
1			
<b>GEV No.</b>	359672	<b>Ref. No.</b>	R11401450
<b>description</b>	frame		
<b>For models:</b>	212002, 212003, 212010, 212011, 212012, 212013		

			
1			
<b>GEV No.</b>	359671	<b>Ref. No.</b>	R70044200
<b>description</b>	gasket		
<b>For models:</b>	212002, 212003, 212010, 212011, 212012, 212013		

			
1			
<b>GEV No.</b>	359670	<b>Ref. No.</b>	R71500150
<b>description</b>	lamp glass L 105mm W 40mm thickness 4mm		
<b>For models:</b>	212002, 212003, 212010, 212011, 212012, 212013		



1

<b>GEV No.</b>	359674	<b>Ref. No.</b>	R65270450
<b>description</b>	lamp socket 24V socket G4 connection cable 100mm ømm H 16mm with 2 hole fixing mounting distance 20mm holder length 26mm Qty 1 pcs		
<b>For models:</b>	212002, 212003, 212010, 212011, 212012, 212013		



1

<b>GEV No.</b>	359500	<b>Ref. No.</b>	X02.30.102.00
<b>description</b>	lamp socket 250V socket E27 connection cable 250mm ø 35mm H 38mm mounting distance 38mm Qty 1 pcs		
<b>For models:</b>	541003		



1

<b>GEV No.</b>	359375	<b>Ref. No.</b>	R65270510
<b>description</b>	lamp socket complete without lamp socket E14 mounting measurements 55x70mm		
<b>For models:</b>	212001, 212004, 212005, 212006, 212007, 212008, 212009, 212017, 212018, 212019, 212020		



1

<b>GEV No.</b>	357098	<b>Ref. No.</b>	101011
<b>description</b>	lamp socket L 150mm socket E14 H 45mm mounting distance 124mm		
<b>For models:</b>	531028, 531029, 531030, 531031		



1

<b>GEV No.</b>	359639	<b>Ref. No.</b>	EL06900
<b>description</b>	lamp socket socket E14 with grip fixing		
<b>For models:</b>	531010, 531011, 531012, 531013, 531014, 531015, 531016, 531017		



1

<b>GEV No.</b>	359848	<b>Ref. No.</b>	02.30.045.00
<b>description</b>	lamp socket socket E27 double for HATCO heated bridge GR		
<b>For models:</b>	276003, 276004, 276005, 276006, 276007, 276008, 276009, 276010		



1

<b>GEV No.</b>	359847	<b>Ref. No.</b>	02.30.044.00
<b>description</b>	lamp socket socket E27 for HATCO heated bridge GR		
<b>For models:</b>	276003, 276004, 276005, 276006, 276007, 276008, 276009, 276010		



1

<b>GEV No.</b>	359673	<b>Ref. No.</b>	R11401440	
<b>description</b>	lamp socket socket G4 mounting measurements 37x103mm			
<b>For models:</b>	212002, 212003, 212010, 212011, 212012, 212013			
<b>spare parts for</b>	359673			
	<b>GEV No.</b>	359674	<b>Ref. No.</b>	R65270450
	lamp socket 24V socket G4 connection cable 100mm ømm H 16mm with 2 hole fixing mounting distance 20mm holder length 26mm Qty 1 pcs			





1

<b>GEV No.</b>	359453	<b>Ref. No.</b>	LAM00001	
<b>description</b>	oven lamp complete 230V 25W socket G9 L 70mm W 55mm Qty 2 pcs			
<b>For models:</b>	211007			
<b>spare parts for</b>	359453			
	<b>GEV No.</b>	357105	<b>Ref. No.</b>	—
	lamp socket socket G9 250V mounting measurements 55x70mm connection male faston 6.3mm H 32mm			
<b>accessories for</b>	359453			
	<b>GEV No.</b>	560062	<b>Ref. No.</b>	252917 60000000
	flat-headed bolt thread M4 thread L 10mm SS DIN 7985/ISO 7045 Qty 20 pcs intake Phillips head ø 8mm head thickness 2mm			



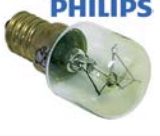

lamps			
light bulbs			
			
1			
<b>GEV No.</b>	359610	<b>Ref. No.</b>	IB5946010
<b>description</b>	light bulb t.max. 300°C socket E14 15W 230V ø 22mm L 47mm lens L 20mm for oven lamp type Philips		
<b>For models:</b>	541001, 541002		

			
1			
<b>GEV No.</b>	359612	<b>Ref. No.</b>	101010 74420260 PF7070E-15 PI-B102 PIB102
<b>description</b>	light bulb t.max. 300°C socket E14 25W 230V ø 25mm L 56mm lens L 30mm for oven lamp type Philips		
<b>For models:</b>	531001, 531002, 531003, 531004, 531005, 531006, 531007, 531008, 531028, 531029, 531030, 531031, 531034, 531039, 531040, 531046		

halogen lamps			
for socket E14 / E27			
			
1			
<b>GEV No.</b>	359728	<b>Ref. No.</b>	EL06600
<b>description</b>	halogen lamp socket E14 230V 40W ø 25mm lens L 54mm L 80mm temp.-resist. 300°C Qty 1		
<b>For models:</b>	531010, 531011, 531012, 531013, 531014, 531015, 531016, 531017		

for socket G4 / G6.35 / G9			
			
1 <b>500°C</b>			
<b>GEV No.</b>	359599	<b>Ref. No.</b>	R65270020
<b>description</b>	halogen lamp socket G4 12V 20W temp.-resist. 500°C		
<b>For models:</b>	212002, 212003, 212010, 212011, 212012, 212013		

			
1 <b>500°C</b>			
<b>GEV No.</b>	359074	<b>Ref. No.</b>	01201470
<b>description</b>	halogen lamp socket G6.35 12V 35W temp.-resist. 500°C		
<b>For models:</b>	212038, 212039, 212040, 212041		

			
1			
<b>GEV No.</b>	359946	<b>Ref. No.</b>	VE1005A1
<b>description</b>	halogen lamp socket G9 230V 40W temp.-resist. 300°C		
<b>For models:</b>	211003		

### residual heat indicators

			
1			
<b>GEV No.</b>	359326	<b>Ref. No.</b>	853400070
<b>description</b>	residual heat indicator 4-fold		
<b>For models:</b>	131012, 132005, 132006, 132206		

			
1			
<b>GEV No.</b>	359328	<b>Ref. No.</b>	853400080
<b>description</b>	residual heat indicator double		
<b>For models:</b>	131011, 132005, 132006, 132205		

			
1			
<b>GEV No.</b>	357003	<b>Ref. No.</b>	6A001404
<b>description</b>	residual heat indicator single 250V connection male faston 6.3mm mounting ø 14mm temp.-resist. 180°C		

### timers

#### programme timers

			
1			
<b>GEV No.</b>	403577	<b>Ref. No.</b>	R65095000
<b>description</b>	gear motor CDC 4901F1 engines 1 chambers 1 operation time 20s 230V 50Hz shaft ø 6x4.6mm shaft L 24mm		
<b>For models:</b>	212002, 212003, 212010, 212011, 212012, 212013		



1

<b>GEV No.</b>	400115	<b>Ref. No.</b>	R65095000 (old version)
<b>description</b>	gear motor FIBER P25 engines 1 chambers 1 operation time 20s 230V 50/60Hz shaft ø 6x4.6mm shaft L 24mm type M51BJOR000		



1

<b>GEV No.</b>	360005	<b>Ref. No.</b>	238052
<b>description</b>	timer BIGATTI D94 engines 1 chambers 1 operation time 20min 230V shaft ømm shaft Lmm manuf. no. WE006 motor type 82354021L		
<b>For models:</b>	811001, 811002, 811003		



1

<b>GEV No.</b>	360349	<b>Ref. No.</b>	238053	
<b>description</b>	timer CDC 11803 engines 1 chambers 3 operation time 150s 230V shaft ømm shaft Lmm manuf. no. 11803F1BEE000.0010 motor type M48R ATS type 11803F1 / 238046			
<b>For models:</b>	811001, 811002, 811003			
<b>spare parts for</b>	360349			
	<b>GEV No.</b>	360673	<b>Ref. No.</b>	—
	motor kit pinion ø 6.8mm teeth 15 230V voltage AC 50/60Hz turn direction clockwise motor ø 48mm H 18.5mm motor type UDS-40NE1RNZ165 cable length 150mm with holder			





1

<b>GEV No.</b>	360743	<b>Ref. No.</b>	PRG30002 PRG30005
<b>description</b>	timer CDC 11902F1 engines 1 chambers 2 operation time 240s 230V 50/60Hz manuf. no. 11902F1AGE000.0070 motor type M48R 230V		
<b>For models:</b>	211006, 211014, 211016, 211020, 211024, 211026, 212014, 212015, 212016		





1

<b>GEV No.</b>	360329	<b>Ref. No.</b>	01201040	
<b>description</b>	timer CDC 11902F3 engines 1 chambers 2 operation time 240s 230V manuf. no. PWE5J02H620 motor type M51B10R0000			
<b>For models:</b>	211039, 211045, 211046, 212034, 212036, 212038, 212040			
<b>spare parts for</b>	360329			
	<b>GEV No.</b>	360118	<b>Ref. No.</b>	—
	motor CDC pinion ø 4.9mm teeth 10 230V voltage AC 50/60Hz turn direction right motor ø 47mm H 19.3mm motor type M48R ATS for timer cable length 260mm 1.9/2.5W			





1

<b>GEV No.</b>	360525	<b>Ref. No.</b>	23247	
<b>description</b>	timer CDC 11904 engines 1 chambers 4 operation time 10min 230V shaft ømm shaft Lmm manuf. no. 11904F1 / BCR000.0000 motor type M48R ATS			
<b>For models:</b>	711002, 711003, 711004, 711005, 711006, 711007, 711008, 711009, 711010, 711011, 711012, 711013, 711014, 711015, 711016, 711017, 711018, 711019			
<b>spare parts for</b>	360525			
	<b>GEV No.</b>	360118	<b>Ref. No.</b>	—
	motor CDC pinion ø 4.9mm teeth 10 230V voltage AC 50/60Hz turn direction right motor ø 47mm H 19.3mm motor type M48R ATS for timer cable length 260mm 1.9/2.5W			

1

<b>GEV No.</b>	360524	<b>Ref. No.</b>	23222
<b>description</b>	timer CDC 11904 engines 1 chambers 4 operation time 12min 230V shaft ømm shaft Lmm manif. no. 11904F1 / BDR000.0000 motor type M48R ATS		
<b>For models:</b>	711004, 711005, 711006, 711007, 711008, 711009, 711010, 711011, 711012, 711013, 711014, 711015, 711016, 711017, 711018, 711019		
<b>spare parts for</b>	360524		
	<b>GEV No.</b>	360118	<b>Ref. No.</b> —



1

<b>GEV No.</b>	360565	<b>Ref. No.</b>	23780
<b>description</b>	timer CDC 11904 engines 1 chambers 4 operation time 18min 230V 50/60Hz shaft ømm shaft Lmm manif. no. 11904F1BFE000.0030 motor type M48R ATS voltage AC		
<b>For models:</b>	711004, 711005, 711006, 711007, 711008, 711009, 711010, 711011, 711012, 711013, 711014, 711015, 711016, 711017, 711018, 711019		



1

<b>GEV No.</b>	360566	<b>Ref. No.</b>	23259
<b>description</b>	timer CDC 11904 engines 1 chambers 4 operation time 15min 115V 60Hz shaft ømm shaft Lmm manif. no. 11904F1BEI000.0010 motor type M48R ATS voltage AC		
<b>For models:</b>	711004, 711005, 711006, 711007, 711008, 711009, 711010, 711011, 711012, 711013, 711014, 711015, 711016, 711017, 711018, 711019		





1

<b>GEV No.</b>	360752	<b>Ref. No.</b>	R65090190
<b>description</b>	timer CDC 4902F1 engines 1 chambers 2 operation time 8min 230V shaft ømm shaft Lmm		
<b>For models:</b>	212002, 212003, 212004, 212006, 212008, 212017, 212019		





1

<b>GEV No.</b>	360550	<b>Ref. No.</b>	23248
<b>description</b>	timer CDC 11904 engines 1 chambers 4 operation time 15min 230V 50/60Hz shaft ømm shaft Lmm manif. no. 11904F1 / BER000.0000		
<b>For models:</b>	711004, 711005, 711006, 711007, 711008, 711009, 711010, 711011, 711012, 711013, 711014, 711015, 711016, 711017, 711018, 711019		
<b>spare parts for</b>	360550		
	<b>GEV No.</b>	360118	<b>Ref. No.</b> —



1

<b>GEV No.</b>	360133	<b>Ref. No.</b>	238066
<b>description</b>	timer CDC 7804DV engines 2 chambers 4 operation time 60s / 20min 230V shaft ømm shaft Lmm manif. no. 7804DV / 360133 motor type M37RN/M37LN		
<b>For models:</b>	915234, 915235, 915236, 915237		
<b>spare parts for</b>	360133		
	<b>GEV No.</b>	360119	<b>Ref. No.</b> —
	<b>GEV No.</b>	360131	<b>Ref. No.</b> —



1

<b>GEV No.</b>	360413	<b>Ref. No.</b>	VN032
<b>description</b>	timer FIBER P19 engines 1 chambers 2 operation time 4min 230V 50Hz shaft ømm shaft Lmm		
<b>For models:</b>	211003		



1

<b>GEV No.</b>	360165	<b>Ref. No.</b>	23247 (old version)
<b>description</b>	timer FIBER P20 engines 1 chambers 4 operation time 10min 230V shaft ømm shaft Lmm manif. no. P205J04J414 motor type M51B-J0R6400		
<b>spare parts for</b>	360165		
	<b>GEV No.</b>	360673	<b>Ref. No.</b> —
	motor kit pinion ø 6.8mm teeth 15 230V voltage AC 50/60Hz turn direction clockwise motor ø 48mm H 18.5mm motor type UDS-40NE1RNZ165 cable length 150mm with holder		

electric timers



1

<b>GEV No.</b>	350135	<b>Ref. No.</b>	R65090090
<b>description</b>	timer MS65 operation time 120min time spreadmin 1CO/2NO at 250V 16A permanent position yes time range 0-120min impulse electric shaft ø 6x4.6mm shaft L 21mm mounting distance 28mm connection male faston 6.3mm screw mounting 250V voltage AC 50Hz		
<b>For models:</b>	212004, 212006, 212008, 212017, 212019		

mechanical timers



1

<b>GEV No.</b>	350134 <sup>1</sup>	<b>Ref. No.</b>	KTM001
<b>description</b>	time switch kit M2 2-pole operation time 120min impulse mechanical 2CO at 250V 16A permanent position yes shaft ø 6x4.6mm shaft 6x4.6mm shaft L 22mm mounting distance 28mm ambient temperature max. 125°C with knob		

<sup>1</sup>incl. knob and symbol



1

<b>GEV No.</b>	350128 <sup>1</sup>	<b>Ref. No.</b>	RG04342
<b>description</b>	timer C20 2-pole operation time 5min 2NO at 250V 16A shaft ø 6x4.6mm shaft L 20mm mounting distance 28mm		
<b>For models:</b>	451001		

<sup>1</sup>incl. knob



1

<b>GEV No.</b>	350181	<b>Ref. No.</b>	401550010
<b>description</b>	timer C20 with bell 2-pole operation time 15min impulse mechanical 2NO at 250V 16A permanent position yes shaft ø 6x4.6mm shaft 6x4.6mm shaft L 20mm mounting distance 28mm		
<b>For models:</b>	535001, 535002, 535004		



1

<b>GEV No.</b>	350202 <sup>1</sup>	<b>Ref. No.</b>	SA1115
<b>description</b>	timer G 2-pole operation time 30min impulse mechanical 2NO at 250V 16A permanent position yes shaft ø 6x4.6mm shaft 6x4.6mm shaft L 17mm mounting distance 28mm connection male faston 6.3mm TEMPOMATIC		
<b>For models:</b>	512018		

<sup>1</sup>incl. knob and symbol







1

<b>GEV No.</b>	350130	<b>Ref. No.</b>	6111300001 PRG30001
<b>description</b>	timer M11 with bell 1-pole operation time 120min impulse mechanical 1NO at 250V 16A permanent position yes shaft ø 6x4.6mm shaft L 23mm mounting distance 28mm mounting thread M4 connection male faston 6.3mm 4 hole fixing shaft flat upper		
<b>For models:</b>	211004, 211005, 211006, 211007, 211010, 211011, 211012, 211013, 211014, 211015, 211016, 211017, 211018, 211023, 211024, 211028, 212014		





			
1			
<b>GEV No.</b>	350182	<b>Ref. No.</b>	0AT93623 A0AT93623
<b>description</b>	timer M11 with bell 1-pole operation time 15min impulse mechanical 1NO at 250V 16A permanent position no shaft ø 6x4.6mm shaft 6x4.6mm shaft L 15mm mounting distance 28mm		
<b>For models:</b>	221007		

			
1			
<b>GEV No.</b>	350124	<b>Ref. No.</b>	8301080
<b>description</b>	timer M12 1-pole operation time 30min impulse mechanical 1NO at 250V 10A permanent position no shaft ø 6mm shaft 6mm shaft L 15mm mounting distance 28mm		
<b>For models:</b>	512002, 512003, 512004		
<b>accessories for</b>	350124		
		<b>GEV No.</b>	110372
		<b>Ref. No.</b>	—
	dial plate graduation 30min permanent position no rotation 30-330° ø 60mm timers knob ø 45mm		

			
1			
<b>GEV No.</b>	350159	<b>Ref. No.</b>	21004130
<b>description</b>	timer M2 2-pole operation time 120min impulse mechanical 2CO at 250V 16A permanent position yes shaft ø 6x4.6mm shaft 6x4.6mm shaft L 22mm mounting distance 28mm mounting thread M4 connection male faston 6.3mm ambient temperature max. 125°C with buzzer		
<b>spare parts for</b>	350159		
		<b>GEV No.</b>	350186
		<b>Ref. No.</b>	TM023
	timer M2 2-pole operation time 120min impulse mechanical 2CO at 250V 16A permanent position yes shaft ø 6x4.6mm shaft 6x4.6mm shaft L 23mm mounting distance 28mm		
		<b>GEV No.</b>	401062
		<b>Ref. No.</b>	—
	buzzer board 230VAC L 48mm W 45mm connection Faston 6.3mm		

			
1			
<b>GEV No.</b>	350184	<b>Ref. No.</b>	KTM003
<b>description</b>	timer M2 2-pole operation time 120min impulse mechanical 2CO at 250V 16A permanent position yes shaft ø 6x4.6mm shaft 6x4.6mm shaft L 23mm mounting distance 28mm		

			
1			
<b>GEV No.</b>	350186	<b>Ref. No.</b>	TM023
<b>description</b>	timer M2 2-pole operation time 120min impulse mechanical 2CO at 250V 16A permanent position yes shaft ø 6x4.6mm shaft 6x4.6mm shaft L 23mm mounting distance 28mm		
<b>For models:</b>	211002, 211003		
<b>accessories for</b>	350186		
		<b>GEV No.</b>	112627
		<b>Ref. No.</b>	—
	knob time 120min ø 58mm shaft ø 6x4.6mm shaft flat lower		

			
1			
<b>GEV No.</b>	350195	<b>Ref. No.</b>	3000000
<b>description</b>	timer M2 2-pole operation time 15min impulse mechanical 2NO at 250V 16A permanent position no shaft ø 6x4.6mm shaft 6x4.6mm shaft L 22mm mounting distance 28mm mounting thread M4 connection male faston 6.3mm		
<b>For models:</b>	221011, 221012		

			
1			
<b>GEV No.</b>	350185 <sup>1</sup>	<b>Ref. No.</b>	KTM005
<b>description</b>	timer M2 2-pole operation time 60min impulse mechanical 2CO at 250V 16A permanent position yes shaft 6x4.6mm shaft L 23mm mounting distance 28mm		

<sup>1</sup>incl. knob



audible timers



1

<b>GEV No.</b>	350187	<b>Ref. No.</b>	TM1005A0
<b>description</b>	timer M2 2-pole operation time 60min impulse mechanical 2CO at 250V 16A permanent position yes shaft ø 6x4.6mm shaft 6x4.6mm shaft L 23mm mounting distance 28mm		
<b>For models:</b>	211001		



1

<b>GEV No.</b>	350161 <sup>1</sup>	<b>Ref. No.</b>	SA1092
<b>description</b>	timer M2 3-pole operation time 5min impulse mechanical 3NO at 250V 16A permanent position no shaft ø 6x4.6mm shaft 6x4.6mm shaft L 22.5mm mounting distance 28mm connection male faston 6.3mm		
<b>For models:</b>	451003, 451004		

<sup>1</sup>incl. knob and symbol



1

<b>GEV No.</b>	360409	<b>Ref. No.</b>	401550000
<b>description</b>	timer MT49 2-pole operation time 15min impulse mechanical 2NO at 250V 16A permanent position no shaft 6x4.6mm shaft L 17mm mounting distance 28mm		
<b>For models:</b>	222002, 222003		



1

<b>GEV No.</b>	360447	<b>Ref. No.</b>	SA1087
<b>description</b>	timer T203 1-pole operation time 5min impulse mechanical 1NO at 250V 16(3)A permanent position no shaft ø 6x4.6mm shaft 6x4.6mm shaft L 16mm mounting distance 30mm connection rear ambient temperature max. 55°C		
<b>For models:</b>	451003, 451004		



1

<b>GEV No.</b>	350180	<b>Ref. No.</b>	401550025
<b>description</b>	audible timer operation time 120min ø 56mm shaft ø 6x4.6mm shaft L 24mm mounting distance 28mm		
<b>For models:</b>	111003		



1

<b>GEV No.</b>	350036	<b>Ref. No.</b>	1031006400
<b>description</b>	audible timer operation time 60min ø 55mm shaft ø 6x4.6mm shaft L 22mm mounting distance 28mm		

alarm devices

alarm units



1

<b>GEV No.</b>	350114	<b>Ref. No.</b>	6A021955
<b>description</b>	buzzer 110-240VAC ø 22.5mm H 68mm built-in version mounting ø 22.5 80dB		

buzzers

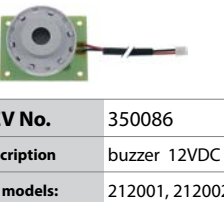

1

<b>GEV No.</b>	350086	<b>Ref. No.</b>	R65301440
<b>description</b>	buzzer 12VDC connection cable 200mm PCB buzzer 20dB		
<b>For models:</b>	212001, 212002, 212003		





contactors

GENERAL ELECTRIC (AEG)

power contactors



1

<b>GEV No.</b>	380239	<b>Ref. No.</b>	6A047031 BN6A047031
<b>description</b>	power contactor resistive load 20A 230VAC (AC3/400V) 8.4A/4kW main contacts 3NO auxiliary contacts 1NC connection screw connection type LS05 01A type AEG LS05 01A type GE MC1A 301A		
<b>For models:</b>	134003, 134203, 141005, 141007, 141013, 141016, 141021, 144010		



1

<b>GEV No.</b>	380837	<b>Ref. No.</b>	8301090
<b>description</b>	power contactor resistive load 20A 400VAC (AC3/400V) 9A/4kW main contacts 3NO auxiliary contacts 1NO connection screw connection type AEG LS0510A type GE MC1A 310A		
<b>For models:</b>	512002, 512003, 512004		



1

<b>GEV No.</b>	381095	<b>Ref. No.</b>	KVE019 VE1095A0
<b>description</b>	power contactor resistive load 25A 230VAC (AC3/400V) 12A/5.5kW main contacts 3NO auxiliary contacts 1NO connection screw connection type AEG type GE CL01A400T6		
<b>For models:</b>	211003		



1

<b>GEV No.</b>	380245	<b>Ref. No.</b>	6A047034 BN6A047034
<b>description</b>	power contactor resistive load 25A 230VAC (AC3/400V) 9A/4kW main contacts 3NO auxiliary contacts 1NC connection screw connection type AEG LS4K 01A type GE CL00A 301 H 85mm		
<b>For models:</b>	144008		



1

<b>GEV No.</b>	380262	<b>Ref. No.</b>	BN6A047036
<b>description</b>	power contactor resistive load 32A 230VAC (AC3/400V) 17A/7.5kW main contacts 3NO auxiliary contacts 1NC connection screw connection type AEG LS7K01A type GE CL02A 301 H 85mm		
<b>For models:</b>	144009, 144012		



1

<b>GEV No.</b>	380261	<b>Ref. No.</b>	853310065
<b>description</b>	power contactor resistive load 32A 230VAC (AC3/400V) 17A/7.5kW main contacts 3NO auxiliary contacts 1NO connection screw connection type AEG LS7K 10A type GE CL02A 310		
<b>For models:</b>	136002, 136202		



## ISKRA (FANAL)

## power contactors



1

<b>GEV No.</b>	380212	<b>Ref. No.</b>	120461
<b>description</b>	power contactor resistive load 20A 230VAC (AC3/400V) 8.5A/5.5kW main contacts 3NO auxiliary contacts 1NC connection screw connection type Fanal K07M 01 type ISKRA DSL7 01		
<b>For models:</b>	SP2-12, SP2-S12		

## LOVATO

## power contactors





1

<b>GEV No.</b>	381102	<b>Ref. No.</b>	0221005
<b>description</b>	power contactor resistive load 20A 24VAC (AC3/400V) 9A/4kW main contacts 4NO auxiliary contacts connection screw connection type 11BG09T4A24		
<b>For models:</b>	442003, 442004, 442005, 442006, 442007, 442008		



1

<b>GEV No.</b>	380855	<b>Ref. No.</b>	41826630300
<b>description</b>	power contactor resistive load 25A 230VAC (AC3/400V) 4.2kW main contacts 3NO auxiliary contacts 1NO		
<b>For models:</b>	124001, 124002		
<b>accessories for</b>	380855		
	<b>GEV No.</b>	380055	<b>Ref. No.</b> —
	RC circuit voltage AC/DC suitable for BF09-32 rated 240V		
	<b>GEV No.</b>	380118	<b>Ref. No.</b> —
	auxiliary contact contacts 1NO/1NC AC1 10A for contactors BF series connection screw type G480/11		



1

<b>GEV No.</b>	380083	<b>Ref. No.</b>	120444 120481
<b>description</b>	power contactor resistive load 25A 230VAC (AC3/400V) 9A/4.2kW main contacts 3NO auxiliary contacts 1NC connection screw connection type BF0901A230		
<b>For models:</b>	SP3		



1

<b>GEV No.</b>	380714	<b>Ref. No.</b>	EN17000
<b>description</b>	power contactor resistive load 25A 230VAC (AC3/400V) 9A/4.2kW main contacts 3NO auxiliary contacts 1NO connection screw connection type BF0910A230		
<b>For models:</b>	531010, 531011, 531012, 531013, 531014, 531015, 531016, 531017		



1

<b>GEV No.</b>	380525	<b>Ref. No.</b>	0221108
<b>description</b>	power contactor resistive load 25A 230VAC (AC3/400V) 9A/4.2kW main contacts 4NO auxiliary contacts connection screw connection type BF09T4A230		



1

<b>GEV No.</b>	381103	<b>Ref. No.</b>	0221106
<b>description</b>	power contactor resistive load 25A 24VAC (AC3/400V) 9A/4.2kW main contacts 4NO auxiliary contacts connection screw connection type BF09T4A024		
<b>For models:</b>	442003, 442004, 442005, 442006, 442007, 442008		



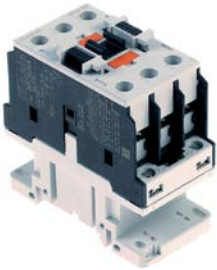

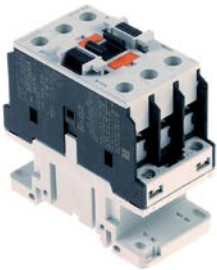
			
1			
<b>GEV No.</b>	380722	<b>Ref. No.</b>	0221013
<b>description</b>	power contactor resistive load 56A 230VAC (AC3/400V) 32A/16kW main contacts 3NO auxiliary contacts connection screw connection type BF3200A230		

			
1			
<b>GEV No.</b>	381104	<b>Ref. No.</b>	0221112
<b>description</b>	power contactor resistive load 56A 24VAC (AC3/400V) 32A/16kW main contacts 3NO auxiliary contacts connection screw connection type BF3200A024		
<b>For models:</b>	442003, 442004, 442005, 442006, 442007, 442008		

overload switches

			
1			
<b>GEV No.</b>	381099	<b>Ref. No.</b>	0221133
<b>description</b>	overload switch setting range 13-18A for contactors BF (09-38) series connection screw		
<b>For models:</b>	442003, 442004, 442005, 442006, 442007, 442008		

			
1			
<b>GEV No.</b>	381100	<b>Ref. No.</b>	0221134
<b>description</b>	overload switch setting range 17-23A for contactors BF (09-38) series connection screw		

			
1			
<b>GEV No.</b>	380753	<b>Ref. No.</b>	0221123
<b>description</b>	overload switch setting range 2.5-4A for contactors BF (09-38) series connection screw		

			
1			
<b>GEV No.</b>	381112	<b>Ref. No.</b>	120869
<b>description</b>	overload switch setting range 2-3.3A type RF38 0330		
<b>For models:</b>	SP3		

			
1			
<b>GEV No.</b>	381101	<b>Ref. No.</b>	0221136
<b>description</b>	overload switch setting range 24-32A for contactors BF (09-38) series connection screw		

			
1			
<b>GEV No.</b>	380754	<b>Ref. No.</b>	0221124
<b>description</b>	overload switch setting range 4-6.5A for contactors BF (09-38) series connection screw		
<b>For models:</b>	442003, 442004, 442005, 442006, 442007, 442008		

			
1			
<b>GEV No.</b>	381097	<b>Ref. No.</b>	0221129
<b>description</b>	overload switch setting range 6.3-10A for contactors BF (09-38) series connection screw		
<b>For models:</b>	442003, 442004, 442005, 442006, 442007, 442008		



1

<b>GEV No.</b>	381098	<b>Ref. No.</b>	0221130
<b>description</b>	overload switch setting range 9-14A for contactors BF (09-38) series connection screw		
<b>For models:</b>	442003, 442004, 442005, 442006, 442007, 442008		

**MOELLER/EATON**

**power contactors**







1

<b>GEV No.</b>	380172	<b>Ref. No.</b>	877121000
<b>description</b>	power contactor resistive load 20A 230VAC (AC3/400V) 9A/4kW main contacts 3NO auxiliary contacts 1NC connection screw connection type DILEM 01		
<b>For models:</b>	644006, 644007, 644008, 644009, 644010, 644011, 644012		



1

<b>GEV No.</b>	380550	<b>Ref. No.</b>	R65140550 R65140700
<b>description</b>	power contactor resistive load 20A 230VAC (AC3/400V) 9A/4kW main contacts 3NO auxiliary contacts 1NC connection screw connection type DILM9 01		
<b>For models:</b>	212001, 212002, 212003, 212010, 212011, 212012, 212013		
<b>accessories for</b>	380550		
	<b>GEV No.</b>	380555	<b>Ref. No.</b> —
	auxiliary contact contacts 2NO/2NC AC15 16A for contactors DILEM connection screw type DILA-XHI22		
	<b>GEV No.</b>	380556	<b>Ref. No.</b> —
	auxiliary contact contacts 4NO AC15 16A for contactors DILM 7-32 connection screw type DILA-XHI40		
	<b>GEV No.</b>	380557	<b>Ref. No.</b> —
	auxiliary contact contacts 4NC AC15 16A for contactors DILM 7-32 connection screw type DILA-XHI04		
	<b>GEV No.</b>	380558	<b>Ref. No.</b> —
	auxiliary contact contacts 3NO/1NC AC15 16A for contactors DILM 7-32 connection screw type DILA-XHI31		
	<b>GEV No.</b>	380559	<b>Ref. No.</b> —
	auxiliary contact contacts 1NO/3NC AC15 16A for contactors DILM 7-32 connection screw type DILA-XHI13		

**accessories for** 380550

	<b>GEV No.</b>	380568	<b>Ref. No.</b>	—
	RC circuit suitable for DILM 9-12 rated 110-240V			



1

<b>GEV No.</b>	381005	<b>Ref. No.</b>	R65140710
<b>description</b>	power contactor resistive load 35A 230VAC (AC3/400V) 17A/7.5kW main contacts 3NO auxiliary contacts 1NC connection screw connection type DILM 17-01		
<b>For models:</b>	212003, 212012, 212013		

**overload switches**



1

<b>GEV No.</b>	381006	<b>Ref. No.</b>	R65160420 R65160760
<b>description</b>	overload switch connection screw setting range 1-1.6A type ZB12		
<b>For models:</b>	212003, 212012, 212013		

**auxiliary contacts**



1

<b>GEV No.</b>	381007	<b>Ref. No.</b>	R65140730
<b>description</b>	auxiliary contact contacts 1NO/1NC AC15 10A for contactors connection screw type DILA-XHI11		
<b>For models:</b>	212002, 212010, 212011		



1

<b>GEV No.</b>	380565	<b>Ref. No.</b>	R65140740
<b>description</b>	auxiliary contact contacts 1NO/1NC AC15 10A for contactors DIL 17-32 connection screw type DILM 32-CHI11-S		
<b>For models:</b>	212003, 212012, 212013		



SIEMENS

power contactors



1

<b>GEV No.</b>	380526	<b>Ref. No.</b>	01201680
<b>description</b>	power contactor resistive load 20A 230VAC (AC3/400V) 8.4A/4kW main contacts 4NO auxiliary contacts connection screw connection type 3TG10-10-0A2L2		
<b>For models:</b>	211039, 211042, 211043, 211044, 211045, 211046, 212034, 212035, 212036, 212037, 212038, 212039, 212040, 212041		



1

<b>GEV No.</b>	380652	<b>Ref. No.</b>	R65140380
<b>description</b>	power contactor resistive load 22A 230VAC (AC3/400V) 9A/4kW main contacts 3NO auxiliary contacts 1NC connection screw connection type 3RT10-16-1AP02		
<b>For models:</b>	212004, 212005, 212006, 212007, 212008, 212009, 212017, 212018		



1

<b>GEV No.</b>	380389	<b>Ref. No.</b>	229037 74550230 MACM187300
<b>description</b>	power contactor resistive load 22A 230VAC (AC3/400V) 9A/4kW main contacts 3NO auxiliary contacts 1NO connection screw connection type 3RT10-16-1AP01		
<b>For models:</b>	123118, 123119, 124101, 124102, 126101, 126103, 146006, 146007, 531003, 531004, 531005, 531006, 531007, 531008, 813001		



1

<b>GEV No.</b>	380390	<b>Ref. No.</b>	74550500
<b>description</b>	power contactor resistive load 40A 230VAC (AC3/400V) 12A/5.5kW main contacts 3NO auxiliary contacts connection screw connection type 3RT10-24-1AL20 50/60Hz		
<b>For models:</b>	531007, 531008		



1

<b>GEV No.</b>	380646	<b>Ref. No.</b>	R65140400
<b>description</b>	power contactor resistive load 40A 230VAC (AC3/400V) 17A/7.5kW main contacts 3NO auxiliary contacts connection screw connection type 3RT10-25-1AL20		
<b>For models:</b>	212019, 212020		

auxiliary contacts



1

<b>GEV No.</b>	380647	<b>Ref. No.</b>	R65140430
<b>description</b>	auxiliary contact contacts 1NO/1NC AC15 3A for contactors 3RT102 3 RT103 connection screw connection type 3RH1921-1EA11 resistive load 10A AC-12 10A		
<b>For models:</b>	212018, 212020		

overload switches



1

<b>GEV No.</b>	380656	<b>Ref. No.</b>	R65160110
<b>description</b>	overload switch setting range 0.63-1A		



TELEMECANIQUE (Schneider Electric)

power contactors



1			
<b>GEV No.</b>	380962	<b>Ref. No.</b>	00-695521-062
<b>description</b>	contactor resistive load 20A 230VAC (AC3/400V) 9A/4kW main contacts 4NO connection screw connection type LC1K09004U7		
<b>For models:</b>	811011, 811012, 811013, 811014, 811015, 812011, 812012, 812013, 812014, 812015		



1			
<b>GEV No.</b>	380479	<b>Ref. No.</b>	401531090
<b>description</b>	power contactor resistive load 25A 230VAC (AC3/400V) 9A/4kW main contacts 3NO auxiliary contacts 1NO/1NC connection screw connection type LC1D09P7		



1			
<b>GEV No.</b>	380976	<b>Ref. No.</b>	401531000
<b>description</b>	power contactor resistive load 32A 230VAC (AC3/400V) 18A/7.5kW main contacts 3NO auxiliary contacts 1NO/1NC connection screw connection		
<b>For models:</b>	114001, 114002, 244003, 244004, 244007, 244008		



1			
<b>GEV No.</b>	380979	<b>Ref. No.</b>	401531050
<b>description</b>	power contactor resistive load 40A 230VAC (AC3/400V) 25A/11kW main contacts 3NO auxiliary contacts 1NO/1NC connection screw connection type LC1D25P7		
<b>For models:</b>	244009, 244021		

miscellaneous

accessories



1			
<b>GEV No.</b>	381096	<b>Ref. No.</b>	KVM1075A VM1075A0 VM1075A1
<b>description</b>	clip for contactor		
<b>For models:</b>	211003		

relays

power relays

with DIN rail mounting

lateral



1				
<b>GEV No.</b>	380336	<b>Ref. No.</b>	R65170100	
<b>description</b>	power relays FINDER 230VAC 16A 2NO connection male faston 6.3mm DIN rail manuf. no. 62.82.8.230.0308			
<b>For models:</b>	212001, 212005, 212007, 212009			
<b>accessories for</b>	380336			
	<b>GEV No.</b>	380703	<b>Ref. No.</b>	—
	adapter for flange mounting suitable for Finder relay 62 series.			
	<b>GEV No.</b>	380811	<b>Ref. No.</b>	—
	adapter with bracket mounting suitable for Finder relay 62 series.			
	<b>GEV No.</b>	380954	<b>Ref. No.</b>	—
	adapter hole distance 54mm bracket mounting suitable for Finder relay 62 series. L 41mm W 39mm H 49mm			

Table continues overleaf

<b>accessories for</b> 380336			
	<b>GEV No.</b>	381003	<b>Ref. No.</b> —
adapter for DIN rail mounting suitable for FINDER relay 62 series.			
	<b>GEV No.</b>	381039	<b>Ref. No.</b> —
adapter for DIN rail mounting suitable for FINDER relay 62 series.			

with bracket mounting

1			
<b>GEV No.</b>	380312	<b>Ref. No.</b>	229023 229024
<b>description</b>	power relays FINDER 230VAC 10A 3CO connection male faston 4.8mm bracket mounting dimensions 52x32.2x36.5mm manuf. no. 60.63.8.230.0000		
<b>For models:</b>	811001, 811002, 811003, 915234, 915235, 915236, 915237		

1			
<b>GEV No.</b>	380139	<b>Ref. No.</b>	0648301900 826630250 929115 WY28286002
<b>description</b>	power relays FINDER 230VAC 16A 2CO connection F6.3 bracket mounting dimensions 68x38.2x35.8mm manuf. no. 62.82.8.230.0000		
<b>For models:</b>	135001, 135002, 135003, 135004, 744001, 744002, 813001, 913013, 913014, 913015, 913016, 913017, 913018, 913019, 913020, 913021, 913022, 913023, 913024, 914003, 914004, 914005, 914006, 914009, 914010, 914011, 914012, 914021, 914022, 914023, 914024		

1			
<b>GEV No.</b>	380702	<b>Ref. No.</b>	229039 229040
<b>description</b>	power relays FINDER 230VAC 16A 3NO connection male faston 6.3mm flange dimensions 36x38x68mm manuf. no. 62.83.8.230.0300 230V		
<b>For models:</b>	812001, 812002, 812003, 812004, 812005, 812006, 812007, 812008, 812009, 812010, 915234, 915235, 915236, 915237, 915460, 915461, 915462, 915463, 915464, 915465		

1			
<b>GEV No.</b>	380900	<b>Ref. No.</b>	01200020
<b>description</b>	power relays FINDER 230VAC 20A 1NO/1NC connection F6.3 bracket mounting dimensions 36.5x32.2x51.8mm manuf. no. 65.31.8.230.0000 2-pole		
<b>For models:</b>	212034, 212036, 212038, 212040		

1			
<b>GEV No.</b>	380185	<b>Ref. No.</b>	229029 880302100
<b>description</b>	power relays Italiana Relè 230VAC 30A 1NO connection F6.3 bracket mounting dimensions 36.5x32.2x51.8mm manuf. no. A10-230AC-FA		
<b>For models:</b>	644006, 813001		

1			
<b>GEV No.</b>	380368	<b>Ref. No.</b>	WY18460001
<b>description</b>	power relays ZETTLER ELECTRONICS 230VAC 30A 1NO/1NC connection male faston 6.3mm bracket mounting manuf. no. AZ 2280-1A-240AF AZ2280-1C-240AF		

with male contacts

bullet connectors, 8 contacts

1			
<b>GEV No.</b>	380951	<b>Ref. No.</b>	CR0683840
<b>description</b>	power relays FINDER 230VAC 10A 2CO connection plug-in connection round 8-pole manuf. no. 60.12.4.101.0040 90.26/ZVE8 250V		
<b>For models:</b>	146002, 146007		



female contact 2.0mm







1

<b>GEV No.</b>	380048	<b>Ref. No.</b>	8301370
<b>description</b>	power relays 24VDC 5A 2CO plug-in connection with socket 250V 2-pole		
<b>For models:</b>	512002, 512003, 512004		



1

<b>GEV No.</b>	380377	<b>Ref. No.</b>	6A047070	
<b>description</b>	power relays FINDER 220-240VAC 10A 2CO connection F2 plug-in connection manuf. no. 55.32.8.230.0000 94.92.3 250V			
<b>accessories for</b>	380377			
	<b>GEV No.</b>	380341	<b>Ref. No.</b>	—
	relay socket 4-pole contacts 12 300V voltage AC 6A Italiana Relè manuf. no. ZMD4			
	<b>GEV No.</b>	380378	<b>Ref. No.</b>	—
	relay socket 2-pole 55/85 dimensions 70.5x30x27mm 250V voltage AC 10A FINDER manuf. no. 94.72			
	<b>GEV No.</b>	380384	<b>Ref. No.</b>	6A047074
	relay socket 2-pole contacts male faston 2.8mm 250V voltage AC 10A W 23mm for			
	<b>GEV No.</b>	380399	<b>Ref. No.</b>	—
	relay socket 4-pole dimensions 76.2x27x86.1mm 250V voltage AC 1A FINDER manuf. no. 94.94.3			





1

<b>GEV No.</b>	380494	<b>Ref. No.</b>	WY18460003	
<b>description</b>	power relays FINDER 230VAC 7A 4CO connection F2 plug-in connection manuf. no. 55.34.8.230.0054 94.74/ZMD4 250V connection 2mm			
<b>accessories for</b>	380494			
	<b>GEV No.</b>	380341	<b>Ref. No.</b>	—
	relay socket 4-pole contacts 12 300V voltage AC 6A Italiana Relè manuf. no. ZMD4			
	<b>GEV No.</b>	380399	<b>Ref. No.</b>	—
	relay socket 4-pole dimensions 76.2x27x86.1mm 250V voltage AC 1A FINDER manuf. no. 94.94.3			

plug-in/print relays



1

<b>GEV No.</b>	380333	<b>Ref. No.</b>	R65170050	
<b>description</b>	print relay 230VAC 2CO at 250V 8A connection pins raster size 5mm FINDER manuf. no. 40.52.8.230.0000 95.65/95.75			
<b>For models:</b>	212002, 212003			
<b>accessories for</b>	380333			
	<b>GEV No.</b>	380340	<b>Ref. No.</b>	—
	relay socket dimensions 62x36x15mm 250V voltage AC 10A Italiana Relè manuf. no. ZMEM/5			
	<b>GEV No.</b>	380505	<b>Ref. No.</b>	—
	relay socket 2CO 40.52 dimensions 81.9x15.5x75mm 250V voltage AC 10A FINDER manuf. no. 95.95.3			
	<b>GEV No.</b>	381181	<b>Ref. No.</b>	—
	relay socket 2-pole 40.51/40.52/40.61 connection screw clamp dimensions 15.8x78.6mm 250V voltage AC 10A FINDER manuf. no. 95.75			

relay sockets



1

<b>GEV No.</b>	380384	<b>Ref. No.</b>	6A047074	
<b>description</b>	relay socket 2-pole contacts male faston 2.8mm 250V voltage AC 10A W 23mm for			
<b>accessories for</b>	380384			
	<b>GEV No.</b>	380804	<b>Ref. No.</b>	—
	support bracket			



1

<b>GEV No.</b>	380802	<b>Ref. No.</b>	WY18454101	
<b>description</b>	relay socket 4-pole 55/85 dimensions 70.5x30x27mm 250V voltage AC 10A FINDER manuf. no. 94.74			
<b>accessories for</b>	380802			
	<b>GEV No.</b>	380804	<b>Ref. No.</b>	—
	support bracket			



1

<b>GEV No.</b>	380638	<b>Ref. No.</b>	MA2609500
<b>description</b>	relay socket 8-pole dimensions 51x41x23mm 250V 10A FINDER manuf. no. 90.26		
<b>For models:</b>	146002, 146007		

level relays

GIEMME



1

<b>GEV No.</b>	400537	<b>Ref. No.</b>	WY18080001
<b>description</b>	level relay 230V voltage AC 50/60Hz 8A connection F6.3 type RL1E/2C/F		
<b>For models:</b>	742001, 742002, 742003, 742004		



1

<b>GEV No.</b>	400786	<b>Ref. No.</b>	WY18045
<b>description</b>	level relay 230V voltage AC 5A connection F6.3 type MFC 2S		
<b>For models:</b>	742005		

miscellaneous



1

<b>GEV No.</b>	402067	<b>Ref. No.</b>	877121500
<b>description</b>	level relay 230V voltage AC type RNP20-023		
<b>For models:</b>	644007, 644010, 644011, 644012		

time relays

time relays



1

<b>GEV No.</b>	381421	<b>Ref. No.</b>	R65090450
<b>description</b>	time relay CROUZET EMAR7 88 829 117 time range 0.1s-20h 240VAC 5A NO connection grip connection		
<b>For models:</b>	212002, 212003		



1

<b>GEV No.</b>	380489	<b>Ref. No.</b>	R65090480
<b>description</b>	time relay CROUZET MUR1-88826105 time range 0.1s-100h 24-240VAC/24VDC 8A mounting measurements DIN railmm 1CO connection grip connection		
<b>For models:</b>	212001		

magnetrons



1

<b>GEV No.</b>	402121	<b>Ref. No.</b>	RV-MZA299WRE0
<b>description</b>	Magnetron type 2M240H(L2)		
<b>For models:</b>	213001		



1

<b>GEV No.</b>	402119	<b>Ref. No.</b>	RV-MZA335WRZZ
<b>description</b>	Magnetron type 2M281H(L)		
<b>For models:</b>	213002		

1

<b>GEV No.</b>	402120	<b>Ref. No.</b>	RV-MZA322WREZ
<b>description</b>	Magnetron type 2M282H(L)		
<b>For models:</b>	213003		

1

<b>GEV No.</b>	402131	<b>Ref. No.</b>	RTRNPA005WRZZ
<b>description</b>	transformer primary 230VAC secondary 12VAC 60VA secondaryA H 50mm L 45mm W 74mm connection cable 50/60Hz type RTRNPA-005WRZZ		
<b>For models:</b>	213002, 213003		

1

<b>GEV No.</b>	403323	<b>Ref. No.</b>	8301360 con schedina 8301360 old
<b>description</b>	transformer primary 230VAC secondary 24VDC 12VA secondary 0.5A connection cable 50/60Hz with rectifier		

with clamp terminal

1

<b>GEV No.</b>	402080	<b>Ref. No.</b>	0223026
<b>description</b>	transformer primary 220/380VAC secondary 0-20VAC 600VA connection screw connection 50/60Hz		

1

<b>GEV No.</b>	402081	<b>Ref. No.</b>	0223032
<b>description</b>	transformer primary 220/380VAC secondary 0-21.4VAC 900VA connection screw connection 50/60Hz		
<b>For models:</b>	442006		

transformers

open transformers

with cable connection

1

<b>GEV No.</b>	403094	<b>Ref. No.</b>	8301350 8301350 old
<b>description</b>	transformer primary 230/400VAC secondary 24VDC 18VA secondary 0.75A L 57mm W 26mm connection cable 50/60Hz with rectifier		
<b>For models:</b>	512002, 512003, 512004		

1

<b>GEV No.</b>	400058	<b>Ref. No.</b>	098792
<b>description</b>	transformer primary 230V secondary 15V 15VA connection cable 250mm 50/60Hz		
<b>For models:</b>	743001		

1

<b>GEV No.</b>	402086	<b>Ref. No.</b>	0223011
<b>description</b>	transformer primary 230/400VAC secondary 0-9/0-24VAC 64.5VA connection screw 50/60Hz		
<b>For models:</b>	442003, 442004, 442005, 442006, 442007, 442008		



1

<b>GEV No.</b>	402084	<b>Ref. No.</b>	0223049
<b>description</b>	transformer primary 380/400VAC secondary 0-24VAC 1150VA connection screw connection 50/60Hz		



1

<b>GEV No.</b>	402082	<b>Ref. No.</b>	0223035
<b>description</b>	transformer primary 380/400VAC secondary 0-33,1VAC 1150VA connection screw connection 50/60Hz		



1

<b>GEV No.</b>	402083	<b>Ref. No.</b>	0223042
<b>description</b>	transformer primary 380/400VAC secondary 0-46VAC 1150VA connection screw connection 50/60Hz		

encapsulated transformers

multiple connections



1

<b>GEV No.</b>	402085	<b>Ref. No.</b>	0223004
<b>description</b>	transformer primary 230VAC secondary 24VAC 30VA secondary 1.25A connection male faston 6.3mm 50/60Hz type 65.16.230.323.224.05		
<b>For models:</b>	442010		

PMA



1

<b>GEV No.</b>	400126	<b>Ref. No.</b>	R65180420
<b>description</b>	transformer primary 230VAC secondary 12VAC 20VA secondary 2.1A connection screw 50Hz		
<b>For models:</b>	212001, 212002, 212003, 212005, 212007, 212009, 212010, 212011, 212012, 212013, 212018, 212020		

for lighting



1

<b>GEV No.</b>	403698	<b>Ref. No.</b>	00012590
<b>description</b>	transformer primary 230VAC secondary 12VAC 105VA secondary A L 128mm W 38mm H 28mm 50/60Hz		
<b>For models:</b>	212038, 212039, 212040, 212041		

HV transformers



1

<b>GEV No.</b>	402130	<b>Ref. No.</b>	RTRN-A717WRZZ
<b>description</b>	HV transformer primary 230/240V 50Hz type RTRN-A717WRZZ for microwaves		
<b>For models:</b>	213001		



electric components



1

<b>GEV No.</b>	402129	<b>Ref. No.</b>	RTRN-A741WRZZ
<b>description</b>	HV transformer primary 235V 50Hz type RTRN-A741WRZZ for microwaves		
<b>For models:</b>	213002		



1

<b>GEV No.</b>	402128	<b>Ref. No.</b>	RTRN-A742WRZZ
<b>description</b>	HV transformer primary 235V 50Hz type RTRN-A742WRZZ for microwaves		
<b>For models:</b>	213002		



1

<b>GEV No.</b>	378370	<b>Ref. No.</b>	74700883
<b>description</b>	electronic controller CAREL PYAO1R0523 mounting measurements 71x29mm built-in depth 74mm 230V voltage AC NTC relay outputs 3 NO-10A(10) CO-8A(4) NO-8A(4) NTC NTC DI yes protection IP54 -50 up to +90°C display 3½ digits		
<b>For models:</b>	651118		

DIXELL

refrigeration controllers  
built-in version



1

<b>GEV No.</b>	402143	<b>Ref. No.</b>	R35-0375
<b>description</b>	electronic controller DIXELL R35-0375 mounting measurements 71x29mm		
<b>For models:</b>	621004, 621005, 622004		



1

<b>GEV No.</b>	378256	<b>Ref. No.</b>	AK15038-014 R00084 S900.02
<b>description</b>	electronic controller DIXELL XR02CX-5NOC0 mounting measurements 71x29mm built-in depth 56mm 230V voltage AC NTC relay outputs 1 CO-8A(4) NTC protection IP54 defrosting function/time control -40 up to +110°C display 2½ digit		
<b>For models:</b>	554013, 611007, 611008, 611009, 611010, 611011, 611015, 621018		
<b>spare parts for</b>	378256		

<b>GEV No.</b>	379161	<b>Ref. No.</b>	167211 74700916 BN167211 Q32-0578 R00213 RC0321 S900.32
<b>description</b>	temperature probe NTC 10kOhm cable thermoplastic probe -40 up to +110°C cable -40 up to +110°C probe ø6x14mm cable length 3m without screw connection 2-wire		
<b>accessories for</b>	378256		
<b>GEV No.</b>	378194	<b>Ref. No.</b>	—
<b>description</b>	temperature probe NTC 10kOhm cable PVC probe -20 up to +80°C cable -10 up to 100°C probe ø7x24.5mm cable length 1.5m without screw connection 2-wire		

Table continues overleaf

electronic controllers

CAREL

refrigeration controllers  
built-in version



1

<b>GEV No.</b>	378301	<b>Ref. No.</b>	74700742
<b>description</b>	electronic controller CAREL mounting measurements 71x29mm built-in depth 65mm 250V voltage AC NTC relay outputs 12A/10A with screw clamps protection IP65 -50 up to +90°C display 2½ digits + algebraic sign resolution 1°C RoomTempIN 1 TempIN3 1 type PJA0-S0A01K front measurements 81x36mm		
<b>For models:</b>	651010, 651011, 651012, 652004		



1

<b>GEV No.</b>	378329	<b>Ref. No.</b>	74700881
<b>description</b>	electronic controller CAREL PYAO1C0522 mounting measurements 71x29mm built-in depth 59mm 230V voltage AC NTC relay outputs 1 CO-12A(2) NTC yes protection IP65 -50 up to +90°C display 3½ digits		
<b>For models:</b>	651015, 651016, 651017, 651018, 651019, 651025, 651026, 651032, 651033, 651034, 651035, 651036, 651037, 651038, 651046, 651047, 651048, 651049, 651050, 651072, 651073, 651074, 651075, 651076, 651077, 651078, 651079, 651080, 651081, 651089, 651090, 651091, 651097, 651098, 651099, 651100, 651101, 651102, 651103, 651104, 651105, 651106, 651107, 651108, 651109, 651110, 651111, 651112, 651113, 651114...(Other models you can see in the webshop)		



<b>accessories for</b> 378256			
<b>GEV No.</b>	379057	<b>Ref. No.</b>	—
temperature probe NTC 10kOhm cable PVC probe -20 up to +80°C cable -10 up to 100°C probe ø6x25mm cable length 3m 2-wire			
<b>GEV No.</b>	379160	<b>Ref. No.</b>	0646305800 167212 BN167212
temperature probe NTC 10kOhm cable thermoplastic probe -40 up to +110°C cable -40 up to +110°C probe ø6x14mm cable length 1.5m without screw connection 2-wire			
<b>GEV No.</b>	379161	<b>Ref. No.</b>	167211 74700916 BN167211 Q32-0578 R00213 RC0321 S900.32
temperature probe NTC 10kOhm cable thermoplastic probe -40 up to +110°C cable -40 up to +110°C probe ø6x14mm cable length 3m without screw connection 2-wire			
<b>GEV No.</b>	379343	<b>Ref. No.</b>	—
temperature probe NTC 10kOhm cable silicone probe -40 up to +110°C cable -50 up to +180°C probe ø6x40mm cable length 3m 2-wire			
<b>GEV No.</b>	379458	<b>Ref. No.</b>	—
temperature probe NTC 10kOhm cable silicone probe -40 up to +110°C cable -50 up to +180°C probe ø6x40mm cable length 1.5m without screw connection 2-wire			

			
<b>GEV No.</b>	378273	<b>Ref. No.</b>	GN650BT.16
<b>description</b>	electronic controller DIXELL XR06CX-5N0C1 mounting measurements 71x29mm 230V voltage AC NTC -40 up to +110°C display 2½ digit DEF Relay 8A fan relay 8A compressor relay 20A		
<b>For models:</b>	611013, 611014, 613016, 613017, 621019		

			
<b>GEV No.</b>	378363	<b>Ref. No.</b>	R35-XR06CX
<b>description</b>	electronic controller DIXELL XR06CX-5R0C1 mounting measurements 71x29mm 230V voltage AC NTC relay outputs 3 NO-20A(8) CO-8A(3) NO-5A(2) NTC NTC DI protection IP54 -40 up to +110°C display 3½ digits		
<b>For models:</b>	628004		
<b>accessories for</b>	378363		
<b>GEV No.</b>	381249	<b>Ref. No.</b>	—
temperature probe NTC 10kOhm cable PVC probe -40 up to +110°C cable -10 up to 100°C connection 2-wire thread probe ø6x14mm cable length 3m			













			
<b>GEV No.</b>	378000	<b>Ref. No.</b>	A08EB22
<b>description</b>	electronic controller DIXELL XR20CX-5N0C1 mounting measurements 71x29mm 230V voltage AC NTC/PTC relay outputs 1 NO-20A(8) NTC/PTC NTC/PTC/DI protection IP54 -50 up to +150°C display 3½ digits		
<b>accessories for</b>	378000		
<b>GEV No.</b>	378194	<b>Ref. No.</b>	—
temperature probe NTC 10kOhm cable PVC probe -20 up to +80°C cable -10 up to 100°C probe ø7x24.5mm cable length 1.5m without screw connection 2-wire			
	<b>GEV No.</b>	378551	<b>Ref. No.</b>
adapter for reducer mounting measurements 71x29mm			
<b>GEV No.</b>	379052	<b>Ref. No.</b>	—
temperature probe PTC 1kOhm cable silicone probe -50 up to +150°C cable -50 up to +180°C probe ø6x40mm cable length 1.5m without screw connection 2-wire			
<b>GEV No.</b>	379053	<b>Ref. No.</b>	—
temperature probe PTC 1kOhm cable PVC probe -50 up to +150°C cable -10 up to 100°C probe ø6x30mm cable length 3m without screw connection 2-wire			
<b>GEV No.</b>	379057	<b>Ref. No.</b>	—
temperature probe NTC 10kOhm cable PVC probe -20 up to +80°C cable -10 up to 100°C probe ø6x25mm cable length 3m 2-wire			
<b>GEV No.</b>	379064	<b>Ref. No.</b>	—
temperature probe PTC 1kOhm cable silicone probe -50 up to +150°C cable -50 up to +180°C probe ø6x40mm cable length 3m without screw connection 2-wire			
<b>GEV No.</b>	379142	<b>Ref. No.</b>	—
temperature probe PTC 1kOhm cable PVC probe -50 up to +150°C cable -10 up to 100°C probe ø6x30mm cable length 1.5m without screw connection 2-wire			
<b>GEV No.</b>	379160	<b>Ref. No.</b>	0646305800 167212 BN167212
temperature probe NTC 10kOhm cable thermoplastic probe -40 up to +110°C cable -40 up to +110°C probe ø6x14mm cable length 1.5m without screw connection 2-wire			
<b>GEV No.</b>	379161	<b>Ref. No.</b>	167211 74700916 BN167211 Q32-0578 R00213 RC0321 S900.32
temperature probe NTC 10kOhm cable thermoplastic probe -40 up to +110°C cable -40 up to +110°C probe ø6x14mm cable length 3m without screw connection 2-wire			
<b>GEV No.</b>	379343	<b>Ref. No.</b>	—
temperature probe NTC 10kOhm cable silicone probe -40 up to +110°C cable -50 up to +180°C probe ø6x40mm cable length 3m 2-wire			
<b>GEV No.</b>	379458	<b>Ref. No.</b>	—
temperature probe NTC 10kOhm cable silicone probe -40 up to +110°C cable -50 up to +180°C probe ø6x40mm cable length 1.5m without screw connection 2-wire			
<b>GEV No.</b>	379781	<b>Ref. No.</b>	—
temperature probe PTC 1kOhm cable thermoplastic probe -50 up to +150°C cable -40 up to +110°C probe ø6x14mm cable length 1.5m without screw connection 2-wire			





Table continues overleaf

accessories for 378000			
GEV No.	379782	Ref. No.	—
	temperature probe PTC 1kOhm cable thermoplastic probe -50 up to +150°C cable -40 up to +110°C probe ø6x14mm cable length 3m 2-wire resistor 1kOhm		
GEV No.	402818	Ref. No.	—
	programming key 4K for electronic controller DIXELL		
GEV No.	699260	Ref. No.	—
	connection cable L 2m connection coded plug		



1

GEV No.	402144	Ref. No.	R35-XR60C R35-XR60CX
<b>description</b>	electronic controller DIXELL XR60CX -5N0C1 mounting measurements 71x29mm 230V voltage AC NTC/PTC relay outputs 3 NO-20A(8) CO-8A(3) NO-5A(2) NTC/PTC NTC/PTC DI -50 up to +150°C display 3½ digits		
<b>For models:</b>	621004, 621005, 622004		
accessories for 402144			
GEV No.	378194	Ref. No.	—
	temperature probe NTC 10kOhm cable PVC probe -20 up to +80°C cable -10 up to 100°C probe ø7x24.5mm cable length 1.5m without screw connection 2-wire		
GEV No.	378551	Ref. No.	—
	adapter for reducer mounting measurements 71x29mm		
GEV No.	379052	Ref. No.	—
	temperature probe PTC 1kOhm cable silicone probe -50 up to +150°C cable -50 up to +180°C probe ø6x40mm cable length 1.5m without screw connection 2-wire		
GEV No.	379053	Ref. No.	—
	temperature probe PTC 1kOhm cable PVC probe -50 up to +150°C cable -10 up to 100°C probe ø6x30mm cable length 3m without screw connection 2-wire		
GEV No.	379057	Ref. No.	—
	temperature probe NTC 10kOhm cable PVC probe -20 up to +80°C cable -10 up to 100°C probe ø6x25mm cable length 3m 2-wire		
GEV No.	379064	Ref. No.	—
	temperature probe PTC 1kOhm cable silicone probe -50 up to +150°C cable -50 up to +180°C probe ø6x40mm cable length 3m without screw connection 2-wire		
GEV No.	379160	Ref. No.	0646305800 167212 BN167212
	temperature probe NTC 10kOhm cable thermoplastic probe -40 up to +110°C cable -40 up to +110°C probe ø6x14mm cable length 1.5m without screw connection 2-wire		
GEV No.	379161	Ref. No.	167211 74700916 BN167211 Q32-0578 R00213 RC0321 S900.32
	temperature probe NTC 10kOhm cable thermoplastic probe -40 up to +110°C cable -40 up to +110°C probe ø6x14mm cable length 3m without screw connection 2-wire		

accessories for 402144			
GEV No.	379343	Ref. No.	—
	temperature probe NTC 10kOhm cable silicone probe -40 up to +110°C cable -50 up to +180°C probe ø6x40mm cable length 3m 2-wire		
GEV No.	379458	Ref. No.	—
	temperature probe NTC 10kOhm cable silicone probe -40 up to +110°C cable -50 up to +180°C probe ø6x40mm cable length 1.5m without screw connection 2-wire		
GEV No.	379782	Ref. No.	—
	temperature probe PTC 1kOhm cable thermoplastic probe -50 up to +150°C cable -40 up to +110°C probe ø6x14mm cable length 3m 2-wire resistor 1kOhm		
GEV No.	402818	Ref. No.	—
	programming key 4K for electronic controller DIXELL		



1







GEV No.	378228	Ref. No.	16815108
<b>description</b>	electronic controller DIXELL XW20L-5N0C1 mounting measurements 150x30mm built-in depth 65.5mm 230V voltage AC NTC/PTC relay outputs 2 NO-20A(8) CO-8A(3) NTC/PTC DI -50 up to +150°C display 3½ digits		
<b>For models:</b>	621007, 622005		
accessories for 378228			
GEV No.	378194	Ref. No.	—
	temperature probe NTC 10kOhm cable PVC probe -20 up to +80°C cable -10 up to 100°C probe ø7x24.5mm cable length 1.5m without screw connection 2-wire		
GEV No.	379052	Ref. No.	—
	temperature probe PTC 1kOhm cable silicone probe -50 up to +150°C cable -50 up to +180°C probe ø6x40mm cable length 1.5m without screw connection 2-wire		
GEV No.	379053	Ref. No.	—
	temperature probe PTC 1kOhm cable PVC probe -50 up to +150°C cable -10 up to 100°C probe ø6x30mm cable length 3m without screw connection 2-wire		
GEV No.	379057	Ref. No.	—
	temperature probe NTC 10kOhm cable PVC probe -20 up to +80°C cable -10 up to 100°C probe ø6x25mm cable length 3m 2-wire		
GEV No.	379064	Ref. No.	—
	temperature probe PTC 1kOhm cable silicone probe -50 up to +150°C cable -50 up to +180°C probe ø6x40mm cable length 3m without screw connection 2-wire		
GEV No.	379160	Ref. No.	0646305800 167212 BN167212
	temperature probe NTC 10kOhm cable thermoplastic probe -40 up to +110°C cable -40 up to +110°C probe ø6x14mm cable length 1.5m without screw connection 2-wire		

Table continues overleaf



<b>accessories for</b> 378228			
GEV No.	379161	Ref. No.	167211 74700916 BN167211 Q32-0578 R00213 RC0321 S900.32
temperature probe NTC 10kOhm cable thermoplastic probe -40 up to +110°C cable -40 up to +110°C probe ø6x14mm cable length 3m without screw connection 2-wire			
GEV No.	379162	Ref. No.	—
temperature probe NTC 10kOhm cable thermoplastic probe -40 up to +110°C cable -40 up to +110°C probe ø6x14mm cable length 6m 2-wire			
GEV No.	379343	Ref. No.	—
temperature probe NTC 10kOhm cable silicone probe -40 up to +110°C cable -50 up to +180°C probe ø6x40mm cable length 3m 2-wire			
GEV No.	379458	Ref. No.	—
temperature probe NTC 10kOhm cable silicone probe -40 up to +110°C cable -50 up to +180°C probe ø6x40mm cable length 1.5m without screw connection 2-wire			
GEV No.	402818	Ref. No.	—
programming key 4K for electronic controller DIXELL			



<b>GEV No.</b>	402011	<b>Ref. No.</b>	16815100 16815107
<b>description</b>	electronic controller DIXELL XW60L-5N0C1 mounting measurements 150x30mm built-in depth 50mm 230V voltage AC NTC relay outputs 4 NO-20A(8) CO-8A(3) NO-8A(3) NO-8A(3) NTC/PTC NTC/PTC DI protection IP65 -50 up to +150°C display 3½ digits		
<b>For models:</b>	201780, 614015, 614016, 614017, 614018, 621007, 622005		
<b>accessories for</b> 402011			
GEV No.	378194	Ref. No.	—
temperature probe NTC 10kOhm cable PVC probe -20 up to +80°C cable -10 up to 100°C probe ø7x24.5mm cable length 1.5m without screw connection 2-wire			
GEV No.	379057	Ref. No.	—
temperature probe NTC 10kOhm cable PVC probe -20 up to +80°C cable -10 up to 100°C probe ø6x25mm cable length 3m 2-wire			
GEV No.	379160	Ref. No.	0646305800 167212 BN167212
temperature probe NTC 10kOhm cable thermoplastic probe -40 up to +110°C cable -40 up to +110°C probe ø6x14mm cable length 1.5m without screw connection 2-wire			
GEV No.	379161	Ref. No.	167211 74700916 BN167211 Q32-0578 R00213 RC0321 S900.32
temperature probe NTC 10kOhm cable thermoplastic probe -40 up to +110°C cable -40 up to +110°C probe ø6x14mm cable length 3m without screw connection 2-wire			

<b>accessories for</b> 402011			
GEV No.	379162	Ref. No.	—
temperature probe NTC 10kOhm cable thermoplastic probe -40 up to +110°C cable -40 up to +110°C probe ø6x14mm cable length 6m 2-wire			
GEV No.	379343	Ref. No.	—
temperature probe NTC 10kOhm cable silicone probe -40 up to +110°C cable -50 up to +180°C probe ø6x40mm cable length 3m 2-wire			
GEV No.	379458	Ref. No.	—
temperature probe NTC 10kOhm cable silicone probe -40 up to +110°C cable -50 up to +180°C probe ø6x40mm cable length 1.5m without screw connection 2-wire			

built-in version 2-piece



<b>GEV No.</b>	402068	<b>Ref. No.</b>	880312100
<b>description</b>	power PCB DIXELL XM470K-500C1 mounting measurements 132x152mm built-in depth 40mm 230V voltage AC NTC relay outputs 4 NO-8A(3) NO-20A(8) NO-8A(3) NO-16A(3) NO-8A(3) NTC NTC NTC -40 up to +110°C display		
<b>For models:</b>	644008, 644009		
<b>accessories for</b> 402068			
GEV No.	378278	Ref. No.	—
keypad unit DIXELL T640 mounting measurements 150x30mm built-in depth 23mmV voltage relay outputs°C display 3½ digits			



electric components

EKTRON

refrigeration controllers

built-in version



1	<b>GEV No.</b>	378034	<b>Ref. No.</b>	SL0531
<b>description</b>	electronic controller EKTRON type REK31ED-0021 mounting measurements 71x29mm 230V voltage AC NTC/PTC relay outputs 1 CO-8A(4) NTC/PTC NTC/PTC built-in depth 71mm defr. funct. yes -50 up to +95°C display 3 digits			
<b>For models:</b>	272008, 611023, 625017, 625018, 633001, 633002, 634001, 634002, 634003			
<b>accessories for</b>	378034			
	<b>GEV No.</b>	379053	<b>Ref. No.</b>	—
	temperature probe PTC 1kOhm cable PVC probe -50 up to +150°C cable -10 up to 100°C probe ø6x30mm cable length 3m without screw connection 2-wire			
	<b>GEV No.</b>	379782	<b>Ref. No.</b>	—
	temperature probe PTC 1kOhm cable thermoplastic probe -50 up to +150°C cable -40 up to +110°C probe ø6x14mm cable length 3m 2-wire resistor 1kOhm			

ELIWELL

refrigeration controllers

built-in version



1	<b>GEV No.</b>	379570	<b>Ref. No.</b>	16811201
<b>description</b>	electronic controller ELIWELL type ID961 mounting measurements 71x29mm 12V voltage AC/DC NTC/PTC relay outputs 1 relay -50 up to +150°C display 3½ digits RoomTempIN yes compressor relay 8A			
<b>For models:</b>	551010, 551011, 554016, 554017, 554018, 554019, 611016			
<b>accessories for</b>	379570			
	<b>GEV No.</b>	379053	<b>Ref. No.</b>	—
	temperature probe PTC 1kOhm cable PVC probe -50 up to +150°C cable -10 up to 100°C probe ø6x30mm cable length 3m without screw connection 2-wire			
	<b>GEV No.</b>	379064	<b>Ref. No.</b>	—
	temperature probe PTC 1kOhm cable silicone probe -50 up to +150°C cable -50 up to +180°C probe ø6x40mm cable length 3m without screw connection 2-wire			
	<b>GEV No.</b>	379161	<b>Ref. No.</b>	167211 74700916 BN167211 Q32-0578 R00213 RC0321 S900.32
	temperature probe NTC 10kOhm cable thermoplastic probe -40 up to +110°C cable -40 up to +110°C probe ø6x14mm cable length 3m without screw connection 2-wire			

<b>accessories for</b>	379570			
	<b>GEV No.</b>	379782	<b>Ref. No.</b>	—
	temperature probe PTC 1kOhm cable thermoplastic probe -50 up to +150°C cable -40 up to +110°C probe ø6x14mm cable length 3m 2-wire resistor 1kOhm			

1	<b>GEV No.</b>	379025	<b>Ref. No.</b>	16814001
<b>description</b>	electronic controller ELIWELL type ID961LX mounting measurements 71x29mm 230V voltage AC NTC/PTC relay outputs 1 front measurements 76.2x35mm protection IP65 -55 up to +150°C display 3½ digits			
<b>For models:</b>	551010, 551011, 611016			

1	<b>GEV No.</b>	378022	<b>Ref. No.</b>	R35-0156
<b>description</b>	electronic controller ELIWELL type ID974 mounting measurements 71x29mm 230V voltage AC NTC/PTC front measurements 33x75mm protection IP65 -50 up to +150°C display 3½ digits			

1	<b>GEV No.</b>	378294	<b>Ref. No.</b>	1681405
<b>description</b>	electronic controller ELIWELL type IWC720 mounting measurements 150x30mm 230V voltage AC NTC relay outputs 2 relays -50 up to +110°C display 3½ digits RoomTempIN yes DigiIN1 yes DEF Relay 8A compressor relay 24A			





EVCO - EVERY CONTROL

universal controllers

built-in version



1

<b>GEV No.</b>	378293	<b>Ref. No.</b>	0646305702 MC2869305
<b>description</b>	electronic controller EVCO mounting measurements 71x29mm 230V voltage AC NTC relay outputs 1 -99 up to +150°C display 4 digits 16A default setting +50 up to +70°C type EVK401N7VHXX01		
<b>For models:</b>	913013, 913014, 913015, 913016, 913017, 913018, 913019, 913020, 913021, 913022, 913023, 913024, 913114, 913115, 913116, 913117, 913246, 913247, 913248, 913249, 913250, 913251, 913252, 913253, 913254, 913255, 913256, 913257, 913258, 913259, 913260, 913261, 913262, 913263, 913264, 913265, 913266, 914003, 914004, 914005, 914006, 914009, 914010, 914011, 914012, 914021, 914022, 914023, 914024, 914103...(Other models you can see in the webshop)		
<b>accessories for</b>	378293		
	<b>GEV No.</b>	<b>Ref. No.</b>	—
	temperature probe NTC 10kOhm cable thermoplastic probe -40 up to +110°C cable -40 up to +110°C probe ø6x35mm cable length 3m without screw connection 2-wire		
	<b>GEV No.</b>	<b>Ref. No.</b>	—
	temperature probe NTC 10kOhm cable PVC probe -20 up to +80°C cable -10 up to 100°C probe ø6x25mm cable length 3m 2-wire		
	<b>GEV No.</b>	<b>Ref. No.</b>	0646305800 167212 BN167212
	temperature probe NTC 10kOhm cable thermoplastic probe -40 up to +110°C cable -40 up to +110°C probe ø6x14mm cable length 1.5m without screw connection 2-wire		
	<b>GEV No.</b>	<b>Ref. No.</b>	167211 74700916 BN167211 Q32-0578 R00213 RC0321 S900.32
	temperature probe NTC 10kOhm cable thermoplastic probe -40 up to +110°C cable -40 up to +110°C probe ø6x14mm cable length 3m without screw connection 2-wire		
	<b>GEV No.</b>	<b>Ref. No.</b>	—
	temperature probe NTC 10kOhm cable PVC probe -20 up to +80°C cable -10 up to 100°C probe ø6x25mm cable length 1.5m 2-wire protection IP67		
	<b>GEV No.</b>	<b>Ref. No.</b>	—
	temperature probe NTC 10kOhm cable silicone probe -40 up to +110°C cable -50 up to +180°C probe ø6x40mm cable length 3m 2-wire		
	<b>GEV No.</b>	<b>Ref. No.</b>	—
	temperature probe NTC 10kOhm cable silicone probe -40 up to +110°C cable -50 up to +180°C probe ø6x40mm cable length 1.5m without screw connection 2-wire		
	<b>GEV No.</b>	<b>Ref. No.</b>	—
	temperature probe NTC 2kOhm cable thermoplastic probe -40 up to +110°C cable -40 up to +110°C probe ø6x35mm cable length 2m without screw connection 2-wire resistor 2kOhm		
	<b>GEV No.</b>	<b>Ref. No.</b>	—
	temperature probe NTC 10kOhm cable PVC probe -20 up to +80°C cable -10 up to 100°C probe ø6x40mm cable length 1.5m without screw connection 2-wire		



1

<b>GEV No.</b>	379590	<b>Ref. No.</b>	5310060
<b>description</b>	electronic controller EVERY CONTROL mounting measurements 71x29mm 12V voltage AC TC/J protection IP65 0-500°C type FK400A front measurements 33x75mm		
<b>accessories for</b>	379590		
	<b>GEV No.</b>	<b>Ref. No.</b>	—
	temperature probe thermocouple J (Fe-CuNi) cable Vetrotex probe -50 up to +750°C cable -50 up to +350°C probe ø6x100mm cable length 3m without screw connection cable colours red/blue 2-wire		

refrigeration controllers

built-in version



1

<b>GEV No.</b>	379820	<b>Ref. No.</b>	BN1681114
<b>description</b>	electronic controller EVERY CONTROL type EVC20S35N7ALX30 mounting measurements 165x45mm 230V voltage AC NTC relay outputs 3 NO-16A(5) NO-8A(4) CO-8A(4) NTC NTC DI for fridge front measurementsmm built-in depth 56mm protection IP00 yes yes yes -40° up to 105°C display 4 digits		
<b>For models:</b>	621020, 621021, 622020, 622021		

miscellaneous

refrigeration controllers



1

<b>GEV No.</b>	378411	<b>Ref. No.</b>	996380
<b>description</b>	power PCB EVCO type EVC80P16P7FRL01 mounting measurements 170x120mm		
<b>For models:</b>	671004, 671005, 671007, 671008		

speed controllers



1

<b>GEV No.</b>	401679	<b>Ref. No.</b>	5423300
<b>description</b>	speed controller voltage input 230V/50Hz 1PhV vantage output 0-208/230V 0-240Hz 3PhV 1500W max. 18.4A load current 8.1A length external size 145mm width external size 115mm D 125mm wall-mounted version		





# probes

## universal probes

### temperature probes

			
<b>GEV No.</b>	379160	<b>Ref. No.</b>	0646305800 167212 BN167212
<b>description</b>	temperature probe NTC 10kOhm cable thermoplastic probe -40 up to +110°C cable -40 up to +110°C probe ø6x14mm cable length 1.5m without screw connection 2-wire		
<b>For models:</b>	201780, 551010, 551011, 551012, 551013, 554016, 554017, 554018, 554019, 611017, 621007, 622005, 622020, 622021, 913013, 913014, 913015, 913016, 913017, 913018, 914003, 914004, 914005, 914006, 914015, 914016, 914017, 914018		

			
<b>GEV No.</b>	379161	<b>Ref. No.</b>	167211 74700916 BN167211 Q32-0578 R00213 RC0321 S900.32
<b>description</b>	temperature probe NTC 10kOhm cable thermoplastic probe -40 up to +110°C cable -40 up to +110°C probe ø6x14mm cable length 3m without screw connection 2-wire		
<b>For models:</b>	201780, 272008, 611007, 611008, 611009, 611010, 611011, 611015, 611023, 621004, 621005, 621007, 621020, 621021, 621023, 621024, 621025, 621026, 621027, 621028, 621029, 621030, 621031, 621032, 621033, 621034, 621035, 621036, 621045, 621046, 621047, 621048, 621049, 621050, 622004, 622005, 622020, 622021, 622022, 622023, 622024, 622025, 622026, 622027, 622028, 622029, 622034, 622035, 622036, 622037...(Other models you can see in the webshop)		

			
<b>GEV No.</b>	379130 <sup>1</sup>	<b>Ref. No.</b>	R65325000
<b>description</b>	temperature probe Pt100 cable Vetrotex probe -200 up to +600°C cable -50 up to +350°C probe ø6x100mm cable length 1.4m without screw connection 3-wire resistance at 0°C 100Ohm		
<b>For models:</b>	212001, 212002, 212003		

<sup>1</sup>3-wire

			
<b>GEV No.</b>	381363	<b>Ref. No.</b>	R65320220
<b>description</b>	temperature probe thermocouple K (NiCr-Ni) probe -50 up to 1150°C cable -50 up to +180°C cable length 1.5m thread M10x1 adapter length 93mm adapter ø 6mm cable colours silver/yellow probe L 90/14mm probe ø 6/3mm		
<b>For models:</b>	212005, 212007, 212009, 212010, 212011, 212012, 212013, 212018, 212020		



## producer-specific probes

### probes

			
<b>GEV No.</b>	379753	<b>Ref. No.</b>	6942216 6942236 9590088
<b>description</b>	probe NTC cable PVC probe -40 up to +110°C cable -10 up to 100°C connection 2-wire thread M15x1.75 probe ø8x29mm cable length 3.1m		
<b>For models:</b>	621014, 622009, 622014, 622018		

			
<b>GEV No.</b>	401344	<b>Ref. No.</b>	95.16.23
<b>description</b>	temperature probe 2x NTC 10K cable silicone probe -40 up to +110°C cable -50 up to +180°C connection plug thread probe ø3mm cable length 0.6/0.8m		
<b>For models:</b>	745002		

			
<b>GEV No.</b>	401478	<b>Ref. No.</b>	99.16.23
<b>description</b>	temperature probe 3x NTC 10kOhm cable silicone probe -40 up to +110°C cable -50 up to +180°C connection plug thread probe ø3mm cable length 0.86m		
<b>For models:</b>	745002		

			
<b>GEV No.</b>	402078	<b>Ref. No.</b>	094872
<b>description</b>	temperature probe NTC 10kOhm cable probe -40 up to +110°C cable°C connection male faston 6.3mm thread 1/4" probe ø10x25mm cable lengthm		
<b>For models:</b>	743001		
<b>spare parts for</b>	402078		
	<b>GEV No.</b>	528110	<b>Ref. No.</b> 095624
O-ring EPDM thickness 2.62mm ID ø 12.37mm Qty 1 pcs			



<b>GEV No.</b>	402905	<b>Ref. No.</b>	00-775612-001
<b>description</b>	temperature probe NTC 10kOhm cable PVC probe -40 up to +110°C cable -10 up to 100°C connection coded plug thread probe ø5x35mm cable length 0.2m		
<b>For models:</b>	813002, 813003, 813004		
<b>accessories for</b>	402905		
	<b>GEV No.</b>	692218	<b>Ref. No.</b>
			00-775489-001
	probe clip for temperature probe L 35mm W 24mm H 5mm		



<b>GEV No.</b>	379002	<b>Ref. No.</b>	92.16.23
<b>description</b>	temperature probe NTC 10kOhm cable silicone probe -40 up to +110°C cable -50 up to +180°C connection 2-wire thread probe ø3x20mm cable length 0.3m		
<b>For models:</b>	745001		



<b>GEV No.</b>	400910	<b>Ref. No.</b>	231014
<b>description</b>	temperature probe NTC 10kOhm cable silicone probe -40 up to +110°C cable -50 up to +180°C connection coded plug thread probe ø4.5x30mm cable length 0.35m		
<b>For models:</b>	813001		



<b>GEV No.</b>	401626	<b>Ref. No.</b>	95.60.00
<b>description</b>	temperature probe NTC 10kOhm cable silicone probe -40 up to +110°C cable -50 up to +180°C connection plug thread probe ø22x50mm cable length 0.1m		
<b>For models:</b>	745002		



<b>GEV No.</b>	401627	<b>Ref. No.</b>	99.60.00
<b>description</b>	temperature probe NTC 10kOhm cable silicone probe -40 up to +110°C cable -50 up to +180°C connection plug thread probe ø22x50mm cable length 0.24m		
<b>For models:</b>	745002		

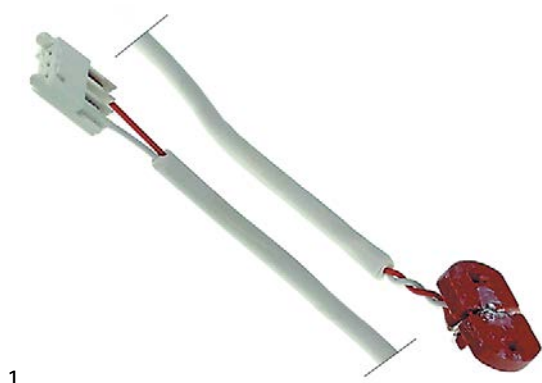

<b>GEV No.</b>	378003	<b>Ref. No.</b>	100127
<b>description</b>	temperature probe NTC cable PVC probe -40 up to +125°C cable -10 up to 100°C connection coded plug thread cable length 0.24m		
<b>For models:</b>	246009, 246012		



<b>GEV No.</b>	379521	<b>Ref. No.</b>	FH-HZA070WRE0
<b>description</b>	temperature probe Pt100 cable glass fibre probe -100 up to 450°C cable -50 up to +350°C connection coded plug thread probe ø3.5x10mm cable length 0.2m		
<b>For models:</b>	213002, 213003		



<b>GEV No.</b>	378552	<b>Ref. No.</b>	00002660
<b>description</b>	temperature probe Pt100 cable Vetrotex probe -100 up to 450°C cable°C connection coded plug thread M10 probe ø4x100mm cable length 1m		
<b>For models:</b>	211042, 211043, 211044, 212035, 212037, 212039, 212041		



<b>GEV No.</b>	378001	<b>Ref. No.</b>	100114
<b>description</b>	temperature probe Pt1000 probe -70 up to +500°C cable length 0.5m		
<b>For models:</b>	131216, 131217, 131218, 246009, 246010, 246011, 246012, 246013, 246014		



1

<b>GEV No.</b>	378002	<b>Ref. No.</b>	100126
<b>description</b>	temperature probe PTC 1kOhm cable probe -50 up to +150°C cable°C connection 2-wire thread probe ø2x2mm cable lengthm		
<b>For models:</b>	131216, 131217, 131218, 246009, 246010, 246011, 246012, 246013, 246014		



1

<b>GEV No.</b>	402105	<b>Ref. No.</b>	1011296
<b>description</b>	temperature probe PTC 2kOhm cable probe -50 up to +150°C cable°C connection male faston 2.8mm thread probe ø10x30mm cable lengthm		
<b>For models:</b>	741003		

### core probes



1

<b>GEV No.</b>	379134	<b>Ref. No.</b>	R65320900
<b>description</b>	core temperature probe Pt100 cable PTFE probe -40 up to +250°C cable -40 up to +250°C connection plug probe ø4x100mm thread cable length 1m handle ø 15mm handle length 83mm		
<b>For models:</b>	212002, 212003		



1

<b>GEV No.</b>	378679	<b>Ref. No.</b>	965295
<b>description</b>	core temperature probe Pt1000 connection 8-wire probe ø4x100mm cable length 5m handle ø 16mm handle length 110mm		
<b>For models:</b>	671004, 671005, 671007, 671008		



1

<b>GEV No.</b>	379773 <sup>1</sup>	<b>Ref. No.</b>	R65321120
<b>description</b>	core temperature probe thermocouple K (NiCr-Ni) cable PTFE probe -40 up to +250°C cable -40 up to +250°C connection plug probe ø3.5x90mm thread cable length 1.1m handle ømm handle length 90mm		
<b>For models:</b>	212001, 212002, 212003, 212005, 212007, 212009, 212010, 212011, 212012, 212013		

## accessories

### fasteners



1

<b>GEV No.</b>	692218	<b>Ref. No.</b>	00-775489-001
<b>description</b>	probe clip for temperature probe L 35mm W 24mm H 5mm		
<b>For models:</b>	813002, 813003		

### plugs/bushes



1

<b>GEV No.</b>	378016	<b>Ref. No.</b>	LAR65320920
<b>description</b>	female connector 4-pole		
<b>For models:</b>	212001, 212002, 212003, 212005, 212007, 212009, 212010, 212011, 212012, 212013		



1

<b>GEV No.</b>	378017	<b>Ref. No.</b>	LAR65321020
<b>description</b>	lid for plug contact		
<b>For models:</b>	212001, 212002, 212003, 212005, 212007, 212009, 212010, 212011, 212012, 212013, 212018, 212020		

### miscellaneous



1

<b>GEV No.</b>	379856	<b>Ref. No.</b>	R86020420
<b>description</b>	bag for core temperature probe		
<b>For models:</b>	212002, 212003, 212005, 212007, 212009, 212010, 212011, 212012, 212013		

<sup>1</sup>multipoint probe



## electronics

### electronics accessories

			
1			
<b>GEV No.</b>	401044	<b>Ref. No.</b>	GMADIA067WRF0
<b>description</b>	disc H 36mm W 82mm plastic		
<b>For models:</b>	213002, 213003		

			
1			
<b>GEV No.</b>	697352	<b>Ref. No.</b>	5320750
<b>description</b>	spacer piece for PCB H 6mm thread M4		

### EPROMS

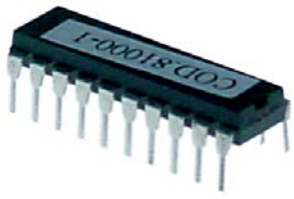
			
1			
<b>GEV No.</b>	401559	<b>Ref. No.</b>	81021
<b>description</b>	EPROM CODE 81000-1		
<b>For models:</b>	813001		

### rectifiers

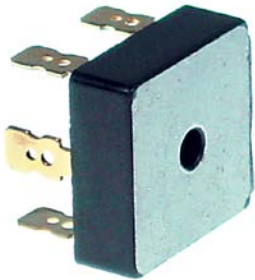
			
1			
<b>GEV No.</b>	401501	<b>Ref. No.</b>	100116
<b>description</b>	rectifier		
<b>For models:</b>	131216, 131217, 131218, 246009, 246010, 246011, 246012, 246013, 246014		



			
1			
<b>GEV No.</b>	401888	<b>Ref. No.</b>	FW-QZA117WRK0
<b>description</b>	rectifier for microwave		
<b>For models:</b>	213002, 213003		

### PCBs

			
1			
<b>GEV No.</b>	401496	<b>Ref. No.</b>	500232
<b>description</b>	control PCB		
<b>For models:</b>	246009, 246012		

			
1			
<b>GEV No.</b>	401499	<b>Ref. No.</b>	100119
<b>description</b>	control PCB		
<b>For models:</b>	131216, 131217, 131218, 246009, 246010, 246011, 246012, 246013, 246014		

			
1			
<b>GEV No.</b>	402298	<b>Ref. No.</b>	100118
<b>description</b>	control PCB		
<b>For models:</b>	131216, 131217, 131218, 246009, 246010, 246011, 246012, 246013, 246014		

			
1			
<b>GEV No.</b>	402107	<b>Ref. No.</b>	11231
<b>description</b>	control PCB coffee machine 16889		
<b>For models:</b>	741003		
<b>accessories for</b>	402107		
		<b>GEV No.</b>	112948
		<b>Ref. No.</b>	11543
	knob switch zero mark ø 30mm shaft ø 6x4.6mm shaft flat right grey		



1

<b>GEV No.</b>	402108	<b>Ref. No.</b>	15710
<b>description</b>	control PCB coffee machine 16889		
<b>For models:</b>	741003		



1

<b>GEV No.</b>	402109	<b>Ref. No.</b>	1011319
<b>description</b>	control PCB coffee machine 16889		
<b>For models:</b>	741003		



1

<b>GEV No.</b>	402088	<b>Ref. No.</b>	0V2143
<b>description</b>	control PCB coffee machine KORO		
<b>For models:</b>	743001		



1

<b>GEV No.</b>	403701	<b>Ref. No.</b>	01900081
<b>description</b>	control PCB combi-steamer EKF series L 432mm W 80mm		
<b>For models:</b>	212037, 212039, 212041		

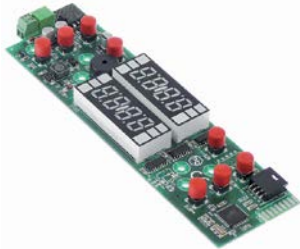



1

<b>GEV No.</b>	403225	<b>Ref. No.</b>	SCH30011
<b>description</b>	control PCB convection oven G544		
<b>For models:</b>	211029		



1

<b>GEV No.</b>	403204	<b>Ref. No.</b>	00-897545-005		
<b>description</b>	control PCB dishwasher C502/C602 L 148mm W 126mm without EPROM only for Ecomax				
<b>For models:</b>	812011, 812012, 812013, 812014, 812015, 813004				
<b>accessories for</b>	403204				
		<b>GEV No.</b>	403030	<b>Ref. No.</b>	—
	EPROM type REV. L2.3/6101 CODE 897547-6				
		<b>GEV No.</b>	403031	<b>Ref. No.</b>	—
	EPROM				

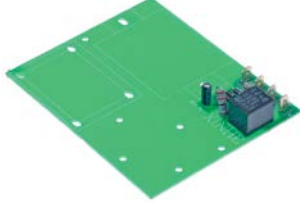

1

<b>GEV No.</b>	403208	<b>Ref. No.</b>	8301960
<b>description</b>	control PCB dough mixers TF17/22/30 TR17/22/30 L 124mm W 102mm 230/400V		
<b>For models:</b>	512002, 512003, 512004		





1

<b>GEV No.</b>	401731	<b>Ref. No.</b>	IB5940915
<b>description</b>	control PCB drink mixer Orione 230V		
<b>For models:</b>	721004		



			
1			
<b>GEV No.</b>	402090	<b>Ref. No.</b>	251653
<b>description</b>	display coffee machine KORO		
<b>For models:</b>	743001		

			
1			
<b>GEV No.</b>	400787	<b>Ref. No.</b>	WY26020
<b>description</b>	display espresso machine Pegaso		
<b>For models:</b>	742001, 742002, 742003, 742004		

			
1			
<b>GEV No.</b>	401500	<b>Ref. No.</b>	100129
<b>description</b>	display PCB		
<b>For models:</b>	131216, 131217, 131218, 246009, 246010, 246011, 246012, 246013, 246014		

			
1			
<b>GEV No.</b>	402813	<b>Ref. No.</b>	HR600.07 RC0419
<b>description</b>	display PCB for fridge L 150mm W 37mm suitable for ER400/600 with potentiometer with thermostat type LTC-20HT		
<b>For models:</b>	621023, 621024, 621025, 621026, 621029, 621030, 621031, 621032, 621033, 621034, 622022, 622023, 622026, 622027		

			
1			
<b>GEV No.</b>	401024	<b>Ref. No.</b>	DPWBFC157WRKZ
<b>description</b>	display PCB microwave R15 type DPWBFC157WRKZ		
<b>For models:</b>	213001		

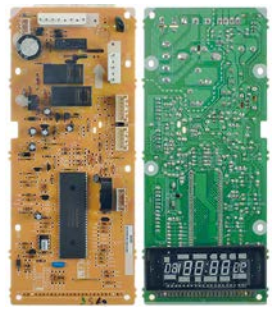
			
1			
<b>GEV No.</b>	401014	<b>Ref. No.</b>	DPWBFC482WRKZ DPWBFC482WRKZ1
<b>description</b>	display PCB microwave R23		
<b>For models:</b>	213002		

			
1			
<b>GEV No.</b>	401043	<b>Ref. No.</b>	DPWBFC484WRKZ
<b>description</b>	display PCB microwave R23		
<b>For models:</b>	213002		

			
1			
<b>GEV No.</b>	401045	<b>Ref. No.</b>	DPWBFC366WRKZ DPWBFC366WRKZ1
<b>description</b>	display PCB microwave R25		
<b>For models:</b>	213003		

			
1			
<b>GEV No.</b>	403726	<b>Ref. No.</b>	01202500
<b>description</b>	display PCB pizza oven EKF L 364mm W 54mm		
<b>For models:</b>	211042, 211043, 211044, 212035		



1

<b>GEV No.</b>	402812	<b>Ref. No.</b>	RC0429
<b>description</b>	display PCB refrigerator EF400/600 L 150mm W 38mm with potentiometer with thermostat type LTC-24HT		
<b>For models:</b>	622024, 622028		



1

<b>GEV No.</b>	401332	<b>Ref. No.</b>	R65300540
<b>description</b>	keypad PCB		
<b>For models:</b>	212002, 212003		



1

<b>GEV No.</b>	401957	<b>Ref. No.</b>	R65302180
<b>description</b>	keypad PCB		
<b>For models:</b>	212002, 212003		



1

<b>GEV No.</b>	401661	<b>Ref. No.</b>	R65301800 R65301810 R65301820
<b>description</b>	keypad PCB combi-steamer MVE04 kit		
<b>For models:</b>	212001		



1

<b>GEV No.</b>	401958	<b>Ref. No.</b>	R65302150
<b>description</b>	keypad PCB combi-steamer without steam generator suitable for LAINOX 2 type K probes		
<b>For models:</b>	212002, 212003		
<b>spare parts for</b>	401958		
	<b>GEV No.</b>	379130	<b>Ref. No.</b> R65325000
	temperature probe Pt100 cable Vetrotex probe -200 up to +600°C cable -50 up to +350°C probe ø6x100mm cable length 1.4m without screw connection 3-wire resistance at 0°C 100Ohm		
	<b>GEV No.</b>	381363	<b>Ref. No.</b> R65320220
	temperature probe thermocouple K (NiCr-Ni) probe -50 up to 1150°C cable -50 up to +180°C cable length 1.5m thread M10x1 adapter length 93mm adapter ø 6mm cable colours silver/yellow probe L 90/14mm probe ø 6/3mm		
<b>accessories for</b>	401958		
	<b>GEV No.</b>	381363	<b>Ref. No.</b> R65320220
	temperature probe thermocouple K (NiCr-Ni) probe -50 up to 1150°C cable -50 up to +180°C cable length 1.5m thread M10x1 adapter length 93mm adapter ø 6mm cable colours silver/yellow probe L 90/14mm probe ø 6/3mm		

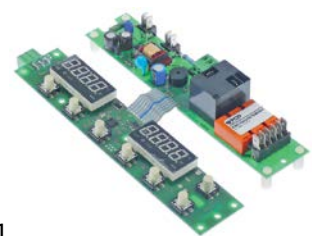

1

<b>GEV No.</b>	403206	<b>Ref. No.</b>	SCH30008
<b>description</b>	keypad PCB convection oven 500/800 L 200mm 12V with display H 40mm mounting pos. horizontal buttons 7		
<b>For models:</b>	211020, 211026		





1

<b>GEV No.</b>	403032	<b>Ref. No.</b>	00-897560-001 00-897560-002
<b>description</b>	keypad PCB dishwasher C402(S)-/C502(S)-/C602(S)-xx L 185mm W 35mm suitable for COOKMAX with display buttons 4		
<b>For models:</b>	811011, 811012, 811013, 811014, 811015, 812011, 812012, 812013, 812014, 812015, 813002, 813003, 813004		





1 

<b>GEV No.</b>	402089	<b>Ref. No.</b>	251865
<b>description</b>	keypad PCB for coffee machine		
<b>For models:</b>	743001		
<b>accessories for</b>	402089		
	<b>GEV No.</b>	402110	<b>Ref. No.</b> 251785
	push button set 8-piece transparent		
	<b>GEV No.</b>	527289	<b>Ref. No.</b> 251787
	button grey		

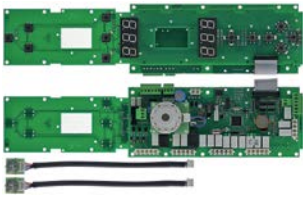
1 

<b>GEV No.</b>	403829	<b>Ref. No.</b>	R65302100
<b>description</b>	keypad PCB for combi-steamer L 437mm W 103mm		
<b>For models:</b>	212010, 212011, 212012, 212013		

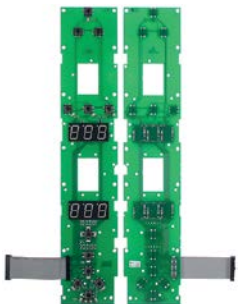
1 

<b>GEV No.</b>	403823	<b>Ref. No.</b>	R65302240
<b>description</b>	keypad PCB for combi-steamer L 443mm W 83mm		
<b>For models:</b>	212010, 212011, 212012, 212013		

1 

<b>GEV No.</b>	401687	<b>Ref. No.</b>	95.23.00
<b>description</b>	keypad PCB milk foamer F5/F10		
<b>For models:</b>	745002		

1 

<b>GEV No.</b>	401686	<b>Ref. No.</b>	94.24.00
<b>description</b>	keypad PCB milk foamer Foamino		
<b>For models:</b>	745001		

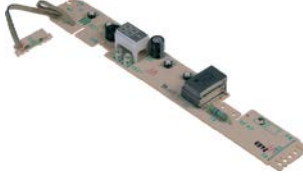
1 

<b>GEV No.</b>	402069	<b>Ref. No.</b>	6113321
<b>description</b>	keypad PCB refrigerator GKV5710		
<b>For models:</b>	621014, 622009		

1 

<b>GEV No.</b>	403725	<b>Ref. No.</b>	01900090
<b>description</b>	main PCB combi-steamer L 262mm W 108mm		
<b>For models:</b>	212037, 212039, 212041		

1 

<b>GEV No.</b>	403209	<b>Ref. No.</b>	R65302280
<b>description</b>	main PCB combi-steamer REV051/077/1015 L 250mm W 105mm LAINOX		
<b>For models:</b>	212005, 212007, 212009, 212018, 212020		

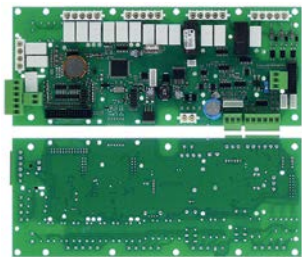

1

<b>GEV No.</b>	403824	<b>Ref. No.</b>	R65302250
<b>description</b>	main PCB for combi-steamer L 250mm W 103mm		
<b>For models:</b>	212010, 212011, 212012, 212013		



1

<b>GEV No.</b>	401333	<b>Ref. No.</b>	R65300490
<b>description</b>	PCB		
<b>For models:</b>	212002, 212003		



1

<b>GEV No.</b>	402077	<b>Ref. No.</b>	PE1510B0
<b>description</b>	PCB		



1

<b>GEV No.</b>	401495	<b>Ref. No.</b>	500736
<b>description</b>	PCB 2.5kW		
<b>For models:</b>	246009, 246012		



1

<b>GEV No.</b>	697124	<b>Ref. No.</b>	MF2141
<b>description</b>	PCB 230/400V		
<b>For models:</b>	422001, 433001, 433002		

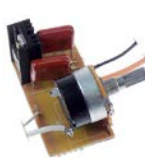

1

<b>GEV No.</b>	401733	<b>Ref. No.</b>	KOKD020
<b>description</b>	PCB 230V		

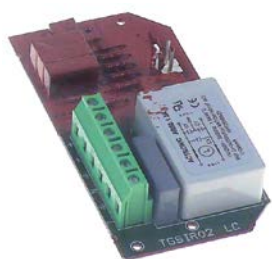

1

<b>GEV No.</b>	401734	<b>Ref. No.</b>	IB5940700
<b>description</b>	PCB 230V		



1

<b>GEV No.</b>	402091	<b>Ref. No.</b>	252604
<b>description</b>	PCB coffee machine KORO 16Bit		
<b>For models:</b>	743001		

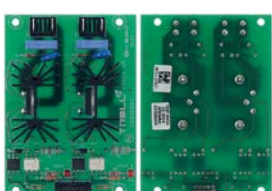

1





<b>GEV No.</b>	403699	<b>Ref. No.</b>	01900100
<b>description</b>	PCB combi-steamer EKF 523 L 102mm W 54mm		
<b>For models:</b>	212037		





			
1			
<b>GEV No.</b>	403700	<b>Ref. No.</b>	01900480
<b>description</b>	PCB combi-steamer EKF series L 105mm W 98mm suitable for TECNOEKA		
<b>For models:</b>	212039, 212041		

			
1			
<b>GEV No.</b>	403697	<b>Ref. No.</b>	01900430
<b>description</b>	PCB combi-steamer EKF664/EKF1064 L 128mm W 67mm		
<b>For models:</b>	212039, 212041		

			
1			
<b>GEV No.</b>	401962	<b>Ref. No.</b>	R65301910
<b>description</b>	PCB combi-steamer HME 611/1011		
<b>For models:</b>	212002, 212003		

			
1			
<b>GEV No.</b>	403033	<b>Ref. No.</b>	00-897545-003
<b>description</b>	PCB control L 147mm W 125mm without EPROM 230V		
<b>For models:</b>	811011, 811012, 811013, 811014, 811015, 812011, 812012, 812013, 812014, 812015, 813002, 813003		
<b>accessories for</b>	403033		
	<b>GEV No.</b>	403030	<b>Ref. No.</b> —
	EPROM type REV. L2.3/6101 CODE 897547-6		
	<b>GEV No.</b>	403031	<b>Ref. No.</b> —
	EPROM		
	<b>GEV No.</b>	403702	<b>Ref. No.</b> —
	EPROM Rev. 1.6 (04.06.2013)		

			
1			
<b>GEV No.</b>	403239	<b>Ref. No.</b>	SCH30010
<b>description</b>	PCB convection oven 824/524 L 180mm W 70mm 230V 12V voltage AC		
<b>For models:</b>	211029		

			
1			
<b>GEV No.</b>	401727	<b>Ref. No.</b>	19413007
<b>description</b>	PCB cutter C4-C6 230V		
<b>For models:</b>	471001		

			
1			
<b>GEV No.</b>	401846	<b>Ref. No.</b>	121287
<b>description</b>	PCB dishwasher COMENDA, HOONVED		
<b>For models:</b>	SP1, SP2-12, SP2-S12, SP3		

			
1			
<b>GEV No.</b>	402221	<b>Ref. No.</b>	SL2990
<b>description</b>	PCB dough rolling machine FI32-FI42 L 95mm W 80mm 230V 50/60Hz		
<b>For models:</b>	513004, 513005, 513006, 513008, 513009, 513010		



1

<b>GEV No.</b>	692027	<b>Ref. No.</b>	5310000
<b>description</b>	PCB dough rolling machine STP30/40 new edition 230V		



1

<b>GEV No.</b>	401730	<b>Ref. No.</b>	IB5940800
<b>description</b>	PCB drink mixer Dragone 50/60Hz 230V		
<b>For models:</b>	721003		



1

<b>GEV No.</b>	401732	<b>Ref. No.</b>	IB5940910
<b>description</b>	PCB drink mixer Orione 50Hz 230V		
<b>For models:</b>	721004		



1

<b>GEV No.</b>	401729	<b>Ref. No.</b>	IB5940005
<b>description</b>	PCB drink mixer Sirio 50/60Hz 110-250V 1.5A		
<b>For models:</b>	721002, 721005		



1

<b>GEV No.</b>	401728	<b>Ref. No.</b>	IB5940000
<b>description</b>	PCB drink mixer Sirio 50/60Hz 120/240V 1.6A		
<b>For models:</b>	721002, 721005		



1

<b>GEV No.</b>	401494	<b>Ref. No.</b>	500235
<b>description</b>	PCB flow control valve 3kW		
<b>For models:</b>	246009, 246012		

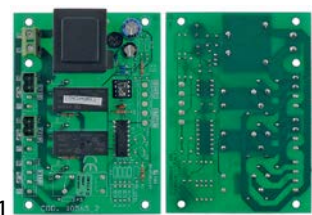

1

<b>GEV No.</b>	401834	<b>Ref. No.</b>	7121000001
<b>description</b>	PCB for oven L 110mm W 80mm 230V		
<b>For models:</b>	211006, 211007		



1

<b>GEV No.</b>	360664	<b>Ref. No.</b>	R00303
<b>description</b>	PCB for planetary mixer AP7 L 90mm W 90mm		
<b>For models:</b>	511010		



1

<b>GEV No.</b>	400797	<b>Ref. No.</b>	S3319
<b>description</b>	PCB for slicer 230V		
<b>For models:</b>	411011		
<b>accessories for</b>	400797		

<b>GEV No.</b>	346052	<b>Ref. No.</b>	—
<b>description</b>	push switch mounting measurements 30x22mm black/green 2CO 250V 16A illuminated connection male faston 6.3mm ambient temperature max. 125/55°C protection IP65		

1

<b>GEV No.</b>	403596	<b>Ref. No.</b>	S3285
<b>description</b>	PCB for slicer 50Hz 230V		
<b>For models:</b>	411013, 411014, 411015, 411016, 411017, 411019		
<b>spare parts for</b>	403596		
	GEV No.	348122	Ref. No. P9501
push switch green/red 230V connection cable 1800mm			



1

<b>GEV No.</b>	403570	<b>Ref. No.</b>	S3321
<b>description</b>	PCB for slicer OG30E suitable for OMAS		
<b>For models:</b>	411012		





1

<b>GEV No.</b>	403515	<b>Ref. No.</b>	IB5940702
<b>description</b>	PCB fruit squeezer APOLLO L 111mm W 56mm 230V		
<b>For models:</b>	723001		



1

<b>GEV No.</b>	300367	<b>Ref. No.</b>	IB5944014
<b>description</b>	PCB hand blenders CICLONE with potentiometer 230V		
<b>For models:</b>	473001		
<b>accessories for</b>	300367		
	GEV No.	111235	Ref. No. IB4200705
knob switch zero mark t.max.°C temperature range°C ø 23mm shaft ø 5.5mm black			
	GEV No.	401954	Ref. No. —
control PCB			



1

<b>GEV No.</b>	401953	<b>Ref. No.</b>	IB5944010
<b>description</b>	PCB hand blenders VORTEX with potentiometer 230V		



1

<b>GEV No.</b>	697908	<b>Ref. No.</b>	SL0883
<b>description</b>	PCB L 102mm W 95mm 50/60Hz 230/400V		
<b>For models:</b>	421006, 421007, 421008, 422005, 422006, 433003, 433004, 433005		



1

<b>GEV No.</b>	401900	<b>Ref. No.</b>	215029
<b>description</b>	PCB L 120mm W 80mm		
<b>For models:</b>	812001, 812002, 812003, 812004, 812005, 812006, 812007, 812008, 812009, 812010, 915234, 915235, 915236, 915237, 915460, 915461, 915462, 915463, 915464, 915465		



1

<b>GEV No.</b>	403708	<b>Ref. No.</b>	411024
<b>description</b>	PCB L 68mm W 30mm for switch		



1

<b>GEV No.</b>	403476	<b>Ref. No.</b>	SCH30028
<b>description</b>	PCB L 90mm W 48mm H 40mm		
<b>For models:</b>	211029		



1

<b>GEV No.</b>	401738	<b>Ref. No.</b>	IV5940505T
<b>description</b>	PCB meat mincer Mod.12 230/400V type TGM7-L		
<b>For models:</b>	421003		



1

<b>GEV No.</b>	403890	<b>Ref. No.</b>	29411002+19702005
<b>description</b>	PCB meat mincer TGM7 230/400V		



1

<b>GEV No.</b>	403504	<b>Ref. No.</b>	SL0556
<b>description</b>	PCB meat mincer/cheese grater GR 12S suitable for FIMAR 230V		
<b>For models:</b>	431002		



1

<b>GEV No.</b>	403556	<b>Ref. No.</b>	SL3436
<b>description</b>	PCB meat mincer/cheese grater GR 12S suitable for FIMAR 400V		
<b>For models:</b>	431002		



1

<b>GEV No.</b>	401561	<b>Ref. No.</b>	MF2140
<b>description</b>	PCB meat mincer/cheese grater Mod.12-22 230V		
<b>For models:</b>	422001, 433001, 433002		



1

<b>GEV No.</b>	401048	<b>Ref. No.</b>	FPWBFA367WRKZ
<b>description</b>	PCB microwave R15 type FPWBFA367		
<b>For models:</b>	213001		



1

<b>GEV No.</b>	401046	<b>Ref. No.</b>	FPWBFA335WRE0
<b>description</b>	PCB microwave R23 type 06XA335A		
<b>For models:</b>	213002, 213003		

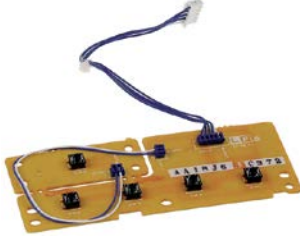

1

<b>GEV No.</b>	401047	<b>Ref. No.</b>	DPWBFC372WRKZ
<b>description</b>	PCB microwave R25 type AA18J6FC372		
<b>For models:</b>	213002, 213003		



1

<b>GEV No.</b>	401685	<b>Ref. No.</b>	95.26.10
<b>description</b>	PCB milk foamer		
<b>For models:</b>	745002		



1

<b>GEV No.</b>	401688	<b>Ref. No.</b>	99.26.10
<b>description</b>	PCB milk foamer F5/F10		
<b>For models:</b>	745002		



1

<b>GEV No.</b>	401689	<b>Ref. No.</b>	90.38.00
<b>description</b>	PCB milk foamer F5/F10		
<b>For models:</b>	745002		





1

<b>GEV No.</b>	401385	<b>Ref. No.</b>	LF1033020
<b>description</b>	PCB Mod.12 230/400V type TGM7		
<b>For models:</b>	421003, 431001		



1

<b>GEV No.</b>	400955	<b>Ref. No.</b>	19411008
<b>description</b>	PCB slicer 230/400V		
<b>For models:</b>	470001, 471001, 481001		
<b>accessories for</b>	400955		
	<b>GEV No.</b>	401357	<b>Ref. No.</b> MF2138
	momentary push switch mounting measurements ø22mm 1NO/1NC/indicator light 400V 4A indicator lamp 24V 0-1 connection screw ambient temperature max. 125/55°C protection IP40		
	<b>GEV No.</b>	401709	<b>Ref. No.</b> —
	protective cover external size 57x32mm internal size 47x22mm matt finish rubber H 27.5mm		





1

<b>GEV No.</b>	400954	<b>Ref. No.</b>	19411007
<b>description</b>	PCB slicer/cutter 50/60Hz 230V		
<b>For models:</b>	470001, 471001, 481001		



1

<b>GEV No.</b>	402093	<b>Ref. No.</b>	0230040
<b>description</b>	PCB vacuum packing machine B35 / B-M 42/42XL H_HD4		
<b>For models:</b>	442006, 442008		
<b>spare parts for</b>	402093		
	<b>GEV No.</b>	358596	<b>Ref. No.</b> —
	fine fuse size ø5x20mm 0.25A slow-acting rated 250V Qty 10 pcs		



1

<b>GEV No.</b>	402095	<b>Ref. No.</b>	0230042
<b>description</b>	PCB vacuum packing machine B35 / B-M 42/42XL H_HD4 with sensor		
<b>For models:</b>	442006, 442008		

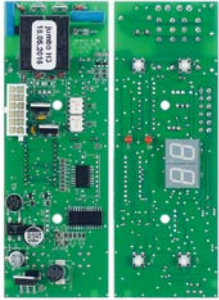

1

<b>GEV No.</b>	402092	<b>Ref. No.</b>	0230036
<b>description</b>	PCB vacuum packing machine JUMBO		
<b>For models:</b>	442003, 442004, 442005, 442007		

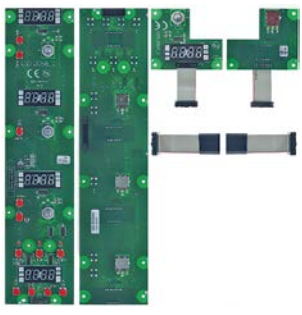

1

<b>GEV No.</b>	403844	<b>Ref. No.</b>	SCH30003 SCH30004
<b>description</b>	PCB kit combi-steamer L 340mm W 80mm suitable for PIRON with ribbon cable display digital		
<b>For models:</b>	212024, 212025		



1

<b>GEV No.</b>	401497	<b>Ref. No.</b>	100620
<b>description</b>	power PCB		
<b>For models:</b>	246009, 246012		





1

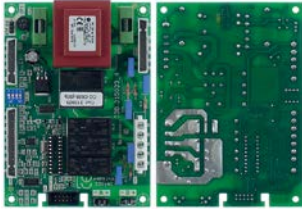

<b>GEV No.</b>	401498	<b>Ref. No.</b>	100120
<b>description</b>	power PCB		
<b>For models:</b>	131216, 131217, 131218, 246010, 246011, 246013, 246014		



1

<b>GEV No.</b>	400899	<b>Ref. No.</b>	215023
<b>description</b>	power PCB dishwasher LP10/20/30 without EPROM		
<b>For models:</b>	813001		
<b>accessories for</b>	400899		
	<b>GEV No.</b>	400761	<b>Ref. No.</b> —
	plug connector 5-pole		
	<b>GEV No.</b>	400900	<b>Ref. No.</b> —
	EPROM CODE 225029-3		
	<b>GEV No.</b>	401558	<b>Ref. No.</b> —
	EPROM CODE 81000-1		

**accessories for** 400899

	<b>GEV No.</b>	403241	<b>Ref. No.</b>	—
	EPROM type U61E for dishwasher CODE 81001-3			
	<b>GEV No.</b>	550048	<b>Ref. No.</b>	—
	female bullet			

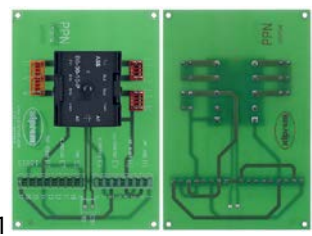

1

<b>GEV No.</b>	402826	<b>Ref. No.</b>	SL2921
<b>description</b>	power PCB for potato peeler device L 150mm W 100mm		
<b>For models:</b>	451003, 451004		



1

<b>GEV No.</b>	401613	<b>Ref. No.</b>	RG04232
<b>description</b>	power PCB PP4-PP8-PP15 Expo 230/400V type TASF99		
<b>For models:</b>	451001		

central units



1

<b>GEV No.</b>	400539	<b>Ref. No.</b>	18090016
<b>description</b>	control box 1-3-group for coffee machine 230V type 3GR+LIV+TEA DE		



1

<b>GEV No.</b>	347913	<b>Ref. No.</b>	SA1220
<b>description</b>	control box 230/240V		
<b>For models:</b>	512010, 512011, 512012, 512013, 512014, 512015, 512016, 512017, 512018, 512019, 512020, 512021, 512022		







1

<b>GEV No.</b>	402213	<b>Ref. No.</b>	WY18090030
<b>description</b>	control box 3-group coffee machine 115V type 3GR+LIV+TEA		
<b>For models:</b>	742001, 742002, 742003, 742004, 742019, 742020		



1

<b>GEV No.</b>	400796	<b>Ref. No.</b>	WY18090031
<b>description</b>	control box 3-group for coffee machine 230V type 3GR+LIV+TEA		
<b>For models:</b>	742001, 742002, 742003, 742004, 742019, 742020		



1

<b>GEV No.</b>	348170	<b>Ref. No.</b>	SA1210
<b>description</b>	control box 400V		
<b>For models:</b>	512010, 512011, 512012, 512013, 512014, 512015, 512016, 512017, 512018, 512019, 512020, 512021, 512022		



1

<b>GEV No.</b>	401092	<b>Ref. No.</b>	50PAA78246
<b>description</b>	control box 400V		
<b>For models:</b>	481003		



1

<b>GEV No.</b>	401684	<b>Ref. No.</b>	8301030
<b>description</b>	control box 400V		

## keypads

### front foils



1

<b>GEV No.</b>	401959	<b>Ref. No.</b>	R67450510
<b>description</b>	front foil combi-steamer MVE042P		
<b>For models:</b>	212001		

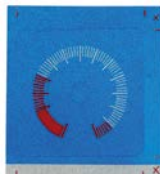

1

<b>GEV No.</b>	696452	<b>Ref. No.</b>	MSC04V238
<b>description</b>	front foil cutter C9VV CE blue L 60mm W 60mm		
<b>For models:</b>	471001		



1

<b>GEV No.</b>	401949	<b>Ref. No.</b>	025981
<b>description</b>	front foil dishwasher GL35		
<b>For models:</b>	811001, 811002		





			
<b>GEV No.</b>	401948	<b>Ref. No.</b>	025982
<b>description</b>	front foil dishwasher GS40		
<b>For models:</b>	811003		

			
<b>GEV No.</b>	401947	<b>Ref. No.</b>	025983
<b>description</b>	front foil dishwasher GS50/GS51		
<b>For models:</b>	812001, 812002, 812003, 812004, 812005, 812006, 812007, 812008, 812009, 812010, 915234, 915235, 915236, 915237, 915460, 915461, 915462, 915463, 915464, 915465		

			
<b>GEV No.</b>	401963	<b>Ref. No.</b>	80856
<b>description</b>	front foil dishwasher HM		
<b>For models:</b>	813001		

			
<b>GEV No.</b>	402352	<b>Ref. No.</b>	73500510
<b>description</b>	front foil pizza oven PIZZY DUO model DUO L 550mm W 111mm		
<b>For models:</b>	531002, 531004, 531006, 531008		

			
<b>GEV No.</b>	401741	<b>Ref. No.</b>	RG04348
<b>description</b>	front foil potato peeler PP4-PP8-PP15 Expo black L 139mm W 99mm		
<b>For models:</b>	451001		

			
<b>GEV No.</b>	402059	<b>Ref. No.</b>	X07.03.465.00
<b>description</b>	front foil toaster TOASTMAX L 185mm W 85mm		
<b>For models:</b>	222004, 222005		

			
<b>GEV No.</b>	402060	<b>Ref. No.</b>	X07.03.466.00
<b>description</b>	front foil toaster TOASTMAX L 265mm W 85mm		
<b>For models:</b>	222004, 222005		

			
Image not available			
<b>GEV No.</b>	401376	<b>Ref. No.</b>	19420168
<b>description</b>	keypad foil		
<b>For models:</b>	431001		

			
<b>GEV No.</b>	401587	<b>Ref. No.</b>	5800370
<b>description</b>	keypad foil dough rolling machine STP 30/40 P30/40/45/35 Start/Stop L 100mm W 80mm		

			
<b>GEV No.</b>	511927	<b>Ref. No.</b>	SL1504
<b>description</b>	keypad foil for potato peeler device silver L 175mm W 61mm buttons 3		
<b>For models:</b>	451004		

			
<b>GEV No.</b>	401690	<b>Ref. No.</b>	92.11.00
<b>description</b>	keypad foil milk foamer Foamino for milk foamer L 93mm W 26mm buttons 2		
<b>For models:</b>	745001		



1

<b>GEV No.</b>	401691	<b>Ref. No.</b>	95.12.00
<b>description</b>	keypad foil milk foamer MilkFoamer for milk foamer buttons 6		
<b>For models:</b>	745002		



1

<b>GEV No.</b>	401739	<b>Ref. No.</b>	IB4100930
<b>description</b>	keypad foil Orione for mixer grey L 160mm W 34mm buttons 3		
<b>For models:</b>	721004		

**spare parts for** 402097



<b>GEV No.</b>	541528	<b>Ref. No.</b>	0810101
----------------	--------	-----------------	---------

manometer ø 40mm pressure range 0 up to 1bar connection angled connection ø 5mm



1

<b>GEV No.</b>	402099	<b>Ref. No.</b>	0900104
<b>description</b>	membrane keypad vacuum packing machine with frame		

membrane keypads



1

<b>GEV No.</b>	402098	<b>Ref. No.</b>	0900102
<b>description</b>	membrane keypad vacuum packing machine B35-16 with frame		
<b>For models:</b>	442006, 442008		



1

<b>GEV No.</b>	402100	<b>Ref. No.</b>	0900105
<b>description</b>	membrane keypad vacuum packing machine with frame		

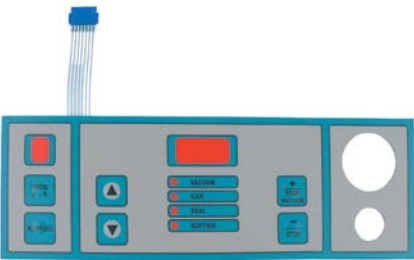

1

<b>GEV No.</b>	402094	<b>Ref. No.</b>	0810050
<b>description</b>	membrane keypad vacuum packing machine H100		



1

<b>GEV No.</b>	402096	<b>Ref. No.</b>	0900100
<b>description</b>	membrane keypad with frame		
<b>For models:</b>	442003, 442004, 442005, 442007		

keypad units





Back



Front

1

<b>GEV No.</b>	402097	<b>Ref. No.</b>	0900101	
<b>description</b>	membrane keypad vacuum packing machine JUMBO complete			
<b>spare parts for</b>	402097			
	<b>GEV No.</b>	347153	<b>Ref. No.</b>	0220006
	push switch mounting measurements ø22mm black 2NO 300V 5A connection screw ambient temperature max. 85°C protection IP40			
	<b>GEV No.</b>	402092	<b>Ref. No.</b>	0230036
	PCB vacuum packing machine JUMBO			



1

<b>GEV No.</b>	401737	<b>Ref. No.</b>	19702021
<b>description</b>	keypad unit buttons 2 blue L 130mm W 41mm		
<b>For models:</b>	470001, 471001, 481001		



1

<b>GEV No.</b>	401736	<b>Ref. No.</b>	19702022
<b>description</b>	keypad unit buttons 2 white L 130mm W 41mm		
<b>For models:</b>	470001, 471001, 481001		



1

<b>GEV No.</b>	400795	<b>Ref. No.</b>	WY18371049
<b>description</b>	keypad unit coffee machine Atlas/OrionEco/EPU1PG buttons 5 L 89mm W 42mm		
<b>For models:</b>	742001, 742002, 742003, 742004		





1

<b>GEV No.</b>	400789	<b>Ref. No.</b>	WY18371027
<b>description</b>	keypad unit coffee machine/espresso maker MININOVA/EPUMINIV buttons 5 L 66mm W 43mm		
<b>For models:</b>	742005		



1

<b>GEV No.</b>	401735	<b>Ref. No.</b>	LF1033021
<b>description</b>	keypad unit meat mincer TC12 buttons 3 cable length 90mm L 130mm W 41mm cable colours brown/yellow/grey/green/pink/white		
<b>For models:</b>	421003, 431001		
<b>accessories for</b>	401735		
	<b>GEV No.</b>	401373	<b>Ref. No.</b> 19563034
	gasket for keypad housing L 135mm W 50mm		



1

<b>GEV No.</b>	401378	<b>Ref. No.</b>	IV5940515T
<b>description</b>	keypad unit meat mincer TC12 edition since year of construction 2005 L 130mm W 41mm complete		
<b>For models:</b>	421003		



1

<b>GEV No.</b>	401694	<b>Ref. No.</b>	19702004
<b>description</b>	keypad unit slicer BAYONNE/CICLONE/SAN-DANIELE buttons 2 L 130mm W 41mm		
<b>For models:</b>	470001, 471001, 481001		
<b>accessories for</b>	401694		
	<b>GEV No.</b>	401373	<b>Ref. No.</b> 19563034
	gasket for keypad housing L 135mm W 50mm		



1

<b>GEV No.</b>	403002	<b>Ref. No.</b>	19702000
<b>description</b>	keypad unit slicer buttons 2 MIRRA/SAN-DANIELE/YORK L 120mm W 48mm		
<b>accessories for</b>	403002		
	<b>GEV No.</b>	403004	<b>Ref. No.</b> 19563030
	gasket for keypad housing L 122mm W 52mm		

control panel



1

<b>GEV No.</b>	504870	<b>Ref. No.</b>	8001900
<b>description</b>	control panel vacuum packing machine H100 L 355mm grey H 155mm D 50mm		

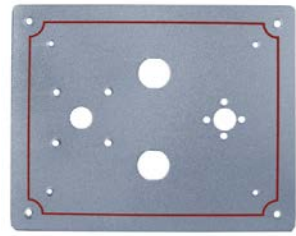

1

<b>GEV No.</b>	697351	<b>Ref. No.</b>	8301040
<b>description</b>	switch panel dough mixers TF17/22/30 TR17/22/30 L 200mm W 160mm		
<b>For models:</b>	512002, 512003, 512004		



1

<b>GEV No.</b>	692068	<b>Ref. No.</b>	0600020
<b>description</b>	switch panel vacuum packing machine JUMBO Combivac L 258mm W 55mm thickness 2.3mm		





1

<b>GEV No.</b>	692069	<b>Ref. No.</b>	0600011
<b>description</b>	switch panel vacuum packing machine JUMBO L 288mm W 88mm thickness 20mm digital		

accessories

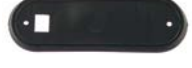
			
1			
<b>GEV No.</b>	403004	<b>Ref. No.</b>	19563030
<b>description</b>	gasket for keypad housing L 122mm W 52mm		

			
1			
<b>GEV No.</b>	401373	<b>Ref. No.</b>	19563034
<b>description</b>	gasket for keypad housing L 135mm W 50mm		
<b>For models:</b>	421003, 431001, 470001, 471001, 481001		



 <p>Image not available</p>			
1			
<b>GEV No.</b>	401375	<b>Ref. No.</b>	19563118
<b>description</b>	keypad housing		
<b>For models:</b>	431001		

			
1			
<b>GEV No.</b>	402111	<b>Ref. No.</b>	251786
<b>description</b>	push button L 60mm W 11mm H 9mm grey		
<b>For models:</b>	743001		

			
1			
<b>GEV No.</b>	402110	<b>Ref. No.</b>	251785
<b>description</b>	push button set 8-piece transparent		
<b>For models:</b>	743001		
<b>accessories for</b>	402110		
	<b>GEV No.</b>	402089	<b>Ref. No.</b> 251865
	keypad PCB for coffee machine		
	<b>GEV No.</b>	527289	<b>Ref. No.</b> 251787
	button grey		

solenoid valves

solenoid valves (water)

<b>ELBI</b>			
<b>straight</b>			
			
1			
<b>GEV No.</b>	373017	<b>Ref. No.</b>	120173 240016
<b>description</b>	solenoid valve single straight 230VAC inlet 3/4" outlet 11.5mm DN10 ELBI		
<b>For models:</b>	812008, 812010, 813001, 915462, 915465, SP1		
<b>spare parts for</b>	373017		
	<b>GEV No.</b>	370467	<b>Ref. No.</b> —
	 solenoid valve filter suitable for ELBI		

<b>angled</b>			
			
1			
<b>GEV No.</b>	370833	<b>Ref. No.</b>	CR0682320
<b>description</b>	solenoid valve single angled 230VAC inlet 3/4" outlet 11.5mm input 18.5-20l/min DN10 ELBI		
<b>For models:</b>	146002, 146006, 147003, 147005, 147006, 147007		

			
1			
<b>GEV No.</b>	370246	<b>Ref. No.</b>	240010
<b>description</b>	solenoid valve double straight 230VAC inlet 3/4" outlet 11.5mm t.max. 90°C ELBI plastic output B 0.5l/min flow regulating valve outlet B red		
<b>For models:</b>	811003, 915234, 915235, 915236, 915237		

spare parts and accessories

solenoid coils

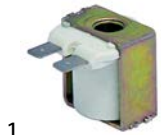

<b>GEV No.</b>	371016	<b>Ref. No.</b>	630969
<b>description</b>	solenoid coil ELBI 230VAC 50/60Hz pressure range 0 up to 10bar coil type EATON (INVENSYS) tolerance ±15%		
<b>For models:</b>	SP1, SP2-12, SP2-S12, SP3		

reducers

outlet side



<b>GEV No.</b>	371060	<b>Ref. No.</b>	R65110520
<b>description</b>	reducer ELBI flow rate 0.25l/min pressure range 0 up to 10bar tolerance ±15/25% green		
<b>For models:</b>	212010, 212011, 212012, 212013		

INTERELEKTRIK

medium temperature: 90°C 90°C 60°C  
 ambient temperature: 60°C 25°C 60°C  
 duty cycle: 40% 100% 100%

with reducers



<b>GEV No.</b>	370675	<b>Ref. No.</b>	00-883658-001
<b>description</b>	solenoid valve single straight 230VAC inlet 3/4" outlet 10.5mm input 5l/min t.max. 90°C		
<b>For models:</b>	811014, 811015, 812014, 812015, 813002, 813003, 813004		
<b>accessories for</b>	370675		



<b>GEV No.</b>	520015	<b>Ref. No.</b>	00-775559-007 00-775559-008 00-775559-013 00-775559-016 143004
supply hose ID ø 10mm ED ø 17mm L 5m operating p. 20bar burst p. 60bar t.max. 95°C grey Qty 5m			



MÜLLER

medium temperature: 90°C  
 duty cycle: 100%

solenoid valves with reducers

2-fold



<b>GEV No.</b>	370522	<b>Ref. No.</b>	679459
<b>description</b>	solenoid valve double 230VAC inlet 3/4" outlet 14.5mm DN10 t.max. 90°C duty cycle 100% MÜLLER plastic output A 3l/min output B 3l/min		
<b>For models:</b>	741003		
<b>spare parts for</b>	370522		
	<b>GEV No.</b>	371017	<b>Ref. No.</b> —
solenoid coil MÜLLER 230VAC connection male faston 6.3mm			
	<b>GEV No.</b>	371285	<b>Ref. No.</b> —
reducer MÜLLER type MR07 flow rate 3l/min mounting measurements 10mm nominal flow at 4bar pressure range 1-10bar approval KTW tolerance ±20% violet			



RPE



<b>GEV No.</b>	370857	<b>Ref. No.</b>	00-883658-002
<b>description</b>	solenoid valve single straight 230VAC inlet 3/4" outlet 10.5mm input 15l/min t.max. 90°C RPE plastic		
<b>For models:</b>	811011, 811012, 811013, 812011, 812012, 812013, 813002, 813004		

JOHN GUEST



<b>GEV No.</b>	370772	<b>Ref. No.</b>	ELE30005
<b>description</b>	solenoid valve double straight 230VAC inlet 3/4" outlet JG 8 DN10 t.max. 60°C duty cycle 100% RPE		
<b>For models:</b>	212015, 212016, 212024, 212025		
<b>accessories for</b>	370772		
	<b>GEV No.</b>	371265	<b>Ref. No.</b> —
reducer flow rate 3l/min black			
	<b>GEV No.</b>	371269	<b>Ref. No.</b> R65110500
reducer flow rate 0.07-0.14l/min brown			

<b>GEV No.</b>	374090	<b>Ref. No.</b>	01201800
<b>description</b>	solenoid valve triple straight 220-240VAC inlet 3/4" outlet JG 8 DN8 t.max. 25/60/90°C duty cycle 100% RPE output A 0.2l/min output B 0.2l/min output C 0.2l/min flow regulating valve outlet A red flow regulating valve outlet B red flow regulating valve outlet C red		
<b>For models:</b>	212040, 212041		



<b>GEV No.</b>	374012	<b>Ref. No.</b>	01201860
<b>description</b>	solenoid valve single straight 220-240VAC inlet 3/4" outlet JG 8 input 10-12l/min t.max. 60°C duty cycle 100% RPE plastic flow regulating valve outlet brown flow regulating valve inlet white output A 0.07-0.14l/min 2-ways medium temp max. 25°C male faston 6.3mm		
<b>For models:</b>	211039, 211042, 211043, 211044, 211045, 211046, 212034, 212035, 212036, 212037		



<b>GEV No.</b>	374032 <sup>1</sup>	<b>Ref. No.</b>	R65110230
<b>description</b>	solenoid valve double straight 230VAC inlet 3/4" outlet 10mm DN10 plastic output A w/t membrane (constantly open)		
<b>For models:</b>	212001, 212002, 212003, 212010, 212011, 212012, 212013		

<sup>1</sup>cylindrical outlet

2-fold



<b>GEV No.</b>	374037	<b>Ref. No.</b>	01203180
<b>description</b>	solenoid valve double straight 220-240VAC inlet 3/4" outlet JG 8 input 10-12l/min t.max. 60°C duty cycle 100% RPE plastic flow regulating valve inlet white output A 0.2-0.33l/min output B 0.2-0.33l/min flow regulating valve outlet A red flow regulating valve outlet B red output A John Guest 8mm output B John Guest 8mm		
<b>For models:</b>	212038, 212039		



<b>GEV No.</b>	370768 <sup>1</sup>	<b>Ref. No.</b>	R65110200
<b>description</b>	solenoid valve single straight 230VAC inlet 3/4" outlet 10mm input/ min output/ min DN10 t.max. 90°C duty cycle 100% RPE		
<b>For models:</b>	212001, 212002, 212003, 212004, 212005, 212010, 212011, 212012, 212013, 212018, 212020		

<sup>1</sup>cylindrical outlet



<b>GEV No.</b>	374103	<b>Ref. No.</b>	ELE001
<b>description</b>	solenoid valve double straight 220-240VAC inlet 3/4" outlet JG 8 input 4-4.5l/min output 0.07-0.14l/min flow regulating valve inlet yellow output A brown/ min output B brown/ min		

reducers

outlet side



<b>GEV No.</b>	371269	<b>Ref. No.</b>	R65110500
<b>description</b>	reducer flow rate 0.07-0.14l/min brown		
<b>For models:</b>	212001, 212002		



<b>GEV No.</b>	374031	<b>Ref. No.</b>	R65110210
<b>description</b>	solenoid valve double straight 230VAC inlet 3/4 outlet JG 10 input 10-12l/min t.max. 90°C RPE plastic flow regulating valve inlet white + outlet reducer red		
<b>For models:</b>	212006, 212008, 212010, 212011, 212012, 212013, 212017, 212019		

solenoid valves with reducers

single









<b>GEV No.</b>	374009	<b>Ref. No.</b>	ELE30004
<b>description</b>	solenoid valve single straight 220-240VAC inlet 3/4" outlet JG 8 input 10-12l/min output 0.07-0.14l/min t.max. 60°C duty cycle 100% RPE plastic flow regulating valve outlet brown flow regulating valve inlet white 1-ways medium temp max. 25°C		
<b>For models:</b>	211005, 211006, 211010, 211012, 211013, 211014, 211015, 211016, 211018, 211020, 211023, 211024, 211026, 211027, 211029, 212014		

3-fold



<b>GEV No.</b>	374033	<b>Ref. No.</b>	R65110240
<b>description</b>	solenoid valve triple straight 230VAC inlet 3/4" outlet 10mm input 10-12l/min t.max. 90°C RPE plastic flow regulating valve inlet white output B w/t membrane (constantly open)		
<b>For models:</b>	212007, 212009, 212018, 212020		

TP			
			
<b>GEV No.</b>	370017	<b>Ref. No.</b>	240011
<b>description</b>	solenoid valve single straight 230VAC inlet 3/4" outlet 11.5mm DN10 TP p max 10bar		
<b>For models:</b>	811003, 812001, 812002, 812003, 812004, 812005, 812006, 812007, 812008, 812009, 812010, 915234, 915235, 915236, 915237, 915460, 915461, 915463, 915464		
<b>spare parts for</b>	370017		
	GEV No.	371013	Ref. No. —
solenoid coil TP 230VAC 50/60Hz			
<b>accessories for</b>	370017		
	GEV No.	371220	Ref. No. —
reducer TP flow rate 3l/min red tolerance ±15%			
	GEV No.	371221	Ref. No. —
reducer TP flow rate 5.5l/min yellow tolerance ±15%			
	GEV No.	371222	Ref. No. —
reducer TP flow rate 6l/min grey tolerance ±15%			
	GEV No.	371223	Ref. No. —
reducer TP flow rate 10l/min white tolerance ±15%			
	GEV No.	371224	Ref. No. —
reducer TP flow rate 12l/min bronze tolerance ±15%			
	GEV No.	371225	Ref. No. —
reducer TP flow rate 16l/min light brown tolerance ±15%			
	GEV No.	371226	Ref. No. —
reducer TP flow rate 20l/min red tolerance ±15%			
	GEV No.	371230	Ref. No. —
reducer TP flow rate 0.25l/min red tolerance ±25%			
	GEV No.	371231	Ref. No. —
reducer TP flow rate 0.35l/min violet tolerance ±25%			
	GEV No.	371232	Ref. No. —
reducer TP flow rate 0.5l/min orange tolerance ±25%			
	GEV No.	371233	Ref. No. —
reducer TP flow rate 0.8l/min white tolerance ±25%			
	GEV No.	371234	Ref. No. —
reducer TP flow rate 1l/min light blue tolerance ±25%			
	GEV No.	371235	Ref. No. —
reducer TP flow rate 1.2l/min brown tolerance ±25%			
	GEV No.	371236	Ref. No. —
reducer TP flow rate 1.5l/min light brown tolerance ±25%			

accessories for 370017			
	GEV No.	371237	Ref. No. —
reducer TP flow rate 2.5l/min yellow tolerance ±25%			
	GEV No.	371238	Ref. No. —
reducer TP flow rate 3.4l/min dark green tolerance ±25%			
	GEV No.	371239	Ref. No. —
reducer TP flow rate 5l/min black tolerance ±25%			
	GEV No.	371240	Ref. No. —
reducer TP flow rate 8l/min blue tolerance ±20%			





















TP			
			
<b>GEV No.</b>	370015	<b>Ref. No.</b>	120145
<b>description</b>	solenoid valve single angled 230VAC inlet 3/4" outlet 11.5mm DN10 TP		
<b>For models:</b>	SP3		
<b>accessories for</b>	370015		
	GEV No.	371220	Ref. No. —
reducer TP flow rate 3l/min red tolerance ±15%			
	GEV No.	371221	Ref. No. —
reducer TP flow rate 5.5l/min yellow tolerance ±15%			
	GEV No.	371222	Ref. No. —
reducer TP flow rate 6l/min grey tolerance ±15%			
	GEV No.	371223	Ref. No. —
reducer TP flow rate 10l/min white tolerance ±15%			
	GEV No.	371224	Ref. No. —
reducer TP flow rate 12l/min bronze tolerance ±15%			
	GEV No.	371225	Ref. No. —
reducer TP flow rate 16l/min light brown tolerance ±15%			
	GEV No.	371226	Ref. No. —
reducer TP flow rate 20l/min red tolerance ±15%			
	GEV No.	371230	Ref. No. —
reducer TP flow rate 0.25l/min red tolerance ±25%			
	GEV No.	371231	Ref. No. —
reducer TP flow rate 0.35l/min violet tolerance ±25%			
	GEV No.	371232	Ref. No. —
reducer TP flow rate 0.5l/min orange tolerance ±25%			
	GEV No.	371233	Ref. No. —
reducer TP flow rate 0.8l/min white tolerance ±25%			

Table continues overleaf







accessories for		370015		
	GEV No.	371234	Ref. No.	—
	reducer TP flow rate 1l/min light blue tolerance ±25%			
	GEV No.	371235	Ref. No.	—
	reducer TP flow rate 1.2l/min brown tolerance ±25%			
	GEV No.	371236	Ref. No.	—
	reducer TP flow rate 1.5l/min light brown tolerance ±25%			
	GEV No.	371237	Ref. No.	—
	reducer TP flow rate 2.5l/min yellow tolerance ±25%			
	GEV No.	371238	Ref. No.	—
	reducer TP flow rate 3.4l/min dark green tolerance ±25%			
	GEV No.	371239	Ref. No.	—
	reducer TP flow rate 5l/min black tolerance ±25%			
	GEV No.	371240	Ref. No.	—
	reducer TP flow rate 8l/min blue tolerance ±20%			

			
1			
<b>GEV No.</b>	370395	<b>Ref. No.</b>	23116
<b>description</b>	solenoid valve double angled 230VAC inlet 3/4" inputl/min output 0.8/0.8l/min DN10 t.max. 90°C TP plastic outlet 11.5mm output A 0.8l/min output B 0.8l/min flow regulating valve outlet A white flow regulating valve outlet B white		
<b>For models:</b>	711008, 711009		

			
Image not available			
1			
<b>GEV No.</b>	370011	<b>Ref. No.</b>	120144
<b>description</b>	solenoid valve double angled 230VAC inlet 3/4" outlet 11.5mm		
<b>For models:</b>	SP2-12, SP2-S12		

solenoid valves with reducers				
				
1				
<b>GEV No.</b>	370437	<b>Ref. No.</b>	23010	
<b>description</b>	solenoid valve double angled 230VAC inlet 3/4" input 10l/min output 1.2/1.2l/min DN10 t.max. 90°C TP plastic flow regulating valve inlet white outlet 11.5mm output A 1.2l/min output B 1.2l/min flow regulating valve outlet A dark brown flow regulating valve outlet B dark brown			
<b>For models:</b>	711010, 711011, 711014, 711015, 711016, 711017, 711018, 711019			

			
1			
<b>GEV No.</b>	370435	<b>Ref. No.</b>	23542
<b>description</b>	solenoid valve double angled 230VAC inlet 3/4" t.max. 90°C TP plastic outlet 11.5mm output A 0.5l/min output B 0.8l/min flow regulating valve outlet A orange flow regulating valve outlet B white		
<b>For models:</b>	711004, 711005, 711006, 711007		

				
1				
<b>GEV No.</b>	370436	<b>Ref. No.</b>	23498	
<b>description</b>	solenoid valve double angled 230VAC inlet 3/4" inputl/min output 0.6/0.6l/min DN10 t.max. 90°C TP plastic outlet 11.5mm output A 0.6l/min output B 0.6l/min flow regulating valve outlet A orange flow regulating valve outlet B orange			
<b>For models:</b>	711002, 711003			

			
1			
<b>GEV No.</b>	370438	<b>Ref. No.</b>	23502
<b>description</b>	solenoid valve double angled 230VAC inlet 3/4" t.max. 90°C TP plastic outlet 11.5mm output A 1.2l/min output B 0.8l/min flow regulating valve outlet A dark brown flow regulating valve outlet B white		
<b>For models:</b>	711012, 711013		



1

<b>GEV No.</b>	370682	<b>Ref. No.</b>	120188
<b>description</b>	solenoid valve single angled 230VAC inlet 3/4" outlet 11.5mm input 16l/min TP plastic flow regulating valve inlet pink 8VA		
<b>For models:</b>	SP2-12, SP2-S12		



1

<b>GEV No.</b>	370449	<b>Ref. No.</b>	23220
<b>description</b>	solenoid valve single angled 230VAC inlet 3/4" outlet 11.5mm input 2.5l/min output/min DN10 t.max. 90°C TP plastic flow regulating valve inlet yellow		
<b>For models:</b>	711014, 711015, 711016, 711017, 711018, 711019		



1

<b>GEV No.</b>	370426	<b>Ref. No.</b>	23497
<b>description</b>	solenoid valve single angled 230VAC inlet 3/4" outlet 11.5mm input/min output 0.6l/min DN10 t.max. 90°C TP plastic flow regulating valve outlet orange		
<b>For models:</b>	711001, 711002, 711003, 711004, 711005, 711006, 711007		



1

<b>GEV No.</b>	370399	<b>Ref. No.</b>	23115
<b>description</b>	solenoid valve single angled 230VAC inlet 3/4" outlet 11.5mm input/min output 0.8l/min DN10 t.max. 90°C TP plastic		
<b>For models:</b>	711008, 711009		



1

<b>GEV No.</b>	370427	<b>Ref. No.</b>	23001
<b>description</b>	solenoid valve single angled 230VAC inlet 3/4" outlet 11.5mm input/min output 1.2l/min DN10 t.max. 90°C TP plastic flow regulating valve outlet dark brown		
<b>For models:</b>	711010, 711011, 711012, 711013, 711014, 711015, 711016, 711017, 711018, 711019		



1

<b>GEV No.</b>	370354	<b>Ref. No.</b>	41826630220
<b>description</b>	solenoid valve single angled 230VAC inlet 3/4" outlet 11.5mm output 5l/min t.max. 90°C TP plastic flow regulating valve outlet black flow regulating valve inlet white		
<b>For models:</b>	135001, 135002, 135003, 135004, 135201, 135202, 135203, 135204		

various



1

<b>GEV No.</b>	370641	<b>Ref. No.</b>	00-775897-001
<b>description</b>	solenoid valve 220-240VAC outlet 10mm plastic inlet 10mm		
<b>For models:</b>	811014, 811015, 812014, 812015, 813003, 813004		



1

<b>GEV No.</b>	370636	<b>Ref. No.</b>	240020
<b>description</b>	solenoid valve single CO 230VAC outlet 10.5mm MILANO 00168401 plastic 3-ways inlet 10.5mm 50/60Hz male faston 6.3mm		
<b>For models:</b>	812008, 812010, 915462, 915465		
<b>accessories for</b>	370636		



<b>GEV No.</b>	371142	<b>Ref. No.</b>	133009
reducer for solenoid valve ø 8.2mm			

1

<b>GEV No.</b>	372216	<b>Ref. No.</b>	251895 253818
<b>description</b>	solenoid valve with pressure switch single, angled 230VAC outlet 11mm inlet 3/4"mm		
<b>For models:</b>	743001		

metal  
ASCO  
2-way



1

<b>GEV No.</b>	370509	<b>Ref. No.</b>	0280042
<b>description</b>	solenoid valve 2-ways 24VAC inlet 1/2" outlet 1/2" connection 1/2" L 52mm DN 12.5mm slide-on receptacle DIN -20° up to 85°C membranes NBR (water) p max 7bar 1/2" brass		
<b>For models:</b>	442006		

3-way



1

<b>GEV No.</b>	370510	<b>Ref. No.</b>	0280052
<b>description</b>	solenoid valve brass 3-ways 24VAC connection 1/4" L 43mm DN 4.4mm -20 up to +90°C membranes NBR (water) p max 3bar p min 0bar 1/4"		

spare parts and accessories

O-rings



1

<b>GEV No.</b>	371095	<b>Ref. No.</b>	WY12305
<b>description</b>	O-ring Viton thickness 1.78mm ID ø 6.07mm Qty 1 pcs		
<b>For models:</b>	742001, 742002, 742003, 742004, 742005, 742017, 742018, 742019, 742020		

BÜRKERT

solenoid valves (various)



1

<b>GEV No.</b>	370143	<b>Ref. No.</b>	90.19.10
<b>description</b>	solenoid valve 2-way 196V voltage DC BÜRKERT		
<b>For models:</b>	745002		

M&M

spare parts and accessories

solenoid coils



1

<b>GEV No.</b>	370524	<b>Ref. No.</b>	15385
<b>description</b>	membrane silicone ø 12mm L 16mm		
<b>For models:</b>	741003		



## ODE

## 5-way



1

<b>GEV No.</b>	370477	<b>Ref. No.</b>	098761
<b>description</b>	solenoid valve brass 230VAC outlet 1/8" 5-way body outer cone slide-on receptacle DIN ODE coil type BDA/LBA p max 15bar coffee machine		
<b>For models:</b>	743001		
<b>spare parts for</b>	370477		
	<b>GEV No.</b>	371150	<b>Ref. No.</b> 099057
	solenoid coil ODE 230VAC 16VA coil type BDV seat ø 13.5mm 750Ohm		
	<b>GEV No.</b>	371191	<b>Ref. No.</b> 099056
	solenoid coil ODE 230VAC 10VA 50Hz coil type LBA seat ø 10mm		
	<b>GEV No.</b>	371192	<b>Ref. No.</b> 099105
	solenoid valve body ø 13mm		
	<b>GEV No.</b>	371193	<b>Ref. No.</b> 097472
	valve insert L 30mm ø 12mm Viton		
	<b>GEV No.</b>	371194	<b>Ref. No.</b> 0V1953
	solenoid valve body ø 10mm		
	<b>GEV No.</b>	371195	<b>Ref. No.</b> 099058
	valve insert L 24mm ø 9mm Viton		
	<b>GEV No.</b>	510177	<b>Ref. No.</b> 094594
	O-ring EPDM thickness 1.78mm ID ø 7.66mm Qty 1 pcs		
	<b>GEV No.</b>	520333	<b>Ref. No.</b> 095529
	hose connector brass straight thread 1/8" hose ø 7mm Qty 1 pcs		
	<b>GEV No.</b>	520334	<b>Ref. No.</b> 0V2509
	angle piece thread 1/8" with coupling angled hose ø 5mm		

## spare parts and accessories

## gaskets



1

<b>GEV No.</b>	371196	<b>Ref. No.</b>	099059
<b>description</b>	O-ring ø 12mm for valve body		
<b>For models:</b>	743001		

## solenoid coils



1

<b>GEV No.</b>	371191	<b>Ref. No.</b>	099056
<b>description</b>	solenoid coil ODE 230VAC 10VA 50Hz coil type LBA seat ø 10mm		
<b>For models:</b>	743001		



1

<b>GEV No.</b>	371150	<b>Ref. No.</b>	099057
<b>description</b>	solenoid coil ODE 230VAC 16VA coil type BDV seat ø 13.5mm 750Ohm		
<b>For models:</b>	743001		

## valve inserts



1

<b>GEV No.</b>	371195	<b>Ref. No.</b>	099058
<b>description</b>	valve insert L 24mm ø 9mm Viton		
<b>For models:</b>	743001		



1

<b>GEV No.</b>	371193	<b>Ref. No.</b>	097472
<b>description</b>	valve insert L 30mm ø 12mm Viton		
<b>For models:</b>	743001		

## valve bodies



1

<b>GEV No.</b>	371194	<b>Ref. No.</b>	0V1953
<b>description</b>	solenoid valve body ø 10mm		
<b>For models:</b>	743001		



1

<b>GEV No.</b>	371192	<b>Ref. No.</b>	099105
<b>description</b>	solenoid valve body ø 13mm		
<b>For models:</b>	743001		





PARKER			
2-way			
VE-140 series			
			
1			
<b>GEV No.</b>	370141 <sup>1</sup>	<b>Ref. No.</b>	WY18161990
<b>description</b>	solenoid valve 2-ways 208-240 inlet 1/4" outlet 1/4" connection 1/4" L 40mm DN 3mm slide-on receptacle DIN -10 up to 140°C type series VE-140 coil type ZB09 membranes ruby p max 8bar SS		
<b>For models:</b>	742005		



<sup>1</sup>SS housing

			
1			
<b>GEV No.</b>	370140	<b>Ref. No.</b>	WY18162002 WY18162004 WY4618162005
<b>description</b>	solenoid valve 2-way-ways 230VAC connection 1/8" L 30mm DN 2.5mm slide-on receptacle DIN -10 up to 140°C coil type DZ06S6 membranes ruby p max 14bar brass		
<b>For models:</b>	742001, 742002, 742003, 742004, 742005		

3-way			
VE-128 series			
			
1			
<b>GEV No.</b>	370057	<b>Ref. No.</b>	WY18151
<b>description</b>	solenoid valve 3-ways 230VAC body outer cone DN 1.2mm slide-on receptacle DIN -20° up to 140°C PARKER type series VE-128 coil type ZB09 membranes ruby p max 10bar brass flange 32x32mm		
<b>For models:</b>	742001, 742002, 742003, 742004, 742005, 742017, 742018, 742019, 742020		
<b>spare parts for</b>	370057		
	<b>GEV No.</b>	370062	<b>Ref. No.</b> —
solenoid valve body PARKER 3-ways outer cone			
	<b>GEV No.</b>	371029	<b>Ref. No.</b> —
solenoid coil PARKER 230VAC 9VA coil type ZB09 seat ø 14mm H 33mm W 34mm D 43mm			
<b>accessories for</b>	370057		
	<b>GEV No.</b>	371090	<b>Ref. No.</b> —
power socket plug type DIN 43650A screw			
	<b>GEV No.</b>	371095	<b>Ref. No.</b> WY12305
O-ring Viton thickness 1.78mm ID ø 6.07mm Qty 1 pcs			

<b>accessories for</b>	370057		
	<b>GEV No.</b>	371100	<b>Ref. No.</b> —
O-ring silicone thickness 1.78mm ID ø 6.07mm Qty 1 pcs			

solenoid valves (various)			
			
1			
<b>GEV No.</b>	370525	<b>Ref. No.</b>	WY18150
<b>description</b>	solenoid valve 3-ways 110VAC body outer cone DN 1.5mm slide-on receptacle DIN -20 up to +140°C PARKER type series E131F membranes ruby p max 10bar p min 0bar with flange plate 110V brass voltage AC flange 32x32mm		
<b>For models:</b>	742001, 742002, 742003, 742004, 742005, 742017, 742018, 742019, 742020		

solenoid valves (various)			
			
1			
<b>GEV No.</b>	370523	<b>Ref. No.</b>	11753
<b>description</b>	solenoid valve 230VAC connection M&M coil type 2700 230V brass		
<b>For models:</b>	741003		
<b>spare parts for</b>	370523		
	<b>GEV No.</b>	370524	<b>Ref. No.</b> 15385
membrane silicone ø 12mm L 16mm			
	<b>GEV No.</b>	371022	<b>Ref. No.</b> —
solenoid coil M&M 230VAC 10VA 50Hz coil type 2700 seat ø 10mm			



solenoid valves (refrigeration)

CASTEL

valve bodies

STANDARD series

suitable for refrigerants R22, R134a, R404A, R407C, R410A, R507



<b>GEV No.</b>	370151	<b>Ref. No.</b>	20410
----------------	--------	-----------------	-------

**description** solenoid valve body NC type 1028/2 S p max 45bar connection 1/4" soldering connection DN 2.2mm -35 up to +105°C L 125mm refrigeration straight CASTEL

**For models:** 711002, 711003, 711004, 711005, 711006, 711007, 711008, 711009, 711010, 711011, 711012, 711013, 711014, 711015, 711016, 711017, 711018, 711019

**accessories for** 370151

	<b>GEV No.</b>	371084	<b>Ref. No.</b>	—
	solenoid coil CASTEL 230VAC 8VA 50/60Hz connection cable 1000mm type CM2			

	<b>GEV No.</b>	371090	<b>Ref. No.</b>	—
	power socket plug type DIN 43650A screw			

	<b>GEV No.</b>	371301	<b>Ref. No.</b>	—
	solenoid coil CASTEL 110VAC 8VA 50/60Hz seat ø 11.5mm connection DIN 43650A type HF2			

	<b>GEV No.</b>	371314	<b>Ref. No.</b>	—
	solenoid coil CASTEL 240VAC 8VA 50/60Hz seat ø 11.5mm			

	<b>GEV No.</b>	371321	<b>Ref. No.</b>	—
	solenoid coil CASTEL 12/24VAC 50/60Hz seat ø 11.5mm connection DIN 43650A type HF2			



<b>GEV No.</b>	370383	<b>Ref. No.</b>	20409
----------------	--------	-----------------	-------

**description** solenoid valve body NC type 1068/M10S p max 45bar connection 10mm soldering connection DN 7mm -35 up to +105°C L 111mm refrigeration straight CASTEL

**For models:** 711016, 711017, 711018, 711019

**accessories for** 370383

	<b>GEV No.</b>	371084	<b>Ref. No.</b>	—
	solenoid coil CASTEL 230VAC 8VA 50/60Hz connection cable 1000mm type CM2			

	<b>GEV No.</b>	371090	<b>Ref. No.</b>	—
	power socket plug type DIN 43650A screw			

**accessories for** 370383

	<b>GEV No.</b>	371301	<b>Ref. No.</b>	—
	solenoid coil CASTEL 110VAC 8VA 50/60Hz seat ø 11.5mm connection DIN 43650A type HF2			

	<b>GEV No.</b>	371314	<b>Ref. No.</b>	—
	solenoid coil CASTEL 240VAC 8VA 50/60Hz seat ø 11.5mm			

	<b>GEV No.</b>	371321	<b>Ref. No.</b>	—
	solenoid coil CASTEL 12/24VAC 50/60Hz seat ø 11.5mm connection DIN 43650A type HF2			

spare parts and accessories

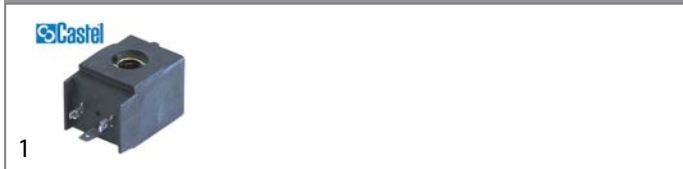

<b>GEV No.</b>	371041	<b>Ref. No.</b>	23091
----------------	--------	-----------------	-------

**description** solenoid coil CASTEL 240VAC 8VA 50/60Hz seat ø 11.5mm connection DIN 43650A type HM2

**For models:** 711002, 711003, 711004, 711005, 711006, 711007, 711008, 711009, 711010, 711011, 711012, 711013, 711014, 711015, 711016, 711017, 711018, 711019

**accessories for** 371041

	<b>GEV No.</b>	371090	<b>Ref. No.</b>	—
	power socket plug type DIN 43650A screw			

	<b>GEV No.</b>	371092	<b>Ref. No.</b>	—
	power socket plug type DIN large cable length 1000mm			

CEME

valves

with pipe clamp



<b>GEV No.</b>	370380	<b>Ref. No.</b>	R30-0031
----------------	--------	-----------------	----------

**description** solenoid valve straight CEME type 6806 230V p max 25bar connection 6mm soldering connection -45 up to +125°C refrigeration 50Hz

**For models:** 621004, 628004



SANHUA

valves



1

<b>GEV No.</b>	370757	<b>Ref. No.</b>	995508
<b>description</b>	solenoid valve type MDF-A03-6H001 230VAC p max 45bar pressure range 2 up to 31bar connection 10mm soldering connection -30 up to +105°C SANHUA refrigeration tube ø 10mm L 111mm		
<b>For models:</b>	671005, 671007		

various

valve bodies



1

<b>GEV No.</b>	370478	<b>Ref. No.</b>	20853
<b>description</b>	solenoid valve body connection 6mm soldering connection refrigeration angled 90°		
<b>For models:</b>	711001, 711002, 711003		

Solenoid valve - accessories



1

<b>GEV No.</b>	370516	<b>Ref. No.</b>	0280072
<b>description</b>	nut thread M8x0.75 for solenoid coil		



1

<b>GEV No.</b>	371095	<b>Ref. No.</b>	WY12305
<b>description</b>	O-ring Viton thickness 1.78mm ID ø 6.07mm Qty 1 pcs		
<b>For models:</b>	742001, 742002, 742003, 742004, 742005, 742017, 742018, 742019, 742020		



1

<b>GEV No.</b>	371142	<b>Ref. No.</b>	133009
<b>description</b>	reducer for solenoid valve ø 8.2mm		
<b>For models:</b>	812008, 812010, 915462, 915465		



1

<b>GEV No.</b>	370515	<b>Ref. No.</b>	0280071
<b>description</b>	solenoid coil 24V voltage AC seat ø 9mm		
<b>For models:</b>	442010		



1

<b>GEV No.</b>	370508	<b>Ref. No.</b>	0280024
<b>description</b>	solenoid coil 3-way 24V 6mm		



1

<b>GEV No.</b>	530903	<b>Ref. No.</b>	R65090300
<b>description</b>	solenoid coil plug type F6.3x0.8 230V for combi-steamer		
<b>For models:</b>	212005, 212007, 212009, 212018, 212020		



1

<b>GEV No.</b>	370517	<b>Ref. No.</b>	0280075
<b>description</b>	solenoid valve body nominal dimension 2.8mm		
<b>For models:</b>	442003, 442004		

			
1			
<b>GEV No.</b>	370519	<b>Ref. No.</b>	0280080
<b>description</b>	solenoid valve body nominal dimension 2.8mm		

			
1			
<b>GEV No.</b>	370518	<b>Ref. No.</b>	0280078
<b>description</b>	solenoid valve body nominal dimension 6mm		
<b>For models:</b>	442005, 442007, 442008, 442010		

**solenoid valves for vacuum machines**

			
1			
<b>GEV No.</b>	370520	<b>Ref. No.</b>	0900858
<b>description</b>	solenoid valve 2-way 24VACV inlet 1/4" outlet ø4 vacuum packing machine		
<b>For models:</b>	442006		

			
1			
<b>GEV No.</b>	370507	<b>Ref. No.</b>	0280021
<b>description</b>	solenoid valve 2-ways 24VAC inlet 1/8" outlet 1/8"mm L 31mm DN 3.3mm 1/8" brass		
<b>For models:</b>	442006, 442008		

			
1			
<b>GEV No.</b>	370506	<b>Ref. No.</b>	0280010
<b>description</b>	solenoid valve 3-ways 24VAC inlet 1/8" outlet 1/8"mm L 35mm body inner cone DN 2.8mm 1/8" 24V brass		
<b>For models:</b>	442006		

			
1			
<b>GEV No.</b>	370514	<b>Ref. No.</b>	0280029
<b>description</b>	solenoid valve assembly 24VAC inlet 1/2" 3 coils coil type VA12 24V thread 1/2" hose ø 21mm H200+SA		

			
1			
<b>GEV No.</b>	370513	<b>Ref. No.</b>	0280027
<b>description</b>	solenoid valve assembly 24VAC inlet 1/2" outlet 10.5mm 2 coils coil type VA12 thread 1/2" JP		

			
1			
<b>GEV No.</b>	370800	<b>Ref. No.</b>	0280035
<b>description</b>	solenoid valve assembly 24VAC inlet 1/2" outlet 10.5mm 2 coils coil type VA12 thread 1/2" JP		
<b>For models:</b>	442010		

			
1			
<b>GEV No.</b>	370816	<b>Ref. No.</b>	0280026
<b>description</b>	solenoid valve assembly 24VAC inlet 1/2" outlet 21mm 2 coils coil type VA12 24V thread 1/2" hose ø 21mm J35/J42/B35		

			
1			
<b>GEV No.</b>	370511	<b>Ref. No.</b>	0280025
<b>description</b>	solenoid valve assembly 24VAC inlet 1/2" outlet 7.5mm 2 coils coil type VA12 thread 1/2" MJ		







			
1			
<b>GEV No.</b>	370787	<b>Ref. No.</b>	0280039
<b>description</b>	solenoid valve assembly 24VAC inlet 1/2" outlet 7.5mm 2 coils coil type VA12 thread 1/2" MJ		

			
1			
<b>GEV No.</b>	370503	<b>Ref. No.</b>	0900833
<b>description</b>	solenoid valve assembly thread 1/2" hose ø 21mm 24V coil type VA12 J42		
<b>For models:</b>	442007		

			
1			
<b>GEV No.</b>	370505	<b>Ref. No.</b>	0900836
<b>description</b>	solenoid valve assembly 3 coils 24V thread 1/2" hose ø 21mm coil type VA12 B42(XL)+SA		

			
1			
<b>GEV No.</b>	692064	<b>Ref. No.</b>	0280032
<b>description</b>	solenoid valve assembly thread 1/2" hose ø 6mm 24V H200		

			
1			
<b>GEV No.</b>	370501	<b>Ref. No.</b>	0900831
<b>description</b>	solenoid valve assembly thread 1/2" hose ø 10mm 24V coil type VA12 JP		
<b>For models:</b>	442004		

			
1			
<b>GEV No.</b>	370500	<b>Ref. No.</b>	0900830
<b>description</b>	solenoid valve assembly thread 1/2" hose ø 7.5mm 24V coil type VA12 MJ		
<b>For models:</b>	442003		

			
1			
<b>GEV No.</b>	370504	<b>Ref. No.</b>	0900835
<b>description</b>	solenoid valve assembly thread 1/2" hose ø 21mm 24V coil type VA12 B35+SA 3 coils		

## pressure switches

for warewashing

ø 58mm with male faston 6.3mm

with connection horizontal

			
1			
<b>GEV No.</b>	370502	<b>Ref. No.</b>	0900832
<b>description</b>	solenoid valve assembly thread 1/2" hose ø 21mm 24V coil type VA12 J35		
<b>For models:</b>	442005		

			
1			
<b>GEV No.</b>	541002	<b>Ref. No.</b>	224002
<b>description</b>	pressure control pressure range 110/60mbar connection 6mm ø 58mm pressure connection horizontal warewashing pressure connection ø 6mm		
<b>For models:</b>	813001		

			
1			
<b>GEV No.</b>	541011	<b>Ref. No.</b>	224010
<b>description</b>	pressure control pressure range 110/70mbar connection 6mm ø 58mm pressure connection horizontal warewashing		
<b>For models:</b>	812002, 812004, 812007, 812008, 812009, 812010, 915234, 915235, 915236, 915237, 915460, 915461, 915462, 915463, 915464, 915465		



			
1			
<b>GEV No.</b>	541307	<b>Ref. No.</b>	130629
<b>description</b>	pressure control pressure range 30/12mbar connection male faston 6.3mm ø 58mm pressure connection horizontal warewashing pressure connection ø 6mm		
<b>For models:</b>	SP1, SP2-12, SP2-S12		

			
1			
<b>GEV No.</b>	541001	<b>Ref. No.</b>	224004
<b>description</b>	pressure control pressure range 35/17mbar connection 6mm ø 58mm pressure connection horizontal warewashing		
<b>For models:</b>	811001, 811002, 811003		

			
1			
<b>GEV No.</b>	541003	<b>Ref. No.</b>	224003
<b>description</b>	pressure control pressure range 55/35mbar connection 6mm ø 58mm pressure connection horizontal warewashing pressure connection ø 6mm		
<b>For models:</b>	812001, 812002, 812003, 812004, 812005, 812006, 812007, 812008, 812009, 812010, 915234, 915235, 915236, 915237, 915460, 915461, 915462, 915463, 915464, 915465		

			
1			
<b>GEV No.</b>	541631	<b>Ref. No.</b>	130632
<b>description</b>	pressure control pressure range 75/45mbar connection 6mm ø 55mm pressure connection ø 5.5mm		
<b>For models:</b>	SP3		

pressure transmitters

			
1			
<b>GEV No.</b>	541786	<b>Ref. No.</b>	00-775866-002
<b>description</b>	pressure transmitter pressure range 0-50mbar output voltage 0.5-3.5VDC input voltage 5VDC max 200mbar		
<b>For models:</b>	811011, 811012, 811013, 811014, 811015, 812011, 812012, 812013, 812014, 812015, 813002, 813003, 813004		
<b>accessories for</b>	541786		
	<b>GEV No.</b>	520027	<b>Ref. No.</b>
			00-324402-005 00-324402-014 143013
PVC hose ID ø 4mm ED ø 7mm L 10m thickness 1.5mm t.max. 60°C transparent			

accessories

			
1			
<b>GEV No.</b>	541109	<b>Ref. No.</b>	035031
<b>description</b>	Y-piece plastic hose ø 8-6-8mm for pressure switch		
<b>For models:</b>	812002, 812007, 812009, 915234, 915235, 915236, 915237, 915460		

for coffee machines

ø 38mm

			
1			
<b>GEV No.</b>	541089	<b>Ref. No.</b>	WY20155
<b>description</b>	pressure control ø 38mm pressure range 0.5-1.2bar pressure connection vertical 16A 250V coffee machine parts connection 1/8" ambient temperature max. 125°C pressure connection 1/8"		
<b>For models:</b>	742005		





ø 45mm



<b>GEV No.</b>	541930	<b>Ref. No.</b>	17955
<b>description</b>	pressure control ø 45mm pressure range 0.155/0.125bar 155/125mmWS p max 0.5bar connection 8mm pressure connection 8mm		
<b>For models:</b>	741001, 741002		

miscellaneous



<b>GEV No.</b>	541021	<b>Ref. No.</b>	WY20150
<b>description</b>	pressure control pressure range adjustable 0.5-1.4bar connection 1/4" 30A 3-pole type P302 coffee machine parts SIRAI		
<b>For models:</b>	742001, 742002, 742003, 742004, 742017, 742018, 742019, 742020		
<b>accessories for</b>	541021		
	<b>GEV No.</b>	550262	<b>Ref. No.</b> —
	flat gasket copper ED ø 20mm ID ø 14mm thickness 2mm		
	<b>GEV No.</b>	890100	<b>Ref. No.</b> —
	PTFE tape reel L 12m W 12mm -200 up to +260°C approval DIN-DVGW, KTW temperature-resistant, elastic for fine thread thickness 0.1mm		

for steam control



<b>GEV No.</b>	541795	<b>Ref. No.</b>	CR0587800
<b>description</b>	pressure control ø 45mm pressure connection vertical steam control pressure range -1 up to +1bar connection male faston 6.3mm BECK pressure connection 3/8"		
<b>For models:</b>	146002, 146007		



<b>GEV No.</b>	541074	<b>Ref. No.</b>	R63070050
<b>description</b>	pressure control ø 45mm triggering pressure 0.5bar reset pressure 0.35bar pressure connection vertical steam control pressure range 0.35/0.51bar connection 1/8" pressure connection 1/8"		
<b>For models:</b>	212001, 212002, 212003, 212005, 212007, 212009, 212010, 212011, 212012, 212013, 212018, 212020		



<b>GEV No.</b>	541350	<b>Ref. No.</b>	6A022200
<b>description</b>	pressure control pressure range adjustable 0.3-0.8bar connection 1/4" CO 250V 10A ambient temperature max. 60°C pressure connection 1/4"		

for refrigeration

SAGI NO MIYA



<b>GEV No.</b>	541479	<b>Ref. No.</b>	23175
<b>description</b>	pressure control HD reset automatic refrigeration type HTB-X114 connection 2.4mm		
<b>For models:</b>	711002, 711003, 711004, 711005, 711006, 711007, 711008, 711009, 711010, 711011, 711012, 711013, 711014, 711015, 711016, 711017, 711018, 711019		

electrodes



<b>GEV No.</b>	402106	<b>Ref. No.</b>	13926
<b>description</b>	electrode push-in total length 50mm probe L 40mm insulated probe length 35mm connection F2.8 ø 5mm		
<b>For models:</b>	741003		





<b>GEV No.</b>	402104	<b>Ref. No.</b>	687867
<b>description</b>	electrode bloc flange with thread total length 175mm probe L 155/115/90/60/45/30mm insulated probe length 10mm connection F2.8		
<b>For models:</b>	741003		



<b>GEV No.</b>	401872	<b>Ref. No.</b>	WY20261
<b>description</b>	level electrode 1/4" total length 100mm probe L 64mm insulated probe length 17mm connection male faston 6.3mm stainless steel ø 2.5mm		



			
1			
<b>GEV No.</b>	400790	<b>Ref. No.</b>	WY20251
<b>description</b>	level electrode 1/4" total length 125mm probe L 98mm insulated probe length 26mm connection male faston 6.3mm stainless steel ø 3mm rubber		
<b>For models:</b>	742001, 742002, 742003, 742004, 742005, 742017, 742018, 742019, 742020		
<b>accessories for</b>	400790		
	<b>GEV No.</b>	527188	<b>Ref. No.</b> WY25742
	screw connection thread 1/8" IT - 1/8" ET 1-way brass for level electrode ømm L 20mm		

## accessories

### screw connections

			
1			
<b>GEV No.</b>	527188	<b>Ref. No.</b>	WY25742
<b>description</b>	screw connection thread 1/8" IT - 1/8" ET 1-way brass for level electrode ømm L 20mm		
<b>For models:</b>	742005		

## flow meters and flow sensors

### flow meters

#### GICAR

			
1			
<b>GEV No.</b>	400004	<b>Ref. No.</b>	WY18126
<b>description</b>	flow meter thread 1/4" stainless steel with LED plug connection approval NSF		
<b>For models:</b>	742001, 742002, 742003, 742004, 742019, 742020		
<b>accessories for</b>	400004		
	<b>GEV No.</b>	400256	<b>Ref. No.</b> —
	plug GICAR for flow meter		

			
1			
<b>GEV No.</b>	400782	<b>Ref. No.</b>	098707
<b>description</b>	flow meter hose ø 6mm plastic plug-in connection approval NSF		
<b>For models:</b>	743001		

## compressors

### ACC/ZEL

#### R134A

#### LBP monophase

Lower evaporation temperature below -20°C

			
1			
<b>GEV No.</b>	605126	<b>Ref. No.</b>	RC0047 S900.41
<b>description</b>	compressor coolant R134a type OF1350A 220-240V 50Hz LBPkg 1/4HP power input 158W cylinder capacity 7.5cm <sup>3</sup> RSIR H 183mmWWWWWWWWW ZEL		
<b>For models:</b>	272008, 611007, 611008, 611009, 611013, 611014, 611023, 613016, 613017, 621018, 621026, 621029, 621030, 621031, 621032, 621033, 621034, 621035, 621036, 622026, 622027, 625003, 625014, 625015, 625016, 625017, 634001, 634002, 634003		



HMBP monophase

High/Medium evaporation temperature above -20/-15 °C



1

<b>GEV No.</b>	605008	<b>Ref. No.</b>	141555100065 141565100030
<b>description</b>	compressor coolant R134a type GL80TB 220-240V 50Hz HMBP fully hermetic 9.5kg 1/5HP power input 554W cylinder capacity 7.6cm <sup>3</sup> CSIR H 175.5mm 165W 215W 290W 390W 500W 615W 727W 840W test method ASHRAE ambient temperature max. 43°C		
<b>For models:</b>	201780, 621007, 622005		

R404a/R507

LBP monophase

Lower evaporation temperature below -20°C



1

<b>GEV No.</b>	605073	<b>Ref. No.</b>	141565100180
<b>description</b>	compressor coolant R404a/R507 type MP14FB 220-240V 50Hz LBP fully hermetic 13.9kg 1/2HP cylinder capacity 14cm <sup>3</sup> CSIR H 203.6mm 439W 584W 746W 926W 1124W test method ASHRAE		
<b>For models:</b>	613022, 613023, 613026, 613027, 613028, 613029, 613030, 613031, 621007, 622005		

HMBP monophase

High/Medium evaporation temperature above -20/-15 °C



1

<b>GEV No.</b>	605068	<b>Ref. No.</b>	880218000
<b>description</b>	compressor coolant R404a/R507 type ML45TB 220-240V 50Hz HMBP fully hermetic 10kg 1/5HP cylinder capacity 4.5cm <sup>3</sup> CSIR H 175.5mmW 192W 246W 309W 382W 465W 557W 659W 771W test method ASHRAE		
<b>For models:</b>	641001		



1

<b>GEV No.</b>	605069	<b>Ref. No.</b>	880218400
<b>description</b>	compressor coolant R404a/R507 type ML80TG 220-240V 50Hz HMBP fully hermetic 11.2kg 3/8HP cylinder capacity 7.6cm <sup>3</sup> CSIR H 175.5mmWWW 386W 487W 603W 734W 880W 1041W test method ASHRAE ambient temperature max. 43°C		
<b>For models:</b>	641006, 641008		



1

<b>GEV No.</b>	605028	<b>Ref. No.</b>	880216900
<b>description</b>	compressor coolant R404a/R507 type ML90TB 220-240V 50Hz HMBP fully hermetic 11.6kg 3/8HP cylinder capacity 8.85cm <sup>3</sup> CSIR H 175.5mmW 323W 418W 532W 666W 819W 990W 1181W 1391W test method ASHRAE ambient temperature max. 43°C		
<b>For models:</b>	641009, 641010, 641011, 641014, 641015		





1

<b>GEV No.</b>	605071	<b>Ref. No.</b>	880217400
<b>description</b>	compressor coolant R404a/R507 type MS26TB 230V 50Hz HMBP fully hermetic 23kg cylinder capacity 25.9cm <sup>3</sup> CSR 1295W 1687W 2132W 2631W 3184W 3791W test method ASHRAE		
<b>For models:</b>	644006, 644011, 644012		



1

<b>GEV No.</b>	605072	<b>Ref. No.</b>	880216500
<b>description</b>	compressor coolant R404a/R507 type MX18TBa 220-240V 50Hz HMBP fully hermetic 17.2kg 7/8HP cylinder capacity 18.4cm <sup>3</sup> CSR H 213mmW 640W 839W 1076W 1350W 1663W 2013W 2400W 2826W test method ASHRAE ambient temperature max. 43°C		
<b>For models:</b>	644008, 644009		
<b>spare parts for</b>	605072		
	<b>GEV No.</b>	<b>Ref. No.</b>	—
	365006		
	operating capacitor capacity 16µF 400V tolerance 5% 50/60Hz ambient temperature max. -25 to +85°C ø 35mm L 121mm M8 aluminium connection cable 300mm MKP protection IP65		
	<b>GEV No.</b>	<b>Ref. No.</b>	—
	365128		
	operating capacitor capacity 16µF 450V tolerance 5% 50-60Hz ambient temperature max. -25 to +85°C ø 40mm L 100mm M8 aluminium connection male faston 6.3mm 16.26.16 protection		

CUBIGEL

R404a/R507

LBP monophase

Lower evaporation temperature below -20°C



1

<b>GEV No.</b>	605176	<b>Ref. No.</b>	141565100021
<b>description</b>	compressor coolant R404a/R507 type ML90FB 220-240V 50Hz LBP 11kg 1/3HP cylinder capacity 8.85cm <sup>3</sup> CSIR H 198mm 305W 394W 495W 606W 729WWWWWW test method ASHRAE		
<b>For models:</b>	613020, 613021, 613022, 613024, 613025, 613027, 613028, 613030, 613031, 613032, 613033		



1

<b>GEV No.</b>	605180	<b>Ref. No.</b>	Q32-0705
<b>description</b>	compressor coolant R404a/R507 type MX23FB 220-240V 50Hz LBP 17.5kg 1HP power input 7/8W cylinder capacity 23.2cm <sup>3</sup> CSR H 221mm 749W 982W 1246W 1541W 1868WWWWWW		
<b>For models:</b>	622004		



1

<b>GEV No.</b>	605075	<b>Ref. No.</b>	BN141565100195
<b>description</b>	compressor coolant R404a/R507a type MX21FB_A 220-240V 50Hz LBP 16.5kg 3/4HP cylinder capacity 20.72cm <sup>3</sup> CSR H 220mm 575W 655W 742W 836W 938WWWWWW test method ASHRAE		
<b>For models:</b>	622021		



HMBP monophase

High/Medium evaporation temperature above -20/-15 °C



1

<b>GEV No.</b>	605013	<b>Ref. No.</b>	880216700
<b>description</b>	compressor coolant R404a/R507 type ML60TB 220-240V 50Hz HMBP fully hermetic 10.1kg 1/4HP power input 647W cylinder capacity 5.68cm <sup>3</sup> CSIR H 175.5mmW 244W 319W 407W 511W 628W 760W 906W 1067W test method ASHRAE		
<b>For models:</b>	641002, 641003, 641004, 641005, 641007		



1

<b>GEV No.</b>	605029	<b>Ref. No.</b>	880217000
<b>description</b>	compressor coolant R404a/R507 type MP12RB 220-240V 50Hz HMBP fully hermetic 13.5kg 1/2HP cylinder capacity 12cm <sup>3</sup> CSR H 203.6mmW 561W 734W 933W 1157W 1407W 1681W 1982WW test method ASHRAE ambient temperature max. 43°C		
<b>For models:</b>	641012, 641016		



1

<b>GEV No.</b>	605067	<b>Ref. No.</b>	880217100
<b>description</b>	compressor coolant R404a/R507 type MPT14RA 220-240V 50Hz HMBP fully hermetic 13.5kg 1/2HP cylinder capacity 14.32cm <sup>3</sup> CSR H 210mmWWW 665W 720W 775W 829W 882W 934W test method ASHRAE		
<b>For models:</b>	641013, 641017, 644007		

EMBRACO / ASPERA

R134A

HBP monophase

High evaporation temperature above -15°C



1

<b>GEV No.</b>	605086	<b>Ref. No.</b>	23857
<b>description</b>	compressor coolant R134a type EMT45HDR 220-240V 50Hz HBP fully hermetic 7.7kg 1/8HP power inputW cylinder capacity 3.97cm <sup>3</sup> CSIRWW 162W 207W 256W 314W 383W 467W test method ASHRAE		
<b>For models:</b>	711001		

HMBP monophase

High/Medium evaporation temperature above -20/-15 °C



1

<b>GEV No.</b>	605244	<b>Ref. No.</b>	RC0564
<b>description</b>	compressor coolant R134a type FF112HBK 220-240V 50Hz HMBP 10.8kg 1/3HP cylinder capacity 11.15cm <sup>3</sup> CSIR H 180mm 223W 304W 405W 527W 671W 836W 1024W 1236W 1471W test method EN 12900		
<b>For models:</b>	621047, 622036, 622039, 633002		



R404a/R507

LBP monophase

Lower evaporation temperature below -20°C



<b>GEV No.</b>	605144	<b>Ref. No.</b>	995745
<b>description</b>	compressor coolant R404a/R507 type NEK2168GK 220-240V 50Hz LBP 22.9kg 3/4HP cylinder capacity 14.28cm <sup>3</sup> CSR H 200mm 345W 454W 587W 742W 921W 1123W		
<b>For models:</b>	617005, 617006, 671008		

HMBP monophase

High/Medium evaporation temperature above -20/-15 °C



<b>GEV No.</b>	605004	<b>Ref. No.</b>	74865635
<b>description</b>	compressor coolant R404a/R507 type EMT6152GK 220-240V 50Hz HMBP fully hermetic 7.8kg 1/5HP cylinder capacity 4.5cm <sup>3</sup> CSIR H 166mm WWW 267W 332W 351W 437W 535W 646W 769W test method ASHRAE		
<b>For models:</b>	651011, 651012, 652004		



<b>GEV No.</b>	605149	<b>Ref. No.</b>	8802189
<b>description</b>	compressor coolant R404a/R507 type NEK6144GK 220-240V 50Hz HMBP fully hermetic 10kg 1/6HP cylinder capacity 4.51cm <sup>3</sup> CSIR H 190mmW 271W 326W 395W 480W 580W 694W 825W test method ASHRAE46		



<b>GEV No.</b>	605165	<b>Ref. No.</b>	74865634
<b>description</b>	compressor coolant R404a/R507 type NT6226GK 220-240V 50Hz HMBP 18.1kg 1HP cylinder capacity 22.4cm <sup>3</sup> CSR H 234mmW 1314W 1650W 2058W 2532W 3068W 3658W 4298W		
<b>For models:</b>	651072, 651073, 651074, 651075, 651086, 651088, 651100, 651101, 651102, 651103, 651104, 651105, 651106, 651107, 651110, 651111, 651112, 651113, 651114, 651115, 651118, 651119, 651120		

R600A

LBP monophase

Lower evaporation temperature below -20°C



<b>GEV No.</b>	605085	<b>Ref. No.</b>	6119659
<b>description</b>	compressor coolant R600a type EMT45CDP 220-240V 50Hz HBP fully hermetic 7.7kg 1/8HP power input 152W cylinder capacity 6.78cm <sup>3</sup> RSIRWW 164W 209W 262W 322W 392W 477W test method ASHRAE		
<b>For models:</b>	621014, 621015, 622009, 622018, 622019, 625011, 625012, 625013		

<b>spare parts for</b>	605085			
	<b>GEV No.</b>	381088	<b>Ref. No.</b>	6940650
	start relay			
	<b>GEV No.</b>	390620	<b>Ref. No.</b>	6940609
	overload protector for engine protective curcuit breaker T0357/07 t.max. 150°C reset automatic			







HBP monophase

High evaporation temperature above -15°C

R600a



1

<b>GEV No.</b>	605083	<b>Ref. No.</b>	6119717
<b>description</b>	compressor coolant R600a type EMT30CDP 220-240V 50Hz HBP fully hermetic 7.2kg 1/8HP cylinder capacity 4.5cm <sup>3</sup> RSIR H 158mmWW 112W 142W 180W 222W 268W 320W test method ASHRAE		
<b>For models:</b>	625010, 629001		
<b>spare parts for</b>	605083		
	<b>GEV No.</b>	381088	<b>Ref. No.</b> 6940650
	start relay		
	<b>GEV No.</b>	390621	<b>Ref. No.</b> 6941014
	overload protector for engine protective curcuit breaker T0224/07 t.max. 150°C reset automatic		

L'UNITE HERMETIQUE / TECUMSEH

R404A

HMBP monophase

High/Medium evaporation temperature above -20/-15 °C



1

<b>GEV No.</b>	605025	<b>Ref. No.</b>	23441 Q32-0703
<b>description</b>	compressor coolant R404A type AE4430Z-FZ 220-240V 50Hz HMBP fully hermetic 10.2kg 1/4HP power input 427W cylinder capacity 5.7cm <sup>3</sup> CSIR H 186mmWW 258W 346W 441W 550W 682W 794W test method EN 12900 908W		
<b>For models:</b>	621004, 711006, 711007, 711008, 711009		
<b>spare parts for</b>	605025		
	<b>GEV No.</b>	380061	<b>Ref. No.</b> —
	start relay MTRP0027-31 120/240V voltage AC 8A 1NO		



1

<b>GEV No.</b>	605023	<b>Ref. No.</b>	23505
<b>description</b>	compressor coolant R404A type AE4450Z 220-240V 50Hz HMBP fully hermetic 12.5kg 3/8HP cylinder capacity 8.85cm <sup>3</sup> CSIR H 207mmWW 434W 567W 734W 927W 1270W 1367W test method EN 12900 1729W		



1

<b>GEV No.</b>	605036	<b>Ref. No.</b>	23444
<b>description</b>	compressor coolant R404A type AEZ4425Z 220-240V 50Hz 9.8kg 1/5HP power inputW cylinder capacity 4.5cm <sup>3</sup> CSIR H 186mmWW 198W 263W 341W 432W test method EN 12900 723W		
<b>For models:</b>	711018, 711019		



1

<b>GEV No.</b>	605021	<b>Ref. No.</b>	23436
<b>description</b>	compressor coolant R404A type AEZ4425Z 220-240V 50Hz HMBP fully hermetic 9.8kg 1/5HP cylinder capacity 4.5cm <sup>3</sup> CSIR H 186mmWW 198W 263W 341W 432W 537W 629W test method EN 12900 723W		
<b>For models:</b>	711004, 711005		



1

<b>GEV No.</b>	605022	<b>Ref. No.</b>	23437
<b>description</b>	compressor coolant R404A type AEZ4440Z 230V 50Hz HMBP fully hermetic 21kg cylinder capacity 7.55cm <sup>3</sup> CSIR H 292mm 415W 517W 637W 772W 919W 1074W test method EN 12900 1234W		
<b>For models:</b>	711010, 711011		

SECOF DANFOSS

R404a/R507

LBP monophase

Lower evaporation temperature below -20°C

SECOF



1

<b>GEV No.</b>	605058	<b>Ref. No.</b>	14155510055
<b>description</b>	compressor coolant R404a/R507 type SC15CL 220-240V 50Hz LBP fully hermetic 13.8kg 1/2HP cylinder capacity 15.28cm <sup>3</sup> CSIR H 219mm 486W 637W 813W 1017W 1251W 1699W test method ASHRAE 175W 358W		
<b>For models:</b>	614016		
<b>spare parts for</b>	605058		
	<b>GEV No.</b>	380058	<b>Ref. No.</b> —
	start relay DANFOSS 117U6019/F278 HST		

Tecumseh



1

<b>GEV No.</b>	605026	<b>Ref. No.</b>	23503
<b>description</b>	compressor coolant R404A type CAJ9480Z 220-240V 50Hz HMBP fully hermetic 22kg 3/4HP cylinder capacity 15.2cm <sup>3</sup> CSR H 271mm 393W 571W 774W 1009W 1284W 1607W 1989W 2334W test method EN 12900 2699W		
<b>For models:</b>	711016, 711017		

accessories

starting relays

miscellaneous



1

<b>GEV No.</b>	381087	<b>Ref. No.</b>	6940863
<b>description</b>	start relay		
<b>For models:</b>	622012, 668006, 668009, 668010		



1

<b>GEV No.</b>	605070	<b>Ref. No.</b>	880224900
<b>description</b>	compressor coolant R404A type CAJ9513Z 220-240V 50Hz HMBP fully hermetic 23kg 1.1HP cylinder capacity 24.2cm <sup>3</sup> CSR H 282mmW 930W 1269W 1654W 2086W 2568W 3096W 3671W test method EN 12900 4278W		



1

<b>GEV No.</b>	381088	<b>Ref. No.</b>	6940650
<b>description</b>	start relay		
<b>For models:</b>	621014, 621015, 622009, 622013, 622018, 622019, 625010, 625011, 625012, 625013, 629001		



overload protector (klixon)



1

<b>GEV No.</b>	390621	<b>Ref. No.</b>	6941014
<b>description</b>	overload protector for engine protective circuit breaker T0224/07 t.max. 150°C reset automatic		
<b>For models:</b>	625010, 629001		



1

<b>GEV No.</b>	390620	<b>Ref. No.</b>	6940609
<b>description</b>	overload protector for engine protective circuit breaker T0357/07 t.max. 150°C reset automatic		
<b>For models:</b>	621014, 621015, 622009, 622018, 622019, 625011, 625012, 625013		

evaporation and condensing trays

condensing trays heated

producer-specific







1

<b>GEV No.</b>	750005	<b>Ref. No.</b>	222312100
<b>description</b>	condensing tray heated L 240mm W 240mm H 250mm		
<b>For models:</b>	644010		
<b>spare parts for</b>	750005		
	<b>GEV No.</b>	418732	<b>Ref. No.</b> 877107800
	heating element 650W 230V L 280mm W 95mm H 87mm L1 65mm L2 215mm cable length 1500mm connection distance 86mm tube ø 8.5mm heating circuits 1 immersion heater		



1





<b>GEV No.</b>	750003	<b>Ref. No.</b>	226303600
<b>description</b>	condensing tray heated L 240mm W 240mm H 75mm 230V 650W connect with power contactor		
<b>For models:</b>	644008, 644009		
<b>spare parts for</b>	750003		
	<b>GEV No.</b>	348139	<b>Ref. No.</b> —
	float switch 250V 1A 1NO or 1NC thread M16x1.5 ø 17.4mm L 100.5mm mounting ø 28mm cable length 1500mm temp.-resist. -20 up to +90°C		
	<b>GEV No.</b>	418732	<b>Ref. No.</b> 877107800
	heating element 650W 230V L 280mm W 95mm H 87mm L1 65mm L2 215mm cable length 1500mm connection distance 86mm tube ø 8.5mm heating circuits 1 immersion heater		
<b>accessories for</b>	750003		
	<b>GEV No.</b>	380185	<b>Ref. No.</b> 229029 880302100
	power relays Italiana Relè 230VAC 30A 1NO connection F6.3 bracket mounting dimensions 36.5x32.2x51.8mm manuf. no. A10-230AC-FA		



1

<b>GEV No.</b>	750006	<b>Ref. No.</b>	222312200
<b>description</b>	condensing tray heated L 380mm W 240mm H 250mm		
<b>For models:</b>	644011, 644012		



			
1			
<b>GEV No.</b>	750004	<b>Ref. No.</b>	227206000
<b>description</b>	condensing tray heated L 380mm W 240mm H 75mm 230V 750W with float switch		
<b>For models:</b>	644006		
<b>spare parts for</b>	750004		
	<b>GEV No.</b>	348139	<b>Ref. No.</b> —
	float switch 250V 1A 1NO or 1NC thread M16x1.5 ø 17.4mm L 100.5mm mounting ø 28mm cable length 1500mm temp.-resist. -20 up to +90°C		
	<b>GEV No.</b>	418733	<b>Ref. No.</b> 877107900
	heating element 750W 230V L 430mm W 95mm H 98mm L1 85mm L2 345mm cable length 1500mm connection cable connection distance 86mm tube ø 8.5mm heating circuits 1 immersion heater		
<b>accessories for</b>	750004		
	<b>GEV No.</b>	380185	<b>Ref. No.</b> 229029 880302100
	power relays Italiana Relè 230VAC 30A 1NO connection F6.3 bracket mounting dimensions 36.5x32.2x51.8mm manuf. no. A10-230AC-FA		

## fans

## axial fans

## ebm-papst

			
1			
<b>GEV No.</b>	601482 <sup>1</sup>	<b>Ref. No.</b>	880102000
<b>description</b>	axial fan L 119mm W 119mm H 38mm 230VAC 50/60Hz 13W bearing slide bearing manuf. no. 4580ZW connection cable 310mm ebm-papst temp.-resist. 65°C		
<b>For models:</b>	641010, 641011, 641012, 641013, 641014, 641015, 641016, 641017, 644007, 644008, 644009		

<sup>1</sup>with ball bearings

			
1			
<b>GEV No.</b>	601089 <sup>1</sup>	<b>Ref. No.</b>	880101400
<b>description</b>	axial fan L 119mm W 119mm H 38mm 230VAC 50/60Hz 19W bearing slide bearing manuf. no. 4650N metal connection male faston 2.8mm ebm-papst fan wheel ø 110mm temp.-resist. 55°C		
<b>For models:</b>	644006, 644010		
<b>accessories for</b>	601089		
	<b>GEV No.</b>	550898	<b>Ref. No.</b> —
	connecting cable cable length 2000mm connection F 2.8 connection distance 7.9mm for axial flow fan		
	<b>GEV No.</b>	691104	<b>Ref. No.</b> —
	guard ø 115mm mounting distance 105mm for axial fan 119mm		

<sup>1</sup>with slide bearings

			
1			
<b>GEV No.</b>	601030 <sup>1</sup>	<b>Ref. No.</b>	R65060050
<b>description</b>	axial fan L 119mm W 119mm H 38mm 230VAC 50Hz 18W bearing ball bearing manuf. no. 4656Z metal connection male faston 2.8mm ebm-papst fan wheel ø 110mm temp.-resist. 75°C		
<b>For models:</b>	212002, 212003, 212005, 212007, 212009, 212010, 212011, 212012, 212013, 212018, 212020		
<b>accessories for</b>	601030		
	<b>GEV No.</b>	550898	<b>Ref. No.</b> —
	connecting cable cable length 2000mm connection F 2.8 connection distance 7.9mm for axial flow fan		
	<b>GEV No.</b>	692497	<b>Ref. No.</b> —
	guard ø 105mm mounting distance 150mm for axial fan ebm-papst-mm		

<sup>1</sup>with ball bearings



1

<b>GEV No.</b>	601481 <sup>1</sup>	<b>Ref. No.</b>	880103500
<b>description</b>	axial fan L 127mm W 127mm H 38mm 230VAC 50/60Hz 18W bearing slide bearing manuf. no. 5950W metal connection male faston 2.8mm ebm-papst fan wheel ø 120mm temp.-resist. 75°C		
<b>For models:</b>	644011, 644012		

<sup>1</sup>with slide bearings



1

<b>GEV No.</b>	601496 <sup>1</sup>	<b>Ref. No.</b>	251867
<b>description</b>	axial fan L 60mm W 60mm H 25mm 12VDC 0.8W bearing ball bearing manuf. no. 612NME plastic connection cable 310mm ebm-papst fan wheel ø 55mm with plug		
<b>For models:</b>	743001		

<sup>1</sup>with ball bearings



1

<b>GEV No.</b>	601038 <sup>1</sup>	<b>Ref. No.</b>	880100800 880101300
<b>description</b>	axial fan L 80mm W 80mm H 38mm 230VAC 50/60Hz 12W bearing ball bearing manuf. no. 8556N metal connection cable 300mm ebm-papst fan wheel ø 75mm temp.-resist. 90°C airflow 50m <sup>3</sup> /h		
<b>For models:</b>	641001, 641002, 641003, 641004, 641005, 641006, 641007, 641008, 641009		
<b>accessories for</b>	601038		
	<b>GEV No.</b>	691102	<b>Ref. No.</b> —
	guard ø 75mm mounting distance 71mm for axial fan 80mm		

<sup>1</sup>with ball bearings

import



1

<b>GEV No.</b>	601604 <sup>1</sup>	<b>Ref. No.</b>	RC0011 RC0654 S900.34
<b>description</b>	axial fan L 119mm W 119mm H 38mm 230VAC 50/60Hz 17/15W bearing slide bearing manuf. no. AA1282HS-AT connection cable 300mm fan wheel ø 110mm temp.-resist. 70°C input current 0.1A airflow 130m <sup>3</sup> /h 2600rpm		
<b>For models:</b>	272006, 272007, 272008, 611007, 611008, 611009, 611010, 611011, 611023, 621018, 621023, 621024, 621025, 621026, 621027, 621028, 621029, 621030, 621031, 621032, 621033, 621034, 621035, 621036, 621045, 621046, 621047, 621048, 621049, 621050, 622022, 622023, 622024, 622025, 622026, 622027, 622028, 622029, 622034, 622035, 622036, 622037, 622038, 622039, 625002, 625003, 625014, 625015, 625016, 625017...(Other models you can see in the webshop)		

<sup>1</sup>with slide bearings



1

<b>GEV No.</b>	601510 <sup>1</sup>	<b>Ref. No.</b>	C23856
<b>description</b>	axial fan L 119mm W 119mm H 38mm 230VAC 50/60Hz 22/21W bearing ball bearing connection male faston 6.3mm SUNON temp.-resist. 70°C		

<sup>1</sup>with ball bearings



1

<b>GEV No.</b>	601080 <sup>1</sup>	<b>Ref. No.</b>	MACM303000 X02.12.082.00
<b>description</b>	axial fan L 119mm W 119mm H 38mm 230VAC 50/60Hz 23/20W bearing ball bearing connection male faston 2.8mm metal ADDA fan wheel ø 110mm temp.-resist. 70°C		
<b>For models:</b>	141020, 222004, 222005		
<b>accessories for</b>	601080		
	<b>GEV No.</b>	550898	<b>Ref. No.</b> —
	connecting cable cable length 2000mm connection F 2.8 connection distance 7.9mm for axial flow fan		

<sup>1</sup>with ball bearings  
Table continues overleaf



<b>accessories for</b>	601080		
	GEV No.	692519	Ref. No. —
	guard L 120mm W 120mm plastic		



<b>GEV No.</b>	601679	<b>Ref. No.</b>	100302
<b>description</b>	axial fan L 60mm W 60mm H 25mm 24VDC 1.9W bearing magnetic bearing connection cable cable length 300mm SUNON fan wheel ø 55mm temp.-resist. -10 up to +70°C housing plastic		
<b>For models:</b>	131216, 131217, 131218, 246009, 246010, 246011, 246012, 246013, 246014		



<b>GEV No.</b>	601335 <sup>1</sup>	<b>Ref. No.</b>	100301
<b>description</b>	axial fan L 80mm W 80mm H 25mm 24VDC 1.7W bearing slide bearing connection cable plastic SUNON fan wheel ø 75mm temp.-resist. 70°C		
<b>For models:</b>	131216, 131217, 131218, 246009, 246010, 246011, 246012, 246013, 246014		



<sup>1</sup>with slide bearings



<b>GEV No.</b>	601081 <sup>1</sup>	<b>Ref. No.</b>	R65060010
<b>description</b>	axial fan L 80mm W 80mm H 38mm 230VAC 50/60Hz 14/13.5W bearing ball bearing connection male faston 2.8mm metal ADDA fan wheel ø 75mm temp.-resist. 70°C		
<b>For models:</b>	212001		
<b>accessories for</b>	601081		
	GEV No.	691102	Ref. No. —
	guard ø 75mm mounting distance 71mm for axial fan 80mm		

<sup>1</sup>with ball bearings



<b>GEV No.</b>	601055 <sup>1</sup>	<b>Ref. No.</b>	1648110150 6A036420 BN1648110150 GN2100TN.35 X02.12.093.00
<b>description</b>	axial fan L 92mm W 92mm H 25mm 230VAC 50/60Hz 14.5/14W bearing ball bearing connection male faston 2.8mm metal ADDA fan wheel ø 85mm temp.-resist. 70°C		
<b>For models:</b>	541003, 551010, 551011, 551012, 551013, 611013, 611014, 611016, 611017, 613016, 613017, 613020, 613021, 613022, 613023, 613024, 613025, 613026, 613027, 613028, 613029, 613030, 613031, 613032, 613033		
<b>accessories for</b>	601055		
	GEV No.	550898	Ref. No. —
	connecting cable cable length 2000mm connection male faston 2.8 connection distance 7.9mm for axial flow fan		
	GEV No.	691103	Ref. No. —
	guard ø 90mm mounting distance 83mm for axial fan 92mm		

<sup>1</sup>with ball bearings



## refrigeration fans

### refrigeration motors universal

#### ebm-papst



#### miscellaneous



<b>GEV No.</b>	601783	<b>Ref. No.</b>	GN650TN.34 S900.37
<b>description</b>	fan motor 10W 230V 50/60Hz L3 87mm W 67mm cable length 400mm 1300rpm ebm-papst M4Q045-CA03-51/C18 3 mounting options bearing slide bearing for refrigerated counters		
<b>For models:</b>	611007, 611008, 611009, 611010, 611013, 611014, 613016, 613017, 621018, 621019		
<b>spare parts for</b>	601783		
	GEV No.	601413	Ref. No. 10014
	fixing plate suitable for fanwheel ED ø 32mm shaft ø 7 mounting distance 26mm		
<b>accessories for</b>	601783		
	GEV No.	601385	Ref. No. 20095
	fan wheel sucking ø 172mm fan wheel mounting 25.4mm blade angle 34° W 42mm aluminium		

ELCO			
N series - multi fit			
			
1			
<b>GEV No.</b>	601427	<b>Ref. No.</b>	880100300
<b>description</b>	fan motor ELCO 10W 230V 50/60Hz bearing slide bearing L1 49mm L2 59mm L3 86.5mm W 83mm connection cable 500mm 1300/1550rpm 5 mounting options VNT10-20/028		
<b>For models:</b>	641001, 641002, 641003, 641004, 641005, 641006, 641007, 641008, 641009, 641010, 641011, 641012, 641013, 641014, 641015, 641016, 641017, 644006, 644007, 644008, 644009, 644010, 644011, 644012		
<b>spare parts for</b>	601427		
	<b>GEV No.</b>	560140	<b>Ref. No.</b> 260402 260418
	hexagonal nut thread M4 H 4.8mm SS WS 7 Qty 20 pcs DIN/ISO DIN 985 self-locking		
	<b>GEV No.</b>	560332	<b>Ref. No.</b> 260502
	plain washer ID ø 4.3mm ED ø 9mm thickness 0.8mm SS Qty 1 pcs		
	<b>GEV No.</b>	560340	<b>Ref. No.</b> —
	hexagonal nut thread M4 H 3.2mm WS 7 SS DIN/ISO DIN 934 / ISO 4032/8673 Qty 1 pcs		
	<b>GEV No.</b>	601413	<b>Ref. No.</b> 10014
	fixing plate suitable for fanwheel ED ø 32mm shaft ø 7 mounting distance 26mm		

			
1			
<b>GEV No.</b>	601430	<b>Ref. No.</b>	1648000510
<b>description</b>	fan motor ELCO 5W 230V 50/60Hz bearing slide bearing L1 48mm L2 52mm L3 79.5mm W 83mm connection cable 500mm 1300/1550rpm 5 mounting options VNT5-13/027		
<b>For models:</b>	551010, 551011, 611016		
<b>spare parts for</b>	601430		
	<b>GEV No.</b>	560140	<b>Ref. No.</b> 260402 260418
	hexagonal nut thread M4 H 4.8mm SS WS 7 Qty 20 pcs DIN/ISO DIN 985 self-locking		
	<b>GEV No.</b>	560332	<b>Ref. No.</b> 260502
	plain washer ID ø 4.3mm ED ø 9mm thickness 0.8mm SS Qty 1 pcs		
	<b>GEV No.</b>	560340	<b>Ref. No.</b> —
	hexagonal nut thread M4 H 3.2mm WS 7 SS DIN/ISO DIN 934 / ISO 4032/8673 Qty 1 pcs		
	<b>GEV No.</b>	601413	<b>Ref. No.</b> 10014
	fixing plate suitable for fanwheel ED ø 32mm shaft ø 7 mounting distance 26mm		

N series - standard			
			
1			
<b>GEV No.</b>	601359	<b>Ref. No.</b>	Q32-0132
<b>description</b>	fan motor 18W 230V 50/60Hz bearing slide bearing W 83mm connection 3-wire cable length 1000mm 1300/1550rpm 3 mounting options VNT18-30/150		
<b>For models:</b>	621004		
<b>spare parts for</b>	601359		
	<b>GEV No.</b>	601413	<b>Ref. No.</b> 10014
	fixing plate suitable for fanwheel ED ø 32mm shaft ø 7 mounting distance 26mm		

			
1			
<b>GEV No.</b>	601442	<b>Ref. No.</b>	1648001017 BN1648001017
<b>description</b>	fan motor ELCO 10W 230V 50-60Hz bearing slide bearing L1 45mm L3 83mm W 83mm cable length 1800mm 1300/1550rpm 3 mounting options VN10-20/507 triple		
<b>For models:</b>	201780, 613020, 613021, 613022, 613024, 613025, 613027, 613028, 613030, 613031, 613032, 613033, 621007, 621021, 622005, 622021		
<b>spare parts for</b>	601442		
	<b>GEV No.</b>	601413	<b>Ref. No.</b> 10014
	fixing plate suitable for fanwheel ED ø 32mm shaft ø 7 mounting distance 26mm		



RE series



<b>GEV No.</b>	601608	<b>Ref. No.</b>	Q32-0590
<b>description</b>	fan motor 18W 230/240V 50/60Hz W 90mm cable length 1000mm 2600rpm ELCO R18-25/010 3 mounting options bearing slide bearing H 110mm L 90mm		
<b>For models:</b>	621005, 622004		
<b>spare parts for</b>	601608		
	<b>GEV No.</b>	601413	<b>Ref. No.</b> 10014
	fixing plate suitable for fanwheel ED ø 32mm shaft ø 7 mounting distance 26mm		

accessories

fan wheels

aluminium

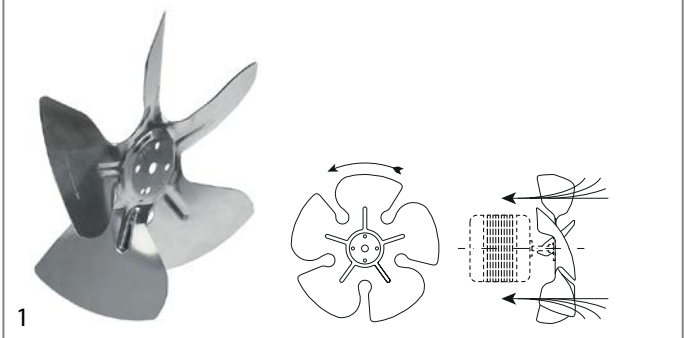

<b>GEV No.</b>	601385	<b>Ref. No.</b>	20095
<b>description</b>	fan wheel sucking ø 172mm fan wheel mounting 25.4mm blade angle 34° W 42mm aluminium		
<b>For models:</b>	711002, 711003		

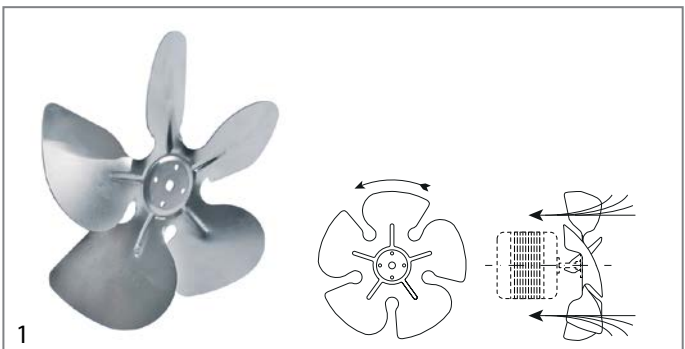

<b>GEV No.</b>	601282	<b>Ref. No.</b>	1495200034
<b>description</b>	fan wheel sucking ø 200mm fan wheel mounting 25.4mm blade angle 34° W 44mm aluminium		
<b>For models:</b>	201780, 621007, 622005		



<b>GEV No.</b>	601172	<b>Ref. No.</b>	1495230034 BN1495230034
<b>description</b>	fan wheel sucking ø 230mm fan wheel mounting 25.4mm blade angle 34° W 50mm aluminium		
<b>For models:</b>	621007, 622005, 622021		

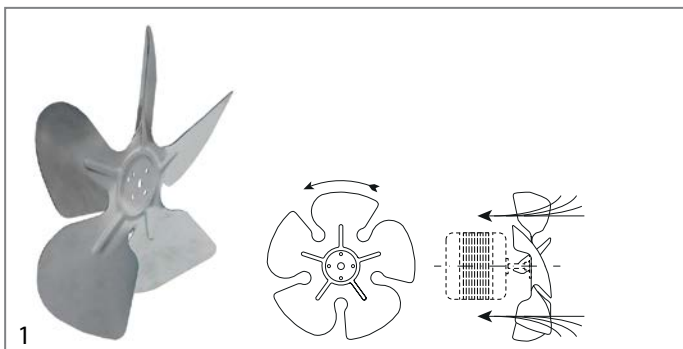

<b>GEV No.</b>	601414	<b>Ref. No.</b>	20031
<b>description</b>	fan wheel sucking ø 254mm fan wheel mounting 25.4mm blade angle 31° W 46mm aluminium		
<b>For models:</b>	711014, 711015, 711016, 711017, 711018, 711019		

plastic

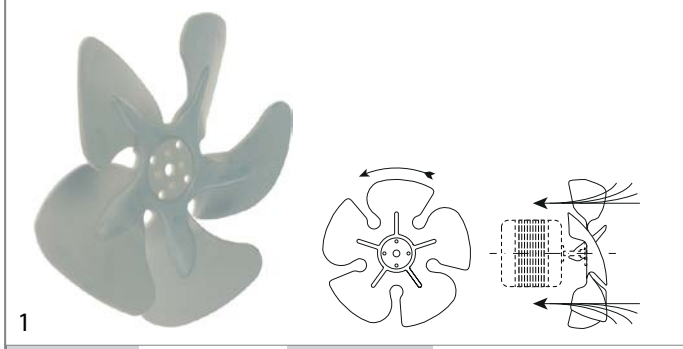

<b>GEV No.</b>	601412	<b>Ref. No.</b>	10213
<b>description</b>	fan wheel sucking ø 154mm fan wheel mounting 25.4mm blade angle 28° W 34mm plastic		
<b>For models:</b>	711002, 711003, 711004, 711005, 711006, 711007, 711008, 711009, 711010, 711011, 711012, 711013, 711014, 711015, 711016, 711017, 711018, 711019		



fan guards





1

<b>GEV No.</b>	601738	<b>Ref. No.</b>	S900.38
<b>description</b>	guard for fan wheel ø 170mm ø 216mm H 30mm mounting distance 1 224 up to 254mm mounting distance 2 94.5mm		
<b>For models:</b>	611007, 611008, 611009, 611013, 611014, 613016, 613017, 621018		

cooling motors (complete)



1

<b>GEV No.</b>	601739	<b>Ref. No.</b>	GN650BT.11 RC0229
<b>description</b>	fan 230V 10W 50Hz fan wheel ø 230mm shaft L 20mm L 86mm W 67mm blade angle 34° connection spate terminal M4 cable length 1100mm		
<b>For models:</b>	611023, 621019, 625017, 625018, 633001, 633002		
<b>spare parts for</b>	601739		
	<b>GEV No.</b>	601172	<b>Ref. No.</b> 1495230034 BN1495230034
	fan wheel sucking ø 230mm fan wheel mounting 25.4mm blade angle 34° W 50mm aluminium		
	<b>GEV No.</b>	601757	<b>Ref. No.</b> —
	fan motor 10W 230V 50/60Hz L1 43.5mm L3 82mm W 67mm cable length 1500mm 1300/1550rpm ebm-papst M4Q045-CA03-75 5 mounting options bearing slide bearing		
	<b>GEV No.</b>	601783	<b>Ref. No.</b> GN650TN.34 S900.37
	fan motor 10W 230V 50/60Hz L3 87mm W 67mm cable length 400mm 1300rpm ebm-papst M4Q045-CA03-51/C18 3 mounting options bearing slide bearing for refrigerated counters		

cooling motors (various)

refrigeration motors with foot



1

<b>GEV No.</b>	601418	<b>Ref. No.</b>	23029
<b>description</b>	fan motor 10W 230V 50Hz L1 48mm L2 70mm L3 85mm W 83mm feet depth 72mm cable length 500mm connection with plug		
<b>For models:</b>	711002, 711003, 711014, 711015, 711016, 711017, 711018, 711019		



1

<b>GEV No.</b>	601419	<b>Ref. No.</b>	23067
<b>description</b>	fan motor 20W 230V 50/60Hz L1 42mm L3 91.5mm W 83mm feet depth 88mm cable length 500mm connection with plug		
<b>For models:</b>	711014, 711015, 711016, 711017, 711018, 711019		

cold air circulating fans (complete)

HIDRIA

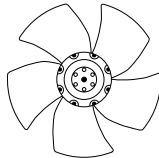
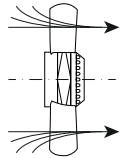
1

<b>GEV No.</b>	601811	<b>Ref. No.</b>	995870
<b>description</b>	fan type R09R-3030HP-4M-2543 fan wheel ø 300mm 230V 50/60Hz 65/90W suitable capacitor 2.5µF HIDRIA suitable for blast chiller suitable for FRIULINOX 1400/1500rpm blowing H 138mm cable lengthmm mounting distance 265mm		
<b>For models:</b>	671005, 671007		

cold air circulating fans

cold air circulating fans



<b>GEV No.</b>	601477	<b>Ref. No.</b>	6118791
<b>description</b>	fan motor 230V 50-60Hz shaft L 22mm shaft ø 3mm type F61-10		
<b>For models:</b>	629001		
<b>accessories for</b>	601477		



<b>GEV No.</b>	601480	<b>Ref. No.</b>	6299905
<b>description</b>	fan wheel blowing ø 164mm W 27mm shaft intake ø 3mm plastic blades 3		



<b>GEV No.</b>	601479	<b>Ref. No.</b>	6118787 6118795
<b>description</b>	fan motor 230V 50-60Hz shaft L 22mm shaft ø 3mm type F61-10G		
<b>For models:</b>	621015, 622019		
<b>accessories for</b>	601479		



<b>GEV No.</b>	601480	<b>Ref. No.</b>	6299905
<b>description</b>	fan wheel blowing ø 164mm W 27mm shaft intake ø 3mm plastic blades 3		



<b>GEV No.</b>	601478	<b>Ref. No.</b>	6118751
<b>description</b>	fan motor 230V 50-60Hz shaft L 22mm shaft ø 3mm type F61-10G with plug		
<b>For models:</b>	621014, 622009, 622018		
<b>accessories for</b>	601478		



<b>GEV No.</b>	601480	<b>Ref. No.</b>	6299905
<b>description</b>	fan wheel blowing ø 164mm W 27mm shaft intake ø 3mm plastic blades 3		

accessories

fan wheels for cold air circulating fans



<b>GEV No.</b>	601480	<b>Ref. No.</b>	6299905
<b>description</b>	fan wheel blowing ø 164mm W 27mm shaft intake ø 3mm plastic blades 3		
<b>For models:</b>	621014, 621015, 622009, 622018, 622019, 625011, 625012, 625013, 629001		

brackets for cold air circulating fans



<b>GEV No.</b>	691504	<b>Ref. No.</b>	7427581
<b>description</b>	bracket		
<b>For models:</b>	621014, 622009, 622018, 625011, 625012, 625013		



<b>GEV No.</b>	691478	<b>Ref. No.</b>	7422558
<b>description</b>	bracket for fan		
<b>For models:</b>	621015, 622019, 629001		



<b>GEV No.</b>	691479	<b>Ref. No.</b>	7427579 7430145
<b>description</b>	bracket for fan		
<b>For models:</b>	621014, 622009, 622018, 625011, 625012, 625013		

cold air circulating fans

 <p>1</p>			
<b>GEV No.</b>	750398	<b>Ref. No.</b>	R35-0177
<b>description</b>	fan motor 230/240V 50/60Hz 35W shaft $\phi$ 6mm shaft L 14mm W 62mm H 73mm		
<b>For models:</b>	628004		
<b>accessories for</b>	750398		
	<b>GEV No.</b>	601413	<b>Ref. No.</b> 10014
	fixing plate suitable for fanwheel ED $\phi$ 32mm shaft $\phi$ 7 mounting distance 26mm		
	<b>GEV No.</b>	602184	<b>Ref. No.</b> —
	fixing plate suitable for fanwheel ED $\phi$ 33mm shaft $\phi$ 6 mounting distance 17mm		

cross flow fans

EMMEVI - FERGAS

with standard coil

 <p>1</p>			
<b>GEV No.</b>	601018	<b>Ref. No.</b>	01202330
<b>description</b>	cross flow fan TG 180 roller $\phi$ 60mm roller length 180mm motor position right 230V/50Hz 25W universal bearing silicone connection male faston 6.3mm -10 up to +60°C 230V connections 1-2 1950U/min		
<b>For models:</b>	211039, 211042, 211043, 211044, 211045, 211046, 212034, 212035, 212036, 212037, 212038, 212039, 212040, 212041		

with moulded coils

 <p>1</p>			
<b>GEV No.</b>	601852	<b>Ref. No.</b>	74845036
<b>description</b>	cross flow fan roller $\phi$ 60mm roller length 420mm laminated core thickness 40mm motor position right 230V/50Hz 65W refrigeration bearing rubber connection cable -10 up to +60°C 230V cable length 2000mm with moulded coil		
<b>For models:</b>	651074, 651075, 651086, 651088, 651102, 651103, 651106, 651107, 651108, 651109, 651112, 651113, 651115, 651116, 651118, 651120, 651121		

accessories for cross flow fans

air ducts

 <p>1</p>			
<b>GEV No.</b>	701630	<b>Ref. No.</b>	00012330
<b>description</b>	air duct for cross flow fan for combi-steamer plastic grey		
<b>For models:</b>	211039, 211042, 211043, 211044, 211045, 211046, 212034, 212035, 212036, 212037, 212038, 212039, 212040, 212041		

hot air motors

 <p>1</p>			
<b>GEV No.</b>	550857	<b>Ref. No.</b>	R58003870
<b>description</b>	counterflange for fan motor ED $\phi$ 50mm int. $\phi$ 2 16mm thickness 6mm brass		
<b>For models:</b>	212002, 212010, 212011		

 <p>1</p>			
<b>GEV No.</b>	550859	<b>Ref. No.</b>	R58003850
<b>description</b>	counterflange for fan motor ED $\phi$ 60mm int. $\phi$ 1 34mm int. $\phi$ 2 25mm thickness 6mm brass		
<b>For models:</b>	212003, 212012, 212013		

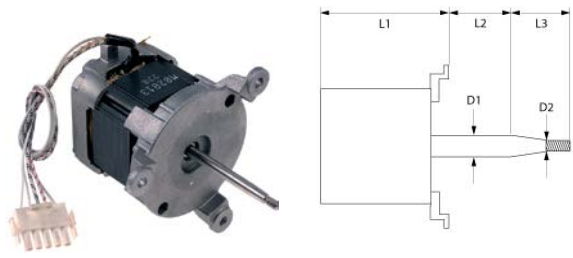
 <p>1</p>			
<b>GEV No.</b>	601491	<b>Ref. No.</b>	KVN010 VN1035A0
<b>description</b>	fan motor		
<b>For models:</b>	211002		

1

<b>GEV No.</b>	500656	<b>Ref. No.</b>	R65040520
<b>description</b>	fan motor 200-240/415V 3 phase 50/60Hz 0.15/0.55kW 900/1400rpm speeds 2 L1 150mm L2 50mm L3 48mm D1 ø 24mm D2 ø 20mm M12L IT 2.3/1.3-1.2/0.7A at 50Hz 200-240/415V at 60Hz 200-240/480V at 50Hz 900/1400rpm at 60Hz 1100/1700rpm type 3042D4050		
<b>For models:</b>	212012, 212013		
<b>spare parts for</b>	500656		
	<b>GEV No.</b>	511172	<b>Ref. No.</b> R70020050
shaft sealing ID ø 24mm ED ø 29mm thickness 3mm			

1

<b>GEV No.</b>	602099	<b>Ref. No.</b>	01202600 01202600+01203600
<b>description</b>	fan motor 220/240V 1 phase 50/60Hz 0.12kW 2800/3400rpm suitable capacitor 6.3 type 1004.2459		



1

<b>GEV No.</b>	500662	<b>Ref. No.</b>	403000200 MOT30002 R65041000
<b>description</b>	fan motor 220-240V 1 phase 50/60Hz 0.12kW 2800/3200rpm speeds 1 L1 85mm L2 7mm L3 47mm L4 12mm D1 ø 8/6mm D2 ø 12mm MSR ET 1.6A power input 0.25W suitable capacitor 5µF/400V		
<b>For models:</b>	111001, 111002, 111003, 212001, 212004, 212005, 212006, 212007, 212008, 212009, 212015, 212016		

1

<b>GEV No.</b>	500661	<b>Ref. No.</b>	R65040431
<b>description</b>	fan motor 220-240V 1 phase 50Hz 0.03/0.2kW 0.05/0.25HP 1400/2700rpm speeds 2 L1 123mm L2 77mm L3 30mm D1 ø 15mm D2 ø 12mm M10L ET 1.6/0.6A suitable capacitor 10µF/450V at 50Hz 1400/2700rpm type 1057D1901		
<b>For models:</b>	212010, 212011		

1

<b>GEV No.</b>	500658	<b>Ref. No.</b>	R65040530
<b>description</b>	fan motor 230/400V 3 phase 50/60Hz 0.55kW 1400/1700rpm speeds 1 L1 145mm L2 47mm L3 47mm D1 ø 24mm D2 ø 20mm M12L IT 2.6-2.3/1.5-1.3A (at 50-60Hz)A Cos(φ) 0.73 at 50Hz 200-240/415V at 60Hz 200-240/480V at 50Hz 1400rpm at 60Hz 1700rpm		
<b>For models:</b>	212003, 212012, 212013		
<b>spare parts for</b>	500658		
	<b>GEV No.</b>	511172	<b>Ref. No.</b> R70020050
shaft sealing ID ø 24mm ED ø 29mm thickness 3mm			
<b>accessories for</b>	500658		
	<b>GEV No.</b>	560449	<b>Ref. No.</b> R58004000
hexagonal screw thread M12x1.5 L thread L 22mm bore ø 6.3mm WS 19 total length 30mm			
	<b>GEV No.</b>	601244	<b>Ref. No.</b> R75400440
fan wheel D1 ø 350mm H1 114mm blades 12 D2 ø 19.5mm D3 ø 23mm H2 45mm			

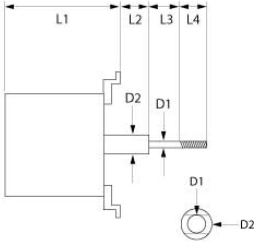
1

<b>GEV No.</b>	601856	<b>Ref. No.</b>	R65041010
<b>description</b>	fan motor 230V 1 phase 50Hz 0.075kW 2650rpm speeds 1 L1 85mm L2 30mm L3 23mm L4 12mm D1 $\varnothing$ 8x6mm D2 $\varnothing$ 8mm 0.6A suitable capacitor 5 $\mu$ F/400V		
<b>For models:</b>	212017, 212018, 212019, 212020		
<b>accessories for</b>	601856		
	<b>GEV No.</b>	365017	<b>Ref. No.</b>
			00-226568-009 206010 631208 VE1145A0
	operating capacitor capacity 5 $\mu$ F 450V tolerance 5% 50/60Hz ambient temperature max. -25 to +85°C $\varnothing$ 28mm L 54mm M8 plastic connection male faston 6.3mm 16.10.08 protection		

1

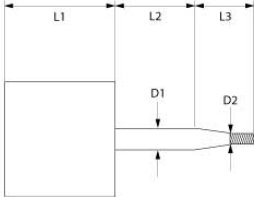
<b>GEV No.</b>	500663	<b>Ref. No.</b>	R65040421
<b>description</b>	fan motor 230V 1 phase 50Hz 0.18kW 0.25HP 2800rpm speeds 1 L1 123mm L2 77mm L3 30mm D1 $\varnothing$ 15mm D2 $\varnothing$ 12mm M10L ET 1.6A suitable capacitor 10 $\mu$ F/400V Cos(f) 0.95 at 50Hz 2800rpm type 1057C2401		
<b>For models:</b>	212002, 212010, 212011		

1

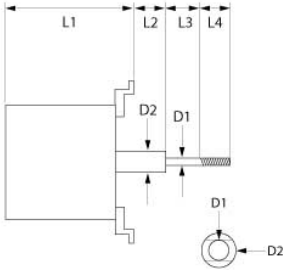
<b>GEV No.</b>	500964	<b>Ref. No.</b>	MOT30004 MOT30006
<b>description</b>	fan motor 230V 3 phase 50Hz 0.08kW 2700rpm speeds 1 L1 78mm L2 7mm L3 47mm L4 12mm D1 $\varnothing$ 8/6mm D2 $\varnothing$ 12mm M5R ET at 50Hz 2700rpm suitable capacitor 6.3 $\mu$ F/450V with capacitor 6,3 $\mu$ F/450V		
<b>For models:</b>	211006, 211014, 211016, 211020, 211024, 211026, 211029, 212014		

1

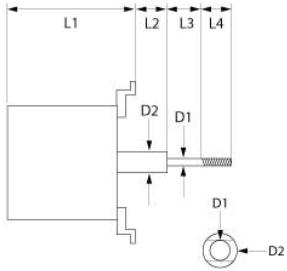
<b>GEV No.</b>	601493	<b>Ref. No.</b>	KVN003 VN1000B0 VN1000B1
<b>description</b>	fan motor 230V 3 phase 50HzkW speeds 1 L1 85mm L2 32mm L3 28mm L4 29mm D1 $\varnothing$ 8mm D2 $\varnothing$ 12mm		
<b>For models:</b>	211003		

1

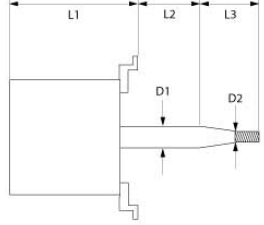
<b>GEV No.</b>	601492	<b>Ref. No.</b>	KVN017 VN1035B0
<b>description</b>	fan motor L1 130mm L2 18mm L3 23mm D1 $\varnothing$ 8mm D2 $\varnothing$ 7mm mounting thread M6R ET		
<b>For models:</b>	211001		



1

<b>GEV No.</b>	602148	<b>Ref. No.</b>	R75400470
<b>description</b>	fan wheel blades 12 D1 $\varnothing$ 350mm D2 $\varnothing$ 19.5mm D3 $\varnothing$ 23mm H1 118mm H2 50mm		
<b>For models:</b>	212003, 212012, 212013		



1

<b>GEV No.</b>	602096	<b>Ref. No.</b>	00002570
<b>description</b>	fan wheel blades 30 D1 $\varnothing$ 160mm D2 $\varnothing$ 6.8mm D3 $\varnothing$ 6.9mm H1 38mm H2 24mm H3 4mm		
<b>For models:</b>	211039		



1

<b>GEV No.</b>	602097	<b>Ref. No.</b>	00005870 11951439400
<b>description</b>	fan wheel blades 38 D1 ø 200mm D2 ø 6.5x8mm D3 ø 7mm H1 38mm H2 22mm H3 3mm		
<b>For models:</b>	211042, 211043, 211044, 211045, 211046, 212034, 212035, 212036, 212037		



1

<b>GEV No.</b>	602098	<b>Ref. No.</b>	00007180 00007181
<b>description</b>	fan wheel blades 45 D1 ø 196mm D2 ø 6.5x8mm D3 ø 8mm H1 60mm H2 23mm H3 3mm		
<b>For models:</b>	212038, 212039, 212040, 212041		



1

<b>GEV No.</b>	602146	<b>Ref. No.</b>	R75400490
<b>description</b>	fan wheel blades 8 D1 ø 220mm D2 ø 11mm D3 ø 16mm H1 83mm H2 25mm		
<b>For models:</b>	212002, 212010, 212011		



1

<b>GEV No.</b>	601353	<b>Ref. No.</b>	R75400510
<b>description</b>	fan wheel D1 ø 150mm H1 50mm blades 36 D2 ø 8mm D3 ø 6/8mm H2 26mm		
<b>For models:</b>	212001		



1

<b>GEV No.</b>	601450	<b>Ref. No.</b>	403000250 VEN30002
<b>description</b>	fan wheel D1 ø 160mm H1 45mm blades 36 D2 ø 8mm D3 ø 8mm H2 24mm		
<b>For models:</b>	111001, 111002, 111003, 211006, 211014, 211016		



1

<b>GEV No.</b>	601246	<b>Ref. No.</b>	R75400410
<b>description</b>	fan wheel D1 ø 180mm H1 77mm blades 12 D2 ø 8mm D3 ø 6mm H2 25.5mm		
<b>For models:</b>	212004, 212005, 212006, 212007, 212008, 212009, 212017, 212018, 212019, 212020		



1

<b>GEV No.</b>	601487	<b>Ref. No.</b>	KVN008 KVN1025A VN1025A0
<b>description</b>	fan wheel D1 ø 196mm H1 61mm blades 39 D2 ø 10/8mm D3 ø 10mm H2 32mm		
<b>For models:</b>	211003		



1

<b>GEV No.</b>	601489	<b>Ref. No.</b>	KVN011 VN1050A0
<b>description</b>	fan wheel D1 ø 197mm H1 32mm blades 39 D2 ø 8mm D3 ø 8mm H2 12mm		
<b>For models:</b>	211002		



1

<b>GEV No.</b>	601776	<b>Ref. No.</b>	KVN1020A VN041
<b>description</b>	fan wheel D1 ø 197mm H1 43mm blades 39 D2 ø 8mm D3 ø 8x6.5mm H2 28mm		



1

<b>GEV No.</b>	601778	<b>Ref. No.</b>	VEN30004
<b>description</b>	fan wheel D1 ø 197mm H1 43mm blades 45 D2 ø 8mm D3 ø 8x6.8mm H2 14mm H3 1.5mm		
<b>For models:</b>	211029, 212015, 212016		



1

<b>GEV No.</b>	601560	<b>Ref. No.</b>	VEN30003
<b>description</b>	fan wheel D1 ø 200mm H1 45mm blades 44 D2 ø 8mm D3 ø 8mm H2 24mm		
<b>For models:</b>	211020, 211024, 211026, 212014		



1

<b>GEV No.</b>	601243	<b>Ref. No.</b>	R75400400
<b>description</b>	fan wheel D1 ø 220mm H1 78mm blades 12 D2 ø 11mm D3 ø 16mm H2 29mm		
<b>For models:</b>	212002		



1

<b>GEV No.</b>	601244	<b>Ref. No.</b>	R75400440
<b>description</b>	fan wheel D1 ø 350mm H1 114mm blades 12 D2 ø 19.5mm D3 ø 23mm H2 45mm		
<b>For models:</b>	212003, 212012, 212013		



1

<b>GEV No.</b>	601497	<b>Ref. No.</b>	0939130
<b>description</b>	fan wheel for motor cooling ø 206mm		



1

<b>GEV No.</b>	550856	<b>Ref. No.</b>	LA58003860 R58003860
<b>description</b>	flange for fan motor ED ø 50mm int. ø 1 19.5mm int. ø 2 16mm thickness 3mm brass		
<b>For models:</b>	212002, 212010, 212011		



1

<b>GEV No.</b>	550858	<b>Ref. No.</b>	R58003840
<b>description</b>	flange for fan motor ED ø 60mm int. ø 1 28.5mm int. ø 2 25mm thickness 4mm brass		
<b>For models:</b>	212003, 212012, 212013		





1

<b>GEV No.</b>	550860	<b>Ref. No.</b>	R58005500
<b>description</b>	flange for gasket ED ø 35mm int. ø 1 22mm int. ø 2 9mm thickness 8mm brass		
<b>For models:</b>	212001		



			
1			
<b>GEV No.</b>	560449	<b>Ref. No.</b>	R58004000
<b>description</b>	hexagonal screw thread M12x1.5 L thread L 22mm bore ø 6.3mm WS 19 total length 30mm		
<b>For models:</b>	212003, 212012, 212013		

			
1			
<b>GEV No.</b>	550861	<b>Ref. No.</b>	R70020020
<b>description</b>	shaft seal for fan motor ID ø 7.5mm ED ø 22mm thickness 7mm		
<b>For models:</b>	212001		

			
1			
<b>GEV No.</b>	511171	<b>Ref. No.</b>	R70020040
<b>description</b>	shaft seal ID ø 14.5mm ED ø 20mm thickness 3mm		
<b>For models:</b>	212002, 212010, 212011		

			
1			
<b>GEV No.</b>	511172	<b>Ref. No.</b>	R70020050
<b>description</b>	shaft sealing ID ø 24mm ED ø 29mm thickness 3mm		
<b>For models:</b>	212003, 212012, 212013		

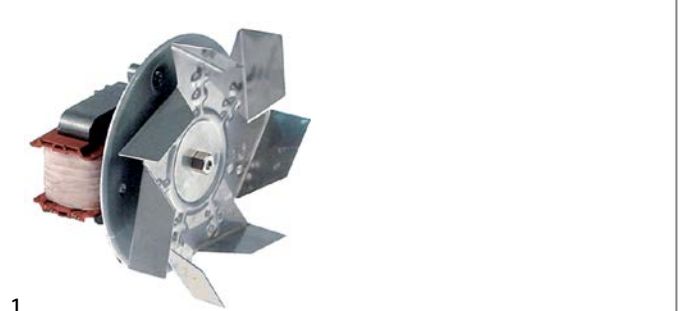

hot air fans

miscellaneous

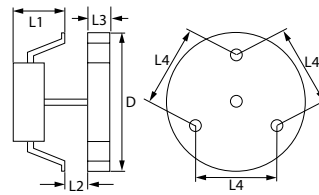

1



<b>GEV No.</b>	601054	<b>Ref. No.</b>	1037117200
<b>description</b>	hot air fan 220-240V 32W 50/60Hz L1 60mm L2 10mm L3 25mm L4 87mm fan wheel ø 150mm FIME type C20X0E01/46		
<b>spare parts for</b>	601054		
	<b>GEV No.</b>	601441	<b>Ref. No.</b> —
	fan wheel ø 150mm W 25mm shaft intake ø 6x5mm stainless steel blades 7		
<b>accessories for</b>	601054		
	<b>GEV No.</b>	550879	<b>Ref. No.</b> —
	insulation ø 130mm thickness 3mm hole ø 20mm for hot air fan		



1

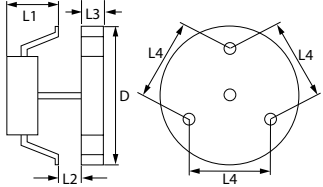

<b>GEV No.</b>	601694	<b>Ref. No.</b>	MOT30005
<b>description</b>	hot air fan 220-240V 33W 50/60Hz L1 57mm L2 13mm L3 21mm L4 87mm fan wheel ø 150mm IMS type VRB150H2022		
<b>For models:</b>	211004, 211005, 211010, 211011, 211012, 211013, 211015, 211017, 211018, 211023, 211027, 211028, 215001, 215002, 215003, 215004		



1

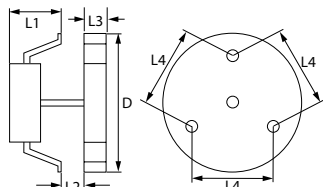



<b>GEV No.</b>	601531	<b>Ref. No.</b>	195TL110
<b>description</b>	hot air fan 220V 30W 50Hz L1 70mm L2 12mm L3 30mm L4 87mm fan wheel ø 155mm FIME type C30R0407		
<b>For models:</b>	913114, 913115, 913116, 913117, 913246, 913247, 913248, 913249, 913250, 913251, 913252, 913253, 913254, 913255, 913256, 913257, 913258, 913259, 913260, 913261, 913262, 913263, 913264, 913265, 913266, 914103, 914105, 914107, 914109, 914114, 914116, 914118, 914120, 914121, 914122, 914123, 914124, 914201, 914202, 914203, 914204, 914205, 914206, 914207, 914208, 914209, 914210, 914211, 914212, 914213...(Other models you can see in the webshop)		

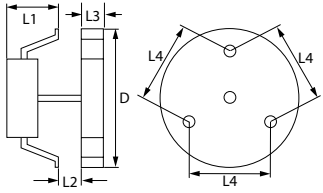

2



<b>GEV No.</b>	601011	<b>Ref. No.</b>	0682300800
<b>description</b>	hot air fan 220-240V 40W 50/60Hz L1 65mm L2 15mm L3 25mm L4 87mm fan wheel ø 150mm FIME type C25R8023CLH		
<b>For models:</b>	913013, 913014, 913015, 913016, 913017, 913018, 914003, 914004, 914005, 914006, 914015, 914016, 914017, 914018		
<b>accessories for</b>	601011		
	<b>GEV No.</b>	550879	<b>Ref. No.</b> —
insulation ø 130mm thickness 3mm hole ø 20mm for hot air fan			
	<b>GEV No.</b>	601260	<b>Ref. No.</b> —
nut thread M6L IT for hot air fan			



1

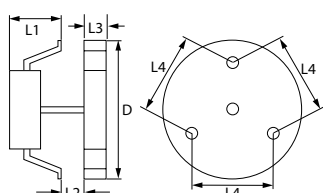



<b>GEV No.</b>	601696	<b>Ref. No.</b>	MA4330800
<b>description</b>	hot air fan 230V 40W 50/60Hz L1 70mm L2 11mm L3 29mm L4 87mm fan wheel ø 155mm with ball bearing		
<b>For models:</b>	121101, 121104, 122110		
<b>spare parts for</b>	601696		
	<b>GEV No.</b>	550879	<b>Ref. No.</b> —
insulation ø 130mm thickness 3mm hole ø 20mm for hot air fan			

Table continues overleaf



<b>spare parts for</b> 601696			
	<b>GEV No.</b>	601261	<b>Ref. No.</b> —
fan wheel ø 154mm W 25mm shaft intake ø 6x5mm chrome-plated blades 7			

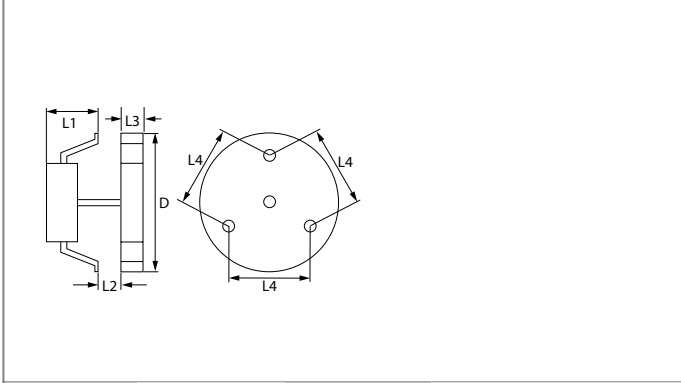

<b>GEV No.</b>	602100	<b>Ref. No.</b>	01203230 01203231
<b>description</b>	hot air fan 240V 59W 50/60Hz L1 80mm L2 16mm fan wheel ø 150mm IMS type 138251		
<b>For models:</b>	211038		

**accessories**  
fan wheels for hot air fans

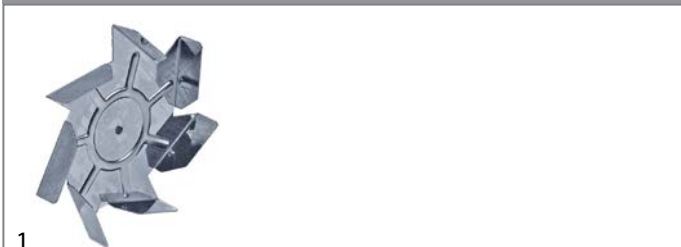

<b>GEV No.</b>	601630	<b>Ref. No.</b>	1034400200
<b>description</b>	fan wheel ø 150mm W 25mm shaft intake ø 6x5mm chrome-plated blades 7		

**miscellaneous**

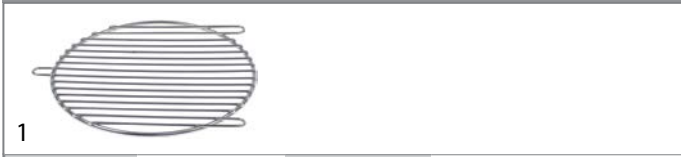

<b>GEV No.</b>	701623	<b>Ref. No.</b>	R75300150
<b>description</b>	guard ø 170mm hole ø 7mm for hot air fan combi-steamer		
<b>For models:</b>	212004, 212005, 212006, 212007, 212008, 212009, 212017, 212018, 212019, 212020		



<b>GEV No.</b>	551434	<b>Ref. No.</b>	R58004010
<b>description</b>	plain washer ø 30mm thickness 3mm hole ø 12.5mm for fan wheel combi-steamer		
<b>For models:</b>	212003, 212012, 212013		

**radial fans**

**miscellaneous**

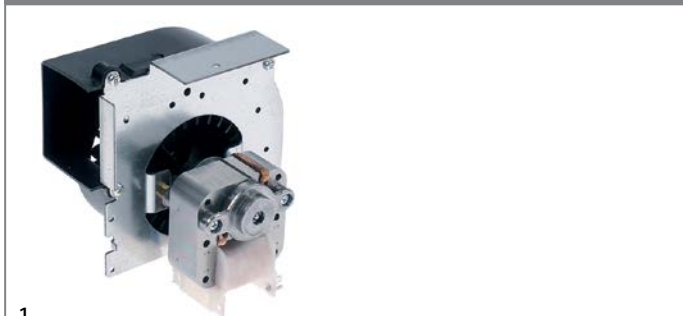

<b>GEV No.</b>	601167	<b>Ref. No.</b>	FMOTEA482WRKZ
<b>description</b>	radial fan 230V voltage AC 50Hz H1 129mm L1 131mm D1 ø 75mm W1 103mm W2 44mm H2 57mm W3 61mm H3 61mm for microwaves		
<b>For models:</b>	213002, 213003		

**extractor fans**

**speed controllers**



<b>GEV No.</b>	403436	<b>Ref. No.</b>	381001
<b>description</b>	speed controller EHN 3/1 voltage input 230V voltage output 100/125/145/180/230V max. 3A relay 2A length external size 240mm width external size 190mm D 90mm		

1

<b>GEV No.</b>	403437	<b>Ref. No.</b>	381002
<b>description</b>	speed controller EHN 5 voltage input 230V vottage output 100/125/145/180/230V max. 5A relay 2A length external size 240mm width external size 190mm D 160mm		



1

<b>GEV No.</b>	403438	<b>Ref. No.</b>	381003
<b>description</b>	speed controller EHN 7 voltage input 230V vottage output 100/125/145/180/230V max. 7A relay 2A length external size 240mm width external size 190mm D 160mm		

speed controllers



1

<b>GEV No.</b>	401679	<b>Ref. No.</b>	5423300
<b>description</b>	speed controller voltage input 230V/50Hz 1PhV vottage output 0-208/230V 0-240Hz 3PhV 1500W max. 18.4A load current 8.1A length external size 145mm width external size 115mm D 125mm wall-mounted version		

motors

gear motors

for grills



1

<b>GEV No.</b>	499209	<b>Ref. No.</b>	637075100
<b>description</b>	gear motor KENTA type K9113069 23W 230V 50Hz 2.5rpm shaft ø 6x8mm L 108mm W 58mm H 66mm		
<b>For models:</b>	262001		

for gyros grills

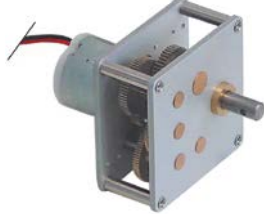

1

<b>GEV No.</b>	500503	<b>Ref. No.</b>	PT0162
<b>description</b>	gear motor 12V 1rpm		
<b>For models:</b>	254001, 254002, 254003, 254004, 254005, 254006, 254007, 254008, 254009, 254010, 254011, 254012		



1

<b>GEV No.</b>	500070	<b>Ref. No.</b>	PT0153
<b>description</b>	gear motor POTIS 230V 50Hz 1rpm shaft ø 8mm L 64mm W 64mm H 80mm		
<b>For models:</b>	254001, 254002, 254003, 254004, 254005, 254006, 254007, 254008, 254009, 254010, 254011, 254012		



1

<b>GEV No.</b>	500502	<b>Ref. No.</b>	PT0156
<b>description</b>	gear motor POTIS type 427 220-240V 50Hz 2rpm shaft ø 8mm L 64mm W 64mm H 56mm capacitor 0.12µF		
<b>For models:</b>	254001, 254002, 254003, 254004, 254005, 254006, 254007, 254008, 254009, 254010, 254011, 254012		



1

<b>GEV No.</b>	500797	<b>Ref. No.</b>	PT0152
<b>description</b>	gear motor POTIS type PT0152 3.5W 230V voltage AC 50Hz 1rpm shaft ø 18mm L 160mm W 115mm H 95mm with housing		
<b>spare parts for</b>	500797		
	<b>GEV No.</b>	<b>Ref. No.</b>	<b>PT0176</b>
	 rocker switch mounting measurements 30x11mm black 1CO 250V 16A I O II connection male faston 6.3mm ambient temperature max. 90°C protection IP40 with neutral position		

for combi-steamers



1

<b>GEV No.</b>	502288	<b>Ref. No.</b>	R65090250
<b>description</b>	gear kit 8W 230V voltage AC 30rpm shaft ø 6mm L 75mm W 87mm H 84mm conversion kit		
<b>For models:</b>	212010, 212011, 212012, 212013, 212018, 212020		
<b>spare parts for</b>	502288		
	<b>GEV No.</b>	<b>Ref. No.</b>	—
	 gear motor METEOR type 58U59DB4A1/00 8W 230V voltage AC 50Hz 30rpm shaft ø 6x5mm L 69mm W 49mm H 65mm		

for automatic coffee machines



1

<b>GEV No.</b>	601486	<b>Ref. No.</b>	252030
<b>description</b>	gear motor 90W 230V 50Hz 48rpm shaft ø 15mm L 95mm W 61mm H 90mm for coffee machine		
<b>For models:</b>	743001		



1

<b>GEV No.</b>	601488	<b>Ref. No.</b>	251866
<b>description</b>	gear motor 90W 230V 50Hz 70rpm shaft ø 15mm L 96mm W 55mm H 90mm for coffee machine		
<b>For models:</b>	743001		



1

<b>GEV No.</b>	601490	<b>Ref. No.</b>	098708
<b>description</b>	gear motor LIP type 111 48W 230V 50Hz 8rpm shaft ø 6x8.5mm L 110mm W 71mm H 80mm		
<b>For models:</b>	743001		

for microwaves



1

<b>GEV No.</b>	601969	<b>Ref. No.</b>	RMOTDA310WRZZ
<b>description</b>	gear motor ELENYSYS type SM16 HK36M0HZ 3.5W 220-240V voltage AC 50-60Hz 10-12rpm shaft ø 6.5x4.5mm for microwaves ø 49mm		

miscellaneous



1

<b>GEV No.</b>	500730	<b>Ref. No.</b>	IB9865132
<b>description</b>	gear motor CIARAMELLA 150W 230V voltage DC 50/60Hz shaft ø 14mm L 205mm W 115mm H 80mm for citrus juicers		
<b>For models:</b>	723001		



1

<b>GEV No.</b>	500932	<b>Ref. No.</b>	IB5036000
<b>description</b>	gear motor CROUZET 3.5W 230V 50Hz shaft ø 8mm L 80mm W 60mm H 40mm for pizza display		
<b>For models:</b>	541001, 541002		

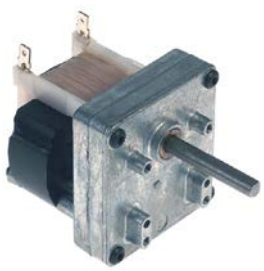
1

<b>GEV No.</b>	601483	<b>Ref. No.</b>	02.12.079.00
<b>description</b>	gear motor MERKLE type 4515UI-063 230V 50Hz 11rpm shaft $\varnothing$ 7x8mm L 125mm W 76mm H 69mm for toaster		
<b>For models:</b>	222004, 222005		

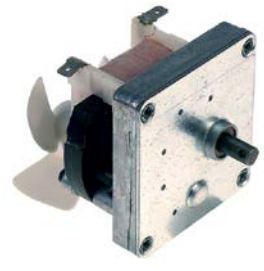

1

<b>GEV No.</b>	601484	<b>Ref. No.</b>	02.12.026.00
<b>description</b>	gear motor MK type S4355L 230V 50Hz shaft $\varnothing$ 7x8mm L 76mm W 70mm H 92mm for hot display		
<b>For models:</b>	541003		

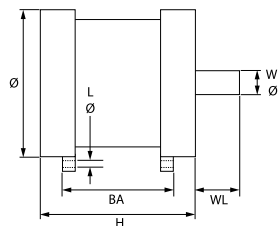
1

<b>GEV No.</b>	500720	<b>Ref. No.</b>	19400408
<b>description</b>	motor 230/400V 3 phase 50/60Hz 890rpm shaft $\varnothing$ 16.5mm shaft length 32mm $\varnothing$ 130mm H 120mm mounting distance 87mm hole $\varnothing$ 8mm GEMMA 350		



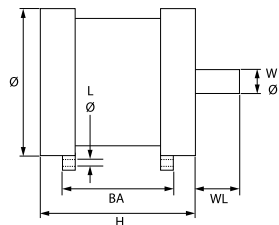

1

<b>GEV No.</b>	500721	<b>Ref. No.</b>	19400108
<b>description</b>	motor 230V 1 phase 50/60Hz 890rpm shaft $\varnothing$ 16.5mm shaft length 32mm $\varnothing$ 130mm H 140mm mounting distance 108mm hole $\varnothing$ 8mm GEMMA 350		

motors

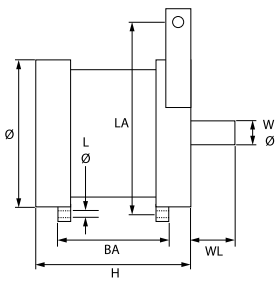
for slicers

1

<b>GEV No.</b>	500717	<b>Ref. No.</b>	SM400108
<b>description</b>	motor 230V 1 phase 147W 50Hz 1400rpm shaft $\varnothing$ 15mm shaft length 21mm $\varnothing$ 135mm H 120mm mounting distance 63mm hole distance 155mm hole $\varnothing$ 8mm type C71/40 275-300 CASTELLOTTI		

1

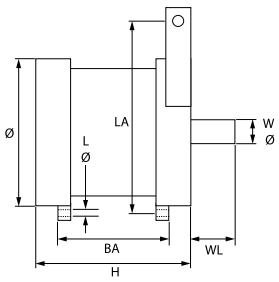
<b>GEV No.</b>	500718	<b>Ref. No.</b>	SM402215
<b>description</b>	motor 400V 3 phase 210W 50Hz 1400rpm shaft $\varnothing$ 15mm shaft length 22mm $\varnothing$ 135mm H 120mm mounting distance 63mm hole distance 155mm hole $\varnothing$ 8mm 275-300 CASTELLOTTI		

1

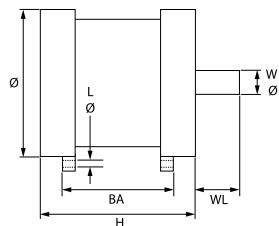
<b>GEV No.</b>	500715	<b>Ref. No.</b>	AMC648
<b>description</b>	motor 230V 1 phase 50Hz 1400rpm shaft $\varnothing$ 15mm shaft length 23mm $\varnothing$ 110mm H 98mm mounting distance 69mm hole $\varnothing$ 6mm 220		
<b>For models:</b>	411001		
<b>spare parts for</b>	500715		

<b>GEV No.</b>	365013	<b>Ref. No.</b>	19410301 19410303 206001
operating capacitor capacity 8 $\mu$ F 400V tolerance 5%Hz ambient temperature max. -25 to +85°C $\varnothing$ 31.5mm L 55mm M8 plastic connection male faston 6.3mm protection			



1

<b>GEV No.</b>	501376	<b>Ref. No.</b>	M8240
<b>description</b>	motor 230V 1 phase 50Hz shaft ø 19.5mm shaft length 56mm ø 145mm hole ø 8mm hole distance 115mm L 222mm		
<b>For models:</b>	411016, 411017		

group 4



1

<b>GEV No.</b>	499325	<b>Ref. No.</b>	M8375
<b>description</b>	motor 230V 50Hz OG30E		
<b>For models:</b>	411012		



1

<b>GEV No.</b>	499081	<b>Ref. No.</b>	M8342
<b>description</b>	motor 230V 50Hz shaft ø 15mm shaft length 34mm L 130mm		
<b>For models:</b>	411013, 411019		



1

<b>GEV No.</b>	499064	<b>Ref. No.</b>	M8349
<b>description</b>	motor 230V 50Hz shaft ø 15mm shaft length 34mm L 95mm		
<b>For models:</b>	411011		

for bar blender



1

<b>GEV No.</b>	500728	<b>Ref. No.</b>	IB5000800
<b>description</b>	motor for bar blender 220V 450W 50Hz 18000rpm thread M6L shaft ø 8mm mounting distance 36mm H 60mm L 165mm W 80mm mounting thread M4 Dragone CIARAMELLA		
<b>For models:</b>	721003		



1

<b>GEV No.</b>	500729	<b>Ref. No.</b>	IB5000900
<b>description</b>	motor for bar blender 230V 750W 50Hz 14000/24000rpm thread M8L mounting distance 90mm Orione		
<b>For models:</b>	721004		



1

<b>GEV No.</b>	500731	<b>Ref. No.</b>	IB9865200
<b>description</b>	motor for bar blender 230V 100W 50/60Hz 14000rpm shaft ø 10mm shaft length 143mm H 83mm L 260mm W 83mm Sirio CIARAMELLA		
<b>For models:</b>	721002, 721005		



1

<b>GEV No.</b>	500732	<b>Ref. No.</b>	IB9865201
<b>description</b>	motor for bar blender 230V 100W 50/60Hz 14000rpm shaft ø 18mm shaft length 143mm H 83mm L 260mm W 83mm Sirio CIARAMELLA		
<b>For models:</b>	721002, 721005		



1

<b>GEV No.</b>	499202	<b>Ref. No.</b>	CO1665
<b>description</b>	motor for mixer 230V 50Hz 1 phase shaft ø 10mm shaft length 125mm H 117mm L 70mm W 62mm		
<b>For models:</b>	721006, 721007		



for cutters



1			
<b>GEV No.</b>	500887	<b>Ref. No.</b>	SL0939
<b>description</b>	motor 2 speeds 600/800W 400V 50Hz 3 phase shaft ø 14mm flange ø 160mm 1400/2800rpm type DN80B2/4 ø 150mm H 200mm L 230mm MOTORI ELETTRICI 0.6/0.8kW		
<b>For models:</b>	471004		



1			
<b>GEV No.</b>	500886	<b>Ref. No.</b>	SL0040
<b>description</b>	motor 230/400V 50Hz 1400rpm type 80 3 phase shaft ø 14mm ø 150mm H 200mm L 230mm flange ø 160mm 750W 0.75kW		
<b>For models:</b>	451004, 471003, 471004		



1			
<b>GEV No.</b>	500897	<b>Ref. No.</b>	MSC04N136
<b>description</b>	motor 230V 50Hz 1 phase shaft ø 20mm shaft length 25mm mounting distance 64mm ø 100mm H 140mm C4-C6-C9		
<b>For models:</b>	471001		



1			
<b>GEV No.</b>	500885	<b>Ref. No.</b>	SL0041
<b>description</b>	motor 750W 230V 50Hz 1 phase shaft ø 14mm flange ø 160mm 1400rpm type MN80C/4 ø 150mm H 200mm L 230mm ICME 0.75kW		
<b>For models:</b>	451004, 471003, 471004		

for ice-cube maker

complete



1			
<b>GEV No.</b>	500727	<b>Ref. No.</b>	IB5000801
<b>description</b>	motor 350W 230V 50Hz 1 phase 12000rpm CIARAMELLA 0.35kW		
<b>For models:</b>	715001		

for meat mincers

motors



1			
<b>GEV No.</b>	501536	<b>Ref. No.</b>	29401502
<b>description</b>	motor 250W 230V 50Hz 1 phase shaft ø 11mm flange ø 90mm 2800rpm type 1-MP63 A2 ø 120mm H 130mm L 195mm fixing dimensions 80x100mm 0.25kW		
<b>For models:</b>	421002		



1			
<b>GEV No.</b>	500860	<b>Ref. No.</b>	LF2037050
<b>description</b>	motor meat mincer/cheese grater 230V		
<b>For models:</b>	431001		



1			
<b>GEV No.</b>	500858	<b>Ref. No.</b>	IV5050802
<b>description</b>	motor meat mincer/cheese grater 230V 1 phase		
<b>For models:</b>	421003		



1

<b>GEV No.</b>	500859	<b>Ref. No.</b>	IV5050803
<b>description</b>	motor meat mincer/cheese grater 400V		
<b>For models:</b>	421003		

rotors



1

<b>GEV No.</b>	500726	<b>Ref. No.</b>	MF2095A
<b>description</b>	rotor 230V ø 89.2mm shaft ø 25mm shaft length 357mm Mod.12 meat mincer/cheese grater		
<b>For models:</b>	421001, 433001		



1

<b>GEV No.</b>	500725	<b>Ref. No.</b>	MF2202
<b>description</b>	rotor 400V ø 89.2mm shaft ø 25mm shaft length 357mm Mod.22 meat mincer/cheese grater		
<b>For models:</b>	422001, 433002		

stators



1

<b>GEV No.</b>	500828	<b>Ref. No.</b>	MF2096
<b>description</b>	stator 230V 50Hz 4-pole 1400rpm 1 phase ø 150mm ID ø 90mm H 70mm with temperature protection Mod.12		
<b>For models:</b>	421001, 433001		



1

<b>GEV No.</b>	500830	<b>Ref. No.</b>	MF2203
<b>description</b>	stator 230V 50Hz 6-pole 900rpm 1 phase ø 150mm ID ø 103mm H 90mm with temperature protection Mod.22		
<b>For models:</b>	422001, 433002		

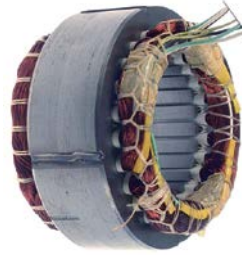

1

<b>GEV No.</b>	500829	<b>Ref. No.</b>	MF2097
<b>description</b>	stator 400V 50Hz 4-pole 1400rpm 3 phase ø 150mm ID ø 83.6mm H 50mm with temperature protection Mod.12		
<b>For models:</b>	421001, 433001		



1

<b>GEV No.</b>	500831	<b>Ref. No.</b>	MF2204
<b>description</b>	stator 400V 50Hz 6-pole 900rpm 3 phase ø 150mm ID ø 90mm H 70mm with temperature protection Mod.22		
<b>For models:</b>	422001, 433002		

for vegetable slicers



1

<b>GEV No.</b>	500719	<b>Ref. No.</b>	IV5050002
<b>description</b>	motor 230V 515W 50Hz 1 phase shaft ø 14mm shaft length 37mm mounting distance 154mm TM		
<b>For models:</b>	481001		



1

<b>GEV No.</b>	499254	<b>Ref. No.</b>	SL1470
<b>description</b>	motor 450W 230V 50Hz 1 phase shaft ø 14mm flange ø 160mm 1320rpm type MYT 712-4 ø 140mm H 180mm L 220mm 0.45kW		
<b>For models:</b>	451003, 481004, 513004, 513005, 513006, 513008, 513009, 513010		





for automatic coffee machines

1



<b>GEV No.</b>	601494	<b>Ref. No.</b>	251777
<b>description</b>	motor for coffee grinder 230V 48W 50/60Hz 1 phase shaft $\varnothing$ 7.5mm shaft length 24mm H 70mm L 120mm W 70mm KORO- ESPRESSO FISE		
<b>For models:</b>	743001		

1



<b>GEV No.</b>	601495	<b>Ref. No.</b>	098808	
<b>description</b>	motor for mixer 230V 50/60Hz 1 phase shaft $\varnothing$ 4mm shaft length 27mm KORO- ESPRESSO			
<b>For models:</b>	743001			
<b>accessories for</b>	601495			
	<b>GEV No.</b>	527278	<b>Ref. No.</b>	097916
	 impellor $\varnothing$ 32mm			

for coffee grinders

complete

1



<b>GEV No.</b>	500949	<b>Ref. No.</b>	WY28247001
<b>description</b>	motor 250W 230V 50Hz 1 phase 1.9A shaft $\varnothing$ 15mm shaft length 54mm thread M10L 1300rpm type 11004007 RPM 0.25kW		
<b>For models:</b>	744001, 744002		

for potato peelers

1



<b>GEV No.</b>	500711	<b>Ref. No.</b>	RG04260A
<b>description</b>	motor 230V 50Hz 1 phase shaft $\varnothing$ 10mm shaft length 21mm 1400rpm $\varnothing$ 120mm H 170mm mounting distance 136mm PP4 Expo		
<b>For models:</b>	451001		

1



<b>GEV No.</b>	500713	<b>Ref. No.</b>	RG08260A
<b>description</b>	motor 230V 50Hz 1 phase shaft $\varnothing$ 12mm shaft length 23mm 1400rpm type RG08260A mounting distance 188mm PP8 Expo		

1



<b>GEV No.</b>	500712	<b>Ref. No.</b>	RG04260B
<b>description</b>	motor 400V 50Hz 3 phase shaft $\varnothing$ 10mm shaft length 21mm 1400rpm $\varnothing$ 120mm H 170mm mounting distance 136mm PP4 Expo		
<b>For models:</b>	451001		

1



<b>GEV No.</b>	500714	<b>Ref. No.</b>	RG08260B
<b>description</b>	motor 400V 50Hz 3 phase shaft $\varnothing$ 12mm shaft length 23mm 1400rpm mounting distance 188mm PP8 Expo		

for mozzarella slicers

1

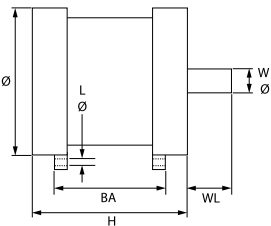

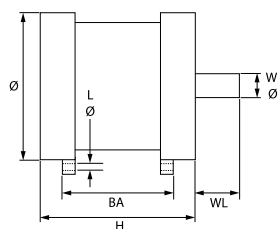

<b>GEV No.</b>	500723	<b>Ref. No.</b>	IB5053003
<b>description</b>	motor 230/400V 260W 50/60Hz 3 phase 1400rpm shaft $\varnothing$ 15mm shaft length 31mm $\varnothing$ 115mm H 155mm mounting distance 110mm hole $\varnothing$ 10mm type C71/70 Athos CASTELLOTTI		

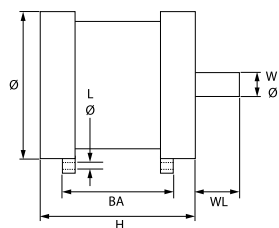

1

<b>GEV No.</b>	500722	<b>Ref. No.</b>	IB5053002
<b>description</b>	motor 230V 260W 50Hz 1 phase 1400rpm shaft $\varnothing$ 15mm shaft length 31mm $\varnothing$ 115mm H 155mm mounting distance 110mm hole $\varnothing$ 10mm type C71/70 Athos CASTELLOTTI		



1

<b>GEV No.</b>	500716	<b>Ref. No.</b>	IB5053004
<b>description</b>	motor 240V 260W 50Hz 1 phase 1400rpm shaft $\varnothing$ 15mm shaft length 31mm $\varnothing$ 115mm H 155mm mounting distance 110mm hole $\varnothing$ 10mm Athos		

for hand blenders

motors



1

<b>GEV No.</b>	698373	<b>Ref. No.</b>	SL2899
<b>description</b>	motor for hand blender 230V 50Hz shaft $\varnothing$ 8mm mounting distance 55mm H 150mm		
<b>For models:</b>	473007, 473008		

universal



1

<b>GEV No.</b>	500471	<b>Ref. No.</b>	8300530
<b>description</b>	motor 1100W 400V 50/60Hz 3 phase shaft $\varnothing$ 19mm flange $\varnothing$ 120mm 1370/1700rpm type AT80C4 $\varnothing$ 160mm H 200mm L 250mm Lafert		
<b>For models:</b>	512002, 512003, 512004		



1

<b>GEV No.</b>	499205	<b>Ref. No.</b>	SL3311
<b>description</b>	motor 1500/1800W 230/400-277/480V 50/60Hz 3 phase shaft $\varnothing$ 24/27mm flange $\varnothing$ 139mm 1400/1680rpm type TN90L/4 $\varnothing$ 160mm H 222mm L 280mm DRdrives 1.5/1.8kW		
<b>For models:</b>	512013, 512014, 512017, 512018, 512021, 512022		



1

<b>GEV No.</b>	500887	<b>Ref. No.</b>	SL0939
<b>description</b>	motor 2 speeds 600/800W 400V 50Hz 3 phase shaft $\varnothing$ 14mm flange $\varnothing$ 160mm 1400/2800rpm type DN80B2/4 $\varnothing$ 150mm H 200mm L 230mm MOTORI ELETTRICI 0.6/0.8kW		
<b>For models:</b>	471004		



1

<b>GEV No.</b>	500472	<b>Ref. No.</b>	8300540
<b>description</b>	motor 2000W 400V 50Hz 3 phase shaft $\varnothing$ 24mm flange $\varnothing$ 140mm 1400rpm type YS9034 $\varnothing$ 170mm H 210mm L 290mm TIANYANG 2kW		
<b>For models:</b>	512004		



1

<b>GEV No.</b>	500886	<b>Ref. No.</b>	SL0040
<b>description</b>	motor 230/400V 50Hz 1400rpm type 80 3 phase shaft $\varnothing$ 14mm $\varnothing$ 150mm H 200mm L 230mm flange $\varnothing$ 160mm 750W 0.75kW		
<b>For models:</b>	451004, 471003, 471004		



1

<b>GEV No.</b>	501536	<b>Ref. No.</b>	29401502
<b>description</b>	motor 250W 230V 50Hz 1 phase shaft ø 11mm flange ø 90mm 2800rpm type 1-MP63 A2 ø 120mm H 130mm L 195mm fixing dimensions 80x100mm 0.25kW		
<b>For models:</b>	421002		



1

<b>GEV No.</b>	500821	<b>Ref. No.</b>	5420300
<b>description</b>	motor 370W 230V 50Hz 1 phase shaft ø 14mm flange ø 160mm 1400rpm ø 140mm H 180mm L 220mm ICME 0.37kW		



1

<b>GEV No.</b>	500903	<b>Ref. No.</b>	5420200
<b>description</b>	motor 250W 230V 50Hz 1 phase shaft ø 14mm flange ø 160mm 1400rpm type M71B4 ø 140mm H 180mm L 220mm ICME 0.25kW		



1

<b>GEV No.</b>	499254	<b>Ref. No.</b>	SL1470
<b>description</b>	motor 450W 230V 50Hz 1 phase shaft ø 14mm flange ø 160mm 1320rpm type MYT 712-4 ø 140mm H 180mm L 220mm 0.45kW		
<b>For models:</b>	451003, 481004, 513004, 513005, 513006, 513008, 513009, 513010		



1

<b>GEV No.</b>	501373	<b>Ref. No.</b>	5420200alt
<b>description</b>	motor 250W 230V 50Hz 1 phase shaft ø 14mm flange ø 160mm 1420rpm type 62 ø 140mm L 260mm 0.25kW shaft length 32mm		



1

<b>GEV No.</b>	500473	<b>Ref. No.</b>	PF08300 SL3309
<b>description</b>	motor 750W 230/400V 50Hz 3 phase shaft ø 19mm flange ø 120mm 1400rpm type FS80B4 ø 150mm H 200mm L 240mm ICME 0.75kW		
<b>For models:</b>	512011, 512012, 512015, 512016, 512019, 512020		



1

<b>GEV No.</b>	501404	<b>Ref. No.</b>	2420200
<b>description</b>	motor 370W 230V 50Hz 1 phase shaft ø 14mm flange ø 160mm 1370rpm type S71B4 L 260mm 0.37kW shaft length 32mm		



1

<b>GEV No.</b>	500885	<b>Ref. No.</b>	SL0041
<b>description</b>	motor 750W 230V 50Hz 1 phase shaft ø 14mm flange ø 160mm 1400rpm type MN80C/4 ø 150mm H 200mm L 230mm ICME 0.75kW		
<b>For models:</b>	451004, 471003, 471004		



1

<b>GEV No.</b>	601463	<b>Ref. No.</b>	2510631
<b>description</b>	motor 90W 230V 50Hz 1 phase shaft ø 9mm flange ø 80mm 1300rpm type AMM56ZAA4 ø 110mm H 150mm L 170mm Lafert 0.09kW		



1

<b>GEV No.</b>	500886	<b>Ref. No.</b>	SL0040
<b>description</b>	motor 230/400V 50Hz 1400rpm type 80 3 phase shaft ø 14mm ø 150mm H 200mm L 230mm flange ø 160mm 750W 0.75kW		
<b>For models:</b>	451004, 471003, 471004		



1

<b>GEV No.</b>	500860	<b>Ref. No.</b>	LF2037050
<b>description</b>	motor meat mincer/cheese grater 230V		
<b>For models:</b>	431001		



1

<b>GEV No.</b>	500858	<b>Ref. No.</b>	IV5050802
<b>description</b>	motor meat mincer/cheese grater 230V 1 phase		
<b>For models:</b>	421003		



1

<b>GEV No.</b>	500859	<b>Ref. No.</b>	IV5050803
<b>description</b>	motor meat mincer/cheese grater 400V		
<b>For models:</b>	421003		

accessories

vibration absorber



1

<b>GEV No.</b>	527256	<b>Ref. No.</b>	WY15105
<b>description</b>	vibration damper H 15mm ø 15mm thread M4 thread L 2x 10mm		
<b>For models:</b>	742001, 742002, 742003, 742004, 742005, 742017, 742018, 742019, 742020		

miscellaneous



1

<b>GEV No.</b>	601498	<b>Ref. No.</b>	0939131
<b>description</b>	guard ø 220mm W 92mm		



pumps





wash and rinse pumps

FIR

pumps







1

<b>GEV No.</b>	499151	<b>Ref. No.</b>	01-240783-001
<b>description</b>	pump inlet ø 45mm outlet ø 40mm type 3910.1421 230V 50Hz 1 phase 0.37kW 0.5HP L 190mm rotation direction right capacitor 10µF FIR		
<b>For models:</b>	812011, 812012, 812013, 812014, 812015		
<b>spare parts for</b>	499151		
	<b>GEV No.</b>	365015	<b>Ref. No.</b> 19410307 R65190180 WY19050
	operating capacitor capacity 10µF 400V tolerance 5%Hz ambient temperature max. -25 to +85°C ø 35.5mm L 59mm M8 plastic connection male faston 6.3mm protection		
	<b>GEV No.</b>	510508	<b>Ref. No.</b> —
	pump cover FIR inlet ø 45mm outlet ø 40mm pump type PU 0.5/3911 turn direction right ø 160mm ID ø 125mm inner height 25mm		
	<b>GEV No.</b>	510607	<b>Ref. No.</b> —
	impellor ø 85mm H 29mm shaft intake ø 9x8mm rotation direction right blades 6		
	<b>GEV No.</b>	510692	<b>Ref. No.</b> —
	mechanical shaft seal for shaft ø 11mm slide ring ext. ø 24mm slide ring H 13mm counter ring mounting ø 26mm height counter ring 8mm counter ring int. ø 14mm		
	<b>GEV No.</b>	521702	<b>Ref. No.</b> —
	pump cover gasket thickness 3.5x4.5mm Qty 1 pcs		



1





<b>GEV No.</b>	499109	<b>Ref. No.</b>	100797
<b>description</b>	pump inlet ø 63mm outlet ø 53mm type 5233.4051 220-240/380-415V 50Hz 3 phase 1.1kW 1.5HP L 345mm rotation direction left FIR		
<b>For models:</b>	SP3		
<b>spare parts for</b>	499109		
	<b>GEV No.</b>	502274	<b>Ref. No.</b> 630138
	pump cover FIR inlet ø 63mm outlet ø 53mm		
	<b>GEV No.</b>	510523	<b>Ref. No.</b> 630306
	fan wheel ø 142mm shaft intake ø 15mm blades 12		
	<b>GEV No.</b>	510612	<b>Ref. No.</b> 631653
	impellor ø 110mm H 34mm M8R		
	<b>GEV No.</b>	510693	<b>Ref. No.</b> 141002 630501
	mechanical shaft seal for shaft ø 12mm slide ring ext. ø 24mm slide ring H 15.5mm slide ring int. ø 11mm counter ring mounting ø 24mm height counter ring 8mm counter ring int. ø 13.5mm		
	<b>GEV No.</b>	524416	<b>Ref. No.</b> 630411
	pump cover gasket thickness 4x4mm Qty 1 pcs		

HANNING

pumps





1

<b>GEV No.</b>	499147	<b>Ref. No.</b>	00-775854-001
<b>description</b>	pump inlet ø 28mm outlet ø 26mm type UP30-324RU 220-240V 50Hz 1 phase 0.14kW L 170mm rotation direction left capacitor 4µF HANNING		
<b>For models:</b>	811014, 811015, 812014, 812015, 813003, 813004		
<b>spare parts for</b>	499147		
	<b>GEV No.</b>	365031	<b>Ref. No.</b> —
	operating capacitor capacity 4µF 450V tolerance 5% 50/60Hz ambient temperature max. -25 to +85°C ø 31mm L 58mm M8 plastic connection male faston 6.3mm protection		
	<b>GEV No.</b>	507558	<b>Ref. No.</b> —
	mechanical shaft seal for shaft ø 7mm height counter ring 5mm ID ø 6.75mm ED ø 20mm mounting ø counter ring 18.5/slide ring 20mm		
	<b>GEV No.</b>	532644	<b>Ref. No.</b> —
	O-ring EPDM thickness 3mm ID ø 78mm Qty 1 pcs		
<b>accessories for</b>	499147		
	<b>GEV No.</b>	507498	<b>Ref. No.</b> 00-883837-001
	protective plate for wash pump suitable for HOBART L 300mm W 200mm		







1

<b>GEV No.</b>	500534	<b>Ref. No.</b>	00-324093-021
<b>description</b>	pump inlet ø 28mm outlet ø 26mm type UP60-184 230V 50Hz 1 phase 0.27kW 0.37HP L 190mm rotation direction left capacitor 5µF HANNING p max 0.77bar Qmax. 160l/min		
<b>For models:</b>	811011, 811012, 811013, 811014, 811015		
<b>spare parts for</b>	500534		
	<b>GEV No.</b>	365017	<b>Ref. No.</b> 00-226568-009 206010 631208 VE1145A0
	operating capacitor capacity 5µF 450V tolerance 5% 50/60Hz ambient temperature max. -25 to +85°C ø 28mm L 54mm M8 plastic connection male faston 6.3mm 16.10.08 protection		
	<b>GEV No.</b>	507558	<b>Ref. No.</b> —
	mechanical shaft seal for shaft ø 7mm height counter ring 5mm ID ø 6.75mm ED ø 20mm mounting ø counter ring 18.5/slide ring 20mm		
	<b>GEV No.</b>	532644	<b>Ref. No.</b> —
	O-ring EPDM thickness 3mm ID ø 78mm Qty 1 pcs		





LGB



1			
<b>GEV No.</b>	500511	<b>Ref. No.</b>	100785
<b>description</b>	pump inlet $\varnothing$ 30mm outlet $\varnothing$ 29mm type ZF140SX 230V 50Hz 1 phase 0.36kW 0.5HP L 190mm rotation direction right LGB		
<b>For models:</b>	SP1		
<b>spare parts for</b>	500511		
	<b>GEV No.</b>	365017	<b>Ref. No.</b> 00-226568-009 206010 631208 VE1145A0
	operating capacitor capacity 5 $\mu$ F 450V tolerance 5% 50/60Hz ambient temperature max. -25 to +85°C $\varnothing$ 28mm L 54mm M8 plastic connection male faston 6.3mm 16.10.08 protection		
	<b>GEV No.</b>	510703	<b>Ref. No.</b> 141007 630530
	mechanical shaft seal for shaft $\varnothing$ 13mm slide ring H 13mm height counter ring 5.5mm ED $\varnothing$ 26mm		
	<b>GEV No.</b>	521230	<b>Ref. No.</b> 631695
	impellor $\varnothing$ 86mm H 16mm M7L		
	<b>GEV No.</b>	521526	<b>Ref. No.</b> 630135
	pump cover LGB inlet $\varnothing$ 30mm outlet $\varnothing$ 30mm auxiliary pressure connection 12mm supporting pressure open turn direction right $\varnothing$ 117mm ID $\varnothing$ 95mm inner height 19mm		
	<b>GEV No.</b>	521706	<b>Ref. No.</b> 630424
	pump cover gasket		



1			
<b>GEV No.</b>	499150	<b>Ref. No.</b>	00-883833-001
<b>description</b>	pump inlet $\varnothing$ 45mm outlet $\varnothing$ 40mm type ZF220SX 230V 50Hz 1 phase 0.4kW L 190mm rotation direction right capacitor 12.5 $\mu$ F LGB		
<b>For models:</b>	813002, 813003, 813004		
<b>spare parts for</b>	499150		
	<b>GEV No.</b>	521036	<b>Ref. No.</b> 00-883833-010
	service kit for pump type ZF220SX HOBART 50Hz impellor, pump cover gasket, mechanical shaft seal		
<b>accessories for</b>	499150		
	<b>GEV No.</b>	365014	<b>Ref. No.</b> RG04290
	operating capacitor capacity 12.5 $\mu$ F 450V tolerance 5%Hz ambient temperature max. -25 to +85°C $\varnothing$ 35mm L 70mm M8 plastic connection male faston 6.3mm 45S.C3DS.12.5 protection		





1			
<b>GEV No.</b>	499011	<b>Ref. No.</b>	100820
<b>description</b>	pump inlet $\varnothing$ 50mm outlet $\varnothing$ 40mm type ZF350SX 230V 50Hz 1 phase 0.63kW L 201mm rotation direction right LGB 2800rpm suitable capacitor 12.5 $\mu$ F		
<b>For models:</b>	SP2-12, SP2-S12		
<b>spare parts for</b>	499011		
	<b>GEV No.</b>	365014	<b>Ref. No.</b> RG04290
	operating capacitor capacity 12.5 $\mu$ F 450V tolerance 5%Hz ambient temperature max. -25 to +85°C $\varnothing$ 35mm L 70mm M8 plastic connection male faston 6.3mm 45S.C3DS.12.5 protection		
	<b>GEV No.</b>	510702	<b>Ref. No.</b> 630536
	mechanical shaft seal height counter ring 5.5mm ID $\varnothing$ 12mm		
	<b>GEV No.</b>	521086	<b>Ref. No.</b> —
	pump cover LGB inlet $\varnothing$ 50mm outlet $\varnothing$ 40mm		
	<b>GEV No.</b>	521278	<b>Ref. No.</b> 631703
	impellor $\varnothing$ 93mm H 32mm pump type ZF350SX thread M8L		

Table continues overleaf



<b>spare parts for</b> 499011			
	GEV No.	521714	Ref. No. 630431
pump cover gasket thickness 4x4mm Qty 1 pcs			









1

<b>GEV No.</b>	500156	<b>Ref. No.</b>	130109
<b>description</b>	pump inlet ø 50mm outlet ø 50mm type ZF400SX 230V 50Hz 1 phase 0.6kW 0.8HP L 210mm rotation direction right capacitor 16µF LGB		
<b>For models:</b>	812001, 812002, 812003, 812004, 812005, 812006, 812007, 812008, 812009, 812010, 915234, 915235, 915236, 915237, 915460, 915461, 915462, 915463, 915464, 915465		
<b>spare parts for</b> 500156			
	GEV No.	509020	Ref. No. 124031
impellor ø 104mm H 25mm M8L			
	GEV No.	510703	Ref. No. 141007 630530
mechanical shaft seal for shaft ø 13mm slide ring H 13mm height counter ring 5.5mm ED ø 26mm			
	GEV No.	513713	Ref. No. 315017
pump cover bottom part			
	GEV No.	521548	Ref. No. 116019
pump cover LGB inlet ø 50mm outlet ø 50mm			
	GEV No.	521562	Ref. No. 116021
pump cover			
	GEV No.	521734	Ref. No. 315022
pump cover bottom part			
	GEV No.	523509	Ref. No. 314001
deep-groove ball bearing type 6201-2RS shaft ø 12mm ED ø 32mm W 10mm with sealing discs deep-groove ball bearing DIN 625-1			
	GEV No.	532623	Ref. No. —
O-ring EPDM thickness 2.62mm ID ø 120.32mm Qty 1 pcs			

<b>accessories for</b> 500156			
	GEV No.	365021	Ref. No. 00-226568-013 10.27.00 206004 631202 MF2144 SL0177
operating capacitor capacity 16µF 425V tolerance 5% 50/60Hz ambient temperature max. -25 to +85°C ø 35mm L 73mm single M8 plastic connection male faston 6.3mm 416.10.99 protection			









1

<b>GEV No.</b>	500543	<b>Ref. No.</b>	130126
<b>description</b>	pump inlet ø 50mm outlet ø 50mm type ZF400VSX 230V 50Hz 1 phase 0.85kW 1.2HP L 245mm rotation direction right capacitor 16µF LGB		
<b>spare parts for</b> 500543			
	GEV No.	365021	Ref. No. 00-226568-013 10.27.00 206004 631202 MF2144 SL0177
operating capacitor capacity 16µF 425V tolerance 5% 50/60Hz ambient temperature max. -25 to +85°C ø 35mm L 73mm single M8 plastic connection male faston 6.3mm 416.10.99 protection			
	GEV No.	509020	Ref. No. 124031
impellor ø 104mm H 25mm M8L			
	GEV No.	510703	Ref. No. 141007 630530
mechanical shaft seal for shaft ø 13mm slide ring H 13mm height counter ring 5.5mm ED ø 26mm			
	GEV No.	521548	Ref. No. 116019
pump cover LGB inlet ø 50mm outlet ø 50mm			
	GEV No.	521734	Ref. No. 315022
pump cover bottom part			
	GEV No.	532623	Ref. No. —
O-ring EPDM thickness 2.62mm ID ø 120.32mm Qty 1 pcs			















1

<b>GEV No.</b>	500361	<b>Ref. No.</b>	80112
<b>description</b>	pump inlet ø 60mm outlet ø 49mm type ZF400SX 230V 50Hz 1 phase 0.8kW 1HP L 210mm rotation direction right capacitor 16µF LGB		
<b>For models:</b>	813001		
<b>spare parts for</b>	500361		
	<b>GEV No.</b>	365021	<b>Ref. No.</b> 00-226568-013 10.27.00 206004 631202 MF2144 SL0177
	operating capacitor capacity 16µF 425V tolerance 5% 50/60Hz ambient temperature max. -25 to +85°C ø 35mm L 73mm single M8 plastic connection male faston 6.3mm 416.10.99 protection		
	<b>GEV No.</b>	509020	<b>Ref. No.</b> 124031
	impellor ø 104mm H 25mm M8L		
	<b>GEV No.</b>	510703	<b>Ref. No.</b> 141007 630530
	mechanical shaft seal for shaft ø 13mm slide ring H 13mm height counter ring 5.5mm ED ø 26mm		
	<b>GEV No.</b>	521547	<b>Ref. No.</b> 116013
	pump cover LGB inlet ø 60mm outlet ø 50mm supporting pressure M8 turn direction right ø 160mm ID ø 127mm inner height 36mm		
	<b>GEV No.</b>	521736	<b>Ref. No.</b> 315011
	pump cover bottom part bottom part		
	<b>GEV No.</b>	532623	<b>Ref. No.</b> —
	O-ring EPDM thickness 2.62mm ID ø 120.32mm Qty 1 pcs		
<b>accessories for</b>	500361		
	<b>GEV No.</b>	513264	<b>Ref. No.</b> 80545
	fastening angle for wash pump		



1

<b>GEV No.</b>	500153	<b>Ref. No.</b>	999134
<b>description</b>	pump inlet ø outlet ø type W180SX 230V 50Hz 1 phase 0.19kW 0.26HP L 220mm rotation direction right capacitor 5µF LGB		
<b>spare parts for</b>	500153		
	<b>GEV No.</b>	365017	<b>Ref. No.</b> 00-226568-009 206010 631208 VE1145A0
	operating capacitor capacity 5µF 450V tolerance 5% 50/60Hz ambient temperature max. -25 to +85°C ø 28mm L 54mm M8 plastic connection male faston 6.3mm 16.10.08 protection		
	<b>GEV No.</b>	510703	<b>Ref. No.</b> 141007 630530
	mechanical shaft seal for shaft ø 13mm slide ring H 13mm height counter ring 5.5mm ED ø 26mm		
	<b>GEV No.</b>	513267	<b>Ref. No.</b> 480054
	end cap for wash pump suitable for pump casing		
	<b>GEV No.</b>	513283	<b>Ref. No.</b> 437082
	gasket		
	<b>GEV No.</b>	518177	<b>Ref. No.</b> 111023
	drain unit thread 3/4" ID ø 35mm hose ø 24mm		
	<b>GEV No.</b>	518204	<b>Ref. No.</b> 429065
	screw connection for filter ø 67mm		
	<b>GEV No.</b>	518205	<b>Ref. No.</b> 437079 80182
	flat gasket rubber ED ø 61mm ID ø 47mm thickness 2mm Qty 1 pcs		
	<b>GEV No.</b>	521147	<b>Ref. No.</b> 315024
	flange		
	<b>GEV No.</b>	521221	<b>Ref. No.</b> 124048
	impellor ø 67mm H 16mm rotation direction right thread M7L shaft ø 13mm shaft length 12mm blades 8		
	<b>GEV No.</b>	528800	<b>Ref. No.</b> —
	O-ring EPDM thickness 2.62mm ID ø 75.87mm Qty 1 pcs		

booster pumps I



1			
<b>GEV No.</b>	500150	<b>Ref. No.</b>	999135
<b>description</b>	pump inlet ø outlet ø type W210SX 230V 50Hz 1 phase 0.24kW 0.33HP L 230mm rotation direction right capacitor 6.3µF LGB		
<b>For models:</b>	811003		
<b>spare parts for</b>	500150		
	<b>GEV No.</b>	365012	<b>Ref. No.</b> 01201030 19410308 206009
	operating capacitor capacity 6.3µF 450V tolerance 5% 50Hz ambient temperature max. -25 to +85°C ø 30mm L 61mm M8 plastic connection male faston 6.3mm protection		
	<b>GEV No.</b>	509004	<b>Ref. No.</b> 124049
	impellor ø 71mm H 16mm M7L rotation direction right shaft ø 13mm shaft length 13mm blades 8		
	<b>GEV No.</b>	510703	<b>Ref. No.</b> 141007 630530
	mechanical shaft seal for shaft ø 13mm slide ring H 13mm height counter ring 5.5mm ED ø 26mm		
	<b>GEV No.</b>	513267	<b>Ref. No.</b> 480054
	end cap for wash pump suitable for pump casing		
	<b>GEV No.</b>	513275	<b>Ref. No.</b> 456074
	O-ring EPDM thickness 1.78mm ID ø 82.27mm Qty 1 pcs		
	<b>GEV No.</b>	518177	<b>Ref. No.</b> 111023
	drain unit thread 3/4" ID ø 35mm hose ø 24mm		
	<b>GEV No.</b>	518204	<b>Ref. No.</b> 429065
	screw connection for filter ø 67mm		
	<b>GEV No.</b>	518205	<b>Ref. No.</b> 437079 80182
	flat gasket rubber ED ø 61mm ID ø 47mm thickness 2mm Qty 1 pcs		
	<b>GEV No.</b>	521147	<b>Ref. No.</b> 315024
	flange		

1			
<b>GEV No.</b>	500359	<b>Ref. No.</b>	130143
<b>description</b>	pump inlet ø 12 outlet ø 12 type PPL46DX 230V 50Hz 0.33kW capacitor 10µF LGB		
<b>For models:</b>	813001		
<b>spare parts for</b>	500359		
	<b>GEV No.</b>	698663	<b>Ref. No.</b> —
	impellor ø 60mm H 12mm with flute shaft intake ø 12mm W 60mm suitable for LGB		
<b>accessories for</b>	500359		
	<b>GEV No.</b>	365015	<b>Ref. No.</b> 19410307 R65190180 WY19050
	operating capacitor capacity 10µF 400V tolerance 5%Hz ambient temperature max. -25 to +85°C ø 35.5mm L 59mm M8 plastic connection male faston 6.3mm protection		

drain pumps

ASKOLL

1			
<b>GEV No.</b>	500210	<b>Ref. No.</b>	130123
<b>description</b>	drain pump 230V 40W		
<b>For models:</b>	811001, 811002, 811003		





1

<b>GEV No.</b>	499102	<b>Ref. No.</b>	999161
<b>description</b>	drain pump inlet ø 24mm outlet ø 22mm 230-240V 25W 50Hz ASKOLL type R113 retrofit kit		
<b>For models:</b>	812002, 812004, 812007, 812008, 812009, 812010, 915234, 915235, 915236, 915237, 915460, 915461, 915462, 915463, 915464, 915465		



2

<b>GEV No.</b>	500214	<b>Ref. No.</b>	130105
<b>description</b>	drain pump inlet ø 30mm outlet ø 22mm 230/240V 30W 50Hz ASKOLL type R113		
<b>For models:</b>	812001, 812002, 812003, 812004, 812005, 812006, 812007, 812008, 812009, 812010, 915234, 915235, 915236, 915237, 915460, 915461, 915462, 915463, 915464, 915465		

HANNING



1

<b>GEV No.</b>	500363	<b>Ref. No.</b>	80117
<b>description</b>	drain pump 40W 230V		
<b>For models:</b>	813001		



1

<b>GEV No.</b>	499148	<b>Ref. No.</b>	00-883993-001
<b>description</b>	drain pump 80W 220-240V inlet ø 24mm outlet ø 24mm 50Hz type BE22B3-197 HANNING rotation direction right		
<b>For models:</b>	813003, 813004		

GRE



1

<b>GEV No.</b>	500967	<b>Ref. No.</b>	100803
<b>description</b>	drain pump inlet ø 30mm outlet ø 22mm 100W 230V 50Hz GRE		
<b>For models:</b>	SP2-12, SP2-S12		

<b>spare parts for</b>	500967		
------------------------	--------	--	--

	<b>GEV No.</b>	500307	<b>Ref. No.</b>	—
---	----------------	--------	-----------------	---

filter				
--------	--	--	--	--

	<b>GEV No.</b>	500899	<b>Ref. No.</b>	630139
---	----------------	--------	-----------------	--------

pump cover inlet ø 30mm outlet ø 22mm pump type 500.213				
---	--	--	--	--



1

<b>GEV No.</b>	499146	<b>Ref. No.</b>	00-883993-012
<b>description</b>	drain pump 80W 230V inlet ø 24mm outlet ø 24mm 50Hz type BE22B3-204 HANNING		
<b>For models:</b>	811012, 811013, 811015, 812012, 812013, 812015		



electric components

accessories

holders



<b>GEV No.</b>	513717	<b>Ref. No.</b>	035064
<b>description</b>	fastening angle for drain pump		
<b>For models:</b>	812001, 812002, 812003, 812004, 812005, 812006, 812007, 812008, 812009, 812010, 915234, 915235, 915236, 915237, 915460, 915461, 915463, 915464		
<b>accessories for</b>	513717		
	<b>GEV No.</b>	518171	<b>Ref. No.</b> 111030 111999
opposite support mounting pos. lower for wash arm support			

booster pumps II

pump motors

flange connection



<b>GEV No.</b>	500689	<b>Ref. No.</b>	91.39.10
<b>description</b>	motor RPM type C021002 60W 230V 50/60Hz connection flange L 170mm W 105mm H 130mm capacitor 4µF		
<b>For models:</b>	745002		

clip connection



<b>GEV No.</b>	500950	<b>Ref. No.</b>	WY18303
<b>description</b>	pump motor RPM type C013728 120W 230V 50Hz connection clip ø 100mm L 145mm capacitor 8µF		
<b>For models:</b>	742001, 742002, 742003, 742004, 742005		
<b>accessories for</b>	500950		
	<b>GEV No.</b>	527146	<b>Ref. No.</b> WY26310002 WY83260016R
coupling set with clip			

pump heads

FLUID-O-TECH



<b>GEV No.</b>	500174	<b>Ref. No.</b>	WY26303001
<b>description</b>	pump head PA104 FLUID-O-TECH L 82mm 100l/h connection 3/8" GAS with bypass brass clip connection for coffee machine shaft ø 4.8x11mm NSF		
<b>For models:</b>	742001, 742002, 742003, 742004, 742017, 742018, 742019, 742020		
<b>accessories for</b>	500174		
	<b>GEV No.</b>	520126	<b>Ref. No.</b> —
clamp for pump/motor			

accessories



<b>GEV No.</b>	527146	<b>Ref. No.</b>	WY26310002 WY83260016R
<b>description</b>	coupling set with clip		
<b>For models:</b>	742001, 742002, 742003, 742004, 742017, 742018, 742019, 742020		



<b>GEV No.</b>	527190	<b>Ref. No.</b>	WY56116
<b>description</b>	filter with integrated fine filter brass T1: 3/8" T2: 3/8" pump inlet		
<b>For models:</b>	742001, 742002, 742003, 742004, 742005		



<b>GEV No.</b>	365015	<b>Ref. No.</b>	19410307 R65190180 WY19050
<b>description</b>	operating capacitor capacity 10µF 400V tolerance 5%Hz ambient temperature max. -25 to +85°C ø 35.5mm L 59mm M8 plastic connection male faston 6.3mm protection		
<b>For models:</b>	212001, 431001, 744001, 744002		



			
1			
<b>GEV No.</b>	365017	<b>Ref. No.</b>	00-226568-009 206010 631208 VE1145A0
<b>description</b>	operating capacitor capacity 5µF 450V tolerance 5% 50/60Hz ambient temperature max. -25 to +85°C ø 28mm L 54mm M8 plastic connection male faston 6.3mm 16.10.08 protection		
<b>For models:</b>	211001, 211002, 811001, 811002, 811011, 811012, 811013, 811014, 811015, SP1		



			
1			
<b>GEV No.</b>	365012	<b>Ref. No.</b>	01201030 19410308 206009
<b>description</b>	operating capacitor capacity 6.3µF 450V tolerance 5% 50Hz ambient temperature max. -25 to +85°C ø 30mm L 61mm M8 plastic connection male faston 6.3mm protection		
<b>For models:</b>	211039, 211042, 211043, 211044, 211045, 211046, 212034, 212035, 212036, 212037, 212038, 212039, 212040, 212041, 811003		

vibration pumps

			
1			
<b>GEV No.</b>	520330	<b>Ref. No.</b>	0V4275
<b>description</b>	bracket rubber dimensions 69x44x4mm		
<b>For models:</b>	743001		

			
1			
<b>GEV No.</b>	520152	<b>Ref. No.</b>	252021
<b>description</b>	hose connector Santoprene grommet ø 7mm grommet length 14mm		
<b>For models:</b>	743001		

			
1			
<b>GEV No.</b>	390625	<b>Ref. No.</b>	0V1301
<b>description</b>	thermal fuse switch-off temp. 110°C suitable for ULKA pump Klixon		
<b>For models:</b>	743001		

			
1			
<b>GEV No.</b>	500568	<b>Ref. No.</b>	R65110600
<b>description</b>	vibration pump 230V 32W 50Hz inlet ø 7 outlet ø 1/8" IT CEME type E512/A32		
<b>For models:</b>	212010, 212011, 212012, 212013, 212018, 212020		
<b>spare parts for</b>	500568		
		<b>GEV No.</b>	390698
		<b>Ref. No.</b>	—
		<b>description</b>	thermal fuse switch-off temp. 110°C suitable for ULKA pump
		<b>GEV No.</b>	520153
		<b>Ref. No.</b>	—
		<b>description</b>	bracket rubber dimensions 53x34x28mm

			
1			
<b>GEV No.</b>	500694	<b>Ref. No.</b>	94.21.00
<b>description</b>	vibration pump 230V 40W 50Hz inlet ø 6 outlet ø 7 THERMOPLAN type ETXM17-P/DLC L 100mm		
<b>For models:</b>	745001		





1

<b>GEV No.</b>	500438	<b>Ref. No.</b>	WY26304
<b>description</b>	vibration pump type 1106PAILM1N 208/240V 50/60Hz 50W inlet ø 1/8" IT outlet ø 1/8" IT outlet conical L 128mm FLUID-O-TECH		
<b>For models:</b>	742005		



1



<b>GEV No.</b>	500124	<b>Ref. No.</b>	098760
<b>description</b>	vibration pump type EX 5 230V 48W 50/60Hz inlet ø 6 outlet ø 1/8" IT flat seal ULKA brass L 123mm		
<b>For models:</b>	743001		
<b>accessories for</b>	500124		
	<b>GEV No.</b>	520152	<b>Ref. No.</b> 252021
	hose connector Santoprene grommet ø 7mm grommet length 14mm		
	<b>GEV No.</b>	520330	<b>Ref. No.</b> 0V4275
	bracket rubber dimensions 69x44x4mm		

### pumps for milk foamers

**pumps**



1

<b>GEV No.</b>	500691	<b>Ref. No.</b>	95.39.00
<b>description</b>	pump 230V 180W 50/60 L 230mm LEROY SOMER type D18P/T for milk foamer		
<b>For models:</b>	745002		
<b>spare parts for</b>	500691		
	<b>GEV No.</b>	500692	<b>Ref. No.</b> 90.39.10
	pump motor 180W 230V 50/60Hz LEROY SOMER L 140mm for milk foamer 1340/1560rpm		
	<b>GEV No.</b>	500693	<b>Ref. No.</b> 92.21.20
	pump head L 85mm for milk foamer		

### pump motors



1

<b>GEV No.</b>	500692	<b>Ref. No.</b>	90.39.10
<b>description</b>	pump motor 180W 230V 50/60Hz LEROY SOMER L 140mm for milk foamer 1340/1560rpm		
<b>For models:</b>	745002		
<b>accessories for</b>	500692		
	<b>GEV No.</b>	500693	<b>Ref. No.</b> 92.21.20
	pump head L 85mm for milk foamer		

### pump heads



1

<b>GEV No.</b>	500693	<b>Ref. No.</b>	92.21.20
<b>description</b>	pump head L 85mm for milk foamer		
<b>For models:</b>	745002		
<b>accessories for</b>	500693		
	<b>GEV No.</b>	500692	<b>Ref. No.</b> 90.39.10
	pump motor 180W 230V 50/60Hz LEROY SOMER L 140mm for milk foamer 1340/1560rpm		

### pumps for ice machines







1



<b>GEV No.</b>	601413	<b>Ref. No.</b>	10014
<b>description</b>	fixing plate suitable for fanwheel ED ø 32mm shaft ø 7 mounting distance 26mm		
<b>For models:</b>	711004, 711005, 711006, 711007, 711008, 711009, 711010, 711011, 711012, 711013, 711014, 711015, 711016, 711017, 711018, 711019		





			
1			
<b>GEV No.</b>	530639	<b>Ref. No.</b>	10066
<b>description</b>	impellor suitable for REBO ø 42mm ID ø 6x7mm H 17mm		
<b>For models:</b>	711001, 711002, 711003		

<b>spare parts for</b> 500165			
	<b>GEV No.</b>	601413	<b>Ref. No.</b> 10014
fixing plate suitable for fanwheel ED ø 32mm shaft ø 7 mounting distance 26mm			

			
1			
<b>GEV No.</b>	500590	<b>Ref. No.</b>	23377 C23377
<b>description</b>	pump FIR type 4240.2300 120W 230V 50/60Hz inlet ø 22mm outlet ø 22mm L 240mm rotation direction right for ice-cube maker capacitor 5µF		
<b>For models:</b>	711004, 711005, 711006, 711007, 711008, 711009, 711010, 711011, 711012, 711013, 711014, 711015, 711016, 711017, 711018, 711019		
<b>spare parts for</b>	500590		
	<b>GEV No.</b>	601412	<b>Ref. No.</b> 10213
fan wheel sucking ø 154mm fan wheel mounting 25.4mm blade angle 28° W 34mm plastic			
	<b>GEV No.</b>	601413	<b>Ref. No.</b> 10014
fixing plate suitable for fanwheel ED ø 32mm shaft ø 7 mounting distance 26mm			

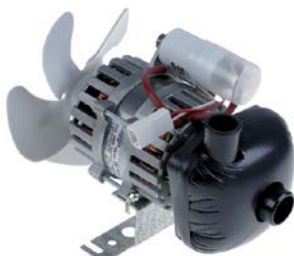

			
1			
<b>GEV No.</b>	500161	<b>Ref. No.</b>	23076 C23076
<b>description</b>	pump REBO type NR40 55W 230V 50Hz outlet ø 17mm L 110mm rotation direction left for ice-cube maker		
<b>For models:</b>	711001, 711002, 711003		
<b>spare parts for</b>	500161		
	<b>GEV No.</b>	500970	<b>Ref. No.</b> 23073
pump motor 55W 230V 50Hz REBO L 205mm type outlet ømm suitable for for ice maker			

			
1			
<b>GEV No.</b>	500970	<b>Ref. No.</b>	23073
<b>description</b>	pump motor 55W 230V 50Hz REBO L 205mm type outlet ømm suitable for for ice maker		
<b>For models:</b>	711001, 711002, 711003		

			
1			
<b>GEV No.</b>	500165	<b>Ref. No.</b>	23002
<b>description</b>	pump REBO type 63/35 120W 230V 50/60Hz inlet ø 28mm outlet ø 26mm L 180mm rotation direction right for ice-cube maker capacitor 5µF		
<b>For models:</b>	711004, 711005, 711006, 711007, 711008, 711009, 711010, 711011, 711012, 711013, 711014, 711015, 711016, 711017, 711018, 711019		
<b>spare parts for</b>	500165		
	<b>GEV No.</b>	365017	<b>Ref. No.</b> 00-226568-009 206010 631208 VE1145A0
operating capacitor capacity 5µF 450V tolerance 5% 50/60Hz ambient temperature max. -25 to +85°C ø 28mm L 54mm M8 plastic connection male faston 6.3mm 16.10.08 protection			
	<b>GEV No.</b>	601412	<b>Ref. No.</b> 10213
fan wheel sucking ø 154mm fan wheel mounting 25.4mm blade angle 28° W 34mm plastic			

vacuum pumps

vacuum pumps

			
1			
<b>GEV No.</b>	500987	<b>Ref. No.</b>	0430130
<b>description</b>	vacuum pump 4m³/h 230V 0.1kW 50Hz type PB 0004 B 000		
<b>spare parts for</b>	500987		
	<b>GEV No.</b>	500988	<b>Ref. No.</b> —
level glass thread 1/2" plastic			



<b>GEV No.</b>	499006	<b>Ref. No.</b>	0431300
<b>description</b>	vacuum pump 8m <sup>3</sup> /h 220/240V 0.35kW 50/60Hz type PB0008		

rotor vanes

<b>GEV No.</b>	691992	<b>Ref. No.</b>	0939056
<b>description</b>	rotor vane for vacuum pumps L 20mm W 14mm H 3mm		
<b>For models:</b>	442003, 442004, 442005, 442006, 442007, 442008		

<b>GEV No.</b>	691585	<b>Ref. No.</b>	0939065
<b>description</b>	rotor vane L 100mm W 40mm H 4mm		
<b>For models:</b>	442003, 442004, 442005, 442006, 442007, 442008		

<b>GEV No.</b>	692070	<b>Ref. No.</b>	0939054
<b>description</b>	rotor vane L 28mm W 14mm H 3mm		
<b>For models:</b>	442003, 442004, 442005, 442006, 442007, 442008		

<b>GEV No.</b>	691584	<b>Ref. No.</b>	0939060
<b>description</b>	rotor vane L 70mm W 18mm H 4mm		
<b>For models:</b>	442003, 442004, 442005, 442006, 442007, 442008		

level glasses

<b>GEV No.</b>	691563	<b>Ref. No.</b>	0438015
<b>description</b>	level glass thread 1"		
<b>For models:</b>	442003, 442004, 442005, 442006, 442007, 442008		

<b>GEV No.</b>	691561	<b>Ref. No.</b>	0438000
<b>description</b>	level glass thread 1/2"		

<b>GEV No.</b>	691562	<b>Ref. No.</b>	0438005
<b>description</b>	level glass thread 3/4"		
<b>For models:</b>	442003, 442004, 442005, 442006, 442007, 442008, 442010		

magnetic-drive pumps

<b>GEV No.</b>	500690	<b>Ref. No.</b>	91.39.20
<b>description</b>	magnetic-drive pump		
<b>For models:</b>	745002		

accessories

pump covers

<b>GEV No.</b>	500899	<b>Ref. No.</b>	630139
<b>description</b>	pump cover inlet ø 30mm outlet ø 22mm pump type 500.213		
<b>For models:</b>	SP2-12, SP2-S12		
<b>spare parts for</b>	500899		
<b>GEV No.</b>	500307	<b>Ref. No.</b>	—
<b>description</b>	filter		





pump cover gaskets

1			
<b>GEV No.</b>	513283	<b>Ref. No.</b>	437082
<b>description</b>	gasket		

condensators & interference suppression filters

operating capacitors

plastic

1			
<b>GEV No.</b>	365166	<b>Ref. No.</b>	00-226568-002
<b>description</b>	capacitor capacity 4µF 450V tolerance 5% 50Hz ambient temperature max. -25 to +85°C ø 30mm L 57mm M8 plastic connection male faston 6.3mm protection		
<b>For models:</b>	811014, 811015, 812014, 813003, 813004		

1			
<b>GEV No.</b>	365015	<b>Ref. No.</b>	19410307 R65190180 WY19050
<b>description</b>	operating capacitor capacity 10µF 400V tolerance 5%Hz ambient temperature max. -25 to +85°C ø 35.5mm L 59mm M8 plastic connection male faston 6.3mm protection		
<b>For models:</b>	212001, 431001, 744001, 744002		

1			
<b>GEV No.</b>	365014	<b>Ref. No.</b>	RG04290
<b>description</b>	operating capacitor capacity 12.5µF 450V tolerance 5%Hz ambient temperature max. -25 to +85°C ø 35mm L 70mm M8 plastic connection male faston 6.3mm 45S.C3DS.12.5 protection		
<b>For models:</b>	451001		

1			
<b>GEV No.</b>	365021	<b>Ref. No.</b>	00-226568-013 10.27.00 206004 631202 MF2144 SL0177
<b>description</b>	operating capacitor capacity 16µF 425V tolerance 5% 50/60Hz ambient temperature max. -25 to +85°C ø 35mm L 73mm single M8 plastic connection male faston 6.3mm 416.10.99 protection		
<b>For models:</b>	421001, 421006, 431002, 433001, 433003, 433004, 433005, 745002, 812001, 812002, 812003, 812004, 812005, 812006, 812007, 812008, 812009, 812010, 813002, 813003, 915234, 915235, 915236, 915237, 915460, 915461, 915462, 915463, 915464, 915465, SP2-12, SP2-512		

1			
<b>GEV No.</b>	365009	<b>Ref. No.</b>	401590400 CON30001
<b>description</b>	operating capacitor capacity 2.5µF 400V tolerance 5% 50Hz ambient temperature max. -25 to +85°C ø 36.5mm L 55mm M8 plastic connection male faston 6.3mm 1.27.65C3 protection		
<b>For models:</b>	111001, 111002, 111003, 211006, 211014, 211016, 211020, 211024, 211026		

1			
<b>GEV No.</b>	365019	<b>Ref. No.</b>	206005 IV5820020 MF2223
<b>description</b>	operating capacitor capacity 20µF 400V tolerance 5% 50/60Hz ambient temperature max. -25 to +85°C ø 39.5mm L 70mm M8 plastic connection male faston 6.3mm 16.10.25. protection		
<b>For models:</b>	422001, 433002, 481001, 813001		

1			
<b>GEV No.</b>	365109	<b>Ref. No.</b>	IV5820025
<b>description</b>	operating capacitor capacity 25µF 400V tolerance 5%Hz ambient temperature max. -25 to +85°C ø 44mm L 70mm M8 plastic connection male faston 6.3mm protection		
<b>For models:</b>	421003		



			
1			
<b>GEV No.</b>	365092	<b>Ref. No.</b>	RG08290
<b>description</b>	operating capacitor capacity 25 $\mu$ F 450V tolerance 5% 50Hz $\varnothing$ 45mm L 75mm plastic		

			
1			
<b>GEV No.</b>	365017	<b>Ref. No.</b>	00-226568-009 206010 631208 VE1145A0
<b>description</b>	operating capacitor capacity 5 $\mu$ F 450V tolerance 5% 50/60Hz ambient temperature max. -25 to +85°C $\varnothing$ 28mm L 54mm M8 plastic connection male faston 6.3mm 16.10.08 protection		
<b>For models:</b>	211001, 211002, 811001, 811002, 811011, 811012, 811013, 811014, 811015, SP1		

			
1			
<b>GEV No.</b>	365012	<b>Ref. No.</b>	01201030 19410308 206009
<b>description</b>	operating capacitor capacity 6.3 $\mu$ F 450V tolerance 5% 50Hz ambient temperature max. -25 to +85°C $\varnothing$ 30mm L 61mm M8 plastic connection male faston 6.3mm protection		
<b>For models:</b>	211039, 211042, 211043, 211044, 211045, 211046, 212034, 212035, 212036, 212037, 212038, 212039, 212040, 212041, 811003		

			
1			
<b>GEV No.</b>	365013	<b>Ref. No.</b>	19410301 19410303 206001
<b>description</b>	operating capacitor capacity 8 $\mu$ F 400V tolerance 5%Hz ambient temperature max. -25 to +85°C $\varnothing$ 31.5mm L 55mm M8 plastic connection male faston 6.3mm protection		
<b>For models:</b>	411001, 421002		

## ferrite rings

			
1			
<b>GEV No.</b>	691295	<b>Ref. No.</b>	R65280450
<b>description</b>	ferrite ring ID $\varnothing$ 17mm ED $\varnothing$ 28mm H 20mm for protection		
<b>For models:</b>	212001		

			
1			
<b>GEV No.</b>	365054	<b>Ref. No.</b>	R65280490
<b>description</b>	ferrite ring ID $\varnothing$ 22mm ED $\varnothing$ 38mm H 17mm for protection		
<b>For models:</b>	212002, 212003, 212010, 212011, 212012, 212013		

## filters

## interference suppression filters

			
1			
<b>GEV No.</b>	365053	<b>Ref. No.</b>	S06-0036 S06-0038
<b>description</b>	interference suppression filter capacity 0.1 $\mu$ F(X1)+2x5000pF(Y2) 1.5M $\Omega$ hm		
<b>For models:</b>	621004, 621005, 622004, 628004		

			
1			
<b>GEV No.</b>	365086	<b>Ref. No.</b>	631209
<b>description</b>	interference suppression filter type 10S7E-G1474253105-Q 115/250V 50/60Hz conductor 2 with E connection male faston 6.3mm L 40mm $\varnothing$ 40mm Hmm Wmm M8 plastic Qty 1 pcs		
<b>For models:</b>	SP1, SP2-12, SP2-S12, SP3		

			
1			
<b>GEV No.</b>	365045	<b>Ref. No.</b>	1037116500
<b>description</b>	interference suppression filter type FC701Y2F 250V 50-60Hz conductor 2 with E connection cable 200mm L 40mm $\varnothing$ 30mm Hmm Wmm plastic Qty 1 pcs		





			
1			
<b>GEV No.</b>	365044	<b>Ref. No.</b>	R65280200
<b>description</b>	interference suppression filter type FC701Y2F 250V 50-60Hz conductor 2 with E connection cable 200mm L 42mm ø 23mm Hmm Wmm plastic Qty 1 pcs		
<b>For models:</b>	212001, 212002, 212003, 212010, 212011, 212012, 212013		

line filters  
with housing

			
1			
<b>GEV No.</b>	365077	<b>Ref. No.</b>	0V3512
<b>description</b>	line filter type 411524410 250V 50/60Hz conductor 2 with E connection male faston 6.3mm L 50mm ø 38mm Hmm Wmm M8 plastic Qty 1 pcs		
<b>For models:</b>	743001		

RC circuits

			
1			
<b>GEV No.</b>	365211	<b>Ref. No.</b>	C23457
<b>description</b>	interference suppression filter type XRY RC MKPX2 275V connection plug		
<b>For models:</b>	711002, 711003, 711004, 711005, 711006, 711007, 711008, 711009, 711010, 711011, 711012, 711013, 711014, 711015, 711016, 711017, 711018, 711019		

			
1			
<b>GEV No.</b>	365076	<b>Ref. No.</b>	02.13.306.00
<b>description</b>	RC circuit 110-240V 50/60Hz conductor 2 connection cable Qty 1 pcs		
<b>For models:</b>	276003, 276004, 276005, 276006, 276007, 276008, 276009, 276010		

			
1			
<b>GEV No.</b>	365155	<b>Ref. No.</b>	R65280130
<b>description</b>	RC circuit 250/630V connection male faston 6.3mm cable length 65mm capacity 47nF 100Ohm		
<b>For models:</b>	212002, 212003		

HV capacitors

			
1			
<b>GEV No.</b>	365087	<b>Ref. No.</b>	RC-QZA264WRE0 RC-QZA391WRZZ
<b>description</b>	HV capacitor for microwave 0.94µF type RC-QZA391WRZZ 2300V 50/60Hz double connection male faston 6.3mm L 94mm H 38mm W 66mm dependent on equipment aluminium Qty 1 pcs		
<b>For models:</b>	213002		

			
1			
<b>GEV No.</b>	365088	<b>Ref. No.</b>	RC-QZA320WRZZ
<b>description</b>	HV capacitor for microwave 1.07µF type RC-QZA393WRZZ 2300V 50/60Hz double connection male faston 6.3mm L 98mm H 37mm W 65mm dependent on equipment aluminium Qty 1 pcs		
<b>For models:</b>	213001, 213003		

fuses

fine fuses

			
1			
<b>GEV No.</b>	358530	<b>Ref. No.</b>	926284
<b>description</b>	fine fuse size ø5x20mm 0.8A fast-acting rated 250V Qty 10 pcs		
<b>For models:</b>	813001		

			
1			
<b>GEV No.</b>	358610	<b>Ref. No.</b>	QFS-CA026WRZZ
<b>description</b>	fine fuse size ø5x20mm 10A fast-acting rated 250V Qty 10 pcs		
<b>For models:</b>	213001, 213002, 213003		

			
1			
<b>GEV No.</b>	358532	<b>Ref. No.</b>	R65200200
<b>description</b>	fine fuse size ø5x20mm 2A fast-acting rated 250V Qty 10 pcs		
<b>For models:</b>	212001, 212002, 212003, 212010, 212011, 212012, 212013		



1

<b>GEV No.</b>	358677	<b>Ref. No.</b>	228004 228010
<b>description</b>	fine fuse size ø5x20mm 4A fast-acting rated 250V Qty 10 pcs		
<b>For models:</b>	812001, 812002, 812003, 812004, 812005, 812006, 812007, 812008, 812009, 812010, 813001, 915234, 915235, 915236, 915237, 915460, 915461, 915462, 915463, 915464, 915465		



1

<b>GEV No.</b>	358533	<b>Ref. No.</b>	01143561
<b>description</b>	fine fuse size ø5x20mm 6.3A fast-acting rated 250V Qty 10 pcs		
<b>For models:</b>	273001		



1

<b>GEV No.</b>	358593	<b>Ref. No.</b>	097544 R65200086
<b>description</b>	fine fuse size ø5x20mm 0.125A slow-acting rated 250V Qty 10 pcs		
<b>For models:</b>	212002, 212003, 212010, 212011, 212012, 212013, 743001		



1

<b>GEV No.</b>	358595	<b>Ref. No.</b>	R65200320
<b>description</b>	fine fuse size ø5x20mm 0.2A slow-acting rated 250V Qty 10 pcs		
<b>For models:</b>	212002, 212010, 212011		

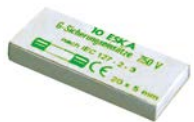

1

<b>GEV No.</b>	358703	<b>Ref. No.</b>	R65200350
<b>description</b>	fine fuse size ø5x20mm 0.4A slow-acting rated 250V Qty 10 pcs		
<b>For models:</b>	212003, 212012, 212013		

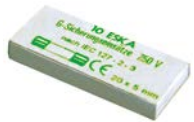

1

<b>GEV No.</b>	358601	<b>Ref. No.</b>	097103
<b>description</b>	fine fuse size ø5x20mm 1.25A slow-acting rated 250V Qty 10 pcs		
<b>For models:</b>	743001		



1

<b>GEV No.</b>	358603	<b>Ref. No.</b>	PT0195
<b>description</b>	fine fuse size ø5x20mm 2A slow-acting rated 250V Qty 10 pcs		



1

<b>GEV No.</b>	358760	<b>Ref. No.</b>	926283
<b>description</b>	fine fuse size ø6.3x32mm 0.315A medium lag rated 250V Qty 10 pcs		
<b>For models:</b>	813001		



1

<b>GEV No.</b>	358851	<b>Ref. No.</b>	095636
<b>description</b>	fuse size ø6.3x32mm 15A slow-acting rated 250V Qty 1 pcs		
<b>For models:</b>	743001		

various



1

<b>GEV No.</b>	358140	<b>Ref. No.</b>	QFS-CA017WRE0
<b>description</b>	fuse size ø6.3x32mm 17A		
<b>For models:</b>	213002, 213003		

fine fuse holders



1

<b>GEV No.</b>	550558	<b>Ref. No.</b>	WY19122
<b>description</b>	fuse holder suitable fuse ø5x20mm ø 12.5mm 10A rated 250V connection F4.8		
<b>For models:</b>	742001, 742002, 742003, 742004		





1

<b>GEV No.</b>	358388	<b>Ref. No.</b>	8301070
<b>description</b>	fuse holder suitable fuse ø6.3x32mm ø 15.2mm 15A rated 250V connection male faston 4.8mm		
<b>For models:</b>	512002, 512003, 512004		





 <p>1</p>			
<b>GEV No.</b>	358852	<b>Ref. No.</b>	251863
<b>description</b>	fuse holder suitable fuse $\phi 6.3 \times 32 \text{mm}$ $\phi 16 \text{mm}$ 1-pole 16A rated 250V L 52mm connection male faston 4.8mm/6.3mm		
<b>For models:</b>	743001		

 <p>1</p>			
<b>GEV No.</b>	358512	<b>Ref. No.</b>	R65210020
<b>description</b>	fuse holder		
<b>For models:</b>	212001, 212002, 212003, 212004, 212005, 212006, 212007, 212008, 212009, 212010, 212011, 212012, 212013, 212017, 212018, 212019, 212020		

 <p>1</p>			
<b>GEV No.</b>	551234	<b>Ref. No.</b>	210010
<b>description</b>	fuse holder suitable fuse $\phi 5 \times 20 \text{mm}$ 1-pole 6.3A rated 600V L 52mm W 8mm H 51mm connection screw clamp cross section $4 \text{mm}^2$		
<b>For models:</b>	812001, 812002, 812005, 812007, 812009, 915234, 915235, 915460		

 <p>1</p>			
<b>GEV No.</b>	550499	<b>Ref. No.</b>	H.228047
<b>description</b>	fuse holder suitable fuse $\phi 5 \times 20 \text{mm}$ 6.3A rated 500V		
<b>For models:</b>	813001		

 <p>1</p>			
<b>GEV No.</b>	358026	<b>Ref. No.</b>	00-775548-001
<b>description</b>	fuse holder suitable fuse $\phi 6.3 \times 32 \text{mm}$ 10A rated 800V L 61mm W 10mm H 65mm cross section $4 \text{mm}^2$		
<b>For models:</b>	811011, 811012, 811013, 811014, 811015, 812011, 812012, 812013, 812014, 812015		

 <p>1</p>			
<b>GEV No.</b>	550519	<b>Ref. No.</b>	H.228048
<b>description</b>	cover plate suitable fuse A rated V connection for fuse holder		
<b>For models:</b>	813001		

 <p>1</p>			
<b>GEV No.</b>	358834	<b>Ref. No.</b>	QFS-IA002WRE0 QFS-IA010WRZZ
<b>description</b>	fuse holder for fine fuse $\phi 6.3 \times 32 \text{mm}$ suitable fuse $\phi 6.3 \times 32 \text{mm}$ $\phi 15 \text{mm}$ 0.8A rated 5KV L 230mm connection F6.3 with fuse 0.8A fast-acting		
<b>For models:</b>	213001, 213002, 213003		

### thermal fuses

 <p>1</p>			
<b>GEV No.</b>	358853	<b>Ref. No.</b>	1002584
<b>description</b>	thermal fuse switch-off temp. $167^\circ \text{C}$ nominal A cable length 460mm		
<b>For models:</b>	741001		

 <p>1</p>			
<b>GEV No.</b>	358854	<b>Ref. No.</b>	10915
<b>description</b>	thermal fuse switch-off temp. $167^\circ \text{C}$ nominal A cable length 830mm		
<b>For models:</b>	741001, 741002		

 <p>1</p>			
<b>GEV No.</b>	358173	<b>Ref. No.</b>	S160P025
<b>description</b>	thermal fuse switch-off temp. $216^\circ \text{C}$ nominal A		
<b>For models:</b>	236004		

### overload switches

 <p>1</p>			
<b>GEV No.</b>	358514	<b>Ref. No.</b>	R65160300
<b>description</b>	overload switch drop-away current 0.8A		
<b>For models:</b>	212010, 212011		

 <p>1</p>			
<b>GEV No.</b>	358516	<b>Ref. No.</b>	R65160320
<b>description</b>	overload switch drop-away current 2A		
<b>For models:</b>	212002, 212010, 212011		

## electric accessories

### plugs - couplings - power sockets

#### protective contact plugs



<b>GEV No.</b>	550241 <sup>1</sup>	<b>Ref. No.</b>	PT0207
<b>description</b>	plug CEE7/7 type E+F angled 3-pole contacts P+N+E max. 16A max 250V with switch thermoplastic countries D/F/B/I		

<sup>1</sup>incl. rocker switch

#### protective contact power sockets

#### producer-specific power sockets

#### miscellaneous



<b>GEV No.</b>	550975	<b>Ref. No.</b>	401590000
<b>description</b>	built-in socket max. 16A with earth pin countries B 240V mounting ø 43mm 1 phase L/N/PE		
<b>For models:</b>	955001, 955002, 955003, 955004		



<b>GEV No.</b>	550054	<b>Ref. No.</b>	PT0206
<b>description</b>	power socket CEE7/4 type F built-in version contacts P+N+E max. 16A max 230V protection IP44 with fine fuse countries DE H 62mm mounting ø 45mm W 50mm		

#### appliance sockets/plugs

#### low temperature appliances 70°C



<b>GEV No.</b>	550704	<b>Ref. No.</b>	50.32.00 IB5520000
<b>description</b>	low temperature appliance plug C14 male faston 6.3mm max 10A/250V T70 mounting distance 40mm hole ø 3.5mm thermoplastic		
<b>For models:</b>	721002, 721004, 721005, 745002		



<b>GEV No.</b>	550758	<b>Ref. No.</b>	94.20.00
<b>description</b>	low temperature appliance plug C14 max 15A/250V T70 plastic male faston 6.3mm		
<b>For models:</b>	745001		



<b>GEV No.</b>	550962 <sup>1</sup>	<b>Ref. No.</b>	KODK008A
<b>description</b>	low temperature appliance plug C14 max 15A/250V T70 with cable		

<sup>1</sup>with cable

### cables

#### power supply cables



<b>GEV No.</b>	551085	<b>Ref. No.</b>	SL0130
<b>description</b>	cable CEE7/7 type E+F 3-pole contacts P+N+E 1.5mm <sup>2</sup> max. 16A max 230V 2m with plug H05VV-F 3G1.5		
<b>For models:</b>	273002, 273003, 273004, 279004, 611023, 621045, 621046, 621047, 621048, 621049, 621050, 622034, 622035, 622036, 622037, 622038, 622039		





<b>GEV No.</b>	551203	<b>Ref. No.</b>	CAV30013 CAV30014
<b>description</b>	connecting cable CEE7/7 type E+F 3-pole contacts P+N+E 2.5mm <sup>2</sup> max. 16A max 230V 2m H07 RN-F with plug		
<b>For models:</b>	211017, 211029		



<b>GEV No.</b>	550726	<b>Ref. No.</b>	KODK008B
<b>description</b>	low temperature appliance supply cable CEE7/7 - C15 3-pole contacts P+N+E 1mm <sup>2</sup> max. 10A max 250V 2.0m H05VVF T70 2-pole + earthing insulation PVC		





			
1			
<b>GEV No.</b>	550927	<b>Ref. No.</b>	19410530
<b>description</b>	low temperature appliance supply cable CEE7/7 3-pole 1mm <sup>2</sup> 1.5m T70 with connector strip insulation PVC		
<b>For models:</b>	411001, 431001, 481001, 541004		

			
1			
<b>GEV No.</b>	550553	<b>Ref. No.</b>	IB5503010
<b>description</b>	medium temperature appliance supply cable CEE7/7 - C15 3-pole contacts P+N+E 1mm <sup>2</sup> max. 10A max 250V 2.0m H05VVFT120 insulation PVC countries D/F/B/I black		
<b>For models:</b>	721002, 721004, 721005		

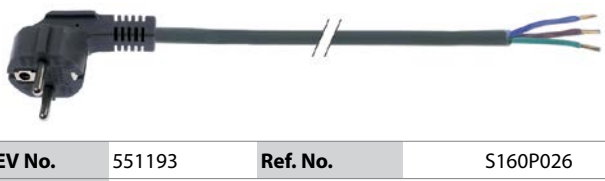
			
1			
<b>GEV No.</b>	550767	<b>Ref. No.</b>	19410536
<b>description</b>	plug CEE 4-pole 3-pole+Nmm <sup>2</sup> max. 16A max 415V 1.5m with cable		

			
1			
<b>GEV No.</b>	551193	<b>Ref. No.</b>	S160P026
<b>description</b>	power lead CEE7/7 type E+F 3-pole contacts P+N+E 1.5mm <sup>2</sup> max. 16A max 230V 1.37m H07RN-F 3G1.50mm <sup>2</sup> countries A/B/D/F/I		
<b>For models:</b>	236004		

			
1			
<b>GEV No.</b>	551263	<b>Ref. No.</b>	CE116
<b>description</b>	power lead CEE7/7 type E+F 3-pole contacts P+N+E max. 16A max 250V 1.5m H07 RN-F with power terminal block countries D/F/B/I black		
<b>For models:</b>	211001, 211002		

			
1			
<b>GEV No.</b>	550071	<b>Ref. No.</b>	402010100
<b>description</b>	spiral cable plug type CEE7/7 type E+F 1.5mm <sup>2</sup> 3-pole with plug L 500mm expansion 5:1 countries A/D/I black		
<b>For models:</b>	955001, 955002, 955003, 955004		

			
1			
<b>GEV No.</b>	551102	<b>Ref. No.</b>	00-227748-001
<b>description</b>	cable gland ID ø 10mm mounting ø 12mm Neoprene -30 up to +120°C Qty 1 pcs		
<b>For models:</b>	813002, 813003, 813004		

			
1			
<b>GEV No.</b>	524662	<b>Ref. No.</b>	00-695661-004
<b>description</b>	cable gland thread M25 cable ø 16mm mounting ø 25mm Qty 1 pcs plastic WS 33		
<b>For models:</b>	811011, 811012, 811013, 811014, 811015, 812011, 812012, 812013, 812014, 812015		

			
1			
<b>GEV No.</b>	524663	<b>Ref. No.</b>	00-695661-005
<b>description</b>	cable gland thread M32 cable ø 21mm mounting ø 32mm Qty 1 pcs plastic WS 42		
<b>For models:</b>	813002, 813003, 813004		

 <p>1</p>			
<b>GEV No.</b>	550971	<b>Ref. No.</b>	1037115100 402086016 MA1037115100
<b>description</b>	cable gland thread PG16 cable ø 14mm mounting ø 22.5mm Qty 1 pcs plastic WS 27		
<b>For models:</b>	111001, 112001, 112002, 113005, 113006, 113013, 113014, 114001, 114002, 116002, 141017, 141018, 141019, 143017, 143018, 143019, 143020, 144001, 145002, 147003, 221001, 221002, 243002, 243005, 244003, 244004, 244007, 244008, 244009, 244021, 255006, 255007		

 <p>1</p>			
<b>GEV No.</b>	550973	<b>Ref. No.</b>	1037112400 MA1037112400
<b>description</b>	cable gland thread PG21 cable ø 17mm mounting ø 28mm Qty 1 pcs plastic WS 34		
<b>For models:</b>	121104, 122103, 122104, 122105, 122106, 122110, 123110, 123111, 123112, 123113, 123114, 123115, 123118, 123119, 123120, 124101, 124102, 124105, 125101, 125102, 125103, 126101, 126103, 127102, 127103, 146006, 147005, 147006, 147007		

 <p>1</p>			
<b>GEV No.</b>	550990 <sup>1</sup>	<b>Ref. No.</b>	RG04332 RG04334
<b>description</b>	cable gland thread PG7 cable ø 8mm mounting ø 15mm Qty 1 plastic WS 19		
<b>For models:</b>	451001		

<sup>1</sup>incl. fastening nut

fastening nuts			
 <p>1</p>			
<b>GEV No.</b>	550972	<b>Ref. No.</b>	1037115200 MA1037115200
<b>description</b>	nut thread PG16 WS 30 plastic Qty 1 pcs thickness 6mm mounting ømm cable ømm		
<b>For models:</b>	141017, 141018, 141019, 143017, 143018, 143019, 143020, 144001, 145002, 147003		

 <p>1</p>			
<b>GEV No.</b>	550974	<b>Ref. No.</b>	1037114500 MA1037114500
<b>description</b>	nut thread PG21 WS 34 plastic Qty 1 pcs thickness 7.5mm mounting ømm cable ømm		
<b>For models:</b>	121104, 122103, 122104, 122105, 122106, 122110, 123110, 123111, 123112, 123113, 123114, 123115, 123118, 123119, 123120, 124101, 124102, 124105, 125101, 125102, 125103, 126101, 126103, 127102, 127103, 141005, 141007, 141011, 141012, 141013, 141016, 141021, 143021, 143022, 143023, 143024, 143025, 143026, 143027, 143028, 143029, 143030, 143031, 143032, 146006, 146007, 147005, 147006, 147007		

miscellaneous			
 <p>1</p>			
<b>GEV No.</b>	401960	<b>Ref. No.</b>	R66110320
<b>description</b>	cable set		
<b>For models:</b>	212002, 212003, 212010, 212011, 212012, 212013		

terminals			
porcelain clamps			
 <p>1</p>			
<b>GEV No.</b>	550115	<b>Ref. No.</b>	1037117600 MA1037117600
<b>description</b>	porcelain terminal block 2-pole 10mm <sup>2</sup> max. 30A max 450V L 37mm W 37mm H 23mm mounting distancemm Qty 1 pcs		
<b>For models:</b>	124105, 144001		

 <p>1</p>			
<b>GEV No.</b>	555001	<b>Ref. No.</b>	0639803201
<b>description</b>	porcelain terminal block 2-pole 6mm <sup>2</sup> max. 30A max 450V L 26mm W 24mm H 20mm mounting distancemm Qty 1 pcs		
<b>For models:</b>	910005, 910006, 910007		







 <p>1</p>			
<b>GEV No.</b>	555000	<b>Ref. No.</b>	MC2850500
<b>description</b>	porcelain terminal block 3-pole 4mm <sup>2</sup> hole distance 12mm max. 30A max 450V L 34mm W 25mm H 18mm mounting distance 12mm Qty 1 pcs		
<b>For models:</b>	913114, 913115, 913116, 913117, 913246, 913247, 913248, 913249, 913250, 913251, 913252, 913253, 913254, 913255, 913256, 913257, 913258, 913259, 913260, 913261, 913262, 913263, 913264, 913265, 913266, 914103, 914105, 914107, 914109, 914114, 914116, 914118, 914120, 914121, 914122, 914123, 914124, 914201, 914202, 914203, 914204, 914205, 914206, 914207, 914208, 914209, 914210, 914211, 914212, 914213...(Other models you can see in the webshop)		

 <p>1</p>			
<b>GEV No.</b>	358393	<b>Ref. No.</b>	098793
<b>description</b>	lustre terminal 4-pole max. 24A max 450V suitable fuse ø5x20mm cross section 2.5mm <sup>2</sup> with fuse holder		
<b>For models:</b>	743001		

terminal blocks

 <p>1</p>			
<b>GEV No.</b>	550239	<b>Ref. No.</b>	6A036360
<b>description</b>	lustre terminal 12-pole cross section 16mm <sup>2</sup> max. 75A max 500V temp.-resist. 150°C		

<p>connection terminals with screw/faston connections</p>  <p>1</p>			
<b>GEV No.</b>	550458	<b>Ref. No.</b>	251856
<b>description</b>	power terminal block 3-pole max. 25A max 450V connection ø2.5mm <sup>2</sup> / F6.3 temp.-resist. 150°C		
<b>For models:</b>	743001		

 <p>1</p>			
<b>GEV No.</b>	550232	<b>Ref. No.</b>	19410822 R02.15.030.00
<b>description</b>	lustre terminal 12-pole cross section 2.5mm <sup>2</sup> max. 32A max 450V temp.-resist. 150°C		
<b>For models:</b>	276003, 276004, 276005, 276006, 276007, 276008, 276009, 276010, 721002, 721005, 723001		

 <p>1</p>			
<b>GEV No.</b>	550516	<b>Ref. No.</b>	MOR30005
<b>description</b>	power terminal block 3-pole max. 40A max 400V connection M6/ male faston 6.3mm temp.-resist. 150°C cross section 6mm <sup>2</sup> mounting distance 66.5mm		
<b>For models:</b>	211029		

 <p>1</p>			
<b>GEV No.</b>	508353	<b>Ref. No.</b>	X02.15.052.00
<b>description</b>	lustre terminal 3-pole cross section 4mm <sup>2</sup> max. 32A max 750V temp.-resist. 150°C		
<b>For models:</b>	222004, 222005		

 <p>1</p>			
<b>GEV No.</b>	550278	<b>Ref. No.</b>	1037117300 MA1037117300
<b>description</b>	power terminal block 3-pole max. 40A max 400V connection ø6mm <sup>2</sup> / F6.3 temp.-resist. 150°C cross section 6mm <sup>2</sup>		
<b>For models:</b>	124105, 125101, 125102, 125103, 145002		

terminal blocks with fuse holder

 <p>1</p>			
<b>GEV No.</b>	358391	<b>Ref. No.</b>	097241
<b>description</b>	lustre terminal 2-pole max. 24A max 450V suitable fuse ø5x20mm cross section 2.5mm <sup>2</sup> with fuse holder		
<b>For models:</b>	743001		

 <p>1</p>			
<b>GEV No.</b>	550534 <sup>1</sup>	<b>Ref. No.</b>	150226 CR0588180
<b>description</b>	power terminal block 3-pole max. 40A max 450V connection ø6mm <sup>2</sup> / F6.3 temp.-resist. 150°C cross section 6mm <sup>2</sup> mounting distance 67mm with ground lug		
<b>For models:</b>	144001, 146002, 147003, SP1		

<sup>1</sup>with ground lug



1

<b>GEV No.</b>	550349	<b>Ref. No.</b>	6A036204
<b>description</b>	power terminal block 4-pole max. 40A max 400V connection $\phi 6\text{mm}^2$ / F6.3 temp.-resist. 150°C cross section $6\text{mm}^2$		



1

<b>GEV No.</b>	550961 <sup>1</sup>	<b>Ref. No.</b>	IB469 IG5469
<b>description</b>	power terminal block 4-pole max. 40A max 450V connection $\phi 6\text{mm}^2$ / F6.3 temp.-resist. 150°C cross section $6\text{mm}^2$ with ground lug		

<sup>1</sup>with ground lug



1

<b>GEV No.</b>	550110	<b>Ref. No.</b>	PD409B
<b>description</b>	power terminal block 5-pole max. 40A max 250V connection M6/ male faston 6.3mm temp.-resist. 130°C		
<b>For models:</b>	221005, 221021		



1

<b>GEV No.</b>	550517	<b>Ref. No.</b>	402080100
<b>description</b>	power terminal block 5-pole max. 40A max 450V connection M6/ male faston 6.3mm temp.-resist. 150°C cross section $6\text{mm}^2$		
<b>For models:</b>	111001, 112001, 112002, 113005, 113006, 113013, 113014, 114001, 114002, 221001, 221002, 243002, 243005, 244003, 244004, 244007, 244008, 244009, 244021, 255006, 255007		



1

<b>GEV No.</b>	550411	<b>Ref. No.</b>	1037104000 130321 220011 74610340 MA1037104000
<b>description</b>	power terminal block 6-pole max. 40A max 450V connection $\phi 6\text{mm}^2$ / F6.3 temp.-resist. 150°C cross section $6\text{mm}^2$		
<b>For models:</b>	121104, 122103, 122104, 122105, 122106, 122110, 123110, 123111, 123112, 123113, 123114, 123115, 123118, 123119, 123120, 124101, 124102, 126101, 126103, 531003, 531004, 531005, 531006, 531007, 531008, 812001, 812002, 812003, 812004, 812005, 812006, 812007, 812008, 812009, 812010, 813001, 915234, 915235, 915236, 915237, 915460, 915461, 915462, 915463, 915464, 915465, SP2-12, SP2-S12		



1

<b>GEV No.</b>	550977 <sup>1</sup>	<b>Ref. No.</b>	41826630100 CRO588170
<b>description</b>	power terminal block 6-pole max. 40A max 450V connection $\phi 6\text{mm}^2$ / F6.3 temp.-resist. 150°C cross section $6\text{mm}^2$ with ground lug		
<b>For models:</b>	127102, 127103, 131007, 131008, 131009, 131011, 131012, 131207, 131208, 131209, 132003, 132004, 132005, 132006, 132203, 132204, 132205, 132206, 133004, 133005, 133006, 133016, 133017, 133018, 133019, 133020, 133021, 137001, 137003, 137004, 137201, 141011, 141012, 141013, 141014, 141015, 141016, 143017, 143018, 143019, 143020, 143021, 143022, 143023, 143024, 143025, 143026, 143027, 143028, 143029...(Other models you can see in the webshop)		

<sup>1</sup>with ground lug

### connection terminals with screw connection



1

<b>GEV No.</b>	551021	<b>Ref. No.</b>	OAT93621 A0AT93621
<b>description</b>	porcelain terminal block 3-pole max. 15A max 500V connection screw temp.-resist. 150°C with fastening angle t.max. 150°C Qty 1 pcs		
<b>For models:</b>	221007		



1

<b>GEV No.</b>	550470	<b>Ref. No.</b>	418564500550 826630180
<b>description</b>	power terminal block 3-pole max. 40A max 400V connection M6/M6 temp.-resist. 150°C cross section $6\text{mm}^2$		
<b>For models:</b>	131001, 131002, 131003, 131004, 131005, 131006, 131010, 131201, 131202, 131203, 131204, 131205, 131206, 131210, 132001, 132002, 132201, 132202		



1

<b>GEV No.</b>	550507	<b>Ref. No.</b>	01200980 09950957300
<b>description</b>	power terminal block 4-pole max. 40A max 400V connection M6/M6 temp.-resist. 150°C		
<b>For models:</b>	211039, 211042, 211043, 211044, 211045, 211046, 212034, 212035, 212036, 212037		



			
1			
<b>GEV No.</b>	550355	<b>Ref. No.</b>	01201760
<b>description</b>	power terminal block 6-pole max. 40A max 400V connection M6/M6 temp.-resist. 150°C cross section 6mm <sup>2</sup> hole distance 122mm		
<b>For models:</b>	212038, 212039, 212040, 212041		

			
1			
<b>GEV No.</b>	550356	<b>Ref. No.</b>	637054300 MSC04N202A
<b>description</b>	power terminal block 2-pole max 450V max. 16A cable ø 15mm cross section 1.5mm <sup>2</sup>		
<b>For models:</b>	471001		

connection terminals with faston connections

			
1			
<b>GEV No.</b>	550989	<b>Ref. No.</b>	1029406
<b>description</b>	connection terminal 4-pole max. 25A max 450V connection F6.3/F6.3 temp.-resist. 90°C cross section 2.5/4mm <sup>2</sup>		
<b>For models:</b>	741003		

			
1			
<b>GEV No.</b>	550991	<b>Ref. No.</b>	IB5893000
<b>description</b>	power terminal block 3-pole max 400V max. 16A cable ømm cross section 2.5mm <sup>2</sup> connection with screw with cable run		

connection terminals with strain relief

			
1			
<b>GEV No.</b>	550988	<b>Ref. No.</b>	17242
<b>description</b>	power terminal block 2-pole max 400V max. 16A cable ø 10.5mm cross section 2.5mm <sup>2</sup> connection male faston 6.3mm/screw connection with strain relief		
<b>For models:</b>	741001, 741002, 741003		

			
1			
<b>GEV No.</b>	550764	<b>Ref. No.</b>	RG04207
<b>description</b>	power terminal block 3-pole max 450V max. 16A cable ø 14.5mm cross section 1.5mm <sup>2</sup> connection male faston 6.3mm mounting ø 28mm with strain relief		
<b>For models:</b>	451001		

			
1			
<b>GEV No.</b>	550976	<b>Ref. No.</b>	402085500
<b>description</b>	power terminal block 2-pole max 450V max. 16A cable ø 10.5mm cross section 1.5mm <sup>2</sup> with strain relief		
<b>For models:</b>	113003, 113004, 113011, 113012, 115001, 115002, 116001, 221003, 221004, 222002, 222003, 243001, 244001, 244002, 244005, 244006, 244010, 245001, 245002, 245003, 245004, 245005, 245007, 245008, 255001, 255002, 255003, 255004, 261001, 261002, 262002, 262003, 271004, 271005, 271006, 272001, 272002, 276001, 279001, 535001, 535002, 535004, 955001, 955002, 955003, 955004, HD3NK		

			
1			
<b>GEV No.</b>	550765	<b>Ref. No.</b>	RG04207 +2x 19410802
<b>description</b>	power terminal block 5-pole max 450V max. 16A cable ø 14.5mm cross section 1.5mm <sup>2</sup> connection male faston 6.3mm mounting ø 28mm with strain relief		

connection boxes

			
1			
<b>GEV No.</b>	550755 <sup>1</sup>	<b>Ref. No.</b>	00002260
<b>description</b>	connecting cable 3-pole contacts P+N+E with strain relief black L 1600mm 2.5mm <sup>2</sup>		
<b>For models:</b>	211038		

<sup>1</sup>with cable 1600mm



			
1			
<b>GEV No.</b>	550300	<b>Ref. No.</b>	459018
<b>description</b>	power terminal block 3-pole contacts P+N+E		
<b>For models:</b>	811001, 811002, 811003		

			
1			
<b>GEV No.</b>	550671	<b>Ref. No.</b>	MOR30002
<b>description</b>	power terminal block 6-pole contacts 3P+N+E		
<b>For models:</b>	211006, 211013, 211014, 211015, 211016, 211023, 211024, 211026, 212014, 212015, 212016		

terminal boards

			
1			
<b>GEV No.</b>	550413	<b>Ref. No.</b>	6A046400
<b>description</b>	terminal board 3-pole thread M5 L 55mm W 36mm		

			
1			
<b>GEV No.</b>	550985	<b>Ref. No.</b>	74670620
<b>description</b>	terminal board 3-pole thread M6 L 83mm W 53mm		
<b>For models:</b>	531001, 531002		

rail-mounted terminals

rail-mounted terminal blocks

			
1			
<b>GEV No.</b>	550421 <sup>1</sup>	<b>Ref. No.</b>	R65220090 R65220091
<b>description</b>	rail-mounted terminal block 5-pole contacts 3P+N+E cross section 1.0-10mm <sup>2</sup>		
<b>For models:</b>	212001, 212002, 212004, 212005, 212006, 212007, 212008, 212009, 212010, 212011, 212017, 212018, 212019, 212020		

<sup>1</sup>with fused terminal block

			
1			
<b>GEV No.</b>	550420	<b>Ref. No.</b>	R65220080
<b>description</b>	rail-mounted terminal block 5-pole contacts 3P+N+E cross section 1.5-16mm <sup>2</sup>		
<b>For models:</b>	212003		

WIELAND

rail-mounted terminals type 9700A

			
1			
<b>GEV No.</b>	550376	<b>Ref. No.</b>	74610020
<b>description</b>	rail-mounted terminal WIELAND type 9700A/16 S35 2.5-35mm <sup>2</sup> top-hat rail 35mm grey W 16mm L 59mm		
<b>For models:</b>	531004, 531006, 531008		

			
1			
<b>GEV No.</b>	550381	<b>Ref. No.</b>	74610070
<b>description</b>	rail-mounted terminal WIELAND type 9700A/8 S35 1.0-10mm <sup>2</sup> top-hat rail 35mm grey W 8mm L 46.6mm		
<b>For models:</b>	531008		

			
1			
<b>GEV No.</b>	550416	<b>Ref. No.</b>	74610190
<b>description</b>	rail-mounted terminal WIELAND type 9700A/8 SL2 S35 1.0-10mm <sup>2</sup> top-hat rail 35mm yellow/green W 8mm L 53mm		
<b>For models:</b>	531004, 531006, 531008		

miscellaneous

			
1			
<b>GEV No.</b>	551234	<b>Ref. No.</b>	210010
<b>description</b>	fuse holder suitable fuse ø5x20mm 1-pole 6.3A rated 600V L 52mm W 8mm H 51mm connection screw clamp cross section 4mm <sup>2</sup>		
<b>For models:</b>	812001, 812002, 812005, 812007, 812009, 915234, 915235, 915460		





 <p>1</p>			
<b>GEV No.</b>	551079	<b>Ref. No.</b>	MA20802799
<b>description</b>	rail-mounted terminal 6mm <sup>2</sup> yellow/green for DIN rail 35mm H 35mm 1-pole		
<b>For models:</b>	141017, 141018, 141019		

 <p>1</p>			
<b>GEV No.</b>	550794	<b>Ref. No.</b>	MOR30001
<b>description</b>	terminal 1-pole cross section 6-16mm <sup>2</sup> Qty 1 pcs		
<b>For models:</b>	210042, 211004, 211005, 211006, 211010, 211011, 211012, 211013, 211014, 211015, 211016, 211017, 211018, 211020, 211023, 211024, 211026, 211027, 211028, 211029, 212014, 212015, 212016, 212024, 212025		

accessories universal			
terminal block end brackets			
 <p>1</p>			
<b>GEV No.</b>	550984	<b>Ref. No.</b>	74610080
<b>description</b>	terminal block end bracket for DIN-rail		
<b>For models:</b>	531004, 531006, 531008		

 <p>1</p>			
<b>GEV No.</b>	693955	<b>Ref. No.</b>	1878400 MA1878400 VM250
<b>description</b>	terminal grounding cable		
<b>For models:</b>	121104, 122103, 122104, 122105, 122106, 122110, 123110, 123111, 123112, 123113, 123114, 123115, 123118, 123119, 123120, 124005, 124101, 124102, 124105, 125101, 125102, 125103, 126101, 126103, 127001, 127102, 127103, 141019, 144001, 144010, 144012, 145002, 146006, 146007, 147003, 147005, 147006, 147007, 211001, 211002, 211003		

accessories			
holders			
 <p>1</p>			
<b>GEV No.</b>	550766	<b>Ref. No.</b>	19410820
<b>description</b>	bracket for connector strip cross section 2.5mm <sup>2</sup> 3-pole plastic L 51mm W 31mm		
<b>For models:</b>	723001		



terminal boxes			
 <p>1</p>			
<b>GEV No.</b>	551214	<b>Ref. No.</b>	S900.48
<b>description</b>	terminal box 4-pole L 90mm W 52mm H 28mm with strain relief Qty 1 pcs		
<b>For models:</b>	611007, 611008, 611009, 611011		

various			
 <p>1</p>			
<b>GEV No.</b>	550987	<b>Ref. No.</b>	CE1130A0
<b>description</b>	power terminal block 5-pole with cable cable length 1400mm		
<b>For models:</b>	211003		

 <p>1</p>			
<b>GEV No.</b>	551090	<b>Ref. No.</b>	GN650TN.16 RC0235
<b>description</b>	terminal box 5-pole L 95mm W 63mm H 27mm		
<b>For models:</b>	611013, 611014, 611023, 613016, 613017, 621018, 621019, 621023, 621024, 621025, 621026, 621027, 621028, 621029, 621030, 621031, 621032, 621033, 621034, 621035, 621036, 621045, 621046, 621047, 621048, 621049, 621050, 622022, 622023, 622024, 622025, 622026, 622027, 622028, 622029, 622034, 622035, 622036, 622037, 622038, 622039, 625014, 625015, 625016, 625017, 625018		

switch boxes

			
1			
<b>GEV No.</b>	524664	<b>Ref. No.</b>	00-229169-007
<b>description</b>	gasket for switch box L 415mm W 12mm foam rubber		
<b>For models:</b>	813002, 813003, 813004		

			
1			
<b>GEV No.</b>	106806	<b>Ref. No.</b>	404500110
<b>description</b>	gas tap PEL type 20S gas inlet pipe flange ø21mm bypass nozzle ø 0mm gas outlet M16x1.5 (tube ø 10/8mm) thermocouple connection M8x1 pilot connection shaft ø 8x6.5mm shaft L 23/15mm shaft flat upper		
<b>spare parts for</b>	106806		
	<b>GEV No.</b>	101060	<b>Ref. No.</b> GS8036P
	magnet unit standard L 39mm D1 ø 15.4mm D2 ø 11mm suitable for PEL20-21/JUNKERS/EGA		
	<b>GEV No.</b>	101230	<b>Ref. No.</b> —
	thermocouple nut T1: M8x1 T2: M18x1 aluminium		

electronic components

transistor

			
1			
<b>GEV No.</b>	401502	<b>Ref. No.</b>	100115
<b>description</b>	transistor type IGBT		
<b>For models:</b>	131216, 131217, 131218, 246010, 246013		



<b>21S series</b>			
			
1			
<b>GEV No.</b>	101095	<b>Ref. No.</b>	BN6A011490 CO3139
<b>description</b>	gas tap PEL type 21S gas inlet M16x1.5 (tube ø 10mm) bypass nozzle ø 0.35mm gas outlet M16x1.5 (tube ø 10/8mm) thermocouple connection M8x1 pilot connection M10x1 shaft ø 8x6.5mm shaft L 22/15mm shaft flat lower		
<b>For models:</b>	143001, 143002, 143003, 143004, 143011, 143012, 143013, 143014, 143015, 143016, 243109, 243110		
<b>spare parts for</b>	101095		
	<b>GEV No.</b>	100408	<b>Ref. No.</b> —
	bypass nozzle type PEL20/21 bore ø 0.35mm thread M5x0.5		
	<b>GEV No.</b>	101060	<b>Ref. No.</b> GS8036P
	magnet unit standard L 39mm D1 ø 15.4mm D2 ø 11mm suitable for PEL20-21/JUNKERS/EGA		
	<b>GEV No.</b>	101206	<b>Ref. No.</b> —
	gas tap front part shaft ø 8x6.5mm shaft L 22/15mm shaft flat upper/lower suitable for PEL21		
	<b>GEV No.</b>	101230	<b>Ref. No.</b> —
	thermocouple nut T1: M8x1 T2: M18x1 aluminium		
<b>accessories for</b>	101095		
	<b>GEV No.</b>	100908	<b>Ref. No.</b> 41822450110 6A016110 6A017000 822450040 822450110 BN6A017000 MA673500
	olive for pipe ø 10mm Qty 1 pcs		
	<b>GEV No.</b>	100909	<b>Ref. No.</b> 822450450
	union screw thread M10x1 for pipe ø 4mm Qty 1 pcs		
	<b>GEV No.</b>	100909	<b>Ref. No.</b> 822450450
	union screw thread M10x1 for pipe ø 6mm Qty 1 pcs		
	<b>GEV No.</b>	101246	<b>Ref. No.</b> 673600 6A016120 MA673600
	olive for pipe ø 4mm Qty 1 pcs		













Table continues overleaf



<b>accessories for</b> 101095				
	GEV No.	101278	Ref. No.	6A011480 MA86720
olive for pipe ø 10mm Qty 1 pcs				
	GEV No.	101286	Ref. No.	—
olive ID ø 6mm Qty 1 pcs				
	GEV No.	101300	Ref. No.	6A011485 MA1326500
union nut thread M16x1.5 tube ø 10mm				
	GEV No.	101450	Ref. No.	—
olive for pipe ø 8mm L 12.7mm Qty 1 pcs ED ø 10mm				
	GEV No.	101451	Ref. No.	—
union nut thread M16x1.5 tube ø 8mm				
	GEV No.	110081	Ref. No.	GS.3602
knob ø 70mm shaft ø 8x6.5mm shaft flat universal				
	GEV No.	112206	Ref. No.	—
knob dial plate silver gas tap PEL21/22/23 t.max.°C ED ø 63mm ID ø 45.5mm				

				
1				
<b>GEV No.</b>	103329	<b>Ref. No.</b>	6A011490	
<b>description</b>	gas tap PEL type 21S gas inlet M16x1.5 (tube ø 10mm) bypass nozzle ø 0.35mm gas outlet M16x1.5 (tube ø 10/8mm) thermocouple connection M8x1 pilot connection M10x1 shaft ø 8x6.5mm shaft L 22/15mm shaft flat upper			
<b>For models:</b>	131001, 131002, 131003, 131004, 131005, 131006, 131010, 131201, 131202, 131203, 131204, 131205, 131206, 131210, 132001, 132002, 132201, 132202, 133001, 133002, 133003, 133007, 133008, 133009, 133010, 133011, 133012, 133013, 133014, 133015, 133022, 133023, 133024, 133201, 133202, 133203, 133207, 133208, 133209, 133210, 133211, 133212, 133213, 133214, 133215, 133222, 133223, 133224, 136001, 136005...(Other models you can see in the webshop)			

				
1				
<b>GEV No.</b>	101397	<b>Ref. No.</b>	826920040 GS3875 MA1888700	
<b>description</b>	gas tap PEL type 21S gas inlet M16x1.5 (tube ø 10mm) bypass nozzle ø 0.35mm gas outlet M16x1.5 (tube ø 10/8mm) thermocouple connection M9x1 pilot connection M10x1 shaft ø 8x6.5mm shaft L 22/15mm shaft flat lower			
<b>For models:</b>	121001, 121002, 121003, 121005, 122001, 122002, 123001, 123002, 123003, 123004, 123005, 123006, 123007, 123008, 123009, 123101, 123102, 131001, 131002, 131003, 131004, 131005, 131006, 132001, 132002, 133001, 133002, 133003, 133009, 133010, 133011, 133012, 133013, 133014, 133015, 133203, 133209, 133210, 133211, 133212, 133213, 133214, 133215, 231001, 231002, 231003, 231004, 233002, 233003, 234003...(Other models you can see in the webshop)			
<b>spare parts for</b>	101397			
	GEV No.	100408	Ref. No.	—
bypass nozzle type PEL20/21 bore ø 0.35mm thread M5x0.5				

<b>spare parts for</b> 101397				
	GEV No.	101060	Ref. No.	GS8036P
magnet unit standard L 39mm D1 ø 15.4mm D2 ø 11mm suitable for PEL20-21/JUNKERS/EGA				
	GEV No.	101206	Ref. No.	—
gas tap front part shaft ø 8x6.5mm shaft L 22/15mm shaft flat upper/lower suitable for PEL21				
	GEV No.	101231	Ref. No.	—
thermocouple nut T1: M9x1 T2: M18x1				
<b>accessories for</b> 101397				
	GEV No.	100908	Ref. No.	41822450110 6A016110 6A017000 822450040 822450110 BN6A017000 MA673500
union screw thread M10x1 for pipe ø 4mm Qty 1 pcs				
	GEV No.	100909	Ref. No.	822450450
union screw thread M10x1 for pipe ø 6mm Qty 1 pcs				
	GEV No.	101246	Ref. No.	673600 6A016120 MA673600
olive for pipe ø 4mm Qty 1 pcs				
	GEV No.	101278	Ref. No.	6A011480 MA86720
olive for pipe ø 10mm Qty 1 pcs				
	GEV No.	101286	Ref. No.	—
olive ID ø 6mm Qty 1 pcs				
	GEV No.	101300	Ref. No.	6A011485 MA1326500
union nut thread M16x1.5 tube ø 10mm				
	GEV No.	101450	Ref. No.	—
olive for pipe ø 8mm L 12.7mm Qty 1 pcs ED ø 10mm				
	GEV No.	101451	Ref. No.	—
union nut thread M16x1.5 tube ø 8mm				
	GEV No.	110081	Ref. No.	GS.3602
knob ø 70mm shaft ø 8x6.5mm shaft flat universal				
	GEV No.	112206	Ref. No.	—
knob dial plate silver gas tap PEL21/22/23 t.max.°C ED ø 63mm ID ø 45.5mm				



















				
1				
<b>GEV No.</b>	101693	<b>Ref. No.</b>	1031500200	
<b>description</b>	gas tap PEL type 21S gas inlet M16x1.5 (tube ø 10mm) bypass nozzle ø 0.7mm gas outlet M16x1.5 (tube ø 10/8mm) thermocouple connection M8x1 pilot connection M10x1 shaft ø 6x4.6mm shaft L 35/28mm shaft flat right			
<b>spare parts for</b>	101693			
	GEV No.	100552	Ref. No.	—
bypass nozzle type PEL20/21 bore ø 0.7mm thread M5x0.5				

Table continues overleaf

<b>spare parts for</b> 101693			
	GEV No.	101060	Ref. No. GS8036P
magnet unit standard L 39mm D1 ø 15.4mm D2 ø 11mm suitable for PEL20-21/JUNKERS/EGA			
	GEV No.	101230	Ref. No. —
thermocouple nut T1: M8x1 T2: M18x1 aluminium			
	GEV No.	101877	Ref. No. —
gas tap front part shaft ø 6x4.6mm type PEL21			
<b>accessories for</b> 101693			
	GEV No.	100908	Ref. No. 41822450110 6A016110 6A017000 822450040 822450110 BN6A017000 MA673500
union screw thread M10x1 for pipe ø 4mm Qty 1 pcs			
	GEV No.	100909	Ref. No. 822450450
union screw thread M10x1 for pipe ø 6mm Qty 1 pcs			
	GEV No.	101246	Ref. No. 673600 6A016120 MA673600
olive for pipe ø 4mm Qty 1 pcs			
	GEV No.	101278	Ref. No. 6A011480 MA86720
olive for pipe ø 10mm Qty 1 pcs			
	GEV No.	101286	Ref. No. —
olive ID ø 6mm Qty 1 pcs			
	GEV No.	101300	Ref. No. 6A011485 MA1326500
union nut thread M16x1.5 tube ø 10mm			
	GEV No.	101450	Ref. No. —
olive for pipe ø 8mm L 12.7mm Qty 1 pcs ED ø 10mm			
	GEV No.	101451	Ref. No. —
union nut thread M16x1.5 tube ø 8mm			









			
1			
GEV No.	101913	Ref. No.	1031501300
<b>description</b> gas tap PEL type 21S gas inlet M16x1.5 (tube ø 10mm) bypass nozzle ø 0.9mm gas outlet M16x1.5 (tube ø 10/8mm) thermocouple connection M8x1 pilot connection M10x1 shaft ø 6x4.6mm shaft L 35/28mm shaft flat right			
<b>spare parts for</b> 101913			
	GEV No.	100528	Ref. No. 41822450260 822450260 BN822450260 MA1889000
bypass nozzle type PEL20/21 bore ø 0.9mm thread M5x0.5			
	GEV No.	101060	Ref. No. GS8036P
magnet unit standard L 39mm D1 ø 15.4mm D2 ø 11mm suitable for PEL20-21/JUNKERS/EGA			
	GEV No.	101230	Ref. No. —
thermocouple nut T1: M8x1 T2: M18x1 aluminium			





<b>spare parts for</b> 101913			
	GEV No.	101877	Ref. No. —
gas tap front part shaft ø 6x4.6mm type PEL21			
<b>accessories for</b> 101913			
	GEV No.	100908	Ref. No. 41822450110 6A016110 6A017000 822450040 822450110 BN6A017000 MA673500
union screw thread M10x1 for pipe ø 4mm Qty 1 pcs			
	GEV No.	100909	Ref. No. 822450450
union screw thread M10x1 for pipe ø 6mm Qty 1 pcs			
	GEV No.	101246	Ref. No. 673600 6A016120 MA673600
olive for pipe ø 4mm Qty 1 pcs			
	GEV No.	101278	Ref. No. 6A011480 MA86720
olive for pipe ø 10mm Qty 1 pcs			
	GEV No.	101286	Ref. No. —
olive ID ø 6mm Qty 1 pcs			
	GEV No.	101300	Ref. No. 6A011485 MA1326500
union nut thread M16x1.5 tube ø 10mm			
	GEV No.	101450	Ref. No. —
olive for pipe ø 8mm L 12.7mm Qty 1 pcs ED ø 10mm			
	GEV No.	101451	Ref. No. —
union nut thread M16x1.5 tube ø 8mm			
	GEV No.	110078	Ref. No. —
knob without symbol ø 70mm shaft ø 6x4.6mm shaft flat universal			
	GEV No.	112206	Ref. No. —
knob dial plate silver gas tap PEL21/22/23 t.max.°C ED ø 63mm ID ø 45.5mm			

			
1			
GEV No.	101824	Ref. No.	CR0580450
<b>description</b> gas tap PEL type 21S gas inlet pipe flange ø21mm bypass nozzle ø 0.9mm gas outlet M16x1.5 (tube ø 10/8mm) thermocouple connection M9x1 pilot connection M10x1 shaft ø 8x6.5mm shaft L 22/15mm shaft flat upper pipe input ø 9mm			
<b>For models:</b> 121101, 121102, 121105, 121106, 122101, 122102, 141001, 141002, 141003, 141004, 141005, 141006, 141007, 141009, 141010, 146008, 146009			







22S/O series			
			
1			
<b>GEV No.</b>	101086	<b>Ref. No.</b>	853310186 MA1888600
<b>description</b>	gas tap PEL type 22S/O gas inlet M20x1.5 (tube ø 12mm) bypass nozzle ø 0.35mm gas outlet M20x1.5 (tube ø 12/10mm) thermocouple connection M9x1 pilot connection M10x1 shaft ø 10x8mm shaft L 25/17mm shaft flat lower		
<b>For models:</b>	136001, 136201, 141021		
<b>spare parts for</b>	101086		
	<b>GEV No.</b>	100259	<b>Ref. No.</b> —
bypass nozzle type PEL22 bore ø 0.35mm thread M6x0.5			
	<b>GEV No.</b>	101058	<b>Ref. No.</b> —
magnet unit L 39mm D1 ø 15.4mm D2 ø 13.5mm suitable for PEL22/EGA24197 standard			
	<b>GEV No.</b>	101201	<b>Ref. No.</b> —
gas tap front part shaft ø 10x8mm shaft L 25/17mm shaft flat upper/lower suitable for PEL22			
	<b>GEV No.</b>	101231	<b>Ref. No.</b> —
thermocouple nut T1: M9x1 T2: M18x1			
	<b>GEV No.</b>	101240	<b>Ref. No.</b> —
gas connection thread M20x1.5 tube ø 12/10mm for PEL gas taps with gasket and screws horizontal			
	<b>GEV No.</b>	101460	<b>Ref. No.</b> —
O-ring ø 12.37mm D1 ø 2.62mm suitable for PEL22			
	<b>GEV No.</b>	101461	<b>Ref. No.</b> —
screw kit suitable for PEL22 Qty 4 pcs			
<b>accessories for</b>	101086		
	<b>GEV No.</b>	100908	<b>Ref. No.</b> 41822450110 6A016110 6A017000 822450040 822450110 BN6A017000 MA673500
union screw thread M10x1 for pipe ø 4mm Qty 1 pcs			
	<b>GEV No.</b>	100909	<b>Ref. No.</b> 822450450
union screw thread M10x1 for pipe ø 6mm Qty 1 pcs			
	<b>GEV No.</b>	101241	<b>Ref. No.</b> —
gas connection thread M20x1.5 tube ø 12/10mm for PEL gas taps vertical			
	<b>GEV No.</b>	101246	<b>Ref. No.</b> 673600 6A016120 MA673600
olive for pipe ø 4mm Qty 1 pcs			
	<b>GEV No.</b>	101248	<b>Ref. No.</b> MA673300
olive for pipe ø 12mm Qty 1 pcs suitable for PEL			
	<b>GEV No.</b>	101249	<b>Ref. No.</b> 673400 6A011470
olive for pipe ø 10mm Qty 1 pcs			
	<b>GEV No.</b>	101250	<b>Ref. No.</b> 6A011475
union nut thread M20x1.5 for pipe ø 10mm			







accessories for 101086			
	<b>GEV No.</b>	101251	<b>Ref. No.</b> 6A016200 MA673100
union nut thread M20x1.5 for pipe ø 12mm			
	<b>GEV No.</b>	101286	<b>Ref. No.</b> —
olive ID ø 6mm Qty 1 pcs			
	<b>GEV No.</b>	110080	<b>Ref. No.</b> —
knob ø 70mm shaft ø 10x8mm shaft flat universal			
	<b>GEV No.</b>	112206	<b>Ref. No.</b> —
knob dial plate silver gas tap PEL21/22/23 t.max. °C ED ø 63mm ID ø 45.5mm			

COPRECI

CPMM18700			
			
1			
<b>GEV No.</b>	107469	<b>Ref. No.</b>	SVG181
<b>description</b>	gas tap COPRECI type CPMM18700 gas inlet M10x0.75 bypass nozzle ømm gas outlet 2x M10x1 (tube ø 5mm) thermocouple connection M8x1 pilot connection M10x1 shaft ø 6x4.6mm shaft L 17/10mm shaft flat upper front fixing M15x1		
<b>For models:</b>	221015		

SABAF

			
1			
<b>GEV No.</b>	104775	<b>Ref. No.</b>	404000260
<b>description</b>	gas tap SABAF type 10 gas inlet pipe flange ø14mm bypass nozzle ø 0.56mm gas outlet 1/4" (tube ø 8mm) front fixing thermocouple connection M8x1 shaft ø 8x6.5mm shaft L 32/12.5mm shaft flat right		
<b>For models:</b>	111002, 111003, 112003, 112004		
<b>spare parts for</b>	104775		
	<b>GEV No.</b>	106724	<b>Ref. No.</b> —
magnet unit L 30mm D1 ø 12.5mm D2 ø 8.5mm suitable for SABAF			
<b>accessories for</b>	104775		
	<b>GEV No.</b>	101277	<b>Ref. No.</b> 404000204 404000263 PT0010
olive ID ø 8mm Qty 1 pcs			
	<b>GEV No.</b>	520656	<b>Ref. No.</b> —
union nut thread 1/4" tube ø 6/8mm			



			
1			
<b>GEV No.</b>	106577	<b>Ref. No.</b>	404000261
<b>description</b>	gas tap SABAF type 10 gas inlet pipe flange ø23mm bypass nozzle ø 0.38mm gas outlet 1/4" (tube ø 8mm) front fixing thermocouple connection M8x1 shaft ø 8x6.5mm shaft L 32/12.5mm shaft flat right		
<b>For models:</b>	111002, 111003, 112003, 112004		
<b>spare parts for</b>	106577		
	<b>GEV No.</b>	106724	<b>Ref. No.</b> —
	magnet unit L 30mm D1 ø 12.5mm D2 ø 8.5mm suitable for SABAF		
<b>accessories for</b>	106577		
	<b>GEV No.</b>	101277	<b>Ref. No.</b> 404000204 404000263 PT0010
	olive ID ø 8mm Qty 1 pcs		
	<b>GEV No.</b>	101376	<b>Ref. No.</b> —
	gasket ID ø 8mm ED ø 12mm H 3/5mm		
	<b>GEV No.</b>	101751	<b>Ref. No.</b> —
	bracket		
	<b>GEV No.</b>	520656	<b>Ref. No.</b> —
	union nut thread 1/4" tube ø 6/8mm		

### MADEC (MP)

with pipe outlet

			
1			
<b>GEV No.</b>	103203 <sup>1</sup>	<b>Ref. No.</b>	PT0085
<b>description</b>	gas tap MADEC type LPG with pipe outlet with thermocouple and knob gas inlet M12x1 (tube ø 8mm) bypass nozzle ø 1mm gas outlet M12x1 (tube ø 8mm) thermocouple connection M8x1 front fixing M12x1 shaft ø 6x4.6mm shaft L 29.5/21mm shaft flat right		

<sup>1</sup>incl. thermocouple and knob

			
1			
<b>GEV No.</b>	103202 <sup>1</sup>	<b>Ref. No.</b>	PT0085
<b>description</b>	gas tap MADEC type natural gas with pipe outlet with thermocouple and knob gas inlet M12x1 (tube ø 8mm) bypass nozzle ø 0.65mm gas outlet M12x1 (tube ø 8mm) thermocouple connection M8x1 front fixing M12x1 shaft ø 6x4.6mm shaft L 29.5/21mm shaft flat right		
<b>accessories for</b>	103202		
	<b>GEV No.</b>	102054	<b>Ref. No.</b> —
	thermocouple M8x1 L 320mm M8x1		
	<b>GEV No.</b>	110149	<b>Ref. No.</b> PT0114
	knob gas tap without ignition flame t.max.°C temperature range°C ø 50mm shaft ø 6x4.6mm shaft flat right black		

<sup>1</sup>incl. thermocouple and knob

### MP

gas taps

			
1			
<b>GEV No.</b>	107775	<b>Ref. No.</b>	G1302
<b>description</b>	gas tap MP type 7KPa with nozzle outlet (with nozzle) gas inlet pipe flange ø23mm bypass nozzle ømm gas outlet ø 18mm external nozzle ø 1.03mm thermocouple connection M8x1 shaft ø 8x5mm shaft L 28/13mm shaft flat left		
<b>For models:</b>	263010, 263011, 263012, 263013, 263024, 263025, 263026		

### miscellaneous

			
1			
<b>GEV No.</b>	103139	<b>Ref. No.</b>	G2204
<b>description</b>	gas tap gas inlet 1/4" left bypass nozzle ømm gas outlet M10x1 external nozzle ø 1.2mm pilot connection thermocouple connection M8x1 shaft ø 5.5x7mm shaft L 16/8.5mm shaft flat upper		
<b>For models:</b>	225008, 247002		



gas thermostats

SIT





630 Eurosit series

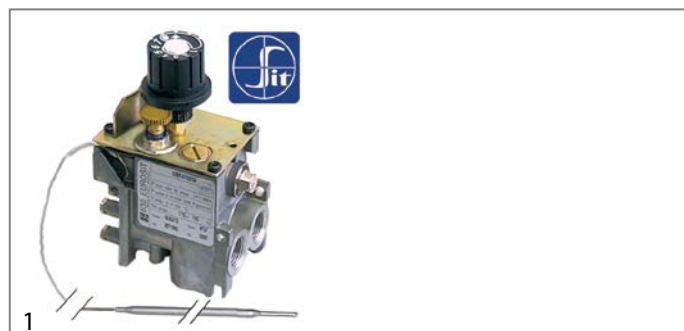

<b>GEV No.</b>	107688	<b>Ref. No.</b>	CR0585671
<b>description</b>	gas thermostat 100-340°C gas inlet 3/8" gas outlet 3/8" thermocouple connection M9x1 pilot connection M10x1 probe ø 4mm probe L 72mm capillary pipe 1050mm		
<b>For models:</b>	141006, 141009, 141010, 143005, 143006, 143007, 143008, 143009, 143010		



<b>GEV No.</b>	101188	<b>Ref. No.</b>	8219900 MACM097000
<b>description</b>	gas thermostat type 630 Eurosit series t.max. 190°C 110-190°C gas inlet 3/8" gas outlet 3/8" thermocouple connection M9x1 pilot connection M10x1 probe ø 4mm probe L 202mm capillary pipe 1050mm SIT		
<b>For models:</b>	144002		



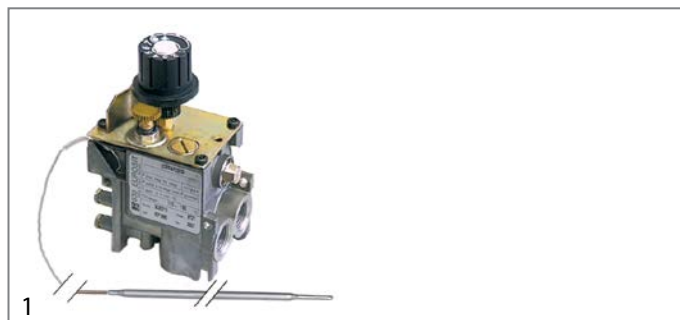

<b>accessories for</b>	101188			
	<b>GEV No.</b>	100904	<b>Ref. No.</b>	1394700 6A011608 MA1394700
	locking screw M10x1 for pipe ø 4mm Qty 1 pcs			
	<b>GEV No.</b>	100905	<b>Ref. No.</b>	—
	locking screw M10x1 for pipe ø 6mm Qty 1 pcs			
	<b>GEV No.</b>	101273	<b>Ref. No.</b>	6A011625 MA417810
	olive for pipe ø 12mm L 9.5mm brass Qty 1 pcs suitable for universal			
	<b>GEV No.</b>	101276	<b>Ref. No.</b>	459300 6A011620 MA459300
	union screw thread 3/8" tube ø 12mm Qty 1 pcs			
	<b>GEV No.</b>	101333	<b>Ref. No.</b>	1888200 8219951 MA1888200
	plug thread 3/8" with O-ring			

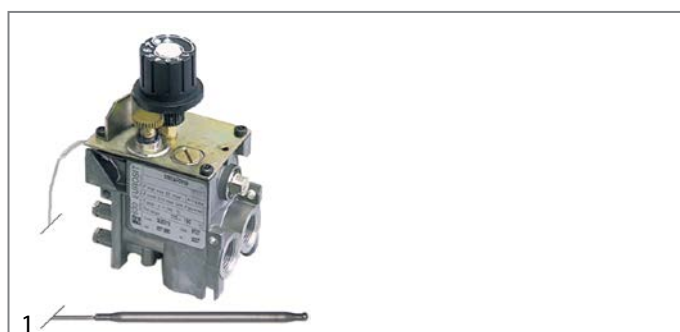











<b>GEV No.</b>	103076	<b>Ref. No.</b>	CR0508680
<b>description</b>	gas thermostat type 630 Eurosit series t.max. 190°C 110-190°C gas inlet 3/8" gas outlet 3/8" thermocouple connection M9x1 pilot connection M10x1 probe ø 4mm probe L 202mm capillary pipe 1050mm SIT		
<b>For models:</b>	124103		



<b>GEV No.</b>	101409	<b>Ref. No.</b>	1031504800
<b>description</b>	gas thermostat type 630 Eurosit series t.max. 280°C 40-280°C gas inlet 3/8" gas outlet 3/8" thermocouple connection M9x1 pilot connection M10x1 probe ø 4mm probe L 72mm capillary pipe 1050mm SIT		

<b>spare parts for</b>	101409			
	<b>GEV No.</b>	101333	<b>Ref. No.</b>	1888200 8219951 MA1888200
	plug thread 3/8" with O-ring			
<b>accessories for</b>	101409			
	<b>GEV No.</b>	100904	<b>Ref. No.</b>	1394700 6A011608 MA1394700
	locking screw M10x1 for pipe ø 4mm Qty 1 pcs			
	<b>GEV No.</b>	100905	<b>Ref. No.</b>	—
	locking screw M10x1 for pipe ø 6mm Qty 1 pcs			
	<b>GEV No.</b>	101273	<b>Ref. No.</b>	6A011625 MA417810
	olive for pipe ø 12mm L 9.5mm brass Qty 1 pcs suitable for universal			
	<b>GEV No.</b>	101276	<b>Ref. No.</b>	459300 6A011620 MA459300
	union screw thread 3/8" tube ø 12mm Qty 1 pcs			

			
1			
<b>GEV No.</b>	101915	<b>Ref. No.</b>	41826920012
<b>description</b>	gas thermostat type 630 Eurosit series t.max. 320°C 80-320°C gas inlet 3/8" gas outlet 3/8" thermocouple connection M9x1 pilot connection M10x1 probe ø 4mm probe L 72mm capillary pipe 1050mm SIT		
<b>For models:</b>	131003, 131005, 131201, 131202, 131203, 131204, 131205, 131206, 131210, 132201, 132202, 133001, 133002, 133003, 133009, 133010, 133011, 133012, 133013, 133014, 133015, 133024, 133201, 133202, 133203, 133209, 133210, 133211, 133212, 133213, 133214, 133215, 133224		
<b>accessories for</b>	101915		
	<b>GEV No.</b>	100825	<b>Ref. No.</b> —
	gas tap spindle shaft ø 8x6.5mm shaft L 22/14mm suitable for EUROSIT		
	<b>GEV No.</b>	100904	<b>Ref. No.</b> 1394700 6A011608 MA1394700
	locking screw M10x1 for pipe ø 4mm Qty 1 pcs		
	<b>GEV No.</b>	100905	<b>Ref. No.</b> —
	locking screw M10x1 for pipe ø 6mm Qty 1 pcs		
	<b>GEV No.</b>	100949	<b>Ref. No.</b> —
	gasket suitable for 630 Eurosit series		
	<b>GEV No.</b>	101273	<b>Ref. No.</b> 6A011625 MA417810
	olive for pipe ø 12mm L 9.5mm brass Qty 1 pcs suitable for universal		
	<b>GEV No.</b>	101276	<b>Ref. No.</b> 459300 6A011620 MA459300
	union screw thread 3/8" tube ø 12mm Qty 1 pcs		
	<b>GEV No.</b>	101333	<b>Ref. No.</b> 1888200 8219951 MA1888200
	plug thread 3/8" with O-ring		
	<b>GEV No.</b>	101390	<b>Ref. No.</b> —
	gas tap spindle shaft ø 6x4.6mm shaft L 32/15mm gas tap with ignition flame suitable for ZANUSSI, MARENO for gas thermostat EUROSIT		
	<b>GEV No.</b>	101392	<b>Ref. No.</b> 41824710060 824710060
	adapter suitable for 630 Eurosit series		
	<b>GEV No.</b>	110357	<b>Ref. No.</b> 41822160011 822160011
	gas tap spindle shaft ø 8x6.5mm shaft L 36/12mm suitable for 630 Eurosit series		
	<b>GEV No.</b>	110358	<b>Ref. No.</b> —
	adapter shaft ø 10x8mm shaft L 29/18mm suitable for 630 Eurosit series		

			
1			
<b>GEV No.</b>	101125	<b>Ref. No.</b>	1887600 826920010
<b>description</b>	gas thermostat type 630 Eurosit series t.max. 340°C 100-340°C gas inlet 3/8" gas outlet 3/8" thermocouple connection M9x1 pilot connection M10x1 probe ø 4mm probe L 72mm capillary pipe 1050mm SIT		
<b>For models:</b>	133001, 133002, 133003, 133009, 133010, 133011, 133012, 133013, 133014, 133015, 133024, 133203, 133209, 133210, 133211, 133212, 133213, 133214, 133215		
<b>accessories for</b>	101125		
	<b>GEV No.</b>	100825	<b>Ref. No.</b> —
	gas tap spindle shaft ø 8x6.5mm shaft L 22/14mm suitable for EUROSIT		
	<b>GEV No.</b>	100904	<b>Ref. No.</b> 1394700 6A011608 MA1394700
	locking screw M10x1 for pipe ø 4mm Qty 1 pcs		
	<b>GEV No.</b>	100905	<b>Ref. No.</b> —
	locking screw M10x1 for pipe ø 6mm Qty 1 pcs		
	<b>GEV No.</b>	100949	<b>Ref. No.</b> —
	gasket suitable for 630 Eurosit series		
	<b>GEV No.</b>	101273	<b>Ref. No.</b> 6A011625 MA417810
	olive for pipe ø 12mm L 9.5mm brass Qty 1 pcs suitable for universal		
	<b>GEV No.</b>	101276	<b>Ref. No.</b> 459300 6A011620 MA459300
	union screw thread 3/8" tube ø 12mm Qty 1 pcs		
	<b>GEV No.</b>	101333	<b>Ref. No.</b> 1888200 8219951 MA1888200
	plug thread 3/8" with O-ring		
	<b>GEV No.</b>	101390	<b>Ref. No.</b> —
	gas tap spindle shaft ø 6x4.6mm shaft L 32/15mm gas tap with ignition flame suitable for ZANUSSI, MARENO for gas thermostat EUROSIT		
	<b>GEV No.</b>	101392	<b>Ref. No.</b> 41824710060 824710060
	adapter suitable for 630 Eurosit series		
	<b>GEV No.</b>	110357	<b>Ref. No.</b> 41822160011 822160011
	gas tap spindle shaft ø 8x6.5mm shaft L 36/12mm suitable for 630 Eurosit series		
	<b>GEV No.</b>	110358	<b>Ref. No.</b> —
	adapter shaft ø 10x8mm shaft L 29/18mm suitable for 630 Eurosit series		



PEL

25ST series



1

<b>GEV No.</b>	107470	<b>Ref. No.</b>	CR0933740
<b>description</b>	gas thermostat PEL type 25ST 90-250°C gas inlet M16x1.5 (tube ø 10mm) bypass nozzle ø 1mm gas outlet M16x1.5 (tube ø 10/8mm) thermocouple connection M8x1 pilot connection M10x1 capillary pipe 1200mm probe ø 6mm probe L 120mm shaft ø 8x6.5mm shaft L 26/15mm shaft flat upper		
<b>For models:</b>	123104, 123107, 123109		







1

<b>GEV No.</b>	107515	<b>Ref. No.</b>	CR0933730
<b>description</b>	gas thermostat PEL type 25ST up to 280°C gas inlet M16x1.5 (tube ø 10mm) bypass nozzle ø 1mm gas outlet M16x1.5 (tube ø 10/8mm) thermocouple connection M8x1 pilot connection M10x1 capillary pipe 1200mm probe ø 6mm probe L 120mm shaft ø 8x6.5mm shaft L 26/15mm shaft flat upper		
<b>For models:</b>	123103, 123106, 123108, 123117		

SABAF



1

<b>GEV No.</b>	101687	<b>Ref. No.</b>	CO2279	
<b>description</b>	gas thermostat SABAF t.max. 300°C gas inlet pipe flange ø16mm bypass nozzle ø 0.37mm gas outlet M13x1 IT (tube ø 8mm) gas outlet 2 thermocouple connection M8x1 pilot connection capillary pipe 850mm probe ø 4mm probe L 140mm shaft ø 8x6.5mm shaft L 17/12mm shaft flat lower			
<b>For models:</b>	223003			
<b>accessories for</b>	101687			
	<b>GEV No.</b>	101277	<b>Ref. No.</b>	404000204 404000263 PT0010
	olive ID ø 8mm Qty 1 pcs			
	<b>GEV No.</b>	101376	<b>Ref. No.</b>	—
	gasket ID ø 8mm ED ø 12mm H 3/5mm			
	<b>GEV No.</b>	101477	<b>Ref. No.</b>	—
	union screw thread M13x1 tube ø 8mm Qty 1 pcs			
	<b>GEV No.</b>	101751	<b>Ref. No.</b>	—
	bracket			



1

<b>GEV No.</b>	101173	<b>Ref. No.</b>	1699400	
<b>description</b>	gas thermostat SABAF type SABAF t.max. 300°C gas inlet M13x1 ET (tube ø 8mm) bypass nozzle ø 0.8mm gas outlet 3/8" ET (tube ø 10mm) gas outlet 2 thermocouple connection M8x1 pilot connection capillary pipe 850mm probe ø 4mm probe L 140mm shaft ø 6x4.6mm shaft L 37/15mm shaft flat lower			
<b>spare parts for</b>	101173			
	<b>GEV No.</b>	101060	<b>Ref. No.</b>	GS8036P
	magnet unit standard L 39mm D1 ø 15.4mm D2 ø 11mm suitable for PEL20-21/JUNKERS/EGA			
<b>accessories for</b>	101173			
	<b>GEV No.</b>	101277	<b>Ref. No.</b>	404000204 404000263 PT0010
	olive ID ø 8mm Qty 1 pcs			
	<b>GEV No.</b>	101278	<b>Ref. No.</b>	6A011480 MA86720
	olive for pipe ø 10mm Qty 1 pcs			
	<b>GEV No.</b>	101474	<b>Ref. No.</b>	—
	air mixing tube for pilot burner			
	<b>GEV No.</b>	101476	<b>Ref. No.</b>	1665300 MA1665300
	union nut thread M13x1 for pipe ø 8mm			
	<b>GEV No.</b>	101478	<b>Ref. No.</b>	1665200 MA1665200
	union nut thread 3/8" for pipe ø 10mm			
	<b>GEV No.</b>	110361	<b>Ref. No.</b>	—
	knob without symbol ø 65mm shaft ø 6x4.6mm shaft flat lower black			
	<b>GEV No.</b>	110603	<b>Ref. No.</b>	—
	knob dial plate gas thermostat t.max. 300°C 90-300°C			



## gas valves and ignition boxes







## gas control valves

SIT

NOVASIT













1



GEV No.	101187	Ref. No.	826920090
<b>description</b>	gas valve SIT series Novasit 820 0.17VHz gas inlet 1/2" gas outlet 1/2" thermocouple connection M9x1 pilot connection M10x1 ignition pressurebar pressure range 5-50mbar pressure regulator connection blind equiv. no. 0.820.301 supply Operator millivolt		
<b>For models:</b>	137002, 137202		
<b>spare parts for</b>	101187		
	GEV No.	101065	Ref. No. —
magnet unit with cable L 44mm D1 ø 30mm D2 ø 20mm suitable for NOVASIT			
<b>accessories for</b>	101187		
	GEV No.	100110	Ref. No. 826920110
pilot burner SIT type 190 series 3 flames nozzle ømm gas connectionmm			
	GEV No.	101305	Ref. No. —
gas connection straight 1/2" flange 45x45mm ELETTROSIT/V4400/4600/4605 suitable for SIT/HONEYWELL hole distance 36x36mm			
	GEV No.	101306	Ref. No. MA2865800
gas connection angled flange 45x45mm hole distance 36x36mm 1/2" ELETTROSIT/V4400/4600/4605 screw with O-ring suitable for SIT/HONEYWELL			
	GEV No.	101307	Ref. No. —
gas connection straight flange 45x45mm hole distance 36x36mm 3/4" ELETTROSIT/V4400/4600/4605 screw with O-ring suitable for SIT/HONEYWELL			
	GEV No.	101308	Ref. No. —
gas connection angled flange 45x45mm hole distance 36x36mm 3/4" ELETTROSIT/V4400/4600/4605 screw with O-ring suitable for SIT/HONEYWELL			
	GEV No.	102116	Ref. No. 826920100
thermopile ROBERTSHAW L 900mm probe ø 9mm probe L 57mm 250-750mV screw connection 7/16"			





1







GEV No.	101908	Ref. No.	A050010 MA1871200
<b>description</b>	gas valve SIT series Novasit 820 230V 50Hz gas inlet 1/2" gas outlet 1/2" thermocouple connection M9x1 pilot connection M10x1 ignition pressurebar pressure regulator connection blind equiv. no. 0.820.018 output pilot burner M10x1 input pressure max. 60bar setting range 3-30bar		
<b>For models:</b>	146002, 147003		
<b>spare parts for</b>	101908		
	GEV No.	101065	Ref. No. —
magnet unit with cable L 44mm D1 ø 30mm D2 ø 20mm suitable for NOVASIT			
	GEV No.	101313	Ref. No. —
solenoid coil 230V 50Hz			
<b>accessories for</b>	101908		
	GEV No.	100006	Ref. No. —
piezoelectric igniter suitable for ELETTROSIT body plastic blowing connection ø2.4mm ø 14mm			
	GEV No.	101305	Ref. No. —
gas connection straight 1/2" flange 45x45mm ELETTROSIT/V4400/4600/4605 suitable for SIT/HONEYWELL hole distance 36x36mm			
	GEV No.	101306	Ref. No. MA2865800
gas connection angled flange 45x45mm hole distance 36x36mm 1/2" ELETTROSIT/V4400/4600/4605 screw with O-ring suitable for SIT/HONEYWELL			
	GEV No.	101307	Ref. No. —
gas connection straight flange 45x45mm hole distance 36x36mm 3/4" ELETTROSIT/V4400/4600/4605 screw with O-ring suitable for SIT/HONEYWELL			
	GEV No.	101308	Ref. No. —
gas connection angled flange 45x45mm hole distance 36x36mm 3/4" ELETTROSIT/V4400/4600/4605 screw with O-ring suitable for SIT/HONEYWELL			
	GEV No.	101312	Ref. No. A050003
microswitch			
	GEV No.	101314	Ref. No. —
solenoid coil 24V 50Hz			
	GEV No.	101317	Ref. No. —
plug with cable L 1000mm suitable for NOVASIT			
	GEV No.	101318	Ref. No. —
cover cap for solenoid coil suitable for NOVASIT			



accessories			
 <p>1</p>			
<b>GEV No.</b>	101306	<b>Ref. No.</b>	MA2865800
<b>description</b>	gas connection angled flange 45x45mm hole distance 36x36mm 1/2" ELETTROSIT/V4400/4600/4605 screw with O-ring suitable for SIT/HONEYWELL		
<b>For models:</b>	146002		
<b>spare parts for</b>	101306		
 <p>O-ring EPDM thickness 2.62mm ID ø 31.42mm Qty 1 pcs</p>			

 <p>1</p>			
<b>GEV No.</b>	101674	<b>Ref. No.</b>	824710350
<b>description</b>	knob extension L 57mm NOVA 822/826/827		
<b>For models:</b>	137002, 137202		



 <p>1</p>			
<b>GEV No.</b>	101312	<b>Ref. No.</b>	A050003
<b>description</b>	microswitch		

 <p>1</p>			
<b>GEV No.</b>	100110	<b>Ref. No.</b>	826920110
<b>description</b>	pilot burner SIT type 190 series 3 flames nozzle ømm gas connectionmm		
<b>For models:</b>	137002, 137202		
<b>accessories for</b>	100110		
 <p>GEV No. 100202 Ref. No. — pilot burner nozzle natural gas code 41 Qty 1 pcs nozzle ø 0.41mm</p>			
 <p>GEV No. 100203 Ref. No. 822140370 pilot burner nozzle LPG code 25 Qty 1 pcs nozzle ø 0.25mm</p>			
 <p>GEV No. 100701 Ref. No. 1949900 826650010 MA1888300 MA1949900 ignition electrode connection M4 Qty 1 pcs</p>			
 <p>GEV No. 100906 Ref. No. 6A011707 MA1888400 screw connection thread M10x1 for ignition electrode brass Qty 1 pcs WS 10</p>			
 <p>GEV No. 100907 Ref. No. MA1891700 screw connection thread M10x1 Qty 1 pcs type SEF 1 ømm for thermocouple</p>			
 <p>GEV No. 100908 Ref. No. 41822450110 6A016110 6A017000 822450040 822450110 BN6A017000 MA673500 union screw thread M10x1 for pipe ø 4mm Qty 1 pcs</p>			

accessories for 100110			
 <p>GEV No. 100909 Ref. No. 822450450 union screw thread M10x1 for pipe ø 6mm Qty 1 pcs</p>			
 <p>GEV No. 101282 Ref. No. MA469000 olive for pipe ø 4mm L 7.4mm Qty 1 pcs</p>			
 <p>GEV No. 101287 Ref. No. — olive for pipe ø 6mm Qty 1 pcs</p>			
 <p>GEV No. 102110 Ref. No. — pilot tube copper pipe ø 4mm thickness 1mm L 3000mm</p>			
 <p>GEV No. 102111 Ref. No. — pilot tube copper pipe ø 6mm thickness 1mm L 3000mm</p>			
 <p>GEV No. 107650 Ref. No. 822140360 pilot burner nozzle SIT LPG code 30 Qty 1 pcs</p>			

safety valves

SIT 440 series

 <p>1</p>			
<b>GEV No.</b>	101101	<b>Ref. No.</b>	GS3713
<b>description</b>	gas valve pressure range 50mbar gas inlet 3/4" gas outlet 3/4" pilot connection M10x1 (tube ø 6mm) thermocouple connection M9x1 type SIT D3		
<b>For models:</b>	233001		
<b>accessories for</b>	101101		
 <p>GEV No. 100904 Ref. No. 1394700 6A011608 MA1394700 locking screw M10x1 for pipe ø 4mm Qty 1 pcs</p>			
 <p>GEV No. 100905 Ref. No. — locking screw M10x1 for pipe ø 6mm Qty 1 pcs</p>			

miscellaneous



<b>GEV No.</b>	103138	<b>Ref. No.</b>	37002
<b>description</b>	gas valve gas inlet 1/4" left		
<b>For models:</b>	225008, 247002		

<b>accessories for</b>	106906			
	<b>GEV No.</b>	100246	<b>Ref. No.</b>	GS3828 SP385C
	pilot burner nozzle natural gas bore ø 0.35mm Qty 1 pcs thread M8x0.75			
	<b>GEV No.</b>	100904	<b>Ref. No.</b>	1394700 6A011608 MA1394700
	locking screw M10x1 for pipe ø 4mm Qty 1 pcs			
	<b>GEV No.</b>	100905	<b>Ref. No.</b>	—
	locking screw M10x1 for pipe ø 6mm Qty 1 pcs			
	<b>GEV No.</b>	102110	<b>Ref. No.</b>	—
	pilot tube copper pipe ø 4mm thickness 1mm L 3000mm			
	<b>GEV No.</b>	102111	<b>Ref. No.</b>	—
	pilot tube copper pipe ø 6mm thickness 1mm L 3000mm			
	<b>GEV No.</b>	107171	<b>Ref. No.</b>	—
	pilot burner nozzle SIT natural/liquid gas bore ø 0.25mm Qty 1 pcs			
	<b>GEV No.</b>	107700	<b>Ref. No.</b>	—
	pilot burner bottom part SIT 100 series nozzle ø 0.25mm			
	<b>GEV No.</b>	107702	<b>Ref. No.</b>	—
	pilot burner bottom part SIT 100 series nozzle ø 0.35mm			

ignition parts









pilot burners

SIT

100 series



<b>GEV No.</b>	106906	<b>Ref. No.</b>	GS3851
<b>description</b>	pilot burner SIT type 100 series 3 flames nozzle ø 0.2mm gas connection 6mm		
<b>For models:</b>	231005, 231006, 231007, 231008, 233002, 233003, 234003, 234004, 234006, 235001		

<b>spare parts for</b>	106906			
	<b>GEV No.</b>	100245	<b>Ref. No.</b>	GC1001
	pilot burner nozzle LPG code 20 bore ø 0.2mm Qty 1 pcs thread M8x0.75			
	<b>GEV No.</b>	100855	<b>Ref. No.</b>	GS8042P
	pilot burner bracket triple			
	<b>GEV No.</b>	100885	<b>Ref. No.</b>	BN6A013104
	air mixing sleeve for pilot burner Qty 1 pcs			
	<b>GEV No.</b>	100916	<b>Ref. No.</b>	—
	compression spring for pilot burner Qty 1 pcs			
	<b>GEV No.</b>	100917	<b>Ref. No.</b>	—
	gasket for pilot burner Qty 1 pcs aluminium			
	<b>GEV No.</b>	100918	<b>Ref. No.</b>	—
	screw for pilot burner			
	<b>GEV No.</b>	107162	<b>Ref. No.</b>	—
	pilot burner cap SIT 3 flames Hmm Lmm Qty 1 pcs			
	<b>GEV No.</b>	107701	<b>Ref. No.</b>	SP385B
	pilot burner bottom part SIT 100 series nozzle ø 0.2mm			
<b>accessories for</b>	106906			
	<b>GEV No.</b>	100245	<b>Ref. No.</b>	GC1001
	pilot burner nozzle LPG code 20 bore ø 0.2mm Qty 1 pcs thread M8x0.75			

accessories

pilot burner caps



<b>GEV No.</b>	107161	<b>Ref. No.</b>	SP385A
<b>description</b>	pilot burner cap SIT 2 flames Hmm Lmm Qty 1 pcs		
<b>For models:</b>	234003, 234004, 234006		

pilot burner bottom parts





<b>GEV No.</b>	107701	<b>Ref. No.</b>	SP385B	
<b>description</b>	pilot burner bottom part SIT 100 series nozzle ø 0.2mm			
<b>For models:</b>	234003, 234004, 234006			
<b>spare parts for</b>	107701			
	<b>GEV No.</b>	100245	<b>Ref. No.</b>	GC1001
	pilot burner nozzle LPG code 20 bore ø 0.2mm Qty 1 pcs thread M8x0.75			
	<b>GEV No.</b>	100916	<b>Ref. No.</b>	—
	compression spring for pilot burner Qty 1 pcs			

Table continues overleaf









<b>spare parts for</b> 107701				
	<b>GEV No.</b>	100917	<b>Ref. No.</b>	—
gasket for pilot burner Qty 1 pcs aluminium				
	<b>GEV No.</b>	100918	<b>Ref. No.</b>	—
screw for pilot burner				
<b>accessories for</b> 107701				
	<b>GEV No.</b>	100246	<b>Ref. No.</b>	GS3828 SP385C
pilot burner nozzle natural gas bore $\varnothing$ 0.35mm Qty 1 pcs thread M8x0.75				
	<b>GEV No.</b>	100904	<b>Ref. No.</b>	1394700 6A011608 MA1394700
locking screw M10x1 for pipe $\varnothing$ 4mm Qty 1 pcs				
	<b>GEV No.</b>	100905	<b>Ref. No.</b>	—
locking screw M10x1 for pipe $\varnothing$ 6mm Qty 1 pcs				
	<b>GEV No.</b>	102110	<b>Ref. No.</b>	—
pilot tube copper pipe $\varnothing$ 4mm thickness 1mm L 3000mm				
	<b>GEV No.</b>	102111	<b>Ref. No.</b>	—
pilot tube copper pipe $\varnothing$ 6mm thickness 1mm L 3000mm				
	<b>GEV No.</b>	102742	<b>Ref. No.</b>	—
pilot burner nozzle LPG code 25 bore $\varnothing$ 0.25mm Qty 1 pcs				

pilot burner brackets

universal

	1			
<b>GEV No.</b>	100855	<b>Ref. No.</b>	GS8042P	
<b>description</b>	pilot burner bracket triple			
<b>For models:</b>	234003, 234004, 234006			
<b>accessories for</b> 100855				
	<b>GEV No.</b>	100855	<b>Ref. No.</b>	GS8042P
pilot burner bracket triple				
	<b>GEV No.</b>	100886	<b>Ref. No.</b>	—
pilot burner bracket suitable for 100 series 3-piece				
	<b>GEV No.</b>	100888	<b>Ref. No.</b>	—
screw bolt for pilot burner				

pilot burner nozzles

	1			
<b>GEV No.</b>	100245	<b>Ref. No.</b>	GC1001	
<b>description</b>	pilot burner nozzle LPG code 20 bore $\varnothing$ 0.2mm Qty 1 pcs thread M8x0.75			

	1			
<b>GEV No.</b>	100246	<b>Ref. No.</b>	GS3828 SP385C	
<b>description</b>	pilot burner nozzle natural gas bore $\varnothing$ 0.35mm Qty 1 pcs thread M8x0.75			
<b>For models:</b>	234003, 234004, 234006			

ignition electrodes

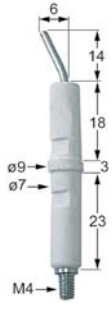
	1			
<b>GEV No.</b>	100706	<b>Ref. No.</b>	636700 853310150 GS3856 MA636700	
<b>description</b>	ignition electrode connection M4 Qty 1 pcs			
<b>For models:</b>	123103, 123104, 123106, 123107, 123108, 123109, 123117, 136001, 136201, 234003, 234004, 234006			

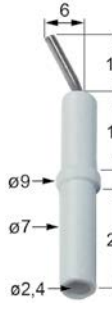
	1			
<b>GEV No.</b>	100707	<b>Ref. No.</b>	6A013302 BN6A013302	
<b>description</b>	ignition electrode D1 $\varnothing$ 7mm D2 $\varnothing$ 9mm connection $\varnothing$ 2.4mm L1 14mm L2 6mm BL1 18mm BL2 3mm BL3 23mm to clip Qty 1 pcs			
<b>For models:</b>	133007, 133008, 133022, 133023, 133207, 133208, 133222, 133223, 134002, 134004, 134006, 134202, 134204, 134206, 136001, 136005, 136006, 136205, 136206, 137002, 137202, 143033, 143034, 144002, 146008, 146009			

miscellaneous

	1			
<b>GEV No.</b>	100885	<b>Ref. No.</b>	BN6A013104	
<b>description</b>	air mixing sleeve for pilot burner Qty 1 pcs			
<b>For models:</b>	141001, 141002, 141003, 141004, 141005, 141006, 141007, 141009, 141010			



140 - 145 -150 series



<b>GEV No.</b>	106943 <sup>1</sup>	<b>Ref. No.</b>	MA1887700
<b>description</b>	pilot burner SIT type 140 series 1 flame nozzle 0mm gas connectionmm		
<b>For models:</b>	121101, 121102, 121105, 121106, 122101, 122102, 123101, 123102		
<b>spare parts for</b>	106943		
	<b>GEV No.</b>	100907	<b>Ref. No.</b> MA1891700
	screw connection thread M10x1 Qty 1 pcs type SEF 1 0mm for thermocouple		







<sup>1</sup>incl. thermocouple fitting



<b>GEV No.</b>	107131	<b>Ref. No.</b>	41826920070
<b>description</b>	pilot burner SIT type 140 series 2 flames nozzle 0mm gas connectionmm		
<b>For models:</b>	131003, 131005, 131201, 131202, 131203, 131204, 131205, 131206, 131210, 132201, 132202		
<b>spare parts for</b>	107131		
	<b>GEV No.</b>	100907	<b>Ref. No.</b> MA1891700
	screw connection thread M10x1 Qty 1 pcs type SEF 1 0mm for thermocouple		
<b>accessories for</b>	107131		
	<b>GEV No.</b>	100204	<b>Ref. No.</b> MA1888000
	pilot burner nozzle SIT LPG code 14 bore 0.18/0.20mm Qty 1 pcs suitable for 140 series		
	<b>GEV No.</b>	100205	<b>Ref. No.</b> 41822140380 822140380 BN822140380
	pilot burner nozzle SIT LPG code 19 bore 0.23/0.26mm Qty 1 pcs suitable for SIT 150 series		
	<b>GEV No.</b>	100206	<b>Ref. No.</b> —
	pilot burner nozzle SIT natural gas code 36 bore 0.60/0.55mm Qty 1 pcs suitable for SIT 150 series		
	<b>GEV No.</b>	100207	<b>Ref. No.</b> 6A013107 822140120 MA1887800
	pilot burner nozzle SIT natural gas code 27 bore 0.40/0.38mm suitable for SIT 140 series		
	<b>GEV No.</b>	100216	<b>Ref. No.</b> —
	pilot burner nozzle SIT natural gas code 38 bore 0.45mm Qty 1 pcs suitable for SIT 150 series		
	<b>GEV No.</b>	100701	<b>Ref. No.</b> 1949900 826650010 MA1888300 MA1949900
	ignition electrode connection M4 Qty 1 pcs		
	<b>GEV No.</b>	100803	<b>Ref. No.</b> —
	gasket for pilot burner Qty 1 pcs		









<b>accessories for</b>	107131		
	<b>GEV No.</b>	100897	<b>Ref. No.</b> 1888100 822450050 MA1888100
	olive for pipe 04mm Qty 1 pcs for pilot burner		
	<b>GEV No.</b>	100898	<b>Ref. No.</b> 822450470
	olive for pipe 06mm Qty 1 pcs for pilot burner		
	<b>GEV No.</b>	100906	<b>Ref. No.</b> 6A011707 MA1888400
	screw connection thread M10x1 for ignition electrode brass Qty 1 pcs WS 10		
	<b>GEV No.</b>	100908	<b>Ref. No.</b> 41822450110 6A016110 6A017000 822450040 822450110 BN6A017000 MA673500
	union screw thread M10x1 for pipe 04mm Qty 1 pcs		
	<b>GEV No.</b>	100909	<b>Ref. No.</b> 822450450
	union screw thread M10x1 for pipe 06mm Qty 1 pcs		







<b>GEV No.</b>	107114 <sup>1</sup>	<b>Ref. No.</b>	4182690030 826920030 MACM029000
<b>description</b>	pilot burner SIT type 140 series 2 flames nozzle 0mm gas connectionmm		
<b>For models:</b>	133001, 133002, 133003, 133009, 133010, 133011, 133012, 133013, 133014, 133015, 133024, 133201, 133202, 133203, 133209, 133210, 133211, 133212, 133213, 133214, 133215, 133224, 141021, 147003		
<b>spare parts for</b>	107114		
	<b>GEV No.</b>	100907	<b>Ref. No.</b> MA1891700
	screw connection thread M10x1 Qty 1 pcs type SEF 1 0mm for thermocouple		
<b>accessories for</b>	107114		
	<b>GEV No.</b>	100204	<b>Ref. No.</b> MA1888000
	pilot burner nozzle SIT LPG code 14 bore 0.18/0.20mm Qty 1 pcs suitable for 140 series		
	<b>GEV No.</b>	100205	<b>Ref. No.</b> 41822140380 822140380 BN822140380
	pilot burner nozzle SIT LPG code 19 bore 0.23/0.26mm Qty 1 pcs suitable for SIT 150 series		
	<b>GEV No.</b>	100206	<b>Ref. No.</b> —
	pilot burner nozzle SIT natural gas code 36 bore 0.60/0.55mm Qty 1 pcs suitable for SIT 150 series		
	<b>GEV No.</b>	100207	<b>Ref. No.</b> 6A013107 822140120 MA1887800
	pilot burner nozzle SIT natural gas code 27 bore 0.40/0.38mm suitable for SIT 140 series		
	<b>GEV No.</b>	100216	<b>Ref. No.</b> —
	pilot burner nozzle SIT natural gas code 38 bore 0.45mm Qty 1 pcs suitable for SIT 150 series		
	<b>GEV No.</b>	100701	<b>Ref. No.</b> 1949900 826650010 MA1888300 MA1949900
	ignition electrode connection M4 Qty 1 pcs		





<sup>1</sup>incl. thermocouple fitting  
Table continues overleaf



<b>accessories for</b>	107114			
	GEV No.	100801	Ref. No.	—
gasket for pilot burner Qty 1 pcs				
	GEV No.	100897	Ref. No.	1888100 822450050 MA1888100
olive for pipe ø 4mm Qty 1 pcs for pilot burner				
	GEV No.	100898	Ref. No.	822450470
olive for pipe ø 6mm Qty 1 pcs for pilot burner				
	GEV No.	100906	Ref. No.	6A011707 MA1888400
screw connection thread M10x1 for ignition electrode brass Qty 1 pcs WS 10				
	GEV No.	100908	Ref. No.	41822450110 6A016110 6A017000 822450040 822450110 BN6A017000 MA673500
union screw thread M10x1 for pipe ø 4mm Qty 1 pcs				
	GEV No.	100909	Ref. No.	822450450
union screw thread M10x1 for pipe ø 6mm Qty 1 pcs				
	GEV No.	102110	Ref. No.	—
pilot tube copper pipe ø 4mm thickness 1mm L 3000mm				
	GEV No.	102111	Ref. No.	—
pilot tube copper pipe ø 6mm thickness 1mm L 3000mm				













<b>GEV No.</b>	107132	<b>Ref. No.</b>	1887700
<b>description</b>	pilot burner SIT type 140 series 2 flames nozzle ømm gas connecti-onmm		
<b>accessories for</b>	107132		
	GEV No.	100204	Ref. No. MA1888000
pilot burner nozzle SIT LPG code 14 bore ø 0.18/0.20mm Qty 1 pcs suitable for 140 series			
	GEV No.	100205	Ref. No. 41822140380 822140380 BN822140380
pilot burner nozzle SIT LPG code 19 bore ø 0.23/0.26mm Qty 1 pcs suitable for SIT 150 series			
	GEV No.	100206	Ref. No. —
pilot burner nozzle SIT natural gas code 36 bore ø 0.60/0.55mm Qty 1 pcs suitable for SIT 150 series			
	GEV No.	100207	Ref. No. 6A013107 822140120 MA1887800
pilot burner nozzle SIT natural gas code 27 bore ø 0.40/0.38mm suitable for SIT 140 series			
	GEV No.	100216	Ref. No. —
pilot burner nozzle SIT natural gas code 38 bore ø 0.45mm Qty 1 pcs suitable for SIT 150 series			

<b>accessories for</b>	107132			
	GEV No.	100701	Ref. No.	1949900 826650010 MA1888300 MA1949900
ignition electrode connection M4 Qty 1 pcs				
	GEV No.	100897	Ref. No.	1888100 822450050 MA1888100
olive for pipe ø 4mm Qty 1 pcs for pilot burner				
	GEV No.	100898	Ref. No.	822450470
olive for pipe ø 6mm Qty 1 pcs for pilot burner				
	GEV No.	100906	Ref. No.	6A011707 MA1888400
screw connection thread M10x1 for ignition electrode brass Qty 1 pcs WS 10				
	GEV No.	100907	Ref. No.	MA1891700
screw connection thread M10x1 Qty 1 pcs type SEF 1 ømm for thermocouple				
	GEV No.	100908	Ref. No.	41822450110 6A016110 6A017000 822450040 822450110 BN6A017000 MA673500
union screw thread M10x1 for pipe ø 4mm Qty 1 pcs				
	GEV No.	100909	Ref. No.	822450450
union screw thread M10x1 for pipe ø 6mm Qty 1 pcs				
	GEV No.	102110	Ref. No.	—
pilot tube copper pipe ø 4mm thickness 1mm L 3000mm				
	GEV No.	102111	Ref. No.	—
pilot tube copper pipe ø 6mm thickness 1mm L 3000mm				

160 series



	1		
<b>GEV No.</b>	100109	<b>Ref. No.</b>	CM040800 MACM040800
<b>description</b>	pilot burner SIT type 160 series 1 flame nozzle ømm gas connecti-onmm		
<b>For models:</b>	124103, 146002		
<b>spare parts for</b>	100109		
	GEV No.	100907	Ref. No. MA1891700
screw connection thread M10x1 Qty 1 pcs type SEF 1 ømm for thermocouple			
<b>accessories for</b>	100109		
	GEV No.	100202	Ref. No. —
pilot burner nozzle natural gas code 41 Qty 1 pcs nozzle ø 0.41mm			
	GEV No.	100203	Ref. No. 822140370
pilot burner nozzle LPG code 25 Qty 1 pcs nozzle ø 0.25mm			









Table continues overleaf

accessories for		100109	
	GEV No.	100701	Ref. No. 1949900 826650010 MA1888300 MA1949900
ignition electrode connection M4 Qty 1 pcs			
	GEV No.	100801	Ref. No. —
gasket for pilot burner Qty 1 pcs			
	GEV No.	100869	Ref. No. —
pilot burner nozzle natural gas code 51 Qty 1 pcs suitable for 160 series nozzle ø 0.51mm			
	GEV No.	100906	Ref. No. 6A011707 MA1888400
screw connection thread M10x1 for ignition electrode brass Qty 1 pcs WS 10			
	GEV No.	100908	Ref. No. 41822450110 6A016110 6A017000 822450040 822450110 BN6A017000 MA673500
union screw thread M10x1 for pipe ø 4mm Qty 1 pcs			
	GEV No.	100909	Ref. No. 822450450
union screw thread M10x1 for pipe ø 6mm Qty 1 pcs			
	GEV No.	101282	Ref. No. MA469000
olive for pipe ø 4mm L 7.4mm Qty 1 pcs			
	GEV No.	101287	Ref. No. —
olive for pipe ø 6mm Qty 1 pcs			
	GEV No.	102110	Ref. No. —
pilot tube copper pipe ø 4mm thickness 1mm L 3000mm			
	GEV No.	102111	Ref. No. —
pilot tube copper pipe ø 6mm thickness 1mm L 3000mm			
	GEV No.	107650	Ref. No. 822140360
pilot burner nozzle SIT LPG code 30 Qty 1 pcs			

190 series



GEV No.	100110	Ref. No.	826920110
<b>description</b>	pilot burner SIT type 190 series 3 flames nozzle ømm gas connectionmm		
<b>For models:</b>	137002, 137202		
<b>accessories for</b>	100110		
	GEV No.	100202	Ref. No. —
pilot burner nozzle natural gas code 41 Qty 1 pcs nozzle ø 0.41mm			
	GEV No.	100203	Ref. No. 822140370
pilot burner nozzle LPG code 25 Qty 1 pcs nozzle ø 0.25mm			
	GEV No.	100701	Ref. No. 1949900 826650010 MA1888300 MA1949900
ignition electrode connection M4 Qty 1 pcs			

accessories for		100110	
	GEV No.	100906	Ref. No. 6A011707 MA1888400
screw connection thread M10x1 for ignition electrode brass Qty 1 pcs WS 10			
	GEV No.	100907	Ref. No. MA1891700
screw connection thread M10x1 Qty 1 pcs type SEF 1 ømm for thermocouple			
	GEV No.	100908	Ref. No. 41822450110 6A016110 6A017000 822450040 822450110 BN6A017000 MA673500
union screw thread M10x1 for pipe ø 4mm Qty 1 pcs			
	GEV No.	100909	Ref. No. 822450450
union screw thread M10x1 for pipe ø 6mm Qty 1 pcs			
	GEV No.	101282	Ref. No. MA469000
olive for pipe ø 4mm L 7.4mm Qty 1 pcs			
	GEV No.	101287	Ref. No. —
olive for pipe ø 6mm Qty 1 pcs			
	GEV No.	102110	Ref. No. —
pilot tube copper pipe ø 4mm thickness 1mm L 3000mm			
	GEV No.	102111	Ref. No. —
pilot tube copper pipe ø 6mm thickness 1mm L 3000mm			
	GEV No.	107650	Ref. No. 822140360
pilot burner nozzle SIT LPG code 30 Qty 1 pcs			

JUNKERS

CB 505 series

pilot burners

















GEV No.	100073	Ref. No.	MA509900
<b>description</b>	pilot burner JUNKERS type CB505018 3 flames natural gas nozzle no.9 gas connection 6mm with primary air		
<b>For models:</b>	123103, 123104, 123106, 123107, 123108, 123109, 123117		
<b>spare parts for</b>	100073		
	GEV No.	100231	Ref. No. —
pilot burner nozzle natural gas gas pressure 25mbar code 4 Qty 1 pcs suitable for JUNKERS CB5050_			
	GEV No.	100703	Ref. No. —
ignition electrode D1 ø 9mm connection M4 D2 ø 11mm L1 8mm BL1 13mm BL2 4mm BL3 22mm to clip			
	GEV No.	100907	Ref. No. MA1891700
screw connection thread M10x1 Qty 1 pcs type SEF 1 ømm for thermocouple			
	GEV No.	101282	Ref. No. MA469000
olive for pipe ø 4mm L 7.4mm Qty 1 pcs			

Table continues overleaf



spare parts for		100073	
	GEV No.	101283	Ref. No. —
	union screw thread M10x1 for pipe ø 4mm Qty 1 pcs		
	GEV No.	101292	Ref. No. 636600
	union screw for igniter suitable for CB 502/505 Qty 1 pcs		
accessories for		100073	
	GEV No.	100217	Ref. No. —
	pilot burner nozzle LPG gas pressure 30mbar code 3 Qty 1 pcs suitable for JUNKERS CB5050_		
	GEV No.	100230	Ref. No. —
	pilot burner nozzle LPG gas pressure 50mbar code 2 Qty 1 pcs suitable for JUNKERS CB5050_		
	GEV No.	100232	Ref. No. —
	pilot burner nozzle natural gas gas pressure 25mbar code 9 Qty 1 pcs suitable for JUNKERS CB5050_		
	GEV No.	100233	Ref. No. —
	pilot burner nozzle LPG gas pressure 50mbar code 8 Qty 1 pcs suitable for JUNKERS CB5050_		
	GEV No.	100234	Ref. No. —
	pilot burner nozzle natural gas gas pressure 20mbar code 14 Qty 1 pcs suitable for JUNKERS CB5050_		
	GEV No.	100909	Ref. No. 822450450
	union screw thread M10x1 for pipe ø 6mm Qty 1 pcs		
	GEV No.	101288	Ref. No. —
	olive for pipe ø 6mm L 6mm aluminium Qty 1 pcs ED ø 8.5mm		

accessories for		102800	
	GEV No.	100209	Ref. No. —
	pilot burner nozzle POLIDORO natural gas code 40 bore ø 0.4mm Qty 1 pcs		
	GEV No.	100701	Ref. No. 1949900 826650010 MA1888300 MA1949900
	ignition electrode connection M4 Qty 1 pcs		
	GEV No.	100908	Ref. No. 41822450110 6A016110 6A017000 822450040 822450110 BN6A017000 MA673500
	union screw thread M10x1 for pipe ø 4mm Qty 1 pcs		
	GEV No.	101280	Ref. No. —
	olive for pipe ø 4mm Qty 1 pcs		

POLIDORO			
pilot burners			
	1		
<b>GEV No.</b>	102800	<b>Ref. No.</b>	853310042
<b>description</b>	pilot burner POLIDORO 3 flames code gas connection 6mm		
<b>For models:</b>	136001, 136201		
spare parts for		102800	
	GEV No.	100906	Ref. No. 6A011707 MA1888400
	screw connection thread M10x1 for ignition electrode brass Qty 1 pcs WS 10		
	GEV No.	100907	Ref. No. MA1891700
	screw connection thread M10x1 Qty 1 pcs type SEF 1 ømm for thermocouple		
	GEV No.	100909	Ref. No. 822450450
	union screw thread M10x1 for pipe ø 6mm Qty 1 pcs		
	GEV No.	101287	Ref. No. —
	olive for pipe ø 6mm Qty 1 pcs		
accessories for		102800	
	GEV No.	100208	Ref. No. —
	pilot burner nozzle POLIDORO LPG code 20 bore ø 0.2mm Qty 1 pcs		





















	1		
<b>GEV No.</b>	100076	<b>Ref. No.</b>	6A013200 6A013220 BN6A013220
<b>description</b>	pilot burner POLIDORO 3 flames natural gas code 29.2 gas connection 6mm		
<b>For models:</b>	133007, 133008, 133022, 133023, 133207, 133208, 133222, 133223, 134002, 134004, 134006, 134202, 134204, 134206, 136001, 136005, 136006, 136205, 136206, 137002, 137202, 143033, 143034, 144002, 146009		
spare parts for		100076	
	GEV No.	100907	Ref. No. MA1891700
	screw connection thread M10x1 Qty 1 pcs type SEF 1 ømm for thermocouple		
accessories for		100076	
	GEV No.	100000	Ref. No. —
	pilot burner nozzle POLIDORO LPG code 22 bore ø 0.22mm Qty 1 pcs		
	GEV No.	100208	Ref. No. —
	pilot burner nozzle POLIDORO LPG code 20 bore ø 0.2mm Qty 1 pcs		
	GEV No.	100209	Ref. No. —
	pilot burner nozzle POLIDORO natural gas code 40 bore ø 0.4mm Qty 1 pcs		
	GEV No.	100701	Ref. No. 1949900 826650010 MA1888300 MA1949900
	ignition electrode connection M4 Qty 1 pcs		
	GEV No.	100906	Ref. No. 6A011707 MA1888400
	screw connection thread M10x1 for ignition electrode brass Qty 1 pcs WS 10		
	GEV No.	100907	Ref. No. MA1891700
	screw connection thread M10x1 Qty 1 pcs type SEF 1 ømm for thermocouple		

Table continues overleaf



accessories for		100076	
	GEV No.	100908	Ref. No.
			41822450110 6A016110 6A017000 822450040 822450110 BN6A017000 MA673500
	union screw thread M10x1 for pipe ø 4mm Qty 1 pcs		
	GEV No.	100909	Ref. No.
			822450450
	union screw thread M10x1 for pipe ø 6mm Qty 1 pcs		
	GEV No.	102110	Ref. No.
			—
	pilot tube copper pipe ø 4mm thickness 1mm L 3000mm		
	GEV No.	102111	Ref. No.
			—
	pilot tube copper pipe ø 6mm thickness 1mm L 3000mm		
	GEV No.	102508	Ref. No.
			—
	union screw thread M10x1 for pipe ø 4mm Qty 5 pcs		
	GEV No.	102509	Ref. No.
			—
	union screw thread M10x1 for pipe ø 6mm Qty 5 pcs		
	GEV No.	102699	Ref. No.
			—
	pilot burner nozzle POLIDORO natural gas code 25.2 bore ø 2x0.25mm Qty 1 pcs 2 bores		
	GEV No.	102795	Ref. No.
			—
	olive for pipe ø 4mm Qty 1 pcs		
	GEV No.	102797	Ref. No.
			—
	olive for pipe ø 6mm Qty 1 pcs		
	GEV No.	106703	Ref. No.
			6A013230 BN6A013230
	pilot burner nozzle POLIDORO natural gas code 27.2 bore ø 2x0.27mm Qty 1 pcs		
	GEV No.	106704	Ref. No.
			6A013240 BN6A013240
	pilot burner nozzle POLIDORO LPG code 16.2 bore ø 2x0.16mm Qty 1 pcs		
	GEV No.	106763	Ref. No.
			—
	pilot burner nozzle POLIDORO natural gas code 27.2A bore ø 2x 0.27mm Qty 1 pcs		
	GEV No.	106859	Ref. No.
			—
	pilot burner nozzle POLIDORO LPG code 24 bore ø 0.24mm Qty 1 pcs		

## PRO-GAS

## 140 - 145 -150 series

## pilot burners



1













GEV No.	101930	Ref. No.	41826920140
<b>description</b>	pilot burner 1 flame without nozzle		
<b>For models:</b>	131001, 131002, 131003, 131004, 131005, 131006, 131010, 131201, 131202, 131203, 131204, 131205, 131206, 131210, 132001, 132002, 132201, 132202		
<b>spare parts for</b>	101930		
	GEV No.	100907	Ref. No.
			MA1891700
	screw connection thread M10x1 Qty 1 pcs type SEF 1 ømm for thermocouple		
<b>accessories for</b>	101930		
	GEV No.	100204	Ref. No.
			MA1888000
	pilot burner nozzle SIT LPG code 14 bore ø 0.18/0.20mm Qty 1 pcs suitable for 140 series		
	GEV No.	100205	Ref. No.
			41822140380 822140380 BN822140380
	pilot burner nozzle SIT LPG code 19 bore ø 0.23/0.26mm Qty 1 pcs suitable for SIT 150 series		
	GEV No.	100206	Ref. No.
			—
	pilot burner nozzle SIT natural gas code 36 bore ø 0.60/0.55mm Qty 1 pcs suitable for SIT 150 series		
	GEV No.	100207	Ref. No.
			6A013107 822140120 MA1887800
	pilot burner nozzle SIT natural gas code 27 bore ø 0.40/0.38mm suitable for SIT 140 series		
	GEV No.	100216	Ref. No.
			—
	pilot burner nozzle SIT natural gas code 38 bore ø 0.45mm Qty 1 pcs suitable for SIT 150 series		
	GEV No.	100701	Ref. No.
			1949900 826650010 MA1888300 MA1949900
	ignition electrode connection M4 Qty 1 pcs		
	GEV No.	100803	Ref. No.
			—
	gasket for pilot burner Qty 1 pcs		
	GEV No.	100897	Ref. No.
			1888100 822450050 MA1888100
	olive for pipe ø 4mm Qty 1 pcs for pilot burner		
	GEV No.	100898	Ref. No.
			822450470
	olive for pipe ø 6mm Qty 1 pcs for pilot burner		
	GEV No.	100906	Ref. No.
			6A011707 MA1888400
	screw connection thread M10x1 for ignition electrode brass Qty 1 pcs WS 10		

Table continues overleaf







<b>accessories for</b> 101930					
	<table border="1"> <tr> <td>GEV No.</td> <td>100908</td> <td>Ref. No.</td> <td>41822450110 6A016110 6A017000 822450040 822450110 BN6A017000 MA673500</td> </tr> </table> <p>union screw thread M10x1 for pipe ø 4mm Qty 1 pcs</p>	GEV No.	100908	Ref. No.	41822450110 6A016110 6A017000 822450040 822450110 BN6A017000 MA673500
GEV No.	100908	Ref. No.	41822450110 6A016110 6A017000 822450040 822450110 BN6A017000 MA673500		
	<table border="1"> <tr> <td>GEV No.</td> <td>100909</td> <td>Ref. No.</td> <td>822450450</td> </tr> </table> <p>union screw thread M10x1 for pipe ø 6mm Qty 1 pcs</p>	GEV No.	100909	Ref. No.	822450450
GEV No.	100909	Ref. No.	822450450		

producer-specific pilot burners

COOKMAX

	1		
<b>GEV No.</b>	103320	<b>Ref. No.</b>	BN826350260
<b>description</b>	cover cap for pilot burner ø 40mm		
<b>For models:</b>	141001, 141002, 141003, 141004, 141005, 141006, 141007, 141009, 141010		



	1		
<b>GEV No.</b>	101929	<b>Ref. No.</b>	822160360
<b>description</b>	mushroom cap suitable for BARON		
<b>For models:</b>	121001, 121002, 121003, 121005, 122001, 122002		



	1				
<b>GEV No.</b>	102754	<b>Ref. No.</b>	826920221		
<b>description</b>	nozzle holder				
<b>For models:</b>	131001, 131002, 131003, 131004, 131005, 131006, 132001, 132002				
<b>accessories for</b> 102754					
	<table border="1"> <tr> <td>GEV No.</td> <td>100898</td> <td>Ref. No.</td> <td>822450470</td> </tr> </table> <p>olive for pipe ø 6mm Qty 1 pcs for pilot burner</p>	GEV No.	100898	Ref. No.	822450470
GEV No.	100898	Ref. No.	822450470		
	<table border="1"> <tr> <td>GEV No.</td> <td>100909</td> <td>Ref. No.</td> <td>822450450</td> </tr> </table> <p>union screw thread M10x1 for pipe ø 6mm Qty 1 pcs</p>	GEV No.	100909	Ref. No.	822450450
GEV No.	100909	Ref. No.	822450450		
	<table border="1"> <tr> <td>GEV No.</td> <td>102606</td> <td>Ref. No.</td> <td>—</td> </tr> </table> <p>pilot burner nozzle SIT natural gas code 36 bore ø 0.60/0.55mm Qty 5 pcs suitable for 150 series</p>	GEV No.	102606	Ref. No.	—
GEV No.	102606	Ref. No.	—		

	1		
<b>GEV No.</b>	102763	<b>Ref. No.</b>	41822160461 822160460
<b>description</b>	nozzle holder		
<b>For models:</b>	131001, 131002, 131003, 131004, 131005, 131006, 131010, 131201, 131202, 131203, 131204, 131205, 131206, 131210, 132001, 132002, 132201, 132202		

	1		
<b>GEV No.</b>	107773	<b>Ref. No.</b>	BN822160590
<b>description</b>	nozzle holder for pilot burner		
<b>For models:</b>	141001, 141002, 141003, 141004, 141005, 141006, 141007, 141009, 141010		

	1		
<b>GEV No.</b>	107739	<b>Ref. No.</b>	BN822160580
<b>description</b>	pilot burner 1 gas connection M9x1mm bore ø 3mm		
<b>For models:</b>	141001, 141002, 141003, 141004, 141005, 141006, 141007, 141009, 141010		



	1				
<b>GEV No.</b>	102980	<b>Ref. No.</b>	1033717300 MA1033717300		
<b>description</b>	pilot burner mushroom cap with mounting thread				
<b>For models:</b>	121101, 121102, 121105, 121106, 122101, 122102				
<b>accessories for</b> 102980					
	<table border="1"> <tr> <td>GEV No.</td> <td>560169</td> <td>Ref. No.</td> <td>—</td> </tr> </table> <p>grub screw thread M3 L 4mm DIN 914/ISO 4027 WS 1.5 Qty 1 pcs</p>	GEV No.	560169	Ref. No.	—
GEV No.	560169	Ref. No.	—		

	1				
<b>GEV No.</b>	102979	<b>Ref. No.</b>	1032501300		
<b>description</b>	pilot burner suitable for MARENO				
<b>accessories for</b> 102979					
	<table border="1"> <tr> <td>GEV No.</td> <td>101860</td> <td>Ref. No.</td> <td>—</td> </tr> </table> <p>nut thread M10x1 H 4mm WS 14 chrome-plated brass Qty 1 pcs</p>	GEV No.	101860	Ref. No.	—
GEV No.	101860	Ref. No.	—		
	<table border="1"> <tr> <td>GEV No.</td> <td>102980</td> <td>Ref. No.</td> <td>1033717300 MA1033717300</td> </tr> </table> <p>pilot burner mushroom cap with mounting thread</p>	GEV No.	102980	Ref. No.	1033717300 MA1033717300
GEV No.	102980	Ref. No.	1033717300 MA1033717300		







<b>GEV No.</b>	101899	<b>Ref. No.</b>	822410310
<b>description</b>	pilot burner type angled suitable for BARON		
<b>For models:</b>	121001, 121002, 121003, 121005, 122001, 122002		





<b>GEV No.</b>	100149	<b>Ref. No.</b>	CO3108	
<b>description</b>	pilot burner bracket			
<b>For models:</b>	243109, 243110			
<b>accessories for</b>	100149			
	<b>GEV No.</b>	100141	<b>Ref. No.</b>	CO3107
	pilot burner cap			
	<b>GEV No.</b>	100161	<b>Ref. No.</b>	CO3151
	pilot burner nozzle bore $\varnothing$ 0.2mm			
	<b>GEV No.</b>	100768	<b>Ref. No.</b>	CO3106
	ignition electrode D1 $\varnothing$ 6mm connection F 2.8x0.8mm D2 $\varnothing$ 8mm L1 8mm L2 2mm BL1 28mm BL2 16mm to clip			

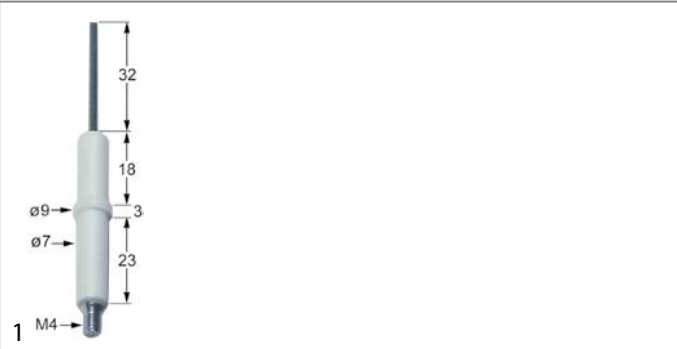

<b>GEV No.</b>	100141	<b>Ref. No.</b>	CO3107	
<b>description</b>	pilot burner cap			
<b>For models:</b>	243109, 243110			
<b>accessories for</b>	100141			
	<b>GEV No.</b>	100149	<b>Ref. No.</b>	CO3108
	pilot burner bracket			
	<b>GEV No.</b>	100161	<b>Ref. No.</b>	CO3151
	pilot burner nozzle bore $\varnothing$ 0.2mm			
	<b>GEV No.</b>	100163	<b>Ref. No.</b>	CO3150
	pilot burner nozzle bore $\varnothing$ 0.3mm			
	<b>GEV No.</b>	100768	<b>Ref. No.</b>	CO3106
	ignition electrode D1 $\varnothing$ 6mm connection F 2.8x0.8mm D2 $\varnothing$ 8mm L1 8mm L2 2mm BL1 28mm BL2 16mm to clip			

electrodes



<b>GEV No.</b>	100701	<b>Ref. No.</b>	1949900 826650010 MA1888300 MA1949900	
<b>description</b>	ignition electrode connection M4 Qty 1 pcs			
<b>For models:</b>	121102, 121105, 123001, 123002, 123003, 123004, 123005, 123006, 123007, 123008, 123009, 123101, 123102, 124103, 126002, 131001, 131002, 131003, 131004, 131005, 131006, 132001, 132002, 133001, 133002, 133003, 133009, 133010, 133011, 133012, 133013, 133014, 133015, 133024, 133203, 133209, 133210, 133211, 133212, 133213, 133214, 133215, 141021, 143001, 143002, 143003, 143004, 143005, 143006, 143007...(Other models you can see in the webshop)			
<b>accessories for</b>	100701			
	<b>GEV No.</b>	100906	<b>Ref. No.</b>	6A011707 MA1888400
	screw connection thread M10x1 for ignition electrode brass Qty 1 pcs WS 10			

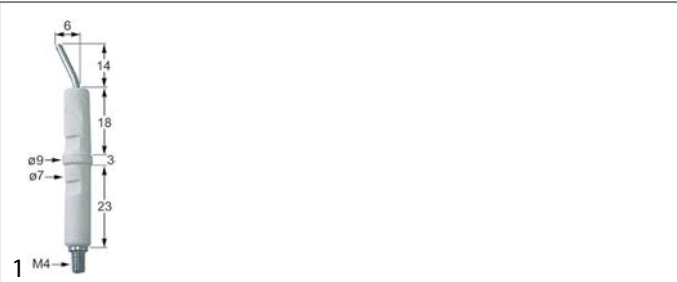

<b>GEV No.</b>	100706	<b>Ref. No.</b>	636700 853310150 GS3856 MA636700
<b>description</b>	ignition electrode connection M4 Qty 1 pcs		
<b>For models:</b>	123103, 123104, 123106, 123107, 123108, 123109, 123117, 136001, 136201, 234003, 234004, 234006		



<b>GEV No.</b>	104772	<b>Ref. No.</b>	404000209
<b>description</b>	ignition electrode D1 $\varnothing$ 5mm cable length 550mm connection $\varnothing$ 2.4mm D2 $\varnothing$ 6mm BL1 16mm BL2 2mm BL3 5mm BL4 8.5mm		
<b>For models:</b>	111002, 111003, 112003, 112004		





<b>GEV No.</b>	100768	<b>Ref. No.</b>	CO3106
<b>description</b>	ignition electrode D1 ø 6mm connection F 2.8x0.8mm D2 ø 8mm L1 8mm L2 2mm BL1 28mm BL2 16mm to clip		
<b>For models:</b>	243109, 243110		

<b>GEV No.</b>	100707	<b>Ref. No.</b>	6A013302 BN6A013302
<b>description</b>	ignition electrode D1 ø 7mm D2 ø 9mm connection ø2.4mm L1 14mm L2 6mm BL1 18mm BL2 3mm BL3 23mm to clip Qty 1 pcs		
<b>For models:</b>	133007, 133008, 133022, 133023, 133207, 133208, 133222, 133223, 134002, 134004, 134006, 134202, 134204, 134206, 136001, 136005, 136006, 136205, 136206, 137002, 137202, 143033, 143034, 144002, 146008, 146009		

<b>GEV No.</b>	106619	<b>Ref. No.</b>	6A013301 BN6A013301
<b>description</b>	ignition electrode D1 ø 7mm D2 ø 9mm L1 17mm BL1 18mm BL2 3mm BL3 23mm to clip connection ø 2.4mm		
<b>For models:</b>	131001, 131002, 131003, 131004, 131005, 131006, 131010, 131201, 131202, 131203, 131204, 131205, 131206, 131210, 132001, 132002, 132201, 132202, 133001, 133002, 133003, 133009, 133010, 133011, 133012, 133013, 133014, 133015, 133024, 133201, 133202, 133203, 133209, 133210, 133211, 133212, 133213, 133214, 133215, 133224, 141006, 141009, 141010		

<b>GEV No.</b>	107153	<b>Ref. No.</b>	G1305
<b>description</b>	ignition electrode flange length 22mm flange width 15mm D1 ø 8mm L1 30mm BL1 30mm BL2 19mm connection ø2.4mm cable length 350mm with flange		
<b>For models:</b>	225008, 247002, 263010, 263011, 263012, 263013, 263024, 263025, 263026		

<b>GEV No.</b>	107468	<b>Ref. No.</b>	SEW932
<b>description</b>	ignition electrode flange length 29mm flange width 9mm D1 ø 7mm D2 ø 8mm L1 2mm L2 12mm BL1 17mm BL2 22mm connection M4		
<b>For models:</b>	221015		

<b>GEV No.</b>	104785	<b>Ref. No.</b>	404530200
<b>description</b>	ignition electrode flange length 38mm flange width 17mm D1 ø 9.5mm L1 15mm BL1 30mm BL2 30mm connection M4 fixing dimensions ø4.5mm mounting distance 28mm		
<b>For models:</b>	113001, 113002, 113007, 113008, 113009, 113010, 113015, 113016, 113017, 113018, 113019, 113020, 243003, 243004, 243006, 243007, 243008		

			
1			
<b>GEV No.</b>	100906	<b>Ref. No.</b>	6A011707 MA1888400
<b>description</b>	screw connection thread M10x1 for ignition electrode brass Qty 1 pcs WS 10		
<b>For models:</b>	121102, 121105, 123101, 123102, 123103, 123104, 123106, 123107, 123108, 123109, 123117, 124103, 131001, 131002, 131003, 131004, 131005, 131006, 131010, 131201, 131202, 131203, 131204, 131205, 131206, 131210, 132001, 132002, 132201, 132202, 133001, 133002, 133003, 133009, 133010, 133011, 133012, 133013, 133014, 133015, 133024, 133201, 133202, 133203, 133209, 133210, 133211, 133212, 133213, 133214...(Other models you can see in the webshop)		

## ignition cables

### pre-assembled cables

			
1			
<b>GEV No.</b>	100179	<b>Ref. No.</b>	41826690062 826690061 CO3130
<b>description</b>	ignition cable cable length 1200mm connection F2.8mm / ø2.4mm		
<b>For models:</b>	131001, 131002, 131003, 131004, 131005, 131006, 131010, 131201, 131202, 131203, 131204, 131205, 131206, 131210, 132001, 132002, 132201, 132202, 243109, 243110		

			
1			
<b>GEV No.</b>	100195	<b>Ref. No.</b>	1950324
<b>description</b>	ignition cable cable length 1200mm connection ø2.4mm / lug M4		

			
1			
<b>GEV No.</b>	102181	<b>Ref. No.</b>	6A041300 6A041410
<b>description</b>	ignition cable cable length 1500mm connection ø2.4mm / ø2.4mm		

			
1			
<b>GEV No.</b>	100191	<b>Ref. No.</b>	41826690550
<b>description</b>	ignition cable cable length 2000mm connection F2.8mm / ø2.4mm		
<b>For models:</b>	131001, 131002, 131003, 131004, 131005, 131006, 131010, 131201, 131202, 131203, 131204, 131205, 131206, 131210, 132001, 132002, 132201, 132202		

			
1			
<b>GEV No.</b>	102189	<b>Ref. No.</b>	CR0508710
<b>description</b>	ignition cable cable length 300mm connection ø2.4mm / lug M4		
<b>For models:</b>	124103		

			
1			
<b>GEV No.</b>	100197	<b>Ref. No.</b>	41826690052 826690051
<b>description</b>	ignition cable cable length 600mm connection F2.8mm / ø2.4mm		
<b>For models:</b>	131001, 131002, 131003, 131004, 131005, 131006, 131010, 131201, 131202, 131203, 131204, 131205, 131206, 131210, 132001, 132002, 132201, 132202		

			
1			
<b>GEV No.</b>	100186	<b>Ref. No.</b>	1936300 402008000 MA1936300
<b>description</b>	ignition cable cable length 600mm connection ø2.4mm / lug M4		
<b>For models:</b>	113001, 113002, 113007, 113008, 113009, 113010, 113015, 113016, 113017, 113018, 123101, 123102, 123103, 123104, 123106, 123107, 123108, 123109, 123117, 143001, 143002, 143003, 143004, 143005, 143006, 143007, 143008, 143009, 143010, 143011, 143012, 143013, 143014, 143015, 143016, 243003, 243004, 243006, 243007, 243008		

			
1			
<b>GEV No.</b>	100199	<b>Ref. No.</b>	GS3682
<b>description</b>	ignition cable cable length 600mm connection ø4mm / F2.8mm		
<b>For models:</b>	234003, 234004, 234006		

			
1			
<b>GEV No.</b>	100016	<b>Ref. No.</b>	2510698 41826690011 BN2510698
<b>description</b>	ignition cable cable length 900mm connection ø2.4mm / ø2.4mm		
<b>For models:</b>	131003, 131005, 131201, 131202, 131203, 131204, 131205, 131206, 131210, 132201, 132202, 133001, 133002, 133003, 133007, 133008, 133009, 133010, 133011, 133012, 133013, 133014, 133015, 133022, 133023, 133024, 133203, 133207, 133208, 133209, 133210, 133211, 133212, 133213, 133214, 133215, 133222, 133223, 134002, 134004, 134006, 134202, 134204, 134206, 136005, 136006, 136205, 136206, 137002, 137202...(Other models you can see in the webshop)		



## piezoelectric igniters

### mounting diameter 18mm



			
1			
<b>GEV No.</b>	100003	<b>Ref. No.</b>	1936100 GS3863 MA1936100
<b>description</b>	piezoelectric igniter body metal blowing mounting ø 18mm connection F2.8x0.8		
<b>For models:</b>	123101, 123102, 123103, 123104, 123106, 123107, 123108, 123109, 123117, 124103, 234003, 234004, 234006		





			
1			
<b>GEV No.</b>	100004	<b>Ref. No.</b>	SEW848
<b>description</b>	piezoelectric igniter body plastic blowing mounting ø 18mm connection ø2.4mm		
<b>For models:</b>	221015		

			
1			
<b>GEV No.</b>	100012	<b>Ref. No.</b>	BN861310850
<b>description</b>	piezoelectric igniter body plastic blowing mounting ø 18mm connection ø2.4mm		
<b>For models:</b>	143001, 143002, 143003, 143004, 143005, 143006, 143007, 143008, 143009, 143010, 143011, 143012, 143013, 143014, 143015, 143016, 143033, 143034, 146008, 146009		
<b>spare parts for</b>	100012		
	<b>GEV No.</b>	101339	<b>Ref. No.</b> —
	 cover cap for piezoelectric igniter		

			
1			
<b>GEV No.</b>	107152	<b>Ref. No.</b>	G1300
<b>description</b>	piezoelectric igniter body plastic blowing mounting ø 18mm connection ø2.4mm front measurements 26mm		
<b>For models:</b>	225008, 247002, 263010, 263011, 263012, 263013, 263024, 263025, 263026		

			
1			
<b>GEV No.</b>	100009	<b>Ref. No.</b>	401540000 418261310850 41826630020 6A041105 BN6A041105 CO3119
<b>description</b>	piezoelectric igniter body plastic blowing mounting ø 18mm connection ø2.4mm front measurements 26mm M18x1.5		
<b>For models:</b>	113015, 113016, 113017, 113018, 113019, 113020, 123001, 123002, 123003, 123004, 123005, 123006, 123007, 123008, 123009, 126002, 131003, 131004, 131005, 131006, 131201, 131202, 131203, 131204, 131205, 131206, 131210, 132201, 132202, 133001, 133002, 133003, 133007, 133008, 133009, 133010, 133011, 133012, 133013, 133014, 133015, 133022, 133023, 133024, 133201, 133202, 133203, 133207, 133208, 133209...(Other models you can see in the webshop)		
<b>accessories for</b>	100009		
	<b>GEV No.</b>	101339	<b>Ref. No.</b> —
	 cover cap for piezoelectric igniter		

<b>accessories for</b>	100009		
	<b>GEV No.</b>	106869	<b>Ref. No.</b> —
	 cover cap for piezoelectric igniter ID ø 22mm ED ø 35mm H 25mm		
	<b>GEV No.</b>	107931	<b>Ref. No.</b> —
	 cover cap for piezoelectric igniter ID ø 21mm ED ø 36mm		

<h3>mounting diameter 22mm</h3>			
			
1			
<b>GEV No.</b>	100005	<b>Ref. No.</b>	GS3720
<b>description</b>	piezoelectric igniter body plastic blowing mounting ø 22mm connection ø2.4mm cable lengthmm SIT		

<h3>accessories</h3>			
			
1			
<b>GEV No.</b>	691392	<b>Ref. No.</b>	41822160540 BN822160540
<b>description</b>	ring for piezoelectric igniter ID ø 18mm ED ø 30mm H 2mm mounting ø 22mm		
<b>For models:</b>	131003, 131004, 131005, 131006, 131201, 131202, 131203, 131204, 131205, 131206, 131210, 132201, 132202, 133001, 133002, 133003, 133007, 133008, 133009, 133010, 133011, 133012, 133013, 133014, 133015, 133022, 133023, 133024, 133201, 133202, 133203, 133207, 133208, 133209, 133210, 133211, 133212, 133213, 133214, 133215, 133222, 133223, 133224, 134002, 134004, 134006, 134202, 134204, 134206, 136005...(Other models you can see in the webshop)		

## ignition units

			
1			
<b>GEV No.</b>	102485	<b>Ref. No.</b>	MA2971400
<b>description</b>	ignition unit outputs 2 220-240VAC 0.6VA 50-60Hz		
<b>For models:</b>	146002, 147003		

			
1			
<b>GEV No.</b>	101002	<b>Ref. No.</b>	A050100
<b>description</b>	ignition unit outputs 2 230VAC dimensions 88x23x34mm mounting distance 73mm inlet F6.3x0.8 outlet F2.8x0.8 0.6VA 50/60Hz		



1

<b>GEV No.</b>	101015	<b>Ref. No.</b>	41826630400 826630040
<b>description</b>	ignition unit outputs 4 230VAC 0.6VA 50Hz		
<b>For models:</b>	131001, 131002, 131003, 131004, 131005, 131006, 131010, 131201, 131202, 131203, 131204, 131205, 131206, 131210, 132001, 132002, 132201, 132202		

## thermocouples

### thermocouple sets universal



1

<b>GEV No.</b>	107647	<b>Ref. No.</b>	SGT316
<b>description</b>	thermocouple set SIT 11-piece L 900mm		
<b>For models:</b>	221015		

### plug-in thermocouples

#### plug-in thermocouples standard

with barrel socket  $\varnothing 6(6.5)$ mm

#### thermocouples SIT

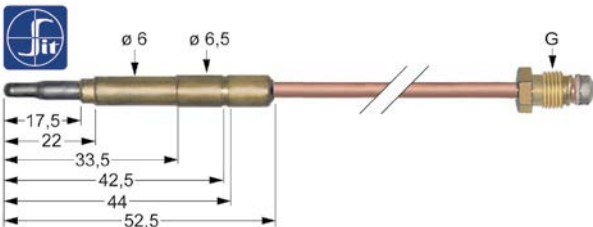

1

<b>GEV No.</b>	107621	<b>Ref. No.</b>	853310070
<b>description</b>	thermocouple SIT M10x1 L 1500mm plug connection $\varnothing 6.0(6.5)$ mm		
<b>For models:</b>	136001, 136201		

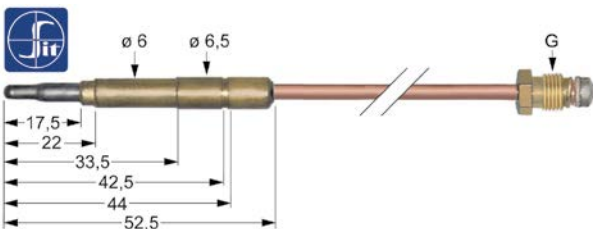

1

<b>GEV No.</b>	107603	<b>Ref. No.</b>	CO3161
<b>description</b>	thermocouple SIT M8x1 L 1000mm plug connection $\varnothing 6.0(6.5)$ mm		
<b>For models:</b>	243109, 243110		

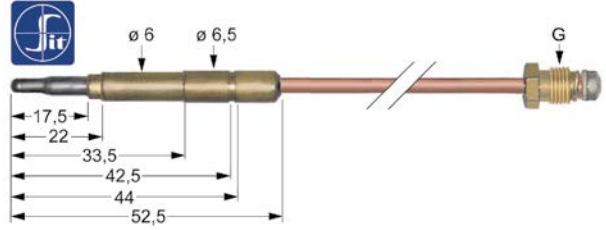

1

<b>GEV No.</b>	107605	<b>Ref. No.</b>	CO3110
<b>description</b>	thermocouple SIT M8x1 L 1500mm plug connection $\varnothing 6.0(6.5)$ mm		
<b>For models:</b>	243110		

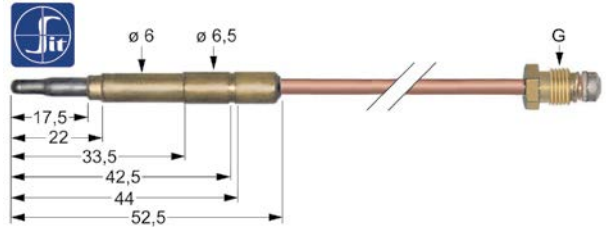

1

<b>GEV No.</b>	107601	<b>Ref. No.</b>	1033027800 1206400 CO3031 MA1206400
<b>description</b>	thermocouple SIT M8x1 L 600mm plug connection $\varnothing 6.0(6.5)$ mm		
<b>For models:</b>	123103, 123106, 123108, 123117, 243109		

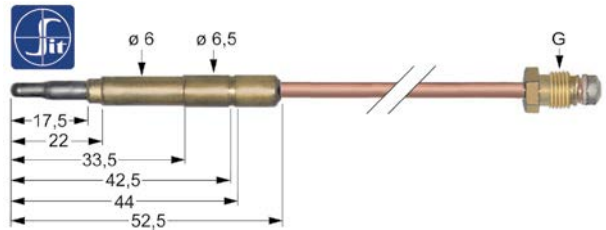

1

<b>GEV No.</b>	107612	<b>Ref. No.</b>	GS3890
<b>description</b>	thermocouple SIT M9x1 L 1000mm plug connection $\varnothing 6.0(6.5)$ mm		
<b>For models:</b>	231001, 231002, 231003, 231004, 231005, 231006, 231007, 231008, 233001, 233002, 233003, 235001		

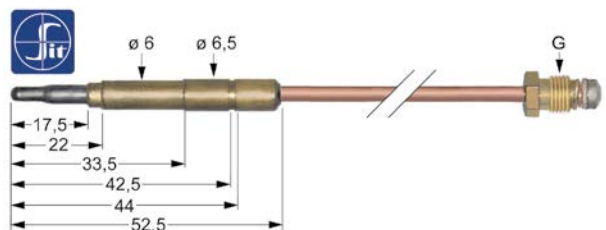

1

<b>GEV No.</b>	107608	<b>Ref. No.</b>	1031504300 6A011912 MA1031504300
<b>description</b>	thermocouple SIT M9x1 L 500mm plug connection $\varnothing 6.0(6.5)$ mm		
<b>For models:</b>	133007, 133008, 133022, 133023, 133207, 133208, 133222, 133223, 143033, 143034		



<b>GEV No.</b>	107609	<b>Ref. No.</b>	GS3895
<b>description</b>	thermocouple SIT M9x1 L 600mm plug connection $\phi 6.0(6.5)$ mm		
<b>For models:</b>	234003, 234004, 234006		

<b>GEV No.</b>	102068	<b>Ref. No.</b>	826920130
<b>description</b>	thermocouple SIT with interrupter M9x1 L 320mm plug connection $\phi 6.0$ mm soldering connection		
<b>For models:</b>	137002, 137202		

<b>GEV No.</b>	107611	<b>Ref. No.</b>	41826920080 6A011904 MA1916000 MACM029100
<b>description</b>	thermocouple SIT M9x1 L 850mm plug connection $\phi 6.0(6.5)$ mm		
<b>For models:</b>	121001, 121002, 121003, 121005, 121101, 121102, 121105, 121106, 122001, 122002, 122101, 122102, 123001, 123002, 123003, 123004, 123005, 123006, 123007, 123008, 123009, 123101, 123102, 126002, 131001, 131002, 131003, 131004, 131005, 131006, 131010, 131201, 131202, 131203, 131204, 131205, 131206, 131210, 132001, 132002, 132201, 132202, 133001, 133002, 133003, 133009, 133010, 133011, 133012, 133013...(Other models you can see in the webshop)		

<b>GEV No.</b>	107177	<b>Ref. No.</b>	6A011909 826920050
<b>description</b>	thermocouple SIT with interrupter M9x1 L 600mm plug connection $\phi 6.0$ mm F 6.3mm		
<b>For models:</b>	133001, 133002, 133003, 133009, 133010, 133011, 133012, 133013, 133014, 133015, 133024, 133201, 133202, 133203, 133209, 133210, 133211, 133212, 133213, 133214, 133215, 133224		

threaded thermocouples (miscellaneous)

<b>GEV No.</b>	106989	<b>Ref. No.</b>	PT0243
<b>description</b>	thermocouple M8x1 L 330mm plug connection $\phi 5.0$ mm		
<b>For models:</b>	254005, 254006, 254007, 254008, 254009, 254010, 254011, 254012		

<b>GEV No.</b>	102247	<b>Ref. No.</b>	1955500 CR0508700 MA1955500
<b>description</b>	thermocouple with interrupter M9x1 L 600mm plug connection $\phi 6.0$ mm cable 700mm		
<b>For models:</b>	123104, 123107, 123109, 124103		

plug-in thermocouples with interruption

<b>GEV No.</b>	107164	<b>Ref. No.</b>	6A011910 BN6A011910
<b>description</b>	thermocouple SIT with interrupter M9x1 L 1000mm plug connection $\phi 6.0(6.5)$ mm soldering connection		
<b>For models:</b>	134002, 134004, 134006, 134202, 134204, 134206, 136001, 136201, 144002		

threaded thermocouples

threaded thermocouples standard

with socket with thread M8x1

SIT

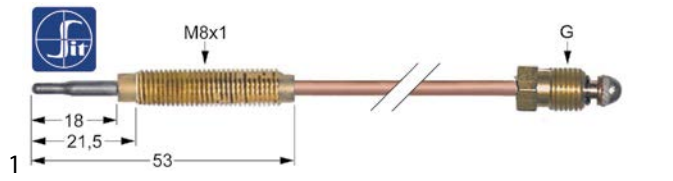

<b>GEV No.</b>	107633	<b>Ref. No.</b>	1665000 MA1665000
----------------	--------	-----------------	----------------------

**description** thermocouple SIT M8x1 L 1200mm M8x1

**For models:** 121102, 121105

**accessories for** 107633

	<b>GEV No.</b>	102067	<b>Ref. No.</b>	939300 MA939300
nut thread M8x1 H 3mm brass Qty 1 pcs type SEF 1				

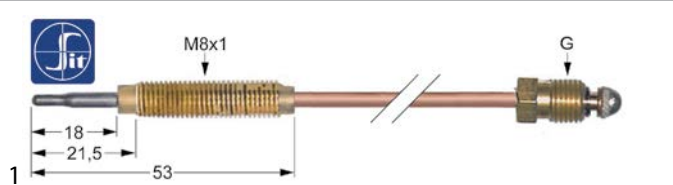

<b>GEV No.</b>	107627	<b>Ref. No.</b>	G1301
----------------	--------	-----------------	-------

**description** thermocouple SIT M8x1 L 220mm M8x1

**For models:** 263010, 263011, 263012, 263013, 263024, 263025, 263026

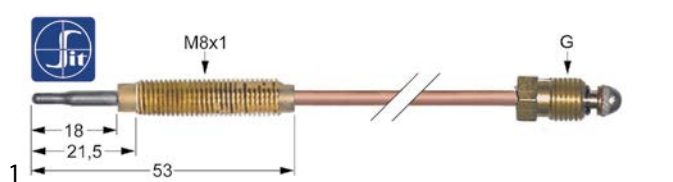

<b>GEV No.</b>	107630	<b>Ref. No.</b>	404050200
----------------	--------	-----------------	-----------

**description** thermocouple SIT M8x1 L 600mm M8x1

**For models:** 111002, 111003, 112003, 112004, 113001, 113002, 113007, 113008, 113009, 113010, 113015, 113016, 113017, 113018, 113019, 113020, 243003, 243004, 243006, 243007, 243008

**accessories for** 107630

	<b>GEV No.</b>	102067	<b>Ref. No.</b>	939300 MA939300
nut thread M8x1 H 3mm brass Qty 1 pcs type SEF 1				

threaded thermocouples (miscellaneous)

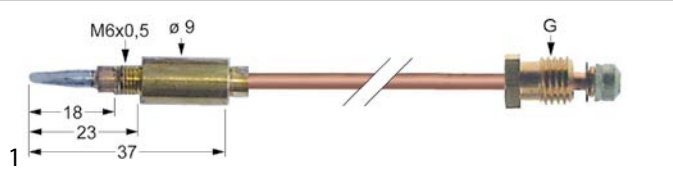

<b>GEV No.</b>	102121	<b>Ref. No.</b>	CO2269
----------------	--------	-----------------	--------

**description** thermocouple M8x1 L 600mm M6x0.5

**For models:** 223003

**accessories for** 102121

	<b>GEV No.</b>	100892	<b>Ref. No.</b>	—
thermocouple nut thread M6x0.5 H 6.5mm WS 8 brass Qty 1 pcs				

threaded thermocouples flexible

with socket with thread M8x1

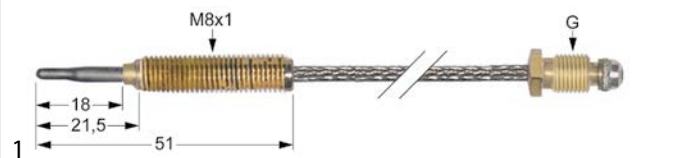

<b>GEV No.</b>	102128	<b>Ref. No.</b>	37003 PT0241
----------------	--------	-----------------	-----------------

**description** thermocouple M8x1 L 320mm M8x1

**For models:** 225008, 247002

**accessories for** 102128

	<b>GEV No.</b>	102067	<b>Ref. No.</b>	939300 MA939300
nut thread M8x1 H 3mm brass Qty 1 pcs type SEF 1				

thermopiles

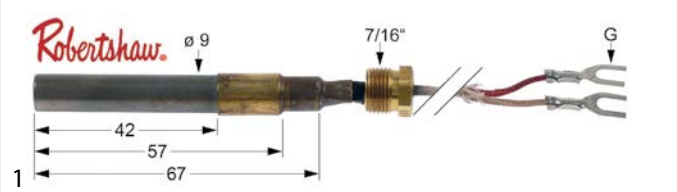

<b>GEV No.</b>	102116	<b>Ref. No.</b>	826920100
----------------	--------	-----------------	-----------

**description** thermopile ROBERTSHAW L 900mm probe ø 9mm probe L 57mm 250-750mV screw connection 7/16"

**For models:** 137002, 137202

accessories

nuts



<b>GEV No.</b>	102067	<b>Ref. No.</b>	939300 MA939300
----------------	--------	-----------------	--------------------

**description** nut thread M8x1 H 3mm brass Qty 1 pcs type SEF 1

**For models:** 121102, 121105, 143001, 143002, 143003, 143004, 143005, 143006, 143007, 143008, 143009, 143010, 143011, 143012, 143013, 143014, 143015, 143016

screws

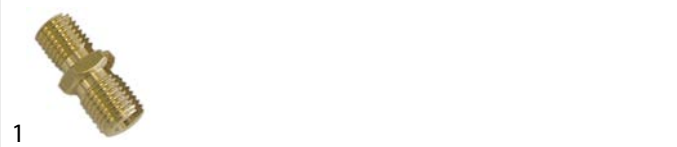



<b>GEV No.</b>	100920	<b>Ref. No.</b>	6A013401
----------------	--------	-----------------	----------

**description** thermocouple fitting thread M8x1 / M9x1 Qty 1 pcs

**For models:** 133001, 133002, 133003, 133007, 133008, 133009, 133010, 133011, 133012, 133013, 133014, 133015, 133022, 133023, 133024, 133201, 133202, 133203, 133207, 133208, 133209, 133210, 133211, 133212, 133213, 133214, 133215, 133222, 133223, 133224, 136005, 136006, 136205, 136206



			
1			
<b>GEV No.</b>	101260	<b>Ref. No.</b>	MA1359100
<b>description</b>	thermocouple fitting thread M8x1 Qty 1 pcs		
<b>For models:</b>	123101, 123102		

miscellaneous			
			
1			
<b>GEV No.</b>	104771	<b>Ref. No.</b>	450401057
<b>description</b>	fastening angle for thermocouple		





## gas burners



### hob burners



#### universal hob burners

#### SABAF

#### 1 series

			
1			
<b>GEV No.</b>	104288	<b>Ref. No.</b>	404000200
<b>description</b>	burner cap 3.6kW ø 120mm		
<b>For models:</b>	111002, 111003, 112003, 112004		
<b>accessories for</b>	104288		
	<b>GEV No.</b>	104289	<b>Ref. No.</b> 404000203
	burner lower part 3/3.6kW for burner cap ø 90/120mm		
	<b>GEV No.</b>	105086	<b>Ref. No.</b> 404000201
	burner ring 3.6kW for burner cap ø 120mm		
	<b>GEV No.</b>	105087	<b>Ref. No.</b> 404000202
	burner head 3.6kW for burner cap ø 120mm		

			
1			
<b>GEV No.</b>	104286	<b>Ref. No.</b>	404000248
<b>description</b>	burner cap 3kW ø 90mm		
<b>For models:</b>	111002, 111003, 112003, 112004		
<b>accessories for</b>	104286		
	<b>GEV No.</b>	104289	<b>Ref. No.</b> 404000203
	burner lower part 3/3.6kW for burner cap ø 90/120mm		

<b>accessories for</b>	104286		
	<b>GEV No.</b>	105089	<b>Ref. No.</b> 404000249
	burner ring 3kW for burner cap ø 90mm		
	<b>GEV No.</b>	105090	<b>Ref. No.</b> 404000250
	burner head 3kW for burner cap ø 90mm		

			
1			
<b>GEV No.</b>	105087	<b>Ref. No.</b>	404000202
<b>description</b>	burner head 3.6kW for burner cap ø 120mm		
<b>For models:</b>	111002, 111003, 112003, 112004		
<b>accessories for</b>	105087		
	<b>GEV No.</b>	104288	<b>Ref. No.</b> 404000200
	burner cap 3.6kW ø 120mm		
	<b>GEV No.</b>	105085	<b>Ref. No.</b> —
	burner cap ø 120mm		
	<b>GEV No.</b>	105086	<b>Ref. No.</b> 404000201
	burner ring 3.6kW for burner cap ø 120mm		
	<b>GEV No.</b>	105088	<b>Ref. No.</b> —
	burner cap A ø 110mm with central hole		
	<b>GEV No.</b>	105089	<b>Ref. No.</b> 404000249
	burner ring 3kW for burner cap ø 90mm		

			
1			
<b>GEV No.</b>	105090	<b>Ref. No.</b>	404000250
<b>description</b>	burner head 3kW for burner cap ø 90mm		
<b>For models:</b>	111002, 111003, 112003, 112004		
<b>accessories for</b>	105090		
	<b>GEV No.</b>	104286	<b>Ref. No.</b> 404000248
	burner cap 3kW ø 90mm		
	<b>GEV No.</b>	104289	<b>Ref. No.</b> 404000203
	burner lower part 3/3.6kW for burner cap ø 90/120mm		
	<b>GEV No.</b>	105089	<b>Ref. No.</b> 404000249
	burner ring 3kW for burner cap ø 90mm		









			
1			
<b>GEV No.</b>	104289	<b>Ref. No.</b>	404000203
<b>description</b>	burner lower part 3/3.6kW for burner cap ø 90/120mm		
<b>For models:</b>	111002, 111003, 112003		
<b>accessories for</b>	104289		
	<b>GEV No.</b>	104286	<b>Ref. No.</b> 404000248
	burner cap 3kW ø 90mm		

Table continues overleaf

<b>accessories for</b>	104289		
	GEV No.	104288	Ref. No. 404000200
	burner cap 3.6kW ø 120mm		
	GEV No.	105086	Ref. No. 404000201
	burner ring 3.6kW for burner cap ø 120mm		
	GEV No.	105087	Ref. No. 404000202
	burner head 3.6kW for burner cap ø 120mm		
	GEV No.	105089	Ref. No. 404000249
	burner ring 3kW for burner cap ø 90mm		
	GEV No.	105090	Ref. No. 404000250
	burner head 3kW for burner cap ø 90mm		
	GEV No.	106482	Ref. No. —
	gas injector thread M6x0.75 WS 7 bore ø 1.1mm		
	GEV No.	106485	Ref. No. —
	gas injector thread M6x0.75 WS 7 bore ø 1.6mm		

	1		
<b>GEV No.</b>	105086	<b>Ref. No.</b>	404000201
<b>description</b>	burner ring 3.6kW for burner cap ø 120mm		
<b>For models:</b>	111002, 111003, 112003, 112004		
<b>accessories for</b>	105086		
	GEV No.	105085	Ref. No. —
	burner cap ø 120mm		
	GEV No.	105087	Ref. No. 404000202
	burner head 3.6kW for burner cap ø 120mm		
	GEV No.	105088	Ref. No. —
	burner cap A ø 110mm with central hole		
	GEV No.	105089	Ref. No. 404000249
	burner ring 3kW for burner cap ø 90mm		

	1		
<b>GEV No.</b>	105089	<b>Ref. No.</b>	404000249
<b>description</b>	burner ring 3kW for burner cap ø 90mm		
<b>For models:</b>	111002, 111003, 112003, 112004		
<b>accessories for</b>	105089		
	GEV No.	104286	Ref. No. 404000248
	burner cap 3kW ø 90mm		
	GEV No.	104289	Ref. No. 404000203
	burner lower part 3/3.6kW for burner cap ø 90/120mm		
	GEV No.	105090	Ref. No. 404000250
	burner head 3kW for burner cap ø 90mm		

<b>FLAM GAS</b>			
<b>FGP series</b>			
	1		
<b>GEV No.</b>	104776	<b>Ref. No.</b>	404000113
<b>description</b>	air mixing tube L 43.4mm ø 14mm		
<b>For models:</b>	113019, 113020		

	1		
<b>GEV No.</b>	104773	<b>Ref. No.</b>	404000111
<b>description</b>	burner cap ø 83mm 4.5kW		

	1		
<b>GEV No.</b>	104762	<b>Ref. No.</b>	404000112
<b>description</b>	burner head for burner cap ø 83mm 4.5kW		

	1		
<b>GEV No.</b>	104763	<b>Ref. No.</b>	404000114
<b>description</b>	burner lower part for burner cap ø 83mm 4.5kW		

	1		
<b>GEV No.</b>	104764	<b>Ref. No.</b>	404000105
<b>description</b>	burner unit 4.5kW complete		

	1		
<b>GEV No.</b>	104784	<b>Ref. No.</b>	404520200
<b>description</b>	nozzle holder nozzle mounting M10x1 tube ø 10mm gas inlet M16x1.5 gas outlet M14x1		
<b>For models:</b>	113001, 113002, 113007, 113008, 113009, 113010, 113015, 113016, 113017, 113018, 113019, 113020, 243003, 243004, 243006, 243007, 243008		







producer-specific hob burners

COOKMAX

600 series

			
1			
<b>GEV No.</b>	105666	<b>Ref. No.</b>	822410340
<b>description</b>	burner cap ø 104mm		
<b>For models:</b>	121001, 121002, 121003, 121005, 122001, 122002		

			
1			
<b>GEV No.</b>	107203	<b>Ref. No.</b>	1032501413 1032501422 CR0937560
<b>description</b>	burner cap ø 85mm 3.5kW		
<b>For models:</b>	121001, 121005, 121101, 121102, 121105, 121106, 122101, 122102		
<b>accessories for</b>	107203		
	<b>GEV No.</b>	103140	<b>Ref. No.</b>
			1032101400 1032101422 CR0795730
	burner head seat ø 75mm for burner cap ø 85mm 3.5kW		

			
1			
<b>GEV No.</b>	105259	<b>Ref. No.</b>	1032501613
<b>description</b>	burner cap ø 95mm with central hole		
<b>accessories for</b>	105259		
	<b>GEV No.</b>	103141	<b>Ref. No.</b>
			1032101500
	burner head ø 95mm suitable for burner 5.5kW		
	<b>GEV No.</b>	103147	<b>Ref. No.</b>
			1032101300 MA1032101300
	burner lower part for burner cap ø 95mm 5.5/7kW		
	<b>GEV No.</b>	103149	<b>Ref. No.</b>
			1036607900 MA1036607900
	gasket L 55mm W 62mm for burner 5.5/7kW		
	<b>GEV No.</b>	105230	<b>Ref. No.</b>
			1033717200 MA1033717200
	nozzle holder		
	<b>GEV No.</b>	105262	<b>Ref. No.</b>
			—
	burner head for burner cap ø 95mm 5.5kW		







			
1			
<b>GEV No.</b>	105667	<b>Ref. No.</b>	822410350
<b>description</b>	burner head for burner cap ø 104mm		
<b>For models:</b>	121001, 121002, 121003, 121005, 122001, 122002		



			
1			
<b>GEV No.</b>	107143	<b>Ref. No.</b>	MACM297300
<b>description</b>	burner head for burner cap ø 95mm 5.5kW		
<b>For models:</b>	121101, 121102, 121105, 121106, 122101, 122102		



			
1			
<b>GEV No.</b>	103141	<b>Ref. No.</b>	1032101500
<b>description</b>	burner head ø 95mm suitable for burner 5.5kW		
<b>For models:</b>	121005		
<b>accessories for</b>	103141		
	<b>GEV No.</b>	103147	<b>Ref. No.</b>
			1032101300 MA1032101300
	burner lower part for burner cap ø 95mm 5.5/7kW		
	<b>GEV No.</b>	103149	<b>Ref. No.</b>
			1036607900 MA1036607900
	gasket L 55mm W 62mm for burner 5.5/7kW		
	<b>GEV No.</b>	105230	<b>Ref. No.</b>
			1033717200 MA1033717200
	nozzle holder		
	<b>GEV No.</b>	105259	<b>Ref. No.</b>
			1032501613
	burner cap ø 95mm with central hole		

			
1			
<b>GEV No.</b>	103140	<b>Ref. No.</b>	1032101400 1032101422 CR0795730
<b>description</b>	burner head seat ø 75mm for burner cap ø 85mm 3.5kW		
<b>For models:</b>	121101, 121102, 121105, 121106, 122101, 122102		
<b>accessories for</b>	103140		
	<b>GEV No.</b>	103146	<b>Ref. No.</b>
			1032101200
	burner lower part for burner cap ø 85mm 3.5kW		
	<b>GEV No.</b>	103148	<b>Ref. No.</b>
			1036607800 MA1036607800
	gasket L 47mm W 53mm suitable for burner 3.5kW		
	<b>GEV No.</b>	105230	<b>Ref. No.</b>
			1033717200 MA1033717200
	nozzle holder		
	<b>GEV No.</b>	107203	<b>Ref. No.</b>
			1032501413 1032501422 CR0937560
	burner cap ø 85mm 3.5kW		

			
1			
<b>GEV No.</b>	103146	<b>Ref. No.</b>	1032101200
<b>description</b>	burner lower part for burner cap ø 85mm 3.5kW		
<b>For models:</b>	121001, 121005		
<b>accessories for</b>	103146		
	GEV No.	103140	Ref. No. 1032101400 1032101422 CR0795730
burner head seat ø 75mm for burner cap ø 85mm 3.5kW			
	GEV No.	103148	Ref. No. 1036607800 MA1036607800
gasket L 47mm W 53mm suitable for burner 3.5kW			
	GEV No.	105230	Ref. No. 1033717200 MA1033717200
nozzle holder			
	GEV No.	107203	Ref. No. 1032501413 1032501422 CR0937560
burner cap ø 85mm 3.5kW			

			
1			
<b>GEV No.</b>	103147	<b>Ref. No.</b>	1032101300 MA1032101300
<b>description</b>	burner lower part for burner cap ø 95mm 5.5/7kW		
<b>For models:</b>	121101, 121102, 121105, 121106, 122101, 122102		
<b>accessories for</b>	103147		
	GEV No.	103141	Ref. No. 1032101500
burner head ø 95mm suitable for burner 5.5kW			
	GEV No.	103147	Ref. No. 1032101300 MA1032101300
burner lower part for burner cap ø 95mm 5.5/7kW			
	GEV No.	103149	Ref. No. 1036607900 MA1036607900
gasket L 55mm W 62mm for burner 5.5/7kW			
	GEV No.	105230	Ref. No. 1033717200 MA1033717200
nozzle holder			
	GEV No.	105259	Ref. No. 1032501613
burner cap ø 95mm with central hole			

			
1			
<b>GEV No.</b>	103148	<b>Ref. No.</b>	1036607800 MA1036607800
<b>description</b>	gasket L 47mm W 53mm suitable for burner 3.5kW		
<b>For models:</b>	121101, 121102, 121105, 121106, 122101, 122102		
<b>accessories for</b>	103148		
	GEV No.	103140	Ref. No. 1032101400 1032101422 CR0795730
burner head seat ø 75mm for burner cap ø 85mm 3.5kW			

<b>accessories for</b>	103148		
	GEV No.	103146	Ref. No. 1032101200
burner lower part for burner cap ø 85mm 3.5kW			
	GEV No.	105230	Ref. No. 1033717200 MA1033717200
nozzle holder			
	GEV No.	107203	Ref. No. 1032501413 1032501422 CR0937560
burner cap ø 85mm 3.5kW			

			
1			
<b>GEV No.</b>	103149	<b>Ref. No.</b>	1036607900 MA1036607900
<b>description</b>	gasket L 55mm W 62mm for burner 5.5/7kW		
<b>For models:</b>	121001, 121005, 121101, 121102, 121105, 121106, 122101, 122102		
<b>accessories for</b>	103149		
	GEV No.	103141	Ref. No. 1032101500
burner head ø 95mm suitable for burner 5.5kW			
	GEV No.	103145	Ref. No. —
burner cap ø 95mm 7kW with central hole			
	GEV No.	103147	Ref. No. 1032101300 MA1032101300
burner lower part for burner cap ø 95mm 5.5/7kW			
	GEV No.	105230	Ref. No. 1033717200 MA1033717200
nozzle holder			
	GEV No.	105259	Ref. No. 1032501613
burner cap ø 95mm with central hole			
	GEV No.	107143	Ref. No. MACM297300
burner head for burner cap ø 95mm 5.5kW			

			
1			
<b>GEV No.</b>	102752	<b>Ref. No.</b>	822410360
<b>description</b>	venturi		
<b>For models:</b>	121001, 121002, 121003, 121005, 122001, 122002		





700, 900, 1000, Giano series			
			
<b>GEV No.</b>	105677	<b>Ref. No.</b>	41822120020 BN822120020
<b>description</b>	air mixing sleeve L 40mm ID ø 40mm ED ø 42mm aluminium		
<b>For models:</b>	131001, 131002, 131003, 131004, 131005, 131006, 131010, 131201, 131202, 131203, 131204, 131205, 131206, 131210, 132001, 132002, 132201, 132202, 141001, 141002, 141003, 141004, 141005, 141006, 141007, 141009, 141010		
<b>accessories for</b>	105677		
			
<b>GEV No.</b>	102753	<b>Ref. No.</b>	BN822160022
<b>description</b>	nozzle holder brass		
			
<b>GEV No.</b>	105668	<b>Ref. No.</b>	41822410071 822410071 BN822410071
<b>description</b>	burner cap 3.5kW ø 84mm		
			
<b>GEV No.</b>	105669	<b>Ref. No.</b>	41822410041 822410041
<b>description</b>	burner head 3.5kW for burner cap ø 84mm		
			
<b>GEV No.</b>	105670	<b>Ref. No.</b>	41822410012 822410011 822410012 BN822410012
<b>description</b>	venturi 3.5kW for burner cap ø 84mm		
			
<b>GEV No.</b>	105671	<b>Ref. No.</b>	41822410081 822410081 BN822410081
<b>description</b>	burner cap 5.7kW ø 102mm		
			
<b>GEV No.</b>	105672	<b>Ref. No.</b>	41822410051 822410051
<b>description</b>	burner head 5.7kW for burner cap ø 102mm		
			
<b>GEV No.</b>	105673	<b>Ref. No.</b>	41822410022 822410021 822410022 BN822410022
<b>description</b>	venturi 5.7kW for burner cap ø 102mm		
			
<b>GEV No.</b>	105674	<b>Ref. No.</b>	BN822410091
<b>description</b>	burner cap 7kW ø 125mm with central hole		
			
<b>GEV No.</b>	105675	<b>Ref. No.</b>	—
<b>description</b>	burner head 7kW for burner cap ø 125mm		
			
<b>GEV No.</b>	105676	<b>Ref. No.</b>	BN822410032
<b>description</b>	venturi 7/10kW for burner cap ø 125mm		
			
<b>GEV No.</b>	105803	<b>Ref. No.</b>	822160030 BN822160031
<b>description</b>	screw connection thread M16x1.5 L 34mm ID ø 9/10.2mm		



			
<b>GEV No.</b>	105668	<b>Ref. No.</b>	41822410071 BN822410071
<b>description</b>	burner cap 3.5kW ø 84mm		
<b>For models:</b>	131001, 131002, 131003, 131004, 131005, 131006, 131010, 131201, 131202, 131203, 131204, 131205, 131206, 131210, 132001, 132002, 132201, 132202, 141001, 141002, 141003, 141004, 141005, 141006, 141007, 141009, 141010		
<b>accessories for</b>	105668		
			
<b>GEV No.</b>	102753	<b>Ref. No.</b>	BN822160022
<b>description</b>	nozzle holder brass		
			
<b>GEV No.</b>	105289	<b>Ref. No.</b>	—
<b>description</b>	air mixing sleeve L 50mm ED ø 45mm ID ø 42mm aluminium		
			
<b>GEV No.</b>	105669	<b>Ref. No.</b>	41822410041 822410041
<b>description</b>	burner head 3.5kW for burner cap ø 84mm		
			
<b>GEV No.</b>	105670	<b>Ref. No.</b>	41822410012 822410011 822410012 BN822410012
<b>description</b>	venturi 3.5kW for burner cap ø 84mm		
			
<b>GEV No.</b>	105803	<b>Ref. No.</b>	822160030 BN822160031
<b>description</b>	screw connection thread M16x1.5 L 34mm ID ø 9/10.2mm		





			
<b>GEV No.</b>	105671	<b>Ref. No.</b>	41822410081 BN822410081
<b>description</b>	burner cap 5.7kW ø 102mm		
<b>For models:</b>	131001, 131002, 131003, 131004, 131005, 131006, 131010, 131201, 131202, 131203, 131204, 131205, 131206, 131210, 132001, 132002, 132201, 132202, 141002, 141003, 141004, 141005, 141006, 141007, 141009, 141010		
<b>accessories for</b>	105671		
			
<b>GEV No.</b>	102753	<b>Ref. No.</b>	BN822160022
<b>description</b>	nozzle holder brass		
			
<b>GEV No.</b>	105289	<b>Ref. No.</b>	—
<b>description</b>	air mixing sleeve L 50mm ED ø 45mm ID ø 42mm aluminium		
			
<b>GEV No.</b>	105672	<b>Ref. No.</b>	41822410051 822410051
<b>description</b>	burner head 5.7kW for burner cap ø 102mm		
			
<b>GEV No.</b>	105673	<b>Ref. No.</b>	41822410022 822410021 822410022 BN822410022
<b>description</b>	venturi 5.7kW for burner cap ø 102mm		
			
<b>GEV No.</b>	105803	<b>Ref. No.</b>	822160030 BN822160031
<b>description</b>	screw connection thread M16x1.5 L 34mm ID ø 9/10.2mm		

			
1			
<b>GEV No.</b>	105674	<b>Ref. No.</b>	BN822410091
<b>description</b>	burner cap 7kW ø 125mm with central hole		
<b>For models:</b>	141001, 141002, 141003, 141004, 141005, 141006, 141007, 141009, 141010		
<b>accessories for</b>	105674		
	<b>GEV No.</b>	102753	<b>Ref. No.</b> BN822160022
nozzle holder brass			
	<b>GEV No.</b>	105289	<b>Ref. No.</b> —
air mixing sleeve L 50mm ED ø 45mm ID ø 42mm aluminium			
	<b>GEV No.</b>	105675	<b>Ref. No.</b> —
burner head 7kW for burner cap ø 125mm			
	<b>GEV No.</b>	105676	<b>Ref. No.</b> BN822410032
venturi 7/10kW for burner cap ø 125mm			
	<b>GEV No.</b>	105803	<b>Ref. No.</b> 822160030 BN822160031
screw connection thread M16x1.5 L 34mm ID ø 9/10.2mm			



			
1			
<b>GEV No.</b>	107203	<b>Ref. No.</b>	1032501413 1032501422 CR0937560
<b>description</b>	burner cap ø 85mm 3.5kW		
<b>For models:</b>	121001, 121005, 121101, 121102, 121105, 121106, 122101, 122102		
<b>accessories for</b>	107203		
	<b>GEV No.</b>	103140	<b>Ref. No.</b> 1032101400 1032101422 CR0795730
burner head seat ø 75mm for burner cap ø 85mm 3.5kW			

			
1			
<b>GEV No.</b>	107169	<b>Ref. No.</b>	1032501622 CR0937570
<b>description</b>	burner cap ø 95mm 5.5kW with central hole		
<b>For models:</b>	121101, 121102, 121105, 121106, 122101, 122102		

			
1			
<b>GEV No.</b>	105669	<b>Ref. No.</b>	41822410041
<b>description</b>	burner head 3.5kW for burner cap ø 84mm		
<b>For models:</b>	131001, 131002, 131003, 131004, 131005, 131006, 131010, 131201, 131202, 131203, 131204, 131205, 131206, 131210, 132001, 132002, 132201, 132202		
<b>accessories for</b>	105669		
	<b>GEV No.</b>	102753	<b>Ref. No.</b> BN822160022
nozzle holder brass			

<b>accessories for</b>	105669		
	<b>GEV No.</b>	105289	<b>Ref. No.</b> —
air mixing sleeve L 50mm ED ø 45mm ID ø 42mm aluminium			
	<b>GEV No.</b>	105668	<b>Ref. No.</b> 41822410071 822410071 BN822410071
burner cap 3.5kW ø 84mm			
	<b>GEV No.</b>	105670	<b>Ref. No.</b> 41822410012 822410011 822410012 BN822410012
venturi 3.5kW for burner cap ø 84mm			
	<b>GEV No.</b>	105803	<b>Ref. No.</b> 822160030 BN822160031
screw connection thread M16x1.5 L 34mm ID ø 9/10.2mm			

			
1			
<b>GEV No.</b>	107695	<b>Ref. No.</b>	BN822410650
<b>description</b>	burner head 3.5kW for burner cap ø 84mm		
<b>For models:</b>	141001, 141002, 141003, 141004, 141005, 141006, 141007, 141009, 141010		

			
1			
<b>GEV No.</b>	105672	<b>Ref. No.</b>	41822410051
<b>description</b>	burner head 5.7kW for burner cap ø 102mm		
<b>For models:</b>	131001, 131002, 131003, 131004, 131005, 131006, 131010, 131201, 131202, 131203, 131204, 131205, 131206, 131210, 132001, 132002, 132201, 132202		
<b>accessories for</b>	105672		
	<b>GEV No.</b>	102753	<b>Ref. No.</b> BN822160022
nozzle holder brass			
	<b>GEV No.</b>	105289	<b>Ref. No.</b> —
air mixing sleeve L 50mm ED ø 45mm ID ø 42mm aluminium			
	<b>GEV No.</b>	105671	<b>Ref. No.</b> 41822410081 822410081 BN822410081
burner cap 5.7kW ø 102mm			
	<b>GEV No.</b>	105673	<b>Ref. No.</b> 41822410022 822410021 822410022 BN822410022
venturi 5.7kW for burner cap ø 102mm			
	<b>GEV No.</b>	105803	<b>Ref. No.</b> 822160030 BN822160031
screw connection thread M16x1.5 L 34mm ID ø 9/10.2mm			



			
1			
<b>GEV No.</b>	107188	<b>Ref. No.</b>	BN822410660
<b>description</b>	burner head 5.7kW ø 141mm for burner cap ø 102mm		
<b>For models:</b>	141002, 141003, 141004, 141005, 141006, 141007, 141009, 141010		

			
1			
<b>GEV No.</b>	107696	<b>Ref. No.</b>	BN822410670
<b>description</b>	burner head 7/10kW for burner cap ø 125mm		
<b>For models:</b>	141001, 141002, 141003, 141004, 141005, 141006, 141007, 141009, 141010		

			
1			
<b>GEV No.</b>	105670	<b>Ref. No.</b>	41822410012 822410011 BN822410012
<b>description</b>	venturi 3.5kW for burner cap ø 84mm		
<b>For models:</b>	131001, 131002, 131003, 131004, 131005, 131006, 131010, 131201, 131202, 131203, 131204, 131205, 131206, 131210, 132001, 132002, 132201, 132202, 141001, 141002, 141003, 141004, 141005, 141006, 141007, 141009, 141010		
<b>accessories for</b>	105670		
	<b>GEV No.</b>	102753	<b>Ref. No.</b> BN822160022
nozzle holder brass			
	<b>GEV No.</b>	105289	<b>Ref. No.</b> —
air mixing sleeve L 50mm ED ø 45mm ID ø 42mm aluminium			
	<b>GEV No.</b>	105668	<b>Ref. No.</b> 41822410071 822410071 BN822410071
burner cap 3.5kW ø 84mm			
	<b>GEV No.</b>	105669	<b>Ref. No.</b> 41822410041 822410041
burner head 3.5kW for burner cap ø 84mm			
	<b>GEV No.</b>	105803	<b>Ref. No.</b> 822160030 BN822160031
screw connection thread M16x1.5 L 34mm ID ø 9/10.2mm			



			
1			
<b>GEV No.</b>	105673	<b>Ref. No.</b>	41822410022 822410021 BN822410022
<b>description</b>	venturi 5.7kW for burner cap ø 102mm		
<b>For models:</b>	131001, 131002, 131003, 131004, 131005, 131006, 131010, 131201, 131202, 131203, 131204, 131205, 131206, 131210, 132001, 132002, 132201, 132202, 141002, 141003, 141004, 141005, 141006, 141007, 141009, 141010		
<b>accessories for</b>	105673		
	<b>GEV No.</b>	102753	<b>Ref. No.</b> BN822160022
nozzle holder brass			
	<b>GEV No.</b>	105289	<b>Ref. No.</b> —
air mixing sleeve L 50mm ED ø 45mm ID ø 42mm aluminium			
	<b>GEV No.</b>	105671	<b>Ref. No.</b> 41822410081 822410081 BN822410081
burner cap 5.7kW ø 102mm			
	<b>GEV No.</b>	105672	<b>Ref. No.</b> 41822410051 822410051
burner head 5.7kW for burner cap ø 102mm			
	<b>GEV No.</b>	105803	<b>Ref. No.</b> 822160030 BN822160031
screw connection thread M16x1.5 L 34mm ID ø 9/10.2mm			

			
1			
<b>GEV No.</b>	105676	<b>Ref. No.</b>	BN822410032
<b>description</b>	venturi 7/10kW for burner cap ø 125mm		
<b>For models:</b>	141001, 141002, 141003, 141004, 141005, 141006, 141007, 141009, 141010		
<b>accessories for</b>	105676		
	<b>GEV No.</b>	102753	<b>Ref. No.</b> BN822160022
nozzle holder brass			
	<b>GEV No.</b>	105289	<b>Ref. No.</b> —
air mixing sleeve L 50mm ED ø 45mm ID ø 42mm aluminium			
	<b>GEV No.</b>	105674	<b>Ref. No.</b> BN822410091
burner cap 7kW ø 125mm with central hole			
	<b>GEV No.</b>	105675	<b>Ref. No.</b> —
burner head 7kW for burner cap ø 125mm			
	<b>GEV No.</b>	105803	<b>Ref. No.</b> 822160030 BN822160031
screw connection thread M16x1.5 L 34mm ID ø 9/10.2mm			



NGCR, NGES (2), NGHT (2) series

			
1			
<b>GEV No.</b>	105573	<b>Ref. No.</b>	GS4357
<b>description</b>	air mixer chamber housing		

			
1			
<b>GEV No.</b>	105572	<b>Ref. No.</b>	GS2825
<b>description</b>	air mixing sleeve		

			
1			
<b>GEV No.</b>	105563	<b>Ref. No.</b>	GS8014S
<b>description</b>	burner complete		
<b>For models:</b>	233001		
<b>spare parts for</b>	105563		
	<b>GEV No.</b>	105564	<b>Ref. No.</b> GS2020
	burner cap slotted		
	<b>GEV No.</b>	105565	<b>Ref. No.</b> GS4353
	burner pipe		

			
1			
<b>GEV No.</b>	105578	<b>Ref. No.</b>	GS2025
<b>description</b>	burner cap 5kW mounting pos. inner slotted		
<b>For models:</b>	231005, 231006, 231007, 231008, 233002, 233003, 235001		

			
1			
<b>GEV No.</b>	105564	<b>Ref. No.</b>	GS2020
<b>description</b>	burner cap slotted		
<b>accessories for</b>	105564		
	<b>GEV No.</b>	696272	<b>Ref. No.</b> AMA266
	grub screw thread M5 L 6mm DIN 916/ISO 4029 intake internal hexagon WS 2.5 Qty 1 pcs		

			
1			
<b>GEV No.</b>	105565	<b>Ref. No.</b>	GS4353
<b>description</b>	burner pipe		

			
1			
<b>GEV No.</b>	105571	<b>Ref. No.</b>	GS2826
<b>description</b>	internal pipe for air mixers		

			
1			
<b>GEV No.</b>	105574	<b>Ref. No.</b>	GS4358
<b>description</b>	nut ø 72.5mm for air mixers		

			
1			
<b>GEV No.</b>	107193	<b>Ref. No.</b>	GS.8033S
<b>description</b>	round burner 10kW connection 1" IT		
<b>For models:</b>	231001, 231002, 231003, 231004, 234003, 234004, 234006, 235001		
<b>accessories for</b>	107193		
	<b>GEV No.</b>	105562	<b>Ref. No.</b> GS4232
	blind screw connection 3/8"		
	<b>GEV No.</b>	105578	<b>Ref. No.</b> GS2025
	burner cap 5kW mounting pos. inner slotted		
	<b>GEV No.</b>	105579	<b>Ref. No.</b> GS4237
	venturi auxiliary pipe for 15kW burner		

			
1			
<b>GEV No.</b>	105579	<b>Ref. No.</b>	GS4237
<b>description</b>	venturi auxiliary pipe for 15kW burner		
<b>For models:</b>	231005, 231006, 231007, 231008, 233002, 233003, 235001		



height extensions

1



<b>GEV No.</b>	210195	<b>Ref. No.</b>	GS4029
<b>description</b>	attachment ring ø 264mm		

1



<b>GEV No.</b>	210194	<b>Ref. No.</b>	GS.2718A GS2718
<b>description</b>	attachment ring ø 300mm		

accessories

pan supports

1



<b>GEV No.</b>	210193	<b>Ref. No.</b>	GS2720
<b>description</b>	pan support ø 275mm		

1



<b>GEV No.</b>	210212	<b>Ref. No.</b>	41822410390 822410110
<b>description</b>	pan support W 272mm L 395mm H 65mm		
<b>For models:</b>	131001, 131002, 131003, 131004, 131005, 131006, 131010, 131201, 131202, 131203, 131204, 131205, 131206, 131210, 132001, 132002, 132201, 132202		

1



<b>GEV No.</b>	210151	<b>Ref. No.</b>	1032101100 1032101101
<b>description</b>	pan support W 295mm L 545mm gas range		
<b>For models:</b>	121001		

1



<b>GEV No.</b>	211055	<b>Ref. No.</b>	408014035
<b>description</b>	pan support W 315mm L 515mm H 43mm stainless steel		
<b>For models:</b>	111002, 111003, 112003, 112004		

1



<b>GEV No.</b>	211092	<b>Ref. No.</b>	408014065
<b>description</b>	pan support W 320mm L 520mm H 45mm		

1



<b>GEV No.</b>	210150	<b>Ref. No.</b>	1032101000 1032101001
<b>description</b>	pan support W 340mm L 545mm		
<b>For models:</b>	121005		

1



<b>GEV No.</b>	210196	<b>Ref. No.</b>	GS4004
<b>description</b>	pan support W 500mm L 500mm		



1

<b>GEV No.</b>	210051	<b>Ref. No.</b>	826330160
<b>description</b>	pan support W 580mm L 390mm H 70mm SS type series 700		

## air mixers



1

<b>GEV No.</b>	106804	<b>Ref. No.</b>	CR0508690
<b>description</b>	air mixer		



1

<b>GEV No.</b>	106805	<b>Ref. No.</b>	CR0508400
<b>description</b>	air mixer		
<b>For models:</b>	124103		



1

<b>GEV No.</b>	105570	<b>Ref. No.</b>	GS8000S
<b>description</b>	air mixer complete		
<b>For models:</b>	231001, 231002, 231003, 231004, 233001, 233002, 233003, 234003, 234004, 234006, 235001		



1

<b>GEV No.</b>	106066	<b>Ref. No.</b>	CM136600
<b>description</b>	air mixing tube dimensions 18x42mm ED ø 24mm		



1

<b>GEV No.</b>	106615	<b>Ref. No.</b>	41822120040
<b>description</b>	air mixing tube L 42mm ø 22mm		
<b>For models:</b>	133001, 133002, 133003, 133009, 133010, 133011, 133012, 133013, 133014, 133015, 133024, 133201, 133202, 133203, 133209, 133210, 133211, 133212, 133213, 133214, 133215, 133224		

## bar burners

## bar burners



1

<b>GEV No.</b>	105684	<b>Ref. No.</b>	41826390023 826390020
<b>description</b>	bar burner 2 row L 437mm W 220mm ømm H 144mm griddle		
<b>For models:</b>	123003, 123004, 123005, 123006, 123007, 123008, 123009, 133001, 133002, 133003, 133009, 133010, 133011, 133012, 133013, 133014, 133015, 133024, 133201, 133202, 133203, 133209, 133210, 133211, 133212, 133213, 133214, 133215, 133224		



1

<b>GEV No.</b>	104156	<b>Ref. No.</b>	1828112 MA1828112
<b>description</b>	bar burner 2 row L 445mm W 200mm ømm H 50mm chargrill stainless steel		
<b>For models:</b>	123101, 123102		



1

<b>GEV No.</b>	105260	<b>Ref. No.</b>	1031504600
<b>description</b>	bar burner 2 row L 450mm W 300mm ømm H 50mm 8.5kW griddle		



1

<b>GEV No.</b>	105863	<b>Ref. No.</b>	GS3648
<b>description</b>	bar burner 2 row L 525mm W 190mm ømm H 55mm grill		
<b>For models:</b>	234003, 234004, 234006		





1

<b>GEV No.</b>	103155	<b>Ref. No.</b>	2519270 BN2519270
<b>description</b>	bar burner 3 row L 610mm W 280mm ømm H 60mm chargrill		
<b>For models:</b>	133007, 133008, 133022, 133023, 133207, 133208, 133222, 133223, 143033, 143034		







			
1			
<b>GEV No.</b>	105694	<b>Ref. No.</b>	826390071
<b>description</b>	bar burner 6 row L 310mm W 620mm ømm H 50mm tilting bratt pan		
<b>For models:</b>	137002, 137202		

			
1			
<b>GEV No.</b>	105486	<b>Ref. No.</b>	1664300
<b>description</b>	bar burner angled L 440mm W 200mm ømm Hmm oven		

			
1			
<b>GEV No.</b>	103136	<b>Ref. No.</b>	46000-3.2
<b>description</b>	bar burner L 455mm W 140mm H 20mm mounting pos. centre		
<b>For models:</b>	263010, 263013		

			
1			
<b>GEV No.</b>	103137	<b>Ref. No.</b>	46000-3.1
<b>description</b>	bar burner L 455mm W 140mm H 20mm mounting pos. left		
<b>For models:</b>	263010, 263013		

			
1			
<b>GEV No.</b>	103135	<b>Ref. No.</b>	46000-3.3
<b>description</b>	bar burner L 455mm W 140mm H 20mm mounting pos. right		
<b>For models:</b>	263010, 263013		

			
1			
<b>GEV No.</b>	105380	<b>Ref. No.</b>	CO3100
<b>description</b>	bar burner ø 22mm Wmm Hmm L 540mm chargrill B50/B80		
<b>For models:</b>	243109, 243110		

			
1			
<b>GEV No.</b>	105381	<b>Ref. No.</b>	CO3158
<b>description</b>	bar burner ø 25mm Wmm Hmm L 542mm chargrill B115		
<b>For models:</b>	243110		

			
1			
<b>GEV No.</b>	104761	<b>Ref. No.</b>	404000100
<b>description</b>	bar burner ø 40mm Wmm Hmm L 385mm flange width 43mm flange length 43mm griddle		
<b>For models:</b>	113001, 113002, 113007, 113008, 113009, 113010, 113015, 113016, 113017, 113018, 243003, 243004, 243006, 243007, 243008		

			
1			
<b>GEV No.</b>	104240	<b>Ref. No.</b>	MA1031501000
<b>description</b>	bar burner ø 40mm Wmm Hmm L 400mm flange ø 61mm 1-row chargrill with bolt M5x12		
<b>For models:</b>	123103, 123104, 123106, 123107, 123108, 123109, 123117		

			
1			
<b>GEV No.</b>	103154	<b>Ref. No.</b>	2519430
<b>description</b>	bar burner ø 40mm Wmm Hmm L 420mm flange width 43mm flange length 43mm fryer		

			
1			
<b>GEV No.</b>	103156	<b>Ref. No.</b>	2519410
<b>description</b>	bar burner ø 50mm Wmm Hmm L 280mm flange width 71mm fryer		





			
1			
<b>GEV No.</b>	105442	<b>Ref. No.</b>	2510651
<b>description</b>	bar burner ø 50mm Wmm Hmm L 345mm flange with bolt M4 flange width 65mm flange length 71mm fryer		

			
1			
<b>GEV No.</b>	105523	<b>Ref. No.</b>	MACM088100
<b>description</b>	bar burner ø 50mm Wmm Hmm L 475mm flange ø 75mm		
<b>For models:</b>	146002		

			
1			
<b>GEV No.</b>	105436	<b>Ref. No.</b>	2510697 BN2510697
<b>description</b>	bar burner ø 50mm Wmm Hmm L 608mm flange width 71mm gas range flange ø 75mm		
<b>For models:</b>	141006, 141009, 141010		

			
1			
<b>GEV No.</b>	105255	<b>Ref. No.</b>	1031504500
<b>description</b>	bar burner ømm W 41mm H 34mm L 490mm flange width 70mm 5.5kW griddle		

			
1			
<b>GEV No.</b>	211091	<b>Ref. No.</b>	503000268
<b>description</b>	chargrill grid L 485mm W 310mm		
<b>For models:</b>	113001, 113002, 113019, 113020, 243007, 243008		

			
1			
<b>GEV No.</b>	211090	<b>Ref. No.</b>	503000285
<b>description</b>	chargrill grid L 485mm W 310mm fish		
<b>For models:</b>	113001, 113002, 113019, 113020, 243007, 243008		

			
1			
<b>GEV No.</b>	210257	<b>Ref. No.</b>	1041301200 MA1041301200
<b>description</b>	chargrill grid L 500mm W 330mm		
<b>For models:</b>	123102		

			
1			
<b>GEV No.</b>	210258	<b>Ref. No.</b>	1041301900 MA1041301900
<b>description</b>	chargrill grid L 500mm W 370mm		
<b>For models:</b>	123101		

			
1			
<b>GEV No.</b>	210166	<b>Ref. No.</b>	CO3126
<b>description</b>	chargrill grid L 540mm W 160mm		
<b>For models:</b>	243109, 243110		

			
1			
<b>GEV No.</b>	210256	<b>Ref. No.</b>	503000305 503000310
<b>description</b>	lava rock grid L 420mm W 240mm H 35mm		
<b>For models:</b>	113001, 113019, 243007, 243008		

			
1			
<b>GEV No.</b>	210259	<b>Ref. No.</b>	2519600
<b>description</b>	lava rock grid L 420mm W 305mm H 25mm		





 <p>1</p>			
<b>GEV No.</b>	211029	<b>Ref. No.</b>	1829522 MA1829522
<b>description</b>	lava rock grid L 464mm W 310mm		
<b>For models:</b>	123101, 123102		

 <p>1</p>			
<b>GEV No.</b>	210257	<b>Ref. No.</b>	1041301200 MA1041301200
<b>description</b>	chargrill grid L 500mm W 330mm		
<b>For models:</b>	123102		

 <p>1</p>			
<b>GEV No.</b>	211010	<b>Ref. No.</b>	CO2927
<b>description</b>	lava rock grid L 498mm W 320mm H 20mm		
<b>For models:</b>	243109		

 <p>1</p>			
<b>GEV No.</b>	210258	<b>Ref. No.</b>	1041301900 MA1041301900
<b>description</b>	chargrill grid L 500mm W 370mm		
<b>For models:</b>	123101		

 <p>1</p>			
<b>GEV No.</b>	211011	<b>Ref. No.</b>	CO3128
<b>description</b>	lava rock grid L 500mm W 480mm H 20mm		
<b>For models:</b>	243110		

 <p>1</p>			
<b>GEV No.</b>	210166	<b>Ref. No.</b>	CO3126
<b>description</b>	chargrill grid L 540mm W 160mm		
<b>For models:</b>	243109, 243110		

 <p>1</p>			
<b>GEV No.</b>	211089	<b>Ref. No.</b>	503000355 503000360
<b>description</b>	lava rock grid L 570mm W 420mm H 35mm		
<b>For models:</b>	113002, 113020		

<p>lava rock grids</p>  <p>1</p>			
<b>GEV No.</b>	210256	<b>Ref. No.</b>	503000305 503000310
<b>description</b>	lava rock grid L 420mm W 240mm H 35mm		
<b>For models:</b>	113001, 113019, 243007, 243008		

<p>chargrill grids</p>  <p>1</p>			
<b>GEV No.</b>	211091	<b>Ref. No.</b>	503000268
<b>description</b>	chargrill grid L 485mm W 310mm		
<b>For models:</b>	113001, 113002, 113019, 113020, 243007, 243008		

 <p>1</p>			
<b>GEV No.</b>	210259	<b>Ref. No.</b>	2519600
<b>description</b>	lava rock grid L 420mm W 305mm H 25mm		

 <p>1</p>			
<b>GEV No.</b>	211090	<b>Ref. No.</b>	503000285
<b>description</b>	chargrill grid L 485mm W 310mm fish		
<b>For models:</b>	113001, 113002, 113019, 113020, 243007, 243008		

 <p>1</p>			
<b>GEV No.</b>	211029	<b>Ref. No.</b>	1829522 MA1829522
<b>description</b>	lava rock grid L 464mm W 310mm		
<b>For models:</b>	123101, 123102		

			
1			
<b>GEV No.</b>	211010	<b>Ref. No.</b>	CO2927
<b>description</b>	lava rock grid L 498mm W 320mm H 20mm		
<b>For models:</b>	243109		

			
1			
<b>GEV No.</b>	211011	<b>Ref. No.</b>	CO3128
<b>description</b>	lava rock grid L 500mm W 480mm H 20mm		
<b>For models:</b>	243110		



			
1			
<b>GEV No.</b>	211089	<b>Ref. No.</b>	503000355 503000360
<b>description</b>	lava rock grid L 570mm W 420mm H 35mm		
<b>For models:</b>	113002, 113020		







**solid top burners**

			
1			
<b>GEV No.</b>	105251	<b>Ref. No.</b>	SI0100294
<b>description</b>	solid top burner ø 120mm H 102mm L 340mm		
<b>For models:</b>	141021		

**ceramic burners**

				
1				
<b>GEV No.</b>	104280	<b>Ref. No.</b>	PT0005	
<b>description</b>	ceramic burner L 160mm W 121mm firing range 130x90mm 1.75kW			
<b>For models:</b>	254005, 254006, 254007			
<b>spare parts for</b>	104280			
	<b>GEV No.</b>	104282	<b>Ref. No.</b>	PT0007+PT0008 PT0007+PT0009
	ceramic plate L 132mm W 92mm H 12mm			

<b>accessories for</b>	104280			
	<b>GEV No.</b>	100611	<b>Ref. No.</b>	PT0012
	gas injector bore ø 0.59mm LPG			
	<b>GEV No.</b>	100612	<b>Ref. No.</b>	PT0013
	gas injector bore ø 1.05mm natural gas			

				
1				
<b>GEV No.</b>	104281	<b>Ref. No.</b>	PT0006	
<b>description</b>	ceramic burner L 216mm W 160mm firing range 177x125mm pipe connection ø 8mm nozzle ø 1.45mm			
<b>For models:</b>	254008, 254009, 254010, 254011, 254012			
<b>spare parts for</b>	104281			
	<b>GEV No.</b>	104282	<b>Ref. No.</b>	PT0007+PT0008 PT0007+PT0009
	ceramic plate L 132mm W 92mm H 12mm			
<b>accessories for</b>	104281			
	<b>GEV No.</b>	100613	<b>Ref. No.</b>	PT0014
	gas injector bore ø 0.81mm LPG			
	<b>GEV No.</b>	100614	<b>Ref. No.</b>	PT0015
	gas injector bore ø 1.45mm natural gas			
	<b>GEV No.</b>	850029	<b>Ref. No.</b>	PT0291
	burner grid L 230mm W 150mm new edition			
	<b>GEV No.</b>	850031	<b>Ref. No.</b>	PT0265
	burner grid L 170mm W 165mm			

**accessories**

**burner grids**

			
1			
<b>GEV No.</b>	850031	<b>Ref. No.</b>	PT0265
<b>description</b>	burner grid L 170mm W 165mm		
<b>For models:</b>	254008		

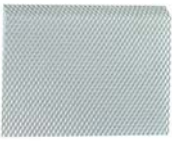

			
1			
<b>GEV No.</b>	850028	<b>Ref. No.</b>	PT0290
<b>description</b>	burner grid L 180mm W 113mm suitable for G1, G2, G3		

			
1			
<b>GEV No.</b>	850032	<b>Ref. No.</b>	PT0266
<b>description</b>	burner grid L 205mm W 160mm		

			
1			
<b>GEV No.</b>	850029	<b>Ref. No.</b>	PT0291
<b>description</b>	burner grid L 230mm W 150mm new edition		

ceramic plates			
			
1			
<b>GEV No.</b>	104282	<b>Ref. No.</b>	PT0007+PT0008 PT0007+PT0009
<b>description</b>	ceramic plate L 132mm W 92mm H 12mm		

### accessories

covers			
			
1			
<b>GEV No.</b>	106809	<b>Ref. No.</b>	41821530120
<b>description</b>	cover L 445mm W 170mm H 25mm for burner		
<b>For models:</b>	131001, 131002, 131003, 131004, 131005, 131006, 131010, 131201, 131202, 131203, 131204, 131205, 131206, 131210, 132001, 132002, 132201, 132202		

nozzle holders			
			
1			
<b>GEV No.</b>	102700	<b>Ref. No.</b>	822160260
<b>description</b>	nozzle holder		
<b>For models:</b>	131001, 131002, 131003, 131004, 131005, 131006, 132001, 132002		



				
1				
<b>GEV No.</b>	105230	<b>Ref. No.</b>	1033717200 MA1033717200	
<b>description</b>	nozzle holder			
<b>For models:</b>	121101, 121102, 121105, 121106, 122101, 122102			
<b>accessories for</b>	105230			
	<b>GEV No.</b>	103140	<b>Ref. No.</b>	1032101400 1032101422 CR0795730
burner head seat ø 75mm for burner cap ø 85mm 3.5kW				
	<b>GEV No.</b>	103141	<b>Ref. No.</b>	1032101500
burner head ø 95mm suitable for burner 5.5kW				
	<b>GEV No.</b>	103146	<b>Ref. No.</b>	1032101200
burner lower part for burner cap ø 85mm 3.5kW				
	<b>GEV No.</b>	103147	<b>Ref. No.</b>	1032101300 MA1032101300
burner lower part for burner cap ø 95mm 5.5/7kW				
	<b>GEV No.</b>	107143	<b>Ref. No.</b>	MACM297300
burner head for burner cap ø 95mm 5.5kW				









				
1				
<b>GEV No.</b>	102753	<b>Ref. No.</b>	BN822160022	
<b>description</b>	nozzle holder brass			
<b>For models:</b>	141001, 141002, 141003, 141004, 141005, 141006, 141007, 141009, 141010			
<b>accessories for</b>	102753			
	<b>GEV No.</b>	105289	<b>Ref. No.</b>	—
air mixing sleeve L 50mm ED ø 45mm ID ø 42mm aluminium				
	<b>GEV No.</b>	105668	<b>Ref. No.</b>	41822410071 822410071 BN822410071
burner cap 3.5kW ø 84mm				
	<b>GEV No.</b>	105669	<b>Ref. No.</b>	41822410041 822410041
burner head 3.5kW for burner cap ø 84mm				

Table continues overleaf

<b>accessories for</b> 102753					
	<table border="1"> <tr> <td>GEV No.</td> <td>105670</td> <td>Ref. No.</td> <td>41822410012 822410011 822410012 BN822410012</td> </tr> </table> <p>venturi 3.5kW for burner cap ø 84mm</p>	GEV No.	105670	Ref. No.	41822410012 822410011 822410012 BN822410012
GEV No.	105670	Ref. No.	41822410012 822410011 822410012 BN822410012		
	<table border="1"> <tr> <td>GEV No.</td> <td>105671</td> <td>Ref. No.</td> <td>41822410081 822410081 BN822410081</td> </tr> </table> <p>burner cap 5.7kW ø 102mm</p>	GEV No.	105671	Ref. No.	41822410081 822410081 BN822410081
GEV No.	105671	Ref. No.	41822410081 822410081 BN822410081		
	<table border="1"> <tr> <td>GEV No.</td> <td>105672</td> <td>Ref. No.</td> <td>41822410051 822410051</td> </tr> </table> <p>burner head 5.7kW for burner cap ø 102mm</p>	GEV No.	105672	Ref. No.	41822410051 822410051
GEV No.	105672	Ref. No.	41822410051 822410051		
	<table border="1"> <tr> <td>GEV No.</td> <td>105673</td> <td>Ref. No.</td> <td>41822410022 822410021 822410022 BN822410022</td> </tr> </table> <p>venturi 5.7kW for burner cap ø 102mm</p>	GEV No.	105673	Ref. No.	41822410022 822410021 822410022 BN822410022
GEV No.	105673	Ref. No.	41822410022 822410021 822410022 BN822410022		
	<table border="1"> <tr> <td>GEV No.</td> <td>105674</td> <td>Ref. No.</td> <td>BN822410091</td> </tr> </table> <p>burner cap 7kW ø 125mm with central hole</p>	GEV No.	105674	Ref. No.	BN822410091
GEV No.	105674	Ref. No.	BN822410091		
	<table border="1"> <tr> <td>GEV No.</td> <td>105675</td> <td>Ref. No.</td> <td>—</td> </tr> </table> <p>burner head 7kW for burner cap ø 125mm</p>	GEV No.	105675	Ref. No.	—
GEV No.	105675	Ref. No.	—		
	<table border="1"> <tr> <td>GEV No.</td> <td>105676</td> <td>Ref. No.</td> <td>BN822410032</td> </tr> </table> <p>venturi 7/10kW for burner cap ø 125mm</p>	GEV No.	105676	Ref. No.	BN822410032
GEV No.	105676	Ref. No.	BN822410032		
	<table border="1"> <tr> <td>GEV No.</td> <td>105803</td> <td>Ref. No.</td> <td>822160030 BN822160031</td> </tr> </table> <p>screw connection thread M16x1.5 L 34mm ID ø 9/10.2mm</p>	GEV No.	105803	Ref. No.	822160030 BN822160031
GEV No.	105803	Ref. No.	822160030 BN822160031		

					
<b>GEV No.</b>	105052	<b>Ref. No.</b>	1306615		
<b>description</b>	nozzle holder ID ø 10mm nozzle mounting M10x1				
<b>accessories for</b> 105052					
	<table border="1"> <tr> <td>GEV No.</td> <td>100469</td> <td>Ref. No.</td> <td>—</td> </tr> </table> <p>gas injector thread M10x1 WS 12 bore ø 1.15mm</p>	GEV No.	100469	Ref. No.	—
GEV No.	100469	Ref. No.	—		
	<table border="1"> <tr> <td>GEV No.</td> <td>100478</td> <td>Ref. No.</td> <td>—</td> </tr> </table> <p>gas injector thread M10x1 WS 12 bore ø 1.75mm</p>	GEV No.	100478	Ref. No.	—
GEV No.	100478	Ref. No.	—		
	<table border="1"> <tr> <td>GEV No.</td> <td>103150</td> <td>Ref. No.</td> <td>—</td> </tr> </table> <p>burner lower part for burner cap ø 110/120mm</p>	GEV No.	103150	Ref. No.	—
GEV No.	103150	Ref. No.	—		
	<table border="1"> <tr> <td>GEV No.</td> <td>104030</td> <td>Ref. No.</td> <td>—</td> </tr> </table> <p>burner head for burner cap ø 80mm</p>	GEV No.	104030	Ref. No.	—
GEV No.	104030	Ref. No.	—		
	<table border="1"> <tr> <td>GEV No.</td> <td>104031</td> <td>Ref. No.</td> <td>—</td> </tr> </table> <p>burner head for burner cap ø 110mm</p>	GEV No.	104031	Ref. No.	—
GEV No.	104031	Ref. No.	—		
	<table border="1"> <tr> <td>GEV No.</td> <td>104032</td> <td>Ref. No.</td> <td>—</td> </tr> </table> <p>burner head for burner cap ø 120mm</p>	GEV No.	104032	Ref. No.	—
GEV No.	104032	Ref. No.	—		
	<table border="1"> <tr> <td>GEV No.</td> <td>104033</td> <td>Ref. No.</td> <td>—</td> </tr> </table> <p>burner lower part for burner cap ø 80mm 1. generation</p>	GEV No.	104033	Ref. No.	—
GEV No.	104033	Ref. No.	—		

<b>accessories for</b> 105052					
	<table border="1"> <tr> <td>GEV No.</td> <td>104034</td> <td>Ref. No.</td> <td>—</td> </tr> </table> <p>burner lower part for burner cap ø 110mm</p>	GEV No.	104034	Ref. No.	—
GEV No.	104034	Ref. No.	—		
	<table border="1"> <tr> <td>GEV No.</td> <td>105051</td> <td>Ref. No.</td> <td>—</td> </tr> </table> <p>air mixing sleeve L 45mm ED ø 45mm ID ø 42mm aluminium</p>	GEV No.	105051	Ref. No.	—
GEV No.	105051	Ref. No.	—		

					
<b>GEV No.</b>	105267	<b>Ref. No.</b>	1781800		
<b>description</b>	nozzle holder nozzle M10x1 M14x1 screw pipe fitting M16x1.5 tube ø 10mm				
<b>accessories for</b> 105267					
	<table border="1"> <tr> <td>GEV No.</td> <td>105051</td> <td>Ref. No.</td> <td>—</td> </tr> </table> <p>air mixing sleeve L 45mm ED ø 45mm ID ø 42mm aluminium</p>	GEV No.	105051	Ref. No.	—
GEV No.	105051	Ref. No.	—		
	<table border="1"> <tr> <td>GEV No.</td> <td>105265</td> <td>Ref. No.</td> <td>—</td> </tr> </table> <p>burner head for burner cap ø 80mm</p>	GEV No.	105265	Ref. No.	—
GEV No.	105265	Ref. No.	—		
	<table border="1"> <tr> <td>GEV No.</td> <td>105266</td> <td>Ref. No.</td> <td>—</td> </tr> </table> <p>burner lower part for burner cap ø 80mm</p>	GEV No.	105266	Ref. No.	—
GEV No.	105266	Ref. No.	—		
	<table border="1"> <tr> <td>GEV No.</td> <td>105269</td> <td>Ref. No.</td> <td>—</td> </tr> </table> <p>burner head ø 158mm for burner cap ø 110mm</p>	GEV No.	105269	Ref. No.	—
GEV No.	105269	Ref. No.	—		
	<table border="1"> <tr> <td>GEV No.</td> <td>105272</td> <td>Ref. No.</td> <td>—</td> </tr> </table> <p>burner lower part for burner cap ø 110mm</p>	GEV No.	105272	Ref. No.	—
GEV No.	105272	Ref. No.	—		
	<table border="1"> <tr> <td>GEV No.</td> <td>105274</td> <td>Ref. No.</td> <td>—</td> </tr> </table> <p>burner head for burner cap ø 120mm</p>	GEV No.	105274	Ref. No.	—
GEV No.	105274	Ref. No.	—		
	<table border="1"> <tr> <td>GEV No.</td> <td>105275</td> <td>Ref. No.</td> <td>—</td> </tr> </table> <p>burner lower part for burner cap ø 120mm</p>	GEV No.	105275	Ref. No.	—
GEV No.	105275	Ref. No.	—		

			
<b>GEV No.</b>	106599	<b>Ref. No.</b>	CR0508630
<b>description</b>	nozzle holder nozzle M10x1 M14x1 screw pipe fitting M16x1.5 tube ø 10mm		
<b>For models:</b>	124103		





			
<b>GEV No.</b>	106600	<b>Ref. No.</b>	CM021700 MACM021700
<b>description</b>	nozzle holder nozzle M10x1 M14x1 screw pipe fitting M16x1.5 tube ø 10mm		
<b>For models:</b>	123101, 123102, 141021, 146002		





			
1			
<b>GEV No.</b>	106601	<b>Ref. No.</b>	1031504900
<b>description</b>	nozzle holder nozzle M10x1 M14x1 screw pipe fitting M16x1.5 tube ø 10mm		

			
1			
<b>GEV No.</b>	104784	<b>Ref. No.</b>	404520200
<b>description</b>	nozzle holder nozzle mounting M10x1 tube ø 10mm gas inlet M16x1.5 gas outlet M14x1		
<b>For models:</b>	113001, 113002, 113007, 113008, 113009, 113010, 113015, 113016, 113017, 113018, 113019, 113020, 243003, 243004, 243006, 243007, 243008		

			
1			
<b>GEV No.</b>	105803	<b>Ref. No.</b>	822160030 BN822160031
<b>description</b>	screw connection thread M16x1.5 L 34mm ID ø 9/10.2mm		
<b>For models:</b>	131001, 131002, 131003, 131004, 131005, 131006, 132001, 132002, 141001, 141002, 141003, 141004, 141005, 141006, 141007, 141009, 141010		
<b>accessories for</b>	105803		
	<b>GEV No.</b>	102753	<b>Ref. No.</b> BN822160022
nozzle holder brass			
	<b>GEV No.</b>	105289	<b>Ref. No.</b> —
air mixing sleeve L 50mm ED ø 45mm ID ø 42mm aluminium			
	<b>GEV No.</b>	105668	<b>Ref. No.</b> 41822410071 822410071 BN822410071
burner cap 3.5kW ø 84mm			
	<b>GEV No.</b>	105669	<b>Ref. No.</b> 41822410041 822410041
burner head 3.5kW for burner cap ø 84mm			
	<b>GEV No.</b>	105670	<b>Ref. No.</b> 41822410012 822410011 822410012 BN822410012
venturi 3.5kW for burner cap ø 84mm			
	<b>GEV No.</b>	105671	<b>Ref. No.</b> 41822410081 822410081 BN822410081
burner cap 5.7kW ø 102mm			
	<b>GEV No.</b>	105672	<b>Ref. No.</b> 41822410051 822410051
burner head 5.7kW for burner cap ø 102mm			

<b>accessories for</b>	105803		
	<b>GEV No.</b>	105673	<b>Ref. No.</b> 41822410022 822410021 822410022 BN822410022
venturi 5.7kW for burner cap ø 102mm			
	<b>GEV No.</b>	105674	<b>Ref. No.</b> BN822410091
burner cap 7kW ø 125mm with central hole			
	<b>GEV No.</b>	105675	<b>Ref. No.</b> —
burner head 7kW for burner cap ø 125mm			
	<b>GEV No.</b>	105676	<b>Ref. No.</b> BN822410032
venturi 7/10kW for burner cap ø 125mm			

<b>miscellaneous</b>			
			
1			
<b>GEV No.</b>	105575	<b>Ref. No.</b>	GS1456
<b>description</b>	compression spring ø 23mm L 35mm wire gauge ø 1.5mm for air mixers		
<b>For models:</b>	221021		

			
1			
<b>GEV No.</b>	104786	<b>Ref. No.</b>	404000109
<b>description</b>	connecting fitting L 27.5mm		

			
1			
<b>GEV No.</b>	109078	<b>Ref. No.</b>	MA1033600
<b>description</b>	level glass for burner		
<b>For models:</b>	124103, 141021		

			
1			
<b>GEV No.</b>	105576	<b>Ref. No.</b>	GS2851
<b>description</b>	ring nut		
<b>For models:</b>	233001		

## gas nozzles

### main nozzles

#### gas nozzles 3/8"

			
1			
<b>GEV No.</b>	100989	<b>Ref. No.</b>	GS282C
<b>description</b>	gas injector T1: 3/8" T2: M12x1.25 WS 19 bore ø 1.4mm LPG pressure range 50mbar 10kW		

			
1			
<b>GEV No.</b>	100992	<b>Ref. No.</b>	GS282E
<b>description</b>	gas injector T1: 3/8" T2: M12x1.25 WS 19 bore ø 1.6mm LPG pressure range 28-30/37mbar 10kW		

			
1			
<b>GEV No.</b>	100991	<b>Ref. No.</b>	GS282F
<b>description</b>	gas injector T1: 3/8" T2: M12x1.25 WS 19 bore ø 1.7mm LPG pressure range 50mbar 13kW		
<b>For models:</b>	231005, 231006, 231007, 231008, 233002, 233003, 235001		

			
1			
<b>GEV No.</b>	100993	<b>Ref. No.</b>	GS282G
<b>description</b>	gas injector T1: 3/8" T2: M12x1.25 WS 19 bore ø 1.95mm LPG pressure range 28-30/37mbar 13kW		
<b>For models:</b>	233002, 233003		

			
1			
<b>GEV No.</b>	106836	<b>Ref. No.</b>	GS2830
<b>description</b>	gas injector T1: 3/8" T2: M12x1.25 WS 19 bore ø 2.1mm pressure range 50mbar		
<b>For models:</b>	233001		

			
1			
<b>GEV No.</b>	100994	<b>Ref. No.</b>	GS282H
<b>description</b>	gas injector T1: 3/8" T2: M12x1.25 WS 19 bore ø 2.35mm natural gas pressure range 20/25mbar 9.3kW		
<b>For models:</b>	231001, 231002, 231003, 231004, 234003, 234004, 234006		

			
1			
<b>GEV No.</b>	100997	<b>Ref. No.</b>	GS282I
<b>description</b>	gas injector T1: 3/8" T2: M12x1.25 WS 19 bore ø 3.2mm natural gas pressure range 20/25mbar 15kW		

			
1			
<b>GEV No.</b>	100995	<b>Ref. No.</b>	GS282N
<b>description</b>	gas injector T1: 3/8" T2: M12x1.25 WS 19 bore ø 3.5mm natural gas pressure range 20mbar		
<b>For models:</b>	233002, 233003		

gas nozzles M6x0.75

			
1			
<b>GEV No.</b>	106591	<b>Ref. No.</b>	1033718900
<b>description</b>	gas injector thread M6x0.75 WS 7 bore ø 1.15mm		

			
1			
<b>GEV No.</b>	106483	<b>Ref. No.</b>	1033718300
<b>description</b>	gas injector thread M6x0.75 WS 7 bore ø 1.35mm		

			
1			
<b>GEV No.</b>	104766	<b>Ref. No.</b>	404000252
<b>description</b>	gas injector thread M6x0.75 WS 7 bore ø 0.85mm		
<b>For models:</b>	112003, 112004		

			
1			
<b>GEV No.</b>	106590	<b>Ref. No.</b>	1033718500
<b>description</b>	gas injector thread M6x0.75 WS 7 bore ø 0.8mm		

			
1			
<b>GEV No.</b>	104767	<b>Ref. No.</b>	404000207
<b>description</b>	gas injector thread M6x0.75 WS 7 bore ø 0.96mm		
<b>For models:</b>	112003, 112004		

			
1			
<b>GEV No.</b>	106588	<b>Ref. No.</b>	1033718600
<b>description</b>	gas injector thread M6x0.75 WS 7 bore ø 0.9mm		







			
1			
<b>GEV No.</b>	106592	<b>Ref. No.</b>	1033719100
<b>description</b>	gas injector thread M6x0.75 WS 7 bore ø 1mm		

			
1			
<b>GEV No.</b>	106593	<b>Ref. No.</b>	1033718400
<b>description</b>	gas injector thread M6x0.75 WS 7 bore ø 1.5mm		

			
1			
<b>GEV No.</b>	104782	<b>Ref. No.</b>	404000251
<b>description</b>	gas injector thread M6x0.75 WS 7 bore ø 0.75mm		

			
1			
<b>GEV No.</b>	106594	<b>Ref. No.</b>	1033718700
<b>description</b>	gas injector thread M6x0.75 WS 7 bore ø 1.75mm		

			
1			
<b>GEV No.</b>	104765	<b>Ref. No.</b>	404000206
<b>description</b>	gas injector thread M6x0.75 WS 7 bore ø 0.8mm		

			
1			
<b>GEV No.</b>	106589	<b>Ref. No.</b>	1033719000
<b>description</b>	gas injector thread M6x0.75 WS 7 bore ø 1.9mm		

			
1			
<b>GEV No.</b>	104781	<b>Ref. No.</b>	404000253
<b>description</b>	gas injector thread M6x0.75 WS 7 bore ø 1.3mm		
<b>For models:</b>	112003, 112004		

<b>gas nozzles M8x0.75</b>			
			
1			
<b>GEV No.</b>	104071	<b>Ref. No.</b>	CO3142
<b>description</b>	gas injector thread M8x0.75 WS 11 bore ø 0.92mm		
<b>For models:</b>	243109, 243110		

			
1			
<b>GEV No.</b>	104778	<b>Ref. No.</b>	404000208
<b>description</b>	gas injector thread M6x0.75 WS 7 bore ø 1.45mm		
<b>For models:</b>	112003, 112004		

<b>gas nozzles M10x1</b>			
			
1			
<b>GEV No.</b>	100633	<b>Ref. No.</b>	404547077
<b>description</b>	gas injector thread M10x1 WS 11 bore ø 0.75mm inner peaked		
<b>For models:</b>	113015, 113016, 113017, 113018, 243003, 243004, 243006, 243007, 243008		

			
1			
<b>GEV No.</b>	104787	<b>Ref. No.</b>	404000254
<b>description</b>	gas injector thread M6x0.75 WS 7 bore ø 1.4mm		

			
1			
<b>GEV No.</b>	100636	<b>Ref. No.</b>	404547093
<b>description</b>	gas injector thread M10x1 WS 11 bore ø 0.9mm inner peaked		
<b>For models:</b>	113001, 113002, 113007, 113008, 113009, 113010, 113015, 113016, 113017, 113018, 243007, 243008		

			
1			
<b>GEV No.</b>	104788	<b>Ref. No.</b>	404000211
<b>description</b>	gas injector thread M6x0.75 WS 7 bore ø 1.58mm		

			
1			
<b>GEV No.</b>	100637	<b>Ref. No.</b>	404547110
<b>description</b>	gas injector thread M10x1 WS 11 bore ø 1.1mm inner peaked		
<b>For models:</b>	113019, 113020		

			
<b>GEV No.</b>	100641	<b>Ref. No.</b>	404547135
<b>description</b>	gas injector thread M10x1 WS 11 bore ø 1.35mm inner peaked		
<b>For models:</b>	113001, 113002, 113007, 113008, 113009, 113010, 113015, 113016, 113017, 113018, 243003, 243004, 243006, 243007, 243008		

			
<b>GEV No.</b>	106595	<b>Ref. No.</b>	CR0508730
<b>description</b>	gas injector thread M10x1 bore ø 0.83mm L 30mm WS 12		

			
<b>GEV No.</b>	100150	<b>Ref. No.</b>	1491100
<b>description</b>	gas injector thread M10x1 bore ø 0.95mm L 30mm WS 12		

			
<b>GEV No.</b>	100670	<b>Ref. No.</b>	1695400
<b>description</b>	gas injector thread M10x1 bore ø 0.9mm L 30mm WS 12		

			
<b>GEV No.</b>	101974	<b>Ref. No.</b>	2715400
<b>description</b>	gas injector thread M10x1 bore ø 1.35mm L 30mm WS 12		

			
<b>GEV No.</b>	100155	<b>Ref. No.</b>	2902500 MA2902500
<b>description</b>	gas injector thread M10x1 bore ø 1.45mm L 30mm WS 12		
<b>For models:</b>	146002		

			
<b>GEV No.</b>	100816	<b>Ref. No.</b>	2715300
<b>description</b>	gas injector thread M10x1 bore ø 1.5mm WS 12		

			
<b>GEV No.</b>	100153	<b>Ref. No.</b>	1631200
<b>description</b>	gas injector thread M10x1 bore ø 1.6mm L 30mm WS 12		

			
<b>GEV No.</b>	106403	<b>Ref. No.</b>	MA707200
<b>description</b>	gas injector thread M10x1 bore ø 1.9mm L 30mm WS 12		
<b>For models:</b>	141021		

			
<b>GEV No.</b>	106465	<b>Ref. No.</b>	41822140270 BN822140270
<b>description</b>	gas injector thread M10x1 WS 12 bore ø 0.8mm		
<b>For models:</b>	131001, 131002, 131003, 131004, 131005, 131006, 131010, 131201, 131202, 131203, 131204, 131205, 131206, 131210, 132001, 132002, 132201, 132202, 141001, 141002, 141003, 141004, 141005, 141006, 141007, 141009, 141010		

			
<b>GEV No.</b>	106473	<b>Ref. No.</b>	41822140150
<b>description</b>	gas injector thread M10x1 WS 12 bore ø 1.05mm		
<b>For models:</b>	131001, 131002, 131003, 131004, 131005, 131006, 131010, 131201, 131202, 131203, 131204, 131205, 131206, 131210, 132001, 132002, 132201, 132202		

			
<b>GEV No.</b>	106466	<b>Ref. No.</b>	BN822140280
<b>description</b>	gas injector thread M10x1 WS 12 bore ø 1.15mm		
<b>For models:</b>	141001, 141002, 141003, 141004, 141005, 141006, 141007, 141009, 141010		

			
<b>GEV No.</b>	106609	<b>Ref. No.</b>	41822140010
<b>description</b>	gas injector thread M10x1 WS 12 bore ø 1.1mm		
<b>For models:</b>	133001, 133002, 133003, 133009, 133010, 133011, 133012, 133013, 133014, 133015, 133024, 133201, 133202, 133203, 133209, 133210, 133211, 133212, 133213, 133214, 133215, 133224		

			
<b>GEV No.</b>	106611	<b>Ref. No.</b>	41822140020
<b>description</b>	gas injector thread M10x1 WS 12 bore ø 1.25mm		
<b>For models:</b>	133001, 133002, 133003, 133009, 133010, 133011, 133012, 133013, 133014, 133015, 133024, 133201, 133202, 133203, 133209, 133210, 133211, 133212, 133213, 133214, 133215, 133224		





			
1			
<b>GEV No.</b>	106610	<b>Ref. No.</b>	41822140160 BN822140160
<b>description</b>	gas injector thread M10x1 WS 12 bore ø 1.2mm		
<b>For models:</b>	131001, 131002, 131003, 131004, 131005, 131006, 131010, 131201, 131202, 131203, 131204, 131205, 131206, 131210, 132001, 132002, 132201, 132202, 141002, 141003, 141004, 141005, 141006, 141007, 141009, 141010		

			
1			
<b>GEV No.</b>	106614	<b>Ref. No.</b>	41822140050
<b>description</b>	gas injector thread M10x1 WS 12 bore ø 1.9mm		
<b>For models:</b>	133001, 133002, 133003, 133009, 133010, 133011, 133012, 133013, 133014, 133015, 133024, 133201, 133202, 133203, 133209, 133210, 133211, 133212, 133213, 133214, 133215, 133224, 137002, 137202		

			
1			
<b>GEV No.</b>	106328	<b>Ref. No.</b>	BN822140030
<b>description</b>	gas injector thread M10x1 WS 12 bore ø 1.3mm		
<b>For models:</b>	141001, 141002, 141003, 141004, 141005, 141006, 141007, 141009, 141010		

			
1			
<b>GEV No.</b>	106458	<b>Ref. No.</b>	41822140060
<b>description</b>	gas injector thread M10x1 WS 12 bore ø 2.1mm		
<b>For models:</b>	133001, 133002, 133003, 133009, 133010, 133011, 133012, 133013, 133014, 133015, 133024, 133201, 133202, 133203, 133209, 133210, 133211, 133212, 133213, 133214, 133215, 133224		

			
1			
<b>GEV No.</b>	106612	<b>Ref. No.</b>	41822140040 BN822140040
<b>description</b>	gas injector thread M10x1 WS 12 bore ø 1.45mm		
<b>For models:</b>	131001, 131002, 131003, 131004, 131005, 131006, 131010, 131201, 131202, 131203, 131204, 131205, 131206, 131210, 132001, 132002, 132201, 132202, 141006, 141009, 141010		

			
1			
<b>GEV No.</b>	106474	<b>Ref. No.</b>	41822140220
<b>description</b>	gas injector thread M10x1 WS 12 bore ø 2mm		
<b>For models:</b>	131001, 131002, 131003, 131004, 131005, 131006, 131010, 131201, 131202, 131203, 131204, 131205, 131206, 131210, 132001, 132002, 132201, 132202		

			
1			
<b>GEV No.</b>	106613	<b>Ref. No.</b>	41822140190 BN822140190
<b>description</b>	gas injector thread M10x1 WS 12 bore ø 1.55mm		
<b>For models:</b>	131001, 131002, 131003, 131004, 131005, 131006, 131010, 131201, 131202, 131203, 131204, 131205, 131206, 131210, 132001, 132002, 132201, 132202, 141001, 141002, 141003, 141004, 141005, 141006, 141007, 141009, 141010		

			
1			
<b>GEV No.</b>	104780	<b>Ref. No.</b>	404547105
<b>description</b>	gas injector thread M10x1 WS 11 bore ø 1.05mm		

			
1			
<b>GEV No.</b>	106454	<b>Ref. No.</b>	41822140210
<b>description</b>	gas injector thread M10x1 WS 12 bore ø 1.8mm		
<b>For models:</b>	131001, 131002, 131003, 131004, 131005, 131006, 131010, 131201, 131202, 131203, 131204, 131205, 131206, 131210, 132001, 132002, 132201, 132202		

			
1			
<b>GEV No.</b>	106494	<b>Ref. No.</b>	0100944
<b>description</b>	gas injector thread M10x1 WS 11 bore ø 1.05mm		

			
1			
<b>GEV No.</b>	106490	<b>Ref. No.</b>	0109074
<b>description</b>	gas injector thread M10x1 WS 11 bore ø 1.25mm		



1

<b>GEV No.</b>	102704	<b>Ref. No.</b>	0101034
<b>description</b>	gas injector thread M10x1 WS 11 bore ø 1.2mm		



1

<b>GEV No.</b>	106495	<b>Ref. No.</b>	0101021
<b>description</b>	gas injector thread M10x1 WS 11 bore ø 2.25mm		



1

<b>GEV No.</b>	101997	<b>Ref. No.</b>	0100931
<b>description</b>	gas injector thread M10x1 WS 11 bore ø 1.4mm		



1

<b>GEV No.</b>	106496	<b>Ref. No.</b>	0102014
<b>description</b>	gas injector thread M10x1 WS 11 bore ø 2.2mm		



1

<b>GEV No.</b>	104779	<b>Ref. No.</b>	404547160
<b>description</b>	gas injector thread M10x1 WS 11 bore ø 1.6mm		



1

<b>GEV No.</b>	106497	<b>Ref. No.</b>	0109073
<b>description</b>	gas injector thread M10x1 WS 11 bore ø 2.4mm		



1

<b>GEV No.</b>	106493	<b>Ref. No.</b>	0100932
<b>description</b>	gas injector thread M10x1 WS 11 bore ø 1.75mm		



1

<b>GEV No.</b>	104768	<b>Ref. No.</b>	404547170
<b>description</b>	gas injector thread M10x1 WS 13 bore ø 1.7mm		



1

<b>GEV No.</b>	104777	<b>Ref. No.</b>	404547090
<b>description</b>	gas injector thread M10x1 WS 11 bore ø 1.7mm		



1

<b>GEV No.</b>	100536	<b>Ref. No.</b>	822140140
<b>description</b>	gas injector thread M10x1 WS 12 bore ø 0.95mm		
<b>For models:</b>	131001, 131002, 131003, 131004, 131005, 131006, 131010, 131201, 131202, 131203, 131204, 131205, 131206, 131210, 132001, 132002, 132201, 132202		



1

<b>GEV No.</b>	106440	<b>Ref. No.</b>	0100906
<b>description</b>	gas injector thread M10x1 WS 11 bore ø 1.85mm		



1

<b>GEV No.</b>	100472	<b>Ref. No.</b>	MA522111
<b>description</b>	gas injector thread M10x1 WS 12 bore ø 1.4mm		
<b>For models:</b>	143001, 143002, 143003, 143004		



1

<b>GEV No.</b>	106498	<b>Ref. No.</b>	0109075
<b>description</b>	gas injector thread M10x1 WS 11 bore ø 1.95mm		





			
1			
<b>GEV No.</b>	103234	<b>Ref. No.</b>	MA1630800
<b>description</b>	nozzle thread M10x1 WS 12 bore ø 1.5mm		
<b>For models:</b>	146002		

			
1			
<b>GEV No.</b>	100685	<b>Ref. No.</b>	2510488
<b>description</b>	gas injector thread M11x1 WS 13 bore ø 1.6mm		

gas nozzles M11x1

			
1			
<b>GEV No.</b>	100682	<b>Ref. No.</b>	2510370
<b>description</b>	gas injector thread M11x1 WS 13 bore ø 1.15mm		

			
1			
<b>GEV No.</b>	100686	<b>Ref. No.</b>	2510717
<b>description</b>	gas injector thread M11x1 WS 13 bore ø 1.7mm		

			
1			
<b>GEV No.</b>	100681	<b>Ref. No.</b>	8220065
<b>description</b>	gas injector thread M11x1 WS 13 bore ø 1.1mm		

			
1			
<b>GEV No.</b>	100689	<b>Ref. No.</b>	2510507
<b>description</b>	gas injector thread M11x1 WS 13 bore ø 1.85mm		

			
1			
<b>GEV No.</b>	106621	<b>Ref. No.</b>	2510411
<b>description</b>	gas injector thread M11x1 WS 13 bore ø 1.3mm		

			
1			
<b>GEV No.</b>	106623	<b>Ref. No.</b>	6A015880
<b>description</b>	gas injector thread M11x1 WS 13 bore ø 1.95mm		

			
1			
<b>GEV No.</b>	106622	<b>Ref. No.</b>	2510365
<b>description</b>	gas injector thread M11x1 WS 13 bore ø 1.4mm		

			
1			
<b>GEV No.</b>	106620	<b>Ref. No.</b>	2510506
<b>description</b>	gas injector thread M11x1 WS 13 bore ø 1mm		

			
1			
<b>GEV No.</b>	100684	<b>Ref. No.</b>	2510381
<b>description</b>	gas injector thread M11x1 WS 13 bore ø 1.55mm		

			
1			
<b>GEV No.</b>	106624	<b>Ref. No.</b>	2510457
<b>description</b>	gas injector thread M11x1 WS 13 bore ø 2.1mm		

			
1			
<b>GEV No.</b>	106625	<b>Ref. No.</b>	2510508
<b>description</b>	gas injector thread M11x1 WS 13 bore ø 2.3mm		

			
1			
<b>GEV No.</b>	106627	<b>Ref. No.</b>	2510382
<b>description</b>	gas injector thread M11x1 WS 13 bore ø 2.45mm		

			
1			
<b>GEV No.</b>	106626	<b>Ref. No.</b>	2510412
<b>description</b>	gas injector thread M11x1 WS 13 bore ø 2.4mm		

			
1			
<b>GEV No.</b>	106569	<b>Ref. No.</b>	2510487
<b>description</b>	gas injector thread M11x1 WS 13 bore ø 2.6mm		

			
1			
<b>GEV No.</b>	106628	<b>Ref. No.</b>	9000208
<b>description</b>	gas injector thread M11x1 WS 13 bore ø 2.8mm		

gas nozzles (other)

			
1			
<b>GEV No.</b>	100611	<b>Ref. No.</b>	PT0012
<b>description</b>	gas injector bore ø 0.59mm LPG		

			
1			
<b>GEV No.</b>	100613	<b>Ref. No.</b>	PT0014
<b>description</b>	gas injector bore ø 0.81mm LPG		

			
1			
<b>GEV No.</b>	100612	<b>Ref. No.</b>	PT0013
<b>description</b>	gas injector bore ø 1.05mm natural gas		

			
1			
<b>GEV No.</b>	100614	<b>Ref. No.</b>	PT0015
<b>description</b>	gas injector bore ø 1.45mm natural gas		

pilot burner nozzles

pilot burner nozzle AB

			
1			
<b>GEV No.</b>	100203	<b>Ref. No.</b>	822140370
<b>description</b>	pilot burner nozzle LPG code 25 Qty 1 pcs nozzle ø 0.25mm		
<b>For models:</b>	137002, 137202		

pilot burner nozzles POLIDORO

			
1			
<b>GEV No.</b>	106704	<b>Ref. No.</b>	6A013240 BN6A013240
<b>description</b>	pilot burner nozzle POLIDORO LPG code 16.2 bore ø 2x0.16mm Qty 1 pcs		
<b>For models:</b>	141001, 141002, 141003, 141004, 141005, 141006, 141007, 141009, 141010, 143033, 143034, 144002, 146008, 146009		

			
1			
<b>GEV No.</b>	106703	<b>Ref. No.</b>	6A013230 BN6A013230
<b>description</b>	pilot burner nozzle POLIDORO natural gas code 27.2 bore ø 2x0.27mm Qty 1 pcs		
<b>For models:</b>	141001, 141002, 141003, 141004, 141005, 141006, 141007, 141009, 141010, 143033, 143034, 144002, 146008, 146009		



pilot burner nozzles SIT

100 series



<b>GEV No.</b>	100245	<b>Ref. No.</b>	GC1001
<b>description</b>	pilot burner nozzle LPG code 20 bore $\varnothing$ 0.2mm Qty 1 pcs thread M8x0.75		



<b>GEV No.</b>	100246	<b>Ref. No.</b>	GS3828 SP385C
<b>description</b>	pilot burner nozzle natural gas bore $\varnothing$ 0.35mm Qty 1 pcs thread M8x0.75		
<b>For models:</b>	234003, 234004, 234006		

140/150 series



<b>GEV No.</b>	100204	<b>Ref. No.</b>	MA1888000
<b>description</b>	pilot burner nozzle SIT LPG code 14 bore $\varnothing$ 0.18/0.20mm Qty 1 pcs suitable for 140 series		
<b>For models:</b>	141021, 143001, 143002, 143003, 143004, 143005, 143006, 143007, 143008, 143009, 143010, 143011, 143012, 143013, 143014, 143015, 143016, 147003		



<b>GEV No.</b>	100205	<b>Ref. No.</b>	41822140380 BN822140380
<b>description</b>	pilot burner nozzle SIT LPG code 19 bore $\varnothing$ 0.23/0.26mm Qty 1 pcs suitable for SIT 150 series		
<b>For models:</b>	131001, 131002, 131003, 131004, 131005, 131006, 131010, 131201, 131202, 131203, 131204, 131205, 131206, 131210, 132001, 132002, 132201, 132202, 133001, 133002, 133003, 133009, 133010, 133011, 133012, 133013, 133014, 133015, 133024, 133201, 133202, 133203, 133209, 133210, 133211, 133212, 133213, 133214, 133215, 133224, 141006, 141009, 141010		



<b>GEV No.</b>	100207	<b>Ref. No.</b>	6A013107 822140120 MA1887800
<b>description</b>	pilot burner nozzle SIT natural gas code 27 bore $\varnothing$ 0.40/0.38mm suitable for SIT 140 series		
<b>For models:</b>	131001, 131002, 131003, 131004, 131005, 131006, 131010, 131201, 131202, 131203, 131204, 131205, 131206, 131210, 132001, 132002, 132201, 132202, 133001, 133002, 133003, 133009, 133010, 133011, 133012, 133013, 133014, 133015, 133024, 133201, 133202, 133203, 133209, 133210, 133211, 133212, 133213, 133214, 133215, 133224, 141021, 143001, 143002, 143003, 143004, 143005, 143006, 143007, 143008, 143009...(Other models you can see in the webshop)		

160 series



<b>GEV No.</b>	107172	<b>Ref. No.</b>	1874700 MA1874700
<b>description</b>	pilot burner nozzle SIT LPG code 25 Qty 1 pcs		
<b>For models:</b>	146002		



<b>GEV No.</b>	107650	<b>Ref. No.</b>	822140360
<b>description</b>	pilot burner nozzle SIT LPG code 30 Qty 1 pcs		
<b>For models:</b>	137002, 137202		



<b>GEV No.</b>	107174	<b>Ref. No.</b>	1033719700 MA1033719700
<b>description</b>	pilot burner nozzle SIT natural gas code 41 Qty 1 pcs		
<b>For models:</b>	146002		

pilot burner nozzles (other)

FIMAR



<b>GEV No.</b>	100161	<b>Ref. No.</b>	CO3151
<b>description</b>	pilot burner nozzle bore $\varnothing$ 0.2mm		
<b>For models:</b>	243109, 243110		



<b>GEV No.</b>	100163	<b>Ref. No.</b>	CO3150
<b>description</b>	pilot burner nozzle bore $\varnothing$ 0.3mm		
<b>For models:</b>	243109, 243110		

bypass nozzles

bypass nozzles PEL20/21



<b>GEV No.</b>	100554	<b>Ref. No.</b>	6A023722 822450200 BN6A023722
<b>description</b>	bypass nozzle type PEL20/21 bore ø 0.45mm thread M5x0.5		
<b>For models:</b>	131001, 131002, 131003, 131004, 131005, 131006, 132001, 132002, 141001, 141002, 141003, 141004, 141005, 141006, 141007, 141009, 141010		



<b>GEV No.</b>	100526	<b>Ref. No.</b>	41822450210
<b>description</b>	bypass nozzle type PEL20/21 bore ø 0.5mm thread M5x0.5		
<b>For models:</b>	131001, 131002, 131003, 131004, 131005, 131006, 131010, 131201, 131202, 131203, 131204, 131205, 131206, 131210, 132001, 132002, 132201, 132202		



<b>GEV No.</b>	100548	<b>Ref. No.</b>	6A023723 BN6A023723
<b>description</b>	bypass nozzle type PEL20/21 bore ø 0.65mm thread M5x0.5		
<b>For models:</b>	141001, 141002, 141003, 141004, 141005, 141006, 141007, 141009, 141010		



<b>GEV No.</b>	100278	<b>Ref. No.</b>	41822450230 BN822450230
<b>description</b>	bypass nozzle type PEL20/21 bore ø 0.75mm thread M5x0.5		
<b>For models:</b>	131001, 131002, 131003, 131004, 131005, 131006, 131010, 131201, 131202, 131203, 131204, 131205, 131206, 131210, 132001, 132002, 132201, 132202, 133001, 133002, 133003, 133009, 133010, 133011, 133012, 133013, 133014, 133015, 133203, 133209, 133210, 133211, 133212, 133213, 133214, 133215, 141002, 141003, 141004, 141005, 141006, 141007, 141009, 141010		



<b>GEV No.</b>	100555	<b>Ref. No.</b>	41822450240 BN822450240
<b>description</b>	bypass nozzle type PEL20/21 bore ø 0.8mm thread M5x0.5		
<b>For models:</b>	131001, 131002, 131003, 131004, 131005, 131006, 131010, 131201, 131202, 131203, 131204, 131205, 131206, 131210, 132001, 132002, 132201, 132202, 133001, 133002, 133003, 133009, 133010, 133011, 133012, 133013, 133014, 133015, 133024, 133201, 133202, 133203, 133209, 133210, 133211, 133212, 133213, 133214, 141001, 141002, 141003, 141004, 141005, 141006, 141007, 141009, 141010		



<b>GEV No.</b>	100556	<b>Ref. No.</b>	GS3687
<b>description</b>	bypass nozzle type PEL20/21 bore ø 0.95mm thread M5x0.5		
<b>For models:</b>	234003, 234004, 234006		



<b>GEV No.</b>	100528	<b>Ref. No.</b>	41822450260 BN822450260 MA1889000
<b>description</b>	bypass nozzle type PEL20/21 bore ø 0.9mm thread M5x0.5		
<b>For models:</b>	131001, 131002, 131003, 131004, 131005, 131006, 131010, 131201, 131202, 131203, 131204, 131205, 131206, 131210, 132001, 132002, 132201, 132202, 133001, 133002, 133003, 133009, 133010, 133011, 133012, 133013, 133014, 133015, 133024, 133201, 133202, 133203, 133209, 133210, 133211, 133212, 133213, 133214, 133215, 133224, 141001, 141002, 141003, 141004, 141005, 141006, 141007, 141009, 141010		



<b>GEV No.</b>	100531	<b>Ref. No.</b>	BN6A023724
<b>description</b>	bypass nozzle type PEL20/21 bore ø 1.15mm thread M5x0.5		
<b>For models:</b>	141002, 141003, 141004, 141005, 141006, 141007, 141009, 141010		



<b>GEV No.</b>	100394	<b>Ref. No.</b>	41822450690
<b>description</b>	bypass nozzle type PEL20/21 bore ø 1.25mm thread M5x0.5		
<b>For models:</b>	133001, 133002, 133003, 133009, 133010, 133011, 133012, 133013, 133014, 133015, 133024, 133201, 133202, 133203, 133209, 133210, 133211, 133212, 133213, 133214, 133215, 133224		



<b>GEV No.</b>	100532	<b>Ref. No.</b>	41822450280 BN822450280
<b>description</b>	bypass nozzle type PEL20/21 bore ø 1.2mm thread M5x0.5		
<b>For models:</b>	131001, 131002, 131003, 131004, 131005, 131006, 131010, 131201, 131202, 131203, 131204, 131205, 131206, 131210, 132001, 132002, 132201, 132202, 141001, 141002, 141003, 141004, 141005, 141006, 141007, 141009, 141010		



<b>GEV No.</b>	100549	<b>Ref. No.</b>	41822450300 BN822450300
<b>description</b>	bypass nozzle type PEL20/21 bore ø 1.35mm thread M5x0.5		
<b>For models:</b>	133001, 133002, 133003, 133009, 133010, 133011, 133012, 133013, 133014, 133015, 133024, 133201, 133202, 133203, 133209, 133210, 133211, 133212, 133213, 133214, 133215, 133224, 141001, 141002, 141003, 141004, 141005, 141006, 141007, 141009, 141010		





<b>GEV No.</b>	100533	<b>Ref. No.</b>	41822450290
<b>description</b>	bypass nozzle type PEL20/21 bore ø 1.3mm thread M5x0.5		
<b>For models:</b>	131001, 131002, 131003, 131004, 131005, 131006, 131010, 131201, 131202, 131203, 131204, 131205, 131206, 131210, 132001, 132002, 132201, 132202, 133001, 133002, 133003, 133009, 133010, 133011, 133012, 133013, 133014, 133015, 133203, 133209, 133210, 133211, 133212, 133213, 133214, 133215		







			
1			
<b>GEV No.</b>	100534	<b>Ref. No.</b>	BN6A023725
<b>description</b>	bypass nozzle type PEL20/21 bore ø 1.4mm thread M5x0.5		
<b>For models:</b>	143033, 143034		

			
1			
<b>GEV No.</b>	106608	<b>Ref. No.</b>	41822450310
<b>description</b>	bypass nozzle type PEL20/21 bore ø 1.6mm thread M5x0.5		
<b>For models:</b>	133001, 133002, 133003, 133009, 133010, 133011, 133012, 133013, 133014, 133015, 133024, 133201, 133202, 133203, 133209, 133210, 133211, 133212, 133213, 133214, 133215, 133224		

			
1			
<b>GEV No.</b>	100529	<b>Ref. No.</b>	MA1889100
<b>description</b>	bypass nozzle type PEL20/21 bore ø 1mm thread M5x0.5		
<b>For models:</b>	143011, 143012, 143013, 143014, 143015, 143016		

			
1			
<b>GEV No.</b>	106871	<b>Ref. No.</b>	CR0586570
<b>description</b>	bypass nozzle type PEL20/21 bore ø 2.2mm thread M5x0.5		
<b>For models:</b>	143011, 143012, 143013, 143014, 143015, 143016		

**bypass nozzles PEL22**

			
1			
<b>GEV No.</b>	106870	<b>Ref. No.</b>	CR0683130
<b>description</b>	bypass nozzle type PEL22 bore ø 1.35mm thread M6x0.5		
<b>For models:</b>	141021		

**bypass nozzles SABAF**

			
1			
<b>GEV No.</b>	106586	<b>Ref. No.</b>	1885000
<b>description</b>	bypass nozzle bore ø 0.5mm thread M4x0.5 SABAF		

			
1			
<b>GEV No.</b>	106587	<b>Ref. No.</b>	1885600
<b>description</b>	bypass nozzle bore ø 0.8mm thread M4x0.5 SABAF		

**gas nozzles sets**

			
1			
<b>GEV No.</b>	106632	<b>Ref. No.</b>	2591665
<b>description</b>	gas injector set		

			
1			
<b>GEV No.</b>	106633	<b>Ref. No.</b>	2591666
<b>description</b>	gas injector set		

			
1			
<b>GEV No.</b>	106634	<b>Ref. No.</b>	2591667
<b>description</b>	gas injector set		

			
1			
<b>GEV No.</b>	106635	<b>Ref. No.</b>	2591721
<b>description</b>	gas injector set		



1

<b>GEV No.</b>	106636	<b>Ref. No.</b>	2591720
<b>description</b>	gas injector set		



1

<b>GEV No.</b>	106640	<b>Ref. No.</b>	2591722
<b>description</b>	gas injector set for tilting bratt pan		

## auxiliary gas parts

### screw connections

#### double nipples



1

<b>GEV No.</b>	106617	<b>Ref. No.</b>	41822450170
<b>description</b>	screw connection T1: 3/8" T2: M16x1.5 tube ø 10mm		
<b>For models:</b>	131003, 131005, 131201, 131202, 131203, 131204, 131205, 131206, 131210, 132201, 132202, 133001, 133002, 133003, 133009, 133010, 133011, 133012, 133013, 133014, 133015, 133024, 133201, 133202, 133203, 133209, 133210, 133211, 133212, 133213, 133214, 133215, 133224		

#### olives







1

<b>GEV No.</b>	101249	<b>Ref. No.</b>	673400 6A011470
<b>description</b>	olive for pipe ø 10mm Qty 1 pcs		
<b>accessories for</b>	101249		
	<b>GEV No.</b>	101250	<b>Ref. No.</b> 6A011475
	union nut thread M20x1.5 for pipe ø 10mm		



1

<b>GEV No.</b>	101278	<b>Ref. No.</b>	6A011480 MA86720
<b>description</b>	olive for pipe ø 10mm Qty 1 pcs		
<b>For models:</b>	121101, 121102, 121105, 121106, 122101, 122102, 123101, 123102, 123103, 123104, 123106, 123107, 123108, 123109, 123117, 124103, 126101, 126103, 131001, 131002, 131003, 131004, 131005, 131006, 131010, 131201, 131202, 131203, 131204, 131205, 131206, 131210, 132001, 132002, 132201, 132202, 133001, 133002, 133003, 133007, 133008, 133009, 133010, 133011, 133012, 133013, 133014, 133015, 133022, 133023...(Other models you can see in the webshop)		
<b>accessories for</b>	101278		
	<b>GEV No.</b>	100943	<b>Ref. No.</b> —
	union nut thread M17x1 tube ø 10mm		
	<b>GEV No.</b>	101300	<b>Ref. No.</b> 6A011485 MA1326500
	union nut thread M16x1.5 tube ø 10mm		
	<b>GEV No.</b>	101478	<b>Ref. No.</b> 1665200 MA1665200
	union nut thread 3/8" for pipe ø 10mm		





1

<b>GEV No.</b>	106638	<b>Ref. No.</b>	6A016300
<b>description</b>	olive for pipe ø 12mm L 10mm Qty 1 pcs		



1



<b>GEV No.</b>	101273	<b>Ref. No.</b>	6A011625 MA417810
<b>description</b>	olive for pipe ø 12mm L 9.5mm brass Qty 1 pcs suitable for universal		
<b>For models:</b>	124103, 143001, 143002, 143003, 143004, 143005, 143006, 143007, 143008, 143009, 143010, 143011, 143012, 143013, 143014, 143015, 143016, 147003		
<b>accessories for</b>	101273		
	<b>GEV No.</b>	100944	<b>Ref. No.</b> —
	union nut thread M18x1.5 for pipe ø 12mm		
	<b>GEV No.</b>	101276	<b>Ref. No.</b> 459300 6A011620 MA459300
	union screw thread 3/8" tube ø 12mm Qty 1 pcs		







1

<b>GEV No.</b>	101248	<b>Ref. No.</b>	MA673300
<b>description</b>	olive for pipe ø 12mm Qty 1 pcs suitable for PEL		
<b>For models:</b>	141021, 146002		
<b>accessories for</b>	101248		
	<b>GEV No.</b>	101251	<b>Ref. No.</b> 6A016200 MA673100
	union nut thread M20x1.5 for pipe ø 12mm		





			
1			
<b>GEV No.</b>	101256	<b>Ref. No.</b>	MA1127400
<b>description</b>	olive for pipe ø 16mm Qty 1 pcs		
<b>For models:</b>	146002, 147003		
<b>accessories for</b>	101256		
	<b>GEV No.</b>	101253	<b>Ref. No.</b> MA1421000
union nut thread M24x1.5 PEL for pipe ø 16mm			



			
1			
<b>GEV No.</b>	106598	<b>Ref. No.</b>	866200 MA866200
<b>description</b>	olive for pipe ø 18mm Qty 1 pcs ED ø 21mm		
<b>For models:</b>	124101, 124102, 124103, 125101, 125102, 125103, 126101, 126103		

			
1			
<b>GEV No.</b>	101282	<b>Ref. No.</b>	MA469000
<b>description</b>	olive for pipe ø 4mm L 7.4mm Qty 1 pcs		
<b>For models:</b>	123103, 123104, 123106, 123107, 123108, 123109, 123117		
<b>accessories for</b>	101282		
	<b>GEV No.</b>	100908	<b>Ref. No.</b> 41822450110 6A016110 6A017000 822450040 822450110 BN6A017000 MA673500
union screw thread M10x1 for pipe ø 4mm Qty 1 pcs			
	<b>GEV No.</b>	101283	<b>Ref. No.</b> —
union screw thread M10x1 for pipe ø 4mm Qty 1 pcs			

			
1			
<b>GEV No.</b>	106637	<b>Ref. No.</b>	6A016900 BN6A016900
<b>description</b>	olive for pipe ø 4mm L 7mm Qty 1 pcs		
<b>For models:</b>	141001, 141002, 141003, 141004, 141005, 141006, 141007, 141009, 141010		

			
1			
<b>GEV No.</b>	101246	<b>Ref. No.</b>	673600 6A016120 MA673600
<b>description</b>	olive for pipe ø 4mm Qty 1 pcs		
<b>For models:</b>	121101, 121102, 121105, 121106, 122101, 122102, 123101, 123102, 123103, 123104, 123106, 123107, 123108, 123109, 123117, 124103, 133001, 133002, 133003, 133007, 133008, 133009, 133010, 133011, 133012, 133013, 133014, 133015, 133022, 133023, 133024, 133201, 133202, 133203, 133207, 133208, 133209, 133210, 133211, 133212, 133213, 133214, 133215, 133222, 133223, 133224, 136001, 136005, 136006, 136205...(Other models you can see in the webshop)		
<b>accessories for</b>	101246		
	<b>GEV No.</b>	100908	<b>Ref. No.</b> 41822450110 6A016110 6A017000 822450040 822450110 BN6A017000 MA673500
union screw thread M10x1 for pipe ø 4mm Qty 1 pcs			

			
1			
<b>GEV No.</b>	100897	<b>Ref. No.</b>	1888100 822450050 MA1888100
<b>description</b>	olive for pipe ø 4mm Qty 1 pcs for pilot burner		
<b>For models:</b>	123101, 123102, 131001, 131002, 131003, 131004, 131005, 131006, 131010, 131201, 131202, 131203, 131204, 131205, 131206, 131210, 132001, 132002, 132201, 132202, 133001, 133002, 133003, 133009, 133010, 133011, 133012, 133013, 133014, 133015, 133024, 133201, 133202, 133203, 133209, 133210, 133211, 133212, 133213, 133214, 133215, 133224, 143001, 143002, 143003, 143004, 143005, 143006, 143007, 143008...(Other models you can see in the webshop)		

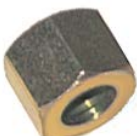

			
1			
<b>GEV No.</b>	100898	<b>Ref. No.</b>	822450470
<b>description</b>	olive for pipe ø 6mm Qty 1 pcs for pilot burner		
<b>For models:</b>	131001, 131002, 131003, 131004, 131005, 131006, 132001, 132002		
<b>accessories for</b>	100898		
	<b>GEV No.</b>	100909	<b>Ref. No.</b> 822450450
union screw thread M10x1 for pipe ø 6mm Qty 1 pcs			

union nuts



			
1			
<b>GEV No.</b>	101478	<b>Ref. No.</b>	1665200 MA1665200
<b>description</b>	union nut thread 3/8" for pipe ø 10mm		
<b>For models:</b>	121102, 121105		



				
1				
<b>GEV No.</b>	101296	<b>Ref. No.</b>	PT0244	
<b>description</b>	union nut thread M12x1 for pipe ø 8mm			
<b>For models:</b>	254008, 254009, 254010, 254011, 254012			
<b>accessories for</b>	101296			
	<b>GEV No.</b>	101277	<b>Ref. No.</b>	404000204 404000263 PT0010
olive ID ø 8mm Qty 1 pcs				



				
1				
<b>GEV No.</b>	101251	<b>Ref. No.</b>	6A016200 MA673100	
<b>description</b>	union nut thread M20x1.5 for pipe ø 12mm			
<b>For models:</b>	141021, 146002, 147003			
<b>accessories for</b>	101251			
	<b>GEV No.</b>	101248	<b>Ref. No.</b>	MA673300
olive for pipe ø 12mm Qty 1 pcs suitable for PEL				

				
1				
<b>GEV No.</b>	101476	<b>Ref. No.</b>	1665300 MA1665300	
<b>description</b>	union nut thread M13x1 for pipe ø 8mm			
<b>For models:</b>	121102, 121105			



				
1				
<b>GEV No.</b>	101253	<b>Ref. No.</b>	MA1421000	
<b>description</b>	union nut thread M24x1.5 PEL for pipe ø 16mm			
<b>For models:</b>	146002			
<b>accessories for</b>	101253			
	<b>GEV No.</b>	101256	<b>Ref. No.</b>	MA1127400
olive for pipe ø 16mm Qty 1 pcs				

				
1				
<b>GEV No.</b>	520223	<b>Ref. No.</b>	86643	
<b>description</b>	union nut thread M16x1 WS 19 L 15mm for pipe ø 10mm			

<b>union screws</b>				
				
1				
<b>GEV No.</b>	100904	<b>Ref. No.</b>	1394700 6A011608 MA1394700	
<b>description</b>	locking screw M10x1 for pipe ø 4mm Qty 1 pcs			
<b>For models:</b>	124103, 131003, 131005, 131201, 131202, 131203, 131204, 131205, 131206, 131210, 132201, 132202, 133001, 133002, 133003, 133009, 133010, 133011, 133012, 133013, 133014, 133015, 133024, 133201, 133202, 133203, 133209, 133210, 133211, 133212, 133213, 133214, 133215, 133224, 134002, 134004, 134006, 134202, 134204, 134206, 143001, 143002, 143003, 143004, 143005, 143006, 143007, 143008, 143009, 143010...(Other models you can see in the webshop)			

				
1				
<b>GEV No.</b>	101300	<b>Ref. No.</b>	6A011485 MA1326500	
<b>description</b>	union nut thread M16x1.5 tube ø 10mm			
<b>For models:</b>	121101, 121102, 121105, 121106, 122101, 122102, 123101, 123102, 123103, 123104, 123106, 123107, 123108, 123109, 123117, 124103, 126101, 126103, 143001, 143002, 143003, 143004, 143005, 143006, 143007, 143008, 143009, 143010, 143011, 143012, 143013, 143014, 143015, 143016, 146002, 147003			
<b>accessories for</b>	101300			
	<b>GEV No.</b>	101278	<b>Ref. No.</b>	6A011480 MA86720
olive for pipe ø 10mm Qty 1 pcs				

				
1				
<b>GEV No.</b>	100906	<b>Ref. No.</b>	6A011707 MA1888400	
<b>description</b>	screw connection thread M10x1 for ignition electrode brass Qty 1 pcs WS 10			
<b>For models:</b>	121102, 121105, 123101, 123102, 123103, 123104, 123106, 123107, 123108, 123109, 123117, 124103, 131001, 131002, 131003, 131004, 131005, 131006, 131010, 131201, 131202, 131203, 131204, 131205, 131206, 131210, 132001, 132002, 132201, 132202, 133001, 133002, 133003, 133009, 133010, 133011, 133012, 133013, 133014, 133015, 133024, 133201, 133202, 133203, 133209, 133210, 133211, 133212, 133213, 133214...(Other models you can see in the webshop)			





				
1				
<b>GEV No.</b>	101250	<b>Ref. No.</b>	6A011475	
<b>description</b>	union nut thread M20x1.5 for pipe ø 10mm			
<b>accessories for</b>	101250			
	<b>GEV No.</b>	101249	<b>Ref. No.</b>	673400 6A011470
olive for pipe ø 10mm Qty 1 pcs				



			
1			
<b>GEV No.</b>	100907	<b>Ref. No.</b>	MA1891700
<b>description</b>	screw connection thread M10x1 Qty 1 pcs type SEF 1 ømm for thermocouple		
<b>For models:</b>	123101, 123102, 123103, 123104, 123106, 123107, 123108, 123109, 123117, 124103, 141001, 141002, 141003, 141004, 141005, 141006, 141007, 141009, 141010, 143033, 143034, 146008, 146009, 147003		

			
1			
<b>GEV No.</b>	104783	<b>Ref. No.</b>	404000205
<b>description</b>	union screw for pipe ø 8mm Qty 1 pcs WS 13		
<b>For models:</b>	111002, 111003		

			
1			
<b>GEV No.</b>	106597	<b>Ref. No.</b>	866000 MA866000
<b>description</b>	union screw thread 3/4" for pipe ø 18mm L 20mm Qty 1 pcs WS 27		
<b>For models:</b>	124101, 124102, 124103, 125101, 125102, 125103, 126101, 126103		

			
1			
<b>GEV No.</b>	100908	<b>Ref. No.</b>	41822450110 6A016110 6A017000 822450040 BN6A017000 MA673500
<b>description</b>	union screw thread M10x1 for pipe ø 4mm Qty 1 pcs		
<b>For models:</b>	121101, 121102, 121105, 121106, 122101, 122102, 123101, 123102, 123103, 123104, 123106, 123107, 123108, 123109, 123117, 124103, 131001, 131002, 131003, 131004, 131005, 131006, 131010, 131201, 131202, 131203, 131204, 131205, 131206, 131210, 132001, 132002, 132201, 132202, 133001, 133002, 133003, 133007, 133008, 133009, 133010, 133011, 133012, 133013, 133014, 133015, 133022, 133023, 133024, 133201...(Other models you can see in the webshop)		
<b>accessories for</b>	100908		
	<b>GEV No.</b>	100897	<b>Ref. No.</b> 1888100 822450050 MA1888100
olive for pipe ø 4mm Qty 1 pcs for pilot burner			
	<b>GEV No.</b>	101246	<b>Ref. No.</b> 673600 6A016120 MA673600
olive for pipe ø 4mm Qty 1 pcs			
	<b>GEV No.</b>	101280	<b>Ref. No.</b>
olive for pipe ø 4mm Qty 1 pcs			
	<b>GEV No.</b>	101282	<b>Ref. No.</b> MA469000
olive for pipe ø 4mm L 7.4mm Qty 1 pcs			

			
1			
<b>GEV No.</b>	100909	<b>Ref. No.</b>	822450450
<b>description</b>	union screw thread M10x1 for pipe ø 6mm Qty 1 pcs		
<b>For models:</b>	131001, 131002, 131003, 131004, 131005, 131006, 132001, 132002		
<b>accessories for</b>	100909		
	<b>GEV No.</b>	100898	<b>Ref. No.</b> 822450470
olive for pipe ø 6mm Qty 1 pcs for pilot burner			
	<b>GEV No.</b>	101286	<b>Ref. No.</b>
olive ID ø 6mm Qty 1 pcs			
	<b>GEV No.</b>	101287	<b>Ref. No.</b>
olive for pipe ø 6mm Qty 1 pcs			
	<b>GEV No.</b>	101288	<b>Ref. No.</b>
olive for pipe ø 6mm L 6mm aluminium Qty 1 pcs ED ø 8.5mm			

locking screws

			
1			
<b>GEV No.</b>	105562	<b>Ref. No.</b>	GS4232
<b>description</b>	blind screw connection 3/8"		
<b>For models:</b>	231001, 231002, 231003, 231004, 234003, 234004, 234006		

angle pieces

			
1			
<b>GEV No.</b>	106618	<b>Ref. No.</b>	41822450010 BN822450010
<b>description</b>	elbow screw joint		
<b>For models:</b>	131003, 131005, 131201, 131202, 131203, 131204, 131205, 131206, 131210, 132201, 132202, 133001, 133002, 133003, 133009, 133010, 133011, 133012, 133013, 133014, 133015, 133024, 133201, 133202, 133203, 133209, 133210, 133211, 133212, 133213, 133214, 133215, 133224, 141006, 141009, 141010		

			
1			
<b>GEV No.</b>	106616	<b>Ref. No.</b>	41822450610
<b>description</b>	elbow screw joint T1: M10x1 tube ø 6mm		
<b>For models:</b>	131001, 131002, 131003, 131004, 131005, 131006, 131010, 131201, 131202, 131203, 131204, 131205, 131206, 131210, 132001, 132002, 132201, 132202		



gas lines

main gas lines

producer-specific



1

<b>GEV No.</b>	107546	<b>Ref. No.</b>	41823561360
<b>description</b>	gas line tube ø 10mm L 430mm aluminium		
<b>For models:</b>	131001, 131002, 131003, 131004, 131005, 131006, 131010, 131201, 131202, 131203, 131204, 131205, 131206, 131210, 132001, 132002, 132201, 132202		
<b>accessories for</b>	107546		
	<b>GEV No.</b>	101278	<b>Ref. No.</b> 6A011480 MA86720
	olive for pipe ø 10mm Qty 1 pcs		
	<b>GEV No.</b>	101300	<b>Ref. No.</b> 6A011485 MA1326500
	union nut thread M16x1.5 tube ø 10mm		

consumables

lava rocks / ceramic briquetts

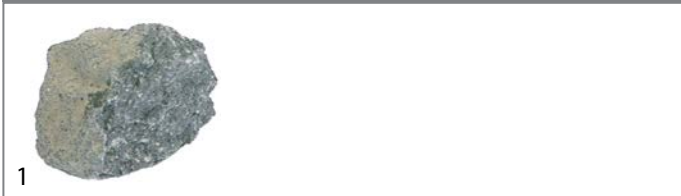

1

<b>GEV No.</b>	211008	<b>Ref. No.</b>	153000150 6A014900 LAVAB50
<b>description</b>	lava rocks size ca.20-70mm Qty 5kg		
<b>For models:</b>	243007, 243008, 243109, 243110		

equipment-specific units

for slicers

covers



1

<b>GEV No.</b>	693786	<b>Ref. No.</b>	SM500503
<b>description</b>	blade covering ø 255mm for knife ø 300mm mounting thread M10 mounting ø 17		
<b>For models:</b>	411003		



1

<b>GEV No.</b>	697457	<b>Ref. No.</b>	AMG006
<b>description</b>	blade covering for knife ø 250mm aluminium		



1

<b>GEV No.</b>	697522	<b>Ref. No.</b>	AMC006
<b>description</b>	blade covering ø 230mm for knife ø 220mm mounting thread M6 mounting ø 12 aluminium		
<b>For models:</b>	411001		

bushes



1

<b>GEV No.</b>	698246	<b>Ref. No.</b>	SM133418
<b>description</b>	threaded bush ET M10x1 blade cover		
<b>For models:</b>	411003		



handles



1

<b>GEV No.</b>	696266	<b>Ref. No.</b>	AMA008
<b>description</b>	cone handle thread M4 ø 9mm L 14mm aluminium slicer		
<b>For models:</b>	411001		



1

<b>GEV No.</b>	696267	<b>Ref. No.</b>	19021110
<b>description</b>	mushroom cap handle thread M4 ø 16mm L 18.5mm aluminium slicer		
<b>For models:</b>	411004, 411005		

miscellaneous



1

<b>GEV No.</b>	697523	<b>Ref. No.</b>	SM503404
<b>description</b>	protector for knife ø 350mm ø 360mm aluminium GEMMA 350		
<b>For models:</b>	411004		

sliding plates



1

<b>GEV No.</b>	697524	<b>Ref. No.</b>	AMC040
<b>description</b>	sliding plate 220 mounting distance 70mm mounting thread M6		
<b>For models:</b>	411001		



1

<b>GEV No.</b>	697525	<b>Ref. No.</b>	AMG040
<b>description</b>	sliding plate 250 mounting distance 70mm mounting thread M8		



1

<b>GEV No.</b>	697526	<b>Ref. No.</b>	SM504120
<b>description</b>	sliding plate 300 mounting distance 87mm		
<b>For models:</b>	411003		

holders



1

<b>GEV No.</b>	696239	<b>Ref. No.</b>	195107E07
<b>description</b>	bracket hole ø 19mm mounting distance 120mm L 160mm W 80mm 300-330		
<b>For models:</b>	411004		



1

<b>GEV No.</b>	696240	<b>Ref. No.</b>	AMM058 AMR058
<b>description</b>	bracket hole ø 7.3mm mounting distance 70mm L 160mm W 20mm shaft ø 15mm shaft L 38mm 220-250		
<b>For models:</b>	411001		



1

<b>GEV No.</b>	696238	<b>Ref. No.</b>	SM500318
<b>description</b>	bracket hole ø 8mm mounting distance 98mm L 140mm W 48mm shaft ø 15mm shaft L 46mm 300		
<b>For models:</b>	411003		

hand guard



1

<b>GEV No.</b>	696252	<b>Ref. No.</b>	19563002
<b>description</b>	protector ø 68mm ID ø 18mm thickness 10mm for sliding plate		
<b>For models:</b>	411004, 411005, 411006		



1

<b>GEV No.</b>	696251	<b>Ref. No.</b>	AMA062
<b>description</b>	protector ø 68mm ID ø 25.8mm thickness 10mm for sliding plate		
<b>For models:</b>	411001		

## locking screws

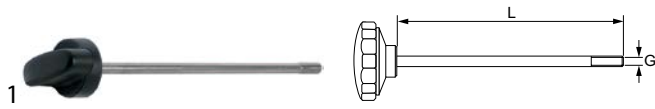

<b>GEV No.</b>	697371	<b>Ref. No.</b>	T5002
----------------	--------	-----------------	-------

**description** locking screw thread M8 L 200mm

**For models:** 411015, 411018

**spare parts for** 697371



<b>GEV No.</b>	697766	<b>Ref. No.</b>	I1926
----------------	--------	-----------------	-------

handle L 50mm W 17mm  $\phi$  35mm thread M8

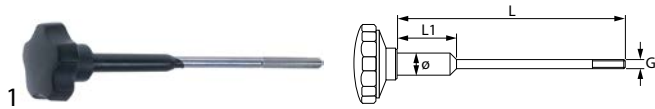

<b>GEV No.</b>	697513	<b>Ref. No.</b>	AMC032 AMG032
----------------	--------	-----------------	------------------

**description** locking screw thread M6 L 148mm  $\phi$  10mm L1 51mm handle  $\phi$  40mm

**For models:** 411001

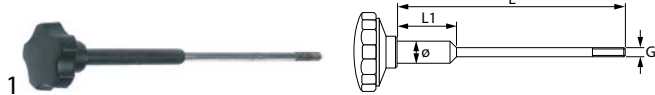

<b>GEV No.</b>	698078	<b>Ref. No.</b>	SM212740
----------------	--------	-----------------	----------

**description** locking screw thread M6 L 200mm  $\phi$  10mm L1 80mm

**For models:** 411003

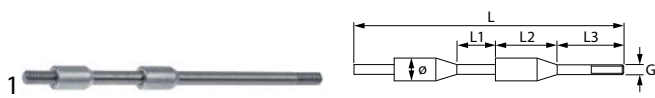

<b>GEV No.</b>	697740	<b>Ref. No.</b>	19530532
----------------	--------	-----------------	----------

**description** locking screw thread M6 L 185mm  $\phi$  10mm D1  $\phi$  10mm L2 18mm L3 18mm

**For models:** 411005, 411006

**accessories for** 697740



<b>GEV No.</b>	111054	<b>Ref. No.</b>	19564016
----------------	--------	-----------------	----------

star handle thread M6  $\phi$  40mm L 29mm blue



<b>GEV No.</b>	698200	<b>Ref. No.</b>	19562502
----------------	--------	-----------------	----------

star handle thread M6  $\phi$  40mm L 29mm black

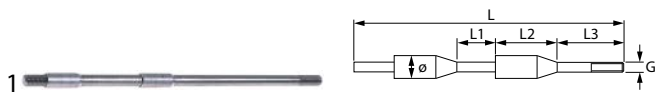

<b>GEV No.</b>	696230	<b>Ref. No.</b>	19530507
----------------	--------	-----------------	----------

**description** locking screw thread M8 L 235mm  $\phi$  10mm D1  $\phi$  10mm without handle

**For models:** 411004

## handles



<b>GEV No.</b>	697766	<b>Ref. No.</b>	I1926
----------------	--------	-----------------	-------

**description** handle L 50mm W 17mm  $\phi$  35mm thread M8

**For models:** 411015, 411016, 411017, 411018



<b>GEV No.</b>	698200	<b>Ref. No.</b>	19562502
----------------	--------	-----------------	----------

**description** star handle thread M6  $\phi$  40mm L 29mm black

**For models:** 411005, 411006



<b>GEV No.</b>	111054	<b>Ref. No.</b>	19564016
----------------	--------	-----------------	----------

**description** star handle thread M6  $\phi$  40mm L 29mm blue

**For models:** 411006



<b>GEV No.</b>	697443	<b>Ref. No.</b>	19562504 19564013
----------------	--------	-----------------	----------------------

**description** star handle thread M8  $\phi$  50mm L 29mm black

**For models:** 411001, 411004

## adjustment knobs



<b>GEV No.</b>	697509	<b>Ref. No.</b>	AMC102
----------------	--------	-----------------	--------

**description** adjusting knob 0-12  $\phi$  55mm shaft  $\phi$  12mm shaft L 35mm handle  $\phi$  42mm

**For models:** 411001







			
1			
<b>GEV No.</b>	697767	<b>Ref. No.</b>	11976
<b>description</b>	adjusting knob 0-15 ø 50mm shaft ø 12mm shaft L 30mm handle ø 43mm		
<b>For models:</b>	411013		

			
1			
<b>GEV No.</b>	697510	<b>Ref. No.</b>	19562402 19564020
<b>description</b>	adjusting knob 0-15 ø 60mm shaft ø 12mm shaft L 32mm		
<b>For models:</b>	411003, 411005, 411006		

			
1			
<b>GEV No.</b>	696693	<b>Ref. No.</b>	19562404
<b>description</b>	adjusting knob 0-15 ø 68mm shaft ø 18mm shaft L 47mm handle ø 53mm		
<b>For models:</b>	411004		

			
1			
<b>GEV No.</b>	697511	<b>Ref. No.</b>	19562404 old
<b>description</b>	adjusting knob 0-15 ø 68mm shaft ø 18mm shaft L 47mm handle ø 58mm		

			
1			
<b>GEV No.</b>	696500	<b>Ref. No.</b>	19562404 (old version)
<b>description</b>	adjusting knob 0-24 ø 68mm shaft ø 18mm shaft L 37mm handle ø 56mm		

			
1			
<b>GEV No.</b>	697512	<b>Ref. No.</b>	19562410
<b>description</b>	ring for handle ø 72mm ID ø 35mm thickness 10mm plastic black		
<b>For models:</b>	411004		

eccentric disc for slice thickness			
			
1			
<b>GEV No.</b>	697507	<b>Ref. No.</b>	SM190100011
<b>description</b>	eccentrics for cutting thickness hole ø 12mm groove width 6.5mm ED ø 56mm thickness 21mm		
<b>For models:</b>	411003		

			
1			
<b>GEV No.</b>	697756	<b>Ref. No.</b>	19563505LG
<b>description</b>	eccentrics for cutting thickness hole ø 12mm groove width 6mm ED ø 56mm thickness 10mm		
<b>For models:</b>	411006		

			
1			
<b>GEV No.</b>	697506	<b>Ref. No.</b>	AMI092
<b>description</b>	eccentrics for cutting thickness hole ø 12mm groove width 6mm ED ø 56mm thickness 20mm		
<b>For models:</b>	411001		

			
1			
<b>GEV No.</b>	697508	<b>Ref. No.</b>	SM190100022
<b>description</b>	eccentrics for cutting thickness hole ø 18mm groove width 8mm ED ø 85mm thickness 24.5mm		
<b>For models:</b>	411004		

springs			
			
1			
<b>GEV No.</b>	696211	<b>Ref. No.</b>	AMC672
<b>description</b>	compression spring ø 11.5mm L 46mm wire gauge ø 1.3mm slicer 220		
<b>For models:</b>	411001		

			
1			
<b>GEV No.</b>	696208	<b>Ref. No.</b>	SM370111
<b>description</b>	compression spring ø 13.5mm L 57mm wire gauge ø 1.4mm slicer 275-300		
<b>For models:</b>	411003		

1			
<b>GEV No.</b>	696209	<b>Ref. No.</b>	19390205
<b>description</b>	compression spring ø 13.5mm L 92mm wire gauge ø 1.4mm slicer		
<b>For models:</b>	411004		

1			
<b>GEV No.</b>	696210	<b>Ref. No.</b>	19390600
<b>description</b>	compression spring ø 14mm L 16mm wire gauge ø 1.2mm slicer 220-250		

1			
<b>GEV No.</b>	696205	<b>Ref. No.</b>	SM370104
<b>description</b>	compression spring ø 22/28mm L 22mm wire gauge ø 2mm conical slicer D1 ø 22mm D2 ø 28mm 250-300		

1			
<b>GEV No.</b>	696207	<b>Ref. No.</b>	AMC244
<b>description</b>	compression spring ø 23/25mm L 19mm wire gauge ø 1.5mm conical slicer D1 ø 23mm D2 ø 25mm 220-250		
<b>For models:</b>	411001		

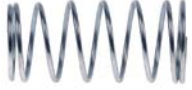
1			
<b>GEV No.</b>	696206	<b>Ref. No.</b>	AMC254 AMG254
<b>description</b>	compression spring ø 23/25mm L 53mm wire gauge ø 1.5mm conical slicer D1 ø 23mm D2 ø 25mm 220-250		
<b>For models:</b>	411001		

1			
<b>GEV No.</b>	696212	<b>Ref. No.</b>	AMA814
<b>description</b>	compression spring ø 7.6mm L 22mm wire gauge ø 0.7mm slicer 195-220		
<b>For models:</b>	411001		

1			
<b>GEV No.</b>	696213	<b>Ref. No.</b>	AME410
<b>description</b>	compression spring ø 7.6mm L 28mm wire gauge ø 0.7mm slicer PARKER		

### spring washers

1			
<b>GEV No.</b>	696253	<b>Ref. No.</b>	19342005 AMA096
<b>description</b>	spring washer ID ø 12mm ED ø 25mm Qty 1 pcs		
<b>For models:</b>	411001, 411003, 411005		

1			
<b>GEV No.</b>	696254	<b>Ref. No.</b>	19342006
<b>description</b>	spring washer ID ø 19mm ED ø 32mm Qty 1 pcs		
<b>For models:</b>	411004		

### guiding pieces

#### for sliding plates

1			
<b>GEV No.</b>	696246	<b>Ref. No.</b>	19500107
<b>description</b>	guide L 112mm W 56mm hole ø 19mm shaft ø 19mm shaft L 56mm mounting thread M8 300-330 aluminium		
<b>For models:</b>	411004		

1			
<b>GEV No.</b>	696247	<b>Ref. No.</b>	AMM064 AMR064
<b>description</b>	guide L 80mm W 54mm H 37mm hole ø 15mm shaft intake ø 12mm mounting thread M8 220-250		
<b>For models:</b>	411001		

1			
<b>GEV No.</b>	696697	<b>Ref. No.</b>	S3808 S3891
<b>description</b>	guide L 85mm W 40mm H 25mm hole ø 16mm		
<b>For models:</b>	411013, 411019		





			
1			
<b>GEV No.</b>	696245	<b>Ref. No.</b>	SM500218
<b>description</b>	guide L 87mm W 56mm H 38mm hole ø 15mm shaft intake ø 12mm mounting thread M6 275-300 aluminium		
<b>For models:</b>	411003		

			
1			
<b>GEV No.</b>	696276	<b>Ref. No.</b>	AMA066
<b>description</b>	connection plate L 83mm W 12mm thickness 4mm hole ø 6.5mm hole distance 69mm		
<b>For models:</b>	411001		

for carriage

			
1			
<b>GEV No.</b>	696244	<b>Ref. No.</b>	SM500618
<b>description</b>	guide L 120mm W 122mm H 66mm hole ø 18mm thread M22 220-250		

			
1			
<b>GEV No.</b>	696243	<b>Ref. No.</b>	AMM212
<b>description</b>	guide L 122mm W 116mm H 59mm hole ø 20mm thread M8 220-250		
<b>For models:</b>	411001		

			
1			
<b>GEV No.</b>	696279	<b>Ref. No.</b>	SM190830
<b>description</b>	connection plate L 37mm W 33mm hole distance 18mm aperture 6x12mm thickness 2.5mm		

			
1			
<b>GEV No.</b>	696270	<b>Ref. No.</b>	AMA220
<b>description</b>	grub screw slicer thread M8 L 27mm plastic		
<b>For models:</b>	411001		

			
1			
<b>GEV No.</b>	696289	<b>Ref. No.</b>	19534029
<b>description</b>	knurled nut for carriage thread M22 ø 32mm chrome-plated 220-250 Qty 1 pcs WS H 7mm		

			
1			
<b>GEV No.</b>	696231	<b>Ref. No.</b>	19534034
<b>description</b>	spindle thread M8 L 32mm ø 10.5mm 220-250		

			
1			
<b>GEV No.</b>	696288	<b>Ref. No.</b>	19534024
<b>description</b>	threaded bush thread M22 L 20mm ID ø 11mm 220-250		

			
1			
<b>GEV No.</b>	696278	<b>Ref. No.</b>	19533200
<b>description</b>	threaded plate thread M6 L 36mm W 15mm hole distance 18mm thickness 4mm		

bushes

			
1			
<b>GEV No.</b>	696686	<b>Ref. No.</b>	B6275
<b>description</b>	bush ED ø 20mm ID ø 18mm H 20mm SS		
<b>For models:</b>	411012		

			
1			
<b>GEV No.</b>	696283	<b>Ref. No.</b>	19324108
<b>description</b>	bush for carriage ED ø 20mm ID ø 18mm H 20mm bronze		

			
1			
<b>GEV No.</b>	696282	<b>Ref. No.</b>	19324005
<b>description</b>	bush for carriage ED $\varnothing$ 22mm ID $\varnothing$ 19mm H 20mm bronze		
<b>For models:</b>	411004		

spindles			
			
1			
<b>GEV No.</b>	696229	<b>Ref. No.</b>	19530612
<b>description</b>	spindle for carriage $\varnothing$ 18mm L 445mm thread M8 250-275		

			
1			
<b>GEV No.</b>	696227	<b>Ref. No.</b>	AMC242
<b>description</b>	spindle for carriage $\varnothing$ 20mm L 385mm thread M8 220		
<b>For models:</b>	411001		

			
1			
<b>GEV No.</b>	696225	<b>Ref. No.</b>	AMI080
<b>description</b>	spindle for sliding plate $\varnothing$ 12mm L 120mm		
<b>For models:</b>	411001		

			
1			
<b>GEV No.</b>	696224	<b>Ref. No.</b>	SM521218
<b>description</b>	spindle for sliding plate $\varnothing$ 12mm L 130mm 275-300		
<b>For models:</b>	411003		

			
1			
<b>GEV No.</b>	696226	<b>Ref. No.</b>	19530705
<b>description</b>	spindle for sliding plate $\varnothing$ 19mm L 120mm thread M8 250-370		
<b>For models:</b>	411004		

accessories			
			
1			
<b>GEV No.</b>	696269	<b>Ref. No.</b>	SM130201
<b>description</b>	countersunk screw thread M6 L 16mm stainless steel head $\varnothing$ 11mm set with plain washer slicer		

			
1			
<b>GEV No.</b>	696268	<b>Ref. No.</b>	AMC246
<b>description</b>	oval head screw thread M8 stainless steel L 10mm slicer $\varnothing$ 22mm		
<b>For models:</b>	411001		

hand guard			
			
1			
<b>GEV No.</b>	696287	<b>Ref. No.</b>	19562382
<b>description</b>	hand protection for sharpener units L 210mm W 105mm hole $\varnothing$ 5.3mm mounting distance 54mm 195		

			
1			
<b>GEV No.</b>	696284	<b>Ref. No.</b>	19562201
<b>description</b>	hand protection for knife $\varnothing$ 220mm H 80mm W 35mm hole $\varnothing$ 4.8mm mounting distance 47mm plastic		
<b>For models:</b>	411001		

			
1			
<b>GEV No.</b>	697298	<b>Ref. No.</b>	19562202
<b>description</b>	hand protection for knife $\varnothing$ 250mm		

			
1			
<b>GEV No.</b>	696285	<b>Ref. No.</b>	SM501203
<b>description</b>	hand protection for knife $\varnothing$ 300mm H 180mm W 95mm hole $\varnothing$ 5mm mounting distance 85mm aluminium		
<b>For models:</b>	411003		

			
1			
<b>GEV No.</b>	696286	<b>Ref. No.</b>	19521311
<b>description</b>	hand protection for knife $\varnothing$ 350mm H 200mm W 118mm hole $\varnothing$ 5mm mounting distance 85mm aluminium		
<b>For models:</b>	411004		





 <p>1</p>			
<b>GEV No.</b>	698196	<b>Ref. No.</b>	19562324
<b>description</b>	hand protection for carriage 275-300 H 220mm W 150mm thickness 4mm hole ø 6mm mounting distance 88mm		

 <p>1</p>			
<b>GEV No.</b>	697805	<b>Ref. No.</b>	C6537
<b>description</b>	hand protection for carriage C300 CE H 170mm W 250mm thickness 8mm hole ø 7mm mounting distance 135mm plexiglas suitable for OMAS		
<b>For models:</b>	411013, 411015, 411018		

 <p>1</p>			
<b>GEV No.</b>	697858	<b>Ref. No.</b>	AMA294A
<b>description</b>	hand protection for slicer		
<b>For models:</b>	411001		

 <p>1</p>			
<b>GEV No.</b>	699625	<b>Ref. No.</b>	19562322
<b>description</b>	hand protection slicer H 165mm W 150mm thickness 4mm hole ø 6mm mounting distance 86mm		
<b>For models:</b>	411001		

 <p>1</p>			
<b>GEV No.</b>	698776	<b>Ref. No.</b>	C7127
<b>description</b>	hand protection slicer OG30E H 195mm W 190mm thickness 3.5mm hole ø 6.5mm mounting distance 125mm plexiglas		
<b>For models:</b>	411012		

<p>accessories</p>			
 <p>1</p>			
<b>GEV No.</b>	696281	<b>Ref. No.</b>	19521603
<b>description</b>	spacer bush for hand guard thread M5 ø 16mm L 31mm		
<b>For models:</b>	411001		

 <p>1</p>			
<b>GEV No.</b>	697467	<b>Ref. No.</b>	SM591519
<b>description</b>	blade pulley with spindle D1 ø 40mm D2 ø 63mm D3 ø 80mm shaft ø 15 L 42mm shaft length 194mm mounting thread M5 mounting ø 3-hole		
<b>For models:</b>	411003		

 <p>1</p>			
<b>GEV No.</b>	696234	<b>Ref. No.</b>	AMG022
<b>description</b>	blade pulley with spindle D1 ø 40mm D2 ø 65mm D3 ø 64mm shaft ø 15 L 43mm shaft length 152mm mounting thread M5 mounting ø 3-hole		

 <p>1</p>			
<b>GEV No.</b>	696233	<b>Ref. No.</b>	AMC022
<b>description</b>	blade pulley with spindle D1 ø 40mm D2 ø 69mm D3 ø 65mm shaft ø 15 L 30mm shaft length 147mm mounting thread M5 mounting ø 3-hole		
<b>For models:</b>	411001		

 <p>1</p>			
<b>GEV No.</b>	696232	<b>Ref. No.</b>	19700307
<b>description</b>	blade pulley with spindle D1 ø 57mm D2 ø 78mm D3 ø 95mm shaft ø 20 L 65mm shaft length 220mm mounting thread M5 mounting ø 4 hole		
<b>For models:</b>	411004		

## food holders

## handles



1

<b>GEV No.</b>	697431	<b>Ref. No.</b>	19562901 19564019
<b>description</b>	cone handle thread M6 ø 26mm plastic L 70mm black thread L 10mm		



1

<b>GEV No.</b>	698313	<b>Ref. No.</b>	AMA284
<b>description</b>	handle ø 18.5mm L 44mm plastic food holder		
<b>For models:</b>	411001		
<b>accessories for</b>	698313		



<b>GEV No.</b>	504788	<b>Ref. No.</b>	AMA282
<b>description</b>	screw thread M5 L 50mm Qty 1 pcs		



1

<b>GEV No.</b>	111123	<b>Ref. No.</b>	19562904
<b>description</b>	handle thread M10 IT ø 30mm L 110mm D1 ø 65mm		

## food holders



1

<b>GEV No.</b>	697530	<b>Ref. No.</b>	SM11016007
<b>description</b>	food holder 275-300 L 270mm hole ø 12mm		



1

<b>GEV No.</b>	698190	<b>Ref. No.</b>	19510922
<b>description</b>	food holder 300		

## accessories



1

<b>GEV No.</b>	696220	<b>Ref. No.</b>	AMC270A
<b>description</b>	spindle food holder ø 10mm L 210mm		
<b>For models:</b>	411001		



1

<b>GEV No.</b>	696221	<b>Ref. No.</b>	AMP270
<b>description</b>	spindle food holder ø 12mm L 265mm 300		



1

<b>GEV No.</b>	698193	<b>Ref. No.</b>	19541509
<b>description</b>	thread bolt for handle ø 14mm L 120mm thread M10 stainless steel		

## blades

## pullers



1

<b>GEV No.</b>	697531	<b>Ref. No.</b>	19702508
<b>description</b>	puller for knife ø 300mm hole distance 160mm thread M8		
<b>For models:</b>	411003		



1

<b>GEV No.</b>	697532	<b>Ref. No.</b>	19702512
<b>description</b>	puller for knife ø 357mm hole distance 160mm thread M8		
<b>For models:</b>	411004		

## PTFE



1

<b>GEV No.</b>	697304	<b>Ref. No.</b>	18250403210TF
<b>description</b>	slicing machine blade ED ø 250mm seat ø 40mm 3-hole ID ø 210mm H 17.5mm PTFE 100Cr6		
<b>For models:</b>	411006		



1

<b>GEV No.</b>	697547	<b>Ref. No.</b>	18275403218TF
<b>description</b>	slicing machine blade ED ø 275mm seat ø 40mm 3-hole ID ø 218mm H 21.5mm PTFE 100Cr6		

1

<b>GEV No.</b>	697548	<b>Ref. No.</b>	18275404218TF
<b>description</b>	slicing machine blade ED ø 275mm seat ø 40mm 4 hole ID ø 218mm H 21.5mm PTFE 100Cr6		



1

<b>GEV No.</b>	697552	<b>Ref. No.</b>	18370574300TF
<b>description</b>	slicing machine blade ED ø 370mm seat ø 57mm 4 hole ID ø 300mm H 22.5mm PTFE 100Cr6		



1

<b>GEV No.</b>	696520	<b>Ref. No.</b>	1830040325422TF
<b>description</b>	slicing machine blade ED ø 300mm seat ø 40mm 3-hole PTFE ID ø 254mm H 22.5mm		
<b>For models:</b>	411003		

standard



1

<b>GEV No.</b>	697546	<b>Ref. No.</b>	18195303155
<b>description</b>	slicing machine blade ED ø 195mm seat ø 30mm 3-hole ID ø 155mm H 12.8mm C45 standard		



1

<b>GEV No.</b>	698210	<b>Ref. No.</b>	1830057425422TF
<b>description</b>	slicing machine blade ED ø 300mm seat ø 57mm 4 hole ID ø 254mm H 22.5mm PTFE 100Cr6		



1

<b>GEV No.</b>	697436	<b>Ref. No.</b>	18220403180F
<b>description</b>	slicing machine blade ED ø 220mm seat ø 40mm 3-hole ID ø 180mm H 15.5mm C45		



1

<b>GEV No.</b>	697550	<b>Ref. No.</b>	18330574270TF
<b>description</b>	slicing machine blade ED ø 330mm seat ø 57mm 4 hole ID ø 270mm H 23mm PTFE 100Cr6		



1

<b>GEV No.</b>	697365	<b>Ref. No.</b>	18250403210 L0602
<b>description</b>	slicing machine blade ED ø 250mm seat ø 40mm 3-hole ID ø 210mm H 17.5mm C45 standard		
<b>For models:</b>	411011, 411013, 411016, 411019		



1

<b>GEV No.</b>	697551	<b>Ref. No.</b>	18350574280TF
<b>description</b>	slicing machine blade ED ø 350mm seat ø 57mm 4 hole ID ø 280mm H 22.5mm PTFE 100Cr6		
<b>For models:</b>	411004		



1

<b>GEV No.</b>	697541	<b>Ref. No.</b>	1827540321815
<b>description</b>	slicing machine blade ED ø 275mm seat ø 40mm 3-hole ID ø 218mm H 15.5mm C45 standard		

			
1			
<b>GEV No.</b>	697540	<b>Ref. No.</b>	18275403218
<b>description</b>	slicing machine blade ED ø 275mm seat ø 40mm 3-hole ID ø 218mm H 21.5mm C45 standard		

			
1			
<b>GEV No.</b>	698214	<b>Ref. No.</b>	18300403254
<b>description</b>	slicing machine blade ED ø 300mm seat ø 40mm 3-hole ID ø 254mm H 22.5mm C45 standard		

			
1			
<b>GEV No.</b>	697539	<b>Ref. No.</b>	18275403220
<b>description</b>	slicing machine blade ED ø 275mm seat ø 40mm 3-hole ID ø 220mm H 15.5mm C45 standard		

			
1			
<b>GEV No.</b>	698191	<b>Ref. No.</b>	18300574254 L0606
<b>description</b>	slicing machine blade ED ø 300mm seat ø 57mm 4 hole ID ø 254mm H 22.5mm C45 standard		
<b>For models:</b>	411014, 411017		

			
1			
<b>GEV No.</b>	697538	<b>Ref. No.</b>	18275404218
<b>description</b>	slicing machine blade ED ø 275mm seat ø 40mm 4 hole ID ø 218mm H 21.5mm C45 standard		

			
1			
<b>GEV No.</b>	697375	<b>Ref. No.</b>	18330574270
<b>description</b>	slicing machine blade ED ø 330mm seat ø 57mm 4 hole ID ø 270mm H 23mm 100Cr6 standard		

			
1			
<b>GEV No.</b>	697534	<b>Ref. No.</b>	L0612
<b>description</b>	slicing machine blade ED ø 300mm seat ø 40mm 3-hole ID ø 245mm H 17mm C45 standard		
<b>For models:</b>	411012, 411013, 411015, 411018		

			
1			
<b>GEV No.</b>	697463	<b>Ref. No.</b>	18350574280F
<b>description</b>	slicing machine blade ED ø 350mm seat ø 57mm 4 hole ID ø 280mm H 22.5mm 100Cr6 standard		
<b>For models:</b>	411004		

			
1			
<b>GEV No.</b>	697385	<b>Ref. No.</b>	18300403250
<b>description</b>	slicing machine blade ED ø 300mm seat ø 40mm 3-hole ID ø 250mm H 20mm C45 standard		

			
1			
<b>GEV No.</b>	697399	<b>Ref. No.</b>	18350574280 L0623
<b>description</b>	slicing machine blade ED ø 350mm seat ø 57mm 4 hole ID ø 280mm H 22.5mm C45 standard		
<b>For models:</b>	411014		



1

<b>GEV No.</b>	697460	<b>Ref. No.</b>	18370574300
<b>description</b>	slicing machine blade ED ø 370mm seat ø 57mm 4 hole ID ø 300mm H 22.5mm 100Cr6 standard		



1

<b>GEV No.</b>	697458	<b>Ref. No.</b>	18385574315
<b>description</b>	slicing machine blade ED ø 385mm seat ø 57mm 4 hole ID ø 315mm H 22.5mm 100Cr6 standard		

sharpener units

lids





1

<b>GEV No.</b>	696261	<b>Ref. No.</b>	AME402
<b>description</b>	lid for sharpener units L 104mm W 80mm mounting distance 80mm 220/250/275		



1

<b>GEV No.</b>	696262	<b>Ref. No.</b>	SM501501	
<b>description</b>	lid for sharpener units L 125mm W 103mm mounting distance 88mm 275-300			
<b>accessories for</b>	696262			
	<b>GEV No.</b>	697445	<b>Ref. No.</b>	SM211413
	mushroom cap handle thread M6 handle ø 33mm L 26mm plastic black			
	<b>GEV No.</b>	697517	<b>Ref. No.</b>	IB4206451
	cone handle thread M10 ø 30mm L 66mm black			

push buttons



1

<b>GEV No.</b>	696260	<b>Ref. No.</b>	AMA810 AME426
<b>description</b>	push button for sharpener units ø 12mm L 19mm hole ø 5.2mm 195-220		
<b>For models:</b>	411001		



1

<b>GEV No.</b>	696259	<b>Ref. No.</b>	AME468
<b>description</b>	push button for sharpener units ø 12mm L 19mm hole ø 6mm 220-250		



1

<b>GEV No.</b>	696255	<b>Ref. No.</b>	SM561101
<b>description</b>	push button for sharpener units ø 12mm L 22mm hole ø 6mm 275-300		



1

<b>GEV No.</b>	696257	<b>Ref. No.</b>	SM561101+SM150401
<b>description</b>	push button for sharpener units ø 12mm L 22mm hole ø 6mm 275-300		

holders



1

<b>GEV No.</b>	696263	<b>Ref. No.</b>	SM501401
<b>description</b>	body for sharpener units L 102mm W 46mm H 38mm hole ø 6mm mounting distance 88mm aluminium 275-300		



1

<b>GEV No.</b>	696265	<b>Ref. No.</b>	AME456
<b>description</b>	body for sharpener units L 92mm W 35mm H 28mm hole ø 6mm mounting distance 80mm plastic 220-250		

			
1			
<b>GEV No.</b>	696264	<b>Ref. No.</b>	19562101
<b>description</b>	body for sharpener units L 99mm W 48mm H 28mm hole ø 6mm mounting thread M6 plastic 195-220		
<b>For models:</b>	411001		

			
1			
<b>GEV No.</b>	696242	<b>Ref. No.</b>	SM501303
<b>description</b>	bracket for sharpener units L 52mm W 30mm H 61mm hole ø 12mm mounting thread M8 aluminium		

			
1			
<b>GEV No.</b>	696241	<b>Ref. No.</b>	AME436
<b>description</b>	bracket for sharpener units L 57mm W 25mm H 54mm hole ø 12mm mounting thread M6 aluminium		

knobs

			
1			
<b>GEV No.</b>	697516	<b>Ref. No.</b>	19562700 19564018
<b>description</b>	locking screw thread M5 handle ø 25mm L 8mm		

			
1			
<b>GEV No.</b>	697384	<b>Ref. No.</b>	AME428
<b>description</b>	locking screw thread M6 handle ø 25mm black L 54mm		

			
1			
<b>GEV No.</b>	697514	<b>Ref. No.</b>	SM592400
<b>description</b>	locking screw thread M8 handle ø 30mm L 60mm		

			
1			
<b>GEV No.</b>	697445	<b>Ref. No.</b>	SM211413
<b>description</b>	mushroom cap handle thread M6 handle ø 33mm L 26mm plastic black		

			
1			
<b>GEV No.</b>	697765	<b>Ref. No.</b>	I1953
<b>description</b>	star handle thread M6 ø 30mm L 22mm		
<b>For models:</b>	411013, 411014, 411015, 411019		

sharpener units

			
1			
<b>GEV No.</b>	698655	<b>Ref. No.</b>	A1127
<b>description</b>	blade sharpener OG30E		
<b>For models:</b>	411011, 411012		

			
1			
<b>GEV No.</b>	697860	<b>Ref. No.</b>	A1028
<b>description</b>	blade sharpener suitable for OMAS		
<b>For models:</b>	411018		

spindles

			
1			
<b>GEV No.</b>	696215	<b>Ref. No.</b>	AME412
<b>description</b>	spindle grindstone D1 ø 5mm D2 ø 6mm L 65mm thread M6 IT M4 220-250		

			
1			
<b>GEV No.</b>	696216	<b>Ref. No.</b>	AME424
<b>description</b>	spindle grindstone D1 ø 6mm D2 ø 10mm L 63mm thread M6 220-250		



			
1			
<b>GEV No.</b>	696214	<b>Ref. No.</b>	AMA802 AMA804
<b>description</b>	spindle grindstone D1 ø 6mm D2 ø 10mm L 70mm thread M6 195-220		
<b>For models:</b>	411001		

			
1			
<b>GEV No.</b>	696217	<b>Ref. No.</b>	SM570201
<b>description</b>	spindle grindstone D2 ø 6mm D2 ø 12mm L 78mm thread M6 250-300		

			
1			
<b>GEV No.</b>	696222	<b>Ref. No.</b>	AME442
<b>description</b>	spindle for sharpener units ø 12mm L 67mm thread M8		

			
1			
<b>GEV No.</b>	696223	<b>Ref. No.</b>	SM540501
<b>description</b>	spindle for sharpener units ø 12mm L 98mm thread M8 250-300		

accessories

			
1			
<b>GEV No.</b>	696258	<b>Ref. No.</b>	AME464
<b>description</b>	ball for sharpener units ø 4.8mm metal		

			
1			
<b>GEV No.</b>	696256	<b>Ref. No.</b>	SM150401
<b>description</b>	oval head screw thread M3 L 3.2mm push button		

			
1			
<b>GEV No.</b>	696271	<b>Ref. No.</b>	AME427
<b>description</b>	oval head screw thread M3 L 4.2mm push button		

			
1			
<b>GEV No.</b>	696218	<b>Ref. No.</b>	AME450
<b>description</b>	thread bolt for sharpener units thread M5 ø 5mm L 30mm		

grindstones

			
1			
<b>GEV No.</b>	697492	<b>Ref. No.</b>	SM260101old
<b>description</b>	grindstone ø 40mm thickness 11mm bore ø 6mm grained coarse with bevel, without hub		

			
1			
<b>GEV No.</b>	697797	<b>Ref. No.</b>	SM260101
<b>description</b>	grindstone ø 43mm thickness 12mm bore ø 6mm grained coarse with bevel, with hub		

			
1			
<b>GEV No.</b>	697505	<b>Ref. No.</b>	SM260102
<b>description</b>	grindstone ø 43mm thickness 8mm bore ø 6mm grained fine with bevel, without hub		

			
1			
<b>GEV No.</b>	698197	<b>Ref. No.</b>	19300207
<b>description</b>	grindstone ø 45mm thickness 8mm bore ø 6mm grained fine with bevel, without hub		

			
1			
<b>GEV No.</b>	698198	<b>Ref. No.</b>	19300107C AVA416
<b>description</b>	grindstone ø 45mm thickness 9mm bore ø 6mm grained coarse with bevel, without hub		

			
1			
<b>GEV No.</b>	697393	<b>Ref. No.</b>	19300108C
<b>description</b>	grindstone ø 48mm thickness 15mm bore ø 8mm grained coarse with bevel, without hub		

			
1			
<b>GEV No.</b>	697584	<b>Ref. No.</b>	M6621
<b>description</b>	grindstone ø 51mm thickness 7mm bore ø 14.3mm grained fine with bevel, without hub		
<b>For models:</b>	411014		

grindstones with hub

			
1			
<b>GEV No.</b>	697424	<b>Ref. No.</b>	19300301 M6606
<b>description</b>	grindstone ø 40mm thickness 8mm bore ø 6mm grained coarse with bevel, with hub		
<b>For models:</b>	411001, 411016, 411017		

			
1			
<b>GEV No.</b>	697423	<b>Ref. No.</b>	19300401 M6624
<b>description</b>	grindstone ø 40mm thickness 8mm bore ø 6mm grained fine with bevel, with hub		
<b>For models:</b>	411001, 411012, 411013, 411015, 411016, 411017, 411019		

			
1			
<b>GEV No.</b>	697357	<b>Ref. No.</b>	M6601
<b>description</b>	grindstone ø 50mm thickness 8mm bore ø 6mm grained coarse with bevel, with hub		
<b>For models:</b>	411011		

			
1			
<b>GEV No.</b>	697358	<b>Ref. No.</b>	M6622
<b>description</b>	grindstone ø 50mm thickness 8mm bore ø 6mm grained fine with bevel, with hub		
<b>For models:</b>	411011, 411018		

grindstones cup form

			
1			
<b>GEV No.</b>	697600	<b>Ref. No.</b>	M6615
<b>description</b>	grindstone ø 45mm thickness 10mm bore ø 6mm grained coarse without bevel		
<b>For models:</b>	411012, 411013, 411014, 411015, 411018, 411019		

carriages

handles

			
1			
<b>GEV No.</b>	697515	<b>Ref. No.</b>	SM19014009
<b>description</b>	locking screw thread M8 handle ø 50mm 275-300 L 14mm		

			
1			
<b>GEV No.</b>	691263	<b>Ref. No.</b>	IB4200910
<b>description</b>	pull handle L 160mm H 56mm mounting distance 133mm thread M8		
<b>For models:</b>	221006		

			
1			
<b>GEV No.</b>	697443	<b>Ref. No.</b>	19562504 19564013
<b>description</b>	star handle thread M8 ø 50mm L 29mm black		
<b>For models:</b>	411001, 411004		



holders



<b>GEV No.</b>	696237	<b>Ref. No.</b>	SM500818
<b>description</b>	bracket L 190mm W 100mm mounting distance 48mm suitable for carriage 275-300		



<b>GEV No.</b>	696235	<b>Ref. No.</b>	AMC258
<b>description</b>	bracket L 195mm W 85mm mounting distance 33mm suitable for carriage 220		
<b>For models:</b>	411001		



<b>GEV No.</b>	696236	<b>Ref. No.</b>	AMG258
<b>description</b>	bracket L 200mm W 85mm mounting distance 33mm suitable for carriage 250		

carriage plates

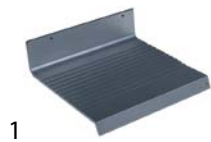

<b>GEV No.</b>	697527	<b>Ref. No.</b>	AME264A
<b>description</b>	carriage L 20mm W 22mm mounting distance 33mm suitable for slicer 220 SIRMAN		
<b>For models:</b>	411001		



<b>GEV No.</b>	697528	<b>Ref. No.</b>	AMG264A
<b>description</b>	carriage L 24mm W 23mm mounting distance 33mm suitable for slicer 250 SIRMAN		



<b>GEV No.</b>	697529	<b>Ref. No.</b>	195104012
<b>description</b>	carriage L 250mm W 275mm mounting distance 33mm suitable for slicer 275-300 SIRMAN		

accessories



<b>GEV No.</b>	696250	<b>Ref. No.</b>	AMA289
<b>description</b>	bracket thread M5 L 25mm ID ø 10mm thickness 20mm 220-250		
<b>For models:</b>	411001		

miscellaneous



<b>GEV No.</b>	697370	<b>Ref. No.</b>	S7595
<b>description</b>	bolt thread M8 ø 10mm L 25mm for equipment foot		
<b>For models:</b>	411018		

<b>accessories for</b>	697370		
	<b>GEV No.</b>	697369	<b>Ref. No.</b>
			P5008
	equipment foot ø 47mm H 35mm bore ø 9mm rubber Qty 1 pcs		



<b>GEV No.</b>	696248	<b>Ref. No.</b>	AMA028
<b>description</b>	bracket thread M10x0.75 ø 30mm for microswitch ID ø 15.2mm thickness 17mm mounting thread M6		
<b>For models:</b>	411001		



<b>GEV No.</b>	696249	<b>Ref. No.</b>	19540905
<b>description</b>	bracket thread M10x0.75 ø 35mm for microswitch ID ø 20.2mm thickness 15mm mounting thread M8 250-300		
<b>For models:</b>	411004		



1

<b>GEV No.</b>	696277	<b>Ref. No.</b>	AMC680
<b>description</b>	connection plate L 37mm W 25mm for motor thickness 4mm hole ø 6mm hole distance 15.5mm		
<b>For models:</b>	411001		



1

<b>GEV No.</b>	696219	<b>Ref. No.</b>	AMC670
<b>description</b>	thread bolt thread M6 ø 11mm L 74mm for motor hole ø 5mm		
<b>For models:</b>	411001		

## for meat mincers

### gearboxes



1

<b>GEV No.</b>	696204	<b>Ref. No.</b>	29401800
<b>description</b>	gearbox motor shaft ø 11mm flange ø 90mm transmission 1/30 drive shaft ø 14mm type 30		
<b>For models:</b>	421002		

### gear wheels



1

<b>GEV No.</b>	698148	<b>Ref. No.</b>	IV2320500
<b>description</b>	auger ø 35.5mm shaft intake ø 17mm W 45mm for mincer Mod.12		
<b>For models:</b>	421003		



1

<b>GEV No.</b>	698205	<b>Ref. No.</b>	SL0125
<b>description</b>	gear wheel double ø 32/70mm shaft intake ø 15mm W 30mm teeth 18/41 splitting tooth width 14/11mm DIN/ISO Mod.12-22		
<b>For models:</b>	421006, 421007, 421008, 422005, 422006, 433003, 433004, 433005		



1

<b>GEV No.</b>	698285	<b>Ref. No.</b>	SL0128
<b>description</b>	gear wheel ø 25mm shaft intake ø 10mm teeth 13 splitting tooth width 20mm DIN/ISO AB groove width 0mm		
<b>For models:</b>	421006, 421007, 421008, 422005, 422006, 433003, 433004, 433005		



1

<b>GEV No.</b>	698149	<b>Ref. No.</b>	IV2330500
<b>description</b>	gear wheel ø 61mm shaft intake ø 17mm teeth 27 tooth width 20mm Mod.12		
<b>For models:</b>	421003		



1

<b>GEV No.</b>	697193	<b>Ref. No.</b>	SL0024
<b>description</b>	sprocket-wheel DIN/ISO 06 B-1 splitting 3/8" teeth 15 shaft intake ø 17mm H 25mm 7-12-18 S-C-F		
<b>For models:</b>	512010, 512011, 512012, 512015, 512016, 512019, 512020		



1

<b>GEV No.</b>	697241	<b>Ref. No.</b>	8300720
<b>description</b>	sprocket-wheel DIN/ISO 06 B-1 splitting 3/8" teeth 16 shaft intake ø 25mm H 28mm 25-38 S-C-F		
<b>For models:</b>	512004		



1

<b>GEV No.</b>	697206	<b>Ref. No.</b>	SL0030
<b>description</b>	sprocket-wheel DIN/ISO 06 B-1 splitting 3/8" teeth 29 shaft intake ø 17mm H 28mm 7-12-18 S-C-F		
<b>For models:</b>	512010, 512011, 512012, 512015, 512016, 512019, 512020		



1

<b>GEV No.</b>	697256	<b>Ref. No.</b>	8300240 SL0100
<b>description</b>	sprocket-wheel DIN/ISO 06 B-1 splitting 3/8" teeth 85 shaft intake ø 60mm H 5mm 25-38 S-C-F		
<b>For models:</b>	512004, 512013, 512014, 512017, 512018, 512021, 512022		





			
1			
<b>GEV No.</b>	697223	<b>Ref. No.</b>	SL0084
<b>description</b>	sprocket-wheel DIN/ISO 08 B-1 splitting 1/2" teeth 29 shaft intake ø 20mm H 30mm 25-38 S-C-F		
<b>For models:</b>	512013, 512014, 512017, 512018, 512021, 512022		

			
1			
<b>GEV No.</b>	697130	<b>Ref. No.</b>	8300860
<b>description</b>	sprocket-wheel DIN/ISO 08 B-1 splitting 1/2" teeth 29 shaft intake ø 25mm H 30mm 33-42-53 TF-TR		
<b>For models:</b>	512004		

drive shafts

for blades

			
1			
<b>GEV No.</b>	698038	<b>Ref. No.</b>	MF2127
<b>description</b>	drive shaft ENTERPRISE model 12 ø 9.5mm L 53mm thread M12x1.75 D1 ø 20mm thread L 20mm		
<b>For models:</b>	421001, 433001		

			
1			
<b>GEV No.</b>	698292	<b>Ref. No.</b>	SL2521
<b>description</b>	drive shaft ENTERPRISE model 12 ø 9.5mm L 67mm thread M12x1.75 D1 ø 18mm thread L 698mm		
<b>For models:</b>	421006, 433003, 433005		

for augers

			
1			
<b>GEV No.</b>	698289	<b>Ref. No.</b>	SL0140
<b>description</b>	drive shaft model 12 ø 16/17mm L 78mm		
<b>For models:</b>	421006, 433003		

			
1			
<b>GEV No.</b>	698159	<b>Ref. No.</b>	LF2037012
<b>description</b>	drive shaft model 12 ø 16mm L 95mm D1 ø 25mm shaft diameter 17x17mm		
<b>For models:</b>	431001		

			
1			
<b>GEV No.</b>	698150	<b>Ref. No.</b>	IV2080500
<b>description</b>	drive shaft model 12 ø 17mm L 128mm D1 ø 25mm shaft diameter 17x17mm		
<b>For models:</b>	421003		

			
1			
<b>GEV No.</b>	697245	<b>Ref. No.</b>	SL2615
<b>description</b>	spindle D1 ø 20mm for coupling ø 17mm L 113mm 12-18 C-F		
<b>For models:</b>	512015, 512016, 512019, 512020		

			
1			
<b>GEV No.</b>	698287	<b>Ref. No.</b>	SL0124
<b>description</b>	spindle ø 15mm L 30mm thread M14x1.5 total length 45mm		
<b>For models:</b>	421006, 433003		

locking screws

locking screws

			
1			
<b>GEV No.</b>	697138	<b>Ref. No.</b>	SL0138
<b>description</b>	locking screw thread M10 thread L 30mm		
<b>For models:</b>	421006, 433003		

			
1			
<b>GEV No.</b>	698092	<b>Ref. No.</b>	MF2115
<b>description</b>	locking screw thread M10 thread L 30mm handle ø 60mm plastic		
<b>For models:</b>	421001, 422001, 433001, 433002		



1

<b>GEV No.</b>	698296	<b>Ref. No.</b>	29561600
<b>description</b>	locking screw thread M8 thread L 26mm handle ø 47mm black plastic edition unitl 07/2014		
<b>For models:</b>	421002		



1

<b>GEV No.</b>	698183	<b>Ref. No.</b>	IV4200500
<b>description</b>	locking screw thread M8 L 26mm handle ø 40mm		
<b>For models:</b>	421003		

**lids**



1

<b>GEV No.</b>	698017	<b>Ref. No.</b>	SL2833
<b>description</b>	lid model 12-22 ø 100mm plastic mounting distance 85mm		
<b>For models:</b>	421006, 421007, 431002, 433003, 433004, 433005		
<b>accessories for</b>	698017		
	<b>GEV No.</b>	<b>Ref. No.</b>	SL2573
	699592		
	plug for lid ø 75mm plastic for meat mincer/cheese grater		



1

<b>GEV No.</b>	699592	<b>Ref. No.</b>	SL2573
<b>description</b>	plug for lid ø 75mm plastic for meat mincer/cheese grater		
<b>For models:</b>	431002, 433003, 433004, 433005		
<b>accessories for</b>	699592		
	<b>GEV No.</b>	<b>Ref. No.</b>	SL2833
	698017		
	lid model 12-22 ø 100mm plastic mounting distance 85mm		

**funnel trays**



1

<b>GEV No.</b>	698077	<b>Ref. No.</b>	MF2113
<b>description</b>	hopper filling pipe central L 275mm W 200mm H 50mm tube ø 52mm		
<b>For models:</b>	421001, 433001		



1

<b>GEV No.</b>	698179	<b>Ref. No.</b>	IV2270500 LF2037041
<b>description</b>	hopper filling pipe central L 340mm W 250mm H 60mm tube ø 52mm		
<b>For models:</b>	421003, 431001		

**holders**



1

<b>GEV No.</b>	698237	<b>Ref. No.</b>	29661200
<b>description</b>	bracket model 8 ID ø 51mm hole ø 7mm mounting distance 65mm plastic H 40mm for motor mounting distance 1 84mm		



1

<b>GEV No.</b>	698235	<b>Ref. No.</b>	29030501
<b>description</b>	bracket model 8 ø 57mm ID ø 42mm hole ø 7mm mounting distance 84mm aluminium		







ring nuts

			
1			
<b>GEV No.</b>	698639	<b>Ref. No.</b>	SL0197
<b>description</b>	ring nut ENTERPRISE model 22 ED ø 185mm ID ø 75mm stainless steel thread M96x2		
<b>For models:</b>	421007, 421008, 422005, 422006, 433004		

			
1			
<b>GEV No.</b>	698049	<b>Ref. No.</b>	MF2134
<b>description</b>	ring nut Unger model 12 stainless steel		

			
1			
<b>GEV No.</b>	698070	<b>Ref. No.</b>	MF2254
<b>description</b>	ring nut Unger model 22 stainless steel thread M94x2		

			
1			
<b>GEV No.</b>	698161	<b>Ref. No.</b>	IV2540505L LF2037074
<b>description</b>	ring nut ENTERPRISE model 12 ID ø 62mm stainless steel		
<b>For models:</b>	421003, 431001		

			
1			
<b>GEV No.</b>	698231	<b>Ref. No.</b>	29030401
<b>description</b>	ring nut ENTERPRISE model 8 ID ø 68mm aluminium		
<b>For models:</b>	421002		

			
1			
<b>GEV No.</b>	697123	<b>Ref. No.</b>	SL0171
<b>description</b>	ring nut ENTERPRISE model 12 stainless steel		
<b>For models:</b>	421006, 433003, 433005		

			
1			
<b>GEV No.</b>	699596	<b>Ref. No.</b>	SL3327R0
<b>description</b>	ring nut model 12 ED ø 91mm thickness 30mm ID ø 80mm aluminium		
<b>For models:</b>	421006, 433003, 433005		

			
1			
<b>GEV No.</b>	698040	<b>Ref. No.</b>	MF2133
<b>description</b>	ring nut Unger model 12 ED ø 89mm thickness 27mm ID ø 64mm stainless steel thread M82x2		
<b>For models:</b>	421001, 433001		



1

<b>GEV No.</b>	698039	<b>Ref. No.</b>	MF2132
<b>description</b>	ring nut Unger model 12 ID ø 78mm aluminium		
<b>For models:</b>	421001, 433001		

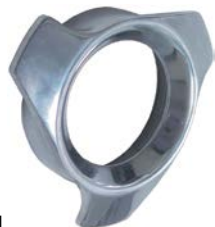

1

<b>GEV No.</b>	698057	<b>Ref. No.</b>	MF2220
<b>description</b>	ring nut Unger model 22 ID ø 73mm aluminium		
<b>For models:</b>	422001, 433002		



1

<b>GEV No.</b>	698058	<b>Ref. No.</b>	MF2221
<b>description</b>	ring nut Unger model 22 ID ø 74mm stainless steel thread M94x2		
<b>For models:</b>	422001, 433002		

augers

complete



1

<b>GEV No.</b>	698037	<b>Ref. No.</b>	F2124PS MF2124 MF2124+MF2127
<b>description</b>	auger model 12 ø 53mm L 135mm stainless steel with spindle ENTERPRISE		
<b>For models:</b>	421001, 433001		



1

<b>GEV No.</b>	698035	<b>Ref. No.</b>	MF2122 MF2122+MF2127
<b>description</b>	auger model 12 ø 53mm L 140mm aluminium with spindle ENTERPRISE		
<b>For models:</b>	421001, 433001		



1

<b>GEV No.</b>	698043	<b>Ref. No.</b>	MF2125 MF2125+MF2128
<b>description</b>	auger model 12 ø 53mm L 145mm cast iron with spindle Unger		



1

<b>GEV No.</b>	698044	<b>Ref. No.</b>	MF2126 MF2126+MF2129
<b>description</b>	auger model 12 ø 53mm L 145mm stainless steel with spindle Unger		



1

<b>GEV No.</b>	698036	<b>Ref. No.</b>	MF2123 MF2123+2127
<b>description</b>	auger model 12 ø 53mm L 150mm cast iron with spindle ENTERPRISE		
<b>For models:</b>	421001, 433001		



1

<b>GEV No.</b>	698281	<b>Ref. No.</b>	SA5350
<b>description</b>	auger model 12 ø 54mm L 150mm cast iron with spindle ENTERPRISE		
<b>For models:</b>	421006, 433003, 433005		



1



<b>GEV No.</b>	698282	<b>Ref. No.</b>	SA5300
<b>description</b>	auger model 12 ø 54mm L 150mm stainless steel with spindle ENTERPRISE		
<b>For models:</b>	421006, 433003, 433005		

1



<b>GEV No.</b>	698055	<b>Ref. No.</b>	MF2216 MF2216+MF2217
<b>description</b>	auger model 22 ø 64mm L 150mm stainless steel with spindle ENTERPRISE		
<b>For models:</b>	422001, 433002		

1



<b>GEV No.</b>	698053	<b>Ref. No.</b>	F2214PS MF2214 MF2214+MF2217
<b>description</b>	auger model 22 ø 63mm L 150mm aluminium with spindle ENTERPRISE		
<b>For models:</b>	422001, 433002		

1



<b>GEV No.</b>	698062	<b>Ref. No.</b>	MF2251 MF2251+MF2252
<b>description</b>	auger model 22 ø 64mm L 175mm stainless steel with spindle Unger		

1



<b>GEV No.</b>	698054	<b>Ref. No.</b>	MF2215 MF2215+MF2217
<b>description</b>	auger model 22 ø 63mm L 150mm cast iron with spindle ENTERPRISE		
<b>For models:</b>	422001, 433002		

1



<b>GEV No.</b>	699589	<b>Ref. No.</b>	SA5500
<b>description</b>	auger model 22 ø 65mm L 183mm stainless steel with bolt		
<b>For models:</b>	421007, 421008, 422005, 422006, 433004		

1



<b>GEV No.</b>	698063	<b>Ref. No.</b>	F2242PU MF2242 MF2242+MF2243 MF2242+MF2252
<b>description</b>	auger model 22 ø 63mm L 175mm cast iron with spindle Unger		

1



<b>GEV No.</b>	698228	<b>Ref. No.</b>	29030301
<b>description</b>	auger model 8 ø 45mm L 100mm aluminium with spindle ENTERPRISE		
<b>For models:</b>	421002		

1



<b>GEV No.</b>	698160	<b>Ref. No.</b>	IV2520505L LF2037072
<b>description</b>	auger ø 53mm L 115mm stainless steel standard shaft diameter 17x17mm with spindle type Mod.12		
<b>For models:</b>	421003, 431001		

augers chambers

outer parts



1

<b>GEV No.</b>	698232	<b>Ref. No.</b>	IV2540500L
<b>description</b>	auger chamber ENTERPRISE model 12 inlet ø 58mm stainless steel		
<b>For models:</b>	421003		



1

<b>GEV No.</b>	698638	<b>Ref. No.</b>	SL3986
<b>description</b>	auger chamber ENTERPRISE model 22 inlet ø 62mm stainless steel		
<b>For models:</b>	422006		



1

<b>GEV No.</b>	698230	<b>Ref. No.</b>	29030201
<b>description</b>	auger chamber ENTERPRISE model 8 aluminium edition unitl 07/2014		
<b>For models:</b>	421002		

inner parts



1

<b>GEV No.</b>	698032	<b>Ref. No.</b>	MF2117
<b>description</b>	auger chamber ENTERPRISE model 12 inlet ø 56mm cast iron		
<b>For models:</b>	421001, 433001		



1

<b>GEV No.</b>	698283	<b>Ref. No.</b>	SL0142
<b>description</b>	auger chamber ENTERPRISE model 12 inlet ø 60mm stainless steel		
<b>For models:</b>	421006, 433003		



1

<b>GEV No.</b>	698034	<b>Ref. No.</b>	MF2118
<b>description</b>	auger chamber ENTERPRISE model 12 inlet ø 61mm stainless steel		
<b>For models:</b>	421001, 433001		



1

<b>GEV No.</b>	698050	<b>Ref. No.</b>	MF2212
<b>description</b>	auger chamber ENTERPRISE model 22 inlet ø 62mm aluminium		
<b>For models:</b>	422001, 433002		



1

<b>GEV No.</b>	698051	<b>Ref. No.</b>	MF2210
<b>description</b>	auger chamber ENTERPRISE model 22 inlet ø 62mm cast iron		
<b>For models:</b>	422001, 433002		



1

<b>GEV No.</b>	698052	<b>Ref. No.</b>	MF2211
<b>description</b>	auger chamber ENTERPRISE model 22 inlet ø 62mm stainless steel thread M94x2		
<b>For models:</b>	422001, 433002		

<b>accessories for</b>	698052		
	<b>GEV No.</b>	690058	<b>Ref. No.</b> —
counter support for off-set 19mm mounting distance 14.25mm W 28mm L 52mm H 50mm type 6000/6004 no. 6000-020701			





			
1			
<b>GEV No.</b>	698041	<b>Ref. No.</b>	MF2120
<b>description</b>	auger chamber Unger model 12 inlet ø 59mm cast iron		

			
1			
<b>GEV No.</b>	698042	<b>Ref. No.</b>	MF2121
<b>description</b>	auger chamber Unger model 12 stainless steel		

			
1			
<b>GEV No.</b>	698059	<b>Ref. No.</b>	MF2240
<b>description</b>	auger chamber Unger model 22 inlet ø 62mm cast iron		

			
1			
<b>GEV No.</b>	698061	<b>Ref. No.</b>	F2255 + F2213 MF2255
<b>description</b>	auger chamber Unger model 22 inlet ø 62mm cast iron for double-bladed knife		

			
1			
<b>GEV No.</b>	698060	<b>Ref. No.</b>	MF2250
<b>description</b>	auger chamber Unger model 22 stainless steel		

miscellaneous			
			
1			
<b>GEV No.</b>	698293	<b>Ref. No.</b>	SL2917
<b>description</b>	screw thread M10x1.5 WS 18 for mincer		
<b>For models:</b>	421006, 421007, 433003, 433004, 433005		

plungers			
			
1			
<b>GEV No.</b>	698229	<b>Ref. No.</b>	29561800
<b>description</b>	plunger ø 41mm L 95mm total length 200mm		
<b>For models:</b>	421002		

			
1			
<b>GEV No.</b>	698080	<b>Ref. No.</b>	MF2114 MF2208
<b>description</b>	plunger ø 46mm L 120mm total length 240mm plastic hollow		
<b>For models:</b>	421001, 422001, 433001, 433002		

			
1			
<b>GEV No.</b>	698659	<b>Ref. No.</b>	LF2032017
<b>description</b>	plunger ø 48mm L 125mm total length 280mm plastic hollow		
<b>For models:</b>	431001		

			
1			
<b>GEV No.</b>	698279	<b>Ref. No.</b>	SL0134
<b>description</b>	plunger ø 50mm L 105mm total length 240mm		
<b>For models:</b>	421005, 421006, 421007, 421008, 422005, 422006, 433003, 433004, 433005		



			
1			
<b>GEV No.</b>	698280	<b>Ref. No.</b>	SL0841
<b>description</b>	plunger ø 50mm L 155mm total length 290mm		
<b>For models:</b>	481004		

for cutters

drive shafts

			
1			
<b>GEV No.</b>	693940	<b>Ref. No.</b>	MSC04N104
<b>description</b>	drive shaft D1 ø 65mm ø 15mm L 170mm C4-C4VV		
<b>For models:</b>	471001		

			
1			
<b>GEV No.</b>	694061	<b>Ref. No.</b>	36G7000
<b>description</b>	drive shaft ø 22mm stainless steel L 137mm CL3		
<b>For models:</b>	471003		

containers

			
1			
<b>GEV No.</b>	698976	<b>Ref. No.</b>	40750080
<b>description</b>	sump GN 1/3 H 200mm plastic		
<b>For models:</b>	481001		

lids









			
1			
<b>GEV No.</b>	691664	<b>Ref. No.</b>	MSC04V052A
<b>description</b>	lid for cutter ø 225mm ID ø 204mm plastic with gasket C4-C6 edition since 08/2003		
<b>For models:</b>	471001		

			
1			
<b>GEV No.</b>	693943	<b>Ref. No.</b>	MSC09V052A
<b>description</b>	lid for cutter ø 265mm ID ø 240mm plastic with gasket C9VV edition since 10/2003		

			
1			
<b>GEV No.</b>	694243	<b>Ref. No.</b>	36Z0665
<b>description</b>	lid ø 215mm ID ø 210mm plastic with magnet CL 3-5-8		
<b>For models:</b>	471003, 471004		











blades			
spacer rings			
 <p>Image not available</p>			
<b>GEV No.</b>	696035	<b>Ref. No.</b>	MSC04N068P
<b>description</b>	spacer ring ED ø 60mm int. ø 1 30mm H 12mm mounting distance 46mm 4 hole hole ø 4.2mm plastic C4-C4VV		
<b>For models:</b>	471001		

				
<b>GEV No.</b>	696020	<b>Ref. No.</b>	MSC04N068	
<b>description</b>	spacer ring ED ø 60mm int. ø 1 30mm H 14mm mounting distance 46mm 4 hole hole ø 4.2mm plastic C4-C4VV			
<b>For models:</b>	471001			
<b>accessories for</b>	696020			
	<b>GEV No.</b>	696037	<b>Ref. No.</b>	MSC04N062
	blade holder ED ø 60mm int. ø 1 15mm int. ø 2 30mm H 77mm mounting distance 46mm 4 hole hole ø 3mm plastic C4-C4VV			
	<b>GEV No.</b>	696174	<b>Ref. No.</b>	MSC04N064F
	mixer mounting pos. upper L 98mm seat ø 33mm mounting distance 46mm 4 hole hole ø 4.4mm thickness 2mm model C4-C6			
	<b>GEV No.</b>	696175	<b>Ref. No.</b>	MSC04N072F
	knife mounting pos. lower L 93mm seat ø 33mm mounting distance 46mm 4 hole hole ø 4.4mm thickness 2mm model C4-C6			
	<b>GEV No.</b>	696176	<b>Ref. No.</b>	MSC04N064
	knife mounting pos. upper L 98mm seat ø 33mm mounting distance 46mm 4 hole hole ø 4.4mm thickness 2mm model C4-C6			
	<b>GEV No.</b>	696177	<b>Ref. No.</b>	MSC04N072
	knife mounting pos. lower L 93mm seat ø 33mm mounting distance 46mm 4 hole hole ø 4.4mm thickness 2mm model C4-C6			
	<b>GEV No.</b>	696178	<b>Ref. No.</b>	MSC04N064Z
	knife mounting pos. upper L 98mm seat ø 42mm mounting distance 46mm 4 hole hole ø 4.4mm thickness 2mm model C4-C6			
	<b>GEV No.</b>	696179	<b>Ref. No.</b>	MSC04N072Z
	knife mounting pos. lower L 93mm seat ø 33mm mounting distance 46mm 4 hole hole ø 4.4mm thickness 2mm model C4-C6			

				
<b>GEV No.</b>	696042	<b>Ref. No.</b>	MSC06N068P	
<b>description</b>	spacer ring ED ø 60mm int. ø 1 30mm H 18mm mounting distance 46mm 4 hole hole ø 4.2mm plastic C6-C6VV			
<b>accessories for</b>	696042			
	<b>GEV No.</b>	696040	<b>Ref. No.</b>	MSC06N062P
	blade holder ED ø 60mm int. ø 1 15mm int. ø 2 30mm H 128mm mounting distance 46mm 4 hole hole ø 3mm plastic ø 60 C6-C6VV-mm			

<b>accessories for</b>	696042			
	<b>GEV No.</b>	696180	<b>Ref. No.</b>	MSC04N064V
	knife mounting pos. upper L 98mm seat ø 33mm mounting distance 46mm 4 hole hole ø 4.4mm thickness 2mm model C4-C6			

			
<b>GEV No.</b>	696041	<b>Ref. No.</b>	MSC06N068
<b>description</b>	spacer ring ED ø 60mm int. ø 1 30mm H 20mm mounting distance 46mm 4 hole hole ø 4.2mm plastic C6-C6VV		

<b>accessories for</b>	696041			
	<b>GEV No.</b>	696039	<b>Ref. No.</b>	MSC06N062
	blade holder ED ø 60mm int. ø 1 15mm int. ø 2 30mm H 133mm mounting distance 46mm 4 hole hole ø 3mm plastic C6-C6VV			
	<b>GEV No.</b>	696174	<b>Ref. No.</b>	MSC04N064F
	mixer mounting pos. upper L 98mm seat ø 33mm mounting distance 46mm 4 hole hole ø 4.4mm thickness 2mm model C4-C6			
	<b>GEV No.</b>	696175	<b>Ref. No.</b>	MSC04N072F
	knife mounting pos. lower L 93mm seat ø 33mm mounting distance 46mm 4 hole hole ø 4.4mm thickness 2mm model C4-C6			
	<b>GEV No.</b>	696176	<b>Ref. No.</b>	MSC04N064
	knife mounting pos. upper L 98mm seat ø 33mm mounting distance 46mm 4 hole hole ø 4.4mm thickness 2mm model C4-C6			
	<b>GEV No.</b>	696177	<b>Ref. No.</b>	MSC04N072
	knife mounting pos. lower L 93mm seat ø 33mm mounting distance 46mm 4 hole hole ø 4.4mm thickness 2mm model C4-C6			
	<b>GEV No.</b>	696178	<b>Ref. No.</b>	MSC04N064Z
	knife mounting pos. upper L 98mm seat ø 42mm mounting distance 46mm 4 hole hole ø 4.4mm thickness 2mm model C4-C6			
	<b>GEV No.</b>	696179	<b>Ref. No.</b>	MSC04N072Z
	knife mounting pos. lower L 93mm seat ø 33mm mounting distance 46mm 4 hole hole ø 4.4mm thickness 2mm model C4-C6			

			
<b>GEV No.</b>	697106	<b>Ref. No.</b>	36G0650
<b>description</b>	spacer ring ED ø 63mm int. ø 1 39mm mounting distance 52mm hole ø 5.5mm plastic CL 3-5-8		
<b>For models:</b>	471004		









				
<b>GEV No.</b>	696000	<b>Ref. No.</b>	MSC09V068	
<b>description</b>	spacer ring ED ø 72mm int. ø 1 38mm H 24mm mounting distance 58mm 4 hole hole ø 5mm plastic C9VV			
<b>accessories for</b>	696000			
	<b>GEV No.</b>	696036	<b>Ref. No.</b>	MSC09V062
	blade holder ED ø 72mm int. ø 1 20mm int. ø 2 38mm H 165mm mounting distance 58mm 4 hole hole ø 3.5mm plastic C9VV			



Table continues overleaf









accessories for		696000	
	GEV No.	696182	Ref. No. MSC09V064F
mixer mounting pos. upper L 119mm seat ø 42mm mounting distance 58mm 4 hole hole ø 4.4mm thickness 2.5mm model C9VV			
	GEV No.	696183	Ref. No. MSC09V072F
mixer mounting pos. lower L 112mm seat ø 42mm mounting distance 58mm 4 hole hole ø 4.4mm thickness 2.5mm model C9VV			
	GEV No.	696184	Ref. No. MSC09V064
knife mounting pos. upper L 119mm seat ø 42mm mounting distance 58mm 4 hole hole ø 4.4mm thickness 2.5mm model C9VV			
	GEV No.	696185	Ref. No. MSC09V072
knife mounting pos. lower L 112mm seat ø 42mm mounting distance 58mm 4 hole hole ø 4.4mm thickness 2.5mm model C9VV			
	GEV No.	696186	Ref. No. MSC09V064Z
knife mounting pos. upper L 119mm seat ø 42mm mounting distance 58mm 4 hole hole ø 4.4mm thickness 2.5mm model C9VV			
	GEV No.	696187	Ref. No. MSC09V072Z
knife mounting pos. lower L 112mm seat ø 42mm mounting distance 58mm 4 hole hole ø 4.4mm thickness 2.5mm model C9VV			

## holders



1

GEV No.	696040	Ref. No.	MSC06N062P
<b>description</b>	blade holder ED ø 60mm int. ø 1 15mm int. ø 2 30mm H 128mm mounting distance 46mm 4 hole hole ø 3mm plastic ø 60 C6-C6VV-mm		
<b>accessories for</b>	696040		
	GEV No.	696042	Ref. No. MSC06N068P
spacer ring ED ø 60mm int. ø 1 30mm H 18mm mounting distance 46mm 4 hole hole ø 4.2mm plastic C6-C6VV			
	GEV No.	696180	Ref. No. MSC04N064V
knife mounting pos. upper L 98mm seat ø 33mm mounting distance 46mm 4 hole hole ø 4.4mm thickness 2mm model C4-C6			

	1		
<b>GEV No.</b>	696039	<b>Ref. No.</b>	MSC06N062
<b>description</b>	blade holder ED ø 60mm int. ø 1 15mm int. ø 2 30mm H 133mm mounting distance 46mm 4 hole hole ø 3mm plastic C6-C6VV		
<b>accessories for</b>	696039		
	GEV No.	696041	Ref. No. MSC06N068
spacer ring ED ø 60mm int. ø 1 30mm H 20mm mounting distance 46mm 4 hole hole ø 4.2mm plastic C6-C6VV			
	GEV No.	696174	Ref. No. MSC04N064F
mixer mounting pos. upper L 98mm seat ø 33mm mounting distance 46mm 4 hole hole ø 4.4mm thickness 2mm model C4-C6			
	GEV No.	696175	Ref. No. MSC04N072F
knife mounting pos. lower L 93mm seat ø 33mm mounting distance 46mm 4 hole hole ø 4.4mm thickness 2mm model C4-C6			
	GEV No.	696176	Ref. No. MSC04N064
knife mounting pos. upper L 98mm seat ø 33mm mounting distance 46mm 4 hole hole ø 4.4mm thickness 2mm model C4-C6			
	GEV No.	696177	Ref. No. MSC04N072
knife mounting pos. lower L 93mm seat ø 33mm mounting distance 46mm 4 hole hole ø 4.4mm thickness 2mm model C4-C6			
	GEV No.	696178	Ref. No. MSC04N064Z
knife mounting pos. upper L 98mm seat ø 42mm mounting distance 46mm 4 hole hole ø 4.4mm thickness 2mm model C4-C6			
	GEV No.	696179	Ref. No. MSC04N072Z
knife mounting pos. lower L 93mm seat ø 33mm mounting distance 46mm 4 hole hole ø 4.4mm thickness 2mm model C4-C6			



	1		
<b>GEV No.</b>	696038	<b>Ref. No.</b>	MSC04N062P
<b>description</b>	blade holder ED ø 60mm int. ø 1 15mm int. ø 2 30mm H 72mm mounting distance 46mm 4 hole hole ø 3mm plastic C4-C4VV		
<b>For models:</b>	471001		
<b>accessories for</b>	696038		
	GEV No.	696035	Ref. No. MSC04N068P
spacer ring ED ø 60mm int. ø 1 30mm H 12mm mounting distance 46mm 4 hole hole ø 4.2mm plastic C4-C4VV			

Table continues overleaf





<b>accessories for</b>	696038		
	<b>GEV No.</b>	696180	<b>Ref. No.</b> MSC04N064V
knife mounting pos. upper L 98mm seat ø 33mm mounting distance 46mm 4 hole hole ø 4.4mm thickness 2mm model C4-C6			



<b>GEV No.</b>	696037	<b>Ref. No.</b>	MSC04N062
<b>description</b>	blade holder ED ø 60mm int. ø 1 15mm int. ø 2 30mm H 77mm mounting distance 46mm 4 hole hole ø 3mm plastic C4-C4VV		
<b>For models:</b>	471001		
<b>accessories for</b>	696037		
	<b>GEV No.</b>	696020	<b>Ref. No.</b> MSC04N068
spacer ring ED ø 60mm int. ø 1 30mm H 14mm mounting distance 46mm 4 hole hole ø 4.2mm plastic C4-C4VV			
	<b>GEV No.</b>	696174	<b>Ref. No.</b> MSC04N064F
mixer mounting pos. upper L 98mm seat ø 33mm mounting distance 46mm 4 hole hole ø 4.4mm thickness 2mm model C4-C6			
	<b>GEV No.</b>	696175	<b>Ref. No.</b> MSC04N072F
knife mounting pos. lower L 93mm seat ø 33mm mounting distance 46mm 4 hole hole ø 4.4mm thickness 2mm model C4-C6			
	<b>GEV No.</b>	696176	<b>Ref. No.</b> MSC04N064
knife mounting pos. upper L 98mm seat ø 33mm mounting distance 46mm 4 hole hole ø 4.4mm thickness 2mm model C4-C6			
	<b>GEV No.</b>	696177	<b>Ref. No.</b> MSC04N072
knife mounting pos. lower L 93mm seat ø 33mm mounting distance 46mm 4 hole hole ø 4.4mm thickness 2mm model C4-C6			
	<b>GEV No.</b>	696178	<b>Ref. No.</b> MSC04N064Z
knife mounting pos. upper L 98mm seat ø 42mm mounting distance 46mm 4 hole hole ø 4.4mm thickness 2mm model C4-C6			
	<b>GEV No.</b>	696179	<b>Ref. No.</b> MSC04N072Z
knife mounting pos. lower L 93mm seat ø 33mm mounting distance 46mm 4 hole hole ø 4.4mm thickness 2mm model C4-C6			



<b>GEV No.</b>	651037	<b>Ref. No.</b>	36G7010
<b>description</b>	blade holder ED ø 63mm int. ø 1 39mm int. ø 2 10mm H 81.5mm mounting distance 52mm thread M5 plastic CL 3-5-8		
<b>For models:</b>	471003, 471004		



<b>GEV No.</b>	696036	<b>Ref. No.</b>	MSC09V062
<b>description</b>	blade holder ED ø 72mm int. ø 1 20mm int. ø 2 38mm H 165mm mounting distance 58mm 4 hole hole ø 3.5mm plastic C9VV		
<b>accessories for</b>	696036		
	<b>GEV No.</b>	696000	<b>Ref. No.</b> MSC09V068
spacer ring ED ø 72mm int. ø 1 38mm H 24mm mounting distance 58mm 4 hole hole ø 5mm plastic C9VV			
	<b>GEV No.</b>	696182	<b>Ref. No.</b> MSC09V064F
mixer mounting pos. upper L 119mm seat ø 42mm mounting distance 58mm 4 hole hole ø 4.4mm thickness 2.5mm model C9VV			
	<b>GEV No.</b>	696183	<b>Ref. No.</b> MSC09V072F
mixer mounting pos. lower L 112mm seat ø 42mm mounting distance 58mm 4 hole hole ø 4.4mm thickness 2.5mm model C9VV			
	<b>GEV No.</b>	696184	<b>Ref. No.</b> MSC09V064
knife mounting pos. upper L 119mm seat ø 42mm mounting distance 58mm 4 hole hole ø 4.4mm thickness 2.5mm model C9VV			
	<b>GEV No.</b>	696185	<b>Ref. No.</b> MSC09V072
knife mounting pos. lower L 112mm seat ø 42mm mounting distance 58mm 4 hole hole ø 4.4mm thickness 2.5mm model C9VV			
	<b>GEV No.</b>	696186	<b>Ref. No.</b> MSC09V064Z
knife mounting pos. upper L 119mm seat ø 42mm mounting distance 58mm 4 hole hole ø 4.4mm thickness 2.5mm model C9VV			
	<b>GEV No.</b>	696187	<b>Ref. No.</b> MSC09V072Z
knife mounting pos. lower L 112mm seat ø 42mm mounting distance 58mm 4 hole hole ø 4.4mm thickness 2.5mm model C9VV			

blades

blades serrated

	<b>GEV No.</b>	696187	<b>Ref. No.</b> MSC09V072Z
<b>description</b>	knife mounting pos. lower L 112mm seat ø 42mm mounting distance 58mm 4 hole hole ø 4.4mm thickness 2.5mm model C9VV		

	<b>GEV No.</b>	696179	<b>Ref. No.</b> MSC04N072Z
<b>description</b>	knife mounting pos. lower L 93mm seat ø 33mm mounting distance 46mm 4 hole hole ø 4.4mm thickness 2mm model C4-C6		
<b>For models:</b>	471001		

			
1			
<b>GEV No.</b>	696186	<b>Ref. No.</b>	MSC09V064Z
<b>description</b>	knife mounting pos. upper L 119mm seat ø 42mm mounting distance 58mm 4 hole hole ø 4.4mm thickness 2.5mm model C9VV		

			
1			
<b>GEV No.</b>	696178	<b>Ref. No.</b>	MSC04N064Z
<b>description</b>	knife mounting pos. upper L 98mm seat ø 42mm mounting distance 46mm 4 hole hole ø 4.4mm thickness 2mm model C4-C6		
<b>For models:</b>	471001		

## blades smooth

			
1			
<b>GEV No.</b>	696185	<b>Ref. No.</b>	MSC09V072
<b>description</b>	knife mounting pos. lower L 112mm seat ø 42mm mounting distance 58mm 4 hole hole ø 4.4mm thickness 2.5mm model C9VV		

			
1			
<b>GEV No.</b>	696177	<b>Ref. No.</b>	MSC04N072
<b>description</b>	knife mounting pos. lower L 93mm seat ø 33mm mounting distance 46mm 4 hole hole ø 4.4mm thickness 2mm model C4-C6		
<b>For models:</b>	471001		

			
1			
<b>GEV No.</b>	696184	<b>Ref. No.</b>	MSC09V064
<b>description</b>	knife mounting pos. upper L 119mm seat ø 42mm mounting distance 58mm 4 hole hole ø 4.4mm thickness 2.5mm model C9VV		

			
1			
<b>GEV No.</b>	696176	<b>Ref. No.</b>	MSC04N064
<b>description</b>	knife mounting pos. upper L 98mm seat ø 33mm mounting distance 46mm 4 hole hole ø 4.4mm thickness 2mm model C4-C6		
<b>For models:</b>	471001		

			
1			
<b>GEV No.</b>	696180	<b>Ref. No.</b>	MSC04N064V
<b>description</b>	knife mounting pos. upper L 98mm seat ø 33mm mounting distance 46mm 4 hole hole ø 4.4mm thickness 2mm model C4-C6		
<b>For models:</b>	471001		

			
1			
<b>GEV No.</b>	696181	<b>Ref. No.</b>	MSC04N064P
<b>description</b>	knife mounting pos. upper L 98mm seat ø 33mm mounting distance 46mm 4 hole hole ø 4.4mm thickness 2mm model C4-C6		
<b>For models:</b>	471001		

			
1			
<b>GEV No.</b>	696173	<b>Ref. No.</b>	36G7030
<b>description</b>	knife mounting pos. upper seat ø 42mm mounting distance 52mm hole ø 5.5mm thickness 2mm model CL 3-5-8		
<b>For models:</b>	471003, 471004		

## mixers

			
1			
<b>GEV No.</b>	696183	<b>Ref. No.</b>	MSC09V072F
<b>description</b>	mixer mounting pos. lower L 112mm seat ø 42mm mounting distance 58mm 4 hole hole ø 4.4mm thickness 2.5mm model C9VV		

			
1			
<b>GEV No.</b>	696182	<b>Ref. No.</b>	MSC09V064F
<b>description</b>	mixer mounting pos. upper L 119mm seat ø 42mm mounting distance 58mm 4 hole hole ø 4.4mm thickness 2.5mm model C9VV		

			
1			
<b>GEV No.</b>	696174	<b>Ref. No.</b>	MSC04N064F
<b>description</b>	mixer mounting pos. upper L 98mm seat ø 33mm mounting distance 46mm 4 hole hole ø 4.4mm thickness 2mm model C4-C6		
<b>For models:</b>	471001		





blades with adaptor (complete)

			
1			
<b>GEV No.</b>	696526	<b>Ref. No.</b>	COLCL3L2
<b>description</b>	knife complete ø 200mm H 115mm CL3		
<b>For models:</b>	471003		

			
1			
<b>GEV No.</b>	696794	<b>Ref. No.</b>	COLCL58L2
<b>description</b>	knife smooth ø 200mm H 133mm CL 5-8		
<b>For models:</b>	471004		

protective coverings

			
1			
<b>GEV No.</b>	696189	<b>Ref. No.</b>	MSC04N075
<b>description</b>	protective covering for cutter blade mounting pos. lower model C4-C6		
<b>For models:</b>	471001		

			
1			
<b>GEV No.</b>	696188	<b>Ref. No.</b>	MSC04N073
<b>description</b>	protective covering for cutter blade mounting pos. upper model C4-C6		
<b>For models:</b>	471001		

miscellaneous

			
1			
<b>GEV No.</b>	696472	<b>Ref. No.</b>	36M5620
<b>description</b>	connector FIMAR L 40mm W 20mm plastic		
<b>For models:</b>	471003, 471004		

			
1			
<b>GEV No.</b>	696190	<b>Ref. No.</b>	MSC04N174
<b>description</b>	grindstone for knife L 60mm W 25mm thickness 12mm with handle		
<b>For models:</b>	471001		

			
1			
<b>GEV No.</b>	696378	<b>Ref. No.</b>	MSC04N028
<b>description</b>	guide for container plastic		
<b>For models:</b>	471001		

			
1			
<b>GEV No.</b>	696525	<b>Ref. No.</b>	SA1085
<b>description</b>	plunger for cutter L 135mm ø 80mm plastic		
<b>For models:</b>	471003		

			
1			
<b>GEV No.</b>	696191	<b>Ref. No.</b>	MSC04N200
<b>description</b>	scraper L 121mm W 82mm plastic		
<b>For models:</b>	471001		

## for vegetable slicers

## lids



1

<b>GEV No.</b>	696198	<b>Ref. No.</b>	IV2280010
<b>description</b>	lid for vegetable slicer stainless steel ø 220mm TM		
<b>For models:</b>	481001		

## press levers



1

<b>GEV No.</b>	697900	<b>Ref. No.</b>	IV4010000
<b>description</b>	press lever L 180mm W 145mm H 140mm plastic TM		
<b>For models:</b>	481001		

## holders



1

<b>GEV No.</b>	696100	<b>Ref. No.</b>	IV4010030
<b>description</b>	bracket for microswitch H 39mm L 65mm W 26mm TM		
<b>For models:</b>	481001		

## ejector discs



1

<b>GEV No.</b>	697294	<b>Ref. No.</b>	40751DESP
<b>description</b>	ejector H 17mm seat ø 25mm hole distance 41mm TMA		
<b>For models:</b>	481001		



1

<b>GEV No.</b>	699110	<b>Ref. No.</b>	50SCA78300
<b>description</b>	ejector disc flat H 10mm ø 200mm seat ø 50mm shaft diameter 19mm hole distance 39mm		
<b>For models:</b>	481005		

## grating discs



1

<b>GEV No.</b>	697497	<b>Ref. No.</b>	40751DT02 480012
<b>description</b>	grating disc type DT2 ø 205mm seat ø 19mm slicing thickness 2mm SS/aluminium		



1

<b>GEV No.</b>	697489	<b>Ref. No.</b>	40751DT03 480013
<b>description</b>	grating disc type DT3 ø 205mm seat ø 19mm slicing thickness 3mm SS/aluminium		



1

<b>GEV No.</b>	696167	<b>Ref. No.</b>	40751DT04 480014
<b>description</b>	grating disc type DT4 ø 205mm seat ø 19mm slicing thickness 4mm SS/aluminium		



1

<b>GEV No.</b>	697491	<b>Ref. No.</b>	40751DT07 480015
<b>description</b>	grating disc type DT7 ø 205mm seat ø 19mm H 34.5mm slicing thickness 7mm SS/aluminium		

1

<b>GEV No.</b>	697498	<b>Ref. No.</b>	40751DT09
<b>description</b>	grating disc type DT9 ø 205mm seat ø 19mm slicing thickness 9mm SS/aluminium		



1

<b>GEV No.</b>	697496	<b>Ref. No.</b>	40751DTV
<b>description</b>	grating disc type DTV ø 205mm seat ø 19mm SS/aluminium		

cutting discs

blades smooth

cutting discs



1

<b>GEV No.</b>	697504	<b>Ref. No.</b>	40751DF01
<b>description</b>	slicing disk type DF1 ø 205mm seat ø 19mm slicing thickness 1mm aluminium		



1

<b>GEV No.</b>	697502	<b>Ref. No.</b>	40751DF10 480006
<b>description</b>	slicing disk type DF10 ø 205mm seat ø 19mm slicing thickness 10mm aluminium		



1

<b>GEV No.</b>	697494	<b>Ref. No.</b>	40751DF14
<b>description</b>	slicing disk type DF14 ø 205mm seat ø 19mm slicing thickness 14mm aluminium		



1

<b>GEV No.</b>	697302	<b>Ref. No.</b>	40751DF02 480001
<b>description</b>	slicing disk type DF2 ø 205mm seat ø 19mm slicing thickness 2mm aluminium		



1

<b>GEV No.</b>	697503	<b>Ref. No.</b>	40751DF03
<b>description</b>	slicing disk type DF3 ø 205mm seat ø 19mm slicing thickness 3mm aluminium		



1

<b>GEV No.</b>	697485	<b>Ref. No.</b>	40751DF04 480003
<b>description</b>	slicing disk type DF4 ø 205mm seat ø 19mm slicing thickness 4mm aluminium		



1

<b>GEV No.</b>	697484	<b>Ref. No.</b>	40751DF08
<b>description</b>	slicing disk type DF8 ø 205mm seat ø 19mm slicing thickness 8mm aluminium		



1

<b>GEV No.</b>	697389	<b>Ref. No.</b>	480070
<b>description</b>	slicing disk type E1 ø 206mm seat ø 19mm slicing thickness 1mm plastic		

blades round



1

<b>GEV No.</b>	697303	<b>Ref. No.</b>	40751DF05
<b>description</b>	slicing disk type DF5 ø 205mm seat ø 19mm slicing thickness 5mm aluminium		

stick slicing discs



1

<b>GEV No.</b>	697488	<b>Ref. No.</b>	40751DQ10 480011
<b>description</b>	stick slicing disc type DQ10 ø 205mm seat ø 19mm slicing thickness 10mm aluminium		



1

<b>GEV No.</b>	697493	<b>Ref. No.</b>	40751DQ04 480008
<b>description</b>	stick slicing disc type DQ4 ø 205mm seat ø 19mm slicing thickness 4mm aluminium		



1

<b>GEV No.</b>	697495	<b>Ref. No.</b>	40751DQ06 480009
<b>description</b>	stick slicing disc type DQ6 ø 205mm seat ø 19mm slicing thickness 6mm aluminium		



1

<b>GEV No.</b>	697486	<b>Ref. No.</b>	40751DQ08 480010
<b>description</b>	stick slicing disc type DQ8 ø 205mm seat ø 19mm slicing thickness 8mm aluminium		

cubing grids



1

<b>GEV No.</b>	697490	<b>Ref. No.</b>	40751PS10 480018
<b>description</b>	cubing grid type PS10 ø 210mm seat ø 38mm slicing thickness 10mm aluminium		



1

<b>GEV No.</b>	697499	<b>Ref. No.</b>	40751PS14 480019
<b>description</b>	cubing grid type PS14 ø 210mm seat ø 38mm slicing thickness 14mm aluminium		



1

<b>GEV No.</b>	697501	<b>Ref. No.</b>	40751PS20 480020
<b>description</b>	cubing grid type PS20 ø 210mm seat ø 38mm slicing thickness 20mm aluminium		



1

<b>GEV No.</b>	697487	<b>Ref. No.</b>	40751PS08 480017
<b>description</b>	cubing grid type PS8 ø 210mm seat ø 38mm slicing thickness 8mm aluminium		



plungers



1			
<b>GEV No.</b>	698186	<b>Ref. No.</b>	IV98407400
<b>description</b>	plunger ø 50mm L 140mm plastic TMA		
<b>For models:</b>	481001		

spindles



1			
<b>GEV No.</b>	696098	<b>Ref. No.</b>	IV2080050
<b>description</b>	spindle L1 18.5mm L2 10.5mm D1 ø 6mm D2 ø 5mm for microswitch total length 30.5mm TM		
<b>For models:</b>	481001		

miscellaneous



1			
<b>GEV No.</b>	696099	<b>Ref. No.</b>	IV75MTM
<b>description</b>	compression spring ø 7.2mm L 19mm wire gauge ø 0.7mm for microswitch model TM		
<b>For models:</b>	481001		



1			
<b>GEV No.</b>	110703	<b>Ref. No.</b>	1829200 IMPUG001 MA1829200 SL0106
<b>description</b>	cylindrical handle thread M10 ø 28mm L 87mm		
<b>For models:</b>	123101, 123102, 431002, 433003, 433004, 433005, 481004, 530009, 530010, 530011, 530012, 531020, 531021, 531022, 531023		



1			
<b>GEV No.</b>	696192	<b>Ref. No.</b>	IV7400010
<b>description</b>	latch mounting distance 15mm stainless steel TM		
<b>For models:</b>	481001		



1			
<b>GEV No.</b>	692145	<b>Ref. No.</b>	36G6600
<b>description</b>	pulley disc ø 157mm disc width 31mm shaft intake ø 15mm overall width 30mm plastic for potato peeler device		
<b>For models:</b>	451003, 451004, 481004		

for cheese graters

lids



1			
<b>GEV No.</b>	698017	<b>Ref. No.</b>	SL2833
<b>description</b>	lid model 12-22 ø 100mm plastic mounting distance 85mm		
<b>For models:</b>	421006, 421007, 431002, 433003, 433004, 433005		

<b>accessories for</b>	698017		
	<b>GEV No.</b>	699592	<b>Ref. No.</b>
			SL2573



plug for lid ø 75mm plastic for meat mincer/cheese grater



1			
<b>GEV No.</b>	699592	<b>Ref. No.</b>	SL2573
<b>description</b>	plug for lid ø 75mm plastic for meat mincer/cheese grater		
<b>For models:</b>	431002, 433003, 433004, 433005		

<b>accessories for</b>	699592		
	<b>GEV No.</b>	698017	<b>Ref. No.</b>
			SL2833



lid model 12-22 ø 100mm plastic mounting distance 85mm



press levers



1			
<b>GEV No.</b>	698236	<b>Ref. No.</b>	MF2162
<b>description</b>	press lever Mod.12-22		
<b>For models:</b>	433001, 433002		

rubbing cylinders

complete



1			
<b>GEV No.</b>	698158	<b>Ref. No.</b>	LF2037035
<b>description</b>	grating cylinder ø 75mm L 140mm ID ø 14mm shaft ø 15mm stainless steel Mod.12		
<b>For models:</b>	431001		



1			
<b>GEV No.</b>	698015	<b>Ref. No.</b>	MF2158
<b>description</b>	grating cylinder ø 79mm L 155mm ID ø 25mm stainless steel Mod.12-22		
<b>For models:</b>	433001, 433002		

rubbing cylinders



1			
<b>GEV No.</b>	698234	<b>Ref. No.</b>	MF2156
<b>description</b>	grating cylinder ø 79mm L 142.2mm ID ø 71mm Mod.12-22		
<b>For models:</b>	433001, 433002		

side parts



1			
<b>GEV No.</b>	698016	<b>Ref. No.</b>	MF2155
<b>description</b>	side panel ID ø 25mm ED ø 71mm W 24mm aluminium Mod.12-22		
<b>For models:</b>	433001, 433002		

gear wheels



1			
<b>GEV No.</b>	698148	<b>Ref. No.</b>	IV2320500
<b>description</b>	auger ø 35.5mm shaft intake ø 17mm W 45mm for mincer Mod.12		
<b>For models:</b>	421003		



1			
<b>GEV No.</b>	698149	<b>Ref. No.</b>	IV2330500
<b>description</b>	gear wheel ø 61mm shaft intake ø 17mm teeth 27 tooth width 20mm Mod.12		
<b>For models:</b>	421003		

miscellaneous



1			
<b>GEV No.</b>	698011	<b>Ref. No.</b>	MF2160
<b>description</b>	bolt for press lever ø 8mm L 60mm		
<b>For models:</b>	433001, 433002		



1			
<b>GEV No.</b>	110703	<b>Ref. No.</b>	1829200 IMPUG001 MA1829200 SL0106
<b>description</b>	cylindrical handle thread M10 ø 28mm L 87mm		
<b>For models:</b>	123101, 123102, 431002, 433003, 433004, 433005, 481004, 530009, 530010, 530011, 530012, 531020, 531021, 531022, 531023		





for mozzarella slicers

accessories



1

<b>GEV No.</b>	696197	<b>Ref. No.</b>	IB1263050
<b>description</b>	body for mozzarella cutter ø 180mm ID ø 42mm aluminium Athos		



1

<b>GEV No.</b>	696097	<b>Ref. No.</b>	IB2183000
<b>description</b>	bracket L 94mm W 12mm mounting distance 50mm protection cap Athos		



1

<b>GEV No.</b>	696193	<b>Ref. No.</b>	IB4023000A
<b>description</b>	protection cap ø 188mm H 51mm mounting distance 95mm plastic white Athos		

for potato peelers

drive shafts



1

<b>GEV No.</b>	692147	<b>Ref. No.</b>	36G6590
<b>description</b>	drive shaft for potato peeler device L 134mm		
<b>For models:</b>	451003, 451004		



1

<b>GEV No.</b>	696054	<b>Ref. No.</b>	RG04270
<b>description</b>	shaft set with gasket and ball bearing potato peeler PP4 Expo shaft 25x14mm		
<b>For models:</b>	451001		



1

<b>GEV No.</b>	696055	<b>Ref. No.</b>	RG08270
<b>description</b>	shaft set with gasket and ball bearing potato peeler PP8-PP15 Expo shaft 28x14mm		

lids



1

<b>GEV No.</b>	696454	<b>Ref. No.</b>	36Z6501
<b>description</b>	lid for potato peeler device ø 430mm ID ø 380mm plastic mounting distance 220mm H 80mm		
<b>For models:</b>	451003, 451004		

<b>accessories for</b>	696454		
	<b>GEV No.</b>	901522	<b>Ref. No.</b>
			SL2871
	lid gasket suitable for FIMAR for potato peeler device L 1280mm external height 12mm external width 12mm		

			
1			
<b>GEV No.</b>	696199	<b>Ref. No.</b>	RG04002
<b>description</b>	lid potato peeler ø 310mm ID ø 280mm plastic mounting distance 59mm PP4-PP8-PP15 Expo		
<b>For models:</b>	451001		

## abrasive side elements

## brush discs

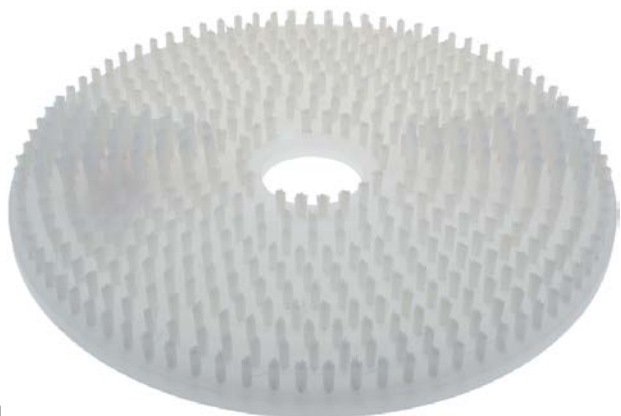
			
1			
<b>GEV No.</b>	696385	<b>Ref. No.</b>	36G6880
<b>description</b>	brush disc for potato peeler device ø 387mm H 46mm hole ø 65.5mm		
<b>For models:</b>	451003, 451004		

## inserts



			
1			
<b>GEV No.</b>	696202	<b>Ref. No.</b>	RG04016
<b>description</b>	abrasive band potato peeler ø 300mm L 205mm mounting distance 120mm PP4 Expo		
<b>For models:</b>	451001		

			
1			
<b>GEV No.</b>	696203	<b>Ref. No.</b>	RG08016
<b>description</b>	abrasive band potato peeler ø 300mm L 270mm mounting distance 160mm PP8 Expo		

## grinding discs

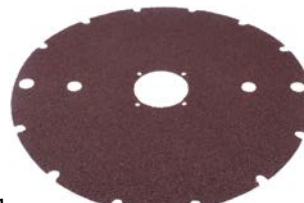
			
1			
<b>GEV No.</b>	696201	<b>Ref. No.</b>	RG04025
<b>description</b>	grating disc ø 280mm potato peeler PP4-PP8 Expo		
<b>For models:</b>	451001		

			
1			
<b>GEV No.</b>	696386	<b>Ref. No.</b>	SL2494
<b>description</b>	grinding disc ø 367mm for potato peeler device edition until year of construction 01/2008		
<b>For models:</b>	451003, 451004		

				
1				
<b>GEV No.</b>	696446	<b>Ref. No.</b>	ACPTA	
<b>description</b>	grinding disc ø 380mm for potato peeler device			
<b>For models:</b>	451003, 451004			
<b>spare parts for</b>	696446			
	<b>GEV No.</b>	696441	<b>Ref. No.</b>	—
	grinding disc ø 370mm for potato peeler device edition since 01/2008			









## pulleys

			
1			
<b>GEV No.</b>	696047	<b>Ref. No.</b>	RG08268
<b>description</b>	pulley disc ø 116mm disc width 33mm shaft intake ø 16mm overall width 33mm type flat metal for potato peeler device		



miscellaneous



1	<b>GEV No.</b>	696539	<b>Ref. No.</b>	SA1064
	<b>description</b>	bottom for potato peeler device complete with spindle plastic ø 400mm		
	<b>For models:</b>	451003, 451004		
	<b>spare parts for</b>	696539		
	<b>GEV No.</b>	523526	<b>Ref. No.</b>	29320101 36F0090
	<b>description</b>	deep-groove ball bearing type 6302-2RS shaft ø 15mm ED ø 42mm W 13mm with sealing discs deep-groove ball bearing DIN 625-1		
	<b>GEV No.</b>	692006	<b>Ref. No.</b>	SL0010
	<b>description</b>	slot nut W 5mm H 5mm L 20mm		
	<b>GEV No.</b>	692145	<b>Ref. No.</b>	36G6600
	<b>description</b>	pulley disc ø 157mm disc width 31mm shaft intake ø 15mm overall width 30mm plastic for potato peeler device		
	<b>GEV No.</b>	692147	<b>Ref. No.</b>	36G6590
	<b>description</b>	drive shaft for potato peeler device L 134mm		
	<b>GEV No.</b>	696406	<b>Ref. No.</b>	3190830
	<b>description</b>	disc for potato peeler device ED ø 42mm ID ø 28.7mm thickness 4.5mm		
	<b>GEV No.</b>	696408	<b>Ref. No.</b>	36G5950
	<b>description</b>	bush for potato peeler device ED ø 20mm ID ø 16mm thickness 2mm L 19.4mm		
	<b>GEV No.</b>	696412	<b>Ref. No.</b>	3600870
	<b>description</b>	bottom plastic		
	<b>GEV No.</b>	698352	<b>Ref. No.</b>	3151300 SL3943
	<b>description</b>	shaft seal ID ø 28mm ED ø 42mm thickness 7mm		
	<b>accessories for</b>	696539		
	<b>GEV No.</b>	532609	<b>Ref. No.</b>	3151750
	<b>description</b>	O-ring NBR thickness 7mm ID ø 387mm Qty 1 pcs		
	<b>GEV No.</b>	696538	<b>Ref. No.</b>	—
	<b>description</b>	abrasive band for potato peeler device ø 400mm L 205mm mounting distance 165mm		



1	<b>GEV No.</b>	696412	<b>Ref. No.</b>	3600870
	<b>description</b>	bottom plastic		
	<b>For models:</b>	451003, 451004		



1	<b>GEV No.</b>	696408	<b>Ref. No.</b>	36G5950
	<b>description</b>	bush for potato peeler device ED ø 20mm ID ø 16mm thickness 2mm L 19.4mm		
	<b>For models:</b>	451003, 451004		



1	<b>GEV No.</b>	696407	<b>Ref. No.</b>	36D9660
	<b>description</b>	deflector for potato peeler device plastic L 144mm W 38mm H 130mm thread 1/4"/M6		
	<b>For models:</b>	451004		



1	<b>GEV No.</b>	696406	<b>Ref. No.</b>	3190830
	<b>description</b>	disc for potato peeler device ED ø 42mm ID ø 28.7mm thickness 4.5mm		
	<b>For models:</b>	451003, 451004		



1

<b>GEV No.</b>	696540	<b>Ref. No.</b>	35X1150
<b>description</b>	drain pipe ø 99mm for potato peeler device plastic L 520mm ID ø 90mm		
<b>For models:</b>	451003		



1

<b>GEV No.</b>	696458	<b>Ref. No.</b>	36C0011
<b>description</b>	frame W 202mm H 154mm thickness 4mm plastic for potato peeler device		
<b>For models:</b>	451003, 451004		



1

<b>GEV No.</b>	696760	<b>Ref. No.</b>	RG04246
<b>description</b>	plate for motor stainless steel		
<b>For models:</b>	451001		



1

<b>GEV No.</b>	696046	<b>Ref. No.</b>	RG04268
<b>description</b>	pulley disc ø 116mm disc width 25mm shaft intake ø 16mm overall width 25mm type flat metal for potato peeler device		
<b>For models:</b>	451001		



1

<b>GEV No.</b>	696543	<b>Ref. No.</b>	36G6620
<b>description</b>	V-ripped belt pulley grooves 12 disc ø 38mm shaft intake ø 14mm disc width 30mm groove depth 1.5mm groove width 1mm overall width 37mm aluminium H 38mm shaft ø 14mm		
<b>For models:</b>	451003, 451004, 481004		



1

<b>GEV No.</b>	696044	<b>Ref. No.</b>	RG04250
<b>description</b>	V-ripped belt pulley grooves 8 disc ø 25mm shaft intake ø 10mm disc width 28mm groove depth 2mm groove width 2mm overall width 28mm type TB2.34		
<b>For models:</b>	451001		

## door mechanics

### door seals

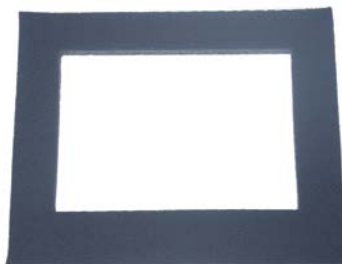

1

<b>GEV No.</b>	696168	<b>Ref. No.</b>	RG04154
<b>description</b>	door seal L 143mm W 120mm thickness 4mm internal size 104x75mm PP4 Expo		
<b>For models:</b>	451001		



1

<b>GEV No.</b>	696051	<b>Ref. No.</b>	RG08052
<b>description</b>	door seal L 170mm W 135mm thickness 8mm internal size 90x115mm PP8 Expo		



1

<b>GEV No.</b>	901523	<b>Ref. No.</b>	37Q7860
<b>description</b>	gasket suitable for FIMAR for potato peeler device L 204mm W 155mm external height 12mm		
<b>For models:</b>	451003, 451004		



doors



1

<b>GEV No.</b>	696052	<b>Ref. No.</b>	RG04136
<b>description</b>	door W 135mm H 115mm with gasket PP4 Expo		
<b>For models:</b>	451001		



1

<b>GEV No.</b>	696049	<b>Ref. No.</b>	RG08050 RG08050+RG08052
<b>description</b>	door W 164mm H 150mm with gasket PP8-PP15 Expo		

miscellaneous



1

<b>GEV No.</b>	696045	<b>Ref. No.</b>	RG08038
<b>description</b>	bolt L 59mm SS ø 7mm		



1

<b>GEV No.</b>	696458	<b>Ref. No.</b>	36C0011
<b>description</b>	frame W 202mm H 154mm thickness 4mm plastic for potato peeler device		
<b>For models:</b>	451003, 451004		



1

<b>GEV No.</b>	696048	<b>Ref. No.</b>	RG08040
<b>description</b>	handle L 180mm W 118mm H 50mm aluminium PP8-PP15 Expo		





1

<b>GEV No.</b>	696053	<b>Ref. No.</b>	RG04138
<b>description</b>	handle L 180mm W 20mm thickness 6mm SS PP4 Expo		
<b>For models:</b>	451001		



1

<b>GEV No.</b>	696292	<b>Ref. No.</b>	RG08046	
<b>description</b>	joint L 42mm W 16mm H 16mm IT M8 hole ø 8mm U-shape for door PP8-PP15 Expo			
<b>accessories for</b>	696292			
	<b>GEV No.</b>	696293	<b>Ref. No.</b>	RG08048
	joint L 70mm W 20mm thickness 8mm thread M8 thread L 20mm hole ø 8.3mm plate for door PP8-PP15 Expo			



1

<b>GEV No.</b>	696293	<b>Ref. No.</b>	RG08048	
<b>description</b>	joint L 70mm W 20mm thickness 8mm thread M8 thread L 20mm hole ø 8.3mm plate for door PP8-PP15 Expo			
<b>accessories for</b>	696293			
	<b>GEV No.</b>	696292	<b>Ref. No.</b>	RG08046
	joint L 42mm W 16mm H 16mm IT M8 hole ø 8mm U-shape for door PP8-PP15 Expo			



1

<b>GEV No.</b>	696555	<b>Ref. No.</b>	36D9550
<b>description</b>	threaded bush L 17mm thread M6 for door		
<b>For models:</b>	451003, 451004		

## for dough mixers

## drive shafts



1

<b>GEV No.</b>	697847	<b>Ref. No.</b>	SL3203
<b>description</b>	drive shaft D1 ø 20mm for coupling ø 17mm L 113mm 12-18 CN-FN		
<b>For models:</b>	512015, 512016, 512019, 512020		



1

<b>GEV No.</b>	697335	<b>Ref. No.</b>	8300690 8301900
<b>description</b>	drive shaft D1 ø 20mm for gearbox ø 25mm L 487mm D2 ø 20mm		
<b>For models:</b>	512002, 512003		



1

<b>GEV No.</b>	698416	<b>Ref. No.</b>	SL3266
<b>description</b>	drive shaft D1 ø 25mm for dough hook L 82mm D2 ø 30mm IT M18x1.5/M8		
<b>For models:</b>	512014, 512017, 512018, 512021, 512022		



1

<b>GEV No.</b>	697336	<b>Ref. No.</b>	8301910
<b>description</b>	drive shaft D1 ø 25mm for gearbox ø 25mm L 545mm D2 ø 25mm		
<b>For models:</b>	512004		



1

<b>GEV No.</b>	697337	<b>Ref. No.</b>	8300700 8301920
<b>description</b>	drive shaft D1 ø 25mm for gearbox ø 28mm L 545mm D2 ø 25mm		



1

<b>GEV No.</b>	697394	<b>Ref. No.</b>	8300810
<b>description</b>	drive shaft D1 ø 25mm ø 22mm L 295mm D2 ø 20mm		
<b>For models:</b>	512002, 512003		



1

<b>GEV No.</b>	697314	<b>Ref. No.</b>	8300460
<b>description</b>	drive shaft D1 ø 30mm for dough hook ø 25mm L 84mm IT M18x1.5		
<b>For models:</b>	512002, 512003		



1

<b>GEV No.</b>	697315	<b>Ref. No.</b>	8300470
<b>description</b>	drive shaft for dough hook ø 30mm L 96mm 33-42-53 TF-TR IT M22x1.5		
<b>For models:</b>	512004		



1

<b>GEV No.</b>	692655	<b>Ref. No.</b>	SA1031
<b>description</b>	drive shaft ø 120mm H 85mm		
<b>For models:</b>	512014, 512017, 512018, 512021, 512022		



1

<b>GEV No.</b>	692884	<b>Ref. No.</b>	SA1025
<b>description</b>	drive shaft ø 25mm with toothed chain drive L 465mm 25FN, 25CN, 38FN, 38CN teeth 16		
<b>For models:</b>	512014, 512018, 512022		



1

<b>GEV No.</b>	697245	<b>Ref. No.</b>	SL2615
<b>description</b>	spindle D1 ø 20mm for coupling ø 17mm L 113mm 12-18 C-F		
<b>For models:</b>	512015, 512016, 512019, 512020		



locking levers



1

<b>GEV No.</b>	697265	<b>Ref. No.</b>	SL2629
<b>description</b>	locking lever thread M10 thread L 90mm		
<b>For models:</b>	512015, 512016, 512019, 512020		



1

<b>GEV No.</b>	697266	<b>Ref. No.</b>	SL2630
<b>description</b>	locking lever thread M12 thread L 109mm		
<b>For models:</b>	512014, 512017, 512018, 512021, 512022		

lids

plastic



1

<b>GEV No.</b>	697140	<b>Ref. No.</b>	SA1004
<b>description</b>	lid ø 335mm 12 S-C-F		
<b>For models:</b>	512011, 512015, 512019		



1

<b>GEV No.</b>	697141	<b>Ref. No.</b>	SA1005
<b>description</b>	lid ø 376mm 18 S-C-F		
<b>For models:</b>	512012, 512016, 512020		



1

<b>GEV No.</b>	697142	<b>Ref. No.</b>	SA1006
<b>description</b>	lid ø 415mm 25 S-C-F		
<b>For models:</b>	512013, 512017, 512018, 512021		



1

<b>GEV No.</b>	697143	<b>Ref. No.</b>	SA1007
<b>description</b>	lid ø 465mm 38 S-C-F		
<b>For models:</b>	512014, 512018, 512022		

protective grid



1

<b>GEV No.</b>	697320	<b>Ref. No.</b>	8300000
<b>description</b>	guard ø 340mm 17		
<b>For models:</b>	512002		



1

<b>GEV No.</b>	697321	<b>Ref. No.</b>	8300010
<b>description</b>	guard ø 380mm 22		
<b>For models:</b>	512003		



1

<b>GEV No.</b>	697322	<b>Ref. No.</b>	8300020
<b>description</b>	guard ø 420mm 33		
<b>For models:</b>	512004		

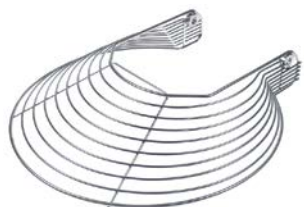

1

<b>GEV No.</b>	698407	<b>Ref. No.</b>	SL3420
<b>description</b>	guard ø 470mm		
<b>For models:</b>	512014, 512018, 512022		



1

<b>GEV No.</b>	696669	<b>Ref. No.</b>	SL3150
<b>description</b>	lid ø 275mm 7 S		
<b>For models:</b>	512010		

### spacer rings



1

<b>GEV No.</b>	697118	<b>Ref. No.</b>	SL0020
<b>description</b>	spacer ring ø 22mm ID ø 18mm H 31.5mm		
<b>For models:</b>	512010, 512011, 512012		



1

<b>GEV No.</b>	697198	<b>Ref. No.</b>	SL2617
<b>description</b>	spacer ring ø 25mm ID ø 21mm H 53mm		
<b>For models:</b>	512015, 512016, 512019, 512020		

### flange bearings



1

<b>GEV No.</b>	693112	<b>Ref. No.</b>	8300830
<b>description</b>	flange bearing type UCF204 shaft ø 20mm 4 hole flange hole distance 64mm H 33mm flange length 86mm flange width 86mm hole ø 12mm flange F204 ball bearing UC204G2 FH 25.5mm		
<b>For models:</b>	512002, 512003		



1

<b>GEV No.</b>	697278	<b>Ref. No.</b>	8300840 SL0086
<b>description</b>	flange bearing type UCF205 shaft ø 25mm 4 hole flange hole distance 70mm H 36mm flange length 95mm flange width 95mm hole ø 12mm flange F205 ball bearing UC205G2 FH 27mm		
<b>For models:</b>	512004, 512013, 512014, 512017, 512018, 512021, 512022		

### gearboxes



1

<b>GEV No.</b>	697840	<b>Ref. No.</b>	8300590
<b>description</b>	gearbox motor shaft ø 25mm flange ø 120mm transmission 1/30 drive shaft ø 19mm type 50		
<b>For models:</b>	512002, 512003, 512004		

### chains

#### roller chains 05B-1 single





1

<b>GEV No.</b>	697259	<b>Ref. No.</b>	SL3364
<b>description</b>	chain DIN/ISO 05 B-1 splitting 8mm links 63 internal width 3mm roller ø 5mm single		
<b>For models:</b>	512010		







1 			
<b>GEV No.</b>	697282	<b>Ref. No.</b>	SL2682
<b>description</b>	chain DIN/ISO 05 B-1 splitting 8mm links 71 internal width 3mm rollerø 5mm single		
<b>For models:</b>	512015, 512016, 512019, 512020		
<b>accessories for</b>	697282		
	<b>GEV No.</b>	697264	<b>Ref. No.</b> SL1545
	connector single DIN/ISO 05 B-1 splitting 8mm		



1 			
<b>GEV No.</b>	697260	<b>Ref. No.</b>	SL0058
<b>description</b>	chain DIN/ISO 05 B-1 splitting 8mm links 72 internal width 3mm rollerø 5mm single		
<b>For models:</b>	512011, 512012		

roller chains 06B-1 single

1 			
<b>GEV No.</b>	697200	<b>Ref. No.</b>	SL1111
<b>description</b>	roller chain DIN/ISO 06 B-1 splitting 3/8" / 9.525mm links 35 internal width 5.72mm rollerø 6.35mm single		
<b>For models:</b>	512010		

1 			
<b>GEV No.</b>	697204	<b>Ref. No.</b>	SL2681
<b>description</b>	roller chain DIN/ISO 06 B-1 splitting 3/8" / 9.525mm links 36 internal width 5.72mm rollerø 6.35mm single		
<b>For models:</b>	512016, 512020		

1 			
<b>GEV No.</b>	697202	<b>Ref. No.</b>	SL0026
<b>description</b>	roller chain DIN/ISO 06 B-1 splitting 3/8" / 9.525mm links 37 internal width 5.72mm rollerø 6.35mm single		
<b>For models:</b>	512012		

1 			
<b>GEV No.</b>	697203	<b>Ref. No.</b>	SL2680
<b>description</b>	roller chain DIN/ISO 06 B-1 splitting 3/8" / 9.525mm links 38 internal width 5.72mm rollerø 6.35mm single		
<b>For models:</b>	512015, 512019		
<b>accessories for</b>	697203		
	<b>GEV No.</b>	697069	<b>Ref. No.</b> SL1629
	connector single DIN/ISO 06 B-1 splitting 3/8" links 1 L 17.8mm internal width 8.8mm rollerø 3mm metal		

1 			
<b>GEV No.</b>	697201	<b>Ref. No.</b>	SL0025
<b>description</b>	roller chain DIN/ISO 06 B-1 splitting 3/8" / 9.525mm links 40 internal width 5.72mm rollerø 6.35mm single		
<b>For models:</b>	512011		

1 			
<b>GEV No.</b>	697127	<b>Ref. No.</b>	8300870
<b>description</b>	roller chain DIN/ISO 06 B-1 splitting 3/8" / 9.525mm links 42 internal width 5.72mm rollerø 6.35mm single		
<b>For models:</b>	512002, 512003		

1 			
<b>GEV No.</b>	697126	<b>Ref. No.</b>	8300210
<b>description</b>	roller chain DIN/ISO 06 B-1 splitting 3/8" / 9.525mm links 63 internal width 5.72mm rollerø 6.35mm		
<b>For models:</b>	512002, 512003		

1 			
<b>GEV No.</b>	697283	<b>Ref. No.</b>	SL2686
<b>description</b>	roller chain DIN/ISO 06 B-1 splitting 3/8" / 9.525mm links 69 internal width 5.72mm rollerø 6.35mm single		
<b>For models:</b>	512014, 512018, 512022		

1 			
<b>GEV No.</b>	697262	<b>Ref. No.</b>	SL0102
<b>description</b>	roller chain DIN/ISO 06 B-1 splitting 3/8" / 9.525mm links 71 internal width 5.72mm rollerø 6.35mm single		
<b>For models:</b>	512013		

1 			
<b>GEV No.</b>	697112	<b>Ref. No.</b>	8300220
<b>description</b>	roller chain DIN/ISO 06 B-1 splitting 3/8" / 9.525mm links 74 internal width 5.72mm rollerø 6.35mm single		
<b>For models:</b>	512004		

roller chains 08B-1 single

1 			
<b>GEV No.</b>	697220	<b>Ref. No.</b>	SL3438
<b>description</b>	roller chain DIN/ISO 08 B-1 splitting 1/2" / 12.7mm links 34 internal width 7.75mm rollerø 8.51mm single		
<b>For models:</b>	512014, 512018, 512022		

1 			
<b>GEV No.</b>	697128	<b>Ref. No.</b>	8300880
<b>description</b>	roller chain DIN/ISO 08 B-1 splitting 1/2" / 12.7mm links 37 internal width 7.75mm rollerø 8.51mm single		
<b>For models:</b>	512004		

## connectors



1

<b>GEV No.</b>	697264	<b>Ref. No.</b>	SL1545
<b>description</b>	connector single DIN/ISO 05 B-1 splitting 8mm		
<b>For models:</b>	512010, 512011, 512012, 512015, 512016, 512019, 512020		



1

<b>GEV No.</b>	697069	<b>Ref. No.</b>	SL1629
<b>description</b>	connector single DIN/ISO 06 B-1 splitting 3/8" links 1 L 17.8mm internal width 8.8mm rollerø 3mm metal		
<b>For models:</b>	512010, 512011, 512012, 512013, 512014, 512015, 512016, 512017, 512018, 512019, 512020, 512021, 512022		



1

<b>GEV No.</b>	693276	<b>Ref. No.</b>	SL1632
<b>description</b>	connector single DIN/ISO 08 B-1 splitting 1/2" links 1 L 23mm internal width 11.8mm rollerø 4.3mm metal		
<b>For models:</b>	512013, 512014, 512017, 512018, 512021, 512022		

## dough hooks

## with mounting thread



1

<b>GEV No.</b>	698566	<b>Ref. No.</b>	8308500
<b>description</b>	dough hook		
<b>For models:</b>	512001		



1

<b>GEV No.</b>	697316	<b>Ref. No.</b>	8300480
<b>description</b>	dough hook thread M18x1.5 usable height 220mm 17-22 TF-TR		
<b>For models:</b>	512002, 512003		



1

<b>GEV No.</b>	697153	<b>Ref. No.</b>	SL0069
<b>description</b>	dough hook thread M18x1.5 usable height 290mm 25-38 S-C-F		
<b>For models:</b>	512014, 512017, 512018, 512021, 512022		



1

<b>GEV No.</b>	697317	<b>Ref. No.</b>	8101610 8300490
<b>description</b>	dough hook thread M22x1.5 usable height 285mm 33-42-53 TF-TR		
<b>For models:</b>	512004		

## with mounting groove



1



<b>GEV No.</b>	697151	<b>Ref. No.</b>	SL1107
<b>description</b>	dough hook shaft ø 17mm usable height 225mm 7 S		
<b>For models:</b>	512010		





1

<b>GEV No.</b>	697117	<b>Ref. No.</b>	SL0011
<b>description</b>	dough hook shaft ø 17mm usable height 235mm 12-18 S-C-F		
<b>For models:</b>	512011, 512012, 512015, 512016, 512019, 512020		





			
1			
<b>GEV No.</b>	697852	<b>Ref. No.</b>	SA1030
<b>description</b>	dough hook shaft ø 25mm usable height 290mm 25-38 SN,CN,FN		
<b>For models:</b>	512013, 512014, 512017, 512018, 512021, 512022		
<b>spare parts for</b>	697852		
	<b>GEV No.</b>	697153	<b>Ref. No.</b> SL0069
	dough hook thread M18x1.5 usable height 290mm 25-38 S-C-F		
<b>accessories for</b>	697852		
	<b>GEV No.</b>	697784	<b>Ref. No.</b> SL2057
	slot nut W 8mm H 7mm L 20mm		

			
1			
<b>GEV No.</b>	699593	<b>Ref. No.</b>	SA1029
<b>description</b>	bearing block for dough hook with ball bearing mounting pos. upper ø 120mm ID ø 52mm H 59mm for 25SN/38SN		
<b>For models:</b>	512013		
<b>spare parts for</b>	699593		
	<b>GEV No.</b>	523513	<b>Ref. No.</b> 8300190 MF2171 SL0233
	deep-groove ball bearing type 6205-2RS shaft ø 25mm ED ø 52mm W 15mm with sealing discs deep-groove ball bearing DIN 625-1		

			
1			
<b>GEV No.</b>	697251	<b>Ref. No.</b>	SL0016
<b>description</b>	bearing block for mixer bowl mounting pos. lower ø 103mm ID ø 40mm H 58mm 7-12-18 S-C-F		
<b>For models:</b>	512010, 512011, 512012, 512015, 512016, 512019, 512020		

bearing blocks

			
1			
<b>GEV No.</b>	697324	<b>Ref. No.</b>	8301490
<b>description</b>	bearing block for dough hook mounting pos. upper ø 140mm ID ø 52mm int. ø 1 55mm H 90mm 33-42-53 TF-TR		
<b>For models:</b>	512004		

			
1			
<b>GEV No.</b>	697252	<b>Ref. No.</b>	SL0074
<b>description</b>	bearing block for mixer bowl mounting pos. lower ø 145mm ID ø 42mm int. ø 1 47mm H 79mm 25-38 S-C-F		
<b>For models:</b>	512013, 512014, 512017, 512018, 512021, 512022		

			
1			
<b>GEV No.</b>	697196	<b>Ref. No.</b>	SL0022
<b>description</b>	bearing block for dough hook mounting pos. upper ø 103mm ID ø 40mm H 55mm 7-12-18 S-C-F		
<b>For models:</b>	512010, 512011, 512012, 512015, 512016, 512019, 512020		

			
1			
<b>GEV No.</b>	697325	<b>Ref. No.</b>	8300200
<b>description</b>	bearing block for mixer bowl mounting pos. lower ø 148mm ID ø 52mm H 83mm		
<b>For models:</b>	512002, 512003, 512004		

			
1			
<b>GEV No.</b>	697323	<b>Ref. No.</b>	8301480
<b>description</b>	bearing block for dough hook mounting pos. upper ø 107mm ID ø 52mm H 57mm 17-22 TF-TR		
<b>For models:</b>	512002, 512003		

			
1			
<b>GEV No.</b>	697197	<b>Ref. No.</b>	SL2626
<b>description</b>	bearing block mounting pos. upper ø 100mm ID ø 42mm H 55mm edition until 08/2003 12-18 C-F		
<b>For models:</b>	512015, 512016, 512019, 512020		



1

<b>GEV No.</b>	697211	<b>Ref. No.</b>	SL2627
<b>description</b>	bearing block mounting pos. upper ø 120mm ID ø 47mm H 48mm 25-38 C-F		
<b>For models:</b>	512014, 512017, 512018, 512021, 512022		

## mixer bowls

## fasteners

## transmission technology and ball bearings

## drive flanges



1

<b>GEV No.</b>	697173	<b>Ref. No.</b>	SL2635
<b>description</b>	drive flange ø 280mm ID ø 50mm thickness 3mm 12-18 C		
<b>For models:</b>	512019, 512020		



1

<b>GEV No.</b>	697174	<b>Ref. No.</b>	SL2636
<b>description</b>	drive flange ø 330mm ID ø 60mm thickness 4mm 25-38 C		
<b>For models:</b>	512018, 512021, 512022		

## mounting flanges



1

<b>GEV No.</b>	697182	<b>Ref. No.</b>	SL2632
<b>description</b>	mounting flange ø 300mm ID ø 113mm thickness 3mm 12 C		
<b>For models:</b>	512019		



1

<b>GEV No.</b>	697183	<b>Ref. No.</b>	SL2633
<b>description</b>	mounting flange ø 340mm ID ø 113mm thickness 3mm 18 C		
<b>For models:</b>	512020		



1

<b>GEV No.</b>	697184	<b>Ref. No.</b>	SL2637
<b>description</b>	mounting flange ø 380mm ID ø 168mm thickness 4mm 25 C		
<b>For models:</b>	512018, 512021		



1

<b>GEV No.</b>	697185	<b>Ref. No.</b>	SL2634
<b>description</b>	mounting flange ø 430mm ID ø 168mm thickness 4mm 38 C		
<b>For models:</b>	512018, 512022		

## flanges



Image not available

1

<b>GEV No.</b>	697191	<b>Ref. No.</b>	SL2867
<b>description</b>	flange for mixer bowl 25-38 F		
<b>For models:</b>	512014, 512017, 512018		



			
1			
<b>GEV No.</b>	697190	<b>Ref. No.</b>	SL2866
<b>description</b>	flange for mixer bowl ø 105mm D1 ø 50mm thickness 23mm 12-18 F		
<b>For models:</b>	512015, 512016		

			
1			
<b>GEV No.</b>	697187	<b>Ref. No.</b>	SL2620
<b>description</b>	flange for mounting flange ø 120mm D1 ø 50mm thickness 20mm 12-18 C		
<b>For models:</b>	512019, 512020		

			
1			
<b>GEV No.</b>	697188	<b>Ref. No.</b>	SL2621
<b>description</b>	flange for mounting flange ø 180mm D1 ø 60mm thickness 22mm 25-38 C		
<b>For models:</b>	512018, 512021, 512022		

<b>bolts</b>			
			
1			
<b>GEV No.</b>	697176	<b>Ref. No.</b>	SL2622
<b>description</b>	bolt ø 24mm 12-18 C		
<b>For models:</b>	512019, 512020		

			
1			
<b>GEV No.</b>	697177	<b>Ref. No.</b>	SL2623
<b>description</b>	bolt ø 29mm ID ø 8.5mm 25-38 C		
<b>For models:</b>	512018, 512021, 512022		

<b>sealing washers</b>			
			
1			
<b>GEV No.</b>	697179	<b>Ref. No.</b>	SL1890
<b>description</b>	gasket for mounting flange ID ø 300-340mm 12-18 C		
<b>For models:</b>	512019, 512020		

			
1			
<b>GEV No.</b>	697180	<b>Ref. No.</b>	SL1034
<b>description</b>	gasket for mounting flange ID ø 380-430mm 25-38 C		
<b>For models:</b>	512018, 512021		

			
1			
<b>GEV No.</b>	697181	<b>Ref. No.</b>	SL1334
<b>description</b>	gasket for mounting flange ID ø 430mm 50 C		
<b>For models:</b>	512018, 512022		

<b>mixer bowls</b>			
			
1			
<b>GEV No.</b>	697155	<b>Ref. No.</b>	SL1106
<b>description</b>	mixer bowl for dough mixer ID ø 260mm H 200mm fixed 7 S		
<b>For models:</b>	512010		

			
1			
<b>GEV No.</b>	697162	<b>Ref. No.</b>	SA1150
<b>description</b>	mixer bowl for dough mixer ID ø 320mm H 210mm detachable 12 C		
<b>For models:</b>	512019		



<b>GEV No.</b>	697156	<b>Ref. No.</b>	SL0008
<b>description</b>	mixer bowl for dough mixer ID ø 320mm H 210mm fixed 12 S-F		
<b>For models:</b>	512011, 512015		



<b>GEV No.</b>	697163	<b>Ref. No.</b>	SA1160
<b>description</b>	mixer bowl for dough mixer ID ø 360mm H 210mm detachable 18 C		
<b>For models:</b>	512020		



<b>GEV No.</b>	697157	<b>Ref. No.</b>	SL0009
<b>description</b>	mixer bowl for dough mixer ID ø 360mm H 210mm fixed 18 S-F		
<b>For models:</b>	512012, 512016		



<b>GEV No.</b>	697164	<b>Ref. No.</b>	SA1170
<b>description</b>	mixer bowl for dough mixer ID ø 400mm H 260mm detachable 25 C		
<b>For models:</b>	512018, 512021		



<b>GEV No.</b>	697158	<b>Ref. No.</b>	SL0067
<b>description</b>	mixer bowl for dough mixer ID ø 400mm H 260mm fixed 25 S-F		
<b>For models:</b>	512013, 512017, 512018		



<b>GEV No.</b>	697165	<b>Ref. No.</b>	SA1180
<b>description</b>	mixer bowl for dough mixer ID ø 450mm H 260mm detachable 38 C		
<b>For models:</b>	512018, 512022		



<b>GEV No.</b>	697159	<b>Ref. No.</b>	SL0068
<b>description</b>	mixer bowl for dough mixer ID ø 450mm H 260mm fixed 38 S-F		
<b>For models:</b>	512014, 512018		



dough separator



1

<b>GEV No.</b>	697339	<b>Ref. No.</b>	8301210
<b>description</b>	pastry rod L 330mm W 30mm thickness 10mm hole distance 60mm hole ø 11mm 17-22 TF-TR		
<b>For models:</b>	512002, 512003		



1

<b>GEV No.</b>	697169	<b>Ref. No.</b>	SL0071 SL3371
<b>description</b>	pastry rod L 367mm W 25mm thickness 12mm hole distance 45mm hole ø 11mm 25-38 S-C-F		
<b>For models:</b>	512013, 512014, 512017, 512018, 512021, 512022		



1

<b>GEV No.</b>	697340	<b>Ref. No.</b>	8301220
<b>description</b>	pastry rod L 405mm W 30mm thickness 10mm hole distance 60mm hole ø 12mm TF-TR 33		
<b>For models:</b>	512004		

spindles

for lids



1

<b>GEV No.</b>	697137	<b>Ref. No.</b>	8300270
<b>description</b>	spindle for lid ø 15mm D1 ø 13mm L 250mm		
<b>For models:</b>	512004		



1

<b>GEV No.</b>	697145	<b>Ref. No.</b>	SL1110
<b>description</b>	spindle for lid ø 15mm L 173mm		
<b>For models:</b>	512010		



1

<b>GEV No.</b>	697146	<b>Ref. No.</b>	SL0021
<b>description</b>	spindle for lid ø 15mm L 199mm		
<b>For models:</b>	512011, 512012, 512015, 512016, 512019, 512020		



1

<b>GEV No.</b>	697136	<b>Ref. No.</b>	8300260
<b>description</b>	spindle for lid ø 15mm L 210mm		
<b>For models:</b>	512002, 512003		



1

<b>GEV No.</b>	697147	<b>Ref. No.</b>	SL0076
<b>description</b>	spindle for lid ø 15mm L 244mm		
<b>For models:</b>	512013, 512014, 512017, 512018, 512021, 512022		

for mixer bowls



1

<b>GEV No.</b>	697114	<b>Ref. No.</b>	SL0014
<b>description</b>	spindle for mixer bowl ø 17mm D1 ø 20mm L 127mm 7-12-18 S-C-F		
<b>For models:</b>	512010, 512011, 512012, 512015, 512016, 512019, 512020		





1

<b>GEV No.</b>	697115	<b>Ref. No.</b>	SL0072
<b>description</b>	spindle for mixer bowl ø 20mm D1 ø 25mm L 138mm 25-38 S-C-F		
<b>For models:</b>	512013, 512014, 512017, 512018, 512021, 512022		

			
1			
<b>GEV No.</b>	697135	<b>Ref. No.</b>	8300250
<b>description</b>	spindle for mixer bowl ø 25mm D1 ø 30mm L 176mm		
<b>For models:</b>	512002, 512003, 512004		

## miscellaneous

			
1			
<b>GEV No.</b>	698900	<b>Ref. No.</b>	SL3204
<b>description</b>	spindle		
<b>For models:</b>	512014, 512017, 512018, 512021, 512022		



			
1			
<b>GEV No.</b>	697268	<b>Ref. No.</b>	SL2624
<b>description</b>	spindle ø 12mm L 170mm		
<b>For models:</b>	512015, 512016, 512019, 512020		

			
1			
<b>GEV No.</b>	697269	<b>Ref. No.</b>	SL2625
<b>description</b>	spindle ø 12mm L 190mm		
<b>For models:</b>	512014, 512017, 512018, 512021, 512022		

## gear wheels

			
1			
<b>GEV No.</b>	697254	<b>Ref. No.</b>	SL1117
<b>description</b>	sprocket-wheel DIN/ISO 05 B-1 splitting 8mm teeth 76 shaft intake ø 50mm H 4mm 7 S		
<b>For models:</b>	512010		

			
1			
<b>GEV No.</b>	697255	<b>Ref. No.</b>	SL0057
<b>description</b>	sprocket-wheel DIN/ISO 05 B-1 splitting 8mm teeth 85 shaft intake ø 50mm H 4mm 12-18 S-C-F		
<b>For models:</b>	512011, 512012, 512015, 512016, 512019, 512020		

			
1			
<b>GEV No.</b>	697134	<b>Ref. No.</b>	8300710
<b>description</b>	sprocket-wheel DIN/ISO 06 B-1 splitting 3/8" teeth 14 shaft intake ø 22mm H 25mm 17-22 TF-TR		
<b>For models:</b>	512001, 512002, 512003		
<b>accessories for</b>	697134		
	<b>GEV No.</b>	560207	<b>Ref. No.</b>
			8300280 AMA086
	grub screw thread M8 L 10mm steel DIN 916/ISO 4029 intake internal hexagon WS 4 Qty 1 pcs		

			
1			
<b>GEV No.</b>	697193	<b>Ref. No.</b>	SL0024
<b>description</b>	sprocket-wheel DIN/ISO 06 B-1 splitting 3/8" teeth 15 shaft intake ø 17mm H 25mm 7-12-18 S-C-F		
<b>For models:</b>	512010, 512011, 512012, 512015, 512016, 512019, 512020		

			
1			
<b>GEV No.</b>	697132	<b>Ref. No.</b>	8300410
<b>description</b>	sprocket-wheel DIN/ISO 06 B-1 splitting 3/8" teeth 15 shaft intake ø 25mm 17-22 TF-TR		
<b>For models:</b>	512002, 512003		

			
1			
<b>GEV No.</b>	697241	<b>Ref. No.</b>	8300720
<b>description</b>	sprocket-wheel DIN/ISO 06 B-1 splitting 3/8" teeth 16 shaft intake ø 25mm H 28mm 25-38 S-C-F		
<b>For models:</b>	512004		

			
1			
<b>GEV No.</b>	697206	<b>Ref. No.</b>	SL0030
<b>description</b>	sprocket-wheel DIN/ISO 06 B-1 splitting 3/8" teeth 29 shaft intake ø 17mm H 28mm 7-12-18 S-C-F		
<b>For models:</b>	512010, 512011, 512012, 512015, 512016, 512019, 512020		

			
1			
<b>GEV No.</b>	697129	<b>Ref. No.</b>	8300850
<b>description</b>	sprocket-wheel DIN/ISO 06 B-1 splitting 3/8" teeth 29 shaft intake ø 20mm 17-22 TF-TR		
<b>For models:</b>	512002, 512003		







			
1			
<b>GEV No.</b>	697131	<b>Ref. No.</b>	8300230
<b>description</b>	sprocket-wheel DIN/ISO 06 B-1 splitting 3/8" teeth 72 shaft intake ø 60mm H 5mm 17-22 TF-TR		
<b>For models:</b>	512002, 512003		

			
1			
<b>GEV No.</b>	697256	<b>Ref. No.</b>	8300240 SL0100
<b>description</b>	sprocket-wheel DIN/ISO 06 B-1 splitting 3/8" teeth 85 shaft intake ø 60mm H 5mm 25-38 S-C-F		
<b>For models:</b>	512004, 512013, 512014, 512017, 512018, 512021, 512022		

			
1			
<b>GEV No.</b>	697133	<b>Ref. No.</b>	8300420
<b>description</b>	sprocket-wheel DIN/ISO 08 B-1 splitting 1/2" teeth 15 shaft intake ø 30mm H 28mm 33-42-53 TF-TR		
<b>For models:</b>	512004		

			
1			
<b>GEV No.</b>	697223	<b>Ref. No.</b>	SL0084
<b>description</b>	sprocket-wheel DIN/ISO 08 B-1 splitting 1/2" teeth 29 shaft intake ø 20mm H 30mm 25-38 S-C-F		
<b>For models:</b>	512013, 512014, 512017, 512018, 512021, 512022		

			
1			
<b>GEV No.</b>	697130	<b>Ref. No.</b>	8300860
<b>description</b>	sprocket-wheel DIN/ISO 08 B-1 splitting 1/2" teeth 29 shaft intake ø 25mm H 30mm 33-42-53 TF-TR		
<b>For models:</b>	512004		

			
1			
<b>GEV No.</b>	698415	<b>Ref. No.</b>	SA1047
<b>description</b>	sprocket-wheel DIN/ISO 08 B-1 splitting 1/2" teeth 29 shaft intake ø 30mm H 107mm		
<b>For models:</b>	512014, 512017, 512018, 512021, 512022		

accessories

			
1			
<b>GEV No.</b>	697248	<b>Ref. No.</b>	SL2524
<b>description</b>	coupling ø 40mm H 38mm shaft intake ø 17mm 12-18 C-F		
<b>For models:</b>	512015, 512016, 512019, 512020		

			
1			
<b>GEV No.</b>	697848	<b>Ref. No.</b>	SL3205
<b>description</b>	coupling ø 40mm H 38mm shaft intake ø 17mm 12-18 CN-FN		
<b>For models:</b>	512015, 512016, 512019, 512020		

miscellaneous

			
1			
<b>GEV No.</b>	697350	<b>Ref. No.</b>	8300370
<b>description</b>	bush for lid		
<b>For models:</b>	512001, 512002, 512003, 512004		

			
1			
<b>GEV No.</b>	697150	<b>Ref. No.</b>	SL0036
<b>description</b>	bush for microswitch ID ø 15mm		
<b>For models:</b>	512010, 512011, 512012, 512013, 512014, 512015, 512016, 512017, 512018, 512019, 512020, 512021, 512022		

			
1			
<b>GEV No.</b>	697318	<b>Ref. No.</b>	8301590
<b>description</b>	flange for gearbox ø 100mm ID ø 70mm		
<b>For models:</b>	512002, 512003, 512004		

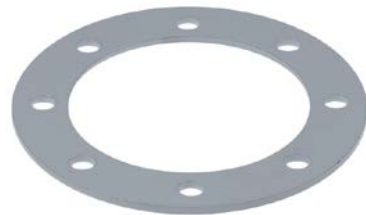
			
1			
<b>GEV No.</b>	697319	<b>Ref. No.</b>	8301600
<b>description</b>	flange for gearbox ø 140mm ID ø 95mm		
<b>For models:</b>	512004		

			
1			
<b>GEV No.</b>	697281	<b>Ref. No.</b>	SL2638
<b>description</b>	protector for mixer bowl L 205mm H 125mm		
<b>For models:</b>	512011, 512012		

<b>gear wheels</b>			
			
1			
<b>GEV No.</b>	699594	<b>Ref. No.</b>	CO0548
<b>description</b>	gear wheel ø 56mm shaft intake ø 19mm W 19mm teeth 24 brass tooth width 15,5mm		
<b>For models:</b>	511002		

<b>miscellaneous</b>			
			
1			
<b>GEV No.</b>	699595	<b>Ref. No.</b>	CO0578
<b>description</b>	coupling titanium ED ø 40mm ID ø 30mm 52 H 25mm		
<b>For models:</b>	511003, 511004		

<b>for dough roller</b>			
<b>wipers</b>			
			
1			
<b>GEV No.</b>	693895	<b>Ref. No.</b>	4001020 S43RA54004
<b>description</b>	wiper for dough roller L 330mm mounting pos. front P30		

			
1			
<b>GEV No.</b>	693898	<b>Ref. No.</b>	4001010
<b>description</b>	wiper for dough roller L 330mm mounting pos. rear P30		

			
1			
<b>GEV No.</b>	697149	<b>Ref. No.</b>	SL0035
<b>description</b>	stop for lid ID ø 15mm thread M8		
<b>For models:</b>	512010, 512011, 512013, 512014, 512015, 512016, 512017, 512018, 512019, 512020, 512021, 512022		

			
1			
<b>GEV No.</b>	697353	<b>Ref. No.</b>	8301270
<b>description</b>	stop bolt for lid ø 20mm L 15mm		
<b>For models:</b>	512001, 512002, 512003, 512004		

**for planetary mixers****beaters**

			
1			
<b>GEV No.</b>	692881	<b>Ref. No.</b>	ACRF20BR
<b>description</b>	stirrer for planetary mixer shaft ø 25 H 320mm W 205mm		
<b>For models:</b>	511002		



1



<b>GEV No.</b>	698586	<b>Ref. No.</b>	SA1280
<b>description</b>	wiper for dough roller L 420/460mm mounting pos. bottom at the back FI42/FIP42		
<b>For models:</b>	513005, 513006, 513009, 513010		

1



<b>GEV No.</b>	698585	<b>Ref. No.</b>	SA1270
<b>description</b>	wiper for dough roller L 420/460mm mounting pos. bottom in the front FI42/FIP42		
<b>For models:</b>	513005, 513006, 513009, 513010		

1



<b>GEV No.</b>	693896	<b>Ref. No.</b>	4001030
<b>description</b>	wiper for dough roller L 456mm mounting pos. front P40		

1



<b>GEV No.</b>	693899	<b>Ref. No.</b>	4001040
<b>description</b>	wiper for dough roller L 456mm mounting pos. rear P40		

roll units (complete)

1



<b>GEV No.</b>	696580	<b>Ref. No.</b>	SA1285
<b>description</b>	roller assembly L 165mm mounting pos. upper		
<b>For models:</b>	513004, 513008		

rollers

1



<b>GEV No.</b>	698593	<b>Ref. No.</b>	SL2443 SL2443R0
<b>description</b>	roller for dough roller suitable for FIMAR for model FI32 L 320mm ø 55mm mounting pos. bottom at the back		
<b>For models:</b>	513004, 513006, 513008, 513010		

1



<b>GEV No.</b>	698594	<b>Ref. No.</b>	SL2444 SL2444R0
<b>description</b>	roller for dough roller suitable for FIMAR for model FI32 L 320mm ø 55mm mounting pos. bottom in the front		
<b>For models:</b>	513004, 513006, 513008, 513010		

1



<b>GEV No.</b>	698589	<b>Ref. No.</b>	SL2449 SL2449R0
<b>description</b>	roller for dough roller suitable for FIMAR for model FI42 L 215mm ø 55mm mounting pos. upper at the back		
<b>For models:</b>	513005, 513009		



1

<b>GEV No.</b>	698587	<b>Ref. No.</b>	SL2450 SL2450R0
<b>description</b>	roller for dough roller suitable for FIMAR for model FI42 L 215mm ø 55mm mounting pos. upper in the front		
<b>For models:</b>	513005, 513009		



1

<b>GEV No.</b>	693905	<b>Ref. No.</b>	3003000
<b>description</b>	roller L 167mm ø 48mm mounting pos. upper in the front		



1

<b>GEV No.</b>	698592	<b>Ref. No.</b>	SL2445 SL2445R1
<b>description</b>	roller for dough roller suitable for FIMAR for model FI42 L 420mm ø 55mm mounting pos. bottom at the back		
<b>For models:</b>	513005, 513006, 513009, 513010		



1

<b>GEV No.</b>	693932	<b>Ref. No.</b>	3003900
<b>description</b>	roller L 298mm ø 48mm mounting pos. bottom at the back		



1

<b>GEV No.</b>	698590	<b>Ref. No.</b>	SL2446 SL2446R1
<b>description</b>	roller for dough roller suitable for FIMAR for model FI42 L 420mm ø 55mm mounting pos. bottom in the front		
<b>For models:</b>	513005, 513006, 513009, 513010		



1

<b>GEV No.</b>	693908	<b>Ref. No.</b>	3003800
<b>description</b>	roller L 298mm ø 48mm mounting pos. bottom in the front		



1

<b>GEV No.</b>	693907	<b>Ref. No.</b>	3003160
<b>description</b>	roller L 298mm ø 52mm mounting pos. upper in the front		

1

<b>GEV No.</b>	693904	<b>Ref. No.</b>	3003180
<b>description</b>	roller L 298mm ø 56mm mounting pos. upper at the back		

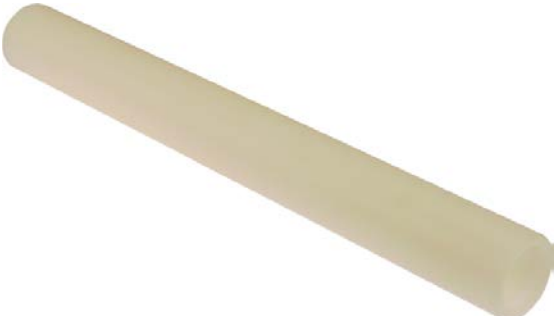

1

<b>GEV No.</b>	693912	<b>Ref. No.</b>	3003950
<b>description</b>	roller L 422mm ø 48mm mounting pos. bottom at the back		



1

<b>GEV No.</b>	693909	<b>Ref. No.</b>	3003850 S75EC54007
<b>description</b>	roller L 422mm ø 48mm mounting pos. bottom in the front		

### holders



1

<b>GEV No.</b>	692445	<b>Ref. No.</b>	SA1260
<b>description</b>	lever hole ø 10mm H 18.5mm hole distance 32mm		
<b>For models:</b>	513004, 513005, 513006, 513008, 513009, 513010		

### levers



1

<b>GEV No.</b>	700666	<b>Ref. No.</b>	3004500
<b>description</b>	lever for dough roller P30		



1

<b>GEV No.</b>	697338	<b>Ref. No.</b>	3004550
<b>description</b>	lever shaft intake ø 8.3mm L 230mm P40		

### accessories



1

<b>GEV No.</b>	700667	<b>Ref. No.</b>	3004600
<b>description</b>	balance weight for dough roller ø 25mm L 15mm thread M5		



1

<b>GEV No.</b>	697348	<b>Ref. No.</b>	3004650
<b>description</b>	balance weight for dough roller ø 25mm L 20mm thread M5		

### couplings



1

<b>GEV No.</b>	694396	<b>Ref. No.</b>	SL2430
<b>description</b>	coupling ø 36.5mm ID ø 25mm H 17mm		
<b>For models:</b>	513004, 513005, 513006, 513008, 513009, 513010		



1

<b>GEV No.</b>	694395	<b>Ref. No.</b>	SL2429
<b>description</b>	coupling ø 42mm ID ø 18mm H 12mm		
<b>For models:</b>	513004, 513005, 513006, 513008, 513009, 513010		



1

<b>GEV No.</b>	693646	<b>Ref. No.</b>	4203250
<b>description</b>	coupling set ø 42.8mm ID ø 25mm H 21mm		



1

<b>GEV No.</b>	693919	<b>Ref. No.</b>	4203300
<b>description</b>	mixer coupling		

pulleys



1

<b>GEV No.</b>	696456 <sup>1</sup>	<b>Ref. No.</b>	SL2432
<b>description</b>	round belt pulley disc ø 70mm double shaft intake ø 14mm groove depth 3mm disc width 31mm groove width 5mm overall width 31mm ABS plastic		
<b>For models:</b>	513004, 513005, 513006, 513008, 513009, 513010		

<sup>1</sup>double



1

<b>GEV No.</b>	693926 <sup>1</sup>	<b>Ref. No.</b>	3150080 A90UL78002
<b>description</b>	round belt pulley disc ø 76mm double shaft intake ø 14mm groove depth 6mm disc width 29mm groove width 10mm overall width 32mm plastic P30-P40		

<sup>1</sup>double



1

<b>GEV No.</b>	697285 <sup>1</sup>	<b>Ref. No.</b>	3150030
<b>description</b>	round belt pulley disc ø 96mm double shaft intake ø 14mm type 14x11 groove depth 6mm disc width 29mm groove width 10mm overall width 31mm plastic P30-P40 shaft ø 24mm		

<sup>1</sup>double



1

<b>GEV No.</b>	696795	<b>Ref. No.</b>	SL2433
<b>description</b>	round belt pulley grooves 8 disc ø 105mm shaft intake ø 14mm disc width 31mm groove depth 3mm groove width 5mm overall width 31mm double		
<b>For models:</b>	513004, 513005, 513006, 513008, 513009, 513010		

pinions

rear mounting



1

<b>GEV No.</b>	694393	<b>Ref. No.</b>	SL2426
<b>description</b>	pinion ø 46.5mm H 35mm mounting pos. rear ID ø 17mm without coupling for dough roller		
<b>For models:</b>	513004, 513005, 513006, 513008, 513009, 513010		



1

<b>GEV No.</b>	697109	<b>Ref. No.</b>	3203510
<b>description</b>	pinion ø 47.5mm H 35mm mounting pos. rear ID ø 25mm for dough roller		



front mounting



1

<b>GEV No.</b>	694394	<b>Ref. No.</b>	SL2427 SL3252
<b>description</b>	pinion $\varnothing$ 46.5mm H 34mm mounting pos. front ID $\varnothing$ 12mm for coupling for dough roller		
<b>For models:</b>	513004, 513005, 513006, 513008, 513009, 513010		



1

<b>GEV No.</b>	697108	<b>Ref. No.</b>	3203410 3203411
<b>description</b>	pinion $\varnothing$ 47.5mm H 35mm mounting pos. front ID $\varnothing$ 14mm for dough roller		

springs



1

<b>GEV No.</b>	693920	<b>Ref. No.</b>	5003010 SL2883
<b>description</b>	spring for pinion $\varnothing$ 49mm thickness 1.5mm Qty 2 pcs		
<b>For models:</b>	513004, 513005, 513006, 513008, 513009, 513010		

roller covers

upper

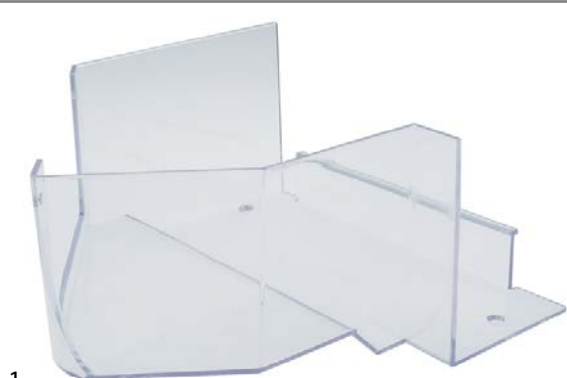

1

<b>GEV No.</b>	696541	<b>Ref. No.</b>	SL2960
<b>description</b>	hand protection mounting pos. upper L 280mm W 277mm H 135mm FI42		
<b>For models:</b>	513005, 513009		



1

<b>GEV No.</b>	697343	<b>Ref. No.</b>	4100380
<b>description</b>	hand protection mounting pos. upper L 360mm W 130mm H 250mm P40		



1

<b>GEV No.</b>	696796	<b>Ref. No.</b>	SL4105
<b>description</b>	hand protection mounting pos. upper L 398mm W 245mm H 140mm FIP42N		
<b>For models:</b>	513010		



1

<b>GEV No.</b>	697342	<b>Ref. No.</b>	4100060
<b>description</b>	hand protection mounting pos. upper P30		

## bottom



1

<b>GEV No.</b>	698405	<b>Ref. No.</b>	SL2455
<b>description</b>	hand protection mounting pos. lower L 380mm W 110mm H 75mm FI32		
<b>For models:</b>	513004, 513008		



1

<b>GEV No.</b>	692299	<b>Ref. No.</b>	S61IE54003
<b>description</b>	hand protection mounting pos. lower L 440mm W 90mm H 70mm RM 42 edition until 2011		



1

<b>GEV No.</b>	698583	<b>Ref. No.</b>	SL2456
<b>description</b>	hand protection mounting pos. lower L 480mm W 82mm H 80mm FI42/FIP42		
<b>For models:</b>	513005, 513006, 513009, 513010		



1

<b>GEV No.</b>	697341	<b>Ref. No.</b>	4100070
<b>description</b>	hand protection mounting pos. lower P30		

## side parts



1

<b>GEV No.</b>	697332	<b>Ref. No.</b>	3003400
<b>description</b>	side panel for dough roller mounting pos. upper right W 40mm L 125mm H 100mm P30-P40 bore ø 14.3mm depth of bore 19mm		



1

<b>GEV No.</b>	697333	<b>Ref. No.</b>	3003450
<b>description</b>	side panel for dough roller mounting pos. upper right W 40mm L 135mm H 100mm P40T		



1

<b>GEV No.</b>	693922	<b>Ref. No.</b>	3004200
<b>description</b>	side panel for dough roller mounting pos. upper/lower right W 40mm L 125mm H 100mm P30-P40		



1

<b>GEV No.</b>	691911	<b>Ref. No.</b>	3004300
<b>description</b>	side panel for dough roller mounting pos. bottom left W 20mm L 115mm H 80mm P30-P40		





1

<b>GEV No.</b>	694448	<b>Ref. No.</b>	3004301
<b>description</b>	side panel for dough roller mounting pos. bottom left W 20mm L 117mm H 80mm P30-P40		







			
1			
<b>GEV No.</b>	692040	<b>Ref. No.</b>	3003410 S52SR54001
<b>description</b>	side panel for dough roller mounting pos. upper left W 20mm L 115mm H 80mm P30-P40		

			
1			
<b>GEV No.</b>	697334	<b>Ref. No.</b>	3003550
<b>description</b>	side panel for dough roller mounting pos. upper left W 20mm L 125mm H 80mm P40T		

spindles			
			
1			
<b>GEV No.</b>	694392	<b>Ref. No.</b>	SL2425
<b>description</b>	spindle for dough rolling machine ø 24mm L 174mm		
<b>For models:</b>	513004, 513005, 513006, 513008, 513009, 513010		

			
1			
<b>GEV No.</b>	693923	<b>Ref. No.</b>	3003650
<b>description</b>	spindle ø 22mm L 156mm		

bars			
			
1			
<b>GEV No.</b>	693915	<b>Ref. No.</b>	3100400
<b>description</b>	bar ø 5mm L 315mm P30		

			
1			
<b>GEV No.</b>	693916	<b>Ref. No.</b>	3100500
<b>description</b>	bar ø 5mm L 440mm P40		

spindles			
eccentric			
			
1			
<b>GEV No.</b>	693890	<b>Ref. No.</b>	3003200
<b>description</b>	spindle ø 25mm L 244mm mounting pos. upper in the front eccentric		

			
1			
<b>GEV No.</b>	693892	<b>Ref. No.</b>	3004000
<b>description</b>	spindle ø 25mm L 373mm mounting pos. upper in the front eccentric		

			
1			
<b>GEV No.</b>	693893	<b>Ref. No.</b>	3004050
<b>description</b>	spindle ø 25mm L 499mm mounting pos. bottom in the front eccentric		

cylindric			
			
1			
<b>GEV No.</b>	693885	<b>Ref. No.</b>	3003300
<b>description</b>	spindle ø 25mm L 212mm mounting pos. upper at the back cylindrical		

			
1			
<b>GEV No.</b>	693887	<b>Ref. No.</b>	3004100
<b>description</b>	spindle ø 25mm L 342mm mounting pos. bottom at the back cylindrical		

			
1			
<b>GEV No.</b>	693888	<b>Ref. No.</b>	3003350
<b>description</b>	spindle ø 25mm L 467mm mounting pos. bottom at the back cylindrical		

miscellaneous



1	<b>GEV No.</b>	697346	<b>Ref. No.</b>	5873100
<b>description</b> ball handle thread M4 ø 20mm black				



1	<b>GEV No.</b>	697328	<b>Ref. No.</b>	5163010
<b>description</b> compression spring ø 7mm L 19.5mm wire gauge ø 0.6mm				



1	<b>GEV No.</b>	697347	<b>Ref. No.</b>	3002170
<b>description</b> distance washer for dough roller ø 11mm H 30mm				



1	<b>GEV No.</b>	697344	<b>Ref. No.</b>	4203000
<b>description</b> lever for dough roller				



1	<b>GEV No.</b>	693921	<b>Ref. No.</b>	4203100
<b>description</b> lid for side part ø 30.5mm H 11mm				



1	<b>GEV No.</b>	697345	<b>Ref. No.</b>	3003700
<b>description</b> screw for lever L 37mm				



1	<b>GEV No.</b>	698417	<b>Ref. No.</b>	SL3019
<b>description</b> spacer piece for dough roller ø 8mm H 20mm				
<b>For models:</b> 513004, 513005, 513008, 513009				



1	<b>GEV No.</b>	697855	<b>Ref. No.</b>	SL2476
<b>description</b> spacer piece for dough roller ø 8mm L 35mm				
<b>For models:</b> 513004, 513005, 513006, 513008, 513009, 513010				



1	<b>GEV No.</b>	698335	<b>Ref. No.</b>	SL2953
<b>description</b> spacer piece for dough roller ø 8mm thread M4 L 50mm				
<b>For models:</b> 513004, 513005, 513006, 513008, 513009, 513010				

for pizza press

gearboxes

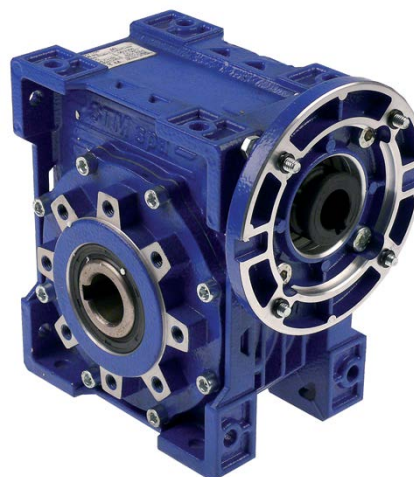

1	<b>GEV No.</b>	697326	<b>Ref. No.</b>	PF08410
<b>description</b> gearbox motor shaft ø 19mm flange ø 120mm transmission 1/70 drive shaft ø 25mm type UMI 63				

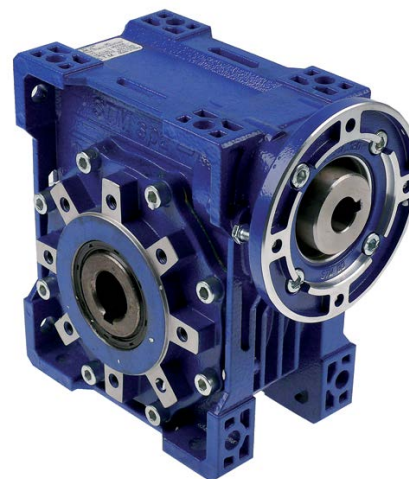

1	<b>GEV No.</b>	697327	<b>Ref. No.</b>	PF08400
<b>description</b> gearbox motor shaft ø 19mm flange ø 120mm transmission 1/70 drive shaft ø 28mm type UMI 75				

for bar blender

blenders

jar components

jars



1

<b>GEV No.</b>	696081	<b>Ref. No.</b>	IB4050800
<b>description</b>	blender jar plastic 1500ml for mixer Dragone		
<b>For models:</b>	721003		



1

<b>GEV No.</b>	696082	<b>Ref. No.</b>	IB4050900
<b>description</b>	blender jar plastic 2000ml for mixer Orione		
<b>For models:</b>	721004		



1

<b>GEV No.</b>	696083	<b>Ref. No.</b>	IB2260900A
<b>description</b>	blender jar stainless steel 2000ml for mixer Orione		
<b>For models:</b>	721004		

complete



1

<b>GEV No.</b>	696084	<b>Ref. No.</b>	IB9865520
<b>description</b>	blender jar plastic 1500ml complete for mixer Dragone		
<b>For models:</b>	721003		



1

<b>GEV No.</b>	696085	<b>Ref. No.</b>	IB9865521
<b>description</b>	blender jar plastic 1500ml for mixing complete for mixer Dragone		
<b>For models:</b>	721003		



1

<b>GEV No.</b>	696437	<b>Ref. No.</b>	ACBP150C
<b>description</b>	blender jar plastic 1500ml with mixer disc		
<b>For models:</b>	721008		



1

<b>GEV No.</b>	696347	<b>Ref. No.</b>	ACBP150L
<b>description</b>	blender jar plastic 1500ml with blade		
<b>For models:</b>	721008		



1

<b>GEV No.</b>	696087	<b>Ref. No.</b>	IB9865320.04
<b>description</b>	blender jar plastic 2000ml complete for mixer Orione		



1

<b>GEV No.</b>	696086	<b>Ref. No.</b>	IB9865321.05
<b>description</b>	blender jar plastic 2000ml for mixing complete for mixer Orione		
<b>For models:</b>	721004		



1

<b>GEV No.</b>	696089	<b>Ref. No.</b>	IB9865323.06
<b>description</b>	blender jar stainless steel 2000ml complete for mixer Orione		



1

<b>GEV No.</b>	696088	<b>Ref. No.</b>	IB9865324.04
<b>description</b>	blender jar stainless steel 2000ml for mixing complete for mixer Orione		
<b>For models:</b>	721004		

lids



1

<b>GEV No.</b>	651060	<b>Ref. No.</b>	CO1407
<b>description</b>	lid ø 130mm rubber nominal-ø 115mm hole ø 44mm		
<b>For models:</b>	715002, 721008		



1

<b>GEV No.</b>	696072	<b>Ref. No.</b>	IB4000820
<b>description</b>	lid ø 148mm plastic nominal-ø 120mm hole ø 48mm Dragone		
<b>For models:</b>	721003		



1

<b>GEV No.</b>	696073	<b>Ref. No.</b>	IB4100920
<b>description</b>	lid ø 156mm rubber nominal-ø 136mm hole ø 48mm Orione		
<b>For models:</b>	721004		



1

<b>GEV No.</b>	696070	<b>Ref. No.</b>	IB4050905
<b>description</b>	lid lock ø 48mm H 50mm plastic		
<b>For models:</b>	721003, 721004		

gaskets



1

<b>GEV No.</b>	651007	<b>Ref. No.</b>	CO1402
<b>description</b>	gasket ED ø 75mm ID ø 55mm thickness 3mm Qty 1 pcs		
<b>For models:</b>	721008		



1

<b>GEV No.</b>	696076	<b>Ref. No.</b>	IB4100915
<b>description</b>	gasket silicone ED ø 68mm ID ø 48mm thickness 2mm Qty 1 pcs		
<b>For models:</b>	721004		



1

<b>GEV No.</b>	696071	<b>Ref. No.</b>	IB4104040
<b>description</b>	O-ring EPDM thickness 3.53mm ID ø 52.39mm Qty 1 pcs		
<b>For models:</b>	721004		



1

<b>GEV No.</b>	696075	<b>Ref. No.</b>	IB4104031
<b>description</b>	V-ring ID ø 8mm thickness 5mm		
<b>For models:</b>	721003		

holders



1

<b>GEV No.</b>	696080	<b>Ref. No.</b>	IB4010910
<b>description</b>	bracket for jar ø 121mm nominal-ø 100mm hole ø 49mm plastic Orione		
<b>For models:</b>	721004		



1

<b>GEV No.</b>	651052	<b>Ref. No.</b>	CO1403
<b>description</b>	bracket for jar ø 87mm nominal-ø 60mm plastic		
<b>For models:</b>	721008		

blades

spare blades



1

<b>GEV No.</b>	696065	<b>Ref. No.</b>	IB2680900 IB2680901
<b>description</b>	knife W 73mm H 47mm hole ø 6x8mm Orione		
<b>For models:</b>	721004		

couplings



1

<b>GEV No.</b>	696061	<b>Ref. No.</b>	IB2000801
<b>description</b>	coupling ø 20mm H 10mm stainless steel Dragone		
<b>For models:</b>	721003		



1

<b>GEV No.</b>	696062	<b>Ref. No.</b>	IB2000901
<b>description</b>	coupling ø 25mm H 17mm IT M5L stainless steel Orione		
<b>For models:</b>	721004		

1

<b>GEV No.</b>	696063	<b>Ref. No.</b>	IB2000903
<b>description</b>	coupling ø 28mm H 17mm IT M5L stainless steel Orione		
<b>For models:</b>	721004		

blades with adaptor (complete)



1

<b>GEV No.</b>	696501	<b>Ref. No.</b>	CO1401
<b>description</b>	slicing unit complete for blenders ø 73mm		
<b>For models:</b>	721008		



1

<b>GEV No.</b>	696074	<b>Ref. No.</b>	IB9865335.05
<b>description</b>	slicing unit plastic jar stainless steel Orione		



1

<b>GEV No.</b>	696077	<b>Ref. No.</b>	IB9865336.06
<b>description</b>	slicing unit stainless steel jar ø 70mm stainless steel Orione		

mixer discs



1

<b>GEV No.</b>	696060	<b>Ref. No.</b>	IB2100933
<b>description</b>	mixer disc ø 50mm hole ø 10mm H 6.5mm aluminium Orione		
<b>For models:</b>	721004		



1

<b>GEV No.</b>	696290	<b>Ref. No.</b>	IB2100932
<b>description</b>	mixer disc ø 50mm hole ø 27mm H 8mm aluminium Orione		
<b>For models:</b>	721004		

mixer discs (complete)



1

<b>GEV No.</b>	696542	<b>Ref. No.</b>	CO1400
<b>description</b>	mixer disc complete ø 73mm hole ø 6mm		
<b>For models:</b>	721008		



1

<b>GEV No.</b>	696057	<b>Ref. No.</b>	IB9865322.05
<b>description</b>	mixer disc complete plastic jar ø 70mm stainless steel Orione		



1

<b>GEV No.</b>	696056	<b>Ref. No.</b>	IB98653220.04
<b>description</b>	mixer disc complete stainless steel jar ø 70mm stainless steel Oriane		

spindles



1

<b>GEV No.</b>	696291	<b>Ref. No.</b>	IB2100931
<b>description</b>	spindle ø 10mm L 60mm IT M5L Oriane		
<b>For models:</b>	721004		



1

<b>GEV No.</b>	696058	<b>Ref. No.</b>	IB2000902
<b>description</b>	spindle ø 10mm L 76.5mm D1 ø 23.5mm ID ø 21.5mm IT M5L aluminium Oriane		
<b>For models:</b>	721004		



1

<b>GEV No.</b>	695169	<b>Ref. No.</b>	IB2000806
<b>description</b>	spindle ø 8mm L 53mm T1: M5L T2: M6L steel Dragone		
<b>For models:</b>	721003		

miscellaneous



1

<b>GEV No.</b>	695119	<b>Ref. No.</b>	IB2000910
<b>description</b>	cap nuts thread M5L WS 10 SS Qty 1 pcs		
<b>For models:</b>	721003, 721004		



1

<b>GEV No.</b>	696064	<b>Ref. No.</b>	IB2000915
<b>description</b>	screw ø 10mm L 13.6mm thread M4		
<b>For models:</b>	721004		



1

<b>GEV No.</b>	696059	<b>Ref. No.</b>	IB2000926
<b>description</b>	union nut ø 70mm ID ø 46.8mm H 10.5mm stainless steel		
<b>For models:</b>	721004		

holders



1

<b>GEV No.</b>	696079	<b>Ref. No.</b>	IB4000810
<b>description</b>	bracket for jar ø 116mm int. ø 1 24mm int. ø 2 79mm Dragone		
<b>For models:</b>	721003		



1

<b>GEV No.</b>	696078	<b>Ref. No.</b>	IB4010900
<b>description</b>	bracket for jar ø 129mm int. ø 1 16mm int. ø 2 100mm Oriane		
<b>For models:</b>	721004		



actuators

group 1



1

<b>GEV No.</b>	698203	<b>Ref. No.</b>	IB4100905
<b>description</b>	mixer coupling for jar ø 36mm H 14mm IT M6L teeth 6 rubber Dragone		
<b>For models:</b>	721003, 721004		



1

<b>GEV No.</b>	698202	<b>Ref. No.</b>	IB4000815
<b>description</b>	mixer coupling for motor ø 36mm H 14mm IT M6L teeth 6 plastic Dragone		
<b>For models:</b>	721003		



1

<b>GEV No.</b>	696069	<b>Ref. No.</b>	IB4100900
<b>description</b>	mixer coupling motor ø 36mm H 14mm IT M8L teeth 6 plastic Orione		
<b>For models:</b>	721004		



1

<b>GEV No.</b>	651041	<b>Ref. No.</b>	CO1757
<b>description</b>	mixer coupling ø 22mm H 13mm IT M6L teeth 4 stainless steel		
<b>For models:</b>	721008		

group 2



1

<b>GEV No.</b>	651042	<b>Ref. No.</b>	CO1404
<b>description</b>	mixer coupling ø 32.5mm H 12mm teeth 4 rubber		
<b>For models:</b>	721008		

mixers

jars



1

<b>GEV No.</b>	698318	<b>Ref. No.</b>	IB4050100
<b>description</b>	blender jar plastic ø 105mm H 150mm		
<b>For models:</b>	721002, 721005		



1

<b>GEV No.</b>	698564	<b>Ref. No.</b>	3935 65010100
<b>description</b>	blender jar SS ø 104mm H 150mm DMB / DMB20		
<b>For models:</b>	721002, 721005		

holders

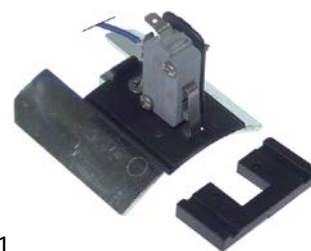

1

<b>GEV No.</b>	650100	<b>Ref. No.</b>	IB9866020
<b>description</b>	bracket with microswitch for jar W 62mm H 60mm		
<b>For models:</b>	721002, 721005		

## mixer discs



1

<b>GEV No.</b>	696091	<b>Ref. No.</b>	IB2100110
<b>description</b>	knife drink mixer ø 26mm IT M5 H 19mm Sirio		
<b>For models:</b>	721002, 721005		



1

<b>GEV No.</b>	696066	<b>Ref. No.</b>	IB2200100
<b>description</b>	mixer disc drink mixer ø 25mm ID ø 5mm Sirio		
<b>For models:</b>	721002, 721005		

## accessories



1

<b>GEV No.</b>	696093	<b>Ref. No.</b>	IB2100100
<b>description</b>	spacer bush ø 8mm ID ø 5.3mm H 14mm Sirio		
<b>For models:</b>	721002, 721005		

## for hand blenders

## flanges



1

<b>GEV No.</b>	698354	<b>Ref. No.</b>	SL3612
<b>description</b>	flange for hand blender ø 92mm H 40mm MX40 / MX42S		
<b>For models:</b>	473007, 473008		



1

<b>GEV No.</b>	696798	<b>Ref. No.</b>	SL3386
<b>description</b>	flange green ø 90mm H 44mm MX25		
<b>For models:</b>	473006		

## housings



1

<b>GEV No.</b>	699140	<b>Ref. No.</b>	SL3385
----------------	--------	-----------------	--------

**description** housing left green MX25 L 275mm ø 100mm

**For models:** 473006

**accessories for** 699140

<b>GEV No.</b>	699138	<b>Ref. No.</b>	SL3384
----------------	--------	-----------------	--------



housing right green MX25 L 275mm ø 100mm



1

<b>GEV No.</b>	699137	<b>Ref. No.</b>	SL3081
----------------	--------	-----------------	--------

**description** housing left green MX40 / MX42S L 330mm ø 120mm

**For models:** 473007, 473008

**accessories for** 699137

<b>GEV No.</b>	699136	<b>Ref. No.</b>	SL3080
----------------	--------	-----------------	--------



housing right green MX40 / MX42S L 330mm ø 120mm



1

<b>GEV No.</b>	699138	<b>Ref. No.</b>	SL3384
----------------	--------	-----------------	--------

**description** housing right green MX25 L 275mm ø 100mm

**For models:** 473006

**accessories for** 699138

<b>GEV No.</b>	699140	<b>Ref. No.</b>	SL3385
----------------	--------	-----------------	--------





housing left green MX25 L 275mm ø 100mm





			
1			
<b>GEV No.</b>	699136	<b>Ref. No.</b>	SL3080
<b>description</b>	housing right green MX40 / MX42S L 330mm ø 120mm		
<b>For models:</b>	473007, 473008		
<b>accessories for</b>	699136		
	<b>GEV No.</b>	<b>Ref. No.</b>	SL3081
	699137		
	housing left green MX40 / MX42S L 330mm ø 120mm		

couplings

			
1			
<b>GEV No.</b>	651031	<b>Ref. No.</b>	IB4004046
<b>description</b>	coupling D1 ø 12mm D2 ø 23mm int. ø 1 8mm thread M6L L 45mm teeth 4 CICLONE		
<b>For models:</b>	470001		

			
1			
<b>GEV No.</b>	651030	<b>Ref. No.</b>	IB4004045
<b>description</b>	coupling D1 ø 12mm D2 ø 24mm thread M8L L 35mm teeth 8 VORTEX edition until year of construction 09/2004		
<b>For models:</b>	470003		

			
1			
<b>GEV No.</b>	651027	<b>Ref. No.</b>	IB4004043.04
<b>description</b>	coupling D1 ø 18mm D2 ø 21mm int. ø 1 12mm thread M8L L 36mm teeth 8 VORTEX edition since year of construction 10/2004		

			
1			
<b>GEV No.</b>	651032	<b>Ref. No.</b>	IB4004048
<b>description</b>	coupling D1 ø 18mm D2 ø 21mm int. ø 1 8mm thread M6L L 36mm teeth 4 CICLONE		
<b>For models:</b>	473001, 473002		

			
1			
<b>GEV No.</b>	651022	<b>Ref. No.</b>	IB4004045.04
<b>description</b>	coupling tooth 8 ø 24mm H 45mm VORTEX edition since year of construction 10/2004		
<b>For models:</b>	470003		

			
1			
<b>GEV No.</b>	692146	<b>Ref. No.</b>	SA1063
<b>description</b>	coupling with pin D1 ø 20mm D2 ø 25mm L 34mm		
<b>For models:</b>	473006, 473007, 473008		

			
1			
<b>GEV No.</b>	697856	<b>Ref. No.</b>	SL3611
<b>description</b>	insert for coupling rubber ø 8mm H 6mm		
<b>For models:</b>	473006, 473007, 473008		

blender sticks

bushes

			
1			
<b>GEV No.</b>	651021	<b>Ref. No.</b>	IB2104020
<b>description</b>	bush ø 11mm ID ø 8mm L 10.3mm		
<b>For models:</b>	470003		

gaskets

			
1			
<b>GEV No.</b>	651023	<b>Ref. No.</b>	IB4104005
<b>description</b>	gasket mixer bowl ED ø 46mm ID ø 32mm CICLONE/VORTEX		
<b>For models:</b>	470001, 470003		

			
1			
<b>GEV No.</b>	651056	<b>Ref. No.</b>	IB4104015
<b>description</b>	sealing ring ED ø 16mm ID ø 8mm CICLONE		
<b>For models:</b>	470001		

## bearing blocks



1

<b>GEV No.</b>	697914	<b>Ref. No.</b>	SL3349
<b>description</b>	bearing block hole $\varnothing$ 15mm H 76mm		
<b>For models:</b>	473006		



1

<b>GEV No.</b>	651024	<b>Ref. No.</b>	IB9866003
<b>description</b>	bearing block with gasket and ball bearing mounting pos. lower $\varnothing$ 49.5mm ID $\varnothing$ 24mm H 31.5mm VORTEX		
<b>For models:</b>	470003		



1

<b>GEV No.</b>	697406	<b>Ref. No.</b>	SL3415
<b>description</b>	blender attachment mounting pos. lower $\varnothing$ 95mm ID $\varnothing$ 25mm H 84mm FM3		
<b>For models:</b>	473007, 473008		



1

<b>GEV No.</b>	697412	<b>Ref. No.</b>	SL0740
<b>description</b>	bushing mounting pos. centre $\varnothing$ 25mm ID $\varnothing$ 22mm H 15mm FM3		
<b>For models:</b>	473006, 473007, 473008		

## miscellaneous



1

<b>GEV No.</b>	697408	<b>Ref. No.</b>	SL0777
<b>description</b>	disc $\varnothing$ 45.5mm ID $\varnothing$ 9mm FM3		
<b>For models:</b>	473006, 473007, 473008		

## blades

## spare blades



1

<b>GEV No.</b>	651034	<b>Ref. No.</b>	IB2680401
<b>description</b>	knife hole $\varnothing$ 6x5mm CICLEONE		
<b>For models:</b>	470001		



1

<b>GEV No.</b>	651033	<b>Ref. No.</b>	IB2680400
<b>description</b>	knife hole $\varnothing$ 6x8mm VORTEX		
<b>For models:</b>	470003		

## blades with adaptor (complete)



1

<b>GEV No.</b>	697411	<b>Ref. No.</b>	SL0744
<b>description</b>	knife $\varnothing$ 60mm hole $\varnothing$ 8mm H 22mm FM3		
<b>For models:</b>	473006, 473007, 473008		



1

<b>GEV No.</b>	651025	<b>Ref. No.</b>	IB9866004
<b>description</b>	knife with spindle $\varnothing$ 60mm hole $\varnothing$ 8mm H 40mm VORTEX		
<b>For models:</b>	470003		
<b>spare parts for</b>	651025		
	<b>GEV No.</b>	<b>Ref. No.</b>	IB2680400
		knife hole $\varnothing$ 6x8mm VORTEX	

## accessories



1

<b>GEV No.</b>	651035	<b>Ref. No.</b>	IB1980406
<b>description</b>	blade holder CICLEONE		
<b>For models:</b>	470001		



1

<b>GEV No.</b>	651036	<b>Ref. No.</b>	IB1980407
<b>description</b>	screw for knife thread M4L CICLEONE		
<b>For models:</b>	470001		



blender sticks



1

<b>GEV No.</b>	698353	<b>Ref. No.</b>	ME4040
<b>description</b>	blender stick FM3 L 400mm flange ø 47mm with blade		
<b>For models:</b>	473007, 473008		
<b>spare parts for</b>	698353		
	<b>GEV No.</b>	<b>Ref. No.</b>	SL0744
	knife ø 60mm hole ø 8mm H 22mm FM3		



1

<b>GEV No.</b>	698309	<b>Ref. No.</b>	ME4050
<b>description</b>	blender stick L 500mm flange ø 47mm with blade		
<b>For models:</b>	473007, 473008		



1

<b>GEV No.</b>	698333	<b>Ref. No.</b>	ME2530
<b>description</b>	blender stick MX25 L 310mm with blade		
<b>For models:</b>	473006		

spindles



1

<b>GEV No.</b>	698364	<b>Ref. No.</b>	IB2104004
<b>description</b>	drive shaft for hand blender D1 ø 18mm D2 ø 8mm L 430mm		
<b>For models:</b>	470003		

beaters

gearboxes

driven gears



1

<b>GEV No.</b>	697401	<b>Ref. No.</b>	SL0739
<b>description</b>	drive shaft D1 ø 8mm L 63mm FM3		
<b>For models:</b>	473007		
<b>accessories for</b>	697401		
	<b>GEV No.</b>	<b>Ref. No.</b>	SL0753
	roll pin ø 3mm L 20mm SS 1475		



1

<b>GEV No.</b>	697403	<b>Ref. No.</b>	SA8900
<b>description</b>	gear wheel double ø 45mm shaft ø 8mm shaft L 70mm with spindle FM3		
<b>For models:</b>	473007		



1

<b>GEV No.</b>	697404	<b>Ref. No.</b>	SA8800
<b>description</b>	gear wheel single shaft ø 8mm shaft L 70mm with spindle FM3		
<b>For models:</b>	473007		

beaters



1

<b>GEV No.</b>	697416	<b>Ref. No.</b>	SL0743
<b>description</b>	whisk ø 90mm L 265mm hole ø 8mm		
<b>For models:</b>	473007		

beaters (complete)



1



<b>GEV No.</b>	698458	<b>Ref. No.</b>	FRUSTAFM3
<b>description</b>	whisk motor shaft ø 8mm flange ø 40mm MX40 / FX40		
<b>For models:</b>	473007		
<b>spare parts for</b>	698458		
	<b>GEV No.</b>	<b>Ref. No.</b>	—
	gearbox FM3		

Table continues overleaf

<b>spare parts for</b> 698458			
	<b>GEV No.</b>	697416	<b>Ref. No.</b> SL0743
whisk ø 90mm L 265mm hole ø 8mm			

miscellaneous



1	<b>GEV No.</b>	550963	<b>Ref. No.</b>	IB5894000
<b>description</b> bend relief ID ø 7mm				
<b>For models:</b> 473001, 473002				



1	<b>GEV No.</b>	346961	<b>Ref. No.</b>	IB4004042
<b>description</b> push button ø 10mm L 62mm VORTEX				



1	<b>GEV No.</b>	346954	<b>Ref. No.</b>	IB4004047
<b>description</b> push button ø 10mm L 72mm CICLONE				
<b>For models:</b> 473001, 473002				



1	<b>GEV No.</b>	698406	<b>Ref. No.</b>	SL3350
<b>description</b> spindle for hand blender SS L 295mm ø 8mm				
<b>For models:</b> 473006				

for citrus juicers

spillage trays



1	<b>GEV No.</b>	696354	<b>Ref. No.</b>	CO1447
<b>description</b> drain tray for citrus juicers ø 180mm hole ø 34mm H 87mm SS				
<b>For models:</b> 723005				



1	<b>GEV No.</b>	696092	<b>Ref. No.</b>	IB2260700
<b>description</b> tray ø 170mm hole ø 31mm H 74mm stainless steel model APOLLO				
<b>For models:</b> 723001				

gaskets



1	<b>GEV No.</b>	696067	<b>Ref. No.</b>	IB4180700
<b>description</b> gasket ø 26mm ID ø 11mm H 12mm for citrus juicers				
<b>For models:</b> 723001				



1	<b>GEV No.</b>	696068	<b>Ref. No.</b>	IB4100110
<b>description</b> gasket ø 85mm H 18mm drink mixer hole distance 55x75mm model Sirio				
<b>For models:</b> 721002, 721005				

juicer insert



1	<b>GEV No.</b>	960107	<b>Ref. No.</b>	IB4000720
<b>description</b> juicer insert				
<b>For models:</b> 723001				



1	<b>GEV No.</b>	650155	<b>Ref. No.</b>	CO1405
<b>description</b> juicer insert for citrus juicers ø 119mm H 48mm SS				
<b>For models:</b> 723005				



spindles



1			
<b>GEV No.</b>	696090	<b>Ref. No.</b>	IB2080700
<b>description</b>	spindle L 66.5mm model APOLLO WS 14 IT M8L		
<b>For models:</b>	723001		



1			
<b>GEV No.</b>	696095	<b>Ref. No.</b>	IB2080710
<b>description</b>	spindle ø 8mm L 85mm motor model Sirio suitable for flange		
<b>For models:</b>	723001		

miscellaneous



1			
<b>GEV No.</b>	523000	<b>Ref. No.</b>	IB7300700
<b>description</b>	thrust ball bearing shaft ø 12mm ED ø 26mm W 9mm type 51101 DIN 711		
<b>For models:</b>	723001		

for fridges

housing and bezels

holders



1			
<b>GEV No.</b>	691491	<b>Ref. No.</b>	7424773
<b>description</b>	bracket		

caps



1			
<b>GEV No.</b>	692372	<b>Ref. No.</b>	PS900.03 RC0736
<b>description</b>	cap grey ø 16.5mm mounting ø 12.5mm H 7mm Qty 1 pcs		
<b>For models:</b>	611007, 611008, 611009, 611010, 611011, 611023, 625017, 625018		

miscellaneous

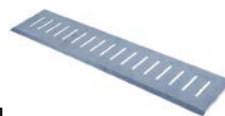

1			
<b>GEV No.</b>	691590	<b>Ref. No.</b>	33277017
<b>description</b>	protective plate L 580mm H 125mm		
<b>For models:</b>	201780, 621007, 622005		

miscellaneous



1			
<b>GEV No.</b>	696413	<b>Ref. No.</b>	GN650TN.01
<b>description</b>	screw thread M6 L 18mm		
<b>For models:</b>	621018, 621019		

for refrigerated counters

spare parts and accessories



1			
<b>GEV No.</b>	691499	<b>Ref. No.</b>	876032300 879008600
<b>description</b>	bush eccentric for glass plate		
<b>For models:</b>	641001, 641002, 641003, 641010, 641011, 641012, 641013, 641014, 641015, 641016, 641017		



1			
<b>GEV No.</b>	691498	<b>Ref. No.</b>	870730700
<b>description</b>	bush for glass plate ø 7.5mm		
<b>For models:</b>	631001, 631002, 631003, 631004, 631005, 631006, 636001, 636002, 636003, 636004, 636005, 636006, 641001, 641002, 641003, 641004, 641005, 641006, 641007, 641008, 641010, 641011, 641012, 641013, 641014, 641015, 641016, 641017		



1			
<b>GEV No.</b>	691497	<b>Ref. No.</b>	879002300 890004800
<b>description</b>	fastening angle for glass plate		
<b>For models:</b>	641001, 641002, 641003, 641004, 641005, 641006, 641007, 641008, 641010, 641011, 641012, 641013, 641014, 641015, 641016, 641017		



1

<b>GEV No.</b>	697917	<b>Ref. No.</b>	S900.29
<b>description</b>	fixing plate with opposite support thread M5		
<b>For models:</b>	611007, 611010		
<b>accessories for</b>	697917		
	<b>GEV No.</b>	697916	<b>Ref. No.</b> S900.28
	screw bolt with nut L 8mm thread M5 ø 6mm		





1

<b>GEV No.</b>	691500	<b>Ref. No.</b>	875036000
<b>description</b>	glass panel L 959mm W 602mm thickness 6mm		
<b>For models:</b>	641001		



1

<b>GEV No.</b>	697916	<b>Ref. No.</b>	S900.28
<b>description</b>	screw bolt with nut L 8mm thread M5 ø 6mm		
<b>For models:</b>	611007, 611010, 611014		
<b>accessories for</b>	697916		
	<b>GEV No.</b>	697917	<b>Ref. No.</b> S900.29
	fixing plate with opposite support thread M5		



1

<b>GEV No.</b>	691502	<b>Ref. No.</b>	875059400
<b>description</b>	glass panel mounting pos. lateral		
<b>For models:</b>	641003		



1

<b>GEV No.</b>	691493	<b>Ref. No.</b>	879002200 890004700
<b>description</b>	suction cup for glass plate		
<b>For models:</b>	641001, 641002, 641003, 641004, 641005, 641006, 641007, 641008, 641010, 641011, 641012, 641013, 641014, 641015, 641016, 641017		

### doors



1

<b>GEV No.</b>	691480	<b>Ref. No.</b>	8754405 875440500
<b>description</b>	door W 545mm H 335mm with gasket		
<b>For models:</b>	641003, 641005, 641007, 641008, 641010, 641011, 641012, 641013, 641014, 641015, 641016, 641017		

## for display coolers

## glass panels

## glass panels



1

<b>GEV No.</b>	691501	<b>Ref. No.</b>	875036200
<b>description</b>	glass panel L 1419mm W 602mm thickness 6mm		
<b>For models:</b>	641003		

## for ice-cube maker

## drain systems

## drain fittings





1

<b>GEV No.</b>	695620	<b>Ref. No.</b>	10472
<b>description</b>	drain fitting straight connection 24mm for ice maker		
<b>For models:</b>	711001, 711002, 711003, 711004, 711005, 711006, 711007, 711008, 711009, 711010, 711011, 711012, 711013, 711014, 711015, 711016, 711017, 711018, 711019		









			
1			
<b>GEV No.</b>	695039	<b>Ref. No.</b>	10471
<b>description</b>	drain fitting thread M30x2 L 40.7mm straight connection 17mm for ice-cube maker		
<b>For models:</b>	711014, 711015, 711016, 711017, 711018, 711019		

<b>overflow pipes</b>			
			
1			
<b>GEV No.</b>	695622	<b>Ref. No.</b>	10305
<b>description</b>	lid for overflow pipe tube ø 34mm		
<b>For models:</b>	711004, 711005, 711006, 711007, 711008, 711009, 711010, 711011, 711012, 711013, 711014, 711015, 711016, 711017, 711018, 711019		
<b>accessories for</b>	695622		
	<b>GEV No.</b>	695086	<b>Ref. No.</b> 10133
	overflow pipe tube ø 20.5mm pipe length 88.6mm		

			
1			
<b>GEV No.</b>	695083	<b>Ref. No.</b>	13028
<b>description</b>	overflow pipe ID ø 22mm D1 ø 27mm D2 ø 19mm L 144mm		
<b>For models:</b>	711001, 711002, 711003		

			
1			
<b>GEV No.</b>	695086	<b>Ref. No.</b>	10133
<b>description</b>	overflow pipe tube ø 20.5mm pipe length 88.6mm		
<b>For models:</b>	711004, 711005, 711006, 711007, 711008, 711009, 711010, 711011, 711012, 711013, 711014, 711015, 711016, 711017, 711018, 711019		
<b>accessories for</b>	695086		
	<b>GEV No.</b>	532517	<b>Ref. No.</b> 20233
	O-ring silicone thickness 1.78mm ID ø 17.17mm Qty 1 pcs		
	<b>GEV No.</b>	695059	<b>Ref. No.</b> 10007
	hose connector for ice-cube maker		
	<b>GEV No.</b>	695537	<b>Ref. No.</b> 13006
	gasket silicone ED ø 40mm ID ø 30mm thickness 2mm Qty 1 pcs		
	<b>GEV No.</b>	695622	<b>Ref. No.</b> 10305
	lid for overflow pipe tube ø 34mm		

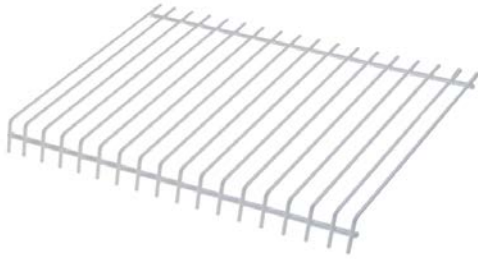
<b>ice chutes</b>			
<b>slide grates</b>			
			
1			
<b>GEV No.</b>	694281	<b>Ref. No.</b>	D12001
<b>description</b>	slide grate for ice-cube maker L 325mm W 210mm		
<b>For models:</b>	711004, 711005, 711006, 711007		

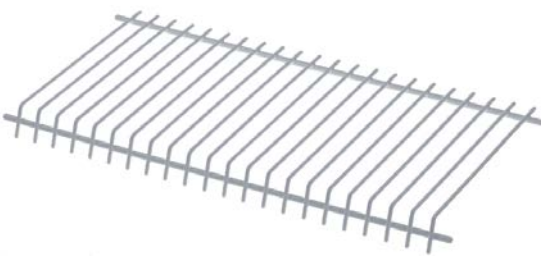
			
1			
<b>GEV No.</b>	692769	<b>Ref. No.</b>	D12008
<b>description</b>	slide grate for ice-cube type A L 435mm W 207mm H 26mm		
<b>For models:</b>	711008, 711009, 711010, 711011, 711012, 711013		

<b>filters</b>			
			
1			
<b>GEV No.</b>	694878	<b>Ref. No.</b>	18106
<b>description</b>	filter L 230mm W 190mm thickness 1mm		
<b>For models:</b>	711004, 711005, 711006, 711007, 711008, 711009, 711010, 711011, 711012, 711013, 711014, 711015, 711016, 711017, 711018, 711019		

<b>doors</b>			
<b>doors</b>			
			
1			
<b>GEV No.</b>	695510	<b>Ref. No.</b>	10103
<b>description</b>	door for ice-cube maker W 293mm H 182mm thickness 24mm		
<b>For models:</b>	711001, 711002, 711003		



1

<b>GEV No.</b>	695511	<b>Ref. No.</b>	10277
<b>description</b>	door for ice-cube maker W 293mm H 182mm thickness 25mm		
<b>For models:</b>	711002, 711003		



1

<b>GEV No.</b>	695512	<b>Ref. No.</b>	10081
<b>description</b>	door for ice-cube maker W 293mm H 182mm thickness 25mm		
<b>For models:</b>	711002, 711003		



1

<b>GEV No.</b>	695513	<b>Ref. No.</b>	C10303
<b>description</b>	door for ice-cube maker W 337mm H 207mm thickness 22mm		
<b>For models:</b>	711004, 711005, 711006, 711007		



1

<b>GEV No.</b>	695514	<b>Ref. No.</b>	C10297
<b>description</b>	door for ice-cube maker W 447mm H 217mm thickness 22mm		
<b>For models:</b>	711008, 711009, 711010, 711011, 711012, 711013		



1

<b>GEV No.</b>	695515	<b>Ref. No.</b>	C10275
<b>description</b>	door for ice-cube maker W 675mm H 307mm thickness 28mm		
<b>For models:</b>	711014, 711015, 711016, 711017, 711018, 711019		

**curtains**  
with holder



1

<b>GEV No.</b>	695356	<b>Ref. No.</b>	C22106
<b>description</b>	curtain for ice maker W 275mm H 140mm with holder shaft length 275mm shaft ø 7.5mm		
<b>For models:</b>	711001, 711002, 711003		



1

<b>GEV No.</b>	695506	<b>Ref. No.</b>	C22034
<b>description</b>	curtain for ice maker W 328mm H 150mm with holder shaft length 325mm shaft ø 7.5mm		
<b>For models:</b>	711004, 711005, 711006, 711007		



1

<b>GEV No.</b>	695507	<b>Ref. No.</b>	C22035
<b>description</b>	curtain for ice maker W 433mm H 165mm with holder shaft length 438mm shaft ø 7.5mm		
<b>For models:</b>	711008, 711009, 711010, 711011, 711012, 711013		





1

<b>GEV No.</b>	695508	<b>Ref. No.</b>	C22059
<b>description</b>	curtain for ice maker W 660mm H 165mm with holder shaft length 665mm shaft ø 7.5mm		
<b>For models:</b>	711014, 711015, 711016, 711017, 711018, 711019		



 <p>1</p>			
<b>GEV No.</b>	696594	<b>Ref. No.</b>	K10532
<b>description</b>	curtain for ice-cube maker W 273mm H 160mm shaft length 280mm shaft ø 7.6mm holder length 316mm		

without holder			
 <p>1</p>			
<b>GEV No.</b>	695619	<b>Ref. No.</b>	C10532
<b>description</b>	curtain for ice maker W 275mm H 80mm shaft length 280mm shaft ø 7.5mm		
<b>For models:</b>	711001, 711002, 711003		

 <p>1</p>			
<b>GEV No.</b>	695116	<b>Ref. No.</b>	C10533
<b>description</b>	curtain for ice-cube maker W 320mm H 80mm shaft length 325mm shaft ø 7.5mm		
<b>For models:</b>	711004, 711005, 711006, 711007		

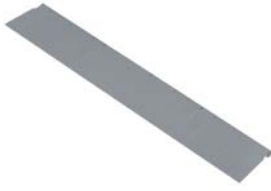

 <p>1</p>			
<b>GEV No.</b>	695117	<b>Ref. No.</b>	C10534
<b>description</b>	curtain for ice-cube maker W 430mm H 80mm shaft length 440mm shaft ø 7.5mm complete with rod		
<b>For models:</b>	711008, 711009, 711010, 711011, 711012, 711013		

accessories			
holders			
 <p>1</p>			
<b>GEV No.</b>	696754	<b>Ref. No.</b>	10526
<b>description</b>	curtain holder for ice maker W 107mm H 35mm suitable for CB316-416-425		
<b>For models:</b>	711008, 711009, 711010, 711011, 711012, 711013		

lamellas			
 <p>1</p>			
<b>GEV No.</b>	695082	<b>Ref. No.</b>	10005
<b>description</b>	lamella for curtain L 69mm W 23mm ID ø 8mm		

suction system			
intake filters			
 <p>1</p>			
<b>GEV No.</b>	695532	<b>Ref. No.</b>	20005
<b>description</b>	round filters ø 28mm H 60mm		
<b>For models:</b>	711004, 711005, 711006, 711007, 711008, 711009, 711010, 711011, 711012, 711013, 711014, 711015, 711016, 711017, 711018, 711019		

gaskets			
miscellaneous			
 <p>1</p>			
<b>GEV No.</b>	695534	<b>Ref. No.</b>	13143
<b>description</b>	gasket silicone ED ø 36mm ID ø 23.5mm thickness 3mm Qty 1 pcs		
<b>For models:</b>	711004, 711005, 711006, 711007, 711008, 711009, 711010, 711011, 711012, 711013, 711014, 711015, 711016, 711017, 711018, 711019		

 <p>1</p>			
<b>GEV No.</b>	695537	<b>Ref. No.</b>	13006
<b>description</b>	gasket silicone ED ø 40mm ID ø 30mm thickness 2mm Qty 1 pcs		
<b>For models:</b>	711001, 711002, 711003, 711004, 711005, 711006, 711007, 711008, 711009, 711010, 711011, 711012, 711013, 711014, 711015, 711016, 711017, 711018, 711019		
<b>accessories for</b>	695537		
<b>GEV No.</b>	695059	<b>Ref. No.</b>	10007
<b>description</b>	 hose connector for ice-cube maker		

## housing and bezels

## ventilation grilles



1

<b>GEV No.</b>	694877	<b>Ref. No.</b>	C10205
<b>description</b>	bezel for aspiration with filter L 260mm W 22mm H 252mm mounting pos. front		
<b>For models:</b>	711004, 711005, 711006, 711007, 711008, 711009, 711010, 711011, 711012, 711013, 711014, 711015, 711016, 711017, 711018, 711019		

## hoses

## formed hoses

## straight

## silicone hoses



1

<b>GEV No.</b>	530754	<b>Ref. No.</b>	13107
<b>description</b>	silicone hose ID ø 13mm ED ø 19mm L 0.13m t.max. 200°C for ice-cube maker		
<b>For models:</b>	711008, 711009, 711010, 711011		



1

<b>GEV No.</b>	530752	<b>Ref. No.</b>	13106
<b>description</b>	silicone hose ID ø 13mm ED ø 19mm L 0.15m t.max. 200°C for ice-cube maker		
<b>For models:</b>	711006, 711007		



1

<b>GEV No.</b>	530757	<b>Ref. No.</b>	13108
<b>description</b>	silicone hose ID ø 13mm ED ø 19mm L 0.24m t.max. 200°C for ice-cube maker		
<b>For models:</b>	711012, 711013		



1

<b>GEV No.</b>	530758	<b>Ref. No.</b>	13109
<b>description</b>	silicone hose ID ø 13mm ED ø 19mm L 0.26m t.max. 200°C for ice-cube maker		
<b>For models:</b>	711014, 711015, 711016, 711017		



1

<b>GEV No.</b>	530759	<b>Ref. No.</b>	13110
<b>description</b>	silicone hose ID ø 13mm ED ø 19mm L 0.35m t.max. 200°C for ice-cube maker		
<b>For models:</b>	711018, 711019		



1

<b>GEV No.</b>	530749	<b>Ref. No.</b>	13105
<b>description</b>	silicone hose ID ø 13mm ED ø 19mm L 0.7m t.max. 200°C for ice-cube maker		
<b>For models:</b>	711004, 711005		



1

<b>GEV No.</b>	530731	<b>Ref. No.</b>	13056
<b>description</b>	silicone hose ID ø 16mm ED ø 23mm L 0.03m t.max. 200°C for ice-cube maker		
<b>For models:</b>	711001, 711002, 711003		



1

<b>GEV No.</b>	530737	<b>Ref. No.</b>	13137
<b>description</b>	silicone hose ID ø 16mm ED ø 23mm L 0.29m t.max. 200°C for ice-cube maker		
<b>For models:</b>	711006, 711007		



1

<b>GEV No.</b>	530738	<b>Ref. No.</b>	13139
<b>description</b>	silicone hose ID ø 16mm ED ø 23mm L 0.4m t.max. 200°C for ice-cube maker		
<b>For models:</b>	711012, 711013		



1

<b>GEV No.</b>	530739	<b>Ref. No.</b>	13140
<b>description</b>	silicone hose ID ø 16mm ED ø 23mm L 0.5m t.max. 200°C for ice-cube maker		
<b>For models:</b>	711014, 711015, 711016, 711017		



1

<b>GEV No.</b>	530740	<b>Ref. No.</b>	13141
<b>description</b>	silicone hose ID ø 16mm ED ø 23mm L 0.61m t.max. 200°C for ice-cube maker		
<b>For models:</b>	711018, 711019		



1

<b>GEV No.</b>	530063	<b>Ref. No.</b>	MA1036100700
<b>description</b>	silicone hose ID ø 18mm ED ø 25mm L 1m t.max. 200°C transparent		
<b>For models:</b>	126101, 126103		





1

<b>GEV No.</b>	530764	<b>Ref. No.</b>	13138
<b>description</b>	silicone hose ID ø 18mm ED ø 27mm L 0.3m t.max. 200°C for ice-cube maker		
<b>For models:</b>	711008, 711009, 711010, 711011		





1 			
<b>GEV No.</b>	530736	<b>Ref. No.</b>	13136
<b>description</b>	silicone hose straight for ice-cube maker ID ø 18mm ED ø 25mm L 213mm		
<b>For models:</b>	711004, 711005		

form L			
1 			
<b>GEV No.</b>	530750	<b>Ref. No.</b>	13061
<b>description</b>	formed hose L-shape for ice-cube maker ID ø 14/19mm ED ø 18/22mm L 240mm W 45mm		
<b>For models:</b>	711006, 711007		

1 			
<b>GEV No.</b>	530755	<b>Ref. No.</b>	13030
<b>description</b>	formed hose L-shape for ice-cube maker ID ø 15/19mm ED ø 20/23mm L 330mm W 70mm		
<b>For models:</b>	711012, 711013		

1 			
<b>GEV No.</b>	695107	<b>Ref. No.</b>	13005
<b>description</b>	formed hose L-shape for ice-cube maker ID ø 17mm ED ø 23.5mm L 70mm W 50mm		
<b>For models:</b>	711004, 711005, 711006, 711007, 711008, 711009, 711010, 711011, 711012, 711013, 711014, 711015, 711016, 711017, 711018, 711019		

1 			
<b>GEV No.</b>	530732	<b>Ref. No.</b>	13055
<b>description</b>	silicone hose L-shape for ice-cube maker ID ø 17mm ED ø 24mm L 120mm W 50mm		
<b>For models:</b>	711001, 711002, 711003		

form U			
group 1			
1 			
<b>GEV No.</b>	530747	<b>Ref. No.</b>	13058
<b>description</b>	formed hose U-shape for ice-cube maker ID ø 17/23mm ED ø 25/31mm L 610mm W 120mm		
<b>For models:</b>	711018, 711019		

1 			
<b>GEV No.</b>	530745	<b>Ref. No.</b>	13062
<b>description</b>	formed hose U-shape for ice-cube maker ID ø 17/25mm ED ø 25/31mm L 300mm W 90mm		
<b>For models:</b>	711006, 711007		



group 2			
1 			
<b>GEV No.</b>	695099	<b>Ref. No.</b>	13021
<b>description</b>	formed hose U-shape for ice-cube maker ID ø 17/26mm ED ø 25/32mm L 460mm W 100mm		
<b>For models:</b>	711012, 711013		

1 			
<b>GEV No.</b>	695097	<b>Ref. No.</b>	13003
<b>description</b>	formed hose U-shape for ice-cube maker ID ø 18/26mm ED ø 25/31mm L 280mm W 75mm		
<b>For models:</b>	711004, 711005		

1 			
<b>GEV No.</b>	695100	<b>Ref. No.</b>	13015
<b>description</b>	formed hose U-shape for ice-cube maker ID ø 18/26mm ED ø 25/32mm L 560mm W 90mm		
<b>For models:</b>	711014, 711015, 711016, 711017		

1 			
<b>GEV No.</b>	530746	<b>Ref. No.</b>	13059
<b>description</b>	formed hose U-shape for ice-cube maker ID ø 18/27mm ED ø 25/32mm L 670mm W 90mm		
<b>For models:</b>	711018, 711019		

hose connectors

with thread			
1 			
<b>GEV No.</b>	695059	<b>Ref. No.</b>	10007
<b>description</b>	hose connector for ice-cube maker		
<b>accessories for</b>	695059		
	<b>GEV No.</b>	695537	<b>Ref. No.</b>
			13006
	gasket silicone ED ø 40mm ID ø 30mm thickness 2mm Qty 1 pcs		

without thread

1 			
<b>GEV No.</b>	695058	<b>Ref. No.</b>	10006
<b>description</b>	hose connector 2-way for ice-cube maker		

			
1			
<b>GEV No.</b>	695527	<b>Ref. No.</b>	C26452
<b>description</b>	hose connector 3-way for hose for ice-cube maker		
<b>For models:</b>	711002, 711003, 711004, 711005, 711006, 711007, 711008, 711009, 711010, 711011, 711012, 711013, 711014, 711015, 711016, 711017, 711018, 711019		

## miscellaneous

			
1			
<b>GEV No.</b>	695533	<b>Ref. No.</b>	10404
<b>description</b>	butt splice connector thread M23x1.5 for hose ID 18mm		
<b>For models:</b>	711004, 711005, 711006, 711007, 711008, 711009, 711010, 711011, 711012, 711013, 711014, 711015, 711016, 711017, 711018, 711019		

			
1			
<b>GEV No.</b>	695536	<b>Ref. No.</b>	10096
<b>description</b>	nut for drain assembly		
<b>For models:</b>	711001, 711002, 711003, 711004, 711005, 711006, 711007, 711008, 711009, 711010, 711011, 711012, 711013, 711014, 711015, 711016, 711017, 711018, 711019		

			
1			
<b>GEV No.</b>	695535	<b>Ref. No.</b>	10405
<b>description</b>	nut for ice-cube maker thread M23x1.5		
<b>For models:</b>	711004, 711005, 711006, 711007, 711008, 711009, 711010, 711011, 711012, 711013, 711014, 711015, 711016, 711017, 711018, 711019		

## for ice crusher

## handles

			
1			
<b>GEV No.</b>	696096	<b>Ref. No.</b>	IB2080712
<b>description</b>	handle rod L 160mm ø 10mm T1: M8 T2: M10		
<b>For models:</b>	715001		

## V-belts

			
1			
<b>GEV No.</b>	698222	<b>Ref. No.</b>	IB7003012
<b>description</b>	poly-v belt grooves 6 W 12mm L 526mm profile TB2		
<b>For models:</b>	715001		

## bodies

			
1			
<b>GEV No.</b>	696196	<b>Ref. No.</b>	IB1273460
<b>description</b>	body ice crusher ID ø 98.5mm L 210mm aluminium		
<b>For models:</b>	715001		

## for espresso machines

## filter holders

## filter holders standard

## filter holders (complete)

			
1			
<b>GEV No.</b>	528088	<b>Ref. No.</b>	WY27311055
<b>description</b>	filter holder with outlet, 2-fold suitable for WEGA 2-way ID 0mm outlet distancemm		
<b>For models:</b>	742017, 742018, 742019, 742020		



			
1			
<b>GEV No.</b>	528000	<b>Ref. No.</b>	WY27311054
<b>description</b>	filter holder with outlet, single suitable for WEGA 1-way ID ø 62mm outlet distancemm		
<b>For models:</b>	742017, 742018, 742019, 742020		

filter holder without spout

			
1			
<b>GEV No.</b>	528085	<b>Ref. No.</b>	WY27311010
<b>description</b>	filter holder suitable for WEGA without outlet mounting ø 82mm outlet 3/8" ID ø 61mm wedge height 9.6mm wedge position horizontal number of wedges 2 lever inclined		
<b>For models:</b>	742001, 742002, 742003, 742004, 742017, 742018, 742019, 742020		

handles

with external thread			
			
1			
<b>GEV No.</b>	111150	<b>Ref. No.</b>	WY15263010
<b>description</b>	handle ø 39mm thread M12x1.75 thread L 17mm L 128mm black		
<b>For models:</b>	742001, 742002, 742003, 742004, 742017, 742018, 742019, 742020		

end caps

			
1			
<b>GEV No.</b>	527179	<b>Ref. No.</b>	WY15486006
<b>description</b>	end cap ø 24.3mm chrome-plated		
<b>For models:</b>	742001, 742002, 742003, 742004, 742017, 742018, 742019, 742020		

spouts

with thread 3/8"			
			
1			
<b>GEV No.</b>	529000	<b>Ref. No.</b>	WY27032001
<b>description</b>	filter holder spout thread 3/8" 1-way curved/long outlet distancemm		
<b>For models:</b>	742001, 742002, 742003, 742004, 742017, 742018, 742019, 742020		

			
1			
<b>GEV No.</b>	529032	<b>Ref. No.</b>	WY27042001
<b>description</b>	filter holder spout thread 3/8" 2-way curved outlet distance 48mm		
<b>For models:</b>	742001, 742002, 742003, 742004, 742017, 742018, 742019, 742020		

			
1			
<b>GEV No.</b>	529894	<b>Ref. No.</b>	WY27050
<b>description</b>	filter holder spout thread 3/8" 3-way curved outlet distancemm		
<b>For models:</b>	742001, 742002, 742003, 742004, 742017, 742018, 742019, 742020		

accessories

			
1			
<b>GEV No.</b>	529063	<b>Ref. No.</b>	WY27060201
<b>description</b>	extension thread 3/8" for filter holder outlet		
<b>For models:</b>	742001, 742002, 742003, 742004		

filters

for 1 cup

			
1			
<b>GEV No.</b>	529011	<b>Ref. No.</b>	WY27142
<b>description</b>	coffee filter ø 70mm mounting ø 60mm H 24.5mm cups 1 amount of coffee 7g perforation ø 0.4mm		
<b>For models:</b>	742001, 742002, 742003, 742004, 742017, 742018, 742019, 742020		

for 2 cups

			
1			
<b>GEV No.</b>	529013	<b>Ref. No.</b>	WY27171
<b>description</b>	coffee filter ø 70mm mounting ø 60.5mm H 25.5mm cups 2 amount of coffee 14g perforation ø 0.3x0.3mm square		
<b>For models:</b>	742001, 742002, 742003, 742004, 742017, 742018, 742019, 742020		

for 3 and more cups



1

<b>GEV No.</b>	529229	<b>Ref. No.</b>	WY27190
<b>description</b>	coffee filter ø 70mm mounting ø 60mm H 28mm cups 3 amount of coffee 21g		
<b>For models:</b>	742001, 742002, 742003, 742004, 742017, 742018, 742019, 742020		

blind filters



1

<b>GEV No.</b>	529023	<b>Ref. No.</b>	WY27173
<b>description</b>	blind filter ø 70mm mounting ø 60mm H 18mm		
<b>For models:</b>	742001, 742002, 742003, 742004, 742017, 742018, 742019, 742020		

filter holder springs



1

<b>GEV No.</b>	529079	<b>Ref. No.</b>	WY27255
<b>description</b>	filter holder spring L 70mm W 60mm wire gauge ø 1.3mm for espresso filter holder		
<b>For models:</b>	742001, 742002, 742003, 742004, 742017, 742018, 742019, 742020		

brewing units

shower screens

with upstand



1

<b>GEV No.</b>	528417	<b>Ref. No.</b>	WY27104
<b>description</b>	shower screen ø 58mm H 19mm		
<b>For models:</b>	742005, 742017, 742018, 742019, 742020		

filter holder gaskets

flat

with bevel 45x2



1

<b>GEV No.</b>	528969	<b>Ref. No.</b>	WY12228
<b>description</b>	filter holder gasket with bevel 45x2 D1 ø 73.5mm D2 ø 57.5mm H 8.5mm with inside notch		
<b>For models:</b>	742001, 742002, 742003, 742004, 742005, 742017, 742018, 742019, 742020		



1

<b>GEV No.</b>	528970	<b>Ref. No.</b>	WY12225 WY12227
<b>description</b>	filter holder gasket with bevel 45x2 D1 ø 73.5mm D2 ø 57.5mm H 8mm with inside notch		
<b>For models:</b>	742001, 742002, 742003, 742004, 742005, 742017, 742018, 742019, 742020		

O-rings



1

<b>GEV No.</b>	510409	<b>Ref. No.</b>	200815
<b>description</b>	O-ring EPDM thickness 5.34mm ID ø 56.52mm Qty 1 pcs		
<b>For models:</b>	SP2-12, SP2-S12, SP3		

brewing units with solenoid valve

pipes



1

<b>GEV No.</b>	527619	<b>Ref. No.</b>	WY15451025
<b>description</b>	aspiration tube ø 8mm L 150mm T1: M8x1.25 PTFE		

brewing units manual

components

nozzle holders





1

<b>GEV No.</b>	527253	<b>Ref. No.</b>	WY27119
<b>description</b>	nozzle holder thread M30x1.5 IT M16x1.5 IT 1 M6 ø 25mm int. ø 110mm L 66mm total length 82mm WS 36 chrome-plated brass		
<b>For models:</b>	742001, 742002, 742003, 742004, 742005, 742017, 742018, 742019, 742020		







components			
drain units			
screw connections			
			
1			
<b>GEV No.</b>	527208	<b>Ref. No.</b>	WY23055
<b>description</b>	drain connection thread 1/8" L 22mm chrome-plated WS 20		
<b>For models:</b>	742001, 742002, 742003, 742004, 742005, 742017, 742018, 742019, 742020		

nozzles			
with thread			
			
1			
<b>GEV No.</b>	528486	<b>Ref. No.</b>	WY10300C
<b>description</b>	nozzle bore ø 0.7mm thread M6x0.75 L 9mm WS 7		
<b>For models:</b>	742001, 742002, 742003, 742004, 742005, 742017, 742018, 742019, 742020		

screw connections			
			
1			
<b>GEV No.</b>	527270	<b>Ref. No.</b>	WY27118
<b>description</b>	end cap thread M16x1.5 ID ø 8.9mm L 21mm chrome-plated WS 22		
<b>For models:</b>	742001, 742002, 742003, 742004, 742005, 742017, 742018, 742019, 742020		

			
1			
<b>GEV No.</b>	520707	<b>Ref. No.</b>	WY25785
<b>description</b>	screw cap thread 3/8" thread L 8mm brass WS 21 head thickness 6mm		
<b>For models:</b>	742001, 742002, 742003, 742004, 742018, 742020		

			
1			
<b>GEV No.</b>	527177	<b>Ref. No.</b>	WY27120
<b>description</b>	screw cap thread M30x1.5 L 36mm chrome-plated key number 26		
<b>For models:</b>	742001, 742002, 742003, 742004, 742005, 742017, 742018, 742019, 742020		

gaskets			
			
1			
<b>GEV No.</b>	528186	<b>Ref. No.</b>	WY12013
<b>description</b>	base plate L 34mm H 4.6mm W 34mm		
<b>For models:</b>	742001, 742002, 742003, 742004, 742005, 742017, 742018, 742019, 742020		

water dispersions			
water dispersions			
group 2			
			
1			
<b>GEV No.</b>	529230	<b>Ref. No.</b>	WY27105
<b>description</b>	water distributor ø 30mm hole ø 2mm H 14mm ET M10x1 grooves 6 2mm brass 2 holes perforation ø 1.7mm		
<b>For models:</b>	742005		

			
1			
<b>GEV No.</b>	527203	<b>Ref. No.</b>	WY27105000
<b>description</b>	water distributor ø 30mm with central hole hole ø 4.4mm H 15mm ET M10x1 IT M5 grooves 6 2mm brass		
<b>For models:</b>	742001, 742002, 742003, 742004, 742017, 742018, 742019, 742020		

safety valves			
safety valves			
1/8"			
			
1			
<b>GEV No.</b>	529331	<b>Ref. No.</b>	WY20357
<b>description</b>	safety valve connection 1/8" triggering pressure 1.8bar		
<b>For models:</b>	742005		

3/8"			
			
1			
<b>GEV No.</b>	529332	<b>Ref. No.</b>	WY20352
<b>description</b>	safety valve connection 3/8" triggering pressure 1.9bar approval CE 0036 sealed		
<b>For models:</b>	742001, 742002, 742003, 742004, 742017, 742018, 742019, 742020		

## expansion valves

## brass 3-way



1

<b>GEV No.</b>	529224	<b>Ref. No.</b>	WY56200
<b>description</b>	expansion valve		
<b>For models:</b>	742005		



1

<b>GEV No.</b>	529336	<b>Ref. No.</b>	WY56210
<b>description</b>	expansion valve		
<b>For models:</b>	742005		



1

<b>GEV No.</b>	527252	<b>Ref. No.</b>	WY20366
<b>description</b>	expansion valve connection 1/8"		
<b>For models:</b>	742005		



1

<b>GEV No.</b>	529333	<b>Ref. No.</b>	WY20361
<b>description</b>	expansion valve connection 3/8"		
<b>For models:</b>	742001, 742002, 742003, 742004		

## drain pans

## drain pans



1

<b>GEV No.</b>	528600	<b>Ref. No.</b>	WY15502
<b>description</b>	drain pan connection 3/8"		
<b>For models:</b>	742001, 742002, 742003, 742004, 742005, 742017, 742018, 742019, 742020		

## aerators and air bleeders



1

<b>GEV No.</b>	529304	<b>Ref. No.</b>	WY56150
<b>description</b>	aerator and air bleeder screw connection 1/4"		
<b>For models:</b>	742001, 742002, 742003, 742004, 742005, 742017, 742018, 742019, 742020		

## boilers

## heat exchangers

## injector tubes



1

<b>GEV No.</b>	527774	<b>Ref. No.</b>	WY52001612
<b>description</b>	injector pipe boiler tube ø 10mm pipe length 108mm T1: 3/8" T2: 3/8" copper		
<b>For models:</b>	742001, 742002, 742003, 742004, 742017, 742018, 742019, 742020		



1

<b>GEV No.</b>	527796	<b>Ref. No.</b>	WY52002788
<b>description</b>	injector pipe boiler tube ø 6mm pipe length 80mm T1: 1/4" T2: 1/4" copper		
<b>For models:</b>	742001, 742002, 742003, 742004, 742017, 742018, 742019, 742020		

## accessories



1

<b>GEV No.</b>	531076	<b>Ref. No.</b>	WY23135
<b>description</b>	thread bolt		
<b>For models:</b>	742001, 742002, 742003, 742004		



steam/water taps

steam/water taps

steam taps

knobs



1

<b>GEV No.</b>	527182	<b>Ref. No.</b>	WY15272
<b>description</b>	knob steam $\phi$ 46mm shaft $\phi$ 6x6mm		
<b>For models:</b>	742001, 742002, 742003, 742004, 742005		

components

shafts



1

<b>GEV No.</b>	529110	<b>Ref. No.</b>	WY25311
<b>description</b>	shaft for coffee machine tap L 110mm		
<b>For models:</b>	742005		



1

<b>GEV No.</b>	529218	<b>Ref. No.</b>	WY25309
<b>description</b>	shaft for coffee machine tap L 145mm		
<b>For models:</b>	742001, 742002, 742003, 742004		

bushes



1

<b>GEV No.</b>	529718	<b>Ref. No.</b>	WY25657
<b>description</b>	bush for steam tap D1 $\phi$ 14.7mm ID $\phi$ 7.2mm H 3.5mm brass		
<b>For models:</b>	742001, 742002, 742003, 742004, 742005		

gaskets



1

<b>GEV No.</b>	528313	<b>Ref. No.</b>	WY12204
<b>description</b>	shaft sealing D1 $\phi$ 12.5mm D2 $\phi$ 7.9mm thickness 8.8mm rubber for steam tap		
<b>For models:</b>	742001, 742002, 742003, 742004, 742005		

gasket supports



1

<b>GEV No.</b>	527195	<b>Ref. No.</b>	WY25616
<b>description</b>	piston for tap $\phi$ 17.6mm L 13.1mm thread M3/M16 SS		
<b>For models:</b>	742001, 742002, 742003, 742004, 742005		

tap bodies



1

<b>GEV No.</b>	529670	<b>Ref. No.</b>	WY53003
<b>description</b>	tap body		
<b>For models:</b>	742001, 742002, 742003, 742004, 742005		

union nuts



1

<b>GEV No.</b>	527198	<b>Ref. No.</b>	WY25385
<b>description</b>	union nut thread 3/8" ID $\phi$ 8.3mm L 19mm WS 20		
<b>For models:</b>	742001, 742002, 742003, 742004, 742005		

union screws



1

<b>GEV No.</b>	527196	<b>Ref. No.</b>	WY25461
<b>description</b>	union screw thread M16x1 outer ID $\phi$ 10.6mm brass		
<b>For models:</b>	742001, 742002, 742003, 742004, 742005		

## valve bodies



1

<b>GEV No.</b>	529073	<b>Ref. No.</b>	WY561021
<b>description</b>	front part for coffee machine tap		



1

<b>GEV No.</b>	529658	<b>Ref. No.</b>	WY561001
<b>description</b>	front part for coffee machine tap		
<b>For models:</b>	742001, 742002, 742003, 742004		

## screw connections



1

<b>GEV No.</b>	527250	<b>Ref. No.</b>	WY25691003
<b>description</b>	connecting fitting L 29mm ID ø 8mm WS 22 brass thread 3/8" IT - 3/8" ET		
<b>For models:</b>	742005		



1

<b>GEV No.</b>	527199	<b>Ref. No.</b>	WY25678001
<b>description</b>	screw connection for tap L 36mm ID ø 8.6mm WS 20 brass thread 3/8" ET - 1/2" ET		
<b>For models:</b>	742001, 742002, 742003, 742004, 742005		

## water taps

## knobs



1

<b>GEV No.</b>	527183	<b>Ref. No.</b>	WY15273
<b>description</b>	knob water ø 6x6mm		
<b>For models:</b>	742001, 742002, 742003, 742004		

## steam/water pipes

## steam pipes



1

<b>GEV No.</b>	529231	<b>Ref. No.</b>	WY56119023
<b>description</b>	steam pipe with handle L 180mm IT 3/8"		
<b>For models:</b>	742005		



1

<b>GEV No.</b>	527254	<b>Ref. No.</b>	WY56119001
<b>description</b>	steam tap with tube handle thread 3/8" IT H 205mm W 135mm tube ø 8mm chrome-plated		
<b>For models:</b>	742001, 742002, 742003, 742004		

## nozzles for steam pipes



1

<b>GEV No.</b>	527209	<b>Ref. No.</b>	WY25762
<b>description</b>	steam nozzle thread M10x1.25 IT L 16mm 5 holes bore ø 1.5mm chrome-plated		
<b>For models:</b>	742001, 742002, 742003, 742004, 742005		





1

<b>GEV No.</b>	527212	<b>Ref. No.</b>	WY30250
<b>description</b>	water nozzle thread M10x1.25 IT ø 18mm L 47mm holes chrome-plated		
<b>For models:</b>	742001, 742002, 742003, 742004, 742005		





nozzles for water pipes			
components			
 <p>1</p>			
<b>GEV No.</b>	527205	<b>Ref. No.</b>	WY25761
<b>description</b>	internal nozzle thread M10 for water pipe L 22mm bore ø 3mm WS 10		
<b>For models:</b>	742001, 742002, 742003, 742004, 742005		

water pipes			
 <p>1</p>			
<b>GEV No.</b>	529771	<b>Ref. No.</b>	WY56119024
<b>description</b>	water pipe complete		
<b>For models:</b>	742005		

 <p>1</p>			
<b>GEV No.</b>	527194	<b>Ref. No.</b>	WY56119003
<b>description</b>	water pipe thread 3/8" IT		
<b>For models:</b>	742001, 742002, 742003, 742004		

accessories			
gaskets			
 <p>1</p>			
<b>GEV No.</b>	510893	<b>Ref. No.</b>	200810 456015
<b>description</b>	O-ring EPDM thickness 2.62mm ID ø 9.92mm Qty 1 pcs		
<b>For models:</b>	812001, 812002, 812003, 812004, 812005, 812006, 812007, 812008, 812009, 812010, 915234, 915235, 915236, 915237, 915460, 915461, 915462, 915463, 915464, 915465, SP2-12, SP2-S12		

tube handles			
 <p>1</p>			
<b>GEV No.</b>	527251	<b>Ref. No.</b>	WY15296000
<b>description</b>	tube handle for pipe ø 8mm rubber		
<b>For models:</b>	742001, 742002, 742003, 742004		

union nuts			
 <p>1</p>			
<b>GEV No.</b>	527258	<b>Ref. No.</b>	WY25391
<b>description</b>	union nut thread 3/8" IT L 31.5mm hole ø 12.8mm chrome-plated brass		
<b>For models:</b>	742001, 742002, 742003, 742004, 742005		

fine filters			
 <p>1</p>			
<b>GEV No.</b>	527173	<b>Ref. No.</b>	WY10254
<b>description</b>	fine filter ø 11.1mm H 7.4mm for expansion valve		
<b>For models:</b>	742001, 742002, 742003, 742004, 742005, 742017, 742018, 742019, 742020		

 <p>1</p>			
<b>GEV No.</b>	528357	<b>Ref. No.</b>	WY10253
<b>description</b>	fine filter ø 8.5mm H 22mm		
<b>For models:</b>	742001, 742002, 742003, 742004, 742005, 742017, 742018, 742019, 742020		

intake valves			
 <p>1</p>			
<b>GEV No.</b>	529074	<b>Ref. No.</b>	WY61006 WY61013
<b>description</b>	intake valve for coffee makers		
<b>For models:</b>	742001, 742002, 742003, 742004		

 <p>1</p>			
<b>GEV No.</b>	529107	<b>Ref. No.</b>	WY61015
<b>description</b>	intake valve for coffee makers		
<b>For models:</b>	742001, 742002, 742003, 742004		

## accessories

## bolts



1

<b>GEV No.</b>	527171	<b>Ref. No.</b>	WY25315
<b>description</b>	pressure bolt ø 8mm L 35.7mm stainless steel for filling valve		
<b>For models:</b>	742001, 742002, 742003, 742004		

## gaskets



1

<b>GEV No.</b>	528309	<b>Ref. No.</b>	WY12205
<b>description</b>	shaft sealing ED ø 13mm ID ø 7.5mm U-shape		
<b>For models:</b>	742001, 742002, 742003, 742004		

## levers



1

<b>GEV No.</b>	529222	<b>Ref. No.</b>	WY25201
<b>description</b>	handle for intake tap		
<b>For models:</b>	742001, 742002, 742003, 742004		



1

<b>GEV No.</b>	529223	<b>Ref. No.</b>	WY25202
<b>description</b>	lever for intake tap thread M8 ø 8mm L 80mm chrome-plated steel		
<b>For models:</b>	742001, 742002, 742003, 742004		

## miscellaneous



1

<b>GEV No.</b>	528310	<b>Ref. No.</b>	WY25615
<b>description</b>	piston		
<b>For models:</b>	742001, 742002, 742003, 742004		

## screw connections



1

<b>GEV No.</b>	527186	<b>Ref. No.</b>	WY23202
<b>description</b>	angle piece thread 1/4" ET conical - 3/8" ET for filling valve ID ø 7mm		
<b>For models:</b>	742001, 742002, 742003, 742004		



1

<b>GEV No.</b>	527197	<b>Ref. No.</b>	WY25744
<b>description</b>	reducer thread 3/8" IT - 1/8" IT brass WS 20 L 26mm		
<b>For models:</b>	742001, 742002, 742003, 742004, 742005		



1

<b>GEV No.</b>	527187	<b>Ref. No.</b>	WY25680
<b>description</b>	screw connection thread 3/8" ET - M18x1.5 ET for filling valve brass		
<b>For models:</b>	742001, 742002, 742003, 742004		



1

<b>GEV No.</b>	527204	<b>Ref. No.</b>	WY4303001
<b>description</b>	T-piece thread 3/8" ET - 3/8" IT - 1/4" IT L 31mm for filling valve WS 23 W 40mm brass		
<b>For models:</b>	742001, 742002, 742003, 742004		



1

<b>GEV No.</b>	527189	<b>Ref. No.</b>	WY43020
<b>description</b>	T-piece thread 3/8" for pump brass		
<b>For models:</b>	742001, 742002, 742003, 742004, 742005		

## level glasses

## level glasses

## gaskets



1

<b>GEV No.</b>	529408	<b>Ref. No.</b>	WY12200
<b>description</b>	gasket D1 ø 16mm D2 ø 10mm H 8mm water level glass		
<b>For models:</b>	742001, 742002, 742003, 742004		





balls			
			
1			
<b>GEV No.</b>	529355	<b>Ref. No.</b>	WY15300
<b>description</b>	ball ø 6mm plastic for level glass		
<b>For models:</b>	742001, 742002, 742003, 742004		

level glasses			
			
1			
<b>GEV No.</b>	528091	<b>Ref. No.</b>	WY21202
<b>description</b>	level glass L 83mm W 32mm thickness 8mm		
<b>For models:</b>	742001, 742002, 742003, 742004		

level glasses (complete)			
			
1			
<b>GEV No.</b>	527184	<b>Ref. No.</b>	WY56001
<b>description</b>	water level tube		
<b>For models:</b>	742001, 742002, 742003, 742004		



level glass holders			
			
1			
<b>GEV No.</b>	529221	<b>Ref. No.</b>	WY53002
<b>description</b>	bracket for level glass T1: 3/8" T2: M20x1.5 mounting pos. upper		
<b>For models:</b>	742001, 742002, 742003, 742004		

level glass pipes			
			
1			
<b>GEV No.</b>	693327	<b>Ref. No.</b>	853310179
<b>description</b>	water level tube ø 10mm H 100mm		
<b>For models:</b>	136001, 136002, 136201, 136202		

			
1			
<b>GEV No.</b>	531177	<b>Ref. No.</b>	WY21300
<b>description</b>	water level tube ø 11mm H 170mm ID ø 8mm		
<b>For models:</b>	742001, 742002, 742003, 742004		

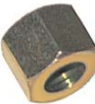
screw connections			
			
1			
<b>GEV No.</b>	527191	<b>Ref. No.</b>	WY25383
<b>description</b>	union nut thread M20x1.5 hole ø 12.6mm H 16.6mm WS 24 brass		
<b>For models:</b>	742001, 742002, 742003, 742004		

pipes			
union nuts			
			
1			
<b>GEV No.</b>	101478	<b>Ref. No.</b>	1665200 MA1665200
<b>description</b>	union nut thread 3/8" for pipe ø 10mm		
<b>For models:</b>	121102, 121105		

non-return valves				
complete				
				
1				
<b>GEV No.</b>	529889	<b>Ref. No.</b>	099101	
<b>description</b>	non-return valve thread 1/8" IT - 1/8" ET			
<b>For models:</b>	743001			
<b>accessories for</b>	529889			
	<b>GEV No.</b>	691535	<b>Ref. No.</b>	251143
				
	disc ID ø 10mm ED ø 14mm thicknessmm aluminium Qty 1 pcs			

screw connections			
end caps			
			
1			
<b>GEV No.</b>	527180	<b>Ref. No.</b>	WY15486
<b>description</b>	hole cover mounting ømm ø 34.6mm H 18mm plastic Qty 1 pcs		
<b>For models:</b>	742001, 742002, 742003, 742004		

washers



<b>GEV No.</b>	691535	<b>Ref. No.</b>	251143
<b>description</b>	disc ID ø 10mm ED ø 14mm thicknessmm aluminium Qty 1 pcs		
<b>For models:</b>	743001		

T-pieces



<b>GEV No.</b>	527831	<b>Ref. No.</b>	WY23215
<b>description</b>	T-piece thread 1/4" T1: 1/2" T2: 1/2" ID ø 12.2mm int. ø 1 12.6mm L 50mm brass for boiler		
<b>For models:</b>	742001, 742002, 742003, 742004, 742017, 742018, 742019, 742020		

angle pieces



<b>GEV No.</b>	527830	<b>Ref. No.</b>	WY23214
<b>description</b>	angle piece T1: 1/2" T2: 1/2" int. ø 1 12.3mm int. ø 2 12.6mm L 50mm brass for boiler		
<b>For models:</b>	742001, 742002, 742003, 742004, 742017, 742018, 742019, 742020		

for coffee grinders

grinding burrs

grinding burrs straight

standard



<b>GEV No.</b>	527241	<b>Ref. No.</b>	WY28217000
<b>description</b>	grinding burrs pair turn direction right D1 ø 63.3mm ID ø 38mm H 9mm tooth spacing 3mm hole ø 5.5mm bore ø 8.5mm mounting ø 50 straight suitable for WEGA, COMPAK, ASTORIA		
<b>For models:</b>	744001, 744002		



<b>GEV No.</b>	527242	<b>Ref. No.</b>	WY28217005
<b>description</b>	grinding burrs pair turn direction right D1 ø 80mm ID ø 41mm H 10.3mm tooth spacing 4mm hole ø 6mm bore ø 10mm mounting ø 60.5 straight suitable for WEGA, COMPAK, ASTORIA		
<b>For models:</b>	744001, 744002		

TITAN



<b>GEV No.</b>	527036	<b>Ref. No.</b>	WY28217004
<b>description</b>	grinding burrs pair turn direction right D1 ø 63.5mm ID ø 38mm H 9.2mm tooth spacing 3.8mm hole ø 5.5mm bore ø 8.5mm mounting ø 50 titanium		
<b>For models:</b>	744001, 744002		

grinding burrs holders



<b>GEV No.</b>	527379	<b>Ref. No.</b>	WY28326018
<b>description</b>	grinding burr holder suitable for WEGA		
<b>For models:</b>	744001, 744002		



<b>GEV No.</b>	527573	<b>Ref. No.</b>	WY28360009
<b>description</b>	grinding burr holder suitable for WEGA		
<b>For models:</b>	744001, 744002		

spillage trays



<b>GEV No.</b>	527038	<b>Ref. No.</b>	WY28400010
<b>description</b>	drain tray for coffee grinder		
<b>For models:</b>	744001, 744002		





dosing containers

dosing container lids

			
1			
<b>GEV No.</b>	526173	<b>Ref. No.</b>	WY28054012
<b>description</b>	lid for dosing container L 199mm W 168mm H 50mm		
<b>For models:</b>	744001, 744002		

adjusting screws

			
1			
<b>GEV No.</b>	527178	<b>Ref. No.</b>	WY28286003
<b>description</b>	adjusting screw for coffee grinders thread M6		
<b>For models:</b>	744001, 744002		

springs

group 1

			
1			
<b>GEV No.</b>	527150	<b>Ref. No.</b>	WY28360027
<b>description</b>	torsion spring ø 38mm L2 18mm wire gauge ø 1.8mm L1 9mm L3 57mm for dosing pump lever right		
<b>For models:</b>	744001, 744002		

glass cylinders

			
1			
<b>GEV No.</b>	527094	<b>Ref. No.</b>	WY28286001
<b>description</b>	cylinder for dosing container ø 125mm H 72mm plexiglas		
<b>For models:</b>	744001, 744002		

levers

levers

			
1			
<b>GEV No.</b>	527043	<b>Ref. No.</b>	WY28196004
<b>description</b>	lever dosing pump plastic		
<b>For models:</b>	744001, 744002		

coffee powder dispenser

			
1			
<b>GEV No.</b>	527143	<b>Ref. No.</b>	WY28022001
<b>description</b>	coffee discharge chute rubber for coffee grinder		
<b>For models:</b>	744001, 744002		

coffee presses

components

bolts

			
1			
<b>GEV No.</b>	527206	<b>Ref. No.</b>	WY28360019
<b>description</b>	pressure pin L 70.2mm T1: M8 T2: M8 chrome-plated ø 10mm		
<b>For models:</b>	744001, 744002		

springs

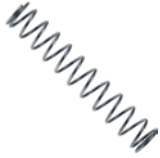
			
1			
<b>GEV No.</b>	527147	<b>Ref. No.</b>	WY28360003
<b>description</b>	compression spring ø 15.1mm L 85mm wire gauge ø 1.3mm		
<b>For models:</b>	744001, 744002		

pressers

			
1			
<b>GEV No.</b>	527047	<b>Ref. No.</b>	WY28360021
<b>description</b>	coffee press ø 57mm thread M8 plastic for coffee grinder		
<b>For models:</b>	744001, 744002		

buttons



1

<b>GEV No.</b>	527099	<b>Ref. No.</b>	WY28360022
<b>description</b>	frame for push-button plastic		
<b>For models:</b>	744001, 744002		



1

<b>GEV No.</b>	527091	<b>Ref. No.</b>	WY28360001
<b>description</b>	push button		
<b>For models:</b>	744001, 744002		

bodies



1

<b>GEV No.</b>	527093	<b>Ref. No.</b>	WY28070006
<b>description</b>	container body polished for coffee grinder ø 127.5mm aluminium		
<b>For models:</b>	744001, 744002		



1

<b>GEV No.</b>	527042	<b>Ref. No.</b>	WY28002012
<b>description</b>	retaining ring polished ø 130mm		
<b>For models:</b>	744001, 744002		

automatic grinding

automatic grinding



1

<b>GEV No.</b>	527139	<b>Ref. No.</b>	WY28002007
<b>description</b>	housing for microswitch with switch mechanism H 68mm for model K5/K6/K8		
<b>For models:</b>	744001, 744002		

return spring



1

<b>GEV No.</b>	527138	<b>Ref. No.</b>	WY28360026
<b>description</b>	cover plate mounting pos. lower plastic for coffee grinder		
<b>For models:</b>	744001, 744002		



1

<b>GEV No.</b>	527095	<b>Ref. No.</b>	WY28360020
<b>description</b>	return spring set with spring for coffee grinder		
<b>For models:</b>	744001, 744002		

sector plates



1

<b>GEV No.</b>	527141	<b>Ref. No.</b>	WY28190001
<b>description</b>	sector plates stainless steel suitable for WEGA, COMPAK for coffee grinder		
<b>For models:</b>	744001, 744002		

ratches

ratches





1

<b>GEV No.</b>	527092	<b>Ref. No.</b>	WY28159306
<b>description</b>	ratchet for coffee grinder ø 39.5mm plastic		
<b>For models:</b>	744001, 744002		





stars			
complete			
			
1			
<b>GEV No.</b>	527045	<b>Ref. No.</b>	WY28326017
<b>description</b>	star for coffee grinder complete		
<b>For models:</b>	744001, 744002		

			
1			
<b>GEV No.</b>	527046	<b>Ref. No.</b>	WY28002015
<b>description</b>	star for dosing unit complete		
<b>For models:</b>	744001, 744002		

			
1			
<b>GEV No.</b>	527041	<b>Ref. No.</b>	WY28326014
<b>description</b>	star mounting pos. lower		
<b>For models:</b>	744001, 744002		

bottom			
			
1			
<b>GEV No.</b>	527044	<b>Ref. No.</b>	WY28326015
<b>description</b>	star mounting pos. lower		
<b>For models:</b>	744001, 744002		

accessories			
			
1			
<b>GEV No.</b>	527192	<b>Ref. No.</b>	WY28002014
<b>description</b>	shaft L 46mm thread M6 brass for coffee grinder		
<b>For models:</b>	744001, 744002		

adjustment mechanism			
lockable adjustment			
			
1			
<b>GEV No.</b>	527048	<b>Ref. No.</b>	WY28126012
<b>description</b>	pressure pin for setting ring		
<b>For models:</b>	744001, 744002		

setting rings			
			
1			
<b>GEV No.</b>	527137	<b>Ref. No.</b>	WY28286006
<b>description</b>	setting ring for coffee grinder ø 140mm ID ø 47.7mm H 38mm suitable for WEGA, COMPAK plastic		
<b>For models:</b>	744001, 744002		

			
1			
<b>GEV No.</b>	527000	<b>Ref. No.</b>	WY28360024
<b>description</b>	setting ring for grind stone ID ø 80mm H 50mm thread M92x1.5		
<b>For models:</b>	744001, 744002		

accessories			
handles			
			
1			
<b>GEV No.</b>	527142	<b>Ref. No.</b>	WY28126013
<b>description</b>	handle for coffee grinder rubber		
<b>For models:</b>	744001, 744002		

coffee beans containers

container lids



1

<b>GEV No.</b>	527039	<b>Ref. No.</b>	WY28054002
<b>description</b>	lid for coffee beans container ø 182mm		
<b>For models:</b>	744001, 744002		

1

<b>GEV No.</b>	527843	<b>Ref. No.</b>	252423
<b>description</b>	lid L 180mm W 160mm H 3mm plastic transparent for coffee beans container		
<b>For models:</b>	743001		

coffee beans containers



1

<b>GEV No.</b>	527144	<b>Ref. No.</b>	WY28357001
<b>description</b>	coffee beans container complete incl. lid and funnel magnet ø 187mm H 255mm seat ø 47mm K392		
<b>For models:</b>	744001, 744002		





1

<b>GEV No.</b>	527145	<b>Ref. No.</b>	WY28357
<b>description</b>	coffee beans container without magnet ø 187mm H 255mm K003 A.		
<b>For models:</b>	744001, 744002		



1

<b>GEV No.</b>	527572	<b>Ref. No.</b>	251770	
<b>description</b>	coffee grinder			
<b>For models:</b>	743001			
<b>spare parts for</b>	527572			
	<b>GEV No.</b>	402076	<b>Ref. No.</b>	251779
	sensor for coffee grinder complete			
	<b>GEV No.</b>	527249	<b>Ref. No.</b>	095840
	grinding burr turn direction right D1 ø 63mm ID ø 38mm H 9mm tooth spacing 3mm hole ø 5.5mm bore ø 8.5mm mounting ø 48 straight suitable for N & W			
	<b>GEV No.</b>	601494	<b>Ref. No.</b>	251777
	motor for coffee grinder 230V 48W 50/60Hz 1 phase shaft ø 7.5mm shaft length 24mm H 70mm L 120mm W 70mm KORO-ESPRESSO FISE			

protection caps



1

<b>GEV No.</b>	527097	<b>Ref. No.</b>	WY28360013
<b>description</b>	protection cap for coffee grinder ø 75mm plastic		
<b>For models:</b>	744001, 744002		



hopper magnets



1

<b>GEV No.</b>	347058	<b>Ref. No.</b>	WY28206000
<b>description</b>	magnet L 23.5mm W 13.3mm H 5mm hole ø 4.9mm		
<b>For models:</b>	744001, 744002		

locks



1

<b>GEV No.</b>	527088	<b>Ref. No.</b>	WY28326016
<b>description</b>	catch for coffee beans container L 51mm W 42.5mm thickness 3mm plastic		
<b>For models:</b>	744001, 744002		

support for filter holder



1

<b>GEV No.</b>	527037	<b>Ref. No.</b>	WY28126011
<b>description</b>	bracket for filter holder short L 125mm W 82mm H 24mm plastic		
<b>For models:</b>	744001, 744002		



1

<b>GEV No.</b>	527098	<b>Ref. No.</b>	WY28126006
<b>description</b>	filter holder support long L 175mm aluminium		
<b>For models:</b>	744001, 744002		

counters

counters



1

<b>GEV No.</b>	527096	<b>Ref. No.</b>	WY28070005
<b>description</b>	counter for dosing unit		
<b>For models:</b>	744001, 744002		

for pour machines

filter pans

filter pans

MELITTA



1

<b>GEV No.</b>	960011	<b>Ref. No.</b>	16394
<b>description</b>	filter pan plastic W 185mm D 167mm H 135mm black type SF202S filter no. 960010 suitable for MELITTA		
<b>For models:</b>	741001		



1

<b>GEV No.</b>	960009	<b>Ref. No.</b>	14667 16615
<b>description</b>	filter pan plastic W 185mm D 167mm H 135mm brown filter no. 960010 suitable for MELITTA		
<b>For models:</b>	741001, 741002		

funnels



1

<b>GEV No.</b>	527838	<b>Ref. No.</b>	11090	
<b>description</b>	funnel plastic ED ø 115mm MELITTA 193W L 66mm			
<b>For models:</b>	741003			
<b>accessories for</b>	527838			
	<b>GEV No.</b>	527842	<b>Ref. No.</b>	17842
	lid plastic ø 95mm black			



1

<b>GEV No.</b>	527836	<b>Ref. No.</b>	16268
<b>description</b>	funnel plastic ED ø 182mm MELITTA M170		
<b>For models:</b>	741001, 741002		



1

<b>GEV No.</b>	527841	<b>Ref. No.</b>	14129
<b>description</b>	lid plastic ED ø 190mm MELITTA 193W		
<b>For models:</b>	741003		
<b>accessories for</b>	527841		
	<b>GEV No.</b>	<b>Ref. No.</b>	19398
	O-ring silicone thickness 4.5mm ID ø 170.5mm Qty 1 pcs		

housing and bezels

control panel



1

<b>GEV No.</b>	527835	<b>Ref. No.</b>	16267
<b>description</b>	control panel M170 plastic ED ø 190mm MELITTA		
<b>For models:</b>	741001, 741002		



1

<b>GEV No.</b>	527842	<b>Ref. No.</b>	17842
<b>description</b>	lid plastic ø 95mm black		
<b>For models:</b>	741001		

filters



1

<b>GEV No.</b>	528979	<b>Ref. No.</b>	673679
<b>description</b>	screen ø 60mm thickness 1.5mm SS		
<b>For models:</b>	741001, 741003		

lids



1

<b>GEV No.</b>	527837	<b>Ref. No.</b>	16266
<b>description</b>	lid plastic ED ø 182mm MELITTA M170		
<b>For models:</b>	741001, 741002		



water containers

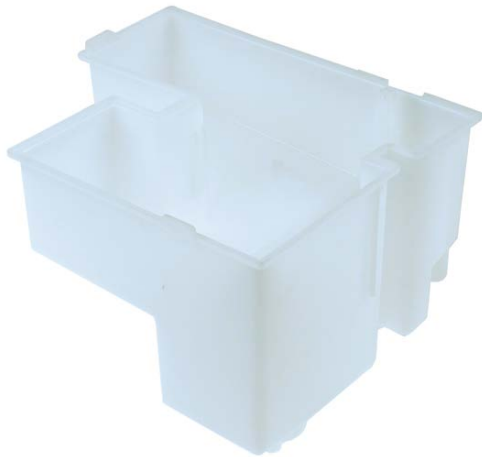

1

<b>GEV No.</b>	527839	<b>Ref. No.</b>	653893
<b>description</b>	water container plastic H 140mm L 246mm W 205mm MELITTA 193W		
<b>For models:</b>	741003		



1

<b>GEV No.</b>	527840	<b>Ref. No.</b>	16269
<b>description</b>	water container plastic H 180mm L 305mm W 150mm MELITTA M170		
<b>For models:</b>	741001, 741002		

for cup coffee machines

lids



1

<b>GEV No.</b>	696193	<b>Ref. No.</b>	IB4023000A
<b>description</b>	protection cap ø 188mm H 51mm mounting distance 95mm plastic white Athos		

instant mixer units



1

<b>GEV No.</b>	527279	<b>Ref. No.</b>	251833
<b>description</b>	coffee device type Z3000		
<b>For models:</b>	743001		



1

<b>GEV No.</b>	527277	<b>Ref. No.</b>	251869
<b>description</b>	flange for mixing hopper		
<b>For models:</b>	743001		



1

<b>GEV No.</b>	527278	<b>Ref. No.</b>	097916
<b>description</b>	impellor ø 32mm		
<b>For models:</b>	743001		



1

<b>GEV No.</b>	527275	<b>Ref. No.</b>	251768
<b>description</b>	intake body plastic		
<b>For models:</b>	743001		
<b>accessories for</b>	527275		
	<b>GEV No.</b>	527276	<b>Ref. No.</b>
			251767
	lid plastic for intake body		



1

<b>GEV No.</b>	527276	<b>Ref. No.</b>	251767
<b>description</b>	lid plastic for intake body		
<b>For models:</b>	743001		



1

<b>GEV No.</b>	527274	<b>Ref. No.</b>	251874
<b>description</b>	mixing hopper plastic		
<b>For models:</b>	743001		

## coffee spouts

### coffee spouts



1

<b>GEV No.</b>	527283	<b>Ref. No.</b>	096868
<b>description</b>	coffee spout for coffee powder container rectangular		
<b>For models:</b>	743001		



1

<b>GEV No.</b>	527282	<b>Ref. No.</b>	098939
<b>description</b>	coffee spout for coffee powder container round		
<b>For models:</b>	743001		

## coffee beans containers

### container lids

1

<b>GEV No.</b>	527843	<b>Ref. No.</b>	252423
<b>description</b>	lid L 180mm W 160mm H 3mm plastic transparent for coffee beans container		
<b>For models:</b>	743001		

## coffee beans containers



1

<b>GEV No.</b>	527280	<b>Ref. No.</b>	251908	
<b>description</b>	container complete incl. coil, lift and scraper for instant unit			
<b>For models:</b>	743001			
<b>accessories for</b>	527280			
	<b>GEV No.</b>	527282	<b>Ref. No.</b>	098939
	coffee spout for coffee powder container round			



1

<b>GEV No.</b>	527834	<b>Ref. No.</b>	252462	
<b>description</b>	container standard			
<b>For models:</b>	743001			
<b>accessories for</b>	527834			
	<b>GEV No.</b>	527283	<b>Ref. No.</b>	096868
	coffee spout for coffee powder container rectangular			





1

<b>GEV No.</b>	527281	<b>Ref. No.</b>	251875
<b>description</b>	container with auger gear for instant unit		
<b>For models:</b>	743001		
<b>accessories for</b>	527281		
	<b>GEV No.</b>	527282	<b>Ref. No.</b> 098939
	coffee spout for coffee powder container round		

accessories



1

<b>GEV No.</b>	527285	<b>Ref. No.</b>	252424
<b>description</b>	base part for coffee beans container		
<b>For models:</b>	743001		
<b>accessories for</b>	527285		
	<b>GEV No.</b>	527284	<b>Ref. No.</b> 252536
	increasing for coffee beans container		



1

<b>GEV No.</b>	527284	<b>Ref. No.</b>	252536
<b>description</b>	increasing for coffee beans container		
<b>For models:</b>	743001		
<b>accessories for</b>	527284		
	<b>GEV No.</b>	527843	<b>Ref. No.</b> 252423
	lid L 180mm W 160mm H 3mm plastic transparent for coffee beans container		

grinding units

automatic grinding



1

<b>GEV No.</b>	402076	<b>Ref. No.</b>	251779
<b>description</b>	sensor for coffee grinder complete		
<b>For models:</b>	743001		

grinding burrs



1

<b>GEV No.</b>	527249	<b>Ref. No.</b>	095840
<b>description</b>	grinding burr turn direction right D1 ø 63mm ID ø 38mm H 9mm tooth spacing 3mm hole ø 5.5mm bore ø 8.5mm mounting ø 48 straight suitable for N & W		
<b>For models:</b>	743001		

mechanical components



1

<b>GEV No.</b>	520334	<b>Ref. No.</b>	0V2509
<b>description</b>	angle piece thread 1/8" with coupling angled hose ø 5mm		
<b>For models:</b>	743001		

keys



1

<b>GEV No.</b>	527290	<b>Ref. No.</b>	0V1654
<b>description</b>	service key		
<b>For models:</b>	743001		

## water containers



1

<b>GEV No.</b>	527286	<b>Ref. No.</b>	251873
<b>description</b>	water container complete		
<b>For models:</b>	743001		
<b>spare parts for</b>	527286		
	<b>GEV No.</b>	<b>Ref. No.</b>	<b>251876</b>
	float with magnet ømm L 23.5mm W 16mm H 17mm plastic		

## counters



1

<b>GEV No.</b>	527273	<b>Ref. No.</b>	251862
<b>description</b>	counter coffee machine impulse 10imp/s mounting measurements 22x30mm 12VDC		
<b>For models:</b>	743001		

## for milk foamers



1

<b>GEV No.</b>	527378	<b>Ref. No.</b>	90.35.00
<b>description</b>	bracket for milk foamer for pump		
<b>For models:</b>	745002		



1

<b>GEV No.</b>	527296	<b>Ref. No.</b>	94.13.10
<b>description</b>	connecting block for milk foamer		
<b>For models:</b>	745001		



1

<b>GEV No.</b>	527324	<b>Ref. No.</b>	94.36.00
<b>description</b>	connecting fitting for milk foamer		
<b>For models:</b>	745001		



1

<b>GEV No.</b>	527356	<b>Ref. No.</b>	90.36.21
<b>description</b>	connecting fitting for milk foamer		
<b>For models:</b>	745002		



1

<b>GEV No.</b>	527376	<b>Ref. No.</b>	90.36.50
<b>description</b>	connecting fitting for milk foamer		
<b>For models:</b>	745002		



1

<b>GEV No.</b>	527361	<b>Ref. No.</b>	90.15.20
<b>description</b>	connection angle for milk foamer ED ø 6mm		
<b>For models:</b>	745002		

1

<b>GEV No.</b>	527297	<b>Ref. No.</b>	94.13.30
<b>description</b>	drain pipe for milk foamer		
<b>For models:</b>	745001		



1

<b>GEV No.</b>	527298	<b>Ref. No.</b>	90.14.10
<b>description</b>	foamer for milk foamer ED ø 16mm H 34mm		
<b>For models:</b>	745002		



1

<b>GEV No.</b>	527321	<b>Ref. No.</b>	90.14.00
<b>description</b>	foamer for milk foamer ED ø 16mm H 66mm		
<b>For models:</b>	745001		



1

<b>GEV No.</b>	527377	<b>Ref. No.</b>	94.43.00
<b>description</b>	formed hose for milk foamer L-shape		
<b>For models:</b>	745001		



1

<b>GEV No.</b>	527363	<b>Ref. No.</b>	92.16.11
<b>description</b>	gasket for milk foamer L 540mm		
<b>For models:</b>	745001		

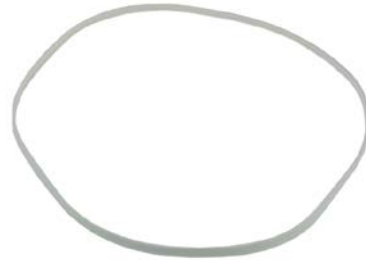

1

<b>GEV No.</b>	527362	<b>Ref. No.</b>	90.18.11
<b>description</b>	gasket for milk foamer L 930mm		
<b>For models:</b>	745002		



1

<b>GEV No.</b>	527272	<b>Ref. No.</b>	20.19.15
<b>description</b>	gasket for milk foamer V-shape ID ø 9mm ED ø 15mm H 7mm		
<b>For models:</b>	745002		



1

<b>GEV No.</b>	527364	<b>Ref. No.</b>	90.39.23
<b>description</b>	gear wheel pair for milk foamer		
<b>For models:</b>	745002		



1

<b>GEV No.</b>	527358	<b>Ref. No.</b>	90.13.20
<b>description</b>	lid for milk foamer for outlet		
<b>For models:</b>	745002		

			
1			
<b>GEV No.</b>	527368	<b>Ref. No.</b>	94.08.13
<b>description</b>	lid for mixer for milk foamer		
<b>For models:</b>	745001		

			
1			
<b>GEV No.</b>	527369	<b>Ref. No.</b>	95.08.13
<b>description</b>	lid for mixer for milk foamer		
<b>For models:</b>	745002		

			
1			
<b>GEV No.</b>	527294	<b>Ref. No.</b>	90.08.11
<b>description</b>	mixer for milk foamer air/milk		
<b>For models:</b>	745001		

			
1			
<b>GEV No.</b>	527367	<b>Ref. No.</b>	94.08.10
<b>description</b>	mixer for milk foamer air/milk		
<b>For models:</b>	745001		

			
1			
<b>GEV No.</b>	527365	<b>Ref. No.</b>	94.08.00
<b>description</b>	mixer for milk foamer complete with hose		
<b>For models:</b>	745001		

			
1			
<b>GEV No.</b>	527291	<b>Ref. No.</b>	20.19.22
<b>description</b>	shaft seal ID ø 11mm ED ø 22mm thickness 8mm for milk foamer		
<b>For models:</b>	745002		

			
1			
<b>GEV No.</b>	527374	<b>Ref. No.</b>	94.21.30
<b>description</b>	silicone hose for milk foamer glass fibre braided ID ø 4mm ED ø 8mm L 120mm		
<b>For models:</b>	745001		

			
1			
<b>GEV No.</b>	527375	<b>Ref. No.</b>	94.21.20
<b>description</b>	silicone hose for milk foamer glass fibre braided ID ø 4mm ED ø 8mm L 230mm		
<b>For models:</b>	745001		

			
1			
<b>GEV No.</b>	527371	<b>Ref. No.</b>	95.08.20
<b>description</b>	silicone hose for milk foamer ID ø 5mm ED ø 8mm L 180mm		
<b>For models:</b>	745002		

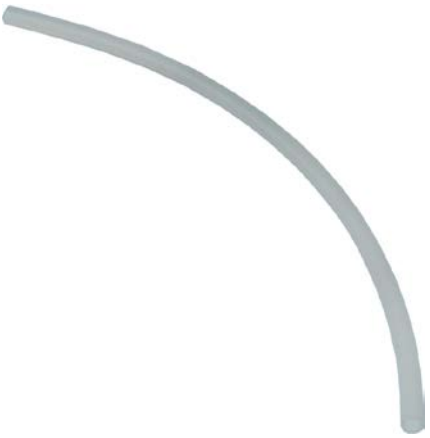

1

<b>GEV No.</b>	527372	<b>Ref. No.</b>	99.08.20
<b>description</b>	silicone hose for milk foamer ID ø 5mm ED ø 8mm L 310mm		
<b>For models:</b>	745002		



1

<b>GEV No.</b>	527370	<b>Ref. No.</b>	90.36.60
<b>description</b>	silicone hose for milk foamer ID ø 6.4mm ED ø 13.2mm L 50mm		
<b>For models:</b>	745002		



1

<b>GEV No.</b>	527373	<b>Ref. No.</b>	90.20.00
<b>description</b>	silicone hose ID ø 5mm ED ø 8mm L 115mm		
<b>For models:</b>	745002		



1

<b>GEV No.</b>	527357	<b>Ref. No.</b>	90.13.10
<b>description</b>	spout for milk foamer		
<b>For models:</b>	745002		



1

<b>GEV No.</b>	527359	<b>Ref. No.</b>	90.15.10
<b>description</b>	spout for milk foamer		
<b>For models:</b>	745002		



1

<b>GEV No.</b>	527295	<b>Ref. No.</b>	90.08.30
<b>description</b>	suction valve for milk foamer ED ø 20mm H 41mm hose ø 7mm		
<b>For models:</b>	745001, 745002		



1

<b>GEV No.</b>	527292	<b>Ref. No.</b>	50.23.40
<b>description</b>	valve for milk foamer with spring		
<b>For models:</b>	745002		



1

<b>GEV No.</b>	527293	<b>Ref. No.</b>	50.23.50
<b>description</b>	valve support for milk foamer		
<b>For models:</b>	745001, 745002		

for bain marie

spare parts and accessories



1

<b>GEV No.</b>	691318	<b>Ref. No.</b>	500400365
<b>description</b>	fixing plate mounting pos. right		
<b>For models:</b>	111001, 111002, 111003, 112001, 112002, 112003, 112004, 113001, 113002, 113003, 113004, 113005, 113006, 113007, 113008, 113009, 113010, 113011, 113012, 113013, 113014, 113015, 113016, 113017, 113018, 113019, 113020, 114003, 115001, 115002, 116001, 116002, 118001, 118002		

## housing and bezels



1

<b>GEV No.</b>	691357	<b>Ref. No.</b>	450134000
<b>description</b>	fastening angle		
<b>For models:</b>	114003, 115001, 115002, 116001, 116002		

## for pyroceram ranges

## ceramic hobs

## ceramic glass plates



1

<b>GEV No.</b>	691407	<b>Ref. No.</b>	6A001400
<b>description</b>	ceramic plate L 550mm W 320mm thickness 6mm		
<b>For models:</b>	132205, 132206		

## for crepes makers

## cast plates



1

<b>GEV No.</b>	691259	<b>Ref. No.</b>	IGS701213
<b>description</b>	cast plate ø 350mm		



1

<b>GEV No.</b>	691260	<b>Ref. No.</b>	IGS701233
<b>description</b>	cast plate ø 350mm		

## for deep fryers

## lids



1

<b>GEV No.</b>	691353	<b>Ref. No.</b>	1041306013R
<b>description</b>	lid L 440mm W 245mm for fryer		

## housing and bezels



1

<b>GEV No.</b>	691357	<b>Ref. No.</b>	450134000
<b>description</b>	fastening angle		
<b>For models:</b>	114003, 115001, 115002, 116001, 116002		

## miscellaneous



1

<b>GEV No.</b>	514402	<b>Ref. No.</b>	452510015
<b>description</b>	drain filter ø 37.5mm		
<b>For models:</b>	114003, 116001, 116002		



1

<b>GEV No.</b>	541922	<b>Ref. No.</b>	408712120
<b>description</b>	drain pipe L 120mm thread 3/4"		
<b>For models:</b>	114001, 114002		



1

<b>GEV No.</b>	541923	<b>Ref. No.</b>	408712060
<b>description</b>	drain pipe L 60mm thread 3/4"		
<b>For models:</b>	114003, 116001, 116002		



for grills

sumps



1

<b>GEV No.</b>	696481	<b>Ref. No.</b>	KOB131
<b>description</b>	grease collecting tray L 290mm W 26mm H 32mm		
<b>For models:</b>	255009		



1

<b>GEV No.</b>	696482	<b>Ref. No.</b>	KO-B150
<b>description</b>	grease collecting tray L 489mm W 26mm H 32mm		
<b>For models:</b>	255012, 255014		



1

<b>GEV No.</b>	696483	<b>Ref. No.</b>	KO-B158
<b>description</b>	grease collecting tray L 535mm W 27mm H 29mm		
<b>For models:</b>	255013		

for griddles

spare parts and accessories



1

<b>GEV No.</b>	691318	<b>Ref. No.</b>	500400365
<b>description</b>	fixing plate mounting pos. right		
<b>For models:</b>	111001, 111002, 111003, 112001, 112002, 112003, 112004, 113001, 113002, 113003, 113004, 113005, 113006, 113007, 113008, 113009, 113010, 113011, 113012, 113013, 113014, 113015, 113016, 113017, 113018, 113019, 113020, 114003, 115001, 115002, 116001, 116002, 118001, 118002		

housing and bezels



1

<b>GEV No.</b>	691349	<b>Ref. No.</b>	1044314900 MA1044314900
<b>description</b>	spraying protection L 520mm W 390mm H 75mm		
<b>For models:</b>	123103, 123104, 123110, 123111, 123112		



1

<b>GEV No.</b>	691350	<b>Ref. No.</b>	1044315000 MA1044315000
<b>description</b>	spraying protection L 520mm W 590mm H 75mm		
<b>For models:</b>	123106, 123107, 123108, 123113, 123114, 123115		



1

<b>GEV No.</b>	691351	<b>Ref. No.</b>	1044320700 MA1044320700
<b>description</b>	spraying protection L 520mm W 790mm H 75mm		
<b>For models:</b>	123109, 123117		

## sumps



1

<b>GEV No.</b>	691386	<b>Ref. No.</b>	41826161370
<b>description</b>	grease collecting tray L 110mm W 170mm H 85mm		
<b>For models:</b>	133004, 133005, 133006, 133016, 133017, 133018, 133019, 133020, 133021, 133106, 133119, 133204, 133205, 133206, 133216, 133217, 133218, 133219, 133220, 133221, 133227, 133228		

## drain stoppers



1

<b>GEV No.</b>	691331	<b>Ref. No.</b>	97313000 MA97313000
<b>description</b>	outflow plug for grease drain flange 30x70mm H 100mm		
<b>For models:</b>	123103, 123104, 123106, 123107, 123108, 123109, 123110, 123111, 123112, 123113, 123114, 123115, 123117, 123120		



1

<b>GEV No.</b>	691330	<b>Ref. No.</b>	1033705600
<b>description</b>	outflow plug for grease drain $\phi$ 32mm L 50mm ID $\phi$ 17.8mm ED $\phi$ 25.5mm		



1

<b>GEV No.</b>	691454	<b>Ref. No.</b>	2515000
<b>description</b>	outflow plug $\phi$ 62mm L 130mm		

## for convection ovens/combi-steamers



1

<b>GEV No.</b>	692843	<b>Ref. No.</b>	00004380
<b>description</b>	spacer bush ID $\phi$ 7mm H 7.5mm ED $\phi$ 17.5mm for glass plate white Spacer		
<b>For models:</b>	211038, 211039, 211042, 211043, 211044, 211045, 211046		

## injection nozzles



1

<b>GEV No.</b>	691278	<b>Ref. No.</b>	R58006130
<b>description</b>	injection nozzle bore $\phi$ 1mm for combi-steamer		
<b>For models:</b>	212001, 212002, 212003, 212010, 212011, 212012, 212013		

## injection pipes





1

<b>GEV No.</b>	692821	<b>Ref. No.</b>	R18200540
<b>description</b>	injection pipe for combi-steamer H 75mm ED $\phi$ 8mm ID $\phi$ 6mm L 105mm		
<b>For models:</b>	212001		







			
1			
<b>GEV No.</b>	692832	<b>Ref. No.</b>	R11201990
<b>description</b>	injection pipe for combi-steamer U-shape ED ø 8mm ID ø 6mm		
<b>For models:</b>	212003		

			
1			
<b>GEV No.</b>	692820	<b>Ref. No.</b>	R11200650
<b>description</b>	injection pipe with holder for combi-steamer ED ø 8mm ID ø 6mm L 150mm H 75mm		
<b>For models:</b>	212002, 212010, 212011		

<b>filters</b>			
			
1			
<b>GEV No.</b>	691269	<b>Ref. No.</b>	R18200260
<b>description</b>	drain filter ø 43mm		
<b>For models:</b>	212001		

			
1			
<b>GEV No.</b>	691270	<b>Ref. No.</b>	R10201700
<b>description</b>	drain filter ø 76mm		
<b>For models:</b>	212002, 212010, 212011, 212012, 212013		

			
1			
<b>GEV No.</b>	691271	<b>Ref. No.</b>	R10201710
<b>description</b>	drain filter ø 87mm		
<b>For models:</b>	212003		

<b>housing and bezels</b>			
			
1			
<b>GEV No.</b>	691524	<b>Ref. No.</b>	KVM1116A VM1116A0
<b>description</b>	cover left		
<b>For models:</b>	211002, 211003		

			
1			
<b>GEV No.</b>	691522	<b>Ref. No.</b>	VM1046A0
<b>description</b>	cover mounting pos. left		
<b>For models:</b>	211002, 211003		

			
1			
<b>GEV No.</b>	691523	<b>Ref. No.</b>	VM1045A0
<b>description</b>	cover right		
<b>For models:</b>	211002, 211003		

			
1			
<b>GEV No.</b>	691525	<b>Ref. No.</b>	VM1115A0
<b>description</b>	cover right		
<b>For models:</b>	211002, 211003		

<b>glass panels</b>			
			
1			
<b>GEV No.</b>	694950	<b>Ref. No.</b>	VET30017
<b>description</b>	door glass for combi-steamer L 485mm mounting pos. inner W 415mm thickness 4mm		
<b>For models:</b>	211004, 211005, 211010, 211017, 211018, 211028		

			
1			
<b>GEV No.</b>	700162	<b>Ref. No.</b>	AL27600
<b>description</b>	glass panel L 410mm W 131mm thickness 4mm rectangular		
<b>For models:</b>	531010, 531011, 531012, 531013, 531014, 531015, 531016, 531017		



1

<b>GEV No.</b>	694406	<b>Ref. No.</b>	VET00021 VET30021
<b>description</b>	glass panel L 549mm W 420mm H 30mm thickness 4mm mounting pos. outer for hot air oven		
<b>For models:</b>	211004, 211017, 211018, 211028		

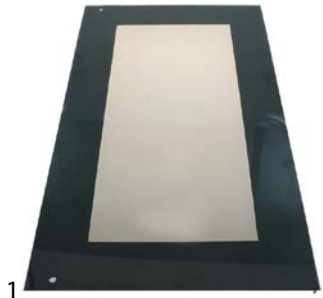

1

<b>GEV No.</b>	694338	<b>Ref. No.</b>	803000031 VET00016
<b>description</b>	glass panel L 750mm W 420mm thickness 4mm mounting pos. outer for oven		
<b>For models:</b>	211006, 211013, 211015		

## Fans - accessories



1

<b>GEV No.</b>	701630	<b>Ref. No.</b>	00012330
<b>description</b>	air duct for cross flow fan for combi-steamer plastic grey		
<b>For models:</b>	211039, 211042, 211043, 211044, 211045, 211046, 212034, 212035, 212036, 212037, 212038, 212039, 212040, 212041		

## cleaning system

## cleaning arms



1

<b>GEV No.</b>	542409	<b>Ref. No.</b>	R58007020
<b>description</b>	mounting flange with gasket for wash arm suitable for LAINOX combi-steamer		
<b>For models:</b>	212010, 212011, 212012, 212013, 212018, 212020		

## hoses

1

<b>GEV No.</b>	694953	<b>Ref. No.</b>	R80150040
<b>description</b>	hose ID ø 13mm ED ø 23mm L 1mm EPDM blue/white t.max. 120°C for combi-steamer		
<b>For models:</b>	212018, 212020		

## screw connections



1

<b>GEV No.</b>	542411	<b>Ref. No.</b>	R58007050
<b>description</b>	bolt for fixing wash arm M12x1 L 110mm		
<b>For models:</b>	212018, 212020		



1

<b>GEV No.</b>	542412	<b>Ref. No.</b>	R58007000
<b>description</b>	bolt for flange wash arm L 50mm M12x1 suitable for combi-steamer		
<b>For models:</b>	212010, 212011, 212012, 212013, 212018, 212020		

## doors



1

<b>GEV No.</b>	699174	<b>Ref. No.</b>	21100350
<b>description</b>	door glass L 720mm W 480mm H 70mm inner		
<b>For models:</b>	211043, 211046		



1

<b>GEV No.</b>	691298	<b>Ref. No.</b>	R18100000
<b>description</b>	oven door complete		
<b>For models:</b>	212001		



1

<b>GEV No.</b>	692837	<b>Ref. No.</b>	LA11401340 R11401340
<b>description</b>	protective plate upper for glass plate combi-steamer H 8mm W 8mm		
<b>For models:</b>	212002, 212003		

door mechanics

holders

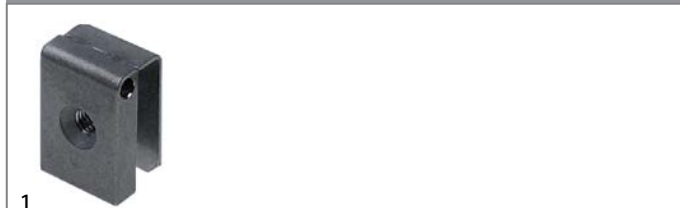

1

<b>GEV No.</b>	691272	<b>Ref. No.</b>	R18203910
<b>description</b>	bracket for glass plate mounting pos. lower		
<b>For models:</b>	212002, 212003		

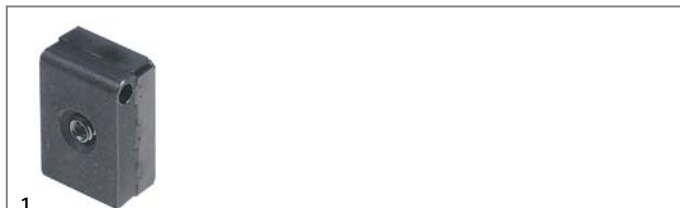



1

<b>GEV No.</b>	691273	<b>Ref. No.</b>	R18203920
<b>description</b>	bracket for glass plate mounting pos. upper		
<b>For models:</b>	212002, 212003		

vibration pumps



1

<b>GEV No.</b>	500568	<b>Ref. No.</b>	R65110600
<b>description</b>	vibration pump 230V 32W 50Hz inlet $\varnothing$ 7 outlet $\varnothing$ 1/8" IT CEME type E512/A32		
<b>For models:</b>	212010, 212011, 212012, 212013, 212018, 212020		
<b>spare parts for</b>	500568		
	<b>GEV No.</b>	390698	<b>Ref. No.</b> —
	thermal fuse switch-off temp. 110°C suitable for ULKA pump		
	<b>GEV No.</b>	520153	<b>Ref. No.</b> —
	bracket rubber dimensions 53x34x28mm		

miscellaneous



1

<b>GEV No.</b>	696428	<b>Ref. No.</b>	11201970 R11201970
<b>description</b>	extension U-shape for injection pipe D1 $\varnothing$ 8mm D2 $\varnothing$ 10mm L 212mm WS 12 stainless steel		
<b>For models:</b>	212003, 212012, 212013		

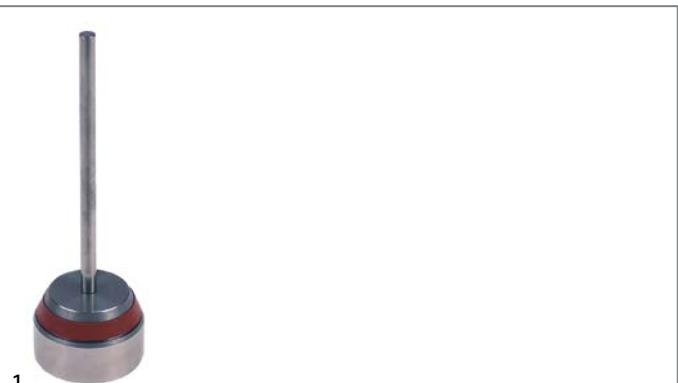

1

<b>GEV No.</b>	691290	<b>Ref. No.</b>	R10100140
<b>description</b>	extractor stubs complete		
<b>For models:</b>	212002, 212003, 212010, 212011, 212012, 212013		





1			
<b>GEV No.</b>	693325	<b>Ref. No.</b>	853310100
<b>description</b>	frame for level glass		
<b>For models:</b>	136001, 136201		

2			
<b>GEV No.</b>	691282	<b>Ref. No.</b>	R58005350
<b>description</b>	gasket for door handle D1 ø 30mm D2 ø 18mm mounting pos. upper H 1.4mm		
<b>For models:</b>	212001, 212002, 212003		

1			
<b>GEV No.</b>	691291	<b>Ref. No.</b>	R70060020
<b>description</b>	gasket for extractor stubs D1 ø 30mm D2 ø 35mm W 9mm		
<b>For models:</b>	212002, 212003, 212010, 212011, 212012, 212013		

1			
<b>GEV No.</b>	690099	<b>Ref. No.</b>	R58002150
<b>description</b>	hinge pin mounting pos. upper for door		
<b>For models:</b>	212002, 212003, 212010, 212011, 212012, 212013, 212017, 212018, 212019, 212020		

1			
<b>GEV No.</b>	696547	<b>Ref. No.</b>	R11202270
<b>description</b>	injection pipe angled for combi-steamer D1 ø 10mm D2 ø 8mm L 170mm		
<b>For models:</b>	212002, 212003, 212010, 212011, 212012, 212013		



1			
<b>GEV No.</b>	691289	<b>Ref. No.</b>	R58004830
<b>description</b>	nut thread M18x1 H 5mm WS 22 brass Qty 1 pcs for door handle		
<b>For models:</b>	212001, 212002, 212003		

1			
<b>GEV No.</b>	691296	<b>Ref. No.</b>	R61400052
<b>description</b>	plain washer ID ø 10.5mm ED ø 21mm thickness 2mm SS Qty 1 pcs for fan wheel		
<b>For models:</b>	212002, 212010, 212011		

1			
<b>GEV No.</b>	691292	<b>Ref. No.</b>	R10401710
<b>description</b>	plain washer ID ø 12mm ED ø 17.5mm thickness 1mm SS Qty 1 pcs		
<b>For models:</b>	212002, 212003		

1			
<b>GEV No.</b>	691283	<b>Ref. No.</b>	R58003240
<b>description</b>	pressure bolt for door handle D1 ø 8mm D2 ø 11mm L 73mm thread M6 bolt 16mm bolt ø 5mm		
<b>For models:</b>	212001, 212002, 212003		

1			
<b>GEV No.</b>	691297	<b>Ref. No.</b>	R62030118
<b>description</b>	reducer thread 1/4" / 1/8"		
<b>For models:</b>	212001, 212002, 212003, 212005, 212007, 212009, 212010, 212011, 212012, 212013, 212018, 212020		

1				
<b>GEV No.</b>	692340	<b>Ref. No.</b>	LAR62030113	
<b>description</b>	reducer with O-ring brass thread 1/4" / 1/8" Qty 1 pcs total length 25mm			
<b>spare parts for</b>	692340			
	<b>GEV No.</b>	529544	<b>Ref. No.</b>	—
		O-ring EPDM thickness 2.62mm ID ø 7.59mm Qty 1 pcs		

1			
<b>GEV No.</b>	691280	<b>Ref. No.</b>	R58005340
<b>description</b>	sealing disc for door handle mounting pos. lower ED ø 25mm ID ø 5.5mm H 5mm		
<b>For models:</b>	212001, 212002, 212003		



 <p>1</p>			
<b>GEV No.</b>	691281	<b>Ref. No.</b>	R58004270
<b>description</b>	spacer piece for door handle L 34mm ID ø 6mm ED ø 8mm		
<b>For models:</b>	212001, 212002, 212003		

 <p>1</p>			
<b>GEV No.</b>	692300	<b>Ref. No.</b>	LA70050180 R70050100
<b>description</b>	stopper with screw connection for glass plate D1 ø 15mm L 8mm thread M4		
<b>For models:</b>	212002, 212003, 212010, 212011, 212012, 212013, 212017, 212018, 212019, 212020		

for hot dog machines

lids

 <p>1</p>			
<b>GEV No.</b>	691299	<b>Ref. No.</b>	502000400
<b>description</b>	lid ø 200mm		
<b>For models:</b>	261001, HD3NK		

glass cylinders

 <p>1</p>			
<b>GEV No.</b>	691325	<b>Ref. No.</b>	407860003
<b>description</b>	glass cylinder ø 193.5mm H 240mm		
<b>For models:</b>	261001, 261002, HD3NK		

miscellaneous

 <p>1</p>			
<b>GEV No.</b>	691301	<b>Ref. No.</b>	502000350
<b>description</b>	bottom plate for hot dog machine perforated ø 190mm		
<b>For models:</b>	261001, 261002, HD3NK		

 <p>1</p>			
<b>GEV No.</b>	691302	<b>Ref. No.</b>	502000600
<b>description</b>	connection plate for hot dog machine aluminium HD-01		

 <p>1</p>			
<b>GEV No.</b>	691305	<b>Ref. No.</b>	502000601
<b>description</b>	connection plate for hot dog machine aluminium HD-02		

 <p>1</p>			
<b>GEV No.</b>	691303	<b>Ref. No.</b>	502000602
<b>description</b>	connection plate for hot dog machine aluminium HD-03		
<b>For models:</b>	261001, HD3NK		

 <p>1</p>			
<b>GEV No.</b>	691306	<b>Ref. No.</b>	502000700
<b>description</b>	connection plate for hot dog machine aluminium HD-04		
<b>For models:</b>	261001		

 <p>1</p>			
<b>GEV No.</b>	691304	<b>Ref. No.</b>	502000500
<b>description</b>	connection plate for hot dog machine L 195mm W 195mm thickness 7.5mm aluminium HD-xN		
<b>For models:</b>	261001, 261002, HD3NK		

 <p>1</p>			
<b>GEV No.</b>	691359	<b>Ref. No.</b>	630011300
<b>description</b>	mounting angle		
<b>For models:</b>	262001		

 <p>1</p>			
<b>GEV No.</b>	691358	<b>Ref. No.</b>	630011200
<b>description</b>	mounting angle L 207mm		
<b>For models:</b>	262001		



<b>GEV No.</b>	691300	<b>Ref. No.</b>	452005400
<b>description</b>	seperating plate for hot dog machine perforated L 230mm W 178mm		
<b>For models:</b>	261001, 261002, HD3NK		

## skewers



<b>GEV No.</b>	691316	<b>Ref. No.</b>	408706100
<b>description</b>	bun spikes ø 24.8mm hot dog grill aluminium		
<b>For models:</b>	261001, HD3NK		

## water containers



<b>GEV No.</b>	691307	<b>Ref. No.</b>	408735100 408735101
<b>description</b>	water container for hot dog machine ø 197mm		
<b>For models:</b>	261001, 261002, HD3NK		

## gear wheels



<b>GEV No.</b>	693062	<b>Ref. No.</b>	633100300
<b>description</b>	gear wheel teeth 11 shaft intake ø 8mm ø 31mm hub ø 18mm stainless steel		
<b>For models:</b>	262001		

## for tilting bratt pans

## gearboxes



<b>GEV No.</b>	691411	<b>Ref. No.</b>	2510632 2518600
<b>description</b>	gearbox motor shaft ø 9mm flange ø 70mm transmission 1/28 drive shaft ø 14mm		

## motors



<b>GEV No.</b>	601463	<b>Ref. No.</b>	2510631
<b>description</b>	motor 90W 230V 50Hz 1 phase shaft ø 9mm flange ø 80mm 1300rpm type AMM56ZAA4 ø 110mm H 150mm L 170mm Lafert 0.09kW		

## spindles



<b>GEV No.</b>	691448	<b>Ref. No.</b>	2934500
<b>description</b>	bush ø 25mm		



<b>GEV No.</b>	693320	<b>Ref. No.</b>	822160171
<b>description</b>	threaded rod		
<b>For models:</b>	137001, 137002, 137003, 137004, 137201, 137202		

## miscellaneous



<b>GEV No.</b>	523510	<b>Ref. No.</b>	19320201 50IBA71269 8303070 C8014 C8055
<b>description</b>	deep-groove ball bearing type 6202-2RS shaft ø 15mm ED ø 35mm W 11mm with sealing discs deep-groove ball bearing DIN 625-1		
<b>For models:</b>	411011, 411014, 431001, 481003, 481005, 512001		



<b>GEV No.</b>	694535	<b>Ref. No.</b>	822160140
<b>description</b>	spindle L 460mm ø 10mm for tilting bratt pan		
<b>For models:</b>	137001, 137002, 137003, 137004, 137201, 137202		



1

<b>GEV No.</b>	691352	<b>Ref. No.</b>	1041724100
<b>description</b>	stockpot L 650mm W 350mm H 95mm		

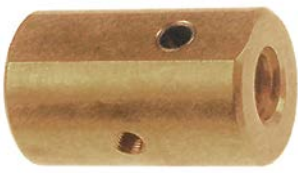

1

<b>GEV No.</b>	693321	<b>Ref. No.</b>	822160160
<b>description</b>	threaded bush		
<b>For models:</b>	137001, 137002, 137003, 137004, 137201, 137202		

for boiling pans

glass panels



Image not available

1

<b>GEV No.</b>	693324	<b>Ref. No.</b>	853310043
<b>description</b>	glass panel L 29mm W 29mm thickness 3.5mm square		
<b>For models:</b>	136001, 136201		

for microwaves

housings

outer parts



1

<b>GEV No.</b>	112544	<b>Ref. No.</b>	JBTN-A896WRM0
<b>description</b>	push button W 60mm H 26mm silver		
<b>For models:</b>	213002, 213003		

inner parts



1

<b>GEV No.</b>	694265	<b>Ref. No.</b>	FCOVPA032WRKZ FCOVPA036WRKZ
<b>description</b>	cooking chamber ceiling L 326mm W 323mm H 40mm		
<b>For models:</b>	213002, 213003		



1

<b>GEV No.</b>	112545	<b>Ref. No.</b>	JBTN-B263WRTZ
<b>description</b>	push button set W 91mm H 35mm for microwaves silver		
<b>For models:</b>	213001		



1

<b>GEV No.</b>	691603	<b>Ref. No.</b>	PCUSUA404WRP0 PCUSUA404WRPO
<b>description</b>	suppressor L 8mm ø 14mm for push-button		
<b>For models:</b>	213002, 213003		

ceramic plates



1

<b>GEV No.</b>	691039	<b>Ref. No.</b>	FGLSPA062WRE0
<b>description</b>	ceramic plate L 335mm W 330mm for microwaves		
<b>For models:</b>	213001		



1

<b>GEV No.</b>	691469	<b>Ref. No.</b>	TC3-3215
<b>description</b>	ceramic plate ø 255mm		

## doors

## films



1

<b>GEV No.</b>	691993	<b>Ref. No.</b>	PSHEPA428WRE0
<b>description</b>	film L 288mm W 178mm self-adhesive for door inside		
<b>For models:</b>	213003		

## tension springs



1

<b>GEV No.</b>	691600	<b>Ref. No.</b>	MSPRCA097WRE0
<b>description</b>	tension spring $\varnothing$ 9mm for cam total length 47mm wire gauge $\varnothing$ 1mm		
<b>For models:</b>	213002, 213003		

## for pasta cookers

## spare parts and accessories



1

<b>GEV No.</b>	698471	<b>Ref. No.</b>	CO1356
<b>description</b>	lid for gearbox cast iron suitable for MPF1.5-2.5		
<b>For models:</b>	516001		

## for noodle machine



1

<b>GEV No.</b>	696455	<b>Ref. No.</b>	CO1342
<b>description</b>	lid for noodle machine L 190mm W 194mm H 18.5mm plastic transparent		
<b>For models:</b>	516001		

## for ovens

## spare parts and accessories



1

<b>GEV No.</b>	691318	<b>Ref. No.</b>	500400365
<b>description</b>	fixing plate mounting pos. right		
<b>For models:</b>	111001, 111002, 111003, 112001, 112002, 112003, 112004, 113001, 113002, 113003, 113004, 113005, 113006, 113007, 113008, 113009, 113010, 113011, 113012, 113013, 113014, 113015, 113016, 113017, 113018, 113019, 113020, 114003, 115001, 115002, 116001, 116002, 118001, 118002		

## doors



1

<b>GEV No.</b>	691375	<b>Ref. No.</b>	507009030
<b>description</b>	oven door H 435mm W 650mm complete		
<b>For models:</b>	111001, 111002, 111003		

## for pizza ovens

## spare parts and accessories



1

<b>GEV No.</b>	691317	<b>Ref. No.</b>	454500360
<b>description</b>	fastening angle for handle		





glass panels



<b>GEV No.</b>	693412	<b>Ref. No.</b>	73700850
<b>description</b>	glass panel L 385mm W 135mm thickness 5mm rectangular with gasket		
<b>For models:</b>	531001, 531002, 531003, 531004		

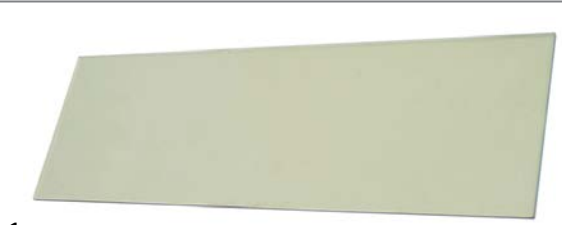

<b>GEV No.</b>	700162	<b>Ref. No.</b>	AL27600
<b>description</b>	glass panel L 410mm W 131mm thickness 4mm rectangular		
<b>For models:</b>	531010, 531011, 531012, 531013, 531014, 531015, 531016, 531017		



<b>GEV No.</b>	700962	<b>Ref. No.</b>	VETRO005
<b>description</b>	glass panel L 415mm W 108mm thickness 5mm rectangular for door		
<b>For models:</b>	530009, 530010, 530011, 530012, 531020, 531021, 531022, 531023		
<b>accessories for</b>	700962		
<b>GEV No.</b>	901400	<b>Ref. No.</b>	GUARN003
<b>description</b>	window gasket suitable for GGF L 416mm external weith 113mm Qty 1m thickness 2.5mm		

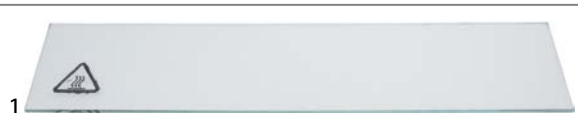

<b>GEV No.</b>	694501	<b>Ref. No.</b>	101006
<b>description</b>	glass panel L 525mm W 130mm thickness 5mm		
<b>For models:</b>	531028, 531029, 531030, 531031		



<b>GEV No.</b>	694528	<b>Ref. No.</b>	PI-B133 PIB133
<b>description</b>	glass panel L 660mm W 105mm thickness 5mm		
<b>For models:</b>	531034, 531039, 531040		



<b>GEV No.</b>	693414	<b>Ref. No.</b>	73700840
<b>description</b>	glass panel L 697mm W 135mm thickness 5mm rectangular		
<b>For models:</b>	531005, 531006, 531007, 531008		

firebricks



<b>GEV No.</b>	850108	<b>Ref. No.</b>	76000090 7600090
<b>description</b>	firebrick L 1056mm W 526mm H 14mm delivery freight forwarding company only		
<b>For models:</b>	531007, 531008		



<b>GEV No.</b>	850071	<b>Ref. No.</b>	76000500
<b>description</b>	firebrick L 615mm W 330mm H 15mm delivery freight forwarding company only		
<b>For models:</b>	531001, 531002		



<b>GEV No.</b>	850106	<b>Ref. No.</b>	49100050 76000120
<b>description</b>	firebrick L 660mm W 307mm H 14mm delivery freight forwarding company only		
<b>For models:</b>	531001, 531002		



1

<b>GEV No.</b>	850107	<b>Ref. No.</b>	76000110
<b>description</b>	firebrick L 660mm W 526mm H 14mm delivery freight forwarding company only		
<b>For models:</b>	531003, 531004, 531005, 531006		



1

<b>GEV No.</b>	850109	<b>Ref. No.</b>	TAVEL011
<b>description</b>	firebrick L 718mm W 359mm H 17mm delivery freight forwarding company only		
<b>For models:</b>	530009, 530010, 530011, 530012, 531020, 531021, 531022, 531023		

miscellaneous



1

<b>GEV No.</b>	698558	<b>Ref. No.</b>	E1K0300
<b>description</b>	bush L 20.5mm ø 16mm ID ø 10mm		
<b>For models:</b>	531010, 531011, 531012, 531013, 531014, 531015, 531016, 531017		



1

<b>GEV No.</b>	690992	<b>Ref. No.</b>	71000310
<b>description</b>	door hinge		
<b>For models:</b>	531001, 531002		



1

<b>GEV No.</b>	514420	<b>Ref. No.</b>	71000300
<b>description</b>	door hinge L 76mm W 30mm mounting pos. left thickness 30mm for pizza oven		
<b>For models:</b>	531003, 531004, 531005, 531006, 531007, 531008		



1

<b>GEV No.</b>	698560	<b>Ref. No.</b>	E1K0200
<b>description</b>	hinge L 40mm W 50mm H 73mm mounting pos. left		
<b>For models:</b>	531010, 531011, 531012, 531013, 531014, 531015, 531016, 531017		



1

<b>GEV No.</b>	698559	<b>Ref. No.</b>	E1K0100
<b>description</b>	hinge L 40mm W 50mm H 73mm mounting pos. right		
<b>For models:</b>	531010, 531011, 531012, 531013, 531014, 531015, 531016, 531017		

for rice cookers



1

<b>GEV No.</b>	694342	<b>Ref. No.</b>	A01505131
<b>description</b>	silicon insert for rice cooker ø 293mm thickness 1.3mm		
<b>For models:</b>	236003		



for rolling grills

pipes

bushes

 <p>1</p>			
<b>GEV No.</b>	693060	<b>Ref. No.</b>	633080100
<b>description</b>	bushing PTFE		
<b>For models:</b>	262001		

pipes



 <p>1</p>			
<b>GEV No.</b>	693713	<b>Ref. No.</b>	634210100
<b>description</b>	pipe with gear wheel L 370mm for roller grill		



gear wheels

 <p>1</p>			
<b>GEV No.</b>	693062	<b>Ref. No.</b>	633100300
<b>description</b>	gear wheel teeth 11 shaft intake ø 8mm ø 31mm hub ø 18mm stainless steel		
<b>For models:</b>	262001		

for saladettes

spare parts and accessories

 <p>1</p>			
<b>GEV No.</b>	697917	<b>Ref. No.</b>	S900.29
<b>description</b>	fixing plate with opposite support thread M5		
<b>For models:</b>	611007, 611010		
<b>accessories for</b>	697917		
			
<b>GEV No.</b>	697916	<b>Ref. No.</b>	S900.28
<b>description</b>	screw bolt with nut L 8mm thread M5 ø 6mm		

 <p>1</p>			
<b>GEV No.</b>	697916	<b>Ref. No.</b>	S900.28
<b>description</b>	screw bolt with nut L 8mm thread M5 ø 6mm		
<b>For models:</b>	611007, 611010, 611014		
<b>accessories for</b>	697916		
			
<b>GEV No.</b>	697917	<b>Ref. No.</b>	S900.29
<b>description</b>	fixing plate with opposite support thread M5		

for sliding doors

door guides

 <p>1</p>			
<b>GEV No.</b>	693733	<b>Ref. No.</b>	SS4350
<b>description</b>	guide sliding door L 54mm plastic 20		

miscellaneous



 <p>1</p>			
<b>GEV No.</b>	690570	<b>Ref. No.</b>	0140403100
<b>description</b>	rubber pad		
<b>For models:</b>	912001, 912002, 912003, 912004, 912005, 912006, 912007, 912008, 912009, 912010, 912011, 912012, 912013, 912014, 912015, 912016, 912017, 912018, 912019, 912020, 912021, 912022, 912023, 912024, 912025, 912026, 912027, 912028, 912029, 912030, 912031, 912032, 912033, 912034, 912035, 912036, 913001, 913002, 913003, 913004, 913005, 913006, 913007, 913008, 913009, 913010, 913011, 913012, 913013, 913014...(Other models you can see in the webshop)		



for dishwashers



drain and intake components

COOKMAX

drain /intake bodies

 <p>1</p>			
<b>GEV No.</b>	512110	<b>Ref. No.</b>	190225
<b>description</b>	drain connection thread 1¼" hose ø 30mm		
<b>For models:</b>	SP1, SP2-12, SP2-S12		
<b>accessories for</b>	512110		
			
<b>GEV No.</b>	512111	<b>Ref. No.</b>	200867
<b>description</b>	O-ring EPDM thickness 2.62mm ID ø 45.69mm Qty 1 pcs		



			
1			
<b>GEV No.</b>	518194	<b>Ref. No.</b>	136023
<b>description</b>	drain fitting thread 1/4" hose ø 30mm		
<b>For models:</b>	812001, 812002, 812003, 812004, 812005, 812006, 812007, 812008, 812009, 812010, 915234, 915235, 915236, 915237, 915460, 915461, 915462, 915463, 915464, 915465		
<b>accessories for</b>	518194		
	<b>GEV No.</b>	513059	<b>Ref. No.</b> 437063
	flat gasket rubber ED ø 52mm ID ø 40mm thickness 3mm Qty 1 pcs		
	<b>GEV No.</b>	513103	<b>Ref. No.</b> 417081
	screw connection thread 1/4" H 10mm		

			
1			
<b>GEV No.</b>	518177	<b>Ref. No.</b>	111023
<b>description</b>	drain unit thread 3/4" ID ø 35mm hose ø 24mm		
<b>For models:</b>	811001, 811002, 811003		
<b>accessories for</b>	518177		
	<b>GEV No.</b>	513266	<b>Ref. No.</b> 417104
	nut		
	<b>GEV No.</b>	518176	<b>Ref. No.</b> 478056
	rinse pipe		



			
1			
<b>GEV No.</b>	511677	<b>Ref. No.</b>	00-324053-000
<b>description</b>	flange with gasket ED ø 107mm ID ø 70mm for pump		
<b>For models:</b>	811011, 811012, 811013, 811014, 811015, 812011, 812012, 812013, 812014, 812015		

			
1			
<b>GEV No.</b>	507496	<b>Ref. No.</b>	00-324056-000
<b>description</b>	gasket ED ø 100mm ID ø 80mm		
<b>For models:</b>	811011, 811012, 811013, 811014, 811015, 812011, 812012, 812013, 812014, 812015		

			
1			
<b>GEV No.</b>	518210	<b>Ref. No.</b>	437015
<b>description</b>	gasket with 6 holes ED ø 99mm ID ø 51mm		
<b>For models:</b>	812001, 812002, 812003, 812004, 812005, 812006, 812007, 812008, 812009, 812010, 915234, 915235, 915236, 915237, 915460, 915461, 915462, 915463, 915464, 915465		

			
1			
<b>GEV No.</b>	511298	<b>Ref. No.</b>	160201
<b>description</b>	hose connector hose ø 35mm		
<b>For models:</b>	SP3		
<b>accessories for</b>	511298		
	<b>GEV No.</b>	510356	<b>Ref. No.</b> 180102
	nut thread 1/2"		
	<b>GEV No.</b>	510876	<b>Ref. No.</b> 200412
	flat gasket rubber ED ø 45mm ID ø 33mm thickness 3mm Qty 1 pcs		

			
1			
<b>GEV No.</b>	513726	<b>Ref. No.</b>	468152
<b>description</b>	hose connector plastic ø 24mm		
<b>For models:</b>	812001, 812002, 812003, 812004, 812005, 812006, 812007, 812008, 812009, 812010, 915234, 915235, 915236, 915237, 915460, 915461, 915462, 915463, 915464, 915465		

			
1			
<b>GEV No.</b>	513257	<b>Ref. No.</b>	144003
<b>description</b>	hose connector with exhaust ventilation plastic		
<b>For models:</b>	812001, 812002, 812005, 812007, 812008, 812009, 812010, 915234, 915235, 915236, 915237, 915460, 915461, 915462, 915463, 915464, 915465		
<b>accessories for</b>	513257		
	<b>GEV No.</b>	513269	<b>Ref. No.</b> 423024
	hose holder		



			
1			
<b>GEV No.</b>	513269	<b>Ref. No.</b>	423024
<b>description</b>	hose holder		
<b>For models:</b>	812001, 812002, 812005, 812007, 812008, 812009, 812010, 915234, 915235, 915236, 915237, 915460, 915461, 915462, 915463, 915464, 915465		







			
1			
<b>GEV No.</b>	518074	<b>Ref. No.</b>	478059
<b>description</b>	intake body ED ø 103mm ID ø 43mm hose ø 50mm		
<b>For models:</b>	812001, 812002, 812003, 812004, 812005, 812006, 812007, 812008, 812009, 812010, 915234, 915235, 915236, 915237, 915460, 915461, 915462, 915463, 915464, 915465		

			
1			
<b>GEV No.</b>	517404	<b>Ref. No.</b>	00-323802-001
<b>description</b>	intake body ED ø 105mm H 110mm ID ø 75mm hose ø 31mm		
<b>For models:</b>	811011, 811012, 811013, 811014, 811015, 812011, 812012, 812013, 812014, 812015		

			
1			
<b>GEV No.</b>	518064	<b>Ref. No.</b>	136020
<b>description</b>	intake body ED ø 140mm ID ø 102mm hose ø 50/60mm		
<b>For models:</b>	813001		

			
1			
<b>GEV No.</b>	512113	<b>Ref. No.</b>	160310
<b>description</b>	intake body thread 1½" ED ø 50mm		
<b>For models:</b>	SP1, SP2-12, SP2-S12		
<b>accessories for</b>	512113		
		<b>GEV No.</b>	528192
		<b>Ref. No.</b>	—
	O-ring EPDM thickness 3mm ID ø 56mm Qty 1 pcs		

			
1			
<b>GEV No.</b>	519583	<b>Ref. No.</b>	180248
<b>description</b>	intake/drain body thread 1½" ED ø 130mm ID ø 90mm hose ø 50mm		
<b>For models:</b>	SP3		

			
1			
<b>GEV No.</b>	510356	<b>Ref. No.</b>	180102
<b>description</b>	nut thread 1½"		
<b>For models:</b>	SP3		
<b>accessories for</b>	510356		
		<b>GEV No.</b>	510876
		<b>Ref. No.</b>	200412
	flat gasket rubber ED ø 45mm ID ø 33mm thickness 3mm Qty 1 pcs		
		<b>GEV No.</b>	511298
		<b>Ref. No.</b>	160201
	hose connector hose ø 35mm		

			
1			
<b>GEV No.</b>	511332	<b>Ref. No.</b>	180145
<b>description</b>	nut thread 1¾"		
<b>For models:</b>	SP1, SP2-12, SP2-S12		

			
1			
<b>GEV No.</b>	512109	<b>Ref. No.</b>	180147
<b>description</b>	screw connection thread 1¼"		
<b>For models:</b>	SP1, SP2-12, SP2-S12		

			
1			
<b>GEV No.</b>	513103	<b>Ref. No.</b>	417081
<b>description</b>	screw connection thread 1¼" H 10mm		
<b>For models:</b>	812001, 812002, 812003, 812004, 812005, 812006, 812007, 812008, 812009, 812010, 915234, 915235, 915236, 915237, 915460, 915461, 915462, 915463, 915464, 915465		

<b>filters</b>			
			
1			
<b>GEV No.</b>	518057	<b>Ref. No.</b>	408006
<b>description</b>	bracket		
<b>For models:</b>	812001, 812002, 812003, 812004, 812005, 812006, 812007, 812008, 812009, 812010, 915234, 915235, 915236, 915237, 915460, 915461, 915462, 915463, 915464, 915465		



1			
<b>GEV No.</b>	519485	<b>Ref. No.</b>	180832
<b>description</b>	filter L 265mm W 250mm		
<b>For models:</b>	SP2-12, SP2-S12		



1			
<b>GEV No.</b>	518603	<b>Ref. No.</b>	332091
<b>description</b>	filter L 268mm W 235mm mounting pos. left		
<b>For models:</b>	SP3		



1			
<b>GEV No.</b>	518602	<b>Ref. No.</b>	332090
<b>description</b>	filter L 268mm W 235mm mounting pos. right		
<b>For models:</b>	SP3		



1			
<b>GEV No.</b>	518065	<b>Ref. No.</b>	80470
<b>description</b>	filter support H 140mm ø 140mm		
<b>For models:</b>	813001		



1			
<b>GEV No.</b>	508374	<b>Ref. No.</b>	80259
<b>description</b>	flat filter H 35mm L 540mm W 274mm		
<b>For models:</b>	813001		



1			
<b>GEV No.</b>	512336	<b>Ref. No.</b>	180824
<b>description</b>	flat filter L 210mm W 210mm		
<b>For models:</b>	SP1		



1			
<b>GEV No.</b>	507499	<b>Ref. No.</b>	00-898189-001
<b>description</b>	flat filter L 523mm W 253mm H 15mm		
<b>For models:</b>	813002, 813003, 813004		



1			
<b>GEV No.</b>	524830	<b>Ref. No.</b>	01-240630-003
<b>description</b>	round filters ø 136mm H 47mm		
<b>For models:</b>	811015, 812012, 812013, 812015		



1			
<b>GEV No.</b>	510022	<b>Ref. No.</b>	121052 121081
<b>description</b>	round filters ø 153mm H 120mm		
<b>For models:</b>	812001, 812002, 812003, 812004, 812005, 812006, 812007, 812008, 812009, 812010, 813001, 915234, 915235, 915236, 915237, 915460, 915461, 915462, 915463, 915464, 915465		



1			
<b>GEV No.</b>	511333	<b>Ref. No.</b>	180818
<b>description</b>	round filters ø 240mm H 95mm		
<b>For models:</b>	SP3		



1			
<b>GEV No.</b>	502217	<b>Ref. No.</b>	01-240630-002
<b>description</b>	round filters ø 32.5mm H 49mm		
<b>For models:</b>	811011, 811012, 811013, 811014, 811015, 812011, 812012, 812013, 812014, 812015		





1			
<b>GEV No.</b>	518192 <sup>1</sup>	<b>Ref. No.</b>	121078
<b>description</b>	round filters ø 60mm H 118mm		
<b>For models:</b>	812001, 812002, 812003, 812004, 812005, 812006, 812007, 812008, 812009, 812010, 915234, 915235, 915236, 915237, 915460, 915461, 915462, 915463, 915464, 915465		

<sup>1</sup>for drain pump





			
1			
<b>GEV No.</b>	510639	<b>Ref. No.</b>	333006
<b>description</b>	round filters ø 90mm H 105mm		
<b>For models:</b>	SP2-12, SP2-S12		

			
1			
<b>GEV No.</b>	512337	<b>Ref. No.</b>	332029
<b>description</b>	round filters suction ø 63mm H 87mm		
<b>For models:</b>	SP1		



			
1			
<b>GEV No.</b>	518203	<b>Ref. No.</b>	121100
<b>description</b>	round filters suction/outflow		
<b>For models:</b>	811003		

			
1			
<b>GEV No.</b>	518204	<b>Ref. No.</b>	429065
<b>description</b>	screw connection for filter ø 67mm		
<b>For models:</b>	811003		

overflow pipes			
			
1			
<b>GEV No.</b>	510227	<b>Ref. No.</b>	200950
<b>description</b>	gasket Viton ID ø 27mm ED ø 44mm H 7mm		
<b>For models:</b>	SP3		

			
1			
<b>GEV No.</b>	511321	<b>Ref. No.</b>	180725
<b>description</b>	lid for overflow pipe		
<b>For models:</b>	SP1, SP2-12, SP2-S12		
<b>accessories for</b>	511321		
	<b>GEV No.</b>	510028	<b>Ref. No.</b>
			180730
	overflow pipe L 120mm ø 26mm		

			
1			
<b>GEV No.</b>	511320	<b>Ref. No.</b>	180724
<b>description</b>	overflow pipe L 103mm ø 26mm		
<b>For models:</b>	SP1		
<b>accessories for</b>	511320		
	<b>GEV No.</b>	511321	<b>Ref. No.</b>
			180725
	lid for overflow pipe		
	<b>GEV No.</b>	511322	<b>Ref. No.</b>
			200869
	O-ring EPDM thickness 3.53mm ID ø 20.22mm Qty 1 pcs		
	<b>GEV No.</b>	511323	<b>Ref. No.</b>
			450232
	compression spring ø 41.3mm L 57mm wire gauge ø 2mm		
	<b>GEV No.</b>	512109	<b>Ref. No.</b>
			180147
	screw connection thread 1¼"		
	<b>GEV No.</b>	560249	<b>Ref. No.</b>
			—
	sheet metal screws ø 3.9mm L 13mm SS Qty 20 pcs DIN 7982/ISO 7050 intake Phillips head ø 7.5mm		

			
1			
<b>GEV No.</b>	510028	<b>Ref. No.</b>	180730
<b>description</b>	overflow pipe L 120mm ø 26mm		
<b>For models:</b>	SP2-12, SP2-S12		
<b>accessories for</b>	510028		
	<b>GEV No.</b>	511321	<b>Ref. No.</b>
			180725
	lid for overflow pipe		
	<b>GEV No.</b>	511322	<b>Ref. No.</b>
			200869
	O-ring EPDM thickness 3.53mm ID ø 20.22mm Qty 1 pcs		

			
1			
<b>GEV No.</b>	518191 <sup>1</sup>	<b>Ref. No.</b>	142042 142053
<b>description</b>	overflow pipe L 147mm ø 35mm		
<b>For models:</b>	812001, 812002, 812003, 812004, 812005, 812006, 812007, 812008, 812009, 812010, 915234, 915235, 915236, 915237, 915460, 915461, 915462, 915463, 915464, 915465		

<sup>1</sup>for drain pump



1

<b>GEV No.</b>	518193	<b>Ref. No.</b>	142052
<b>description</b>	overflow pipe L 148mm ø 36mm		
<b>For models:</b>	812001, 812002, 812003, 812004, 812005, 812006, 812007, 812008, 812009, 812010, 915234, 915235, 915236, 915237, 915460, 915463		



1

<b>GEV No.</b>	517580	<b>Ref. No.</b>	01-240744-002
<b>description</b>	overflow pipe L 160mm ø 90mm		
<b>For models:</b>	811011, 811012, 811013, 811014, 811015, 812011, 812012, 812013, 812014, 812015		



1

<b>GEV No.</b>	518202	<b>Ref. No.</b>	142051
<b>description</b>	overflow pipe L 168mm ø 22mm		
<b>For models:</b>	811003		



1

<b>GEV No.</b>	524660	<b>Ref. No.</b>	00-883737-001
<b>description</b>	overflow pipe L 270mm ø 32mm		
<b>For models:</b>	813002, 813003, 813004		



1

<b>GEV No.</b>	510645	<b>Ref. No.</b>	180729
<b>description</b>	overflow pipe L 283mm ø 42mm		
<b>For models:</b>	SP3		
<b>accessories for</b>	510645		
	<b>GEV No.</b>	510227	<b>Ref. No.</b> 200950
	gasket Viton ID ø 27mm ED ø 44mm H 7mm		



1

<b>GEV No.</b>	513180	<b>Ref. No.</b>	80249
<b>description</b>	overflow pipe L 287mm ø 38mm		
<b>For models:</b>	813001		
<b>accessories for</b>	513180		
	<b>GEV No.</b>	510072	<b>Ref. No.</b> 456016
	O-ring EPDM thickness 3.53mm ID ø 32.93mm Qty 1 pcs		

containers

salt tanks



1

<b>GEV No.</b>	524177	<b>Ref. No.</b>	480005
<b>description</b>	lid ø 69mm H 20mm for salt tank ID ø 50mm		
<b>For models:</b>	811003, 812008, 812010, 915234, 915235, 915236, 915237, 915462, 915465		
<b>accessories for</b>	524177		
	<b>GEV No.</b>	524148	<b>Ref. No.</b> —
	O-ring EPDM thickness 3.53mm ID ø 40.86mm Qty 1 pcs		



1

<b>GEV No.</b>	510018	<b>Ref. No.</b>	429011
<b>description</b>	nut ø 92mm H 10.5mm for salt tank ID ø 64mm		
<b>For models:</b>	811003, 812008, 812010, 915234, 915235, 915236, 915237, 915462, 915465		





 <p>1</p>			
<b>GEV No.</b>	510032	<b>Ref. No.</b>	406998
<b>description</b>	salt tank without gasket new model		
<b>For models:</b>	811003, 812008, 812010, 915234, 915235, 915236, 915237, 915462, 915465		
<b>spare parts for</b>	510032		
	<b>GEV No.</b>	506015	<b>Ref. No.</b> 456052
	O-ring EPDM thickness 3.53mm ID ø 39.69mm Qty 1 pcs		
	<b>GEV No.</b>	510018	<b>Ref. No.</b> 429011
	nut ø 92mm H 10.5mm for salt tank ID ø 64mm		
	<b>GEV No.</b>	510071	<b>Ref. No.</b> 437034
	flat gasket rubber ED ø 81mm ID ø 68mm thickness 3mm for salt tank Qty 1 pcs		
	<b>GEV No.</b>	524177	<b>Ref. No.</b> 480005
	lid ø 69mm H 20mm for salt tank ID ø 50mm		

accessories

 <p>1</p>			
<b>GEV No.</b>	510071	<b>Ref. No.</b>	437034
<b>description</b>	flat gasket rubber ED ø 81mm ID ø 68mm thickness 3mm for salt tank Qty 1 pcs		
<b>For models:</b>	811003, 812008, 812010, 915234, 915235, 915236, 915237, 915462, 915465		



boilers

boilers for dishwashers

 <p>1</p>			
<b>GEV No.</b>	513243	<b>Ref. No.</b>	80389
<b>description</b>	boiler		
<b>For models:</b>	813001		

 <p>1</p>			
<b>GEV No.</b>	518576	<b>Ref. No.</b>	104050
<b>description</b>	boiler		

 <p>1</p>			
<b>GEV No.</b>	513709	<b>Ref. No.</b>	104056
<b>description</b>	boiler ø 110mm L 295mm		
<b>For models:</b>	811003		

 <p>1</p>			
<b>GEV No.</b>	504375	<b>Ref. No.</b>	01-240791-001
<b>description</b>	boiler ø 133mm L 420mm flange 3 hole flange flange ø 47.5mm		
<b>For models:</b>	812011, 812012, 812013, 813002, 813004		
<b>accessories for</b>	504375		
	<b>GEV No.</b>	504379	<b>Ref. No.</b> 00-774512-001
	plug for draining ø 10mm L 18mm		
	<b>GEV No.</b>	530821	<b>Ref. No.</b> 00-774080-001 413169
	silicone hose ID ø 10mm ED ø 15mm L 1m thickness 2.5mm operating pressure without pressure burst pressure non defined t.max. 200°C transparent Shore 60°		

 <p>1</p>			
<b>GEV No.</b>	518235	<b>Ref. No.</b>	104060
<b>description</b>	boiler ø 145mm L 405mm flange 3 hole flange		
<b>For models:</b>	812001, 812002, 812003, 812004, 812005, 812006, 812007, 812008, 812009, 812010, 915234, 915235, 915236, 915237, 915460, 915461, 915462, 915463, 915464, 915465		





 <p>1</p>			
<b>GEV No.</b>	511428	<b>Ref. No.</b>	330353
<b>description</b>	boiler ø 150mm L 340mm		
<b>For models:</b>	SP1		

			
1			
<b>GEV No.</b>	518377	<b>Ref. No.</b>	104026
<b>description</b>	boiler ø 150mm L 360mm		
<b>For models:</b>	915234, 915235, 915236, 915237		

			
1			
<b>GEV No.</b>	511630	<b>Ref. No.</b>	330368
<b>description</b>	boiler ø 150mm L 445mm flange 3 hole flange inlet ø 57.5		
<b>For models:</b>	SP2-12, SP2-S12		

			
1			
<b>GEV No.</b>	511000	<b>Ref. No.</b>	330342
<b>description</b>	boiler ø 160mm L 500mm capacity 10l flange 3 hole flange inlet ø 12		
<b>For models:</b>	SP3		

			
1			
<b>GEV No.</b>	518098	<b>Ref. No.</b>	104906
<b>description</b>	boiler with safety thermostat 2600W 230V ø 110mm L 295mm W 110mm H 115mm connection 11mm hose ø 6mm with thermostat inlet ø 11mm		
<b>spare parts for</b>	518098		

	<b>GEV No.</b>	390233	<b>Ref. No.</b>	236039 926189
	bi-metal safety thermostat hole distance 24mm switch-off temp. 110°C 1NC 1-pole 16A connection F6.3 2 hole fixing without holder			
	<b>GEV No.</b>	390319	<b>Ref. No.</b>	236048
	bi-metal thermostat hole distance 23.8mm switch-off temp. 80°C 1NC 1-pole 16A connection F6.3 2 hole fixing			
	<b>GEV No.</b>	418642	<b>Ref. No.</b>	230113
	heating element 2600W 230V mounting ø 38.5mm heating circuits 1 L 260mm W 33mm H 24mm number of thermostat sleeves 1 thermostat sleeves ø 7mm length thermostat sleeves 175mm thermostat sleeve eccentric, non clinging tube ø 6.5mm hole distance 57mm 3 hole flange connection male faston 6.3mm immersion heater			
	<b>GEV No.</b>	521120	<b>Ref. No.</b>	456075
	O-ring EPDM thickness 5.34mm ID ø 37.47mm Qty 1 pcs			

accessories			
			
1			
<b>GEV No.</b>	504378	<b>Ref. No.</b>	01-240452-001
<b>description</b>	hose connector thread 1/8" thread L 44mm hose ø 5mm		
<b>For models:</b>	813002, 813003, 813004		

			
1			
<b>GEV No.</b>	517799	<b>Ref. No.</b>	143228
<b>description</b>	pipe for boiler ø 9mm L 245mm		
<b>For models:</b>	811003		

			
1			
<b>GEV No.</b>	504379	<b>Ref. No.</b>	00-774512-001
<b>description</b>	plug for draining ø 10mm L 18mm		
<b>For models:</b>	811011, 811012, 811013, 811014, 811015, 812011, 812012, 812013, 812014, 812015, 813002, 813003, 813004		

			
1			
<b>GEV No.</b>	527207	<b>Ref. No.</b>	WY25743
<b>description</b>	reducer thread 1/4" IT - 1/8" ET brass WS 17		
<b>For models:</b>	742005		

			
1			
<b>GEV No.</b>	530821	<b>Ref. No.</b>	00-774080-001 413169
<b>description</b>	silicone hose ID ø 10mm ED ø 15mm L 1m thickness 2.5mm operating pressure without pressure burst pressure non defined t.max. 200°C transparent Shore 60°		
<b>For models:</b>	741001, 741002, 741003, 811011, 811012, 811013, 811014, 811015, 812011, 812012, 812013, 812014, 812015, 813002, 813003, 813004		

softener cartridges			
softening columns			
			
1			
<b>GEV No.</b>	530395	<b>Ref. No.</b>	117007
<b>description</b>	softener 4-fold L 380mm W 180mm		
<b>For models:</b>	812008, 812010, 915462, 915465		

complete



1

<b>GEV No.</b>	530327	<b>Ref. No.</b>	00-775918-001 00-775918-010
<b>description</b>	softener		
<b>For models:</b>	811014, 811015, 812014, 812015, 813003, 813004		
<b>accessories for</b>	530327		
	<b>GEV No.</b>	530174	<b>Ref. No.</b> 00-775918-050
	lid kit for softener		



1

<b>GEV No.</b>	513048	<b>Ref. No.</b>	00-886756-001
<b>description</b>	duct ID ø 41mm ED ø 50mm		
<b>For models:</b>	813002, 813003, 813004		



1

<b>GEV No.</b>	513000	<b>Ref. No.</b>	480057
<b>description</b>	lid rubber ED ø 27mm		
<b>For models:</b>	812001, 812002, 812003, 812004, 812005, 812006, 812007, 812008, 812009, 812010, 915234, 915235, 915236, 915237, 915460, 915461, 915462, 915463, 915464, 915465		

housing and bezels

fastening angles



1

<b>GEV No.</b>	510937	<b>Ref. No.</b>	330725
<b>description</b>	mounting angle for solenoid valve		
<b>For models:</b>	SP2-12, SP2-S12		



1

<b>GEV No.</b>	513708	<b>Ref. No.</b>	480058
<b>description</b>	lid rubber ø 17mm mounting ø 17mm		
<b>For models:</b>	812001, 812002, 812003, 812004, 812005, 812006, 812007, 812008, 812009, 812010, 915234, 915235, 915236, 915237, 915460, 915461, 915462, 915463, 915464, 915465		

hood mechanics for dishwashers

bolts



1

<b>GEV No.</b>	510988	<b>Ref. No.</b>	340493
<b>description</b>	bolt for hood joint		
<b>For models:</b>	SP3		

miscellaneous



1

<b>GEV No.</b>	513070	<b>Ref. No.</b>	00-886756-004
<b>description</b>	duct ID ø 14mm ED ø 19mm		
<b>For models:</b>	811011, 811012, 811013, 811014, 811015, 812011, 812012, 812013, 812014, 812015, 813002, 813003, 813004		



1

<b>GEV No.</b>	502220	<b>Ref. No.</b>	00-883965-001
<b>description</b>	screw bolt ED ø 10mm L 22mm thread M5 kit for roller		
<b>For models:</b>	813002, 813003, 813004		



1

<b>GEV No.</b>	513049	<b>Ref. No.</b>	00-886756-003
<b>description</b>	duct ID ø 29mm ED ø 38mm		
<b>For models:</b>	811011, 811012, 811013, 811014, 811015, 812011, 812012, 812013, 812014, 812015, 813002, 813003, 813004		

bushes



1			
<b>GEV No.</b>	510848	<b>Ref. No.</b>	290821
<b>description</b>	spacer bush for switch hood mechanics		
<b>For models:</b>	SP3		

spring holders



1			
<b>GEV No.</b>	517405	<b>Ref. No.</b>	00-883683-002
<b>description</b>	spring holder for hood spring		
<b>For models:</b>	813002, 813003, 813004		

guide bars



1			
<b>GEV No.</b>	511681	<b>Ref. No.</b>	00-883477-001
<b>description</b>	guide L 480mm mounting pos. lower for hood		
<b>For models:</b>	813002, 813003		



1			
<b>GEV No.</b>	513724	<b>Ref. No.</b>	80068 80069
<b>description</b>	guide bar L 590mm hood mechanics		
<b>For models:</b>	813001		



1			
<b>GEV No.</b>	513126	<b>Ref. No.</b>	180642
<b>description</b>	guide bar L 615mm W 30mm H 29mm		
<b>For models:</b>	SP3		



1			
<b>GEV No.</b>	502223	<b>Ref. No.</b>	01-246900-001
<b>description</b>	spacer for hood L 79mm W 24mm H 10mm		
<b>For models:</b>	813002, 813003, 813004		



1			
<b>GEV No.</b>	502224	<b>Ref. No.</b>	00-886987-001
<b>description</b>	spacer kit for hood L 79mm W 24mm H 10mm		
<b>For models:</b>	813002, 813003		

hood handles

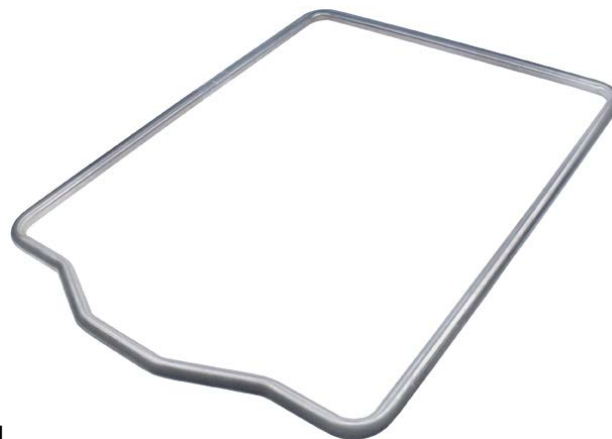

1			
<b>GEV No.</b>	513719	<b>Ref. No.</b>	80027
<b>description</b>	hood handle		
<b>For models:</b>	813001		

hood handle supports



1			
<b>GEV No.</b>	513202	<b>Ref. No.</b>	80190
<b>description</b>	bearing for hood handle plastic		
<b>For models:</b>	813001		





1			
<b>GEV No.</b>	502222	<b>Ref. No.</b>	00-898024-001
<b>description</b>	bearing for hood handle plastic L 47mm W 38mm H 20mm		
<b>For models:</b>	813002, 813003, 813004		





1			
<b>GEV No.</b>	513192	<b>Ref. No.</b>	926243
<b>description</b>	guide for hood handle		
<b>For models:</b>	813001		





 <p>1</p>			
<b>GEV No.</b>	510211	<b>Ref. No.</b>	190637
<b>description</b>	guide for hood handle L 78mm W 50mm H 22mm without roller		
<b>For models:</b>	SP3		
<b>accessories for</b>	510211		
 <p>GEV No. 510336 Ref. No. —</p> <p>bolt L 12.5mm thread M3 for hinge SS WS 7</p>			

 <p>1</p>			
<b>GEV No.</b>	510868	<b>Ref. No.</b>	191013
<b>description</b>	handle holder hood mechanics		
<b>For models:</b>	SP3		

 <p>1</p>			
<b>GEV No.</b>	510869	<b>Ref. No.</b>	191014
<b>description</b>	handle holder hood mechanics		
<b>For models:</b>	SP3		

<p>rollers</p>  <p>1</p>			
<b>GEV No.</b>	502221	<b>Ref. No.</b>	00-898080-001
<b>description</b>	roller ø 29mm for hood mechanics kit hole ø 10mm		
<b>For models:</b>	813002, 813003, 813004		
<b>accessories for</b>	502221		
 <p>GEV No. 502220 Ref. No. 00-883965-001</p> <p>screw bolt ED ø 10mm L 22mm thread M5 kit for roller</p>			

<p>miscellaneous</p>  <p>1</p>			
<b>GEV No.</b>	510864	<b>Ref. No.</b>	190607
<b>description</b>	bush for spring holder hood mechanics		
<b>For models:</b>	SP3		

 <p>1</p>			
<b>GEV No.</b>	508375	<b>Ref. No.</b>	80105
<b>description</b>	fixing support		
<b>For models:</b>	813001		

 <p>1</p>			
<b>GEV No.</b>	513274	<b>Ref. No.</b>	80998
<b>description</b>	hexagonal screw thread M4 plastic WS 7 thread L 6mm		
<b>For models:</b>	813001		

 <p>1</p>			
<b>GEV No.</b>	511204	<b>Ref. No.</b>	190638
<b>description</b>	roller		
<b>For models:</b>	SP3		

 <p>1</p>			
<b>GEV No.</b>	502226	<b>Ref. No.</b>	00-228828-000
<b>description</b>	rubber pad ED ø 9mm black		
<b>For models:</b>	813002, 813003, 813004		

 <p>1</p>			
<b>GEV No.</b>	511393	<b>Ref. No.</b>	190149
<b>description</b>	strengthening for handle holder hood mechanics		
<b>For models:</b>	SP3		

## basket guides

## guide bars



1

<b>GEV No.</b>	530609	<b>Ref. No.</b>	15038
<b>description</b>	guide bar mounting pos. right L 422mm W 43mm H 39mm		
<b>For models:</b>	811003		



## air traps



## air traps



1

<b>GEV No.</b>	510759	<b>Ref. No.</b>	161316
<b>description</b>	air trap		
<b>For models:</b>	SP1, SP2-12, SP2-S12		



<b>spare parts for</b>	510759		
	<b>GEV No.</b>	502036	<b>Ref. No.</b> 200805
	O-ring EPDM thickness 2.62mm ID ø 28.25mm Qty 1 pcs		
	<b>GEV No.</b>	510760	<b>Ref. No.</b> 161317
	hose connector		
	<b>GEV No.</b>	510761	<b>Ref. No.</b> 200944
	flat gasket rubber D1 ø 38mm D2 ø 25mm thickness 2mm Qty 1 pcs		

<b>accessories for</b>	510759		
	<b>GEV No.</b>	510760	<b>Ref. No.</b> 161317
	hose connector		
	<b>GEV No.</b>	510761	<b>Ref. No.</b> 200944
	flat gasket rubber D1 ø 38mm D2 ø 25mm thickness 2mm Qty 1 pcs		
	<b>GEV No.</b>	512283	<b>Ref. No.</b> —
	flat gasket rubber D1 ø 38.5mm D2 ø 24.5mm thickness 2mm Qty 1 pcs		





1

<b>GEV No.</b>	511282	<b>Ref. No.</b>	161310
<b>description</b>	air trap		
<b>For models:</b>	SP3		
<b>spare parts for</b>	511282		
	<b>GEV No.</b>	511283	<b>Ref. No.</b> 200927
	flat gasket rubber ED ø 30mm ID ø 20mm thickness 2mm Qty 1 pcs		

<b>spare parts for</b>	511282		
	<b>GEV No.</b>	511284	<b>Ref. No.</b> 270121
	nut		
	<b>GEV No.</b>	511285	<b>Ref. No.</b> —
	hose ED ø 9.5mm ID ø 5mm L 1075mm equiv. no. 161311		
	<b>GEV No.</b>	511286	<b>Ref. No.</b> 450143
	hose clamp ø 38mm wire gauge ø 3.2mm Qty 1 pcs		
<b>accessories for</b>	511282		
	<b>GEV No.</b>	511283	<b>Ref. No.</b> 200927
	flat gasket rubber ED ø 30mm ID ø 20mm thickness 2mm Qty 1 pcs		
	<b>GEV No.</b>	511284	<b>Ref. No.</b> 270121
	nut		
	<b>GEV No.</b>	511285	<b>Ref. No.</b> —
	hose ED ø 9.5mm ID ø 5mm L 1075mm equiv. no. 161311		
	<b>GEV No.</b>	511286	<b>Ref. No.</b> 450143
	hose clamp ø 38mm wire gauge ø 3.2mm Qty 1 pcs		



1

<b>GEV No.</b>	518488	<b>Ref. No.</b>	107005
<b>description</b>	air trap		
<b>For models:</b>	811001, 811002, 811003, 812001, 812002, 812003, 812004, 812005, 812006, 812007, 812008, 812009, 812010, 915234, 915235, 915236, 915237, 915460, 915461, 915462, 915463, 915464, 915465		
<b>accessories for</b>	518488		
	<b>GEV No.</b>	504618	<b>Ref. No.</b> —
	O-ring EPDM thickness 2.62mm ID ø 15.54mm Qty 1 pcs		
	<b>GEV No.</b>	510075	<b>Ref. No.</b> 437019
	flat gasket rubber ED ø 22mm ID ø 13mm thickness 1.5mm Qty 1 pcs		
	<b>GEV No.</b>	510106	<b>Ref. No.</b> 468029
	hose connector for air trap		





1

<b>GEV No.</b>	503162	<b>Ref. No.</b>	01-240372-001
<b>description</b>	air trap complete L 77mm W 83mm connection ø 24mm hose ø 6mm		
<b>For models:</b>	811011, 811012, 811013, 811014, 811015, 812011, 812012, 812013, 812014, 812015, 813002, 813003, 813004		
<b>accessories for</b>	503162		
	<b>GEV No.</b>	520027	<b>Ref. No.</b> 00-324402-005 00-324402-014 143013
	PVC hose ID ø 4mm ED ø 7mm L 10m thickness 1.5mm t.max. 60°C transparent		





			
1			
<b>GEV No.</b>	518200	<b>Ref. No.</b>	984005
<b>description</b>	air trap ø 34mm H 78mm hose ø 6mm plastic		
<b>For models:</b>	811001, 811002, 811003, 812001, 812002, 812003, 812004, 812005, 812006, 812007, 812008, 812009, 812010, 813001, 915234, 915235, 915236, 915237, 915460, 915461, 915462, 915463, 915464, 915465		
<b>spare parts for</b>	518200		
	<b>GEV No.</b>	504618	<b>Ref. No.</b> —
	O-ring EPDM thickness 2.62mm ID ø 15.54mm Qty 1 pcs		
	<b>GEV No.</b>	510075	<b>Ref. No.</b> 437019
	flat gasket rubber ED ø 22mm ID ø 13mm thickness 1.5mm Qty 1 pcs		
	<b>GEV No.</b>	510106	<b>Ref. No.</b> 468029
	hose connector for air trap		

			
1			
<b>GEV No.</b>	511286	<b>Ref. No.</b>	450143
<b>description</b>	hose clamp ø 38mm wire gauge ø 3.2mm Qty 1 pcs		
<b>For models:</b>	SP3		

			
1			
<b>GEV No.</b>	510760	<b>Ref. No.</b>	161317
<b>description</b>	hose connector		
<b>For models:</b>	SP1, SP2-12, SP2-S12		

air trap accessories			
			
1			
<b>GEV No.</b>	510761	<b>Ref. No.</b>	200944
<b>description</b>	flat gasket rubber D1 ø 38mm D2 ø 25mm thickness 2mm Qty 1 pcs		
<b>For models:</b>	SP1, SP2-12, SP2-S12		

			
1			
<b>GEV No.</b>	510106	<b>Ref. No.</b>	468029
<b>description</b>	hose connector for air trap		
<b>For models:</b>	811001, 811002, 811003, 812001, 812002, 812003, 812004, 812005, 812006, 812007, 812008, 812009, 812010, 915234, 915235, 915236, 915237, 915460, 915461, 915462, 915463, 915464, 915465		

			
1			
<b>GEV No.</b>	510877	<b>Ref. No.</b>	200415
<b>description</b>	flat gasket rubber ED ø 18mm ID ø 10mm thickness 3mm Qty 1 pcs		
<b>For models:</b>	SP1, SP2-12, SP2-S12		

			
1			
<b>GEV No.</b>	511284	<b>Ref. No.</b>	270121
<b>description</b>	nut		
<b>For models:</b>	SP3		

			
1			
<b>GEV No.</b>	510075	<b>Ref. No.</b>	437019
<b>description</b>	flat gasket rubber ED ø 22mm ID ø 13mm thickness 1.5mm Qty 1 pcs		
<b>For models:</b>	811001, 811002, 811003, 812001, 812002, 812003, 812004, 812005, 812006, 812007, 812008, 812009, 812010, 915234, 915235, 915236, 915237, 915460, 915461, 915462, 915463, 915464, 915465		

pipes			
			
1			
<b>GEV No.</b>	513047	<b>Ref. No.</b>	00-883512-001
<b>description</b>	pipe 14x2.0mm tube ø 14mm L 933mm PE-Xb		
<b>For models:</b>	813002, 813003, 813004		

			
1			
<b>GEV No.</b>	511283	<b>Ref. No.</b>	200927
<b>description</b>	flat gasket rubber ED ø 30mm ID ø 20mm thickness 2mm Qty 1 pcs		
<b>For models:</b>	SP3		



backflow preventers

backflow preventers





<b>GEV No.</b>	504265	<b>Ref. No.</b>	620535
<b>description</b>	backflow preventer		
<b>For models:</b>	SP1, SP2-12, SP2-S12, SP3		





<b>GEV No.</b>	511672	<b>Ref. No.</b>	00-775759-001	
<b>description</b>	backflow preventer			
<b>For models:</b>	811011, 811012, 811013, 812011, 812012, 812013, 813002, 813004			
<b>accessories for</b>	511672			
	<b>GEV No.</b>	502228	<b>Ref. No.</b>	00-324384-000
	nut for back flow restrictor ø 35mm WS 30			
	<b>GEV No.</b>	507495	<b>Ref. No.</b>	00-775305-001
	gasket ED ø 34mm ID ø 25.5mm thickness 2.5mm Qty 1 pcs			



<b>GEV No.</b>	511673	<b>Ref. No.</b>	00-883817-001	
<b>description</b>	backflow preventer			
<b>For models:</b>	813003			
<b>spare parts for</b>	511673			
	<b>GEV No.</b>	511680	<b>Ref. No.</b>	00-324313-002
	ball for back flow restrictor ø 8mm			
<b>accessories for</b>	511673			
	<b>GEV No.</b>	511675	<b>Ref. No.</b>	00-775531-001
	blind plug for back flow restrictor ø 10mm L 26mm rubber			



<b>GEV No.</b>	511674	<b>Ref. No.</b>	01-240142-001	
<b>description</b>	backflow preventer			
<b>For models:</b>	811012, 811013, 811015, 812012, 812013, 812015			
<b>spare parts for</b>	511674			
	<b>GEV No.</b>	511680	<b>Ref. No.</b>	00-324313-002
	ball for back flow restrictor ø 8mm			
<b>accessories for</b>	511674			
	<b>GEV No.</b>	511675	<b>Ref. No.</b>	00-775531-001
	blind plug for back flow restrictor ø 10mm L 26mm rubber			



<b>GEV No.</b>	518297	<b>Ref. No.</b>	144011
<b>description</b>	backflow preventer		
<b>For models:</b>	812001, 812002, 812003, 812004, 812005, 812006, 812007, 812008, 812009, 812010, 915234, 915235, 915236, 915237, 915460, 915461, 915463, 915464		



<b>GEV No.</b>	518486	<b>Ref. No.</b>	144010
<b>description</b>	backflow preventer connection 1/2" dishwasher hose ø 12mm		
<b>For models:</b>	811003, 813001		





1			
<b>GEV No.</b>	524457	<b>Ref. No.</b>	00-775540-001 01-297510-002
<b>description</b>	backflow preventer kit		
<b>For models:</b>	811014, 811015, 812014, 812015, 813002, 813003, 813004		
<b>spare parts for</b>	524457		
	<b>GEV No.</b>	<b>Ref. No.</b>	
	502228	00-324384-000	
	nut for back flow restrictor ø 35mm WS 30		
<b>accessories for</b>	524457		
	<b>GEV No.</b>	<b>Ref. No.</b>	
	520015	00-775559-007 00-775559-008 00-775559-013 00-775559-016 143004	
	supply hose ID ø 10mm ED ø 17mm L 5m operating p. 20bar burst p. 60bar t.max. 95°C grey Qty 5m		

1			
<b>GEV No.</b>	502228	<b>Ref. No.</b>	00-324384-000
<b>description</b>	nut for back flow restrictor ø 35mm WS 30		
<b>For models:</b>	811011, 811012, 811013, 811014, 811015, 812011, 812012, 812013, 812014, 812015, 813002, 813003, 813004		

miscellaneous

1			
<b>GEV No.</b>	518241	<b>Ref. No.</b>	480087
<b>description</b>	cover		
<b>For models:</b>	811003		

non-return valves

1			
<b>GEV No.</b>	520886	<b>Ref. No.</b>	R65110640
<b>description</b>	non-return valve plastic total length 67mm		
<b>For models:</b>	212010, 212011, 212012, 212013		

1			
<b>GEV No.</b>	510349	<b>Ref. No.</b>	160755
<b>description</b>	plug D1 ø 87mm mounting ø 72mm ID ø 60mm		
<b>For models:</b>	SP1		
<b>accessories for</b>	510349		
	<b>GEV No.</b>	<b>Ref. No.</b>	
	510947	200489	
	flat gasket rubber ED ø 85mm ID ø 73mm thickness 2mm Qty 1 pcs equiv. no. 200489 suitable for COMENDA		

accessories

1			
<b>GEV No.</b>	511680	<b>Ref. No.</b>	00-324313-002
<b>description</b>	ball for back flow restrictor ø 8mm		
<b>For models:</b>	811012, 811013, 811015, 812015		

1			
<b>GEV No.</b>	524046	<b>Ref. No.</b>	441139
<b>description</b>	vibration damper L 40mm W 25mm H 25mm for pump		
<b>For models:</b>	SP3		

1			
<b>GEV No.</b>	511675	<b>Ref. No.</b>	00-775531-001
<b>description</b>	blind plug for back flow restrictor ø 10mm L 26mm rubber		
<b>For models:</b>	811012, 811013, 812012, 812013, 813002, 813003		

1			
<b>GEV No.</b>	511676	<b>Ref. No.</b>	00-324097-000
<b>description</b>	water inlet for tank plastic D1 ø 18mm for HOBART		
<b>For models:</b>	813003		

door mechanics

bolts

			
1			
<b>GEV No.</b>	502219	<b>Ref. No.</b>	01-240151-001
<b>description</b>	door bolt ø 8mm L 15mm thread M5 stainless steel		
<b>For models:</b>	811011, 811012, 811013, 811014, 811015, 812011, 812012, 812013, 812014, 812015		

springs

tension springs

			
1			
<b>GEV No.</b>	510064	<b>Ref. No.</b>	450288
<b>description</b>	tension spring ø 13mm total length 78mm wire gauge ø 2.5mm L1 14mm L2 50mm L3 14mm		
<b>For models:</b>	SP2-12, SP2-S12		

linkage

			
1			
<b>GEV No.</b>	518355	<b>Ref. No.</b>	304021
<b>description</b>	door pin stop rod		
<b>For models:</b>	812001, 812002, 812003, 812004, 812005, 812006, 812007, 812008, 812009, 812010, 915234, 915235, 915236, 915237, 915460, 915461, 915462, 915463, 915464, 915465		

sliding plates

			
1			
<b>GEV No.</b>	518356	<b>Ref. No.</b>	307003
<b>description</b>	sliding plate sliding plate		
<b>For models:</b>	812001, 812002, 812003, 812004, 812005, 812006, 812007, 812008, 812009, 812010, 915234, 915235, 915236, 915237, 915460, 915461, 915462, 915463, 915464, 915465		

			
1			
<b>GEV No.</b>	518353	<b>Ref. No.</b>	307005
<b>description</b>	stop plastic for door L 60mm W 12.5mm H 10mm		
<b>For models:</b>	811003		



hinges

			
1			
<b>GEV No.</b>	518301	<b>Ref. No.</b>	311019
<b>description</b>	door hinge mounting pos. left/right		
<b>For models:</b>	812001, 812002, 812003, 812004, 812005, 812006, 812007, 812008, 812009, 812010, 915234, 915235, 915236, 915237, 915460, 915461, 915462, 915463, 915464, 915465		

			
1			
<b>GEV No.</b>	503171	<b>Ref. No.</b>	R00098
<b>description</b>	hinge mounting pos. bottom left/right		
<b>For models:</b>	611015		

			
1			
<b>GEV No.</b>	510090	<b>Ref. No.</b>	449036
<b>description</b>	spring door lock spring mounting pos. door lock		
<b>For models:</b>	811001, 811002, 811003		

hinge camps

			
1			
<b>GEV No.</b>	502225	<b>Ref. No.</b>	01-294108-001
<b>description</b>	hinge block plastic T1: M5		
<b>For models:</b>	811011, 811012, 811013, 811014, 811015, 812011, 812012, 812013, 812014, 812015		
<b>accessories for</b>	502225		
	<b>GEV No.</b>	502219	<b>Ref. No.</b> 01-240151-001
	 door bolt ø 8mm L 15mm thread M5 stainless steel		



 <p>1</p>			
<b>GEV No.</b>	518262	<b>Ref. No.</b>	311009
<b>description</b>	hinge camp mounting pos. left		
<b>For models:</b>	811001, 811002, 811003		

 <p>1</p>			
<b>GEV No.</b>	518261	<b>Ref. No.</b>	311008
<b>description</b>	hinge camp mounting pos. right		
<b>For models:</b>	811001, 811002, 811003		

<p>hinge pins</p>  <p>1</p>			
<b>GEV No.</b>	518264	<b>Ref. No.</b>	325034
<b>description</b>	hinge pin hinge pin		
<b>For models:</b>	811003		

 <p>1</p>			
<b>GEV No.</b>	518267	<b>Ref. No.</b>	325036
<b>description</b>	hinge pin hinge pin		
<b>For models:</b>	812001, 812002, 812003, 812004, 812005, 812006, 812007, 812008, 812009, 812010, 915234, 915235, 915236, 915237, 915460, 915461, 915462, 915463, 915464, 915465		

 <p>1</p>			
<b>GEV No.</b>	511628	<b>Ref. No.</b>	341927
<b>description</b>	hinge pin ø 6mm L 60mm thread M6x1 stainless steel		
<b>For models:</b>	SP1, SP2-12, SP2-S12		

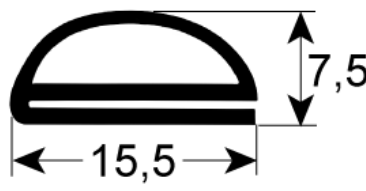
<p>door seals</p>  <p>1</p>			
<b>GEV No.</b>	511577	<b>Ref. No.</b>	200217
<b>description</b>	door seal L 595mm W 15.5mm H 7mm Qty 1 suitable for COMENDA		
<b>For models:</b>	SP2-12, SP2-S12		

<p>door bumpers</p>  <p>1</p>			
<b>GEV No.</b>	518066	<b>Ref. No.</b>	417041
<b>description</b>	door bumper end stop		
<b>For models:</b>	812001, 812002, 812003, 812004, 812005, 812006, 812007, 812008, 812009, 812010, 915234, 915235, 915236, 915237, 915460, 915461, 915462, 915463, 915464, 915465		

 <p>1</p>			
<b>GEV No.</b>	505295	<b>Ref. No.</b>	01-240741-001
<b>description</b>	door bumper H 7.5mm L 17mm W 10mm		
<b>For models:</b>	811011, 811012, 811013, 811014, 811015, 812011, 812012, 812013, 812014, 812015		

 <p>1</p>			
<b>GEV No.</b>	518354	<b>Ref. No.</b>	028078
<b>description</b>	door bumper slotted hole disc		
<b>For models:</b>	811003		

<p>door shafts</p>  <p>1</p>			
<b>GEV No.</b>	518263	<b>Ref. No.</b>	304017
<b>description</b>	door shaft		
<b>For models:</b>	811001, 811002		

<p>locks</p>  <p>1</p>			
<b>GEV No.</b>	518242	<b>Ref. No.</b>	329012
<b>description</b>	door catch		
<b>For models:</b>	811001, 811002, 811003		

			
1			
<b>GEV No.</b>	510008	<b>Ref. No.</b>	180506
<b>description</b>	door catch for dishwasher		
<b>For models:</b>	SP1, SP2-12, SP2-S12		

			
1			
<b>GEV No.</b>	512287	<b>Ref. No.</b>	01-240763-001
<b>description</b>	door catch L 51mm W 35mm H 13mm		
<b>For models:</b>	811011, 811012, 811013, 811014, 811015, 812011, 812012, 812013, 812014, 812015		

			
1			
<b>GEV No.</b>	513138	<b>Ref. No.</b>	994012
<b>description</b>	door catch with nut door locking catch		
<b>For models:</b>	812001, 812002, 812003, 812004, 812005, 812006, 812007, 812008, 812009, 812010, 915234, 915235, 915236, 915237, 915460, 915461, 915462, 915463, 915464, 915465		

			
1			
<b>GEV No.</b>	692100	<b>Ref. No.</b>	180508
<b>description</b>	snap lock L 36mm ø 17mm		
<b>For models:</b>	SP2-12, SP2-S12		

			
1			
<b>GEV No.</b>	518298	<b>Ref. No.</b>	325066
<b>description</b>	spigot door catch		
<b>For models:</b>	812001, 812002, 812003, 812004, 812005, 812006, 812007, 812008, 812009, 812010, 915234, 915235, 915236, 915237, 915460, 915461, 915462, 915463, 915464, 915465		

<b>miscellaneous</b>			
			
1			
<b>GEV No.</b>	513203	<b>Ref. No.</b>	80277
<b>description</b>	bracket for lever		
<b>For models:</b>	813001		

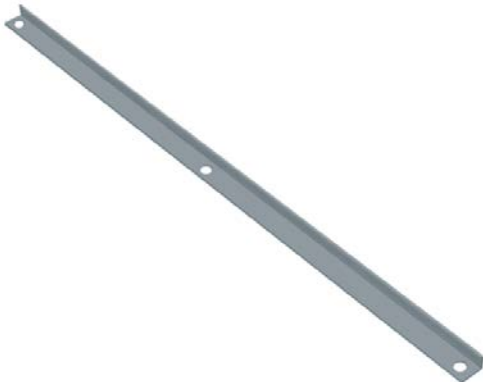
			
1			
<b>GEV No.</b>	518247	<b>Ref. No.</b>	033291
<b>description</b>	fastening angle for door seal		
<b>For models:</b>	811001, 811002		

			
1			
<b>GEV No.</b>	518249	<b>Ref. No.</b>	033294
<b>description</b>	fastening angle for door seal		
<b>For models:</b>	811003		

			
1			
<b>GEV No.</b>	519524	<b>Ref. No.</b>	00-226640-000
<b>description</b>	handle for door mechanism PVC ø 23mm L 122mm		
<b>For models:</b>	813002, 813003, 813004		

			
1			
<b>GEV No.</b>	513204	<b>Ref. No.</b>	80275
<b>description</b>	opposite support for spring ø 28mm L 100mm		
<b>For models:</b>	813001		

			
1			
<b>GEV No.</b>	504376	<b>Ref. No.</b>	01-240176-001
<b>description</b>	slide bearing plastic ED ø 15mm ID ø 8mm D2 ø 10mm		
<b>For models:</b>	811011, 811012, 811013, 811014, 811015, 812011, 812012, 812013, 812014, 812015		

			
1			
<b>GEV No.</b>	502227	<b>Ref. No.</b>	00-883931-001
<b>description</b>	spanner for tension spring ø 10mm L 285mm thread M10x1.5		
<b>For models:</b>	813002, 813003, 813004		

			
1			
<b>GEV No.</b>	502218	<b>Ref. No.</b>	00-883947-001
<b>description</b>	spare parts kit for door mechanism door link with door lift handle		
<b>For models:</b>	813002, 813003, 813004		

			
1			
<b>GEV No.</b>	519523	<b>Ref. No.</b>	01-240764-001
<b>description</b>	spring for door latch L 45mm W 25mm		
<b>For models:</b>	811011, 811012, 811013, 811014, 811015, 812011, 812012, 812013, 812014, 812015		

screw connections			
			
1			
<b>GEV No.</b>	510117	<b>Ref. No.</b>	160788
<b>description</b>	end cap thread M10x1.5 WS 23 plastic Qty 1 pcs thread L 15mm		
<b>For models:</b>	SP1, SP3		

			
1			
<b>GEV No.</b>	511576	<b>Ref. No.</b>	160789
<b>description</b>	nut thread M10x1.5 H 5mm WS 19 plastic Qty 1 pcs		
<b>For models:</b>	SP1, SP3		

			
1			
<b>GEV No.</b>	505288	<b>Ref. No.</b>	00-695664-004
<b>description</b>	nut thread M25x1.5 H 6mm WS 30 Qty 1 pcs for cable gland		
<b>For models:</b>	811011, 811012, 811013, 811014, 811015, 812011, 812012, 812013, 812014, 812015		

washing and rinsing systems			
			
1			
<b>GEV No.</b>	510231	<b>Ref. No.</b>	190675
<b>description</b>	bush for rinse arm ø 23mm H 20mm		
<b>For models:</b>	SP3		

			
1			
<b>GEV No.</b>	511355	<b>Ref. No.</b>	190645
<b>description</b>	bush for wash arm		
<b>For models:</b>	SP2-12, SP2-S12		

			
1			
<b>GEV No.</b>	512492	<b>Ref. No.</b>	191100
<b>description</b>	collector for rinsing L 60mm W 70mm connection ø 13mm suitable for COMENDA		
<b>For models:</b>	SP3		



1

<b>GEV No.</b>	507497	<b>Ref. No.</b>	00-883481-001
<b>description</b>	connection wash pipe $\varnothing$ 47mm connection 66x36mm		
<b>For models:</b>	813002, 813003, 813004		



1

<b>GEV No.</b>	513271	<b>Ref. No.</b>	412028
<b>description</b>	connector holder grey		
<b>For models:</b>	811001, 811002, 811003		



1

<b>GEV No.</b>	520702	<b>Ref. No.</b>	WY25782
<b>description</b>	end cap thread 1/4" brass WS 16		
<b>For models:</b>	742001, 742002, 742003, 742004		



1

<b>GEV No.</b>	518461	<b>Ref. No.</b>	303029
<b>description</b>	flange for wash arm support		
<b>For models:</b>	812001, 812002, 812003, 812004, 812005, 812006, 812007, 812008, 812009, 812010, 915234, 915235, 915236, 915237, 915460, 915461, 915462, 915463, 915464, 915465		



1

<b>GEV No.</b>	517403	<b>Ref. No.</b>	00-172986-035
<b>description</b>	flat gasket EPDM ED $\varnothing$ 71mm ID $\varnothing$ 61mm thickness 1.5mm Qty 1 pcs		
<b>For models:</b>	813002, 813003, 813004		



1

<b>GEV No.</b>	518240	<b>Ref. No.</b>	437078
<b>description</b>	flat gasket rubber ED $\varnothing$ 33mm ID $\varnothing$ 17mm thickness 1.5mm Qty 1 pcs		
<b>For models:</b>	811001, 811002, 811003		



1

<b>GEV No.</b>	518444	<b>Ref. No.</b>	199051
<b>description</b>	flow control valve for wash arm $\varnothing$ 16mm H 20mm		
<b>For models:</b>	811003		



1

<b>GEV No.</b>	513277	<b>Ref. No.</b>	437080
<b>description</b>	gasket		
<b>For models:</b>	811003		



1

<b>GEV No.</b>	511579	<b>Ref. No.</b>	200955
<b>description</b>	gasket for wash arm support ID $\varnothing$ 36mm thickness 3mm		
<b>For models:</b>	SP3		



1

<b>GEV No.</b>	518071	<b>Ref. No.</b>	80178
<b>description</b>	gasket for wash arm support L 109mm W 68mm		
<b>For models:</b>	813001		



1

<b>GEV No.</b>	518116	<b>Ref. No.</b>	00-172986-019
<b>description</b>	gasket for wash arm support rubber $\varnothing$ 60mm ID $\varnothing$ 47mm thickness 1mm		
<b>For models:</b>	811011, 811012, 811013, 811014, 811015, 812011, 812012, 812013, 812014, 812015		





1

<b>GEV No.</b>	518238	<b>Ref. No.</b>	143173
<b>description</b>	manifold $\varnothing$ 12mm L 98mm		
<b>For models:</b>	813001		





 <p>1</p>			
<b>GEV No.</b>	518144	<b>Ref. No.</b>	00-883496-001
<b>description</b>	nut for wash arm support ED ø 74mm WS 65 hole ø 36mm		
<b>For models:</b>	813002, 813003, 813004		

 <p>1</p>			
<b>GEV No.</b>	518434	<b>Ref. No.</b>	429050
<b>description</b>	rinse arm support mounting pos. upper		
<b>For models:</b>	811001, 811002, 811003		

 <p>1</p>			
<b>GEV No.</b>	518139	<b>Ref. No.</b>	01-240021-001
<b>description</b>	nut for wash arm support ø 60mm		
<b>For models:</b>	811011, 811012, 811013, 811014, 811015, 812011, 812012, 812013, 812014, 812015		

 <p>1</p>			
<b>GEV No.</b>	518443	<b>Ref. No.</b>	468165
<b>description</b>	rinse arm support mounting pos. upper		
<b>For models:</b>	811001, 811002, 811003		

 <p>1</p>			
<b>GEV No.</b>	518596	<b>Ref. No.</b>	417038
<b>description</b>	nut wash pipe		
<b>For models:</b>	811003		

 <p>1</p>			
<b>GEV No.</b>	518125	<b>Ref. No.</b>	143240
<b>description</b>	rinse hose ø 17.5mm		
<b>For models:</b>	812001, 812002, 812003, 812004, 812005, 812006, 812007, 812008, 812009, 812010, 915234, 915235, 915236, 915237, 915460, 915461, 915462, 915463, 915464, 915465		

 <p>1</p>			
<b>GEV No.</b>	511668	<b>Ref. No.</b>	190674
<b>description</b>	reducer for wash pipe ø 18mm		
<b>For models:</b>	SP3		

 <p>1</p>			
<b>GEV No.</b>	510256	<b>Ref. No.</b>	332526
<b>description</b>	rinse pipe mounting pos. upper ø 8mm L 300mm S5		
<b>For models:</b>	SP3		

 <p>1</p>			
<b>GEV No.</b>	513259	<b>Ref. No.</b>	111026
<b>description</b>	rinse arm support mounting pos. upper		
<b>For models:</b>	811003		

 <p>1</p>			
<b>GEV No.</b>	518148	<b>Ref. No.</b>	01-240097-001
<b>description</b>	rinse pipe ø 17mm L 60mm		
<b>For models:</b>	811011, 811012, 811013, 811014, 811015, 812011, 812012, 812013, 812014, 812015		

 <p>1</p>			
<b>GEV No.</b>	518149	<b>Ref. No.</b>	00-883479-002
<b>description</b>	rinse pipe ø 17mm L 69mm		
<b>For models:</b>	813002, 813003, 813004		

			
1			
<b>GEV No.</b>	511185	<b>Ref. No.</b>	261005
<b>description</b>	screw for wash arm support mounting pos. upper		
<b>For models:</b>	SP2-12, SP2-S12		

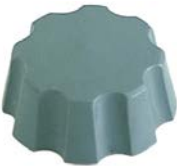
			
1			
<b>GEV No.</b>	518003	<b>Ref. No.</b>	447128
<b>description</b>	screw cap		
<b>For models:</b>	812001, 812002, 812003, 812004, 812005, 812006, 812007, 812008, 812009, 812010, 915234, 915235, 915236, 915237, 915460, 915461, 915462, 915463, 915464, 915465		

			
1			
<b>GEV No.</b>	513127	<b>Ref. No.</b>	80285
<b>description</b>	screw connection		

			
1			
<b>GEV No.</b>	513286	<b>Ref. No.</b>	80281
<b>description</b>	screw connection		
<b>For models:</b>	813001		

			
1			
<b>GEV No.</b>	510011	<b>Ref. No.</b>	429008
<b>description</b>	screw connection plastic		
<b>For models:</b>	811001, 811002, 811003		

			
1			
<b>GEV No.</b>	518119	<b>Ref. No.</b>	00-774072-001
<b>description</b>	slide ring PTFE ED ø 19mm ID ø 14.5mm thickness 0.5mm for rinse arm Qty 1 pcs suitable for HOBART		
<b>For models:</b>	811011, 811012, 811013, 811014, 811015, 812011, 812012, 812013, 812014, 812015, 813002, 813003, 813004		

			
1			
<b>GEV No.</b>	518120	<b>Ref. No.</b>	00-774072-002
<b>description</b>	slide ring PTFE ED ø 21mm ID ø 16mm thickness 0.5mm for rinse arm Qty 1 pcs		
<b>For models:</b>	811011, 811012, 811013, 811014, 811015, 812011, 812012, 812013, 812014, 812015, 813002, 813003, 813004		

			
1			
<b>GEV No.</b>	511678	<b>Ref. No.</b>	00-774072-007
<b>description</b>	slide ring PTFE ED ø 24mm ID ø 13mm thickness 1mm for rinse arm Qty 1 pcs		
<b>For models:</b>	811011, 811012, 811013, 811014, 811015, 812011, 812012, 812013, 812014, 812015, 813002, 813003, 813004		

			
1			
<b>GEV No.</b>	513270	<b>Ref. No.</b>	80316
<b>description</b>	throttle disc		
<b>For models:</b>	813001		

			
1			
<b>GEV No.</b>	518337	<b>Ref. No.</b>	199039
<b>description</b>	throttle disc		
<b>For models:</b>	915234, 915235, 915236, 915237		

			
1			
<b>GEV No.</b>	518458	<b>Ref. No.</b>	199045
<b>description</b>	throttle disc		
<b>For models:</b>	812001, 812002, 812003, 812004, 812005, 812006, 812007, 812008, 812009, 812010, 915234, 915235, 915236, 915237, 915460, 915461, 915462, 915463, 915464, 915465		









			
1			
<b>GEV No.</b>	518459	<b>Ref. No.</b>	199043
<b>description</b>	throttle disc		
<b>For models:</b>	812001, 812002, 812003, 812004, 812005, 812006, 812007, 812008, 812009, 812010, 915234, 915235, 915236, 915237, 915460, 915461, 915462, 915463, 915464, 915465		



			
1			
<b>GEV No.</b>	510112	<b>Ref. No.</b>	454002
<b>description</b>	Thumb screw thread M10 thread L 10mm ø 22mm H 4.5mm SS		
<b>For models:</b>	812001, 812002, 812003, 812004, 812005, 812006, 812007, 812008, 812009, 812010, 915234, 915235, 915236, 915237, 915460, 915461, 915462, 915463, 915464, 915465		

			
1			
<b>GEV No.</b>	511679	<b>Ref. No.</b>	00-324071-000
<b>description</b>	T-piece connection 17.5mm plastic L 80mm W 40mm connection 1: 13.5mm connection 2: 13.5mm suitable for HOBART		
<b>For models:</b>	811011, 811012, 811013, 811014, 811015, 813002, 813003, 813004		
<b>accessories for</b>	511679		
	<b>GEV No.</b>	520573	<b>Ref. No.</b> 00-324510-202
	hose clamp ø 20mm wire gauge ø 2mm Qty 1 pcs		

			
1			
<b>GEV No.</b>	510338	<b>Ref. No.</b>	170701
<b>description</b>	union nut dosing pump thread 1/2" ø 32mm H 15mm for dosing pump		
<b>For models:</b>	SP1, SP2-12, SP2-S12, SP3		

			
1			
<b>GEV No.</b>	518484	<b>Ref. No.</b>	449045
<b>description</b>	wash arm support for stationary arms mounting pos. upper		
<b>For models:</b>	811003		



			
1			
<b>GEV No.</b>	513714	<b>Ref. No.</b>	80237
<b>description</b>	wash pipe		
<b>For models:</b>	813001		
<b>spare parts for</b>	513714		
	<b>GEV No.</b>	518141	<b>Ref. No.</b> —
	wash arm support thread M46x2 ø 44mm ID ø 39mm L 112.5mm W 86mm hole ø 12mm		



			
1			
<b>GEV No.</b>	511670	<b>Ref. No.</b>	00-883529-001
<b>description</b>	wash pipe ø 28x56mm stainless steel L-shape L1 685mm L2 275mm		
<b>For models:</b>	813002, 813003, 813004		
<b>accessories for</b>	511670		
	<b>GEV No.</b>	507497	<b>Ref. No.</b> 00-883481-001
	connection wash pipe ø 47mm connection 66x36mm		

washing and rinsing systems (sorted by producer)

COOKMAX



wash pipes

			
1			
<b>GEV No.</b>	513714	<b>Ref. No.</b>	80237
<b>description</b>	wash pipe		
<b>For models:</b>	813001		
<b>spare parts for</b>	513714		
	<b>GEV No.</b>	518141	<b>Ref. No.</b> —
	wash arm support thread M46x2 ø 44mm ID ø 39mm L 112.5mm W 86mm hole ø 12mm		

			
1			
<b>GEV No.</b>	513715	<b>Ref. No.</b>	115113
<b>description</b>	wash pipe		
<b>For models:</b>	812001, 812002, 812003, 812004, 812005, 812006, 812007, 812008, 812009, 812010, 915234, 915235, 915236, 915237, 915460, 915461, 915462, 915463, 915464, 915465		
<b>accessories for</b>	513715		
	<b>GEV No.</b>	518339	<b>Ref. No.</b> 437064
	gasket D2 ø 50mm thickness 2mm with 3 screw holes wash arm support equiv. no. 437064 suitable for COLGED hole ø 50mm hole distance 67mm		
	<b>GEV No.</b>	518461	<b>Ref. No.</b> 303029
	flange for wash arm support		







1



<b>GEV No.</b>	524658	<b>Ref. No.</b>	01-294029-001
<b>description</b>	rinse arm L 395mm nozzles 7 mounting ø 14mm with rinse arm shaft		
<b>For models:</b>	811011, 811012, 811013, 811014, 811015		
<b>spare parts for</b>	524658		
	<b>GEV No.</b>	511678	<b>Ref. No.</b> 00-774072-007
	slide ring PTFE ED ø 24mm ID ø 13mm thickness 1mm for rinse arm Qty 1 pcs		
	<b>GEV No.</b>	518119	<b>Ref. No.</b> 00-774072-001
	slide ring PTFE ED ø 19mm ID ø 14.5mm thickness 0.5mm for rinse arm Qty 1 pcs suitable for HOBART		
	<b>GEV No.</b>	518120	<b>Ref. No.</b> 00-774072-002
	slide ring PTFE ED ø 21mm ID ø 16mm thickness 0.5mm for rinse arm Qty 1 pcs		









1



<b>GEV No.</b>	519484	<b>Ref. No.</b>	430343
<b>description</b>	rinse arm L 495mm mounting pos. upper/lower nozzles 6 mounting ø 12mm		
<b>For models:</b>	SP3		
<b>spare parts for</b>	519484		
	<b>GEV No.</b>	510307	<b>Ref. No.</b> 261009
	Thumb screw thread M6 H 3mm thread L 8mm ø 28mm SS		
	<b>GEV No.</b>	510813	<b>Ref. No.</b> 190641
	bush for rinse arm		
	<b>GEV No.</b>	511236	<b>Ref. No.</b> 170963
	nozzle for rinse arm		
	<b>GEV No.</b>	511237	<b>Ref. No.</b> 200850
	O-ring EPDM thickness 1mm ID ø 7mm Qty 1 pcs		
	<b>GEV No.</b>	511238	<b>Ref. No.</b> 450236
	opposite support for rinse jet		
	<b>GEV No.</b>	511242	<b>Ref. No.</b> 450218
	connector holder L 30mm H 16mm W 22mm		

1



<b>GEV No.</b>	513149	<b>Ref. No.</b>	80370
<b>description</b>	rinse arm L 510mm nozzles 5 mounting ø 14mm mounting pos. upper/lower		
<b>For models:</b>	813001		
<b>spare parts for</b>	513149		
	<b>GEV No.</b>	513157	<b>Ref. No.</b> 412030
	connector holder		
	<b>GEV No.</b>	513221	<b>Ref. No.</b> 129059 80371
	rinse arm boss		
	<b>GEV No.</b>	513273	<b>Ref. No.</b> 80375
	rinse arm L 240mm nozzles 2 mounting ø 10mm mounting pos. bottom left		
	<b>GEV No.</b>	513723	<b>Ref. No.</b> 80376
	rinse arm L 240mm nozzles 3 mounting pos. upper/lower		
	<b>GEV No.</b>	518276	<b>Ref. No.</b> —
	rinse jet		
	<b>GEV No.</b>	518281	<b>Ref. No.</b> 454005
	knurled nut thread M6 SS ø 20mm H 4mm		
	<b>GEV No.</b>	518419	<b>Ref. No.</b> 926132
	end cap for rinse arm		
	<b>GEV No.</b>	528485	<b>Ref. No.</b> 456060
	O-ring EPDM thickness 1.78mm ID ø 6.07mm Qty 1 pcs		

1



















<b>GEV No.</b>	524659	<b>Ref. No.</b>	01-240096-003
<b>description</b>	rinse arm L 515mm nozzles 8 mounting ø 16mm with rinse arm shaft edition FX		
<b>For models:</b>	812011, 812012, 812013, 812014, 812015, 813002, 813003, 813004		
<b>spare parts for</b>	524659		
	<b>GEV No.</b>	511678	<b>Ref. No.</b> 00-774072-007
	slide ring PTFE ED ø 24mm ID ø 13mm thickness 1mm for rinse arm Qty 1 pcs		
	<b>GEV No.</b>	518119	<b>Ref. No.</b> 00-774072-001
	slide ring PTFE ED ø 19mm ID ø 14.5mm thickness 0.5mm for rinse arm Qty 1 pcs suitable for HOBART		
	<b>GEV No.</b>	518120	<b>Ref. No.</b> 00-774072-002
	slide ring PTFE ED ø 21mm ID ø 16mm thickness 0.5mm for rinse arm Qty 1 pcs		

Table continues overleaf









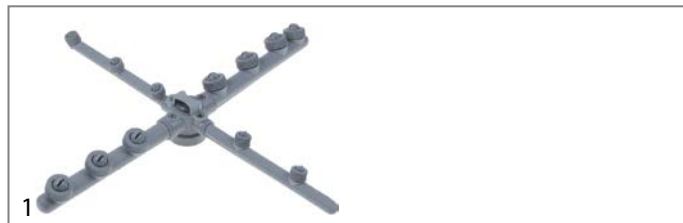



<b>spare parts for</b> 524659			
	<b>GEV No.</b>	518147	<b>Ref. No.</b> 01-240095-001
	rinse arm shaft		
	<b>GEV No.</b>	518152	<b>Ref. No.</b> 01-240205-001
	knurled nut thread M12x1 ø 32mm H 3mm mounting pos. upper/lower SS for wash arm ID ø 11.5mm ED ø 32mm thickness 3mm		



<b>GEV No.</b>	513712	<b>Ref. No.</b>	990103
<b>description</b>	wash and rinse arm wash arm L 350mm rinse arm L 350mm w. jets 6 r. jets 4 mounting ø 14/41mm mounting pos. lower		
<b>For models:</b>	811001, 811002		
<b>spare parts for</b> 513712			
	<b>GEV No.</b>	510130	<b>Ref. No.</b> 429006
	union nut for rinse jet		
	<b>GEV No.</b>	510131	<b>Ref. No.</b> 429007
	union nut for wash jet		
	<b>GEV No.</b>	510138	<b>Ref. No.</b> 140020
	wash jet fine groove		
	<b>GEV No.</b>	510139	<b>Ref. No.</b> 140007
	rinse jet		
	<b>GEV No.</b>	513261	<b>Ref. No.</b> 129056
	wash arm boss		
	<b>GEV No.</b>	513271	<b>Ref. No.</b> 412028
	connector holder grey		
	<b>GEV No.</b>	518028	<b>Ref. No.</b> 454004
	knurled nut thread M5 ø 25mm H 4mm SS		
	<b>GEV No.</b>	518428	<b>Ref. No.</b> 106095
	wash arm mounting pos. right L 160mm mounting ø 19mm nozzles 3		
	<b>GEV No.</b>	518429	<b>Ref. No.</b> 106096
	wash arm mounting pos. left L 155mm mounting ø 15mm nozzles 3		
	<b>GEV No.</b>	518430	<b>Ref. No.</b> 106098
	rinse arm mounting pos. right L 165mm mounting ø 14mm nozzles 2		
	<b>GEV No.</b>	518431	<b>Ref. No.</b> 106097
	rinse arm mounting pos. left L 165mm mounting ø 14mm nozzles 2		



<b>GEV No.</b>	518437	<b>Ref. No.</b>	990104
<b>description</b>	wash and rinse arm wash arm L 400mm rinse arm L 400mm w. jets 7 r. jets 5 mounting ø 14/41mm mounting pos. lower		
<b>For models:</b>	811003		
<b>spare parts for</b> 518437			
	<b>GEV No.</b>	510130	<b>Ref. No.</b> 429006
	union nut for rinse jet		
	<b>GEV No.</b>	510131	<b>Ref. No.</b> 429007
	union nut for wash jet		
	<b>GEV No.</b>	510138	<b>Ref. No.</b> 140020
	wash jet fine groove		
	<b>GEV No.</b>	510139	<b>Ref. No.</b> 140007
	rinse jet		
	<b>GEV No.</b>	513261	<b>Ref. No.</b> 129056
	wash arm boss		
	<b>GEV No.</b>	513271	<b>Ref. No.</b> 412028
	connector holder grey		
	<b>GEV No.</b>	518028	<b>Ref. No.</b> 454004
	knurled nut thread M5 ø 25mm H 4mm SS		
	<b>GEV No.</b>	518439	<b>Ref. No.</b> 106111
	wash arm mounting pos. left L 180mm mounting ø 19mm nozzles 3		
	<b>GEV No.</b>	518440	<b>Ref. No.</b> 106112
	wash arm mounting pos. right L 180mm mounting ø 19mm nozzles 4		
	<b>GEV No.</b>	518441	<b>Ref. No.</b> 106113
	rinse arm mounting pos. left L 190mm mounting ø 14mm nozzles 3 type A		
	<b>GEV No.</b>	518442	<b>Ref. No.</b> 106114
	rinse arm mounting pos. right L 190mm mounting ø 14mm nozzles 2 type B		



















<b>GEV No.</b>	512264	<b>Ref. No.</b>	420531
<b>description</b>	wash and rinse arm wash arm L 410mm rinse arm L 410mm mounting pos. lower w. jets 6 r. jets 4 mounting ø 12/45mm 2 wash arms/2 rinse arms		
<b>For models:</b>	SP1		
<b>spare parts for</b> 512264			
	<b>GEV No.</b>	510307	<b>Ref. No.</b> 261009
	Thumb screw thread M6 H 3mm thread L 8mm ø 28mm SS		

Table continues overleaf





spare parts for		512264		
	GEV No.	510321	Ref. No.	160736
end cap for wash arm				
	GEV No.	510322	Ref. No.	200812
O-ring EPDM thickness 1.78mm ID ø 17.17mm Qty 1 pcs				
	GEV No.	510323	Ref. No.	160734
end cap for rinse arm				
	GEV No.	510325	Ref. No.	170947 170956
nozzle for wash arm				
	GEV No.	510327	Ref. No.	170946
nozzle for rinse arm				
	GEV No.	510329	Ref. No.	190624 190649
bush H 13.5mm D1 ø 20mm D2 ø 16mm D3 ø 12mm for wash arm				
	GEV No.	510901	Ref. No.	200843
O-ring EPDM thickness 2mm ID ø 13mm Qty 1 pcs				
	GEV No.	510902	Ref. No.	200844
O-ring EPDM thickness 2mm ID ø 9.5mm Qty 1 pcs				
	GEV No.	512265	Ref. No.	—
connector holder				
	GEV No.	528583	Ref. No.	200845
O-ring EPDM thickness 2.62mm ID ø 9.13mm Qty 1 pcs				



				
1				
GEV No.	512385	Ref. No.	420551	
description	wash and rinse arm wash arm L 410mm rinse arm L 410mm mounting pos. upper w. jets 6 r. jets 4 mounting ø 12/45mm			
For models:	SP1			
spare parts for		512385		
	GEV No.	510307	Ref. No.	261009
Thumb screw thread M6 H 3mm thread L 8mm ø 28mm SS				
	GEV No.	510322	Ref. No.	200812
O-ring EPDM thickness 1.78mm ID ø 17.17mm Qty 1 pcs				
	GEV No.	510323	Ref. No.	160734
end cap for rinse arm				
	GEV No.	510325	Ref. No.	170947 170956
nozzle for wash arm				
	GEV No.	510327	Ref. No.	170946
nozzle for rinse arm				

spare parts for		512385		
	GEV No.	510329	Ref. No.	190624 190649
bush H 13.5mm D1 ø 20mm D2 ø 16mm D3 ø 12mm for wash arm				
	GEV No.	510901	Ref. No.	200843
O-ring EPDM thickness 2mm ID ø 13mm Qty 1 pcs				
	GEV No.	510902	Ref. No.	200844
O-ring EPDM thickness 2mm ID ø 9.5mm Qty 1 pcs				
	GEV No.	512265	Ref. No.	—
connector holder				
	GEV No.	528583	Ref. No.	200845
O-ring EPDM thickness 2.62mm ID ø 9.13mm Qty 1 pcs				





				
1				
GEV No.	513711	Ref. No.	990075	
description	wash and rinse arm wash arm L 495mm rinse arm L 460mm w. jets 9 r. jets 5 mounting ø 16.5mm mounting pos. lower			
For models:	812001, 812002, 812003, 812004, 812005, 812006, 812007, 812008, 812009, 812010, 915234, 915235, 915236, 915237, 915460, 915461, 915462, 915463, 915464, 915465			
spare parts for		513711		
	GEV No.	510010	Ref. No.	129003 129039
wash arm boss L1 64mm L2 60mm mounting ø 16.5mm				
	GEV No.	510138	Ref. No.	140020
wash jet fine groove				
	GEV No.	510139	Ref. No.	140007
rinse jet				
	GEV No.	513262	Ref. No.	499009
blank nozzle				
	GEV No.	518053	Ref. No.	—
union nut for rinse jet				
	GEV No.	518272	Ref. No.	—
union nut for wash jet				
	GEV No.	518332	Ref. No.	106008
wash arm mounting pos. right L 220mm mounting ø 24mm nozzles 5				
	GEV No.	518333	Ref. No.	106006
wash arm mounting pos. left L 220mm mounting ø 24mm nozzles 4				
	GEV No.	518334	Ref. No.	106007
rinse arm mounting pos. right L 220mm mounting ø 13mm nozzles 3				



 <p>1</p>			
<b>GEV No.</b>	518269	<b>Ref. No.</b>	990108
<b>description</b>	wash and rinse arm wash arm L 495mm rinse arm L 490mm w. jets 9 r. jets 5 mounting ø 16.5mm mounting pos. upper		
<b>For models:</b>	812001, 812002, 812003, 812004, 812005, 812006, 812007, 812008, 812009, 812010, 915234, 915235, 915236, 915237, 915460, 915461, 915462, 915463, 915464, 915465		
<b>spare parts for</b>	518269		
	<b>GEV No.</b>	510010	<b>Ref. No.</b> 129003 129039
	wash arm boss L1 64mm L2 60mm mounting ø 16.5mm		
	<b>GEV No.</b>	510139	<b>Ref. No.</b> 140007
	rinse jet		
	<b>GEV No.</b>	513262	<b>Ref. No.</b> 499009
	blank nozzle		
	<b>GEV No.</b>	518004	<b>Ref. No.</b> 140008
	wash jet		
	<b>GEV No.</b>	518053	<b>Ref. No.</b> —
	union nut for rinse jet		
	<b>GEV No.</b>	518272	<b>Ref. No.</b> —
	union nut for wash jet		
	<b>GEV No.</b>	518332	<b>Ref. No.</b> 106008
	wash arm mounting pos. right L 220mm mounting ø 24mm nozzles 5		
	<b>GEV No.</b>	518333	<b>Ref. No.</b> 106006
	wash arm mounting pos. left L 220mm mounting ø 24mm nozzles 4		
	<b>GEV No.</b>	518334	<b>Ref. No.</b> 106007
	rinse arm mounting pos. right L 220mm mounting ø 13mm nozzles 3		
	<b>GEV No.</b>	518335	<b>Ref. No.</b> 106005
	rinse arm mounting pos. left L 220mm mounting ø 13mm nozzles 3		

 <p>1</p>			
<b>GEV No.</b>	510275	<b>Ref. No.</b>	420526
<b>description</b>	wash and rinse arm wash arm L 505mm rinse arm L 505mm mounting pos. upper/lower w. jets 8 r. jets 5 mounting ø 12/45mm		
<b>For models:</b>	SP2-12, SP2-S12		
<b>spare parts for</b>	510275		
	<b>GEV No.</b>	510307	<b>Ref. No.</b> 261009
	Thumb screw thread M6 H 3mm thread L 8mm ø 28mm SS		

<b>spare parts for</b>	510275		
	<b>GEV No.</b>	510321	<b>Ref. No.</b> 160736
	end cap for wash arm		
	<b>GEV No.</b>	510322	<b>Ref. No.</b> 200812
	O-ring EPDM thickness 1.78mm ID ø 17.17mm Qty 1 pcs		
	<b>GEV No.</b>	510323	<b>Ref. No.</b> 160734
	end cap for rinse arm		
	<b>GEV No.</b>	510325	<b>Ref. No.</b> 170947 170956
	nozzle for wash arm		
	<b>GEV No.</b>	510327	<b>Ref. No.</b> 170946
	nozzle for rinse arm		
	<b>GEV No.</b>	510329	<b>Ref. No.</b> 190624 190649
	bush H 13.5mm D1 ø 20mm D2 ø 16mm D3 ø 12mm for wash arm		
	<b>GEV No.</b>	510902	<b>Ref. No.</b> 200844
	O-ring EPDM thickness 2mm ID ø 9.5mm Qty 1 pcs		
	<b>GEV No.</b>	512265	<b>Ref. No.</b> —
	connector holder		
	<b>GEV No.</b>	528583	<b>Ref. No.</b> 200845
	O-ring EPDM thickness 2.62mm ID ø 9.13mm Qty 1 pcs		

 <p>1</p>			
<b>GEV No.</b>	518597	<b>Ref. No.</b>	420553
<b>description</b>	wash arm		
<b>For models:</b>	SP3		
<b>spare parts for</b>	518597		
	<b>GEV No.</b>	509999	<b>Ref. No.</b> —
	bush for rinse arm H 53mm ø 48.5mm SS		
	<b>GEV No.</b>	510236	<b>Ref. No.</b> 260568
	plain washer ID ø 21mm ED ø 28mm thickness 1mm SS Qty 1 pcs		
	<b>GEV No.</b>	511241	<b>Ref. No.</b> 191075
	knurled nut thread M26x1 stainless steel ø 48.6mm H 10mm		





1

<b>GEV No.</b>	518315	<b>Ref. No.</b>	129053
<b>description</b>	wash arm H 397mm L 400mm nozzles 6 mounting pos. upper		
<b>For models:</b>	811003		



1

<b>GEV No.</b>	524657	<b>Ref. No.</b>	01-294032-001
<b>description</b>	wash arm L 390mm nozzles 7 mounting ø 17/45mm		
<b>For models:</b>	811011, 811012, 811013, 811014, 811015		
<b>spare parts for</b>	524657		
	<b>GEV No.</b>	524665	<b>Ref. No.</b> 01-240028-001
	blank nozzle for cleaning M20		
<b>accessories for</b>	524657		
	<b>GEV No.</b>	518153	<b>Ref. No.</b> 01-294038-001
	wash arm support mounting pos. upper		



1

<b>GEV No.</b>	513145	<b>Ref. No.</b>	80311
<b>description</b>	wash arm L 510mm nozzles 10 mounting ø 16mm mounting pos. upper and bottom		
<b>For models:</b>	813001		



1

<b>GEV No.</b>	524645	<b>Ref. No.</b>	01-240050-001
<b>description</b>	wash arm L 515mm nozzles 8 mounting ø 17/45mm mounting pos. upper/lower		
<b>For models:</b>	812011, 812012, 812013, 812014, 812015, 813002, 813003, 813004		
<b>spare parts for</b>	524645		
	<b>GEV No.</b>	524665	<b>Ref. No.</b> 01-240028-001
	blank nozzle for cleaning M20		



1

<b>GEV No.</b>	518130	<b>Ref. No.</b>	420572R
<b>description</b>	wash arm L 535mm mounting pos. upper/lower nozzles 10 mounting ø 20/58mm complete with rinse pipe		
<b>For models:</b>	SP3		
<b>spare parts for</b>	518130		
	<b>GEV No.</b>	509999	<b>Ref. No.</b> —
	bush for rinse arm H 53mm ø 48.5mm SS		
	<b>GEV No.</b>	511241	<b>Ref. No.</b> 191075
	knurled nut thread M26x1 stainless steel ø 48.6mm H 10mm		



1

<b>GEV No.</b>	513262	<b>Ref. No.</b>	499009
<b>description</b>	blank nozzle		
<b>For models:</b>	812001, 812002, 812003, 812004, 812005, 812006, 812007, 812008, 812009, 812010, 915234, 915235, 915236, 915237, 915460, 915461, 915462, 915463, 915464, 915465		



1

<b>GEV No.</b>	524665	<b>Ref. No.</b>	01-240028-001
<b>description</b>	blank nozzle for cleaning M20		
<b>For models:</b>	811011, 811012, 811013, 811014, 811015, 812011, 812012, 812013, 812014, 812015, 813002, 813003, 813004		



1

<b>GEV No.</b>	510813	<b>Ref. No.</b>	190641
<b>description</b>	bush for rinse arm		
<b>For models:</b>	SP3		



1

<b>GEV No.</b>	510329	<b>Ref. No.</b>	190624 190649
<b>description</b>	bush H 13.5mm D1 ø 20mm D2 ø 16mm D3 ø 12mm for wash arm		
<b>For models:</b>	SP1, SP2-12, SP2-S12		





1

<b>GEV No.</b>	510232	<b>Ref. No.</b>	190673
<b>description</b>	bush ø 23mm H 21mm for rinse arm		
<b>For models:</b>	SP3		





1			
<b>GEV No.</b>	513157	<b>Ref. No.</b>	412030
<b>description</b>	connector holder		
<b>For models:</b>	813001		

1			
<b>GEV No.</b>	511242	<b>Ref. No.</b>	450218
<b>description</b>	connector holder L 30mm H 16mm W 22mm		
<b>For models:</b>	SP3		



1			
<b>GEV No.</b>	518410	<b>Ref. No.</b>	441010
<b>description</b>	end cap		
<b>For models:</b>	811003		



1			
<b>GEV No.</b>	510323	<b>Ref. No.</b>	160734
<b>description</b>	end cap for rinse arm		
<b>For models:</b>	SP1, SP2-12, SP2-S12		

1				
<b>GEV No.</b>	518419	<b>Ref. No.</b>	926132	
<b>description</b>	end cap for rinse arm			
<b>For models:</b>	813001			
<b>accessories for</b>	518419			
	<b>GEV No.</b>	528485	<b>Ref. No.</b>	456060
O-ring EPDM thickness 1.78mm ID ø 6.07mm Qty 1 pcs				

1			
<b>GEV No.</b>	510321	<b>Ref. No.</b>	160736
<b>description</b>	end cap for wash arm		
<b>For models:</b>	SP1, SP2-12, SP2-S12		



1			
<b>GEV No.</b>	518281	<b>Ref. No.</b>	454005
<b>description</b>	knurled nut thread M6 SS ø 20mm H 4mm		
<b>For models:</b>	813001		



1				
<b>GEV No.</b>	510327	<b>Ref. No.</b>	170946	
<b>description</b>	nozzle for rinse arm			
<b>For models:</b>	SP1, SP2-12, SP2-S12			
<b>accessories for</b>	510327			
	<b>GEV No.</b>	510902	<b>Ref. No.</b>	200844
O-ring EPDM thickness 2mm ID ø 9.5mm Qty 1 pcs				

1				
<b>GEV No.</b>	511236	<b>Ref. No.</b>	170963	
<b>description</b>	nozzle for rinse arm			
<b>For models:</b>	SP3			
<b>accessories for</b>	511236			
	<b>GEV No.</b>	511237	<b>Ref. No.</b>	200850
O-ring EPDM thickness 1mm ID ø 7mm Qty 1 pcs				
	<b>GEV No.</b>	511238	<b>Ref. No.</b>	450236
opposite support for rinse jet				

1			
<b>GEV No.</b>	510325	<b>Ref. No.</b>	170947 170956
<b>description</b>	nozzle for wash arm		
<b>For models:</b>	SP1, SP2-12, SP2-S12		

1			
<b>GEV No.</b>	511238	<b>Ref. No.</b>	450236
<b>description</b>	opposite support for rinse jet		
<b>For models:</b>	SP3		

1				
<b>GEV No.</b>	513273	<b>Ref. No.</b>	80375	
<b>description</b>	rinse arm L 240mm nozzles 2 mounting ø 10mm mounting pos. bottom left			
<b>For models:</b>	813001			
<b>accessories for</b>	513273			
	<b>GEV No.</b>	518276	<b>Ref. No.</b>	—
rinse jet				

			
1			
<b>GEV No.</b>	513723	<b>Ref. No.</b>	80376
<b>description</b>	rinse arm L 240mm nozzles 3 mounting pos. upper/lower		
<b>For models:</b>	813001		
<b>accessories for</b>	513723		
	<b>GEV No.</b>	518276	<b>Ref. No.</b> —
	rinse jet		

			
1			
<b>GEV No.</b>	518329	<b>Ref. No.</b>	106035
<b>description</b>	rinse arm mounting pos. left L 110mm mounting ø 13mm nozzles 2		
<b>For models:</b>	811001, 811002, 811003		

			
1			
<b>GEV No.</b>	518431	<b>Ref. No.</b>	106097
<b>description</b>	rinse arm mounting pos. left L 165mm mounting ø 14mm nozzles 2		
<b>For models:</b>	811001, 811002		

			
1			
<b>GEV No.</b>	518441	<b>Ref. No.</b>	106113
<b>description</b>	rinse arm mounting pos. left L 190mm mounting ø 14mm nozzles 3 type A		
<b>For models:</b>	811003		

			
1			
<b>GEV No.</b>	518409	<b>Ref. No.</b>	106094
<b>description</b>	rinse arm mounting pos. left L 190mm mounting ø 19mm nozzles 3		
<b>For models:</b>	812001, 812002, 812003, 812004, 812005, 812006, 812007, 812008, 812009, 812010, 915234, 915235, 915236, 915237, 915460, 915461, 915462, 915463, 915464, 915465		

			
1			
<b>GEV No.</b>	518335	<b>Ref. No.</b>	106005
<b>description</b>	rinse arm mounting pos. left L 220mm mounting ø 13mm nozzles 3		
<b>For models:</b>	812001, 812002, 812003, 812004, 812005, 812006, 812007, 812008, 812009, 812010, 915234, 915235, 915236, 915237, 915460, 915461, 915462, 915463, 915464, 915465		

			
1			
<b>GEV No.</b>	518328	<b>Ref. No.</b>	106036
<b>description</b>	rinse arm mounting pos. right L 110mm mounting ø 13mm nozzles 2		
<b>For models:</b>	811001, 811002, 811003		

			
1			
<b>GEV No.</b>	518430	<b>Ref. No.</b>	106098
<b>description</b>	rinse arm mounting pos. right L 165mm mounting ø 14mm nozzles 2		
<b>For models:</b>	811001, 811002		

			
1			
<b>GEV No.</b>	518442	<b>Ref. No.</b>	106114
<b>description</b>	rinse arm mounting pos. right L 190mm mounting ø 14mm nozzles 2 type B		
<b>For models:</b>	811003		



			
1			
<b>GEV No.</b>	518334	<b>Ref. No.</b>	106007
<b>description</b>	rinse arm mounting pos. right L 220mm mounting ø 13mm nozzles 3		
<b>For models:</b>	812001, 812002, 812003, 812004, 812005, 812006, 812007, 812008, 812009, 812010, 915234, 915235, 915236, 915237, 915460, 915461, 915462, 915463, 915464, 915465		

			
1			
<b>GEV No.</b>	513221	<b>Ref. No.</b>	129059 80371
<b>description</b>	rinse arm boss		
<b>For models:</b>	813001		

			
1			
<b>GEV No.</b>	518326	<b>Ref. No.</b>	129002
<b>description</b>	rinse arm boss		
<b>For models:</b>	811001, 811002, 811003		









			
1			
<b>GEV No.</b>	510139	<b>Ref. No.</b>	140007
<b>description</b>	rinse jet		
<b>For models:</b>	811001, 811002, 811003, 812001, 812002, 812003, 812004, 812005, 812006, 812007, 812008, 812009, 812010, 915234, 915235, 915236, 915237, 915460, 915461, 915462, 915463, 915464, 915465		
<b>accessories for</b>	510139		
	<b>GEV No.</b>	510130	<b>Ref. No.</b> 429006
union nut for rinse jet			

			
1			
<b>GEV No.</b>	513154	<b>Ref. No.</b>	140028
<b>description</b>	rinse jet		
<b>For models:</b>	813001		

			
1			
<b>GEV No.</b>	518282	<b>Ref. No.</b>	303032
<b>description</b>	sealing ring for wash arm support stainless steel		
<b>For models:</b>	813001		

			
1			
<b>GEV No.</b>	510146	<b>Ref. No.</b>	119003
<b>description</b>	swirl ø 18.5mm H 7mm hole ø 2mm		
<b>For models:</b>	811003		



			
1			
<b>GEV No.</b>	510130	<b>Ref. No.</b>	429006
<b>description</b>	union nut for rinse jet		
<b>For models:</b>	811001, 811002, 811003, 812001, 812002, 812003, 812004, 812005, 812006, 812007, 812008, 812009, 812010, 915234, 915235, 915236, 915237, 915460, 915461, 915462, 915463, 915464, 915465		
<b>accessories for</b>	510130		
	<b>GEV No.</b>	510139	<b>Ref. No.</b> 140007
rinse jet			

			
1			
<b>GEV No.</b>	510131	<b>Ref. No.</b>	429007
<b>description</b>	union nut for wash jet		
<b>For models:</b>	811001, 811002, 811003, 812001, 812002, 812003, 812004, 812005, 812006, 812007, 812008, 812009, 812010, 915234, 915235, 915236, 915237, 915460, 915461, 915462, 915463, 915464, 915465		
<b>accessories for</b>	510131		
	<b>GEV No.</b>	510138	<b>Ref. No.</b> 140020
wash jet fine groove			

			
1			
<b>GEV No.</b>	510144	<b>Ref. No.</b>	140010
<b>description</b>	union nut for wash jet		
<b>For models:</b>	811003		

			
1			
<b>GEV No.</b>	518429	<b>Ref. No.</b>	106096
<b>description</b>	wash arm mounting pos. left L 155mm mounting ø 15mm nozzles 3		
<b>For models:</b>	811001, 811002		

			
1			
<b>GEV No.</b>	518439	<b>Ref. No.</b>	106111
<b>description</b>	wash arm mounting pos. left L 180mm mounting ø 19mm nozzles 3		
<b>For models:</b>	811003		

			
1			
<b>GEV No.</b>	518333	<b>Ref. No.</b>	106006
<b>description</b>	wash arm mounting pos. left L 220mm mounting ø 24mm nozzles 4		
<b>For models:</b>	812001, 812002, 812003, 812004, 812005, 812006, 812007, 812008, 812009, 812010, 915234, 915235, 915236, 915237, 915460, 915461, 915462, 915463, 915464, 915465		
<b>accessories for</b>	518333		
	<b>GEV No.</b>	518004	<b>Ref. No.</b> 140008
wash jet			
	<b>GEV No.</b>	518272	<b>Ref. No.</b> —
union nut for wash jet			

			
1			
<b>GEV No.</b>	518428	<b>Ref. No.</b>	106095
<b>description</b>	wash arm mounting pos. right L 160mm mounting ø 19mm nozzles 3		
<b>For models:</b>	811001, 811002		



<b>GEV No.</b>	518440	<b>Ref. No.</b>	106112
<b>description</b>	wash arm mounting pos. right L 180mm mounting ø 19mm nozzles 4		
<b>For models:</b>	811003		



<b>GEV No.</b>	518332	<b>Ref. No.</b>	106008
<b>description</b>	wash arm mounting pos. right L 220mm mounting ø 24mm nozzles 5		
<b>For models:</b>	812001, 812002, 812003, 812004, 812005, 812006, 812007, 812008, 812009, 812010, 915234, 915235, 915236, 915237, 915460, 915461, 915462, 915463, 915464, 915465		
<b>accessories for</b>	518332		
	<b>GEV No.</b>	518004	<b>Ref. No.</b>
			140008
<b>description</b>	wash jet		
	<b>GEV No.</b>	518272	<b>Ref. No.</b>
			—
<b>description</b>	union nut for wash jet		





<b>GEV No.</b>	513261	<b>Ref. No.</b>	129056
<b>description</b>	wash arm boss		
<b>For models:</b>	811001, 811002, 811003		



<b>GEV No.</b>	518004	<b>Ref. No.</b>	140008
<b>description</b>	wash jet		
<b>For models:</b>	812001, 812002, 812003, 812004, 812005, 812006, 812007, 812008, 812009, 812010, 915234, 915235, 915236, 915237, 915460, 915461, 915462, 915463, 915464, 915465		



<b>GEV No.</b>	510138	<b>Ref. No.</b>	140020
<b>description</b>	wash jet fine groove		
<b>For models:</b>	811001, 811002, 811003, 812001, 812002, 812003, 812004, 812005, 812006, 812007, 812008, 812009, 812010, 915234, 915235, 915236, 915237, 915460, 915461, 915462, 915463, 915464, 915465		
<b>accessories for</b>	510138		
	<b>GEV No.</b>	510131	<b>Ref. No.</b>
			429007
<b>description</b>	union nut for wash jet		



<b>GEV No.</b>	518150	<b>Ref. No.</b>	441009
<b>description</b>	gasket		
<b>For models:</b>	812001, 812002, 812003, 812004, 812005, 812006, 812007, 812008, 812009, 812010, 813001, 915234, 915235, 915236, 915237, 915460, 915461, 915462, 915463, 915464, 915465		



<b>GEV No.</b>	511241	<b>Ref. No.</b>	191075
<b>description</b>	knurled nut thread M26x1 stainless steel ø 48.6mm H 10mm		
<b>For models:</b>	SP3		



<b>GEV No.</b>	513266	<b>Ref. No.</b>	417104
<b>description</b>	nut		
<b>For models:</b>	811001, 811002, 811003		



<b>GEV No.</b>	511671	<b>Ref. No.</b>	01-240631-001
<b>description</b>	nut for wash arm support mounting pos. lower ED ø 60mm ID ø 36mm H 45mm connection ø 42mm		
<b>For models:</b>	811011, 811012, 811013, 811014, 811015		



<b>GEV No.</b>	512474	<b>Ref. No.</b>	01-240631-002
<b>description</b>	nut for wash arm support mounting pos. lower ED ø 60mm ID ø 36mm H 72mm connection ø 42mm		
<b>For models:</b>	812011, 812012, 812013, 812014, 812015		





1

<b>GEV No.</b>	513124	<b>Ref. No.</b>	80314
<b>description</b>	nut M24x1.5		
<b>For models:</b>	813001		
<b>accessories for</b>	513124		
	<b>GEV No.</b>	513123	<b>Ref. No.</b>
			—
	wash arm bearing mounting pos. upper/lower		





1

<b>GEV No.</b>	513161	<b>Ref. No.</b>	80310
<b>description</b>	wash arm bearing mounting pos. upper		
<b>For models:</b>	813001		
<b>accessories for</b>	513161		
	<b>GEV No.</b>	513124	<b>Ref. No.</b>
			80314
	nut M24x1.5		



1

<b>GEV No.</b>	518171	<b>Ref. No.</b>	111030 111999
<b>description</b>	opposite support mounting pos. lower for wash arm support		
<b>For models:</b>	812001, 812002, 812003, 812004, 812005, 812006, 812007, 812008, 812009, 812010, 915234, 915235, 915236, 915237, 915460, 915461, 915462, 915463, 915464, 915465		
<b>accessories for</b>	518171		
	<b>GEV No.</b>	513717	<b>Ref. No.</b>
			035064 35064
	fastening angle for drain pump		



1

<b>GEV No.</b>	510644	<b>Ref. No.</b>	330824
<b>description</b>	wash arm bearing ø 25mm H 52mm		
<b>For models:</b>	SP3		



1

<b>GEV No.</b>	518069	<b>Ref. No.</b>	80177
<b>description</b>	wash arm support		
<b>For models:</b>	813001		
<b>accessories for</b>	518069		
	<b>GEV No.</b>	518071	<b>Ref. No.</b>
			80178
	gasket for wash arm support L 109mm W 68mm		



1

<b>GEV No.</b>	518143	<b>Ref. No.</b>	00-775933-003
<b>description</b>	slide ring for wash arm ED ø 46mm ID ø 41mm thickness 3mm		
<b>For models:</b>	811011, 811012, 811013, 811014, 811015, 812011, 812012, 812013, 812014, 812015, 813002, 813003, 813004		



1

<b>GEV No.</b>	518340	<b>Ref. No.</b>	199052
<b>description</b>	throttle disc		
<b>For models:</b>	811001, 811002, 811003		



1

<b>GEV No.</b>	511256	<b>Ref. No.</b>	191083
<b>description</b>	wash arm support mounting pos. lower		
<b>For models:</b>	SP1		



1

<b>GEV No.</b>	512269	<b>Ref. No.</b>	190223
<b>description</b>	wash arm support mounting pos. lower		
<b>For models:</b>	SP1		



1

<b>GEV No.</b>	518031	<b>Ref. No.</b>	115075
<b>description</b>	wash arm support mounting pos. lower H 108mm		
<b>For models:</b>	812001, 812002, 812003, 812004, 812005, 812006, 812007, 812008, 812009, 812010, 915234, 915235, 915236, 915237, 915460, 915461, 915462, 915463, 915464, 915465		



1

<b>GEV No.</b>	518145	<b>Ref. No.</b>	00-883488-001	
<b>description</b>	wash arm support mounting pos. lower			
<b>For models:</b>	813002, 813003, 813004			
<b>accessories for</b>	518145			
	<b>GEV No.</b>	517403	<b>Ref. No.</b>	00-172986-035
	flat gasket EPDM ED ø 71mm ID ø 61mm thickness 1.5mm Qty 1 pcs			
	<b>GEV No.</b>	518143	<b>Ref. No.</b>	00-775933-003
	slide ring for wash arm ED ø 46mm ID ø 41mm thickness 3mm			
	<b>GEV No.</b>	518144	<b>Ref. No.</b>	00-883496-001
	nut for wash arm support ED ø 74mm WS 65 hole ø 36mm			



1

<b>GEV No.</b>	518024	<b>Ref. No.</b>	115076
<b>description</b>	wash arm support mounting pos. lower H 126.5mm		
<b>For models:</b>	915234, 915235, 915236, 915237		



1





<b>GEV No.</b>	518174	<b>Ref. No.</b>	115110
<b>description</b>	wash arm support mounting pos. lower D1 ø 38mm D2 ø 59mm H 69mm ID ø 13mm		
<b>For models:</b>	811001, 811002, 811003		





1

<b>GEV No.</b>	518146	<b>Ref. No.</b>	00-883467-001
<b>description</b>	wash arm support mounting pos. upper		
<b>For models:</b>	813002, 813003, 813004		





			
1			
<b>GEV No.</b>	518153	<b>Ref. No.</b>	01-294038-001
<b>description</b>	wash arm support mounting pos. upper		
<b>For models:</b>	811011, 811012, 811013, 811014, 811015, 812011, 812012, 812013, 812014, 812015		
<b>accessories for</b>	518153		
	<b>GEV No.</b>	518116	<b>Ref. No.</b> 00-172986-019
	gasket for wash arm support rubber ø 60mm ID ø 47mm thickness 1mm		
	<b>GEV No.</b>	518139	<b>Ref. No.</b> 01-240021-001
	nut for wash arm support ø 60mm		
	<b>GEV No.</b>	518143	<b>Ref. No.</b> 00-775933-003
	slide ring for wash arm ED ø 46mm ID ø 41mm thickness 3mm		
	<b>GEV No.</b>	518148	<b>Ref. No.</b> 01-240097-001
	rinse pipe ø 17mm L 60mm		

			
1			
<b>GEV No.</b>	512488	<b>Ref. No.</b>	190944
<b>description</b>	wash arm support mounting pos. upper thread M6		
<b>For models:</b>	SP2-12, SP2-S12		

			
1			
<b>GEV No.</b>	510448	<b>Ref. No.</b>	190209
<b>description</b>	wash arm support with rinse arm shaft mounting pos. upper		
<b>For models:</b>	SP1		

			
1			
<b>GEV No.</b>	510114	<b>Ref. No.</b>	190227
<b>description</b>	wash arm support with rinse arm shaft mounting pos. upper/lower ø 74mm H 142mm		
<b>For models:</b>	SP3		

rinse arm shafts			
			
1			
<b>GEV No.</b>	518170	<b>Ref. No.</b>	143174
<b>description</b>	extension for rinse arm shaft		
<b>For models:</b>	812001, 812002, 812003, 812004, 812005, 812006, 812007, 812008, 812009, 812010, 915234, 915235, 915236, 915237, 915460, 915461, 915462, 915463, 915464, 915465		

			
1			
<b>GEV No.</b>	510013	<b>Ref. No.</b>	325001
<b>description</b>	rinse arm shaft		
<b>For models:</b>	811001, 811002, 811003		

			
1			
<b>GEV No.</b>	510108	<b>Ref. No.</b>	327006
<b>description</b>	rinse arm shaft		
<b>For models:</b>	812001, 812002, 812003, 812004, 812005, 812006, 812007, 812008, 812009, 812010, 915234, 915235, 915236, 915237, 915460, 915461, 915462, 915463, 915464, 915465		

			
1			
<b>GEV No.</b>	513159	<b>Ref. No.</b>	80380
<b>description</b>	rinse arm shaft		
<b>For models:</b>	813001		



1

<b>GEV No.</b>	513160	<b>Ref. No.</b>	80282
<b>description</b>	rinse arm shaft		
<b>For models:</b>	813001		



1

<b>GEV No.</b>	518147	<b>Ref. No.</b>	01-240095-001
<b>description</b>	rinse arm shaft		
<b>For models:</b>	811011, 811012, 811013, 811014, 811015, 812011, 812012, 812013, 812014, 812015, 813002, 813003, 813004		



1

<b>GEV No.</b>	518172	<b>Ref. No.</b>	325064
<b>description</b>	rinse arm shaft		
<b>For models:</b>	811001, 811002, 811003		



1

<b>GEV No.</b>	518405	<b>Ref. No.</b>	325045
<b>description</b>	rinse arm shaft mounting pos. lower		
<b>For models:</b>	915234, 915235, 915236, 915237		



1

<b>GEV No.</b>	524096	<b>Ref. No.</b>	80283
<b>description</b>	rinse arm shaft mounting pos. lower ø 16mm H 38mm thread M12x1.75		
<b>For models:</b>	813001		



1

<b>GEV No.</b>	518176	<b>Ref. No.</b>	478056
<b>description</b>	rinse pipe		
<b>For models:</b>	811001, 811002, 811003		

**accessories for** 518176



<b>GEV No.</b>	513266	<b>Ref. No.</b>	417104
<b>description</b>	nut		

## for toasters

## miscellaneous



1

<b>GEV No.</b>	691472	<b>Ref. No.</b>	X05.03.040.00
<b>description</b>	chain US norm 25-1 splitting 6mm links 30 internal width 3.3mm rollerø 4.3mm single closed		
<b>For models:</b>	222004, 222005		



1

<b>GEV No.</b>	691473	<b>Ref. No.</b>	X05.03.044.00
<b>description</b>	chain US norm 25-1 splitting 6mm links 31 internal width 3.3mm rollerø 4.3mm single closed		
<b>For models:</b>	222004, 222005		



1

<b>GEV No.</b>	694056	<b>Ref. No.</b>	X05.03.042.00
<b>description</b>	conveyor belt L 570mm W 260mm wire gauge ø 1.2mm for conveyor toaster		
<b>For models:</b>	222004, 222005		





1

<b>GEV No.</b>	694057	<b>Ref. No.</b>	X05.03.041.00
<b>description</b>	conveyor belt L 580mm W 180mm wire gauge ø 1.2mm for conveyor toaster		
<b>For models:</b>	222004, 222005		





1

<b>GEV No.</b>	694059	<b>Ref. No.</b>	X05.07.025.00
<b>description</b>	drive shaft ø 9.5mm L 235mm		
<b>For models:</b>	222004, 222005		
<b>accessories for</b>	694059		
	<b>GEV No.</b>	691470	<b>Ref. No.</b> X05.03.043.00
	retaining ring E D1 ø 8mm D2 ø 16mm SS DIN 6799 thickness 1mm for shaft ø 9-12mm		
	<b>GEV No.</b>	694060	<b>Ref. No.</b> X05.02.024.00
	flange for spindle		



1

<b>GEV No.</b>	694058	<b>Ref. No.</b>	X05.07.026.00
<b>description</b>	drive shaft ø 9.5mm L 320mm		
<b>For models:</b>	222004, 222005		
<b>accessories for</b>	694058		
	<b>GEV No.</b>	691470	<b>Ref. No.</b> X05.03.043.00
	retaining ring E D1 ø 8mm D2 ø 16mm SS DIN 6799 thickness 1mm for shaft ø 9-12mm		
	<b>GEV No.</b>	694060	<b>Ref. No.</b> X05.02.024.00
	flange for spindle		



1

<b>GEV No.</b>	694060	<b>Ref. No.</b>	X05.02.024.00
<b>description</b>	flange for spindle		
<b>For models:</b>	222004, 222005		

gear wheels



1

<b>GEV No.</b>	691474	<b>Ref. No.</b>	X05.09.052.00 X05.09.053.00
<b>description</b>	sprocket-wheel DIN/ISO splitting 25-1 teeth 24 shaft intake ø 19mm H 18mm hub ø 19mm metal ø 50mm		
<b>For models:</b>	222004, 222005		



1

<b>GEV No.</b>	691475	<b>Ref. No.</b>	X05.09.054.00 X05.09.055.00
<b>description</b>	sprocket-wheel DIN/ISO splitting 25-1 teeth 36 shaft intake ø 9.5mm H 18mm hub ø 19mm metal ø 74mm		
<b>For models:</b>	222004, 222005		

pliers

pliers



1

<b>GEV No.</b>	690010	<b>Ref. No.</b>	408012003
<b>description</b>	plier for toaster H 180mm total length 100mm		
<b>For models:</b>	222002, 222003		

for vacuum packers

air valves



1

<b>GEV No.</b>	691551	<b>Ref. No.</b>	0281005
<b>description</b>	air valve connection 1" 24VAC		
<b>For models:</b>	442006		



1

<b>GEV No.</b>	691555	<b>Ref. No.</b>	0900852
<b>description</b>	air valve connection 1¼"		
<b>For models:</b>	442006		



1

<b>GEV No.</b>	691553	<b>Ref. No.</b>	0281025
<b>description</b>	air valve connection 2"		
<b>spare parts for</b>	691553		
	<b>GEV No.</b>	691573	<b>Ref. No.</b> 0931205
	maintenance set for air valve size 2"		

**lids**



1

<b>GEV No.</b>	691586	<b>Ref. No.</b>	0900738
<b>description</b>	lid L 670mm W 670mm H 300 II		



1

<b>GEV No.</b>	692062	<b>Ref. No.</b>	0620010 0620011
<b>description</b>	lid with gasket L 475mm W 460mm H 75mm B42/J42/H-200		

**air cylinders**

**air cylinders**



1

<b>GEV No.</b>	691547	<b>Ref. No.</b>	0286015
<b>description</b>	air cylinder ø 110mm H 47mm shaft length 29mm		



1

<b>GEV No.</b>	691548	<b>Ref. No.</b>	0286017
<b>description</b>	air cylinder ø 110mm H 47mm shaft length 29mm		



1

<b>GEV No.</b>	691549	<b>Ref. No.</b>	0286020
<b>description</b>	air cylinder ø 110mm shaft length 47mm		



1

<b>GEV No.</b>	691544	<b>Ref. No.</b>	0286000
<b>description</b>	air cylinder ø 50mm H 25mm		





1

<b>GEV No.</b>	691545	<b>Ref. No.</b>	0286005
<b>description</b>	air cylinder ø 80mm H 30mm		



1

<b>GEV No.</b>	691546	<b>Ref. No.</b>	0286010
<b>description</b>	air cylinder ø 80mm H 48mm		
<b>spare parts for</b>	691546		
	<b>GEV No.</b>	691581	<b>Ref. No.</b>
			0931405
<b>description</b>	membrane ø 80mm H 24mm		

insert plates



1

<b>GEV No.</b>	692063	<b>Ref. No.</b>	0307050
<b>description</b>	insert plate L 740mm W 490mm thickness 20mm F80 KL		

rubber bumper



1

<b>GEV No.</b>	691570	<b>Ref. No.</b>	0940205
<b>description</b>	rubber pad type H200		



1

<b>GEV No.</b>	691571	<b>Ref. No.</b>	0940210
<b>description</b>	rubber pad type H300		



1

<b>GEV No.</b>	691569	<b>Ref. No.</b>	0940203
<b>description</b>	rubber pad type JUMBO		

oil separator filters

with thread



1

<b>GEV No.</b>	691534	<b>Ref. No.</b>	0939000 0939160
<b>description</b>	oil separator filter flow rate 4m <sup>3</sup> /h ø 35mm L 52mm thread 3/8"		
<b>For models:</b>	442003, 442004, 442005, 442006, 442007, 442008		



1

<b>GEV No.</b>	691954	<b>Ref. No.</b>	0939162
<b>description</b>	oil separator filter flow rate 8m <sup>3</sup> /h ø 35mm L 85mm thread 3/8"		
<b>For models:</b>	442010		



1

<b>GEV No.</b>	691536	<b>Ref. No.</b>	0939001 0939161
<b>description</b>	oil separator filter flow rate 8m <sup>3</sup> /h ø 40mm L 70mm thread 1/2"		
<b>For models:</b>	442003, 442004, 442005, 442006, 442007, 442008, 442010		

without thread



1

<b>GEV No.</b>	691540	<b>Ref. No.</b>	0939010 0939170
<b>description</b>	oil separator filter flow rate 100m <sup>3</sup> /h ø 72mm L 248mm		
<b>For models:</b>	442003, 442004, 442005, 442006, 442007, 442008		



1

<b>GEV No.</b>	691541	<b>Ref. No.</b>	0939015 0939175
<b>description</b>	oil separator filter flow rate 160m <sup>3</sup> /h ø 72mm L 375mm		
<b>For models:</b>	442003, 442004, 442005, 442006, 442007, 442008		



1

<b>GEV No.</b>	691537	<b>Ref. No.</b>	0939003 0939163
<b>description</b>	oil separator filter flow rate 16m <sup>3</sup> /h ø 52mm L 120mm		
<b>For models:</b>	442003, 442004, 442005, 442006, 442007, 442008		



1

<b>GEV No.</b>	691538	<b>Ref. No.</b>	0939005 0939165
<b>description</b>	oil separator filter flow rate 21m <sup>3</sup> /h ø 72mm L 128mm		
<b>For models:</b>	442003, 442004, 442005, 442006, 442007, 442008		



1

<b>GEV No.</b>	691539	<b>Ref. No.</b>	0939011 0939171
<b>description</b>	oil separator filter flow rate 63m <sup>3</sup> /h ø 72mm L 206mm		
<b>For models:</b>	442003, 442004, 442005, 442006, 442007, 442008		

air cushions



1

<b>GEV No.</b>	572001	<b>Ref. No.</b>	0301310
<b>description</b>	air cushion L 310mm W 85mm		



1

<b>GEV No.</b>	572002	<b>Ref. No.</b>	0301330
<b>description</b>	air cushion L 330mm W 85mm		



1

<b>GEV No.</b>	572003	<b>Ref. No.</b>	0301370
<b>description</b>	air cushion L 370mm W 85mm		



1

<b>GEV No.</b>	572004	<b>Ref. No.</b>	0301390
<b>description</b>	air cushion L 390mm W 85mm		



1

<b>GEV No.</b>	572005	<b>Ref. No.</b>	0301410
<b>description</b>	air cushion L 410mm W 85mm		



1

<b>GEV No.</b>	572009	<b>Ref. No.</b>	0301580
<b>description</b>	air cushion L 580mm W 85mm		



1

<b>GEV No.</b>	572006	<b>Ref. No.</b>	0301440
<b>description</b>	air cushion L 440mm W 85mm		



1

<b>GEV No.</b>	572010	<b>Ref. No.</b>	0301620 0301640
<b>description</b>	air cushion L 620mm W 85mm		



1

<b>GEV No.</b>	572007	<b>Ref. No.</b>	0301490
<b>description</b>	air cushion L 490mm W 85mm		



1

<b>GEV No.</b>	572011	<b>Ref. No.</b>	0301660
<b>description</b>	air cushion L 660mm W 85mm		



1

<b>GEV No.</b>	572008	<b>Ref. No.</b>	0301550
<b>description</b>	air cushion L 550mm W 85mm		



1

<b>GEV No.</b>	572012	<b>Ref. No.</b>	0301740
<b>description</b>	air cushion L 740mm W 85mm		

			
1			
<b>GEV No.</b>	572013	<b>Ref. No.</b>	0301800
<b>description</b>	air cushion L 800mm W 85mm		

			
1			
<b>GEV No.</b>	572014	<b>Ref. No.</b>	0301850
<b>description</b>	air cushion L 850mm W 85mm		

			
1			
<b>GEV No.</b>	572015	<b>Ref. No.</b>	0301860
<b>description</b>	air cushion L 860mm W 85mm		

membranes

			
1			
<b>GEV No.</b>	691582	<b>Ref. No.</b>	0931410
<b>description</b>	membrane ø 110mm H 34mm		
<b>For models:</b>	442006		

			
1			
<b>GEV No.</b>	691579	<b>Ref. No.</b>	0931226
<b>description</b>	membrane ø 48mm H 5mm		

			
1			
<b>GEV No.</b>	691580	<b>Ref. No.</b>	0931400
<b>description</b>	membrane ø 50mm H 19mm		
<b>For models:</b>	442003, 442004		

			
1			
<b>GEV No.</b>	691581	<b>Ref. No.</b>	0931405
<b>description</b>	membrane ø 80mm H 24mm		
<b>For models:</b>	442005, 442006, 442007, 442008		

			
1			
<b>GEV No.</b>	691578	<b>Ref. No.</b>	0931206
<b>description</b>	membrane ø 90mm H 1mm		

oils

			
1			
<b>GEV No.</b>	890296	<b>Ref. No.</b>	0439510
<b>description</b>	oil type V32 1l for vacuum packing machine		
<b>For models:</b>	442003, 442004, 442005, 442006, 442007, 442008, 442010		





1

<b>GEV No.</b>	890253	<b>Ref. No.</b>	0439520
<b>description</b>	oil type VM100 1l for vacuum packing machine		
<b>For models:</b>	442003, 442004, 442005, 442006, 442007, 442008		



1

<b>GEV No.</b>	890200	<b>Ref. No.</b>	0439502
<b>description</b>	oil type VM32 0.25l for vacuum packing machine		
<b>For models:</b>	442003, 442004, 442005, 442006, 442007, 442008		



1

<b>GEV No.</b>	890247	<b>Ref. No.</b>	0439500
<b>description</b>	oil type VM22 0.05l for vacuum packing machine		
<b>For models:</b>	442003, 442004, 442005, 442006, 442007, 442008		



1

<b>GEV No.</b>	890250	<b>Ref. No.</b>	0439503
<b>description</b>	oil type VM32 0.3l for vacuum packing machine		
<b>For models:</b>	442003, 442004, 442005, 442006, 442007, 442008, 442010		



1

<b>GEV No.</b>	890248	<b>Ref. No.</b>	0439501
<b>description</b>	oil type VM22 1l for vacuum packing machine		
<b>For models:</b>	442003, 442004, 442005, 442006, 442007, 442008		



1

<b>GEV No.</b>	890251	<b>Ref. No.</b>	0439505
<b>description</b>	oil type VM32 0.5l for vacuum packing machine		
<b>For models:</b>	442003, 442004, 442005, 442006, 442007, 442008		



1

<b>GEV No.</b>	890252	<b>Ref. No.</b>	0439510 old version
<b>description</b>	oil type VM32 1l for vacuum packing machine		

oil filter



1

<b>GEV No.</b>	691543	<b>Ref. No.</b>	0939091
<b>description</b>	oil filter size 160-300		
<b>For models:</b>	442003, 442004, 442005, 442006, 442007, 442008		



1

<b>GEV No.</b>	691542	<b>Ref. No.</b>	0939090
<b>description</b>	oil filter size 63-100 ø 78mm L 78mm		
<b>For models:</b>	442003, 442004, 442005, 442006, 442007, 442008		

PTFE tapes



1

<b>GEV No.</b>	691526	<b>Ref. No.</b>	0305505
<b>description</b>	PTFE tape W 15mm thickness 0.25mm Qty supplied by meter		



1

<b>GEV No.</b>	691953	<b>Ref. No.</b>	0305513
<b>description</b>	PTFE tape W 46mm		
<b>For models:</b>	442010		



1

<b>GEV No.</b>	693842	<b>Ref. No.</b>	0305515
<b>description</b>	PTFE tape W 46mm thickness 0.1mm Qty supplied by meter		
<b>For models:</b>	442003, 442004, 442005, 442006, 442007, 442008, 442010		



sealing bars



1

<b>GEV No.</b>	691587	<b>Ref. No.</b>	0380590
<b>description</b>	bracket for sealing bar L 365mm W 25mm H 50mm aluminium		



1

<b>GEV No.</b>	691632	<b>Ref. No.</b>	0300010 0300011
<b>description</b>	sealing bar L 277mm W 15mm H 31mm		



1

<b>GEV No.</b>	691997	<b>Ref. No.</b>	0300041
<b>description</b>	sealing bar L 280mm W 16mm H 34mm double		



1

<b>GEV No.</b>	692469	<b>Ref. No.</b>	0300116
<b>description</b>	sealing bar L 355mm W 15mm H 31mm double welding		
<b>For models:</b>	442005		



1

<b>GEV No.</b>	692103	<b>Ref. No.</b>	0300210
<b>description</b>	sealing bar L 420mm W 16mm H 34mm double		
<b>For models:</b>	442007		



1

<b>GEV No.</b>	691998	<b>Ref. No.</b>	0300215
<b>description</b>	sealing bar L 425mm W 16mm H 34mm cut-off seal		



1

<b>GEV No.</b>	698069	<b>Ref. No.</b>	KODK012
<b>description</b>	sealing bar L 460mm W 25mm H 70mm		



1

<b>GEV No.</b>	691816	<b>Ref. No.</b>	0300337
<b>description</b>	sealing bar L 500mm W 16mm H 34mm double		



1

<b>GEV No.</b>	692468	<b>Ref. No.</b>	0300320
<b>description</b>	sealing bar L 520mm W 15.5mm H 31mm		
<b>For models:</b>	442006		



1

<b>GEV No.</b>	691999	<b>Ref. No.</b>	0300332
<b>description</b>	sealing bar L 525mm W 16mm H 35mm double		



1

<b>GEV No.</b>	692126	<b>Ref. No.</b>	0300310
<b>description</b>	sealing bar L 605mm W 15mm H 32mm		
<b>For models:</b>	442006		

contacts for sealing bars



1

<b>GEV No.</b>	691559	<b>Ref. No.</b>	0900170
<b>description</b>	terminal for sealing bar mounting pos. left type DS		



1

<b>GEV No.</b>	691557	<b>Ref. No.</b>	0900152 0900160
<b>description</b>	terminal for sealing bar mounting pos. left type TS		



1

<b>GEV No.</b>	691556	<b>Ref. No.</b>	0900150
<b>description</b>	terminal for sealing bar mounting pos. left/right type table DS		



1

<b>GEV No.</b>	691560	<b>Ref. No.</b>	0900172
<b>description</b>	terminal for sealing bar mounting pos. right type DS		



1

<b>GEV No.</b>	691558	<b>Ref. No.</b>	0900154 0900161
<b>description</b>	terminal for sealing bar mounting pos. right type TS		

heating wires



1

<b>GEV No.</b>	418506	<b>Ref. No.</b>	KODK001
<b>description</b>	heating wire L 454mm Qty 1		
<b>For models:</b>	441001		



1

<b>GEV No.</b>	572016	<b>Ref. No.</b>	0305003
<b>description</b>	heating wire W 3.5mm L 3000mm Qty 1		
<b>For models:</b>	442010		



1

<b>GEV No.</b>	572020	<b>Ref. No.</b>	0305000 (3 meters)
<b>description</b>	heating wire W 3.5mm thickness 0.3mm Qty 3m		





1

<b>GEV No.</b>	572050	<b>Ref. No.</b>	0305000
<b>description</b>	heating wire W 3.5mm thickness 0.3mm Qty supplied by meter		
<b>For models:</b>	442003, 442004, 442005, 442006, 442007, 442008, 442010		



1

<b>GEV No.</b>	572052	<b>Ref. No.</b>	0305019 0305020
<b>description</b>	heating wire W 5mm L 3000mm thickness 0.2mm Qty 1		
<b>For models:</b>	442003, 442004, 442005, 442006, 442007, 442008, 442010		



1

<b>GEV No.</b>	572053	<b>Ref. No.</b>	0305025 0305028
<b>description</b>	heating wire W 8mm L 3000mm thickness 0.2mm Qty 1		
<b>For models:</b>	442003, 442004, 442005, 442006, 442007, 442008, 442010		

service kits



1

<b>GEV No.</b>	890254	<b>Ref. No.</b>	0940100
<b>description</b>	service kit container capacity 0.05l for vacuum packing machine type MJ		
<b>For models:</b>	442003		



1

<b>GEV No.</b>	890255	<b>Ref. No.</b>	0940110
<b>description</b>	service kit container capacity 0.2l for vacuum packing machine type JP		
<b>For models:</b>	442004		



1

<b>GEV No.</b>	890262	<b>Ref. No.</b>	0940120
<b>description</b>	service kit for vacuum packing machine type B35 / B-M 42/42XL		
<b>For models:</b>	442007, 442008		



1

<b>GEV No.</b>	890261	<b>Ref. No.</b>	0940125
<b>description</b>	service kit for vacuum packing machine type B42 XL BA/Toucan BA		



1

<b>GEV No.</b>	890263	<b>Ref. No.</b>	0940140
<b>description</b>	service kit for vacuum packing machine type F80/P80 LL		



1

<b>GEV No.</b>	890256	<b>Ref. No.</b>	0940115
<b>description</b>	service kit for vacuum packing machine type J35/J42/B35		
<b>For models:</b>	442005, 442007		



1

<b>GEV No.</b>	890264	<b>Ref. No.</b>	0940130
<b>description</b>	service kit for vacuum packing machine type M46-M/F/P 52		
<b>For models:</b>	442006		



1

<b>GEV No.</b>	890265	<b>Ref. No.</b>	0940160
<b>description</b>	service kit for vacuum packing machine type P2-40/50/75		

### cut off wires



1

<b>GEV No.</b>	572018	<b>Ref. No.</b>	0305009
<b>description</b>	cut off wire ø 1.1mm Qty 3m		
<b>For models:</b>	442010		



1

<b>GEV No.</b>	572051	<b>Ref. No.</b>	0305010
<b>description</b>	cut off wire ø 1.1mm Qty supplied by meter		
<b>For models:</b>	442003, 442004, 442005, 442006, 442007, 442008, 442010		

### vacuum valves

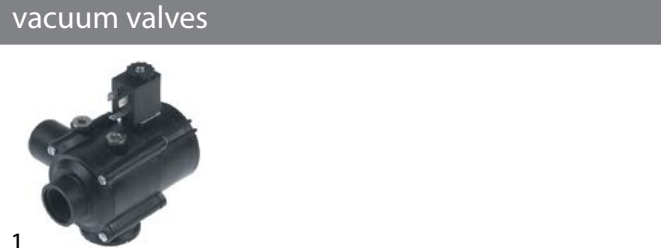

1

<b>GEV No.</b>	691550	<b>Ref. No.</b>	0281000
<b>description</b>	vacuum valve connection 1"		
<b>For models:</b>	442006		



1

<b>GEV No.</b>	691554	<b>Ref. No.</b>	0900850
<b>description</b>	vacuum valve connection 1 1/4"		
<b>For models:</b>	442006		



			
1			
<b>GEV No.</b>	691552	<b>Ref. No.</b>	0281020
<b>description</b>	vacuum valve connection 2"		

			
1			
<b>GEV No.</b>	691567	<b>Ref. No.</b>	0939113
<b>description</b>	locking screw thread 3/4" plastic		
<b>For models:</b>	442003, 442004, 442005, 442006, 442007, 442008		

locking screws

			
1			
<b>GEV No.</b>	691568	<b>Ref. No.</b>	0939115
<b>description</b>	locking screw thread 1" plastic		
<b>For models:</b>	442003, 442004, 442005, 442006, 442007, 442008		

maintenance sets

			
1			
<b>GEV No.</b>	691577	<b>Ref. No.</b>	0931225
<b>description</b>	maintenance set for air valve size 1"		
<b>For models:</b>	442006		

			
1			
<b>GEV No.</b>	691566	<b>Ref. No.</b>	0939110
<b>description</b>	locking screw thread 1/2" plastic		
<b>For models:</b>	442003, 442004, 442005, 442006, 442007, 442008		

			
1			
<b>GEV No.</b>	691575	<b>Ref. No.</b>	0900872
<b>description</b>	maintenance set for air valve size 1/4"		
<b>For models:</b>	442006		

			
1			
<b>GEV No.</b>	691565	<b>Ref. No.</b>	0939105
<b>description</b>	locking screw thread 1/4" SS		
<b>For models:</b>	442003, 442004, 442005, 442006, 442007, 442008, 442010		

			
1			
<b>GEV No.</b>	691573	<b>Ref. No.</b>	0931205
<b>description</b>	maintenance set for air valve size 2"		

			
1			
<b>GEV No.</b>	691564	<b>Ref. No.</b>	0939102
<b>description</b>	locking screw thread 1/8" SS		
<b>For models:</b>	442003, 442004, 442005, 442006, 442007, 442008		



1

<b>GEV No.</b>	691576	<b>Ref. No.</b>	0931220
<b>description</b>	maintenance set for vacuum valve size 1"		
<b>For models:</b>	442006		



1

<b>GEV No.</b>	691574	<b>Ref. No.</b>	0900870
<b>description</b>	maintenance set for vacuum valve size 1 1/4"		
<b>For models:</b>	442006		



1

<b>GEV No.</b>	691572	<b>Ref. No.</b>	0931200
<b>description</b>	maintenance set for vacuum valve size 2"		

miscellaneous



1

<b>GEV No.</b>	691955	<b>Ref. No.</b>	0400735
<b>description</b>	flange ID ø 54mm L 80mm W 40mm H 14mm		



1

<b>GEV No.</b>	692470	<b>Ref. No.</b>	0380710
<b>description</b>	guide bar L 425mm W 25mm H 25mm for vacuum packing machine		

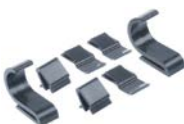

1

<b>GEV No.</b>	697921	<b>Ref. No.</b>	0330116
<b>description</b>	mounting clip set plastic for front panel		



1

<b>GEV No.</b>	692471	<b>Ref. No.</b>	0810112
<b>description</b>	non-return valve ID ø 8mm ED ø 10mm L 39.5mm for vacuum packing machine		



1

<b>GEV No.</b>	690977	<b>Ref. No.</b>	0380702
<b>description</b>	rail for gasket L 280mm aluminium		



1

<b>GEV No.</b>	692065	<b>Ref. No.</b>	0065250
<b>description</b>	retaining ring for vacuum packing machine shaft ø 6mm thickness 0.7mm SS DIN 471		



1

<b>GEV No.</b>	691583	<b>Ref. No.</b>	0931230
<b>description</b>	sound damper ID ø 51.5mm ED ø 57mm H 32mm		



1

<b>GEV No.</b>	692066	<b>Ref. No.</b>	0390500
<b>description</b>	spindle ED ø 6mm L 127mm		

for heated display cases

miscellaneous



1

<b>GEV No.</b>	691105	<b>Ref. No.</b>	IB1926000
<b>description</b>	coupling for pizza display		
<b>For models:</b>	541001, 541002		



1

<b>GEV No.</b>	691106	<b>Ref. No.</b>	IB7506000
<b>description</b>	door hinge kit for glass door mounting pos. upper/lower		
<b>For models:</b>	541001, 541002		



1

<b>GEV No.</b>	691508	<b>Ref. No.</b>	X04.17.1054.00
<b>description</b>	rotation plate		
<b>For models:</b>	541003		

for woks



1

<b>GEV No.</b>	540666	<b>Ref. No.</b>	GS3846
<b>description</b>	water nozzle thread 1/8"		
<b>For models:</b>	231005, 231006, 231007, 231008		

knobs

universal knobs



1

<b>GEV No.</b>	110235	<b>Ref. No.</b>	548810000
<b>description</b>	knob energy regulator 1-3 t.max.°C ø 50mm shaft ø 6x4.6mm shaft flat upper black		
<b>For models:</b>	221017, 221018		





1

<b>GEV No.</b>	110234	<b>Ref. No.</b>	PT0113
<b>description</b>	knob switch 7-position t.max.°C ø 50mm shaft ø 6x4.6mm shaft flat upper black		



1

<b>GEV No.</b>	111533	<b>Ref. No.</b>	MANOP003	
<b>description</b>	knob thermostat t.max. 500°C ø 50mm shaft ø 6x4.6mm shaft flat upper black temperature range 0-500°C rotation 270°			
<b>For models:</b>	530009, 530010, 530011, 530012, 531020, 531021, 531022, 531023			
<b>accessories for</b>	111533			
	<b>GEV No.</b>	110135	<b>Ref. No.</b>	—
	rosette knob up to ø 52mm			



1

<b>GEV No.</b>	110932	<b>Ref. No.</b>	AC06200
<b>description</b>	knob switch zero mark t.max.°C ø 42mm shaft ø 6x4.6mm shaft flat upper black		
<b>For models:</b>	531010, 531011, 531012, 531013, 531014, 531015, 531016, 531017		



1

<b>GEV No.</b>	112121	<b>Ref. No.</b>	122-2009
<b>description</b>	knob thermostat t.max. 180°C ø 48mm shaft ø 6x4.6mm shaft flat upper temperature range 70-180°C rotation 270°		
<b>For models:</b>	244012		



1

<b>GEV No.</b>	112687	<b>Ref. No.</b>	CR-B113 KO-B103 KOB103 WFB102
<b>description</b>	knob zero mark t.max.°C ø 38mm shaft ø 6x4.6mm shaft flat lower black		
<b>For models:</b>	223007, 223008, 225009, 255009, 255012, 255013, 255014		



1

<b>GEV No.</b>	111492	<b>Ref. No.</b>	MAN30014
<b>description</b>	knob zero mark t.max.°C ø 47mm shaft ø 6x4.6mm shaft flat right nickel		
<b>For models:</b>	211011, 211012, 211017, 211018, 211023, 211024, 212014		

producer-specific knobs

COOKMAX



1

<b>GEV No.</b>	112539	<b>Ref. No.</b>	MN1090A0
<b>description</b>	knob time 120min t.max.°C ø 41mm shaft ø 6x4.6mm shaft flat lower silver		
<b>For models:</b>	211002, 211003		



1

<b>GEV No.</b>	112795	<b>Ref. No.</b>	PD405020A
<b>description</b>	knob 0-450 t.max.°C ø 76mm shaft ø 6x4.6mm shaft flat upper		



1

<b>GEV No.</b>	111704	<b>Ref. No.</b>	824710140
<b>description</b>	knob connection 10x8 ø 70mm water cold (1/2 turn) shaft ø 10x8mm shaft flat upper t.max.°C		
<b>For models:</b>	136001, 136002, 136003, 136004, 136201, 136202		



1

<b>GEV No.</b>	111709	<b>Ref. No.</b>	824710150
<b>description</b>	knob connection 10x8 water warm (1/2 turn) total lengthmm mounting pos. ø 70mm		
<b>For models:</b>	136001, 136002, 136201, 136202		





1

<b>GEV No.</b>	111693	<b>Ref. No.</b>	824710410
<b>description</b>	knob energy regulator 1-10 t.max.°C ø 70mm shaft ø 6x4.6mm shaft flat upper black		
<b>For models:</b>	131011, 131012, 132005, 132006, 132205, 132206		





			
1			
<b>GEV No.</b>	111696	<b>Ref. No.</b>	824710260
<b>description</b>	knob energy regulator 1-8 + MAX t.max.°C ø 55mm shaft ø 6x4.6mm shaft flat upper black		
<b>For models:</b>	137001, 137003, 137004, 137201		

			
1			
<b>GEV No.</b>	112030	<b>Ref. No.</b>	PD405I+PD405M
<b>description</b>	knob gas tap with ignition flame ø 76mm shaft ø 8x6.5mm shaft flat left red		

			
1			
<b>GEV No.</b>	111692	<b>Ref. No.</b>	824710290
<b>description</b>	knob energy regulator t.max.°C ø 70mm shaft ø 6x4.6mm shaft flat upper black		
<b>For models:</b>	131011, 131012, 132005, 132006, 132205, 132206, 136002, 136202		

			
1			
<b>GEV No.</b>	110149	<b>Ref. No.</b>	PT0114
<b>description</b>	knob gas tap without ignition flame t.max.°C temperature range°C ø 50mm shaft ø 6x4.6mm shaft flat right black		
<b>For models:</b>	254005, 254006, 254007, 254008, 254009, 254010, 254011, 254012		

			
1			
<b>GEV No.</b>	111689	<b>Ref. No.</b>	824710100
<b>description</b>	knob gas tap PEL21/22/23 t.max.°C ø 70mm shaft ø 8x6.5mm shaft flat upper black		
<b>For models:</b>	121001, 121002, 121003, 121005, 122001, 122002, 123001, 123002, 123003, 123004, 123005, 123006, 123007, 123008, 123009, 131001, 131002, 131003, 131004, 131005, 131006, 132001, 132002, 133001, 133002, 133003, 133007, 133008, 133009, 133010, 133011, 133012, 133013, 133014, 133015, 133022, 133023, 133207, 133208, 133222, 133223, 136001		

			
1			
<b>GEV No.</b>	112465	<b>Ref. No.</b>	824710700
<b>description</b>	knob gas thermostat Eurosit t.max. 190°C 110-190°C ø 70mm shaft ø 8x6.5mm shaft flat upper black		
<b>For models:</b>	134002, 134004, 134006		

			
1			
<b>GEV No.</b>	112862	<b>Ref. No.</b>	824710120
<b>description</b>	knob gas tap PEL22/23 t.max.°C ø 70mm shaft ø 10x8mm shaft flat upper chrome-plated		
<b>For models:</b>	136001, 136201		

			
1			
<b>GEV No.</b>	111698	<b>Ref. No.</b>	824710070
<b>description</b>	knob gas thermostat Eurosit t.max. 300°C 100-300°C ø 70mm shaft ø 8x6.5mm shaft flat upper black		
<b>For models:</b>	133001, 133002, 133003, 133009, 133010, 133011, 133012, 133013, 133014, 133015, 133024, 133203, 133209, 133210, 133211, 133212, 133213, 133214, 133215		

			
1			
<b>GEV No.</b>	111694	<b>Ref. No.</b>	824710110
<b>description</b>	knob gas thermostat Eurosit t.max. 320°C 80-320°C ø 55mm shaft ø 8x6.5mm shaft flat upper black		
<b>For models:</b>	131003, 131005, 133024, 133203, 133209, 133210, 133211, 133212, 133213, 133214, 133215		

			
1			
<b>GEV No.</b>	112852	<b>Ref. No.</b>	CR0905990
<b>description</b>	knob gas thermostat t.max. 190°C 110-190°C ø 79mm shaft ø 8x6mm chrome-plated		
<b>For models:</b>	144002		

			
1			
<b>GEV No.</b>	110081	<b>Ref. No.</b>	GS.3602
<b>description</b>	knob ø 70mm shaft ø 8x6.5mm shaft flat universal		
<b>For models:</b>	231001, 231002, 231003, 231004, 231005, 231006, 231007, 231008, 234003, 234004, 234006, 235001		

			
1			
<b>GEV No.</b>	112025	<b>Ref. No.</b>	100117
<b>description</b>	knob potentiometer 1-6 ø 54mm shaft ø 6x4.6mm shaft flat lower		
<b>For models:</b>	131216, 131217, 131218, 246009, 246010, 246011, 246012, 246013, 246014		

			
1			
<b>GEV No.</b>	112024	<b>Ref. No.</b>	100107
<b>description</b>	knob potentiometer MIN/MAX ø 54mm shaft ø 6x4.6mm shaft flat lower		
<b>For models:</b>	131216, 131217, 131218, 246009, 246010, 246011, 246012, 246013, 246014		

			
1			
<b>GEV No.</b>	112466	<b>Ref. No.</b>	41824710230
<b>description</b>	knob switch 0-1-0-1 t.max.°C ø 70mm shaft ø 6x4.6mm shaft flat horizontal black		
<b>For models:</b>	137003, 137004		

			
1			
<b>GEV No.</b>	112481	<b>Ref. No.</b>	824710710
<b>description</b>	knob switch 0-1-2-3 ø 55mm shaft ø 6x4.6mm shaft flat upper black		
<b>For models:</b>	131004, 131006, 131007, 131008, 131009, 131207, 131208, 131209, 132003, 132004, 132203, 132204		

			
1			
<b>GEV No.</b>	111691	<b>Ref. No.</b>	824710320
<b>description</b>	knob switch 7-position t.max.°C ø 70mm shaft ø 6x4.6mm shaft flat upper black		
<b>For models:</b>	131007, 131008, 131009, 132003, 132004		

			
1			
<b>GEV No.</b>	111771	<b>Ref. No.</b>	R69030170
<b>description</b>	knob switch zero mark ø 42mm shaft ø 6x4.6mm shaft flat upper black		
<b>For models:</b>	212002, 212003		

			
1			
<b>GEV No.</b>	111239	<b>Ref. No.</b>	MAN30008
<b>description</b>	knob switch zero mark ø 47mm shaft ø 6x4.6mm shaft flat right black		
<b>For models:</b>	211004, 211005, 211006, 211010, 211013, 211014, 211015, 211016, 212015, 212016, 215001, 215002, 215003, 215004		

			
1			
<b>GEV No.</b>	110276	<b>Ref. No.</b>	IB4206412
<b>description</b>	knob switch zero mark t.max.°C temperature range°C ø 49mm shaft ø 6x4.6mm shaft flat upper black		
<b>For models:</b>	221006		





			
1			
<b>GEV No.</b>	112537	<b>Ref. No.</b>	A02011006
<b>description</b>	knob switch zero mark t.max.°C ø 41mm shaft ø 6x4.6mm shaft flat left black		

			
1			
<b>GEV No.</b>	110093	<b>Ref. No.</b>	450323
<b>description</b>	knob switch zero mark t.max.°C ø 42mm shaft ø 5x5mm shaft flat black		
<b>For models:</b>	SP3		

			
1			
<b>GEV No.</b>	111702	<b>Ref. No.</b>	824710240
<b>description</b>	knob thermostat t.max. 100°C 40-100°C ø 70mm shaft ø 6x4.6mm shaft flat upper black		
<b>For models:</b>	134207, 135001, 135002, 135003, 135004, 136003, 136004		

			
1			
<b>GEV No.</b>	112737	<b>Ref. No.</b>	CR0795740
<b>description</b>	knob thermostat t.max. 185°C 115-185°C ø 79mm shaft ø 6x4.6mm shaft flat upper black for fryer		
<b>For models:</b>	124102		

			
1			
<b>GEV No.</b>	112463	<b>Ref. No.</b>	824710680
<b>description</b>	knob thermostat t.max. 190°C 120-190°C ø 70mm shaft ø 6x4.6mm shaft flat upper black rotation 270°		
<b>For models:</b>	134001, 134003, 134005		

			
1			
<b>GEV No.</b>	111695	<b>Ref. No.</b>	824710270
<b>description</b>	knob thermostat t.max. 300°C 50-300°C ø 55mm shaft ø 6x4.6mm shaft flat upper black rotation 240°		
<b>For models:</b>	131004, 131006, 131007, 131008, 131009, 131207, 131208, 131209, 132003, 132004, 132203, 132204, 137001, 137002, 137003, 137004, 137201, 137202		

			
1			
<b>GEV No.</b>	111699	<b>Ref. No.</b>	824710250
<b>description</b>	knob thermostat t.max. 300°C 50-300°C ø 70mm shaft ø 6x4.6mm shaft flat upper black		
<b>For models:</b>	133004, 133005, 133006, 133016, 133017, 133018, 133019, 133020, 133021, 133106, 133119, 137003, 137004		

			
1			
<b>GEV No.</b>	112517	<b>Ref. No.</b>	2599214
<b>description</b>	knob thermostat t.max. 300°C ø 65mm shaft ø 6x4.6mm shaft flat upper black temperature range 50-300°C rotation 370°		

			
1			
<b>GEV No.</b>	112033	<b>Ref. No.</b>	PD405H+PD405P
<b>description</b>	knob thermostat t.max. 300°C ø 76mm shaft ø 6x4.6mm shaft flat upper red temperature range 50-300°C		

			
1			
<b>GEV No.</b>	112519	<b>Ref. No.</b>	CR0502150
<b>description</b>	knob universal ø 67mm shaft ø 6x4.6mm shaft flat horizontal		

			
1			
<b>GEV No.</b>	112518	<b>Ref. No.</b>	CR0502140
<b>description</b>	knob universal ø 67mm shaft ø 6x4.6mm shaft flat vertical		

			
1			
<b>GEV No.</b>	111421	<b>Ref. No.</b>	7000000
<b>description</b>	knob zero mark ø 48mm shaft ø 6x4.6mm shaft flat upper black		
<b>For models:</b>	221011, 221012, 221019, 221020		

			
1			
<b>GEV No.</b>	112691	<b>Ref. No.</b>	CR-B115 KOB120 KO-B120-150 PIB149 PI-B149-150 WFB114 WF-B114-150
<b>description</b>	knob zero mark ø 54mm shaft ø 6x4.6mm shaft flat upper black		
<b>For models:</b>	223007, 223008, 225009, 255009, 255012, 255013, 255014, 531034, 531039, 531040		

			
1			
<b>GEV No.</b>	112944	<b>Ref. No.</b>	73600140
<b>description</b>	knob 1-10 t.max.°C ø 50mm shaft ø 6x4.6mm shaft flat lower silver		

			
1			
<b>GEV No.</b>	112926	<b>Ref. No.</b>	402590500
<b>description</b>	knob energy regulator 1-3 t.max.°C temperature range°C ø 42mm shaft ø 6x4.6mm shaft flat upper black		
<b>For models:</b>	221001, 221002, 221003, 221004		

			
1			
<b>GEV No.</b>	112533 <sup>1</sup>	<b>Ref. No.</b>	0AT93617 A0AT93617
<b>description</b>	knob energy regulator t.max.°C ø 48mm shaft ø 6x4.6mm shaft flat upper black		
<b>For models:</b>	221007		

<sup>1</sup>with rosette 70mm

			
1			
<b>GEV No.</b>	112927	<b>Ref. No.</b>	402593200
<b>description</b>	knob gas tap without ignition flame t.max.°C temperature range°C ø 42mm shaft ø 6x4.6mm shaft flat right		
<b>For models:</b>	111002, 111003, 112003, 112004		

			
1			
<b>GEV No.</b>	112928	<b>Ref. No.</b>	402593100
<b>description</b>	knob gas tap without ignition flame t.max.°C temperature range°C ø 42mm shaft ø 6x4.6mm shaft flat upper		
<b>For models:</b>	113001, 113002, 113007, 113008, 113009, 113010, 243003, 243004, 243006, 243007, 243008		

			
1			
<b>GEV No.</b>	112945	<b>Ref. No.</b>	7422505
<b>description</b>	knob ø 22mm shaft ø 6x4.6mm shaft flat vertical white		
<b>For models:</b>	621015, 622013, 622019, 625010, 629001		

			
1			
<b>GEV No.</b>	111772	<b>Ref. No.</b>	R69030260
<b>description</b>	knob ø 42mm shaft ø 6x4.6mm shaft flat universal		
<b>For models:</b>	212001, 212002, 212003		



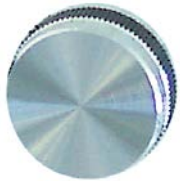

			
1			
<b>GEV No.</b>	110929	<b>Ref. No.</b>	IB4200700 IB4200701
<b>description</b>	knob potentiometer t.max.°C temperature range°C ø 23mm shaft ø 6mm silver		
<b>For models:</b>	721003, 721004, 723001		

			
1			
<b>GEV No.</b>	112939	<b>Ref. No.</b>	X05.30.093.00 X05.30.098.00
<b>description</b>	knob switch zero mark ø 45mm shaft ø 6mm		
<b>For models:</b>	541003		

			
1			
<b>GEV No.</b>	112925	<b>Ref. No.</b>	402593300
<b>description</b>	knob switch 7-position t.max.°C temperature range°C ø 42mm shaft ø 6x4.6mm shaft flat upper black		
<b>For models:</b>	111001, 112001, 112002		

			
1			
<b>GEV No.</b>	112280	<b>Ref. No.</b>	IB4200100
<b>description</b>	knob switch zero mark t.max.°C temperature range°C ø 16mm shaft ø 6mm black/grey		
<b>For models:</b>	721002, 721005		

			
1			
<b>GEV No.</b>	112948	<b>Ref. No.</b>	11543
<b>description</b>	knob switch zero mark ø 30mm shaft ø 6x4.6mm shaft flat right grey		
<b>For models:</b>	741003		

			
1			
<b>GEV No.</b>	112916	<b>Ref. No.</b>	KODK003
<b>description</b>	knob switch zero mark t.max.°C temperature range°C ø 18mm shaft ø 5.5mm		

			
1			
<b>GEV No.</b>	111825	<b>Ref. No.</b>	05.30.043.00
<b>description</b>	knob switch zero mark ø 30mm shaft ø 6x4.6mm shaft flat right silver		
<b>For models:</b>	276003, 276004, 276005, 276006, 276007, 276008, 276009, 276010		

			
1			
<b>GEV No.</b>	111235	<b>Ref. No.</b>	IB4200705
<b>description</b>	knob switch zero mark t.max.°C temperature range°C ø 23mm shaft ø 5.5mm black		
<b>For models:</b>	473001		

			
1			
<b>GEV No.</b>	111586	<b>Ref. No.</b>	00002780
<b>description</b>	knob switch zero mark ø 43mm shaft ø 6x4.6mm shaft flat lower black		
<b>For models:</b>	212036, 212038, 212040		

			
1			
<b>GEV No.</b>	112283	<b>Ref. No.</b>	MSC04V236
<b>description</b>	knob switch zero mark t.max.°C temperature range°C ø 23mm shaft ø 6mm black		
<b>For models:</b>	471001		



1

<b>GEV No.</b>	110970	<b>Ref. No.</b>	5873320
<b>description</b>	knob switch zero mark t.max.°C°C ø 19mm shaft ø 6mm black/red		



1

<b>GEV No.</b>	112535	<b>Ref. No.</b>	01143562
<b>description</b>	knob switch zero mark t.max.°C°C ø 23mm shaft ø 6x4.6mm shaft flat upper silver		
<b>For models:</b>	273001		



1

<b>GEV No.</b>	111769	<b>Ref. No.</b>	72800360
<b>description</b>	knob thermostat 1-10 ø 54mm shaft ø 6x4.6mm shaft flat lower		
<b>For models:</b>	531001, 531002, 531003, 531004, 531005, 531006, 531007, 531008		



1

<b>GEV No.</b>	112940	<b>Ref. No.</b>	73600130
<b>description</b>	knob thermostat 1-10 t.max.°C°C ø 50mm shaft ø 6x4.6mm shaft flat lower black		



1

<b>GEV No.</b>	112918	<b>Ref. No.</b>	402592130
<b>description</b>	knob thermostat t.max. 110°C temperature range 30-110°C ø 42mm shaft ø 6x4.6mm shaft flat upper rotation 270° black		
<b>For models:</b>	116001, 116002		



1

<b>GEV No.</b>	112921	<b>Ref. No.</b>	402592005
<b>description</b>	knob thermostat t.max. 190°C temperature range 50-190°C ø 42mm shaft ø 6x4.6mm shaft flat lower rotation 270° black		
<b>For models:</b>	114002		



1

<b>GEV No.</b>	112922	<b>Ref. No.</b>	402592000
<b>description</b>	knob thermostat t.max. 190°C temperature range 50-190°C ø 42mm shaft ø 6x4.6mm shaft flat upper rotation 270° black		
<b>For models:</b>	244001, 244002, 244003, 244004, 244005, 244006, 244007, 244008, 244009, 244021		



1

<b>GEV No.</b>	112668	<b>Ref. No.</b>	KMN1091B
<b>description</b>	knob thermostat t.max. 260°C ø 41mm shaft ø 6x4.6mm shaft flat lower silver		



1

<b>GEV No.</b>	112543	<b>Ref. No.</b>	MN1101A0 MN1101B0
<b>description</b>	knob thermostat t.max. 260°C ø 45mm shaft ø 6x4.6mm shaft flat lower silver temperature range 80-260°C rotation 270°		
<b>For models:</b>	211001		





1

<b>GEV No.</b>	112540	<b>Ref. No.</b>	MN1091A0
<b>description</b>	knob thermostat t.max. 300°C ø 41mm shaft ø 6x4.6mm shaft flat lower silver temperature range 80-300°C rotation 270°		
<b>For models:</b>	211002, 211003		



			
1			
<b>GEV No.</b>	110422	<b>Ref. No.</b>	1031019900
<b>description</b>	knob thermostat t.max. 300°C ø 45mm shaft ø 6x4.6mm shaft flat right black temperature range 50-300°C rotation 270°		

			
1			
<b>GEV No.</b>	112938	<b>Ref. No.</b>	402593000
<b>description</b>	knob thermostat t.max. 300°C temperature range 50-300°C ø 42mm shaft ø 6x4.6mm shaft flat upper rotation 270° black		
<b>For models:</b>	111001, 111002, 111003, 113003, 113004, 113005, 113006, 113011, 113012, 113013, 113014, 243001, 243002, 243005, 255001, 255002, 255003, 255004, 255006, 255007, 535001, 535002, 535004		

			
1			
<b>GEV No.</b>	112941	<b>Ref. No.</b>	73601100
<b>description</b>	knob thermostat t.max. 500°C ø 50mm shaft ø 6x4.6mm shaft flat lower black temperature range 50-500°C rotation 270°		

			
1			
<b>GEV No.</b>	112619 <sup>1</sup>	<b>Ref. No.</b>	040574
<b>description</b>	knob thermostat t.max. 80°C 30-80°C ø 41mm shaft ø 6x4.6mm shaft flat lower black		
<b>For models:</b>	271001, 271002, 271003		

<sup>1</sup>with rosette 58mm

			
1			
<b>GEV No.</b>	511304	<b>Ref. No.</b>	450315
<b>description</b>	knob thermostat t.max. 90°C 30-90°C ø 43mm shaft ø 6x4.6mm shaft flat -135°		
<b>For models:</b>	SP1, SP2-12, SP2-S12, SP3		

			
1			
<b>GEV No.</b>	112919	<b>Ref. No.</b>	402591100
<b>description</b>	knob thermostat t.max. 90°C temperature range 30-90°C ø 42mm shaft ø 6x4.6mm shaft flat right rotation 270° black		
<b>For models:</b>	272001, 272002, 955001, 955002		

			
1			
<b>GEV No.</b>	112914	<b>Ref. No.</b>	IB4206010
<b>description</b>	knob thermostat t.max. 90°C temperature range 30-90°C ø 42mm shaft ø 6x4.6mm shaft flat upper		
<b>For models:</b>	541001, 541002, 541004		

			
1			
<b>GEV No.</b>	112920	<b>Ref. No.</b>	402591000
<b>description</b>	knob thermostat t.max. 90°C temperature range 30-90°C ø 42mm shaft ø 6x4.6mm shaft flat upper rotation 270° black		
<b>For models:</b>	114003, 115001, 115002, 244010, 245001, 245002, 245003, 245004, 245005, 245007, 245008, 261001, 261002, 262002, 262003, 271004, 271005, 271006, 955003, 955004, HD3NK		

			
1			
<b>GEV No.</b>	112923	<b>Ref. No.</b>	402590820
<b>description</b>	knob time 120min t.max.°C temperature range°C ø 42mm shaft ø 6x4.6mm shaft flat upper black		
<b>For models:</b>	111003		

			
1			
<b>GEV No.</b>	112937	<b>Ref. No.</b>	402590750
<b>description</b>	knob time 15min + permanent ON t.max.°C temperature range°C ø 42mm shaft ø 6x4.6mm shaft flat left		
<b>For models:</b>	222002, 222003		



1

<b>GEV No.</b>	112924	<b>Ref. No.</b>	402590770
<b>description</b>	knob time 15min + permanent ON t.max.°C temperature range°C ø 42mm shaft ø 6x4.6mm shaft flat left black		
<b>For models:</b>	535001, 535002, 535004		



1

<b>GEV No.</b>	112542	<b>Ref. No.</b>	MN1100A0
<b>description</b>	knob time 60min t.max.°C ø 45mm shaft ø 6x4.6mm shaft flat lower gold		
<b>For models:</b>	211001		



1

<b>GEV No.</b>	112929	<b>Ref. No.</b>	402590700
<b>description</b>	knob toaster t.max.°C temperature range°C ø 42mm shaft ø 6x4.6mm shaft flat right		
<b>For models:</b>	222002		



1

<b>GEV No.</b>	112930	<b>Ref. No.</b>	402590900
<b>description</b>	knob toaster t.max.°C temperature range°C ø 42mm shaft ø 6x4.6mm shaft flat right		
<b>For models:</b>	222003		



1

<b>GEV No.</b>	111452	<b>Ref. No.</b>	101002
<b>description</b>	knob zero mark ø 53mm shaft ø 6x4.6mm shaft flat upper red/black		
<b>For models:</b>	531028, 531029, 531030, 531031		



1

<b>GEV No.</b>	111708	<b>Ref. No.</b>	824710080
<b>description</b>	marker red		
<b>For models:</b>	131001, 131002, 131003, 131004, 131005, 131006, 131007, 131008, 131009, 131011, 131012, 132001, 132002, 132003, 132004, 132005, 132006, 132205, 132206, 133004, 133005, 133006, 133016, 133017, 133018, 133019, 133020, 133021, 135001, 135002, 135003, 135004, 137001, 137002, 137003, 137004, 137201, 137202		



1

<b>GEV No.</b>	110601	<b>Ref. No.</b>	1842000
<b>description</b>	knob dial plate gas tap with ignition flame t.max.°C		



1

<b>GEV No.</b>	110606	<b>Ref. No.</b>	1039107300
<b>description</b>	knob dial plate switch 7-position t.max.°C		



1

<b>GEV No.</b>	110610	<b>Ref. No.</b>	1218500
<b>description</b>	knob dial plate thermostat t.max. 90°C 30-90°C		

### steam/water taps

### steam/water taps



1

<b>GEV No.</b>	527182	<b>Ref. No.</b>	WY15272
<b>description</b>	knob steam ø 46mm shaft ø 6x6mm		
<b>For models:</b>	742001, 742002, 742003, 742004, 742005		

			
1			
<b>GEV No.</b>	527183	<b>Ref. No.</b>	WY15273
<b>description</b>	knob water ø 6x6mm		
<b>For models:</b>	742001, 742002, 742003, 742004		

miscellaneous

			
1			
<b>GEV No.</b>	527259	<b>Ref. No.</b>	WY15271
<b>description</b>	knob push-in ø 34/60mm shaft ø 5x5mm black H 21.4mm L 49mm		
<b>For models:</b>	742001, 742002, 742003, 742004, 742017, 742018, 742019, 742020		

accessories

button springs

			
1			
<b>GEV No.</b>	550132	<b>Ref. No.</b>	PD2451
<b>description</b>	knob spring ø 6x4.6mm Qty 10 pcs		
<b>For models:</b>	221005		

fascias

			
1			
<b>GEV No.</b>	112946	<b>Ref. No.</b>	07.01.034.00
<b>description</b>	bezel 0-7 dimensions 51x60mm		
<b>For models:</b>	276003, 276004, 276005, 276006, 276007, 276008, 276009, 276010		

gaskets

			
1			
<b>GEV No.</b>	693918	<b>Ref. No.</b>	825110510
<b>description</b>	gasket for knob rubber D1 ø 19mm D2 ø 4mm thickness 1mm		
<b>For models:</b>	133004, 133005, 133006, 133016, 133017, 133018, 133019, 133020, 133021, 133106, 133119, 133204, 133205, 133206, 133216, 133217, 133218, 133219, 133220, 133221, 133227, 133228, 137003, 137004, 137203, 137204		

			
1			
<b>GEV No.</b>	112529	<b>Ref. No.</b>	2519490
<b>description</b>	gasket for knob rubber D1 ø 36mm D2 ø 46mm thickness 9mm		

			
1			
<b>GEV No.</b>	693796	<b>Ref. No.</b>	825110500
<b>description</b>	gasket for knob rubber D1 ø 38mm D2 ø 4mm thickness 1mm		
<b>For models:</b>	132205, 132206		

rosettes

			
1			
<b>GEV No.</b>	112541	<b>Ref. No.</b>	KMN1095A MN1095A0
<b>description</b>	rosette for knob up to ø 41mm		
<b>For models:</b>	211002, 211003		

			
1			
<b>GEV No.</b>	110105	<b>Ref. No.</b>	402595001
<b>description</b>	rosette knob ø 42mm ø 56mm zero mark		
<b>For models:</b>	535001, 535002, 535004		

			
1			
<b>GEV No.</b>	110310	<b>Ref. No.</b>	191040 402595000
<b>description</b>	rosette knob up to ø 45mm		
<b>For models:</b>	111001, 111002, 111003, 112001, 112002, 112003, 112004, 113001, 113002, 113003, 113004, 113005, 113006, 113007, 113008, 113009, 113010, 113011, 113012, 113013, 113014, 114001, 114002, 114003, 115001, 115002, 116001, 116002, 221001, 221002, 221003, 221004, 222002, 222003, 243001, 243002, 243003, 243004, 243005, 243006, 243007, 243008, 244001, 244002, 244003, 244004, 244005, 244006, 244007, 244008...(Other models you can see in the webshop)		

## handles and hand wheels

### hand wheels

#### hand wheels



1

<b>GEV No.</b>	691441	<b>Ref. No.</b>	6A039710
<b>description</b>	hand wheel ø 160mm D1 ø 32mm bore ø 20mm depth of bore 24mm thread M6 hole distance 6mm groove widthmm L1 35mm L2 60mm handle length 70mm no fold-away handle		

### cylindrical handles

#### fixed



1

<b>GEV No.</b>	112943	<b>Ref. No.</b>	73600750
<b>description</b>	cylindrical handle thread M10 ø 27mm L 91mm		
<b>For models:</b>	531001, 531002, 531003, 531004, 531005, 531006, 531007, 531008		



1

<b>GEV No.</b>	110703	<b>Ref. No.</b>	1829200 IMPUG001 MA1829200 SL0106
<b>description</b>	cylindrical handle thread M10 ø 28mm L 87mm		
<b>For models:</b>	123101, 123102, 431002, 433003, 433004, 433005, 481004, 530009, 530010, 530011, 530012, 531020, 531021, 531022, 531023		



1

<b>GEV No.</b>	112917	<b>Ref. No.</b>	IB4206430
<b>description</b>	cylindrical handle thread M8 ø 23mm L 55mm		
<b>For models:</b>	221006		



1

<b>GEV No.</b>	691314	<b>Ref. No.</b>	407803000 MF2359
<b>description</b>	cylindrical handle thread M8 ø 28mm L 86mm		
<b>For models:</b>	113001, 113002, 113019, 113020, 221001, 221002, 221003, 221004, 243007, 243008, 433001, 433002, 535001, 535002		



1

<b>GEV No.</b>	690158	<b>Ref. No.</b>	AC06600
<b>description</b>	cylindrical handle thread M8 ø 29mm L 112mm		
<b>For models:</b>	531010, 531011, 531012, 531013, 531014, 531015, 531016, 531017		

### cone handles



1

<b>GEV No.</b>	112942	<b>Ref. No.</b>	73600470
<b>description</b>	cone handle thread M10 ø 29mm L 67mm plastic black		



1

<b>GEV No.</b>	697517	<b>Ref. No.</b>	IB4206451
<b>description</b>	cone handle thread M10 ø 30mm L 66mm black		
<b>For models:</b>	715001		



1

<b>GEV No.</b>	110704	<b>Ref. No.</b>	407803190
<b>description</b>	cone handle thread M6 ø 16mm L 25mm plastic black		
<b>For models:</b>	114001, 114002, 114003, 115001, 115002, 116001, 116002, 244004, 244005, 244007, 244008, 244009		





			
1			
<b>GEV No.</b>	691395	<b>Ref. No.</b>	41824710510
<b>description</b>	cone handle thread M8 ø 24mm L 59mm black		
<b>For models:</b>	133007, 133008, 133022, 133023		

			
1			
<b>GEV No.</b>	697431	<b>Ref. No.</b>	19562901 19564019
<b>description</b>	cone handle thread M6 ø 26mm plastic L 70mm black thread L 10mm		

			
1			
<b>GEV No.</b>	111480	<b>Ref. No.</b>	KO-B100 KOB100 WFB100
<b>description</b>	cone handle thread M6 ø 29mm L 37.5mm plastic black		
<b>For models:</b>	225009, 255009, 255012, 255013, 255014		

			
1			
<b>GEV No.</b>	696266	<b>Ref. No.</b>	AMA008
<b>description</b>	cone handle thread M4 ø 9mm L 14mm aluminium slicer		
<b>For models:</b>	411001		

mushroom cap handles

			
1			
<b>GEV No.</b>	696267	<b>Ref. No.</b>	19021110
<b>description</b>	mushroom cap handle thread M4 ø 16mm L 18.5mm aluminium slicer		
<b>For models:</b>	411004, 411005		

			
1			
<b>GEV No.</b>	112936	<b>Ref. No.</b>	407803050
<b>description</b>	mushroom cap handle thread M5 handle ø 25mm L 17mm plastic black		
<b>For models:</b>	255001, 255002, 255003, 255004, 255006, 255007, 535004		

			
1			
<b>GEV No.</b>	112935	<b>Ref. No.</b>	407802001
<b>description</b>	mushroom cap handle thread M5 handle ø 30mm L 19mm plastic black		
<b>For models:</b>	261001, 261002, 262002, 262003, HD3NK		

			
1			
<b>GEV No.</b>	697445	<b>Ref. No.</b>	SM211413
<b>description</b>	mushroom cap handle thread M6 handle ø 33mm L 26mm plastic black		

ball handles

			
1			
<b>GEV No.</b>	697346	<b>Ref. No.</b>	5873100
<b>description</b>	ball handle thread M4 ø 20mm black		

			
1			
<b>GEV No.</b>	691311	<b>Ref. No.</b>	407803200
<b>description</b>	ball handle thread M6 ø 20mm		
<b>For models:</b>	255001, 255002, 255003, 255004, 255006, 255007		

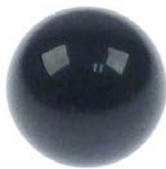

1

<b>GEV No.</b>	112694	<b>Ref. No.</b>	MSC04N018
<b>description</b>	ball handle thread M6 ø 20mm with metal bush black plastic		
<b>For models:</b>	471001		



1

<b>GEV No.</b>	101718	<b>Ref. No.</b>	GS2014
<b>description</b>	ball handle thread M8 ø 25mm with metal bush black		
<b>For models:</b>	233001		



1

<b>GEV No.</b>	691438	<b>Ref. No.</b>	6A019360
<b>description</b>	ball handle thread M8 ø 40mm black		

### star handles



1

<b>GEV No.</b>	698183	<b>Ref. No.</b>	IV4200500
<b>description</b>	locking screw thread M8 L 26mm handle ø 40mm		
<b>For models:</b>	421003		



1

<b>GEV No.</b>	697765	<b>Ref. No.</b>	I1953
<b>description</b>	star handle thread M6 ø 30mm L 22mm		
<b>For models:</b>	411013, 411014, 411015, 411019		



1

<b>GEV No.</b>	698200	<b>Ref. No.</b>	19562502
<b>description</b>	star handle thread M6 ø 40mm L 29mm black		
<b>For models:</b>	411005, 411006		



1

<b>GEV No.</b>	111054	<b>Ref. No.</b>	19564016
<b>description</b>	star handle thread M6 ø 40mm L 29mm blue		
<b>For models:</b>	411006		



1

<b>GEV No.</b>	697443	<b>Ref. No.</b>	19562504 19564013
<b>description</b>	star handle thread M8 ø 50mm L 29mm black		
<b>For models:</b>	411001, 411004		

### handle bars

#### producer-specific handle rails

##### TECNOEKA



1

<b>GEV No.</b>	694993	<b>Ref. No.</b>	00011680
<b>description</b>	door handle ø 18mm L 350mm stainless steel M5 black matt		
<b>For models:</b>	211038, 211039, 211044, 211045		

#### handle bars



1

<b>GEV No.</b>	691516	<b>Ref. No.</b>	0H3195A0
<b>description</b>	handle rod tube ø 18mm thickness 1mm L 508mm		
<b>For models:</b>	211001		





1

<b>GEV No.</b>	691515	<b>Ref. No.</b>	0H1925A0
<b>description</b>	handle rod tube ø 18mm thickness 1mm L 518mm		
<b>For models:</b>	211002		



1

<b>GEV No.</b>	691514	<b>Ref. No.</b>	0H1930A0
<b>description</b>	handle rod tube ø 18mm thickness 1mm L 718mm		
<b>For models:</b>	211003		



1

<b>GEV No.</b>	691373	<b>Ref. No.</b>	500504080
<b>description</b>	handle rod tube ø 30.5mm thickness 1.5mm L 460mm SS		
<b>For models:</b>	955001, 955002		



1

<b>GEV No.</b>	691372	<b>Ref. No.</b>	500504280
<b>description</b>	handle rod tube ø 30.5mm thickness 1.5mm L 660mm SS		
<b>For models:</b>	955004		

consoles



1

<b>GEV No.</b>	692217	<b>Ref. No.</b>	KMG1015B
<b>description</b>	console for handle rod H 43mm kit mounting pos. left/right		





1

<b>GEV No.</b>	691517	<b>Ref. No.</b>	MG1015A0
<b>description</b>	console for handle rod tube ø 18mm		
<b>For models:</b>	211001, 211002, 211003		



1

<b>GEV No.</b>	690115	<b>Ref. No.</b>	407803100	
<b>description</b>	console pair GN 667 tube ø 30mm H 59mm A 78mm B 37mm C 56mm plastic			
<b>For models:</b>	955001, 955002, 955003, 955004			
<b>accessories for</b>	690115			
	<b>GEV No.</b>	690439	<b>Ref. No.</b>	—
		handle rod tube ø 30mm thickness 1.5mm L 300mm SS		
	<b>GEV No.</b>	690440	<b>Ref. No.</b>	—
		handle rod tube ø 30mm thickness 1.5mm L 500mm SS		
	<b>GEV No.</b>	690441	<b>Ref. No.</b>	—
		handle rod tube ø 30mm thickness 1.5mm L 700mm SS		

bracket handles

			
1			
<b>GEV No.</b>	691598	<b>Ref. No.</b>	FHNDMA011WRY0
<b>description</b>	actuator L 173mm W 15mm for pull handle		
<b>For models:</b>	213003		

			
1			
<b>GEV No.</b>	700736	<b>Ref. No.</b>	407801500
<b>description</b>	pull handle		
<b>For models:</b>	244001, 244002, 244003, 244004, 244005, 244006, 244007		



			
1			
<b>GEV No.</b>	691327	<b>Ref. No.</b>	CM073100 MACM073100
<b>description</b>	pull handle L 119mm H 37mm mounting distance 105mm handle M6		
<b>For models:</b>	124101, 124102, 124103, 126101, 126103		

			
1			
<b>GEV No.</b>	700737	<b>Ref. No.</b>	407802100
<b>description</b>	pull handle L 120mm H 32mm mounting distance 110mm thread M4 W 17mm		
<b>For models:</b>	119003, 119004, 244008, 244009, 244021		

			
1			
<b>GEV No.</b>	691510	<b>Ref. No.</b>	A040575
<b>description</b>	pull handle L 130mm H 44mm mounting distance 112mm		
<b>For models:</b>	271001, 271002, 271003		

			
1			
<b>GEV No.</b>	691263	<b>Ref. No.</b>	IB4200910
<b>description</b>	pull handle L 160mm H 56mm mounting distance 133mm thread M8		
<b>For models:</b>	221006		

			
1			
<b>GEV No.</b>	691315	<b>Ref. No.</b>	408015110
<b>description</b>	pull handle L 190mm H 48mm mounting distance 173mm handle M6		
<b>For models:</b>	111003		

			
1			
<b>GEV No.</b>	691597	<b>Ref. No.</b>	JHNDMA039WRM0 JHNDMA039WRM0
<b>description</b>	pull handle L 195mm H 51mm mounting distance 180mm for micro-waves handle M4		
<b>For models:</b>	213002, 213003		
<b>spare parts for</b>	691597		
	<b>GEV No.</b>	691598	<b>Ref. No.</b>
			FHNDMA-011WRY0
	actuator L 173mm W 15mm for pull handle		

			
1			
<b>GEV No.</b>	691328	<b>Ref. No.</b>	1031110900
<b>description</b>	pull handle L 248mm H 56mm mounting distance 235mm handle M6		

			
1			
<b>GEV No.</b>	691374	<b>Ref. No.</b>	408015100
<b>description</b>	pull handle L 515mm H 50mm mounting distance 497mm handle M6		
<b>For models:</b>	111001, 111002, 111003		



			
1			
<b>GEV No.</b>	691336	<b>Ref. No.</b>	1031111000
<b>description</b>	pull handle L 544mm H 55mm mounting distance 530mm handle M6		

			
1			
<b>GEV No.</b>	691927	<b>Ref. No.</b>	MAG30008
<b>description</b>	pull handle L 550mm H 45mm mounting distance 512mm for oven handle M5		
<b>For models:</b>	211004, 211017, 211018		

			
1			
<b>GEV No.</b>	691312	<b>Ref. No.</b>	407801100
<b>description</b>	pull handle L 91mm H 26mm mounting distance 73mm handle M4		
<b>For models:</b>	244008, 244009, 244021		



fasteners

locking screws

			
1			
<b>GEV No.</b>	697516	<b>Ref. No.</b>	19562700 19564018
<b>description</b>	locking screw thread M5 handle ø 25mm L 8mm		

levers

without handle

			
1			
<b>GEV No.</b>	691477	<b>Ref. No.</b>	72000860
<b>description</b>	handle rod thread M10		
<b>accessories for</b>	691477		
	<b>GEV No.</b>	112942	<b>Ref. No.</b> 73600470
	cone handle thread M10 ø 29mm L 67mm plastic black		
	<b>GEV No.</b>	112943	<b>Ref. No.</b> 73600750
	cylindrical handle thread M10 ø 27mm L 91mm		

			
1			
<b>GEV No.</b>	514013	<b>Ref. No.</b>	1031400400 MA1031400400
<b>description</b>	lever equiv. no. 1031400400		
<b>For models:</b>	126101, 126103		

lever handles

			
1			
<b>GEV No.</b>	514015	<b>Ref. No.</b>	1036702000 MA1036702000
<b>description</b>	lever handle plastic black		
<b>For models:</b>	126101, 126103		

folding grill handles

			
1			
<b>GEV No.</b>	111483	<b>Ref. No.</b>	KO-B107 KOB107
<b>description</b>	cone handle ø 26mm bore ø 12mm L 155mm plastic black for contact grill		
<b>For models:</b>	255009, 255012, 255013, 255014		

			
1			
<b>GEV No.</b>	111484	<b>Ref. No.</b>	WFB104
<b>description</b>	cone handle ø 26mm bore ø 12mm L 155mm plastic red for waffle iron		
<b>For models:</b>	225009		

			
1			
<b>GEV No.</b>	691340	<b>Ref. No.</b>	408015020
<b>description</b>	handle tube ø 26mm thickness 6mm L 220mm plastic for contact grill		
<b>For models:</b>	255001, 255002, 255006, 255007		

			
1			
<b>GEV No.</b>	691341	<b>Ref. No.</b>	408015010
<b>description</b>	handle tube ø 26mm thickness 6mm L 325mm plastic for contact grill black		
<b>For models:</b>	255003, 255004		

recessed handles

			
1			
<b>GEV No.</b>	695599	<b>Ref. No.</b>	P22-0057
<b>description</b>	handle L 220mm W 107mm H 28mm mounting measurements 204x94mm		
<b>For models:</b>	628004		

hand cranks

			
1			
<b>GEV No.</b>	693323	<b>Ref. No.</b>	826900620
<b>description</b>	hand crank bore ø 10mm L 130mm with folding handle		
<b>For models:</b>	137001, 137002, 137003, 137004, 137201, 137202		
<b>accessories for</b>	693323		
	<b>GEV No.</b>	691397	<b>Ref. No.</b> 418227994250 8227994250
	roll pin ø 4mm L 26mm		

miscellaneous

			
1			
<b>GEV No.</b>	691511	<b>Ref. No.</b>	A02011007
<b>description</b>	door handle L 160mm W 36mm hole distance 116mm		

			
1			
<b>GEV No.</b>	691492	<b>Ref. No.</b>	7042411
<b>description</b>	door handle L 190mm W 83mm hole distance 155mm refrigerator white H 25mm		
<b>For models:</b>	621015, 622013, 625010, 629001		

			
1			
<b>GEV No.</b>	691313	<b>Ref. No.</b>	407803035
<b>description</b>	handle		
<b>For models:</b>	535004		

			
1			
<b>GEV No.</b>	691308	<b>Ref. No.</b>	407800100
<b>description</b>	handle L 140mm W 22mm hole distance 120mm Qty 1 pcs		
<b>For models:</b>	244001, 244002, 244003, 244004, 244005, 244007, 244008, 244009, 244021		

			
1			
<b>GEV No.</b>	697766	<b>Ref. No.</b>	I1926
<b>description</b>	handle L 50mm W 17mm ø 35mm thread M8		
<b>For models:</b>	411015, 411016, 411017, 411018		

accessories

extensions

			
1			
<b>GEV No.</b>	696096	<b>Ref. No.</b>	IB2080712
<b>description</b>	handle rod L 160mm ø 10mm T1: M8 T2: M10		
<b>For models:</b>	715001		

			
1			
<b>GEV No.</b>	691348	<b>Ref. No.</b>	408701500
<b>description</b>	threaded part L 26mm thread M6		
<b>For models:</b>	255001, 255002, 255003, 255004, 255006, 255007		



miscellaneous



1

<b>GEV No.</b>	690149	<b>Ref. No.</b>	AC07100
<b>description</b>	hand protection for door handle		
<b>For models:</b>	531010, 531011, 531012, 531013, 531014, 531015, 531016, 531017		



1

<b>GEV No.</b>	524876	<b>Ref. No.</b>	72087030
<b>description</b>	thread bolt for handle ø 15mm T1: M10x1.5 T2: M14x2 total length 100mm		
<b>For models:</b>	531001, 531002, 531003, 531004, 531005, 531006, 531007, 531008		

locks

locking devices

producer-specific

COOKMAX



1

<b>GEV No.</b>	695426	<b>Ref. No.</b>	1483010
<b>description</b>	housing plastic grey		
<b>For models:</b>	201780, 621007, 622005		



1

<b>GEV No.</b>	691481	<b>Ref. No.</b>	7043513	
<b>description</b>	key cylinder			
<b>For models:</b>	668006, 668009, 668010			
<b>accessories for</b>	691481			
	<b>GEV No.</b>	691482	<b>Ref. No.</b>	7042814
spare keys for key cylinder 691481				



1

<b>GEV No.</b>	691483	<b>Ref. No.</b>	7041775 7041789	
<b>description</b>	key cylinder			
<b>For models:</b>	621015, 622013, 622019			
<b>accessories for</b>	691483			
	<b>GEV No.</b>	691484	<b>Ref. No.</b>	7042837
spare keys for key cylinder 691483				



1

<b>GEV No.</b>	691489	<b>Ref. No.</b>	7043343	
<b>description</b>	key cylinder			
<b>For models:</b>	622009, 622012			
<b>accessories for</b>	691489			
	<b>GEV No.</b>	691486	<b>Ref. No.</b>	7042196 7043341
spare keys for key cylinder 691485, 691489				



1

<b>GEV No.</b>	691485	<b>Ref. No.</b>	7042356 7042846	
<b>description</b>	key cylinder closer			
<b>For models:</b>	625010, 629001			
<b>accessories for</b>	691485			
	<b>GEV No.</b>	691486	<b>Ref. No.</b>	7042196 7043341
spare keys for key cylinder 691485, 691489				



1

<b>GEV No.</b>	691527	<b>Ref. No.</b>	252137
<b>description</b>	key cylinder with key		
<b>For models:</b>	743001		

	1		
<b>GEV No.</b>	691482	<b>Ref. No.</b>	7042814
<b>description</b>	spare keys for key cylinder 691481		
<b>For models:</b>	668006, 668009, 668010		

	1		
<b>GEV No.</b>	691484	<b>Ref. No.</b>	7042837
<b>description</b>	spare keys for key cylinder 691483		
<b>For models:</b>	621015, 622013, 622019		

	1		
<b>GEV No.</b>	691486	<b>Ref. No.</b>	7042196 7043341
<b>description</b>	spare keys for key cylinder 691485, 691489		
<b>For models:</b>	621014, 622009, 622012, 622018, 625010, 625011, 625012, 625013, 629001		





## handle latches



universal

inside fixing



locks





<b>GEV No.</b>	694054	<b>Ref. No.</b>	00006390	
<b>description</b>	door handle for headed units L 145mm W 40mm H 62mm spring length 33mm inner black			
<b>For models:</b>	212034, 212035, 212036, 212037			
<b>spare parts for</b>	694054			
	<b>GEV No.</b>	514390	<b>Ref. No.</b>	R61620132
	spring for door handle ø 6mm L 54mm W 27.5mm			
	<b>GEV No.</b>	694675	<b>Ref. No.</b>	—
	door catch L 88mm W 40mm H 37mm spring length 33mm mounting distance 60mm			
	<b>GEV No.</b>	694734	<b>Ref. No.</b>	—
	door handle L 165mm W 40mm H 25mm black			
	<b>GEV No.</b>	694735	<b>Ref. No.</b>	—
	cap ø 32mm black			
<b>accessories for</b>	694054			
	<b>GEV No.</b>	691123	<b>Ref. No.</b>	—
	duct for door opener			

<b>accessories for</b>	694054			
	<b>GEV No.</b>	694055	<b>Ref. No.</b>	—
	door catch L 25mm W 14mm total length 54mm thread M8 thread L 29mm			
	<b>GEV No.</b>	694066	<b>Ref. No.</b>	MAG30001-B
	door catch with spigot 2-stage L 28mm W 14mm H 15mm H1 16mm total length 51mm thread M8 thread L 23mm stainless steel			
	<b>GEV No.</b>	694067	<b>Ref. No.</b>	R69010260
	door catch with spigot 1-stage L 26mm total length 51mm thread M8			



<b>GEV No.</b>	694234	<b>Ref. No.</b>	00006090	
<b>description</b>	door handle for headed units L 145mm W 40mm H 62mm spring length 40mm inner black			
<b>For models:</b>	212038, 212039			
<b>spare parts for</b>	694234			
	<b>GEV No.</b>	514450	<b>Ref. No.</b>	—
	spring for door handle ø 6mm L 61mm W 27.5mm			
	<b>GEV No.</b>	694734	<b>Ref. No.</b>	—
	door handle L 165mm W 40mm H 25mm black			
	<b>GEV No.</b>	694735	<b>Ref. No.</b>	—
	cap ø 32mm black			



<b>GEV No.</b>	694225	<b>Ref. No.</b>	MAG30001-A MAG30019	
<b>description</b>	door handle for headed units L 145mm W 40mm H 62mm spring length 55mm inner black			
<b>For models:</b>	212014, 212015, 212016, 212024, 212025			
<b>spare parts for</b>	694225			
	<b>GEV No.</b>	514451	<b>Ref. No.</b>	—
	spring for door handle ø 6mm L 76mm W 27.5mm			
	<b>GEV No.</b>	694734	<b>Ref. No.</b>	—
	door handle L 165mm W 40mm H 25mm black			
	<b>GEV No.</b>	694735	<b>Ref. No.</b>	—
	cap ø 32mm black			





1

<b>GEV No.</b>	694882	<b>Ref. No.</b>	00005060
<b>description</b>	door handle L 165mm W 40mm H 62mm inner black		
<b>For models:</b>	212040, 212041		
<b>accessories for</b>	694882		
	<b>GEV No.</b>	694881	<b>Ref. No.</b> 00005050
	door catch total length 40mm M8 thread L 23mm W 26mm		

producer-specific

COOKMAX



1

<b>GEV No.</b>	514390	<b>Ref. No.</b>	R61620132
<b>description</b>	spring for door handle ø 6mm L 54mm W 27.5mm		
<b>For models:</b>	212010, 212011, 212012, 212013		

miscellaneous



1

<b>GEV No.</b>	691286	<b>Ref. No.</b>	R58001780
<b>description</b>	catch for glass plate		
<b>For models:</b>	212002, 212003, 212010, 212011, 212012, 212013, 212017, 212018, 212019, 212020		



1

<b>GEV No.</b>	694883	<b>Ref. No.</b>	00010950
<b>description</b>	fixing plate L 100mm W 45mm H 2mm		
<b>For models:</b>	212038, 212039, 212040, 212041		



1

<b>GEV No.</b>	694884	<b>Ref. No.</b>	00011060
<b>description</b>	fixing plate L 100mm W 45mm H 5mm		
<b>For models:</b>	212038, 212039, 212040, 212041		



1

<b>GEV No.</b>	694885	<b>Ref. No.</b>	01502400
<b>description</b>	threaded bush L 17mm W 11mm M8		

## hinges

### piano hinges

#### producer-specific

#### COOKMAX



1

<b>GEV No.</b>	701171	<b>Ref. No.</b>	0511304900
<b>description</b>	hinge W 31mm mounting distance 30mm thickness 1mm total length 40mm set		
<b>For models:</b>	912001, 912002, 912003, 912004, 912005, 912006, 912007, 912008, 912009, 912010, 912011, 912012, 912013, 912014, 912015, 912016, 912017, 912018, 912019, 912020, 912021, 912022, 912023, 912024, 912025, 912026, 912027, 912028, 912029, 912030, 912031, 912032, 912033, 912034, 912035, 912036, 913001, 913002, 913003, 913004, 913005, 913006, 913007, 913008, 913009, 913010, 913011, 913012, 913013, 913014...(Other models you can see in the webshop)		

#### LAVINOX



1

<b>GEV No.</b>	701171	<b>Ref. No.</b>	0511304900
<b>description</b>	hinge W 31mm mounting distance 30mm thickness 1mm total length 40mm set		
<b>For models:</b>	912001, 912002, 912003, 912004, 912005, 912006, 912007, 912008, 912009, 912010, 912011, 912012, 912013, 912014, 912015, 912016, 912017, 912018, 912019, 912020, 912021, 912022, 912023, 912024, 912025, 912026, 912027, 912028, 912029, 912030, 912031, 912032, 912033, 912034, 912035, 912036, 913001, 913002, 913003, 913004, 913005, 913006, 913007, 913008, 913009, 913010, 913011, 913012, 913013, 913014...(Other models you can see in the webshop)		

spring assisted hinges

universal

INTERKLIMAT

hinges

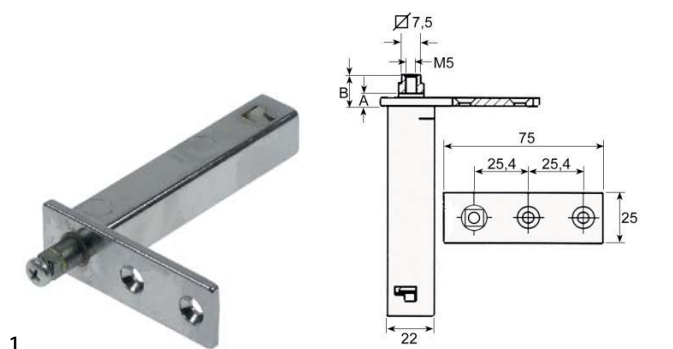

<b>GEV No.</b>	690622	<b>Ref. No.</b>	GN650TN.14 RC0089
<b>description</b>	spring assisted hinge series 28L mounting pos. left/right L 75mm W 25mm H 103mm A 13mm B 18mm mounting measurements 22x22mm intake 7.5x7.5 refrigeration units		
<b>For models:</b>	611013, 611014, 613016, 613017, 621018, 621019, 625017, 625018		

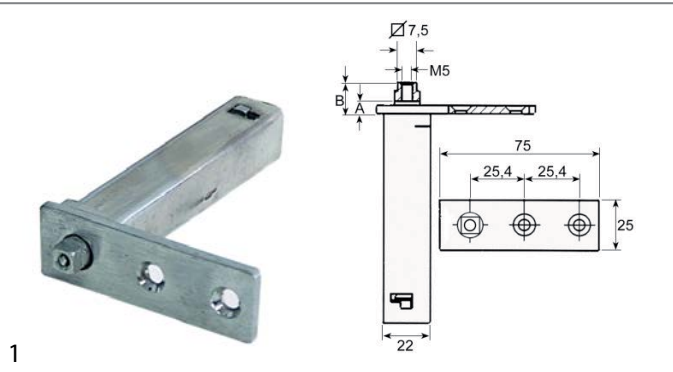

<b>GEV No.</b>	690714	<b>Ref. No.</b>	74708096
<b>description</b>	spring assisted hinge series 28XC mounting pos. left/right L 75mm W 25mm H 103mm A 8mm B 11mm intake 7.5x7.5 refrigeration units mounting distance 25mm		
<b>For models:</b>	621038, 621039, 622031		

producer-specific

DESMON



<b>GEV No.</b>	701011	<b>Ref. No.</b>	P28-0847
<b>description</b>	spring assisted hinge with hinge camp L 74mm W 24mm shaft length 18mm mounting distance 25mm mounting measurements 22x22x100mm		
<b>For models:</b>	621004, 621005, 622004		

GIGA



<b>GEV No.</b>	701011	<b>Ref. No.</b>	P28-0847
<b>description</b>	spring assisted hinge with hinge camp L 74mm W 24mm shaft length 18mm mounting distance 25mm mounting measurements 22x22x100mm		
<b>For models:</b>	621004, 621005, 622004		

oven hinges

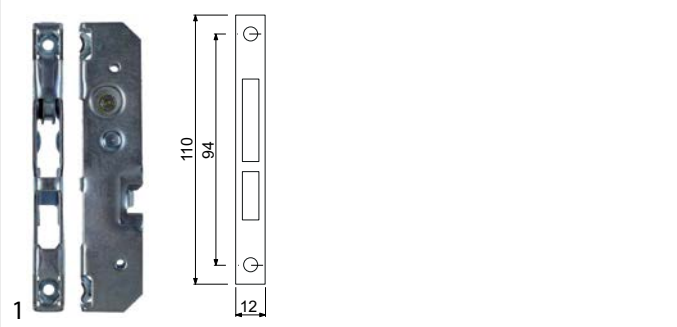

<b>GEV No.</b>	700003	<b>Ref. No.</b>	1034400800
<b>description</b>	opposite support L 110mm W 12mm mounting distance 94mm		

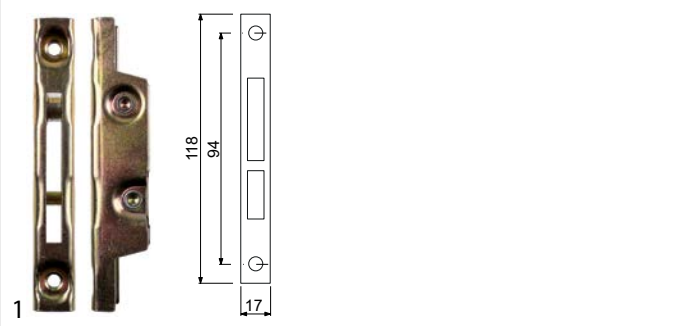

<b>GEV No.</b>	700001	<b>Ref. No.</b>	41826410050 6A035930 MA1304500
<b>description</b>	opposite support L 118mm W 17mm mounting distance 94mm		
<b>For models:</b>	121101, 121102, 121104, 121105, 121106, 122110, 131003, 131004, 131005, 131006, 131007, 131008, 131009, 131201, 131202, 131203, 131204, 131205, 131206, 131207, 131208, 131209, 131210, 132003, 132004, 132201, 132202, 132203, 132204, 133024, 133203, 133209, 133210, 133211, 133212, 133213, 133214, 133215, 141005, 141006, 141007, 141009, 141010, 141013, 141016, 141021		



1

<b>GEV No.</b>	701559	<b>Ref. No.</b>	CR1000A0
<b>description</b>	opposite support mounting distance 81mm L 134mm W 10mm		
<b>For models:</b>	211002, 211003		



1

<b>GEV No.</b>	700841	<b>Ref. No.</b>	00003170 7424000002
<b>description</b>	opposite support mounting distance 85mm L 107mm W 12.5mm for hinge		
<b>For models:</b>	211004, 211005, 211006, 211010, 211013, 211014, 211015, 211016, 211017, 211018, 211020, 211023, 211024, 211026, 211028, 211038, 211039, 211042, 211043, 211044, 211045, 211046		



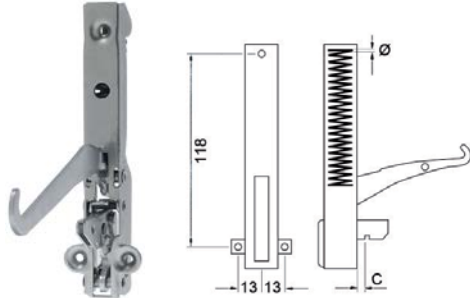

1

<b>GEV No.</b>	700739	<b>Ref. No.</b>	408790310
<b>description</b>	opposite support mounting distance 91mm L 115mm W 10mm		
<b>For models:</b>	111001, 111002, 111003		









1



<b>GEV No.</b>	690030	<b>Ref. No.</b>	1034400400	
<b>description</b>	oven hinge mounting distance 118mm lug mounting 13mm lever length 117mm groove distance 10mm spring thickness 3.5mm mounting ear position left/right spring length 60mm L 155mm W 21mm			
<b>accessories for</b>	690030			
	<b>GEV No.</b>	700003	<b>Ref. No.</b>	1034400800
	opposite support L 110mm W 12mm mounting distance 94mm			





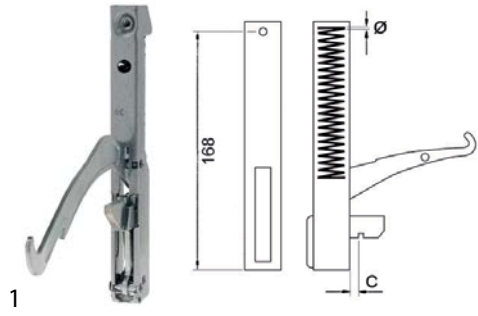

1

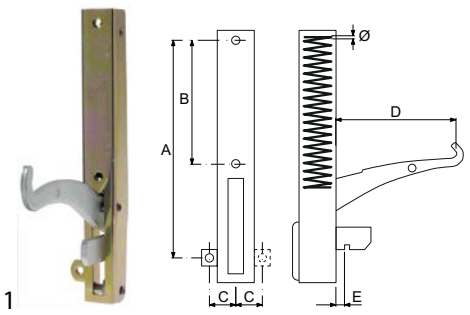

<b>GEV No.</b>	700623	<b>Ref. No.</b>	7424000003	
<b>description</b>	oven hinge mounting distance 154mm lever length 91mm groove distance 14mm spring thickness 3mm mounting pos. left/right zinc-coated steel			
<b>For models:</b>	211004, 211005, 211010, 211017, 211018, 211028			
<b>accessories for</b>	700623			
	<b>GEV No.</b>	700628	<b>Ref. No.</b>	—
	opposite support right oven hinge			
	<b>GEV No.</b>	700629	<b>Ref. No.</b>	—
	opposite support mounting distance 75mm L 95mm W 26mm left H 46mm M5 cut-out 10X30mm oven hinge			
	<b>GEV No.</b>	700841	<b>Ref. No.</b>	00003170 7424000002
	opposite support mounting distance 85mm L 107mm W 12.5mm for hinge			

			
<b>GEV No.</b>	700627	<b>Ref. No.</b>	742400001
<b>description</b>	oven hinge mounting distance 154mm mounting distance 2mm lug mountingmm lever length 79mm groove distance 14mm spring thickness 3.5mm mounting ear position spring length 54mm L 165mm mounting pos. left/right zinc-coated steel		
<b>For models:</b>	211006, 211013, 211015, 211016, 211020		
<b>accessories for</b>	700627		
	<b>GEV No.</b>	700628	<b>Ref. No.</b> —
	opposite support right oven hinge		
	<b>GEV No.</b>	700629	<b>Ref. No.</b> —
	opposite support mounting distance 75mm L 95mm W 26mm left H 46mm M5 cut-out 10X30mm oven hinge		
	<b>GEV No.</b>	700841	<b>Ref. No.</b> 00003170 742400002
	opposite support mounting distance 85mm L 107mm W 12.5mm for hinge		

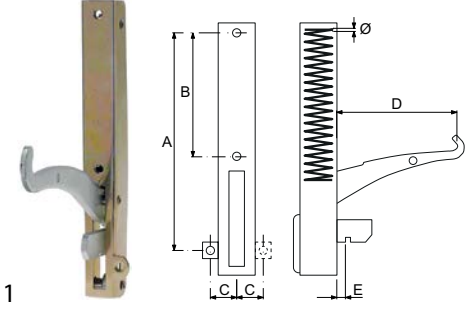
			
<b>GEV No.</b>	700738	<b>Ref. No.</b>	408790300
<b>description</b>	oven hinge mounting distance 168mm lever length 158mm groove distance 15mm spring thickness 3.8mm spring length 65mm L 178mm		
<b>For models:</b>	111001, 111002, 111003		
<b>accessories for</b>	700738		
	<b>GEV No.</b>	700739	<b>Ref. No.</b> 408790310
	opposite support mounting distance 91mm L 115mm W 10mm		



			
<b>GEV No.</b>	700005	<b>Ref. No.</b>	1304700
<b>description</b>	oven hinge mounting distance 173mm mounting distance 2 105mm lug mounting 14mm lever length 118mm groove distance 7mm spring thickness 3.5mm mounting ear position left spring length 112mm W 25mm		
<b>accessories for</b>	700005		
	<b>GEV No.</b>	700001	<b>Ref. No.</b> 41826410050 6A035930 826410050 MA1304500
	opposite support L 118mm W 17mm mounting distance 94mm		



			
<b>GEV No.</b>	700004	<b>Ref. No.</b>	1304600
<b>description</b>	oven hinge mounting distance 173mm mounting distance 2 105mm lug mounting 14mm lever length 119mm groove distance 7mm spring thickness 3.5mm mounting ear position right spring length 112mm L 206mm W 25mm		
<b>accessories for</b>	700004		
	<b>GEV No.</b>	700001	<b>Ref. No.</b> 41826410050 6A035930 826410050 MA1304500
	opposite support L 118mm W 17mm mounting distance 94mm		

			
<b>GEV No.</b>	700006	<b>Ref. No.</b>	6A035910
<b>description</b>	oven hinge mounting distance 173mm mounting distance 2 105mm lug mounting 14mm lever length 120mm groove distance 11mm spring thickness 3.5mm mounting ear position left spring length 112mm W 25mm		
<b>For models:</b>	131003, 131004, 131005, 131006, 131007, 131008, 131009, 131201, 131202, 131203, 131204, 131205, 131206, 131207, 131208, 131209, 131210, 132003, 132004, 132201, 132202, 132203, 132204, 133024, 133203, 133209, 133210, 133211, 133212, 133213, 133214, 133215		
<b>accessories for</b>	700006		
	<b>GEV No.</b>	700001	<b>Ref. No.</b> 41826410050 6A035930 826410050 MA1304500
	opposite support L 118mm W 17mm mounting distance 94mm		
	<b>GEV No.</b>	700007	<b>Ref. No.</b> 6A035920 BN6A035920
	oven hinge mounting distance 173mm mounting distance 2 105mm lug mounting 14mm lever length 120mm groove distance 11mm spring thickness 3.5mm mounting ear position right spring length 112mm W 25mm		

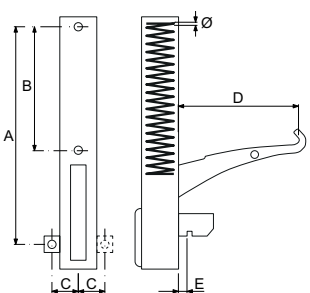
			
<b>GEV No.</b>	701544	<b>Ref. No.</b>	KCR012 KCR1025A
<b>description</b>	oven hinge mounting distance 82mm spring thickness 3mm spring length 57mm L 155mm code A1 left/right Qty 2 pcs		

			
<b>GEV No.</b>	701545	<b>Ref. No.</b>	KCR1020A0 KCR1020B
<b>description</b>	oven hinge mounting distance 82mm spring thickness 3mm spring length 57mm L 155mm code A2 left/right Qty 2 pcs		

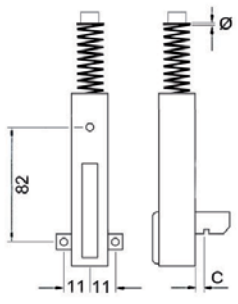
			
			
<b>GEV No.</b>	700007	<b>Ref. No.</b>	6A035920 BN6A035920
<b>description</b>	oven hinge mounting distance 173mm mounting distance 2 105mm lug mounting 14mm lever length 120mm groove distance 11mm spring thickness 3.5mm mounting ear position right spring length 112mm W 25mm		
<b>For models:</b>	131003, 131004, 131005, 131006, 131007, 131008, 131009, 131201, 131202, 131203, 131204, 131205, 131206, 131207, 131208, 131209, 131210, 132003, 132004, 132201, 132202, 132203, 132204, 133024, 133203, 133209, 133210, 133211, 133212, 133213, 133214, 133215, 141005, 141006, 141007, 141009, 141010, 141013, 141016, 141021		
<b>accessories for</b>	700007		
	<b>GEV No.</b>	700001	<b>Ref. No.</b> 41826410050 6A035930 826410050 MA1304500
	opposite support L 118mm W 17mm mounting distance 94mm		
	<b>GEV No.</b>	700006	<b>Ref. No.</b> 6A035910
	oven hinge mounting distance 173mm mounting distance 2 105mm lug mounting 14mm lever length 120mm groove distance 11mm spring thickness 3.5mm mounting ear position left spring length 112mm W 25mm		

			
			
<b>GEV No.</b>	700759	<b>Ref. No.</b>	KCR013 KCR1015A
<b>description</b>	oven hinge mounting distance 82mm spring thickness 3mm spring length 57mm L 155mm code A3 left/right Qty 2 pcs		
<b>accessories for</b>	700759		
	<b>GEV No.</b>	701559	<b>Ref. No.</b> CR1000A0
	opposite support mounting distance 81mm L 134mm W 10mm		



1

<b>GEV No.</b>	700760	<b>Ref. No.</b>	CR1065A0 KCR020
<b>description</b>	oven hinge mounting distance 87mm spring thickness 3mm L 150mm left/right Qty 2 pcs		
<b>For models:</b>	211001		
<b>accessories for</b>	700760		
	<b>GEV No.</b>	<b>Ref. No.</b>	—
	opposite support mounting distance 94mm L 112mm W 10mm		



1

<b>GEV No.</b>	701537	<b>Ref. No.</b>	00007510
<b>description</b>	oven hinge set pair mounting distance 155mm mounting distance 2mm lug mountingmm lever length 77mm groove distance 14mm spring thickness 4mm mounting ear position spring length 53mm L 165mm mounting pos. left/right W 22mm		
<b>For models:</b>	211043, 211046		



1

<b>GEV No.</b>	701538	<b>Ref. No.</b>	00003180
<b>description</b>	oven hinge set mounting distance 155mm mounting distance 2mm lug mountingmm lever length 77mm groove distance 14mm spring thickness 3.5mm mounting ear position spring length 53mm L 165mm mounting pos. left/right W 22mm pair		
<b>For models:</b>	211038, 211039, 211042		

### door bearing



1

<b>GEV No.</b>	700758	<b>Ref. No.</b>	7043459
<b>description</b>	bearing block L 42mm W 38mm H 48mm mounting distance 28mm bolt 51mm bolt ø 8mm		
<b>For models:</b>	621014, 622009, 622012, 622018		



1

<b>GEV No.</b>	701539	<b>Ref. No.</b>	00012580 00013340
<b>description</b>	oven hinge set mounting distance 155mm mounting distance 2mm lug mountingmm lever length 78mm groove distance 12mm spring thickness 3.2mm mounting ear position spring length 53mm L 165mm mounting pos. left/right W 22mm pair		
<b>For models:</b>	211044, 211045		



1

<b>GEV No.</b>	700975	<b>Ref. No.</b>	HF600.19 RC0536
<b>description</b>	bolt L 20mm mounting pos. upper/lower thread M5 ø 7mm for hinge		
<b>For models:</b>	621023, 621024, 621025, 621026, 621027, 621028, 621029, 621030, 621031, 621032, 621033, 621034, 621035, 621036, 621045, 621046, 621047, 621048, 621049, 621050, 622022, 622023, 622024, 622025, 622026, 622027, 622028, 622029, 622034, 622035, 622036, 622037, 622038, 622039		





1

<b>GEV No.</b>	692491	<b>Ref. No.</b>	R00096
<b>description</b>	bolt L 21mm mounting pos. lower thread M5 ø 7mm complete for door hinge Qty 1 pcs		
<b>For models:</b>	611015		



 <p>1</p>			
<b>GEV No.</b>	700756	<b>Ref. No.</b>	7113077
<b>description</b>	bolt L 21mm thread M6 ø 6mm for hinge		
<b>For models:</b>	621015, 622013, 622014, 622019, 625010, 629001		

 <p>1</p>			
<b>GEV No.</b>	701257	<b>Ref. No.</b>	S900.06
<b>description</b>	bolt L 25mm mounting pos. upper thread M5 ø 7mm complete for door hinge Qty 1 pcs		
<b>For models:</b>	611007, 611008, 611009, 611010, 611011, 621018, 621019		

 <p>1</p>			
<b>GEV No.</b>	701032	<b>Ref. No.</b>	GN2100TN.03 GN2100TN.06 RC0175
<b>description</b>	bolt L 32.4mm mounting pos. upper thread M8x1.25 ø 5/7mm with nut for door		
<b>For models:</b>	611013, 611014, 611023, 613016, 613017, 621036, 622029		

 <p>1</p>			
<b>GEV No.</b>	700750	<b>Ref. No.</b>	7113761
<b>description</b>	bolt L 48mm thread M6 ø 8mm for hinge		
<b>For models:</b>	621014, 622009, 622012, 622018		

 <p>1</p>			
<b>GEV No.</b>	700755	<b>Ref. No.</b>	7043029 7043461
<b>description</b>	bolt L 50mm ø 8mm		
<b>For models:</b>	621014, 622009, 622012, 622018		

 <p>1</p>			
<b>GEV No.</b>	692542	<b>Ref. No.</b>	74708200
<b>description</b>	bracket L 180mm H 7mm mounting pos. upper without bolt suitable for AFINOX		
<b>For models:</b>	621038, 621039, 622031		

 <p>1</p>			
<b>GEV No.</b>	692573	<b>Ref. No.</b>	74708202
<b>description</b>	bracket L 230mm W 32mm H 14mm mounting pos. lower without bolt suitable for AFINOX		
<b>For models:</b>	621038, 621039, 622031		

 <p>1</p>			
<b>GEV No.</b>	700606	<b>Ref. No.</b>	H49-0003
<b>description</b>	bush for hinge		
<b>For models:</b>	628004		

 <p>1</p>			
<b>GEV No.</b>	700976	<b>Ref. No.</b>	GN2100TN.070 RC0176
<b>description</b>	bush L 20mm ø 9mm ID ø 7.1mm for hinge		
<b>For models:</b>	621023, 621024, 621025, 621026, 621027, 621028, 621034, 621035, 621036, 621045, 621046, 621047, 621048, 621049, 621050, 622022, 622023, 622024, 622025, 622028, 622029, 622034, 622035, 622036, 622037, 622038, 622039, 625014, 625015, 625016, 625017, 625018		

 <p>1</p>			
<b>GEV No.</b>	700754	<b>Ref. No.</b>	7422079
<b>description</b>	bush L 30mm ø 9mm white for hinge		
<b>For models:</b>	621015, 622013, 622014, 625010, 629001		

 <p>1</p>			
<b>GEV No.</b>	700752	<b>Ref. No.</b>	7429351
<b>description</b>	bush L 46mm mounting pos. left ø 14mm white for hinge		
<b>For models:</b>	621014, 622009, 622012		

 <p>1</p>			
<b>GEV No.</b>	700753	<b>Ref. No.</b>	7429349
<b>description</b>	bush L 46mm mounting pos. right ø 14mm white for hinge		
<b>For models:</b>	621014, 622009, 622012		

			
1			
<b>GEV No.</b>	700751	<b>Ref. No.</b>	7429517
<b>description</b>	bush L 49mm ø 11mm white for hinge		
<b>For models:</b>	621014, 622009, 622012		

			
1			
<b>GEV No.</b>	691288	<b>Ref. No.</b>	R58002520
<b>description</b>	door bolt		
<b>For models:</b>	212002, 212003, 212010, 212011, 212012, 212013, 212017, 212018, 212019, 212020		

			
1			
<b>GEV No.</b>	690992	<b>Ref. No.</b>	71000310
<b>description</b>	door hinge		
<b>For models:</b>	531001, 531002		

			
1			
<b>GEV No.</b>	701437	<b>Ref. No.</b>	1412262
<b>description</b>	door hinge L 45mm W 35mm mounting pos. upper bolt 14.5mm bolt ø 6mm refrigerator		
<b>For models:</b>	613020, 613021, 613022, 613023, 613024, 613025, 613026, 613027, 613028, 613029, 613030, 613031, 613032, 613033, 614015, 614016, 614017, 614018		

			
1			
<b>GEV No.</b>	514420	<b>Ref. No.</b>	71000300
<b>description</b>	door hinge L 76mm W 30mm mounting pos. left thickness 30mm for pizza oven		
<b>For models:</b>	531003, 531004, 531005, 531006, 531007, 531008		

			
1			
<b>GEV No.</b>	701300	<b>Ref. No.</b>	01-240709-001
<b>description</b>	door hinge L 90mm W 19mm H 29mm mounting pos. left bottom thickness 3mm		
<b>For models:</b>	812011, 812012, 812013, 812014, 812015		

			
1			
<b>GEV No.</b>	701301	<b>Ref. No.</b>	01-240709-002
<b>description</b>	door hinge L 90mm W 19mm H 29mm mounting pos. right bottom thickness 3mm		
<b>For models:</b>	812011, 812012, 812013, 812014, 812015		

			
1			
<b>GEV No.</b>	691287	<b>Ref. No.</b>	R18404500
<b>description</b>	hinge		
<b>For models:</b>	212002, 212003, 212010, 212011, 212012, 212013		

			
1			
<b>GEV No.</b>	691284	<b>Ref. No.</b>	R58001760
<b>description</b>	hinge for glass plate		
<b>For models:</b>	212002, 212003, 212010, 212011, 212012, 212013, 212017, 212018, 212019, 212020		

			
1			
<b>GEV No.</b>	691453	<b>Ref. No.</b>	2519910
<b>description</b>	hinge for tilting bratt pan		







			
1			
<b>GEV No.</b>	692258	<b>Ref. No.</b>	S900.55
<b>description</b>	hinge L 30mm W 30mm H 45mm mounting pos. bottom left thickness 3mm		
<b>For models:</b>	611007		

			
1			
<b>GEV No.</b>	699245	<b>Ref. No.</b>	32213056
<b>description</b>	hinge L 58.5mm W 35mm H 109mm mounting pos. lower bolt 94mm bolt ø 8mm with accessories		
<b>For models:</b>	613020, 613021, 613022, 613023, 613024, 613025, 613026, 613027, 613028, 613029, 613030, 613031, 613032, 613033, 614015, 614016, 614017, 614018		

			
1			
<b>GEV No.</b>	692374	<b>Ref. No.</b>	S900.05
<b>description</b>	hinge L 30mm W 30mm H 45mm mounting pos. bottom right thickness 3mm Qty 1 pcs		
<b>For models:</b>	611007, 611008, 611009, 611010, 611011		

			
1			
<b>GEV No.</b>	691277	<b>Ref. No.</b>	R18201270
<b>description</b>	hinge mounting pos. bottom left		
<b>For models:</b>	212001		

			
1			
<b>GEV No.</b>	700974	<b>Ref. No.</b>	HF600.08 RC0535
<b>description</b>	hinge L 49mm W 40mm H 43mm mounting pos. lower thickness 4mm		
<b>For models:</b>	621023, 621024, 621025, 621026, 621027, 621028, 621029, 621030, 621031, 621032, 621033, 621034, 621035, 621036, 621045, 621046, 621047, 621048, 621049, 621050, 622022, 622023, 622024, 622025, 622026, 622027, 622028, 622029, 622034, 622035, 622036, 622037, 622038, 622039		

			
1			
<b>GEV No.</b>	690538	<b>Ref. No.</b>	32140098
<b>description</b>	hinge mounting pos. bottom left with bolt		
<b>For models:</b>	621007, 622005		



			
1			
<b>GEV No.</b>	700973	<b>Ref. No.</b>	HF600.01 RC0534
<b>description</b>	hinge L 51mm W 40mm mounting pos. upper thickness 3mm		
<b>For models:</b>	621023, 621024, 621025, 621026, 621027, 621028, 621029, 621030, 621031, 621032, 621033, 621034, 621035, 621036, 621045, 621046, 621047, 621048, 621049, 621050, 622022, 622023, 622024, 622025, 622026, 622027, 622028, 622029, 622034, 622035, 622036, 622037, 622038, 622039		

			
1			
<b>GEV No.</b>	690537	<b>Ref. No.</b>	32140097
<b>description</b>	hinge mounting pos. bottom right with bolt		
<b>For models:</b>	201780, 621007, 622005		

			
1			
<b>GEV No.</b>	692174	<b>Ref. No.</b>	14850003
<b>description</b>	hinge mounting pos. upper left with bolt		
<b>For models:</b>	201780, 621007, 622005		

			
1			
<b>GEV No.</b>	690539	<b>Ref. No.</b>	14850002
<b>description</b>	hinge mounting pos. upper right with bolt		
<b>For models:</b>	201780, 621007, 622005		

			
1			
<b>GEV No.</b>	692428	<b>Ref. No.</b>	BN14850010
<b>description</b>	hinge mounting pos. upper right with bolt		
<b>For models:</b>	621020, 621021, 622020, 622021		

			
1			
<b>GEV No.</b>	700757	<b>Ref. No.</b>	9450057
<b>description</b>	hinge refrigerator		
<b>For models:</b>	621015, 622013, 622019, 625010, 629001		
<b>spare parts for</b>	700757		
	<b>GEV No.</b>	700756	<b>Ref. No.</b> 7113077
	bolt L 21mm thread M6 ø 6mm for hinge		

			
1			
<b>GEV No.</b>	691451	<b>Ref. No.</b>	2547860 BN2547860
<b>description</b>	hinge bearing mounting pos. bottom left/upper right with bolt		
<b>For models:</b>	131001, 131002, 131003, 131004, 131005, 131006, 131010, 131201, 131202, 131203, 131204, 131205, 131206, 131210, 132001, 132002, 132201, 132202, 133007, 133008, 133022, 133023, 133207, 133208, 133222, 133223, 134001, 134002, 134003, 134004, 134005, 134006, 134201, 134202, 134203, 134204, 134205, 134206, 136003, 136004, 136005, 136006, 136203, 136204, 136205, 136206, 137003, 137004, 137203, 137204...(Other models you can see in the webshop)		

			
1			
<b>GEV No.</b>	691347	<b>Ref. No.</b>	1044230423
<b>description</b>	hinge bearing mounting pos. bottom right without bolt		

			
1			
<b>GEV No.</b>	691276	<b>Ref. No.</b>	R18201260
<b>description</b>	hinge bearing mounting pos. upper left		
<b>For models:</b>	212001		

			
1			
<b>GEV No.</b>	690586	<b>Ref. No.</b>	R11200560
<b>description</b>	hinge bearing mounting pos. upper left without bolt		
<b>For models:</b>	212002, 212003		

			
1			
<b>GEV No.</b>	691452	<b>Ref. No.</b>	2547870 BN2547870
<b>description</b>	hinge bearing mounting pos. upper left/bottom right with bolt		
<b>For models:</b>	131001, 131002, 131003, 131004, 131005, 131006, 131010, 131201, 131202, 131203, 131204, 131205, 131206, 131210, 132001, 132002, 132201, 132202, 133007, 133008, 133022, 133023, 133207, 133208, 133222, 133223, 134001, 134002, 134003, 134004, 134005, 134006, 134201, 134202, 134203, 134204, 134205, 134206, 136003, 136004, 136005, 136006, 136203, 136204, 136205, 136206, 137003, 137004, 137203, 137204...(Other models you can see in the webshop)		

			
1			
<b>GEV No.</b>	691346	<b>Ref. No.</b>	1044237100
<b>description</b>	hinge bearing mounting pos. upper right without bolt		



1 

<b>GEV No.</b>	691285	<b>Ref. No.</b>	R58001770
<b>description</b>	hinge bolt		
<b>For models:</b>	212002, 212003, 212010, 212011, 212012, 212013, 212017, 212018, 212019, 212020		

1 

<b>GEV No.</b>	692760	<b>Ref. No.</b>	P99-0031
<b>description</b>	hinge camp L 185mm W 50mm H 10mm mounting pos. lower for DESMON		
<b>For models:</b>	621004, 621005, 622004		

1 

<b>GEV No.</b>	701038	<b>Ref. No.</b>	GN650TN.15
<b>description</b>	hinge camp mounting pos. upper right L 99mm W 64mm H 30mm hole distance 60mm shaft diameter 8x8mm		
<b>For models:</b>	621018, 621019		

1 

<b>GEV No.</b>	690099	<b>Ref. No.</b>	R58002150
<b>description</b>	hinge pin mounting pos. upper for door		
<b>For models:</b>	212002, 212003, 212010, 212011, 212012, 212013, 212017, 212018, 212019, 212020		

miscellaneous

1 

<b>GEV No.</b>	691106	<b>Ref. No.</b>	IB7506000
<b>description</b>	door hinge kit for glass door mounting pos. upper/lower		
<b>For models:</b>	541001, 541002		

1 

<b>GEV No.</b>	700926	<b>Ref. No.</b>	040607
<b>description</b>	door hinge L 75mm W 60mm mounting distance 48mm		
<b>For models:</b>	271001, 271002, 271003		

accessories

bushes

1 

<b>GEV No.</b>	694886	<b>Ref. No.</b>	00006080
<b>description</b>	bush ID ø 7mm ED ø 12mm L 10mm		
<b>For models:</b>	212034, 212035, 212036, 212037		

miscellaneous

1 

<b>GEV No.</b>	692307	<b>Ref. No.</b>	01-240789-001
<b>description</b>	plain washer for hinge ID ø 8mm ED ø 18mm plastic thickness 1mm Qty 1 pcs		
<b>For models:</b>	812011, 812012, 812013, 812014, 812015		

pullouts

drawer slides

producer-specific

1 

<b>GEV No.</b>	691339	<b>Ref. No.</b>	1031006100
<b>description</b>	drawer slide L 525mm pull-out lengthmm W 57mm H 15mm mounting pos. right		
<b>accessories for</b>	691339		
	<b>GEV No.</b>	692500	<b>Ref. No.</b> 1031006200
drawer slide L 525mm W 57mm H 15mm mounting pos. left			

rollers



rollers

accessories

1 

<b>GEV No.</b>	560133	<b>Ref. No.</b>	260404
<b>description</b>	hexagonal nut thread M6 H 5mm WS 10 SS DIN/ISO DIN 934 / ISO 4032/8673 Qty 20 pcs		
<b>For models:</b>	SP1, SP2-12, SP2-S12, SP3		

roller with holder

 <p>1</p>			
<b>GEV No.</b>	690713	<b>Ref. No.</b>	0855358100
<b>description</b>	roller rollerø 22mm B1 6mm with holder SS/brass mounting pos. right door (right) bearing ball bearing Qty 1 pcs H 11mm L 64mm mounting distance 38/50mm		
<b>For models:</b>	912001, 912002, 912003, 912004, 912005, 912006, 912007, 912008, 912009, 912010, 912011, 912012, 912013, 912014, 912015, 912016, 912017, 912018, 912019, 912020, 912021, 912022, 912023, 912024, 912025, 912026, 912027, 912028, 912029, 912030, 912031, 912032, 912033, 912034, 912035, 912036, 913001, 913002, 913003, 913004, 913005, 913006, 913007, 913008, 913009, 913010, 913011, 913012, 913013, 913014...(Other models you can see in the webshop)		
<b>accessories for</b>	690713		
	<b>GEV No.</b>	690570	<b>Ref. No.</b> 0140403100
	rubber pad		

 <p>1</p>			
<b>GEV No.</b>	690567	<b>Ref. No.</b>	0855309701
<b>description</b>	roller rollerø 22mm B1 6mm with holder SS/Nylon mounting pos. left door bearing ball bearing Qty 1 pcs H 12mm L 64mm mounting distance 38/50mm		
<b>For models:</b>	912001, 912002, 912003, 912004, 912005, 912006, 912007, 912008, 912009, 912010, 912011, 912012, 912013, 912014, 912015, 912016, 912017, 912018, 912019, 912020, 912021, 912022, 912023, 912024, 912025, 912026, 912027, 912028, 912029, 912030, 912031, 912032, 912033, 912034, 912035, 912036, 913001, 913002, 913003, 913004, 913005, 913006, 913007, 913008, 913009, 913010, 913011, 913012, 913013, 913014...(Other models you can see in the webshop)		

 <p>1</p>			
<b>GEV No.</b>	690711	<b>Ref. No.</b>	0855309601
<b>description</b>	roller rollerø 22mm B1 6mm with holder SS/Nylon mounting pos. right door (left) bearing ball bearing Qty 1 pcs H 11mm L 63mm mounting distance 38/50mm		
<b>For models:</b>	912001, 912002, 912003, 912004, 912005, 912006, 912007, 912008, 912009, 912010, 912011, 912012, 912013, 912014, 912015, 912016, 912017, 912018, 912019, 912020, 912021, 912022, 912023, 912024, 912025, 912026, 912027, 912028, 912029, 912030, 912031, 912032, 912033, 912034, 912035, 912036, 913001, 913002, 913003, 913004, 913005, 913006, 913007, 913008, 913009, 913010, 913011, 913012, 913013, 913014...(Other models you can see in the webshop)		

 <p>1</p>			
<b>GEV No.</b>	692427	<b>Ref. No.</b>	SS1601B1
<b>description</b>	roller rollerø 26mm B1 6mm with holder SS/plastic mounting pos. rear bearing ball bearing Qty 1 pcs H 4mm L 66mm mounting distance 40/50mm		

accessories

 <p>1</p>			
<b>GEV No.</b>	693731	<b>Ref. No.</b>	SS1602
<b>description</b>	bracket for roller mounting pos. left		

 <p>1</p>			
<b>GEV No.</b>	693733	<b>Ref. No.</b>	SS4350
<b>description</b>	guide sliding door L 54mm plastic 20		

 <p>1</p>			
<b>GEV No.</b>	690570	<b>Ref. No.</b>	0140403100
<b>description</b>	rubber pad		
<b>For models:</b>	912001, 912002, 912003, 912004, 912005, 912006, 912007, 912008, 912009, 912010, 912011, 912012, 912013, 912014, 912015, 912016, 912017, 912018, 912019, 912020, 912021, 912022, 912023, 912024, 912025, 912026, 912027, 912028, 912029, 912030, 912031, 912032, 912033, 912034, 912035, 912036, 913001, 913002, 913003, 913004, 913005, 913006, 913007, 913008, 913009, 913010, 913011, 913012, 913013, 913014...(Other models you can see in the webshop)		



# fittings for catering equipment

## outlet taps

### universal



1

<b>GEV No.</b>	540747	<b>Ref. No.</b>	172-5008
<b>description</b>	outlet tap chrome-plated brass angled W 30mm H 40mm thread 1/2" IT		
<b>For models:</b>	244012		

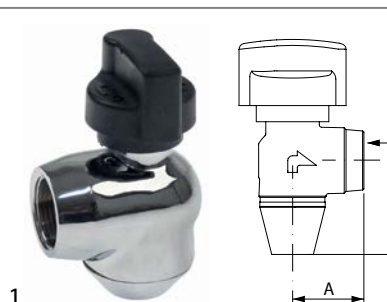

1

<b>GEV No.</b>	540699	<b>Ref. No.</b>	CR0846920
<b>description</b>	outlet tap W 35mm H 35mm thread 3/4" IT		
<b>For models:</b>	124101, 124102, 124103, 125101, 125102, 125103		

### producer-specific

#### COOKMAX



1

<b>GEV No.</b>	514006	<b>Ref. No.</b>	409002110
<b>description</b>	drain pipe L 200mm thread ø 22mm		
<b>For models:</b>	114001, 114002, 114003, 115001, 115002, 116001, 116002, 244004, 244005, 244007, 244008, 244009		



1

<b>GEV No.</b>	540651	<b>Ref. No.</b>	1033300300
<b>description</b>	drain pipe total length 210mm shaft ø 22mm		



1

<b>GEV No.</b>	540776	<b>Ref. No.</b>	1040424
<b>description</b>	outlet tap L 83mm without handle thread 3/4" IT shaft L 9mm shaft ø 10x7.3mm handle M6		
<b>spare parts for</b>	540776		
	<b>GEV No.</b>	532453	<b>Ref. No.</b> —
	O-ring EPDM thickness 2.62mm ID ø 21.89mm Qty 1 pcs		
<b>accessories for</b>	540776		
	<b>GEV No.</b>	514006	<b>Ref. No.</b> 409002110
	drain pipe L 200mm thread ø 22mm		
	<b>GEV No.</b>	514217	<b>Ref. No.</b> —
	handle for outlet tap		
	<b>GEV No.</b>	540651	<b>Ref. No.</b> 1033300300
	drain pipe total length 210mm shaft ø 22mm		
	<b>GEV No.</b>	540734	<b>Ref. No.</b> —
	drain pipe thread		
	<b>GEV No.</b>	693082	<b>Ref. No.</b> —
	lever handle thread		



1

<b>GEV No.</b>	540763	<b>Ref. No.</b>	409002100
<b>description</b>	outlet tap L 84mm without handle thread 3/4" IT		
<b>For models:</b>	114001, 114002, 114003, 115001, 115002, 116001, 116002, 244004, 244005, 244007, 244008, 244009		
<b>spare parts for</b>	540763		
	<b>GEV No.</b>	532453	<b>Ref. No.</b> —
	O-ring EPDM thickness 2.62mm ID ø 21.89mm Qty 1 pcs		
<b>accessories for</b>	540763		
	<b>GEV No.</b>	110704	<b>Ref. No.</b> 407803190
	cone handle thread M6 ø 16mm L 25mm plastic black		
	<b>GEV No.</b>	514006	<b>Ref. No.</b> 409002110
	drain pipe L 200mm thread ø 22mm		
	<b>GEV No.</b>	540651	<b>Ref. No.</b> 1033300300
	drain pipe total length 210mm shaft ø 22mm		
	<b>GEV No.</b>	540734	<b>Ref. No.</b> —
	drain pipe thread		

Table continues overleaf

<b>accessories for</b>	540763			
	GEV No.	691355	Ref. No.	408704100
	lever L 64mm for outlet tap thread M6 ET - M6 ET			





<b>GEV No.</b>	514005	<b>Ref. No.</b>	1031024110
<b>description</b>	outlet tap without handle thread 3/4" IT shaft L 12mm		

<b>accessories for</b>	514005			
	GEV No.	106597	Ref. No.	866000 MA866000
	union screw thread 3/4" for pipe ø 18mm L 20mm Qty 1 pcs WS 27			

	GEV No.	106598	Ref. No.	866200 MA866200
	olive for pipe ø 18mm Qty 1 pcs ED ø 21mm			

	GEV No.	514011	Ref. No.	—
	lever right equiv. no. 1031400100			

	GEV No.	514015	Ref. No.	1036702000 MA1036702000
	lever handle plastic black			

	GEV No.	540651	Ref. No.	1033300300
	drain pipe total length 210mm shaft ø 22mm			

	GEV No.	691334	Ref. No.	1044235100
	lever for outlet tap right thread			

	GEV No.	691356	Ref. No.	1033720900
	extension for lever outlet tap			

aerators and air bleeders



<b>GEV No.</b>	540826	<b>Ref. No.</b>	853310021
<b>description</b>	aerator and air bleeder thread 1/2" ET WS 24 chrome-plated brass L 30mm		
<b>For models:</b>	136001, 136002, 136201, 136202		



<b>GEV No.</b>	540825	<b>Ref. No.</b>	6A022231
<b>description</b>	aerator and air bleeder thread 3/8" ET WS 24 chrome-plated L 37mm		

drain taps

brass

drain taps



<b>GEV No.</b>	548001	<b>Ref. No.</b>	6A021050
<b>description</b>	drain tap 1 1/2" IT O-ring seal kettle connection with union nut A 80mm B1 68mm B2 132mm		

<b>spare parts for</b>	548001		
------------------------	--------	--	--

	GEV No.	505092	Ref. No.	—
	O-ring EPDM thickness 5.34mm ID ø 43.82mm Qty 1 pcs			

	GEV No.	540213	Ref. No.	—
	handle ID ø 5mm L 117mm			



<b>GEV No.</b>	540276	<b>Ref. No.</b>	853310059
<b>description</b>	drain tap connection with union nut thread 1 1/2"		
<b>For models:</b>	136001, 136002, 136201, 136202		

<b>spare parts for</b>	540276		
------------------------	--------	--	--

	GEV No.	532374	Ref. No.	—
	O-ring silicone thickness 5.34mm ID ø 43.82mm Qty 10 pcs			

<b>accessories for</b>	540276			
	GEV No.	514251	Ref. No.	—
	gasket fibre ED ø 46mm ID ø 38mm thickness 2mm Qty 1 pcs			



accessories



1

<b>GEV No.</b>	540959	<b>Ref. No.</b>	6A001451
<b>description</b>	gasket for drain tap hose ext. ø 60mm ID ø 50mm H 2mm		



1

<b>GEV No.</b>	540119	<b>Ref. No.</b>	MA1420925
<b>description</b>	O-ring EPDM thickness 2.5mm ID ø 59mm Qty 1 pcs		
<b>For models:</b>	146002, 146006		

test taps

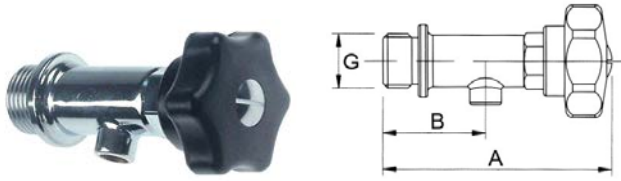

1

<b>GEV No.</b>	540818	<b>Ref. No.</b>	6A022250
<b>description</b>	test tap thread 1/2" ET W 88mm W1 38mm		

safety fittings



1

<b>GEV No.</b>	548000	<b>Ref. No.</b>	853310056	
<b>description</b>	safety fitting thread 1"			
<b>For models:</b>	136001, 136002, 136201, 136202			
<b>spare parts for</b>	548000			
	<b>GEV No.</b>	540826	<b>Ref. No.</b>	853310021
	aerator and air bleeder thread 1/2" ET WS 24 chrome-plated brass L 30mm			



1

<b>GEV No.</b>	514404	<b>Ref. No.</b>	2591677	
<b>description</b>	safety fitting thread 3/4" 0.45bar conversion kit with manometer			
<b>spare parts for</b>	514404			
	<b>GEV No.</b>	514276	<b>Ref. No.</b>	6A022230
	safety fitting thread 3/4" 0.45bar H 165mm ø 65mm			
	<b>GEV No.</b>	540825	<b>Ref. No.</b>	6A022231
	aerator and air bleeder thread 3/8" ET WS 24 chrome-plated L 37mm			
	<b>GEV No.</b>	540832	<b>Ref. No.</b>	6A022233
	fitting support thread 1/2" ET suitable for manometer			
	<b>GEV No.</b>	540835	<b>Ref. No.</b>	6A022235
	screw cap thread 3/4"			
	<b>GEV No.</b>	541901	<b>Ref. No.</b>	CR0589110
	manometer ø 63mm pressure range 0 up to 1bar 0 up to 14.5PSI thread 1/4" connection on the backside			



1

<b>GEV No.</b>	514276	<b>Ref. No.</b>	6A022230	
<b>description</b>	safety fitting thread 3/4" 0.45bar H 165mm ø 65mm			
<b>spare parts for</b>	514276			
	<b>GEV No.</b>	514094	<b>Ref. No.</b>	—
	angle piece thread 3/8"			
	<b>GEV No.</b>	514276	<b>Ref. No.</b>	6A022230
	safety fitting thread 3/4" 0.45bar H 165mm ø 65mm			
	<b>GEV No.</b>	540825	<b>Ref. No.</b>	6A022231
	aerator and air bleeder thread 3/8" ET WS 24 chrome-plated L 37mm			
	<b>GEV No.</b>	540828	<b>Ref. No.</b>	—
	manometer siphon thread 3/8"			
	<b>GEV No.</b>	541579	<b>Ref. No.</b>	—
	manometer ø 52mm pressure range 0 up to 1bar connection marking 0.5 thread 1/4"			

accessories



<b>GEV No.</b>	540832	<b>Ref. No.</b>	6A022233
<b>description</b>	fitting support thread 1/2" ET suitable for manometer		
<b>accessories for</b>	540832		
	<b>GEV No.</b>	510166	<b>Ref. No.</b> —
flat gasket fibre ED 31.3mm ID 26.3mm thickness 1.2mm Qty 1 pcs			



<b>GEV No.</b>	540835	<b>Ref. No.</b>	6A022235
<b>description</b>	screw cap thread 3/4"		
<b>spare parts for</b>	540835		
	<b>GEV No.</b>	513016	<b>Ref. No.</b> —
O-ring EPDM thickness 3.53mm ID 26.58mm Qty 1 pcs			
<b>accessories for</b>	540835		
	<b>GEV No.</b>	513016	<b>Ref. No.</b> —
O-ring EPDM thickness 3.53mm ID 26.58mm Qty 1 pcs			



<b>GEV No.</b>	514405	<b>Ref. No.</b>	6A022232
<b>description</b>	ring for safety fitting 23.5mm		



<b>GEV No.</b>	802132	<b>Ref. No.</b>	WY15318
<b>description</b>	equipment foot tube 52mm thread M10 thread L 10mm H 60-75mm SS size 2" Qty 1 pcs		
<b>For models:</b>	742001, 742002, 742003, 742004		



<b>GEV No.</b>	691476	<b>Ref. No.</b>	X05.30.092.00
<b>description</b>	equipment foot thread 3/8"-16UNC thread L 12mm H 101-135mm plastic size 1 1/2" Qty 1 pcs		
<b>For models:</b>	222004, 222005		



<b>GEV No.</b>	700761	<b>Ref. No.</b>	20613
<b>description</b>	equipment foot tube 50mm thread M10 thread L 12mm H 130-180mm SS size 2" Qty 1 pcs		
<b>For models:</b>	711008, 711009, 711010, 711011, 711012, 711013, 711014, 711015, 711016, 711017, 711018, 711019		



<b>GEV No.</b>	701172	<b>Ref. No.</b>	0805318400
<b>description</b>	equipment foot tube 52mm thread M10 thread L 18mm H 140/195mm SS size 2" Qty 1 pcs		
<b>For models:</b>	912001, 912002, 912003, 912004, 912005, 912006, 912007, 912008, 912009, 912010, 912011, 912012, 912013, 912014, 912015, 912016, 912017, 912018, 912019, 912020, 912021, 912022, 912023, 912024, 912025, 912026, 912027, 912028, 912029, 912030, 912031, 912032, 912033, 912034, 912035, 912036, 913001, 913002, 913003, 913004, 913005, 913006, 913007, 913008, 913009, 913010, 913011, 913012, 913013, 913014...(Other models you can see in the webshop)		

equipment feet and end caps

equipment feet

with screw mounting

universal



<b>GEV No.</b>	527176	<b>Ref. No.</b>	WY15321
<b>description</b>	equipment foot tube 50mm thread M10 thread L 9mm H 88-100mm SS size 2" Qty 1 pcs		
<b>For models:</b>	742001, 742002, 742003, 742004		





1			
<b>GEV No.</b>	701203	<b>Ref. No.</b>	407812300
<b>description</b>	equipment foot tube ø 58mm thread M10 thread L 20mm H 110-170mm plastic size 2 1/3" Qty 1 pcs		
<b>For models:</b>	111001, 111002, 111003, 119001, 119002, 119003, 119004		

1			
<b>GEV No.</b>	513287	<b>Ref. No.</b>	79028
<b>description</b>	equipment foot tube ø 60mm thread M12 thread L 33mm H 155-235mm SS size 2" Qty 1 pcs		
<b>For models:</b>	813001		

1			
<b>GEV No.</b>	701205	<b>Ref. No.</b>	7043485
<b>description</b>	equipment foot tube ø 67mm thread M10 thread L 15mm H 150-210mm SS size 2 1/2" Qty 1 pcs		
<b>For models:</b>	621014, 622009, 622012, 622018		

1			
<b>GEV No.</b>	701202	<b>Ref. No.</b>	407812200
<b>description</b>	equipment foot tube ø 67mm thread M10 thread L 21mm H 115/175mm SS size 2 1/2" Qty 1 pcs		
<b>For models:</b>	244021		

<b>with fixing plate</b>			
1			
<b>GEV No.</b>	701204	<b>Ref. No.</b>	2519500
<b>description</b>	equipment foot tube ø 52mm plate size 67x67mm hole distance 51x51mm H 120-190mm SS size 2" Qty 1 pcs		

1			
<b>GEV No.</b>	700724	<b>Ref. No.</b>	6086113 MA6086113
<b>description</b>	equipment foot tube ø 58mm plate size 70x70mm hole distance 56x56mm H 130-210mm SS size 2 1/4" Qty 1 pcs		
<b>For models:</b>	141005, 141006, 141007, 141009, 141010, 141013, 141016, 141021, 143033, 143034, 144001, 144002, 144007, 144008, 144009, 144010, 144012, 146002, 146006, 147003, 147005, 147006, 147007		

1			
<b>GEV No.</b>	700220	<b>Ref. No.</b>	1467516
<b>description</b>	equipment foot tube ø 64mm plate size 76/90mm hole distance 60x80mm H 115-170mm SS size 2 1/2" Qty 1 pcs		
<b>For models:</b>	201780, 621007, 622005		

1			
<b>GEV No.</b>	700742	<b>Ref. No.</b>	41826490142
<b>description</b>	equipment foot tube ø 64mm plate size 88x100mm hole distance 70x80mm H 135-200mm SS size 2" Qty 1 pcs		
<b>For models:</b>	131001, 131002, 131003, 131004, 131005, 131006, 131007, 131008, 131009, 131010, 131201, 131202, 131203, 131204, 131205, 131206, 131207, 131208, 131209, 131210, 132001, 132002, 132003, 132004, 132201, 132202, 132203, 132204, 133001, 133002, 133003, 133004, 133005, 133006, 133007, 133008, 133009, 133010, 133011, 133012, 133013, 133014, 133015, 133016, 133017, 133018, 133019, 133020, 133021, 133022...(Other models you can see in the webshop)		

bullet feet

plastic

1			
<b>GEV No.</b>	700117	<b>Ref. No.</b>	407810810
<b>description</b>	equipment foot pipe type 30x30 thickness 1.2-1.5mm H 23-55mm plastic Qty 1 pcs load capacity 90kg		
<b>For models:</b>	245003		



1

<b>GEV No.</b>	700108	<b>Ref. No.</b>	SS2016
<b>description</b>	equipment foot pipe type 40x40 thickness 1-1.2mm H 17-55mm plastic Qty 1 pcs		
<b>spare parts for</b>	700108		
	<b>GEV No.</b>	<b>Ref. No.</b>	—
	 O-ring EPDM thickness 2.62mm ID ø 18.72mm Qty 10 pcs		

plastic/SS



1

<b>GEV No.</b>	700869	<b>Ref. No.</b>	0805324100
<b>description</b>	equipment foot pipe type 40x40 thickness 1-1.2mm H 23-92mm plastic/SS Qty 1 pcs		
<b>For models:</b>	943001, 943002, 943003, 943004, 943005, 943006, 943007, 943008, 943009, 943010, 943011, 943012, 943013, 943014, 943015, 943016		

screw-in feet



1

<b>GEV No.</b>	527271	<b>Ref. No.</b>	50.31.00
<b>description</b>	equipment feet kit thread M6 thread L 10mm ø 20mm H 23mm Qty 4 pcs		
<b>For models:</b>	745001, 745002		



1

<b>GEV No.</b>	696484	<b>Ref. No.</b>	CR-B112 KO-B117 KOB117 WFB111
<b>description</b>	equipment foot thread 3/8" Whitworth thread L 24mm ø 43mm H 24mm Qty 1 pcs		
<b>For models:</b>	223007, 223008, 225009, 255009, 255012, 255013, 255014		



1

<b>GEV No.</b>	695353	<b>Ref. No.</b>	10017
<b>description</b>	equipment foot thread L 17mm ø 18mm H 40mm WS 24 Qty 1 pcs		
<b>For models:</b>	711001, 711002, 711003, 711004, 711005, 711006, 711007		



1

<b>GEV No.</b>	700972	<b>Ref. No.</b>	S900.13 SL0494
<b>description</b>	equipment foot thread M10 thread L 16mm ø 29mm H 11.5mm Qty 1 pcs for fridge		
<b>For models:</b>	611007, 611008, 611009, 611010, 611011, 611013, 613016, 621019, 621023, 621024, 621025, 621026, 621027, 621028, 621029, 621030, 621031, 621032, 621033, 621034, 621035, 621036, 621045, 621046, 621047, 621048, 621049, 621050, 622022, 622023, 622024, 622025, 622026, 622027, 622028, 622029, 622034, 622035, 622036, 622037, 622038, 622039, 625002, 625003, 625014, 625015, 625016, 625017, 625018		



1

<b>GEV No.</b>	802156	<b>Ref. No.</b>	00002790
<b>description</b>	equipment foot thread M10 thread L 20mm ø 60mm H 50mm Qty 1 pcs		
<b>For models:</b>	211038, 211039, 211042, 211043, 211044, 211045, 211046, 212034, 212035, 212036, 212037, 212038, 212039, 212040, 212041		



1

<b>GEV No.</b>	697331	<b>Ref. No.</b>	5874000
<b>description</b>	equipment foot thread M10 thread L 32mm ø 34mm H 12mm Qty 1 pcs		





1

<b>GEV No.</b>	695545	<b>Ref. No.</b>	PIE30001
<b>description</b>	equipment foot thread M10 thread L 32mm ø 40mm H 12mm Qty 1 pcs		
<b>For models:</b>	211004, 211005, 211006, 211010, 211011, 211012, 211013, 211014, 211015, 211016, 211017, 211018, 211020, 211023, 211024, 211026, 211027, 215001, 215002, 215003, 215004, 215005, 215006		





			
1			
<b>GEV No.</b>	699184	<b>Ref. No.</b>	PD2456
<b>description</b>	equipment foot thread M10 thread L 40mm ø 45mm H 53mm		
<b>For models:</b>	221005, 221021		

			
1			
<b>GEV No.</b>	695601	<b>Ref. No.</b>	461010
<b>description</b>	equipment foot thread M17 thread L 23mm ø 24mm H 11mm plastic WS 24 Qty 1 pcs		
<b>For models:</b>	811001, 811002, 811003		

			
1			
<b>GEV No.</b>	701101	<b>Ref. No.</b>	01-294066-001
<b>description</b>	equipment foot thread M10 thread L 60mm ø 30mm H 10mm Qty 1 pcs suitable for HOBART		
<b>For models:</b>	811011, 811012, 811013, 811014, 811015, 812011, 812012, 812013, 812014, 812015		

			
1			
<b>GEV No.</b>	696094	<b>Ref. No.</b>	IB4356015
<b>description</b>	equipment foot thread M4 thread L 10mm ø 15mm H 10mm Qty 1 pcs		
<b>For models:</b>	721004		

			
1			
<b>GEV No.</b>	701207	<b>Ref. No.</b>	7042301
<b>description</b>	equipment foot thread M10 WS 22 L 20mm		
<b>For models:</b>	621015, 622013, 622019, 625010, 629001		

			
1			
<b>GEV No.</b>	693791	<b>Ref. No.</b>	19560201
<b>description</b>	equipment foot thread M5 thread L 10mm ø 36mm H 27mm Qty 1 pcs		
<b>For models:</b>	411001, 411003, 411005, 411006		

			
1			
<b>GEV No.</b>	696801	<b>Ref. No.</b>	SL3361
<b>description</b>	equipment foot thread M10x1.5 thread L 15mm ø 50mm H 62mm WS 13		
<b>For models:</b>	512013, 512014, 512015, 512016, 512017, 512018, 512019, 512020, 512021, 512022		

			
1			
<b>GEV No.</b>	696043	<b>Ref. No.</b>	MSC04N114K MSC04N114K + MSC04N115K
<b>description</b>	equipment foot thread M5 thread L 8mm ø 28mm H 24mm Qty 1 pcs C4-C6-C9		
<b>For models:</b>	471001		

			
1			
<b>GEV No.</b>	513321	<b>Ref. No.</b>	210207
<b>description</b>	equipment foot thread M10x1.5 thread L 22mm H 29mm WS 25 Qty 1 pcs		
<b>For models:</b>	SP2-12, SP2-S12		

			
1			
<b>GEV No.</b>	691264	<b>Ref. No.</b>	IB4356000
<b>description</b>	equipment foot thread M6 thread L 16mm ø 25mm H 6mm Qty 1 pcs		
<b>For models:</b>	541001, 541002		



<b>GEV No.</b>	527255	<b>Ref. No.</b>	WY15314001
<b>description</b>	equipment foot thread M8 thread L 11mm ø 47mm H 45mm rubber Qty 1 pcs		
<b>For models:</b>	742005		



<b>GEV No.</b>	701323	<b>Ref. No.</b>	R00080
<b>description</b>	equipment foot thread M8 thread L 21mm ø 29mm H 14mm L 35mm		
<b>For models:</b>	611015		



<b>GEV No.</b>	697770	<b>Ref. No.</b>	19560202
<b>description</b>	equipment foot thread M8 thread L 12mm ø 47mm H 35mm Qty 1 pcs		
<b>For models:</b>	411004		

### bolting feet



<b>GEV No.</b>	514009	<b>Ref. No.</b>	1036021613 MA1036021613
<b>description</b>	equipment foot L 50mm W 29mm H 25mm bore ø 10mm mounting distance 40mm Qty 1 pcs		
<b>For models:</b>	121102, 121104, 122101, 122102, 122103, 122104, 122105, 122106, 122110, 123101, 123102, 123103, 123104, 123106, 123107, 123108, 123109, 123110, 123111, 123112, 123113, 123114, 123115, 123117, 123118, 123119, 123120, 124101, 124102, 124103, 124105, 125101, 125102, 125103, 126101, 126103, 127102		



<b>GEV No.</b>	691344	<b>Ref. No.</b>	407810500 636002100
<b>description</b>	equipment foot thread M8 thread L 20mm ø 23mm H 12mm Qty 1 pcs		
<b>For models:</b>	112001, 112002, 112003, 112004, 113001, 113002, 113003, 113004, 113005, 113006, 113007, 113008, 113009, 113010, 113011, 113012, 113013, 113014, 113015, 113016, 113017, 113018, 113019, 113020, 114001, 114002, 114003, 115001, 115002, 116001, 116002, 118001, 118002, 221001, 221002, 221003, 221004, 223002, 243001, 243002, 243003, 243004, 243005, 243006, 243007, 243008, 244008, 244009, 245001, 245002...(Other models you can see in the webshop)		



<b>GEV No.</b>	691521	<b>Ref. No.</b>	KPD1001A PD1000A0 PD1001A0
<b>description</b>	equipment foot ø 8mm L 35mm W 35mm H 37mm bore ø 8mm mounting distance 40mm Qty 4 pcs		
<b>For models:</b>	211001, 211002, 211003		



<b>GEV No.</b>	695612	<b>Ref. No.</b>	IV4083500
<b>description</b>	equipment foot thread M8 thread L 20mm ø 29mm H 11mm Qty 1 pcs		
<b>For models:</b>	541004		



<b>GEV No.</b>	698290	<b>Ref. No.</b>	SL0235
<b>description</b>	equipment foot ø 22mm H 13.5mm bore ø 5mm Qty 1 pcs		
<b>For models:</b>	421006, 421007, 431002, 433003, 433004, 433005, 481004		





<b>GEV No.</b>	513284	<b>Ref. No.</b>	461019 IB4356005
<b>description</b>	equipment foot thread M8 thread L 20mm ø 30mm H 12mm Qty 1 pcs		
<b>For models:</b>	221006, 812001, 812002, 812003, 812004, 812005, 812006, 812007, 812008, 812009, 812010, 915234, 915235, 915236, 915237, 915460, 915461, 915462, 915463, 915464, 915465		





<b>GEV No.</b>	527181	<b>Ref. No.</b>	WY28360015
<b>description</b>	equipment foot ø 28mm H 14mm rubber bore ø 6.5mm Qty 1 pcs		
<b>For models:</b>	744001, 744002		





 <p>1</p>			
<b>GEV No.</b>	691509	<b>Ref. No.</b>	OAT93602 A0AT93602
<b>description</b>	equipment foot ø 28mm H 17.5mm rubber bore ø 6mm Qty 1 pcs		
<b>For models:</b>	221007		

 <p>1</p>			
<b>GEV No.</b>	701206	<b>Ref. No.</b>	7402121
<b>description</b>	equipment foot ø 32mm H 14mm mounting ø 10mm overall height 25.5mm plastic Qty 1 pcs		
<b>For models:</b>	621015, 622013, 622019, 625010		

 <p>1</p>			
<b>GEV No.</b>	691345	<b>Ref. No.</b>	407810000
<b>description</b>	equipment foot ø 28mm H 21mm bore ø 5mm Qty 1 pcs hole ø 10mm		
<b>For models:</b>	535001, 535002, 535004, 535005, 535006		

 <p>1</p>			
<b>GEV No.</b>	697330	<b>Ref. No.</b>	8301340
<b>description</b>	equipment foot ø 35mm H 38mm bore ø 20mm rubber Qty 1 pcs		
<b>For models:</b>	512001, 512002, 512003, 512004		
<b>accessories for</b>	697330		
		<b>GEV No.</b>	697329
		<b>Ref. No.</b>	8301330 8301560
	bolt for equipment foot thread M12 ø 20mm H 30mm thread L 38mm		

 <p>1</p>			
<b>GEV No.</b>	692308	<b>Ref. No.</b>	210204
<b>description</b>	equipment foot ø 29mm H 12mm rubber Qty 1 pcs		
<b>For models:</b>	SP1		

 <p>1</p>			
<b>GEV No.</b>	697369	<b>Ref. No.</b>	P5008
<b>description</b>	equipment foot ø 47mm H 35mm bore ø 9mm rubber Qty 1 pcs		
<b>For models:</b>	411018		
<b>accessories for</b>	697369		
		<b>GEV No.</b>	697370
		<b>Ref. No.</b>	S7595
	bolt thread M8 ø 10mm L 25mm for equipment foot		

 <p>1</p>			
<b>GEV No.</b>	697764	<b>Ref. No.</b>	P5011
<b>description</b>	equipment foot ø 35mm H 30mm bore ø 6mm Qty 1 pcs		
<b>For models:</b>	411011, 411012		

equipment feet with stem

 <p>1</p>			
<b>GEV No.</b>	700391	<b>Ref. No.</b>	GLEGA074WRE0
<b>description</b>	equipment foot ø 20mm H 12mm mounting ø 7.5mm overall height 18mm plastic Qty 1 pcs		
<b>For models:</b>	213001		

end caps and plugs

housing plugs

 <p>1</p>			
<b>GEV No.</b>	691343	<b>Ref. No.</b>	407810100
<b>description</b>	plug mounting ø 6mm ø 11mm H 10mm plastic Qty 1 pcs		
<b>For models:</b>	119003, 119004, 222002, 222003, 244001, 244002, 244003, 244004, 244005, 244006, 244007, 244010, 261001, 261002, 262002, 262003, 279001, HD3NK		

### for circular pipes



1

<b>GEV No.</b>	527160	<b>Ref. No.</b>	WY15483
<b>description</b>	hole cover mounting ø 12.5mm ø 14.6mm plastic Qty 1 pcs		
<b>For models:</b>	742001, 742002, 742003, 742004		



1

<b>GEV No.</b>	527185	<b>Ref. No.</b>	WY15482
<b>description</b>	hole cover mounting ø 22mm ø 28.5mm H 11mm plastic Qty 1 pcs		
<b>For models:</b>	742001, 742002, 742003, 742004		



1

<b>GEV No.</b>	527180	<b>Ref. No.</b>	WY15486
<b>description</b>	hole cover mounting ømm ø 34.6mm H 18mm plastic Qty 1 pcs		
<b>For models:</b>	742001, 742002, 742003, 742004		

### for square pipes



1

<b>GEV No.</b>	691342	<b>Ref. No.</b>	407825000
<b>description</b>	end cap L 30mm W 20mm Qty 1 pcs for square pipes		
<b>For models:</b>	114003, 276001, 279001		

### miscellaneous



1

<b>GEV No.</b>	697329	<b>Ref. No.</b>	8301330 8301560
<b>description</b>	bolt for equipment foot thread M12 ø 20mm H 30mm thread L 38mm		
<b>For models:</b>	512001, 512002, 512003, 512004		
<b>accessories for</b>	697329		



<b>GEV No.</b>	697330	<b>Ref. No.</b>	8301340
<b>description</b>	equipment foot ø 35mm H 38mm bore ø 20mm rubber Qty 1 pcs		

## EQUIPMENT FEET AND END CAPS COOKMAX

### DERBY RUOTE

#### with fixing plate

#### chrome-plated steel



1

<b>GEV No.</b>	701173	<b>Ref. No.</b>	0961300001
<b>description</b>	swivel castor ø 125mm plate fixing housing chrome-plated sheet steel plate size 95x70mm hole distance 50x70mm capacity 80kg bearing slide bearing wheel body polypropylene tread TPE tyres H 162mm wheel width 30mm Qty 1 pcs		
<b>For models:</b>	912001, 912002, 912003, 912004, 912005, 912006, 912007, 912008, 912009, 912010, 912011, 912012, 912013, 912014, 912015, 912016, 912017, 912018, 912019, 912020, 912021, 912022, 912023, 912024, 912025, 912026, 912027, 912028, 912029, 912030, 912031, 912032, 912033, 912034, 912035, 912036, 913001, 913002, 913003, 913004, 913005, 913006, 913007, 913008, 913009, 913010, 913011, 913012, 913013, 913014...(Other models you can see in the webshop)		



1

<b>GEV No.</b>	701174	<b>Ref. No.</b>	0961300101
<b>description</b>	swivel castor with swivel brake ø 125mm plate fixing housing chrome-plated sheet steel plate size 95x70mm hole distance 50x70mm capacity 80kg bearing slide bearing wheel body polypropylene tread TPE tyres H 162mm wheel width 30mm Qty 1 pcs		
<b>For models:</b>	912001, 912002, 912003, 912004, 912005, 912006, 912007, 912008, 912009, 912010, 912011, 912012, 912013, 912014, 912015, 912016, 912017, 912018, 912019, 912020, 912021, 912022, 912023, 912024, 912025, 912026, 912027, 912028, 912029, 912030, 912031, 912032, 912033, 912034, 912035, 912036, 913001, 913002, 913003, 913004, 913005, 913006, 913007, 913008, 913009, 913010, 913011, 913012, 913013, 913014...(Other models you can see in the webshop)		

#### with bolt hole

#### chrome-plated steel





1

<b>GEV No.</b>	700733	<b>Ref. No.</b>	408791210
<b>description</b>	swivel castor ø 125mm bolt hole bolt hole ø 12mm housing chrome-plated sheet steel capacity 100kg bearing ball bearing wheel body polypropylene tread TPE tyres H 159mm wheel width 30mm Qty 1 pcs		
<b>For models:</b>	955001, 955002, 955003, 955004		



			
1			
<b>GEV No.</b>	700732	<b>Ref. No.</b>	408792100
<b>description</b>	swivel castor with swivel brake ø 125mm bolt hole bolt hole ø 12mm housing chrome-plated sheet steel capacity 100kg bearing ball bearing wheel body polypropylene tread TPE tyres H 159mm wheel width 30mm Qty 1 pcs		
<b>For models:</b>	955001, 955002, 955003, 955004		

<b>spare parts and accessories</b>			
<b>miscellaneous</b>			
			
1			
<b>GEV No.</b>	700134	<b>Ref. No.</b>	260415
<b>description</b>	nut SS thread M8 self-locking		
<b>For models:</b>	SP3		

<b>TENTE</b>			
<b>with fixing plate</b>			
<b>chrome-plated steel</b>			
			
1			
<b>GEV No.</b>	700214	<b>Ref. No.</b>	147805
<b>description</b>	swivel castor ø 100mm plate fixing housing zinc-plated sheet steel plate size 105x85mm hole distance 60x78mm capacity 80kg bearing slide bearing wheel body polypropylene tread TPE tyres H 128mm wheel width 32mm		
<b>For models:</b>	201780, 621007, 622005		

			
1			
<b>GEV No.</b>	700213 <sup>1</sup>	<b>Ref. No.</b>	147806
<b>description</b>	swivel castor with swivel brake ø 100mm plate fixing housing zinc-plated sheet steel plate size 105x85mm hole distance 60x78mm capacity 80kg bearing slide bearing wheel body polypropylene tread TPE tyres H 128mm wheel width 32mm Qty 1 pcs		
<b>For models:</b>	201780, 621007, 622005		

<sup>1</sup>with swivel brake

<b>miscellaneous</b>			
<b>with spigot</b>			
<b>ø75mm</b>			
			
1			
<b>GEV No.</b>	700206	<b>Ref. No.</b>	8301580
<b>description</b>	swivel castor ø 75mm with thread bolt housing chrome-plated steel thread L 30mm thread ø M12x1.5mm capacity 100kg bearing ball bearing wheel body polyamide tread PVC H 100mm wheel width 35mm -20 up to +60°C Qty 1 pcs		
<b>For models:</b>	512001, 512002, 512003, 512004		

			
1			
<b>GEV No.</b>	700195 <sup>1</sup>	<b>Ref. No.</b>	8301570
<b>description</b>	swivel castor with brake ø 75mm with thread bolt housing chrome-plated steel thread L 30mm thread ø M12x1.5mm capacity 100kg bearing ball bearing wheel body polyamide tread PVC H 100mm wheel width 35mm -20 up to +60°C Qty 1 pcs		
<b>For models:</b>	512001, 512002, 512003, 512004		

<sup>1</sup>with swivel brake

<b>diverse sets</b>			
			
1			
<b>GEV No.</b>	701073	<b>Ref. No.</b>	81020320
<b>description</b>	swivel castor set ø 125mm plate fixing housing zinc-coated steel plate size 102x83mm bearing ball bearing wheel body polypropylene tread TPE tyres wheel width 32mm Qty 4 pcs		
<b>For models:</b>	628004		

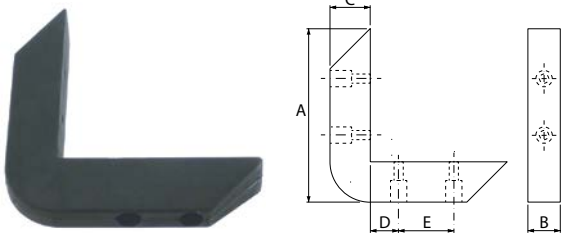
<b>bumper angles</b>			
			
1			
<b>GEV No.</b>	690938	<b>Ref. No.</b>	407830000
<b>description</b>	bumper angle outer length 126mm inner length 99mm W 27mm H 29mm mounting distance 30mm hole distance 35mm hole ø 5mm rubber black		
<b>For models:</b>	955001, 955002, 955003, 955004		

## baskets

### crumb screens

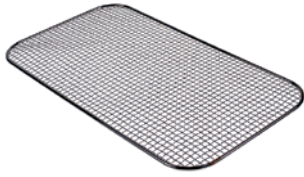

1

<b>GEV No.</b>	970614	<b>Ref. No.</b>	CR0508560
<b>description</b>	crumb screen L 400mm W 220mm suitable for fryer		
<b>For models:</b>	124103		

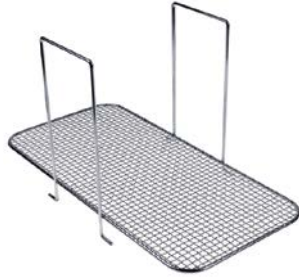

1

<b>GEV No.</b>	970615	<b>Ref. No.</b>	1031112600 MA1031112600
<b>description</b>	crumb screen L 388mm W 186mm suitable for fryer		
<b>For models:</b>	124101, 124102		

### wire baskets for hot dog machines



1

<b>GEV No.</b>	691360	<b>Ref. No.</b>	408009000
<b>description</b>	grid basket for hot dog grill ø 175mm H 215mm		
<b>For models:</b>	261001, 261002, HD3NK		

## warewashing baskets

### system basket GASTROTOP 500x500mm

#### universal baskets



1

<b>GEV No.</b>	973084	<b>Ref. No.</b>	90816003
<b>description</b>	cutlery basket L 500mm W 500mm H 100mm mesh type close-meshed		



1

<b>GEV No.</b>	973082	<b>Ref. No.</b>	90816001
<b>description</b>	mix basket L 500mm W 500mm H 100mm mesh type wide-meshed usable height 75mm		



1

<b>GEV No.</b>	973119	<b>Ref. No.</b>	90816002
<b>description</b>	mix basket L 500mm W 500mm H 150mm usable height 115mm		



1

<b>GEV No.</b>	973085	<b>Ref. No.</b>	90816005
<b>description</b>	plate basket L 500mm W 500mm H 100mm plates 15		



1

<b>GEV No.</b>	973099	<b>Ref. No.</b>	90816007
<b>description</b>	plate basket L 500mm W 500mm H 100mm plates 8		

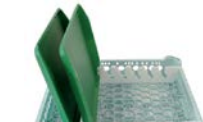

1

<b>GEV No.</b>	973083	<b>Ref. No.</b>	90816012
<b>description</b>	tray rack L 500mm W 500mm H 100mm tablets 8		

**spare parts for** 973083

<b>GEV No.</b>	973118	<b>Ref. No.</b>	—
----------------	--------	-----------------	---

divider for tray basket 500x500mm plastic Qty 2





glass basket



1

<b>GEV No.</b>	973078	<b>Ref. No.</b>	90816017
<b>description</b>	glass basket L 500mm W 500mm number of glasses 16 H 100mm usable height 75mm size of compartment 113x113mm		



1

<b>GEV No.</b>	973079	<b>Ref. No.</b>	90811618
<b>description</b>	glass basket L 500mm W 500mm number of glasses 16 H 150mm usable height 115mm size of compartment 113x113mm		



1

<b>GEV No.</b>	973080 <sup>1</sup>	<b>Ref. No.</b>	90816019
<b>description</b>	glass basket L 500mm W 500mm number of glasses 16 H 186-250mm usable height 151-215mm size of compartment 113x113mm		
<b>spare parts for</b>	973080		
	<b>GEV No.</b>	973000	<b>Ref. No.</b>
	bolt for glass basket Qty 20 pcs		

<sup>1</sup>adjustable height



1

<b>GEV No.</b>	973081 <sup>1</sup>	<b>Ref. No.</b>	90816020
<b>description</b>	glass basket L 500mm W 500mm number of glasses 16 H 251-340mm usable height 216-305mm size of compartment 113x113mm		

<sup>1</sup>adjustable height



1

<b>GEV No.</b>	973086	<b>Ref. No.</b>	90816021
<b>description</b>	glass basket L 500mm W 500mm number of glasses 25 H 100mm usable height 75mm size of compartment 88x88mm		



1

<b>GEV No.</b>	973087	<b>Ref. No.</b>	90816022
<b>description</b>	glass basket L 500mm W 500mm number of glasses 25 H 150mm usable height 115mm size of compartment 88x88mm		



1

<b>GEV No.</b>	973088 <sup>1</sup>	<b>Ref. No.</b>	90816023
<b>description</b>	glass basket L 500mm W 500mm number of glasses 25 H 186-250mm usable height 151-215mm size of compartment 88x88mm		

<sup>1</sup>adjustable height



1

<b>GEV No.</b>	973089 <sup>1</sup>	<b>Ref. No.</b>	90816024
<b>description</b>	glass basket L 500mm W 500mm number of glasses 25 H 251-340mm usable height 216-305mm size of compartment 88x88mm		

<sup>1</sup>adjustable height



1

<b>GEV No.</b>	973090	<b>Ref. No.</b>	90816025
<b>description</b>	glass basket L 500mm W 500mm number of glasses 36 H 100mm usable height 65mm size of compartment 73x73mm		



1

<b>GEV No.</b>	973091	<b>Ref. No.</b>	90816026
<b>description</b>	glass basket L 500mm W 500mm number of glasses 36 H 150mm usable height 115mm size of compartment 73x73mm		

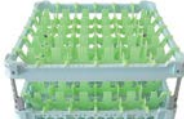

1

<b>GEV No.</b>	973092 <sup>1</sup>	<b>Ref. No.</b>	90816027
<b>description</b>	glass basket L 500mm W 500mm number of glasses 36 H 186-250mm usable height 151-215mm size of compartment 73x73mm		

<sup>1</sup>adjustable height





1

<b>GEV No.</b>	973093 <sup>1</sup>	<b>Ref. No.</b>	90816028
<b>description</b>	glass basket L 500mm W 500mm number of glasses 36 H 251-340mm usable height 216-305mm size of compartment 73x73mm		

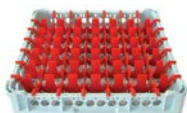
<sup>1</sup>adjustable height

			
1			
<b>GEV No.</b>	973094	<b>Ref. No.</b>	90816029
<b>description</b>	glass basket L 500mm W 500mm number of glasses 49 H 100mm usable height 75mm size of compartment 63x63mm		

			
1			
<b>GEV No.</b>	973095	<b>Ref. No.</b>	90816030
<b>description</b>	glass basket L 500mm W 500mm number of glasses 49 H 150mm usable height 115mm size of compartment 63x63mm		

			
1			
<b>GEV No.</b>	973096 <sup>1</sup>	<b>Ref. No.</b>	90816031
<b>description</b>	glass basket L 500mm W 500mm number of glasses 49 H 186-250mm usable height 151-215mm size of compartment 63x63mm		

<sup>1</sup>adjustable height

			
1			
<b>GEV No.</b>	973097 <sup>1</sup>	<b>Ref. No.</b>	90816032
<b>description</b>	glass basket L 500mm W 500mm number of glasses 49 H 251-340mm usable height 216-305mm size of compartment 63x63mm		

<sup>1</sup>adjustable height

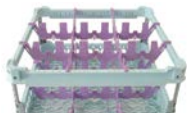
			
1			
<b>GEV No.</b>	973076 <sup>1</sup>	<b>Ref. No.</b>	90816015
<b>description</b>	glass basket L 500mm W 500mm number of glasses 9 H 186-250mm usable height 151-215mm size of compartment 146x146mm		

<sup>1</sup>adjustable height

			
1			
<b>GEV No.</b>	973077 <sup>1</sup>	<b>Ref. No.</b>	90816016
<b>description</b>	glass basket L 500mm W 500mm number of glasses 9 H 216-305mm usable height 251-340mm size of compartment 146x146mm		

<sup>1</sup>adjustable height

accessories

cutlery inserts

			
1			
<b>GEV No.</b>	971116	<b>Ref. No.</b>	90816013
<b>description</b>	cutlery insert L 110mm W 110mm ømm H 140mm		

basket holders

			
1			
<b>GEV No.</b>	971156	<b>Ref. No.</b>	530238
<b>description</b>	basket support L 585mm W 585mm H 200mm SS		
<b>For models:</b>	SP3		

basket carriages

			
1			
<b>GEV No.</b>	973098	<b>Ref. No.</b>	90956007
<b>description</b>	basket transport trolley without handle plastic for basket 500x500mm		

shelves and shelf rails

chargrill grids

			
1			
<b>GEV No.</b>	210166	<b>Ref. No.</b>	CO3126
<b>description</b>	chargrill grid L 540mm W 160mm		
<b>For models:</b>	243109, 243110		





grates



universal

without upstand

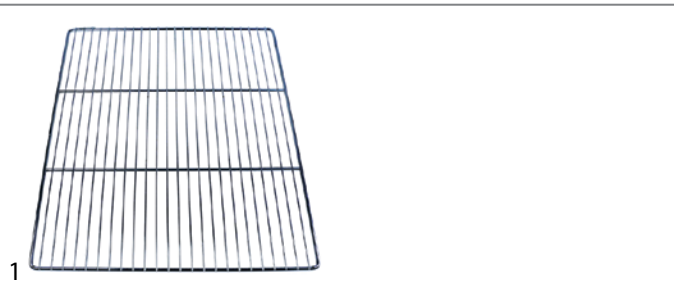

<b>GEV No.</b>	970126	<b>Ref. No.</b>	74768026
<b>description</b>	grate W 530mm D 650mm GN 2/1 plastic-coated steel wire gauge frame 8mm lengthwise wires gauge 5mm crossing wires 2 white suitable for refrigerator		
<b>For models:</b>	621038, 621039, 622031		
<b>accessories for</b>	970126		
	<b>GEV No.</b>	690330	<b>Ref. No.</b> —
	rack L 1000mm W 22mm H 4mm aperture 3x8mm hole distance 12.5mm stainless steel		
	<b>GEV No.</b>	694700	<b>Ref. No.</b> —
	shelf support L 31/28mm W 22mm H 18mm SS Qty 12 pcs		
	<b>GEV No.</b>	694701	<b>Ref. No.</b> —
	shelf support L 31/28mm W 22mm H 17mm SS with hook Qty 12 pcs		







<b>GEV No.</b>	970123	<b>Ref. No.</b>	GN650TN.08
<b>description</b>	grate W 650mm D 530mm GN 2/1 stainless steel wire gauge frame 7.8mm lengthwise wires gauge 3.8mm crossing wires 2 suitable for refrigerator		
<b>For models:</b>	621019		
<b>accessories for</b>	970123		
	<b>GEV No.</b>	690330	<b>Ref. No.</b> —
	rack L 1000mm W 22mm H 4mm aperture 3x8mm hole distance 12.5mm stainless steel		
	<b>GEV No.</b>	694700	<b>Ref. No.</b> —
	shelf support L 31/28mm W 22mm H 18mm SS Qty 12 pcs		
	<b>GEV No.</b>	694701	<b>Ref. No.</b> —
	shelf support L 31/28mm W 22mm H 17mm SS with hook Qty 12 pcs		

with upstand

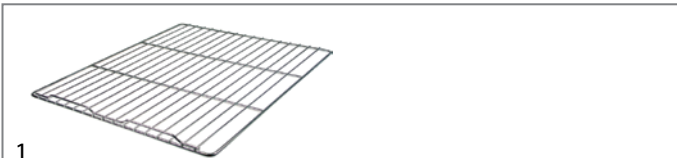

<b>GEV No.</b>	970836	<b>Ref. No.</b>	400740000
<b>description</b>	grate W 335mm D 530mm plastic-coated steel wire gauge frame 9.5mm lengthwise wires gauge 4mm crossing wires 2 white AMITEK		
<b>For models:</b>	611015		



<b>GEV No.</b>	970527	<b>Ref. No.</b>	MA2306800
<b>description</b>	grate W 530mm D 650mm GN 2/1 chrome-plated steel with hinge camp crossing wires 2 suitable for refrigerator		
<b>For models:</b>	141005, 141006, 141007, 141009, 141010, 141013, 141016, 141021		
<b>accessories for</b>	970527		
	<b>GEV No.</b>	690330	<b>Ref. No.</b> —
	rack L 1000mm W 22mm H 4mm aperture 3x8mm hole distance 12.5mm stainless steel		
	<b>GEV No.</b>	694700	<b>Ref. No.</b> —
	shelf support L 31/28mm W 22mm H 18mm SS Qty 12 pcs		
	<b>GEV No.</b>	694701	<b>Ref. No.</b> —
	shelf support L 31/28mm W 22mm H 17mm SS with hook Qty 12 pcs		

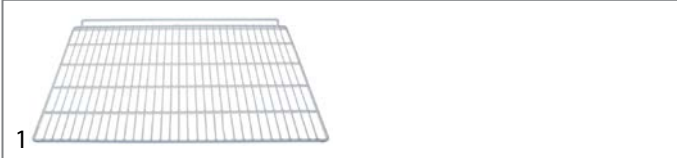

<b>GEV No.</b>	970772	<b>Ref. No.</b>	GRP600
<b>description</b>	grate W 650mm D 530mm GN 2/1 H 40mm plastic-coated steel with hinge camp crossing wires 4		
<b>For models:</b>	621034, 621035, 621036, 621047, 621050, 622028, 622029, 622036, 622039		



<b>GEV No.</b>	970626	<b>Ref. No.</b>	1440065530 BN1440065530
<b>description</b>	grate W 650mm D 530mm GN 2/1 plastic-coated steel with hinge camp crossing wires 2 grey suitable for refrigerator		
<b>For models:</b>	201780, 621007, 621020, 621021, 622005, 622020, 622021		



1

<b>GEV No.</b>	970492	<b>Ref. No.</b>	Q32-0002
<b>description</b>	grate W 650mm D 530mm GN 2/1 plastic-coated steel with hinge camp for fridge crossing wires 2 grey		
<b>For models:</b>	621004, 621005, 622004		
<b>accessories for</b>	970492		
	GEV No.	690991	Ref. No. 4180014
	guide U-shape L 630mm W 15mm H 19mm mounting pos. left/right		

producer-specific



1

<b>GEV No.</b>	210260	<b>Ref. No.</b>	OAT93606 A0AT93606
<b>description</b>	chargrill grid W 250mm D 450mm chrome-plated steel with handle suitable for salamander grill		
<b>For models:</b>	221007		

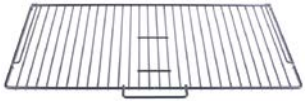

1

<b>GEV No.</b>	691370	<b>Ref. No.</b>	408011500
<b>description</b>	chargrill grid W 300mm D 645mm chrome-plated steel with handle for salamander grill		
<b>For models:</b>	221002		

grates



1

<b>GEV No.</b>	692114	<b>Ref. No.</b>	822410120
<b>description</b>	chimney grate L 400mm W 70mm H 25mm		
<b>For models:</b>	131001, 131002, 131003, 131004, 131005, 131006, 131007, 131008, 131009, 131011, 131012, 132001, 132002, 132003, 132004, 132005, 132006, 132205, 132206, 133001, 133002, 133003, 133004, 133005, 133006, 133009, 133010, 133011, 133012, 133013, 133014, 133015, 133016, 133017, 133018, 133019, 133020, 133021, 133024, 133203, 133209, 133210, 133211, 133212, 133213, 133214, 133215, 135001, 135002, 135003...(Other models you can see in the webshop)		

grid attachments

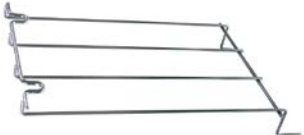

1

<b>GEV No.</b>	691371	<b>Ref. No.</b>	408013100
<b>description</b>	rack support		
<b>For models:</b>	111001, 111002, 111003		

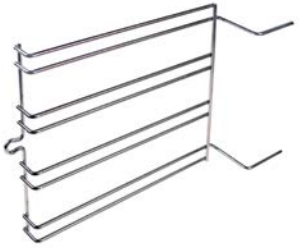

1

<b>GEV No.</b>	691518	<b>Ref. No.</b>	GRL1010A0 GRL1010A1 KGRL1010A
<b>description</b>	rack support L 310mm H 250mm mounting pos. left/right		
<b>For models:</b>	211002		



1

<b>GEV No.</b>	691520	<b>Ref. No.</b>	GRL1090A0
<b>description</b>	rack support L 320mm H 235mm mounting pos. left/right		
<b>For models:</b>	211001		



1

<b>GEV No.</b>	691519	<b>Ref. No.</b>	GRL1025A0
<b>description</b>	rack support L 570mm H 230mm mounting pos. left/right		
<b>For models:</b>	211003		



shelf rails and supports

producer-specific



1

<b>GEV No.</b>	701628	<b>Ref. No.</b>	R58001850
<b>description</b>	bolt for setting bar L 21mm thread ø M5mm		
<b>For models:</b>	212004, 212005, 212006, 212007, 212008, 212009, 212017, 212018, 212019, 212020		



1

<b>GEV No.</b>	690258	<b>Ref. No.</b>	FR1231190
<b>description</b>	guide U-shape L 615mm W 13mm H 20mm mounting pos. left/right		
<b>For models:</b>	621020, 621021, 622020, 622021		



1

<b>GEV No.</b>	690991	<b>Ref. No.</b>	4180014
<b>description</b>	guide U-shape L 630mm W 15mm H 19mm mounting pos. left/right		
<b>For models:</b>	621004, 621005, 622004		



1

<b>GEV No.</b>	701320	<b>Ref. No.</b>	400920000
<b>description</b>	pair of setting bar U-shape L 550mm W 20mm H 13mm mounting pos. left/right		
<b>For models:</b>	611015		



1

<b>GEV No.</b>	696388	<b>Ref. No.</b>	CG11 GN2100TN.31 S900.10
<b>description</b>	pair of setting bar U-shape L 550mm W 20mm H 17mm mounting pos. left/right		
<b>For models:</b>	611007, 611008, 611009, 611010, 611011, 611023, 613016, 613017		



1

<b>GEV No.</b>	690566	<b>Ref. No.</b>	33510071
<b>description</b>	pair of setting bar U-shape L 615mm W 26mm inner high 18mm mounting pos. left/right		
<b>For models:</b>	201780, 621007, 622005		



1

<b>GEV No.</b>	700327	<b>Ref. No.</b>	33580092
<b>description</b>	rack L 1260mm W 35mm mounting pos. left		
<b>For models:</b>	201780, 621007, 622005		



1

<b>GEV No.</b>	700326	<b>Ref. No.</b>	33580091
<b>description</b>	rack L 1260mm W 35mm mounting pos. right		
<b>For models:</b>	201780, 621007, 622005		



1

<b>GEV No.</b>	694921	<b>Ref. No.</b>	H49-0063
<b>description</b>	shelf support L 18mm W 23mm H 26mm Qty 1		
<b>For models:</b>	621004, 621005, 622004		





1

<b>GEV No.</b>	690626	<b>Ref. No.</b>	051306100 0531306100
<b>description</b>	shelf support L 32mm W 14mm H 20mm		
<b>For models:</b>	912025, 912026, 912027, 912028, 912029, 912030, 912031, 912032, 912033, 912034, 912035, 912036, 913001, 913002, 913003, 913004, 913005, 913006, 913007, 913008, 913009, 913010, 913011, 913012, 921001, 921002, 921003, 921004, 921005, 921006, 921007, 921008, 921009, 921010, 921011, 921012, 921013, 921014, 921015, 921016, 921017, 921018, 921019, 921020, 921021, 921022, 921023, 921024, 922001, 922002...(Other models you can see in the webshop)		

			
1			
<b>GEV No.</b>	690969	<b>Ref. No.</b>	P99-0036
<b>description</b>	shelf support L 33/28mm W 22mm H 18mm		
<b>For models:</b>	628004		

			
1			
<b>GEV No.</b>	694276	<b>Ref. No.</b>	H49-0062
<b>description</b>	shelf support L 34mm W 23mm H 31mm		
<b>For models:</b>	621004, 621005, 622004		

			
1			
<b>GEV No.</b>	694507	<b>Ref. No.</b>	AG G350.08
<b>description</b>	shelf support L 38/26mm W 22mm H 24mm SS Qty 4 pcs		
<b>For models:</b>	621029, 621030, 621031, 622026, 622027, 625002, 625003, 633001, 633002		

			
1			
<b>GEV No.</b>	692758	<b>Ref. No.</b>	453500160
<b>description</b>	shelf support L 40mm W 30mm		
<b>For models:</b>	271005, 271006		

## gaskets

### refrigeration gaskets

#### plug-in gaskets

#### profile 9048

We offer custom-made gaskets for this profile

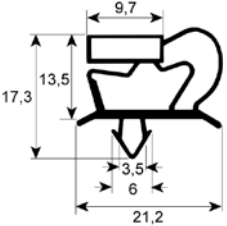
			
1			
<b>GEV No.</b>	900842	<b>Ref. No.</b>	14413690499 BN14413690499
<b>description</b>	refrigeration gasket profile 9048 W 370mm L 500mm plug size		
<b>For models:</b>	551010, 551011, 551012, 551013, 611016, 611017		

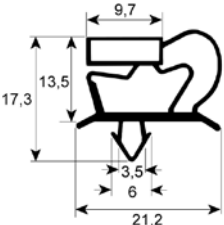
			
1			
<b>GEV No.</b>	901172	<b>Ref. No.</b>	14414300254
<b>description</b>	refrigeration gasket profile 9048 W 383mm L 254mm plug size		
<b>For models:</b>	613020, 613021, 613022, 613023, 613024, 613025, 613026, 613027, 613028, 613029, 613030, 613031, 613032, 613033, 614015, 614016, 614017, 614018		

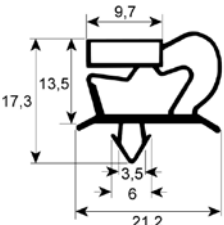
			
1			
<b>GEV No.</b>	901173	<b>Ref. No.</b>	14414300569
<b>description</b>	refrigeration gasket profile 9048 W 383mm L 569mm plug size		
<b>For models:</b>	613020, 613021, 613022, 613023, 613024, 613025, 613026, 613027, 613028, 613029, 613030, 613031, 613032, 613033, 614015, 614016, 614017, 614018		

#### profile 9952

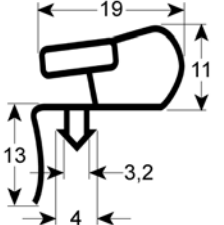
			
1			
<b>GEV No.</b>	900801	<b>Ref. No.</b>	7108357
<b>description</b>	refrigeration gasket profile 9952 W 580mm L 1650mm plug size		
<b>For models:</b>	621015, 622013		

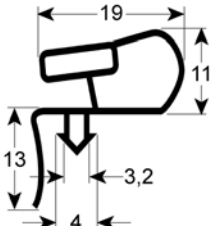
			
1			
<b>GEV No.</b>	900798	<b>Ref. No.</b>	7108393
<b>description</b>	refrigeration gasket profile 9952 W 580mm L 760mm plug size		
<b>For models:</b>	629001		

<b>GEV No.</b>	900800	<b>Ref. No.</b>	7109407
<b>description</b>	refrigeration gasket profile 9952 W 710mm L 1565mm plug size		
<b>For models:</b>	621014, 622009, 622012		

<b>GEV No.</b>	900799	<b>Ref. No.</b>	7108401
<b>description</b>	refrigeration gasket profile 9952 W 730mm L 1380mm plug size		

profile 9703

We offer custom-made gaskets for this profile

<b>GEV No.</b>	901484	<b>Ref. No.</b>	74702806
<b>description</b>	refrigeration gasket profile 9703 W 662mm L 1555mm plug size L1 1545mm W1 652mm external size		
<b>For models:</b>	621038, 621039, 622031		

profile 9010

We offer custom-made gaskets for this profile

<b>GEV No.</b>	900617	<b>Ref. No.</b>	H25-0056
<b>description</b>	refrigeration gasket profile 9010 W 515mm L 620mm plug size		

<b>GEV No.</b>	901365	<b>Ref. No.</b>	H25-0160
<b>description</b>	refrigeration gasket profile 9010 W 565mm L 685mm plug size		
<b>For models:</b>	628004		

<b>GEV No.</b>	900598	<b>Ref. No.</b>	H25-0016
<b>description</b>	refrigeration gasket profile 9010 W 655mm L 1550mm plug size		

<b>GEV No.</b>	900600	<b>Ref. No.</b>	H25-0051
<b>description</b>	refrigeration gasket profile 9010 W 660mm L 1585mm plug size		
<b>For models:</b>	621004, 621005, 622004		

profile 9150

<b>GEV No.</b>	901279	<b>Ref. No.</b>	RC0072 S900.08
<b>description</b>	refrigeration gasket profile 9150 W 395mm L 490mm plug size		
<b>For models:</b>	611007, 611008, 611009, 611010, 611011, 611023		

<b>GEV No.</b>	901493	<b>Ref. No.</b>	R00056
<b>description</b>	refrigeration gasket profile 9150 W 396mm L 494mm plug size		
<b>For models:</b>	611015		

profile 9157

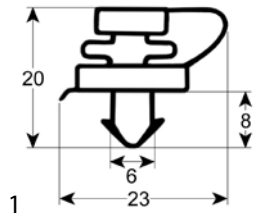

<b>GEV No.</b>	901822	<b>Ref. No.</b>	R00153
<b>description</b>	refrigeration gasket profile 9157 W 395mm L 225mm plug size AK901		
<b>For models:</b>	611015		

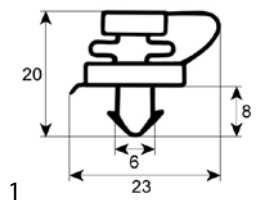

<b>GEV No.</b>	901281	<b>Ref. No.</b>	RC0421
<b>description</b>	refrigeration gasket profile 9157 W 570mm L 1650mm plug size Qty 1		
<b>For models:</b>	621026, 621046, 621049, 622024, 622035, 622038		

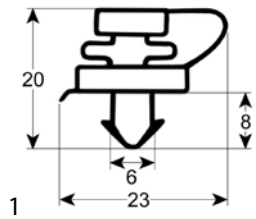

<b>GEV No.</b>	901975	<b>Ref. No.</b>	SNACK400TN.06
<b>description</b>	refrigeration gasket profile 9157 W 615mm L 1445mm plug size		
<b>For models:</b>	621018		

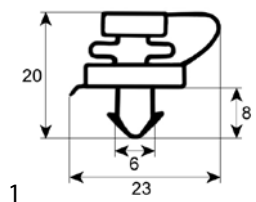

<b>GEV No.</b>	901333	<b>Ref. No.</b>	GN650TN.13
<b>description</b>	refrigeration gasket profile 9157 W 695mm L 1477mm plug size L1 1467mm W1 685mm external size		
<b>For models:</b>	621019		

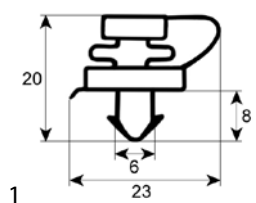

<b>GEV No.</b>	901282	<b>Ref. No.</b>	RC0426
<b>description</b>	refrigeration gasket profile 9157 W 750mm L 1700mm plug size		
<b>For models:</b>	621034, 621047, 621050, 622028, 622036, 622039		

profile 9041

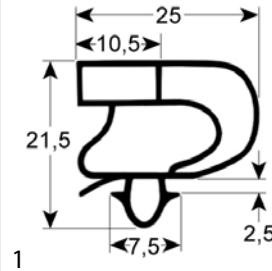

<b>GEV No.</b>	901957	<b>Ref. No.</b>	GN2100TN.33
<b>description</b>	refrigeration gasket profile 9041 W 385mm L 595mm plug size		
<b>For models:</b>	613016, 613017		

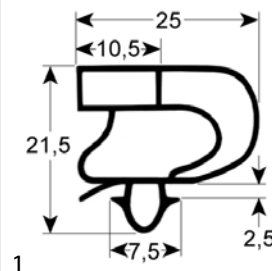

<b>GEV No.</b>	901958	<b>Ref. No.</b>	PA2100TN.9
<b>description</b>	refrigeration gasket profile 9041 W 460mm L 592mm plug size		
<b>For models:</b>	611013, 611014		

profile 9794

We offer custom-made gaskets for this profile

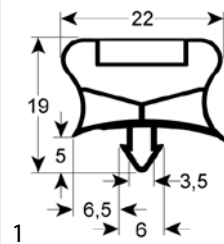

<b>GEV No.</b>	901525	<b>Ref. No.</b>	BN14415991560
<b>description</b>	gasket profile 9794 W 570mm L 1500mm plug size		
<b>For models:</b>	621020, 621021, 622020, 622021		

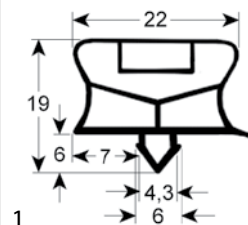

<b>GEV No.</b>	902391	<b>Ref. No.</b>	14414300149
<b>description</b>	refrigeration gasket profile 9794 W 150mm L 380mm		
<b>For models:</b>	613020, 613021, 613022, 613023, 613024, 613025, 613026, 613027, 613028, 613029, 613030, 613031, 613032, 613033, 614015, 614016, 614017, 614018		





<b>GEV No.</b>	900344	<b>Ref. No.</b>	14415991559
<b>description</b>	refrigeration gasket profile 9794 W 595mm L 1565mm plug size		
<b>For models:</b>	201780, 621007, 622005		

**profile 9794Z (blast freezer)**

<b>GEV No.</b>	901800 <sup>1</sup>	<b>Ref. No.</b>	996457
<b>description</b>	blast freezer gasket profile 9794Z W 847mm L 685mm for blast chiller suitable for FRIULINOX		
<b>For models:</b>	671007		

<sup>1</sup>for blast freezer

**profile 9195**

*We offer custom-made gaskets for this profile*

<b>GEV No.</b>	902435	<b>Ref. No.</b>	996453
<b>description</b>	refrigeration gasket profile 9195 W 400mm L 690mm		
<b>For models:</b>	671004		

**profile 9326**

<b>GEV No.</b>	901959	<b>Ref. No.</b>	RC0770
<b>description</b>	refrigeration gasket profile 9326 W 535mm L 1155mm plug size		
<b>For models:</b>	633002		

**gaskets for heated units**

**window seals**

<b>GEV No.</b>	900787	<b>Ref. No.</b>	R70044650
<b>description</b>	window gasket profile 1515 L 2200mm suitable for LAINOX		
<b>For models:</b>	212002		

<b>GEV No.</b>	900501	<b>Ref. No.</b>	R70044260
<b>description</b>	window gasket profile 1530 L 1200mm Qty 1		
<b>For models:</b>	212003, 212010, 212011, 212012, 212013		

<b>GEV No.</b>	900483	<b>Ref. No.</b>	R70044150
<b>description</b>	window gasket profile 1530 L 2400mm Qty 1		
<b>For models:</b>	212003		

<b>GEV No.</b>	900500	<b>Ref. No.</b>	R70044250
<b>description</b>	window gasket profile 1530 L 900mm Qty 1		
<b>For models:</b>	212001, 212002		

door seals

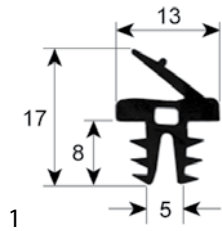

<b>GEV No.</b>	900914	<b>Ref. No.</b>	7323000016
<b>description</b>	door seal profile 2300 Qty supplied by meter		
<b>For models:</b>	211004, 211005, 211006		

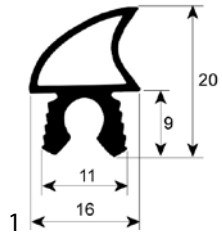

<b>GEV No.</b>	900792	<b>Ref. No.</b>	409081000
<b>description</b>	door seal profile 2748 L 1750mm		
<b>For models:</b>	111001, 111002, 111003		

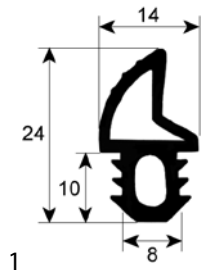

<b>GEV No.</b>	901159	<b>Ref. No.</b>	7323000019
<b>description</b>	door seal profile 2755 L 2780mm		
<b>For models:</b>	211007		

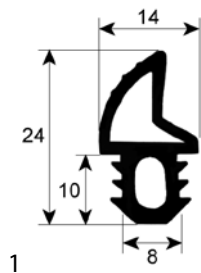

<b>GEV No.</b>	900913	<b>Ref. No.</b>	GUA30002
<b>description</b>	door seal profile 2755 Qty supplied by meter		
<b>For models:</b>	211004, 211005, 211006, 211010, 211011, 211012, 211013, 211014, 211015, 211016, 211017, 211018, 211020, 211023, 211024, 211026, 211027, 211028, 211029, 212014, 212015, 212016, 212024, 212025		

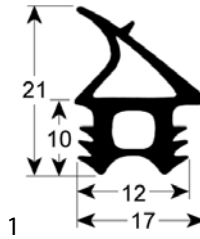

<b>GEV No.</b>	902452	<b>Ref. No.</b>	R70044820
<b>description</b>	door seal profile 2761 W 585mm L 615mm outer plug size Qty 1 suitable for LAINOX		
<b>For models:</b>	212010, 212011		

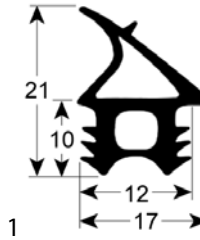

<b>GEV No.</b>	902134	<b>Ref. No.</b>	R70044830
<b>description</b>	door seal profile 2761 W 620mm L 780mm external size Qty 1 suitable for LAINOX		
<b>For models:</b>	212012, 212013		

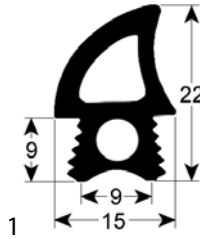

<b>GEV No.</b>	902419	<b>Ref. No.</b>	01000810
<b>description</b>	door seal profile 2767 L 1780mm suitable for TECNOEKA		
<b>For models:</b>	211038		

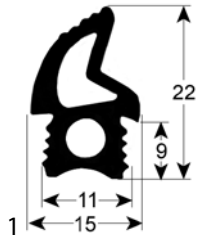

<b>GEV No.</b>	902196	<b>Ref. No.</b>	01000310
<b>description</b>	door seal profile 2769 L 1850mm		
<b>For models:</b>	211039, 211042		

<b>GEV No.</b>	902195	<b>Ref. No.</b>	01000710 01000780
<b>description</b>	door seal profile 2769 L 2140mm		
<b>For models:</b>	211043, 211046		

<b>GEV No.</b>	900802	<b>Ref. No.</b>	GN1110A2
<b>description</b>	door seal profile 2769 L 2200mm Qty 1		
<b>For models:</b>	211002, 211003		

<b>GEV No.</b>	900804	<b>Ref. No.</b>	GN1110A0
<b>description</b>	door seal profile 2769 L 2500mm		

<b>GEV No.</b>	900805	<b>Ref. No.</b>	N/A
<b>description</b>	door seal profile 2769 Qty supplied by meter		

1

<b>GEV No.</b>	900488	<b>Ref. No.</b>	R70044330
<b>description</b>	door seal profile 2770/2771 H 380mm W 420mm outer plug size Qty 1		
<b>For models:</b>	212001		

1

<b>GEV No.</b>	900489	<b>Ref. No.</b>	R70044340
<b>description</b>	door seal profile 2770/2771 H 440mm W 600mm outer plug size Qty 1		
<b>For models:</b>	212004, 212005		

1

<b>GEV No.</b>	900788	<b>Ref. No.</b>	R70044230
<b>description</b>	door seal profile 2770/2771 H 580mm W 680mm outer plug size Qty 1		
<b>For models:</b>	212002		



<b>GEV No.</b>	900491	<b>Ref. No.</b>	R70044110
<b>description</b>	door seal profile 2770/2771 H 800mm W 680mm outer plug size Qty 1		
<b>For models:</b>	212003		

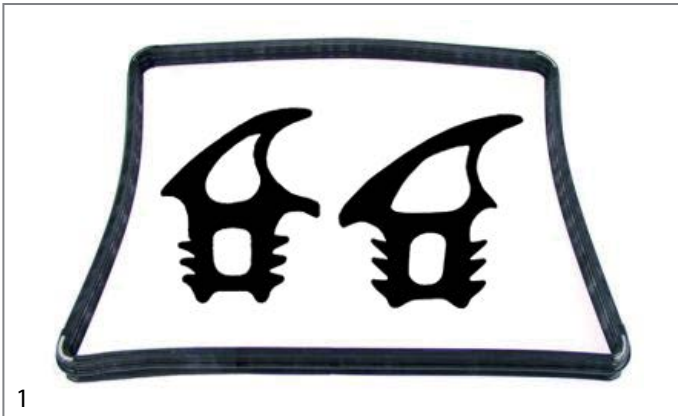

<b>GEV No.</b>	901402	<b>Ref. No.</b>	R70044410
<b>description</b>	door seal profile 2770/2771 H 820mm W 600mm outer plug size Qty 1		
<b>For models:</b>	212008, 212009, 212019, 212020		

door seals with fixing hook



<b>GEV No.</b>	900803	<b>Ref. No.</b>	GN1235A0 KGN1235A
<b>description</b>	door seal L 480mm W 320mm to be hooked in external size		
<b>For models:</b>	211001		



<b>GEV No.</b>	901917	<b>Ref. No.</b>	CR0931990
<b>description</b>	door seal L 570mm W 295mm 4-sided		
<b>For models:</b>	121101, 121102, 121104, 121105, 121106, 122110		

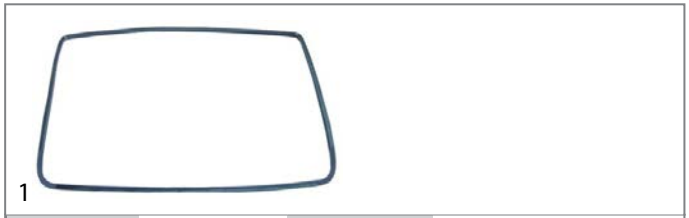

<b>GEV No.</b>	900404	<b>Ref. No.</b>	1036608000
<b>description</b>	oven gasket L 450mm W 330mm external size		

O-rings

EPDM

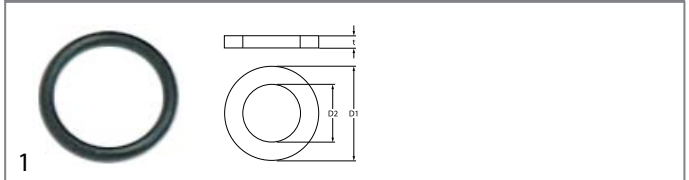

<b>GEV No.</b>	510302	<b>Ref. No.</b>	OPP077.00.00
<b>description</b>	O-ring EPDM ID $\phi$ 12.42mm thickness 1.78mm Qty 1 pcs		
<b>For models:</b>	852002, 852004		

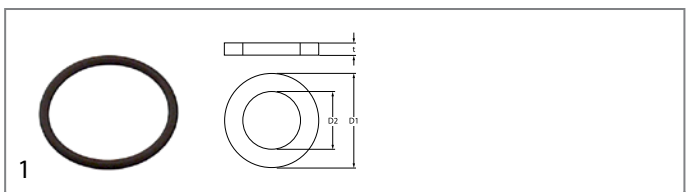

<b>GEV No.</b>	532533	<b>Ref. No.</b>	90.36.20
<b>description</b>	O-ring EPDM thickness 1.5mm ID $\phi$ 17mm Qty 1 pcs		
<b>For models:</b>	745001, 745002		

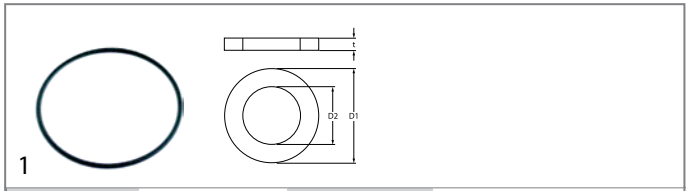

<b>GEV No.</b>	345896	<b>Ref. No.</b>	0065736 0065788
<b>description</b>	O-ring EPDM thickness 1.5mm ID $\phi$ 37mm Qty 1 pcs		

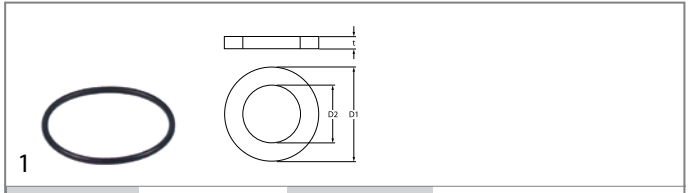

<b>GEV No.</b>	527166	<b>Ref. No.</b>	WY28159305
<b>description</b>	O-ring EPDM thickness 1.6mm ID $\phi$ 27mm Qty 1 pcs		
<b>For models:</b>	744001, 744002		

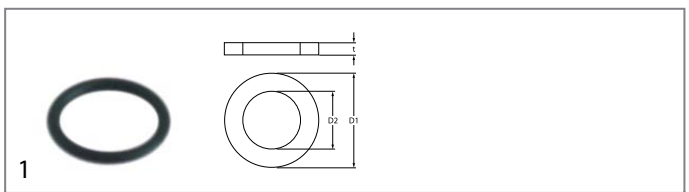

<b>GEV No.</b>	529545	<b>Ref. No.</b>	252684
<b>description</b>	O-ring EPDM thickness 1.78mm ID $\phi$ 10.82mm Qty 1 pcs		
<b>For models:</b>	743001		



<b>GEV No.</b>	504512	<b>Ref. No.</b>	0P.P097.00.00
<b>description</b>	O-ring EPDM thickness 1.78mm ID $\phi$ 14mm Qty 1 pcs		
<b>For models:</b>	852001, 852003, 852004		

<b>GEV No.</b>	504574	<b>Ref. No.</b>	456019
<b>description</b>	O-ring EPDM thickness 1.78mm ID $\phi$ 9.25mm Qty 1 pcs		
<b>For models:</b>	811001, 811002, 811003		

<b>GEV No.</b>	528243	<b>Ref. No.</b>	0P.P076.00.00
<b>description</b>	O-ring EPDM thickness 1.78mm ID $\phi$ 15.6mm Qty 1 pcs		
<b>For models:</b>	822001, 822002, 822003, 822004		

<b>GEV No.</b>	511237	<b>Ref. No.</b>	200850
<b>description</b>	O-ring EPDM thickness 1mm ID $\phi$ 7mm Qty 1 pcs		
<b>For models:</b>	SP3		

<b>GEV No.</b>	510322	<b>Ref. No.</b>	200812
<b>description</b>	O-ring EPDM thickness 1.78mm ID $\phi$ 17.17mm Qty 1 pcs		
<b>For models:</b>	SP1, SP2-12, SP2-S12		

<b>GEV No.</b>	540119	<b>Ref. No.</b>	MA1420925
<b>description</b>	O-ring EPDM thickness 2.5mm ID $\phi$ 59mm Qty 1 pcs		
<b>For models:</b>	146002, 146006		

<b>GEV No.</b>	528485	<b>Ref. No.</b>	456060
<b>description</b>	O-ring EPDM thickness 1.78mm ID $\phi$ 6.07mm Qty 1 pcs		
<b>For models:</b>	813001		

<b>GEV No.</b>	529412	<b>Ref. No.</b>	456006 WY12300
<b>description</b>	O-ring EPDM thickness 2.62mm ID $\phi$ 10.78mm Qty 1 pcs		
<b>For models:</b>	742001, 742002, 742003, 742004, 742005, 811001, 811002, 811003		

<b>GEV No.</b>	510177	<b>Ref. No.</b>	094594
<b>description</b>	O-ring EPDM thickness 1.78mm ID $\phi$ 7.66mm Qty 1 pcs		
<b>For models:</b>	743001		

<b>GEV No.</b>	518227	<b>Ref. No.</b>	456020
<b>description</b>	O-ring EPDM thickness 2.62mm ID $\phi$ 12.37mm Qty 1 pcs		
<b>For models:</b>	811001, 811002, 811003, 812001, 812002, 812003, 812004, 812005, 812006, 812007, 812008, 812009, 812010, 915234, 915235, 915236, 915237, 915460, 915461, 915462, 915463, 915464, 915465		

<b>GEV No.</b>	513275	<b>Ref. No.</b>	456074
<b>description</b>	O-ring EPDM thickness 1.78mm ID $\phi$ 82.27mm Qty 1 pcs		
<b>For models:</b>	811001, 811002, 811003		

<b>GEV No.</b>	528110	<b>Ref. No.</b>	095624
<b>description</b>	O-ring EPDM thickness 2.62mm ID $\phi$ 12.37mm Qty 1 pcs		
<b>For models:</b>	743001		

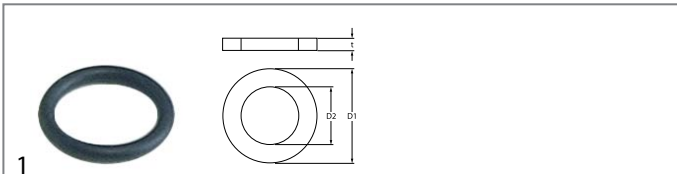

1

<b>GEV No.</b>	529251	<b>Ref. No.</b>	OP.P072.00.00
<b>description</b>	O-ring EPDM thickness 2.62mm ID ø 15.08mm Qty 1 pcs		
<b>For models:</b>	821001, 821003, 852001, 852002, 852003		

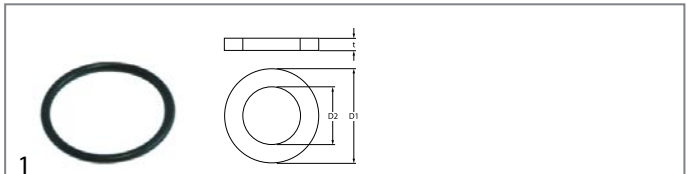

1

<b>GEV No.</b>	512111	<b>Ref. No.</b>	200867
<b>description</b>	O-ring EPDM thickness 2.62mm ID ø 45.69mm Qty 1 pcs		
<b>For models:</b>	SP1, SP2-12, SP2-S12		

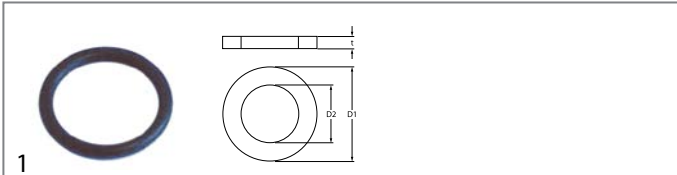

1

<b>GEV No.</b>	507309	<b>Ref. No.</b>	41824710280
<b>description</b>	O-ring EPDM thickness 2.62mm ID ø 17.13mm Qty 1 pcs		
<b>For models:</b>	131001, 131002, 131003, 131004, 131005, 131006, 131010, 131201, 131202, 131203, 131204, 131205, 131206, 131210, 132001, 132002, 132201, 132202		

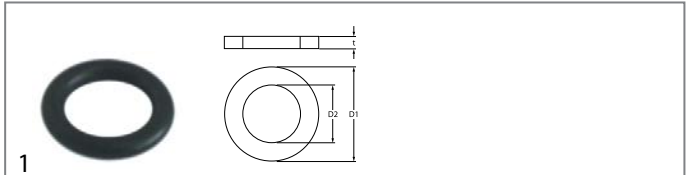

1

<b>GEV No.</b>	528583	<b>Ref. No.</b>	200845
<b>description</b>	O-ring EPDM thickness 2.62mm ID ø 9.13mm Qty 1 pcs		
<b>For models:</b>	SP1, SP2-12, SP2-S12		

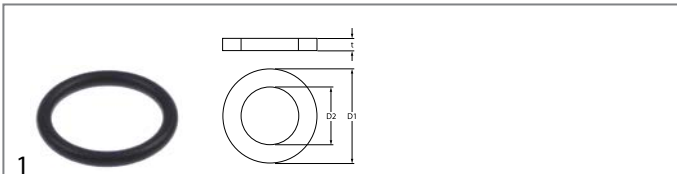

1

<b>GEV No.</b>	516026	<b>Ref. No.</b>	WY12300026
<b>description</b>	O-ring EPDM thickness 2.62mm ID ø 17.86mm Qty 1 pcs		

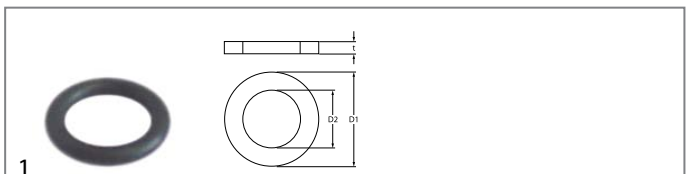

1

<b>GEV No.</b>	528487	<b>Ref. No.</b>	MA2867700
<b>description</b>	O-ring EPDM thickness 2.62mm ID ø 9.19mm Qty 1 pcs		
<b>For models:</b>	146002, 146006, 147003, 147005, 147006, 147007		

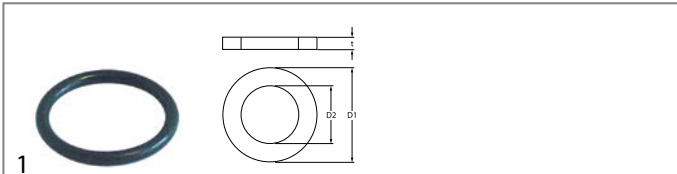

1

<b>GEV No.</b>	505073	<b>Ref. No.</b>	200821 SL0773
<b>description</b>	O-ring EPDM thickness 2.62mm ID ø 20.63mm Qty 1 pcs		
<b>For models:</b>	473006, 473007, 473008, SP1		

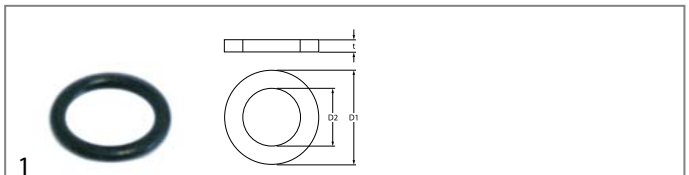

1

<b>GEV No.</b>	510893	<b>Ref. No.</b>	200810 456015
<b>description</b>	O-ring EPDM thickness 2.62mm ID ø 9.92mm Qty 1 pcs		
<b>For models:</b>	812001, 812002, 812003, 812004, 812005, 812006, 812007, 812008, 812009, 812010, 915234, 915235, 915236, 915237, 915460, 915461, 915462, 915463, 915464, 915465, SP2-12, SP2-S12		

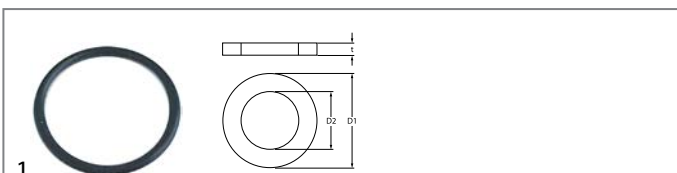

1

<b>GEV No.</b>	502036	<b>Ref. No.</b>	200805
<b>description</b>	O-ring EPDM thickness 2.62mm ID ø 28.25mm Qty 1 pcs		
<b>For models:</b>	SP1, SP2-12, SP2-S12		

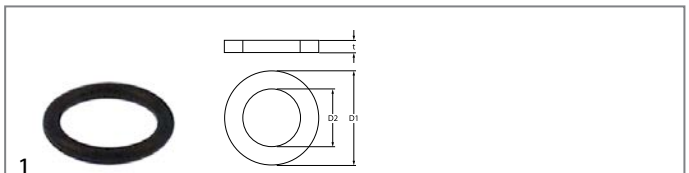

1

<b>GEV No.</b>	527158	<b>Ref. No.</b>	WY12312
<b>description</b>	O-ring EPDM thickness 2mm ID ø 10mm Qty 1 pcs		
<b>For models:</b>	742001, 742002, 742003, 742004, 742005		

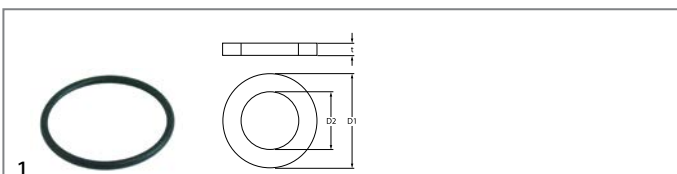

1

<b>GEV No.</b>	505192	<b>Ref. No.</b>	WY12300000
<b>description</b>	O-ring EPDM thickness 2.62mm ID ø 39.34mm Qty 1 pcs		
<b>For models:</b>	742001, 742002, 742003, 742004, 742017, 742018, 742019, 742020		

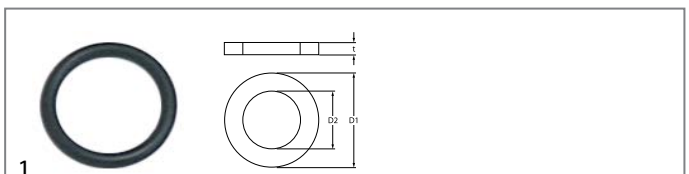

1

<b>GEV No.</b>	510901	<b>Ref. No.</b>	200843
<b>description</b>	O-ring EPDM thickness 2mm ID ø 13mm Qty 1 pcs		
<b>For models:</b>	SP1, SP2-12, SP2-S12		

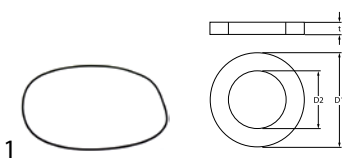
<b>GEV No.</b>	698025	<b>Ref. No.</b>	MF2351
<b>description</b>	O-ring EPDM thickness 2mm ID ø 164.5mm Qty 1 pcs		
<b>For models:</b>	421001, 422001, 433001, 433002		

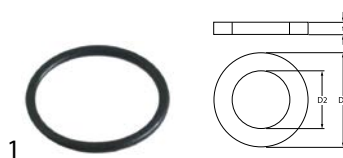

<b>GEV No.</b>	506015	<b>Ref. No.</b>	456052
<b>description</b>	O-ring EPDM thickness 3.53mm ID ø 39.69mm Qty 1 pcs		
<b>For models:</b>	811003, 812008, 812010, 915234, 915235, 915236, 915237, 915462, 915465		

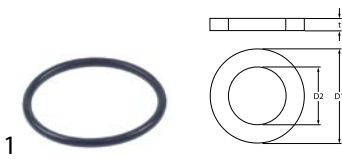

<b>GEV No.</b>	532672	<b>Ref. No.</b>	0065741
<b>description</b>	O-ring EPDM thickness 2mm ID ø 25mm Qty 1 pcs		

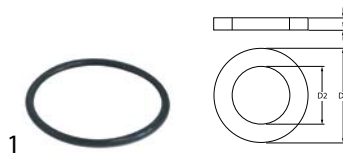

<b>GEV No.</b>	518175	<b>Ref. No.</b>	456061
<b>description</b>	O-ring EPDM thickness 3.53mm ID ø 49.21mm Qty 1 pcs		
<b>For models:</b>	811001, 811002, 811003		



<b>GEV No.</b>	510902	<b>Ref. No.</b>	200844
<b>description</b>	O-ring EPDM thickness 2mm ID ø 9.5mm Qty 1 pcs		
<b>For models:</b>	SP1, SP2-12, SP2-S12		



<b>GEV No.</b>	696071	<b>Ref. No.</b>	IB4104040
<b>description</b>	O-ring EPDM thickness 3.53mm ID ø 52.39mm Qty 1 pcs		
<b>For models:</b>	721004		

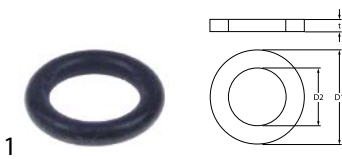

<b>GEV No.</b>	532614	<b>Ref. No.</b>	SM211108
<b>description</b>	O-ring EPDM thickness 3.53mm ID ø 12.29mm Qty 1 pcs		

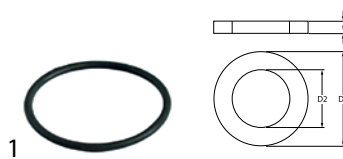

<b>GEV No.</b>	511331	<b>Ref. No.</b>	200842
<b>description</b>	O-ring EPDM thickness 3.53mm ID ø 53.57mm Qty 1 pcs		
<b>For models:</b>	SP1, SP2-12, SP2-S12		

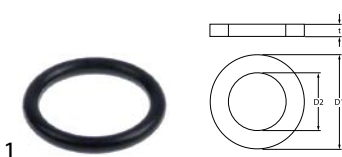

<b>GEV No.</b>	511322	<b>Ref. No.</b>	200869
<b>description</b>	O-ring EPDM thickness 3.53mm ID ø 20.22mm Qty 1 pcs		
<b>For models:</b>	SP1, SP2-12, SP2-S12		

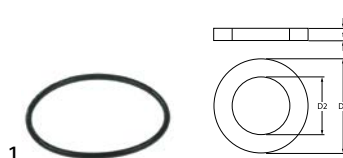

<b>GEV No.</b>	528500	<b>Ref. No.</b>	098701
<b>description</b>	O-ring EPDM thickness 3.53mm ID ø 72.62mm Qty 1 pcs		
<b>For models:</b>	743001		

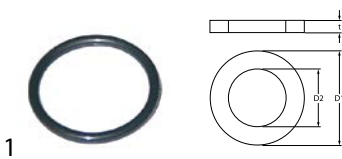

<b>GEV No.</b>	510072	<b>Ref. No.</b>	456016
<b>description</b>	O-ring EPDM thickness 3.53mm ID ø 32.93mm Qty 1 pcs		
<b>For models:</b>	813001		

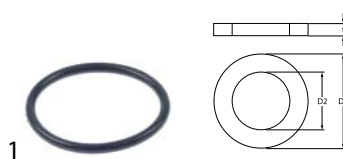

<b>GEV No.</b>	532671	<b>Ref. No.</b>	0065732
<b>description</b>	O-ring EPDM thickness 3mm ID ø 34mm Qty 1 pcs		

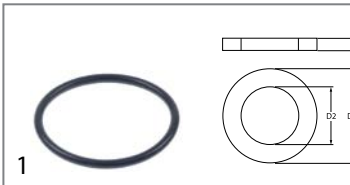

<b>GEV No.</b>	532670	<b>Ref. No.</b>	0065729
<b>description</b>	O-ring EPDM thickness 3mm ID ø 40mm Qty 1 pcs		

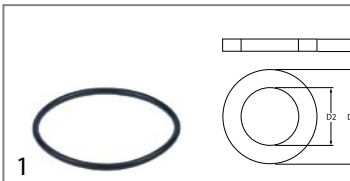

<b>GEV No.</b>	510811	<b>Ref. No.</b>	200816
<b>description</b>	O-ring EPDM thickness 3mm ID ø 59.2mm Qty 1 pcs		
<b>For models:</b>	SP1, SP2-12, SP2-S12, SP3		



<b>GEV No.</b>	510955	<b>Ref. No.</b>	00002001
<b>description</b>	O-ring EPDM thickness 3mm ID ø 6mm Qty 1 pcs		
<b>For models:</b>	211039, 211045, 211046, 212034, 212036, 212037, 212038, 212039, 212040, 212041		

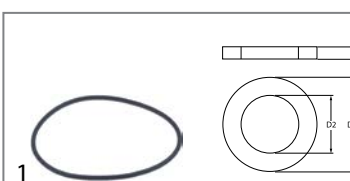

<b>GEV No.</b>	524483	<b>Ref. No.</b>	200807
<b>description</b>	O-ring EPDM thickness 4mm ID ø 110mm Qty 1 pcs		
<b>For models:</b>	SP3		

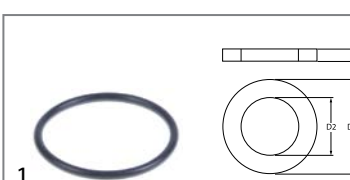

<b>GEV No.</b>	521035	<b>Ref. No.</b>	00-276903-028
<b>description</b>	O-ring EPDM thickness 4mm ID ø 137mm Qty 1 pcs		
<b>For models:</b>	813002, 813003, 813004		

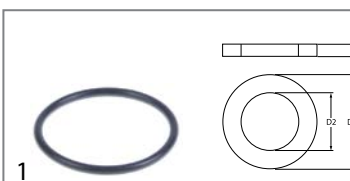

<b>GEV No.</b>	521033	<b>Ref. No.</b>	00-276903-029
<b>description</b>	O-ring EPDM thickness 4mm ID ø 50mm Qty 1 pcs		
<b>For models:</b>	813002, 813003, 813004		

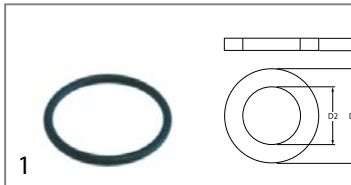

<b>GEV No.</b>	521120	<b>Ref. No.</b>	456075
<b>description</b>	O-ring EPDM thickness 5.34mm ID ø 37.47mm Qty 1 pcs		
<b>For models:</b>	811001, 811002, 811003		



<b>GEV No.</b>	510408	<b>Ref. No.</b>	200820 456002
<b>description</b>	O-ring EPDM thickness 5.34mm ID ø 47mm Qty 1 pcs		
<b>For models:</b>	812001, 812002, 812003, 812004, 812005, 812006, 812007, 812008, 812009, 812010, 813001, 915234, 915235, 915236, 915237, 915460, 915461, 915462, 915463, 915464, 915465, SP1, SP2-12, SP2-S12		

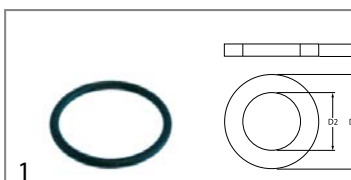

<b>GEV No.</b>	510409	<b>Ref. No.</b>	200815
<b>description</b>	O-ring EPDM thickness 5.34mm ID ø 56.52mm Qty 1 pcs		
<b>For models:</b>	SP2-12, SP2-S12, SP3		

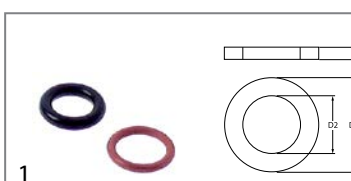

<b>GEV No.</b>	532492	<b>Ref. No.</b>	R70010050
<b>description</b>	O-ring set EPDM thickness 1.78/2.62mm ID ø 9.25/7.59mm Qty 2 pcs		
<b>For models:</b>	212010, 212011, 212012, 212013, 212018, 212020		

silicone

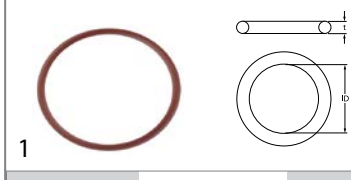

<b>GEV No.</b>	532532	<b>Ref. No.</b>	20.20.31
<b>description</b>	O-ring silicone thickness 1.5mm ID ø 11mm Qty 1 pcs		
<b>For models:</b>	745001, 745002		





<b>GEV No.</b>	532530	<b>Ref. No.</b>	18689
<b>description</b>	O-ring silicone thickness 1.78mm ID ø 15.08mm Qty 1 pcs		
<b>For models:</b>	741001, 741002		

<b>GEV No.</b>	532528	<b>Ref. No.</b>	19398
<b>description</b>	O-ring silicone thickness 4.5mm ID ø 170.5mm Qty 1 pcs		
<b>For models:</b>	741003		

<b>GEV No.</b>	532517	<b>Ref. No.</b>	20233
<b>description</b>	O-ring silicone thickness 1.78mm ID ø 17.17mm Qty 1 pcs		
<b>For models:</b>	711004, 711005, 711006, 711007, 711008, 711009, 711010, 711011, 711012, 711013, 711014, 711015, 711016, 711017, 711018, 711019		

### Viton

<b>GEV No.</b>	521034	<b>Ref. No.</b>	00-276903-055
<b>description</b>	O-ring Viton thickness 1.5mm ID ø 6mm Qty 1 pcs		
<b>For models:</b>	813002, 813003, 813004		

<b>GEV No.</b>	532526	<b>Ref. No.</b>	9400320
<b>description</b>	O-ring silicone thickness 2mm ID ø 30mm Qty 1 pcs		
<b>For models:</b>	741001, 741002		

<b>GEV No.</b>	528687	<b>Ref. No.</b>	CM097900 MACM097900
<b>description</b>	O-ring Viton thickness 1.78mm ID ø 3.69mm Qty 1 pcs		
<b>For models:</b>	124103		

<b>GEV No.</b>	532531	<b>Ref. No.</b>	20.19.23
<b>description</b>	O-ring silicone thickness 2mm ID ø 54mm Qty 1 pcs		
<b>For models:</b>	745002		

<b>GEV No.</b>	371095	<b>Ref. No.</b>	WY12305
<b>description</b>	O-ring Viton thickness 1.78mm ID ø 6.07mm Qty 1 pcs		
<b>For models:</b>	742001, 742002, 742003, 742004, 742005, 742017, 742018, 742019, 742020		

<b>GEV No.</b>	514017	<b>Ref. No.</b>	1814400 MA1814400
<b>description</b>	O-ring silicone thickness 3.53mm ID ø 32.93mm Qty 1 pcs		
<b>For models:</b>	126101, 126103		

<b>GEV No.</b>	512506	<b>Ref. No.</b>	R70010080
<b>description</b>	O-ring Viton thickness 2mm ID ø 14mm Qty 1 pcs		
<b>For models:</b>	212018, 212020		

<b>GEV No.</b>	514021	<b>Ref. No.</b>	1814700 MA1814700
<b>description</b>	O-ring silicone thickness 3.53mm ID ø 49.21mm Qty 1 pcs		
<b>For models:</b>	126101, 126103		

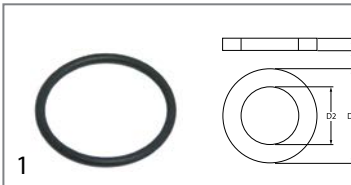

<b>GEV No.</b>	521031	<b>Ref. No.</b>	00-276903-050
<b>description</b>	O-ring Viton thickness 2mm ID ø 24mm Qty 1 pcs		
<b>For models:</b>	811011, 811012, 811013, 811014, 811015, 812011, 812012, 812013, 812014, 812015, 813003		

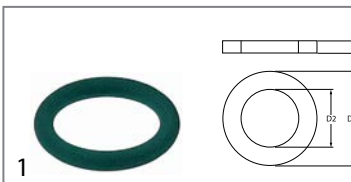

<b>GEV No.</b>	528525	<b>Ref. No.</b>	WY12024
<b>description</b>	O-ring Viton thickness 3.53mm ID ø 18.64mm Qty 1 pcs		
<b>For models:</b>	742001, 742002, 742003, 742004, 742005, 742017, 742018, 742019, 742020		

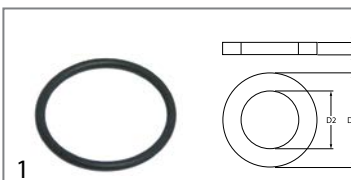

<b>GEV No.</b>	521032	<b>Ref. No.</b>	00-276903-056
<b>description</b>	O-ring Viton thickness 3mm ID ø 25mm Qty 1 pcs		
<b>For models:</b>	813002, 813003, 813004		

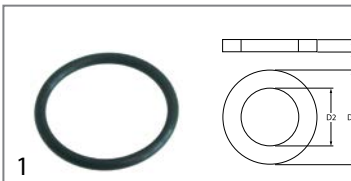

<b>GEV No.</b>	521030	<b>Ref. No.</b>	01-240135-011
<b>description</b>	O-ring Viton thickness 5.34mm ID ø 47mm Qty 1 pcs		
<b>For models:</b>	811011, 811012, 811013, 811014, 811015, 812011, 812012, 812013, 812014, 812015, 813002, 813003, 813004		

**NBR**



<b>GEV No.</b>	532692	<b>Ref. No.</b>	0065786
<b>description</b>	O-ring NBR thickness 1.5mm ID ø 52mm		

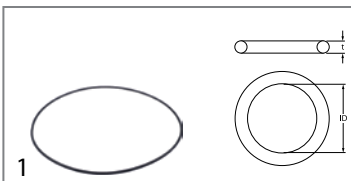

<b>GEV No.</b>	532609	<b>Ref. No.</b>	3151750
<b>description</b>	O-ring NBR thickness 7mm ID ø 387mm Qty 1 pcs		
<b>For models:</b>	451003, 451004		

sealing washers

fibre gaskets



<b>GEV No.</b>	529349	<b>Ref. No.</b>	437030
<b>description</b>	flat gasket FIBER ED ø 22mm ID ø 16.5mm thickness 2mm for thread 3/8" Qty 1 pcs		
<b>For models:</b>	812001, 812002, 812005, 812007, 812009, 915234, 915235, 915236, 915237, 915460		

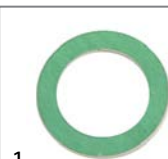

<b>GEV No.</b>	510996	<b>Ref. No.</b>	460502
<b>description</b>	flat gasket FIBER ED ø 31mm ID ø 21.5mm thickness 2mm for thread 1/2" Qty 1 pcs		
<b>For models:</b>	SP2-12, SP2-S12, SP3		



<b>GEV No.</b>	506232	<b>Ref. No.</b>	460535
<b>description</b>	flat gasket fibre ED ø 12.7mm ID ø 6.3mm thickness 2.3mm Qty 1 pcs		
<b>For models:</b>	SP1, SP2-12, SP2-S12		



<b>GEV No.</b>	521110	<b>Ref. No.</b>	460527
<b>description</b>	flat gasket fibre ED ø 20mm ID ø 13mm thickness 2mm Qty 1 pcs		
<b>For models:</b>	SP1		



<b>GEV No.</b>	510404	<b>Ref. No.</b>	6A022280
<b>description</b>	flat gasket fibre ED ø 44mm ID ø 34mm thickness 2mm Qty 1 pcs		

rubber gaskets

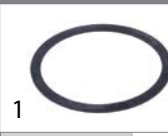



<b>GEV No.</b>	517403	<b>Ref. No.</b>	00-172986-035
<b>description</b>	flat gasket EPDM ED ø 71mm ID ø 61mm thickness 1.5mm Qty 1 pcs		
<b>For models:</b>	813002, 813003, 813004		



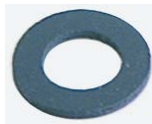

			
1			
<b>GEV No.</b>	510761	<b>Ref. No.</b>	200944
<b>description</b>	flat gasket rubber D1 ø 38mm D2 ø 25mm thickness 2mm Qty 1 pcs		
<b>For models:</b>	SP1, SP2-12, SP2-S12		

			
1			
<b>GEV No.</b>	510886	<b>Ref. No.</b>	200467
<b>description</b>	flat gasket rubber ED ø 21mm ID ø 11.5mm thickness 2mm Qty 1 pcs		
<b>For models:</b>	SP1, SP2-12, SP2-S12		

			
1			
<b>GEV No.</b>	519547	<b>Ref. No.</b>	437041
<b>description</b>	flat gasket rubber ED ø 14.4mm ID ø 15.5mm thickness 2mm Qty 1 pcs size 3/4"		
<b>For models:</b>	811003, 812001, 812002, 812003, 812004, 812005, 812006, 812007, 812008, 812009, 812010, 915234, 915235, 915236, 915237, 915460, 915461, 915462, 915463, 915464, 915465		

			
1			
<b>GEV No.</b>	510075	<b>Ref. No.</b>	437019
<b>description</b>	flat gasket rubber ED ø 22mm ID ø 13mm thickness 1.5mm Qty 1 pcs		
<b>For models:</b>	811001, 811002, 811003, 812001, 812002, 812003, 812004, 812005, 812006, 812007, 812008, 812009, 812010, 915234, 915235, 915236, 915237, 915460, 915461, 915462, 915463, 915464, 915465		

			
1			
<b>GEV No.</b>	528308	<b>Ref. No.</b>	WY12203
<b>description</b>	flat gasket rubber ED ø 15mm ID ø 4mm thickness 4mm Qty 1 pcs		
<b>For models:</b>	742001, 742002, 742003, 742004, 742005		

			
1			
<b>GEV No.</b>	520054 <sup>1</sup>	<b>Ref. No.</b>	200416
<b>description</b>	flat gasket rubber ED ø 23.5mm ID ø 14mm thickness 2.3mm Qty 10 pcs		
<b>For models:</b>	SP1, SP2-12, SP2-S12, SP3		

			
1			
<b>GEV No.</b>	512376	<b>Ref. No.</b>	200870
<b>description</b>	flat gasket rubber ED ø 18mm ID ø 10mm thickness 2mm Qty 1 pcs		
<b>For models:</b>	SP3		

<sup>1</sup>Qty 10 pieces

			
1			
<b>GEV No.</b>	511283	<b>Ref. No.</b>	200927
<b>description</b>	flat gasket rubber ED ø 30mm ID ø 20mm thickness 2mm Qty 1 pcs		
<b>For models:</b>	SP3		

			
1			
<b>GEV No.</b>	510877	<b>Ref. No.</b>	200415
<b>description</b>	flat gasket rubber ED ø 18mm ID ø 10mm thickness 3mm Qty 1 pcs		
<b>For models:</b>	SP1, SP2-12, SP2-S12		

			
1			
<b>GEV No.</b>	518240	<b>Ref. No.</b>	437078
<b>description</b>	flat gasket rubber ED ø 33mm ID ø 17mm thickness 1.5mm Qty 1 pcs		
<b>For models:</b>	811001, 811002, 811003		

			
1			
<b>GEV No.</b>	510989	<b>Ref. No.</b>	160811
<b>description</b>	flat gasket rubber ED ø 18mm ID ø 8.5mm thickness 1mm Qty 1 pcs		
<b>For models:</b>	SP3		

			
1			
<b>GEV No.</b>	510876	<b>Ref. No.</b>	200412
<b>description</b>	flat gasket rubber ED ø 45mm ID ø 33mm thickness 3mm Qty 1 pcs		
<b>For models:</b>	SP3		

			
1			
<b>GEV No.</b>	513059	<b>Ref. No.</b>	437063
<b>description</b>	flat gasket rubber ED ø 52mm ID ø 40mm thickness 3mm Qty 1 pcs		
<b>For models:</b>	812001, 812002, 812003, 812004, 812005, 812006, 812007, 812008, 812009, 812010, 915234, 915235, 915236, 915237, 915460, 915461, 915462, 915463, 915464, 915465		

			
1			
<b>GEV No.</b>	518205	<b>Ref. No.</b>	437079 80182
<b>description</b>	flat gasket rubber ED ø 61mm ID ø 47mm thickness 2mm Qty 1 pcs		
<b>For models:</b>	811003, 813001		

			
1			
<b>GEV No.</b>	510071	<b>Ref. No.</b>	437034
<b>description</b>	flat gasket rubber ED ø 81mm ID ø 68mm thickness 3mm for salt tank Qty 1 pcs		
<b>For models:</b>	811003, 812008, 812010, 915234, 915235, 915236, 915237, 915462, 915465		

			
1			
<b>GEV No.</b>	510947	<b>Ref. No.</b>	200489
<b>description</b>	flat gasket rubber ED ø 85mm ID ø 73mm thickness 2mm Qty 1 pcs equiv. no. 200489 suitable for COMENDA		
<b>For models:</b>	SP1		

			
1			
<b>GEV No.</b>	507495	<b>Ref. No.</b>	00-775305-001
<b>description</b>	gasket ED ø 34mm ID ø 25.5mm thickness 2.5mm Qty 1 pcs		
<b>For models:</b>	811011, 811012, 811013, 811014, 811015, 812011, 812012, 812013, 812014, 812015, 813002, 813003, 813004		

			
1			
<b>GEV No.</b>	518060	<b>Ref. No.</b>	456040
<b>description</b>	gasket rubber ED ø 132mm ID ø 122mm thickness 5mm		
<b>For models:</b>	813001		

			
1			
<b>GEV No.</b>	511158	<b>Ref. No.</b>	200482
<b>description</b>	gasket rubber ED ø 50mm ID ø 35mm thickness 4mm Qty 1 pcs		
<b>For models:</b>	SP3		

			
1			
<b>GEV No.</b>	527163	<b>Ref. No.</b>	WY28360004
<b>description</b>	suppressor rubber ED ø 16mm ID ø 10.5mm thickness 5mm Qty 1 pcs		
<b>For models:</b>	744001, 744002		

plastic gaskets

			
1			
<b>GEV No.</b>	510839	<b>Ref. No.</b>	160804
<b>description</b>	gasket plastic ED ø 13mm ID ø 6.5mm thickness 4mm Qty 1 pcs		
<b>For models:</b>	SP3		

			
1			
<b>GEV No.</b>	510840	<b>Ref. No.</b>	160805
<b>description</b>	gasket plastic ED ø 16mm ID ø 8.5mm thickness 4mm Qty 1 pcs		
<b>For models:</b>	SP2-12, SP2-S12, SP3		

			
1			
<b>GEV No.</b>	695538	<b>Ref. No.</b>	13007
<b>description</b>	gasket plastic ED ø 40mm ID ø 30mm thickness 2mm Qty 1 pcs		
<b>For models:</b>	711001, 711002, 711003, 711004, 711005, 711006, 711007, 711008, 711009, 711010, 711011, 711012, 711013, 711014, 711015, 711016, 711017, 711018, 711019		





copper gaskets			
DIN-7603-A			
			
1			
<b>GEV No.</b>	528660	<b>Ref. No.</b>	WY12154
<b>description</b>	flat gasket copper ED ø 21mm ID ø 17mm thickness 1.5mm suitable for 3/8"		
<b>For models:</b>	742001, 742002, 742003, 742004, 742005, 742017, 742018, 742019, 742020		

			
1			
<b>GEV No.</b>	527161	<b>Ref. No.</b>	WY12158
<b>description</b>	flat gasket copper ED ø 25.8mm ID ø 20.4mm thickness 2mm		
<b>For models:</b>	742001, 742002, 742003, 742004, 742005		

			
1			
<b>GEV No.</b>	527157	<b>Ref. No.</b>	WY12150
<b>description</b>	flat gasket copper ED ø 25mm ID ø 18mm thickness 2mm		
<b>For models:</b>	742001, 742002, 742003, 742004		

DIN-7603-C			
			
1			
<b>GEV No.</b>	527164	<b>Ref. No.</b>	WY12101
<b>description</b>	gasket copper ED ø 23mm ID ø 17mm thickness 3mm for thread 3/8"		
<b>For models:</b>	742001, 742002, 742003, 742004, 742005, 742017, 742018, 742019, 742020		

			
1			
<b>GEV No.</b>	527167	<b>Ref. No.</b>	WY12103
<b>description</b>	gasket copper ED ø 9.8mm ID ø 6.5mm thickness 1.7mm		
<b>For models:</b>	742001, 742002, 742003, 742004, 742005, 742017, 742018, 742019, 742020		

PTFE gaskets			
			
1			
<b>GEV No.</b>	510012	<b>Ref. No.</b>	437008
<b>description</b>	flat gasket PTFE ED ø 16.5mm ID ø 12.5mm thickness 1.5mm Qty 1 pcs equiv. no. 437008		
<b>For models:</b>	811001, 811002, 811003		

			
1			
<b>GEV No.</b>	528314	<b>Ref. No.</b>	WY12010
<b>description</b>	flat gasket PTFE ED ø 20mm ID ø 17mm thickness 2mm Qty 1 pcs suitable for Astoria/Azkoyen/Espresso/Wega		
<b>For models:</b>	742001, 742002, 742003, 742004, 742005		

			
1			
<b>GEV No.</b>	513725	<b>Ref. No.</b>	437100
<b>description</b>	flat gasket PTFE ED ø 21.2mm ID ø 19mm thickness 0.5mm Qty 1 pcs		
<b>For models:</b>	812001, 812002, 812003, 812004, 812005, 812006, 812007, 812008, 812009, 812010, 915234, 915235, 915236, 915237, 915460, 915461, 915462, 915463, 915464, 915465		

			
1			
<b>GEV No.</b>	527154	<b>Ref. No.</b>	WY12025
<b>description</b>	flat gasket PTFE ED ø 22mm ID ø 16.8mm thickness 2mm Qty 1 pcs		
<b>For models:</b>	742001, 742002, 742003, 742004, 742005, 742017, 742018, 742019, 742020		

			
1			
<b>GEV No.</b>	527162	<b>Ref. No.</b>	WY12023
<b>description</b>	flat gasket PTFE ED ø 36mm ID ø 30mm thickness 3mm Qty 1 pcs		
<b>For models:</b>	742001, 742002, 742003, 742004, 742005, 742017, 742018, 742019, 742020		



			
1			
<b>GEV No.</b>	518180	<b>Ref. No.</b>	303018
<b>description</b>	flat gasket PTFE ED ø 40mm ID ø 35mm thickness 3mm Qty 1 pcs equiv. no. 303018/371450-166 suitable for COLGED, HOBART		
<b>For models:</b>	811001, 811002, 811003		

			
1			
<b>GEV No.</b>	514016	<b>Ref. No.</b>	1814500 MA1814500
<b>description</b>	flat gasket PTFE ED ø 45mm ID ø 40mm thickness 4mm Qty 1 pcs equiv. no. 1036500400/1814500 suitable for MARENO		
<b>For models:</b>	126101, 126103		

			
1			
<b>GEV No.</b>	527156	<b>Ref. No.</b>	WY12001
<b>description</b>	flat gasket PTFE ED ø 57.8mm ID ø 43.3mm thickness 2mm Qty 1 pcs		
<b>For models:</b>	742001, 742002, 742003, 742004, 742005, 742017, 742018, 742019, 742020		

			
1			
<b>GEV No.</b>	695534	<b>Ref. No.</b>	13143
<b>description</b>	gasket silicone ED ø 36mm ID ø 23.5mm thickness 3mm Qty 1 pcs		
<b>For models:</b>	711004, 711005, 711006, 711007, 711008, 711009, 711010, 711011, 711012, 711013, 711014, 711015, 711016, 711017, 711018, 711019		

			
1			
<b>GEV No.</b>	518119	<b>Ref. No.</b>	00-774072-001
<b>description</b>	slide ring PTFE ED ø 19mm ID ø 14.5mm thickness 0.5mm for rinse arm Qty 1 pcs suitable for HOBART		
<b>For models:</b>	811011, 811012, 811013, 811014, 811015, 812011, 812012, 812013, 812014, 812015, 813002, 813003, 813004		

			
1			
<b>GEV No.</b>	695537	<b>Ref. No.</b>	13006
<b>description</b>	gasket silicone ED ø 40mm ID ø 30mm thickness 2mm Qty 1 pcs		
<b>For models:</b>	711001, 711002, 711003, 711004, 711005, 711006, 711007, 711008, 711009, 711010, 711011, 711012, 711013, 711014, 711015, 711016, 711017, 711018, 711019		
<b>accessories for</b>	695537		
	<b>GEV No.</b>	695059	<b>Ref. No.</b> 10007
hose connector for ice-cube maker			

			
1			
<b>GEV No.</b>	518120	<b>Ref. No.</b>	00-774072-002
<b>description</b>	slide ring PTFE ED ø 21mm ID ø 16mm thickness 0.5mm for rinse arm Qty 1 pcs		
<b>For models:</b>	811011, 811012, 811013, 811014, 811015, 812011, 812012, 812013, 812014, 812015, 813002, 813003, 813004		

			
1			
<b>GEV No.</b>	696076	<b>Ref. No.</b>	IB4100915
<b>description</b>	gasket silicone ED ø 68mm ID ø 48mm thickness 2mm Qty 1 pcs		
<b>For models:</b>	721004		

			
1			
<b>GEV No.</b>	511678	<b>Ref. No.</b>	00-774072-007
<b>description</b>	slide ring PTFE ED ø 24mm ID ø 13mm thickness 1mm for rinse arm Qty 1 pcs		
<b>For models:</b>	811011, 811012, 811013, 811014, 811015, 812011, 812012, 812013, 812014, 812015, 813002, 813003, 813004		

foam rubber gaskets

silicone gaskets			
			
1			
<b>GEV No.</b>	691332	<b>Ref. No.</b>	2993700 MA2993700
<b>description</b>	flat gasket silicone ED ø 13.8mm ID ø 6mm thickness 1.5mm Qty 1 pcs		
<b>For models:</b>	123118, 123119, 126101, 126103, 144001		

			
1			
<b>GEV No.</b>	691329	<b>Ref. No.</b>	1036607700 MA1036607700
<b>description</b>	foam rubber gasket W 10mm thickness 5mm self-adhesive Qty supplied by meter		
<b>For models:</b>	124101, 124102		

			
1			
<b>GEV No.</b>	651007	<b>Ref. No.</b>	CO1402
<b>description</b>	gasket ED ø 75mm ID ø 55mm thickness 3mm Qty 1 pcs		
<b>For models:</b>	721008		

			
1			
<b>GEV No.</b>	505302	<b>Ref. No.</b>	200925
<b>description</b>	foam rubber gasket W 20mm thickness 1.5mm self-adhesive Qty 1m		
<b>For models:</b>	SP3		





			
1			
<b>GEV No.</b>	505303	<b>Ref. No.</b>	200957
<b>description</b>	foam rubber gasket W 28mm thickness 2.7mm self-adhesive Qty 640mm punched		
<b>For models:</b>	SP3		

			
1			
<b>GEV No.</b>	510881	<b>Ref. No.</b>	200433
<b>description</b>	foam rubber gasket W 6mm thickness 2.5mm self-adhesive Qty 1m		
<b>For models:</b>	SP1		

			
1			
<b>GEV No.</b>	693787	<b>Ref. No.</b>	0320100
<b>description</b>	foam rubber gasket ø 6mm Qty supplied by meter		
<b>For models:</b>	442003, 442004		

			
1			
<b>GEV No.</b>	692067	<b>Ref. No.</b>	0065068
<b>description</b>	V-ring ID ø 45mm ED ø 55mm thickness 9mm		

			
1			
<b>GEV No.</b>	697409	<b>Ref. No.</b>	SL0772
<b>description</b>	V-ring ID ø 7mm ED ø 12mm thickness 5mm		
<b>For models:</b>	451003, 451004, 473006, 473007, 473008		

			
1			
<b>GEV No.</b>	696075	<b>Ref. No.</b>	IB4104031
<b>description</b>	V-ring ID ø 8mm thickness 5mm		
<b>For models:</b>	721003		

### sealing cords

#### square

			
1			
<b>GEV No.</b>	693739	<b>Ref. No.</b>	825110080
<b>description</b>	sealing cord square size 12x12mm t.max. 550°C braided L 5m		
<b>For models:</b>	133001, 133002, 133003, 133004, 133005, 133006, 133009, 133010, 133011, 133012, 133013, 133014, 133015, 133016, 133017, 133018, 133019, 133020, 133021, 133024, 133203, 133209, 133210, 133211, 133212, 133213, 133214, 133215, 137001, 137002, 137003, 137004, 137201, 137202		

### shaft gaskets

#### v-rings

			
1			
<b>GEV No.</b>	696559	<b>Ref. No.</b>	0065063
<b>description</b>	V-ring for shaft ø 32mm ID ø 31mm ED ø 39mm thickness 7mm		

### shaft gaskets

			
1			
<b>GEV No.</b>	527291	<b>Ref. No.</b>	20.19.22
<b>description</b>	shaft seal ID ø 11mm ED ø 22mm thickness 8mm for milk foamer		
<b>For models:</b>	745002		

			
1			
<b>GEV No.</b>	511171	<b>Ref. No.</b>	R70020040
<b>description</b>	shaft seal ID ø 14.5mm ED ø 20mm thickness 3mm		
<b>For models:</b>	212002, 212010, 212011		

			
1			
<b>GEV No.</b>	698211	<b>Ref. No.</b>	IB4104010
<b>description</b>	shaft seal ID ø 15mm ED ø 24mm thickness 5mm		
<b>For models:</b>	470003		



1

<b>GEV No.</b>	516246	<b>Ref. No.</b>	50IAA71178
<b>description</b>	shaft seal ID ø 17mm ED ø 35mm thickness 7mm		
<b>For models:</b>	481003, 481005		



1

<b>GEV No.</b>	697121	<b>Ref. No.</b>	SL0127
<b>description</b>	shaft seal ID ø 17mm ED ø 40mm thickness 7mm		
<b>For models:</b>	421006, 421007, 421008, 422005, 422006, 433003, 433004, 433005, 471003, 471004		



1

<b>GEV No.</b>	698002	<b>Ref. No.</b>	MF2101 SL0139
<b>description</b>	shaft seal ID ø 25mm ED ø 40mm thickness 7mm		
<b>For models:</b>	421001, 421006, 422001, 433001, 433002, 433003		



1

<b>GEV No.</b>	698352	<b>Ref. No.</b>	3151300 SL3943
<b>description</b>	shaft seal ID ø 28mm ED ø 42mm thickness 7mm		
<b>For models:</b>	451003, 451004		



1

<b>GEV No.</b>	697913	<b>Ref. No.</b>	SL0746
<b>description</b>	shaft seal ID ø 8mm ED ø 18mm thickness 5mm		
<b>For models:</b>	473006, 473007, 473008		



1

<b>GEV No.</b>	697407	<b>Ref. No.</b>	SL1454
<b>description</b>	shaft seal ID ø 8mm ED ø 18mm thickness 6mm		
<b>For models:</b>	473006, 473007, 473008		



1

<b>GEV No.</b>	511172	<b>Ref. No.</b>	R70020050
<b>description</b>	shaft sealing ID ø 24mm ED ø 29mm thickness 3mm		
<b>For models:</b>	212003, 212012, 212013		

special gaskets

for combi-steamers



1

<b>GEV No.</b>	699247	<b>Ref. No.</b>	R70045120
<b>description</b>	gasket set for combi-steamer		
<b>For models:</b>	212010, 212011, 212012, 212013, 212018, 212020		

for vacuum packers



1

<b>GEV No.</b>	693787	<b>Ref. No.</b>	0320100
<b>description</b>	foam rubber gasket ø 6mm Qty supplied by meter		
<b>For models:</b>	442003, 442004		

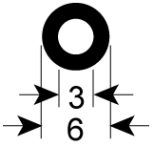

1

<b>GEV No.</b>	570200	<b>Ref. No.</b>	0320220
<b>description</b>	gasket ø 6mm ID ø 3mm silicone for vacuum packing machine		

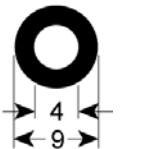

1

<b>GEV No.</b>	570201	<b>Ref. No.</b>	0320228
<b>description</b>	gasket ø 9mm ID ø 4mm silicone Qty supplied by meter for vacuum packing machine		

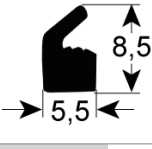

1

<b>GEV No.</b>	900809	<b>Ref. No.</b>	0320215
<b>description</b>	lid gasket W 5.5mm H 9mm silicone Qty supplied by meter for vacuum packing machine		
<b>For models:</b>	442007, 442008		



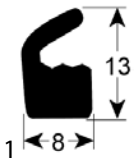

			
<b>GEV No.</b>	900807	<b>Ref. No.</b>	0320210
<b>description</b>	lid gasket W 8mm H 13mm silicone Qty supplied by meter for vacuum packing machine		
<b>For models:</b>	442006		

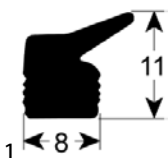
			
<b>GEV No.</b>	900808	<b>Ref. No.</b>	0320212
<b>description</b>	lid gasket W 8mm H 11mm silicone supplied by meter for vacuum packing machine		

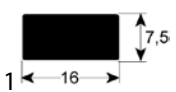
			
<b>GEV No.</b>	900806	<b>Ref. No.</b>	0320200 0320201 0320202
<b>description</b>	gasket W 16mm H 7.5mm silicone Qty supplied by meter for vacuum packing machine		
<b>For models:</b>	442003, 442004, 442005, 442006, 442007, 442008, 442010		

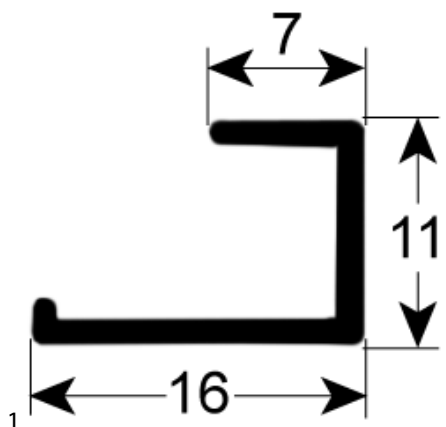
			
<b>GEV No.</b>	518248	<b>Ref. No.</b>	437058
<b>description</b>	door seal L 430mm dishwasher suitable for ELETTRORBAR, WOLK equiv. no. 437058		
<b>For models:</b>	811003		

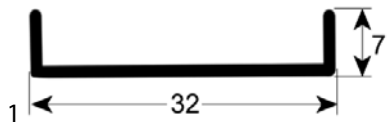
			
<b>GEV No.</b>	518536	<b>Ref. No.</b>	437081
<b>description</b>	door seal L 590mm W 32mm dishwasher suitable for ELETTRORBAR, WOLK equiv. no. 437052		
<b>For models:</b>	812001, 812002, 812003, 812004, 812005, 812006, 812007, 812008, 812009, 812010, 915234, 915235, 915236, 915237, 915460, 915461, 915462, 915463, 915464, 915465		

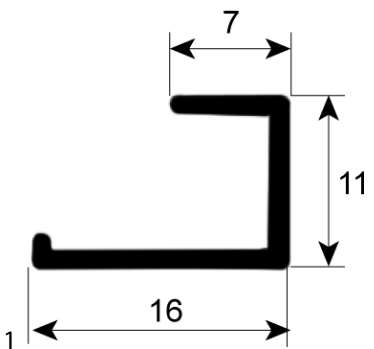
<p>door seals for dishwashers</p> 			
<b>GEV No.</b>	518246	<b>Ref. No.</b>	437057
<b>description</b>	door seal L 395mm dishwasher suitable for ELETTRORBAR, WOLK equiv. no. 437057		
<b>For models:</b>	811001, 811002		

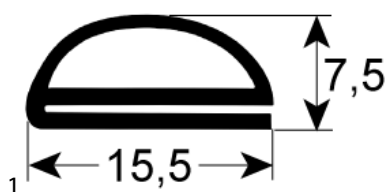
			
<b>GEV No.</b>	511577	<b>Ref. No.</b>	200217
<b>description</b>	door seal L 595mm W 15.5mm H 7mm Qty 1 suitable for COMENDA		
<b>For models:</b>	SP2-12, SP2-S12		

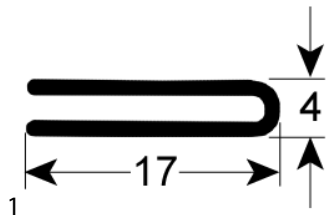
			
<b>GEV No.</b>	511390	<b>Ref. No.</b>	200215
<b>description</b>	door seal L 930mm dishwasher suitable for COMENDA equiv. no. 200215		
<b>For models:</b>	SP1		

			
1			
<b>GEV No.</b>	510881	<b>Ref. No.</b>	200433
<b>description</b>	foam rubber gasket W 6mm thickness 2.5mm self-adhesive Qty 1m		
<b>For models:</b>	SP1		

miscellaneous

			
1			
<b>GEV No.</b>	511939	<b>Ref. No.</b>	GN1240A0
<b>description</b>	gasket external weith 9mm UNOX silicone		
<b>For models:</b>	211001		

			
1			
<b>GEV No.</b>	532527	<b>Ref. No.</b>	11127
<b>description</b>	gasket foam seal silicone		
<b>For models:</b>	741001, 741003		

			
1			
<b>GEV No.</b>	527363	<b>Ref. No.</b>	92.16.11
<b>description</b>	gasket for milk foamer L 540mm		
<b>For models:</b>	745001		

			
1			
<b>GEV No.</b>	527362	<b>Ref. No.</b>	90.18.11
<b>description</b>	gasket for milk foamer L 930mm		
<b>For models:</b>	745002		

			
1			
<b>GEV No.</b>	527272	<b>Ref. No.</b>	20.19.15
<b>description</b>	gasket for milk foamer V-shape ID ø 9mm ED ø 15mm H 7mm		
<b>For models:</b>	745002		

			
1			
<b>GEV No.</b>	510847	<b>Ref. No.</b>	440405
<b>description</b>	gasket polishing agent dosing ID ø 22mm ED ø 32mm external hight 5mm		
<b>For models:</b>	SP1, SP2-12, SP2-S12, SP3		

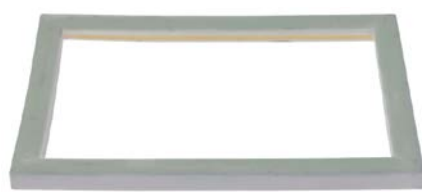
			
1			
<b>GEV No.</b>	901523	<b>Ref. No.</b>	37Q7860
<b>description</b>	gasket suitable for FIMAR for potato peeler device L 204mm W 155mm external hight 12mm		
<b>For models:</b>	451003, 451004		

			
1			
<b>GEV No.</b>	901522	<b>Ref. No.</b>	SL2871
<b>description</b>	lid gasket suitable for FIMAR for potato peeler device L 1280mm external hight 12mm external weith 12mm		
<b>For models:</b>	451003, 451004		

			
1			
<b>GEV No.</b>	901400	<b>Ref. No.</b>	GUARN003
<b>description</b>	window gasket suitable for GGF L 416mm external weith 113mm Qty 1m thickness 2.5mm		
<b>For models:</b>	530009, 530010, 530011, 530012, 531020, 531021, 531022, 531023		



thermostat gaskets

			
1			
<b>GEV No.</b>	512154	<b>Ref. No.</b>	200494
<b>description</b>	gasket for thermostat ID ø 20mm equiv. no. 200494/H200494 hole distance 41mm suitable for COMENDA, HOONVED		
<b>For models:</b>	SP1		

gaskets for wash arm support

			
1			
<b>GEV No.</b>	518025	<b>Ref. No.</b>	437014
<b>description</b>	gasket D1 ø 50mm D2 ø 82mm thickness 2mm with 6 holes wash arm support equiv. no. 437014 suitable for COLGED		
<b>For models:</b>	812001, 812002, 812003, 812004, 812005, 812006, 812007, 812008, 812009, 812010, 915234, 915235, 915236, 915237, 915460, 915461, 915462, 915463, 915464, 915465		

			
1			
<b>GEV No.</b>	518339	<b>Ref. No.</b>	437064
<b>description</b>	gasket D2 ø 50mm thickness 2mm with 3 screw holes wash arm support equiv. no. 437064 suitable for COLGED hole ø 50mm hole distance 67mm		
<b>For models:</b>	812001, 812002, 812003, 812004, 812005, 812006, 812007, 812008, 812009, 812010, 915234, 915235, 915236, 915237, 915460, 915461, 915462, 915463, 915464, 915465		

refrigeration cycle components

valves

Schrader valves

Schrader valves (complete)

			
1			
<b>GEV No.</b>	750101	<b>Ref. No.</b>	S900.42
<b>description</b>	Schrader valve complete connection 1/4" SAE L 130mm		
<b>For models:</b>	611007		

valve bodies

			
1			
<b>GEV No.</b>	750097	<b>Ref. No.</b>	14007
<b>description</b>	valve body for Schrader valve thread 1/4" SAE connection 6mm soldering connection		
<b>For models:</b>	711001, 711002, 711003, 711004, 711005, 711006, 711007, 711008, 711009, 711010, 711011, 711012, 711013, 711014, 711015, 711016, 711017, 711018, 711019		

valve inserts

			
1			
<b>GEV No.</b>	750098	<b>Ref. No.</b>	14005
<b>description</b>	Schrader valve CASTEL 8394/B R22		
<b>For models:</b>	711001, 711002, 711003, 711004, 711005, 711006, 711007, 711008, 711009, 711010, 711011, 711012, 711013, 711014, 711015, 711016, 711017, 711018, 711019		

filter driers

CASTEL

STANDARD series

suitable for refrigerants R12, R22, R134a, R404A, R407C, R410A, R502, R507

			
1			
<b>GEV No.</b>	750038	<b>Ref. No.</b>	14089
<b>description</b>	dryer type 4303/2S connection ODS 1/4"-ODM 3/8" 50cm <sup>3</sup> p max 45bar -40 up to +80°C		
<b>For models:</b>	711014, 711015, 711016, 711017, 711018, 711019		

miscellaneous



1

<b>GEV No.</b>	750165	<b>Ref. No.</b>	5942032 5942034 5942036
<b>description</b>	dryer size 10g ø 16mm L 125mm connection 2,1/4,9mm		
<b>For models:</b>	621014, 621015, 622009, 622012, 622013, 622014, 622018, 622019, 625010, 625011, 625012, 625013, 629001, 668006, 668009, 668010		



2

<b>GEV No.</b>	750075	<b>Ref. No.</b>	14009
<b>description</b>	dryer size 12g ø 16mm L 120mm connection 3/6,3mm		
<b>For models:</b>	711001, 711002, 711003, 711004, 711005, 711006, 711007, 711008, 711009, 711010, 711011, 711012, 711013		



1

<b>GEV No.</b>	750618	<b>Ref. No.</b>	GN1410TN.14
<b>description</b>	dryer size 15g ø 19mm L 114mm connection 2,7/6,5mm type XH9 Qty 1 pcs		
<b>For models:</b>	621018		



1

<b>GEV No.</b>	750254	<b>Ref. No.</b>	880409800
<b>description</b>	dryer size 20g ø 19mm L 138mm connection 2,5/6,2mm		
<b>For models:</b>	641001, 641002, 641003, 641004, 641005, 641006, 641007, 641008, 641009, 641010, 641011, 641012, 641014, 641015, 641016		



1

<b>GEV No.</b>	750324	<b>Ref. No.</b>	RC0066 S900.44
<b>description</b>	dryer size 20g ø 23mm L 117mm connection 4,8/8,3mm		
<b>For models:</b>	272008, 611007, 611008, 611009, 611010, 611011, 611013, 611014, 611023, 613016, 613017, 625017, 625018, 634001, 634002, 634003		



1

<b>GEV No.</b>	750255	<b>Ref. No.</b>	880410000
<b>description</b>	dryer size 40g ø 24mm L 170mm connection 6,6/6,6mm		
<b>For models:</b>	641013, 641017, 644010, 644011, 644012		

refrigeration pipes

capillary pipes



1

<b>GEV No.</b>	694442	<b>Ref. No.</b>	S900.43
<b>description</b>	capillary pipe ID ø 1.15mm copper Qty 1m L 300mm refrigeration ED ø 2.1mm		
<b>For models:</b>	611007, 611008, 611009, 611010, 611011, 611013, 611014, 613016, 613017, 621018, 625002, 625003		

copper pipes uninsulated



1

<b>GEV No.</b>	694452	<b>Ref. No.</b>	GN2100TN.09
<b>description</b>	refrigeration pipe copper ED ø 6mm L 0.5m Qty 1m for evaporator		
<b>For models:</b>	611013, 611014, 613016, 613017		



 <p>Image not available</p>			
1			
<b>GEV No.</b>	694441	<b>Ref. No.</b>	GN650TN.40
<b>description</b>	refrigeration pipe insulated copper ID ø 7mm ED ø 8mm L 1.8m suction line		
<b>For models:</b>	621018, 621019		

			
1			
<b>GEV No.</b>	750147	<b>Ref. No.</b>	5940997
<b>description</b>	evaporator for fridge FKS 5000 L 850mm W 575mm type FKS5000/02 LIEBHERR		

## evaporators

### for fridges

#### producer-specific

			
1			
<b>GEV No.</b>	750300	<b>Ref. No.</b>	HF600.17 RC0589
<b>description</b>	condenser L 170mm W 85mm H 180mm suitable for ER600		
<b>For models:</b>	621047, 622028, 622036, 622039		

			
1			
<b>GEV No.</b>	750146	<b>Ref. No.</b>	5940757
<b>description</b>	evaporator for fridge FKV 4310 L 1000mm W 460mm type FKDV 3712-20 A LIEBHERR		
<b>For models:</b>	621015, 622019		

			
1			
<b>GEV No.</b>	750294	<b>Ref. No.</b>	RC0605
<b>description</b>	evaporator for fridge ER400 L 1000mm W 440mm		
<b>For models:</b>	621026, 621046, 621049		

			
1			
<b>GEV No.</b>	750148	<b>Ref. No.</b>	5940995
<b>description</b>	evaporator for fridge UKS 1800 L 430mm W 460mm LIEBHERR		
<b>For models:</b>	629001		

			
1			
<b>GEV No.</b>	750295	<b>Ref. No.</b>	HR600.04 RC0606
<b>description</b>	evaporator for fridge ER600 L 1000mm W 580mm		
<b>For models:</b>	621029, 621030, 621031, 621032, 621033, 621034, 621035, 621036, 621047, 621050, 622026, 622027, 622036		

			
1			
<b>GEV No.</b>	750410	<b>Ref. No.</b>	GN650TN.21
<b>description</b>	evaporator L 216mm W 130mm H 200mm total length 298mm overall width 130mm overall height 220mm		
<b>For models:</b>	621019		

			
1			
<b>GEV No.</b>	750104	<b>Ref. No.</b>	14330570134
<b>description</b>	evaporator L 410mm W 120mm H 490mm complete with fan		
<b>For models:</b>	201780, 621007, 622005		



1

<b>GEV No.</b>	750103	<b>Ref. No.</b>	14330570135
<b>description</b>	evaporator L 410mm W 120mm H 490mm IN 53W / OUT 10W complete with fan		
<b>For models:</b>	621007, 622005		



1

<b>GEV No.</b>	750200	<b>Ref. No.</b>	D10045
<b>description</b>	evaporator for ice-cube maker 24 cubes L 320mm W 190mm H 40mm		
<b>For models:</b>	711004, 711005, 711006, 711007		



1

<b>GEV No.</b>	750366	<b>Ref. No.</b>	BN14330540140
<b>description</b>	evaporator L 430mm W 140mm H 230mm		
<b>For models:</b>	621021, 622021		



1

<b>GEV No.</b>	750201	<b>Ref. No.</b>	D10046
<b>description</b>	evaporator for ice-cube maker 36 cubes L 440mm W 190mm H 40mm		
<b>For models:</b>	711008, 711009, 711010, 711011, 711012, 711013		

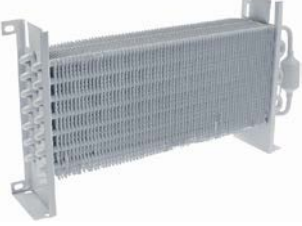

1

<b>GEV No.</b>	750322	<b>Ref. No.</b>	GN2100TN.18 GN2100TN.21
<b>description</b>	evaporator L 505mm W 95mm H 265mm suitable for ER400/ER400G/ER400SS		
<b>For models:</b>	611013, 611014, 613016, 613017		



1

<b>GEV No.</b>	750202	<b>Ref. No.</b>	D10047
<b>description</b>	evaporator for ice-cube maker 60 cubes L 665mm W 190mm H 40mm		
<b>For models:</b>	711014, 711015, 711016, 711017, 711018, 711019		

for ice-cube maker

for ice cube maker



1

<b>GEV No.</b>	750199	<b>Ref. No.</b>	D10079
<b>description</b>	evaporator for ice-cube maker 20 cubes L 225mm W 180mm H 40mm		
<b>For models:</b>	711001, 711002, 711003		

condensors

filters



1

<b>GEV No.</b>	694587	<b>Ref. No.</b>	S900.04
<b>description</b>	air filter for condenser L 218mm W 194mm thickness 6mm Qty 1 pcs		
<b>For models:</b>	611007, 611008, 611009		



1

<b>GEV No.</b>	694446	<b>Ref. No.</b>	S903.08
<b>description</b>	air filter for condenser L 218mm W 205mm thickness 6mm		
<b>For models:</b>	611010, 611011, 621018, 621019		



1

<b>GEV No.</b>	694447	<b>Ref. No.</b>	GN2100TN.34
<b>description</b>	air filter for condenser W 175mm H 228mm thickness 6mm		
<b>For models:</b>	613016, 613017		

condensors

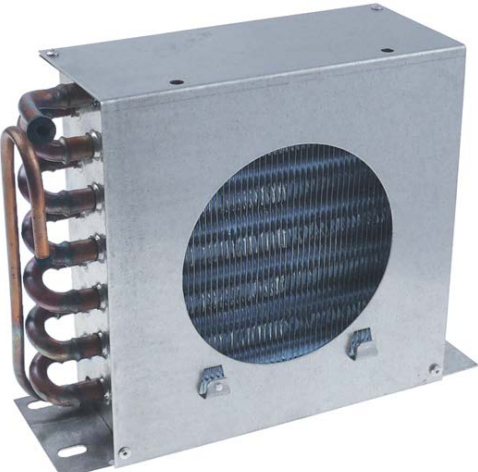

1

<b>GEV No.</b>	750319	<b>Ref. No.</b>	RC0201
<b>description</b>	condenser for pizza table W 228mm D 77mm H 179mm		
<b>For models:</b>	611023		



1

<b>GEV No.</b>	750320	<b>Ref. No.</b>	GN2100TN.08 RC0286
<b>description</b>	condenser for pizza table W 280mm D 190mm H 230mm		
<b>For models:</b>	611013, 611014, 613016, 613017, 633001, 633002		

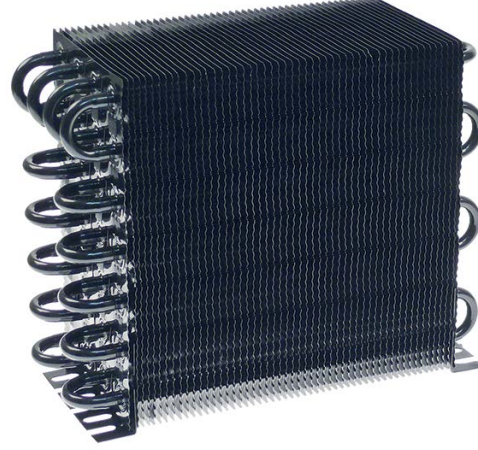

1

<b>GEV No.</b>	750661	<b>Ref. No.</b>	20019
<b>description</b>	condenser W 215mm D 270mm H 117mm Qty 1 pcs		
<b>For models:</b>	711010, 711011		

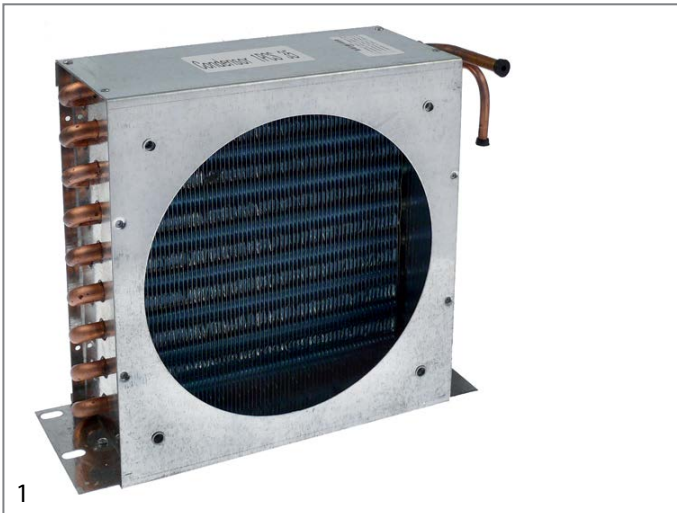

<b>GEV No.</b>	750347	<b>Ref. No.</b>	S900.35
<b>description</b>	condenser W 220mm D 100mm H 230mm L 270mm		
<b>For models:</b>	611007, 611008, 611009		

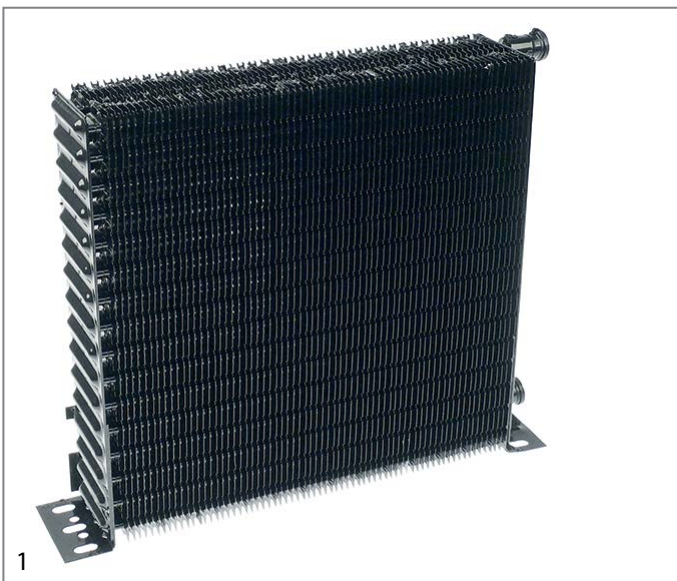

<b>GEV No.</b>	750409	<b>Ref. No.</b>	20175 20558
<b>description</b>	condenser W 260mm D 60mm H 250mm mounting distance 275mm connection ø 8mm		
<b>For models:</b>	711014, 711015		

## condensers water-cooled



<b>GEV No.</b>	750392	<b>Ref. No.</b>	14034
<b>description</b>	condenser tube ø 15mm water-cooled ø 255mm mounting distance 128mm		
<b>For models:</b>	711016, 711017, 711018, 711019		

## transmission technology and ball bearings

## ball bearings

## deep-groove ball bearings 2RS



<b>GEV No.</b>	523073	<b>Ref. No.</b>	IV73060042RS
<b>description</b>	deep-groove ball bearing shaft ø 20mm ED ø 42mm W 12mm type 6004-2RS DIN 625-1		
<b>For models:</b>	481001		

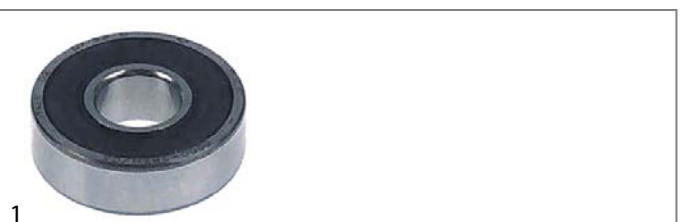

<b>GEV No.</b>	523507	<b>Ref. No.</b>	C8067
<b>description</b>	deep-groove ball bearing type 6000-2RS shaft ø 10mm ED ø 26mm W 8mm with sealing discs deep-groove ball bearing DIN 625-1		
<b>For models:</b>	411015, 411016, 411017, 411018		







			
1			
<b>GEV No.</b>	523551	<b>Ref. No.</b>	SL2473
<b>description</b>	deep-groove ball bearing type 6003-2RS shaft $\varnothing$ 17mm ED $\varnothing$ 35mm W 10mm with sealing discs deep-groove ball bearing DIN 625-1		
<b>For models:</b>	481004, 513004, 513005, 513006, 513008, 513009, 513010, 516001		

			
1			
<b>GEV No.</b>	523522	<b>Ref. No.</b>	SL0073 SL1799
<b>description</b>	deep-groove ball bearing type 6004-2RS shaft $\varnothing$ 20mm ED $\varnothing$ 42mm W 12mm with sealing discs deep-groove ball bearing DIN 625-1		
<b>For models:</b>	421005, 512013, 512014, 512015, 512016, 512017, 512018, 512019, 512020, 512021, 512022, 516001, 516002, 516003, 516004		

			
1			
<b>GEV No.</b>	523525	<b>Ref. No.</b>	19320212 19320213 SL0241
<b>description</b>	deep-groove ball bearing type 6005-2RS shaft $\varnothing$ 25mm ED $\varnothing$ 47mm W 12mm with sealing discs deep-groove ball bearing DIN 625-1		
<b>For models:</b>	512014, 512017, 512018, 512021, 512022		

			
1			
<b>GEV No.</b>	523541	<b>Ref. No.</b>	8301550
<b>description</b>	deep-groove ball bearing type 6006-2RS shaft $\varnothing$ 30mm ED $\varnothing$ 55mm W 13mm with sealing discs deep-groove ball bearing DIN 625-1		
<b>For models:</b>	512004		

			
1			
<b>GEV No.</b>	523501	<b>Ref. No.</b>	314009 IB7306082RS
<b>description</b>	deep-groove ball bearing type 608-2RS shaft $\varnothing$ 8mm ED $\varnothing$ 22mm W 7mm with sealing discs deep-groove ball bearing DIN 625-1		
<b>For models:</b>	470001, 470003, 811001, 811002, 811003		

			
1			
<b>GEV No.</b>	523509	<b>Ref. No.</b>	314001
<b>description</b>	deep-groove ball bearing type 6201-2RS shaft $\varnothing$ 12mm ED $\varnothing$ 32mm W 10mm with sealing discs deep-groove ball bearing DIN 625-1		
<b>For models:</b>	812001, 812002, 812003, 812004, 812005, 812006, 812007, 812008, 812009, 812010, 915234, 915235, 915236, 915237, 915460, 915461, 915462, 915463, 915464, 915465		

			
1			
<b>GEV No.</b>	523510	<b>Ref. No.</b>	19320201 50IBA71269 8303070 C8014 C8055
<b>description</b>	deep-groove ball bearing type 6202-2RS shaft $\varnothing$ 15mm ED $\varnothing$ 35mm W 11mm with sealing discs deep-groove ball bearing DIN 625-1		
<b>For models:</b>	411011, 411014, 431001, 481003, 481005, 512001		

			
1			
<b>GEV No.</b>	523511	<b>Ref. No.</b>	C8022 IV7300505 SL0015 SL0131
<b>description</b>	deep-groove ball bearing type 6203-2RS shaft $\varnothing$ 17mm ED $\varnothing$ 40mm W 12mm with sealing discs deep-groove ball bearing DIN 625-1		
<b>For models:</b>	272003, 272004, 272005, 273010, 273011, 273012, 279003, 411011, 411012, 411013, 411015, 411016, 411017, 411018, 411019, 421003, 421006, 421007, 421008, 422005, 422006, 431002, 433003, 433004, 433005, 511002, 511003, 511004, 512010, 512011, 512012, 512015, 512016, 512019, 512020, 516002, 516003, 516004		



1

<b>GEV No.</b>	523512	<b>Ref. No.</b>	C8024 SL2592 SL3125
<b>description</b>	deep-groove ball bearing type 6204-2RS shaft $\varnothing$ 20mm ED $\varnothing$ 47mm W 14mm with sealing discs deep-groove ball bearing DIN 625-1		
<b>For models:</b>	411014, 411016, 411017, 421007, 421008, 422005, 422006, 433004, 433005, 511001, 511003, 511004, 516002, 516003, 516004		



1

<b>GEV No.</b>	523513	<b>Ref. No.</b>	8300190 MF2171 SL0233
<b>description</b>	deep-groove ball bearing type 6205-2RS shaft $\varnothing$ 25mm ED $\varnothing$ 52mm W 15mm with sealing discs deep-groove ball bearing DIN 625-1		
<b>For models:</b>	433001, 433002, 511002, 512002, 512003, 512004, 512013, 512014, 512017, 512018, 512021, 512022		



1

<b>GEV No.</b>	523524	<b>Ref. No.</b>	SL2735
<b>description</b>	deep-groove ball bearing type 6206-2RS shaft $\varnothing$ 30mm ED $\varnothing$ 62mm W 16mm with sealing discs deep-groove ball bearing DIN 625-1		
<b>For models:</b>	511003, 511004		



1

<b>GEV No.</b>	523504	<b>Ref. No.</b>	19320101
<b>description</b>	deep-groove ball bearing type 626-2RS shaft $\varnothing$ 6mm ED $\varnothing$ 19mm W 6mm with sealing discs deep-groove ball bearing DIN 625-1		
<b>For models:</b>	411001		



1

<b>GEV No.</b>	523526	<b>Ref. No.</b>	29320101 36F0090
<b>description</b>	deep-groove ball bearing type 6302-2RS shaft $\varnothing$ 15mm ED $\varnothing$ 42mm W 13mm with sealing discs deep-groove ball bearing DIN 625-1		
<b>For models:</b>	421002, 451003, 451004		

### deep-groove ball bearings 2Z



1

<b>GEV No.</b>	523508	<b>Ref. No.</b>	5093000
<b>description</b>	deep-groove ball bearing shaft $\varnothing$ 10mm ED $\varnothing$ 30mm W 9mm type 6200-2Z DIN 625-1		



1

<b>GEV No.</b>	692000	<b>Ref. No.</b>	50IBA71268 SL2472
<b>description</b>	deep-groove ball bearing shaft $\varnothing$ 15mm ED $\varnothing$ 35mm W 11mm type 6202-2Z DIN 625-1		
<b>For models:</b>	421005, 471006, 481003, 481005, 511001, 511003, 511004, 513004, 513005, 513006, 513008, 513009, 513010		



1

<b>GEV No.</b>	523057	<b>Ref. No.</b>	C8006
<b>description</b>	deep-groove ball bearing shaft $\varnothing$ 17mm ED $\varnothing$ 35mm W 10mm type 6003-2Z DIN 625-1		
<b>For models:</b>	411016		



1

<b>GEV No.</b>	698613	<b>Ref. No.</b>	C8007
<b>description</b>	deep-groove ball bearing shaft $\varnothing$ 17mm ED $\varnothing$ 40mm W 12mm type 6203-2Z DIN 625-1		
<b>For models:</b>	411011, 411012, 411013, 411015, 411018, 411019		



1

<b>GEV No.</b>	523032	<b>Ref. No.</b>	C8008
<b>description</b>	deep-groove ball bearing shaft $\varnothing$ 20mm ED $\varnothing$ 42mm W 12mm type 6004-2Z DIN 625-1		
<b>For models:</b>	411014		



1

<b>GEV No.</b>	523540	<b>Ref. No.</b>	C8011 SL0118
<b>description</b>	deep-groove ball bearing shaft $\varnothing$ 25mm ED $\varnothing$ 52mm W 15mm type 6205-2Z DIN 625-1		
<b>For models:</b>	411017, 431002, 433003, 433004, 433005, 511003, 511004		

### deep-groove ball bearings Z



1

<b>GEV No.</b>	697842	<b>Ref. No.</b>	19320203 19320204
<b>description</b>	deep-groove ball bearing type 6203-Z shaft $\varnothing$ 17mm ED $\varnothing$ 40mm W 12mm DIN 625-1		
<b>For models:</b>	421001, 422001, 433001, 433002		

### angular contact ball bearings



1

<b>GEV No.</b>	523531	<b>Ref. No.</b>	IV7300500
<b>description</b>	angular contact ball bearing shaft $\varnothing$ 17mm ED $\varnothing$ 40mm W 12mm type 7203-BEP DIN 628		
<b>For models:</b>	421003		



1

<b>GEV No.</b>	697116	<b>Ref. No.</b>	SL0103
<b>description</b>	angular contact ball bearing shaft $\varnothing$ 20mm ED $\varnothing$ 47mm W 20.6mm type 3204-2RS DIN 628		
<b>For models:</b>	512013, 512014, 512017, 512018, 512021, 512022		

### thrust ball bearings



1

<b>GEV No.</b>	523000	<b>Ref. No.</b>	IB7300700
<b>description</b>	thrust ball bearing shaft $\varnothing$ 12mm ED $\varnothing$ 26mm W 9mm type 51101 DIN 711		
<b>For models:</b>	723001		



1

<b>GEV No.</b>	514042	<b>Ref. No.</b>	826900240
<b>description</b>	thrust ball bearing shaft $\varnothing$ 17mm ED $\varnothing$ 35mm W 12mm type 51203 DIN 711		
<b>For models:</b>	137001, 137002, 137003, 137004, 137201, 137202		

flange bearings



1

<b>GEV No.</b>	693112	<b>Ref. No.</b>	8300830
<b>description</b>	flange bearing type UCF204 shaft $\varnothing$ 20mm 4 hole flange hole distance 64mm H 33mm flange length 86mm flange width 86mm hole $\varnothing$ 12mm flange F204 ball bearing UC204G2 FH 25.5mm		
<b>For models:</b>	512002, 512003		



1

<b>GEV No.</b>	697278	<b>Ref. No.</b>	8300840 SL0086
<b>description</b>	flange bearing type UCF205 shaft $\varnothing$ 25mm 4 hole flange hole distance 70mm H 36mm flange length 95mm flange width 95mm hole $\varnothing$ 12mm flange F205 ball bearing UC205G2 FH 27mm		
<b>For models:</b>	512004, 512013, 512014, 512017, 512018, 512021, 512022		

drive belts

poly-v belts

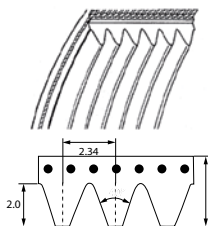
1

<b>GEV No.</b>	692144	<b>Ref. No.</b>	36G6610
<b>description</b>	poly-v belt grooves 12 W 28mm L 559mm profile J		
<b>For models:</b>	451003, 451004, 481004		

1

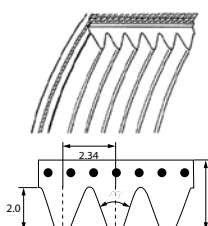
<b>GEV No.</b>	698227	<b>Ref. No.</b>	IV7000010
<b>description</b>	poly-v belt grooves 8 W 18mm L 483mm profile J		
<b>For models:</b>	481001		

1

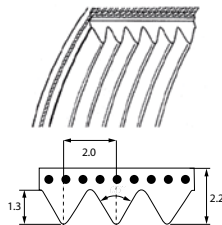
<b>GEV No.</b>	698220	<b>Ref. No.</b>	19310207
<b>description</b>	poly-v belt grooves 10 W 20mm L 380mm profile TB2		
<b>For models:</b>	411004		

1

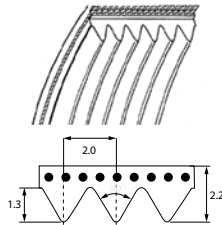
<b>GEV No.</b>	697830	<b>Ref. No.</b>	C4813
<b>description</b>	poly-v belt grooves 11 W 21.5mm L 330mm profile TB2		
<b>For models:</b>	411012, 411015, 411018		

1

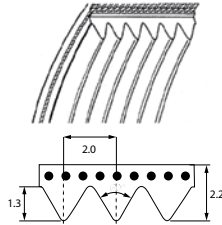
<b>GEV No.</b>	698221	<b>Ref. No.</b>	19310209
<b>description</b>	poly-v belt grooves 11 W 22mm L 480mm profile TB2		

1

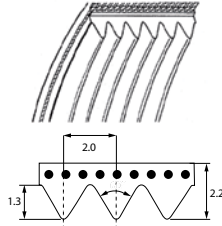
<b>GEV No.</b>	698157	<b>Ref. No.</b>	LF2037056
<b>description</b>	poly-v belt grooves 12 W 24mm L 725mm profile TB2		
<b>For models:</b>	431001		

1

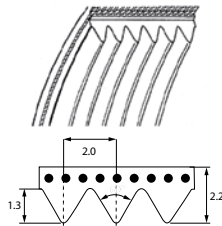
<b>GEV No.</b>	698156	<b>Ref. No.</b>	LF2037058
<b>description</b>	poly-v belt grooves 14 W 28mm L 430mm profile TB2		
<b>For models:</b>	431001		



1

<b>GEV No.</b>	698222	<b>Ref. No.</b>	IB7003012
<b>description</b>	poly-v belt grooves 6 W 12mm L 526mm profile TB2		
<b>For models:</b>	715001		

1

<b>GEV No.</b>	697367	<b>Ref. No.</b>	19310203 C4818
<b>description</b>	poly-v belt grooves 8 W 16mm L 330mm profile TB2		
<b>For models:</b>	411011, 411013, 411019		

1

<b>GEV No.</b>	698223	<b>Ref. No.</b>	MSC04N112A
<b>description</b>	poly-v belt grooves 6 W 12mm L 660mm profile TB2		
<b>For models:</b>	471001		

1

<b>GEV No.</b>	697616	<b>Ref. No.</b>	19310201
<b>description</b>	poly-v belt grooves 8 W 16mm L 345mm profile TB2		
<b>For models:</b>	411005, 411006		

1

<b>GEV No.</b>	698224	<b>Ref. No.</b>	MSC09V112
<b>description</b>	poly-v belt grooves 7 W 14mm L 1186mm profile TB2		

1

<b>GEV No.</b>	698219	<b>Ref. No.</b>	19310206
<b>description</b>	poly-v belt grooves 8 W 16mm L 360mm profile TB2		
<b>For models:</b>	411003		

1

<b>GEV No.</b>	697613	<b>Ref. No.</b>	AMC024
<b>description</b>	poly-v belt grooves 8 W 16mm L 295mm profile TB2		
<b>For models:</b>	411001		

1

<b>GEV No.</b>	698226	<b>Ref. No.</b>	RG08248
<b>description</b>	poly-v belt grooves 10 W 23mm L 432mm profile TB2.34		

1

<b>GEV No.</b>	697280	<b>Ref. No.</b>	AMG024
<b>description</b>	poly-v belt grooves 8 W 16mm L 310mm profile TB2		

1

<b>GEV No.</b>	698225	<b>Ref. No.</b>	RG04248
<b>description</b>	poly-v belt grooves 6 W 14mm L 432mm profile TB2.34		
<b>For models:</b>	451001		

round belts



1

<b>GEV No.</b>	693701	<b>Ref. No.</b>	5070200 A90KI78009
<b>description</b>	round belt ø 8mm L 540mm		



1

<b>GEV No.</b>	694259	<b>Ref. No.</b>	SL2955 SL3196
<b>description</b>	round belt ø 8mm L 750mm mounting pos. lower		
<b>For models:</b>	513004, 513008		

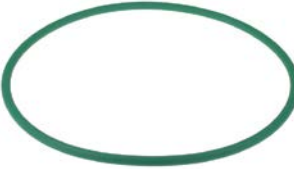

1

<b>GEV No.</b>	693875	<b>Ref. No.</b>	5070010
<b>description</b>	round belt ø 8mm L 784mm		



1

<b>GEV No.</b>	692143	<b>Ref. No.</b>	SL2956 SL3193
<b>description</b>	round belt ø 8mm L 960mm		
<b>For models:</b>	513005, 513006, 513009, 513010		

chains

roller chains 05B-1 single



1

<b>GEV No.</b>	693063	<b>Ref. No.</b>	633110000
<b>description</b>	chain DIN/ISO 05 B-1 splitting 8mm links 35 internal width 3mm rollerø 5mm single closed		
<b>For models:</b>	262001		



1

<b>GEV No.</b>	693064	<b>Ref. No.</b>	633110100
<b>description</b>	chain DIN/ISO 05 B-1 splitting 8mm links 52 internal width 3mm rollerø 5mm single		
<b>For models:</b>	262001		



1

<b>GEV No.</b>	697259	<b>Ref. No.</b>	SL3364
<b>description</b>	chain DIN/ISO 05 B-1 splitting 8mm links 63 internal width 3mm rollerø 5mm single		
<b>For models:</b>	512010		



1

<b>GEV No.</b>	697282	<b>Ref. No.</b>	SL2682	
<b>description</b>	chain DIN/ISO 05 B-1 splitting 8mm links 71 internal width 3mm rollerø 5mm single			
<b>For models:</b>	512015, 512016, 512019, 512020			
<b>accessories for</b>	697282			
	<b>GEV No.</b>	697264	<b>Ref. No.</b>	SL1545
	connector single DIN/ISO 05 B-1 splitting 8mm			



1

<b>GEV No.</b>	697260	<b>Ref. No.</b>	SL0058
<b>description</b>	chain DIN/ISO 05 B-1 splitting 8mm links 72 internal width 3mm rollerø 5mm single		
<b>For models:</b>	512011, 512012		

roller chains 06B-1 single



1

<b>GEV No.</b>	697200	<b>Ref. No.</b>	SL1111
<b>description</b>	roller chain DIN/ISO 06 B-1 splitting 3/8" / 9.525mm links 35 internal width 5.72mm rollerø 6.35mm single		
<b>For models:</b>	512010		



1

<b>GEV No.</b>	697204	<b>Ref. No.</b>	SL2681
<b>description</b>	roller chain DIN/ISO 06 B-1 splitting 3/8" / 9.525mm links 36 internal width 5.72mm rollerø 6.35mm single		
<b>For models:</b>	512016, 512020		



1

<b>GEV No.</b>	697202	<b>Ref. No.</b>	SL0026
<b>description</b>	roller chain DIN/ISO 06 B-1 splitting 3/8" / 9.525mm links 37 internal width 5.72mm rollerø 6.35mm single		
<b>For models:</b>	512012		





1

<b>GEV No.</b>	697203	<b>Ref. No.</b>	SL2680	
<b>description</b>	roller chain DIN/ISO 06 B-1 splitting 3/8" / 9.525mm links 38 internal width 5.72mm rollerø 6.35mm single			
<b>For models:</b>	512015, 512019			
<b>accessories for</b>	697203			
	<b>GEV No.</b>	697069	<b>Ref. No.</b>	SL1629
	connector single DIN/ISO 06 B-1 splitting 3/8" links 1 L 17.8mm internal width 8.8mm rollerø 3mm metal			





1 			
<b>GEV No.</b>	697201	<b>Ref. No.</b>	SL0025
<b>description</b>	roller chain DIN/ISO 06 B-1 splitting 3/8" / 9.525mm links 40 internal width 5.72mm rollerø 6.35mm single		
<b>For models:</b>	512011		

1 			
<b>GEV No.</b>	697127	<b>Ref. No.</b>	8300870
<b>description</b>	roller chain DIN/ISO 06 B-1 splitting 3/8" / 9.525mm links 42 internal width 5.72mm rollerø 6.35mm single		
<b>For models:</b>	512002, 512003		

1 			
<b>GEV No.</b>	697126	<b>Ref. No.</b>	8300210
<b>description</b>	roller chain DIN/ISO 06 B-1 splitting 3/8" / 9.525mm links 63 internal width 5.72mm rollerø 6.35mm		
<b>For models:</b>	512002, 512003		

1 			
<b>GEV No.</b>	697283	<b>Ref. No.</b>	SL2686
<b>description</b>	roller chain DIN/ISO 06 B-1 splitting 3/8" / 9.525mm links 69 internal width 5.72mm rollerø 6.35mm single		
<b>For models:</b>	512014, 512018, 512022		

1 			
<b>GEV No.</b>	697262	<b>Ref. No.</b>	SL0102
<b>description</b>	roller chain DIN/ISO 06 B-1 splitting 3/8" / 9.525mm links 71 internal width 5.72mm rollerø 6.35mm single		
<b>For models:</b>	512013		

1 			
<b>GEV No.</b>	697112	<b>Ref. No.</b>	8300220
<b>description</b>	roller chain DIN/ISO 06 B-1 splitting 3/8" / 9.525mm links 74 internal width 5.72mm rollerø 6.35mm single		
<b>For models:</b>	512004		

roller chains 08B-1 single

1 			
<b>GEV No.</b>	697220	<b>Ref. No.</b>	SL3438
<b>description</b>	roller chain DIN/ISO 08 B-1 splitting 1/2" / 12.7mm links 34 internal width 7.75mm rollerø 8.51mm single		
<b>For models:</b>	512014, 512018, 512022		

1 			
<b>GEV No.</b>	697128	<b>Ref. No.</b>	8300880
<b>description</b>	roller chain DIN/ISO 08 B-1 splitting 1/2" / 12.7mm links 37 internal width 7.75mm rollerø 8.51mm single		
<b>For models:</b>	512004		

roller chains 25-1 single

1 			
<b>GEV No.</b>	691472	<b>Ref. No.</b>	X05.03.040.00
<b>description</b>	chain US norm 25-1 splitting 6mm links 30 internal width 3.3mm rollerø 4.3mm single closed		
<b>For models:</b>	222004, 222005		

1 			
<b>GEV No.</b>	691473	<b>Ref. No.</b>	X05.03.044.00
<b>description</b>	chain US norm 25-1 splitting 6mm links 31 internal width 3.3mm rollerø 4.3mm single closed		
<b>For models:</b>	222004, 222005		

connectors

1 			
<b>GEV No.</b>	697264	<b>Ref. No.</b>	SL1545
<b>description</b>	connector single DIN/ISO 05 B-1 splitting 8mm		
<b>For models:</b>	512010, 512011, 512012, 512015, 512016, 512019, 512020		

1 			
<b>GEV No.</b>	697069	<b>Ref. No.</b>	SL1629
<b>description</b>	connector single DIN/ISO 06 B-1 splitting 3/8" links 1 L 17.8mm internal width 8.8mm rollerø 3mm metal		
<b>For models:</b>	512010, 512011, 512012, 512013, 512014, 512015, 512016, 512017, 512018, 512019, 512020, 512021, 512022		

1 			
<b>GEV No.</b>	693276	<b>Ref. No.</b>	SL1632
<b>description</b>	connector single DIN/ISO 08 B-1 splitting 1/2" links 1 L 23mm internal width 11.8mm rollerø 4.3mm metal		
<b>For models:</b>	512013, 512014, 512017, 512018, 512021, 512022		

# springs

## torsion springs



<b>GEV No.</b>	691532	<b>Ref. No.</b>	0080035
<b>description</b>	compression spring ø 46mm L2 87mm wire gauge ø 10mm L1 340mm L3 87mm		



<b>GEV No.</b>	691533	<b>Ref. No.</b>	0080036
<b>description</b>	compression spring ø 46mm L2 87mm wire gauge ø 10mm L1 340mm L3 87mm		



<b>GEV No.</b>	693789	<b>Ref. No.</b>	4000500
<b>description</b>	spring ø 12mm L2 70mm mounting pos. in the front/at the back wire gauge ø 1.5mm P30-P40 L1 3mm L3mm Qty 1 pcs		



<b>GEV No.</b>	694238	<b>Ref. No.</b>	SL2384
<b>description</b>	spring ømm L2 80mm mounting pos. front wire gauge ø 2mm FI32-FI42-FIP42 L1mm Qty 1 pcs		
<b>For models:</b>	513004, 513005, 513006, 513008, 513009, 513010		



<b>GEV No.</b>	694239	<b>Ref. No.</b>	SL2385
<b>description</b>	spring ømm L2 80mm mounting pos. rear wire gauge ø 2mm FI32-FI42-FIP42 L1mm Qty 1 pcs		
<b>For models:</b>	513004, 513005, 513006, 513008, 513009, 513010		



<b>GEV No.</b>	690272	<b>Ref. No.</b>	1412084 BN1412084
<b>description</b>	torsion spring ø 15mm L2 80mm wire gauge ø 2.5mm mounting pos. left L1 27mm L3 16mm		
<b>For models:</b>	201780, 621007, 621021, 622005, 622021		
<b>accessories for</b>	690272		



<b>GEV No.</b>	690271	<b>Ref. No.</b>	1412083 935696 BN1412083
<b>description</b>	torsion spring ø 15mm L2 80mm wire gauge ø 2.5mm mounting pos. right L1 27mm L3 16mm		



<b>GEV No.</b>	690271	<b>Ref. No.</b>	1412083 935696 BN1412083
----------------	--------	-----------------	--------------------------------

<b>description</b>	torsion spring ø 15mm L2 80mm wire gauge ø 2.5mm mounting pos. right L1 27mm L3 16mm		
<b>For models:</b>	201780, 621007, 621020, 621021, 622005, 622020, 622021, 671004, 671005, 671007, 671008		

**accessories for** 690271



<b>GEV No.</b>	690272	<b>Ref. No.</b>	1412084 BN1412084
----------------	--------	-----------------	----------------------

torsion spring ø 15mm L2 80mm wire gauge ø 2.5mm mounting pos. left L1 27mm L3 16mm



<b>GEV No.</b>	692094	<b>Ref. No.</b>	MD04900
----------------	--------	-----------------	---------

**description** torsion spring ø 17mm L2 32mm wire gauge ø 2.5mm L1 45mm L3mm Qty 1 pcs

**For models:** 531010, 531011, 531012, 531013, 531014, 531015, 531016, 531017



<b>GEV No.</b>	700723	<b>Ref. No.</b>	408702505
----------------	--------	-----------------	-----------

**description** torsion spring ø 20.5mm L1 40mm L2 120mm L3 40mm wire gauge ø 3.6mm

**For models:** 255003, 255004



<b>GEV No.</b>	692336	<b>Ref. No.</b>	KO-B106
----------------	--------	-----------------	---------

**description** torsion spring ø 20mm L1 98mm L2 57mm wire gauge ø 3.5mm for contact grill

**For models:** 255013



<b>GEV No.</b>	692335	<b>Ref. No.</b>	KOB104
----------------	--------	-----------------	--------

**description** torsion spring ø 21.5mm L1 160mm L2 76mm wire gauge ø 4mm for contact grill

**For models:** 255009



<b>GEV No.</b>	692334	<b>Ref. No.</b>	KO-B105
----------------	--------	-----------------	---------

**description** torsion spring ø 21.6mm L1 205mm L2 76mm wire gauge ø 4mm for contact grill

**For models:** 255012, 255014







			
1			
<b>GEV No.</b>	700084	<b>Ref. No.</b>	408702500
<b>description</b>	torsion spring ø 22mm L1 119mm L2 64mm L3 64mm wire gauge ø 3.5mm		
<b>For models:</b>	255001, 255002, 255006, 255007		

			
1			
<b>GEV No.</b>	527150	<b>Ref. No.</b>	WY28360027
<b>description</b>	torsion spring ø 38mm L2 18mm wire gauge ø 1.8mm L1 9mm L3 57mm for dosing pump lever right		
<b>For models:</b>	744001, 744002		

			
1			
<b>GEV No.</b>	690095	<b>Ref. No.</b>	R61620012
<b>description</b>	torsion spring ø 6mm L2 15mm wire gauge ø 0.9mm L1 2x6mm L3 15mm Qty 1 pcs for closing hub		
<b>For models:</b>	212001, 212002, 212003		

compression springs

			
1			
<b>GEV No.</b>	529719	<b>Ref. No.</b>	WY10452
<b>description</b>	compression spring ø 11.3mm L 16mm wire gauge ø 1.5mm for steam-/water-tap for espresso machine		
<b>For models:</b>	742001, 742002, 742003, 742004, 742005		

			
1			
<b>GEV No.</b>	696211	<b>Ref. No.</b>	AMC672
<b>description</b>	compression spring ø 11.5mm L 46mm wire gauge ø 1.3mm slicer 220		
<b>For models:</b>	411001		

			
1			
<b>GEV No.</b>	690091	<b>Ref. No.</b>	R61620041
<b>description</b>	compression spring ø 12mm L 49mm wire gauge ø 1mm		
<b>For models:</b>	212001, 212002, 212003		

			
1			
<b>GEV No.</b>	696208	<b>Ref. No.</b>	SM370111
<b>description</b>	compression spring ø 13.5mm L 57mm wire gauge ø 1.4mm slicer 275-300		
<b>For models:</b>	411003		

			
1			
<b>GEV No.</b>	696209	<b>Ref. No.</b>	19390205
<b>description</b>	compression spring ø 13.5mm L 92mm wire gauge ø 1.4mm slicer		
<b>For models:</b>	411004		

			
1			
<b>GEV No.</b>	696210	<b>Ref. No.</b>	19390600
<b>description</b>	compression spring ø 14mm L 16mm wire gauge ø 1.2mm slicer 220-250		

			
1			
<b>GEV No.</b>	528311	<b>Ref. No.</b>	WY10451
<b>description</b>	compression spring ø 14mm L 39mm wire gauge ø 2.8mm		
<b>For models:</b>	742001, 742002, 742003, 742004		

			
1			
<b>GEV No.</b>	527147	<b>Ref. No.</b>	WY28360003
<b>description</b>	compression spring ø 15.1mm L 85mm wire gauge ø 1.3mm		
<b>For models:</b>	744001, 744002		

			
1			
<b>GEV No.</b>	691531	<b>Ref. No.</b>	0080020
<b>description</b>	compression spring ø 15.2mm L 52mm wire gauge ø 2mm for vacuum packing machine		

			
1			
<b>GEV No.</b>	696205	<b>Ref. No.</b>	SM370104
<b>description</b>	compression spring ø 22/28mm L 22mm wire gauge ø 2mm conical slicer D1 ø 22mm D2 ø 28mm 250-300		

			
1			
<b>GEV No.</b>	696207	<b>Ref. No.</b>	AMC244
<b>description</b>	compression spring ø 23/25mm L 19mm wire gauge ø 1.5mm conical slicer D1 ø 23mm D2 ø 25mm 220-250		
<b>For models:</b>	411001		

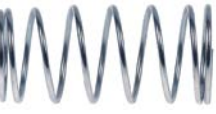
			
1			
<b>GEV No.</b>	696206	<b>Ref. No.</b>	AMC254 AMG254
<b>description</b>	compression spring ø 23/25mm L 53mm wire gauge ø 1.5mm conical slicer D1 ø 23mm D2 ø 25mm 220-250		
<b>For models:</b>	411001		

			
1			
<b>GEV No.</b>	105575	<b>Ref. No.</b>	GS1456
<b>description</b>	compression spring ø 23mm L 35mm wire gauge ø 1.5mm for air mixers		
<b>For models:</b>	221021		

			
1			
<b>GEV No.</b>	511982	<b>Ref. No.</b>	450214
<b>description</b>	compression spring ø 25mm L 83mm wire gauge ø 1.7mm for dosing pump warewashing		
<b>For models:</b>	SP1, SP2-12, SP2-S12, SP3		

			
1			
<b>GEV No.</b>	691530	<b>Ref. No.</b>	0080030
<b>description</b>	compression spring ø 32.7mm L 240mm wire gauge ø 5.2mm for vacuum packing machine		

			
1			
<b>GEV No.</b>	527151	<b>Ref. No.</b>	WY28219012
<b>description</b>	compression spring ø 4.5mm L 23mm wire gauge ø 0.4mm for coffee grinder		
<b>For models:</b>	744001, 744002		

			
1			
<b>GEV No.</b>	527152	<b>Ref. No.</b>	WY28219006
<b>description</b>	compression spring ø 4.9mm L 22mm wire gauge ø 0.7mm for push-button for coffee grinder		
<b>For models:</b>	744001, 744002		

			
1			
<b>GEV No.</b>	511323	<b>Ref. No.</b>	450232
<b>description</b>	compression spring ø 41.3mm L 57mm wire gauge ø 2mm		
<b>For models:</b>	SP1, SP2-12, SP2-S12		

			
1			
<b>GEV No.</b>	527149	<b>Ref. No.</b>	WY28219008
<b>description</b>	compression spring ø 44.3mm L 39mm wire gauge ø 2.5mm for star for coffee grinder		
<b>For models:</b>	744001, 744002		

			
1			
<b>GEV No.</b>	528977	<b>Ref. No.</b>	IB76M4005
<b>description</b>	compression spring ø 5.5mm L 15mm wire gauge ø 0.4mm CICLEONE		
<b>For models:</b>	473001, 473002		

			
1			
<b>GEV No.</b>	691262	<b>Ref. No.</b>	IB76M4000
<b>description</b>	compression spring $\phi$ 6mm L 13mm wire gauge $\phi$ 0.8mm		

			
1			
<b>GEV No.</b>	696099	<b>Ref. No.</b>	IV75MTM
<b>description</b>	compression spring $\phi$ 7.2mm L 19mm wire gauge $\phi$ 0.7mm for micro-switch model TM		
<b>For models:</b>	481001		

			
1			
<b>GEV No.</b>	696212	<b>Ref. No.</b>	AMA814
<b>description</b>	compression spring $\phi$ 7.6mm L 22mm wire gauge $\phi$ 0.7mm slicer 195-220		
<b>For models:</b>	411001		

			
1			
<b>GEV No.</b>	696213	<b>Ref. No.</b>	AME410
<b>description</b>	compression spring $\phi$ 7.6mm L 28mm wire gauge $\phi$ 0.7mm slicer PARKER		

			
1			
<b>GEV No.</b>	697328	<b>Ref. No.</b>	5163010
<b>description</b>	compression spring $\phi$ 7mm L 19.5mm wire gauge $\phi$ 0.6mm		

### spring compressors

			
1			
<b>GEV No.</b>	513119	<b>Ref. No.</b>	926009
<b>description</b>	spring compressor		
<b>For models:</b>	813001		

### gas tension springs

#### gas tension springs

			
1			
<b>GEV No.</b>	701302	<b>Ref. No.</b>	0955003
<b>description</b>	gas tension spring 450N hub 90mm D1 $\phi$ 6mm D2 $\phi$ 15mm hole distance 230mm hole $\phi$ 6mm L 240mm		

			
1			
<b>GEV No.</b>	697271	<b>Ref. No.</b>	SL2667
<b>description</b>	gas tension spring for dough mixer 350N hub 85mm D1 $\phi$ 15mm D2 $\phi$ 6mm hole distance 228mm hole $\phi$ 6.2mm 12-18 C-F		
<b>For models:</b>	512015, 512016, 512019, 512020		

			
1			
<b>GEV No.</b>	697272	<b>Ref. No.</b>	SL2668
<b>description</b>	gas tension spring for dough mixer 700N hub 90mm D1 $\phi$ 19mm D2 $\phi$ 8mm hole distance 255mm hole $\phi$ 8.2mm 25-38 C-F		
<b>For models:</b>	512014, 512017, 512018, 512021, 512022		

			
1			
<b>GEV No.</b>	691528	<b>Ref. No.</b>	0810200
<b>description</b>	gas tension spring for vacuum packing machine 370N hub 40mm D1 $\phi$ 18mm D2 $\phi$ 8mm hole distance 145mm hole $\phi$ 6.2mm L 155mm		
<b>For models:</b>	442003, 442004, 442005, 442007		

			
1			
<b>GEV No.</b>	691529	<b>Ref. No.</b>	0810215
<b>description</b>	gas tension spring for vacuum packing machine 500N hub 65mm D1 $\phi$ 18mm D2 $\phi$ 8mm hole distance 225mm hole $\phi$ 6.3mm L 235mm		
<b>For models:</b>	442006, 442008		

### tension springs

			
1			
<b>GEV No.</b>	510064	<b>Ref. No.</b>	450288
<b>description</b>	tension spring $\phi$ 13mm total length 78mm wire gauge $\phi$ 2.5mm L1 14mm L2 50mm L3 14mm		
<b>For models:</b>	SP2-12, SP2-S12		

			
1			
<b>GEV No.</b>	697349	<b>Ref. No.</b>	PF08650
<b>description</b>	tension spring $\phi$ 20mm wire gauge $\phi$ 3mm L1 125mm L2 55mm		

			
1			
<b>GEV No.</b>	691455	<b>Ref. No.</b>	2510545
<b>description</b>	tension spring $\phi$ 24.8mm total length 270mm wire gauge $\phi$ 3mm		

			
1			
<b>GEV No.</b>	513206	<b>Ref. No.</b>	926007
<b>description</b>	tension spring $\phi$ 29.8mm total length 513mm wire gauge $\phi$ 5.8mm		
<b>For models:</b>	813001		

			
1			
<b>GEV No.</b>	700430	<b>Ref. No.</b>	823210031
<b>description</b>	tension spring $\phi$ 33.9mm total length 200mm wire gauge $\phi$ 4.2mm		
<b>For models:</b>	137001, 137002, 137003, 137004, 137201, 137202		

1 

<b>GEV No.</b>	510928	<b>Ref. No.</b>	391316
<b>description</b>	tension spring ø 37mm total length 910mm wire gauge ø 5.3mm for hood C85/140-G75		
<b>For models:</b>	SP3		

1 

<b>GEV No.</b>	700429	<b>Ref. No.</b>	823210020
<b>description</b>	tension spring ø 45mm total length 160mm wire gauge ø 5.3mm		
<b>For models:</b>	137001, 137002, 137003, 137004, 137201, 137202		

1 

<b>GEV No.</b>	504449	<b>Ref. No.</b>	0080107
<b>description</b>	tension spring ø 70mm total length 340mm wire gauge ø 8mm for vacuum packing machine Qty 1 pcs		

1 

<b>GEV No.</b>	691600	<b>Ref. No.</b>	MSPRCA097WRE0
<b>description</b>	tension spring ø 9mm for cam total length 47mm wire gauge ø 1mm		
<b>For models:</b>	213002, 213003		

## coffee accessories

### measuring spoons

1 

<b>GEV No.</b>	960096	<b>Ref. No.</b>	506731
<b>description</b>	coffee spoon amount of coffee 50g plastic		
<b>For models:</b>	741002		

## milk foamers

### milk foamers

1 

<b>GEV No.</b>	802137	<b>Ref. No.</b>	WY83300012R
<b>description</b>	milk foamer connection 3/8" plastic		

## measuring cups

1 

<b>GEV No.</b>	960095	<b>Ref. No.</b>	12414
<b>description</b>	measuring cup 2l plastic		
<b>For models:</b>	741002		

## kitchen accessories

### gastronorm

#### bridges

1 

<b>GEV No.</b>	691337	<b>Ref. No.</b>	CR0506490
<b>description</b>	bridge for Gastronorm container L1 525mm L2 505mm SS W 72mm H 15mm Qty 1 pcs		
<b>For models:</b>	125102		





manometers

			
1			
<b>GEV No.</b>	541262	<b>Ref. No.</b>	WY21112 WY21115
<b>description</b>	manometer double scale ø 63mm pressure range 0-3 / 0-15bar connection on the backside thread 1/8"		
<b>For models:</b>	742001, 742002, 742003, 742004, 742017, 742018, 742019, 742020		

			
1			
<b>GEV No.</b>	541528	<b>Ref. No.</b>	0810101
<b>description</b>	manometer ø 40mm pressure range 0 up to 1bar connection angled connection ø 5mm		
<b>For models:</b>	442003, 442004, 442005, 442006, 442007, 442008		

			
1			
<b>GEV No.</b>	541261	<b>Ref. No.</b>	WY21105
<b>description</b>	manometer ø 44mm pressure range 0 up to 2.5bar thread 1/8" connection on the backside		
<b>For models:</b>	742005		

			
1			
<b>GEV No.</b>	541334	<b>Ref. No.</b>	853310148
<b>description</b>	manometer ø 60mm pressure range 0 up to 1bar thread 1/8" marking 0.5 kettle connection on the backside		
<b>For models:</b>	136001, 136002, 136201, 136202		

			
1			
<b>GEV No.</b>	541525	<b>Ref. No.</b>	6A022210
<b>description</b>	manometer ø 61mm pressure range 0 up to 1bar thread 1/4" connection on the backside		

			
1			
<b>GEV No.</b>	541901	<b>Ref. No.</b>	CR0589110
<b>description</b>	manometer ø 63mm pressure range 0 up to 1bar 0 up to 14.5PSI thread 1/4" connection on the backside		
<b>For models:</b>	146002, 146007		

water taps

miscellaneous

water taps

accessories

backflow preventers

			
1			
<b>GEV No.</b>	528978	<b>Ref. No.</b>	10944
<b>description</b>	backflow preventer ø 19mm H 20mm Qty 1 pcs		
<b>For models:</b>	741003		

spare parts of other producers

suitable for MONOLITH

			
1			
<b>GEV No.</b>	540452	<b>Ref. No.</b>	OPV080.00.00
<b>description</b>	ceramic cartridge D1 ø 40mm D2 ø 25.5mm H1 30mm H2 40.5mm H3 62mm suitable for KLARCO/ RIVER/ PROGASTRO with 2 locking pins shaft ø 10x10.5mm at 3bar 28l/min type N40D		
<b>For models:</b>	821002		

suitable for RUBINETTERIE DEL FRIULI

			
1			
<b>GEV No.</b>	540415	<b>Ref. No.</b>	6A022453
<b>description</b>	star handle connection cold total lengthmm mounting pos. shaft diameter 7x7mm ø 55mm 35 built-in depth 22mm		

1

<b>GEV No.</b>	540414	<b>Ref. No.</b>	6A022456
<b>description</b>	star handle connection hot total lengthmm mounting pos. shaft diameter 7x7mm ø 55mm 35 built-in depth 22mm		



1

<b>GEV No.</b>	540452	<b>Ref. No.</b>	0P.V080.00.00
<b>description</b>	ceramic cartridge D1 ø 40mm D2 ø 25.5mm H1 30mm H2 40.5mm H3 62mm suitable for KLARCO/ RIVER/ PROGASTRO with 2 locking pins shaft ø 10x10.5mm at 3bar 28l/min type N40D		
<b>For models:</b>	821002		

hose reels

wall-mounted hose reels



1

<b>GEV No.</b>	542952	<b>Ref. No.</b>	5R.M03Q.043
<b>description</b>	hose reel closed hose length 3m connection 1/2" complete with spray gun		
<b>spare parts for</b>	542952		
	<b>GEV No.</b>	542038	<b>Ref. No.</b> 0P.P043.00.00
	spray gun for appliances 3/8" IT L 135mm		

hose reels and spray guns

spray guns



1

<b>GEV No.</b>	542038	<b>Ref. No.</b>	0P.P043.00.00
<b>description</b>	spray gun for appliances 3/8" IT L 135mm		
<b>For models:</b>	852001		







1

<b>GEV No.</b>	542010	<b>Ref. No.</b>	0R.F048.00.00
<b>description</b>	hose connection 3/8" EPDM ID ø 5mm ED ø 12mm straight-curved for hose reel L 3m		
<b>For models:</b>	852001		

cleaning guns



1

<b>GEV No.</b>	541473	<b>Ref. No.</b>	0R.P146.00.00
<b>description</b>	cleaning spray gun connection with snap-on connection DN13 brass		
<b>For models:</b>	852002		
<b>spare parts for</b>	541473		
	<b>GEV No.</b>	540516	<b>Ref. No.</b> —
	coupling bush type DN13 chrome-plated brass connection 1/2" IT		
	<b>GEV No.</b>	540535	<b>Ref. No.</b> —
	nozzle connection snap-on connection short SS		
<b>accessories for</b>	541473		
	<b>GEV No.</b>	540536	<b>Ref. No.</b> —
	foam lance connection snap-on connection plastic total length 182mm		
	<b>GEV No.</b>	541870	<b>Ref. No.</b> —
	foam lance connection snap-on connection aluminium L 450mm		



## dosing pumps

### peristaltic dosing pumps







#### GERMAC

built-in version

with frequency control



1

<b>GEV No.</b>	361268	<b>Ref. No.</b>	440632
<b>description</b>	dosing pump GERMAC frequency control 3l/h 230VAC detergent hose ø 4x6mm hose thermoplastic type G300 built-in version dimensions 67x72x101mm		
<b>For models:</b>	SP1, SP2-12, SP2-S12		
<b>spare parts for</b>	361268		
	<b>GEV No.</b>	361467	<b>Ref. No.</b> —
	pump hose GERMAC detergent hose type thermoplastic hose ø 6x10mm for model G43/G45/G53/G54/G55/G300/G305		
	<b>GEV No.</b>	361557	<b>Ref. No.</b> —
	control PCB type G300/G302/G305 GERMAC		
	<b>GEV No.</b>	361589	<b>Ref. No.</b> —
	roller assembly GERMAC suitable for G42/43/45/53/54/55/300/302/305/705		
<b>accessories for</b>	361268		
	<b>GEV No.</b>	361106	<b>Ref. No.</b> —
	container filter with weight and non-return valve SS hose ø 4x6mm ø 21mm L 51mm non return valve lip valve		
	<b>GEV No.</b>	520090	<b>Ref. No.</b> 00-898252-002 00-898252-005 143194
	PVC hose ID ø 4mm ED ø 6mm L 2m thickness 1mm t.max. 60°C transparent		
	<b>GEV No.</b>	520091	<b>Ref. No.</b> —
	nylon hose ID ø 4mm ED ø 6mm L 2m thickness 1mm operating p. 10bar burst p. 50bar t.max. 100°C transparent		

#### spare parts



1

<b>GEV No.</b>	361554	<b>Ref. No.</b>	200608
<b>description</b>	pump hose GERMAC detergent hose type thermoplastic hose ø 5x8mm for model G200/G250/G252		
<b>For models:</b>	SP1, SP2-12, SP2-S12		

#### SEKO

built-in version

with frequency control



1







<b>GEV No.</b>	361767 <sup>1</sup>	<b>Ref. No.</b>	209021
<b>description</b>	dosing pump SEKO 3l/h 230VAC detergent hose ø 4x6mm hose type K hose Santoprene suction level 1.5m type NBR 3 8W built-in version peristaltic pump		
<b>For models:</b>	811001, 811002, 811003, 812005, 812006, 812007, 812008, 812009, 812010, 813001, 915234, 915235, 915236, 915237, 915460, 915461, 915462, 915463, 915464, 915465		
<b>spare parts for</b>	361767		
	<b>GEV No.</b>	361815	<b>Ref. No.</b> 00-775608-002
	pump hose detergent hose ø 6x10mm hose ø 4x6mm hose type K hose Santoprene type SEKO		

<sup>1</sup>incl. inlet and conveyor hose

without control



1

<b>GEV No.</b>	361150 <sup>1</sup>	<b>Ref. No.</b>	00-775556-011
<b>description</b>	dosing pump SEKO without control 0.4l/h 230VAC rinse aid hose ø 4x6mm hose type D hose Sekobril suction level 1.5m horizontal/vertical type PG dimensions 67x95x52mm		
<b>For models:</b>	811011, 811012, 811013, 811014, 811015, 812013, 812015		
<b>spare parts for</b>	361150		
	<b>GEV No.</b>	361135	<b>Ref. No.</b> 00-775608-001
	pump hose SEKO rinse aid hose ø 3x8mm hose ø 4x6mm hose type D hose Sekobril		
	<b>GEV No.</b>	361136	<b>Ref. No.</b> —
	roller assembly for dosing pump hole ø 4.8x4mm		
	<b>GEV No.</b>	361562	<b>Ref. No.</b> —
	pump cover for dosing pump yellow		
	<b>GEV No.</b>	361866	<b>Ref. No.</b> 00-775507-001
	union nut for hose connector ø 17mm		
<b>accessories for</b>	361150		
	<b>GEV No.</b>	361144	<b>Ref. No.</b> —
	mounting set rinse aid hose type 4x6mm hose length 2m PVC/nylon hose container filter/non-return valve transparent		
	<b>GEV No.</b>	570123	<b>Ref. No.</b> 01-246301-001
	PVC hose ID ø 4mm ED ø 6mm L 3.5m thickness 1mm t.max. 60°C transparent		

<sup>1</sup>with accessories





1

<b>GEV No.</b>	361867	<b>Ref. No.</b>	00-883828-001
<b>description</b>	dosing pump SEKO without control 0.4l/h 230VAC rinse aid hose ø 4x6mm hose type D hose Sekobril suction level 1.5m type NPG 0.4 8W cable length 45mm built-in version counter pressure 1bar		
<b>For models:</b>	813002, 813003, 813004		
<b>spare parts for</b>	361867		
	<b>GEV No.</b>	<b>Ref. No.</b>	<b>00-775608-001</b>
	pump hose SEKO rinse aid hose ø 3x8mm hose ø 4x6mm hose type D hose Sekobril		



1

<b>GEV No.</b>	361869	<b>Ref. No.</b>	00-883828-002
<b>description</b>	dosing pump SEKO without control 3l/h 230VAC detergent hose ø 4x6mm hose type K hose Santoprene suction level 1.5m type NPG 3		
<b>For models:</b>	813002, 813003		
<b>spare parts for</b>	361869		
	<b>GEV No.</b>	<b>Ref. No.</b>	<b>00-775608-002</b>
	pump hose detergent hose ø 6x10mm hose ø 4x6mm hose type K hose Santoprene type SEKO		



1



<b>GEV No.</b>	361868	<b>Ref. No.</b>	00-775556-012
<b>description</b>	dosing pump SEKO without control 3l/h 230VAC detergent hose ø 4x6mm hose type K hose Santoprene suction level 1.5m type PG 8W		
<b>For models:</b>	811011, 811012, 811013, 811014, 811015, 812013, 812015		
<b>spare parts for</b>	361868		
	<b>GEV No.</b>	<b>Ref. No.</b>	<b>00-775608-002</b>
	pump hose detergent hose ø 6x10mm hose ø 4x6mm hose type K hose Santoprene type SEKO		

spare parts



1

<b>GEV No.</b>	698712	<b>Ref. No.</b>	143219
<b>description</b>	dosing hose SEKO detergent hose ø 4x8.6mm hose ø 4x6mm hose type H hose Santoprene		
<b>For models:</b>	811001, 811002, 811003, 812005, 812006, 812007, 812008, 812009, 812010, 915234, 915235, 915236, 915237, 915460, 915461, 915462, 915463, 915464, 915465		





1

<b>GEV No.</b>	361815	<b>Ref. No.</b>	00-775608-002
<b>description</b>	pump hose detergent hose ø 6x10mm hose ø 4x6mm hose type K hose Santoprene type SEKO		
<b>For models:</b>	811011, 811012, 811013, 811014, 811015, 812013, 812015, 813002, 813003		



1

<b>GEV No.</b>	361135	<b>Ref. No.</b>	00-775608-001
<b>description</b>	pump hose SEKO rinse aid hose ø 3x8mm hose ø 4x6mm hose type D hose Sekobril		
<b>For models:</b>	811011, 811012, 811013, 811014, 811015, 812013, 812015, 813002, 813003, 813004		
<b>spare parts for</b>	361135		
	<b>GEV No.</b>	<b>Ref. No.</b>	<b>00-775507-001</b>
	union nut for hose connector ø 17mm		

## piston pumps

spare parts



1

<b>GEV No.</b>	510298	<b>Ref. No.</b>	200444
<b>description</b>	lip valve dosing pump suitable for DB2/DS5		
<b>For models:</b>	SP1, SP2-12, SP2-S12, SP3		















membrane dosing pumps

self-priming

SEKO



<b>GEV No.</b>	361364 <sup>1</sup>	<b>Ref. No.</b>	209025 926278
<b>description</b>	dosing pump type DIB5E self-sucking rinse aid pump rate 0-5cm <sup>3</sup> per stroke pressure connection ø 4x6mm suction connection ø 4x6mm SEKO supporting pressure closed		
<b>For models:</b>	811003, 812001, 812002, 812003, 812004, 812005, 812006, 812007, 812008, 812009, 812010, 813001, 915234, 915235, 915236, 915237, 915460, 915461, 915462, 915463, 915464, 915465		
<b>spare parts for</b>	361364		
	<b>GEV No.</b>	361301	<b>Ref. No.</b> —
hose connector for type DIB3E/DIB5E			
	<b>GEV No.</b>	361302	<b>Ref. No.</b> —
valve bush for type DIB3E/DIB5E			
	<b>GEV No.</b>	361304	<b>Ref. No.</b> —
O-ring EPDM ID ø 11.1mm thickness 1.78mm Qty 1 pcs for type DIB3E/DIB5E			
	<b>GEV No.</b>	361305	<b>Ref. No.</b> —
valve disc for type DIB3E/DIB5E DIB3P/DIB5P			
	<b>GEV No.</b>	361306	<b>Ref. No.</b> —
membrane for type DIB3E/DIB5E ø 49mm hole ø 5mm			
	<b>GEV No.</b>	361307	<b>Ref. No.</b> —
membrane dosing pump ø 68mm hole ø 6mm for type DIB3P/DIB5P			
	<b>GEV No.</b>	361459	<b>Ref. No.</b> —
hose connector ø 6mm for dosing pump			
	<b>GEV No.</b>	361481	<b>Ref. No.</b> —
lip valve for type DIB3P/DIB5P DIB3E/DIB5E			
<b>accessories for</b>	361364		
	<b>GEV No.</b>	361240	<b>Ref. No.</b> —
hose connector 1-way hose ø 6mm plastic connection M10x1			
	<b>GEV No.</b>	361241	<b>Ref. No.</b> —
hose connector 1-way hose ø 9mm plastic connection M10x1			

<sup>1</sup>auxiliary pressure connection closed

various





<b>GEV No.</b>	361002	<b>Ref. No.</b>	620120
<b>description</b>	dosing pump rinse aid inlet 6x8mm outlet 4x6mm pressure connection ø 4x6mm suction connection ø 6x8mm		
<b>For models:</b>	SP1, SP2-12, SP2-S12, SP3		
<b>spare parts for</b>	361002		
	<b>GEV No.</b>	510297	<b>Ref. No.</b> 630614
membrane for dosing pump ED ø 83mm thickness 1mm dosing pump equiv. no. 630614 suitable for COMENDA			
	<b>GEV No.</b>	510298	<b>Ref. No.</b> 200444
lip valve dosing pump suitable for DB2/DS5			
	<b>GEV No.</b>	510299	<b>Ref. No.</b> 180306
hose connector for dosing pump			
	<b>GEV No.</b>	510328	<b>Ref. No.</b> 340483
plunger rinse aid dosing pump			
	<b>GEV No.</b>	510338	<b>Ref. No.</b> 170701
union nut dosing pump thread 1/2" ø 32mm H 15mm for dosing pump			
	<b>GEV No.</b>	510847	<b>Ref. No.</b> 440405
gasket polishing agent dosing ID ø 22mm ED ø 32mm external height 5mm			
	<b>GEV No.</b>	510870	<b>Ref. No.</b> 191018
filter support for dosing pump			
	<b>GEV No.</b>	510894	<b>Ref. No.</b> 381105
press ring for membrane			
	<b>GEV No.</b>	510916	<b>Ref. No.</b> 330543
filter for dosing pump			

spare parts

	<b>GEV No.</b>	510916	<b>Ref. No.</b>	330543
<b>description</b>	filter for dosing pump			
<b>For models:</b>	SP1, SP2-12, SP2-S12, SP3			



			
1			
<b>GEV No.</b>	510870	<b>Ref. No.</b>	191018
<b>description</b>	filter support for dosing pump		
<b>For models:</b>	SP1, SP2-12, SP2-S12, SP3		

			
1			
<b>GEV No.</b>	510847	<b>Ref. No.</b>	440405
<b>description</b>	gasket polishing agent dosing ID ø 22mm ED ø 32mm external height 5mm		
<b>For models:</b>	SP1, SP2-12, SP2-S12, SP3		



			
1			
<b>GEV No.</b>	510298	<b>Ref. No.</b>	200444
<b>description</b>	lip valve dosing pump suitable for DB2/DS5		
<b>For models:</b>	SP1, SP2-12, SP2-S12, SP3		

			
1			
<b>GEV No.</b>	510297	<b>Ref. No.</b>	630614
<b>description</b>	membrane for dosing pump ED ø 83mm thickness 1mm dosing pump equiv. no. 630614 suitable for COMENDA		
<b>For models:</b>	SP1, SP2-12, SP2-S12, SP3		

			
1			
<b>GEV No.</b>	510338	<b>Ref. No.</b>	170701
<b>description</b>	union nut dosing pump thread 1/2" ø 32mm H 15mm for dosing pump		
<b>For models:</b>	SP1, SP2-12, SP2-S12, SP3		

self-priming with supporting pressure

**ELETTROBAR**

			
1			
<b>GEV No.</b>	361362	<b>Ref. No.</b>	987023
<b>description</b>	dosing pump rinse aid pressure connection ø 6mm pressure connection 6		
<b>spare parts for</b>	361362		
	<b>GEV No.</b>	361363	<b>Ref. No.</b>
			199012
	<b>GEV No.</b>	510298	<b>Ref. No.</b>
			200444
	lip valve dosing pump suitable for DB2/DS5		

			
1			
<b>GEV No.</b>	510298	<b>Ref. No.</b>	200444
<b>description</b>	lip valve dosing pump suitable for DB2/DS5		
<b>For models:</b>	SP1, SP2-12, SP2-S12, SP3		

			
1			
<b>GEV No.</b>	361363	<b>Ref. No.</b>	199012
<b>description</b>	membrane		

**GERMAC**

spare parts

			
1			
<b>GEV No.</b>	510298	<b>Ref. No.</b>	200444
<b>description</b>	lip valve dosing pump suitable for DB2/DS5		
<b>For models:</b>	SP1, SP2-12, SP2-S12, SP3		



accessories

container filters



1			
<b>GEV No.</b>	513043	<b>Ref. No.</b>	121017
<b>description</b>	container filter hose ø 4mm		
<b>For models:</b>	811003, 812001, 812002, 812003, 812004, 812005, 812006, 812007, 812008, 812009, 812010, 915234, 915235, 915236, 915237, 915460, 915461, 915462, 915463, 915464, 915465		



1			
<b>GEV No.</b>	361141	<b>Ref. No.</b>	121075
<b>description</b>	container filter with weight ceramic hose ø 4mm		
<b>For models:</b>	811001, 811002, 811003, 812005, 812006, 812007, 812008, 812009, 812010, 915234, 915235, 915236, 915237, 915460, 915461, 915462, 915463, 915464, 915465		



1			
<b>GEV No.</b>	518372	<b>Ref. No.</b>	00-775239-001
<b>description</b>	container filter with weight ceramic hose ø 4mm		
<b>For models:</b>	811011, 811012, 811013, 811014, 811015, 812013, 812015, 813002, 813003, 813004		

container filters with non-return valve



1			
<b>GEV No.</b>	361058	<b>Ref. No.</b>	180726 R65110650
<b>description</b>	container filter with non-return valve SS hose ø 4x6mm ø 20mm L 56mm		
<b>For models:</b>	212010, 212011, 212012, 212013, 212018, 212020, SP1, SP2-12, SP2-S12		

hoses

silicone hoses



1			
<b>GEV No.</b>	361609	<b>Ref. No.</b>	200130
<b>description</b>	silicone hose ID ø 5mm ED ø 8mm L 5m thickness 1.5mm operating pressure without pressure burst pressure non defined t.max. 200°C transparent dosing Qty 5m for peristaltic pump Shore A 55°		
<b>For models:</b>	SP1		

PVC hoses

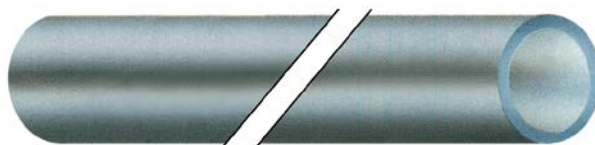

1			
<b>GEV No.</b>	570126	<b>Ref. No.</b>	01-246301-010
<b>description</b>	PVC hose ID ø 4mm ED ø 6mm L 0.28m thickness 1mm t.max. 60°C transparent		
<b>For models:</b>	811011, 811012, 811013, 811014, 811015, 812013, 812015		



1			
<b>GEV No.</b>	570124	<b>Ref. No.</b>	01-246301-008
<b>description</b>	PVC hose ID ø 4mm ED ø 6mm L 0.5m thickness 1mm t.max. 60°C transparent		
<b>For models:</b>	813002, 813003		







1			
<b>GEV No.</b>	520090	<b>Ref. No.</b>	00-898252-002 00-898252-005 143194
<b>description</b>	PVC hose ID ø 4mm ED ø 6mm L 2m thickness 1mm t.max. 60°C transparent		
<b>For models:</b>	811001, 811002, 811003, 812005, 812006, 812007, 812008, 812009, 812010, 813002, 813003, 915234, 915235, 915236, 915237, 915460, 915461, 915462, 915463, 915464, 915465		

<b>accessories for</b>	520090		
	<b>GEV No.</b>	361058	<b>Ref. No.</b>
			180726 R65110650
	<b>GEV No.</b>	361066	<b>Ref. No.</b>
			—
	<b>GEV No.</b>	361106	<b>Ref. No.</b>
			—
	<b>GEV No.</b>	361141	<b>Ref. No.</b>
			121075

Table continues overleaf



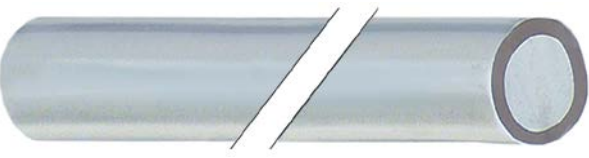

accessories for		520090	
GEV No.	361230	Ref. No.	—
	container filter with weight stainless steel hose ø 4x6mm		
GEV No.	361462	Ref. No.	—
	container filter with weight SS hose ø 4x6mm		
GEV No.	361728	Ref. No.	—
	container filter with 4m 4x6 hose SS hose ø 4x6mm hose length 4000mm		

			
1			
GEV No.	570123	Ref. No.	01-246301-001
description	PVC hose ID ø 4mm ED ø 6mm L 3.5m thickness 1mm t.max. 60°C transparent		
For models:	811011, 811012, 811013, 811014, 811015, 812013, 812015		

			
1			
GEV No.	570127	Ref. No.	01-246301-011
description	PVC hose ID ø 4mm ED ø 6mm L 4m thickness 1mm t.max. 60°C transparent		
For models:	813002, 813003, 813004		

tank inlets			
			
1			
GEV No.	361270	Ref. No.	251213 468151
description	tank inlet SS M12 hose ø 4mm		
For models:	811001, 811002, 811003, 812005, 812006, 812007, 812008, 812009, 812010, 813001, 915234, 915235, 915236, 915237, 915460, 915461, 915462, 915463, 915464, 915465, SP1, SP2-12, SP2-S12		

			
1			
GEV No.	361865	Ref. No.	00-883676-001
description	tank inlet stainless steel M10x1 hose ø 5mm		
For models:	811011, 811012, 811013, 811014, 811015, 812013, 812015, 813003		

miscellaneous			
			
1			
GEV No.	520579	Ref. No.	01-246210-001
description	marker for dosing hose blue ID ø 8mm ED ø 10mm L 40mm		
For models:	811011, 811012, 811013, 811014, 811015, 812013, 812015, 813002, 813003, 813004		



			
1			
GEV No.	521735	Ref. No.	466005
description	spacer piece for rinse aid pump		



## hoses

### supply hoses

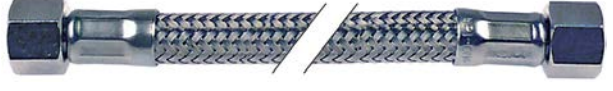
#### stainless steel flexi hoses

##### universal hoses

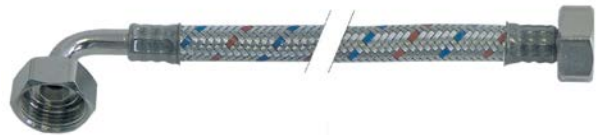
			
1			
			
GEV No.	520148	Ref. No.	WY30405
description	flex hose SS braid straight-straight DN6 connections 1/8" L 200mm approval DVGW operating p. 10bar test pressure 32bar burst p. 95bar		
For models:	742005		

			
1			
			
GEV No.	520578	Ref. No.	01-240316-001
description	flex hose SS braid straight-curved DN10 connection 1: 3/4" connection 2: 3/4" L 2000mm with integrated gasket approval DVGW operating p. 10bar test pressure 32bar burst p. 95bar		
For models:	811011, 811012, 811013, 811014, 811015, 812011, 812012, 812013, 812014, 812015, 813002, 813003, 813004		

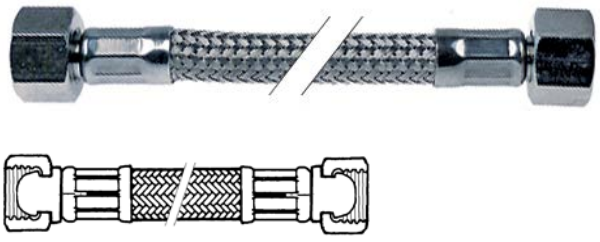

1 

<b>GEV No.</b>	520149	<b>Ref. No.</b>	WY30401
<b>description</b>	flex hose SS braid straight-straight DN6 connections 1/4" L 280mm conical seal approval DVGW operating p. 10bar test pressure 32bar burst p. 95bar		

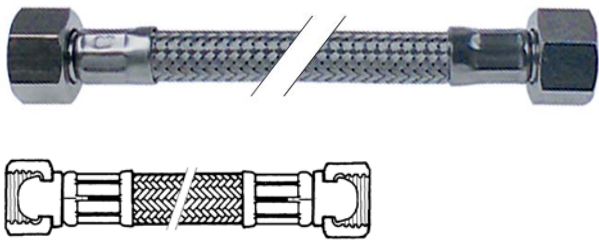
1 

<b>GEV No.</b>	520299	<b>Ref. No.</b>	WY30404
<b>description</b>	flex hose SS braid straight-straight DN8 connections 3/8" L 450mm conical seal approval DVGW operating p. 10bar test pressure 32bar burst p. 95bar		
<b>For models:</b>	742001, 742002, 742003, 742004, 742017, 742018, 742019, 742020		

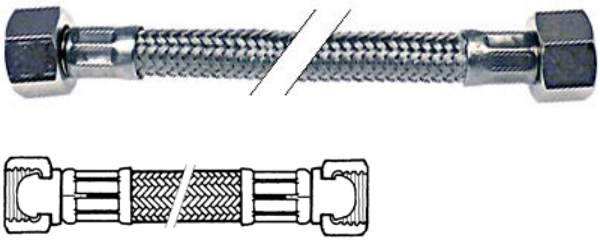
1 

<b>GEV No.</b>	520601	<b>Ref. No.</b>	WY30407
<b>description</b>	flex hose SS braid straight-straight DN8 connections 3/8" L 1000mm conical seal approval DVGW operating p. 10bar test pressure 32bar burst p. 95bar		

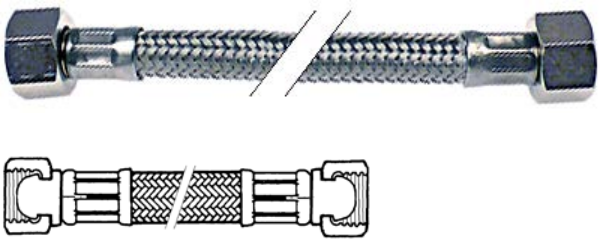
1 

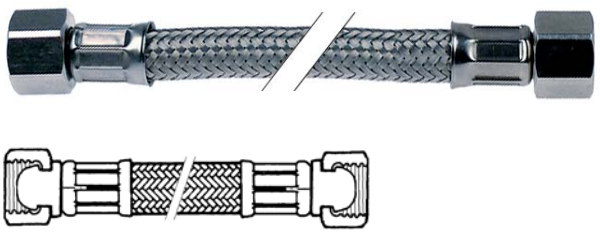

<b>GEV No.</b>	520602	<b>Ref. No.</b>	WY30408
<b>description</b>	flex hose SS braid straight-straight DN8 connections 3/8" L 1500mm conical seal approval DVGW operating p. 10bar test pressure 32bar burst p. 95bar		
<b>For models:</b>	742005, 742017, 742018, 742019, 742020		

1 

<b>GEV No.</b>	520256	<b>Ref. No.</b>	WY30403
<b>description</b>	flex hose SS braid straight-straight DN8 connections 3/8" L 330mm conical seal approval DVGW operating p. 10bar test pressure 32bar burst p. 95bar		
<b>For models:</b>	742001, 742002, 742003, 742004		

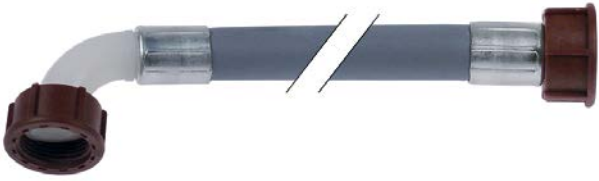
**PVC supply hoses**

1 

<b>GEV No.</b>	520010	<b>Ref. No.</b>	143170	
<b>description</b>	supply hose PVC straight-curved DN13 connections 3/4" L 1500mm operating p. 10bar burst p. 32bar t.max. 90°C blue approval VDE flat seal			
<b>accessories for</b>	520010			
	<b>GEV No.</b>	520053	<b>Ref. No.</b>	—
	screen connection 3/4" D1 ø 26mm D2 ø 15mm Qty 10 pcs rubber thickness 8mm			
	<b>GEV No.</b>	520054	<b>Ref. No.</b>	200416
	flat gasket rubber ED ø 23.5mm ID ø 14mm thickness 2.3mm Qty 10 pcs			

1 

<b>GEV No.</b>	520011	<b>Ref. No.</b>	929169
<b>description</b>	supply hose PVC straight-curved DN13 connections 3/4" L 2000mm operating p. 10bar burst p. 32bar t.max. 90°C approval VDE flat seal		
<b>For models:</b>	811003, 812001, 812002, 812003, 812004, 812005, 812006, 812007, 812008, 812009, 812010, 915234, 915235, 915236, 915237, 915460, 915461, 915462, 915463, 915464, 915465		

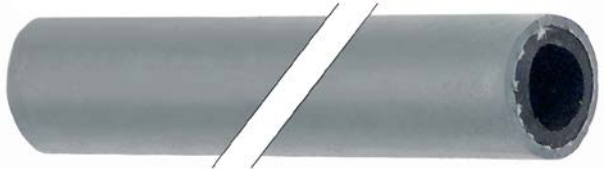
1

<b>GEV No.</b>	520015	<b>Ref. No.</b>	00-775559-007 00-775559-008 00-775559-013 00-775559-016 143004
<b>description</b>	supply hose ID ø 10mm ED ø 17mm L 5m operating p. 20bar burst p. 60bar t.max. 95°C grey Qty 5m		
<b>For models:</b>	812001, 812002, 812003, 812004, 812005, 812006, 812007, 812008, 812009, 812010, 813002, 813003, 813004, 915234, 915235, 915236, 915237, 915460, 915461, 915462, 915463, 915464, 915465		
<b>accessories for</b>	520015		
	<b>GEV No.</b>	504377	<b>Ref. No.</b> 01-240159-001
	hose connector grommet ø 23mm grommet length 25mm total length 55mm for water filling		

pre-rinse hoses

stainless steel flexi hoses



1

<b>GEV No.</b>	541396	<b>Ref. No.</b>	OP.P163.00.00
<b>description</b>	shower hose connections 1/2" L 1050mm SS operating p. 10bar burst p. 90bar t.max. 90°C for pre-rinse units suitable for drinking water rotary with flexible fabric		
<b>For models:</b>	822002, 822003		



1

<b>GEV No.</b>	542858	<b>Ref. No.</b>	OP.P162.00.00
<b>description</b>	shower hose connections 1/2" L 1200mm SS operating p. 10bar burst p. 90bar t.max. 90°C for pre-rinse units suitable for drinking water rotary with flexible fabric		
<b>For models:</b>	822001, 822004		

drain hoses



1

<b>GEV No.</b>	513718	<b>Ref. No.</b>	143120
<b>description</b>	drain hose DN19 L 1500mm straight ø inside 24mm straight ext. ø 28mm outer hose ø 23mm		
<b>For models:</b>	811003		

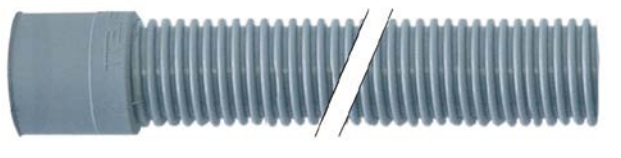

1

<b>GEV No.</b>	530587	<b>Ref. No.</b>	200721
<b>description</b>	drain hose DN28 L 2000mm straight ø inside 32mm straight ext. ø 40mm outer hose ø 35mm		
<b>For models:</b>	SP3		



1

<b>GEV No.</b>	518068	<b>Ref. No.</b>	143136
<b>description</b>	drain hose DN34 L 2000mm elbow ø inside 50mm elbow ext. ø 59mm inner hose ø 35mm outer hose ø 42mm PVC		
<b>For models:</b>	813001		

1

<b>GEV No.</b>	518518	<b>Ref. No.</b>	143178
<b>description</b>	drain hose DN19 L 1500mm A int. ø 21mm A ext. ø 27mm B int. ø 29mm B ext. ø 35mm outer hose ø 25mm		

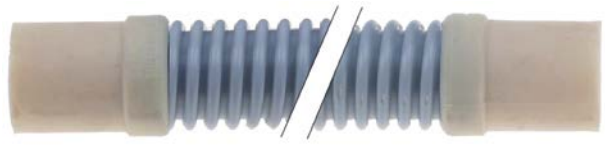

1

<b>GEV No.</b>	530298	<b>Ref. No.</b>	00-324045-000
<b>description</b>	drain hose DN19 L 2100mm A int. ø 19mm A ext. ø 25mm B int. ø 19mm B ext. ø 25mm outer hose ø 24mm		
<b>For models:</b>	811012, 811013, 811015, 812012, 812013, 812015		



1

<b>GEV No.</b>	513258	<b>Ref. No.</b>	127044
<b>description</b>	drain hose DN19 L 270mm A int. ø 22mm A ext. ø 28mm B int. ø 24mm B ext. ø 28mm outer hose ø 22mm		
<b>For models:</b>	812001, 812002, 812003, 812004, 812005, 812006, 812007, 812008, 812009, 812010, 915234, 915235, 915236, 915237, 915460, 915461, 915462, 915463, 915464, 915465		



1

<b>GEV No.</b>	518219	<b>Ref. No.</b>	127037
<b>description</b>	drain hose DN19 L 630mm A int. ø 20mm A ext. ø 27mm B int. ø 21mm B ext. ø 28mm outer hose ø 24mm		
<b>For models:</b>	812001, 812002, 812003, 812004, 812005, 812006, 812007, 812008, 812009, 812010, 915234, 915235, 915236, 915237, 915460, 915461, 915462, 915463, 915464, 915465		



1

<b>GEV No.</b>	530570	<b>Ref. No.</b>	00-323801-001
<b>description</b>	drain hose DN21 L 2000mm A int. ø 21mm A ext. ø 25mm B int. ø 20/29mm B ext. ø 27/35mm outer hose ø 25mm		
<b>For models:</b>	811011, 811014, 812011, 812014, 813002, 813004		



1

<b>GEV No.</b>	530607	<b>Ref. No.</b>	200779
<b>description</b>	drain hose DN24 L 2000mm A int. ø 24mm A ext. ø 28mm B int. ø 28mm B ext. ø 35mm outer hose ø 29mm temp.-resist. 90°C		
<b>For models:</b>	SP1		

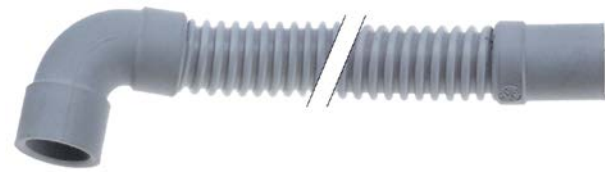

1

<b>GEV No.</b>	530299	<b>Ref. No.</b>	00-883961-001
<b>description</b>	drain hose DN19 L 2000mm straight ø inside 19mm straight ext. ø 25mm elbow ø inside 21mm elbow ext. ø 27mm outer hose ø 25mm		
<b>For models:</b>	813002, 813003, 813004		



1

<b>GEV No.</b>	530613	<b>Ref. No.</b>	200346
<b>description</b>	drain hose DN19 L 3000mm straight ø inside 21mm straight ext. ø 27mm elbow ø inside 21mm elbow ext. ø 27mm outer hose ø 20mm		
<b>For models:</b>	SP2-12, SP2-S12		



1

<b>GEV No.</b>	530819	<b>Ref. No.</b>	143137
<b>description</b>	drain hose DN20 L 2500mm straight ø inside 19mm straight ext. ø 24mm elbow ø inside 22mm elbow ext. ø 27mm outer hose ø 24mm		
<b>For models:</b>	811001, 811002, 811003		

industrial hoses

Niplaflex hoses



1

<b>GEV No.</b>	570561	<b>Ref. No.</b>	143182
<b>description</b>	pressure hose ID ø 10mm ED ø 17mm L 40m thickness 3.5mm operating p. 10bar burst p. 30bar t.max. 110°C		
<b>For models:</b>	915234, 915235, 915236, 915237		

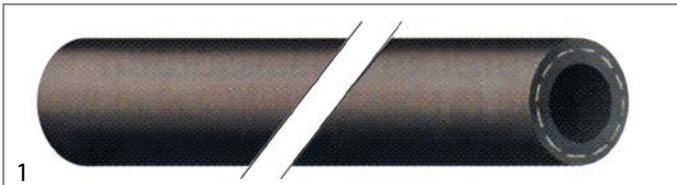
<b>GEV No.</b>	530562	<b>Ref. No.</b>	143010 200122
<b>description</b>	pressure hose ID ø 13mm ED ø 21mm L 5m operating p. 10bar burst p. 30bar t.max. 110°C		
<b>For models:</b>	813001, SP1, SP2-12, SP2-S12, SP3		

pressure control hoses



<b>GEV No.</b>	530560	<b>Ref. No.</b>	143005 160121
<b>description</b>	pressure control hose ID ø 5mm ED ø 9mm L 5m operating p. 30bar burst p. 90bar temp.-resist. 60°C		
<b>For models:</b>	811001, 811002, 811003, 812001, 812002, 812003, 812004, 812005, 812006, 812007, 812008, 812009, 812010, 915234, 915235, 915236, 915237, 915460, 915461, 915462, 915463, 915464, 915465, SP1, SP2-12, SP2-S12		

PTFE hoses

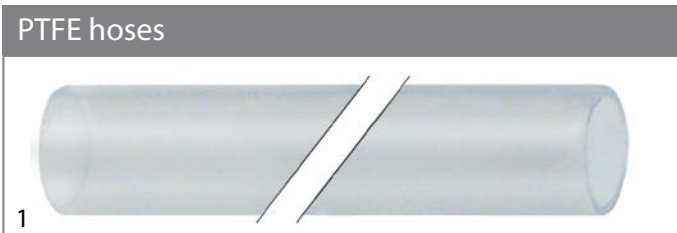

<b>GEV No.</b>	520845 <sup>1</sup>	<b>Ref. No.</b>	252658
<b>description</b>	PTFE hose ED ø 6mm ID ø 3mm thickness 1.5mm Lm		
<b>For models:</b>	743001		

PVC hoses

PVC hoses without fabric



<b>GEV No.</b>	570000	<b>Ref. No.</b>	00-775611-004
<b>description</b>	PVC hose ID ø 10mm ED ø 14mm L 1.1m thickness 2mm t.max. 60°C transparent		
<b>For models:</b>	812014, 812015		

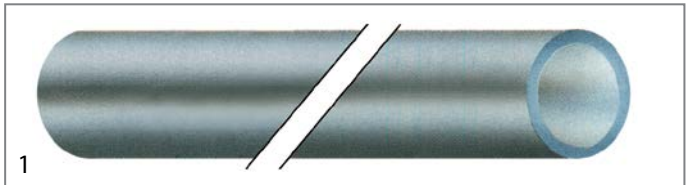

<b>GEV No.</b>	570126	<b>Ref. No.</b>	01-246301-010
<b>description</b>	PVC hose ID ø 4mm ED ø 6mm L 0.28m thickness 1mm t.max. 60°C transparent		
<b>For models:</b>	811011, 811012, 811013, 811014, 811015, 812013, 812015		

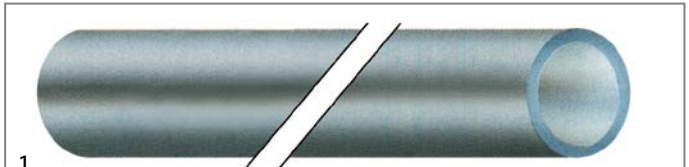

<b>GEV No.</b>	570124	<b>Ref. No.</b>	01-246301-008
<b>description</b>	PVC hose ID ø 4mm ED ø 6mm L 0.5m thickness 1mm t.max. 60°C transparent		
<b>For models:</b>	813002, 813003		











<b>GEV No.</b>	520026	<b>Ref. No.</b>	160105	
<b>description</b>	PVC hose ID ø 4mm ED ø 6mm L 10m thickness 1mm t.max. 60°C transparent			
<b>For models:</b>	SP1, SP2-12, SP2-S12			
<b>accessories for</b>	520026			
	<b>GEV No.</b>	361058	<b>Ref. No.</b>	180726 R65110650
	container filter with non-return valve SS hose ø 4x6mm ø 20mm L 56mm			
	<b>GEV No.</b>	361066	<b>Ref. No.</b>	—
	container filter straight SS hose ø 4x6mm L 37mm non return valve ball valve			
	<b>GEV No.</b>	361106	<b>Ref. No.</b>	—
	container filter with weight and non-return valve SS hose ø 4x6mm ø 21mm L 51mm non return valve lip valve			
	<b>GEV No.</b>	361141	<b>Ref. No.</b>	121075
	container filter with weight ceramic hose ø 4mm			
	<b>GEV No.</b>	361230	<b>Ref. No.</b>	—
	container filter with weight stainless steel hose ø 4x6mm			
	<b>GEV No.</b>	361462	<b>Ref. No.</b>	—
	container filter with weight SS hose ø 4x6mm			
	<b>GEV No.</b>	361728	<b>Ref. No.</b>	—
	container filter with 4m 4x6 hose SS hose ø 4x6mm hose length 4000mm			







			
<b>GEV No.</b>	520383	<b>Ref. No.</b>	H.775601
<b>description</b>	PVC hose ID ø 4mm ED ø 6mm L 2m thickness 1mm t.max. 60°C blue		
<b>For models:</b>	812001, 812002, 812003, 812004, 812005, 812006, 812007, 812008, 812009, 812010, 915234, 915235, 915236, 915237, 915460, 915461, 915462, 915463, 915464, 915465		
<b>accessories for</b>	520383		
	<b>GEV No.</b>	361058	<b>Ref. No.</b> 180726 R65110650
	container filter with non-return valve SS hose ø 4x6mm ø 20mm L 56mm		
	<b>GEV No.</b>	361066	<b>Ref. No.</b> —
	container filter straight SS hose ø 4x6mm L 37mm non return valve ball valve		
	<b>GEV No.</b>	361106	<b>Ref. No.</b> —
	container filter with weight and non-return valve SS hose ø 4x6mm ø 21mm L 51mm non return valve lip valve		
	<b>GEV No.</b>	361141	<b>Ref. No.</b> 121075
	container filter with weight ceramic hose ø 4mm		
	<b>GEV No.</b>	361230	<b>Ref. No.</b> —
	container filter with weight stainless steel hose ø 4x6mm		
	<b>GEV No.</b>	361462	<b>Ref. No.</b> —
	container filter with weight SS hose ø 4x6mm		
	<b>GEV No.</b>	361728	<b>Ref. No.</b> —
	container filter with 4m 4x6 hose SS hose ø 4x6mm hose length 4000mm		

			
<b>GEV No.</b>	520090	<b>Ref. No.</b>	00-898252-002 00-898252-005 143194
<b>description</b>	PVC hose ID ø 4mm ED ø 6mm L 2m thickness 1mm t.max. 60°C transparent		
<b>For models:</b>	811001, 811002, 811003, 812005, 812006, 812007, 812008, 812009, 812010, 813002, 813003, 915234, 915235, 915236, 915237, 915460, 915461, 915462, 915463, 915464, 915465		
<b>accessories for</b>	520090		
	<b>GEV No.</b>	361058	<b>Ref. No.</b> 180726 R65110650
	container filter with non-return valve SS hose ø 4x6mm ø 20mm L 56mm		
	<b>GEV No.</b>	361066	<b>Ref. No.</b> —
	container filter straight SS hose ø 4x6mm L 37mm non return valve ball valve		
	<b>GEV No.</b>	361106	<b>Ref. No.</b> —
	container filter with weight and non-return valve SS hose ø 4x6mm ø 21mm L 51mm non return valve lip valve		
	<b>GEV No.</b>	361141	<b>Ref. No.</b> 121075
	container filter with weight ceramic hose ø 4mm		
	<b>GEV No.</b>	361230	<b>Ref. No.</b> —
	container filter with weight stainless steel hose ø 4x6mm		

<b>accessories for</b>	520090		
	<b>GEV No.</b>	361462	<b>Ref. No.</b> —
	container filter with weight SS hose ø 4x6mm		
	<b>GEV No.</b>	361728	<b>Ref. No.</b> —
	container filter with 4m 4x6 hose SS hose ø 4x6mm hose length 4000mm		

			
<b>GEV No.</b>	570123	<b>Ref. No.</b>	01-246301-001
<b>description</b>	PVC hose ID ø 4mm ED ø 6mm L 3.5m thickness 1mm t.max. 60°C transparent		
<b>For models:</b>	811011, 811012, 811013, 811014, 811015, 812013, 812015		

			
<b>GEV No.</b>	570127	<b>Ref. No.</b>	01-246301-011
<b>description</b>	PVC hose ID ø 4mm ED ø 6mm L 4m thickness 1mm t.max. 60°C transparent		
<b>For models:</b>	813002, 813003, 813004		

			
<b>GEV No.</b>	520027	<b>Ref. No.</b>	00-324402-005 00-324402-014 143013
<b>description</b>	PVC hose ID ø 4mm ED ø 7mm L 10m thickness 1.5mm t.max. 60°C transparent		
<b>For models:</b>	811011, 811012, 811013, 811014, 811015, 812001, 812002, 812003, 812004, 812005, 812006, 812007, 812008, 812009, 812010, 812011, 812012, 812013, 812014, 812015, 915234, 915235, 915236, 915237, 915460, 915461, 915462, 915463, 915464, 915465		

			
<b>GEV No.</b>	520278	<b>Ref. No.</b>	R70070100
<b>description</b>	PVC hose ID ø 6mm ED ø 8mm L 2m thickness 1mm t.max. 60°C transparent		
<b>For models:</b>	212010, 212011, 212012, 212013		

extraction and pressure hoses



<b>GEV No.</b>	570202 <sup>1</sup>	<b>Ref. No.</b>	0322052
<b>description</b>	pressure hose ID ø 7mm ED ø 13mm Lm operating p. 10bar burst p. 30bar temp.-resist. -30 up to +80°C		

<sup>1</sup>by the meter

silicone hoses

without fabric



<b>GEV No.</b>	527371	<b>Ref. No.</b>	95.08.20
<b>description</b>	silicone hose for milk foamer ID ø 5mm ED ø 8mm L 180mm		
<b>For models:</b>	745002		

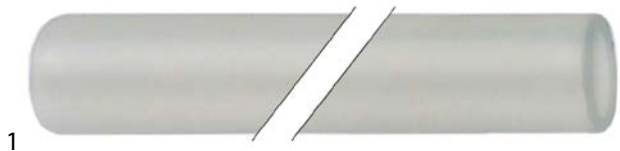

<b>GEV No.</b>	530821	<b>Ref. No.</b>	00-774080-001 413169
<b>description</b>	silicone hose ID ø 10mm ED ø 15mm L 1m thickness 2.5mm operating pressure without pressure burst pressure non defined t.max. 200°C transparent Shore 60°		
<b>For models:</b>	741001, 741002, 741003, 811011, 811012, 811013, 811014, 811015, 812011, 812012, 812013, 812014, 812015, 813002, 813003, 813004		

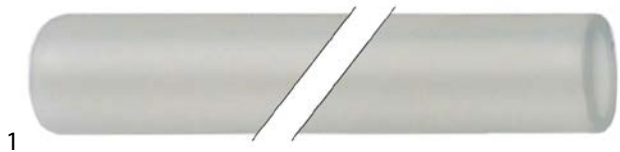

<b>GEV No.</b>	530822	<b>Ref. No.</b>	1003369
<b>description</b>	silicone hose ID ø 10mm ED ø 16mm L 1m thickness 3mm operating pressure without pressure burst pressure non defined t.max. 200°C transparent		
<b>For models:</b>	741003		

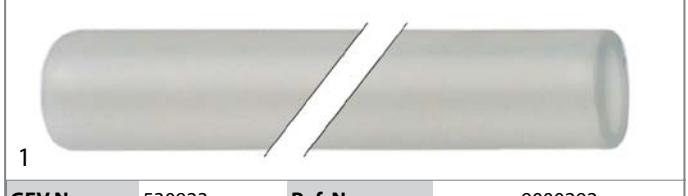

<b>GEV No.</b>	530823	<b>Ref. No.</b>	9000292
<b>description</b>	silicone hose ID ø 12mm ED ø 16mm L 1m thickness 2mm operating pressure without pressure burst pressure non defined t.max. 200°C transparent		
<b>For models:</b>	741001, 741002, 741003		



<b>GEV No.</b>	530899	<b>Ref. No.</b>	R70060080
<b>description</b>	silicone hose ID ø 13mm ED ø 18mm L 0.08m thickness 2.5mm red for combi-steamer		
<b>For models:</b>	212001, 212002, 212003, 212010, 212011, 212012, 212013		



<b>GEV No.</b>	530754	<b>Ref. No.</b>	13107
<b>description</b>	silicone hose ID ø 13mm ED ø 19mm L 0.13m t.max. 200°C for ice-cube maker		
<b>For models:</b>	711008, 711009, 711010, 711011		

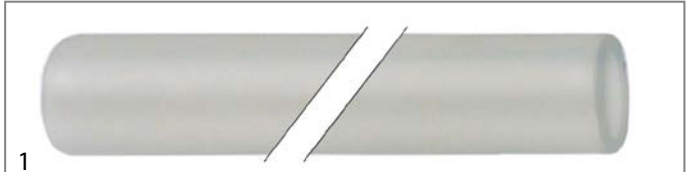

<b>GEV No.</b>	530752	<b>Ref. No.</b>	13106
<b>description</b>	silicone hose ID ø 13mm ED ø 19mm L 0.15m t.max. 200°C for ice-cube maker		
<b>For models:</b>	711006, 711007		

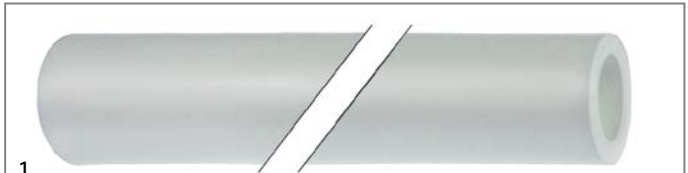

<b>GEV No.</b>	530757	<b>Ref. No.</b>	13108
<b>description</b>	silicone hose ID ø 13mm ED ø 19mm L 0.24m t.max. 200°C for ice-cube maker		
<b>For models:</b>	711012, 711013		

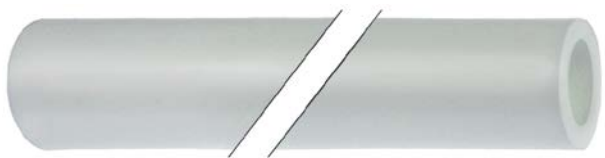

			
1			
<b>GEV No.</b>	530758	<b>Ref. No.</b>	13109
<b>description</b>	silicone hose ID ø 13mm ED ø 19mm L 0.26m t.max. 200°C for ice-cube maker		
<b>For models:</b>	711014, 711015, 711016, 711017		

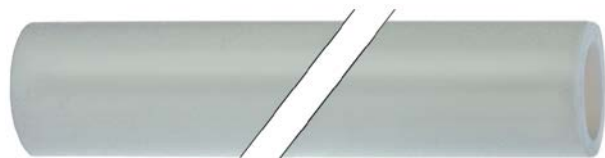
			
1			
<b>GEV No.</b>	530737	<b>Ref. No.</b>	13137
<b>description</b>	silicone hose ID ø 16mm ED ø 23mm L 0.29m t.max. 200°C for ice-cube maker		
<b>For models:</b>	711006, 711007		

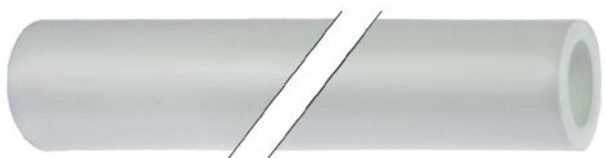
			
1			
<b>GEV No.</b>	530759	<b>Ref. No.</b>	13110
<b>description</b>	silicone hose ID ø 13mm ED ø 19mm L 0.35m t.max. 200°C for ice-cube maker		
<b>For models:</b>	711018, 711019		

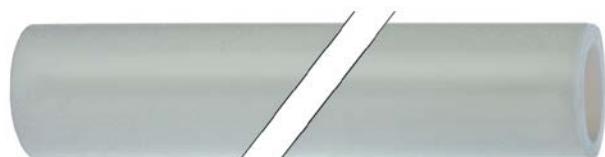
			
1			
<b>GEV No.</b>	530738	<b>Ref. No.</b>	13139
<b>description</b>	silicone hose ID ø 16mm ED ø 23mm L 0.4m t.max. 200°C for ice-cube maker		
<b>For models:</b>	711012, 711013		

			
1			
<b>GEV No.</b>	530749	<b>Ref. No.</b>	13105
<b>description</b>	silicone hose ID ø 13mm ED ø 19mm L 0.7m t.max. 200°C for ice-cube maker		
<b>For models:</b>	711004, 711005		

			
1			
<b>GEV No.</b>	530739	<b>Ref. No.</b>	13140
<b>description</b>	silicone hose ID ø 16mm ED ø 23mm L 0.5m t.max. 200°C for ice-cube maker		
<b>For models:</b>	711014, 711015, 711016, 711017		

			
1			
<b>GEV No.</b>	530731	<b>Ref. No.</b>	13056
<b>description</b>	silicone hose ID ø 16mm ED ø 23mm L 0.03m t.max. 200°C for ice-cube maker		
<b>For models:</b>	711001, 711002, 711003		

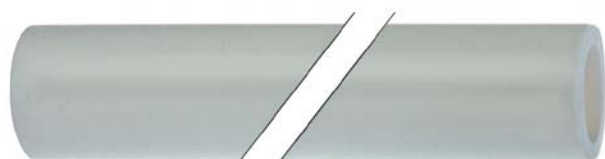
			
1			
<b>GEV No.</b>	530740	<b>Ref. No.</b>	13141
<b>description</b>	silicone hose ID ø 16mm ED ø 23mm L 0.61m t.max. 200°C for ice-cube maker		
<b>For models:</b>	711018, 711019		

			
1			
<b>GEV No.</b>	530063	<b>Ref. No.</b>	MA1036100700
<b>description</b>	silicone hose ID ø 18mm ED ø 25mm L 1m t.max. 200°C transparent		
<b>For models:</b>	126101, 126103		

1

<b>GEV No.</b>	530764	<b>Ref. No.</b>	13138
<b>description</b>	silicone hose ID ø 18mm ED ø 27mm L 0.3m t.max. 200°C for ice-cube maker		
<b>For models:</b>	711008, 711009, 711010, 711011		



1

<b>GEV No.</b>	520842	<b>Ref. No.</b>	097529
<b>description</b>	silicone hose ID ø 3mm ED ø 6mm L 1m thickness 1.5mm t.max. 200°C brown		
<b>For models:</b>	743001		



1

<b>GEV No.</b>	527373	<b>Ref. No.</b>	90.20.00
<b>description</b>	silicone hose ID ø 5mm ED ø 8mm L 115mm		
<b>For models:</b>	745002		

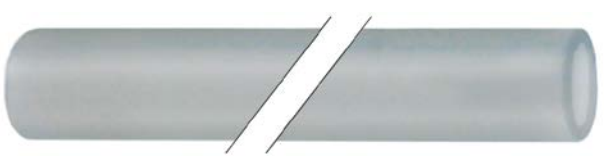

1

<b>GEV No.</b>	361609	<b>Ref. No.</b>	200130
<b>description</b>	silicone hose ID ø 5mm ED ø 8mm L 5m thickness 1.5mm operating pressure without pressure burst pressure non defined t.max. 200°C transparent dosing Qty 5m for peristaltic pump Shore A 55°		
<b>For models:</b>	SP1		



1

<b>GEV No.</b>	520843	<b>Ref. No.</b>	097510
<b>description</b>	silicone hose ID ø 5mm ED ø 9mm L 1m thickness 2mm operating pressure without pressure burst pressure non defined t.max. 200°C brown		
<b>For models:</b>	743001		



1

<b>GEV No.</b>	520844	<b>Ref. No.</b>	097511
<b>description</b>	silicone hose ID ø 6mm ED ø 9mm L 1m thickness 1.5mm operating pressure without pressure burst pressure non defined t.max. 200°C brown		
<b>For models:</b>	743001		

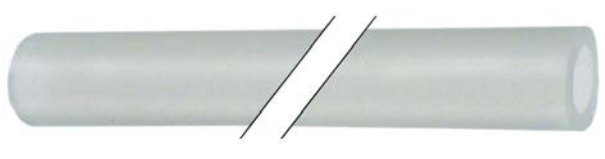

1

<b>GEV No.</b>	570157	<b>Ref. No.</b>	R70070090
<b>description</b>	silicone hose ID ø 7mm ED ø 12mm L 1m thickness 2.5mm transparent for combi-steamer		
<b>For models:</b>	212010, 212011, 212012, 212013		



1

<b>GEV No.</b>	530820	<b>Ref. No.</b>	9000261
<b>description</b>	silicone hose ID ø 8mm ED ø 14mm L 1m thickness 3mm operating pressure without pressure burst pressure non defined t.max. 200°C transparent Shore 60°		
<b>For models:</b>	741003		



1

<b>GEV No.</b>	520840	<b>Ref. No.</b>	097513
<b>description</b>	silicone hose ID ø 9mm ED ø 13mm L 1m thickness 2mm operating pressure without pressure burst pressure non defined t.max. 200°C brown		
<b>For models:</b>	743001		



			
1			
<b>GEV No.</b>	530736	<b>Ref. No.</b>	13136
<b>description</b>	silicone hose straight for ice-cube maker ID ø 18mm ED ø 25mm L 213mm		
<b>For models:</b>	711004, 711005		

for peristaltic pumps

			
1			
<b>GEV No.</b>	361609	<b>Ref. No.</b>	200130
<b>description</b>	silicone hose ID ø 5mm ED ø 8mm L 5m thickness 1.5mm operating pressure without pressure burst pressure non defined t.max. 200°C transparent dosing Qty 5m for peristaltic pump Shore A 55°		
<b>For models:</b>	SP1		

formed hoses

straight

			
1			
<b>GEV No.</b>	530278	<b>Ref. No.</b>	00-883776-001
<b>description</b>	formed hose D1 ø 24mm L 765mm for boiler ID ø 17.5mm		
<b>For models:</b>	813003, 813004		

			
1			
<b>GEV No.</b>	530276	<b>Ref. No.</b>	00-883721-001
<b>description</b>	formed hose D1 ø 25mm D2 ø 17mm L 700mm for wash pump		
<b>For models:</b>	813003		

			
1			
<b>GEV No.</b>	518519	<b>Ref. No.</b>	127054
<b>description</b>	formed hose dishwasher straight equiv. no. 127054		
<b>For models:</b>	811001, 811002, 811003		

			
1			
<b>GEV No.</b>	518070	<b>Ref. No.</b>	127026
<b>description</b>	formed hose dishwasher straight mounting pos. upper equiv. no. 127026		
<b>For models:</b>	812001, 812002, 812003, 812004, 812005, 812006, 812007, 812008, 812009, 812010, 915234, 915235, 915236, 915237, 915460, 915461, 915462, 915463, 915464, 915465		

			
1			
<b>GEV No.</b>	518380	<b>Ref. No.</b>	127036 80189
<b>description</b>	formed hose ext. ø 53 ID ø 43mm L 65mm dishwasher straight mounting pos. upper equiv. no. 127036		
<b>For models:</b>	812001, 812002, 812003, 812004, 812005, 812006, 812007, 812008, 812009, 812010, 813001, 915234, 915235, 915236, 915237, 915460, 915461, 915462, 915463, 915464, 915465		

			
1			
<b>GEV No.</b>	530290	<b>Ref. No.</b>	00-883775-001
<b>description</b>	formed hose hose ext. ø 26mm hose int. ø 19mm L 655mm connection ø 23.5mm		
<b>For models:</b>	813003		

			
1			
<b>GEV No.</b>	508402	<b>Ref. No.</b>	00-883680-001
<b>description</b>	formed hose hose ext. ø 32mm hose int. ø 26mm L 85mm		
<b>For models:</b>	813003, 813004		

form L

			
1			
<b>GEV No.</b>	518639	<b>Ref. No.</b>	143237
<b>description</b>	formed hose end piece A ext. ø 18mm end piece A int. ø 11mm AD2 ø 18mm ø end piece B 11mm L 460mm		
<b>For models:</b>	811003		

			
1			
<b>GEV No.</b>	507494	<b>Ref. No.</b>	00-898247-002
<b>description</b>	formed hose end piece A ext. ø 19mm end piece A int. ø 13mm AD2 ø 19mm ø end piece B 13mm L 485mm for wash pipe		
<b>For models:</b>	813002, 813003, 813004		

			
1			
<b>GEV No.</b>	507492	<b>Ref. No.</b>	00-898247-009
<b>description</b>	formed hose end piece A ext. ø 20mm end piece A int. ø 13mm AD2 ø 19mm ø end piece B 12mm L 755mm		
<b>For models:</b>	812011, 812012, 812013, 812014, 812015, 813002, 813003, 813004		



1			
<b>GEV No.</b>	507493	<b>Ref. No.</b>	00-883524-001
<b>description</b>	formed hose end piece A ext. ø 36.5mm end piece A int. ø 29mm AD2 ø 30mm ø end piece B 22mm L 520mm drain tank - drain pump L-shape		
<b>For models:</b>	813003		



1			
<b>GEV No.</b>	504390	<b>Ref. No.</b>	200612
<b>description</b>	formed hose end piece A ext. ø 56mm end piece A int. ø 45mm AD2 ø 59mm ø end piece B 48mm L 180mm warewashing		
<b>For models:</b>	SP2-12, SP2-S12		



1			
<b>GEV No.</b>	513250	<b>Ref. No.</b>	80188
<b>description</b>	formed hose ID ø 48mm ED ø 60mm thickness 6mm L1 235mm L2 140mm L-shape		
<b>For models:</b>	813001		



1			
<b>GEV No.</b>	513254	<b>Ref. No.</b>	80186
<b>description</b>	formed hose L 340mm warewashing L-shape equiv. no. 80186 ID ø 60mm		
<b>For models:</b>	813001		



1			
<b>GEV No.</b>	518225	<b>Ref. No.</b>	127041
<b>description</b>	formed hose warewashing L-shape equiv. no. 127041		
<b>For models:</b>	812001, 812002, 812003, 812004, 812005, 812006, 812007, 812008, 812009, 812010, 915234, 915235, 915236, 915237, 915460, 915461, 915462, 915463, 915464, 915465		



1			
<b>GEV No.</b>	512380	<b>Ref. No.</b>	201059
<b>description</b>	pressure hose L-shape		
<b>For models:</b>	SP1		

with branch



1			
<b>GEV No.</b>	511929	<b>Ref. No.</b>	143239
<b>description</b>	formed hose ext. ø 17 L 430mm plastic black Qty 1		
<b>For models:</b>	811001, 811002, 811003		

form U



1			
<b>GEV No.</b>	512032	<b>Ref. No.</b>	200611
<b>description</b>	formed hose D1 ø 30mm D2 ø 37mm L 645mm Qty 1		
<b>For models:</b>	SP2-12, SP2-S12		



1			
<b>GEV No.</b>	524820	<b>Ref. No.</b>	201056
<b>description</b>	formed hose D1 ø 75mm D2 ø 83mm L 340mm warewashing black Qty 1		
<b>For models:</b>	SP3		



1			
<b>GEV No.</b>	518517	<b>Ref. No.</b>	127050
<b>description</b>	formed hose for drain pump D1 ø 28mm D2 ø 21mm warewashing U-shape		
<b>For models:</b>	812001, 812002, 812003, 812004, 812005, 812006, 812007, 812008, 812009, 812010, 915234, 915235, 915236, 915237, 915460, 915461, 915462, 915463, 915464, 915465		



1

<b>GEV No.</b>	513260	<b>Ref. No.</b>	143242
<b>description</b>	formed hose warewashing		
<b>For models:</b>	811003		

miscellaneous



1

<b>GEV No.</b>	513293	<b>Ref. No.</b>	143236
<b>description</b>	formed hose ext. ø 18 ID ø 11mm L 535mm dishwasher		
<b>For models:</b>	811003		



1

<b>GEV No.</b>	513716	<b>Ref. No.</b>	127053
<b>description</b>	pressure hose warewashing		
<b>For models:</b>	811003		

for dishwashers

ventilation hoses



1

<b>GEV No.</b>	513265	<b>Ref. No.</b>	143189
<b>description</b>	ventilation hose ext. ø 17 ID ø 14mm L 75mm warewashing back-flow restrictor		
<b>For models:</b>	812001, 812002, 812003, 812004, 812005, 812006, 812007, 812008, 812009, 812010, 915234, 915235, 915236, 915237, 915460, 915461, 915463, 915464		

miscellaneous



1

<b>GEV No.</b>	510806	<b>Ref. No.</b>	160108
<b>description</b>	extraction hose ED ø 8mm ID ø 5mm Qty supplied by meter		
<b>For models:</b>	SP2-12, SP2-S12, SP3		



1

<b>GEV No.</b>	530590	<b>Ref. No.</b>	200117
<b>description</b>	hose ED ø 15mm ID ø 8mm equiv. no. 200117 Qty supplied by meter		
<b>For models:</b>	SP1, SP2-12, SP2-S12, SP3		



1

<b>GEV No.</b>	511573	<b>Ref. No.</b>	161320
<b>description</b>	hose ED ø 9mm ID ø 5mm L 2400mm Qty 1 ext. ø 9.5		
<b>For models:</b>	SP3		



1

<b>GEV No.</b>	570126	<b>Ref. No.</b>	01-246301-010
<b>description</b>	PVC hose ID ø 4mm ED ø 6mm L 0.28m thickness 1mm t.max. 60°C transparent		
<b>For models:</b>	811011, 811012, 811013, 811014, 811015, 812013, 812015		



1

<b>GEV No.</b>	570124	<b>Ref. No.</b>	01-246301-008
<b>description</b>	PVC hose ID ø 4mm ED ø 6mm L 0.5m thickness 1mm t.max. 60°C transparent		
<b>For models:</b>	813002, 813003		



## fittings, hose and pipe connectors

### hose connectors

#### without screw connection



1			
<b>GEV No.</b>	541109	<b>Ref. No.</b>	035031
<b>description</b>	Y-piece plastic hose ø 8-6-8mm for pressure switch		
<b>For models:</b>	812002, 812007, 812009, 915234, 915235, 915236, 915237, 915460		



1			
<b>GEV No.</b>	510843	<b>Ref. No.</b>	180408
<b>description</b>	T-piece plastic hose ø 10-6-10mm		
<b>For models:</b>	SP2-12, SP2-S12, SP3		

### fittings

#### double nipples



1			
<b>GEV No.</b>	527193	<b>Ref. No.</b>	WY23210
<b>description</b>	double nipple brass thread 1/8" - 1/8"		
<b>For models:</b>	742001, 742002, 742003, 742004, 742005		

#### reducers



1			
<b>GEV No.</b>	527207	<b>Ref. No.</b>	WY25743
<b>description</b>	reducer thread 1/4" IT - 1/8" ET brass WS 17		
<b>For models:</b>	742005		



1			
<b>GEV No.</b>	520182	<b>Ref. No.</b>	409017100
<b>description</b>	reducer thread 3/4" ET - 1/2" IT nickel-plated brass total length 17.5mm WS 30		
<b>For models:</b>	244004, 244005, 244007, 244008, 244009, 244021		



1			
<b>GEV No.</b>	527197	<b>Ref. No.</b>	WY25744
<b>description</b>	reducer thread 3/8" IT - 1/8" IT brass WS 20 L 26mm		
<b>For models:</b>	742001, 742002, 742003, 742004, 742005		

#### sleeves



1			
<b>GEV No.</b>	520176	<b>Ref. No.</b>	409021134
<b>description</b>	sleeve thread 3/4" - 3/4" nickel-plated brass WS 32 total length 32mm		
<b>For models:</b>	114001, 114002, 114003, 116001, 116002		

#### angle pieces



1			
<b>GEV No.</b>	541924	<b>Ref. No.</b>	409011100
<b>description</b>	angle piece thread 1/2" IT - 1/2" IT brass		
<b>For models:</b>	245004, 245005, 245007, 245008, 262003		





T-pieces

miscellaneous



1

<b>GEV No.</b>	527204	<b>Ref. No.</b>	WY43030001
<b>description</b>	T-piece thread 3/8" ET - 3/8" IT - 1/4" IT L 31mm for filling valve WS 23 W 40mm brass		
<b>For models:</b>	742001, 742002, 742003, 742004		

screw pipe fittings

angle pieces



1

<b>GEV No.</b>	699452	<b>Ref. No.</b>	R62090633
<b>description</b>	angle piece thread M14x1 tube ø 10mm brass		
<b>For models:</b>	212010, 212011, 212012, 212013, 212018, 212020		

miscellaneous



1

<b>GEV No.</b>	541928	<b>Ref. No.</b>	409006250
<b>description</b>	angle piece thread 3/4"		
<b>For models:</b>	114001, 114002, 114003, 115001, 115002, 116001, 116002		



1

<b>GEV No.</b>	527250	<b>Ref. No.</b>	WY25691003
<b>description</b>	connecting fitting L 29mm ID ø 8mm WS 22 brass thread 3/8" IT - 3/8" ET		
<b>For models:</b>	742005		

extensions



1

<b>GEV No.</b>	541925	<b>Ref. No.</b>	409031140
<b>description</b>	extension fitting thread 1/2" IT - 1/2" ET brass L 40mm		
<b>For models:</b>	245007, 245008		



1

<b>GEV No.</b>	541926	<b>Ref. No.</b>	409032330
<b>description</b>	extension fitting thread 3/4" IT - 3/4" ET brass L 30mm		
<b>For models:</b>	115001, 115002		



1

<b>GEV No.</b>	541927	<b>Ref. No.</b>	409032340
<b>description</b>	extension fitting thread 3/4" IT - 3/4" ET chrome-plated brass L 40mm		
<b>For models:</b>	244021		

hose connectors

plastic



1

<b>GEV No.</b>	362015	<b>Ref. No.</b>	R62090638
<b>description</b>	hose connector plastic straight IT 1/4" hose ø 8mm		
<b>For models:</b>	212018, 212020		



1

<b>GEV No.</b>	362011	<b>Ref. No.</b>	R62090538
<b>description</b>	hose connector plastic straight thread 1/4" hose ø 8x6mm Qty 1 pcs		
<b>For models:</b>	212010, 212011, 212012, 212013, 212018, 212020		

brass



1

<b>GEV No.</b>	520333	<b>Ref. No.</b>	095529
<b>description</b>	hose connector brass straight thread 1/8" hose ø 7mm Qty 1 pcs		
<b>For models:</b>	743001		





			
1			
<b>GEV No.</b>	513253	<b>Ref. No.</b>	108006
<b>description</b>	hose connector brass angled thread 1/4" hose ø 12mm Qty 1 pcs		

producer-specific



			
1			
<b>GEV No.</b>	695533	<b>Ref. No.</b>	10404
<b>description</b>	butt splice connector thread M23x1.5 for hose ID 18mm		
<b>For models:</b>	711004, 711005, 711006, 711007, 711008, 711009, 711010, 711011, 711012, 711013, 711014, 711015, 711016, 711017, 711018, 711019		

			
1			
<b>GEV No.</b>	440027	<b>Ref. No.</b>	R62090482
<b>description</b>	connecting piece for hose ID 6mm WS 15 total length 79mm plastic John Guest		
<b>For models:</b>	212010, 212011, 212012, 212013, 212018, 212020		

			
1			
<b>GEV No.</b>	504377	<b>Ref. No.</b>	01-240159-001
<b>description</b>	hose connector grommet ø 23mm grommet length 25mm total length 55mm for water filling		
<b>For models:</b>	813002, 813003, 813004		



			
1			
<b>GEV No.</b>	520339	<b>Ref. No.</b>	R62090518
<b>description</b>	hose connector thread 1/4" straight grommet ø 10mm grommet length 20mm WS 20 total length 37mm thread L 11mm plastic		
<b>For models:</b>	212010, 212011, 212012, 212013		



			
1			
<b>GEV No.</b>	520360	<b>Ref. No.</b>	R62090508
<b>description</b>	hose connector thread 1/4" with coupling straight plastic		
<b>For models:</b>	212001, 212002, 212003, 212005, 212007, 212009, 212010, 212011, 212012, 212013, 212018, 212020		

			
1			
<b>GEV No.</b>	511679	<b>Ref. No.</b>	00-324071-000
<b>description</b>	T-piece connection 17.5mm plastic L 80mm W 40mm connection 1: 13.5mm connection 2: 13.5mm suitable for HOBART		
<b>For models:</b>	811011, 811012, 811013, 811014, 811015, 813002, 813003, 813004		
<b>accessories for</b>	511679		
	<b>GEV No.</b>	520573	<b>Ref. No.</b> 00-324510-202
hose clamp ø 20mm wire gauge ø 2mm Qty 1 pcs			

push-in fittings

JOHN GUEST

			
1			
<b>GEV No.</b>	520359	<b>Ref. No.</b>	R62090528
<b>description</b>	push-in fitting John Guest angled pipe connection ø 10mm grommet ø 10mm		
<b>For models:</b>	212010, 212011, 212012, 212013, 212018, 212020		
<b>accessories for</b>	520359		
	<b>GEV No.</b>	520973	<b>Ref. No.</b> —
hose John Guest thickness 1.5mm LLDPE blue ID ø 7mm ED ø 10mm			

			
1			
<b>GEV No.</b>	440671	<b>Ref. No.</b>	00011090 R62090648
<b>description</b>	push-in fitting John Guest angled pipe connection ø 8mm grommet ø 8mm		
<b>For models:</b>	211039, 211044, 211045, 211046, 212010, 212011, 212012, 212013, 212036, 212037, 212039, 212041		
<b>accessories for</b>	440671		
	<b>GEV No.</b>	520972	<b>Ref. No.</b> —
hose John Guest thickness 1mm LLDPE blue ID ø 6mm ED ø 8mm			

			
1			
<b>GEV No.</b>	520493	<b>Ref. No.</b>	00006430 R62090618
<b>description</b>	hose connector John Guest straight pipe connection ø 8mm - ø 10mm L 41mm PM201008E NSF, SK		
<b>For models:</b>	211039, 211042, 211043, 211044, 211045, 211046, 212010, 212011, 212012, 212013, 212018, 212020, 212034, 212035, 212036, 212037, 212038, 212039, 212040, 212041		







			
1			
<b>GEV No.</b>	520492	<b>Ref. No.</b>	R62090458
<b>description</b>	push-in fitting John Guest straight pipe connection ø10mm - ø10mm		
<b>For models:</b>	212001, 212002, 212003, 212010, 212011, 212012, 212013		

			
1			
<b>GEV No.</b>	520497	<b>Ref. No.</b>	RAC30001
<b>description</b>	push-in fitting John Guest straight pipe connection ø8mm - ø8mm		
<b>For models:</b>	211005, 211006, 211010, 211012, 211013, 211014, 211015, 211016, 211027, 212014, 212015, 212016, 212024, 212025		

			
1			
<b>GEV No.</b>	520961	<b>Ref. No.</b>	R62090788
<b>description</b>	push-in fitting pipe connection ø6mm - ø10mm		
<b>For models:</b>	212004, 212005, 212006, 212007, 212008, 212009, 212017, 212018, 212019, 212020		

			
1			
<b>GEV No.</b>	520585	<b>Ref. No.</b>	RAC30003
<b>description</b>	plug connector John Guest angled pipe connection ø8mm - ø8mm approval NSF, SK		
<b>For models:</b>	211005, 211006, 211010, 211012, 211013, 211014, 211015, 211016, 211018, 211020, 211023, 211024, 211026, 211027, 211029, 212014, 212015, 212016, 212024, 212025		

			
1			
<b>GEV No.</b>	520494	<b>Ref. No.</b>	R62090478
<b>description</b>	push-in fitting John Guest angled pipe connection ø10mm - ø10mm		
<b>For models:</b>	212001, 212002, 212003, 212010, 212011, 212012, 212013		
<b>accessories for</b>	520494		
	<b>GEV No.</b>	520973	<b>Ref. No.</b> —
hose John Guest thickness 1.5mm LLDPE blue ID ø 7mm ED ø 10mm			

			
1			
<b>GEV No.</b>	520363	<b>Ref. No.</b>	R62090468
<b>description</b>	push-in fitting John Guest T-piece pipe connection ø10mm - ø10mm - ø10mm		
<b>For models:</b>	212010, 212011, 212012, 212013, 212018, 212020		
<b>accessories for</b>	520363		
	<b>GEV No.</b>	520973	<b>Ref. No.</b> —
hose John Guest thickness 1.5mm LLDPE blue ID ø 7mm ED ø 10mm			

			
1			
<b>GEV No.</b>	520495	<b>Ref. No.</b>	R62090608
<b>description</b>	push-in fitting John Guest straight thread 1/8" BSP stub ø 8mm		
<b>For models:</b>	212010, 212011, 212012, 212013, 212018, 212020		
<b>accessories for</b>	520495		
	<b>GEV No.</b>	520971	<b>Ref. No.</b> —
hose thickness 1mm LLDPE blue ID ø 4mm ED ø 6mm operating pressure at 20°C 16bar			

## valves and tank inlets

### ball valves

#### universal

#### mini ball valves

			
1			
<b>GEV No.</b>	514403	<b>Ref. No.</b>	409000200
<b>description</b>	ball valve angled connection 3/8" ET - 1/2" ET DN8 total length 56mm		
<b>For models:</b>	245004, 245005, 245007, 245008, 262003		



ball valves with butterfly handle



1

<b>GEV No.</b>	101895	<b>Ref. No.</b>	GS2004
<b>description</b>	ball valve connection 1/4" IT - 1/4" IT DN10 total length 45mm		
<b>For models:</b>	233001		



1

<b>GEV No.</b>	541921	<b>Ref. No.</b>	409001100
<b>description</b>	ball valve connection 1/2" IT - 1/2" IT DN15 total length 61mm		
<b>For models:</b>	245003, 955001, 955002, 955003, 955004		



1

<b>GEV No.</b>	540658	<b>Ref. No.</b>	1450500 MA1450500
<b>description</b>	ball valve connection 3/4" IT - 3/4" IT DN20 total length 69mm		
<b>For models:</b>	126101, 126103		



1

<b>GEV No.</b>	520836	<b>Ref. No.</b>	409001200
<b>description</b>	ball valve connection 3/4" IT - 3/4" IT total length 54mm handle length 87mm		
<b>For models:</b>	244021		

ball valves with lever handle



1

<b>GEV No.</b>	540758	<b>Ref. No.</b>	6A023010
<b>description</b>	ball valve connection 1" IT - 1" ET DN25 total length 90mm with lever handle handle length 95mm		
<b>For models:</b>	134001, 134002, 134003, 134004, 134005, 134006, 134201, 134202, 134203, 134204, 134205, 134206		

producer-specific

COOKMAX



1

<b>GEV No.</b>	514400	<b>Ref. No.</b>	1031400313 MA1031400313
<b>description</b>	ball valve connection 1/2" IT - 1/2" IT total length 47mm handle length 68mm		
<b>For models:</b>	126101, 126103		
<b>accessories for</b>	514400		
		<b>GEV No.</b>	514098
		<b>Ref. No.</b>	—
	extension for lever L 220mm		



1

<b>GEV No.</b>	514325	<b>Ref. No.</b>	41826901320
<b>description</b>	ball valve connection 1" IT - 1" IT DN25 total length 83mm with lever handle		





1

<b>GEV No.</b>	101995	<b>Ref. No.</b>	GS2006
<b>description</b>	ball valve inlet 3/4" IT outlet 3/4" IT L 70mm without handle		
<b>For models:</b>	233001		
<b>accessories for</b>	101995		
		<b>GEV No.</b>	101713
		<b>Ref. No.</b>	GS4226
	extension		
		<b>GEV No.</b>	101714
		<b>Ref. No.</b>	GS8006S
	handle		
		<b>GEV No.</b>	101718
		<b>Ref. No.</b>	GS2014
	ball handle thread M8 ø 25mm with metal bush black		





			
1			
<b>GEV No.</b>	101713	<b>Ref. No.</b>	GS4226
<b>description</b>	extension		
<b>For models:</b>	233001		

			
1			
<b>GEV No.</b>	101714	<b>Ref. No.</b>	GS80065
<b>description</b>	handle		
<b>For models:</b>	233001		
<b>accessories for</b>	101714		
		<b>GEV No.</b>	101718
		<b>Ref. No.</b>	GS2014
	ball handle thread M8 ø 25mm with metal bush black		

shut-off valves

universal

			
1			
<b>GEV No.</b>	540660	<b>Ref. No.</b>	GS2305
<b>description</b>	shut-off valve total length 105mm pipe connection ø 15mm		
<b>For models:</b>	231005, 231006, 231007, 231008		

			
1			
<b>GEV No.</b>	540415	<b>Ref. No.</b>	6A022453
<b>description</b>	star handle connection cold total lengthmm mounting pos. shaft diameter 7x7mm ø 55mm 35 built-in depth 22mm		

			
1			
<b>GEV No.</b>	540414	<b>Ref. No.</b>	6A022456
<b>description</b>	star handle connection hot total lengthmm mounting pos. shaft diameter 7x7mm ø 55mm 35 built-in depth 22mm		

			
1			
<b>GEV No.</b>	514409	<b>Ref. No.</b>	6A022440
<b>description</b>	shut-off valve connection 1/2" 1/2" straight total length 58mm mounting pos. square shaft 7x7		

			
1			
<b>GEV No.</b>	514270	<b>Ref. No.</b>	853321733
<b>description</b>	shut-off valve mounting pos. right		
<b>For models:</b>	136001, 136002, 136201, 136202		

producer-specific

COOKMAX

			
1			
<b>GEV No.</b>	514267	<b>Ref. No.</b>	41826900070
<b>description</b>	inlet tap connection 1/2" 1/2" total length 35mm mounting pos. right rosette thread G2 27x19G shaft ø 8-10mm		
<b>For models:</b>	136003, 136004, 136005, 136006, 136203, 136204, 136205, 136206		
<b>spare parts for</b>	514267		
		<b>GEV No.</b>	111704
		<b>Ref. No.</b>	824710140
	knob connection 10x8 ø 70mm water cold (1/2 turn) shaft ø 10x8mm shaft flat upper t.max.°C		
		<b>GEV No.</b>	111709
		<b>Ref. No.</b>	824710150
	knob connection 10x8 water warm (1/2 turn) total lengthmm mounting pos. ø 70mm		
		<b>GEV No.</b>	514083
		<b>Ref. No.</b>	—
	rosette connection 27x19G chrome-plated total lengthmm mounting pos.		
		<b>GEV No.</b>	514084
		<b>Ref. No.</b>	—
	nut thread 27x19G WS 34		



			
1			
<b>GEV No.</b>	514271	<b>Ref. No.</b>	853321537
<b>description</b>	shut-off valve connection 1/2" 1/2" total length 35mm mounting pos. left rosette thread G2 27x19G shaft ø 8-10mm		
<b>For models:</b>	136001, 136002, 136201, 136202		
<b>spare parts for</b>	514271		
	<b>GEV No.</b>	111704	<b>Ref. No.</b> 824710140
	knob connection 10x8 ø 70mm water cold (1/2 turn) shaft ø 10x8mm shaft flat upper t.max. °C		
	<b>GEV No.</b>	111709	<b>Ref. No.</b> 824710150
	knob connection 10x8 water warm (1/2 turn) total lengthmm mounting pos. ø 70mm		
	<b>GEV No.</b>	514083	<b>Ref. No.</b> —
	rosette connection 27x19G chrome-plated total lengthmm mounting pos.		
	<b>GEV No.</b>	514084	<b>Ref. No.</b> —
	nut thread 27x19G WS 34		

mixing valves

			
1			
<b>GEV No.</b>	541475 <sup>1</sup>	<b>Ref. No.</b>	0075/6
<b>description</b>	mixing valve thread 1/2" W 61mm D 26mm H 69mm		
<b>For models:</b>	841004, 841005, 841006, 841007, 841008		

<sup>1</sup>with backflow preventer

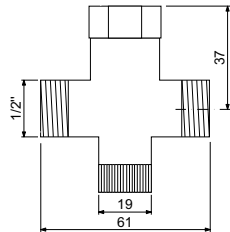



inlet taps

			
1			
<b>GEV No.</b>	514269	<b>Ref. No.</b>	826900260
<b>description</b>	inlet tap connection 1/2" ET tube ø 18mm projection 100mm overall height 230mm spout height 140mm rotation 360°		
<b>For models:</b>	137001, 137002, 137003, 137004, 137201, 137202		
<b>spare parts for</b>	514269		
	<b>GEV No.</b>	548176	<b>Ref. No.</b> —
	tap head without plunger bush bearing thread 1/2" T2: M24x1 D1 ø 18mm D2 ø 24mm H1 18-24mm H2 29mm H3 10mm shaft intake ø 8mm suitable for RUBINETTERIE DEL FRIULI		
	<b>GEV No.</b>	551335	<b>Ref. No.</b> —
	star handle shaft intake ø 8mm shaft length H1 12mm H2 22mm D1 ø 32mm suitable for RUBINETTERIE DEL FRIULI marking blue		

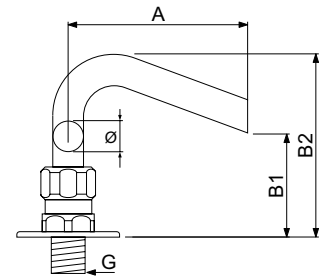
			
1			
<b>GEV No.</b>	514406	<b>Ref. No.</b>	6A022442
<b>description</b>	inlet spout connection 1/2" ET tube ø 18mm projection 105mm overall height 115mm spout height 60mm rotation 90°		



			
1			
<b>GEV No.</b>	540360	<b>Ref. No.</b>	6A022240
<b>description</b>	inlet spout connection 1/2" ET tube ø 18mm projection 105mm overall height 165mm spout height 110mm rotation 360°		
<b>accessories for</b>	540360		
	<b>GEV No.</b>	511470	<b>Ref. No.</b> —
	nut thread 1/2" ø 40mm H 8mm WS 25 brass Qty 1 pcs		

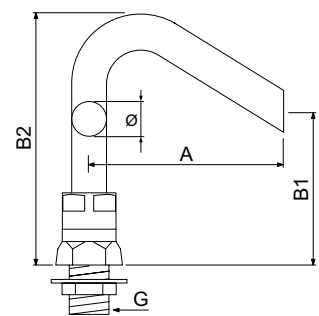





Table continues overleaf



<b>accessories for</b> 540360				
	<b>GEV No.</b>	511474	<b>Ref. No.</b>	—
	flat washer for thread 1/2"			
	<b>GEV No.</b>	511477	<b>Ref. No.</b>	—
	flat gasket rubber ED ø 42mm ID ø 21mm thickness 2mm Qty 1 pcs			

				
1				
<b>GEV No.</b>	540787	<b>Ref. No.</b>	853310001	
<b>description</b>	inlet tap connection 1/2" IT tube ø 20mm rotation 90° H1 165mm H2 100mm L 120mm			
<b>For models:</b>	136001, 136002, 136201, 136202			

				
1				
<b>GEV No.</b>	514408	<b>Ref. No.</b>	6A022910	
<b>description</b>	inlet spout connection 3/8" ET tube ø 12mm projection 58mm overall height 76mm spout height 30mm rotation°			

				
1				
<b>GEV No.</b>	514401	<b>Ref. No.</b>	1031112300	
<b>description</b>	inlet spout connection M16x1.5 tube ø 10mm projection 48mm overall height 35mm spout height 15mm rotation°			
<b>accessories for</b>	514401			
	<b>GEV No.</b>	101278	<b>Ref. No.</b>	6A011480 MA86720
	olive for pipe ø 10mm Qty 1 pcs			
	<b>GEV No.</b>	101300	<b>Ref. No.</b>	6A011485 MA1326500
	union nut thread M16x1.5 tube ø 10mm			

**tank inlets**

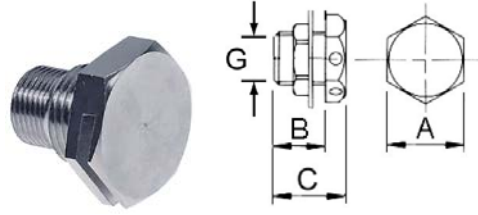
				
1				
<b>GEV No.</b>	691390	<b>Ref. No.</b>	41822160230	
<b>description</b>	tank inlet connection 1/2" - 3/8" WS 30 L1 22mm L2 29mm			
<b>For models:</b>	135001, 135002, 135003, 135004, 135201, 135202, 135203, 135204			

**water softeners**

**softener cartridges**

<b>BILT</b>				
<b>accessories</b>				
				
1				
<b>GEV No.</b>	520585	<b>Ref. No.</b>	RAC30003	
<b>description</b>	plug connector John Guest angled pipe connection ø8mm - ø8mm approval NSF, SK			
<b>For models:</b>	211005, 211006, 211010, 211012, 211013, 211014, 211015, 211016, 211018, 211020, 211023, 211024, 211026, 211027, 211029, 212014, 212015, 212016, 212024, 212025			

**accessories**

				
1				
<b>GEV No.</b>	530174	<b>Ref. No.</b>	00-775918-050	
<b>description</b>	lid kit for softener			
<b>For models:</b>	811014, 811015, 812014, 812015, 813003, 813004			

water filters

BRITA

water filters

PURITY Clean

partial desalination for dishwashers

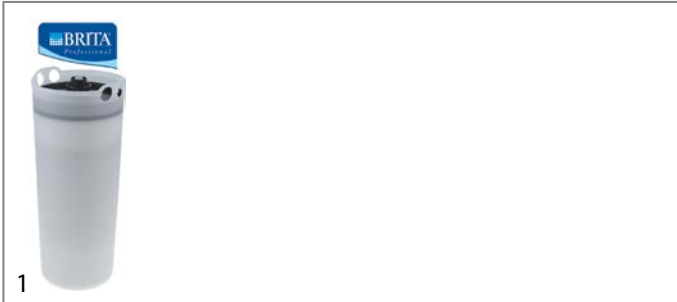

<b>GEV No.</b>	530378	<b>Ref. No.</b>	315645
<b>description</b>	filter cartridge BRITA type Purity 1200 Clean capacity 12000l flow rate 600l/h operation p max 6bar water temperature +4 up to +60°C ø 550mm H 288mm partial desalination for dishwashers		
<b>For models:</b>	831001		

<b>accessories for</b>	530378	<b>GEV No.</b>	530379	<b>Ref. No.</b>	292083
<b>description</b>	water filter BRITA type Purity 1200 Clean capacity 12000l flow rate 600l/h operation p max 6bar water temperature +4 up to +60°C ø 288mm H 550mm partial desalination for dishwashers flow rate 5l/min				



<b>GEV No.</b>	530379	<b>Ref. No.</b>	292083
<b>description</b>	water filter BRITA type Purity 1200 Clean capacity 12000l flow rate 600l/h operation p max 6bar water temperature +4 up to +60°C ø 288mm H 550mm partial desalination for dishwashers flow rate 5l/min		
<b>For models:</b>	831001		

<b>spare parts for</b>	530379	<b>GEV No.</b>	530378	<b>Ref. No.</b>	315645
<b>description</b>	filter cartridge BRITA type Purity 1200 Clean capacity 12000l flow rate 600l/h operation p max 6bar water temperature +4 up to +60°C ø 550mm H 288mm partial desalination for dishwashers				

<b>accessories for</b>	530379	<b>GEV No.</b>	520584	<b>Ref. No.</b>	—
<b>description</b>	flex hose SS straight-curved DN12 connection 1: 3/4" connection 2: 3/4" L 2000mm approval DVGW operating p. 10bar test pressure 32bar burst p. 95bar				

PURITY Quell ST

partial desalination specifically for big coffee makers and combi-steamers  
With or without MAE (electronic display)

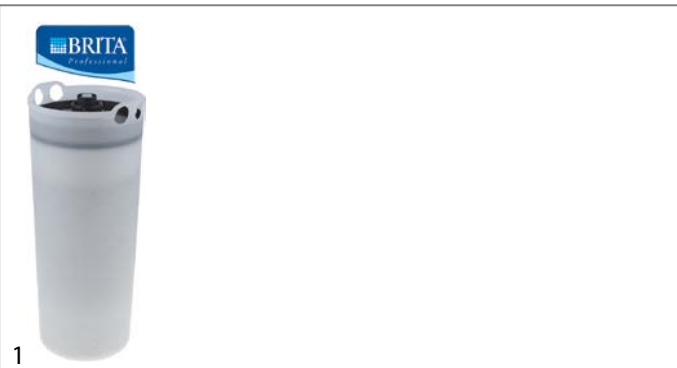

<b>GEV No.</b>	530856	<b>Ref. No.</b>	273000
<b>description</b>	water filter BRITA type PURITY 450 Quell ST capacity 2240-4217l flow rate 350l/h operation p max 6.9bar water temperature +4 up to +30°C ø 249mm H 408mm decarbonisation for coffee machine/combi-steamer		
<b>For models:</b>	831004		



<b>GEV No.</b>	530871	<b>Ref. No.</b>	272700
<b>description</b>	water filter BRITA type PURITY 450 Quell ST capacity 2240-4217l flow rate 350l/h operation p max 6.9bar water temperature +4 up to +30°C ø 249mm H 408mm decarbonisation for coffee machine/combi-steamer without filter head		
<b>For models:</b>	831004		



<b>GEV No.</b>	530845	<b>Ref. No.</b>	273200
<b>description</b>	water filter BRITA type PURITY 600 Quell ST capacity 4420-7207l flow rate 120l/h operation p max 6.9bar water temperature +4 up to +30°C ø 160mm H 400mm decarbonisation for coffee machine/combi-steamer		
<b>For models:</b>	831005		





PURITY Steam

partial desalination specifically for combi-steamers  
With or without MAE (electronic display)







1

<b>GEV No.</b>	530867	<b>Ref. No.</b>	1000653
<b>description</b>	water filter BRITA type PURITY 450 Steam capacity 2754-3680l flow rate 500l/h operation p max 6.9bar water temperature +4 up to +30°C ø 249mm H 408mm decarbonisation for combi-steamer		
<b>For models:</b>	831008		







1

<b>GEV No.</b>	530857	<b>Ref. No.</b>	1002912	
<b>description</b>	water filter BRITA type PURITY 450 Steam capacity 2754-3680l flow rate 500l/h operation p max 6.9bar water temperature +4 up to +30°C ø 249mm H 408mm decarbonisation for combi-steamer with MAE			
<b>For models:</b>	831008			
<b>spare parts for</b>	530857			
	<b>GEV No.</b>	530867	<b>Ref. No.</b>	1000653
	water filter BRITA type PURITY 450 Steam capacity 2754-3680l flow rate 500l/h operation p max 6.9bar water temperature +4 up to +30°C ø 249mm H 408mm decarbonisation for combi-steamer			
<b>accessories for</b>	530857			
	<b>GEV No.</b>	520584	<b>Ref. No.</b>	—
	flex hose SS straight-curved DN12 connection 1: 3/4" connection 2: 3/4" L 2000mm approval DVGW operating p. 10bar test pressure 32bar burst p. 95bar			
	<b>GEV No.</b>	698668	<b>Ref. No.</b>	—
	shut-off valve IT 1" ET 3/4"			





1



<b>GEV No.</b>	530858	<b>Ref. No.</b>	1000654	
<b>description</b>	water filter BRITA type PURITY 450 Steam capacity 2754-3680l flow rate 500l/h operation p max 6.9bar water temperature +4 up to +30°C ø 249mm H 408mm decarbonisation for combi-steamer without MAE			
<b>For models:</b>	831008			
<b>spare parts for</b>	530858			
	<b>GEV No.</b>	530867	<b>Ref. No.</b>	1000653
	water filter BRITA type PURITY 450 Steam capacity 2754-3680l flow rate 500l/h operation p max 6.9bar water temperature +4 up to +30°C ø 249mm H 408mm decarbonisation for combi-steamer			
<b>accessories for</b>	530858			
	<b>GEV No.</b>	520584	<b>Ref. No.</b>	—
	flex hose SS straight-curved DN12 connection 1: 3/4" connection 2: 3/4" L 2000mm approval DVGW operating p. 10bar test pressure 32bar burst p. 95bar			
	<b>GEV No.</b>	698668	<b>Ref. No.</b>	—
	shut-off valve IT 1" ET 3/4"			



1

<b>GEV No.</b>	530859	<b>Ref. No.</b>	1002918	
<b>description</b>	water filter BRITA type PURITY 600 Steam capacity 4734-5771l flow rate 500l/h operation p max 6.9bar water temperature +4 up to +30°C ø 249mm H 520mm decarbonisation for combi-steamer with MAE			
<b>For models:</b>	831009			
<b>spare parts for</b>	530859			
	<b>GEV No.</b>	530868	<b>Ref. No.</b>	1000252
	water filter BRITA type PURITY 600 Steam capacity 4734-5771l flow rate 500l/h operation p max 6.9bar water temperature +4 up to +30°C ø 249mm H 520mm decarbonisation for combi-steamer			
<b>accessories for</b>	530859			
	<b>GEV No.</b>	520584	<b>Ref. No.</b>	—
	flex hose SS straight-curved DN12 connection 1: 3/4" connection 2: 3/4" L 2000mm approval DVGW operating p. 10bar test pressure 32bar burst p. 95bar			
	<b>GEV No.</b>	698668	<b>Ref. No.</b>	—
	shut-off valve IT 1" ET 3/4"			



<b>GEV No.</b>	530860	<b>Ref. No.</b>	1000245
<b>description</b>	water filter BRITA type PURITY 600 Steam capacity 4734-5771l flow rate 500l/h operation p max 6.9bar water temperature +4 up to +30°C ø 249mm H 520mm decarbonisation for combi-steamer without MAE		
<b>For models:</b>	831009		
<b>spare parts for</b>	530860		
	<b>GEV No.</b>	530868	<b>Ref. No.</b> 1000252
<b>accessories for</b>	530860		
	<b>GEV No.</b>	520584	<b>Ref. No.</b> —
<b>description</b>	flex hose SS straight-curved DN12 connection 1: 3/4" connection 2: 3/4" L 2000mm approval DVGW operating p. 10bar test pressure 32bar burst p. 95bar		
	<b>GEV No.</b>	698668	<b>Ref. No.</b> —
<b>description</b>	shut-off valve IT 1" ET 3/4"		

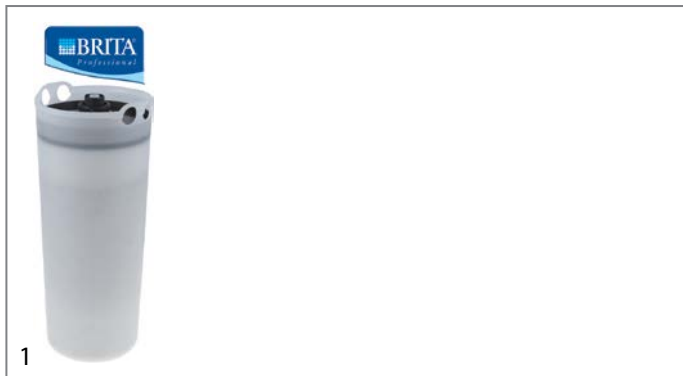

<b>GEV No.</b>	530868	<b>Ref. No.</b>	1000252
<b>description</b>	water filter BRITA type PURITY 600 Steam capacity 4734-5771l flow rate 500l/h operation p max 6.9bar water temperature +4 up to +30°C ø 249mm H 520mm decarbonisation for combi-steamer		
<b>For models:</b>	831009		

accessories

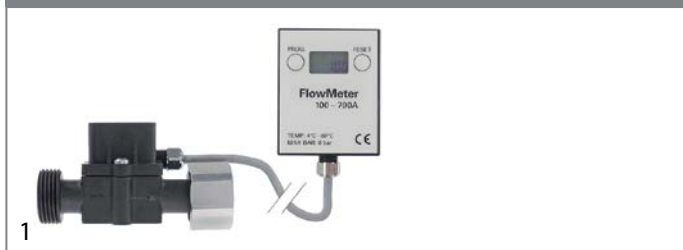

<b>GEV No.</b>	530381	<b>Ref. No.</b>	298905
<b>description</b>	flow meter with digital display connection 3/4" IT - 3/4" ET total length 81mm flow rate 100-700l/h operation p max 8bar water temperature 4-30°C ambient temperature max. 0-60°C display 6 digits type 100-700A		
<b>For models:</b>	831008, 831009		

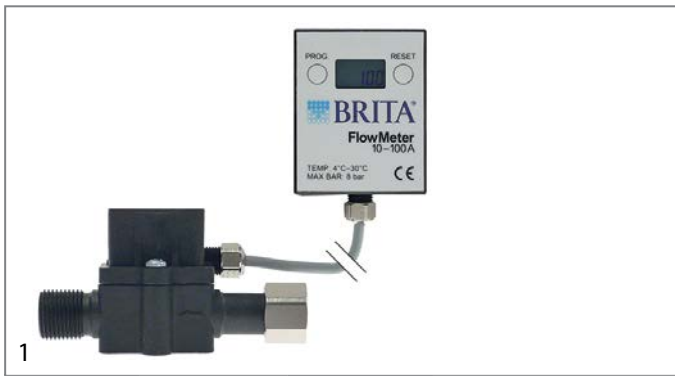

<b>GEV No.</b>	530055	<b>Ref. No.</b>	298900
<b>description</b>	flow meter with digital display connection 3/8" IT - 3/8" ET total length 81mm flow rate 10-100l/h operation p max 8bar water temperature 4-30°C ambient temperature max. 0-60°C cable length 1500mm display 6 digits		
<b>For models:</b>	831008, 831009		



<b>GEV No.</b>	698669	<b>Ref. No.</b>	274100
<b>description</b>	remote display L 139mm cable length 1820mm plastic H 138mm blue for MAE		
<b>For models:</b>	831004, 831005, 831008, 831009		

WATER&MORE

accessories



<b>GEV No.</b>	530055	<b>Ref. No.</b>	298900
<b>description</b>	flow meter with digital display connection 3/8" IT - 3/8" ET total length 81mm flow rate 10-100l/h operation p max 8bar water temperature 4-30°C ambient temperature max. 0-60°C cable length 1500mm display 6 digits		
<b>For models:</b>	831008, 831009		









# drain systems and wash basins

## drain fittings

### universal



1





<b>GEV No.</b>	515042	<b>Ref. No.</b>	1031402200
<b>description</b>	drain fitting size 1½" usable heightmm overall height 32mm ED ø 69mm chrome-plated brass		
<b>accessories for</b>	515042		
	<b>GEV No.</b>	515051	<b>Ref. No.</b> —
	standpipe size 1½" usable height 170mm overall height 185mm ED ø 40mm SS		
	<b>GEV No.</b>	515052	<b>Ref. No.</b> —
	standpipe size 1½" usable height 220mm overall height 235mm ED ø 40mm SS		
	<b>GEV No.</b>	515053	<b>Ref. No.</b> —
	standpipe size 1½" usable height 260mm overall height 275mm ED ø 40mm SS		
	<b>GEV No.</b>	515054	<b>Ref. No.</b> —
	standpipe size 1½" usable height 310mm overall height 325mm ED ø 40mm SS		
	<b>GEV No.</b>	515062	<b>Ref. No.</b> —
	standpipe size 1½" usable height 190mm overall height 200mm ED ø 46mm chrome-plated brass with filter		
	<b>GEV No.</b>	515063	<b>Ref. No.</b> —
	standpipe size 1½" usable height 230mm overall height 240mm ED ø 46mm chrome-plated brass with filter		
	<b>GEV No.</b>	515064	<b>Ref. No.</b> —
	standpipe size 1½" usable height 280mm overall height 290mm ED ø 46mm chrome-plated brass with filter		



### standpipes

#### 1¼"



1







<b>GEV No.</b>	515042	<b>Ref. No.</b>	1031402200
<b>description</b>	drain fitting size 1½" usable heightmm overall height 32mm ED ø 69mm chrome-plated brass		
<b>accessories for</b>	515042		
	<b>GEV No.</b>	515051	<b>Ref. No.</b> —
	standpipe size 1½" usable height 170mm overall height 185mm ED ø 40mm SS		
	<b>GEV No.</b>	515052	<b>Ref. No.</b> —
	standpipe size 1½" usable height 220mm overall height 235mm ED ø 40mm SS		
	<b>GEV No.</b>	515053	<b>Ref. No.</b> —
	standpipe size 1½" usable height 260mm overall height 275mm ED ø 40mm SS		
	<b>GEV No.</b>	515054	<b>Ref. No.</b> —
	standpipe size 1½" usable height 310mm overall height 325mm ED ø 40mm SS		

<b>accessories for</b>	515042		
	<b>GEV No.</b>	515062	<b>Ref. No.</b> —
	standpipe size 1½" usable height 190mm overall height 200mm ED ø 46mm chrome-plated brass with filter		
	<b>GEV No.</b>	515063	<b>Ref. No.</b> —
	standpipe size 1½" usable height 230mm overall height 240mm ED ø 46mm chrome-plated brass with filter		
	<b>GEV No.</b>	515064	<b>Ref. No.</b> —
	standpipe size 1½" usable height 280mm overall height 290mm ED ø 46mm chrome-plated brass with filter		

#### 1½"



1

<b>GEV No.</b>	515042	<b>Ref. No.</b>	1031402200
<b>description</b>	drain fitting size 1½" usable heightmm overall height 32mm ED ø 69mm chrome-plated brass		
<b>accessories for</b>	515042		
	<b>GEV No.</b>	515051	<b>Ref. No.</b> —
	standpipe size 1½" usable height 170mm overall height 185mm ED ø 40mm SS		
	<b>GEV No.</b>	515052	<b>Ref. No.</b> —
	standpipe size 1½" usable height 220mm overall height 235mm ED ø 40mm SS		
	<b>GEV No.</b>	515053	<b>Ref. No.</b> —
	standpipe size 1½" usable height 260mm overall height 275mm ED ø 40mm SS		
	<b>GEV No.</b>	515054	<b>Ref. No.</b> —
	standpipe size 1½" usable height 310mm overall height 325mm ED ø 40mm SS		
	<b>GEV No.</b>	515062	<b>Ref. No.</b> —
	standpipe size 1½" usable height 190mm overall height 200mm ED ø 46mm chrome-plated brass with filter		
	<b>GEV No.</b>	515063	<b>Ref. No.</b> —
	standpipe size 1½" usable height 230mm overall height 240mm ED ø 46mm chrome-plated brass with filter		
	<b>GEV No.</b>	515064	<b>Ref. No.</b> —
	standpipe size 1½" usable height 280mm overall height 290mm ED ø 46mm chrome-plated brass with filter		



1





















<b>GEV No.</b>	515042	<b>Ref. No.</b>	1031402200
<b>description</b>	drain fitting size 1½" usable heightmm overall height 32mm ED ø 69mm chrome-plated brass		
<b>accessories for</b>	515042		
	<b>GEV No.</b>	515051	<b>Ref. No.</b> —
	standpipe size 1½" usable height 170mm overall height 185mm ED ø 40mm SS		
	<b>GEV No.</b>	515052	<b>Ref. No.</b> —
	standpipe size 1½" usable height 220mm overall height 235mm ED ø 40mm SS		
	<b>GEV No.</b>	515053	<b>Ref. No.</b> —
	standpipe size 1½" usable height 260mm overall height 275mm ED ø 40mm SS		





Table continues overleaf

accessories for		515042		
GEV No.	515054	Ref. No.	—	
	standpipe size 1½" usable height 310mm overall height 325mm ED ø 40mm SS			
	standpipe size 1½" usable height 190mm overall height 200mm ED ø 46mm chrome-plated brass with filter			
	standpipe size 1½" usable height 230mm overall height 240mm ED ø 46mm chrome-plated brass with filter			
	standpipe size 1½" usable height 280mm overall height 290mm ED ø 46mm chrome-plated brass with filter			

accessories for		515042		
GEV No.	515054	Ref. No.	—	
	standpipe size 1½" usable height 310mm overall height 325mm ED ø 40mm SS			
	standpipe size 1½" usable height 190mm overall height 200mm ED ø 46mm chrome-plated brass with filter			
	standpipe size 1½" usable height 230mm overall height 240mm ED ø 46mm chrome-plated brass with filter			
	standpipe size 1½" usable height 280mm overall height 290mm ED ø 46mm chrome-plated brass with filter			

				
1				
GEV No.	515042	Ref. No.	1031402200	
description				
drain fitting size 1½" usable heightmm overall height 32mm ED ø 69mm chrome-plated brass				
accessories for				
GEV No.	515051	Ref. No.	—	
	standpipe size 1½" usable height 170mm overall height 185mm ED ø 40mm SS			
	standpipe size 1½" usable height 220mm overall height 235mm ED ø 40mm SS			
	standpipe size 1½" usable height 260mm overall height 275mm ED ø 40mm SS			
	standpipe size 1½" usable height 310mm overall height 325mm ED ø 40mm SS			
	standpipe size 1½" usable height 190mm overall height 200mm ED ø 46mm chrome-plated brass with filter			
	standpipe size 1½" usable height 230mm overall height 240mm ED ø 46mm chrome-plated brass with filter			
	standpipe size 1½" usable height 280mm overall height 290mm ED ø 46mm chrome-plated brass with filter			

producer-specific				
COOKMAX				
				
1				
GEV No.	515133	Ref. No.	0830318600	
description				
drain fitting size 1½" usable heightmm overall heightmm SS				
For models:				
943001, 943002, 943003, 943004, 943005, 943006, 943007, 943008, 943009, 943010, 943011, 943012, 943013, 943014, 943015, 943016				
accessories for				
GEV No.	515134	Ref. No.	0515373900	
	standpipe size 1½" usable height 225mm overall height 250mm ED ø 40mm SS			

				
1				
GEV No.	515042	Ref. No.	1031402200	
description				
drain fitting size 1½" usable heightmm overall height 32mm ED ø 69mm chrome-plated brass				
accessories for				
GEV No.	515051	Ref. No.	—	
	standpipe size 1½" usable height 170mm overall height 185mm ED ø 40mm SS			
	standpipe size 1½" usable height 220mm overall height 235mm ED ø 40mm SS			
	standpipe size 1½" usable height 260mm overall height 275mm ED ø 40mm SS			

				
1				
GEV No.	515134	Ref. No.	0515373900	
description				
standpipe size 1½" usable height 225mm overall height 250mm ED ø 40mm SS				
For models:				
943001, 943002, 943003, 943004, 943005, 943006, 943007, 943008, 943009, 943010, 943011, 943012, 943013, 943014, 943015, 943016				
accessories for				
GEV No.	515134	Ref. No.	0830318600	
	drain fitting size 1½" usable heightmm overall heightmm SS			



			
1			
<b>GEV No.</b>	515086	<b>Ref. No.</b>	1031402300
<b>description</b>	standpipe usable height 135mm overall height 150mm size 1½" SS ED ø 40mm		

### U-bends

			
1			
<b>GEV No.</b>	515122	<b>Ref. No.</b>	1031402400
<b>description</b>	drain connection thread 1½" hose ø 50mm		

## beverage technology

### valves

#### non-return valves

			
1			
<b>GEV No.</b>	440727	<b>Ref. No.</b>	R65110680
<b>description</b>	non-return valve John Guest pipe connection ø10mm - ø10mm operating pressure at 20°C 10bar opening pressure 0.02bar POM		
<b>For models:</b>	212018, 212020		

## water cycle components

### pressure reduction valves

#### pressure reduction valves

##### producer-specific

			
1			
<b>GEV No.</b>	520335	<b>Ref. No.</b>	WY26330
<b>description</b>	pressure reduction valve RB series expo connection 3/8" default setting 3bar setting range 1-6bar p max 40bar t.max. 85°C brass		

### water meters

			
1			
<b>GEV No.</b>	530381	<b>Ref. No.</b>	298905
<b>description</b>	flow meter with digital display connection 3/4" IT - 3/4" ET total length 81mm flow rate 100-700l/h operation p max 8bar water temperature 4-30°C ambient temperature max. 0-60°C display 6 digits type 100-700A		
<b>For models:</b>	831008, 831009		

			
1			
<b>GEV No.</b>	530055	<b>Ref. No.</b>	298900
<b>description</b>	flow meter with digital display connection 3/8" IT - 3/8" ET total length 81mm flow rate 10-100l/h operation p max 8bar water temperature 4-30°C ambient temperature max. 0-60°C cable length 1500mm display 6 digits		
<b>For models:</b>	831008, 831009		

### supply filters

			
1			
<b>GEV No.</b>	695531	<b>Ref. No.</b>	10139
<b>description</b>	supply filter thread 1" total length 100mm plastic with metal filter ø 18mm		
<b>For models:</b>	711001, 711002, 711003		

			
1			
<b>GEV No.</b>	510836	<b>Ref. No.</b>	620209
<b>description</b>	supply filter thread 3/4" ET - 3/4" IT total length 76mm plastic		
<b>For models:</b>	SP1, SP2-12, SP2-S12, SP3		



			
1			
<b>GEV No.</b>	520146	<b>Ref. No.</b>	14666
<b>description</b>	supply filter thread 3/4" IT - 3/4" ET total length 122mm plastic DN17		
<b>For models:</b>	741003		

			
1			
<b>GEV No.</b>	520115	<b>Ref. No.</b>	450105
<b>description</b>	hose clamp ø 25-40mm width 9mm Qty 10 pcs DIN 3017		
<b>For models:</b>	SP2-12, SP2-S12		

## ancillary products

### clamps

#### hose clamps

##### DIN 3017 - W2

			
1			
<b>GEV No.</b>	520111	<b>Ref. No.</b>	450102
<b>description</b>	hose clamp ø 10-16mm width 9mm Qty 10 pcs DIN 3017		
<b>For models:</b>	SP1, SP2-12, SP2-S12, SP3		

			
1			
<b>GEV No.</b>	520116	<b>Ref. No.</b>	450107
<b>description</b>	hose clamp ø 32-50mm width 9mm Qty 5 pcs DIN 3017		
<b>For models:</b>	SP1, SP2-12, SP2-S12, SP3		

			
1			
<b>GEV No.</b>	520112	<b>Ref. No.</b>	450103 R61630011
<b>description</b>	hose clamp ø 12-20mm width 9mm Qty 10 pcs DIN 3017		
<b>For models:</b>	212001, 212002, 212003, 212010, 212011, 212012, 212013, 212018, 212020, SP1, SP2-12, SP2-S12, SP3		

			
1			
<b>GEV No.</b>	520118	<b>Ref. No.</b>	450109
<b>description</b>	hose clamp ø 50-70mm width 9mm Qty 5 pcs DIN 3017		
<b>For models:</b>	SP1, SP2-12, SP2-S12, SP3		

			
1			
<b>GEV No.</b>	520113	<b>Ref. No.</b>	450104
<b>description</b>	hose clamp ø 16-27mm width 9mm Qty 10 pcs DIN 3017		
<b>For models:</b>	SP1		

			
1			
<b>GEV No.</b>	520119	<b>Ref. No.</b>	450119
<b>description</b>	hose clamp ø 60-80mm width 9mm Qty 5 pcs DIN 3017		
<b>For models:</b>	SP3		

			
1			
<b>GEV No.</b>	520114	<b>Ref. No.</b>	450114
<b>description</b>	hose clamp ø 20-32mm width 9mm Qty 10 pcs DIN 3017		
<b>For models:</b>	SP2-12, SP2-S12		

#### double wire clamps

			
1			
<b>GEV No.</b>	520573	<b>Ref. No.</b>	00-324510-202
<b>description</b>	hose clamp ø 20mm wire gauge ø 2mm Qty 1 pcs		
<b>For models:</b>	811011, 811012, 811013, 811014, 811015, 812011, 812012, 812013, 812014, 812015		





 <p>1</p>			
<b>GEV No.</b>	520577	<b>Ref. No.</b>	00-324510-242
<b>description</b>	hose clamp ø 24mm wire gauge ø 2mm Qty 1 pcs		
<b>For models:</b>	811011, 811012, 811013, 811014, 811015, 812011, 812012, 812013, 812014, 812015		

 <p>1</p>			
<b>GEV No.</b>	520574	<b>Ref. No.</b>	00-324510-327
<b>description</b>	hose clamp ø 32mm wire gauge ø 3mm Qty 1 pcs		
<b>For models:</b>	812014, 812015		

 <p>1</p>			
<b>GEV No.</b>	511286	<b>Ref. No.</b>	450143
<b>description</b>	hose clamp ø 38mm wire gauge ø 3.2mm Qty 1 pcs		
<b>For models:</b>	SP3		

 <p>1</p>			
<b>GEV No.</b>	513268	<b>Ref. No.</b>	00-303340-008 423011 450134
<b>description</b>	hose clamp ø 8-10mm wire gauge ø 1mm Qty 1 pcs		
<b>For models:</b>	812001, 812002, 812003, 812004, 812005, 812006, 812007, 812008, 812009, 812010, 813002, 813003, 813004, 915234, 915235, 915236, 915237, 915460, 915461, 915462, 915463, 915464, 915465, SP1, SP2-12, SP2-S12, SP3		

 <p>1</p>			
<b>GEV No.</b>	510959	<b>Ref. No.</b>	450115
<b>description</b>	hose clamp ø 8mm wire gauge ø 1mm Qty 1 pcs		
<b>For models:</b>	SP1		

 <p>1</p>			
<b>GEV No.</b>	511147	<b>Ref. No.</b>	450125
<b>description</b>	wire clamp ø 12-14mm wire gauge ø 1.5mm zinc-coated steel Qty 1 pcs		
<b>For models:</b>	SP3		

double wire clamps with screw

 <p>1</p>			
<b>GEV No.</b>	505281	<b>Ref. No.</b>	00-323945-015
<b>description</b>	hose clamp ø 15mm zinc-coated steel Qty 20 pcs		
<b>For models:</b>	811011, 811012, 811013, 811014, 811015, 812011, 812012, 812013, 812014, 812015, 813002, 813003, 813004		

 <p>1</p>			
<b>GEV No.</b>	505282	<b>Ref. No.</b>	00-323945-016
<b>description</b>	hose clamp ø 16mm zinc-coated steel Qty 20 pcs		
<b>For models:</b>	811014, 811015, 812014, 812015		

 <p>1</p>			
<b>GEV No.</b>	505283	<b>Ref. No.</b>	00-323945-018
<b>description</b>	hose clamp ø 18mm zinc-coated steel Qty 20 pcs		
<b>For models:</b>	811011, 811012, 811013, 811014, 811015, 812011, 812012, 812013, 812014, 812015, 813002, 813003, 813004		

1

<b>GEV No.</b>	505284	<b>Ref. No.</b>	00-323945-021
<b>description</b>	hose clamp ø 21mm zinc-coated steel Qty 20 pcs		
<b>For models:</b>	811011, 811012, 811013, 812011, 812012, 812013, 813002, 813003, 813004		



1

<b>GEV No.</b>	505285	<b>Ref. No.</b>	00-323945-025
<b>description</b>	hose clamp ø 25mm zinc-coated steel Qty 20 pcs		
<b>For models:</b>	811011, 811012, 811013, 811014, 811015, 812011, 812012, 812013, 812014, 812015, 813002, 813003, 813004		



1

<b>GEV No.</b>	505286	<b>Ref. No.</b>	00-323945-029
<b>description</b>	hose clamp ø 29mm zinc-coated steel Qty 20 pcs		
<b>For models:</b>	813003, 813004		



1

<b>GEV No.</b>	505287	<b>Ref. No.</b>	00-323945-033
<b>description</b>	hose clamp ø 33mm zinc-coated steel Qty 20 pcs		
<b>For models:</b>	811012, 811013, 811014, 811015, 812012, 812013, 812014, 812015, 813003		



1

<b>GEV No.</b>	505293	<b>Ref. No.</b>	00-323945-035
<b>description</b>	hose clamp ø 34-38mm zinc-coated steel Qty 20 pcs		
<b>For models:</b>	811011, 811012, 811013, 811014, 811015, 812011, 812012, 812013, 812014, 813003, 813004		



1

<b>GEV No.</b>	505290	<b>Ref. No.</b>	00-323945-037
<b>description</b>	hose clamp ø 37mm zinc-coated steel Qty 10 pcs		
<b>For models:</b>	811011, 811012, 811013, 811014, 811015, 812011, 812012, 812013, 812014, 812015		



1

<b>GEV No.</b>	505294	<b>Ref. No.</b>	00-323945-053
<b>description</b>	hose clamp ø 53mm zinc-coated steel Qty 10 pcs		
<b>For models:</b>	811011, 811012, 811013, 811014, 811015, 812011, 812012, 812013, 812014, 812015		



1

<b>GEV No.</b>	505291	<b>Ref. No.</b>	00-323945-056
<b>description</b>	hose clamp ø 56mm zinc-coated steel Qty 10 pcs		
<b>For models:</b>	811011, 811012, 811013, 811014, 811015, 812011, 812012, 812013, 812014, 812015		



1

<b>GEV No.</b>	505289	<b>Ref. No.</b>	00-323945-060
<b>description</b>	hose clamp ø 60mm zinc-coated steel Qty 10 pcs		
<b>For models:</b>	813002, 813003, 813004		



1

<b>GEV No.</b>	505292	<b>Ref. No.</b>	00-323945-064
<b>description</b>	hose clamp ø 64-68mm zinc-coated steel Qty 10 pcs		
<b>For models:</b>	813002, 813003, 813004		

## tools

### cleaning tools

#### brushes

#### pipe brushes

#### nylon



1

<b>GEV No.</b>	801463	<b>Ref. No.</b>	10.51.00
<b>description</b>	pipe brush nylon ø 8mm total length 300mm brush length 100mm		
<b>For models:</b>	745001, 745002		

### scrapers



1

<b>GEV No.</b>	705009	<b>Ref. No.</b>	1030000600 MA1030000600
<b>description</b>	scraper for griddle W 80mm		
<b>For models:</b>	123103, 123104, 123106, 123107, 123108, 123109, 123110, 123111, 123112, 123113, 123114, 123115, 123117, 123120, 127102, 127103		

## measuring equipment

### meters

#### pressure measurement

#### digital manometers

#### absolute-pressure measurement



1

<b>GEV No.</b>	800002	<b>Ref. No.</b>	0930300
<b>description</b>	pressure meter 0 up to 1300mbar type GMH 3161-12 vacuum + barometric pressure probe type absolute pressure sensor measurement unit mbar,bar,kPa,MPa,PSI,mmHg,mH2O connections 1 min/max value, tare, hold resolution 1mbar hose ø 4mm accuracy (temperature) ±0.4%FS accuracy (hysteresis) ±0.2%FS overload max. 4 bar interface serial (adapter not included) sensor piezoresistant gauge pressure sensor, int. dimensions 142x71x26mm incl. battery		
<b>For models:</b>	442003, 442004, 442005, 442006, 442007, 442008		

### thermometers

#### built-in thermometers



1

<b>GEV No.</b>	541929	<b>Ref. No.</b>	6111959
<b>description</b>	thermometer mounting measurements 58x25.5mm -40 up to +40°C capillary pipe 700mm probe ø 6mm probe L 85mm		
<b>For models:</b>	668006, 668009, 668010		

ø60mm



1

<b>GEV No.</b>	541879	<b>Ref. No.</b>	74220250 ED07500 PI-B147 PIB147
<b>description</b>	thermometer mounting ø 60mm 0 up to +500°C probe ø 8mm probe L 155mm capillary pipe 1000mm		
<b>For models:</b>	531001, 531002, 531003, 531004, 531005, 531006, 531007, 531008, 531010, 531011, 531012, 531013, 531015, 531016, 531017, 531034, 531039, 531040		



1

<b>GEV No.</b>	403636	<b>Ref. No.</b>	101016
<b>description</b>	thermometer mounting ø 60mm t.max. 500°C 0 up to +500°C probe ø 10mm probe L 55mm capillary pipe 600mm		
<b>For models:</b>	531028, 531029, 531031		



1

<b>GEV No.</b>	403658	<b>Ref. No.</b>	101015 103015
<b>description</b>	thermometer mounting ø 60mm t.max. 500°C 0 up to +500°C probe ø 8mm probe L 100mm capillary pipe 950mm		
<b>For models:</b>	531026, 531028, 531029, 531030, 531031		



1

<b>GEV No.</b>	541900	<b>Ref. No.</b>	TERMOM001
<b>description</b>	thermometer mounting ø 60mm t.max. 500°C 0 up to +500°C probe ø 8mm probe L 145mm capillary pipe 450mm		
<b>For models:</b>	530009, 530010, 530011, 530012, 531020, 531021, 531022, 531023		

battery powered



1

<b>GEV No.</b>	379752	<b>Ref. No.</b>	6111963 6111997
<b>description</b>	thermometer mounting measurements 58x25.5mm front measurements 29x62mm battery comp. front up to +100°C cable length 2200mm		
<b>For models:</b>	621015, 629001		

external power supply



1

<b>GEV No.</b>	403623	<b>Ref. No.</b>	X02.16.137.00
<b>description</b>	thermometer mounting measurements 65x20mm 220V 0 up to +99°C cable length 2900mm probe ø 6mm probe L 25mm		
<b>For models:</b>	541003		

## fastening material

### screws

#### sheet metal screws



1

<b>GEV No.</b>	560103	<b>Ref. No.</b>	260706
<b>description</b>	sheet metal screws ø 3.9mm L 13mm SS Qty 20 pcs DIN 7981/ISO 7049 head ø 7.5mm oval head		
<b>For models:</b>	SP1, SP2-12, SP2-S12		





1

<b>GEV No.</b>	560104	<b>Ref. No.</b>	886015000
<b>description</b>	sheet metal screws ø 3.9mm L 19mm SS Qty 20 pcs DIN 7981/ISO 7049 head ø 7.5mm oval head		
<b>For models:</b>	631002, 631003, 631005, 631006, 636001, 636002, 636003, 636004, 636005, 636006		





 <p>Image not available</p>			
1			
<b>GEV No.</b>	560532	<b>Ref. No.</b>	260701
<b>description</b>	sheet-metal screw ø 3.5mm L 12mm SS Qty 1 pcs intake slotted head ø 7mm		
<b>For models:</b>	SP1		

countersunk screws			
			
1			
<b>GEV No.</b>	560215	<b>Ref. No.</b>	WY23510
<b>description</b>	countersunk screw thread M5 L 14mm SS DIN 963/ISO 2009 Qty 20 pcs intake slotted head ø 9.2mm		
<b>For models:</b>	742001, 742002, 742003, 742004		

flat-headed bolts			
			
1			
<b>GEV No.</b>	560062	<b>Ref. No.</b>	252917 60000000
<b>description</b>	flat-headed bolt thread M4 thread L 10mm SS DIN 7985/ISO 7045 Qty 20 pcs intake Phillips head ø 8mm head thickness 2mm		
<b>For models:</b>	743001		

oval head screws			
			
1			
<b>GEV No.</b>	560455	<b>Ref. No.</b>	260238
<b>description</b>	oval head screw thread M4 thread L 10mm L 12.5mm head ø 10mm stainless steel intake slotted Qty 1 pcs		
<b>For models:</b>	SP1, SP2-12, SP2-S12		

			
1			
<b>GEV No.</b>	560319	<b>Ref. No.</b>	RG04062
<b>description</b>	oval head screw thread M6 thread L 14mm intake hexagonal 4mm		
<b>For models:</b>	451001		

hexagonal screws			
			
1			
<b>GEV No.</b>	560202	<b>Ref. No.</b>	8300610
<b>description</b>	hexagonal screw thread M10 thread L 25mm SS WS 17 Qty 1 pcs DIN 933 / ISO 4017		
<b>For models:</b>	512002, 512003, 512004		

			
1			
<b>GEV No.</b>	560203	<b>Ref. No.</b>	8301710
<b>description</b>	hexagonal screw thread M10 thread L 30mm SS WS 17 Qty 1 pcs DIN 933 / ISO 4017		
<b>For models:</b>	512002, 512003, 512004		

			
1			
<b>GEV No.</b>	560081	<b>Ref. No.</b>	260138
<b>description</b>	hexagonal screw thread M4 thread L 10mm SS WS 7 Qty 20 pcs DIN 933 / ISO 4017		
<b>For models:</b>	SP1		

			
1			
<b>GEV No.</b>	560527	<b>Ref. No.</b>	260151
<b>description</b>	hexagonal screw thread M4 thread L 12mm SS WS 7 Qty 1 pcs head thickness 3mm DIN 933 / ISO 4017		
<b>For models:</b>	SP1		

			
1			
<b>GEV No.</b>	560385	<b>Ref. No.</b>	260126
<b>description</b>	hexagonal screw thread M5 thread L 12mm SS WS 8 Qty 1 pcs DIN 933 / ISO 4017		
<b>For models:</b>	SP1, SP2-12, SP2-S12, SP3		

			
1			
<b>GEV No.</b>	560087	<b>Ref. No.</b>	260104
<b>description</b>	hexagonal screw thread M6 thread L 16mm SS WS 10 Qty 20 pcs DIN 933 / ISO 4017		
<b>For models:</b>	SP1, SP3		



1

<b>GEV No.</b>	502214	<b>Ref. No.</b>	260112
<b>description</b>	hexagonal screw thread M8 thread L 16mm SS WS 13 Qty 1 pcs head thickness 5.5mm DIN 933 / ISO 4017		
<b>For models:</b>	SP2-12, SP2-S12, SP3		



1

<b>GEV No.</b>	510990	<b>Ref. No.</b>	260113
<b>description</b>	hexagonal screw thread M8 thread L 20mm SS WS 13 Qty 1 pcs DIN 933 / ISO 4017		
<b>For models:</b>	SP3		



1

<b>GEV No.</b>	560204	<b>Ref. No.</b>	8300380
<b>description</b>	hexagonal screw thread M8 thread L 25mm SS WS 13 Qty 1 pcs DIN 933 / ISO 4017		
<b>For models:</b>	512002, 512003, 512004		



1

<b>GEV No.</b>	560205	<b>Ref. No.</b>	8300290
<b>description</b>	hexagonal screw thread M8 thread L 30mm SS WS 13 Qty 1 pcs DIN 933 / ISO 4017		
<b>For models:</b>	512002, 512003, 512004		



1

<b>GEV No.</b>	560206	<b>Ref. No.</b>	8300310
<b>description</b>	hexagonal screw thread M8 thread L 35mm SS WS 14 Qty 1 pcs DIN 933 / ISO 4017		
<b>For models:</b>	512001, 512002, 512003, 512004		



1

<b>GEV No.</b>	560493	<b>Ref. No.</b>	A86ME24115
<b>description</b>	hexagonal screw thread M8 thread L 35mm zinc-coated steel WS 13 Qty 1 pcs head thickness 4.5mm DIN 933 / ISO 4017		



1

<b>GEV No.</b>	506446	<b>Ref. No.</b>	8301740
<b>description</b>	hexagonal screw thread M8 thread L 40mm SS WS 13 Qty 1 pcs DIN 933 / ISO 4017		
<b>For models:</b>	512002, 512003, 512004		



1

<b>GEV No.</b>	560594	<b>Ref. No.</b>	R61020562
<b>description</b>	hexagonal screw thread M6 thread L 20mm WS 10 total length 59mm		
<b>For models:</b>	212003, 212012, 212013		



1

<b>GEV No.</b>	550528	<b>Ref. No.</b>	00-609782-000
<b>description</b>	safety screw thread M5 WS 8 Qty 10 pcs L 8mm head ø 11mm		
<b>For models:</b>	813002, 813003, 813004		



1

<b>GEV No.</b>	696413	<b>Ref. No.</b>	GN650TN.01
<b>description</b>	screw thread M6 L 18mm		
<b>For models:</b>	621018, 621019		

### cylinder head bolts

DIN 912/ISO 4762



1

<b>GEV No.</b>	527168	<b>Ref. No.</b>	WY23556
<b>description</b>	cylinder head bolt thread M10 thread L 16mm L 30mm WS 8 SS Qty 1 pcs DIN 912/ISO 4762		





1

<b>GEV No.</b>	560026	<b>Ref. No.</b>	WY23560
<b>description</b>	cylinder head bolt thread M4 thread L 16mm WS 3 SS Qty 20 pcs DIN 912/ISO 4762		
<b>For models:</b>	742001, 742002, 742003, 742004, 742005, 742017, 742018, 742019, 742020		





 <p>1</p>			
<b>GEV No.</b>	527170	<b>Ref. No.</b>	WY23558
<b>description</b>	cylinder head bolt thread M6 thread L 8mm WS 5 SS Qty 1 pcs DIN 912/ISO 4762		
<b>For models:</b>	742001, 742002, 742003, 742004, 742005, 742017, 742018, 742019, 742020		

 <p>1</p>			
<b>GEV No.</b>	560225	<b>Ref. No.</b>	8301260
<b>description</b>	cylinder head bolt thread M4 L 30mm thread L 20mm WS 3 intake hexagonal SS Qty 1 pcs head ø 7mm head thickness 4mm DIN 912/ISO 4762		
<b>For models:</b>	512001, 512002, 512003, 512004		

<p>miscellaneous</p>  <p>1</p>			
<b>GEV No.</b>	510953	<b>Ref. No.</b>	260213
<b>description</b>	cylinder head bolt thread M5 thread L 25mm SS Qty 1 pcs intake slotted		
<b>For models:</b>	SP1, SP2-12, SP2-S12, SP3		

<p>side bolts</p>  <p>1</p>			
<b>GEV No.</b>	560052	<b>Ref. No.</b>	260223 886012700
<b>description</b>	side bolts thread M5 L 10mm SS Qty 20 pcs intake slotted head ø 12.5mm		
<b>For models:</b>	641010, 641011, 641012, 641013, 641014, 641015, 641016, 641017, SP1, SP2-12, SP2-S12		

 <p>1</p>			
<b>GEV No.</b>	560053	<b>Ref. No.</b>	886012800
<b>description</b>	side bolts thread M5 L 16mm SS Qty 20 pcs intake slotted head ø 12.5mm		
<b>For models:</b>	631001, 631002, 631003, 631004, 631005, 631006, 636001, 636002, 636003, 636004, 636005, 636006, 641001, 641002, 641003, 641010, 641011, 641012, 641013, 641014, 641015, 641016, 641017, 644010, 644011, 644012		

 <p>1</p>			
<b>GEV No.</b>	560345	<b>Ref. No.</b>	886012400
<b>description</b>	side bolts thread M5 L 22mm SS Qty 1 pcs head ø 12mm		
<b>For models:</b>	641001, 641002, 641003, 641004, 641005, 641006, 641007, 641008		

<p>grub screws</p> <p>DIN 916/ISO 4029</p>  <p>1</p>			
<b>GEV No.</b>	560173	<b>Ref. No.</b>	6A009190
<b>description</b>	grub screw thread M4 L 10mm SS DIN 916/ISO 4029 intake internal hexagon WS 2 Qty 20 pcs		
<b>For models:</b>	131003, 131005, 131201, 131202, 131203, 131204, 131205, 131206, 131210, 132201, 132202, 133001, 133002, 133003, 133009, 133010, 133011, 133012, 133013, 133014, 133015, 133024, 133201, 133202, 133203, 133209, 133210, 133211, 133212, 133213, 133214, 133215, 133224		

 <p>1</p>			
<b>GEV No.</b>	696273	<b>Ref. No.</b>	AMA085 AMI072
<b>description</b>	grub screw thread M5 L 10mm DIN 916/ISO 4029 intake internal hexagon WS 2.5 Qty 1 pcs		
<b>For models:</b>	411001		

 <p>1</p>			
<b>GEV No.</b>	696274	<b>Ref. No.</b>	AMA026
<b>description</b>	grub screw thread M5 L 6/10mm DIN 916/ISO 4029 WS 2.5 set Qty 1 pcs L1 6mm L2 10mm		
<b>For models:</b>	411001		

 <p>1</p>			
<b>GEV No.</b>	696272	<b>Ref. No.</b>	AMA266
<b>description</b>	grub screw thread M5 L 6mm DIN 916/ISO 4029 intake internal hexagon WS 2.5 Qty 1 pcs		
<b>For models:</b>	411001		



 <p>1</p>			
<b>GEV No.</b>	510906	<b>Ref. No.</b>	250206 AMA030
<b>description</b>	grub screw thread M6 L 8mm stainless steel DIN 914/ISO 4027 WS 3 Qty 1 pcs		
<b>For models:</b>	411001, SP3		

 <p>1</p>			
<b>GEV No.</b>	560207	<b>Ref. No.</b>	8300280 AMA086
<b>description</b>	grub screw thread M8 L 10mm steel DIN 916/ISO 4029 intake internal hexagon WS 4 Qty 1 pcs		
<b>For models:</b>	411001, 512002, 512003, 512004		

miscellaneous

 <p>1</p>			
<b>GEV No.</b>	504788	<b>Ref. No.</b>	AMA282
<b>description</b>	screw thread M5 L 50mm Qty 1 pcs		
<b>For models:</b>	411001		

threaded rods

miscellaneous

 <p>1</p>			
<b>GEV No.</b>	527174	<b>Ref. No.</b>	WY10405004 WY23134
<b>description</b>	thread bolt thread M8 L 25mm SS		
<b>For models:</b>	742001, 742002, 742003, 742004, 742005, 742017, 742018, 742019, 742020		

 <p>1</p>			
<b>GEV No.</b>	527172	<b>Ref. No.</b>	WY28360005
<b>description</b>	thread bolt thread M8 L 40mm steel WS 4 intake hexagonal		
<b>For models:</b>	744001, 744002		

knurled screws

 <p>1</p>			
<b>GEV No.</b>	510112	<b>Ref. No.</b>	454002
<b>description</b>	Thumb screw thread M10 thread L 10mm ø 22mm H 4.5mm SS		
<b>For models:</b>	812001, 812002, 812003, 812004, 812005, 812006, 812007, 812008, 812009, 812010, 915234, 915235, 915236, 915237, 915460, 915461, 915462, 915463, 915464, 915465		

 <p>1</p>			
<b>GEV No.</b>	510307	<b>Ref. No.</b>	261009
<b>description</b>	Thumb screw thread M6 H 3mm thread L 8mm ø 28mm SS		
<b>For models:</b>	SP1, SP2-12, SP2-S12, SP3		

miscellaneous

 <p>1</p>			
<b>GEV No.</b>	511006	<b>Ref. No.</b>	260228
<b>description</b>	screw		
<b>For models:</b>	SP3		

 <p>1</p>			
<b>GEV No.</b>	694991	<b>Ref. No.</b>	R58006400
<b>description</b>	screw thread M6 L 16mm for air baffle combi-steamer		
<b>For models:</b>	212001, 212002, 212003, 212010, 212011, 212012, 212013		

nuts

wing nuts

 <p>1</p>			
<b>GEV No.</b>	560147	<b>Ref. No.</b>	AMC678
<b>description</b>	wing nuts thread M6 SS DIN/ISO DIN 315 Qty 20 pcs		
<b>For models:</b>	411001		





cap nuts			
			
1			
<b>GEV No.</b>	695119	<b>Ref. No.</b>	IB2000910
<b>description</b>	cap nuts thread M5L WS 10 SS Qty 1 pcs		
<b>For models:</b>	721003, 721004		

long nuts			
			
1			
<b>GEV No.</b>	540438	<b>Ref. No.</b>	1868700 MA1868700
<b>description</b>	long nut thread M10 L 25mm WS 13 brass Qty 1 pcs		
<b>For models:</b>	126101, 126103		

knurled nuts			
			
1			
<b>GEV No.</b>	518152	<b>Ref. No.</b>	01-240205-001
<b>description</b>	knurled nut thread M12x1 ø 32mm H 3mm mounting pos. upper/lower SS for wash arm ID ø 11.5mm ED ø 32mm thickness 3mm		
<b>For models:</b>	811011, 811012, 811013, 811014, 811015, 812011, 812012, 812013, 812014, 812015, 813002, 813003, 813004		

			
1			
<b>GEV No.</b>	510346	<b>Ref. No.</b>	280409
<b>description</b>	knurled nut thread M17x1 ø 35mm H 6mm SS		
<b>For models:</b>	SP3		

			
1			
<b>GEV No.</b>	518028	<b>Ref. No.</b>	454004
<b>description</b>	knurled nut thread M5 ø 25mm H 4mm SS		
<b>For models:</b>	811001, 811002, 811003		

hexagonal nuts			
DIN 934 / ISO 4032/8673			
			
1			
<b>GEV No.</b>	560129	<b>Ref. No.</b>	260403
<b>description</b>	hexagonal nut thread M5 H 4mm WS 8 SS DIN/ISO DIN 934 / ISO 4032/8673 Qty 1 pcs		
<b>For models:</b>	SP1, SP2-12, SP2-S12		

			
1			
<b>GEV No.</b>	560132	<b>Ref. No.</b>	886003500
<b>description</b>	hexagonal nut thread M5 H 4mm WS 8 SS DIN/ISO DIN 934 / ISO 4032/8673 Qty 20 pcs		
<b>For models:</b>	631001, 631002, 631003, 631004, 631005, 631006, 641001, 641002, 641003, 641004, 641005, 641006, 641007, 641008, 641010, 641011, 641012, 641013, 641014, 641015, 641016, 641017		

			
1			
<b>GEV No.</b>	560133	<b>Ref. No.</b>	260404
<b>description</b>	hexagonal nut thread M6 H 5mm WS 10 SS DIN/ISO DIN 934 / ISO 4032/8673 Qty 20 pcs		
<b>For models:</b>	SP1, SP2-12, SP2-S12, SP3		

			
1			
<b>GEV No.</b>	506166	<b>Ref. No.</b>	260408
<b>description</b>	nut thread M12 H 10mm WS 19 SS DIN/ISO DIN 934 / ISO 4032/8673 Qty 1 pcs		
<b>For models:</b>	SP1, SP2-12, SP2-S12		

ISO 4033 / UNI5587			
			
1			
<b>GEV No.</b>	550866	<b>Ref. No.</b>	R58004020
<b>description</b>	nut thread M10x1.5 H 10mm SS WS 17 Qty 1 pcs DIN/ISO DIN 934 / ISO 4032/8673 left-hand thread		
<b>For models:</b>	212002, 212010, 212011		

			
1			
<b>GEV No.</b>	560470	<b>Ref. No.</b>	260406
<b>description</b>	nut thread M8x1.25 H 8mm WS 13 SS Qty 1 pcs DIN/ISO ISO 4033 / UN15587		
<b>For models:</b>	SP3		

DIN 985			
			
1			
<b>GEV No.</b>	560140	<b>Ref. No.</b>	260402 260418
<b>description</b>	hexagonal nut thread M4 H 4.8mm SS WS 7 Qty 20 pcs DIN/ISO DIN 985 self-locking		
<b>For models:</b>	SP1, SP2-12, SP2-S12, SP3		

hexagonal nuts metric (without norm)			
			
1			
<b>GEV No.</b>	540436	<b>Ref. No.</b>	1033514900 MA1033514900
<b>description</b>	hexagonal nut thread M10x1.25 H 4mm WS 13 brass Qty 1 pcs		
<b>For models:</b>	126101, 126103		

			
1			
<b>GEV No.</b>	521134	<b>Ref. No.</b>	417017
<b>description</b>	hexagonal nut thread M14x1 SS		
<b>For models:</b>	812001, 812002, 812005, 812007, 812009, 915234, 915235, 915236, 915237, 915460		

			
1			
<b>GEV No.</b>	527169	<b>Ref. No.</b>	WY23050
<b>description</b>	hexagonal nut thread M3 H 2.8mm WS 5.5 brass Qty 1 pcs		
<b>For models:</b>	742001, 742002, 742003, 742004, 742005		

			
1			
<b>GEV No.</b>	513266	<b>Ref. No.</b>	417104
<b>description</b>	nut		
<b>For models:</b>	811001, 811002, 811003		

			
1			
<b>GEV No.</b>	550681	<b>Ref. No.</b>	R58004050
<b>description</b>	nut thread M12x1.25 H 5mm WS 17 brass Qty 1 pcs		
<b>For models:</b>	212002, 212003, 212010, 212011, 212012, 212013, 212018, 212020		

			
1			
<b>GEV No.</b>	102382	<b>Ref. No.</b>	1033700200 MA1033700200
<b>description</b>	nut thread M14x1 H 3.5mm WS 18 brass Qty 1 pcs		
<b>For models:</b>	121101, 121102, 121105, 121106, 122101, 122102, 123101, 123102, 124103, 141021, 143001, 143002, 143003, 143004, 143005, 143006, 143007, 143008, 143009, 143010, 143011, 143012, 143013, 143014, 143015, 143016, 146002, 147003		

			
1			
<b>GEV No.</b>	521133	<b>Ref. No.</b>	1325313
<b>description</b>	nut thread M14x1.5 H 6mm WS 19 zinc-coated steel Qty 1 pcs		

			
1			
<b>GEV No.</b>	101345	<b>Ref. No.</b>	41822180010
<b>description</b>	nut thread M15x1 H 3mm WS 19 brass Qty 1 pcs		
<b>For models:</b>	133001, 133002, 133003, 133009, 133010, 133011, 133012, 133013, 133014, 133015, 133024, 133201, 133202, 133203, 133209, 133210, 133211, 133212, 133213, 133214, 133215, 133224		

			
1			
<b>GEV No.</b>	691289	<b>Ref. No.</b>	R58004830
<b>description</b>	nut thread M18x1 H 5mm WS 22 brass Qty 1 pcs for door handle		
<b>For models:</b>	212001, 212002, 212003		

			
1			
<b>GEV No.</b>	527269	<b>Ref. No.</b>	WY25384
<b>description</b>	nut thread M26x1.5 H 5.7mm WS 32 brass Qty 1 pcs		
<b>For models:</b>	742001, 742002, 742003, 742004, 742005		







 <p>1</p>			
<b>GEV No.</b>	102067	<b>Ref. No.</b>	939300 MA939300
<b>description</b>	nut thread M8x1 H 3mm brass Qty 1 pcs type SEF 1		
<b>For models:</b>	121102, 121105, 143001, 143002, 143003, 143004, 143005, 143006, 143007, 143008, 143009, 143010, 143011, 143012, 143013, 143014, 143015, 143016		

hexagonal nuts inch thread			
 <p>1</p>			
<b>GEV No.</b>	510331	<b>Ref. No.</b>	270101
<b>description</b>	nut thread 1/2" H 7mm SS WS 30 Qty 1 pcs		
<b>For models:</b>	SP2-12, SP2-S12, SP3		

 <p>1</p>			
<b>GEV No.</b>	514022	<b>Ref. No.</b>	14044599 MA14044599
<b>description</b>	nut thread 1 1/2" H 12mm SS WS 59 Qty 1 pcs		
<b>For models:</b>	126101, 126103		

 <p>1</p>			
<b>GEV No.</b>	503042	<b>Ref. No.</b>	WY25356
<b>description</b>	nut thread 3/8" H 6mm brass WS 22 Qty 1 pcs		
<b>For models:</b>	742001, 742002, 742003, 742004		

miscellaneous			
 <p>1</p>			
<b>GEV No.</b>	551380	<b>Ref. No.</b>	DAD30010
<b>description</b>	cage nut thread M10 Qty 4 pcs		
<b>For models:</b>	211028, 211029		

 <p>1</p>			
<b>GEV No.</b>	696438	<b>Ref. No.</b>	00-775460-001
<b>description</b>	expanding nut plastic Qty 1 pcs for sheet-metal screw		
<b>For models:</b>	813002, 813003, 813004		

washers			
spring rings			
 <p>1</p>			
<b>GEV No.</b>	560209	<b>Ref. No.</b>	8300620
<b>description</b>	lock washer ID ø 10.3mm ED ø 17.2mm SS Qty 1 pcs for thread M10		
<b>For models:</b>	512002, 512003, 512004		

 <p>1</p>			
<b>GEV No.</b>	560376	<b>Ref. No.</b>	260510
<b>description</b>	lock washer ID ø 4.3mm ED ø 7.3mm SS UNI 1751 A Qty 1 pcs for thread M4		
<b>For models:</b>	SP1, SP2-12, SP2-S12, SP3		

 <p>1</p>			
<b>GEV No.</b>	560122	<b>Ref. No.</b>	260511
<b>description</b>	lock washer ID ø 5.2mm ED ø 9mm SS DIN127 Qty 20 pcs for thread M5		
<b>For models:</b>	SP1, SP2-12, SP2-S12, SP3		

 <p>1</p>			
<b>GEV No.</b>	560123	<b>Ref. No.</b>	260512
<b>description</b>	lock washer ID ø 6.3mm ED ø 11mm SS DIN127 Qty 20 pcs for thread M6		
<b>For models:</b>	SP1, SP2-12, SP2-S12, SP3		

 <p>1</p>			
<b>GEV No.</b>	560208	<b>Ref. No.</b>	260513 8300390
<b>description</b>	lock washer ID ø 8.3mm ED ø 15mm SS Qty 1 pcs		
<b>For models:</b>	512002, 512003, 512004, SP3		

spring washers			
 <p>1</p>			
<b>GEV No.</b>	696253	<b>Ref. No.</b>	19342005 AMA096
<b>description</b>	spring washer ID ø 12mm ED ø 25mm Qty 1 pcs		
<b>For models:</b>	411001, 411003, 411005		

			
1			
<b>GEV No.</b>	696254	<b>Ref. No.</b>	19342006
<b>description</b>	spring washer ID ø 19mm ED ø 32mm Qty 1 pcs		
<b>For models:</b>	411004		

washers

DIN 125A

			
1			
<b>GEV No.</b>	540437	<b>Ref. No.</b>	15800699
<b>description</b>	plain washer ED ø 20mm for thread M10		

			
1			
<b>GEV No.</b>	560332	<b>Ref. No.</b>	260502
<b>description</b>	plain washer ID ø 4.3mm ED ø 9mm thickness 0.8mm SS Qty 1 pcs		
<b>For models:</b>	SP1, SP2-12, SP2-S12, SP3		

			
1			
<b>GEV No.</b>	560112	<b>Ref. No.</b>	260503
<b>description</b>	plain washer ID ø 5.3mm ED ø 10mm thickness 1mm SS Qty 20 pcs DIN 125A for thread M5		
<b>For models:</b>	SP1, SP2-12, SP2-S12		

			
1			
<b>GEV No.</b>	560113	<b>Ref. No.</b>	260504 AMA238 RG04064
<b>description</b>	plain washer ID ø 6.4mm ED ø 12mm thickness 1.6mm SS Qty 20 pcs DIN 125A for thread M6		
<b>For models:</b>	411001, 451001, SP1, SP3		

			
1			
<b>GEV No.</b>	560114	<b>Ref. No.</b>	260505
<b>description</b>	plain washer ID ø 8.4mm ED ø 16mm thickness 1.6mm SS Qty 20 pcs DIN 125A for thread M8		
<b>For models:</b>	SP3		

<b>DIN 9021</b>			
			
1			
<b>GEV No.</b>	560210	<b>Ref. No.</b>	8300630
<b>description</b>	plain washer ID ø 11mm ED ø 30mm thickness 2mm SS Qty 1 pcs DIN 9021 for thread M10		
<b>For models:</b>	512002, 512003, 512004		

			
1			
<b>GEV No.</b>	560117	<b>Ref. No.</b>	260538
<b>description</b>	plain washer ID ø 6.4mm ED ø 18mm thickness 1.5mm SS Qty 20 pcs DIN 9021 for thread M6		
<b>For models:</b>	SP1, SP2-12, SP2-S12, SP3		

miscellaneous

			
1			
<b>GEV No.</b>	691535	<b>Ref. No.</b>	251143
<b>description</b>	disc ID ø 10mm ED ø 14mm thicknessmm aluminium Qty 1 pcs		
<b>For models:</b>	743001		

			
1			
<b>GEV No.</b>	511254	<b>Ref. No.</b>	260537
<b>description</b>	disc ø 13mm D1 ø 20mm thickness 0.8mm		
<b>For models:</b>	SP3		

			
1			
<b>GEV No.</b>	529862	<b>Ref. No.</b>	WY25652
<b>description</b>	flat washer ID ø 12.3mm ED ø 18mm thickness 1mm brass Qty 1 pcs		
<b>For models:</b>	742001, 742002, 742003, 742004		

			
1			
<b>GEV No.</b>	527159	<b>Ref. No.</b>	WY25653
<b>description</b>	flat washer ID ø 9mm ED ø 15.4mm thickness 1mm brass Qty 1 pcs		
<b>For models:</b>	742001, 742002, 742003, 742004		



			
1			
<b>GEV No.</b>	692307	<b>Ref. No.</b>	01-240789-001
<b>description</b>	plain washer for hinge ID ø 8mm ED ø 18mm plastic thickness 1mm Qty 1 pcs		
<b>For models:</b>	812011, 812012, 812013, 812014, 812015		

			
1			
<b>GEV No.</b>	691296	<b>Ref. No.</b>	R61400052
<b>description</b>	plain washer ID ø 10.5mm ED ø 21mm thickness 2mm SS Qty 1 pcs for fan wheel		
<b>For models:</b>	212002, 212010, 212011		

			
1			
<b>GEV No.</b>	691292	<b>Ref. No.</b>	R10401710
<b>description</b>	plain washer ID ø 12mm ED ø 17.5mm thickness 1mm SS Qty 1 pcs		
<b>For models:</b>	212002, 212003		

			
1			
<b>GEV No.</b>	510236	<b>Ref. No.</b>	260568
<b>description</b>	plain washer ID ø 21mm ED ø 28mm thickness 1mm SS Qty 1 pcs		
<b>For models:</b>	SP3		

			
1			
<b>GEV No.</b>	560301	<b>Ref. No.</b>	260530
<b>description</b>	plain washer ID ø 7mm ED ø 22mm thickness 2mm SS Qty 1 pcs		
<b>For models:</b>	SP2-12, SP2-S12, SP3		

			
1			
<b>GEV No.</b>	551434	<b>Ref. No.</b>	R58004010
<b>description</b>	plain washer ø 30mm thickness 3mm hole ø 12.5mm for fan wheel combi-steamer		
<b>For models:</b>	212003, 212012, 212013		

			
1			
<b>GEV No.</b>	527148	<b>Ref. No.</b>	WY25651
<b>description</b>	washer ID ø 17mm ED ø 28mm thickness 2mm brass Qty 1 pcs beveled		
<b>For models:</b>	742001, 742002, 742003, 742004		

			
1			
<b>GEV No.</b>	560214	<b>Ref. No.</b>	8300400
<b>description</b>	washer ID ø 8.5mm ED ø 31.5mm thickness 1mm SS Qty 1 pcs		
<b>For models:</b>	512002, 512003, 512004		

## fasteners

### slot nuts

			
1			
<b>GEV No.</b>	692006	<b>Ref. No.</b>	SL0010
<b>description</b>	slot nut W 5mm H 5mm L 20mm		
<b>For models:</b>	451003, 451004, 471003, 471004, 511003, 511004, 512010, 512011, 512012, 512015, 512016, 512019, 512020		

			
1			
<b>GEV No.</b>	560287	<b>Ref. No.</b>	8301530
<b>description</b>	slot nut W 6mm H 6mm L 20mm		
<b>For models:</b>	512002, 512003		

			
1			
<b>GEV No.</b>	560286	<b>Ref. No.</b>	SL1056
<b>description</b>	slot nut W 6mm H 6mm L 25mm		
<b>For models:</b>	512013, 512014, 512017, 512018, 512021, 512022		

			
1			
<b>GEV No.</b>	560269	<b>Ref. No.</b>	8300450
<b>description</b>	slot nut W 6mm H 6mm L 30mm		

			
1			
<b>GEV No.</b>	560284	<b>Ref. No.</b>	8301540
<b>description</b>	slot nut W 6mm H 6mm L 35mm		
<b>For models:</b>	512004		

			
1			
<b>GEV No.</b>	560181	<b>Ref. No.</b>	SL3899
<b>description</b>	slot nut W 6mm H 6mm L 40mm		
<b>For models:</b>	511003, 511004		

			
1			
<b>GEV No.</b>	697784	<b>Ref. No.</b>	SL2057
<b>description</b>	slot nut W 8mm H 7mm L 20mm		
<b>For models:</b>	512013, 512014, 512017, 512018, 512021, 512022		

1 			
<b>GEV No.</b>	560268	<b>Ref. No.</b>	8300650
<b>description</b>	slot nut W 8mm H 7mm L 35mm		
<b>For models:</b>	512002, 512003, 512004		

1 			
<b>GEV No.</b>	560651	<b>Ref. No.</b>	SL3410
<b>description</b>	slot nut W 8mm H 7mm L 40mm		
<b>For models:</b>	512011, 512012, 512013, 512014, 512015, 512016, 512017, 512018, 512019, 512020, 512021, 512022		

clamps

hose clamps

DIN 3017 - W2

1 			
<b>GEV No.</b>	520111	<b>Ref. No.</b>	450102
<b>description</b>	hose clamp ø 10-16mm width 9mm Qty 10 pcs DIN 3017		
<b>For models:</b>	SP1, SP2-12, SP2-S12, SP3		

1 			
<b>GEV No.</b>	520112	<b>Ref. No.</b>	450103 R61630011
<b>description</b>	hose clamp ø 12-20mm width 9mm Qty 10 pcs DIN 3017		
<b>For models:</b>	212001, 212002, 212003, 212010, 212011, 212012, 212013, 212018, 212020, SP1, SP2-12, SP2-S12, SP3		

1 			
<b>GEV No.</b>	520113	<b>Ref. No.</b>	450104
<b>description</b>	hose clamp ø 16-27mm width 9mm Qty 10 pcs DIN 3017		
<b>For models:</b>	SP1		

1 			
<b>GEV No.</b>	520114	<b>Ref. No.</b>	450114
<b>description</b>	hose clamp ø 20-32mm width 9mm Qty 10 pcs DIN 3017		
<b>For models:</b>	SP2-12, SP2-S12		

1 			
<b>GEV No.</b>	520115	<b>Ref. No.</b>	450105
<b>description</b>	hose clamp ø 25-40mm width 9mm Qty 10 pcs DIN 3017		
<b>For models:</b>	SP2-12, SP2-S12		

1 			
<b>GEV No.</b>	520116	<b>Ref. No.</b>	450107
<b>description</b>	hose clamp ø 32-50mm width 9mm Qty 5 pcs DIN 3017		
<b>For models:</b>	SP1, SP2-12, SP2-S12, SP3		

1 			
<b>GEV No.</b>	520118	<b>Ref. No.</b>	450109
<b>description</b>	hose clamp ø 50-70mm width 9mm Qty 5 pcs DIN 3017		
<b>For models:</b>	SP1, SP2-12, SP2-S12, SP3		

1 			
<b>GEV No.</b>	520119	<b>Ref. No.</b>	450119
<b>description</b>	hose clamp ø 60-80mm width 9mm Qty 5 pcs DIN 3017		
<b>For models:</b>	SP3		

double wire clamps

1 			
<b>GEV No.</b>	520573	<b>Ref. No.</b>	00-324510-202
<b>description</b>	hose clamp ø 20mm wire gauge ø 2mm Qty 1 pcs		
<b>For models:</b>	811011, 811012, 811013, 811014, 811015, 812011, 812012, 812013, 812014, 812015		





 <p>1</p>			
<b>GEV No.</b>	520577	<b>Ref. No.</b>	00-324510-242
<b>description</b>	hose clamp ø 24mm wire gauge ø 2mm Qty 1 pcs		
<b>For models:</b>	811011, 811012, 811013, 811014, 811015, 812011, 812012, 812013, 812014, 812015		

 <p>1</p>			
<b>GEV No.</b>	520574	<b>Ref. No.</b>	00-324510-327
<b>description</b>	hose clamp ø 32mm wire gauge ø 3mm Qty 1 pcs		
<b>For models:</b>	812014, 812015		

 <p>1</p>			
<b>GEV No.</b>	511286	<b>Ref. No.</b>	450143
<b>description</b>	hose clamp ø 38mm wire gauge ø 3.2mm Qty 1 pcs		
<b>For models:</b>	SP3		

 <p>1</p>			
<b>GEV No.</b>	513268	<b>Ref. No.</b>	00-303340-008 423011 450134
<b>description</b>	hose clamp ø 8-10mm wire gauge ø 1mm Qty 1 pcs		
<b>For models:</b>	812001, 812002, 812003, 812004, 812005, 812006, 812007, 812008, 812009, 812010, 813002, 813003, 813004, 915234, 915235, 915236, 915237, 915460, 915461, 915462, 915463, 915464, 915465, SP1, SP2-12, SP2-S12, SP3		

 <p>1</p>			
<b>GEV No.</b>	510959	<b>Ref. No.</b>	450115
<b>description</b>	hose clamp ø 8mm wire gauge ø 1mm Qty 1 pcs		
<b>For models:</b>	SP1		

 <p>1</p>			
<b>GEV No.</b>	511147	<b>Ref. No.</b>	450125
<b>description</b>	wire clamp ø 12-14mm wire gauge ø 1.5mm zinc-coated steel Qty 1 pcs		
<b>For models:</b>	SP3		

double wire clamps with screw

 <p>1</p>			
<b>GEV No.</b>	505281	<b>Ref. No.</b>	00-323945-015
<b>description</b>	hose clamp ø 15mm zinc-coated steel Qty 20 pcs		
<b>For models:</b>	811011, 811012, 811013, 811014, 811015, 812011, 812012, 812013, 812014, 812015, 813002, 813003, 813004		

 <p>1</p>			
<b>GEV No.</b>	505282	<b>Ref. No.</b>	00-323945-016
<b>description</b>	hose clamp ø 16mm zinc-coated steel Qty 20 pcs		
<b>For models:</b>	811014, 811015, 812014, 812015		

 <p>1</p>			
<b>GEV No.</b>	505283	<b>Ref. No.</b>	00-323945-018
<b>description</b>	hose clamp ø 18mm zinc-coated steel Qty 20 pcs		
<b>For models:</b>	811011, 811012, 811013, 811014, 811015, 812011, 812012, 812013, 812014, 812015, 813002, 813003, 813004		



1

<b>GEV No.</b>	505284	<b>Ref. No.</b>	00-323945-021
<b>description</b>	hose clamp ø 21mm zinc-coated steel Qty 20 pcs		
<b>For models:</b>	811011, 811012, 811013, 812011, 812012, 812013, 813002, 813003, 813004		



1

<b>GEV No.</b>	505285	<b>Ref. No.</b>	00-323945-025
<b>description</b>	hose clamp ø 25mm zinc-coated steel Qty 20 pcs		
<b>For models:</b>	811011, 811012, 811013, 811014, 811015, 812011, 812012, 812013, 812014, 812015, 813002, 813003, 813004		



1

<b>GEV No.</b>	505286	<b>Ref. No.</b>	00-323945-029
<b>description</b>	hose clamp ø 29mm zinc-coated steel Qty 20 pcs		
<b>For models:</b>	813003, 813004		



1

<b>GEV No.</b>	505287	<b>Ref. No.</b>	00-323945-033
<b>description</b>	hose clamp ø 33mm zinc-coated steel Qty 20 pcs		
<b>For models:</b>	811012, 811013, 811014, 811015, 812012, 812013, 812014, 812015, 813003		



1

<b>GEV No.</b>	505293	<b>Ref. No.</b>	00-323945-035
<b>description</b>	hose clamp ø 34-38mm zinc-coated steel Qty 20 pcs		
<b>For models:</b>	811011, 811012, 811013, 811014, 811015, 812011, 812012, 812013, 812014, 813003, 813004		



1

<b>GEV No.</b>	505290	<b>Ref. No.</b>	00-323945-037
<b>description</b>	hose clamp ø 37mm zinc-coated steel Qty 10 pcs		
<b>For models:</b>	811011, 811012, 811013, 811014, 811015, 812011, 812012, 812013, 812014, 812015		



1

<b>GEV No.</b>	505294	<b>Ref. No.</b>	00-323945-053
<b>description</b>	hose clamp ø 53mm zinc-coated steel Qty 10 pcs		
<b>For models:</b>	811011, 811012, 811013, 811014, 811015, 812011, 812012, 812013, 812014, 812015		



1

<b>GEV No.</b>	505291	<b>Ref. No.</b>	00-323945-056
<b>description</b>	hose clamp ø 56mm zinc-coated steel Qty 10 pcs		
<b>For models:</b>	811011, 811012, 811013, 811014, 811015, 812011, 812012, 812013, 812014, 812015		



			
1			
<b>GEV No.</b>	505289	<b>Ref. No.</b>	00-323945-060
<b>description</b>	hose clamp ø 60mm zinc-coated steel Qty 10 pcs		
<b>For models:</b>	813002, 813003, 813004		

			
1			
<b>GEV No.</b>	505292	<b>Ref. No.</b>	00-323945-064
<b>description</b>	hose clamp ø 64-68mm zinc-coated steel Qty 10 pcs		
<b>For models:</b>	813002, 813003, 813004		

miscellaneous

			
1			
<b>GEV No.</b>	510923	<b>Ref. No.</b>	440817
<b>description</b>	clamping ring for shaft ø 10mm ID ø 9.4mm H 6mm		
<b>For models:</b>	SP3		

retainer clips

			
1			
<b>GEV No.</b>	691471	<b>Ref. No.</b>	X05.04.531.00
<b>description</b>	retainer clip L 48mm wire gauge ø 2.3mm stainless steel Qty 1 pcs		
<b>For models:</b>	541003		

retaining rings

DIN 471

			
1			
<b>GEV No.</b>	692065	<b>Ref. No.</b>	0065250
<b>description</b>	retaining ring for vacuum packing machine shaft ø 6mm thickness 0.7mm SS DIN 471		

			
1			
<b>GEV No.</b>	519248	<b>Ref. No.</b>	5203100
<b>description</b>	retaining ring shaft ø 10mm thickness 1mm SS DIN 471		

			
1			
<b>GEV No.</b>	528689	<b>Ref. No.</b>	5203200 SL2471
<b>description</b>	retaining ring shaft ø 15mm thickness 1mm steel DIN 471		
<b>For models:</b>	471006, 513004, 513005, 513006, 513008, 513009, 513010		

			
1			
<b>GEV No.</b>	504519	<b>Ref. No.</b>	SL0017
<b>description</b>	retaining ring shaft ø 17mm thickness 1mm SS DIN 471		
<b>For models:</b>	512010, 512011, 512012, 512015, 512016, 512019, 512020, 513004, 513005, 513006, 513008, 513009, 513010		

			
1			
<b>GEV No.</b>	523105	<b>Ref. No.</b>	SL3896
<b>description</b>	retaining ring shaft ø 18mm thickness 1.2mm steel DIN 471		
<b>For models:</b>	511001, 511002, 511003, 511004		

			
1			
<b>GEV No.</b>	514030	<b>Ref. No.</b>	SL0075
<b>description</b>	retaining ring shaft ø 20mm thickness 1.3mm steel DIN 471		
<b>For models:</b>	511003, 511004, 512013, 512014, 512017, 512018, 512021, 512022		

			
1			
<b>GEV No.</b>	693061	<b>Ref. No.</b>	633050500 SL1616
<b>description</b>	retaining ring shaft ø 25mm thickness 1.2mm steel DIN 471		
<b>For models:</b>	262001, 512014, 512015, 512016, 512017, 512018, 512019, 512020, 512021, 512022		

			
1			
<b>GEV No.</b>	560302	<b>Ref. No.</b>	0065251
<b>description</b>	retaining ring shaft ø 8mm thickness 0.8mm SS DIN 471		

DIN 472			
			
1			
<b>GEV No.</b>	528099	<b>Ref. No.</b>	WY10005
<b>description</b>	retaining ring bore ø 11mm thickness 1mm DIN 472		
<b>For models:</b>	742001, 742002, 742003, 742004, 742005, 742017, 742018, 742019, 742020		

			
1			
<b>GEV No.</b>	527257	<b>Ref. No.</b>	WY10002
<b>description</b>	retaining ring bore ø 16mm thickness 1mm SS DIN 472		
<b>For models:</b>	742001, 742002, 742003, 742004		

			
1			
<b>GEV No.</b>	698003	<b>Ref. No.</b>	50BHA76670
<b>description</b>	retaining ring bore ø 35mm thickness 1.5mm steel DIN 472		
<b>For models:</b>	481003, 481005		

			
1			
<b>GEV No.</b>	698004	<b>Ref. No.</b>	SL0132
<b>description</b>	retaining ring bore ø 40mm thickness 1.9mm steel DIN 472		
<b>For models:</b>	421006, 433003		

			
1			
<b>GEV No.</b>	523100	<b>Ref. No.</b>	SL2056
<b>description</b>	retaining ring bore ø 42mm thickness 1.75mm steel DIN 472		
<b>For models:</b>	451003, 451004		

			
1			
<b>GEV No.</b>	523102	<b>Ref. No.</b>	SL0082
<b>description</b>	retaining ring bore ø 47mm thickness 1.8mm steel DIN 472		
<b>For models:</b>	421007, 421008, 422005, 422006, 433004, 433005		

			
1			
<b>GEV No.</b>	523103	<b>Ref. No.</b>	SL0119
<b>description</b>	retaining ring bore ø 52mm thickness 2mm steel DIN 472		
<b>For models:</b>	431002, 433003, 433004, 433005		

DIN 6799			
			
1			
<b>GEV No.</b>	516198	<b>Ref. No.</b>	WY10001
<b>description</b>	retaining ring E D1 ø 6mm D2 ø 12mm SS DIN 6799 thickness 0.7mm for shaft ø 7-9mm		
<b>For models:</b>	742001, 742002, 742003, 742004, 742005		

			
1			
<b>GEV No.</b>	691470	<b>Ref. No.</b>	X05.03.043.00
<b>description</b>	retaining ring E D1 ø 8mm D2 ø 16mm SS DIN 6799 thickness 1mm for shaft ø 9-12mm		
<b>For models:</b>	222004, 222005		

DIN 7993			
			
1			
<b>GEV No.</b>	518308	<b>Ref. No.</b>	303019
<b>description</b>	retaining ring DIN 7993 for drain assembly thickness 3mm ED ø 57mm		
<b>For models:</b>	812001, 812002, 812003, 812004, 812005, 812006, 812007, 812008, 812009, 812010, 915234, 915235, 915236, 915237, 915460, 915461, 915462, 915463, 915464, 915465		





roll pins



1

<b>GEV No.</b>	691398	<b>Ref. No.</b>	418227993140
<b>description</b>	roll pin ø 3mm L 16mm		
<b>For models:</b>	131003, 131005, 131201, 131202, 131203, 131204, 131205, 131206, 131210, 132201, 132202, 133001, 133002, 133003, 133009, 133010, 133011, 133012, 133013, 133014, 133015, 133024, 133201, 133202, 133203, 133209, 133210, 133211, 133212, 133213, 133214, 133215, 133224		



1

<b>GEV No.</b>	692533	<b>Ref. No.</b>	SL0753
<b>description</b>	roll pin ø 3mm L 20mm SS 1475		
<b>For models:</b>	473006		
<b>accessories for</b>	692533		
	<b>GEV No.</b>	697401	<b>Ref. No.</b> SL0739
	drive shaft D1 ø 8mm L 63mm FM3		



1

<b>GEV No.</b>	691397	<b>Ref. No.</b>	418227994250
<b>description</b>	roll pin ø 4mm L 26mm		



1

<b>GEV No.</b>	690968	<b>Ref. No.</b>	WY10701
<b>description</b>	roll pin ø 5mm L 20mm		
<b>For models:</b>	742001, 742002, 742003, 742004		

screw caps



1

<b>GEV No.</b>	520707	<b>Ref. No.</b>	WY25785
<b>description</b>	screw cap thread 3/8" thread L 8mm brass WS 21 head thickness 6mm		
<b>For models:</b>	742001, 742002, 742003, 742004, 742018, 742020		



1

<b>GEV No.</b>	520702	<b>Ref. No.</b>	WY25782
<b>description</b>	end cap thread 1/4" brass WS 16		
<b>For models:</b>	742001, 742002, 742003, 742004		

consumables

lubricants

oils

for vacuum pumps



1

<b>GEV No.</b>	890296	<b>Ref. No.</b>	0439510
<b>description</b>	oil type V32 1l for vacuum packing machine		
<b>For models:</b>	442003, 442004, 442005, 442006, 442007, 442008, 442010		





1

<b>GEV No.</b>	890253	<b>Ref. No.</b>	0439520
<b>description</b>	oil type VM100 1l for vacuum packing machine		
<b>For models:</b>	442003, 442004, 442005, 442006, 442007, 442008		

			
1			
<b>GEV No.</b>	890247	<b>Ref. No.</b>	0439500
<b>description</b>	oil type VM22 0.05l for vacuum packing machine		
<b>For models:</b>	442003, 442004, 442005, 442006, 442007, 442008		

			
1			
<b>GEV No.</b>	890248	<b>Ref. No.</b>	0439501
<b>description</b>	oil type VM22 1l for vacuum packing machine		
<b>For models:</b>	442003, 442004, 442005, 442006, 442007, 442008		

			
1			
<b>GEV No.</b>	890200	<b>Ref. No.</b>	0439502
<b>description</b>	oil type VM32 0.25l for vacuum packing machine		
<b>For models:</b>	442003, 442004, 442005, 442006, 442007, 442008		

			
1			
<b>GEV No.</b>	890250	<b>Ref. No.</b>	0439503
<b>description</b>	oil type VM32 0.3l for vacuum packing machine		
<b>For models:</b>	442003, 442004, 442005, 442006, 442007, 442008, 442010		

			
1			
<b>GEV No.</b>	890251	<b>Ref. No.</b>	0439505
<b>description</b>	oil type VM32 0.5l for vacuum packing machine		
<b>For models:</b>	442003, 442004, 442005, 442006, 442007, 442008		

			
1			
<b>GEV No.</b>	890252	<b>Ref. No.</b>	0439510 old version
<b>description</b>	oil type VM32 1l for vacuum packing machine		

containers

canister

			
1			
<b>GEV No.</b>	890246	<b>Ref. No.</b>	876900100 879013900
<b>description</b>	canister 5L 180mm W 180mm H 200mm		
<b>For models:</b>	641001, 641002, 641003, 641004, 641005, 641006, 641007, 641008, 641009, 641010, 641011, 641012, 641013, 641014, 641015, 641016, 641017		

measuring cups

			
1			
<b>GEV No.</b>	960095	<b>Ref. No.</b>	12414
<b>description</b>	measuring cup 2l plastic		
<b>For models:</b>	741002		

lava rocks / ceramic briquetts

			
1			
<b>GEV No.</b>	211008	<b>Ref. No.</b>	153000150 6A014900 LAVAB50
<b>description</b>	lava rocks size ca.20-70mm Qty 5kg		
<b>For models:</b>	243007, 243008, 243109, 243110		



fuses

fine fuses



1

<b>GEV No.</b>	358530	<b>Ref. No.</b>	926284
<b>description</b>	fine fuse size $\phi$ 5x20mm 0.8A fast-acting rated 250V Qty 10 pcs		
<b>For models:</b>	813001		



1

<b>GEV No.</b>	358610	<b>Ref. No.</b>	QFS-CA026WRZZ
<b>description</b>	fine fuse size $\phi$ 5x20mm 10A fast-acting rated 250V Qty 10 pcs		
<b>For models:</b>	213001, 213002, 213003		



1

<b>GEV No.</b>	358532	<b>Ref. No.</b>	R65200200
<b>description</b>	fine fuse size $\phi$ 5x20mm 2A fast-acting rated 250V Qty 10 pcs		
<b>For models:</b>	212001, 212002, 212003, 212010, 212011, 212012, 212013		



1

<b>GEV No.</b>	358677	<b>Ref. No.</b>	228004 228010
<b>description</b>	fine fuse size $\phi$ 5x20mm 4A fast-acting rated 250V Qty 10 pcs		
<b>For models:</b>	812001, 812002, 812003, 812004, 812005, 812006, 812007, 812008, 812009, 812010, 813001, 915234, 915235, 915236, 915237, 915460, 915461, 915462, 915463, 915464, 915465		



1

<b>GEV No.</b>	358533	<b>Ref. No.</b>	01143561
<b>description</b>	fine fuse size $\phi$ 5x20mm 6.3A fast-acting rated 250V Qty 10 pcs		
<b>For models:</b>	273001		

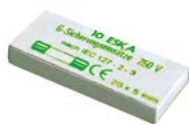

1

<b>GEV No.</b>	358593	<b>Ref. No.</b>	097544 R65200086
<b>description</b>	fine fuse size $\phi$ 5x20mm 0.125A slow-acting rated 250V Qty 10 pcs		
<b>For models:</b>	212002, 212003, 212010, 212011, 212012, 212013, 743001		



1

<b>GEV No.</b>	358595	<b>Ref. No.</b>	R65200320
<b>description</b>	fine fuse size $\phi$ 5x20mm 0.2A slow-acting rated 250V Qty 10 pcs		
<b>For models:</b>	212002, 212010, 212011		



1

<b>GEV No.</b>	358703	<b>Ref. No.</b>	R65200350
<b>description</b>	fine fuse size $\phi$ 5x20mm 0.4A slow-acting rated 250V Qty 10 pcs		
<b>For models:</b>	212003, 212012, 212013		



1

<b>GEV No.</b>	358601	<b>Ref. No.</b>	097103
<b>description</b>	fine fuse size $\phi$ 5x20mm 1.25A slow-acting rated 250V Qty 10 pcs		
<b>For models:</b>	743001		



1

<b>GEV No.</b>	358603	<b>Ref. No.</b>	PT0195
<b>description</b>	fine fuse size $\phi$ 5x20mm 2A slow-acting rated 250V Qty 10 pcs		

$\phi$ 6.3x32mm 250V



1

<b>GEV No.</b>	358760	<b>Ref. No.</b>	926283
<b>description</b>	fine fuse size $\phi$ 6.3x32mm 0.315A medium lag rated 250V Qty 10 pcs		
<b>For models:</b>	813001		



1

<b>GEV No.</b>	358851	<b>Ref. No.</b>	095636
<b>description</b>	fuse size $\phi$ 6.3x32mm 15A slow-acting rated 250V Qty 1 pcs		
<b>For models:</b>	743001		



			
1			
<b>GEV No.</b>	358140	<b>Ref. No.</b>	QFS-CA017WRE0
<b>description</b>	fuse size ø6.3x32mmmm 017A		
<b>For models:</b>	213002, 213003		

fine fuse holders

			
1			
<b>GEV No.</b>	358512	<b>Ref. No.</b>	R65210020
<b>description</b>	fuse holder		
<b>For models:</b>	212001, 212002, 212003, 212004, 212005, 212006, 212007, 212008, 212009, 212010, 212011, 212012, 212013, 212017, 212018, 212019, 212020		

			
1			
<b>GEV No.</b>	550519	<b>Ref. No.</b>	H.228048
<b>description</b>	cover plate suitable fuseA ratedV connection for fuse holder		
<b>For models:</b>	813001		

thermal fuses

			
1			
<b>GEV No.</b>	358853	<b>Ref. No.</b>	1002584
<b>description</b>	thermal fuse switch-off temp. 167°C nominalA cable length 460mm		
<b>For models:</b>	741001		

			
1			
<b>GEV No.</b>	358854	<b>Ref. No.</b>	10915
<b>description</b>	thermal fuse switch-off temp. 167°C nominalA cable length 830mm		
<b>For models:</b>	741001, 741002		

			
1			
<b>GEV No.</b>	358173	<b>Ref. No.</b>	S160P025
<b>description</b>	thermal fuse switch-off temp. 216°C nominalA		
<b>For models:</b>	236004		

<b>A</b>			
alarm devices	96		
appliance sockets/plugs	198		
audible timers	96		
axial fans	156		
<b>B</b>			
ball valves	539		
ballasts	86		
bar burners	240		
beverage technology	549		
bi-metal thermostats	36, 37		
booster pumps I	186		
booster pumps II	188		
brushes	553		
<b>C</b>			
cable glands	199, 199		
cables	198		
cam switches	67		
canister	570		
cap nuts	559		
capillary pipes	500		
capillary tube clips	52		
castors and bumper angles	470		
ceramic burners	244		
ceramic heaters	22		
clamps	550, 564		
cleaning guns	518, 518		
cleaning tools	553		
coil heating elements	22		
cold air circulating fans	162		
cold air circulating fans (complete)	161		
compressors	148		
condensators & interference suppression filters	193		
condensing trays heated	155		
consumables	569		
contactors	97		
container filters	523		
containers	570		
control equipment	76		
control thermostats	38, 47		
copper pipes uninsulated	500		
countersunk screws	555		
cross flow fans	163		
cylinder head bolts	556		
<b>D</b>			
door seals	482		
door seals for dishwashers	497		
door seals with fixing hook	484		
dosing pumps	519		
		double nipples	536
		double wire clamps	550, 564
		double wire clamps with screw	551, 565
		drain fittings	547
		drain hoses	526
		drain pumps	186
		drain systems and wash basins	547
<b>E</b>			
		electric accessories	198
		electric timers	94
		electrodes	147
		electronic controllers	108
		end caps and plugs	469
		energy regulators	35
		evaporators	501
		extraction and pressure hoses	530
		extractor fans	170
<b>F</b>			
		fans	156
		fasteners	563
		fastening material	554
		ferrite rings	194
		filter driers	499
		filters	194
		fine fuses	571
		fittings	536
		flat-headed bolts	555
		float switches	66
		flow heaters	30
		flow meters	148
		fluorescent lamps	86, 86
		foam rubber gaskets	494
		foil heating elements	31
		foot switches	72
		formed hoses	533
		fridge lamps	87
		funnel trays	280
		fuses	195, 571
<b>G</b>			
		gas burners	231
		gas control valves	214
		gas lines	262
		gas nozzles	247
		gas taps	206
		gas thermostats	211
		gaskets for heated units	481
		gaskets for wash arm support	499
		gastronorm	516
		grates	475
		group 1	500

grub screws	557	knurled screws	558
<b>H</b>			
halogen lamp	85	lamps	79
heating cables	21	lava rocks / ceramic briquettes	262, 570
heating elements	3	LED	84
heating elements for bain maries	3	light bulbs	84
heating elements for chip scuttles	4	linear lamps	85
heating elements for coffee machine	9	long nuts	559
heating elements for condensate evaporation	11	lubricants	569
heating elements for contact grills	13	<b>M</b>	
heating elements for convection	26	magnetic switches	72
heating elements for defrosting	11	magnetrons	105
heating elements for fryers	5	measuring cups	516, 570
heating elements for frying pans	4	measuring equipment	553
heating elements for griddles	7	measuring spoons	516
heating elements for gyros grills	8	mechanical timers	94
heating elements for heated cabinets	20	meters	553
heating elements for heating bridges	20	microswitches	61
heating elements for ovens	3	microwave lamps	87
heating elements for pasta cookers	14	milk foamers	516
heating elements for pizza ovens	16	mixing valves	542
heating elements for pizza presses	18	motors	171
heating elements for refrigeration	11	<b>N</b>	
heating elements for salamanders/toasters	18	Niplaflex hoses	527
heating elements for tilting bratt pan	12	non-return valves	549
heating plates	21	nuts	558
hexagonal nuts	559	<b>O</b>	
hexagonal screws	555	oils	569
hob burners	231	operating capacitors	193
hose clamps	550, 564	O-rings	484
hose connectors	536, 537	oval head screws	555
hose reels	518	oven hinges	450
hoses	524	oven lamps	88
hot air fans	168	<b>P</b>	
hot air motors	163	piano hinges	449
hot plates	35	piezoelectric igniters	226
HV capacitors	195	pilot burners	216
<b>I</b>			
ignition cables	226	pipe brushes	553
ignition units	227	plug-in gaskets	478
immersion heating elements	22	plugs - couplings - power sockets	198
indicator lights	79	plunger sockets	53
indicator lights (complete)	81	power supply cables	198
industrial hoses	527	pre-rinse hoses	526
infrared lamps	85	pressure control hoses	528
inlet spouts	542	pressure measurement	553
inlet taps	542	pressure reduction valves	549, 549
<b>K</b>			
key lock switches	67	pressure switches	145
knurled nuts	559	probe clips	52

probes	114	sleeves	536
programme timers	91	slot nuts	563
protective contact plugs	198	softener cartridges	543
protective contact power sockets	198	solenoid valves	133
PTFE hoses	528	solid top burners	244
pump hoses	523	speed controllers	171
pumps	181	spiral cables	199
pumps for ice machines	190	spray guns	518
pumps for milk foamers	190	spring assisted hinges	450
push/momentary push switches	57	spring clips	52
push-in fittings	538	spring rings	561
PVC hoses	528	spring washers	561
PVC supply hoses	525	stainless steel flexi hoses	524, 526
		standpipes	547
<b>Q</b>		starter	86
quartz heating elements	22	supply filters	549, 549
		supply hoses	524
<b>R</b>		switch boxes	206
radial fans	170	switches and momentary switches	54
radiation heaters	29	system switches (ROLD)	65
reducers	536		
refrigeration cycle components	499	<b>T</b>	
refrigeration fans	158	tank inlets	524, 543
refrigeration gaskets	478	temperature probes	114
refrigeration motors universal	158	terminal boxes	205
refrigeration pipes	500	terminals	200
refrigeration thermostats	51	thermal fuses	572
relays	102	thermocouples	228
residual heat indicators	91	thermostat gaskets	499
retainer clips	567	thermostats	36
retaining rings	567	threaded cable glands	199
rocker/momentary rocker switches	54	threaded rods	558
rod thermostats	51	time relays	105
roll pins	569	timers	91
rotary switches	70	toggle switches	61
		tools	553
<b>S</b>		touch sensitive light switches	72
safety bi-metal thermostats	36	transformers	106
safety rod thermostats	51		
safety thermostats	43, 48	<b>U</b>	
safety valves	215	U-bends	549
Schrader valves	499	universal hoses	524
screw caps	569	universal probes	114
screw pipe fittings	537		
screws	554	<b>V</b>	
sealing cords	495	vacuum pumps	191
sealing washers	490	valves	549
shaft gaskets	495	valves and tank inlets	539
sheet metal screws	554	ventilation hoses	535
shelves and shelf rails	474	vibration pumps	189
shut-off valves	541		
side bolts	557	<b>W</b>	
silicone hoses	523, 530	wall-mounted hose reels	518

wash and rinse pumps	181
washers	562
water cycle components	549
water filters	544
water meters	549
water softeners	543
water taps	517
window seals	481
wing nuts	558