



**GAS COMPONENTS**



**ELECTRIC COMPONENTS**



**WATER TECHNOLOGY**



**MECHANICAL COMPONENTS**



**TOOLS**

Spare parts suitable for

**COMENDA**

Find the complete and up-to-date range of products in our GEV Webshop



# Manufacturer catalogue

The most important spare parts and accessories arranged clearly for every manufacturer

- ✓ Complete product range and all appliance data always up to date in the GEV Webshop
- ✓ Alphabetical Index at the end of the catalogue

## GEV Webshop

[www.gev-online.co.uk](http://www.gev-online.co.uk)

[www.gev-online.com](http://www.gev-online.com)



- 🔍 Add to Favourites
- 🔍 Sign In with email address and usual password
- 🔍 Easy-order – place several items in your basket at the same time
- 🔍 Quick Item search – no login needed





## heating elements

### heating elements for pasta cookers

			
1			
<b>GEV No.</b>	415020	<b>Ref. No.</b>	110331
<b>description</b>	heating element 4500W 230V mounting $\varnothing$ 57.5mm heating circuits 3 L 355mm W 35mm H 47mm number of thermostat sleeves 1 thermostat sleeves $\varnothing$ 7mm length thermostat sleeves 295mm thermostat sleeve upper tube $\varnothing$ 8.5mm hole distance 70mm hole $\varnothing$ 10mm connection length 25mm connection male faston 6.3mm 3 hole flange immersion heater		
<b>For models:</b>	AC120, AC150, AC170, AC200, ACR, ACR145, ACR205, ACR225, ACR245, ACR260, ACR265, ACR305, ACR5145, ACR5205, ACR5225, ACR5245, ACR5260, ACR5265, ACR5305, C30, C70, C75, C85, C95, C95E2, F2, F3, F45, F55, F65, F80, G50L, G50LM, G51L, G60L, G61L, G65, G65L, G66, G75, G75L, GE75, GL, GMC, GMC2700, GMC2702, GMC3500, GMC3502, GMC4500, GMC4502...(Other models you can see in the webshop)		

### coil heating elements



			
1			
<b>GEV No.</b>	418823	<b>Ref. No.</b>	110704
<b>description</b>	heating element 1000W 230V L 405mm W 50mm H 25mm tube $\varnothing$ 8.5mm thread M14x1.5 connection M5 heating circuits 1		
<b>For models:</b>	AC100, AC101, AC105, AC120, AC122, AC135, AC150, AC151, AC152, AC170, AC181, AC182, AC200, AC201, AC202, AC241, AC242, AC90, AC91, AC95, ACL100, ACL150, ACR, ACR145, ACR205, ACR225, ACR245, ACR260, ACR265, ACR305, ACR5145, ACR5205, ACR5225, ACR5245, ACR5260, ACR5265, ACR5305, ACS101, ACS101-DIGIT, ACS122, ACS122-DIGIT, ACS151, ACS151-DIGIT, ACS152, ACS152-DIGIT, ACS161-DIGIT, ACS162-DIGIT, ACS181, ACS181-DIGIT, ACS182...(Other models you can see in the webshop)		



			
1			
<b>GEV No.</b>	418824	<b>Ref. No.</b>	110706
<b>description</b>	heating element 1500W 230V L 428mm W 50mm H 25mm tube $\varnothing$ 8.5mm thread M14x1.5 connection M6 connection length 41mm heating circuits 1 2 hole fixing		
<b>For models:</b>	AC101, AC122, AC151, AC152, AC181, AC182, AC201, AC202, AC241, AC242, AC91, ACR, ACR145, ACR205, ACR225, ACR245, ACR260, ACR265, ACR305, NL302, NL302E, NL402, NL402E, NL502, NL502E, NL552, NL552E		

### immersion heating elements

#### 3 hole flange $\varnothing$ 47.5mm

			
1			
<b>GEV No.</b>	420230	<b>Ref. No.</b>	110395
<b>description</b>	heating element 2000W 230V mounting $\varnothing$ 47.5mm heating circuits 1 L 220mm W 28mm H 35mm number of thermostat sleeves 1 thermostat sleeves $\varnothing$ 8mm length thermostat sleeves 200mm thermostat sleeve eccentric, non clinging tube $\varnothing$ 6.2mm hole distance 62mm hole $\varnothing$ 10mm connection male faston 6.3mm 3 hole flange immersion heater		

			
1			
<b>GEV No.</b>	416274	<b>Ref. No.</b>	110398
<b>description</b>	heating element 5000W 230V mounting $\varnothing$ 47.5mm heating circuits 3 L 248mm W 36mm H 34mm number of thermostat sleeves 1 thermostat sleeves $\varnothing$ 7mm length thermostat sleeves 200mm thermostat sleeve eccentric, non clinging tube $\varnothing$ 6.5mm hole distance 64mm hole $\varnothing$ 8mm connection M4 3 hole flange immersion heater		
<b>For models:</b>	BHC30A, BHC30A-2, BHC30HR, BHC30HR380, BHC30HRA, BHC30HRA380, BHC433, BHC433-2, BHC433A, BHC433A-2, BHCHR		
<b>spare parts for</b>	416274		
		<b>GEV No.</b>	510408
		<b>Ref. No.</b>	200820
	O-ring EPDM thickness 5.34mm ID $\varnothing$ 47mm Qty 1 pcs		
<b>accessories for</b>	416274		
		<b>GEV No.</b>	510562
		<b>Ref. No.</b>	—
	O-ring silicone thickness 5.34mm ID $\varnothing$ 47mm Qty 1 pcs		

			
1			
<b>GEV No.</b>	415014	<b>Ref. No.</b>	110366
<b>description</b>	heating element 3000W 230V mounting $\varnothing$ 47.5mm heating circuits 1 L 240mm W 28mm H 44mm number of thermostat sleeves 1 thermostat sleeves $\varnothing$ 7mm length thermostat sleeves 220mm thermostat sleeve not clinging tube $\varnothing$ 6.3mm hole distance 62mm hole $\varnothing$ 8mm connection male faston 6.3mm 3 hole flange immersion heater		
<b>For models:</b>	B10T, B11T, B12T, B13T, B14T, B15T, B15TM, B16T, B16TM, B18T, B18TM, B19T, B19TM, B31, B32, B41, B42, BC25, BC25A, BC25HR, BC30, BC30A, BC30HR, BC30HRA, BR20, BR20A, BR25, BR25A, F20, FC43, FC43A		
<b>accessories for</b>	415014		
		<b>GEV No.</b>	510408
		<b>Ref. No.</b>	200820
	O-ring EPDM thickness 5.34mm ID $\varnothing$ 47mm Qty 1 pcs		
		<b>GEV No.</b>	510562
		<b>Ref. No.</b>	—
	O-ring silicone thickness 5.34mm ID $\varnothing$ 47mm Qty 1 pcs		

electric components



<b>GEV No.</b>	415013	<b>Ref. No.</b>	110364 110396
<b>description</b>	heating element 2400W 230V mounting $\varnothing$ 47.5mm heating circuits 1 L 215mm W 40mm H 35mm number of thermostat sleeves 1 thermostat sleeves $\varnothing$ 6.5mm length thermostat sleeves 190mm thermostat sleeve eccentric, non clinging tube $\varnothing$ 6.5mm hole distance 64mm hole $\varnothing$ 8x10mm connection male faston 6.3mm 3 hole flange immersion heater		
<b>For models:</b>	B15, B16, B18, B19, B20, B20D, B23, B24, B25, B26, B27, LB200, LB200-2, LB200A, LB200A-2, LB215, LB215-2, LB215A, LB215A-2, LB260, LB260-2, LB260A, LB260A-2, LB275, LB275-2, LB275A, LB275A-2		
<b>accessories for</b>	415013		
	<b>GEV No.</b>	510408	<b>Ref. No.</b> 200820
	O-ring EPDM thickness 5.34mm ID $\varnothing$ 47mm Qty 1 pcs		
	<b>GEV No.</b>	510562	<b>Ref. No.</b> —
	O-ring silicone thickness 5.34mm ID $\varnothing$ 47mm Qty 1 pcs		

<b>GEV No.</b>	416273	<b>Ref. No.</b>	110397
<b>description</b>	heating element 3200W 230V mounting $\varnothing$ 42mm heating circuits 1 L 237mm W 35mm H 38mm number of thermostat sleeves 1 thermostat sleeves $\varnothing$ 7mm length thermostat sleeves 200mm thermostat sleeve not clinging tube $\varnothing$ 6.3mm hole distance 66mm hole $\varnothing$ 8mm connection length 26mm connection male faston 6.3mm 3 hole flange immersion heater		
<b>For models:</b>	BHC25, BHC25-2, BHC25A, BHC25A-2, BHC25S, BHC30, BHC30-2, BHC30A, BHC30A-2, BHC30E, BHC30E-2, BHC30EA, BHC30EA-2, BHC30HR, BHC30HR-2, BHC30HR380, BHC30HRA, BHC30HRA-2, BHC30HRA380, BHC433, BHC433-2, BHC433A, BHC433A-2, BHCHR		
<b>accessories for</b>	416273		
	<b>GEV No.</b>	510408	<b>Ref. No.</b> 200820
	O-ring EPDM thickness 5.34mm ID $\varnothing$ 47mm Qty 1 pcs		
	<b>GEV No.</b>	510562	<b>Ref. No.</b> —
	O-ring silicone thickness 5.34mm ID $\varnothing$ 47mm Qty 1 pcs		

### 3 hole flange $\varnothing$ 57.5mm

<b>GEV No.</b>	418624	<b>Ref. No.</b>	110388
<b>description</b>	heating element 10000W 230/400V mounting $\varnothing$ 57.5mm heating circuits 3 L 480mm W 35mm H 43mm number of thermostat sleeves 1 thermostat sleeves $\varnothing$ 7mm length thermostat sleeves 285mm tube $\varnothing$ 8.5mm hole distance 72mm hole $\varnothing$ 8mm immersion heater		
<b>For models:</b>	AC101, AC120, AC122, AC135, AC150, AC151, AC152, AC170, AC181, AC182, AC200, AC201, AC202, AC241, AC242, AC2A, AC91, ACL100, ACL150, ACR, ACR145, ACR205, ACR225, ACR245, ACR260, ACR265, ACR305, ACRS145, ACRS205, ACRS225, ACRS245, ACRS260, ACRS265, ACRS305, ACS101-DIGIT, ACS122-DIGIT, ACS151, ACS151-DIGIT, ACS152, ACS152-DIGIT, ACS161-DIGIT, ACS162-DIGIT, ACS181, ACS181-DIGIT, ACS182, ACS182-DIGIT, ACS201, ACS201-DIGIT, ACS202, ACS202-DIGIT...(Other models you can see in the webshop)		

<b>GEV No.</b>	418891	<b>Ref. No.</b>	110333
<b>description</b>	heating element 7000W 230V mounting $\varnothing$ 57.5mm heating circuits 3 L 350mm W 25mm H 40mm number of thermostat sleeves 1 thermostat sleeves $\varnothing$ 8mm length thermostat sleeves 285mm thermostat sleeve upper centre not clinging tube $\varnothing$ 8mm hole distance 70mm hole $\varnothing$ 8mm connection length 18mm connection male faston 6.3mm immersion heater		
<b>For models:</b>	FC3E, FC3EA, FC3M, FC3MA, FC3MR, FC44E, FC44EA, FC4E, FC4EA, FC4EHR, FC4M, FC4MA		
<b>accessories for</b>	418891		
	<b>GEV No.</b>	510409	<b>Ref. No.</b> 200815
	O-ring EPDM thickness 5.34mm ID $\varnothing$ 56.52mm Qty 1 pcs		

<b>GEV No.</b>	417403	<b>Ref. No.</b>	110385
<b>description</b>	heating element 12000/14000W 240-415V heating circuits 3 L 620mm W 37mm H 51mm number of thermostat sleeves 1 thermostat sleeves $\varnothing$ 8.8mm length thermostat sleeves 290mm tube $\varnothing$ 10mm hole distance 73mm hole $\varnothing$ 8mm		
<b>For models:</b>	AC101, AC122, AC151, AC152, AC181, AC182, AC201, AC202, AC241, AC242, AC91		

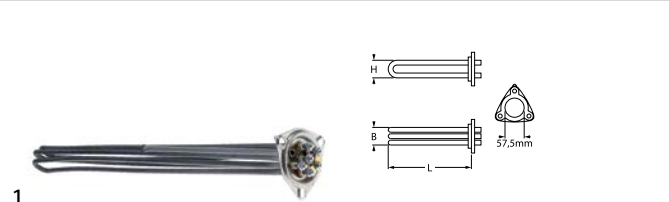

<b>GEV No.</b>	415023	<b>Ref. No.</b>	110367 110379 110382
<b>description</b>	heating element 12500W 230V mounting $\varnothing$ 57.5mm heating circuits 3 L 630mm W 36mm H 48mm number of thermostat sleeves 1 thermostat sleeves $\varnothing$ 7mm length thermostat sleeves 295mm thermostat sleeve eccentric, non clinging tube $\varnothing$ 8.5mm hole distance 76mm hole $\varnothing$ 8x10mm connection M5 3 hole flange immersion heater		
<b>For models:</b>	AC101, AC122, AC151, AC152, AC181, AC182, AC201, AC202, AC241, AC242, AC2A, AC91, AC95, ACL100, ACL150, ACS101, ACS101-DIGIT, ACS122, ACS122-DIGIT, ACS151-DIGIT, ACS152-DIGIT, ACS161-DIGIT, ACS162-DIGIT, ACS181-DIGIT, ACS182-DIGIT, ACS201-DIGIT, ACS202-DIGIT, ACS241-DIGIT, ACS242-DIGIT, ACS91, ACS91-DIGIT, NE00, NG00, NG600, NG600E, NG900, NG900E		

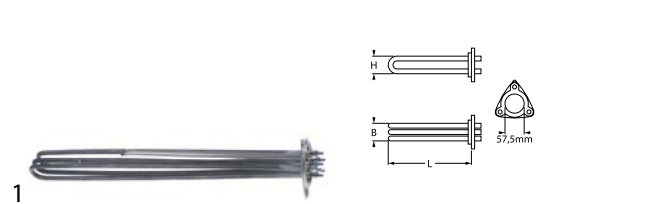

<b>GEV No.</b>	420159	<b>Ref. No.</b>	110392
<b>description</b>	heating element 14000W 230/400V mounting $\varnothing$ 57.5mm heating circuits 3 L 500mm W 36mm H 43mm number of thermostat sleeves 1 thermostat sleeves $\varnothing$ 7.5mm length thermostat sleeves 290mm thermostat sleeve eccentric, non clinging tube $\varnothing$ 8.3mm hole distance 73mm hole $\varnothing$ 10mm connection length 26mm connection M5 3 hole flange		

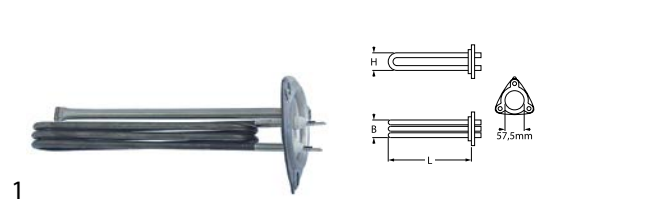

<b>GEV No.</b>	416275	<b>Ref. No.</b>	110361
<b>description</b>	heating element 2200W 230V mounting $\varnothing$ 57.5mm heating circuits 1 L 235mm W 38mm H 38mm number of thermostat sleeves 1 thermostat sleeves $\varnothing$ 7.5mm length thermostat sleeves 214mm thermostat sleeve not clinging tube $\varnothing$ 6.4mm hole distance 72mm hole $\varnothing$ 8mm connection length 22mm connection male faston 6.3mm 3 hole flange immersion heater		
<b>For models:</b>	FC53CBT, FC53LA, FC53LBT, FC54CBT, FC54LBT, LC1200, LC1200RCD, LC700, LC700RCD, LC900, LC900RCD, LF320CBT, LF320L, LF320LA, LF320LBT		

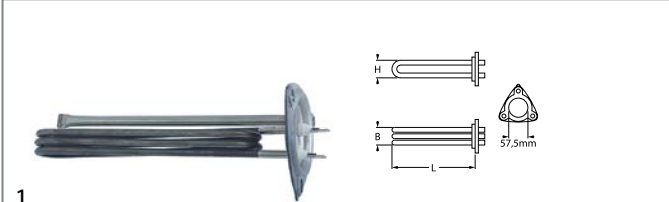

<b>GEV No.</b>	415060	<b>Ref. No.</b>	110363
<b>description</b>	heating element 3000W 230V mounting $\varnothing$ 57.5mm heating circuits 1 L 330mm W 45mm H 29mm number of thermostat sleeves 1 thermostat sleeves $\varnothing$ 7mm length thermostat sleeves 295mm thermostat sleeve not clinging tube $\varnothing$ 6.25mm hole distance 73mm hole $\varnothing$ 8mm connection male faston 6.3mm 3 hole flange immersion heater		
<b>For models:</b>	F300, F45, F55, F65, F80, FC, FC53, FC533, FC533A, FC53A, FC54, FC543, FC543A, FC544, FC544A, FC54A, FC54E, FC54EA, LF280-lav-line, LF315, LF320, LF320A, LF320LA, LF320-lav-line, LF321, LF321A, LF322, LF322A, LF323, LF323A, LF324, LF324A, LF325E, LF325EA, LF700, LF700A, LS550, R40, R50, R70		

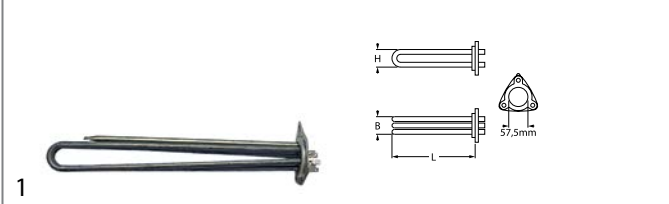

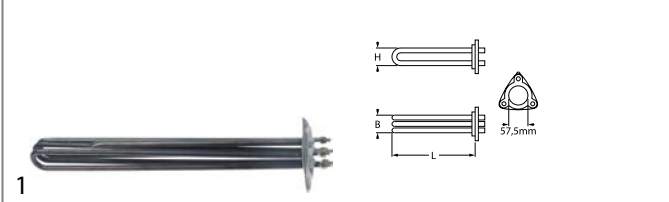

<b>GEV No.</b>	415020	<b>Ref. No.</b>	110331
<b>description</b>	heating element 4500W 230V mounting $\varnothing$ 57.5mm heating circuits 3 L 355mm W 35mm H 47mm number of thermostat sleeves 1 thermostat sleeves $\varnothing$ 7mm length thermostat sleeves 295mm thermostat sleeve upper tube $\varnothing$ 8.5mm hole distance 70mm hole $\varnothing$ 10mm connection length 25mm connection male faston 6.3mm 3 hole flange immersion heater		
<b>For models:</b>	AC120, AC150, AC170, AC200, ACR, ACR145, ACR205, ACR225, ACR245, ACR260, ACR265, ACR305, ACRS145, ACRS205, ACRS225, ACRS245, ACRS260, ACRS265, ACRS305, C30, C70, C75, C85, C95, C95E2, F2, F3, F45, F55, F65, F80, G50L, G50LM, G51L, G60L, G61L, G65, G65L, G66, G75, G75L, GE75, GL, GMC, GMC2700, GMC2702, GMC3500, GMC3502, GMC4500, GMC4502...(Other models you can see in the webshop)		





<b>GEV No.</b>	420091	<b>Ref. No.</b>	110383
<b>description</b>	heating element 5000/6000W 240/415V mounting $\varnothing$ 57.5mm heating circuits 3 L 405mm W 36mm H 41mm number of thermostat sleeves 1 thermostat sleeves $\varnothing$ 7.5mm length thermostat sleeves 280mm tube $\varnothing$ 8.3mm hole distance 73mm hole $\varnothing$ 10mm connection M5 immersion heater		
<b>For models:</b>	AC101, AC120, AC122, AC150, AC151, AC152, AC170, AC181, AC182, AC200, AC201, AC202, AC241, AC242, AC91, ACR, ACR145, ACR205, ACR225, ACR245, ACR260, ACR265, ACR305, GMC, GMC2700, GMC3500, GMC4500, GMC5500, LAV1000, NE3001, NE4001, NE5501, NE7501, NE9001, NG01, NG601, NG601E, NG901, NG901E		



<b>GEV No.</b>	418895	<b>Ref. No.</b>	110332
<b>description</b>	heating element 5000W 230V mounting $\varnothing$ 57.5mm heating circuits 3 L 350mm W 35mm H 40mm number of thermostat sleeves 1 thermostat sleeves $\varnothing$ 7mm length thermostat sleeves 290mm thermostat sleeve eccentric, non clinging tube $\varnothing$ 8.5mm connection male faston 6.3mm		
<b>For models:</b>	LF322MP, LF322MP-A, LF322RCD		
<b>accessories for</b>	418895		
	<b>GEV No.</b>	510409	<b>Ref. No.</b> 200815
	O-ring EPDM thickness 5.34mm ID $\varnothing$ 56.52mm Qty 1 pcs		



<b>GEV No.</b>	415021	<b>Ref. No.</b>	110349
<b>description</b>	heating element 6000W 230V mounting $\varnothing$ 57.5mm heating circuits 3 L 343mm W 37mm H 50mm number of thermostat sleeves 1 thermostat sleeves $\varnothing$ 7mm length thermostat sleeves 294mm thermostat sleeve not clinging tube $\varnothing$ 8.5mm hole distance 72mm hole $\varnothing$ 8mm connection M5 3 hole flange		
<b>For models:</b>	AC100, AC101, AC120, AC122, AC150, AC151, AC152, AC170, AC181, AC182, AC200, AC201, AC202, AC241, AC242, AC2A, AC90, AC91, ACR, ACR145, ACR205, ACR225, ACR245, ACR260, ACR265, ACR305, ACR5145, ACR5205, ACR5225, ACR5245, ACR5260, ACR5265, ACR5305, ACS101-DIGIT, ACS122-DIGIT, ACS151-DIGIT, ACS152-DIGIT, ACS161-DIGIT, ACS162-DIGIT, ACS181-DIGIT, ACS182-DIGIT, ACS201-DIGIT, ACS202-DIGIT, ACS241-DIGIT, ACS242-DIGIT, ACS91-DIGIT, C140, C33, C34, C75BT...(Other models you can see in the webshop)		
<b>spare parts for</b>	415021		
	<b>GEV No.</b>	510409	<b>Ref. No.</b> 200815
	O-ring EPDM thickness 5.34mm ID $\varnothing$ 56.52mm Qty 1 pcs		
<b>accessories for</b>	415021		
	<b>GEV No.</b>	550002	<b>Ref. No.</b> —
	tension strap H 10mm L 21mm W 10mm hole $\varnothing$ 6.5mm for heating element		



<b>GEV No.</b>	420340	<b>Ref. No.</b>	110354
<b>description</b>	heating element 6000W 254/440V mounting $\varnothing$ 57.5mm heating circuits 3 L 410mm W 36mm H 40mm number of thermostat sleeves 1 thermostat sleeves $\varnothing$ 7.4mm length thermostat sleeves 290mm thermostat sleeve eccentric, non clinging tube $\varnothing$ 8.4mm hole distance 72mm hole $\varnothing$ 10mm connection M5 3 hole flange immersion heater		
<b>For models:</b>	AC120, AC150, AC170, AC200, ACR, ACR145, ACR205, ACR225, ACR245, ACR260, ACR265, ACR305, GMC, GMC2700, GMC3500, GMC4500, GMC5500, NE3001, NE4001, NE5501, NE7501, NE9001		



<b>GEV No.</b>	415670	<b>Ref. No.</b>	110343
<b>description</b>	heating element 8000W 230V mounting $\varnothing$ 57.5mm heating circuits 3 L 480mm W 40mm H 50mm number of thermostat sleeves 1 thermostat sleeves $\varnothing$ 7mm length thermostat sleeves 295mm thermostat sleeve not clinging tube $\varnothing$ 10mm hole distance 72mm hole $\varnothing$ 8mm connection M5 3 hole flange immersion heater		
<b>For models:</b>	AC101, AC105, AC120, AC122, AC150, AC151, AC152, AC170, AC181, AC182, AC200, AC201, AC202, AC241, AC242, AC2A, AC91, ACL100, ACL150, ACR, ACR145, ACR205, ACR225, ACR245, ACR260, ACR265, ACR305, ACR5145, ACR5205, ACR5225, ACR5245, ACR5260, ACR5265, ACR5305, ACS101-DIGIT, ACS122-DIGIT, ACS151, ACS151-DIGIT, ACS152, ACS152-DIGIT, ACS161-DIGIT, ACS162-DIGIT, ACS181, ACS181-DIGIT, ACS182, ACS182-DIGIT, ACS201-DIGIT, ACS202-DIGIT, ACS241-DIGIT, ACS242-DIGIT...(Other models you can see in the webshop)		
<b>spare parts for</b>	415670		
	<b>GEV No.</b>	510409	<b>Ref. No.</b> 200815
	O-ring EPDM thickness 5.34mm ID $\varnothing$ 56.52mm Qty 1 pcs		



<b>GEV No.</b>	417633	<b>Ref. No.</b>	110365
<b>description</b>	heating element 8000W 240/415V mounting $\varnothing$ 57.5mm heating circuits 3 L 400mm W 35mm H 46mm number of thermostat sleeves 1 thermostat sleeves $\varnothing$ 7.5mm length thermostat sleeves 290mm thermostat sleeve upper centre not clinging tube $\varnothing$ 10mm hole distance 73mm		
<b>For models:</b>	AC101, AC120, AC122, AC150, AC151, AC152, AC170, AC181, AC182, AC200, AC201, AC202, AC241, AC242, AC91, ACR, ACR145, ACR205, ACR225, ACR245, ACR260, ACR265, ACR305, GMC, GMC2700, GMC3500, GMC4500, GMC5500, LAV1000, NE3001, NE4001, NE5501, NE7501, NE9001, NG01, NG601, NG601E, NG901, NG901E		



<b>GEV No.</b>	415022	<b>Ref. No.</b>	110362
<b>description</b>	heating element 9000W 230/400V mounting $\phi$ 57.5mm heating circuits 3 L 475mm W 36mm H 43mm number of thermostat sleeves 1 thermostat sleeves $\phi$ 7mm length thermostat sleeves 300mm thermostat sleeve eccentric, non clinging tube $\phi$ 10mm hole distance 73mm hole $\phi$ 10mm connection length 30mm connection M5 3 hole flange immersion heater		
<b>For models:</b>	AC100, AC101, AC105, AC120, AC122, AC135, AC150, AC151, AC152, AC170, AC181, AC182, AC200, AC201, AC202, AC241, AC242, AC2A, AC90, AC91, AC95, ACL100, ACL150, ACR, ACR145, ACR205, ACR225, ACR245, ACR260, ACR265, ACR305, ACRS145, ACRS205, ACRS225, ACRS245, ACRS260, ACRS265, ACRS305, ACS101, ACS101-DIGIT, ACS122, ACS122-DIGIT, ACS151, ACS151-DIGIT, ACS152, ACS152-DIGIT, ACS161-DIGIT, ACS162-DIGIT, ACS181, ACS181-DIGIT...(Other models you can see in the webshop)		
<b>spare parts for</b>	415022		
		<b>GEV No.</b>	510409 <b>Ref. No.</b> 200815
	O-ring EPDM thickness 5.34mm ID $\phi$ 56.52mm Qty 1 pcs		

3 hole flange  $\phi$ 60.0mm  
 connection straight  
 group 2

<b>GEV No.</b>	420342	<b>Ref. No.</b>	110386
<b>description</b>	heating element 14000W 230/400V mounting $\phi$ 60mm heating circuits 3 L 620mm W 33mm H 49mm number of thermostat sleeves 1 thermostat sleeves $\phi$ 7.5mm length thermostat sleeves 290mm thermostat sleeve eccentric, non clinging tube $\phi$ 10mm hole distance 83mm hole $\phi$ 10mm connection M5 3 hole flange immersion heater		
<b>For models:</b>	AC101, AC122, AC151, AC152, AC181, AC182, AC201, AC202, AC241, AC242, AC2A, AC90, AC91, ACL100, ACL150, ACS101, ACS101-DIGIT, ACS122, ACS122-DIGIT, ACS151-DIGIT, ACS152-DIGIT, ACS161-DIGIT, ACS162-DIGIT, ACS181-DIGIT, ACS182-DIGIT, ACS201-DIGIT, ACS202-DIGIT, ACS241-DIGIT, ACS242-DIGIT, ACS91, ACS91-DIGIT, GMC, GMC2700, GMC3500, GMC4500, GMC5500, SNL		

with expansion flange 70 x 18mm

<b>GEV No.</b>	415015	<b>Ref. No.</b>	110228
<b>description</b>	heating element 1500W 230V heating circuits 1 flange 70x18mm L 212mm W 68mm H 50mm connection male faston 6.3mm immersion heater expansion flange tube $\phi$ 8.5mm		
<b>For models:</b>	F300		

<b>GEV No.</b>	415061	<b>Ref. No.</b>	110373
<b>description</b>	heating element 2400W 230V heating circuits 1 flange 70x18mm L 383mm W 83mm H 24mm connection male faston 6.3mm immersion heater expansion flange tube $\phi$ 8.5mm		
<b>For models:</b>	F300, F45, F55, F65, F80, LF280-lav-line, LF320-lav-line, R50		
<b>accessories for</b>	415061		
		<b>GEV No.</b>	510429 <b>Ref. No.</b> —
	gasket L 76mm W 23mm hole distance 25mm 3 holes for heating element type DB 70 without thermostat sensor hole		

<b>GEV No.</b>	415016	<b>Ref. No.</b>	110227
<b>description</b>	heating element 3000W 230V heating circuits 3 flange 70x18mm L 398mm W 60mm H 24mm connection male faston 6.3mm immersion heater expansion flange tube $\phi$ 6.3mm		
<b>For models:</b>	C140, C155, C155BT, C155E2, C155RCD, C165, C165E2, C165E2BT, C165E2RCD, C166, C166-2, C30, C70, C75, C75BT, C75M, C75RCD, C85, C95, C95BT, C95E2, C95RCD, F2, F3, F300, GF90, GF90-2004, GF90A, GF90A-2004, LC380, LC380BT, LC380RCD, LC400, LP360, LP360BT, LP360RCD		



<b>GEV No.</b>	420339	<b>Ref. No.</b>	110232
<b>description</b>	heating element 3000W 254V heating circuits 3 flange 70x18mm L 395mm W 61mm H 29mm connection male faston 6.3mm immersion heater expansion flange tube $\phi$ 6.3mm		

with round flange  $\phi$ 47.5mm

<b>GEV No.</b>	416272	<b>Ref. No.</b>	110262
<b>description</b>	heating element 2400W 230V heating circuits 1 mounting $\phi$ 47.5mm L 220mm W 35mm H 37mm round flange connection male faston 6.3mm immersion heater tube $\phi$ 6.5mm thermostat sleeves $\phi$ 7mm number of thermostat sleeves 1 length thermostat sleeves 195mm		
<b>For models:</b>	C1000ERCD, C1300ERCD, LBC210, LBC215, LBC215A, LBC275, LBC275A, LBR, LBR200, LBR215, LBR215A		
<b>spare parts for</b>	416272		
		<b>GEV No.</b>	510408 <b>Ref. No.</b> 200820
	O-ring EPDM thickness 5.34mm ID $\phi$ 47mm Qty 1 pcs		
<b>accessories for</b>	416272		
		<b>GEV No.</b>	510408 <b>Ref. No.</b> 200820
	O-ring EPDM thickness 5.34mm ID $\phi$ 47mm Qty 1 pcs		
		<b>GEV No.</b>	510562 <b>Ref. No.</b> —
	O-ring silicone thickness 5.34mm ID $\phi$ 47mm Qty 1 pcs		
		<b>GEV No.</b>	520235 <b>Ref. No.</b> —
	3 hole flange hole distance 70.5mm perforation $\phi$ 6.5mm ID $\phi$ 53.5mm		
		<b>GEV No.</b>	520236 <b>Ref. No.</b> —
	flange for heating element ID $\phi$ 50mm ED $\phi$ 90mm hole $\phi$ 6.5mm 3 holes		

Table continues overleaf











<b>accessories for</b>	416272		
	GEV No.	550002	Ref. No. —
	tension strap H 10mm L 21mm W 10mm hole ø 6.5mm for heating element		
	GEV No.	550362	Ref. No. —
	blind flange ø 64mm mounting ø 47.5mm		

	1		
<b>GEV No.</b>	416271	<b>Ref. No.</b>	110391
<b>description</b>	heating element 5000W heating circuits 3 mounting ø 47.5mm L 252mm W 35mm H 34mm round flange connection male faston 6.3mm immersion heater tube ø 6.2mm thermostat sleeves ø 8mm number of thermostat sleeves 1 length thermostat sleeves 195mm		
<b>For models:</b>	BC25HR, BC30HR380		

<b>accessories for</b>	416271		
	GEV No.	510408	Ref. No. 200820
	O-ring EPDM thickness 5.34mm ID ø 47mm Qty 1 pcs		
	GEV No.	510562	Ref. No. —
	O-ring silicone thickness 5.34mm ID ø 47mm Qty 1 pcs		
	GEV No.	520235	Ref. No. —
	3 hole flange hole distance 70.5mm perforation ø 6.5mm ID ø 53.5mm		
	GEV No.	520236	Ref. No. —
	flange for heating element ID ø 50mm ED ø 90mm hole ø 6.5mm 3 holes		
	GEV No.	550002	Ref. No. —
	tension strap H 10mm L 21mm W 10mm hole ø 6.5mm for heating element		
	GEV No.	550362	Ref. No. —
	blind flange ø 64mm mounting ø 47.5mm		

<b>with round flange ø57.5mm</b>			
	1		
<b>GEV No.</b>	415019	<b>Ref. No.</b>	110226
<b>description</b>	heating element 3000W 230V heating circuits 3 mounting ø 57.5mm L 338mm W 37mm H 41mm round flange connection male faston 6.3mm immersion heater tube ø 8.5mm connection length 27mm thermostat sleeves ø 7mm number of thermostat sleeves 1 length thermostat sleeves 300mm thermostat sleeve not clinging with 3 hole flange & O-ring		
<b>For models:</b>	C1000E, C1000ERCD, C1001M, C1300E, C1300ERCD, C1301M, C33, C34, GE50RCD, LC1200, LC1200RCD, LC412, LC700, LC700RCD, LC900, LC900RCD, SE, XLC		
<b>accessories for</b>	415019		
	GEV No.	550002	Ref. No. —
	tension strap H 10mm L 21mm W 10mm hole ø 6.5mm for heating element		

<b>with round flange (miscellaneous)</b>			
	1		
<b>GEV No.</b>	417554	<b>Ref. No.</b>	110381
<b>description</b>	heating element 12500W 254/440V mounting ø 73mm L 6150mm W 50mm H 40mm heating circuits 3 flange ø 73mm flange connection screw immersion heater tube ø 10mm thermostat sleeves ø 7.3mm number of thermostat sleeves 1 length thermostat sleeves 300mm thermostat sleeve centre/left		
<b>For models:</b>	AC101, AC120, AC122, AC150, AC151, AC152, AC170, AC181, AC182, AC200, AC201, AC202, AC241, AC242, AC91, ACR, ACR145, ACR205, ACR225, ACR245, ACR260, ACR265, ACR305, GMC, GMC2700, GMC3500, GMC4500, GMC5500, NE3001, NE4001, NE5501, NE7501, NE9001, NG01, NG601, NG601E, NG901, NG901E		

<b>1 1/4"</b>			
	1		
<b>GEV No.</b>	415017	<b>Ref. No.</b>	110208
<b>description</b>	heating element 1500W 230V heating circuits 1 thread 1 1/4" L 295mm W 92mm H 27mm L1 45mm L2 45mm L3 205mm W1 34mm W2 26mm H1 20mm H2 7mm connection M4 immersion heater tube ø 6.3mm flange with thread connection length 28mm		
<b>accessories for</b>	415017		
	GEV No.	510405	Ref. No. —
	flat gasket fibre ED ø 56mm ID ø 42mm thickness 2mm for thread 1 1/4" Qty 1 pcs		
	GEV No.	520232	Ref. No. —
	nut thread 1 1/4" H 5mm nickel-plated brass WS 47 Qty 1 pcs		
	GEV No.	521103	Ref. No. —
	nut thread M4 H 3mm WS 7 brass Qty 20 pcs		
	GEV No.	521104	Ref. No. —
	washer ID ø 4.3mm ED ø 8mm thickness 0.5mm brass Qty 20 pcs for thread M4		
	GEV No.	528021	Ref. No. —
	flat gasket PTFE ED ø 53mm ID ø 42.5mm thickness 3mm Qty 1 pcs equiv. no. 12001/02286 suitable for Astoria/Aurora/Brasilia/Wega		
	GEV No.	560111	Ref. No. —
	plain washer ID ø 4.3mm ED ø 9mm thickness 0.8mm SS Qty 20 pcs DIN 125A for thread M4		
	GEV No.	560131	Ref. No. —
	hexagonal nut thread M4 H 3.2mm WS 7 SS DIN/ISO DIN 934 / ISO 4032/8673 Qty 20 pcs		







1

<b>GEV No.</b>	415062	<b>Ref. No.</b>	110260
<b>description</b>	heating element 1275W 230V heating circuits 1 L 147mm W 103mm H 30mm thread M10 mounting distance 32mm tube $\phi$ 6.5mm connection 6.3 2 hole fixing immersion heater		
<b>For models:</b>	BC25, BC25A, BC25HR, BC30, BC30A, BC30HR, BC30HR380, BC30HRA, BR20, BR20A, BR25, BR25A, FC43, FC43A		
<b>accessories for</b>	415062		
	<b>GEV No.</b>	510416	<b>Ref. No.</b> —
	flat gasket fibre ED $\phi$ 19mm ID $\phi$ 10.5mm thickness 1.5mm for thread M10 Qty 1 pcs		
	<b>GEV No.</b>	510893	<b>Ref. No.</b> 200810 200845
	O-ring EPDM thickness 2.62mm ID $\phi$ 9.92mm Qty 1 pcs		
	<b>GEV No.</b>	520231	<b>Ref. No.</b> —
	nut thread M10x1 H 6mm WS 14 zinc-coated steel Qty 1 pcs		
	<b>GEV No.</b>	521129	<b>Ref. No.</b> —
	nut thread M10 H 6mm SS WS 17 Qty 1 pcs DIN/ISO DIN 439		





1

<b>GEV No.</b>	415012	<b>Ref. No.</b>	110204 110235
<b>description</b>	heating element 1500W 230V heating circuits 1 L 225mm W 120mm H 22mm L1 47mm L2 178mm W1 73mm W2 47mm thread M10x1 mounting distance 41mm tube $\phi$ 6.3mm 2 hole fixing connection male faston 6.3mm immersion heater		
<b>For models:</b>	B10, B10T, B11, B11T, B12, B12T, B13T, B14T, B15, B15T, B15TM, B16, B16T, B16TM, B18, B18T, B18TM, B19, B19T, B19TM, B20, B20D, B23, B24, B25, B26, B27, B31, B32, B41, B42, F20, LBC215, LBC215A, LBC275, LBC275A		
<b>accessories for</b>	415012		
	<b>GEV No.</b>	510416	<b>Ref. No.</b> —
	flat gasket fibre ED $\phi$ 19mm ID $\phi$ 10.5mm thickness 1.5mm for thread M10 Qty 1 pcs		
	<b>GEV No.</b>	510893	<b>Ref. No.</b> 200810 200845
	O-ring EPDM thickness 2.62mm ID $\phi$ 9.92mm Qty 1 pcs		







1

<b>GEV No.</b>	418702	<b>Ref. No.</b>	110261
<b>description</b>	heating element 1500W 230V heating circuits 1 L 300mm W 120mm H 25mm L1 45mm L2 255mm W1 40mm W2 80mm thread M10x1 mounting distance 38mm tube $\phi$ 6.2mm		
<b>For models:</b>	LBC210, LBC215, LBC215A, LBC275, LBC275A, LBR, LBR200, LBR215, LBR215A		
<b>accessories for</b>	418702		
	<b>GEV No.</b>	510893	<b>Ref. No.</b> 200810 200845
	O-ring EPDM thickness 2.62mm ID $\phi$ 9.92mm Qty 1 pcs		
	<b>GEV No.</b>	520231	<b>Ref. No.</b> —
	nut thread M10x1 H 6mm WS 14 zinc-coated steel Qty 1 pcs		



1

<b>GEV No.</b>	415756	<b>Ref. No.</b>	110263
<b>description</b>	heating element 2000W 230V heating circuits 1 L 137mm W 355mm H 25mm thread 1/8" mounting distance 20mm tube $\phi$ 6.3mm connection male faston 6.3mm connection length 27mm immersion heater 2 hole fixing		
<b>For models:</b>	F90M, F90MA, FC, FC53, FC533, FC533A, FC53A, FC53CBT, FC53LA, FC53LBT, FC54, FC543, FC543A, FC543E, FC543EA, FC544, FC544A, FC54A, FC54CBT, FC54E, FC54EA, FC54LBT, FCHR, FCHRA, FCHRT, FCHRTA, LF315, LF320, LF320A, LF320CBT, LF320L, LF320LA, LF320LBT, LF323, LF323A, LF350, LF350A, LF400A, LF450, LF450A, LS550		
<b>spare parts for</b>	415756		
	<b>GEV No.</b>	532049	<b>Ref. No.</b> —
	O-ring EPDM thickness 2.62mm ID $\phi$ 9.92mm Qty 10 pcs		
<b>accessories for</b>	415756		
	<b>GEV No.</b>	361181	<b>Ref. No.</b> —
	nut thread 1/8" H 4.5mm nickel-plated brass WS 14 Qty 1 pcs		
	<b>GEV No.</b>	510416	<b>Ref. No.</b> —
	flat gasket fibre ED $\phi$ 19mm ID $\phi$ 10.5mm thickness 1.5mm for thread M10 Qty 1 pcs		
	<b>GEV No.</b>	510893	<b>Ref. No.</b> 200810 200845
	O-ring EPDM thickness 2.62mm ID $\phi$ 9.92mm Qty 1 pcs		



1





<b>GEV No.</b>	416389	<b>Ref. No.</b>	110269 old
<b>description</b>	heating element 2000W 230V heating circuits 1 L 298mm W 151mm H 28mm thread M12x1 mounting distance 75mm tube $\phi$ 6.3mm connection male faston 6.3mm 2 hole fixing immersion heater L1 22mm L2 98mm L3 45mm W1 11mm W2 265mm		
<b>accessories for</b>	416389		
	<b>GEV No.</b>	361182	<b>Ref. No.</b> —
	nut thread 1/4" H 5mm nickel-plated brass WS 17 Qty 1 pcs		
	<b>GEV No.</b>	510417	<b>Ref. No.</b> —
	flat gasket fibre ED $\phi$ 20mm ID $\phi$ 14mm thickness 2mm Qty 1 pcs		



Table continues overleaf







<b>accessories for</b>	416389		
	GEV No.	520228	Ref. No. —
	tooth lock washer ID ø 15.3mm ED ø 24mm steel Qty 1 pcs for thread M14		
	GEV No.	550262	Ref. No. —
	flat gasket copper ED ø 20mm ID ø 14mm thickness 2mm		

	1		
<b>GEV No.</b>	418902	<b>Ref. No.</b>	110269
<b>description</b>	heating element 2000W 230V heating circuits 1 L 300mm W 140mm H 28mm thread M12x1 mounting distance 70mm tube ø 6.3mm connection male faston 6.3mm 2 hole fixing connection length 35mm immersion heater		
<b>For models:</b>	BHC25, BHC25-2, BHC25A, BHC25A-2, BHC25S, BHC30, BHC30-2, BHC30A, BHC30A-2, BHC30E, BHC30E-2, BHC30EA, BHC30EA-2, BHC433, BHC433-2, BHC433A, BHC433A-2, LB200, LB200-2, LB200A, LB200A-2, LB215, LB215-2, LB215A, LB215A-2, LB260, LB260-2, LB260A, LB260A-2, LB275, LB275-2, LB275A, LB275A-2		

	1		
<b>GEV No.</b>	415198	<b>Ref. No.</b>	110273
<b>description</b>	heating element 2000W 230V heating circuits 1 L 318mm W 85mm H 26mm thread M12x1 mounting distance 77mm tube ø 8.3mm connection male faston 6.3mm 2 hole fixing immersion heater		
<b>accessories for</b>	415198		
	GEV No.	520229	Ref. No. —
	nut thread M12x1 H 4mm WS 16 zinc-coated steel Qty 1 pcs		
	GEV No.	521110	Ref. No. 460527
	flat gasket fibre ED ø 20mm ID ø 13mm thickness 2mm Qty 1 pcs		

	1		
<b>GEV No.</b>	418890	<b>Ref. No.</b>	110288
<b>description</b>	heating element 2000W 230V heating circuits 1 L 430mm W 180mm H 60mm L1 60mm L2 370mm W1 105mm W2 23mm thread M10x1 tube ø 6.3mm connection length 35mm 2 hole fixing connection male faston 6.3mm immersion heater tank		
<b>For models:</b>	FC3MR		

	1		
<b>GEV No.</b>	418836	<b>Ref. No.</b>	110265
<b>description</b>	heating element 2000W 440V L 320mm W 170mm H 23mm thread 1/8" mounting distance 50mm tube ø 6mm connection male faston 6.3mm immersion heater 2 hole fixing		

	1		
<b>GEV No.</b>	416270	<b>Ref. No.</b>	110271
<b>description</b>	heating element 500W 230V heating circuits 1 L 225mm W 95mm H 30mm thread M12x1 mounting distance 86mm tube ø 8.5mm connection male faston 6.3mm 2 hole fixing immersion heater		
<b>For models:</b>	BHC30HR, BHC30HR-2, BHC30HR380, BHC30HRA, BHC30HRA-2, BHC30HRA380, BHCHR		



foil heating elements

	1		
<b>GEV No.</b>	419007	<b>Ref. No.</b>	110285
<b>description</b>	foil heating element L 380mm W 73mm 500W 230V t.max. 140°C with temperature limiter 140°C silicone cable length 200mm thickness 1mm connection male faston 6.3mm		
<b>For models:</b>	FC3E, FC3EA, FC3M, FC3MA, FC44E, FC44EA, FC4E, FC4EA, FC4EHR, FC4M, FC4MA		

thermostats

bi-metal thermostats

bi-metal thermostats

	1		
<b>GEV No.</b>	390025	<b>Ref. No.</b>	120524
<b>description</b>	bi-metal thermostat hole distance 40mm switch-off temp. 55/42°C NC/NO 2-pole 16A 250V connection F6.3 2 hole fixing		
<b>For models:</b>	B10T, B11T, B12T, B13T, B14T, B15T, B15TM, B16T, B16TM, B18T, B18TM, B19T, B19TM, BC25, BC25A, BC25HR, BC30, BC30A, BC30HR, BC30HR380, BC30HRA, BHC25, BHC25-2, BHC25A, BHC25A-2, BHC25S, BHC30, BHC30-2, BHC30A, BHC30A-2, BHC30E, BHC30E-2, BHC30EA, BHC30EA-2, BHC433, BHC433-2, BHC433A, BHC433A-2, BR20, BR20A, BR25, BR25A, FC43, FC43A, LB200, LB200-2, LB200A, LB200A-2, LB215, LB215-2...(Other models you can see in the webshop)		
<b>accessories for</b>	390025		
	GEV No.	512154	Ref. No. 200494
	gasket for thermostat ID ø 20mm equiv. no. 200494/H200494 hole distance 41mm suitable for COMENDA, HOONVED		



			
1			
<b>GEV No.</b>	390089	<b>Ref. No.</b>	120509
<b>description</b>	bi-metal thermostat hole distance 40mm switch-off temp. 58°C 1NC 1-pole 16A connection F6.3 2 hole fixing		
<b>For models:</b>	B10, B11, B12, B15, B16, B18, B19, B20, B20D, B23, B24, B25, B26, B27, B31, B32, B41, B42		

			
1			
<b>GEV No.</b>	390014	<b>Ref. No.</b>	120525
<b>description</b>	thermostat t.max. 85°C temperature range 40-78 / 47-85°C 2-pole 2CO 16A probe ø 6.5mm probe L 95mm capillary pipe 1500mm capillary pipe isolated 1450mm gland nut shaft ø 6x4.6mm shaft L 15mm shaft position right rotation 270°		
<b>For models:</b>	BC25HR, BC30HR, BC30HR380, BC30HRA, BHC25-2, BHC25A-2, BHC30-2, BHC30A-2, BHC30E, BHC30E-2, BHC30EA, BHC30EA-2, BHC433-2, BHC433A-2, C155, C155BT, C155RCD, C165, C165E2BT, C165E2RCD, C75BT, C75RCD, C95, C95BT, C95RCD, FC, FC3M, FC3MA, FC3MR, FC4M, FC4MA, FC53, FC533, FC533A, FC53A, FC53CBT, FC53LA, FC53LBT, FC54, FC543, FC543A, FC544, FC544A, FC54A, FC54CBT, FC54E, FC54EA, FC54LBT, GF70, GF70A...(Other models you can see in the webshop)		



control and safety thermostats

EGO

safety thermostats

55.32\_series

			
1			
<b>GEV No.</b>	375291	<b>Ref. No.</b>	100780 M100780
<b>description</b>	safety thermostat switch-off temp. 344°C 1-pole 20A probe ø 6mm probe L 79mm capillary pipe 900mm capillary pipe isolated 900mm gland nut probe		

			
1			
<b>GEV No.</b>	390006	<b>Ref. No.</b>	120501
<b>description</b>	thermostat t.max. 86°C temperature range 0-86°C 1-pole 1CO 16A probe ø 6.5mm probe L 95mm capillary pipe 1500mm capillary pipe isolatedmm gland nut shaft ø 6x4.6mm shaft L 19mm rotation 270°		
<b>For models:</b>	AC100, AC101, AC105, AC120, AC122, AC135, AC150, AC151, AC152, AC170, AC181, AC182, AC200, AC201, AC202, AC241, AC242, AC2A, AC90, AC91, AC95, ACL100, ACL150, ACR, ACR145, ACR205, ACR225, ACR245, ACR260, ACR265, ACR305, ACS101, ACS101-DIGIT, ACS122, ACS122-DIGIT, ACS151, ACS151-DIGIT, ACS152, ACS152-DIGIT, ACS161-DIGIT, ACS162-DIGIT, ACS181, ACS181-DIGIT, ACS182, ACS182-DIGIT, ACS201, ACS201-DIGIT, ACS202, ACS202-DIGIT, ACS241...(Other models you can see in the webshop)		
<b>accessories for</b>	390006		
	<b>GEV No.</b>	110100	<b>Ref. No.</b> 450315
	knob thermostat t.max. 90°C 0-90°C ø 42mm shaft ø 6x4.6mm shaft flat -135° black		
	<b>GEV No.</b>	110105	<b>Ref. No.</b> 191040
	rosette knob ø 42mm ø 56mm zero mark		

IMIT / TEMPOMATIC / ARTHERMO

control thermostats

			
1			
<b>GEV No.</b>	390914	<b>Ref. No.</b>	120515
<b>description</b>	bi-metal thermostat t.max. 90°C temperature range 0-90°C 1-pole 1CO 10A probe ø 6.5mm probe L 97mm capillary pipe 1000mm capillary pipe isolated 950mm gland nut shaft ø 6x4.6mm shaft L 12mm shaft position upper rotation 270° with housing 250V		
<b>For models:</b>	AC120, AC150, AC170, AC200, ACR, ACR145, ACR205, ACR225, ACR245, ACR260, ACR265, ACR305, G131, G66, GMC, GMC2700, GMC3500, GMC4500, GMC5500, LV1001, LV1501, LV-LVP, LVP1001, LVP1501, NE00, NE02, NE3001, NE3002, NE4001, NE4002, NE5002, NE5501, NE5502, NE7002, NE7501, NE7502, NE9001, NE9002, NE9502, NG00, NG01, NG02, NG1202, NG1202E, NG600, NG600E, NG601, NG601E, NG602, NG602E...(Other models you can see in the webshop)		

			
1			
<b>GEV No.</b>	390915	<b>Ref. No.</b>	120512
<b>description</b>	thermostat t.max. 87.5°C 1-pole 1CO 16A probe ø 6.5mm probe L 97mm capillary pipe 1000mm capillary pipe isolated 950mm shaft ø 6x4.6mm shaft L 20mm shaft position 45° rotation 270° with housing 250V		
<b>For models:</b>	ACR, ACR145, ACR205, ACR225, ACR245, ACR260, ACR265, ACR305, GMC, GMC2700, GMC3500, GMC4500, GMC5500, NE00, NG00, NG600, NG600E, NG900, NG900E, SE, SNL		



<b>GEV No.</b>	390812	<b>Ref. No.</b>	120530
<b>description</b>	thermostat t.max. 87°C temperature range fixes 87°C 1-pole 1CO 16A probe ø 6.5mm probe L 97mm capillary pipe 1500mm capillary pipe isolatedmm gland nut shaft Lmm rotation 270° 250V contacts male faston 6.3mm		
<b>For models:</b>	C1001M, C1301M, LC1200, LC1200RCD, LC412, LC700, LC700RCD, LC900, LC900RCD		



<b>GEV No.</b>	390460	<b>Ref. No.</b>	120530
<b>description</b>	thermostat t.max. 90°C temperature range 30-90°C 1-pole 1CO 16A probe ø 6.5mm probe L 95mm capillary pipe 2000mm capillary pipe isolated 1950mm gland nut shaft ømm shaft Lmm shaft position rotation 270° probe material copper		



<b>GEV No.</b>	390022	<b>Ref. No.</b>	120522
<b>description</b>	thermostat t.max. 90°C temperature range 30-90°C 1-pole 1CO 16A probe ø 9.5mm probe L 50mm capillary pipe 1000mm capillary pipe isolated 1000mm gland nut shaft L 19mm rotation 270°		
<b>For models:</b>	C155BT, C155RCD, C165E2BT, C165E2RCD, C75, C75BT, C75M, C75RCD, C95BT, C95RCD, F45, F55, F65, F80, F90M, F90MA, FC, FC3E, FC3EA, FC3M, FC3MA, FC3MR, FC44E, FC44EA, FC4E, FC4EA, FC4EHR, FC4M, FC4MA, FC53, FC533, FC533A, FC53A, FC53LA, FC54, FC543, FC543A, FC544, FC544A, FC54A, FC54E, FC54EA, GF70, GF70A, LC380BT, LC380RCD, LF280-lav-line, LF315, LF320, LF320A...(Other models you can see in the webshop)		

safety thermostats



<b>GEV No.</b>	390773	<b>Ref. No.</b>	120519
<b>description</b>	safety thermostat switch-off temp. 135°C temperature range 95-135°C 1-pole 1CO 16A probe ø 5mm probe L 130mm capillary pipe 1000mm capillary pipe isolated 900mm gland nut probe		
<b>For models:</b>	AC100, AC101, AC105, AC120, AC122, AC135, AC150, AC151, AC152, AC170, AC181, AC182, AC200, AC201, AC202, AC241, AC242, AC2A, AC90, AC91, AC95, ACL100, ACL150, ACR, ACR145, ACR205, ACR225, ACR245, ACR260, ACR265, ACR305, ACRS145, ACRS205, ACRS225, ACRS245, ACRS260, ACRS265, ACRS305, ACS101, ACS101-DIGIT, ACS122, ACS122-DIGIT, ACS151, ACS151-DIGIT, ACS152, ACS152-DIGIT, ACS161-DIGIT, ACS162-DIGIT, ACS181, ACS181-DIGIT...(Other models you can see in the webshop)		

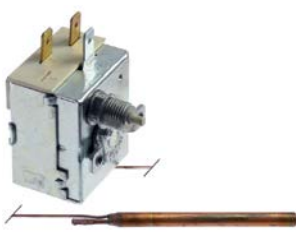

<b>GEV No.</b>	390023	<b>Ref. No.</b>	120519
<b>description</b>	safety thermostat switch-off temp. 90-110°C 1-pole 16A probe ø 6.5mm probe L 90mm capillary pipe 1000mm capillary pipe isolatedmm gland nut probe		

RANCO safety thermostats

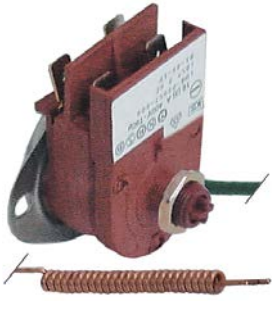

<b>GEV No.</b>	390473	<b>Ref. No.</b>	120536
<b>description</b>	safety thermostat t.max. 105°C temperature range°C 2-pole 2NC 16A probe ø 6mm probe L 50mm capillary pipe 430mm capillary pipe isolated 310mm gland nut shaft ømm shaft Lmm shaft position rotation° probe material copper screw connection M10x0.75		

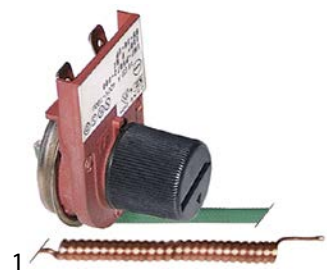
<b>GEV No.</b>	390024	<b>Ref. No.</b>	120523
<b>description</b>	safety thermostat t.max. 110°C temperature range°C 1-pole 1NC 16A probe ø 6mm probe L 50mm capillary pipe 1540mm capillary pipe isolated 160mm gland nut shaft ømm shaft Lmm shaft position rotation° probe material copper with coiled probe switch-off temp. 110°C		
<b>For models:</b>	B10T, B11T, B12T, B13T, B14T, B15T, B15TM, B16T, B16TM, B18T, B18TM, B19T, B19TM, BC25, BC25A, BC25HR, BC30, BC30A, BC30HR, BC30HR380, BC30HRA, BR20, BR20A, BR25, BR25A, C155, C155BT, C155E2, C155RCD, C165E2, C165E2BT, C165E2RCD, C166, C166-2, C75, C75BT, C75M, C75RCD, C95, C95BT, C95E2, C95RCD, F20, F45, F55, F65, F80, F90M, F90MA, FC...(Other models you can see in the webshop)		

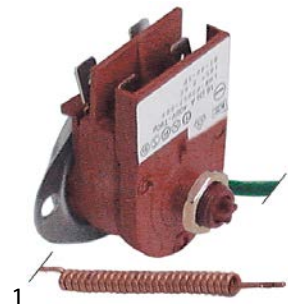

<b>GEV No.</b>	390469	<b>Ref. No.</b>	120526
<b>description</b>	safety thermostat t.max. 110°C temperature range°C 2-pole 2NC 16A probe ø 6mm probe L 50mm capillary pipe 1540mm capillary pipe isolated 160mm gland nut shaft ømm shaft Lmm shaft position rotation° probe material copper screw connection M10x0.75 switch-off temp. 110°C		
<b>For models:</b>	BHC25, BHC25-2, BHC25A, BHC25A-2, BHC25S, BHC30, BHC30-2, BHC30A, BHC30A-2, BHC30E, BHC30E-2, BHC30EA, BHC30EA-2, BHC30HR, BHC30HR-2, BHC30HR380, BHC30HRA, BHC30HRA-2, BHC30HRA380, BHC433, BHC433-2, BHC433A, BHC433A-2, BHCHR, FC53CBT, FC53LBT, FC54CBT, FC54LBT, LB200, LB200-2, LB200A, LB200A-2, LB215, LB215-2, LB215A, LB215A-2, LB260, LB260-2, LB260A, LB260A-2, LB275, LB275-2, LB275A, LB275A-2, LF320CBT, LF320L, LF320LA, LF320LBT, LF321, LF321A...(Other models you can see in the webshop)		

accessories

plunger sockets





<b>GEV No.</b>	510812	<b>Ref. No.</b>	450508
<b>description</b>	thermowell		
<b>For models:</b>	C30, C33, C34, F2, F3, F300, LC380, R40, R50, R70		





<b>GEV No.</b>	511425	<b>Ref. No.</b>	450520
<b>description</b>	thermowell thread 1/2" L 100mm SS triple ø 6.5mm		
<b>For models:</b>	AC101, AC122, AC151, AC152, AC181, AC182, AC201, AC202, AC241, AC242, AC91, ACS101, ACS101-DIGIT, ACS122, ACS122-DIGIT, ACS151, ACS151-DIGIT, ACS152, ACS152-DIGIT, ACS161-DIGIT, ACS162-DIGIT, ACS181, ACS181-DIGIT, ACS182, ACS182-DIGIT, ACS201, ACS201-DIGIT, ACS202, ACS202-DIGIT, ACS241, ACS241-DIGIT, ACS242, ACS242-DIGIT, ACS91, ACS91-DIGIT		







<b>GEV No.</b>	510935	<b>Ref. No.</b>	450515	
<b>description</b>	thermowell thread 1/2" L 107mm SS single ø 8mm			
<b>For models:</b>	AC100, AC101, AC105, AC120, AC122, AC135, AC150, AC151, AC152, AC170, AC181, AC182, AC200, AC201, AC202, AC241, AC242, AC90, AC91, AC95, ACL100, ACL150, ACR, ACR145, ACR205, ACR225, ACR245, ACR260, ACR265, ACR305, ACRS145, ACRS205, ACRS225, ACRS245, ACRS260, ACRS265, ACRS305, ACS101, ACS101-DIGIT, ACS122, ACS122-DIGIT, ACS151, ACS151-DIGIT, ACS152, ACS152-DIGIT, ACS161-DIGIT, ACS162-DIGIT, ACS181, ACS181-DIGIT, ACS182...(Other models you can see in the webshop)			
<b>accessories for</b>	510935			
	<b>GEV No.</b>	361184	<b>Ref. No.</b>	—
	nut thread 1/2" H 6mm nickel-plated brass WS 24 Qty 1 pcs			
	<b>GEV No.</b>	521122	<b>Ref. No.</b>	—
	flat gasket fibre ED ø 31mm ID ø 21.5mm thickness 2mm for thread 1/2" Qty 1 pcs			





<b>GEV No.</b>	510986	<b>Ref. No.</b>	415514 450514 450516	
<b>description</b>	thermowell thread 1/2" L 120mm SS double ø 6.5mm			
<b>For models:</b>	AC100, AC101, AC105, AC120, AC122, AC135, AC150, AC151, AC152, AC170, AC181, AC182, AC200, AC201, AC202, AC241, AC242, AC2A, AC90, AC91, AC95, ACR, ACR145, ACR205, ACR225, ACR245, ACR260, ACR265, ACR305, ACS101, ACS101-DIGIT, ACS122, ACS122-DIGIT, ACS151, ACS151-DIGIT, ACS152, ACS152-DIGIT, ACS161-DIGIT, ACS162-DIGIT, ACS181, ACS181-DIGIT, ACS182, ACS182-DIGIT, ACS201, ACS201-DIGIT, ACS202, ACS202-DIGIT, ACS241, ACS241-DIGIT, ACS242...(Other models you can see in the webshop)			
<b>accessories for</b>	510986			
	<b>GEV No.</b>	361184	<b>Ref. No.</b>	—
	nut thread 1/2" H 6mm nickel-plated brass WS 24 Qty 1 pcs			
	<b>GEV No.</b>	521122	<b>Ref. No.</b>	—
	flat gasket fibre ED ø 31mm ID ø 21.5mm thickness 2mm for thread 1/2" Qty 1 pcs			



			
1			
<b>GEV No.</b>	511426	<b>Ref. No.</b>	450521
<b>description</b>	thermowell thread 1/2" L 35mm SS single ø 6.5mm		
<b>For models:</b>	FC, FCHR, FCHRA, FCHRT, FCHRTA		

			
1			
<b>GEV No.</b>	510987	<b>Ref. No.</b>	450519
<b>description</b>	thermowell thread 1/2" L 44mm SS single ø 10mm		
<b>For models:</b>	C75, C75BT, C75M, C75RCD, F45, F55, F65, F80, F90M, F90MA, FC, FC53, FC533, FC533A, FC53A, FC53CBT, FC53LA, FC53LBT, FC54, FC543, FC543A, FC543E, FC543EA, FC544, FC544A, FC54A, FC54CBT, FC54E, FC54EA, FC54LBT, LC380BT, LC380RCD, LF280-lav-line, LF315, LF320, LF320A, LF320CBT, LF320L, LF320LA, LF320-lav-line, LF320LBT, LF321, LF321A, LF322, LF322A, LF322MP, LF322MP-A, LF322RCD, LF323, LF323A...(Other models you can see in the webshop)		
<b>accessories for</b>	510987		
	<b>GEV No.</b>	361184	<b>Ref. No.</b> —
	nut thread 1/2" H 6mm nickel-plated brass WS 24 Qty 1 pcs		
	<b>GEV No.</b>	521122	<b>Ref. No.</b> —
	flat gasket fibre ED ø 31mm ID ø 21.5mm thickness 2mm for thread 1/2" Qty 1 pcs		

			
1			
<b>GEV No.</b>	550914	<b>Ref. No.</b>	450518
<b>description</b>	thermowell thread 1/8" ID ø 7mm L 52mm brass ø 8.3mm		
<b>For models:</b>	AC101, AC122, AC135, AC151, AC152, AC181, AC182, AC201, AC202, AC241, AC242, AC91, ACR, ACR145, ACR205, ACR225, ACR245, ACR260, ACR265, ACR305, GMC, GMC2700, GMC3500, GMC4500, GMC5500, LAV1000		

<b>miscellaneous</b>			
			
1			
<b>GEV No.</b>	551101	<b>Ref. No.</b>	332821
<b>description</b>	bracket for thermostat hole ø 7mm L 99mm W 72mm thickness 1mm		

			
1			
<b>GEV No.</b>	501353	<b>Ref. No.</b>	200491
<b>description</b>	gasket for thermostat hole ø 6.6mm L 98mm W 68mm thickness 2mm		
<b>For models:</b>	AC100, AC101, AC105, AC120, AC122, AC135, AC150, AC151, AC152, AC170, AC181, AC182, AC200, AC201, AC202, AC241, AC242, AC90, AC91, AC95, ACL100, ACL150, ACR, ACR145, ACR205, ACR225, ACR245, ACR260, ACR265, ACR305, ACRS145, ACRS205, ACRS225, ACRS245, ACRS260, ACRS265, ACRS305, ACS101, ACS101-DIGIT, ACS122, ACS122-DIGIT, ACS151, ACS151-DIGIT, ACS152, ACS152-DIGIT, ACS161-DIGIT, ACS162-DIGIT, ACS181, ACS181-DIGIT, ACS182...(Other models you can see in the webshop)		

## switches and momentary switches

### rocker/momentary rocker switches

27.8x25mm

			
1			
<b>GEV No.</b>	345076	<b>Ref. No.</b>	130444
<b>description</b>	momentary rocker switch mounting measurements 27.8x25mm black 2CO 250V 16A START connection male faston 6.3mm ambient temperature max. 85°C protection IP40		
<b>For models:</b>	C1001M, C1301M, F20, F45, F55, F65, F80, LC1200, LC1200RCD, LC380BT, LC380RCD, LC412, LC700, LC700RCD, LC900, LC900RCD		

			
1			
<b>GEV No.</b>	347714	<b>Ref. No.</b>	130450
<b>description</b>	momentary rocker switch mounting measurements 27.8x25mm black 2NO 250V 16A START connection male faston 6.3mm ambient temperature max. 85°C protection IP40		

			
1			
<b>GEV No.</b>	347695 <sup>1</sup>	<b>Ref. No.</b>	130421
<b>description</b>	momentary rocker switch mounting measurements 27.8x25mm black/green 2CO 250V 16A illuminated cycle connection male faston 6.3mm ambient temperature max. 85°C protection IP40		
<b>For models:</b>	B10, B10T, B11T, B12T, B13T, B14T, B15T, B15TM, B16T, B16TM, B18T, B18TM, B19T, B19TM		

<sup>1</sup>illuminated

			
1			
<b>GEV No.</b>	345843 <sup>1</sup>	<b>Ref. No.</b>	130471
<b>description</b>	momentary rocker switch mounting measurements 27.8x25mm green 2CO 24V 16A illuminated outflow connection male faston 6.3mm ambient temperature max. 85°C protection IP40		
<b>For models:</b>	LF320CBT, LF320L, LF320LA, LF320LBT		

<sup>1</sup>illuminated

			
1			
<b>GEV No.</b>	345201 <sup>1</sup>	<b>Ref. No.</b>	130464
<b>description</b>	momentary rocker switch mounting measurements 27.8x25mm green 2CO 250V 16A illuminated outflow connection male faston 6.3mm ambient temperature max. 85°C protection IP40		
<b>For models:</b>	F90M, F90MA, LC1200, LC700, LC900, LF315, LF320, LF320LA, LF323, LF323A, LF350, LF350A, LF450, LF450A		

<sup>1</sup>illuminated





			
1			
<b>GEV No.</b>	511227 <sup>1</sup>	<b>Ref. No.</b>	130454
<b>description</b>	momentary rocker switch mounting measurements 27.8x25mm green 2CO 250V 16A illuminated regeneration connection male faston 6.3mm ambient temperature max. 85°C protection IP40		

<sup>1</sup>illuminated

			
1			
<b>GEV No.</b>	345030 <sup>1</sup>	<b>Ref. No.</b>	130424
<b>description</b>	momentary rocker switch mounting measurements 27.8x25mm orange 2CO 250V 16A illuminated outflow connection male faston 6.3mm ambient temperature max. 85°C protection IP40		

<sup>1</sup>illuminated

			
1			
<b>GEV No.</b>	345014 <sup>1</sup>	<b>Ref. No.</b>	130422 130429
<b>description</b>	momentary rocker switch mounting measurements 27.8x25mm orange 2CO 250V 16A illuminated rinsing connection male faston 6.3mm ambient temperature max. 85°C protection IP40		
<b>For models:</b>	B10, B10T, B11T, B12T, B13T, B14T, B15T, B15TM, B16T, B16TM, B18T, B18TM, B19T, B19TM, F20		

<sup>1</sup>illuminated

			
1			
<b>GEV No.</b>	345000 <sup>1</sup>	<b>Ref. No.</b>	130421 old version
<b>description</b>	momentary rocker switch mounting measurements 27.8x25mm orange 2CO 250V 16A illuminated START connection male faston 6.3mm ambient temperature max. 85°C protection IP40 2-pole male faston 6.3mm		

<sup>1</sup>illuminated

			
1			
<b>GEV No.</b>	347715	<b>Ref. No.</b>	130498
<b>description</b>	momentary rocker switch mounting measurements 27.8x25mm white 2NO 250V 16A START connection male faston 6.3mm ambient temperature max. 85°C protection IP40		

			
1			
<b>GEV No.</b>	347263	<b>Ref. No.</b>	130499
<b>description</b>	rocker switch mounting measurements 25x25mm white 2CO 250V 16A cycle connection male faston 6.3mm protection IP40		

			
1			
<b>GEV No.</b>	345123	<b>Ref. No.</b>	130447
<b>description</b>	rocker switch mounting measurements 27.8x25mm black 2CO 250V 16A auto/manual connection male faston 6.3mm ambient temperature max. 85°C protection IP40		
<b>For models:</b>	C1001M, C1301M, C155, C155BT, C155RCD, C95, C95BT, C95RCD, LC1200, LC1200RCD, LC412, LC700, LC700RCD, LC900, LC900RCD		

			
1			
<b>GEV No.</b>	345844	<b>Ref. No.</b>	130470
<b>description</b>	momentary rocker switch mounting measurements 27.8x25mm orange 1NO/indicator light 230V 16A regeneration connection male faston 6.3mm ambient temperature max. 85°C protection IP40		
<b>For models:</b>	F90M, F90MA, LF320, LF320A, LF320LA, LF323, LF323A, LF350, LF350A, LF450, LF450A		

			
1			
<b>GEV No.</b>	345861 <sup>1</sup>	<b>Ref. No.</b>	130472
<b>description</b>	momentary rocker switch mounting measurements 27.8x25mm orange 1NO/indicator light indicator lamp 24V 230V 16A regeneration connection male faston 6.3mm ambient temperature max. 85°C protection IP40		
<b>For models:</b>	GF90, GF90A, LF320L, LF320LA, LF400A		

<sup>1</sup>indicator light 24V

			
1			
<b>GEV No.</b>	510281	<b>Ref. No.</b>	160733
<b>description</b>	blank black mounting measurements 27.8x25mm		
<b>For models:</b>	B10, B10T, B11, B11T, B13T, B15, B15T, B15TM, B16, B16T, B16TM, B18, B18T, B18TM, B19, B19T, B19TM, BHC25, BHC25A, BHC25S, BHC30, BHC30A, BHC433, BHC433A, C1001M, C1301M, C155, C155BT, C155RCD, C95, C95BT, C95RCD, F45, F55, F65, F80, F90M, F90MA, FC, FC53, FC533, FC533A, FC53A, FC53CBT, FC53LA, FC53LBT, FC54, FC543, FC543A, FC544...(Other models you can see in the webshop)		

<b>30x22mm</b>			
			
1			
<b>GEV No.</b>	347870	<b>Ref. No.</b>	130468
<b>description</b>	momentary rocker switch mounting measurements 30x22mm green 1NO/indicator light 250V 16A cycle connection male faston 6.3mm ambient temperature max. 100/55°C protection IP40		



1

<b>GEV No.</b>	301304	<b>Ref. No.</b>	130465
<b>description</b>	momentary rocker switch mounting measurements 30x22mm green 2CO 250V 16A illuminated outflow connection male faston 6.3mm ambient temperature max. 100/55°C protection IP40		



1

<b>GEV No.</b>	345124	<b>Ref. No.</b>	130408
<b>description</b>	momentary rocker switch mounting measurements 30x22mm green 2CO 250V 16A illuminated rinsing connection male faston 6.3mm ambient temperature max. 85°C protection IP40		
<b>For models:</b>	B41, B42		

## push/momentary push switches

## 28.5x28.5mm



1

<b>GEV No.</b>	345846	<b>Ref. No.</b>	130459
<b>description</b>	momentary push switch mounting measurements 28.5x28.5mm grey 2CO 250V 16A START connection male faston 6.3mm ambient temperature max. 150°C protection IP40		
<b>For models:</b>	LB200, LB200-2, LB200A, LB215, LB215-2, LB215A, LB215A-2, LB260, LB260-2, LB260A, LB275, LB275-2, LB275A, LB275A-2, LBC210, LBC215, LBC215A, LBC275, LBC275A, LBR, LBR200, LBR215, LBR215A		



1

<b>GEV No.</b>	345845	<b>Ref. No.</b>	130460
<b>description</b>	push switch mounting measurements 28.5x28.5mm green/red 2CO 250V 16A ON-OFF connection male faston 6.3mm ambient temperature max. 150°C protection IP40		
<b>For models:</b>	GF90, GF90A, LB200, LB200-2, LB200A, LB215, LB215-2, LB215A, LB215A-2, LB260, LB260-2, LB260A, LB275, LB275-2, LB275A, LB275A-2, LBC210, LBC215, LBC215A, LBC275, LBC275A, LBR, LBR200, LBR215, LBR215A, LF400A		

## 28.5x52.6mm



1

<b>GEV No.</b>	347928	<b>Ref. No.</b>	130495
<b>description</b>	switch combination mounting measurements 28.5x52.6mm green 2CO 250V 16A with indicator green/red main switch connection male faston 6.3mm ambient temperature max. 150°C		

## accessories

## blank elements



1

<b>GEV No.</b>	510458	<b>Ref. No.</b>	160747
<b>description</b>	blank F20		
<b>For models:</b>	F20		

## push buttons



1

<b>GEV No.</b>	345078	<b>Ref. No.</b>	130419
<b>description</b>	push button		
<b>For models:</b>	B11, B12, B15, B16, B18, B19		



1

<b>GEV No.</b>	345079	<b>Ref. No.</b>	130420
<b>description</b>	push button		
<b>For models:</b>	B11, B12, B15, B16, B18, B19		



1

<b>GEV No.</b>	347577	<b>Ref. No.</b>	870016
<b>description</b>	push button for PCB grey ED ø 7mm ID ø 3mm H 7.7mm		
<b>For models:</b>	GE100, GE115, GE125, GE60, GE60RCD, GE65, GE65RCD, GE75, GE80		



1

<b>GEV No.</b>	347690	<b>Ref. No.</b>	870017
<b>description</b>	push button for PCB white ED ø 20mm ID ø 5mm H 8mm		
<b>For models:</b>	GE100, GE115, GE125, GE60, GE60RCD, GE65, GE65RCD, GE75, GE80		



toggle switches

M12x0.75



<b>GEV No.</b>	345050	<b>Ref. No.</b>	120771
<b>description</b>	toggle switch thread M12x0.75 2CO 250V 10A male faston 6.3mm		

2 hole fixing



<b>GEV No.</b>	345051	<b>Ref. No.</b>	120704
<b>description</b>	toggle switch 2NO 400V 10A connection screw hole distance 34mm		
<b>For models:</b>	F2, F3		

microswitches

lever actuated



<b>GEV No.</b>	347596	<b>Ref. No.</b>	120323
<b>description</b>	microswitch with lever 250V 12A 1CO connection male faston 6.3mm L 42mm ambient temperature max. 125°C mounting distance 22.2mm type VRSR10DA1 actuating force: 35g lever length 30mm		
<b>For models:</b>	B11, B11T, B12, B12T, B15, B15T, B15TM, B16T, B16TM, B18, B18T, B18TM, B19T, B19TM, B41, B42, LB200, LB200-2, LB215, LB215-2, LB215A, LB215A-2, LB260, LB260-2, LB275, LB275-2, LB275A, LB275A-2, LBC210, LBC215, LBC215A, LBC275, LBC275A, LBR, LBR215, LBR215A, R40, R50, R70		



<b>GEV No.</b>	345074	<b>Ref. No.</b>	120341
<b>description</b>	microswitch with lever 250V 16A 1CO connection male faston 6.3mm ambient temperature max. 85°C mounting distance 25mm type C99ZP3 actuating force: 25g lever length 154mm		
<b>For models:</b>	B13T, B14T		



<b>GEV No.</b>	345125	<b>Ref. No.</b>	120324
<b>description</b>	microswitch with lever 250V 16A 1CO connection male faston 6.3mm ambient temperature max. 85°C mounting distance 25mm type C99ZP3 actuating force: 25g lever length 63.5mm		
<b>For models:</b>	B41, B42		



<b>GEV No.</b>	345044	<b>Ref. No.</b>	120349
<b>description</b>	microswitch with lever 250V 16A 1CO connection male faston 6.3mm ambient temperature max. 85°C mounting distance 25mm type C99ZP3 actuating force: 25g lever length 71mm		
<b>For models:</b>	BC25, BC25A, BC25HR, BC30, BC30A, BC30HR, BC30HR380, BC30HRA, BR20, BR20A, BR25, BR25A, FC43, FC43A		



<b>GEV No.</b>	345121	<b>Ref. No.</b>	120346
<b>description</b>	microswitch with lever 250V 16A 1CO connection screw clamp L 49mm L1 64mm ambient temperature max. 85°C mounting distance 25mm type MV30 actuating force: 30g lever length 80mm		
<b>For models:</b>	BC25, BC25A, BC25HR, BC30, BC30A, BC30HR, BC30HR380, BC30HRA, BHC25, BHC25A, BHC25S, BHC30, BHC30A, BHC30E, BHC30EA, BHC30HR, BHC30HR380, BHC30HRA, BHC30HRA380, BHC433, BHC433A, BHCHR, BR20, BR20A, BR25, BR25A, FC43, FC43A		



<b>GEV No.</b>	345052	<b>Ref. No.</b>	120319
<b>description</b>	microswitch with lever 250V 10A 1CO connection screw clamp L 54mm L1 61mm ambient temperature max. 85°C mounting distance 25mm type AZ71209 actuating force: 180g lever length 76mm		
<b>For models:</b>	C33, C34		



<b>GEV No.</b>	345072	<b>Ref. No.</b>	120329
<b>description</b>	microswitch with lever 250V 15A 2NO connection male faston 6.3mm L 42mm L1 44mm ambient temperature max. 85°C mounting distance 25mm type RM actuating force: 250g		
<b>For models:</b>	B15, B16, B18, B19		

pin-plunger actuated

M10



<b>GEV No.</b>	345032	<b>Ref. No.</b>	120313
<b>description</b>	microswitch with plunger thread M10x1 thread L 12mm 250V 16A 1CO connection male faston 6.3mm stroke 7mm mounting distance 22mm L 28mm ambient temperature max. 125°C type SP9603 actuating force: 180g		
<b>For models:</b>	B31, B32, B41, F2, F20, F3, F300, F45, F55, F65, F80, F90M, F90MA, LF280-lav-line, LF315, LF320, LF320A, LF320CBT, LF320L, LF320LA, LF320-lav-line, LF320LBT, LF323, LF323A, LF350, LF350A, LF400A, LF450, LF450A, LS550		



with push button

gas ignition



1

<b>GEV No.</b>	346209	<b>Ref. No.</b>	120304
<b>description</b>	microswitch with plunger 250V 16A 1CO connection male faston 6.3mm ambient temperature max. 125°C thread M10x0.75 thread L 14mm		
<b>For models:</b>	FC3E, FC3EA, FC3M, FC3MA, FC3MR, FC44E, FC44EA, FC4E, FC4EA, FC4EHRT, FC4M, FC4MA		

accessories



1

<b>GEV No.</b>	510858	<b>Ref. No.</b>	190119
<b>description</b>	bracket for microswitch		
<b>For models:</b>	B11, B12, B15, B16, B18, B19		

position switches

CROUZET



1

<b>GEV No.</b>	347740	<b>Ref. No.</b>	120308
<b>description</b>	position switch cast aluminum 1NO/1NC 380V 10A L 87mm W 30mm H 73mm protection IP66 actuating force: 850g screw connection M19 mounting distance 73.5mm		



1

<b>GEV No.</b>	347741	<b>Ref. No.</b>	120312
<b>description</b>	position switch plastic 1NC/1NO 380V 10A L 69mm W 27mm H 26mm protection IP66 screw connection M19 mounting distance 22mm		
<b>For models:</b>	G131, G66		

PIZZATO

FD series



1

<b>GEV No.</b>	345058	<b>Ref. No.</b>	120322
<b>description</b>	position switch cast aluminum 1NC/1NO 400V 3A L 92mm W 40mm H 35mm protection IP67 actuating force: 900g screw connection PG13.5 mounting distance 30x60mm screw		
<b>For models:</b>	C33, C34, LV1001, LV1501, LV-LVP, LVP1001, LVP1501		



1

<b>GEV No.</b>	345862	<b>Ref. No.</b>	120305 120326
<b>description</b>	position switch cast aluminum 1NO/1NC 400V 3A L 118mm W 40mm H 35mm protection IP67 actuating force: 500g screw connection PG13.5 mounting distance 30x60mm		
<b>For models:</b>	G125, G125L, G75, G75L, GE125, GE75, GL, GMC2702, GMC3502, GMC4502, GMC5502, NE00, NE02, NE3001, NE3002, NE4001, NE4002, NE5002, NE5501, NE5502, NE7002, NE7501, NE7502, NE9001, NE9002, NE9502, NG00, NG01, NG02, NG1202, NG1202E, NG600, NG600E, NG601, NG601E, NG602, NG602E, NG900, NG900E, NG901, NG901E, NG902, NG902E, NL302, NL302E, NL402, NL402E, NL502, NL502E, NL552...(Other models you can see in the webshop)		



1

<b>GEV No.</b>	345075	<b>Ref. No.</b>	120335 120343 120364 870129
<b>description</b>	position switch cast aluminum 1NO/1NC 400V 3A L 141mm W 40mm H 35mm protection IP67 actuating force: 300g screw connection PG13.5 mounting distance 30x60mm type FD503		
<b>For models:</b>	C1001M, C1301M, C140, C155, C155E2, C75, C75BT, C75M, C75RCD, C85, C95, C95E2, LC1200, LC1200RCD, LC380, LC400, LC412, LC700, LC700RCD, LC900, LC900RCD, LP360, LP360BT, LP360RCD		



1

<b>GEV No.</b>	345057	<b>Ref. No.</b>	120320
<b>description</b>	position switch cast aluminum 1NO/1NC 400V 3A L 98mm W 40mm H 35mm protection IP67 actuating force: 450g screw connection PG13.5 mounting distance 30x60mm		
<b>For models:</b>	AC101, AC122, AC151, AC152, AC181, AC182, AC201, AC202, AC241, AC242, AC91, ACS101, ACS101-DIGIT, ACS122, ACS122-DIGIT, ACS151, ACS151-DIGIT, ACS152, ACS152-DIGIT, ACS161-DIGIT, ACS162-DIGIT, ACS181, ACS181-DIGIT, ACS182, ACS182-DIGIT, ACS201, ACS201-DIGIT, ACS202, ACS202-DIGIT, ACS241, ACS241-DIGIT, ACS242, ACS242-DIGIT, ACS91, ACS91-DIGIT, C30, C70		



1

<b>GEV No.</b>	347719	<b>Ref. No.</b>	660862
<b>description</b>	position switch kit 400V L 98mm W 44mm H 40mm protection IP67 mounting distance 60/30mm FD552-S2		
<b>For models:</b>	AC101, AC122, AC151, AC152, AC181, AC182, AC201, AC202, AC241, AC242, AC91		



1

<b>GEV No.</b>	347681	<b>Ref. No.</b>	120321
<b>description</b>	position switch with handle with a switch 2NO/2NC 400V protection IP66 mounting distance 60mm FD230		





system switches (ROLD)

			
1			
<b>GEV No.</b>	347400	<b>Ref. No.</b>	190155
<b>description</b>	element holder dimensions 25x25mm ID ø 21.4mm light blue		
<b>For models:</b>	BHC25-2, BHC25A-2, BHC30-2, BHC30A-2, BHC433-2, BHC433A-2, FC3M, FC3MA, FC3MR, FC4M, FC4MA, GF70, GF70A, GF90-2004, GF90A-2004, LB200, LB200-2, LB200A, LB200A-2, LB215, LB215-2, LB215A, LB215A-2, LB260, LB260-2, LB260A, LB260A-2, LB275, LB275-2, LB275A, LB275A-2, LF321, LF321A, LF322, LF322A, LF322MP, LF322MP-A, LF322RCD, LF324, LF324A, LF700, LF700A, LFD32M, LFD32MA		

			
1			
<b>GEV No.</b>	345131	<b>Ref. No.</b>	190140
<b>description</b>	element holder mounting measurements 28.5x28.5mm grey single element holder		
<b>For models:</b>	BC25, BC25A, BC25HR, BC30, BC30A, BC30HR, BC30HR380, BC30HRA, BHC25, BHC25A, BHC25S, BHC30, BHC30A, BHC30HR, BHC30HR380, BHC30HRA, BHC30HRA380, BHC433, BHC433A, BHCHR, BR20, BR20A, BR25, BR25A, C1000ERCD, C1300ERCD, C155, C155BT, C155RCD, C75BT, C75RCD, C95, C95BT, C95RCD, F90M, F90MA, FC, FC43, FC43A, FC53, FC533, FC533A, FC53A, FC53CBT, FC53LA, FC53LBT, FC54, FC543, FC543A, FC543E...(Other models you can see in the webshop)		

			
1			
<b>GEV No.</b>	345130	<b>Ref. No.</b>	130449
<b>description</b>	momentary switch unit 1NO 250V 16A connection male faston 6.3mm		

			
1			
<b>GEV No.</b>	347193	<b>Ref. No.</b>	130449
<b>description</b>	momentary switch unit 1NO 250V 16A connection male faston 6.3mm		

			
1			
<b>GEV No.</b>	348217	<b>Ref. No.</b>	450341
<b>description</b>	push button ø 21mm blue for ROLD		

			
1			
<b>GEV No.</b>	347469	<b>Ref. No.</b>	450342
<b>description</b>	push button ø 21mm blue regeneration edition 2004 series		
<b>For models:</b>	BHC25-2, BHC25A-2, BHC30-2, BHC30A-2, BHC433-2, BHC433A-2, GF70A, GF90-2004, GF90A-2004, LB200A, LB200A-2, LB215A, LB215A-2, LB260A, LB260A-2, LB275A, LB275A-2, LF321A, LF322A, LF322MP, LF322MP-A, LF324A, LF700A, LFD32M, LFD32MA		

			
1			
<b>GEV No.</b>	347099	<b>Ref. No.</b>	450339
<b>description</b>	push button ø 21mm blue START suitable for ROLD		
<b>For models:</b>	BHC25-2, BHC25A-2, BHC30-2, BHC30A-2, BHC433-2, BHC433A-2, FC3M, FC3MA, FC3MR, FC4M, FC4MA, GF70, GF70A, LB200, LB200-2, LB200A, LB200A-2, LB215, LB215-2, LB215A, LB215A-2, LB260, LB260-2, LB260A, LB260A-2, LB275, LB275-2, LB275A, LB275A-2, LF321, LF321A, LF322, LF322A, LF322MP, LF322MP-A, LF322RCD, LF324, LF324A, LF700, LF700A, LFD32M, LFD32MA		

			
1			
<b>GEV No.</b>	347399	<b>Ref. No.</b>	450340
<b>description</b>	push button ø 21mm shaft 3.5x3.5mm dark blue ON-OFF suitable for ROLD		
<b>For models:</b>	FC3M, FC3MA, FC3MR, FC4M, FC4MA, GF70, GF70A, LB200, LB200-2, LB200A, LB200A-2, LB215, LB215-2, LB215A, LB215A-2, LB260, LB260-2, LB260A, LB260A-2, LB275, LB275-2, LB275A, LB275A-2, LF321, LF321A, LF322, LF322A, LF322MP, LF322MP-A, LF322RCD, LF324, LF324A, LF700, LF700A, LFD32M, LFD32MA		

			
1			
<b>GEV No.</b>	347872	<b>Ref. No.</b>	450352
<b>description</b>	push button ø 23mm black programme		

			
1			
<b>GEV No.</b>	345848	<b>Ref. No.</b>	450332
<b>description</b>	push button ø 23mm blue rinsing		
<b>For models:</b>	BHC25, BHC25A, BHC25S, BHC30, BHC30A, BHC433, BHC433A		







			
1			
<b>GEV No.</b>	345132	<b>Ref. No.</b>	450320
<b>description</b>	push button ø 23mm green		

			
1			
<b>GEV No.</b>	347871	<b>Ref. No.</b>	450353
<b>description</b>	push button ø 23mm green main switch with lens		

			
1			
<b>GEV No.</b>	345847	<b>Ref. No.</b>	450326
<b>description</b>	push button ø 23mm green START		
<b>For models:</b>	BC25, BC25A, BC25HR, BC30, BC30A, BC30HR, BC30HR380, BC30HRA, BHC25, BHC25A, BHC25S, BHC30, BHC30A, BHC30HR, BHC30HR380, BHC30HRA, BHC30HRA380, BHC433, BHC433A, BHCHR, BR20, BR20A, BR25, BR25A, FC, FC43, FC43A, FC53, FC533, FC533A, FC53A, FC53CBT, FC53LA, FC53LBT, FC54, FC543, FC543A, FC544, FC544A, FC54A, FC54CBT, FC54LBT		

			
1			
<b>GEV No.</b>	345133	<b>Ref. No.</b>	450321
<b>description</b>	push button ø 23mm grey		
<b>For models:</b>	BC25, BC25A, BC25HR, BC30, BC30A, BC30HR, BC30HR380, BC30HRA, BR20, BR20A, BR25, BR25A, C155, C155BT, C155RCD, C75BT, C75RCD, C95, C95BT, C95RCD, F90M, F90MA, FC, FC43, FC43A, FC53, FC533, FC533A, FC53A, FC54, FC543, FC543A, FC544, FC544A, FC54A, LF280-lav-line, LF315, LF320CBT, LF320-lav-line, LF320LBT, LF450, LF450A		

			
1			
<b>GEV No.</b>	347686	<b>Ref. No.</b>	450328
<b>description</b>	push button ø 23mm grey outflow		
<b>For models:</b>	BHC25, BHC25A, BHC25S, BHC30, BHC30A, BHC433, BHC433A, FC, FC43, FC53, FC533, FC533A, FC53A, FC53CBT, FC53LA, FC53LBT, FC54, FC543, FC543A, FC543E, FC543EA, FC544, FC544A, FC54A, FC54CBT, FC54LBT		

			
1			
<b>GEV No.</b>	345849	<b>Ref. No.</b>	450327
<b>description</b>	push button ø 23mm grey regeneration		
<b>For models:</b>	BHC25A, BHC30A, BHC30HR, BHC30HRA, BHC30HRA380, BHC433A, BHCHR, FC53LA		

			
1			
<b>GEV No.</b>	345850	<b>Ref. No.</b>	450329
<b>description</b>	push button ø 23mm grey rinsing		
<b>For models:</b>	BHC30HR, BHC30HR380, BHC30HRA, BHC30HRA380, BHCHR, LP360BT, LP360RCD		

			
1			
<b>GEV No.</b>	345851	<b>Ref. No.</b>	450331
<b>description</b>	push button ø 23mm grey START		
<b>For models:</b>	LF320, LF320A, LF320L, LF320LA, LF323, LF323A, LF350, LF350A, LF400A		

			
1			
<b>GEV No.</b>	347475	<b>Ref. No.</b>	450357
<b>description</b>	push button ø 23mm white main switch		

			
1			
<b>GEV No.</b>	347929	<b>Ref. No.</b>	450358
<b>description</b>	push button ø 23mm white programme		

			
1			
<b>GEV No.</b>	347098	<b>Ref. No.</b>	130487
<b>description</b>	switch 2CO 250V 16A connection male faston 6.3mm		
<b>For models:</b>	FC3M, FC3MA, FC3MR, FC4M, FC4MA, GF70, GF70A, LB200, LB200-2, LB200A, LB200A-2, LB215, LB215-2, LB215A, LB215A-2, LB260, LB260-2, LB260A, LB260A-2, LB275, LB275-2, LB275A, LB275A-2, LF321, LF321A, LF322, LF322A, LF322MP, LF322MP-A, LF322RCD, LF324, LF324A, LF700, LF700A, LFD32M, LFD32MA		



float switches

<b>GEV No.</b>	345822	<b>Ref. No.</b>	120358
<b>description</b>	float switch thread M16x1.5 1NO or 1NC ø 17.4mm L 98mm mounting ø 16mm 250V 0.5A cable cable length 2000mm		

rotary switches

BREMAS

A1200 series

<b>GEV No.</b>	345019	<b>Ref. No.</b>	120712
<b>description</b>	rotary switch sets of contacts 2 2 0-1 type CA0120002 380V 12A shaft ø 5x5mm shaft L 23mm shaft square connection screw		
<b>For models:</b>	AC101, AC105, AC2A, AC91, AC95, ACL100, ACL150, ACS101, ACS101-DIGIT, ACS91, ACS91-DIGIT, B10, B10T, B11, B11T, B12, B12T, B13T, B14T, B15, B15T, B15TM, B16, B16T, B16TM, B18, B18T, B18TM, B19, B19T, B19TM, BC25, BC30, BHC25, BHC25-2, BHC25A-2, BHC25S, BHC30, BHC30-2, BHC30A-2, BR20, BR25, C33, C34, F2, F3, F300, F45, G131, G66...(Other models you can see in the webshop)		

A1600 series

<b>GEV No.</b>	345054	<b>Ref. No.</b>	120735
<b>description</b>	rotary switch 0-1-2 16A shaft L 25mm connection screw clamp 3 operating positions 6-pole shaft 5x5mm		
<b>For models:</b>	BHC433, FC43, FC43A		

<b>GEV No.</b>	345677 <sup>1</sup>	<b>Ref. No.</b>	120714
<b>description</b>	rotary switch 2 0-1 sets of contacts 4 type CA0160004V 400V 16A shaft ø 5x5mm shaft L 23mm shaft square connection screw		
<b>For models:</b>	B41, B42, LF280-lav-line, LF320-lav-line		

<sup>1</sup>incl. knob and dial plate

<b>GEV No.</b>	300222	<b>Ref. No.</b>	120715
<b>description</b>	rotary switch 3 0-1-2 sets of contacts 4 type CS0167133 400V 16A shaft ø 5x5mm shaft L 24mm shaft square connection screw		
<b>For models:</b>	AC122, AC151, AC152, AC181, AC182, AC201, AC202, AC241, AC242, AC90, ACS122, ACS151, ACS152, ACS181, ACS182, ACS201, ACS202, ACS241, ACS242, SNL		

<b>GEV No.</b>	345840	<b>Ref. No.</b>	120737
<b>description</b>	rotary switch 3 0-1-2 sets of contacts 4 type CS0168308 400V 16A shaft ø 5x5mm shaft L 23mm shaft square connection screw		
<b>For models:</b>	F90M, F90MA, FC, FC53, FC533, FC533A, FC53A, FC54, FC543, FC543A, FC544, FC544A, FC54A, LF320, LF320A, LF320LA, LF323, LF323A, LF350, LF350A, LF400A, LF450, LF450A		

<b>GEV No.</b>	345838	<b>Ref. No.</b>	120744
<b>description</b>	rotary switch 3 0-1-2 sets of contacts 4 type CS0168505 400V 16A shaft ø 5x5mm shaft L 23mm shaft square connection screw		
<b>For models:</b>	BHC30HR, BHC30HR380, BHC30HRA, BHC30HRA380, BHC433-2, BHC433A-2, BHCHR, FC, FC533A, FC53A, FC53CBT, FC53LA, FC53LBT, FC543A, FC544A, FC54A, FC54CBT, FC54LBT, GF90, GF90A, LF320CBT, LF320L, LF320LA, LF320LBT		

<b>GEV No.</b>	345009	<b>Ref. No.</b>	120722
<b>description</b>	rotary switch 3 0-1-2 sets of contacts 6 type CA0168378V 600V 16A shaft ø 5x5mm shaft L 23mm shaft square connection screw		
<b>For models:</b>	AC101, AC105, AC91, AC95, ACL100, ACL150, ACS101, ACS101-DIGIT, ACS122, ACS122-DIGIT, ACS151, ACS151-DIGIT, ACS152, ACS152-DIGIT, ACS161-DIGIT, ACS162-DIGIT, ACS181, ACS181-DIGIT, ACS182, ACS182-DIGIT, ACS201, ACS201-DIGIT, ACS202, ACS202-DIGIT, ACS241, ACS241-DIGIT, ACS242, ACS242-DIGIT, ACS91, ACS91-DIGIT, F20, LAV1001, LAV1501, LF320, LF320A, LF320LA, LF323, LF323A, LF350, LF350A, NL302, NL302E, NL402, NL402E, NL502, NL502E, NL552, NL552E		

<b>GEV No.</b>	300330	<b>Ref. No.</b>	110805
<b>description</b>	rotary switch 3 1-0-2 sets of contacts 2 type CS0168351 400V 16A shaft ø 5x5mm shaft L 25mm shaft square connection screw		
<b>For models:</b>	AC100, AC120, AC122, AC135, AC150, AC151, AC152, AC170, AC181, AC182, AC200, AC201, AC202, AC241, AC242, ACR, ACR145, ACR205, ACR225, ACR245, ACR260, ACR265, ACR305, ACS122, ACS151, ACS152, ACS181, ACS182, ACS201, ACS202, ACS241, ACS242, GMC, GMC2700, GMC3500, GMC4500, GMC5500, NE00, SE, SNL		





			
1			
<b>GEV No.</b>	345315 <sup>1</sup>	<b>Ref. No.</b>	110801
<b>description</b>	rotary switch 3 1-0-2 sets of contacts 6 type CA160007 400V 16A shaft ø 5x5mm shaft L 23mm shaft square with knob connection screw		

<sup>1</sup>incl. knob

			
1			
<b>GEV No.</b>	345839	<b>Ref. No.</b>	120740
<b>description</b>	rotary switch 4 1-0-2-3 sets of contacts 6 type CS0168341 400V 16A shaft ø 5x5mm shaft L 23mm shaft square connection screw		
<b>For models:</b>	BHC433A, FC, FC53, FC533, FC533A, FC53A, FC54, FC543, FC543A, FC544, FC544A, FC54A		

			
1			
<b>GEV No.</b>	347097	<b>Ref. No.</b>	120751
<b>description</b>	rotary switch 5 0-1-2-3-4 sets of contacts 4 type CS0169615V 400V 16A shaft ø 5x5mm shaft L 25mm shaft square connection screw		
<b>For models:</b>	C1001M, C1301M, GF90-2004, GF90A-2004, LC1200, LC1200RCD, LC412, LC700, LC700RCD, LC900, LC900RCD		

			
1			
<b>GEV No.</b>	345842	<b>Ref. No.</b>	120716
<b>description</b>	rotary switch 5 0-1-2-3-4 sets of contacts 6 type CS0168359 400V 16A shaft ø 5x5mm shaft L 23mm shaft square connection screw		
<b>For models:</b>	C1001M, C1301M, C155BT, C155RCD, C95BT, C95RCD, G100L, G101L, G115, G115L, G125, G125L, G131, G50L, G50LM, G51L, G60L, G61L, G65, G65L, G66, G75, G75L, GL, LC1200RCD, LC412, LC700RCD, LC900RCD		

			
1			
<b>GEV No.</b>	345841	<b>Ref. No.</b>	120747
<b>description</b>	rotary switch 5 0-1-2-3-4 sets of contacts 7 type CS0168590 400V 16A shaft ø 5x5mm shaft L 25mm shaft square connection screw		
<b>For models:</b>	C75BT, C75RCD, LC380BT, LC380RCD, LP360BT, LP360RCD		

			
1			
<b>GEV No.</b>	345012	<b>Ref. No.</b>	120728
<b>description</b>	rotary switch 5 0-1-2-3-4 sets of contacts 8 type CS0167898 400V 16A shaft ø 5x5mm shaft L 25mm shaft square connection screw		
<b>For models:</b>	F55, F65, F80		

			
1			
<b>GEV No.</b>	345024	<b>Ref. No.</b>	120729
<b>description</b>	rotary switch 6 0-1-2-3-4-5 sets of contacts 8 type CS0168339 400V 16A shaft ø 5x5mm shaft L 25mm shaft square connection screw		
<b>For models:</b>	C140, C155, C70, C75, C75M, C85, C95, LC1200, LC380, LC400, LC700, LC900, LP360		

## A1700 series

			
1			
<b>GEV No.</b>	345007	<b>Ref. No.</b>	120713
<b>description</b>	rotary switch 4 0-1-2-3 sets of contacts 6 type CS0178766 400V 20A shaft ø 5x5mm shaft L 25mm shaft square connection screw		
<b>For models:</b>	C30, R70		

## A2500 series

			
1			
<b>GEV No.</b>	347688	<b>Ref. No.</b>	120701
<b>description</b>	rotary switch 2 0-1 sets of contacts 2 type 120701 600V 32A shaft ø 5x5mm shaft L 19mm shaft square connection screw		

			
1			
<b>GEV No.</b>	300325	<b>Ref. No.</b>	120736
<b>description</b>	rotary switch 2 0-1 sets of contacts 4 type CA0250004 600V 25A shaft ø 5x5mm shaft square connection screw		
<b>For models:</b>	AC122, AC151, AC152, AC181, AC182, AC201, AC202, AC241, AC242, ACR, ACR145, ACR205, ACR225, ACR245, ACR260, ACR265, ACR305, ACRS145, ACRS205, ACRS225, ACRS245, ACRS260, ACRS265, ACRS305, GMC, GMC2700, GMC2702, GMC3500, GMC3502, GMC4500, GMC4502, GMC5500, GMC5502, LAV1001, LAV1501, LV1001, LV1501, LV-LVP, LVP1001, LVP1501, NE02, NE3001, NE3002, NE4001, NE4002, NE5002, NE5501, NE5502, NE7002, NE7501...(Other models you can see in the webshop)		

			
1			
<b>GEV No.</b>	345004	<b>Ref. No.</b>	120718
<b>description</b>	rotary switch 3 0-1-2 sets of contacts 4 type CS025704300001 600V 32A shaft ø 5x5mm shaft L 24mm shaft square connection screw		
<b>For models:</b>	AC100, NE00, NG00, NG600, NG600E, NG900, NG900E, SE, SNL		





			
1			
<b>GEV No.</b>	347687	<b>Ref. No.</b>	120733
<b>description</b>	rotary switch 3 0-1-2 sets of contacts 4 type CS0257997 600V 32A shaft $\varnothing$ 5x5mm shaft L 24mm shaft square connection screw		
<b>For models:</b>	AC120, AC135, AC150, AC170, AC200, ACR, ACR145, ACR205, ACR225, ACR245, ACR260, ACR265, ACR305, GMC, GMC2700, GMC3500, GMC4500, GMC5500, LAV1000		

touch sensitive light switches

			
1			
<b>GEV No.</b>	403091	<b>Ref. No.</b>	120907
<b>description</b>	light barrier 24-240V 5A range 100mm L 88mm E3F2-DS10Z1-N		
<b>For models:</b>	LAV1000, LAV1001, LAV1501		

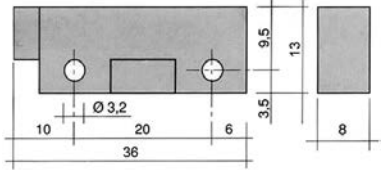
magnetic switches

			
36x13mm			
1			
			
<b>GEV No.</b>	345335	<b>Ref. No.</b>	120366 h33188
<b>description</b>	magnetic switch L 36mm W 13mm 1NO 250V 0.04A P max. 10W connection cable cable length 960mm		
<b>For models:</b>	GF90, GF90A		
<b>accessories for</b>	345335		
	<b>GEV No.</b>	519049	<b>Ref. No.</b> 411010
magnet $\varnothing$ mm L 63mm H 10.7mm W 18.8mm hole distance 52mm M2 hole $\varnothing$ 2mm			

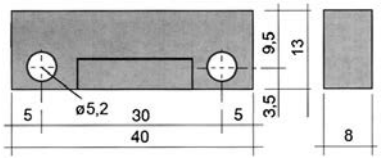
			
40x13mm			
1			
			
<b>GEV No.</b>	345358	<b>Ref. No.</b>	120356
<b>description</b>	magnetic switch L 40mm W 13mm 1NO 250V 0.04A P max. 10W connection cable cable length 900mm		
<b>For models:</b>	BHC25-2, BHC25A-2, BHC30-2, BHC30A-2, BHC30E-2, BHC30EA-2, BHC30HR-2, BHC30HRA-2, BHC433-2, BHC433A-2, FC, FC53, FC533, FC533A, FC53A, FC53CBT, FC53LA, FC53LBT, FC54, FC543, FC543A, FC543E, FC543EA, FC544, FC544A, FC54A, FC54CBT, FC54E, FC54EA, FC54LBT, FCHR, FCHRA, FCHRT, FCHRTA, GE100, GE115, GE50RCD, GE60, GE60RCD, GE65, GE65RCD, GE80, GF90-2004, GF90A-2004, LB200, LB200-2, LB200A, LB200A-2, LB215, LB215-2...(Other models you can see in the webshop)		

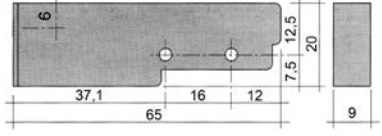
			
65x20mm			
1			
			
<b>GEV No.</b>	345122 <sup>1</sup>	<b>Ref. No.</b>	120333 120342
<b>description</b>	magnetic switch L 65mm W 20mm 1NO 24V 8A P max. 192W connection male faston 6.3mm cable length 344mm		
<b>For models:</b>	AC100, AC101, AC105, AC120, AC122, AC135, AC150, AC151, AC152, AC170, AC181, AC182, AC200, AC201, AC202, AC241, AC242, AC2A, AC90, AC91, AC95, ACL100, ACL150, ACR, ACR145, ACR205, ACR225, ACR245, ACR260, ACR265, ACR305, ACS101, ACS101-DIGIT, ACS122, ACS122-DIGIT, ACS151, ACS151-DIGIT, ACS152, ACS152-DIGIT, ACS161-DIGIT, ACS162-DIGIT, ACS181, ACS181-DIGIT, ACS182, ACS182-DIGIT, ACS201, ACS201-DIGIT, ACS202, ACS202-DIGIT, ACS241...(Other models you can see in the webshop)		

<sup>1</sup>with coded connector



<b>GEV No.</b>	347720	<b>Ref. No.</b>	620273
<b>description</b>	magnetic switch L 65mm W 20mm 1NO 24V connection coded plug cable length 350mm nominal 8A		
<b>For models:</b>	AC101, AC122, AC151, AC152, AC181, AC182, AC201, AC202, AC241, AC242, AC91		

<b>GEV No.</b>	345116	<b>Ref. No.</b>	120348
<b>description</b>	magnetic switch L 65mm W 20mm 1NO 250V 0.4A P max. 100W connection cable cable length 3000mm		
<b>For models:</b>	ACR, ACR145, ACR205, ACR225, ACR245, ACR260, ACR265, ACR305, ACR5145, ACR5205, ACR5225, ACR5245, ACR5260, ACR5265, ACR5305, C1000E, C1000ERCD, C1300E, C1300ERCD, C155, C155BT, C155E2, C155RCD, C165, C165E2, C165E2BT, C165E2RCD, C166, C166-2, C95, C95BT, C95E2, C95RCD, GMC, GMC2700, GMC2702, GMC3500, GMC3502, GMC4500, GMC4502, GMC5500, GMC5502, LC1200, LC1200RCD, LC380BT, LC380RCD, LC412, LC700, LC700RCD, LC900... (Other models you can see in the webshop)		
<b>accessories for</b>	345116		
	<b>GEV No.</b>	345399	<b>Ref. No.</b> —
	magnet ø 3.3mm L 40mm H 8mm W 13mm hole distance 30mm M3		

**M30x1.5**

<b>GEV No.</b>	347880	<b>Ref. No.</b>	120345
<b>description</b>	magnetic switch thread M30x1.5 1NO 20-250V 0.3A connection cable cable length 1900mm		
<b>For models:</b>	C166-2		

**miscellaneous**

<b>GEV No.</b>	511228	<b>Ref. No.</b>	120358
<b>description</b>	magnetic switch		
<b>For models:</b>	ACRS145, ACRS205, ACRS225, ACRS245, ACRS260, ACRS265, ACRS305, ACS101, ACS101-DIGIT, ACS122, ACS122-DIGIT, ACS151, ACS151-DIGIT, ACS152, ACS152-DIGIT, ACS161-DIGIT, ACS162-DIGIT, ACS181, ACS181-DIGIT, ACS182, ACS182-DIGIT, ACS201, ACS201-DIGIT, ACS202, ACS202-DIGIT, ACS241, ACS241-DIGIT, ACS242, ACS242-DIGIT, ACS91, ACS91-DIGIT, C155BT, C155RCD, C165E2BT, C165E2RCD, C75BT, C75RCD, C95BT, C95RCD, FC53CBT, FC53LBT, FC54CBT, FC54LBT, GMC2700, GMC2702, GMC3500, GMC3502, GMC4500, GMC4502, GMC5500...(Other models you can see in the webshop)		

<b>GEV No.</b>	347477	<b>Ref. No.</b>	120317
<b>description</b>	magnetic switch cable length 520mm		
<b>For models:</b>	AC101, AC122, AC151, AC152, AC181, AC182, AC201, AC202, AC241, AC242, AC91, ACL100, ACL150, ACS101, ACS101-DIGIT, ACS122, ACS122-DIGIT, ACS151, ACS151-DIGIT, ACS152, ACS152-DIGIT, ACS161-DIGIT, ACS162-DIGIT, ACS181, ACS181-DIGIT, ACS182, ACS182-DIGIT, ACS201, ACS201-DIGIT, ACS202, ACS202-DIGIT, ACS241, ACS241-DIGIT, ACS242, ACS242-DIGIT, ACS91, ACS91-DIGIT		

**accessories**

**magnets**

<b>GEV No.</b>	347882	<b>Ref. No.</b>	411011
<b>description</b>	magnet ø 5mm L 20mm H mm W mm		
<b>For models:</b>	NG02, NG1202, NG1202E, NG602, NG602E, NG902, NG902E		

<b>GEV No.</b>	347881	<b>Ref. No.</b>	411004
<b>description</b>	magnet ø mm L 35mm H 6mm W 11mm		
<b>For models:</b>	BC25, BC25A, BC25HR, BC30, BC30A, BC30HR, BC30HR380, BC30HRA, BR20, BR20A, BR25, BR25A, FC43, FC43A, GF70, GF70A, LF321, LF321A, LF322, LF322A, LF322MP, LF322MP-A, LF322RCD, LF324, LF324A, LF325E, LF325EA, LF700, LF700A		





1

<b>GEV No.</b>	519049	<b>Ref. No.</b>	411010
<b>description</b>	magnet ømm L 63mm H 10.7mm W 18.8mm hole distance 52mm M2 hole ø 2mm		
<b>For models:</b>	BHC25, BHC25-2, BHC25A, BHC25A-2, BHC25S, BHC30, BHC30-2, BHC30A, BHC30A-2, BHC30E, BHC30E-2, BHC30EA, BHC30EA-2, BHC30HR, BHC30HR-2, BHC30HR380, BHC30HRA, BHC30HRA-2, BHC30HRA380, BHC433, BHC433-2, BHC433A, BHC433A-2, BHC433R		
<b>accessories for</b>	519049		
	<b>GEV No.</b>	560095	<b>Ref. No.</b>
			260712
	sheet metal screws ø 2.9mm L 9.5mm SS Qty 20 pcs DIN 7981/ISO 7049 head ø 5.6mm oval head		

magnetic holders

1

<b>GEV No.</b>	348234	<b>Ref. No.</b>	331754
<b>description</b>	bracket for magnetic switch		
<b>For models:</b>	AC101, AC105, AC122, AC135, AC151, AC152, AC181, AC182, AC201, AC202, AC241, AC242, AC91, AC95, ACRS145, ACRS205, ACRS225, ACRS245, ACRS260, ACRS265, ACRS305, ACS181, ACS181-DIGIT, ACS182, ACS182-DIGIT, ACS201, ACS201-DIGIT, ACS202, ACS202-DIGIT, ACS241, ACS241-DIGIT, ACS242, ACS242-DIGIT, GMC2702, GMC3502, GMC4502, GMC5502, LAV1000, LAV1001, LAV1501		

1

<b>GEV No.</b>	346075	<b>Ref. No.</b>	190806
<b>description</b>	magnet holder		
<b>For models:</b>	AC100, AC101, AC105, AC120, AC122, AC135, AC150, AC151, AC152, AC170, AC181, AC182, AC200, AC201, AC202, AC241, AC242, AC2A, AC90, AC91, AC95, ACL100, ACL150, ACR, ACR145, ACR205, ACR225, ACR245, ACR260, ACR265, ACR305, ACRS145, ACRS205, ACRS225, ACRS245, ACRS260, ACRS265, ACRS305, ACS101, ACS101-DIGIT, ACS122, ACS122-DIGIT, ACS151, ACS151-DIGIT, ACS152, ACS152-DIGIT, ACS161-DIGIT, ACS162-DIGIT, ACS181, ACS181-DIGIT...(Other models you can see in the webshop)		

control equipment

ABB

1

<b>GEV No.</b>	348089	<b>Ref. No.</b>	130410
<b>description</b>	contact block ABB MCB-01 1NC max 400V 8A black/red		
<b>For models:</b>	AC100, AC101, AC105, AC120, AC122, AC135, AC150, AC151, AC152, AC170, AC181, AC182, AC200, AC201, AC202, AC241, AC242, AC90, AC91, AC95, ACR, ACR145, ACR205, ACR225, ACR245, ACR260, ACR265, ACR305, GMC, GMC2700, GMC3500, GMC4500, GMC5500, LAV1000, LV1001, LV1501, LV-LVP, LVP1001, LVP1501, NE00, NE02, NE3001, NE3002, NE4001, NE4002, NE5002, NE5501, NE5502, NE7002, NE7501...(Other models you can see in the webshop)		

switches (complete)

1

<b>GEV No.</b>	347573	<b>Ref. No.</b>	130453
<b>description</b>	emergency stop switch complete yellow/red		
<b>For models:</b>	AC101, AC122, AC151, AC152, AC181, AC182, AC201, AC202, AC241, AC242, AC91, ACS101, ACS101-DIGIT, ACS122, ACS122-DIGIT, ACS151, ACS151-DIGIT, ACS152, ACS152-DIGIT, ACS161-DIGIT, ACS162-DIGIT, ACS181, ACS181-DIGIT, ACS182, ACS182-DIGIT, ACS201, ACS201-DIGIT, ACS202, ACS202-DIGIT, ACS241, ACS241-DIGIT, ACS242, ACS242-DIGIT, ACS91, ACS91-DIGIT, NL302, NL302E, NL402, NL402E, NL502, NL502E, NL552, NL552E		

BRETER

rotary switches

1

<b>GEV No.</b>	347682	<b>Ref. No.</b>	120721
<b>description</b>	rotary selector mounting measurements ø22mm black latching sequence 0-1		
<b>For models:</b>	ACR, ACR145, ACR205, ACR225, ACR245, ACR260, ACR265, ACR305, GMC, GMC2700, GMC3500, GMC4500, GMC5500, NE00, SE		



GENERAL ELECTRIC (AEG)



1

<b>GEV No.</b>	345780	<b>Ref. No.</b>	130477
<b>description</b>	contact block GENERAL ELECTRIC P9B01VN 1NC max 660V 10A		
<b>For models:</b>	ACRS145, ACRS205, ACRS225, ACRS245, ACRS260, ACRS265, ACRS305, GMC2702, GMC3502, GMC4502, GMC5502, LAV1001, LAV1501, NE02, NE3002, NE4002, NE5002, NE5502, NE7002, NE7502, NE9002, NE9502, NG02, NG1202, NG1202E, NG602, NG602E, NG902, NG902E, NL302, NL302E, NL402, NL402E, NL502, NL502E, NL552, NL552E		



1

<b>GEV No.</b>	345779	<b>Ref. No.</b>	130478
<b>description</b>	contact block GENERAL ELECTRIC P9B10VN 1NO max 400V 10A brown		
<b>For models:</b>	ACRS145, ACRS205, ACRS225, ACRS245, ACRS260, ACRS265, ACRS305, GMC2702, GMC3502, GMC4502, GMC5502, LAV1001, LAV1501, NE02, NE3002, NE4002, NE5002, NE5502, NE7002, NE7502, NE9002, NE9502, NG02, NG1202, NG1202E, NG602, NG602E, NG902, NG902E, NL302, NL302E, NL402, NL402E, NL502, NL502E, NL552, NL552E		

signal element



1

<b>GEV No.</b>	347239	<b>Ref. No.</b>	150106
<b>description</b>	signal element mounting measurements ø22mm with socket element green		
<b>For models:</b>	AC100, AC120, AC122, AC135, AC150, AC151, AC152, AC170, AC181, AC182, AC200, AC201, AC202, AC241, AC242, AC90, ACR, ACR145, ACR205, ACR225, ACR245, ACR260, ACR265, ACR305, GMC, GMC2700, GMC3500, GMC4500, GMC5500, LAV1000, LV1001, LV1501, LV-LVP, LVP1001, LVP1501, NE00, NG00, NG600, NG600E, NG900, NG900E, SE, SNL		



1

<b>GEV No.</b>	346889	<b>Ref. No.</b>	150105
<b>description</b>	signal element mounting measurements ø22mm without socket element red		
<b>For models:</b>	AC100, AC120, AC122, AC135, AC150, AC151, AC152, AC170, AC181, AC182, AC200, AC201, AC202, AC241, AC242, AC90, ACR, ACR145, ACR205, ACR225, ACR245, ACR260, ACR265, ACR305, GMC, GMC2700, GMC3500, GMC4500, GMC5500, LAV1000, LV1001, LV1501, LV-LVP, LVP1001, LVP1501, NG00, NG600, NG600E, NG900, NG900E, SNL		

momentary mushroom switches



1

<b>GEV No.</b>	347575	<b>Ref. No.</b>	130476	
<b>description</b>	emergency stop switch mounting measurements ø22mm red latching			
<b>For models:</b>	ACL100, ACL150, ACRS145, ACRS205, ACRS225, ACRS245, ACRS260, ACRS265, ACRS305, ACS101, ACS101-DIGIT, ACS122, ACS122-DIGIT, ACS151, ACS151-DIGIT, ACS152, ACS152-DIGIT, ACS161-DIGIT, ACS162-DIGIT, ACS181, ACS181-DIGIT, ACS182, ACS182-DIGIT, ACS201, ACS201-DIGIT, ACS202, ACS202-DIGIT, ACS241, ACS241-DIGIT, ACS242, ACS242-DIGIT, ACS91-DIGIT, GMC2702, GMC3502, GMC4502, GMC5502, LAV1001, LAV1501, NE02, NE3002, NE4002, NE5002, NE5502, NE7002, NE7502, NE9002, NE9502, NG02, NG1202, NG1202E...(Other models you can see in the webshop)			
<b>accessories for</b>	347575			
	<b>GEV No.</b>	345780	<b>Ref. No.</b>	130477
	contact block GENERAL ELECTRIC P9B01VN 1NC max 660V 10A			

lamps

indicator lights

indicator lights 2-piece (lens and indicator lamp)

indicator light lenses

ø 6mm (type SQ-20)



1

<b>GEV No.</b>	359806	<b>Ref. No.</b>	130707
<b>description</b>	indicator light lens clear Qty 1 pcs ø 6mm		
<b>For models:</b>	BHC25-2, BHC25A-2, BHC30-2, BHC30A-2, BHC433-2, BHC433A-2, C1001M, C1301M, C155, C155BT, C155RCD, C75, C75BT, C75M, C75RCD, C95, C95BT, C95RCD, FC3M, FC3MA, FC3MR, FC4M, FC4MA, FC53LA, GF70, GF70A, GF90-2004, GF90A-2004, LB200, LB200-2, LB200A, LB200A-2, LB215, LB215-2, LB215A, LB215A-2, LB260, LB260-2, LB260A, LB260A-2, LB275, LB275-2, LB275A, LB275A-2, LC1200, LC1200RCD, LC412, LC700, LC700RCD, LC900...(Other models you can see in the webshop)		





1

<b>GEV No.</b>	359803	<b>Ref. No.</b>	130704 130708
<b>description</b>	indicator light lens green Qty 1 pcs ø 6mm		
<b>For models:</b>	BC25, BC25A, BC25HR, BC30, BC30A, BC30HR, BC30HR380, BC30HRA, BHC25, BHC25A, BHC255, BHC30, BHC30A, BHC30HR, BHC30HR380, BHC30HRA, BHC30HRA380, BHC433, BHC433A, BHCHR, BR20, BR20A, BR25, BR25A, C1001M, C1301M, C155, C155BT, C155RCD, C75, C75BT, C75M, C75RCD, C95, C95BT, C95RCD, FC, FC43, FC43A, FC53, FC533, FC533A, FC53A, FC53CBT, FC53LA, FC53LBT, FC54, FC543, FC543A, FC543E...(Other models you can see in the webshop)		





			
1			
<b>GEV No.</b>	359805	<b>Ref. No.</b>	130706
<b>description</b>	indicator light lens red Qty 1 pcs ø 6mm		
<b>For models:</b>	C1001M, C1301M, C155, C155BT, C155RCD, C75, C75BT, C75M, C75RCD, C95, C95BT, C95RCD, LC1200, LC1200RCD, LC412, LC700, LC700RCD, LC900, LC900RCD		



ø12mm (type SDY-3)			
			
1			
<b>GEV No.</b>	359262	<b>Ref. No.</b>	130711
<b>description</b>	indicator light housings mounting measurements ø12mm green round Qty 1 pcs		
<b>For models:</b>	AC101, AC91, G100L, G101L, G115L, G125L, G50L, G50LM, G51L, G60L, G61L, G65L, G75L, GL		

			
1			
<b>GEV No.</b>	359261	<b>Ref. No.</b>	130710
<b>description</b>	indicator light housings mounting measurements ø12mm red round Qty 1 pcs		
<b>For models:</b>	AC101, AC91, G100L, G101L, G115L, G125L, G50L, G50LM, G51L, G60L, G61L, G65L, G75L, GL		

indicator lamps for socket type SQ			
			
1			
<b>GEV No.</b>	359801	<b>Ref. No.</b>	130182
<b>description</b>	indicator lamp 12V white connection male faston 6.3mm no lens ø 6mm		
<b>For models:</b>	BHC25-2, BHC25A-2, BHC30-2, BHC30A-2, BHC30HR, BHC30HR380, BHC30HRA, BHC30HRA380, BHC433-2, BHC433A-2, BHCHR, FC3M, FC3MA, FC3MR, FC4M, FC4MA, GF70, GF70A, GF90-2004, GF90A-2004, LB200, LB200-2, LB200A, LB200A-2, LB215, LB215-2, LB215A, LB215A-2, LB260, LB260-2, LB260A, LB260A-2, LB275, LB275-2, LB275A, LB275A-2, LF321, LF321A, LF322, LF322A, LF322MP, LF322MP-A, LF322RCD, LF324, LF324A, LF700, LF700A, LFD32M, LFD32MA		

			
1			
<b>GEV No.</b>	359109	<b>Ref. No.</b>	130188
<b>description</b>	indicator lamp 230V green connection male faston 6.3mm no lens ø 6mm		
<b>For models:</b>	FC3M, FC3MA, FC3MR, FC4M, FC4MA, GF70, GF70A, GF90-2004, GF90A-2004, LB200, LB200-2, LB200A, LB200A-2, LB215, LB215-2, LB215A, LB215A-2, LB260, LB260-2, LB260A, LB260A-2, LB275, LB275-2, LB275A, LB275A-2, LF321, LF321A, LF322, LF322A, LF322MP, LF322MP-A, LF322RCD, LF324, LF324A, LF700, LF700A, LFD32M, LFD32MA		
<b>accessories for</b>	359109		
	<b>GEV No.</b>	<b>Ref. No.</b>	130707
	 indicator light lens clear Qty 1 pcs ø 6mm		

			
1			
<b>GEV No.</b>	359802	<b>Ref. No.</b>	130181
<b>description</b>	indicator lamp 24V white connection male faston 6.3mm no lens temp.-resist. 120°C ø 6mm		
<b>For models:</b>	C155BT, C155RCD, C75BT, C75RCD, C95BT, C95RCD, FC, FC533A, FC53A, FC53CBT, FC53LA, FC53LBT, FC543A, FC544A, FC54A, FC54CBT, FC54LBT, LC1200RCD, LC700RCD, LC900RCD		

			
1			
<b>GEV No.</b>	347476	<b>Ref. No.</b>	130196
<b>description</b>	indicator light 5V green connection cable 170mm		
<b>For models:</b>	C1001M, C1301M, LC1200, LC1200RCD, LC412, LC700, LC700RCD, LC900, LC900RCD		
<b>accessories for</b>	347476		
	<b>GEV No.</b>	<b>Ref. No.</b>	130707
	 indicator light lens clear Qty 1 pcs ø 6mm		



indicator lamps for socket type SRZ / SDK / SDY / SFK			
			
1			
<b>GEV No.</b>	359129	<b>Ref. No.</b>	130170
<b>description</b>	indicator lamp 24V clear connection male faston 6.3mm		
<b>For models:</b>	AC101, AC91, G100L, G101L, G115L, G125L, G50L, G50LM, G51L, G60L, G61L, G65L, G75L, GL		

indicator lights 3-piece (housing, lens and bulb)

lamps			
neon light bulbs			
			
1			
<b>GEV No.</b>	359000	<b>Ref. No.</b>	130138 870050
<b>description</b>	neon light bulb socket Ba9s 24V 3W clear ø 10mm L 24mm		
<b>For models:</b>	AC100, AC120, AC122, AC135, AC150, AC151, AC152, AC170, AC181, AC182, AC200, AC201, AC202, AC241, AC242, AC90, ACR, ACR145, ACR205, ACR225, ACR245, ACR260, ACR265, ACR305, GMC, GMC2700, GMC3500, GMC4500, GMC5500, LAV1000, LV1001, LV1501, LV-LVP, LVP1001, LVP1501, NE00, NG00, NG600, NG600E, NG900, NG900E, SE, SNL		
<b>accessories for</b>	359000		
	<b>GEV No.</b>	<b>Ref. No.</b>	—
	 lamp socket mounting measurements ø16.2mm socket E10 connection screw		
	<b>GEV No.</b>	<b>Ref. No.</b>	—
	 lamp socket mounting measurements ø19.2mm socket E14 connection screw		
	<b>GEV No.</b>	<b>Ref. No.</b>	—
	 lamp socket mounting measurements ø22.3mm socket E14 connection screw 250/380V ambient temperature at 1W 100°C ambient temperature at 2W 85°C		
	<b>GEV No.</b>	<b>Ref. No.</b>	—
	 lamp socket mounting measurements ø16.2mm socket E10		

Table continues overleaf



<b>accessories for</b>	359000		
	<b>GEV No.</b>	359832	<b>Ref. No.</b> —
	lamp socket mounting measurements ø16.2mm socket Ba9s connection male faston 6.3mm		
	<b>GEV No.</b>	359853	<b>Ref. No.</b> —
	lamp socket mounting measurements ø18.2mm socket Ba9s connection male faston 6.3mm		
	<b>GEV No.</b>	359988	<b>Ref. No.</b> —
	lamp socket mounting measurements ø30.5mm 250V connection F6.3 temp.-resist. 55°C E14		

## indicator lights (complete)

ø 6mm



1

<b>GEV No.</b>	359031	<b>Ref. No.</b>	130157
<b>description</b>	indicator light ø 6mm 230V green		
<b>For models:</b>	BC25, BC25A, BC25HR, BC30, BC30A, BC30HR, BC30HR380, BC30HRA, BHC25, BHC25-2, BHC25A, BHC25A-2, BHC25S, BHC30, BHC30-2, BHC30A, BHC30A-2, BHC30HR, BHC30HR380, BHC30HRA, BHC30HRA380, BHC433, BHC433-2, BHC433A, BHC433A-2, BHCHR, BR20, BR20A, BR25, BR25A, C1001M, C1301M, C155, C155BT, C155RCD, C75, C75BT, C75M, C75RCD, C95, C95BT, C95RCD, FC, FC43, FC43A, FC53, FC533, FC533A, FC53A, FC53CBT...(Other models you can see in the webshop)		



1

<b>GEV No.</b>	359032	<b>Ref. No.</b>	130159
<b>description</b>	indicator light ø 6mm 230V yellow		
<b>For models:</b>	C1001M, C1301M, C155, C75, C75M, C95, LC1200, LC1200RCD, LC412, LC700, LC700RCD, LC900, LC900RCD		

ø10mm

with plug-in socket



1

<b>GEV No.</b>	359036	<b>Ref. No.</b>	130123
<b>description</b>	indicator light ø 10mm clear 230V connection male faston 6.3mm Qty 1 pcs		
<b>For models:</b>	R40, R50, R70		



1

<b>GEV No.</b>	359139	<b>Ref. No.</b>	130115
<b>description</b>	indicator light ø 10mm green 230V connection male faston 6.3mm Qty 1 pcs		
<b>For models:</b>	C30, F2, F3, F300, R40, R50, R70		



1

<b>GEV No.</b>	359138	<b>Ref. No.</b>	130103
<b>description</b>	indicator light ø 10mm red 230V connection male faston 6.3mm Qty 1 pcs		
<b>For models:</b>	C30, F2, F3, F300		



1

<b>GEV No.</b>	359140	<b>Ref. No.</b>	130116
<b>description</b>	indicator light ø 10mm yellow 230V connection male faston 6.3mm Qty 1 pcs		
<b>For models:</b>	C30, F300, R40, R50, R70		

ø12mm

with screw socket



1

<b>GEV No.</b>	359021	<b>Ref. No.</b>	130122
<b>description</b>	indicator light ø 12mm 230V clear connection male faston 6.3mm		



1

<b>GEV No.</b>	359026	<b>Ref. No.</b>	130120
<b>description</b>	indicator light ø 12mm 230V red connection male faston 6.3mm model CM/5		
<b>For models:</b>	C33, C34		



1

<b>GEV No.</b>	359047	<b>Ref. No.</b>	130139
<b>description</b>	indicator light ø 12mm 24V clear connection male faston 6.3mm		



1

<b>GEV No.</b>	359023	<b>Ref. No.</b>	130117 130711
<b>description</b>	indicator light ø 12mm 24V green connection male faston 6.3mm		
<b>For models:</b>	AC105, AC95, G115, G125, G131, G65, G66, G75		



1

<b>GEV No.</b>	359024	<b>Ref. No.</b>	130118 130170 130710
<b>description</b>	indicator light ø 12mm 24V red connection male faston 6.3mm		
<b>For models:</b>	AC105, AC95, G115, G125, G131, G65, G66, G75		





			
1			
<b>GEV No.</b>	359025	<b>Ref. No.</b>	130119
<b>description</b>	indicator light ø 12mm 24V yellow connection male faston 6.3mm		
<b>For models:</b>	G131, G66		

			
1			
<b>GEV No.</b>	359027	<b>Ref. No.</b>	130121
<b>description</b>	indicator light ø 12mm 250V green connection male faston 6.3mm		
<b>For models:</b>	C33, C34		

26.5x25.6mm

			
1			
<b>GEV No.</b>	357172	<b>Ref. No.</b>	130151
<b>description</b>	indicator light mounting measurements 27.8x25mm blue 250V connection male faston 6.3mm type MD50		

			
1			
<b>GEV No.</b>	349000	<b>Ref. No.</b>	130140 130153
<b>description</b>	indicator light mounting measurements 27.8x25mm clear 230V connection male faston 6.3mm		

			
1			
<b>GEV No.</b>	345853	<b>Ref. No.</b>	130168
<b>description</b>	indicator light mounting measurements 27.8x25mm green 230V connection male faston 6.3mm		
<b>For models:</b>	F90M, F90MA, LC380, LC400, LF280-lav-line, LF315, LF320, LF320A, LF320CBT, LF320LA, LF320-lav-line, LF320LBT, LF323, LF323A, LF350, LF350A, LF450, LF450A, LP360, LP360BT, LP360RCD		

			
1			
<b>GEV No.</b>	345854	<b>Ref. No.</b>	130169
<b>description</b>	indicator light mounting measurements 27.8x25mm green 230V connection male faston 6.3mm		
<b>For models:</b>	F90M, F90MA, LC380, LC400, LF280-lav-line, LF315, LF320, LF320A, LF320CBT, LF320LA, LF320-lav-line, LF320LBT, LF323, LF323A, LF350, LF350A, LF450, LF450A, LP360, LP360BT, LP360RCD		

			
1			
<b>GEV No.</b>	345855	<b>Ref. No.</b>	130152
<b>description</b>	indicator light mounting measurements 27.8x25mm green 230V connection male faston 6.3mm temp.-resist. 125°C		
<b>For models:</b>	F90M, F90MA, LC380, LC400, LF280-lav-line, LF315, LF320, LF320A, LF320LA, LF320-lav-line, LF323, LF323A, LF350, LF350A, LF450, LF450A, LP360		

			
1			
<b>GEV No.</b>	345857	<b>Ref. No.</b>	130147
<b>description</b>	indicator light mounting measurements 27.8x25mm green 24V connection male faston 6.3mm temp.-resist. 125°C on/ready		
<b>For models:</b>	GF90, GF90A, LC380BT, LC380RCD, LF320L, LF320LA		

			
1			
<b>GEV No.</b>	345856	<b>Ref. No.</b>	130180
<b>description</b>	indicator light mounting measurements 27.8x25mm green 24V connection male faston 6.3mm temp.-resist. 125°C operating		
<b>For models:</b>	GF90, GF90A, LC380BT, LC380RCD, LF320CBT, LF320L, LF320LA, LF320LBT, LP360BT, LP360RCD		

			
1			
<b>GEV No.</b>	345860	<b>Ref. No.</b>	130178
<b>description</b>	indicator light mounting measurements 27.8x25mm white 24V connection male faston 6.3mm temp.-resist. 125°C on/ready		
<b>For models:</b>	LF400A		

			
1			
<b>GEV No.</b>	359010	<b>Ref. No.</b>	130134
<b>description</b>	indicator light mounting measurements 27.8x25mm yellow 230V connection male faston 6.3mm		
<b>For models:</b>	B10, B10T, B11, B11T, B12, B12T, B13T, B14T, B15, B15T, B15TM, B16, B16T, B16TM, B18, B18T, B18TM, B19, B19T, B19TM, C140, C70, C85, F20, F45, F55, F65, F80		





			
1			
<b>GEV No.</b>	359012	<b>Ref. No.</b>	130136
<b>description</b>	indicator light mounting measurements 27.8x25mm yellow 230V connection male faston 6.3mm		
<b>For models:</b>	B11, B12, B15, B16, B18, B19, C140, C70, C85, F20, F45, F55, F65, F80, LBC210, LBC215, LBC215A, LBC275, LBC275A, LBR, LBR200, LBR215, LBR215A		

			
1			
<b>GEV No.</b>	345844	<b>Ref. No.</b>	130470
<b>description</b>	momentary rocker switch mounting measurements 27.8x25mm orange 1NO/indicator light 230V 16A regeneration connection male faston 6.3mm ambient temperature max. 85°C protection IP40		
<b>For models:</b>	F90M, F90MA, LF320, LF320A, LF320LA, LF323, LF323A, LF350, LF350A, LF450, LF450A		

			
1			
<b>GEV No.</b>	345861 <sup>1</sup>	<b>Ref. No.</b>	130472
<b>description</b>	momentary rocker switch mounting measurements 27.8x25mm orange 1NO/indicator light indicator lamp 24V 230V 16A regeneration connection male faston 6.3mm ambient temperature max. 85°C protection IP40		
<b>For models:</b>	GF90, GF90A, LF320L, LF320LA, LF400A		









<sup>1</sup>indicator light 24V

30x22mm			
			
1			
<b>GEV No.</b>	359029	<b>Ref. No.</b>	130125
<b>description</b>	indicator light mounting measurements 30x22mm 230V green connection male faston 6.3mm temp.-resist. -100 to +800°C flash		
<b>For models:</b>	B20, B20D, B41, B42		

			
1			
<b>GEV No.</b>	359030	<b>Ref. No.</b>	130126
<b>description</b>	indicator light mounting measurements 30x22mm 230V green connection male faston 6.3mm temp.-resist. -100 to +800°C machine stand-by		
<b>For models:</b>	B20, B20D, B41, B42		

screw-on/push-on fit

neon light bulbs

			
1			
<b>GEV No.</b>	359000	<b>Ref. No.</b>	130138 870050
<b>description</b>	neon light bulb socket Ba9s 24V 3W clear ø 10mm L 24mm		
<b>For models:</b>	AC100, AC120, AC122, AC135, AC150, AC151, AC152, AC170, AC181, AC182, AC200, AC201, AC202, AC241, AC242, AC90, ACR, ACR145, ACR205, ACR225, ACR245, ACR260, ACR265, ACR305, GMC, GMC2700, GMC3500, GMC4500, GMC5500, LAV1000, LV1001, LV1501, LV-LVP, LVP1001, LVP1501, NE00, NG00, NG600, NG600E, NG900, NG900E, SE, SNL		
<b>accessories for</b>	359000		
	<b>GEV No.</b>	359060	<b>Ref. No.</b> —
	lamp socket mounting measurements ø16.2mm socket E10 connection screw		
	<b>GEV No.</b>	359063	<b>Ref. No.</b> —
	lamp socket mounting measurements ø19.2mm socket E14 connection screw		
	<b>GEV No.</b>	359064	<b>Ref. No.</b> —
	lamp socket mounting measurements ø22.3mm socket E14 connection screw 250/380V ambient temperature at 1W 100°C ambient temperature at 2W 85°C		
	<b>GEV No.</b>	359685	<b>Ref. No.</b> —
	lamp socket mounting measurements ø16.2mm socket E10		
	<b>GEV No.</b>	359832	<b>Ref. No.</b> —
	lamp socket mounting measurements ø16.2mm socket Ba9s connection male faston 6.3mm		
	<b>GEV No.</b>	359853	<b>Ref. No.</b> —
	lamp socket mounting measurements ø18.2mm socket Ba9s connection male faston 6.3mm		
	<b>GEV No.</b>	359988	<b>Ref. No.</b> —
	lamp socket mounting measurements ø30.5mm 250V connection F6.3 temp.-resist. 55°C E14		

timers

programme timers

			
1			
<b>GEV No.</b>	400934	<b>Ref. No.</b>	121279
<b>description</b>	electronic timer engines chambers operation timeV		
<b>For models:</b>	BHC30E, BHC30EA, FC54E, FC54EA		





1

<b>GEV No.</b>	360048	<b>Ref. No.</b>	120256 120269 120269A
<b>description</b>	timer CDC 4904DV/4905DV engines 2 chambers 5 operation time 4s / 180s 230V shaft ømm shaft Lmm motor type M48L ATS		
<b>For models:</b>	F55, F65, F80, LF320, LF320A, LF320LA, LF323, LF323A, LF350, LF350A		
<b>spare parts for</b>	360048		
	<b>GEV No.</b>	360083	<b>Ref. No.</b> —
	motor CDC pinion ø 4.9mm teeth 10 230V turn direction left motor ø 47mm H 19.3mm motor type M48L ATS for timer		



1

<b>GEV No.</b>	360047	<b>Ref. No.</b>	120268
<b>description</b>	timer CDC 4905DV engines 2 chambers 5 operation time 4s / 150s 230V shaft ømm shaft Lmm manif. no. 4905DV / 360047 motor type M48L ATS		
<b>For models:</b>	F55, F65, F80, LF320, LF320A, LF320LA, LF323, LF323A, LF350, LF350A		
<b>spare parts for</b>	360047		
	<b>GEV No.</b>	360083	<b>Ref. No.</b> —
	motor CDC pinion ø 4.9mm teeth 10 230V turn direction left motor ø 47mm H 19.3mm motor type M48L ATS for timer		





1

<b>GEV No.</b>	360449	<b>Ref. No.</b>	121231
<b>description</b>	timer CDC 4905DV engines 2 chambers 5 230V 50Hz motor type M48R ATS / M48L ATN voltage AC run-time 4/360s		
<b>For models:</b>	F90M, F90MA		



1

<b>GEV No.</b>	360085	<b>Ref. No.</b>	120256
<b>description</b>	timer CDC 4905DV engines 2 chambers 5 run-time 180s		
<b>For models:</b>	F20		
<b>spare parts for</b>	360085		
	<b>GEV No.</b>	360083	<b>Ref. No.</b> —
	motor CDC pinion ø 4.9mm teeth 10 230V turn direction left motor ø 47mm H 19.3mm motor type M48L ATS for timer		



1

<b>GEV No.</b>	360049	<b>Ref. No.</b>	120270
<b>description</b>	timer CDC 4905DV engines 2 chambers 5 operation time 4s / 120s 230V shaft ømm shaft Lmm manif. no. 4905DV / 360049 motor type M48L ATS		
<b>For models:</b>	F55, F65, F80, LF320, LF320A, LF320LA, LF323, LF323A, LF350, LF350A, LF450, LF450A		
<b>spare parts for</b>	360049		
	<b>GEV No.</b>	360083	<b>Ref. No.</b> —
	motor CDC pinion ø 4.9mm teeth 10 230V turn direction left motor ø 47mm H 19.3mm motor type M48L ATS for timer		





1

<b>GEV No.</b>	360285	<b>Ref. No.</b>	121220
<b>description</b>	timer CDC 7805F engines 1 chambers 5 operation time 18min 230V manif. no. 7805 / 121220C motor type M37RN		
<b>For models:</b>	BC25HR, BC30HRA		
<b>spare parts for</b>	360285		
	<b>GEV No.</b>	360119	<b>Ref. No.</b> —
	motor CDC pinion ø 5.4mm teeth 12 230V turn direction right motor ø 37mm motor type M37RN for timer		





1

<b>GEV No.</b>	360006	<b>Ref. No.</b>	120213
<b>description</b>	timer CEM HFD2M16 engines 1 chambers 2 operation time 120s 230V shaft ø 5x5mm shaft L 24mm manif. no. HFD2M16 / 120213 motor type UDS11NE1LH		
<b>For models:</b>	B20, B20D, B23, B24, B25, B26, B27		
<b>spare parts for</b>	360006		
	<b>GEV No.</b>	360113	<b>Ref. No.</b> —
	motor SAIA pinion ø 4mm teeth 12 230V turn direction left motor ø 48mm motor type UDS11NE1LHZ for timer		



1

<b>GEV No.</b>	360011	<b>Ref. No.</b>	120225
<b>description</b>	timer CEM HH3M16 engines 1 chambers 3 operation time 120s 230V manif. no. HH3M16 / 120225 motor type UDS40NE1RNZ165		
<b>For models:</b>	B10, B11, B12, B15, B16, B18, B19		
<b>spare parts for</b>	360011		
	<b>GEV No.</b>	360112	<b>Ref. No.</b> —
	motor SAIA pinion ø 4mm teeth 12 230V turn direction right motor ø 48mm motor type UDS11NE1RHZ for timer		



1

<b>GEV No.</b>	360013	<b>Ref. No.</b>	120222
<b>description</b>	timer CEM HFD3M16 engines 1 chambers 3 operation time 360s 230V shaft ø 5x5mm shaft L 22mm manif. no. HFD3M16 / 120222 motor type UDS11NE1LH		
<b>spare parts for</b>	360013		
	<b>GEV No.</b>	360113	<b>Ref. No.</b> —
	motor SAIA pinion ø 4mm teeth 12 230V turn direction left motor ø 48mm motor type UDS11NE1LHZ for timer		

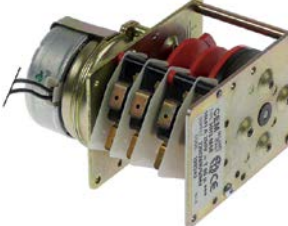



1

<b>GEV No.</b>	360542	<b>Ref. No.</b>	120243
<b>description</b>	timer CEM HH3M16 engines 1 chambers 3 operation time 120s 230V shaft ømm shaft Lmm motor type UDS11NE1RHZ210 type HH3M16 / 120243 voltage AC		





1

<b>GEV No.</b>	360028	<b>Ref. No.</b>	DTB45
<b>description</b>	timer CEM HFD4M16 engines 1 chambers 4 operation time 270s 230V shaft ø 6x4.6mm shaft L 17mm manif. no. HFD4M16 / DTP15 motor type UDS11NE1RH		
<b>spare parts for</b>	360028		
	<b>GEV No.</b>	360112	<b>Ref. No.</b> —
	motor SAIA pinion ø 4mm teeth 12 230V turn direction right motor ø 48mm motor type UDS11NE1RHZ for timer		





1

<b>GEV No.</b>	360012	<b>Ref. No.</b>	120220
<b>description</b>	timer CEM HH3M16 engines 1 chambers 3 operation time 150s 230V shaft ømm shaft Lmm manif. no. HH3M16 / 120220 motor type UDS11NE1RH		
<b>For models:</b>	R40		
<b>spare parts for</b>	360012		
	<b>GEV No.</b>	360112	<b>Ref. No.</b> —
	motor SAIA pinion ø 4mm teeth 12 230V turn direction right motor ø 48mm motor type UDS11NE1RHZ for timer		



1

<b>GEV No.</b>	360008	<b>Ref. No.</b>	120212
<b>description</b>	timer CEM HH3M16 engines 1 chambers 3 operation time 180s 230V manif. no. HH3M16 / 120212 motor type UDS11NE1RH		
<b>For models:</b>	F300		
<b>spare parts for</b>	360008		
	<b>GEV No.</b>	360112	<b>Ref. No.</b> —
	motor SAIA pinion ø 4mm teeth 12 230V turn direction right motor ø 48mm motor type UDS11NE1RHZ for timer		



1

<b>GEV No.</b>	360080	<b>Ref. No.</b>	120277
<b>description</b>	timer CEM HH3M16 engines 1 chambers 3 operation time 20min 230V manif. no. HH3M16 / 120277 motor type UDS11NE1RH		
<b>For models:</b>	LBC210, LBC215, LBC215A, LBC275, LBC275A, LBR, LBR215, LBR215A		
<b>spare parts for</b>	360080		
	<b>GEV No.</b>	360112	<b>Ref. No.</b> —
	motor SAIA pinion ø 4mm teeth 12 230V turn direction right motor ø 48mm motor type UDS11NE1RHZ for timer		





1

<b>GEV No.</b>	360009	<b>Ref. No.</b>	120224
<b>description</b>	timer CEM HH3M16 engines 1 chambers 3 operation time 60s 230V manif. no. HH3M16 / 120224 motor type UDS11NE1RH		
<b>spare parts for</b>	360009		
	<b>GEV No.</b>	360112	<b>Ref. No.</b> —
	motor SAIA pinion ø 4mm teeth 12 230V turn direction right motor ø 48mm motor type UDS11NE1RHZ for timer		





1

<b>GEV No.</b>	360010	<b>Ref. No.</b>	120228
<b>description</b>	timer CEM HH3M16 engines 1 chambers 3 operation time 90s 230V manif. no. HH3M16 / 120228 motor type UDS11NE1RH		
<b>spare parts for</b>	360010		
	<b>GEV No.</b>	360112	<b>Ref. No.</b> —
	motor SAIA pinion ø 4mm teeth 12 230V turn direction right motor ø 48mm motor type UDS11NE1RHZ for timer		



1

<b>GEV No.</b>	360043	<b>Ref. No.</b>	120243 120262
<b>description</b>	timer CEM HH4M16 engines 1 chambers 4 operation time 120s 230V shaft ømm shaft Lmm manif. no. HH4M16 / 120262 motor type UDS11NE1RH		
<b>For models:</b>	B10T, B11T, B12T, B13T, B14T, B15T, B15TM, B16T, B16TM, B18T, B18TM, B19T, B19TM, LBC210, LBC215, LBC215A, LBC275, LBC275A, LBR, LBR200, LBR215, LBR215A		
<b>spare parts for</b>	360043		
	<b>GEV No.</b>	360112	<b>Ref. No.</b> —
	motor SAIA pinion ø 4mm teeth 12 230V turn direction right motor ø 48mm motor type UDS11NE1RHZ for timer		



1

<b>GEV No.</b>	360044	<b>Ref. No.</b>	120263 120264
<b>description</b>	timer CEM HH4M16 engines 1 chambers 4 operation time 150s 230V shaft ømm shaft Lmm manif. no. HH4M16 / 120263 motor type UDS11NE1RH		
<b>For models:</b>	F45, LF280-lav-line, LF315, LF320-lav-line		
<b>spare parts for</b>	360044		
	<b>GEV No.</b>	360112	<b>Ref. No.</b> —
	motor SAIA pinion ø 4mm teeth 12 230V turn direction right motor ø 48mm motor type UDS11NE1RHZ for timer		



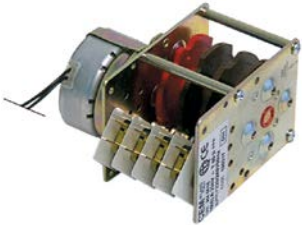



1

<b>GEV No.</b>	360015	<b>Ref. No.</b>	120217
<b>description</b>	timer CEM HH4M16 engines 1 chambers 4 operation time 180s 230V manuf. no. 120217 motor type UDS11NE1LH		
<b>For models:</b>	C30		
<b>spare parts for</b>	360015		
	<b>GEV No.</b>	360113	<b>Ref. No.</b> —
	motor SAIA pinion $\varnothing$ 4mm teeth 12 230V turn direction left motor $\varnothing$ 48mm motor type UDS11NE1LHZ for timer		



1

<b>GEV No.</b>	360014	<b>Ref. No.</b>	120214
<b>description</b>	timer CEM HH4M16 engines 1 chambers 4 operation time 20min 230V manuf. no. HH4M16 / 120214 motor type UDS11NE1RH		
<b>For models:</b>	B12, B12T, B14T, B15T, B15TM, B16, B16T, B16TM, B18T, B18TM, B19, B19T, B19TM, B25, B27		
<b>spare parts for</b>	360014		
	<b>GEV No.</b>	360112	<b>Ref. No.</b> —
	motor SAIA pinion $\varnothing$ 4mm teeth 12 230V turn direction right motor $\varnothing$ 48mm motor type UDS11NE1RHZ for timer		



1

<b>GEV No.</b>	360668	<b>Ref. No.</b>	121208
<b>description</b>	timer CEM HL5M16 engines 2 chambers 5 operation time 40s / 150s 230V shaft $\varnothing$ mm shaft Lmm		
<b>For models:</b>	FC, FC533, FC533A, FC543, FC543A, FC544, FC544A		





1

<b>GEV No.</b>	360478	<b>Ref. No.</b>	120235
<b>description</b>	timer FIBER P25 engines 1 chambers 3 operation time 100s 230V shaft $\varnothing$ mm shaft Lmm motor type M51BJ0R2200		





1

<b>GEV No.</b>	360046	<b>Ref. No.</b>	120267
<b>description</b>	timer FIBER P25 engines 2 chambers 6 operation time 60s / 85s / 120s 230V shaft $\varnothing$ mm shaft Lmm manuf. no. P255J06JD58 motor type M51BJ0R6400 / M51BJ0L6400		
<b>For models:</b>	C140, C155, LC1200, LC400, LC412, LC700, LC900		
<b>spare parts for</b>	360046		
	<b>GEV No.</b>	360673	<b>Ref. No.</b> —
	motor kit pinion $\varnothing$ 6.8mm teeth 15 230V voltage AC 50/60Hz turn direction clockwise motor $\varnothing$ 48mm H 18.5mm motor type UDS40NE1RNZ165 cable length 150mm with holder		
	<b>GEV No.</b>	360674	<b>Ref. No.</b> —
	motor kit pinion $\varnothing$ 6.8mm teeth 15 230V voltage AC 50/60Hz turn direction counterclockwise motor $\varnothing$ 48mm H 18.5mm motor type UDS40NE1RNZ165 cable length 150mm with holder		





1

<b>GEV No.</b>	360050	<b>Ref. No.</b>	120275
<b>description</b>	timer FIBER P25 engines 2 chambers 6 operation time 6s / 3min 230V 50/60Hz shaft $\varnothing$ mm shaft Lmm manuf. no. P255J06JB61 motor type M51BJ0R6400 / M51BJ0L6400		
<b>For models:</b>	C70, C75M, LC1200, LC700, LC900, LP360		
<b>spare parts for</b>	360050		
	<b>GEV No.</b>	360673	<b>Ref. No.</b> —
	motor kit pinion $\varnothing$ 6.8mm teeth 15 230V voltage AC 50/60Hz turn direction clockwise motor $\varnothing$ 48mm H 18.5mm motor type UDS40NE1RNZ165 cable length 150mm with holder		
	<b>GEV No.</b>	360674	<b>Ref. No.</b> —
	motor kit pinion $\varnothing$ 6.8mm teeth 15 230V voltage AC 50/60Hz turn direction counterclockwise motor $\varnothing$ 48mm H 18.5mm motor type UDS40NE1RNZ165 cable length 150mm with holder		





1

<b>GEV No.</b>	360287	<b>Ref. No.</b>	121218
<b>description</b>	timer FIBER P25 engines 2 chambers 6 operation time 6s / 3min 230V shaft ømm shaft Lmm manuf. no. P255J06JBG6 motor type M51B-J0R6400 / M51BJ0L6400		
<b>For models:</b>	C95, LC380		
<b>spare parts for</b>	360287		
	<b>GEV No.</b>	360673	<b>Ref. No.</b> —
	motor kit pinion ø 6.8mm teeth 15 230V voltage AC 50/60Hz turn direction clockwise motor ø 48mm H 18.5mm motor type UDS-40NE1RNZ165 cable length 150mm with holder		
	<b>GEV No.</b>	360674	<b>Ref. No.</b> —
	motor kit pinion ø 6.8mm teeth 15 230V voltage AC 50/60Hz turn direction counterclockwise motor ø 48mm H 18.5mm motor type UDS40NE1RNZ165 cable length 150mm with holder		



1

<b>GEV No.</b>	360086	<b>Ref. No.</b>	120279
<b>description</b>	timer FIBER P26 engines 1 chambers 4 operation time 120s 230V shaft ømm shaft Lmm manuf. no. P265J04H315 motor type M61B40R6400		
<b>For models:</b>	BC25, BC25A, BC30, BC30A, BHC25, BHC25A, BHC25S, BHC30, BHC30A, BR20, BR20A, BR25, BR25A		



1

<b>GEV No.</b>	360041	<b>Ref. No.</b>	120290
<b>description</b>	timer FIBER P26 engines 1 chambers 3 operation time 120s 230V shaft ømm shaft Lmm manuf. no. P265J03H322 motor type M61B40R6400 / M61B40L6400		
<b>For models:</b>	BHC25, BHC25A, BHC25S, BHC30, BHC30A, BHC433, BHC433A, F90M, F90MA, FC, FC43, FC53, FC533, FC533A, FC53A, FC54, FC543, FC543A, FC543E, FC543EA, FC544, FC544A, FC54A, LF315, LF320, LF320A, LF320LA, LF323, LF323A, LF350, LF350A, LF450, LF450A		



1

<b>GEV No.</b>	360286	<b>Ref. No.</b>	120296
<b>description</b>	timer FIBER P26 engines 1 chambers 4 operation time 120s 230V shaft ømm shaft Lmm manuf. no. P265J04H323 motor type M61B40R6400 / 110V		
<b>For models:</b>	BC25HR, BC30HR, BC30HR380		



1

<b>GEV No.</b>	360087	<b>Ref. No.</b>	120291
<b>description</b>	timer FIBER P26 engines 1 chambers 3 operation time 20min 230V shaft ømm shaft Lmm manuf. no. P265J03L130 motor type M61B40R6400		
<b>For models:</b>	BC25A, BC30A, BHC25A, BHC30A, BHC433A, BR20A, BR25A, F90M, F90MA, FC, FC43A, FC53, FC533, FC533A, FC53A, FC54, FC543, FC543A, FC544, FC544A, FC54A, LF320, LF320A, LF320LA, LF323, LF323A, LF350, LF350A, LF450, LF450A		



1

<b>GEV No.</b>	360288	<b>Ref. No.</b>	121217
<b>description</b>	timer FIBER P26 engines 2 chambers 5 operation time 3min/40s 230V manuf. no. P265J05JK42 motor type M61B40R6400 / M61B40L6400		
<b>For models:</b>	FC, FC53, FC53A, FC54, FC54A		



1

<b>GEV No.</b>	360088	<b>Ref. No.</b>	120292
<b>description</b>	timer FIBER P26 engines 2 chambers 5 operation time 40s / 3min 230V manuf. no. P265J05JK18 motor type M61B40R6400 / M61B40L6400		
<b>For models:</b>	BHC433, BHC433A, FC, FC43, FC43A, FC53, FC53A, FC54, FC54A		



1

<b>GEV No.</b>	360516	<b>Ref. No.</b>	120209 120266/B
<b>description</b>	timer run-time 75/120/180s engines 2 chambers 6 CEM 230V 50/60Hz		

## digital timers

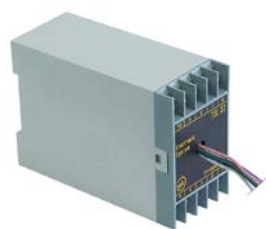

1

<b>GEV No.</b>	400945	<b>Ref. No.</b>	120226
<b>description</b>	timer electronic		
<b>For models:</b>	G131, G66		



1

<b>GEV No.</b>	400946	<b>Ref. No.</b>	120254
<b>description</b>	timer electronic		
<b>For models:</b>	G100L, G101L, G115, G115L, G125, G125L, G50L, G50LM, G51L, G60L, G61L, G65, G65L, G75, G75L, GL		

## alarm devices

## alarm units



1

<b>GEV No.</b>	350158	<b>Ref. No.</b>	120925
<b>description</b>	alarm device 24VAC ø 105mm H 63.5mm screw mounting mounting ø 114 95dB		
<b>For models:</b>	LAV1000, NE02, NE3001, NE3002, NE4001, NE4002, NE5002, NE5501, NE5502, NE7002, NE7501, NE7502, NE9001, NE9002, NE9502, NG01, NG02, NG1202, NG1202E, NG601, NG601E, NG602, NG602E, NG901, NG901E, NG902, NG902E		

## contactors

## ABB

## power contactors



1

<b>GEV No.</b>	381141	<b>Ref. No.</b>	120474
<b>description</b>	power contactor resistive load 100A 24VAC (AC3/400V) 22kW main contacts 3NO connection screw connection type A50-30-00		
<b>For models:</b>	AC101, AC122, AC151, AC152, AC181, AC182, AC201, AC202, AC241, AC242, AC91, ACS101, ACS101-DIGIT, ACS122, ACS122-DIGIT, ACS151, ACS151-DIGIT, ACS152, ACS152-DIGIT, ACS161-DIGIT, ACS162-DIGIT, ACS181, ACS181-DIGIT, ACS182, ACS182-DIGIT, ACS201, ACS201-DIGIT, ACS202, ACS202-DIGIT, ACS241, ACS241-DIGIT, ACS242, ACS242-DIGIT, ACS91, ACS91-DIGIT, NE02, NE3002, NE4002, NE5002, NE5502, NE7002, NE7502, NE9002, NE9502, NG02, NG1202, NG1202E, NG602, NG602E, NG902...(Other models you can see in the webshop)		



1

<b>GEV No.</b>	380106	<b>Ref. No.</b>	120468
<b>description</b>	power contactor resistive load 25A 24VAC (AC3/400V) 9A/4kW main contacts 3NO auxiliary contacts 1NO connection screw connection type A9-30-10		
<b>For models:</b>	AC101, AC122, AC151, AC152, AC181, AC182, AC201, AC202, AC241, AC242, AC2A, AC91, ACL100, ACL150, ACRS145, ACRS205, ACRS225, ACRS245, ACRS260, ACRS265, ACRS305, ACS101, ACS101-DIGIT, ACS122, ACS122-DIGIT, ACS151, ACS151-DIGIT, ACS152, ACS152-DIGIT, ACS161-DIGIT, ACS162-DIGIT, ACS181, ACS181-DIGIT, ACS182, ACS182-DIGIT, ACS201, ACS201-DIGIT, ACS202, ACS202-DIGIT, ACS241, ACS241-DIGIT, ACS242, ACS242-DIGIT, ACS91, ACS91-DIGIT, GMC2702, GMC3502, GMC4502, GMC5502, LAV1000...(Other models you can see in the webshop)		

auxiliary contacts with time control

			
1			
<b>GEV No.</b>	381179	<b>Ref. No.</b>	130929
<b>description</b>	auxiliary contact contacts 1NO/1NC connection screw connection for contactors A9-A75 run-time 0.1-40s		
<b>For models:</b>	AC122, AC151, AC152, AC181, AC182, AC201, AC202, AC241, AC242, ACR, ACR145, ACR205, ACR225, ACR245, ACR260, ACR265, ACR305, ACS101, ACS101-DIGIT, ACS122, ACS122-DIGIT, ACS151, ACS151-DIGIT, ACS152, ACS152-DIGIT, ACS161-DIGIT, ACS162-DIGIT, ACS181, ACS181-DIGIT, ACS182, ACS182-DIGIT, ACS201, ACS201-DIGIT, ACS202, ACS202-DIGIT, ACS241, ACS241-DIGIT, ACS242, ACS242-DIGIT, ACS91, ACS91-DIGIT, GMC, GMC2700, GMC3500, GMC4500, GMC5500, LAV1001, LAV1501, NL302, NL302E...(Other models you can see in the webshop)		

motor protection circuit breakers

			
1			
<b>GEV No.</b>	381142	<b>Ref. No.</b>	121032
<b>description</b>	motor protection circuit breaker type MS225-4.0 setting range 2.5-4A (AC3/380V) 1.5kW contacts 3NO		
<b>For models:</b>	NE02, NE3002, NE4002, NE5002, NE5502, NE7002, NE7502, NE9002, NE9502, NG02, NG1202, NG1202E, NG602, NG602E, NG902, NG902E		

GENERAL ELECTRIC (AEG)

power contactors

			
1			
<b>GEV No.</b>	380245	<b>Ref. No.</b>	120438
<b>description</b>	power contactor resistive load 25A 230VAC (AC3/400V) 9A/4kW main contacts 3NO auxiliary contacts 1NC connection screw connection type AEG LS4K 01A type GE CL00A 301 H 85mm		

			
1			
<b>GEV No.</b>	380244	<b>Ref. No.</b>	120438
<b>description</b>	power contactor resistive load 25A 230VAC (AC3/400V) 9A/4kW main contacts 3NO auxiliary contacts 1NO connection screw connection type AEG LS4K 10A type GE CL00A 310		

			
1			
<b>GEV No.</b>	380248	<b>Ref. No.</b>	120429
<b>description</b>	power contactor resistive load 25A 24VAC (AC3/400V) 9A/4kW main contacts 3NO auxiliary contacts 1NO connection screw connection type AEG LS4K 10A type GE CL00A 310		
<b>For models:</b>	AC120, AC150, AC170, AC200, ACR, ACR145, ACR205, ACR225, ACR245, ACR260, ACR265, ACR305, ACRS145, ACRS205, ACRS225, ACRS245, ACRS260, ACRS265, ACRS305, G100L, G101L, G115, G115L, G125, G125L, G131, G50L, G50LM, G51L, G60L, G61L, G65, G65L, G66, G75, G75L, GL, GMC, GMC2700, GMC2702, GMC3500, GMC3502, GMC4500, GMC4502, GMC5500, GMC5502, NE00, NE3001, NE4001, NE5501...(Other models you can see in the webshop)		

			
1			
<b>GEV No.</b>	380262	<b>Ref. No.</b>	120435
<b>description</b>	power contactor resistive load 32A 230VAC (AC3/400V) 17A/7.5kW main contacts 3NO auxiliary contacts 1NC connection screw connection type AEG LS7K01A type GE CL02A 301 H 85mm		
<b>For models:</b>	C33, C34		



## ISKRA (FANAL)

## power contactors



1

<b>GEV No.</b>	380212	<b>Ref. No.</b>	120461
<b>description</b>	power contactor resistive load 20A 230VAC (AC3/400V) 8.5A/5.5kW main contacts 3NO auxiliary contacts 1NC connection screw connection type Fanal K07M 01 type ISKRA DSL7 01		
<b>For models:</b>	BC25HR, BC30HR, BC30HR380, BC30HRA, BHC30E, BHC30E-2, BHC30EA, BHC30EA-2, BHC30HR, BHC30HR-2, BHC30HR380, BHC30HRA, BHC30HRA-2, BHC30HRA380, BHC433, BHC433-2, BHC433A, BHC433A-2, BHCHR, FC, FC3E, FC3EA, FC3M, FC3MA, FC3MR, FC44E, FC44EA, FC4E, FC4EA, FC4EHRT, FC4M, FC4MA, FC533, FC533A, FC53A, FC543, FC543A, FC543E, FC543EA, FC544, FC544A, FC54A, FCHR, FCHRA, FCHRT, FCHRTA, GF70, GF70A, GF90, GF90-2004... (Other models you can see in the webshop)		

## LOVATO

## power contactors



1

<b>GEV No.</b>	380083	<b>Ref. No.</b>	120444 120481
<b>description</b>	power contactor resistive load 25A 230VAC (AC3/400V) 9A/4.2kW main contacts 3NO auxiliary contacts 1NC connection screw connection type BF0901A230		
<b>For models:</b>	C1000E, C1000ERCD, C1001M, C1300E, C1300ERCD, C1301M, C140, C155, C155BT, C155E2, C155RCD, C165, C165E2, C165E2BT, C165E2RCD, C166, C166-2, C70, C75, C75BT, C75M, C75RCD, C85, C95, C95BT, C95E2, C95RCD, F55, F65, F80, F90M, F90MA, FC54E, FC54EA, GE50RCD, LC1200, LC1200RCD, LC380, LC380BT, LC380RCD, LC400, LC412, LC700, LC700RCD, LC900, LC900RCD, LF320, LF320A, LF320LA, LF323... (Other models you can see in the webshop)		

## TELEMECANIQUE (Schneider Electric)

## power contactors



1

<b>GEV No.</b>	381144	<b>Ref. No.</b>	120441
<b>description</b>	power contactor resistive load 125A 24VAC (AC3/400V) 80A/45kW main contacts 3NO auxiliary contacts 1NC/1NO connection screw connection type LC1D8011B7		
<b>For models:</b>	AC120, AC150, AC170, AC200, ACR, ACR145, ACR205, ACR225, ACR245, ACR260, ACR265, ACR305, ACRS145, ACRS205, ACRS225, ACRS245, ACRS260, ACRS265, ACRS305, GMC, GMC2700, GMC2702, GMC3500, GMC3502, GMC4500, GMC4502, GMC5500, GMC5502, NE3001, NE4001, NE5501, NE7501, NE9001, NG01, NG601, NG601E, NG901, NG901E		



1

<b>GEV No.</b>	380820	<b>Ref. No.</b>	120434
<b>description</b>	power contactor resistive load 25A 230VAC (AC3/400V) 9A/4kW main contacts 3NO auxiliary contacts 1NO/1NC connection screw connection type LC1D0900M7		
<b>For models:</b>	C155, C155BT, C155E2, C155RCD, C165, C165E2, C165E2BT, C165E2RCD, C166, C166-2, C30, C33, C34, C95, C95BT, C95E2, C95RCD, F2, F3, LC1200, LC380, LC380BT, LC380RCD, LC400, LC700, LC900, R40, R50, R70		



1

<b>GEV No.</b>	380617	<b>Ref. No.</b>	120428
<b>description</b>	power contactor resistive load 25A 24VAC (AC3/400V) 9A/4kW main contacts 3NO auxiliary contacts 1NO/1NC connection screw connection type LC1D09B7		
<b>For models:</b>	AC100, AC105, AC120, AC135, AC150, AC170, AC200, AC2A, AC95, ACL100, ACL150, ACR, ACR145, ACR205, ACR225, ACR245, ACR260, ACR265, ACR305, ACRS145, ACRS205, ACRS225, ACRS245, ACRS260, ACRS265, ACRS305, G100L, G101L, G115, G115L, G125, G125L, G131, G50L, G50LM, G51L, G60L, G61L, G65, G65L, G66, G75, G75L, GL, GMC, GMC2700, GMC2702, GMC3500, GMC3502, GMC4500... (Other models you can see in the webshop)		



auxiliary contacts



1			
<b>GEV No.</b>	381143	<b>Ref. No.</b>	130908
<b>description</b>	auxiliary contact contacts 2NC AC15 10A connection screw type LA1DN02		
<b>For models:</b>	ACRS145, ACRS205, ACRS225, ACRS245, ACRS260, ACRS265, ACRS305, GMC2702, GMC3502, GMC4502, GMC5502, LAV1001, LAV1501, NL302, NL302E, NL402, NL402E, NL502, NL502E, NL552, NL552E		

auxiliary contacts with time control



1			
<b>GEV No.</b>	381145	<b>Ref. No.</b>	130913
<b>description</b>	auxiliary contact contacts 1NC/1NO AC15 10A connection screw type LADT2 time delay 0.1-30s		

relays

power relays

with flange mounting



1			
<b>GEV No.</b>	380131	<b>Ref. No.</b>	120459
<b>description</b>	power relays Italiana Relè 230VAC 16A 3CO connection male faston 6.3mm screw mounting manuf. no. B2-3-230AC		
<b>For models:</b>	BC25HR, BC30HR, BC30HR380, BC30HRA, C1000E, C1000ERCD, C1001M, C1300E, C1300ERCD, C1301M, C155, C155E2, C165E2, C165E2BT, C165E2RCD, C166-2, C75, C75M, C95, C95E2, FC3MA, FC4EHRT, FC4MA, GE100, GE115, GE125, GE50RCD, GE60, GE60RCD, GE65, GE65RCD, GE75, GE80, LC1200, LC1200RCD, LC380, LC380BT, LC380RCD, LC400, LC412, LC700, LC700RCD, LC900, LC900RCD, LF322RCD, LFD32E, LFD32EA, LP360, XLC		

with bracket mounting

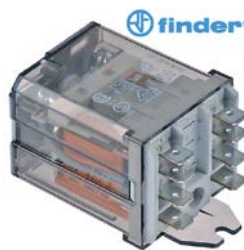

1			
<b>GEV No.</b>	380139	<b>Ref. No.</b>	120460
<b>description</b>	power relays FINDER 230VAC 16A 2CO connection F6.3 bracket mounting dimensions 68x38.2x35.8mm manuf. no. 62.82.8.230.0000		



1			
<b>GEV No.</b>	380403	<b>Ref. No.</b>	120447
<b>description</b>	power relays FINDER 230VAC 16A 3CO connection F6.3 bracket mounting manuf. no. 62.83.8.230.0500		
<b>For models:</b>	C140, C70, C85, GE100, GE115, GE60, GE65, GE80		



1			
<b>GEV No.</b>	380404	<b>Ref. No.</b>	120445
<b>description</b>	power relays FINDER 24VAC 16A 3CO connection male faston 6.3mm bracket mounting manuf. no. 62.83.8.024.0500		
<b>For models:</b>	AC100, AC101, AC105, AC120, AC122, AC135, AC150, AC151, AC152, AC170, AC181, AC182, AC200, AC201, AC202, AC241, AC242, AC2A, AC91, AC95, ACL100, ACL150, ACR, ACR145, ACR205, ACR225, ACR245, ACR260, ACR265, ACR305, ACRS145, ACRS205, ACRS225, ACRS245, ACRS260, ACRS265, ACRS305, ACS101, ACS101-DIGIT, ACS122, ACS122-DIGIT, ACS151, ACS151-DIGIT, ACS152, ACS152-DIGIT, ACS161-DIGIT, ACS162-DIGIT, ACS181, ACS181-DIGIT, ACS182... (Other models you can see in the webshop)		





1





<b>GEV No.</b>	380311	<b>Ref. No.</b>	120460
<b>description</b>	power relays Italiana Relè 230VAC 20A 1NC/1NO connection F6.3 bracket mounting manuf. no. A1B-230AC-FA		
<b>For models:</b>	BHC30E, BHC30EA, BHC30HR, BHC30HR380, BHC30HRA, BH-C30HRA380, BHCHR, C1000E, C1000ERCD, C1001M, C1300E, C1300ERCD, C1301M, FC, FC3EA, FC3MA, FC44EA, FC4EA, FC4MA, FC53, FC533, FC533A, FC53A, FC54, FC543, FC543A, FC544, FC544A, FC54A, FC54E, FC54EA, GE100, GE115, GE125, GE60, GE60RCD, GE65, GE65RCD, GE75, GE80, LC1200, LC1200RCD, LC700, LC700RCD, LC900, LC900RCD, LF322RCD, XLC		

with male contacts  
female contact 2.0mm

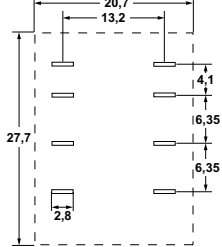

1



<b>GEV No.</b>	380129	<b>Ref. No.</b>	120449
<b>description</b>	power relays 24VAC 12A 2CO connection F2 plug-in connection 94.92.3 250V connection 2mm		
<b>accessories for</b>	380129		
	<b>GEV No.</b>	380341	<b>Ref. No.</b> —
	relay socket 4-pole contacts 12 300V voltage AC 6A Italiana Relè manuf. no. ZMD4		
	<b>GEV No.</b>	380378	<b>Ref. No.</b> —
	relay socket 2-pole 55/85 dimensions 70.5x30x27mm 250V voltage AC 10A FINDER manuf. no. 94.72		
	<b>GEV No.</b>	380384	<b>Ref. No.</b> —
	relay socket 2-pole contacts male faston 2.8mm 250V voltage AC 10A W 23mm for		
	<b>GEV No.</b>	380399	<b>Ref. No.</b> —
	relay socket 4-pole dimensions 76.2x27x86.1mm 250V voltage AC 1A FINDER manuf. no. 94.94.3		



1

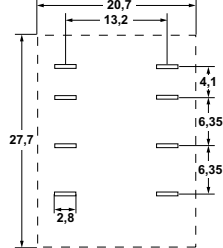



<b>GEV No.</b>	380377	<b>Ref. No.</b>	120479
<b>description</b>	power relays FINDER 220-240VAC 10A 2CO connection F2 plug-in connection manuf. no. 55.32.8.230.0000 94.92.3 250V		
<b>For models:</b>	ACS101, ACS101-DIGIT, ACS122, ACS122-DIGIT, ACS151, ACS151-DIGIT, ACS152, ACS152-DIGIT, ACS161-DIGIT, ACS162-DIGIT, ACS181, ACS181-DIGIT, ACS182, ACS182-DIGIT, ACS201, ACS201-DIGIT, ACS202, ACS202-DIGIT, ACS241, ACS241-DIGIT, ACS242, ACS242-DIGIT, ACS91, ACS91-DIGIT		
<b>accessories for</b>	380377		
	<b>GEV No.</b>	380341	<b>Ref. No.</b> —
	relay socket 4-pole contacts 12 300V voltage AC 6A Italiana Relè manuf. no. ZMD4		
	<b>GEV No.</b>	380378	<b>Ref. No.</b> —
	relay socket 2-pole 55/85 dimensions 70.5x30x27mm 250V voltage AC 10A FINDER manuf. no. 94.72		
	<b>GEV No.</b>	380384	<b>Ref. No.</b> —
	relay socket 2-pole contacts male faston 2.8mm 250V voltage AC 10A W 23mm for		
	<b>GEV No.</b>	380399	<b>Ref. No.</b> —
	relay socket 4-pole dimensions 76.2x27x86.1mm 250V voltage AC 1A FINDER manuf. no. 94.94.3		

plug-in/print relays

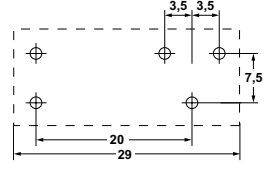

1



<b>GEV No.</b>	380634	<b>Ref. No.</b>	120465
<b>description</b>	print relay 12VDC 1CO at 250V 12A connection pins raster size 3.5mm FINDER manuf. no. 41.31.9.012.0000 95.83.3/95.63		
<b>For models:</b>	FC, FC543E, FC543EA, FCHR, FCHRA, FCHRT, FCHRTA		
<b>accessories for</b>	380634		
	<b>GEV No.</b>	380663	<b>Ref. No.</b> —
	relay socket 250V voltage AC 10A FINDER manuf. no. 95.83.3		

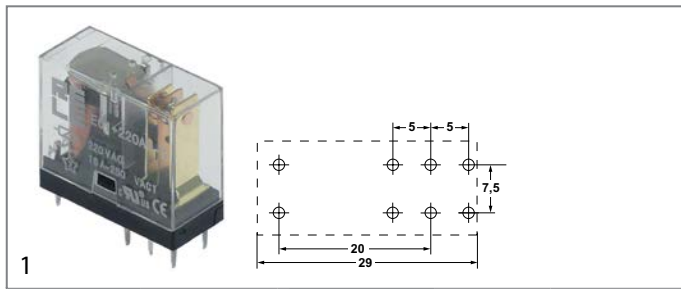

<b>GEV No.</b>	380335	<b>Ref. No.</b>	120478
<b>description</b>	print relay 230VAC 1CO at 250V 16A connection pins raster size 5mm Italiana Relè manuf. no. 40.61.8.230.0000 95.65/95.75		
<b>accessories for</b>	380335		
	<b>GEV No.</b>	380340	<b>Ref. No.</b> —
	relay socket dimensions 62x36x15mm 250V voltage AC 10A Italiana Relè manuf. no. ZMEM/5		
	<b>GEV No.</b>	380505	<b>Ref. No.</b> —
	relay socket 2CO 40.52 dimensions 81.9x15.5x75mm 250V voltage AC 10A FINDER manuf. no. 95.95.3		
	<b>GEV No.</b>	381181	<b>Ref. No.</b> —
	relay socket 2-pole 40.51/40.52/40.61 connection screw clamp dimensions 15.8x78.6mm 250V voltage AC 10A FINDER manuf. no. 95.75		

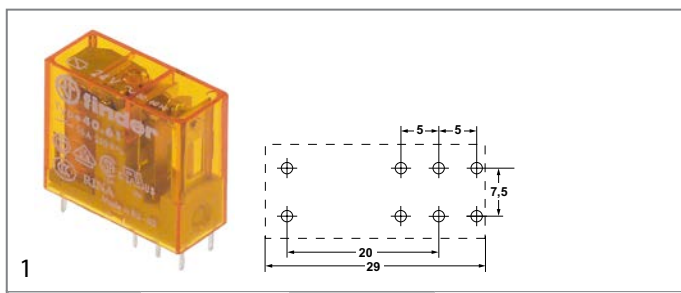

<b>GEV No.</b>	380853	<b>Ref. No.</b>	120476
<b>description</b>	print relay 24VAC 1CO at 250V 16A connection pins raster size 5mm FINDER manuf. no. 40.61.8.024.0000 95.65/95.75		
<b>For models:</b>	AC122, AC151, AC152, AC181, AC182, AC201, AC202, AC241, AC242, ACRS145, ACRS205, ACRS225, ACRS245, ACRS260, ACRS265, ACRS305, ACS101, ACS101-DIGIT, ACS122, ACS122-DIGIT, ACS151, ACS151-DIGIT, ACS152, ACS152-DIGIT, ACS161-DIGIT, ACS162-DIGIT, ACS181, ACS181-DIGIT, ACS182, ACS182-DIGIT, ACS201, ACS201-DIGIT, ACS202, ACS202-DIGIT, ACS241, ACS241-DIGIT, ACS242, ACS242-DIGIT, ACS91, ACS91-DIGIT, GMC2702, GMC3502, GMC4502, GMC5502, LAV1000, LAV1001, LAV1501, NG02, NG1202, NG1202E... (Other models you can see in the webshop)		

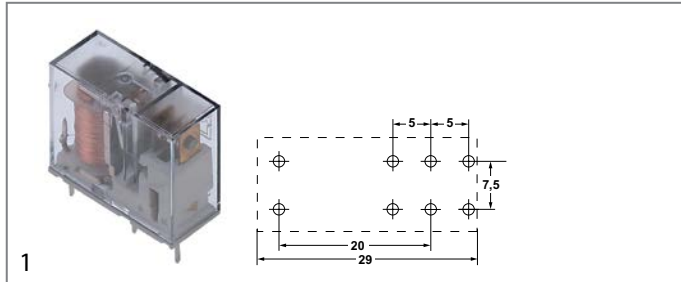

<b>GEV No.</b>	380633	<b>Ref. No.</b>	120480
<b>description</b>	print relay 24VDC 1CO at 250V 16A connection pins raster size 5mm Italiana Relè manuf. no. E61-24DC-S 95.65/95.75		
<b>For models:</b>	FC53LA, GF90, GF90A, LF320L, LF320LA, LF400A		
<b>accessories for</b>	380633		
	<b>GEV No.</b>	380340	<b>Ref. No.</b> —
	relay socket dimensions 62x36x15mm 250V voltage AC 10A Italiana Relè manuf. no. ZMEM/5		
	<b>GEV No.</b>	380505	<b>Ref. No.</b> —
	relay socket 2CO 40.52 dimensions 81.9x15.5x75mm 250V voltage AC 10A FINDER manuf. no. 95.95.3		

<b>accessories for</b>	380633		
	<b>GEV No.</b>	381181	<b>Ref. No.</b> —
	relay socket 2-pole 40.51/40.52/40.61 connection screw clamp dimensions 15.8x78.6mm 250V voltage AC 10A FINDER manuf. no. 95.75		

pulse relays



<b>GEV No.</b>	381195	<b>Ref. No.</b>	120493
<b>description</b>	pulse relay voltage AC/DC 1CO 250V 16A connection screw clamp DIN rail		
<b>For models:</b>	AC2A, ACL100, ACL150, ACS101, ACS101-DIGIT, ACS122, ACS122-DIGIT, ACS151, ACS151-DIGIT, ACS152, ACS152-DIGIT, ACS161-DIGIT, ACS162-DIGIT, ACS181, ACS181-DIGIT, ACS182, ACS182-DIGIT, ACS201, ACS201-DIGIT, ACS202, ACS202-DIGIT, ACS241, ACS241-DIGIT, ACS242, ACS242-DIGIT, ACS91, ACS91-DIGIT, LAV1001, LAV1501, NL302, NL302E, NL402, NL402E, NL502, NL502E, NL552, NL552E		

time relays



<b>GEV No.</b>	381157	<b>Ref. No.</b>	120227
<b>description</b>	time relay FINDER TF24 time range 0.1-60 s 115-230VAC 2CO connection plug-in connection round 8-pole with socket		
<b>For models:</b>	G131, G66		

transformers

open transformers

with clamp terminal



<b>GEV No.</b>	400947	<b>Ref. No.</b>	120608
<b>description</b>	transformer primary 220/230-240-380/400-415V secondary 12-24V 150VA secondary 4.17A 50/60Hz		
<b>For models:</b>	AC100, AC105, AC90, AC95, G100L, G101L, G115, G115L, G125, G125L, G131, G50L, G50LM, G51L, G60L, G61L, G65, G65L, G75, G75L, GL, SNL		









electronic controllers

ELIWELL

universal controllers

built-in version



<b>GEV No.</b>	379708	<b>Ref. No.</b>	450911
<b>description</b>	electronic controller ELIWELL type IC912/H 12-24AC/12-36DCV Pt100 with probe		
<b>For models:</b>	ACR, ACR145, ACR205, ACR225, ACR245, ACR260, ACR265, ACR305, GMC, GMC2700, GMC3500, GMC4500, GMC5500, NE00, NG00, NG600, NG600E, NG900, NG900E, SE		
<b>accessories for</b>	379708		
	<b>GEV No.</b>	379050	<b>Ref. No.</b> —
	temperature probe Pt100 cable Vetrotex probe -200 up to +600°C cable -50 up to +350°C probe ø6x100mm cable length 2.7m without screw connection 3-wire		
	<b>GEV No.</b>	379054	<b>Ref. No.</b> —
	transformer primary 230VAC secondary 12VAC 3VA secondary 0.25A H 40mm L 45mm W 50mm connection screw 50/60Hz type 153/M		
	<b>GEV No.</b>	379058	<b>Ref. No.</b> —
	temperature probe Pt100 cable silicone probe -100 up to 450°C cable -50 up to +180°C probe ø6x100mm cable length 2.8m without screw connection 3-wire resistance at 0°C 1000hm		
	<b>GEV No.</b>	379130	<b>Ref. No.</b> —
	temperature probe Pt100 cable Vetrotex probe -200 up to +600°C cable -50 up to +350°C probe ø6x100mm cable length 1.4m without screw connection 3-wire resistance at 0°C 1000hm		
	<b>GEV No.</b>	379131	<b>Ref. No.</b> —
	temperature probe Pt100 cable Vetrotex probe -200 up to +600°C cable -50 up to +350°C probe ø6x85mm cable length 3m without screw connection 3-wire resistance at 0°C 1000hm		
	<b>GEV No.</b>	379284	<b>Ref. No.</b> —
	temperature probe Pt100 cable Vetrotex probe -200 up to +600°C cable -50 up to +350°C probe ø6x100mm cable length 2m without screw connection 3-wire resistance at 0°C 1000hm		
	<b>GEV No.</b>	400583	<b>Ref. No.</b> —
	transformer primary 230VAC secondary 24VAC 10VA secondary 0.4A connection screw 50Hz		

	<b>GEV No.</b>	403095	<b>Ref. No.</b>	120613
<b>description</b>	transformer primary 220-240/380-415V secondary 12-24-28V 500VA connection screw clamp 50/60Hz			
<b>For models:</b>	LV1001, LV1501, LV-LVP, LVP1001, LVP1501, NE02, NE3001, NE3002, NE4001, NE4002, NE5002, NE5501, NE5502, NE7002, NE7501, NE7502, NE9001, NE9002, NE9502, NG00, NG01, NG600, NG600E, NG601, NG601E, NG900, NG900E, NG901, NG901E			

	<b>GEV No.</b>	403092	<b>Ref. No.</b>	120641
<b>description</b>	transformer primary 24V secondary 12V 40VA H 77mm L 69mm W 91mm connection screw 50/60Hz			
<b>For models:</b>	NE02, NE3002, NE4002, NE5002, NE5502, NE7002, NE7502, NE9002, NE9502			

with plug connection

	<b>GEV No.</b>	400049	<b>Ref. No.</b>	120605
<b>description</b>	transformer primary 115/200/400/440V secondary 230V 110VA connection screw 50/60Hz COMENDA			

power supplies

	<b>GEV No.</b>	378305	<b>Ref. No.</b>	120647
<b>description</b>	power supply primary 24-30V secondary 24V H 84mm L 88mm W 76mm connection screw 50/60Hz 48W 2A			





## probes

### producer-specific probes

#### probes

1 

<b>GEV No.</b>	380938	<b>Ref. No.</b>	120910
<b>description</b>	probe Pt100 cable silicone probe -100 up to 450°C cable -50 up to +180°C connection plug thread 1/2" probe ø6x70mm cable length 6.5m		
<b>For models:</b>	AC122, AC151, AC152, AC181, AC182, AC201, AC202, AC241, AC242, ACR, ACR145, ACR205, ACR225, ACR245, ACR260, ACR265, ACR305, ACRS145, ACRS205, ACRS225, ACRS245, ACRS260, ACRS265, ACRS305, ACS161-DIGIT, ACS162-DIGIT, GMC, GMC2700, GMC2702, GMC3500, GMC3502, GMC4500, GMC4502, GMC5500, GMC5502, LAV1001, LAV1501, NE02, NE3001, NE3002, NE4001, NE4002, NE5002, NE5501, NE5502, NE7002, NE7501, NE7502, NE9001, NE9002...(Other models you can see in the webshop)		
<b>accessories for</b>	380938		
	<b>GEV No.</b>	510355	<b>Ref. No.</b> 460501
	gasket fibre ED ø 24mm ID ø 17mm thickness 2mm Qty 1 pcs		

1 

<b>GEV No.</b>	379904	<b>Ref. No.</b>	120952
<b>description</b>	temperature probe NTC 100kOhm cable silicone probe -40 up to +125°C cable -50 up to +180°C connection 2-wire thread probe ø7x25mm cable length 2.1m		
<b>For models:</b>	BHC30HR, BHC30HR380, BHC30HRA, BHC30HRA380, BHCHR		

1 

<b>GEV No.</b>	378006	<b>Ref. No.</b>	120960
<b>description</b>	temperature probe NTC 40kOhm cable PVC probe -40 up to +110°C cable -10 up to 100°C connection F6.3 thread probe ø4x20mm cable length 0.25m		
<b>For models:</b>	ACL100, ACL150, ACS101, ACS101-DIGIT, ACS122, ACS122-DIGIT, ACS151, ACS151-DIGIT, ACS152, ACS152-DIGIT, ACS161-DIGIT, ACS162-DIGIT, ACS181, ACS181-DIGIT, ACS182, ACS182-DIGIT, ACS201, ACS201-DIGIT, ACS202, ACS202-DIGIT, ACS241, ACS241-DIGIT, ACS242, ACS242-DIGIT, ACS91, ACS91-DIGIT, BHC30-2, BHC30A-2, BHC30E-2, BHC30EA-2, C1000E, C1000ERCD, C1300E, C1300ERCD, FC3E, FC3EA, FC44E, FC44EA, FC4E, FC4EA, FC4EHRT, GE100, GE115, GE125, GE50RCD, GE60, GE60RCD, GE65, GE65RCD, GE75...(Other models you can see in the webshop)		

1 

<b>GEV No.</b>	378341	<b>Ref. No.</b>	120929
<b>description</b>	temperature probe Pt100 cable silicone probe -50 up to +200°C cable -50 up to +180°C connection coded plug thread probe ø6x50mm cable length 6.85m		
<b>For models:</b>	ACRS145, ACRS205, ACRS225, ACRS245, ACRS260, ACRS265, ACRS305, GMC2702, GMC3502, GMC4502, GMC5502, NL302, NL302E, NL402, NL402E, NL502, NL502E, NL552, NL552E		

## sensors

1 

<b>GEV No.</b>	403316	<b>Ref. No.</b>	120355
<b>description</b>	sensor for dishwashers ø M12x1mm L 73mm cable lengthmm		
<b>For models:</b>	C166, NE02, NE3002, NE4002, NE5002, NE5502, NE7002, NE7502, NE9002, NE9502		

## electronics

### PCBs

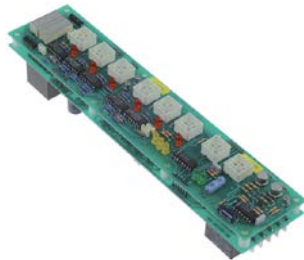
1 

<b>GEV No.</b>	401915	<b>Ref. No.</b>	120274
<b>description</b>	control PCB L 264mm W 57mm		
<b>For models:</b>	F55		

1 

<b>GEV No.</b>	402929	<b>Ref. No.</b>	121306
<b>description</b>	display PCB dishwasher DP45/50 L 85mm W 28mm green 4 digits		

1 

<b>GEV No.</b>	400936	<b>Ref. No.</b>	121211
<b>description</b>	keypad PCB		
<b>For models:</b>	FC, FC543E, FC543EA, FCHR, FCHRA, FCHRT, FCHRTA		

1 

<b>GEV No.</b>	400940	<b>Ref. No.</b>	121267
<b>description</b>	keypad PCB		
<b>For models:</b>	C155E2, C165E2, C95E2		





1

<b>GEV No.</b>	400933	<b>Ref. No.</b>	121277
<b>description</b>	keypad PCB dishwasher BHC 30		
<b>For models:</b>	BHC30E, BHC30EA, FC54E, FC54EA		



1

<b>GEV No.</b>	403119	<b>Ref. No.</b>	121259 121278
<b>description</b>	keypad PCB dishwasher COMENDA L 100mm W 200mm mounting pos. buttons 9		
<b>For models:</b>	ACRS145, ACRS205, ACRS225, ACRS245, ACRS260, ACRS265, ACRS305, GMC2702, GMC3502, GMC4502, GMC5502, LAV1001, LAV1501, NE02, NE3002, NE4002, NE5002, NE5502, NE7002, NE7502, NE9002, NE9502, NG02, NG1202, NG1202E, NG602, NG602E, NG902, NG902E, NL302, NL302E, NL402, NL402E, NL502, NL502E, NL552, NL552E		



1

<b>GEV No.</b>	400935	<b>Ref. No.</b>	121210
<b>description</b>	keypad PCB L 380mm W 60mm buttons 4		
<b>For models:</b>	FC, FC543E, FC543EA, FCHR, FCHRA, FCHRT, FCHRTA		



1

<b>GEV No.</b>	400937	<b>Ref. No.</b>	121216
<b>description</b>	net board L 80mm W 80mm		
<b>For models:</b>	FC, FC543E, FC543EA, FCHR, FCHRA, FCHRT, FCHRTA		



1

<b>GEV No.</b>	400939	<b>Ref. No.</b>	121230
<b>description</b>	PCB		
<b>For models:</b>	C155E2, C165E2, C165E2BT, C165E2RCD, C166, C166-2, C95E2		



1

<b>GEV No.</b>	400942	<b>Ref. No.</b>	121274
<b>description</b>	PCB		
<b>For models:</b>	BHC30HR, BHC30HR380, BHC30HRA, BHC30HRA380, BHCHR		



1

<b>GEV No.</b>	400944	<b>Ref. No.</b>	121237
<b>description</b>	PCB		
<b>For models:</b>	FC, FC533A, FC53A, FC53LA, FC543A, FC544A, FC54A, GF90, GF90A, LF320L, LF320LA, LF400A		



1

<b>GEV No.</b>	698575	<b>Ref. No.</b>	121300
<b>description</b>	PCB dishwasher AP43/48-FW35/40E L 184mm W 34mm		
<b>For models:</b>	FC3E, FC3EA, FC44E, FC44EA, FC4E, FC4EA, FC4EHRT		



1

<b>GEV No.</b>	401902	<b>Ref. No.</b>	121291
<b>description</b>	PCB dishwasher BAC30E		
<b>For models:</b>	BHC30E-2, BHC30EA-2, LF325E, LF325EA		





1

<b>GEV No.</b>	400943	<b>Ref. No.</b>	121239
<b>description</b>	PCB dishwasher C75/C155		
<b>For models:</b>	C155BT, C155RCD, C75BT, C75RCD, C95BT, C95RCD, FC53CBT, FC53LBT, FC54CBT, FC54LBT, LC1200RCD, LC380BT, LC380RCD, LC700RCD, LC900RCD, LF320CBT, LF320LBT, LP360BT, LP360RCD		







			
1			
<b>GEV No.</b>	402881	<b>Ref. No.</b>	121284 121304
<b>description</b>	PCB dishwasher CE-GE L 126mm W 63mm suitable for COMENDA		
<b>For models:</b>	C1000E, C1000ERCD, C1300E, C1300ERCD, GE100, GE115, GE125, GE50RCD, GE60, GE60RCD, GE65, GE65RCD, GE75, GE80, XLC		

			
1			
<b>GEV No.</b>	402715	<b>Ref. No.</b>	121301
<b>description</b>	PCB for dishwashers L 145mm W 105mm		
<b>For models:</b>	FC3E, FC3EA, FC44E, FC44EA, FC4E, FC4EA, FC4EHRT		

			
1			
<b>GEV No.</b>	401846	<b>Ref. No.</b>	121287
<b>description</b>	PCB dishwasher COMENDA, HOONVED		
<b>For models:</b>	BHC25-2, BHC25A-2, BHC30-2, BHC30A-2, BHC433-2, BHC433A-2, C1001M, C1301M, FC3MR, GF70, GF70A, GF90-2004, GF90A-2004, LB200, LB200-2, LB200A, LB200A-2, LB215, LB215-2, LB215A, LB215A-2, LB260, LB260-2, LB260A, LB260A-2, LB275, LB275-2, LB275A, LB275A-2, LC1200, LC1200RCD, LC412, LC700, LC700RCD, LC900, LC900RCD, LF321, LF321A, LF322, LF322A, LF322MP, LF322MP-A, LF322RCD, LF324, LF324A, LF700, LF700A		

			
1			
<b>GEV No.</b>	361986	<b>Ref. No.</b>	121296
<b>description</b>	PCB for rack conveyor dishwashing machine ACS DIGIT L 115mm W 90mm suitable for COMENDA		
<b>For models:</b>	AC2A, ACL100, ACL150, ACS101, ACS101-DIGIT, ACS122, ACS122-DIGIT, ACS151, ACS151-DIGIT, ACS152, ACS152-DIGIT, ACS161-DIGIT, ACS162-DIGIT, ACS181, ACS181-DIGIT, ACS182, ACS182-DIGIT, ACS201, ACS201-DIGIT, ACS202, ACS202-DIGIT, ACS241, ACS241-DIGIT, ACS242, ACS242-DIGIT, ACS91, ACS91-DIGIT, LAV1001, LAV1501, NL302, NL302E, NL402, NL402E, NL502, NL502E, NL552, NL552E		

			
1			
<b>GEV No.</b>	401874	<b>Ref. No.</b>	121302
<b>description</b>	PCB dishwasher FC3M/FC4M L 100mm W 70mm suitable for COMEN-DA 230V		
<b>For models:</b>	FC3M, FC3MA, FC4M, FC4MA		

## keypads

### front foils

			
1			
<b>GEV No.</b>	510726	<b>Ref. No.</b>	460920 460926 490920
<b>description</b>	front foil		
<b>For models:</b>	B10T		

			
1			
<b>GEV No.</b>	403654	<b>Ref. No.</b>	121283
<b>description</b>	PCB dishwasher L 145mm W 105mm		
<b>For models:</b>	C1000E, C1000ERCD, C1300E, C1300ERCD, GE100, GE115, GE125, GE50RCD, GE60, GE60RCD, GE65, GE65RCD, GE75, GE80, XLC		

			
1			
<b>GEV No.</b>	510960	<b>Ref. No.</b>	460912
<b>description</b>	front foil		
<b>For models:</b>	B15T, B16T		

			
1			
<b>GEV No.</b>	511398	<b>Ref. No.</b>	460911
<b>description</b>	front foil		
<b>For models:</b>	B11T, B12T		





			
1			
<b>GEV No.</b>	511399	<b>Ref. No.</b>	460.917
<b>description</b>	front foil		
<b>For models:</b>	B11T, B12T		

			
1			
<b>GEV No.</b>	511401	<b>Ref. No.</b>	460913
<b>description</b>	front foil		
<b>For models:</b>	B18T, B18TM, B19T, B19TM		

			
1			
<b>GEV No.</b>	511402	<b>Ref. No.</b>	460919
<b>description</b>	front foil		
<b>For models:</b>	B15TM, B16TM, B18T, B18TM, B19T, B19TM		

			
1			
<b>GEV No.</b>	511403	<b>Ref. No.</b>	461051
<b>description</b>	front foil		
<b>For models:</b>	BC25, BC30, BHC25, BHC25S, BHC30, BR20, BR25		

			
1			
<b>GEV No.</b>	511404	<b>Ref. No.</b>	461050
<b>description</b>	front foil		
<b>For models:</b>	BC25A, BC30A, BHC25A, BHC30A, BR20A, BR25A		

			
1			
<b>GEV No.</b>	511405	<b>Ref. No.</b>	461057
<b>description</b>	front foil		
<b>For models:</b>	BC25HR, BC30HR, BC30HR380, BC30HRA, FC43		

			
1			
<b>GEV No.</b>	511406	<b>Ref. No.</b>	461235
<b>description</b>	front foil		
<b>For models:</b>	BHC30HR, BHC30HR380, BHC30HRA, BHCHR		

			
1			
<b>GEV No.</b>	511407	<b>Ref. No.</b>	461232
<b>description</b>	front foil		
<b>For models:</b>	BHC30HR, BHC30HRA, BHC30HRA380, BHCHR		

			
1			
<b>GEV No.</b>	511408	<b>Ref. No.</b>	461108
<b>description</b>	front foil		
<b>For models:</b>	LBR, LBR200		

			
1			
<b>GEV No.</b>	511409	<b>Ref. No.</b>	461073
<b>description</b>	front foil		
<b>For models:</b>	LBC210, LBC215, LBC215A, LBC275, LBC275A, LBR, LBR215, LBR215A		

			
1			
<b>GEV No.</b>	511410	<b>Ref. No.</b>	461063
<b>description</b>	front foil		
<b>For models:</b>	BHC433, FC43		

			
1			
<b>GEV No.</b>	511411	<b>Ref. No.</b>	461074
<b>description</b>	front foil		
<b>For models:</b>	LF280-lav-line, LF315, LF320-lav-line		

			
1			
<b>GEV No.</b>	511412	<b>Ref. No.</b>	461101
<b>description</b>	front foil		
<b>For models:</b>	F90M, F90MA, LF320, LF320A, LF320CBT, LF320L, LF320LA, LF320LBT, LF323, LF323A, LF350, LF350A, LF450, LF450A		

			
1			
<b>GEV No.</b>	511413	<b>Ref. No.</b>	461107
<b>description</b>	front foil		
<b>For models:</b>	FC, FC53, FC533, FC533A, FC53A, FC53CBT, FC53LA, FC53LBT, FC54, FC543, FC543A, FC544, FC544A, FC54A, FC54CBT, FC54LBT		

1

<b>GEV No.</b>	511414	<b>Ref. No.</b>	461138
<b>description</b>	front foil		
<b>For models:</b>	G100L, G101L, G115L, G125L, G50L, G50LM, G51L, G60L, G61L, G65L, G75L, GL		



1

<b>GEV No.</b>	511415	<b>Ref. No.</b>	460921
<b>description</b>	front foil		
<b>For models:</b>	C140, C70, C85		



1

<b>GEV No.</b>	511416	<b>Ref. No.</b>	461075
<b>description</b>	front foil		
<b>For models:</b>	LC380, LC400, LP360		



1

<b>GEV No.</b>	511418	<b>Ref. No.</b>	461192
<b>description</b>	front foil		
<b>For models:</b>	C75BT, C75RCD		



1

<b>GEV No.</b>	510999	<b>Ref. No.</b>	460918
<b>description</b>	front foil COMENDA mounting pos. lower		
<b>For models:</b>	B15T, B16T		

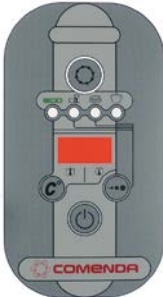

1

<b>GEV No.</b>	403657	<b>Ref. No.</b>	461353
<b>description</b>	front foil dishwasher C1000/1300 GE50/100/125		
<b>For models:</b>	C1000E, C1000ERCD, C1300E, C1300ERCD, GE100, GE115, GE125, GE50RCD, GE60, GE60RCD, GE65, GE65RCD, GE75, GE80, XLC		



1

<b>GEV No.</b>	511420	<b>Ref. No.</b>	461254
<b>description</b>	keypad foil		
<b>For models:</b>	FC54E, FC54EA		



1

<b>GEV No.</b>	511421	<b>Ref. No.</b>	461258
<b>description</b>	keypad foil		
<b>For models:</b>	FC54E, FC54EA		



1

<b>GEV No.</b>	511423	<b>Ref. No.</b>	461170
<b>description</b>	keypad foil		
<b>For models:</b>	C155E2, C165E2, C165E2BT, C165E2RCD, C166, C166-2, C95E2		



1

<b>GEV No.</b>	511424	<b>Ref. No.</b>	461227
<b>description</b>	keypad foil		
<b>For models:</b>	C155E2, C165E2, C95E2		



1 			
<b>GEV No.</b>	511422	<b>Ref. No.</b>	461127
<b>description</b>	keypad foil for dishwasher L 572mm W 60mm buttons 4		
<b>For models:</b>	FC, FC543E, FC543EA, FCHR, FCHRA, FCHRT, FCHRTA		

membrane keypads

1 			
<b>GEV No.</b>	400052	<b>Ref. No.</b>	461052
<b>description</b>	keypad foil		
<b>For models:</b>	C165		

1 			
<b>GEV No.</b>	400053	<b>Ref. No.</b>	461053
<b>description</b>	keypad foil		
<b>For models:</b>	C75, C75M		

control panel

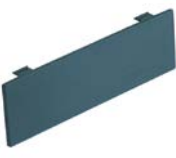

1 			
<b>GEV No.</b>	510966	<b>Ref. No.</b>	460991
<b>description</b>	front panel neutral		

1 			
<b>GEV No.</b>	510962	<b>Ref. No.</b>	460775 460817
<b>description</b>	switch panel		
<b>For models:</b>	B10, B11, B12, B15, B16, B18, B19, F20, F45, F55, F65, F80		

1 			
<b>GEV No.</b>	510253	<b>Ref. No.</b>	460850
<b>description</b>	switch panel dishwasher F45/F55 L 592mm W 75mm white		
<b>For models:</b>	F45, F55, F65, F80		

1 			
<b>GEV No.</b>	510963	<b>Ref. No.</b>	460851
<b>description</b>	switch panel L 473mm W 75mm		
<b>For models:</b>	F20		

solenoid valves  
solenoid valves (water)

ELBI			
straight			
1 			
<b>GEV No.</b>	373017	<b>Ref. No.</b>	120173
<b>description</b>	solenoid valve single straight 230VAC inlet 3/4" outlet 11.5mm DN10 ELBI		
<b>For models:</b>	BHC30-2, BHC30E, BHC30E-2, BHC30EA-2, BHC30HR-2, BHC30HRA-2, GF70, LB200, LB200-2, LB215, LB215-2, LB260, LB260-2, LB275, LB275-2		
<b>spare parts for</b>	373017		
	<b>GEV No.</b>	370467	<b>Ref. No.</b> —
solenoid valve filter suitable for ELBI			

1 			
<b>GEV No.</b>	373007	<b>Ref. No.</b>	120196
<b>description</b>	solenoid valve single angled 220-240VAC inlet 3/4" outlet 11.5mm input 6.7l/min t.max. 90°C duty cycle 100% ELBI plastic flow regulating valve inlet green		
<b>For models:</b>	LBC210, LBC215, LBC215A, LBC275, LBC275A, LBR, LBR200, LBR215, LBR215A		

1 			
<b>GEV No.</b>	370732	<b>Ref. No.</b>	121104
<b>description</b>	solenoid valve single angled 230VAC inlet 3/4" outlet 11.5mm input 8l/min ELBI 319 plastic flow regulating valve inlet red		
<b>For models:</b>	FC3E, FC3EA, FC3MA, FC44E, FC44EA, FC4E, FC4EA, FC4EHR, FC4MA, GE50RCD		



			
1			
<b>GEV No.</b>	370256	<b>Ref. No.</b>	120175
<b>description</b>	solenoid valve triple straight 230VAC inlet 3/4" outlet 11.5mm t.max. 90°C ELBI plastic flow regulating valve inlet red output B 0.5l/min flow regulating valve outlet B red		
<b>For models:</b>	BHC25A, BHC25A-2, BHC30-2, BHC30A, BHC30A-2, BHC30HR, BHC30HRA, BHC30HRA380, BHC433-2, BHC433A, BHC433A-2, BHCHR		

spare parts and accessories



solenoid coils

			
1			
<b>GEV No.</b>	371016	<b>Ref. No.</b>	630969
<b>description</b>	solenoid coil ELBI 230VAC 50/60Hz pressure range 0 up to 10bar coil type EATON (INVENSYS) tolerance ±15%		
<b>For models:</b>	B10T, B11T, B12, B12T, B13T, B14T, B15, B15T, B15TM, B16, B16T, B16TM, B18, B18T, B18TM, B19, B19T, B19TM, B20, B20D, B23, B24, B25, B26, B27, B41, B42, BC25, BC25A, BC25HR, BC30, BC30A, BC30HR, BC30HR380, BC30HRA, BHC25, BHC25-2, BHC25A, BHC25A-2, BHC25S, BHC30, BHC30-2, BHC30A, BHC30A-2, BHC30E, BHC30E-2, BHC30EA, BHC30EA-2, BHC30HR, BHC30HR-2...(Other models you can see in the webshop)		

RPE



















			
1			
<b>GEV No.</b>	374019	<b>Ref. No.</b>	120124
<b>description</b>	solenoid valve double angled 230VAC inlet 3/4" outlet 10mm DN10 RPE		
<b>For models:</b>	FC3EA, FC3MA, FC44EA, FC4EA, FC4MA		



TP

			
1			
<b>GEV No.</b>	370021	<b>Ref. No.</b>	120146
<b>description</b>	solenoid valve double straight 230VAC inlet 3/4" outlet 11.5mm DN10 TP flow regulating valve inlet white		
<b>For models:</b>	B10T, B11T, B12T, B13T, B14T, B15, B15T, B15TM, B16T, B16TM, B18, B18T, B18TM, B19T, B19TM, B20, B20D, B24, B25, B26, B27, B41, BHC25, BHC25-2, BHC25S, BHC30, BHC30-2, BHC30A-2, BHC30HR, BHC30HR380, BHC30HRA, BHC433, BHC433-2, BHC433A-2, BHCHR, F20		
<b>spare parts for</b>	370021		
		<b>GEV No.</b>	371013
		<b>Ref. No.</b>	—
	solenoid coil TP 230VAC 50/60Hz		

<b>accessories for</b>	370021		
	<b>GEV No.</b>	371220	<b>Ref. No.</b>
			—
	reducer TP flow rate 3l/min red tolerance ±15%		
	<b>GEV No.</b>	371221	<b>Ref. No.</b>
			—
	reducer TP flow rate 5.5l/min yellow tolerance ±15%		
	<b>GEV No.</b>	371222	<b>Ref. No.</b>
			—
	reducer TP flow rate 6l/min grey tolerance ±15%		
	<b>GEV No.</b>	371223	<b>Ref. No.</b>
			—
	reducer TP flow rate 10l/min white tolerance ±15%		
	<b>GEV No.</b>	371224	<b>Ref. No.</b>
			—
	reducer TP flow rate 12l/min bronze tolerance ±15%		
	<b>GEV No.</b>	371225	<b>Ref. No.</b>
			—
	reducer TP flow rate 16l/min light brown tolerance ±15%		
	<b>GEV No.</b>	371226	<b>Ref. No.</b>
			—
	reducer TP flow rate 20l/min red tolerance ±15%		
	<b>GEV No.</b>	371230	<b>Ref. No.</b>
			—
	reducer TP flow rate 0.25l/min red tolerance ±25%		
	<b>GEV No.</b>	371231	<b>Ref. No.</b>
			—
	reducer TP flow rate 0.35l/min violet tolerance ±25%		
	<b>GEV No.</b>	371232	<b>Ref. No.</b>
			—
	reducer TP flow rate 0.5l/min orange tolerance ±25%		
	<b>GEV No.</b>	371233	<b>Ref. No.</b>
			—
	reducer TP flow rate 0.8l/min white tolerance ±25%		
	<b>GEV No.</b>	371234	<b>Ref. No.</b>
			—
	reducer TP flow rate 1l/min light blue tolerance ±25%		
	<b>GEV No.</b>	371235	<b>Ref. No.</b>
			—
	reducer TP flow rate 1.2l/min brown tolerance ±25%		
	<b>GEV No.</b>	371236	<b>Ref. No.</b>
			—
	reducer TP flow rate 1.5l/min light brown tolerance ±25%		
	<b>GEV No.</b>	371237	<b>Ref. No.</b>
			—
	reducer TP flow rate 2.5l/min yellow tolerance ±25%		
	<b>GEV No.</b>	371238	<b>Ref. No.</b>
			—
	reducer TP flow rate 3.4l/min dark green tolerance ±25%		
	<b>GEV No.</b>	371239	<b>Ref. No.</b>
			—
	reducer TP flow rate 5l/min black tolerance ±25%		
	<b>GEV No.</b>	371240	<b>Ref. No.</b>
			—
	reducer TP flow rate 8l/min blue tolerance ±20%		



  <b>1</b>			
<b>GEV No.</b>	370025	<b>Ref. No.</b>	120175
<b>description</b>	solenoid valve triple straight 230VAC inlet 3/4" outlet 11.5mm DN10 TP		
<b>spare parts for</b>	370025		
	GEV No.	371013	Ref. No. —
solenoid coil TP 230VAC 50/60Hz			
<b>accessories for</b>	370025		
	GEV No.	371220	Ref. No. —
reducer TP flow rate 3l/min red tolerance ±15%			
	GEV No.	371221	Ref. No. —
reducer TP flow rate 5.5l/min yellow tolerance ±15%			
	GEV No.	371222	Ref. No. —
reducer TP flow rate 6l/min grey tolerance ±15%			
	GEV No.	371223	Ref. No. —
reducer TP flow rate 10l/min white tolerance ±15%			
	GEV No.	371224	Ref. No. —
reducer TP flow rate 12l/min bronze tolerance ±15%			
	GEV No.	371225	Ref. No. —
reducer TP flow rate 16l/min light brown tolerance ±15%			
	GEV No.	371226	Ref. No. —
reducer TP flow rate 20l/min red tolerance ±15%			
	GEV No.	371230	Ref. No. —
reducer TP flow rate 0.25l/min red tolerance ±25%			
	GEV No.	371231	Ref. No. —
reducer TP flow rate 0.35l/min violet tolerance ±25%			
	GEV No.	371232	Ref. No. —
reducer TP flow rate 0.5l/min orange tolerance ±25%			
	GEV No.	371233	Ref. No. —
reducer TP flow rate 0.8l/min white tolerance ±25%			
	GEV No.	371234	Ref. No. —
reducer TP flow rate 1l/min light blue tolerance ±25%			
	GEV No.	371235	Ref. No. —
reducer TP flow rate 1.2l/min brown tolerance ±25%			
	GEV No.	371236	Ref. No. —
reducer TP flow rate 1.5l/min light brown tolerance ±25%			
	GEV No.	371237	Ref. No. —
reducer TP flow rate 2.5l/min yellow tolerance ±25%			

<b>accessories for</b>	370025		
	GEV No.	371238	Ref. No. —
reducer TP flow rate 3.4l/min dark green tolerance ±25%			
	GEV No.	371239	Ref. No. —
reducer TP flow rate 5l/min black tolerance ±25%			
	GEV No.	371240	Ref. No. —
reducer TP flow rate 8l/min blue tolerance ±20%			













  <b>1</b>			
<b>GEV No.</b>	370019	<b>Ref. No.</b>	120142 120197
<b>description</b>	solenoid valve double angled 230VAC inlet 3/4" outlet 11.5mm DN10 TP plastic		
<b>For models:</b>	B12, B12T, B14T, B16, B16T, B16TM, B19, B19T, B19TM, B25, B26, B27, B41, B42, BC25, BC25A, BC25HR, BC30, BC30A, BC30HR, BC30HR380, BR20, BR25, C165, FC43		
<b>spare parts for</b>	370019		
	GEV No.	371013	Ref. No. —
solenoid coil TP 230VAC 50/60Hz			
<b>accessories for</b>	370019		
	GEV No.	371220	Ref. No. —
reducer TP flow rate 3l/min red tolerance ±15%			
	GEV No.	371221	Ref. No. —
reducer TP flow rate 5.5l/min yellow tolerance ±15%			
	GEV No.	371222	Ref. No. —
reducer TP flow rate 6l/min grey tolerance ±15%			
	GEV No.	371223	Ref. No. —
reducer TP flow rate 10l/min white tolerance ±15%			
	GEV No.	371224	Ref. No. —
reducer TP flow rate 12l/min bronze tolerance ±15%			
	GEV No.	371225	Ref. No. —
reducer TP flow rate 16l/min light brown tolerance ±15%			
	GEV No.	371226	Ref. No. —
reducer TP flow rate 20l/min red tolerance ±15%			
	GEV No.	371230	Ref. No. —
reducer TP flow rate 0.25l/min red tolerance ±25%			
	GEV No.	371231	Ref. No. —
reducer TP flow rate 0.35l/min violet tolerance ±25%			
	GEV No.	371232	Ref. No. —
reducer TP flow rate 0.5l/min orange tolerance ±25%			

Table continues overleaf



accessories for		370019		
GEV No.	Ref. No.	Ref. No.	Ref. No.	—
	371233	Ref. No.	—	reducer TP flow rate 0.8l/min white tolerance ±25%
	371234	Ref. No.	—	reducer TP flow rate 1l/min light blue tolerance ±25%
	371235	Ref. No.	—	reducer TP flow rate 1.2l/min brown tolerance ±25%
	371236	Ref. No.	—	reducer TP flow rate 1.5l/min light brown tolerance ±25%
	371237	Ref. No.	—	reducer TP flow rate 2.5l/min yellow tolerance ±25%
	371238	Ref. No.	—	reducer TP flow rate 3.4l/min dark green tolerance ±25%
	371239	Ref. No.	—	reducer TP flow rate 5l/min black tolerance ±25%
	371240	Ref. No.	—	reducer TP flow rate 8l/min blue tolerance ±20%



<b>GEV No.</b>	370110	<b>Ref. No.</b>	120168
<b>description</b>	solenoid valve double angled 24VAC inlet 3/4" outlet 14mm DN10 TP		
<b>For models:</b>	AC135, AC90, SNL		

accessories for		370110		
GEV No.	Ref. No.	Ref. No.	Ref. No.	—
	371035	Ref. No.	—	solenoid coil 24VAC

accessories for		370110		
GEV No.	Ref. No.	Ref. No.	Ref. No.	—
	371220	Ref. No.	—	reducer TP flow rate 3l/min red tolerance ±15%
	371221	Ref. No.	—	reducer TP flow rate 5.5l/min yellow tolerance ±15%
	371222	Ref. No.	—	reducer TP flow rate 6l/min grey tolerance ±15%
	371223	Ref. No.	—	reducer TP flow rate 10l/min white tolerance ±15%
	371224	Ref. No.	—	reducer TP flow rate 12l/min bronze tolerance ±15%
	371225	Ref. No.	—	reducer TP flow rate 16l/min light brown tolerance ±15%

accessories for		370110		
GEV No.	Ref. No.	Ref. No.	Ref. No.	—
	371226	Ref. No.	—	reducer TP flow rate 20l/min red tolerance ±15%
	371230	Ref. No.	—	reducer TP flow rate 0.25l/min red tolerance ±25%
	371231	Ref. No.	—	reducer TP flow rate 0.35l/min violet tolerance ±25%
	371232	Ref. No.	—	reducer TP flow rate 0.5l/min orange tolerance ±25%
	371233	Ref. No.	—	reducer TP flow rate 0.8l/min white tolerance ±25%
	371234	Ref. No.	—	reducer TP flow rate 1l/min light blue tolerance ±25%
	371235	Ref. No.	—	reducer TP flow rate 1.2l/min brown tolerance ±25%
	371236	Ref. No.	—	reducer TP flow rate 1.5l/min light brown tolerance ±25%
	371237	Ref. No.	—	reducer TP flow rate 2.5l/min yellow tolerance ±25%
	371238	Ref. No.	—	reducer TP flow rate 3.4l/min dark green tolerance ±25%
	371239	Ref. No.	—	reducer TP flow rate 5l/min black tolerance ±25%
	371240	Ref. No.	—	reducer TP flow rate 8l/min blue tolerance ±20%

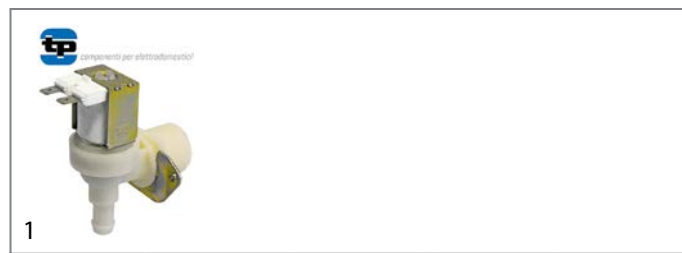

<b>GEV No.</b>	370015	<b>Ref. No.</b>	120112 120145
----------------	--------	-----------------	------------------

<b>description</b>	solenoid valve single angled 230VAC inlet 3/4" outlet 11.5mm DN10 TP		
<b>For models:</b>	C1000E, C1000ERCD, C1001M, C1300E, C1300ERCD, C1301M, C140, C155, C155BT, C155E2, C155RCD, C165E2, C165E2BT, C165E2RCD, C166, C166-2, C30, C33, C34, C70, C75, C75BT, C75M, C75RCD, C85, C95, C95BT, C95E2, C95RCD, F2, F3, F300, F45, F55, F65, F80, F90M, F90MA, FC, FC3M, FC3MR, FC4EHRT, FC4M, FC53, FC533, FC53CBT, FC53LBT, FC54, FC543, FC543E...(Other models you can see in the webshop)		

accessories for		370015		
GEV No.	Ref. No.	Ref. No.	Ref. No.	—
	371220	Ref. No.	—	reducer TP flow rate 3l/min red tolerance ±15%
	371221	Ref. No.	—	reducer TP flow rate 5.5l/min yellow tolerance ±15%

Table continues overleaf



accessories for		370015		
	GEV No.	371222	Ref. No.	—
	reducer TP flow rate 6l/min grey tolerance ±15%			
	GEV No.	371223	Ref. No.	—
	reducer TP flow rate 10l/min white tolerance ±15%			
	GEV No.	371224	Ref. No.	—
	reducer TP flow rate 12l/min bronze tolerance ±15%			
	GEV No.	371225	Ref. No.	—
	reducer TP flow rate 16l/min light brown tolerance ±15%			
	GEV No.	371226	Ref. No.	—
	reducer TP flow rate 20l/min red tolerance ±15%			
	GEV No.	371230	Ref. No.	—
	reducer TP flow rate 0.25l/min red tolerance ±25%			
	GEV No.	371231	Ref. No.	—
	reducer TP flow rate 0.35l/min violet tolerance ±25%			
	GEV No.	371232	Ref. No.	—
	reducer TP flow rate 0.5l/min orange tolerance ±25%			
	GEV No.	371233	Ref. No.	—
	reducer TP flow rate 0.8l/min white tolerance ±25%			
	GEV No.	371234	Ref. No.	—
	reducer TP flow rate 1l/min light blue tolerance ±25%			
	GEV No.	371235	Ref. No.	—
	reducer TP flow rate 1.2l/min brown tolerance ±25%			
	GEV No.	371236	Ref. No.	—
	reducer TP flow rate 1.5l/min light brown tolerance ±25%			
	GEV No.	371237	Ref. No.	—
	reducer TP flow rate 2.5l/min yellow tolerance ±25%			
	GEV No.	371238	Ref. No.	—
	reducer TP flow rate 3.4l/min dark green tolerance ±25%			
	GEV No.	371239	Ref. No.	—
	reducer TP flow rate 5l/min black tolerance ±25%			
	GEV No.	371240	Ref. No.	—
	reducer TP flow rate 8l/min blue tolerance ±20%			

## solenoid valves with reducers



GEV No.	370011	Ref. No.	120144
<b>description</b>	solenoid valve double angled 230VAC inlet 3/4" outlet 11.5mm		
<b>For models:</b>	B12, B12T, B14T, B16, B16T, B16TM, B19, B19T, B19TM, B25, B26, B27, F90M, F90MA, FC, FC533A, FC53A, FC53LA, FC543A, FC543EA, FC544A, FC54A, FC54EA, FCHRA, FCHRTA, LBC210, LBC215, LBC215A, LBC275, LBC275A, LBR, LBR215A, LF320, LF320A, LF320L, LF320LA, LF321, LF321A, LF322, LF322A, LF322MP, LF322MP-A, LF323, LF323A, LF324, LF324A, LF325E, LF325EA, LF350, LF350A...(Other models you can see in the webshop)		



GEV No.	370682	Ref. No.	120188
<b>description</b>	solenoid valve single angled 230VAC inlet 3/4" outlet 11.5mm input 16l/min TP plastic flow regulating valve inlet pink 8VA		
<b>For models:</b>	LF315, LF321, LF321A, LF322, LF322A, LF322MP, LF322MP-A, LF324, LF324A, LF325E, LF325EA, LF700, LF700A, LFD32E, LFD32EA, LFD32M, LFD32MA		



GEV No.	370255	Ref. No.	120179
<b>description</b>	solenoid valve triple angled 230VAC inlet 3/4" outlet 11.5mm plastic		
<b>For models:</b>	BC25, BC25A, BC25HR, BC30, BC30A, BC30HRA, BR20A, BR25A, FC43A		



## spare parts and accessories

## solenoid coils





GEV No.	371199	Ref. No.	630987
<b>description</b>	solenoid coil TP 230VAC 50/60Hz seat ø 9mm connection male faston 6.3mm		
<b>For models:</b>	FC3EA, FC3MA, FC44EA, FC4EA, FC4MA		





metal			
M&M			
2-way			
B204/205/206 series			
			
1			
<b>GEV No.</b>	370076	<b>Ref. No.</b>	120158
<b>description</b>	solenoid valve 2-ways 230VAC connection 3/4" L 82mm DN 25mm slide-on receptacle compact -10 up to +90°C M&M type series B204/205/206 coil type 2700 membranes NBR (water) p max 16bar p min 0.3bar		
<b>For models:</b>	GE100, GE115, GE125, GE60, GE60RCD, GE65, GE65RCD, GE75, GE80		
<b>spare parts for</b>	370076		
	<b>GEV No.</b>	371022	<b>Ref. No.</b> —
	solenoid coil M&M 230VAC 10VA 50Hz coil type 2700 seat ø 10mm		
<b>accessories for</b>	370076		
	<b>GEV No.</b>	371091	<b>Ref. No.</b> 150034
	power socket plug type DIN 43650B cable lengthmm small		

SIRAI			
2-way			
L140-B series			
			
1			
<b>GEV No.</b>	370320	<b>Ref. No.</b>	120141 120191
<b>description</b>	solenoid valve brass 2-ways 24VAC inlet 1/2" outlet 1/2" connection 1/2" L 41mm DN 10mm slide-on receptacle compact -10 up to +90°C SIRAI type series L140-B coil type Z610A membranes NBR (water) p max 12bar p min 0.35bar		
<b>spare parts for</b>	370320		
	<b>GEV No.</b>	371070	<b>Ref. No.</b> 630948
	solenoid coil 24VAC 10VA SIRAI coil type Z610A seat ø 10mm		
	<b>GEV No.</b>	371163	<b>Ref. No.</b> —
	membrane connection 1/2" series L140-B membrane type NBR (water)		
<b>accessories for</b>	370320		
	<b>GEV No.</b>	371091	<b>Ref. No.</b> 150034
	power socket plug type DIN 43650B cable lengthmm small		

L180-B series			
			
1			
<b>GEV No.</b>	370330	<b>Ref. No.</b>	120123
<b>description</b>	solenoid valve 2-ways 24VAC connection 1" L 105mm DN 24mm slide-on receptacle compact -10 up to +90°C SIRAI type series L180-B coil type Z610A membranes NBR (water) p max 12bar p min 0.35bar		
<b>For models:</b>	ACR, ACR145, ACR205, ACR225, ACR245, ACR260, ACR265, ACR305, GMC, GMC2700, GMC3500, GMC4500, GMC5500, NE00, NE3001, NE4001, NE5501, NE7501, NE9001, NG00, NG01, NG02, NG1202, NG1202E, NG600, NG600E, NG601, NG601E, NG602, NG602E, NG900, NG900E, NG901, NG901E, NG902, NG902E, SE		
<b>spare parts for</b>	370330		
	<b>GEV No.</b>	371070	<b>Ref. No.</b> 630948
	solenoid coil 24VAC 10VA SIRAI coil type Z610A seat ø 10mm		
	<b>GEV No.</b>	371173	<b>Ref. No.</b> —
	membrane connection 1" series L180-B membrane type NBR		
<b>accessories for</b>	370330		
	<b>GEV No.</b>	371091	<b>Ref. No.</b> 150034
	power socket plug type DIN 43650B cable lengthmm small		

			
1			
<b>GEV No.</b>	370391	<b>Ref. No.</b>	120122
<b>description</b>	solenoid valve 2-ways 24VAC connection 3/4" L 79mm DN 18mm -10 up to +90°C coil type Z610A membranes NBR (water) p max 12bar p min 0.35bar		
<b>For models:</b>	AC101, AC122, AC151, AC152, AC181, AC182, AC201, AC202, AC241, AC242, AC91, ACR, ACR145, ACR205, ACR225, ACR245, ACR260, ACR265, ACR305, G100L, G101L, G115, G115L, G125, G125L, G131, G50L, G50LM, G51L, G60L, G61L, G65, G65L, G66, G75L, GL, GMC, GMC2700, GMC3500, GMC4500, GMC5500, NE02, NE3002, NE4002, NE5002, NE5502, NE7002, NE7502, NE9002, NE9502		
<b>accessories for</b>	370391		
	<b>GEV No.</b>	371091	<b>Ref. No.</b> 150034
	power socket plug type DIN 43650B cable lengthmm small		

			
1			
<b>GEV No.</b>	370329	<b>Ref. No.</b>	120131 120154
<b>description</b>	solenoid valve 2-ways 24VAC inlet 1/2" outlet 1/2" connection 1/2" L 66mm DN 13.5mm slide-on receptacle compact -10 up to +90°C SIRAI type series L180-B coil type Z610A membranes NBR (water) p max 12bar p min 0.35bar		
<b>For models:</b>	AC101, AC122, AC151, AC152, AC181, AC182, AC201, AC202, AC241, AC242, AC91, ACL100, ACL150, ACR, ACR145, ACR205, ACR225, ACR245, ACR260, ACR265, ACR305, ACRS145, ACRS205, ACRS225, ACRS245, ACRS260, ACRS265, ACRS305, ACS101, ACS101-DIGIT, ACS122, ACS122-DIGIT, ACS151, ACS151-DIGIT, ACS152, ACS152-DIGIT, ACS161-DIGIT, ACS162-DIGIT, ACS181, ACS181-DIGIT, ACS182, ACS182-DIGIT, ACS201, ACS201-DIGIT, ACS202, ACS202-DIGIT, ACS241, ACS241-DIGIT, ACS242, ACS242-DIGIT...(Other models you can see in the webshop)		
<b>spare parts for</b>	370329		
	<b>GEV No.</b>	371070	<b>Ref. No.</b> 630948
<b>accessories for</b>	370329		
	<b>GEV No.</b>	371091	<b>Ref. No.</b> 150034
	power socket plug type DIN 43650B cable lengthmm small		

			
1			
<b>GEV No.</b>	370048	<b>Ref. No.</b>	120158
<b>description</b>	solenoid valve brass 2-ways 230VAC connection 3/4" L 79mm DN 18mm slide-on receptacle compact -10 up to +90°C SIRAI type series L180-B coil type Z610A membranes NBR (water) p max 12bar p min 0.35bar		
<b>spare parts for</b>	370048		
	<b>GEV No.</b>	371085	<b>Ref. No.</b> —
	solenoid coil 230VAC 4VA SIRAI coil type ZB10A seat ø 10mm 50/60Hz		
	<b>GEV No.</b>	371172	<b>Ref. No.</b> —
	membrane connection 3/4" series L180-B membrane type NBR (water)		
<b>accessories for</b>	370048		
	<b>GEV No.</b>	371091	<b>Ref. No.</b> 150034
	power socket plug type DIN 43650B cable lengthmm small		

			
1			
<b>GEV No.</b>	370047	<b>Ref. No.</b>	120174
<b>description</b>	solenoid valve brass 2-ways 230VAC inlet 1/2" outlet 1/2" connection 1/2" L 66mm DN 13.5mm slide-on receptacle compact -10 up to +90°C SIRAI type series L180-B coil type Z610A membranes NBR (water) p max 12bar p min 0.35bar 50/60Hz		
<b>For models:</b>	GE100, GE115, GE125, GE60, GE65, GE75, GE80		
<b>spare parts for</b>	370047		
	<b>GEV No.</b>	371085	<b>Ref. No.</b> —
	solenoid coil 230VAC 4VA SIRAI coil type ZB10A seat ø 10mm 50/60Hz		
	<b>GEV No.</b>	371171	<b>Ref. No.</b> 630631
	membrane series L180-B membrane type NBR (water)		
<b>accessories for</b>	370047		
	<b>GEV No.</b>	371091	<b>Ref. No.</b> 150034
	power socket plug type DIN 43650B cable lengthmm small		

L180-V series

			
1			
<b>GEV No.</b>	370669	<b>Ref. No.</b>	120135
<b>description</b>	solenoid valve brass 2-ways 230VAC inlet 1/2" outlet 1/2" connection 1/2" L 66mm DN 13.5mm 0 up to +130°C SIRAI type series L180-V coil type ZB10A membranes Viton p max 16bar p min 0.35bar 50/60Hz		

solenoid valves steam (water)





2-way

L140-D series

			
1			
<b>GEV No.</b>	370730	<b>Ref. No.</b>	120140 121170
<b>description</b>	solenoid valve brass 2-ways 230VAC inlet 3/4" ET outlet 1/2" IT connection 3/4" L 61mm DN 10mm -10 up to 100°C SIRAI type series L140-D coil type Z610A membranes EPDM p max 10bar p min 0.35bar 50/60Hz		





 <p>1</p>			
<b>GEV No.</b>	370731	<b>Ref. No.</b>	120125
<b>description</b>	solenoid valve brass 2-ways 24VAC inlet 3/4" ET outlet 1/2" IT connection 3/4" L 61mm DN 10mm -10 up to 100°C SIRAI type series L134-D coil type Z610A membranes EPDM p max 10bar p min 0.35bar		
<b>For models:</b>	AC2A		
<b>spare parts for</b>	370731		
	<b>GEV No.</b>	370320	<b>Ref. No.</b> 120141 120191
	solenoid valve brass 2-ways 24VAC inlet 1/2" outlet 1/2" connection 1/2" L 41mm DN 10mm slide-on receptacle compact -10 up to +90°C SIRAI type series L140-B coil type Z610A membranes NBR (water) p max 12bar p min 0.35bar		
	<b>GEV No.</b>	520685	<b>Ref. No.</b> —
	double nipple brass thread 1/2" - 3/4" Qty 1 pcs		
<b>accessories for</b>	370731		
	<b>GEV No.</b>	371091	<b>Ref. No.</b> 150034
	power socket plug type DIN 43650B cable lengthmm small		
	<b>GEV No.</b>	520208	<b>Ref. No.</b> —
	double nipple nickel-plated brass thread 1/2" - 3/4" Qty 1 pcs		



 <p>1</p>			
<b>GEV No.</b>	370705	<b>Ref. No.</b>	120191
<b>description</b>	solenoid valve brass 2-ways 24VAC inlet 3/4" ET outlet 1/2" IT connection 3/4" L 61mm DN 10mm -10 up to 100°C SIRAI type series L140-D coil type Z610A membranes EPDM p max 10bar p min 0.35bar 50/60Hz flow regulating valve inlet black		
<b>For models:</b>	AC101, AC122, AC91, AC95		

 <p>1</p>			
<b>GEV No.</b>	370729	<b>Ref. No.</b>	120192
<b>description</b>	solenoid valve brass 2-ways 24VAC inlet 3/4" ET outlet 1/2" IT connection 3/4" L 61mm DN 10mm -10 up to 100°C SIRAI type series L140-D coil type Z610A membranes EPDM p max 10bar p min 0.35bar 50/60Hz flow regulating valve inlet red		
<b>For models:</b>	AC105		

<p>L145-R series</p>  <p>1</p>			
<b>GEV No.</b>	370311	<b>Ref. No.</b>	120163
<b>description</b>	solenoid valve 2-ways 24VAC connection 1" L 105mm DN 18.5mm slide-on receptacle DIN -60 up to +170°C SIRAI type series L145-R coil type Z534A membranes PTFE (steam) p max 6bar p min 0.4bar		
<b>For models:</b>	AC100, AC101, AC105, AC120, AC122, AC135, AC150, AC151, AC152, AC170, AC181, AC182, AC200, AC201, AC202, AC241, AC242, AC90, AC91, AC95, ACR, ACR145, ACR205, ACR225, ACR245, ACR260, ACR265, ACR305, ACS101, ACS101-DIGIT, ACS122, ACS122-DIGIT, ACS151, ACS151-DIGIT, ACS152, ACS152-DIGIT, ACS161-DIGIT, ACS162-DIGIT, ACS181, ACS181-DIGIT, ACS182, ACS182-DIGIT, ACS201, ACS201-DIGIT, ACS202, ACS202-DIGIT, ACS241, ACS241-DIGIT, ACS242, ACS242-DIGIT...(Other models you can see in the webshop)		
<b>spare parts for</b>	370311		
	<b>GEV No.</b>	371068	<b>Ref. No.</b> 630972
	solenoid coil 24VAC 14VA SIRAI coil type Z534A seat ø 12mm		
	<b>GEV No.</b>	371166	<b>Ref. No.</b> —
	membrane connection 1" series L145-R membrane type PTFE		
<b>accessories for</b>	370311		
	<b>GEV No.</b>	371090	<b>Ref. No.</b> 150033
	power socket plug type DIN 43650A screw		



 <p>1</p>			
<b>GEV No.</b>	370318	<b>Ref. No.</b>	120161
<b>description</b>	solenoid valve 2-ways 24VAC inlet 1/2" outlet 1/2" connection 1/2" L 66mm DN 10mm slide-on receptacle compact -60 up to +170°C SIRAI type series L145-R coil type Z614A membranes PTFE (steam) p max 8bar p min 0.4bar		
<b>For models:</b>	ACS101, ACS101-DIGIT, ACS122, ACS122-DIGIT, ACS151, ACS151-DIGIT, ACS152, ACS152-DIGIT, ACS161-DIGIT, ACS162-DIGIT, ACS181, ACS181-DIGIT, ACS182, ACS182-DIGIT, ACS201, ACS201-DIGIT, ACS202, ACS202-DIGIT, ACS241, ACS241-DIGIT, ACS242, ACS242-DIGIT, ACS91, ACS91-DIGIT, NE02, NE3002, NE4002, NE5002, NE5502, NE7002, NE7502, NE9002, NE9502, NG02, NG1202, NG1202E, NG602, NG602E, NG902, NG902E		
<b>spare parts for</b>	370318		
	<b>GEV No.</b>	371158	<b>Ref. No.</b> 630973
	solenoid coil 24VAC 10VA SIRAI coil type Z614A seat ø 10mm		
	<b>GEV No.</b>	371164	<b>Ref. No.</b> —
	membrane connection 3/8"-1/2" series L145-R membrane type PTFE		
<b>accessories for</b>	370318		
	<b>GEV No.</b>	371091	<b>Ref. No.</b> 150034
	power socket plug type DIN 43650B cable lengthmm small		

			
1			
<b>GEV No.</b>	370324	<b>Ref. No.</b>	120162
<b>description</b>	solenoid valve 2-ways 24VAC inlet 3/4" outlet 3/4" connection 3/4" L 79mm DN 16mm slide-on receptacle DIN -60 up to +170°C SIRAI type series L145-R coil type Z534A membranes PTFE (steam) p max 6bar p min 0.4bar		
<b>For models:</b>	AC100, AC101, AC105, AC120, AC122, AC135, AC150, AC151, AC152, AC170, AC181, AC182, AC200, AC201, AC202, AC241, AC242, AC90, AC91, AC95, ACR, ACR145, ACR205, ACR225, ACR245, ACR260, ACR265, ACR305, ACS101, ACS101-DIGIT, ACS122, ACS122-DIGIT, ACS151, ACS151-DIGIT, ACS152, ACS152-DIGIT, ACS161-DIGIT, ACS162-DIGIT, ACS181, ACS181-DIGIT, ACS182, ACS182-DIGIT, ACS201, ACS201-DIGIT, ACS202, ACS202-DIGIT, ACS241, ACS241-DIGIT, ACS242, ACS242-DIGIT...(Other models you can see in the webshop)		
<b>spare parts for</b>	370324		
	<b>GEV No.</b>	371068	<b>Ref. No.</b> 630972
solenoid coil 24VAC 14VA SIRAI coil type Z534A seat ø 12mm			
	<b>GEV No.</b>	371165	<b>Ref. No.</b> 630625
membrane connection 3/4" series L145-R membrane type PTFE			
<b>accessories for</b>	370324		
	<b>GEV No.</b>	371090	<b>Ref. No.</b> 150033
power socket plug type DIN 43650A screw			

<b>L153-D series</b>			
			
1			
<b>GEV No.</b>	370079	<b>Ref. No.</b>	120167
<b>description</b>	solenoid valve 2-ways 230VAC connection 3/4" L 79mm DN 17mm slide-on receptacle DIN -10 up to 140°C SIRAI type series L153-D coil type Z134A membranes EPDM (steam/water) p max 8bar p min 0.1bar 50Hz		
<b>accessories for</b>	370079		
	<b>GEV No.</b>	371077	<b>Ref. No.</b> —
solenoid coil 230VAC 24VA SIRAI coil type Z110A/Z114A/Z134A seat ø 14mm			

			
1			
<b>GEV No.</b>	370327	<b>Ref. No.</b>	120166
<b>description</b>	solenoid valve 2-ways 24VAC connection 1" L 105mm DN 22mm -10 up to 140°C SIRAI coil type Z923A membranes EPDM (steam/water) p max 8bar p min 0.1bar		
<b>For models:</b>	AC100, AC101, AC105, AC120, AC122, AC135, AC150, AC151, AC152, AC170, AC181, AC182, AC200, AC201, AC202, AC241, AC242, AC90, AC91, AC95, ACR, ACR145, ACR205, ACR225, ACR245, ACR260, ACR265, ACR305, ACS101, ACS101-DIGIT, ACS122, ACS122-DIGIT, ACS151, ACS151-DIGIT, ACS152, ACS152-DIGIT, ACS161-DIGIT, ACS162-DIGIT, ACS181, ACS181-DIGIT, ACS182, ACS182-DIGIT, ACS201, ACS201-DIGIT, ACS202, ACS202-DIGIT, ACS241, ACS241-DIGIT, ACS242, ACS242-DIGIT...(Other models you can see in the webshop)		

			
1			
<b>GEV No.</b>	370325	<b>Ref. No.</b>	120107 120165
<b>description</b>	solenoid valve 2-ways 24VAC inlet 3/4" outlet 3/4" connection 3/4" L 79mm DN 17mm slide-on receptacle DIN -10 up to 140°C SIRAI type series L153-D coil type Z134A membranes EPDM (steam/water) p max 8bar p min 0.1bar 50Hz		
<b>For models:</b>	AC100, AC101, AC105, AC120, AC122, AC135, AC150, AC151, AC152, AC170, AC181, AC182, AC200, AC201, AC202, AC241, AC242, AC90, AC91, AC95, ACR, ACR145, ACR205, ACR225, ACR245, ACR260, ACR265, ACR305, ACS101, ACS101-DIGIT, ACS122, ACS122-DIGIT, ACS151, ACS151-DIGIT, ACS152, ACS152-DIGIT, ACS161-DIGIT, ACS162-DIGIT, ACS181, ACS181-DIGIT, ACS182, ACS182-DIGIT, ACS201, ACS201-DIGIT, ACS202, ACS202-DIGIT, ACS241, ACS241-DIGIT, ACS242, ACS242-DIGIT...(Other models you can see in the webshop)		

<b>spare parts and accessories</b>			
<b>solenoid coils</b>			
			
1			
<b>GEV No.</b>	371071	<b>Ref. No.</b>	630981
<b>description</b>	solenoid coil 230VAC 10VA SIRAI coil type Z610A seat ø 10mm H 33mm L 33mm W 25mm 50/60Hz		
<b>For models:</b>	GE100, GE115, GE125, GE60, GE60RCD, GE65, GE65RCD, GE75, GE80		
<b>accessories for</b>	371071		
	<b>GEV No.</b>	371091	<b>Ref. No.</b> 150034
power socket plug type DIN 43650B cable lengthmm small			

1

<b>GEV No.</b>	371070	<b>Ref. No.</b>	630948
<b>description</b>	solenoid coil 24VAC 10VA SIRAI coil type Z610A seat ø 10mm		
<b>For models:</b>	AC101, AC122, AC151, AC152, AC181, AC182, AC201, AC202, AC241, AC242, AC91, ACR, ACR145, ACR205, ACR225, ACR245, ACR260, ACR265, ACR305, ACRS145, ACRS205, ACRS225, ACRS245, ACRS260, ACRS265, ACRS305, G100L, G101L, G115L, G125L, G50L, G50LM, G51L, G60L, G61L, G65L, G75L, GL, GMC, GMC2700, GMC2702, GMC3500, GMC3502, GMC4500, GMC4502, GMC5500, GMC5502, LAV1001, LAV1501, LV1001...(Other models you can see in the webshop)		
<b>accessories for</b>	371070		
	<b>GEV No.</b>	371091	<b>Ref. No.</b> 150034
	power socket plug type DIN 43650B cable lengthmm small		



1

<b>GEV No.</b>	371178	<b>Ref. No.</b>	630976
<b>description</b>	solenoid coil 24VAC 24VA SIRAI coil type Z110A/Z114A/Z134A seat ø 14mm		

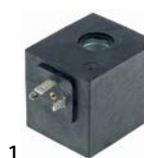

1

<b>GEV No.</b>	371162	<b>Ref. No.</b>	630976
<b>description</b>	solenoid coil 24VAC 27VA SIRAI seat ø 16mm		



1

<b>GEV No.</b>	371158	<b>Ref. No.</b>	630973
<b>description</b>	solenoid coil 24VAC 10VA SIRAI coil type Z614A seat ø 10mm		
<b>For models:</b>	AC100, AC101, AC105, AC120, AC122, AC135, AC150, AC151, AC152, AC170, AC181, AC182, AC200, AC201, AC202, AC241, AC242, AC90, AC91, AC95, ACR, ACR145, ACR205, ACR225, ACR245, ACR260, ACR265, ACR305, ACS101, ACS101-DIGIT, ACS122, ACS122-DIGIT, ACS151, ACS151-DIGIT, ACS152, ACS152-DIGIT, ACS161-DIGIT, ACS162-DIGIT, ACS181, ACS181-DIGIT, ACS182, ACS182-DIGIT, ACS201, ACS201-DIGIT, ACS202, ACS202-DIGIT, ACS241, ACS241-DIGIT, ACS242, ACS242-DIGIT...(Other models you can see in the webshop)		
<b>accessories for</b>	371158		
	<b>GEV No.</b>	371091	<b>Ref. No.</b> 150034
	power socket plug type DIN 43650B cable lengthmm small		

membranes



1

<b>GEV No.</b>	371169	<b>Ref. No.</b>	630629
<b>description</b>	membrane connection 1" series L153-D membrane type EPDM		
<b>For models:</b>	AC100, AC101, AC105, AC120, AC122, AC135, AC150, AC151, AC152, AC170, AC181, AC182, AC200, AC201, AC202, AC241, AC242, AC90, AC91, AC95, ACR, ACR145, ACR205, ACR225, ACR245, ACR260, ACR265, ACR305, ACS101, ACS101-DIGIT, ACS122, ACS122-DIGIT, ACS151, ACS151-DIGIT, ACS152, ACS152-DIGIT, ACS161-DIGIT, ACS162-DIGIT, ACS181, ACS181-DIGIT, ACS182, ACS182-DIGIT, ACS201, ACS201-DIGIT, ACS202, ACS202-DIGIT, ACS241, ACS241-DIGIT, ACS242, ACS242-DIGIT...(Other models you can see in the webshop)		



1

<b>GEV No.</b>	371068	<b>Ref. No.</b>	630972
<b>description</b>	solenoid coil 24VAC 14VA SIRAI coil type Z534A seat ø 12mm		
<b>For models:</b>	AC100, AC101, AC105, AC120, AC122, AC135, AC150, AC151, AC152, AC170, AC181, AC182, AC200, AC201, AC202, AC241, AC242, AC90, AC91, AC95, ACR, ACR145, ACR205, ACR225, ACR245, ACR260, ACR265, ACR305, ACS101, ACS101-DIGIT, ACS122, ACS122-DIGIT, ACS151, ACS151-DIGIT, ACS152, ACS152-DIGIT, ACS161-DIGIT, ACS162-DIGIT, ACS181, ACS181-DIGIT, ACS182, ACS182-DIGIT, ACS201, ACS201-DIGIT, ACS202, ACS202-DIGIT, ACS241, ACS241-DIGIT, ACS242, ACS242-DIGIT...(Other models you can see in the webshop)		



1

<b>GEV No.</b>	371165	<b>Ref. No.</b>	630625
<b>description</b>	membrane connection 3/4" series L145-R membrane type PTFE		
<b>For models:</b>	AC100, AC101, AC105, AC120, AC122, AC135, AC150, AC151, AC152, AC170, AC181, AC182, AC200, AC201, AC202, AC241, AC242, AC90, AC91, AC95, ACR, ACR145, ACR205, ACR225, ACR245, ACR260, ACR265, ACR305, ACS101, ACS101-DIGIT, ACS122, ACS122-DIGIT, ACS151, ACS151-DIGIT, ACS152, ACS152-DIGIT, ACS161-DIGIT, ACS162-DIGIT, ACS181, ACS181-DIGIT, ACS182, ACS182-DIGIT, ACS201, ACS201-DIGIT, ACS202, ACS202-DIGIT, ACS241, ACS241-DIGIT, ACS242, ACS242-DIGIT...(Other models you can see in the webshop)		



			
<b>GEV No.</b>	371168	<b>Ref. No.</b>	630628
<b>description</b>	membrane connection 3/4" series L153-D membrane type EPDM		
<b>For models:</b>	AC100, AC101, AC105, AC120, AC122, AC135, AC150, AC151, AC152, AC170, AC181, AC182, AC200, AC201, AC202, AC241, AC242, AC90, AC91, AC95, ACR, ACR145, ACR205, ACR225, ACR245, ACR260, ACR265, ACR305, ACS101, ACS101-DIGIT, ACS122, ACS122-DIGIT, ACS151, ACS151-DIGIT, ACS152, ACS152-DIGIT, ACS161-DIGIT, ACS162-DIGIT, ACS181, ACS181-DIGIT, ACS182, ACS182-DIGIT, ACS201, ACS201-DIGIT, ACS202, ACS202-DIGIT, ACS241, ACS241-DIGIT, ACS242, ACS242-DIGIT...(Other models you can see in the webshop)		

			
<b>GEV No.</b>	371171	<b>Ref. No.</b>	630631
<b>description</b>	membrane series L180-B membrane type NBR (water)		
<b>For models:</b>	NE02, NE3001, NE3002, NE4001, NE4002, NE5002, NE5501, NE5502, NE7002, NE7501, NE7502, NE9001, NE9002, NE9502, NG02, NG1202, NG1202E, NG602, NG602E, NG902, NG902E		

## solenoid valves (refrigeration)

### CASTEL

#### spare parts and accessories

			
<b>GEV No.</b>	371090	<b>Ref. No.</b>	150033
<b>description</b>	power socket plug type DIN 43650A screw		

## Solenoid valve - accessories

			
<b>GEV No.</b>	371091	<b>Ref. No.</b>	150034
<b>description</b>	power socket plug type DIN 43650B cable lengthmm small		
<b>For models:</b>	AC100, AC101, AC122, AC151, AC152, AC181, AC182, AC201, AC202, AC241, AC242, AC91, ACR, ACR145, ACR205, ACR225, ACR245, ACR260, ACR265, ACR305, ACRS145, ACRS205, ACRS225, ACRS245, ACRS260, ACRS265, ACRS305, ACS101, ACS101-DIGIT, ACS122, ACS122-DIGIT, ACS151, ACS151-DIGIT, ACS152, ACS152-DIGIT, ACS161-DIGIT, ACS162-DIGIT, ACS181, ACS181-DIGIT, ACS182, ACS182-DIGIT, ACS201, ACS201-DIGIT, ACS202, ACS202-DIGIT, ACS241, ACS241-DIGIT, ACS242, ACS242-DIGIT, ACS91...(Other models you can see in the webshop)		

			
<b>GEV No.</b>	371198	<b>Ref. No.</b>	630901
<b>description</b>	solenoid coil 230V voltage AC H 31mm seat ø 9mm ø 23.5mm		
<b>For models:</b>	B12, B16, B19, B25, B26, B27, B31, B32, F2, F3, F300		

## pressure switches

### for warewashing

ø 58mm with male faston 6.3mm

with connection horizontal

			
<b>GEV No.</b>	541011	<b>Ref. No.</b>	130609
<b>description</b>	pressure control pressure range 110/70mbar connection 6mm ø 58mm pressure connection horizontal warewashing		
<b>For models:</b>	AC100, AC90, ACR, ACR145, ACR205, ACR225, ACR245, ACR260, ACR265, ACR305, G125, G75, GE100, GE115, GE60, GE60RCD, GE65, GE65RCD, GE80, GMC, GMC2700, GMC3500, GMC4500, GMC5500, NE00, NG00, NG600, NG600E, NG900, NG900E, SE, SNL		

			
<b>GEV No.</b>	541000	<b>Ref. No.</b>	130607
<b>description</b>	pressure control pressure range 110/75mbar connection male faston 6.3mm ø 58mm pressure connection horizontal warewashing pressure connection ø 6mm		
<b>For models:</b>	B13T, B14T, B15, B15T, B15TM, B16, B16T, B16TM, B18, B18T, B18TM, B19, B19T, B19TM, B41, B42, F2, F20, F3, R50		

			
<b>GEV No.</b>	541972	<b>Ref. No.</b>	130635
<b>description</b>	pressure control pressure range 190/40mbar connection male faston 6.3mm ø 58mm pressure connection horizontal warewashing pressure connection ø 5.5mm		
<b>For models:</b>	GE50RCD		



			
1			
<b>GEV No.</b>	541023	<b>Ref. No.</b>	130616
<b>description</b>	pressure control pressure range 190/80mbar connection 6mm ø 58mm pressure connection horizontal warewashing		
<b>For models:</b>	C1000E, C1000ERCD, C1001M, C1300E, C1300ERCD, C1301M, C155, C155BT, C155E2, C155RCD, C165, C165E2, C165E2BT, C165E2RCD, C166, C166-2, C95, C95BT, C95E2, C95RCD, GE100, GE115, GE60, GE60RCD, GE65, GE65RCD, GE80, XLC		

			
1			
<b>GEV No.</b>	541045	<b>Ref. No.</b>	130629
<b>description</b>	pressure control pressure range 28/12mbar connection 6mm ø 58mm pressure connection horizontal warewashing		

			
1			
<b>GEV No.</b>	541307	<b>Ref. No.</b>	130629
<b>description</b>	pressure control pressure range 30/12mbar connection male faston 6.3mm ø 58mm pressure connection horizontal warewashing pressure connection ø 6mm		
<b>For models:</b>	ACL100, ACL150, BHC25, BHC25-2, BHC25A, BHC25A-2, BHC25S, BHC30, BHC30-2, BHC30A, BHC30A-2, BHC30E, BHC30E-2, BHC30EA, BHC30EA-2, BHC433, BHC433-2, BHC433A, BHC433A-2, FC3E, FC3EA, FC3M, FC3MA, FC3MR, FC44E, FC44EA, FC4E, FC4EA, FC4M, FC4MA, GF70, GF70A, LB200, LB200-2, LB200A, LB200A-2, LB215, LB215-2, LB215A, LB215A-2, LB260, LB260-2, LB260A, LB260A-2, LB275, LB275-2, LB275A, LB275A-2, LF321, LF321A...(Other models you can see in the webshop)		

			
1			
<b>GEV No.</b>	541039	<b>Ref. No.</b>	130621
<b>description</b>	pressure control pressure range 45/25mbar connection 6mm ø 58mm pressure connection horizontal warewashing		
<b>For models:</b>	BC25HR, BC30HR, BC30HR380, BC30HRA, GF90, GF90-2004, GF90A, GF90A-2004, LF315, LF320, LF320A, LF320CBT, LF320L, LF320LA, LF320LBT, LF323, LF323A, LF350, LF350A, LF450, LF450A, LS550		

			
1			
<b>GEV No.</b>	541792	<b>Ref. No.</b>	130605 130622
<b>description</b>	pressure control pressure range 46/30mbar connection male faston 6.3mm ø 58mm pressure connection horizontal warewashing pressure connection ø 6mm		
<b>For models:</b>	AC120, AC122, AC150, AC151, AC152, AC170, AC181, AC182, AC200, AC201, AC202, AC241, AC242, ACR, ACR145, ACR205, ACR225, ACR245, ACR260, ACR265, ACR305, ACRS145, ACRS205, ACRS225, ACRS245, ACRS260, ACRS265, ACRS305, B10, B10T, B11, B11T, B12, B12T, B20, B20D, B23, B24, B25, B26, B27, B31, C140, C155BT, C155RCD, C165E2BT, C165E2RCD, C166-2, C30, C75BT...(Other models you can see in the webshop)		

			
1			
<b>GEV No.</b>	541024	<b>Ref. No.</b>	130617
<b>description</b>	pressure control pressure range 60/40mbar connection 6mm ø 58mm pressure connection horizontal warewashing pressure connection ø 6mm		
<b>For models:</b>	BC25, BC25A, BC30, BC30A, BR20, BR20A, BR25, BR25A, FC43, FC43A		

			
1			
<b>GEV No.</b>	541012	<b>Ref. No.</b>	130604
<b>description</b>	pressure control pressure range 68/40mbar connection 6mm ø 58mm pressure connection horizontal warewashing pressure connection ø 6mm		
<b>For models:</b>	C30, C33, C34, C70, C75, C75BT, C75M, C75RCD, F2, F3, F300, F45, F55, F65, F80, G115, G131, G65, G66, LP360, LP360BT, LP360RCD, R40, R70		

			
1			
<b>GEV No.</b>	541631	<b>Ref. No.</b>	130632
<b>description</b>	pressure control pressure range 75/45mbar connection 6mm ø 55mm pressure connection ø 5.5mm		
<b>For models:</b>	LC1200, LC1200RCD, LC412, LC700, LC700RCD, LC900, LC900RCD		





ø 84mm with coded plug



<b>GEV No.</b>	541308	<b>Ref. No.</b>	130628
<b>description</b>	pressure control 3 pressure ranges pressure range 50/30 50/30 110/70mbar connection 6mm ø 84mm pressure connection horizontal warewashing suitable for COMENDA pressure connection ø 6mm		
<b>For models:</b>	C1000ERCD, C1300ERCD, C155BT, C155RCD, C165E2BT, C165E2RCD, C75BT, C75RCD, C95BT, C95RCD, FC53CBT, FC53LBT, FC54CBT, FC54LBT, GE50RCD, LC1200RCD, LC380BT, LC380RCD, LC700RCD, LC900RCD, LF320CBT, LF320LBT, LP360BT, LP360RCD		

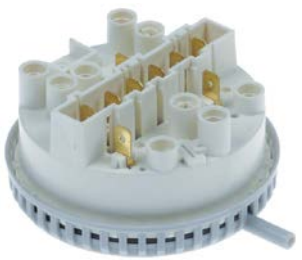

<b>GEV No.</b>	541674	<b>Ref. No.</b>	130620
<b>description</b>	pressure control 3 pressure ranges pressure range 50/30 50/30 160/80mbar connection 6mm ø 84mm pressure connection horizontal warewashing suitable for COMENDA, HOONVED pressure connection ø 6mm		
<b>For models:</b>	AC101, AC105, AC120, AC122, AC135, AC150, AC151, AC152, AC170, AC181, AC182, AC200, AC201, AC202, AC241, AC242, AC2A, AC91, AC95, ACL100, ACL150, ACR, ACR145, ACR205, ACR225, ACR245, ACR260, ACR265, ACR305, ACRS145, ACRS205, ACRS225, ACRS245, ACRS260, ACRS265, ACRS305, ACS101, ACS101-DIGIT, ACS122, ACS122-DIGIT, ACS151, ACS151-DIGIT, ACS152, ACS152-DIGIT, ACS161-DIGIT, ACS162-DIGIT, ACS181, ACS181-DIGIT, ACS182, ACS182-DIGIT...(Other models you can see in the webshop)		

miscellaneous



<b>GEV No.</b>	541310	<b>Ref. No.</b>	130625
<b>description</b>	pressure control pressure range 15mbar		
<b>For models:</b>	C155BT, C155RCD, C165E2BT, C165E2RCD, C166-2, C75BT, C75RCD, C95BT, C95RCD, FC53CBT, FC53LBT, FC54CBT, FC54LBT, LC380BT, LC380RCD, LF320CBT, LF320LBT, LP360BT, LP360RCD		

accessories



<b>GEV No.</b>	541109	<b>Ref. No.</b>	190314
<b>description</b>	Y-piece plastic hose ø 8-6-8mm for pressure switch		
<b>For models:</b>	ACR, ACR145, ACR205, ACR225, ACR245, ACR260, ACR265, ACR305, C166-2, FC3E, FC3EA, FC44E, FC44EA, FC4E, FC4EA, GMC, GMC2700, GMC3500, GMC4500, GMC5500, NE00, NG00, NG600, NG600E, NG900, NG900E		

electrodes



<b>GEV No.</b>	403116	<b>Ref. No.</b>	120951
<b>description</b>	level electrode M10x1.5 probe L 20mm connection M4 ø 4mm		
<b>For models:</b>	BHC30HR, BHC30HR-2, BHC30HR380, BHC30HRA, BHC30HRA-2, BHC30HRA380, BHCHR		



<b>GEV No.</b>	403254	<b>Ref. No.</b>	120954
<b>description</b>	level electrode M10x1.5 total length 55mm probe L 30x40mm insulated probe length 15mm connection M4 ø 4mm Qty 1 pcs		
<b>For models:</b>	BHC30HR, BHC30HR-2, BHC30HR380, BHC30HRA, BHC30HRA-2, BHC30HRA380, BHCHR		



motors

gear motors

for dishwashers



1

<b>GEV No.</b>	601665	<b>Ref. No.</b>	100246
<b>description</b>	gear motor NORD type SK 01-71L/6-4 0.10/0.15W 400V 50Hz 3 phase 12.2/18.8rpm shaft ø 19mm L 363mm speeds 2		
<b>For models:</b>	AC100, AC101, AC105, AC120, AC122, AC135, AC150, AC151, AC152, AC170, AC181, AC182, AC200, AC201, AC202, AC241, AC242, AC90, AC91, AC95, ACS101, ACS101-DIGIT, ACS122, ACS122-DIGIT, ACS151, ACS151-DIGIT, ACS152, ACS152-DIGIT, ACS161-DIGIT, ACS162-DIGIT, ACS181, ACS181-DIGIT, ACS182, ACS182-DIGIT, ACS201, ACS201-DIGIT, ACS202, ACS202-DIGIT, ACS241, ACS241-DIGIT, ACS242, ACS242-DIGIT, ACS91, ACS91-DIGIT, NE02, NE3002, NE4002, NE5002, NE5502, NE7002...(Other models you can see in the webshop)		

pumps

wash and rinse pumps

FIR

pumps

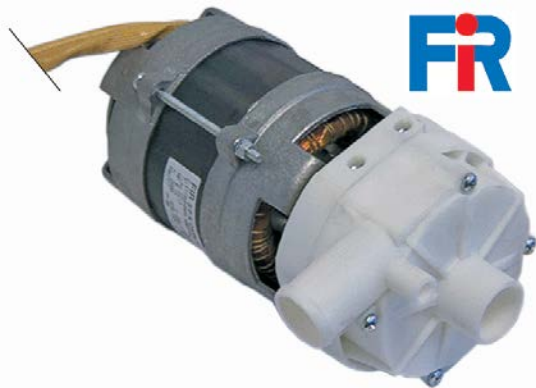

1

<b>GEV No.</b>	500037	<b>Ref. No.</b>	100747
<b>description</b>	pump inlet ø 28mm outlet ø 26mm type 2211.1410 230V 50Hz 1 phase 0.074kW 0.1HP L 190mm rotation direction left capacitor 5µF FIR		
<b>spare parts for</b>	500037		
	<b>GEV No.</b>	365017	<b>Ref. No.</b> 631208
	operating capacitor capacity 5µF 450V tolerance 5% 50/60Hz ambient temperature max. -25 to +85°C ø 28mm L 54mm M8 plastic connection male faston 6.3mm 16.10.08 protection		
	<b>GEV No.</b>	510384	<b>Ref. No.</b> 630131
	pump cover inlet ø 28mm outlet ø 26mm ø 100mm ID ø 76mm		
	<b>GEV No.</b>	510695	<b>Ref. No.</b> —
	mechanical shaft seal height counter ring 5.5mm ID ø 11mm		
	<b>GEV No.</b>	521203	<b>Ref. No.</b> 631660
	impellor ø 72mm H 18mm thread M7 shaft ø 11mm shaft length 32mm blades 3		

<b>spare parts for</b>	500037		
	<b>GEV No.</b>	521703	<b>Ref. No.</b> —
	pump cover gasket EPDM thickness 2.5mm ID ø 75mm Qty 1 pcs		







1

<b>GEV No.</b>	500015	<b>Ref. No.</b>	100303 100701
<b>description</b>	pump inlet ø 28mm outlet ø 26mm type 2228.XXXX 230V 50Hz 1 phase 0.15kW 0.2HP L 190mm rotation direction right capacitor 5µF FIR		
<b>For models:</b>	B10T, B11T, B12T, B15, B16, B18, B19, BR20, BR20A, BR25, BR25A, LBC210, LBC215, LBC215A, LBC275, LBC275A, LBR, LBR200, LBR215, LBR215A		

<b>spare parts for</b>	500015		
	<b>GEV No.</b>	365017	<b>Ref. No.</b> 631208
	operating capacitor capacity 5µF 450V tolerance 5% 50/60Hz ambient temperature max. -25 to +85°C ø 28mm L 54mm M8 plastic connection male faston 6.3mm 16.10.08 protection		
	<b>GEV No.</b>	510510	<b>Ref. No.</b> 630120 630125
	pump cover pump type 2212/2228/2229/2211		
	<b>GEV No.</b>	510532	<b>Ref. No.</b> —
	impellor ø 72mm H 22mm shaft ø 11mm shaft length 32mm blades 3		
	<b>GEV No.</b>	510695	<b>Ref. No.</b> —
	mechanical shaft seal height counter ring 5.5mm ID ø 11mm		
	<b>GEV No.</b>	521703	<b>Ref. No.</b> —
	pump cover gasket EPDM thickness 2.5mm ID ø 75mm Qty 1 pcs		



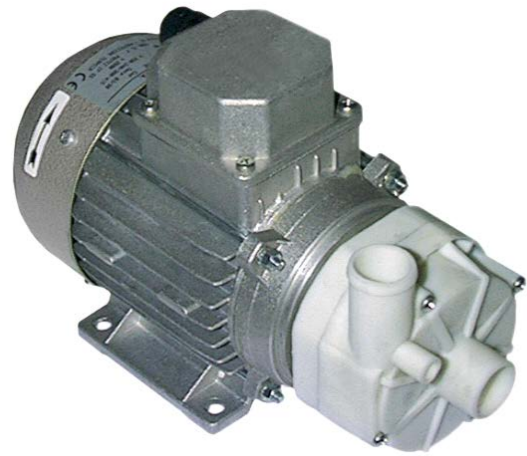

1

<b>GEV No.</b>	500399	<b>Ref. No.</b>	100747
<b>description</b>	pump inlet ø 28mm outlet ø 26mm type 4208.1910 230V 50Hz 1 phase 0.075kW 0.1HP L 190mm rotation direction left capacitor 5µF FIR		
<b>For models:</b>	C155BT, C155RCD, C165E2BT, C165E2RCD, C75BT, C75RCD, C95BT, C95RCD, FC53CBT, FC53LBT, FC54CBT, FC54LBT, LC380BT, LC380RCD, LF320CBT, LF320LBT, LP360BT, LP360RCD		
<b>spare parts for</b>	500399		
	<b>GEV No.</b>	365017	<b>Ref. No.</b> 631208
	operating capacitor capacity 5µF 450V tolerance 5% 50/60Hz ambient temperature max. -25 to +85°C ø 28mm L 54mm M8 plastic connection male faston 6.3mm 16.10.08 protection		
	<b>GEV No.</b>	510384	<b>Ref. No.</b> 630131
	pump cover inlet ø 28mm outlet ø 26mm ø 100mm ID ø 76mm		
	<b>GEV No.</b>	510695	<b>Ref. No.</b> —
	mechanical shaft seal height counter ring 5.5mm ID ø 11mm		
	<b>GEV No.</b>	521203	<b>Ref. No.</b> 631660
	impellor ø 72mm H 18mm thread M7 shaft ø 11mm shaft length 32mm blades 3		
	<b>GEV No.</b>	521703	<b>Ref. No.</b> —
	pump cover gasket EPDM thickness 2.5mm ID ø 75mm Qty 1 pcs		





1

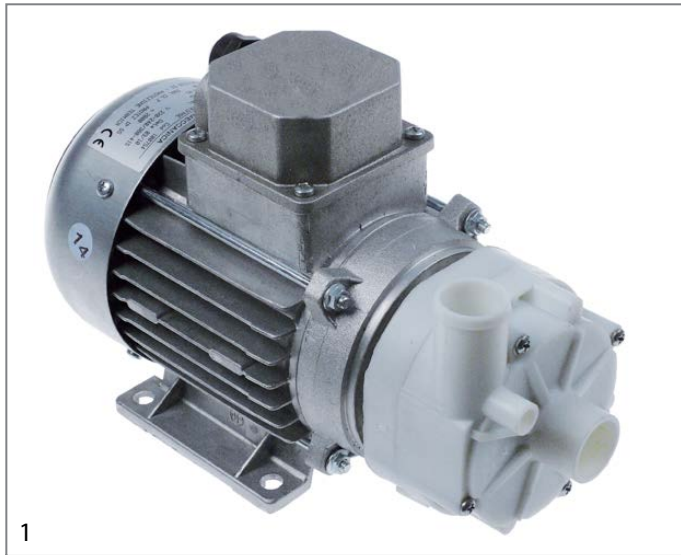



<b>GEV No.</b>	500030	<b>Ref. No.</b>	100647
<b>description</b>	pump inlet ø 28mm outlet ø 26mm type 4226.2540 230/400V 50Hz 3 phase 0.35kW 0.5HP L 260mm rotation direction right FIR		
<b>For models:</b>	AC101, AC120, AC122, AC151, AC152, AC170, AC181, AC182, AC200, AC201, AC202, AC241, AC242, AC2A, AC91, ACL100, ACL150, ACR, ACR145, ACR205, ACR225, ACR245, ACR260, ACR265, ACR305, ACRS145, ACRS205, ACRS225, ACRS245, ACRS260, ACRS265, ACRS305, ACS101, ACS101-DIGIT, ACS122, ACS122-DIGIT, ACS151, ACS151-DIGIT, ACS152, ACS152-DIGIT, ACS161-DIGIT, ACS162-DIGIT, ACS181, ACS181-DIGIT, ACS182, ACS182-DIGIT, ACS201, ACS201-DIGIT, ACS202, ACS202-DIGIT...(Other models you can see in the webshop)		
<b>spare parts for</b>	500030		
	<b>GEV No.</b>	510510	<b>Ref. No.</b> 630120 630125
	pump cover pump type 2212/2228/2229/2211		
	<b>GEV No.</b>	510690	<b>Ref. No.</b> —
	mechanical shaft seal for shaft ø 8mm ED ø 24mm mounting ø 24/26mm		
	<b>GEV No.</b>	521202	<b>Ref. No.</b> 631675
	impellor ø 72mm H 17mm thread M5L		



1



<b>GEV No.</b>	500999	<b>Ref. No.</b>	100754
<b>description</b>	pump inlet ø 28mm outlet ø 26mm type 4226.2541 230/400V 50Hz 3 phase 0.35kW 0.5HP L 260mm rotation direction right FIR		
<b>For models:</b>	AC101, AC122, AC151, AC152, AC181, AC182, AC201, AC202, AC241, AC242, AC91, ACS101, ACS101-DIGIT, ACS122, ACS122-DIGIT, ACS151, ACS151-DIGIT, ACS152, ACS152-DIGIT, ACS161-DIGIT, ACS162-DIGIT, ACS181, ACS181-DIGIT, ACS182, ACS182-DIGIT, ACS201, ACS201-DIGIT, ACS202, ACS202-DIGIT, ACS241, ACS241-DIGIT, ACS242, ACS242-DIGIT, ACS91, ACS91-DIGIT		
<b>spare parts for</b>	500999		
	<b>GEV No.</b>	510510	<b>Ref. No.</b> 630120 630125
	pump cover pump type 2212/2228/2229/2211		
	<b>GEV No.</b>	510690	<b>Ref. No.</b> —
	mechanical shaft seal for shaft ø 8mm ED ø 24mm mounting ø 24/26mm		
	<b>GEV No.</b>	521279	<b>Ref. No.</b> 631687
	impellor ø 64mm H 17mm thread M5L blades 3 metal		

**spare parts for** 500019

	<b>GEV No.</b>	510510	<b>Ref. No.</b>	630120 630125
	pump cover pump type 2212/2228/2229/2211			
	<b>GEV No.</b>	510532	<b>Ref. No.</b>	—
	impellor ø 72mm H 22mm shaft ø 11mm shaft length 32mm blades 3			
	<b>GEV No.</b>	510695	<b>Ref. No.</b>	—
	mechanical shaft seal height counter ring 5.5mm ID ø 11mm			
	<b>GEV No.</b>	521703	<b>Ref. No.</b>	—
	pump cover gasket EPDM thickness 2.5mm ID ø 75mm Qty 1 pcs			



1

<b>GEV No.</b>	500020	<b>Ref. No.</b>	100376
<b>description</b>	pump inlet ø 32mm outlet ø 32mm type 4134.1402 230V 50Hz 1 phase 0.18kW 0.25HP L 180mm rotation direction right capacitor 10µF FIR		
<b>For models:</b>	B23, B24, B25, B26, B27		
<b>spare parts for</b>	500020		
	<b>GEV No.</b>	510506	<b>Ref. No.</b> —
	pump cover pump type 4333/1265		
<b>accessories for</b>	500020		
	<b>GEV No.</b>	504329	<b>Ref. No.</b> —
	blind plug H 17.5mm thread M16x1.5 plastic WS 22 for pump		







1

<b>GEV No.</b>	500019	<b>Ref. No.</b>	100702
<b>description</b>	pump inlet ø 28mm outlet ø 26mm type B229.1405 230V 50Hz 1 phase 0.22kW 0.3HP L 200mm rotation direction right capacitor 5µF FIR		
<b>For models:</b>	B13T, B14T, B15T, B15TM, B16T, B16TM, B18T, B18TM, B19T, B19TM, BC25, BC25A, BC25HR, BC30, BC30A, BC30HR, BC30HR380, BC30HRA, FC43, FC43A, LBC210, LBC215, LBC215A, LBC275, LBC275A		
<b>spare parts for</b>	500019		
	<b>GEV No.</b>	365017	<b>Ref. No.</b> 631208
	operating capacitor capacity 5µF 450V tolerance 5% 50/60Hz ambient temperature max. -25 to +85°C ø 28mm L 54mm M8 plastic connection male faston 6.3mm 16.10.08 protection		









1

<b>GEV No.</b>	500127	<b>Ref. No.</b>	100375 100399 100740
<b>description</b>	pump inlet ø 37mm outlet ø 41mm type 4247.1900 230V 50Hz 1 phase 0.44kW 0.6HP L 200mm rotation direction right capacitor 10µF FIR		
<b>For models:</b>	B31, B32, B41, B42, F2, F20, F3, F300, F45, F55, F65, FC, FC53, FC533, FC533A, FC53A, FC53CBT, FC53LA, FC53LBT, FC54, FC543, FC543A, FC543E, FC543EA, FC544, FC544A, FC54A, FC54CBT, FC54E, FC54EA, FC54LBT, FCHR, FCHRA, FCHRT, FCHRTA, LF315, LF320, LF320A, LF320CBT, LF320L, LF320LA, LF320LBT, LF323, LF323A, LS550, R40, R50, R70		
<b>spare parts for</b>	500127		
	<b>GEV No.</b>	365015	<b>Ref. No.</b> 3068016 631206
	operating capacitor capacity 10µF 400V tolerance 5%Hz ambient temperature max. -25 to +85°C ø 35.5mm L 59mm M8 plastic connection male faston 6.3mm protection		
	<b>GEV No.</b>	510608	<b>Ref. No.</b> 631683
	impellor ø 93mm H 32mm shaft intake ø 9/8mm blades 6 inner height 11mm		
	<b>GEV No.</b>	510692	<b>Ref. No.</b> 630510 630514
	mechanical shaft seal for shaft ø 11mm slide ring ext. ø 24mm slide ring H 13mm counter ring mounting ø 26mm height counter ring 8mm counter ring int. ø 14mm		
	<b>GEV No.</b>	521505	<b>Ref. No.</b> 630129
	pump cover FIR inlet ø 37mm outlet ø 40mm turn direction right ø 160mm ID ø 125mm inner height 25mm		
	<b>GEV No.</b>	521702	<b>Ref. No.</b> 630419
	pump cover gasket thickness 3.5x4.5mm Qty 1 pcs		



1

<b>GEV No.</b>	500017	<b>Ref. No.</b>	100384 100672
<b>description</b>	pump inlet ø 45mm outlet ø 40mm type 1219.1405 230V 50Hz 1 phase 0.73kW 1HP L 300mm rotation direction right capacitor 12.5µF FIR		
<b>For models:</b>	C30, C70, C75, C75BT, C75M, C75RCD, C85, F80, LF450, LF450A		
<b>spare parts for</b>	500017		
	<b>GEV No.</b>	365014	<b>Ref. No.</b> 631207
	operating capacitor capacity 12.5µF 450V tolerance 5%Hz ambient temperature max. -25 to +85°C ø 35mm L 70mm M8 plastic connection male faston 6.3mm 45S.C3DS.12.5 protection		
	<b>GEV No.</b>	510600	<b>Ref. No.</b> 631627 631643
	impellor ø 102mm H 29mm shaft intake ø 9/8mm rotation direction right blades 6		
	<b>GEV No.</b>	510692	<b>Ref. No.</b> 630510 630514
	mechanical shaft seal for shaft ø 11mm slide ring ext. ø 24mm slide ring H 13mm counter ring mounting ø 26mm height counter ring 8mm counter ring int. ø 14mm		
	<b>GEV No.</b>	521539	<b>Ref. No.</b> —
	pump cover FIR inlet ø 45mm outlet ø 40mm auxiliary pressure connection 10mm supporting pressure open turn direction right ø 160mm ID ø 125mm inner height 25mm		
	<b>GEV No.</b>	521702	<b>Ref. No.</b> 630419
	pump cover gasket thickness 3.5x4.5mm Qty 1 pcs		









1

<b>GEV No.</b>	499140	<b>Ref. No.</b>	100386
<b>description</b>	pump inlet ø 45mm outlet ø 40mm type 1219.2504 220/380-240/415V 50Hz 3 phase 1.1kW 1.5HP L 290mm rotation direction right FIR		
<b>For models:</b>	AC101, AC122, AC135, AC150, AC151, AC152, AC170, AC181, AC182, AC200, AC201, AC202, AC241, AC242, AC91, ACS101, ACS101-DIGIT, ACS122, ACS122-DIGIT, ACS151, ACS151-DIGIT, ACS152, ACS152-DIGIT, ACS161-DIGIT, ACS162-DIGIT, ACS181, ACS181-DIGIT, ACS182, ACS182-DIGIT, ACS201, ACS201-DIGIT, ACS202, ACS202-DIGIT, ACS241, ACS241-DIGIT, ACS242, ACS242-DIGIT, ACS91, ACS91-DIGIT, LAV1000, LAV1001, LAV1501, SNL		
<b>spare parts for</b>	499140		
	<b>GEV No.</b>	502007	<b>Ref. No.</b> —
			pump cover gasket
	<b>GEV No.</b>	510529	<b>Ref. No.</b> 631656
			impellor ø 103mm H 30mm shaft intake ø 9/8mm rotation direction right blades 6
	<b>GEV No.</b>	510692	<b>Ref. No.</b> 630510 630514
			mechanical shaft seal for shaft ø 11mm slide ring ext. ø 24mm slide ring H 13mm counter ring mounting ø 26mm height counter ring 8mm counter ring int. ø 14mm
	<b>GEV No.</b>	511187	<b>Ref. No.</b> 630113
			pump cover FIR inlet ø 45mm outlet ø 40mm turn direction right ø 160mm ID ø 122mm inner height 21mm



1

<b>GEV No.</b>	500004	<b>Ref. No.</b>	100707
<b>description</b>	pump inlet ø 45mm outlet ø 40mm type 1219.2521 230/400V 50Hz 3 phase 1.1kW 1.5HP L 300mm rotation direction right capacitor µF FIR		
<b>For models:</b>	C85, F90M, F90MA, LF400A		
<b>spare parts for</b>	500004		
	<b>GEV No.</b>	502007	<b>Ref. No.</b> —
			pump cover gasket
	<b>GEV No.</b>	510529	<b>Ref. No.</b> 631656
			impellor ø 103mm H 30mm shaft intake ø 9/8mm rotation direction right blades 6
	<b>GEV No.</b>	510692	<b>Ref. No.</b> 630510 630514
			mechanical shaft seal for shaft ø 11mm slide ring ext. ø 24mm slide ring H 13mm counter ring mounting ø 26mm height counter ring 8mm counter ring int. ø 14mm
	<b>GEV No.</b>	511187	<b>Ref. No.</b> 630113
			pump cover FIR inlet ø 45mm outlet ø 40mm turn direction right ø 160mm ID ø 122mm inner height 21mm



1











<b>GEV No.</b>	500033	<b>Ref. No.</b>	100346
<b>description</b>	pump inlet ø 45mm outlet ø 40mm type 1221.1400 230V 50Hz 1 phase 0.37kW 0.5HP L 210mm rotation direction right capacitor 12.5µF FIR		
<b>For models:</b>	F300		
<b>spare parts for</b>	500033		
	<b>GEV No.</b>	365014	<b>Ref. No.</b> 631207
			operating capacitor capacity 12.5µF 450V tolerance 5%Hz ambient temperature max. -25 to +85°C ø 35mm L 70mm M8 plastic connection male faston 6.3mm 45S.C3DS.12.5 protection

Table continues overleaf







<b>spare parts for</b> 500033				
	GEV No.	502007	Ref. No.	—
pump cover gasket				
	GEV No.	510607	Ref. No.	—
impellor ø 85mm H 29mm shaft intake ø 9x8mm rotation direction right blades 6				
	GEV No.	510692	Ref. No.	630510 630514
mechanical shaft seal for shaft ø 11mm slide ring ext. ø 24mm slide ring H 13mm counter ring mounting ø 26mm height counter ring 8mm counter ring int. ø 14mm				
	GEV No.	511187	Ref. No.	630113
pump cover FIR inlet ø 45mm outlet ø 40mm turn direction right ø 160mm ID ø 122mm inner height 21mm				



<b>1</b>				
<b>GEV No.</b>	500009	<b>Ref. No.</b>	100363	
<b>description</b>	pump inlet ø 45mm outlet ø 40mm type 1222.1406 230V 50Hz 1 phase 0.37kW 0.5HP L 275mm rotation direction right capacitor 12.5µF FIR			
<b>For models:</b>	F2			
<b>spare parts for</b> 500009				
	GEV No.	365014	Ref. No.	631207
operating capacitor capacity 12.5µF 450V tolerance 5%Hz ambient temperature max. -25 to +85°C ø 35mm L 70mm M8 plastic connection male faston 6.3mm 45S.C3DS.12.5 protection				
	GEV No.	502007	Ref. No.	—
pump cover gasket				
	GEV No.	510607	Ref. No.	—
impellor ø 85mm H 29mm shaft intake ø 9x8mm rotation direction right blades 6				
	GEV No.	510692	Ref. No.	630510 630514
mechanical shaft seal for shaft ø 11mm slide ring ext. ø 24mm slide ring H 13mm counter ring mounting ø 26mm height counter ring 8mm counter ring int. ø 14mm				
	GEV No.	511187	Ref. No.	630113
pump cover FIR inlet ø 45mm outlet ø 40mm turn direction right ø 160mm ID ø 122mm inner height 21mm				



<b>1</b>				
<b>GEV No.</b>	499071	<b>Ref. No.</b>	100336	
<b>description</b>	pump inlet ø 45mm outlet ø 40mm type 1222.2800 440V 60Hz 0.37kW 0.5HP L 275mm rotation direction right FIR			
<b>spare parts for</b> 499071				
	GEV No.	502007	Ref. No.	—
pump cover gasket				
	GEV No.	510528	Ref. No.	630214
flange suitable for pump				
	GEV No.	510692	Ref. No.	630510 630514
mechanical shaft seal for shaft ø 11mm slide ring ext. ø 24mm slide ring H 13mm counter ring mounting ø 26mm height counter ring 8mm counter ring int. ø 14mm				
	GEV No.	511187	Ref. No.	630113
pump cover FIR inlet ø 45mm outlet ø 40mm turn direction right ø 160mm ID ø 122mm inner height 21mm				

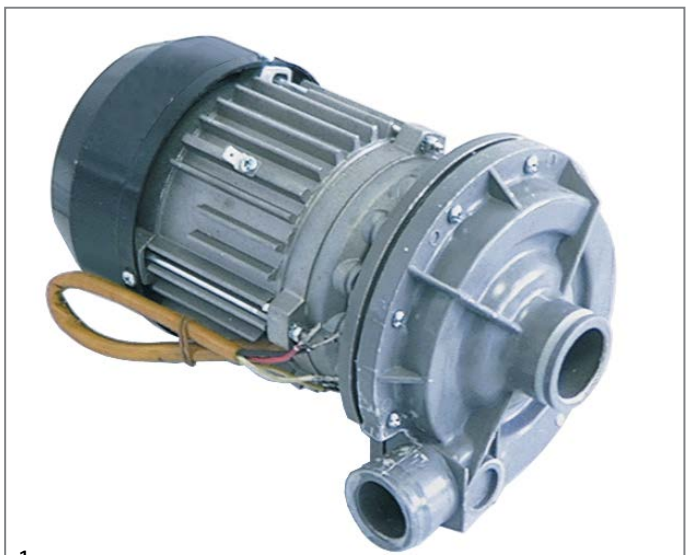







<b>1</b>				
<b>GEV No.</b>	500086	<b>Ref. No.</b>	100365	
<b>description</b>	pump inlet ø 45mm outlet ø 40mm type 1223.1400 230V 50Hz 1 phase 0.55kW 0.75HP L 275mm rotation direction right capacitor 12.5µF FIR			
<b>For models:</b>	F3			
<b>spare parts for</b> 500086				
	GEV No.	365014	Ref. No.	631207
operating capacitor capacity 12.5µF 450V tolerance 5%Hz ambient temperature max. -25 to +85°C ø 35mm L 70mm M8 plastic connection male faston 6.3mm 45S.C3DS.12.5 protection				

Table continues overleaf

<b>spare parts for</b> 500086				
	<b>GEV No.</b>	502007	<b>Ref. No.</b>	—
pump cover gasket				
	<b>GEV No.</b>	510608	<b>Ref. No.</b>	631683
impellor ø 93mm H 32mm shaft intake ø 9/8mm blades 6 inner high 11mm				
	<b>GEV No.</b>	510692	<b>Ref. No.</b>	630510 630514
mechanical shaft seal for shaft ø 11mm slide ring ext. ø 24mm slide ring H 13mm counter ring mounting ø 26mm height counter ring 8mm counter ring int. ø 14mm				
	<b>GEV No.</b>	511187	<b>Ref. No.</b>	630113
pump cover FIR inlet ø 45mm outlet ø 40mm turn direction right ø 160mm ID ø 122mm inner high 21mm				
	<b>GEV No.</b>	521022	<b>Ref. No.</b>	630254
fanwheel cover ID ø 137mm ED ø 142mm H 70mm for wash pump				



				
1				
<b>GEV No.</b>	499045	<b>Ref. No.</b>	100896	
<b>description</b>	pump inlet ø 45mm outlet ø 40mm type 4268.2350 230V 50Hz 1 phase 0.45kW 0.6HP L 205mm rotation direction right capacitor 12.5µF FIR			

				
1				
<b>GEV No.</b>	499139	<b>Ref. No.</b>	100398 100633	
<b>description</b>	pump inlet ø 62mm outlet ø 62mm type 2275.2722 230/400V 50Hz 3 phase 2.6kW L 400mm rotation direction right FIR			
<b>For models:</b>	NE00, NE02, NE3001, NE3002, NE4001, NE4002, NE5002, NE5501, NE5502, NE7002, NE7501, NE7502, NE9001, NE9002, NE9502			
<b>spare parts for</b> 499139				
	<b>GEV No.</b>	510687	<b>Ref. No.</b>	630516
mechanical shaft seal for shaft ø 18mm height counter ring 8mm ID ø 17mm ED ø 39mm H 15mm mounting ø 42mm int. ø 121mm				
	<b>GEV No.</b>	521026	<b>Ref. No.</b>	630418
pump cover gasket ID ø 182.5mm thickness 5x4.5mm				
	<b>GEV No.</b>	521028	<b>Ref. No.</b>	630122
pump cover FIR inlet ø 62mm outlet ø 62mm turn direction right ø 215mm ID ø 175mm inner high 40mm				
	<b>GEV No.</b>	521277	<b>Ref. No.</b>	631628
impellor ø 135mm H 39mm pump type Fir 2275 - 3.6HP thread M14L				
	<b>GEV No.</b>	524676	<b>Ref. No.</b>	630315
fan wheel ø 160mm shaft intake ø 24mm plastic blades 12 W 30mm				





				
1				
<b>GEV No.</b>	500023	<b>Ref. No.</b>	100634	
<b>description</b>	pump inlet ø 63mm outlet ø 47mm type 1225.2725 230/400V 50Hz 3 phase 1.1kW 1.5HP L 335mm rotation direction right FIR			
<b>spare parts for</b> 500023				
	<b>GEV No.</b>	510602	<b>Ref. No.</b>	—
impellor ø 110mm H 34mm rotation direction right thread M8L shaft ø 28mm seat ø 12.2mm blades 6				

Table continues overleaf



<b>spare parts for</b>		500023	
	GEV No.	510693	Ref. No. 630501 H35371
mechanical shaft seal for shaft $\varnothing$ 12mm slide ring ext. $\varnothing$ 24mm slide ring H 15.5mm slide ring int. $\varnothing$ 11mm counter ring mounting $\varnothing$ 24mm height counter ring 8mm counter ring int. $\varnothing$ 13.5mm			
	GEV No.	521513	Ref. No. —
pump cover FIR inlet $\varnothing$ 63mm outlet $\varnothing$ 47mm turn direction right ID $\varnothing$ 150mm inner high 32mm			
	GEV No.	524416	Ref. No. 630411
pump cover gasket thickness 4x4mm Qty 1 pcs			



<b>GEV No.</b>		501452		<b>Ref. No.</b>		100366	
<b>description</b> pump inlet $\varnothing$ 63mm outlet $\varnothing$ 53mm type 1204 220-240V 50Hz 1 phase 1.5kW 2HP L 34mm capacitor internal $\mu$ F FIR							
<b>For models:</b> LC380BT, LC380RCD							
<b>spare parts for</b>		501452					
	GEV No.	510531	Ref. No.	630114			
pump cover FIR inlet $\varnothing$ 63mm outlet $\varnothing$ 53mm auxiliary pressure connection M16x1.5mm supporting pressure open turn direction left $\varnothing$ 185mm ID $\varnothing$ 150mm inner high 37mm							
	GEV No.	510604	Ref. No.	630500 631618			
impeller $\varnothing$ 118mm H 34mm M8R rotation direction left							
	GEV No.	510693	Ref. No.	630501 H35371			
mechanical shaft seal for shaft $\varnothing$ 12mm slide ring ext. $\varnothing$ 24mm slide ring H 15.5mm slide ring int. $\varnothing$ 11mm counter ring mounting $\varnothing$ 24mm height counter ring 8mm counter ring int. $\varnothing$ 13.5mm							
	GEV No.	524416	Ref. No.	630411			
pump cover gasket thickness 4x4mm Qty 1 pcs							



<b>GEV No.</b>		500018		<b>Ref. No.</b>		100361 100716	
<b>description</b> pump inlet $\varnothing$ 63mm outlet $\varnothing$ 53mm type 1204.2528 230/400V 50Hz 3 phase 1.5kW 2HP L 328mm rotation direction left FIR							
<b>spare parts for</b>		500018					
	GEV No.	510523	Ref. No.	630306			
fan wheel $\varnothing$ 142mm shaft intake $\varnothing$ 15mm blades 12							
	GEV No.	510531	Ref. No.	630114			
pump cover FIR inlet $\varnothing$ 63mm outlet $\varnothing$ 53mm auxiliary pressure connection M16x1.5mm supporting pressure open turn direction left $\varnothing$ 185mm ID $\varnothing$ 150mm inner high 37mm							
	GEV No.	510604	Ref. No.	630500 631618			
impeller $\varnothing$ 118mm H 34mm M8R rotation direction left							
	GEV No.	510693	Ref. No.	630501 H35371			
mechanical shaft seal for shaft $\varnothing$ 12mm slide ring ext. $\varnothing$ 24mm slide ring H 15.5mm slide ring int. $\varnothing$ 11mm counter ring mounting $\varnothing$ 24mm height counter ring 8mm counter ring int. $\varnothing$ 13.5mm							
	GEV No.	524416	Ref. No.	630411			
pump cover gasket thickness 4x4mm Qty 1 pcs							







1

<b>GEV No.</b>	500258	<b>Ref. No.</b>	100361 100716
<b>description</b>	pump inlet ø 63mm outlet ø 53mm type 1204.2725 230/400V 50Hz 3 phase 1.5kW 2.01HP L 320mm rotation direction left FIR		
<b>spare parts for</b>	500258		
	GEV No.	510531	Ref. No. 630114
	pump cover FIR inlet ø 63mm outlet ø 53mm auxiliary pressure connection M16x1.5mm supporting pressure open turn direction left ø 185mm ID ø 150mm inner high 37mm		
	GEV No.	510604	Ref. No. 630500 631618
	impellor ø 118mm H 34mm M8R rotation direction left		
	GEV No.	510693	Ref. No. 630501 H35371
	mechanical shaft seal for shaft ø 12mm slide ring ext. ø 24mm slide ring H 15.5mm slide ring int. ø 11mm counter ring mounting ø 24mm height counter ring 8mm counter ring int. ø 13.5mm		
	GEV No.	511667	Ref. No. 630325
	fan wheel ø 123mm H 17mm shaft intake ø 15mm		
	GEV No.	524416	Ref. No. 630411
	pump cover gasket thickness 4x4mm Qty 1 pcs		





1

<b>GEV No.</b>	500031	<b>Ref. No.</b>	100373
<b>description</b>	pump inlet ø 63mm outlet ø 53mm type 1205.2528 230/400V 50Hz 3 phase 2kW 2.7HP L 330mm rotation direction left FIR		
<b>spare parts for</b>	500031		
	GEV No.	510357	Ref. No. 631620
	impellor ø 124mm H 34/16mm thread M8R blades 6		

<b>spare parts for</b>	500031		
	GEV No.	510523	Ref. No. 630306
	fan wheel ø 142mm shaft intake ø 15mm blades 12		
	GEV No.	510531	Ref. No. 630114
	pump cover FIR inlet ø 63mm outlet ø 53mm auxiliary pressure connection M16x1.5mm supporting pressure open turn direction left ø 185mm ID ø 150mm inner high 37mm		
	GEV No.	510693	Ref. No. 630501 H35371
	mechanical shaft seal for shaft ø 12mm slide ring ext. ø 24mm slide ring H 15.5mm slide ring int. ø 11mm counter ring mounting ø 24mm height counter ring 8mm counter ring int. ø 13.5mm		
	GEV No.	524416	Ref. No. 630411
	pump cover gasket thickness 4x4mm Qty 1 pcs		





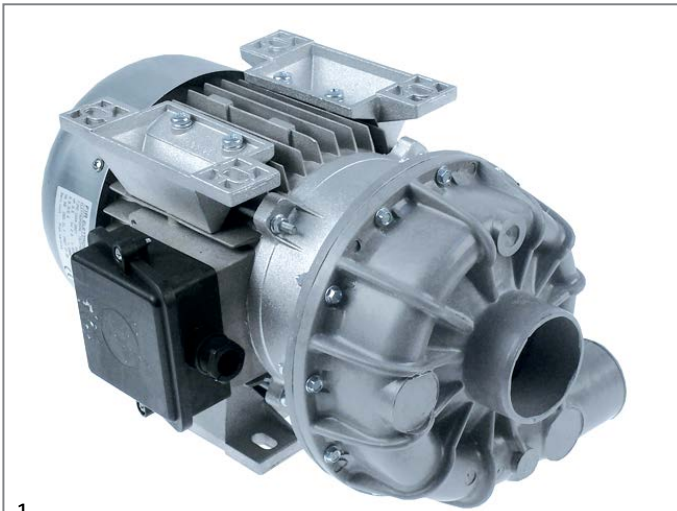

1

<b>GEV No.</b>	500111	<b>Ref. No.</b>	100663
<b>description</b>	pump inlet ø 63mm outlet ø 53mm type 1241.2500 230/400V 50Hz 3 phase 1.1kW 1.5HP L 330mm rotation direction left FIR		
<b>For models:</b>	LC380, LC380BT, LC380RCD, LC400, SE		
<b>spare parts for</b>	500111		
	GEV No.	510531	Ref. No. 630114
	pump cover FIR inlet ø 63mm outlet ø 53mm auxiliary pressure connection M16x1.5mm supporting pressure open turn direction left ø 185mm ID ø 150mm inner high 37mm		
	GEV No.	510612	Ref. No. —
	impellor ø 110mm H 34mm M8R		
	GEV No.	510693	Ref. No. 630501 H35371
	mechanical shaft seal for shaft ø 12mm slide ring ext. ø 24mm slide ring H 15.5mm slide ring int. ø 11mm counter ring mounting ø 24mm height counter ring 8mm counter ring int. ø 13.5mm		
	GEV No.	524416	Ref. No. 630411
	pump cover gasket thickness 4x4mm Qty 1 pcs		





1

<b>GEV No.</b>	500952	<b>Ref. No.</b>	100387 100604 100679 100704 100713
<b>description</b>	pump inlet ø 63mm outlet ø 53mm type 1244.2527 400V 50Hz 3 phase 2.5kW 3.5HP L 360mm rotation direction left FIR		
<b>For models:</b>	ACR, ACR145, ACR205, ACR225, ACR245, ACR260, ACR265, ACR305, ACR5145, ACR5205, ACR5225, ACR5245, ACR5260, ACR5265, ACR5305, GMC, GMC2700, GMC2702, GMC3500, GMC3502, GMC4500, GMC4502, GMC5500, GMC5502, SE		
<b>spare parts for</b>	500952		
	<b>GEV No.</b>	510357	<b>Ref. No.</b> 631620
	impellor ø 124mm H 34/16mm thread M8R blades 6		
	<b>GEV No.</b>	510531	<b>Ref. No.</b> 630114
	pump cover FIR inlet ø 63mm outlet ø 53mm auxiliary pressure connection M16x1.5mm supporting pressure open turn direction left ø 185mm ID ø 150mm inner height 37mm		
	<b>GEV No.</b>	510693	<b>Ref. No.</b> 630501 H35371
	mechanical shaft seal for shaft ø 12mm slide ring ext. ø 24mm slide ring H 15.5mm slide ring int. ø 11mm counter ring mounting ø 24mm height counter ring 8mm counter ring int. ø 13.5mm		
	<b>GEV No.</b>	524416	<b>Ref. No.</b> 630411
	pump cover gasket thickness 4x4mm Qty 1 pcs		



1

<b>GEV No.</b>	501467	<b>Ref. No.</b>	100717
<b>description</b>	pump inlet ø 63mm outlet ø 53mm type 2241.2501 230/400V 50Hz 3 phase 0.89kW 1.5HP L 305mm rotation direction left FIR		
<b>For models:</b>	C95, C95BT, C95E2, C95RCD		

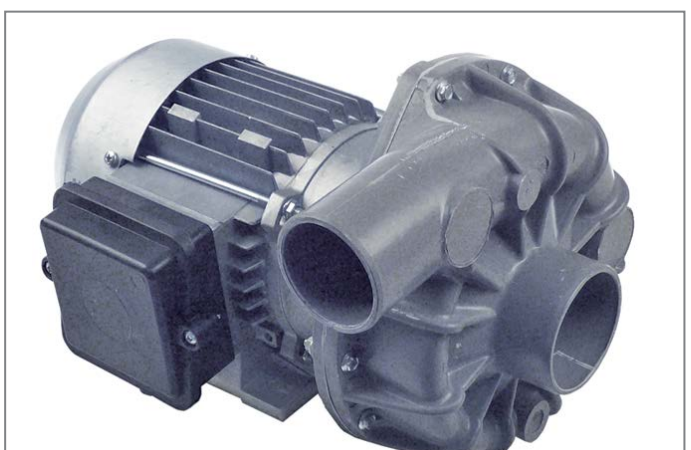

1

<b>GEV No.</b>	499193	<b>Ref. No.</b>	100737
<b>description</b>	pump inlet ø 63mm outlet ø 53mm type 2241.5800 255/440V 60Hz 3 phase 1.1kW L 305mm rotation direction left FIR		



1

<b>GEV No.</b>	499251	<b>Ref. No.</b>	100801
<b>description</b>	pump inlet ø 63mm outlet ø 53mm type 5223.2350 230V 50Hz 1 phase 0.74kW L 314mm rotation direction left capacitor 16µF FIR		
<b>For models:</b>	LC1200, LC1200RCD, LC700, LC700RCD, LC900, LC900RCD		
<b>spare parts for</b>	499251		
	<b>GEV No.</b>	365021	<b>Ref. No.</b> 631202
	operating capacitor capacity 16µF 425V tolerance 5% 50/60Hz ambient temperature max. -25 to +85°C ø 35mm L 73mm single M8 plastic connection male faston 6.3mm 416.10.99 protection		
	<b>GEV No.</b>	502274	<b>Ref. No.</b> 630138
	pump cover FIR inlet ø 63mm outlet ø 53mm		
	<b>GEV No.</b>	502275	<b>Ref. No.</b> 632501
	impellor ø 100mm H 29mm thread M8R blades 6		
	<b>GEV No.</b>	510693	<b>Ref. No.</b> 630501 H35371
	mechanical shaft seal for shaft ø 12mm slide ring ext. ø 24mm slide ring H 15.5mm slide ring int. ø 11mm counter ring mounting ø 24mm height counter ring 8mm counter ring int. ø 13.5mm		
	<b>GEV No.</b>	521022	<b>Ref. No.</b> 630254
	fanwheel cover ID ø 137mm ED ø 142mm H 70mm for wash pump		
	<b>GEV No.</b>	524416	<b>Ref. No.</b> 630411
	pump cover gasket thickness 4x4mm Qty 1 pcs		







1

<b>GEV No.</b>	499300	<b>Ref. No.</b>	100886
<b>description</b>	pump inlet ø 63mm outlet ø 53mm type 5223.4050 230/400V 50Hz 3 phase 1.1kW L 316mm rotation direction left FIR		
<b>For models:</b>	AC2A, ACL100, ACL150		



1

<b>GEV No.</b>	499109	<b>Ref. No.</b>	100797
<b>description</b>	pump inlet ø 63mm outlet ø 53mm type 5233.4051 220-240/380-415V 50Hz 3 phase 1.1kW 1.5HP L 345mm rotation direction left FIR		
<b>For models:</b>	LC1200, LC1200RCD, LC412, LC700, LC700RCD, LC900, LC900RCD		
<b>spare parts for</b>	499109		
	<b>GEV No.</b>	502274	<b>Ref. No.</b> 630138
	pump cover FIR inlet ø 63mm outlet ø 53mm		
	<b>GEV No.</b>	510612	<b>Ref. No.</b> —
	impellor ø 110mm H 34mm M8R		
	<b>GEV No.</b>	510693	<b>Ref. No.</b> 630501 H35371
	mechanical shaft seal for shaft ø 12mm slide ring ext. ø 24mm slide ring H 15.5mm slide ring int. ø 11mm counter ring mounting ø 24mm height counter ring 8mm counter ring int. ø 13.5mm		
	<b>GEV No.</b>	524416	<b>Ref. No.</b> 630411
	pump cover gasket thickness 4x4mm Qty 1 pcs		







1

<b>GEV No.</b>	499113	<b>Ref. No.</b>	H34432
<b>description</b>	pump inlet ø 63mm outlet ø 53mm type 5234.4050 230/400V 50Hz 3 phase 1.62kW 2.2HP L 340mm rotation direction left FIR		
<b>For models:</b>	GF90, GF90-2004, GF90A, GF90A-2004		



1

<b>GEV No.</b>	500741	<b>Ref. No.</b>	100795
<b>description</b>	pump inlet ø 63mm outlet ø 53mm type 5234.4055 230/400V 50Hz 3 phase 1.5kW 2HP L 340mm rotation direction left FIR		
<b>For models:</b>	LC1200, LC1200RCD, LC700, LC700RCD, LC900, LC900RCD		
<b>spare parts for</b>	500741		
	<b>GEV No.</b>	502274	<b>Ref. No.</b> 630138
	pump cover FIR inlet ø 63mm outlet ø 53mm		
	<b>GEV No.</b>	510604	<b>Ref. No.</b> 630500 631618
	impellor ø 118mm H 34mm M8R rotation direction left		
	<b>GEV No.</b>	510693	<b>Ref. No.</b> 630501 H35371
	mechanical shaft seal for shaft ø 12mm slide ring ext. ø 24mm slide ring H 15.5mm slide ring int. ø 11mm counter ring mounting ø 24mm height counter ring 8mm counter ring int. ø 13.5mm		
	<b>GEV No.</b>	524416	<b>Ref. No.</b> 630411
	pump cover gasket thickness 4x4mm Qty 1 pcs		







1

<b>GEV No.</b>	500012	<b>Ref. No.</b>	100387
<b>description</b>	pump type 1243 50Hz rotation direction left FIR		

LGB



1

<b>GEV No.</b>	500510	<b>Ref. No.</b>	100760
<b>description</b>	pump inlet ø 28mm outlet ø 26mm type ZF170SX 230V 50Hz 1 phase 0.3kW 0.41HP L 195mm rotation direction right capacitor 6.3µF LGB		
<b>For models:</b>	BHC25, BHC25A, BHC25S, BHC30, BHC30A, BHC30HR, BHC30HR380, BHC30HRA, BHC30HRA380, BHC433, BHC433A, BHCHR		
<b>spare parts for</b>	500510		
	<b>GEV No.</b>	365012	<b>Ref. No.</b> 631216
	operating capacitor capacity 6.3µF 450V tolerance 5% 50Hz ambient temperature max. -25 to +85°C ø 30mm L 61mm M8 plastic connection male faston 6.3mm protection		
	<b>GEV No.</b>	510703	<b>Ref. No.</b> 630524 630530 630541
	mechanical shaft seal for shaft ø 13mm slide ring H 13mm height counter ring 5.5mm ED ø 26mm		
	<b>GEV No.</b>	521057	<b>Ref. No.</b> 630133
	pump cover LGB inlet ø 28mm outlet ø 26mm auxiliary pressure connection 12mm supporting pressure open turn direction right ø 102mm ID ø 77mm inner height 31mm		
	<b>GEV No.</b>	521225	<b>Ref. No.</b> 631689
	impellor ø 72mm H 22mm rotation direction right thread M7L shaft ø 13mm shaft length 12mm		
	<b>GEV No.</b>	528800	<b>Ref. No.</b> 630427
	O-ring EPDM thickness 2.62mm ID ø 75.87mm Qty 1 pcs		





1

<b>GEV No.</b>	500480	<b>Ref. No.</b>	100802
<b>description</b>	pump inlet ø 28mm outlet ø 28mm type ZF131DX 230V 50Hz 1 phase 0.29kW 0.4HP L 195mm rotation direction left capacitor 6.3µF LGB		
<b>For models:</b>	C1000ERCD, C1300ERCD, FC3E, FC3EA, FC3M, FC3MA, FC3MR, FC44E, FC44EA, FC4E, FC4EA, FC4EHRT, FC4M, FC4MA, GE50RCD, LC1200RCD, LC700RCD, LC900RCD, LF322RCD, XLC		
<b>spare parts for</b>	500480		
	<b>GEV No.</b>	510690	<b>Ref. No.</b> —
	mechanical shaft seal for shaft ø 8mm ED ø 24mm mounting ø 24/26mm		
	<b>GEV No.</b>	521083	<b>Ref. No.</b> —
	impellor ø 73mm H 13mm thread M7R blades 3 metal		
	<b>GEV No.</b>	521084	<b>Ref. No.</b> —
	pump cover LGB inlet ø 28mm outlet ø 25mm auxiliary pressure connection 13mm pump type ZF131DX ID ø 78mm		
	<b>GEV No.</b>	528800	<b>Ref. No.</b> 630427
	O-ring EPDM thickness 2.62mm ID ø 75.87mm Qty 1 pcs		
<b>accessories for</b>	500480		
	<b>GEV No.</b>	365012	<b>Ref. No.</b> 631216
	operating capacitor capacity 6.3µF 450V tolerance 5% 50Hz ambient temperature max. -25 to +85°C ø 30mm L 61mm M8 plastic connection male faston 6.3mm protection		



1





<b>GEV No.</b>	500966	<b>Ref. No.</b>	100827
<b>description</b>	pump inlet ø 29mm outlet ø 31/38mm type FC2006 230V 50Hz 1 phase 0.7kW 0.95HP L 195mm rotation direction left capacitor 16µF LGB		
<b>For models:</b>	FC3E, FC3EA, FC3M, FC3MA, FC3MR, FC44E, FC44EA, FC4E, FC4EA, FC4EHRT, FC4M, FC4MA		
<b>spare parts for</b>	500966		
	<b>GEV No.</b>	365021	<b>Ref. No.</b> 631202
	operating capacitor capacity 16µF 425V tolerance 5% 50/60Hz ambient temperature max. -25 to +85°C ø 35mm L 73mm single M8 plastic connection male faston 6.3mm 416.10.99 protection		
	<b>GEV No.</b>	510703	<b>Ref. No.</b> 630524 630530 630541
	mechanical shaft seal for shaft ø 13mm slide ring H 13mm height counter ring 5.5mm ED ø 26mm		
	<b>GEV No.</b>	521149	<b>Ref. No.</b> 630144
	pump cover LGB outlet ø 38/31mm		
	<b>GEV No.</b>	521150	<b>Ref. No.</b> 632506
	impellor ø 85mm H 17mm thread M8R shaft ø 13mm shaft length 10mm		
	<b>GEV No.</b>	532537	<b>Ref. No.</b> 630433
	O-ring EPDM thickness 3.53mm ID ø 113.9mm Qty 1 pcs		



<b>GEV No.</b>	499348	<b>Ref. No.</b>	100827/1
<b>description</b>	pump inlet ø 29mm outlet ø 31/38mm type FC2006 400V 50Hz 0.6kW L 195mm rotation direction left LGB		
<b>For models:</b>	FC3E, FC3EA, FC3M, FC3MA, FC3MR, FC44E, FC44EA, FC4E, FC4EA, FC4EHRT, FC4M, FC4MA		







<b>GEV No.</b>	500511	<b>Ref. No.</b>	100785
<b>description</b>	pump inlet ø 30mm outlet ø 29mm type ZF140SX 230V 50Hz 1 phase 0.36kW 0.5HP L 190mm rotation direction right LGB		
<b>For models:</b>	BHC25, BHC25-2, BHC25A, BHC25A-2, BHC30, BHC30-2, BHC30A, BHC30A-2, BHC30E, BHC30E-2, BHC30EA, BHC30EA-2, BHC30HR, BHC30HR-2, BHC30HR380, BHC30HRA, BHC30HRA-2, BHC30HRA380, BHC433, BHC433-2, BHC433A, BHC433A-2, BHCHR, LB200, LB200-2, LB200A, LB200A-2, LB215, LB215-2, LB215A, LB215A-2, LB260, LB260-2, LB260A, LB260A-2, LB275, LB275-2, LB275A, LB275A-2		

<b>spare parts for</b> 500511			
	<b>GEV No.</b>	365017	<b>Ref. No.</b> 631208
	operating capacitor capacity 5µF 450V tolerance 5% 50/60Hz ambient temperature max. -25 to +85°C ø 28mm L 54mm M8 plastic connection male faston 6.3mm 16.10.08 protection		
	<b>GEV No.</b>	510703	<b>Ref. No.</b> 630524 630530 630541
	mechanical shaft seal for shaft ø 13mm slide ring H 13mm height counter ring 5.5mm ED ø 26mm		
	<b>GEV No.</b>	521230	<b>Ref. No.</b> 631695
	impellor ø 86mm H 16mm M7L		
	<b>GEV No.</b>	521526	<b>Ref. No.</b> 630135
	pump cover LGB inlet ø 30mm outlet ø 30mm auxiliary pressure connection 12mm supporting pressure open turn direction right ø 117mm ID ø 95mm inner height 19mm		

<b>spare parts for</b> 500511			
	<b>GEV No.</b>	521706	<b>Ref. No.</b> 630424
	pump cover gasket		



<b>GEV No.</b>	500513	<b>Ref. No.</b>	100727
<b>description</b>	pump inlet ø 45mm outlet ø 40mm type FM4023SX 230V 50Hz 1 phase 0.75kW 1HP L 300mm rotation direction right capacitor 16µF LGB		
<b>For models:</b>	LP360, LP360BT, LP360RCD		

<b>spare parts for</b> 500513			
	<b>GEV No.</b>	365021	<b>Ref. No.</b> 631202
	operating capacitor capacity 16µF 425V tolerance 5% 50/60Hz ambient temperature max. -25 to +85°C ø 35mm L 73mm single M8 plastic connection male faston 6.3mm 416.10.99 protection		
	<b>GEV No.</b>	510703	<b>Ref. No.</b> 630524 630530 630541
	mechanical shaft seal for shaft ø 13mm slide ring H 13mm height counter ring 5.5mm ED ø 26mm		
	<b>GEV No.</b>	521246	<b>Ref. No.</b> 631674
	impellor ø 103mm H 26mm thread M8L shaft ø 20mm shaft length 7mm seat ø 8.2mm blades 6		
	<b>GEV No.</b>	521542	<b>Ref. No.</b> 630130
	pump cover LGB inlet ø 45mm outlet ø 40mm auxiliary pressure connection 13mm supporting pressure open ø 150mm ID ø 120mm inner height 25mm		
	<b>GEV No.</b>	521714	<b>Ref. No.</b> 630420 630431
	pump cover gasket thickness 4x4mm Qty 1 pcs		







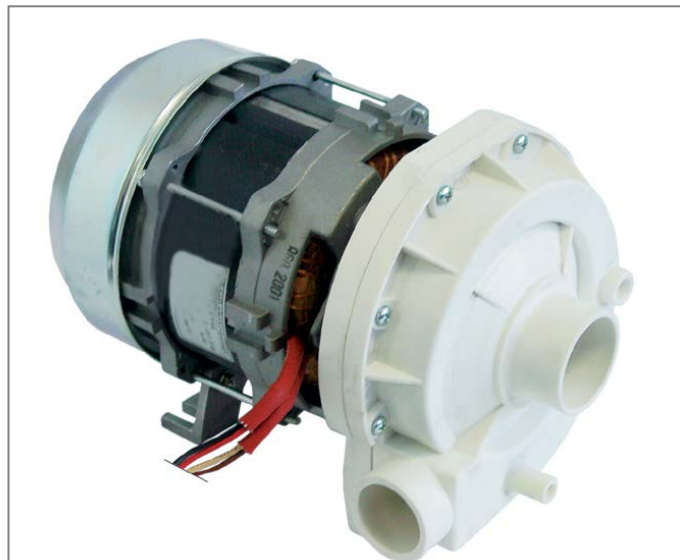

1

<b>GEV No.</b>	499248	<b>Ref. No.</b>	H36612
<b>description</b>	pump inlet ø 45mm outlet ø 40mm type ZF220VSX 230V 50Hz 1 phase 0.85kW L 230mm rotation direction right capacitor 12.5µF LGB		
<b>For models:</b>	GF70, GF70A		
<b>spare parts for</b>	499248		
	<b>GEV No.</b>	365014	<b>Ref. No.</b> 631207
	operating capacitor capacity 12.5µF 450V tolerance 5%Hz ambient temperature max. -25 to +85°C ø 35mm L 70mm M8 plastic connection male faston 6.3mm 45S.C3DS.12.5 protection		
	<b>GEV No.</b>	510556	<b>Ref. No.</b> —
	O-ring EPDM thickness 1.78mm ID ø 94.97mm Qty 1 pcs pump type T110		
	<b>GEV No.</b>	510694	<b>Ref. No.</b> 630528 H33839
	mechanical shaft seal for shaft ø 13mm height counter ring 8mm ID ø 11.5mm H 16mm mounting ø 24/26mm int. ø 14mm		
	<b>GEV No.</b>	521112	<b>Ref. No.</b> H36956
	impellor ø 93mm H 21mm pump type ZF220VSX thread M8L shaft ø 13mm shaft length 11mm		
	<b>GEV No.</b>	521113	<b>Ref. No.</b> H36954
	pump cover LGB inlet ø 45mm outlet ø 40mm pump type ZF220VSX		





1



<b>GEV No.</b>	500512	<b>Ref. No.</b>	100777
<b>description</b>	pump inlet ø 45mm outlet ø 40mm type ZF340VSX 230V 50Hz 1 phase 0.75kW 1HP L 245mm rotation direction right capacitor 16µF LGB		
<b>For models:</b>	LF350, LF350A		
<b>spare parts for</b>	500512		
	<b>GEV No.</b>	365021	<b>Ref. No.</b> 631202
	operating capacitor capacity 16µF 425V tolerance 5% 50/60Hz ambient temperature max. -25 to +85°C ø 35mm L 73mm single M8 plastic connection male faston 6.3mm 416.10.99 protection		
	<b>GEV No.</b>	510702	<b>Ref. No.</b> 630526 630536
	mechanical shaft seal height counter ring 5.5mm ID ø 12mm		
	<b>GEV No.</b>	521246	<b>Ref. No.</b> 631674
	impellor ø 103mm H 26mm thread M8L shaft ø 20mm shaft length 7mm seat ø 8.2mm blades 6		
	<b>GEV No.</b>	521542	<b>Ref. No.</b> 630130
	pump cover LGB inlet ø 45mm outlet ø 40mm auxiliary pressure connection 13mm supporting pressure open ø 150mm ID ø 120mm inner hight 25mm		
	<b>GEV No.</b>	521714	<b>Ref. No.</b> 630420 630431
	pump cover gasket thickness 4x4mm Qty 1 pcs		



<b>1</b>			
<b>GEV No.</b>	499011	<b>Ref. No.</b>	100820
<b>description</b>	pump inlet ø 50mm outlet ø 40mm type ZF350SX 230V 50Hz 1 phase 0.63kW L 201mm rotation direction right LGB 2800rpm suitable capacitor 12.5µF		
<b>For models:</b>	LF321, LF321A, LF322, LF322A, LF322MP, LF322MP-A, LF322RCD, LF324, LF324A, LF325E, LF325EA, LF700, LF700A, LFD32E, LFD32EA, LFD32M, LFD32MA		
<b>spare parts for</b>	499011		
	<b>GEV No.</b>	365014	<b>Ref. No.</b> 631207
	operating capacitor capacity 12.5µF 450V tolerance 5%Hz ambient temperature max. -25 to +85°C ø 35mm L 70mm M8 plastic connection male faston 6.3mm 45S.C3DS.12.5 protection		
	<b>GEV No.</b>	510702	<b>Ref. No.</b> 630526 630536
	mechanical shaft seal height counter ring 5.5mm ID ø 12mm		
	<b>GEV No.</b>	521086	<b>Ref. No.</b> —
	pump cover LGB inlet ø 50mm outlet ø 40mm		
	<b>GEV No.</b>	521278	<b>Ref. No.</b> 631703
	impellor ø 93mm H 32mm pump type ZF350SX thread M8L		



<b>1</b>			
<b>GEV No.</b>	499058	<b>Ref. No.</b>	100819
<b>description</b>	pump inlet ø 50mm outlet ø 40mm type ZF380SX 230V 50Hz 1 phase 0.73kW 0.99HP L 210mm rotation direction right capacitor 16µF LGB		
<b>For models:</b>	LF321, LF321A, LF322, LF322A, LF324, LF324A, LF325E, LF325EA, LF700, LF700A		
<b>spare parts for</b>	499058		
	<b>GEV No.</b>	365021	<b>Ref. No.</b> 631202
	operating capacitor capacity 16µF 425V tolerance 5% 50/60Hz ambient temperature max. -25 to +85°C ø 35mm L 73mm single M8 plastic connection male faston 6.3mm 416.10.99 protection		
	<b>GEV No.</b>	510702	<b>Ref. No.</b> 630526 630536
	mechanical shaft seal height counter ring 5.5mm ID ø 12mm		

<b>spare parts for</b>	499058		
	<b>GEV No.</b>	521086	<b>Ref. No.</b> —
	pump cover LGB inlet ø 50mm outlet ø 40mm		
	<b>GEV No.</b>	521087	<b>Ref. No.</b> 631702
	impellor ø 100mm H 32mm thread M8L		
	<b>GEV No.</b>	521714	<b>Ref. No.</b> 630420 630431
	pump cover gasket thickness 4x4mm Qty 1 pcs		



<b>1</b>			
<b>GEV No.</b>	499247	<b>Ref. No.</b>	100798
<b>description</b>	pump inlet ø 62mm outlet ø 51mm type ZF650DX 230/400V 50Hz 3 phase 1.1kW L 333mm rotation direction left LGB		
<b>For models:</b>	C1000E, C1000ERCD, C1001M, C1300E, C1300ERCD, C1301M, XLC		
<b>spare parts for</b>	499247		
	<b>GEV No.</b>	501399	<b>Ref. No.</b> H34484
	impellor H 42mm thread M8R ED ø 90mm		
	<b>GEV No.</b>	510551	<b>Ref. No.</b> 630426 H33855
	pump cover gasket ID ø 158.3mm pump type 1214/1293/1225/2243/1226/1204/3473/1241 thickness 3.53mm EPDM Qty 1 pcs		
	<b>GEV No.</b>	510694	<b>Ref. No.</b> 630528 H33839
	mechanical shaft seal for shaft ø 13mm height counter ring 8mm ID ø 11.5mm H 16mm mounting ø 24/26mm int. ø 1 14mm		
	<b>GEV No.</b>	521095	<b>Ref. No.</b> —
	impellor ø 110mm H 39mm thread M8R shaft ø 30mm		
	<b>GEV No.</b>	521516	<b>Ref. No.</b> 630137
	pump cover LGB inlet ø 62mm outlet ø 52mm auxiliary pressure connection 12mm supporting pressure closed turn direction left ø 190mm ID ø 150mm inner height 40mm		



<b>GEV No.</b>	500537	<b>Ref. No.</b>	100902
<b>description</b>	pump inlet ø 62mm outlet ø 52mm type ZF522VDX 230V 50Hz 1 phase 0.85kW 1.16HP L 255mm rotation direction left capacitor 16µF auxiliary pressure connection 12mm supporting pressure open LGB		
<b>spare parts for</b>	500537		
	<b>GEV No.</b>	365021	<b>Ref. No.</b> 631202
	operating capacitor capacity 16µF 425V tolerance 5% 50/60Hz ambient temperature max. -25 to +85°C ø 35mm L 73mm single M8 plastic connection male faston 6.3mm 416.10.99 protection		
	<b>GEV No.</b>	510551	<b>Ref. No.</b> 630426 H33855
	pump cover gasket ID ø 158.3mm pump type 1214/1293/1225/2243/1226/1204/3473/1241 thickness 3.53mm EPDM Qty 1 pcs		
	<b>GEV No.</b>	510693	<b>Ref. No.</b> 630501 H35371
	mechanical shaft seal for shaft ø 12mm slide ring ext. ø 24mm slide ring H 15.5mm slide ring int. ø 11mm counter ring mounting ø 24mm height counter ring 8mm counter ring int. ø 13.5mm		
	<b>GEV No.</b>	512420	<b>Ref. No.</b> —
	bracket mounting distance 110mm		
	<b>GEV No.</b>	512421	<b>Ref. No.</b> —
	fan wheel shaft intake ø 11mm ø 110mm H 20mm		
	<b>GEV No.</b>	521058	<b>Ref. No.</b> —
	fanwheel cover suitable for LGB ID ø 138mm ED ø 142mm H 59mm plastic		
	<b>GEV No.</b>	521281	<b>Ref. No.</b> —
	impellor ø 90mm H 30mm thread M8R shaft ø 20mm shaft length 10mm seat ø 8.2mm blades 6		
	<b>GEV No.</b>	521516	<b>Ref. No.</b> 630137
	pump cover LGB inlet ø 62mm outlet ø 52mm auxiliary pressure connection 12mm supporting pressure closed turn direction left ø 190mm ID ø 150mm inner height 40mm		



<b>GEV No.</b>	500780	<b>Ref. No.</b>	100796
<b>description</b>	pump inlet ø 62mm outlet ø 52mm type ZF800DX 230/400V 50Hz 3 phase 1.5kW 2HP L 340mm rotation direction left LGB		
<b>For models:</b>	C1000E, C1000ERCD, C1001M, C1300E, C1300ERCD, C1301M, GE50RCD, XLC		
<b>spare parts for</b>	500780		
	<b>GEV No.</b>	510551	<b>Ref. No.</b> 630426 H33855
	pump cover gasket ID ø 158.3mm pump type 1214/1293/1225/2243/1226/1204/3473/1241 thickness 3.53mm EPDM Qty 1 pcs		
	<b>GEV No.</b>	510694	<b>Ref. No.</b> 630528 H33839
	mechanical shaft seal for shaft ø 13mm height counter ring 8mm ID ø 11.5mm H 16mm mounting ø 24/26mm int. ø 14mm		
	<b>GEV No.</b>	521276	<b>Ref. No.</b> 631692
	impellor ø 120mm H 39mm pump type ZF800DX shaft intake ø 12mm rotation direction left thread M8R pump for ZF800DX blades 6		
	<b>GEV No.</b>	521516	<b>Ref. No.</b> 630137
	pump cover LGB inlet ø 62mm outlet ø 52mm auxiliary pressure connection 12mm supporting pressure closed turn direction left ø 190mm ID ø 150mm inner height 40mm		

LOWARA

pumps



<b>GEV No.</b>	501453	<b>Ref. No.</b>	100729
<b>description</b>	pump inlet ø 44mm outlet ø 35mm type 2MH3TA 220/240V 50Hz 3 phase 0.4kW L 550mm LOWARA		
<b>For models:</b>	ACRS145, ACRS205, ACRS225, ACRS245, ACRS260, ACRS265, ACRS305, ACS101, ACS101-DIGIT, ACS122, ACS122-DIGIT, ACS151, ACS151-DIGIT, ACS152, ACS152-DIGIT, ACS161-DIGIT, ACS162-DIGIT, ACS181, ACS181-DIGIT, ACS182, ACS182-DIGIT, ACS201, ACS201-DIGIT, ACS202, ACS202-DIGIT, ACS241, ACS241-DIGIT, ACS242, ACS242-DIGIT, ACS91, ACS91-DIGIT, GMC2700, GMC2702, GMC3500, GMC3502, GMC4500, GMC4502, GMC5500, GMC5502, NE3002, NE4002, NE5002, NE5502, NE7002, NE7502, NE9002, NE9502, NL302, NL302E, NL402...(Other models you can see in the webshop)		





miscellaneous



<b>GEV No.</b>	500006	<b>Ref. No.</b>	100375
<b>description</b>	pump type AL11 230V 50Hz 1 phase 0.29kW 0.4HP IBMEI		



<b>GEV No.</b>	500016	<b>Ref. No.</b>	100399
<b>description</b>	pump type AL15 1 phase IBMEI		

booster pumps I



<b>GEV No.</b>	499236	<b>Ref. No.</b>	100698 100789
<b>description</b>	pump inlet $\phi$ 1 1/4" IT outlet $\phi$ 1" IT type CEA120/2/A 220-240/380-415V 50Hz 3 phase 0.64kW rotation direction left LOWARA		
<b>For models:</b>	G100L, G101L, G115, G115L, G125, G125L, G50L, G50LM, G51L, G60L, G61L, G65, G65L, G75, G75L, GE100, GE115, GE125, GE60, GE60RCD, GE65, GE65RCD, GE75, GE80, GL, NG00, NG01, NG02, NG1202, NG1202E, NG600, NG600E, NG601, NG601E, NG602, NG602E, NG900, NG900E, NG901, NG901E, NG902, NG902E		



<b>GEV No.</b>	500060	<b>Ref. No.</b>	100302 H25342	
<b>description</b>	pump inlet $\phi$ 1" outlet $\phi$ 1" type PQM60 230V 50Hz 1 phase 0.37kW PEDRELLO			
<b>For models:</b>	GF90, GF90-2004, GF90A, GF90A-2004			
<b>accessories for</b>	500060			
	<b>GEV No.</b>	365015	<b>Ref. No.</b>	3068016 631206
	operating capacitor capacity 10 $\mu$ F 400V tolerance 5%Hz ambient temperature max. -25 to +85°C $\phi$ 35.5mm L 59mm M8 plastic connection male faston 6.3mm protection			



<b>GEV No.</b>	500395	<b>Ref. No.</b>	100736	
<b>description</b>	pump inlet $\phi$ 3/8" IT outlet $\phi$ 3/8" IT type PS45DX 230V 50Hz 0.35kW capacitor 8 $\mu$ F LGB			
<b>For models:</b>	C166-2			
<b>spare parts for</b>	500395			
	<b>GEV No.</b>	365013	<b>Ref. No.</b>	—
	operating capacitor capacity 8 $\mu$ F 400V tolerance 5%Hz ambient temperature max. -25 to +85°C $\phi$ 31.5mm L 55mm M8 plastic connection male faston 6.3mm protection			
	<b>GEV No.</b>	698400	<b>Ref. No.</b>	—
	pump cover gasket pump type PS46 thickness 2mm ID $\phi$ 66mm Qty 1 pcs			

drain pumps

GRE



<b>GEV No.</b>	500967	<b>Ref. No.</b>	100803	
<b>description</b>	drain pump inlet $\phi$ 30mm outlet $\phi$ 22mm 100W 230V 50Hz GRE			
<b>For models:</b>	BHC25-2, BHC25A-2, BHC30-2, BHC30A-2, BHC30E, BHC30E-2, BHC30EA, BHC30EA-2, BHC30HR, BHC30HR-2, BHC30HR380, BHC30HRA, BHC30HRA-2, BHC30HRA380, BHC433-2, BHC433A-2, BHCHR, C1000E, C1300E, LB200, LB200-2, LB200A, LB200A-2, LB215, LB215-2, LB215A, LB215A-2, LB260, LB260-2, LB260A, LB260A-2, LB275, LB275-2, LB275A, LB275A-2, LC1200, LC700, LC900, LF321, LF321A, LF322, LF322A, LF324, LF324A, LF325E, LF325EA, LF700, LF700A, XLC			
<b>spare parts for</b>	500967			
	<b>GEV No.</b>	500307	<b>Ref. No.</b>	—
	filter			
	<b>GEV No.</b>	500899	<b>Ref. No.</b>	630139
	pump cover inlet $\phi$ 30mm outlet $\phi$ 22mm pump type 500.213			



<b>GEV No.</b>	499359	<b>Ref. No.</b>	100893 (new version)
<b>description</b>	drain pump inlet $\phi$ 30mm outlet $\phi$ 22mm 34W 230V 50Hz GRE		





1

<b>GEV No.</b>	500961	<b>Ref. No.</b>	100342
<b>description</b>	drain pump inlet ø 30mm outlet ø 23mm 100W 230V 50Hz GRE		
<b>For models:</b>	BC25HR, BC30HR, BC30HR380, BC30HRA, BHC25, BHC25A, BHC25S, BHC30, BHC30A, BHC30HR, BHC30HR380, BHC30HRA, BHC30HRA380, BHC433, BHC433A, BHCHR, F90M, F90MA, FC, FC43, FC53, FC533, FC533A, FC53A, FC53CBT, FC53LA, FC53LBT, FC54, FC543, FC543A, FC543E, FC543EA, FC544, FC544A, FC54A, FC54CBT, FC54E, FC54EA, FC54LBT, GF70, GF70A, GF90-2004, GF90A-2004, LF315, LF320, LF320A, LF320CBT, LF320L, LF320LA, LF320LBT...(Other models you can see in the webshop)		
<b>accessories for</b>	500961		
	<b>GEV No.</b>	524719	<b>Ref. No.</b> —
	formed hose hose ext. ø 40mm hose int. ø 30mm L 65mm warewashing black Qty 1		



1

<b>GEV No.</b>	499059	<b>Ref. No.</b>	100893
<b>description</b>	drain pump inlet ø 30mm outlet ø 24mm 230V 30W 50Hz HANNING type DPS25-131		
<b>For models:</b>	BHC25-2, BHC25A-2, BHC30-2, BHC30A-2, BHC30E-2, BHC30EA-2, BHC30HR-2, BHC30HRA-2, BHC433-2, BHC433A-2, LB200, LB200A, LB215, LB215A, LB260, LB260A, LB275, LB275A, LF315, LF320A, LF320CBT, LF320LA, LF320LBT, LF321, LF321A, LF322, LF322A, LF322MP, LF322MP-A, LF322RCD, LF323, LF323A, LF324, LF324A, LF325E, LF325EA, LF350, LF350A, LF400A, LF450, LF450A, LF700, LF700A, LFD32E, LFD32EA, LFD32M, LFD32MA		



1

<b>GEV No.</b>	499048	<b>Ref. No.</b>	100695
<b>description</b>	pump inlet ø 30mm outlet ø 24mm 190W 230V 50Hz GRE		
<b>For models:</b>	FC, FCHR, FCHRA, FCHRT, FCHRTA		

service kits



1

<b>GEV No.</b>	500573	<b>Ref. No.</b>	100890
<b>description</b>	drain pump 30W 4-piece 230V inlet ø 24/30mm outlet ø 24mm 50Hz HANNING type DPS25-032 1x pump, 3x pump cover		

HANNING



1

<b>GEV No.</b>	500573	<b>Ref. No.</b>	100890
<b>description</b>	drain pump 30W 4-piece 230V inlet ø 24/30mm outlet ø 24mm 50Hz HANNING type DPS25-032 1x pump, 3x pump cover		

booster pumps II

accessories



1

<b>GEV No.</b>	365015	<b>Ref. No.</b>	3068016 631206
<b>description</b>	operating capacitor capacity 10µF 400V tolerance 5%Hz ambient temperature max. -25 to +85°C ø 35.5mm L 59mm M8 plastic connection male faston 6.3mm protection		
<b>For models:</b>	B23, B24, B25, B26, B27, F2, F3, F55, F65, FC, FC53, FC533, FC533A, FC53A, FC53CBT, FC53LA, FC53LBT, FC54, FC543, FC543A, FC543E, FC543EA, FC544, FC544A, FC54A, FC54CBT, FC54E, FC54EA, FC54LBT, FCHR, FCHRA, FCHRT, FCHRTA, GF90, GF90-2004, GF90A, GF90A-2004, LF315, LF320, LF320A, LF320CBT, LF320L, LF320LA, LF320LBT, LF323, LF323A, LS550, R50, R70		





			
1			
<b>GEV No.</b>	365017	<b>Ref. No.</b>	631208
<b>description</b>	operating capacitor capacity 5µF 450V tolerance 5% 50/60Hz ambient temperature max. -25 to +85°C ø 28mm L 54mm M8 plastic connection male faston 6.3mm 16.10.08 protection		
<b>For models:</b>	B10, B10T, B11, B11T, B12, B12T, B13T, B14T, B15, B15T, B15TM, B16, B16T, B16TM, B18, B18T, B18TM, B19, B19T, B19TM, B20, B20D, B23, B24, B25, B26, B27, BC25, BC25A, BC25HR, BC30, BC30A, BC30HR, BC30HR380, BC30HRA, BHC25, BHC25-2, BHC25A, BHC25A-2, BHC30, BHC30-2, BHC30A, BHC30A-2, BHC30E, BHC30E-2, BHC30EA, BHC30EA-2, BHC30HR, BHC30HR-2, BHC30HR380...(Other models you can see in the webshop)		

			
1			
<b>GEV No.</b>	365012	<b>Ref. No.</b>	631216
<b>description</b>	operating capacitor capacity 6.3µF 450V tolerance 5% 50Hz ambient temperature max. -25 to +85°C ø 30mm L 61mm M8 plastic connection male faston 6.3mm protection		
<b>For models:</b>	BHC25, BHC25A, BHC25S, BHC30, BHC30A, BHC30HR, BHC30HR380, BHC30HRA, BHC30HRA380, BHC433, BHC433A, BHCHR, C1000ERCD, C1300ERCD, FC3E, FC3EA, FC3M, FC3MA, FC3MR, FC44E, FC44EA, FC4E, FC4EA, FC4EHRT, FC4M, FC4MA, GE50RCD, LC1200RCD, LC700RCD, LC900RCD, LF322RCD, XLC		

			
1			
<b>GEV No.</b>	365014	<b>Ref. No.</b>	631207
<b>description</b>	operating capacitor capacity 12.5µF 450V tolerance 5%Hz ambient temperature max. -25 to +85°C ø 35mm L 70mm M8 plastic connection male faston 6.3mm 45S.C3DS.12.5 protection		
<b>For models:</b>	C30, C70, C75, C75BT, C75M, C75RCD, C85, F3, F300, F80, LF321, LF321A, LF322, LF322A, LF322MP, LF322MP-A, LF322RCD, LF324, LF324A, LF325E, LF325EA, LF450, LF450A, LF700, LF700A, LFD32E, LFD32EA, LFD32M, LFD32MA		

			
1			
<b>GEV No.</b>	365021	<b>Ref. No.</b>	631202
<b>description</b>	operating capacitor capacity 16µF 425V tolerance 5% 50/60Hz ambient temperature max. -25 to +85°C ø 35mm L 73mm single M8 plastic connection male faston 6.3mm 416.10.99 protection		
<b>For models:</b>	FC3E, FC3EA, FC3M, FC3MA, FC3MR, FC44E, FC44EA, FC4E, FC4EA, FC4EHRT, FC4M, FC4MA, LC1200, LC1200RCD, LC700, LC700RCD, LC900, LC900RCD, LF321, LF321A, LF322, LF322A, LF324, LF324A, LF325E, LF325EA, LF350, LF350A, LF700, LF700A, LP360, LP360BT, LP360RCD		

			
1			
<b>GEV No.</b>	365017	<b>Ref. No.</b>	631208
<b>description</b>	operating capacitor capacity 5µF 450V tolerance 5% 50/60Hz ambient temperature max. -25 to +85°C ø 28mm L 54mm M8 plastic connection male faston 6.3mm 16.10.08 protection		
<b>For models:</b>	B10, B10T, B11, B11T, B12, B12T, B13T, B14T, B15, B15T, B15TM, B16, B16T, B16TM, B18, B18T, B18TM, B19, B19T, B19TM, B20, B20D, B23, B24, B25, B26, B27, BC25, BC25A, BC25HR, BC30, BC30A, BC30HR, BC30HR380, BC30HRA, BHC25, BHC25-2, BHC25A, BHC25A-2, BHC30, BHC30-2, BHC30A, BHC30A-2, BHC30E, BHC30E-2, BHC30EA, BHC30EA-2, BHC30HR, BHC30HR-2, BHC30HR380...(Other models you can see in the webshop)		

			
1			
<b>GEV No.</b>	365012	<b>Ref. No.</b>	631216
<b>description</b>	operating capacitor capacity 6.3µF 450V tolerance 5% 50Hz ambient temperature max. -25 to +85°C ø 30mm L 61mm M8 plastic connection male faston 6.3mm protection		
<b>For models:</b>	BHC25, BHC25A, BHC25S, BHC30, BHC30A, BHC30HR, BHC30HR380, BHC30HRA, BHC30HRA380, BHC433, BHC433A, BHCHR, C1000ERCD, C1300ERCD, FC3E, FC3EA, FC3M, FC3MA, FC3MR, FC44E, FC44EA, FC4E, FC4EA, FC4EHRT, FC4M, FC4MA, GE50RCD, LC1200RCD, LC700RCD, LC900RCD, LF322RCD, XLC		

## condensators & interference suppression filters

### operating capacitors

#### plastic

			
1			
<b>GEV No.</b>	365015	<b>Ref. No.</b>	3068016 631206
<b>description</b>	operating capacitor capacity 10µF 400V tolerance 5%Hz ambient temperature max. -25 to +85°C ø 35.5mm L 59mm M8 plastic connection male faston 6.3mm protection		
<b>For models:</b>	B23, B24, B25, B26, B27, F2, F3, F55, F65, FC, FC53, FC533, FC533A, FC53A, FC53CBT, FC53LA, FC53LBT, FC54, FC543, FC543A, FC543E, FC543EA, FC544, FC544A, FC54A, FC54CBT, FC54E, FC54EA, FC54LBT, FCHR, FCHRA, FCHRT, FCHRTA, GF90, GF90-2004, GF90A, GF90A-2004, LF315, LF320, LF320A, LF320CBT, LF320L, LF320LA, LF320LBT, LF323, LF323A, LS550, R50, R70		



filters

interference suppression filters



<b>GEV No.</b>	365046	<b>Ref. No.</b>	631209
<b>description</b>	interference suppression filter type 10S7E-G1474253105-Q 115/250V 50/60Hz conductor 2 with E connection male faston 6.3mm L 40mm ø 40mm Hmm Wmm M8 plastic Qty 1 pcs		



<b>GEV No.</b>	365086	<b>Ref. No.</b>	631209
<b>description</b>	interference suppression filter type 10S7E-G1474253105-Q 115/250V 50/60Hz conductor 2 with E connection male faston 6.3mm L 40mm ø 40mm Hmm Wmm M8 plastic Qty 1 pcs		

fuses

fine fuses



<b>GEV No.</b>	358667	<b>Ref. No.</b>	130263
<b>description</b>	fine fuse size ø5x20mm 0.4A fast-acting rated 250V Qty 10 pcs		



<b>GEV No.</b>	358596	<b>Ref. No.</b>	130273
<b>description</b>	fine fuse size ø5x20mm 0.25A slow-acting rated 250V Qty 10 pcs		
<b>For models:</b>	AC122, AC151, AC152, AC181, AC182, AC201, AC202, AC241, AC242, ACR, ACR145, ACR205, ACR225, ACR245, ACR260, ACR265, ACR305, C155BT, C155RCD, C75BT, C75RCD, C95BT, C95RCD, FC53CBT, FC53LA, FC53LBT, FC54CBT, FC54LBT, GF90, GF90A, GMC, GMC2700, GMC3500, GMC4500, GMC5500, LC1200RCD, LC380BT, LC380RCD, LC700RCD, LC900RCD, LF320CBT, LF320L, LF320LA, LF320LBT, LF400A, LP360BT, LP360RCD		



<b>GEV No.</b>	358702	<b>Ref. No.</b>	130262
<b>description</b>	fine fuse size ø5x20mm 0.315A slow-acting rated 250V Qty 10 pcs		



<b>GEV No.</b>	358602	<b>Ref. No.</b>	130265
<b>description</b>	fine fuse size ø5x20mm 1.6A slow-acting rated 250V Qty 10 pcs		
<b>For models:</b>	AC122, AC151, AC152, AC181, AC182, AC201, AC202, AC241, AC242, ACR, ACR145, ACR205, ACR225, ACR245, ACR260, ACR265, ACR305, GMC, GMC2700, GMC3500, GMC4500, GMC5500, NE3001, NE4001, NE5501, NE7501, NE9001, NG01, NG601, NG601E, NG901, NG901E		



<b>GEV No.</b>	358600	<b>Ref. No.</b>	130264
<b>description</b>	fine fuse size ø5x20mm 1A slow-acting rated 250V Qty 10 pcs		
<b>For models:</b>	AC122, AC151, AC152, AC181, AC182, AC201, AC202, AC241, AC242, ACR, ACR145, ACR205, ACR225, ACR245, ACR260, ACR265, ACR305, BHC30E, BHC30EA, C155BT, C155RCD, C75BT, C75RCD, C95BT, C95RCD, FC53CBT, FC53LA, FC53LBT, FC54CBT, FC54E, FC54EA, FC54LBT, GF90, GF90A, GMC, GMC2700, GMC3500, GMC4500, GMC5500, LC1200RCD, LC380BT, LC380RCD, LC700RCD, LC900RCD, LF320CBT, LF320L, LF320LA, LF320LBT, LF400A, LP360BT...(Other models you can see in the webshop)		



<b>GEV No.</b>	358603	<b>Ref. No.</b>	130270
<b>description</b>	fine fuse size ø5x20mm 2A slow-acting rated 250V Qty 10 pcs		
<b>For models:</b>	C155BT, C155RCD, C75BT, C75RCD, C95BT, C95RCD, FC53CBT, FC53LA, FC53LBT, FC54CBT, FC54LBT, GF90, GF90A, LC1200RCD, LC380BT, LC380RCD, LC700RCD, LC900RCD, LF320CBT, LF320L, LF320LA, LF320LBT, LF400A, LP360BT, LP360RCD		



<b>GEV No.</b>	358606	<b>Ref. No.</b>	130266
<b>description</b>	fine fuse size ø5x20mm 4A slow-acting rated 250V Qty 10 pcs		

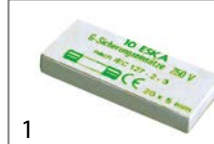



<b>GEV No.</b>	358609	<b>Ref. No.</b>	130274
<b>description</b>	fine fuse size ø5x20mm 5A slow-acting rated 250V Qty 10 pcs		
<b>For models:</b>	C155BT, C155RCD, C75BT, C75RCD, C95BT, C95RCD, FC53CBT, FC53LA, FC53LBT, FC54CBT, FC54LBT, GF90, GF90A, LC1200RCD, LC380BT, LC380RCD, LC700RCD, LC900RCD, LF320CBT, LF320L, LF320LA, LF320LBT, LF400A, LP360BT, LP360RCD		







 <p>1</p>			
<b>GEV No.</b>	358037	<b>Ref. No.</b>	130232
<b>description</b>	fine fuse size $\phi$ 10x38mm 8A slow-acting rated 500V type aM Qty 1 pcs		
<b>For models:</b>	AC100, AC101, AC120, AC122, AC150, AC151, AC152, AC170, AC181, AC182, AC200, AC201, AC202, AC241, AC242, AC90, AC91, ACR, ACR145, ACR205, ACR225, ACR245, ACR260, ACR265, ACR305, ACS101, ACS101-DIGIT, ACS122, ACS122-DIGIT, ACS151, ACS151-DIGIT, ACS152, ACS152-DIGIT, ACS161-DIGIT, ACS162-DIGIT, ACS181, ACS181-DIGIT, ACS182, ACS182-DIGIT, ACS201, ACS201-DIGIT, ACS202, ACS202-DIGIT, ACS241, ACS241-DIGIT, ACS242, ACS242-DIGIT, ACS91, ACS91-DIGIT, GMC...(Other models you can see in the webshop)		

 <p>1</p>			
<b>GEV No.</b>	358021	<b>Ref. No.</b>	130260
<b>description</b>	fine fuse size $\phi$ 10x38mm 2A rated 500V type gI fast-acting Qty 1 pcs		

 <p>1</p>			
<b>GEV No.</b>	358024	<b>Ref. No.</b>	130245
<b>description</b>	fine fuse size $\phi$ 10x38mm 8A rated 500V type gI fast-acting Qty 1 pcs		
<b>For models:</b>	AC120, AC150, AC170, AC200, ACR, ACR145, ACR205, ACR225, ACR245, ACR260, ACR265, ACR305, ACRS145, ACRS205, ACRS225, ACRS245, ACRS260, ACRS265, ACRS305, G100L, G101L, G115L, G125L, G50L, G50LM, G51L, G60L, G61L, G65, G65L, G75, G75L, GL, GMC, GMC2700, GMC2702, GMC3500, GMC3502, GMC4500, GMC4502, GMC5500, GMC5502		

 <p>Image not available</p> <p>1</p>			
<b>GEV No.</b>	358196	<b>Ref. No.</b>	130246
<b>description</b>	fine fuse size $\phi$ 10x38mm 12A rated 500V type Gg fast-acting Qty 1 pcs		

fine fuse holders

 <p>1</p>			
<b>GEV No.</b>	358075	<b>Ref. No.</b>	150710
<b>description</b>	fuse holder for for fuse $\phi$ 10x38mm suitable fuse $\phi$ 10x38mm 1-pole 32A rated 690V for DIN rail 35mm cross section 10mm <sup>2</sup> suitable for for fuse $\phi$ 10x38mm		
<b>For models:</b>	AC100, AC101, AC105, AC120, AC122, AC135, AC150, AC151, AC152, AC170, AC181, AC182, AC200, AC201, AC202, AC241, AC242, AC2A, AC90, AC91, AC95, ACR, ACR145, ACR205, ACR225, ACR245, ACR260, ACR265, ACR305, ACS101, ACS101-DIGIT, ACS122, ACS122-DIGIT, ACS151, ACS151-DIGIT, ACS152, ACS152-DIGIT, ACS161-DIGIT, ACS162-DIGIT, ACS181, ACS181-DIGIT, ACS201, ACS201-DIGIT, ACS202, ACS202-DIGIT, ACS241, ACS241-DIGIT, ACS242...(Other models you can see in the webshop)		

 <p>1</p>			
<b>GEV No.</b>	358027	<b>Ref. No.</b>	130247
<b>description</b>	fine fuse size $\phi$ 10x38mm 16A rated 500V type Gg fast-acting Qty 1 pcs		
<b>For models:</b>	AC100, AC105, AC120, AC150, AC170, AC200, AC90, AC95, ACR, ACR145, ACR205, ACR225, ACR245, ACR260, ACR265, ACR305, ACRS145, ACRS205, ACRS225, ACRS245, ACRS260, ACRS265, ACRS305, G66, GMC, GMC2700, GMC2702, GMC3500, GMC3502, GMC4500, GMC4502, GMC5500, GMC5502, NE00, NE3001, NE4001, NE5501, NE7501, NE9001, SE, SNL		

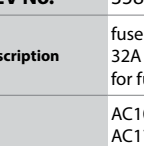
 <p>1</p>			
<b>GEV No.</b>	358075	<b>Ref. No.</b>	150710
<b>description</b>	fuse holder for for fuse $\phi$ 10x38mm suitable fuse $\phi$ 10x38mm 1-pole 32A rated 690V for DIN rail 35mm cross section 10mm <sup>2</sup> suitable for for fuse $\phi$ 10x38mm		
<b>For models:</b>	AC100, AC101, AC105, AC120, AC122, AC135, AC150, AC151, AC152, AC170, AC181, AC182, AC200, AC201, AC202, AC241, AC242, AC2A, AC90, AC91, AC95, ACR, ACR145, ACR205, ACR225, ACR245, ACR260, ACR265, ACR305, ACS101, ACS101-DIGIT, ACS122, ACS122-DIGIT, ACS151, ACS151-DIGIT, ACS152, ACS152-DIGIT, ACS161-DIGIT, ACS162-DIGIT, ACS181, ACS181-DIGIT, ACS201, ACS201-DIGIT, ACS202, ACS202-DIGIT, ACS241, ACS241-DIGIT, ACS242...(Other models you can see in the webshop)		

 <p>1</p>			
<b>GEV No.</b>	358028	<b>Ref. No.</b>	130248
<b>description</b>	fine fuse size $\phi$ 10x38mm 20A rated 500V type Gg fast-acting Qty 1 pcs		
<b>For models:</b>	AC101, AC120, AC122, AC150, AC151, AC152, AC170, AC181, AC182, AC200, AC201, AC202, AC241, AC242, AC91, ACR, ACR145, ACR205, ACR225, ACR245, ACR260, ACR265, ACR305, ACRS145, ACRS205, ACRS225, ACRS245, ACRS260, ACRS265, ACRS305, ACS101, ACS101-DIGIT, ACS122, ACS122-DIGIT, ACS151, ACS151-DIGIT, ACS152, ACS152-DIGIT, ACS161-DIGIT, ACS162-DIGIT, ACS181, ACS181-DIGIT, ACS182, ACS182-DIGIT, ACS201, ACS201-DIGIT, ACS202, ACS202-DIGIT, ACS241, ACS241-DIGIT...(Other models you can see in the webshop)		

line circuit breakers

ABL SURSUM

 <p>1</p>			
<b>GEV No.</b>	358233	<b>Ref. No.</b>	121022
<b>description</b>	line circuit breaker 3-pole 32A tripping type K rated 400V		
<b>For models:</b>	AC101, AC105, AC122, AC151, AC152, AC181, AC182, AC201, AC202, AC241, AC242, AC2A, AC91, AC95, ACL100, ACL150, ACS101, ACS101-DIGIT, ACS122, ACS122-DIGIT, ACS151, ACS151-DIGIT, ACS152, ACS152-DIGIT, ACS161-DIGIT, ACS162-DIGIT, ACS181, ACS181-DIGIT, ACS182, ACS182-DIGIT, ACS201, ACS201-DIGIT, ACS202, ACS202-DIGIT, ACS241, ACS241-DIGIT, ACS242, ACS242-DIGIT, ACS91, ACS91-DIGIT, LAV1000, LV1001, LV1501, LV-LVP, LVP1001, LVP1501, NE02, NE3001, NE3002, NE4001...(Other models you can see in the webshop)		

 <p>1</p>			
<b>GEV No.</b>	358032	<b>Ref. No.</b>	130253
<b>description</b>	fine fuse size $\phi$ 10x38mm 25A rated 500V type Gg fast-acting Qty 1 pcs		
<b>For models:</b>	G115		



## miscellaneous



<b>GEV No.</b>	358126	<b>Ref. No.</b>	121026
<b>description</b>	line circuit breaker 3-pole 80A tripping type C rated 400V connection screw clamp		
<b>For models:</b>	AC101, AC122, AC151, AC152, AC181, AC182, AC201, AC202, AC241, AC242, AC2A, AC91, ACL100, ACL150, ACS101, ACS101-DIGIT, ACS122, ACS122-DIGIT, ACS151, ACS151-DIGIT, ACS152, ACS152-DIGIT, ACS161-DIGIT, ACS162-DIGIT, ACS181, ACS181-DIGIT, ACS182, ACS182-DIGIT, ACS201, ACS201-DIGIT, ACS202, ACS202-DIGIT, ACS241, ACS241-DIGIT, ACS242, ACS242-DIGIT, ACS91, ACS91-DIGIT, NE02, NE3002, NE4002, NE5002, NE5502, NE7002, NE7502, NE9002, NE9502, NG01, NG02, NG1202...(Other models you can see in the webshop)		

## connection terminals with screw connection



<b>GEV No.</b>	551119	<b>Ref. No.</b>	150220
<b>description</b>	rail-mounted terminal 3-pole max 600V connection screw		
<b>For models:</b>	B10T, B11T, B12T, B13T, B14T, F300, F45, R40, R50		

## electric accessories

## cables

## ribbon cables

## group 1



<b>GEV No.</b>	402992	<b>Ref. No.</b>	110482
<b>description</b>	ribbon cable 20-pole L 1250mm plug type 2 row coded		
<b>For models:</b>	BHC30HR-2, BHC30HRA-2, C1000E, C1000ERCD, C1300E, C1300ERCD, FC3E, FC3EA, FC44E, FC44EA, FC4E, FC4EA, FC4EHR, GE100, GE115, GE125, GE50RCD, GE60, GE60RCD, GE65, GE65RCD, GE75, GE80, XLC		

## terminals

## connection terminals with screw/faston connections



<b>GEV No.</b>	550534 <sup>1</sup>	<b>Ref. No.</b>	150226
<b>description</b>	power terminal block 3-pole max. 40A max 450V connection $\phi 6\text{mm}^2$ / F6.3 temp.-resist. 150°C cross section 6mm <sup>2</sup> mounting distance 67mm with ground lug		
<b>For models:</b>	LB200, LB200-2, LB200A, LB200A-2, LB215, LB215-2, LB215A, LB215A-2, LB260, LB260-2, LB260A, LB260A-2, LB275, LB275-2, LB275A, LB275A-2, LBR, LBR200, LBR215, LBR215A		

<sup>1</sup>with ground lug

<b>GEV No.</b>	550411	<b>Ref. No.</b>	130321
<b>description</b>	power terminal block 6-pole max. 40A max 450V connection $\phi 6\text{mm}^2$ / F6.3 temp.-resist. 150°C cross section 6mm <sup>2</sup>		
<b>For models:</b>	FC3E, FC3EA, FC3M, FC3MA, FC3MR, FC44E, FC44EA, FC4E, FC4EA, FC4EHR, FC4M, FC4MA, GF70, GF70A, LF322MP, LF322MP-A, LF322RCD, LFD32E, LFD32EA, LFD32M, LFD32MA		

## electronic components

## condensators

## group 1



<b>GEV No.</b>	511225	<b>Ref. No.</b>	631213
<b>description</b>	operating capacitor capacity 0.1 $\mu\text{F}$		
<b>For models:</b>	AC100, AC105, AC120, AC135, AC150, AC170, AC200, AC90, AC95, ACR, ACR145, ACR205, ACR225, ACR245, ACR260, ACR265, ACR305, SE, SNL		

## equipment-specific units

## for dough mixers

## chains

## connectors





<b>GEV No.</b>	693276	<b>Ref. No.</b>	410903
<b>description</b>	connector single DIN/ISO 08 B-1 splitting 1/2" links 1 L 23mm internal width 11.8mm roller $\phi$ 4.3mm metal		
<b>For models:</b>	AC100, AC101, AC105, AC120, AC122, AC135, AC150, AC151, AC152, AC170, AC181, AC182, AC200, AC201, AC202, AC241, AC242, AC90, AC91, AC95, ACR, ACR145, ACR205, ACR225, ACR245, ACR260, ACR265, ACR305, ACR5145, ACR5205, ACR5225, ACR5245, ACR5260, ACR5265, ACR5305, ACS101, ACS101-DIGIT, ACS122, ACS122-DIGIT, ACS151, ACS151-DIGIT, ACS152, ACS152-DIGIT, ACS161-DIGIT, ACS162-DIGIT, ACS181, ACS181-DIGIT, ACS182, ACS182-DIGIT, ACS201...(Other models you can see in the webshop)		





for espresso machines



brewing units			
filter holder gaskets			
O-rings			
			
1			
<b>GEV No.</b>	510409	<b>Ref. No.</b>	200815
<b>description</b>	O-ring EPDM thickness 5.34mm ID ø 56.52mm Qty 1 pcs		
<b>For models:</b>	AC100, AC101, AC105, AC120, AC122, AC135, AC150, AC151, AC152, AC170, AC181, AC182, AC200, AC201, AC202, AC241, AC242, AC2A, AC90, AC91, AC95, ACR, ACR145, ACR205, ACR225, ACR245, ACR260, ACR265, ACR305, ACS101, ACS101-DIGIT, ACS122, ACS122-DIGIT, ACS151, ACS151-DIGIT, ACS152, ACS152-DIGIT, ACS161-DIGIT, ACS162-DIGIT, ACS181, ACS181-DIGIT, ACS182, ACS182-DIGIT, ACS201, ACS201-DIGIT, ACS202, ACS202-DIGIT, ACS241, ACS241-DIGIT, ACS242...(Other models you can see in the webshop)		

steam/water taps			
steam/water pipes			
accessories			
gaskets			
			
1			
<b>GEV No.</b>	510893	<b>Ref. No.</b>	200810 200845
<b>description</b>	O-ring EPDM thickness 2.62mm ID ø 9.92mm Qty 1 pcs		
<b>For models:</b>	B10, B10T, B11, B11T, B12, B12T, B13T, B14T, B15, B15T, B15TM, B16, B16T, B16TM, B18, B18T, B18TM, B19, B19T, B19TM, B20, B20D, B23, B24, B25, B26, B27, B31, B32, BC25, BC25A, BC25HR, BC30, BC30A, BC30HR, BC30HR380, BC30HRA, BR20, BR20A, BR25, BR25A, F20, F90M, F90MA, FC, FC43, FC43A, FC53, FC533, FC533A...(Other models you can see in the webshop)		



for coffee grinders



			
1			
<b>GEV No.</b>	345019	<b>Ref. No.</b>	120712
<b>description</b>	rotary switch sets of contacts 2 2 0-1 type CA0120002 380V 12A shaft ø 5x5mm shaft L 23mm shaft square connection screw		
<b>For models:</b>	AC101, AC105, AC2A, AC91, AC95, ACL100, ACL150, ACS101, ACS101-DIGIT, ACS91, ACS91-DIGIT, B10, B10T, B11, B11T, B12, B12T, B13T, B14T, B15, B15T, B15TM, B16, B16T, B16TM, B18, B18T, B18TM, B19, B19T, B19TM, BC25, BC30, BHC25, BHC25-2, BHC25A-2, BHC25S, BHC30, BHC30-2, BHC30A-2, BR20, BR25, C33, C34, F2, F3, F300, F45, G131, G66...(Other models you can see in the webshop)		



for garbage disposal units

			
1			
<b>GEV No.</b>	694473	<b>Ref. No.</b>	CH313237
<b>description</b>	knife for garbage disposal unit L 25.5mm W 25.5mm H 25.5mm		
			
1			
<b>GEV No.</b>	694472	<b>Ref. No.</b>	CH312390
<b>description</b>	knife for garbage disposal unit L 95mm W 70mm H 26mm		



for dishwashers

drain and intake components			
COMENDA			
drain /intake bodies			
			
1			
<b>GEV No.</b>	511567	<b>Ref. No.</b>	190122
<b>description</b>	bearing for drain assembly L 53mm H 20mm		
<b>For models:</b>	NE00, SE		
			
1			
<b>GEV No.</b>	510803	<b>Ref. No.</b>	160203
<b>description</b>	connection angle ED ø 35mm ID ø 30mm		
<b>For models:</b>	AC100, AC101, AC105, AC120, AC122, AC135, AC150, AC151, AC152, AC170, AC181, AC182, AC200, AC201, AC202, AC241, AC242, AC90, AC91, AC95, ACR, ACR145, ACR205, ACR225, ACR245, ACR260, ACR265, ACR305, ACRS145, ACRS205, ACRS225, ACRS245, ACRS260, ACRS265, ACRS305, ACS101, ACS101-DIGIT, ACS122, ACS122-DIGIT, ACS151, ACS151-DIGIT, ACS152, ACS152-DIGIT, ACS91, ACS91-DIGIT, B13T, B14T, B15, B15T, B15TM...(Other models you can see in the webshop)		
			
1			
<b>GEV No.</b>	517411	<b>Ref. No.</b>	190326
<b>description</b>	connection angle ED ø 70mm		
<b>For models:</b>	AC120, AC150, AC170, AC200, ACR, ACR145, ACR205, ACR225, ACR245, ACR260, ACR265, ACR305, GMC, GMC2700, GMC3500, GMC4500, GMC5500, LV1001, LV1501, LV-LVP, LVP1001, LVP1501, NE3001, NE4001, NE5501, NE7501, NE9001		



			
<b>GEV No.</b>	510945	<b>Ref. No.</b>	190308
<b>description</b>	connection angle for overflow pipe		
<b>For models:</b>	AC241, AC242, ACL100, ACL150, ACR5145, ACR5205, ACR5225, ACR5245, ACR5260, ACR5265, ACR5305, ACS181, ACS181-DIGIT, ACS182, ACS182-DIGIT, ACS201, ACS201-DIGIT, ACS202, ACS202-DIGIT, ACS241, ACS241-DIGIT, ACS242, ACS242-DIGIT, GMC2702, GMC3502, GMC4502, GMC5502, NG01, NG601E, NG901E, SE, SNL		
<b>accessories for</b>	510945		
	<b>GEV No.</b>	510498	<b>Ref. No.</b> 180109
	nut thread 1 1/2"		
	<b>GEV No.</b>	516254	<b>Ref. No.</b> 200410
	flat gasket rubber ED ø 66mm ID ø 46mm thickness 2.1mm Qty 1 pcs		

			
<b>GEV No.</b>	512110	<b>Ref. No.</b>	190225
<b>description</b>	drain connection thread 1 1/4" hose ø 30mm		
<b>For models:</b>	BHC25, BHC25-2, BHC25A, BHC25A-2, BHC255, BHC30, BHC30-2, BHC30A, BHC30A-2, BHC30E, BHC30E-2, BHC30EA, BHC30EA-2, BHC30HR, BHC30HR-2, BHC30HR380, BHC30HRA, BHC30HRA-2, BHC30HRA380, BHC433, BHC433-2, BHC433A, BHC433A-2, BHCHR, GF70, GF70A, LB200, LB200-2, LB200A, LB200A-2, LB215, LB215-2, LB215A, LB215A-2, LB260, LB260-2, LB260A, LB260A-2, LB275, LB275-2, LB275A, LB275A-2, LF321, LF321A, LF322, LF322A, LF322MP, LF322MP-A, LF322RCD, LF324...(Other models you can see in the webshop)		
<b>accessories for</b>	512110		
	<b>GEV No.</b>	512111	<b>Ref. No.</b> 200867
	O-ring EPDM thickness 2.62mm ID ø 45.69mm Qty 1 pcs		

			
<b>GEV No.</b>	517602	<b>Ref. No.</b>	H15818
<b>description</b>	drain fitting ED ø 21.5mm ID ø 12.5mm hose ø 7.5mm		
<b>For models:</b>	FC3E, FC3EA, FC3MA, FC44E, FC44EA, FC4E, FC4EA, FC4EHR, FC4MA		

			
<b>GEV No.</b>	511431	<b>Ref. No.</b>	270403
<b>description</b>	drain fitting thread 1 1/2"		
<b>For models:</b>	G115, G125, G131, G65, G66, G75		
<b>accessories for</b>	511431		
	<b>GEV No.</b>	511309	<b>Ref. No.</b> 270104
	nut thread 1 1/2" ø 66mm H 9mm WS 51 brass Qty 1 pcs		
	<b>GEV No.</b>	516254	<b>Ref. No.</b> 200410
	flat gasket rubber ED ø 66mm ID ø 46mm thickness 2.1mm Qty 1 pcs		

			
<b>GEV No.</b>	511925	<b>Ref. No.</b>	160308
<b>description</b>	drain fitting thread 1 1/2" ED ø 59mm ID ø 40mm		
<b>For models:</b>	FC, FC53, FC533, FC533A, FC53A, FC53CBT, FC53LA, FC53LBT, FC54, FC543, FC543A, FC543E, FC543EA, FC544, FC544A, FC54A, FC54CBT, FC54E, FC54EA, FC54LBT, FCHR, FCHRA, FCHRT, FCHRTA		

			
<b>GEV No.</b>	510805	<b>Ref. No.</b>	160301 160306 160307
<b>description</b>	drain fitting thread 1 1/2" ED ø 68mm ID ø 39mm		
<b>For models:</b>	AC100, AC101, AC105, AC120, AC122, AC135, AC150, AC151, AC152, AC170, AC181, AC182, AC200, AC201, AC202, AC241, AC242, AC2A, AC90, AC91, AC95, ACL100, ACL150, ACR, ACR145, ACR205, ACR225, ACR245, ACR260, ACR265, ACR305, ACR5145, ACR5205, ACR5225, ACR5245, ACR5260, ACR5265, ACR5305, ACS101, ACS101-DIGIT, ACS122, ACS122-DIGIT, ACS151, ACS151-DIGIT, ACS152, ACS152-DIGIT, ACS161-DIGIT, ACS162-DIGIT, ACS91, ACS91-DIGIT...(Other models you can see in the webshop)		
<b>accessories for</b>	510805		
	<b>GEV No.</b>	510498	<b>Ref. No.</b> 180109
	nut thread 1 1/2"		

			
<b>GEV No.</b>	511308	<b>Ref. No.</b>	270408
<b>description</b>	drain fitting thread 1 1/2" H 40mm ID ø 41/35mm		
<b>For models:</b>	G100L, G101L, G115L, G125L, G50L, G50LM, G51L, G60L, G61L, G65L, G75L, GE125, GE75, GL		







			
<b>GEV No.</b>	524582	<b>Ref. No.</b>	270407 270409
<b>description</b>	drain fitting thread 1 1/2" ID ø 35.5mm		
<b>For models:</b>	AC101, AC105, AC120, AC122, AC135, AC150, AC151, AC152, AC170, AC181, AC182, AC200, AC201, AC202, AC241, AC242, AC91, AC95, ACR, ACR145, ACR205, ACR225, ACR245, ACR260, ACR265, ACR305, ACR5145, ACR5205, ACR5225, ACR5245, ACR5260, ACR5265, ACR5305, ACS101, ACS101-DIGIT, ACS122, ACS122-DIGIT, ACS151, ACS151-DIGIT, ACS152, ACS152-DIGIT, ACS161-DIGIT, ACS162-DIGIT, ACS181, ACS181-DIGIT, ACS182, ACS182-DIGIT, ACS201, ACS201-DIGIT, ACS202...(Other models you can see in the webshop)		
<b>accessories for</b>	524582		
	<b>GEV No.</b>	510876	<b>Ref. No.</b> 200412
	flat gasket rubber ED ø 45mm ID ø 33mm thickness 3mm Qty 1 pcs		

Table continues overleaf





<b>accessories for</b> 524582			
	<b>GEV No.</b>	511298	<b>Ref. No.</b> 160201
hose connector hose ø 35mm			
	<b>GEV No.</b>	511309	<b>Ref. No.</b> 270104
nut thread 1½" ø 66mm H 9mm WS 51 brass Qty 1 pcs			
	<b>GEV No.</b>	516254	<b>Ref. No.</b> 200410
flat gasket rubber ED ø 66mm ID ø 46mm thickness 2.1mm Qty 1 pcs			

	1		
<b>GEV No.</b>	511336	<b>Ref. No.</b>	160307 160309
<b>description</b>	drain fitting thread 1½" ID ø 39mm		
<b>For models:</b>	FC, FC53, FC533, FC533A, FC53A, FC53CBT, FC53LA, FC53LBT, FC54, FC543, FC543A, FC543E, FC543EA, FC544, FC544A, FC54A, FC54CBT, FC54E, FC54EA, FC54LBT, FCHR, FCHRA, FCHRT, FCHRTA		

	1		
<b>GEV No.</b>	511294	<b>Ref. No.</b>	180204
<b>description</b>	flange ED ø 130mm H 9mm ID ø 70mm		
<b>For models:</b>	AC100, AC135, AC90, C33, C34, G115, G131, G65, G66, NE00, SE, SNL		

	1		
<b>GEV No.</b>	510876	<b>Ref. No.</b>	200412
<b>description</b>	flat gasket rubber ED ø 45mm ID ø 33mm thickness 3mm Qty 1 pcs		
<b>For models:</b>	AC100, AC101, AC105, AC120, AC122, AC135, AC150, AC151, AC152, AC170, AC181, AC182, AC200, AC201, AC202, AC241, AC242, AC2A, AC90, AC91, AC95, ACL100, ACL150, ACR, ACR145, ACR205, ACR225, ACR245, ACR260, ACR265, ACR305, ACRS145, ACRS205, ACRS225, ACRS245, ACRS260, ACRS265, ACRS305, ACS101, ACS101-DIGIT, ACS122, ACS122-DIGIT, ACS151, ACS151-DIGIT, ACS152, ACS152-DIGIT, ACS161-DIGIT, ACS162-DIGIT, ACS181, ACS181-DIGIT...(Other models you can see in the webshop)		

	1		
<b>GEV No.</b>	511196	<b>Ref. No.</b>	200919
<b>description</b>	flat gasket rubber ED ø 59mm ID ø 48mm thickness 2mm Qty 1 pcs		
<b>For models:</b>	FC, FC53, FC533, FC533A, FC53A, FC53CBT, FC53LA, FC53LBT, FC54, FC543, FC543A, FC543E, FC543EA, FC544, FC544A, FC54A, FC54CBT, FC54E, FC54EA, FC54LBT, FCHR, FCHRA, FCHRT, FCHRTA, GE50RCD		



	1		
<b>GEV No.</b>	516254	<b>Ref. No.</b>	200410
<b>description</b>	flat gasket rubber ED ø 66mm ID ø 46mm thickness 2.1mm Qty 1 pcs		

	1		
<b>GEV No.</b>	511318	<b>Ref. No.</b>	200913
<b>description</b>	flat gasket rubber ED ø 75mm ID ø 59mm thickness 2mm Qty 1 pcs		
<b>For models:</b>	AC122, AC152, AC182, AC202, AC242, BC25, BC25A, BC25HR, BC30, BC30A, BC30HR, BC30HR380, BC30HRA, BR20, BR20A, BR25, BR25A, FC43, FC43A		

	1		
<b>GEV No.</b>	510832	<b>Ref. No.</b>	200906
<b>description</b>	flat gasket rubber ED ø 92mm ID ø 66mm thickness 2mm Qty 1 pcs equiv. no. 200906/33456		
<b>For models:</b>	AC101, AC105, AC120, AC122, AC135, AC150, AC151, AC152, AC170, AC181, AC182, AC200, AC201, AC202, AC241, AC242, AC2A, AC91, AC95, ACL100, ACL150, ACR, ACR145, ACR205, ACR225, ACR245, ACR260, ACR265, ACR305, ACRS145, ACRS205, ACRS225, ACRS245, ACRS260, ACRS265, ACRS305, ACS101, ACS101-DIGIT, ACS122, ACS122-DIGIT, ACS151, ACS151-DIGIT, ACS152, ACS152-DIGIT, ACS161-DIGIT, ACS162-DIGIT, ACS181, ACS181-DIGIT, ACS182, ACS182-DIGIT...(Other models you can see in the webshop)		

	1		
<b>GEV No.</b>	511290	<b>Ref. No.</b>	200436
<b>description</b>	gasket ED ø 129mm ID ø 95mm		
<b>For models:</b>	B10, B10T, B11, B11T, B12, B12T, B20, B20D, B23, B24, B25, B26, B27, LBC210, LBC215, LBC215A, LBC275, LBC275A, LBR, LBR200, LBR215, LBR215A		

	1		
<b>GEV No.</b>	510807	<b>Ref. No.</b>	160202
<b>description</b>	hose connector hose ø 30mm		
<b>For models:</b>	B41, B42, C30, C33, C34, F2, F3, F300, R40, R50, R70		

			
1			
<b>GEV No.</b>	511298	<b>Ref. No.</b>	160201
<b>description</b>	hose connector hose ø 35mm		
<b>For models:</b>	AC100, AC101, AC105, AC120, AC122, AC135, AC150, AC151, AC152, AC170, AC181, AC182, AC200, AC201, AC202, AC241, AC242, AC2A, AC90, AC91, AC95, ACL100, ACL150, ACR, ACR145, ACR205, ACR225, ACR245, ACR260, ACR265, ACR305, ACRS145, ACRS205, ACRS225, ACRS245, ACRS260, ACRS265, ACRS305, ACS101, ACS101-DIGIT, ACS122, ACS122-DIGIT, ACS151, ACS151-DIGIT, ACS152, ACS152-DIGIT, ACS161-DIGIT, ACS162-DIGIT, ACS181, ACS181-DIGIT...(Other models you can see in the webshop)		
<b>accessories for</b>	511298		
	<b>GEV No.</b>	510356	<b>Ref. No.</b>
			180102
	nut thread 1½"		
	<b>GEV No.</b>	510876	<b>Ref. No.</b>
			200412
	flat gasket rubber ED ø 45mm ID ø 33mm thickness 3mm Qty 1 pcs		

			
1			
<b>GEV No.</b>	511329	<b>Ref. No.</b>	180142
<b>description</b>	intake body thread 1¼" ID ø 32mm		
<b>For models:</b>	BHC25, BHC25-2, BHC25A, BHC25A-2, BHC30, BHC30-2, BHC30A, BHC30A-2, BHC30E-2, BHC30EA-2, BHC30HR, BHC30HR-2, BHC30HR380, BHC30HRA, BHC30HRA-2, BHC30HRA380, BHC433, BHC433-2, BHC433A, BHC433A-2, BHCHR, LB200, LB200A, LB215, LB215A, LB260, LB260A, LB275, LB275A, LF315, LF320A, LF320CBT, LF320LA, LF320LBT, LF321, LF321A, LF322, LF322A, LF322MP, LF322MP-A, LF322RCD, LF323, LF323A, LF324, LF324A, LF325E, LF325EA, LF350, LF350A, LF400A...(Other models you can see in the webshop)		

			
1			
<b>GEV No.</b>	511291	<b>Ref. No.</b>	180210
<b>description</b>	intake body thread 1½" ED ø 140mm H 75mm ID ø 85mm hose ø 30mm		
<b>For models:</b>	B10, B10T, B11, B11T, B12, B12T, B20, B20D, B23, B24, B25, B26, B27, LBC210, LBC215, LBC215A, LBC275, LBC275A, LBR, LBR200, LBR215, LBR215A		

			
1			
<b>GEV No.</b>	510819	<b>Ref. No.</b>	180228
<b>description</b>	intake body thread 1½" ED ø 227mm hose ø 46mm		
<b>For models:</b>	C70, C75, C75BT, C75M, C75RCD, F45, F55, F65, F80, F90M, F90MA, LF280-lav-line, LF315, LF320, LF320A, LF320CBT, LF320L, LF320LA, LF320-lav-line, LF320LBT, LF323, LF323A, LF350, LF350A, LF400A, LF450, LF450A, LP360, LP360BT, LP360RCD, LS550		

			
1			
<b>GEV No.</b>	511330	<b>Ref. No.</b>	160310
<b>description</b>	intake body thread 1½" ID ø 38mm		

			
1			
<b>GEV No.</b>	510472	<b>Ref. No.</b>	180235
<b>description</b>	intake body thread 2" ID ø 50mm		
<b>For models:</b>	AC120, AC150, AC170, AC200, ACR, ACR145, ACR205, ACR225, ACR245, ACR260, ACR265, ACR305, C140, C85, GF90, GF90-2004, GF90A, GF90A-2004, GMC, GMC2700, GMC3500, GMC4500, GMC5500, LC380, LC380BT, LC380RCD, LC400, LV1501, LV-LVP, LVP1501, NE02, NE3001, NE3002, NE4001, NE4002, NE5002, NE5501, NE5502, NE7002, NE7501, NE7502, NE9001, NE9002, NE9502, NG02, NG1202, NG1202E, NG602, NG602E, NG902...(Other models you can see in the webshop)		

			
1			
<b>GEV No.</b>	511295	<b>Ref. No.</b>	180203
<b>description</b>	intake body		
<b>For models:</b>	SE, SNL		

			
1			
<b>GEV No.</b>	510804	<b>Ref. No.</b>	160603
<b>description</b>	intake body ED ø 120mm		
<b>For models:</b>	C30, F2, F3, F300, R40, R70		

			
1			
<b>GEV No.</b>	511338	<b>Ref. No.</b>	180207
<b>description</b>	intake body ED ø 128mm ID ø 60mm		
<b>For models:</b>	AC100, AC135, AC90, C33, C34, NE00, SE, SNL		

			
1			
<b>GEV No.</b>	511430	<b>Ref. No.</b>	160204
<b>description</b>	intake body ED ø 31mm ID ø 15/26mm hose ø 21mm		
<b>For models:</b>	B10, B10T, B11, B11T, B12, B12T, LBC210, LBC215, LBC215A, LBC275, LBC275A, LBR, LBR200, LBR215, LBR215A		



			
1			
<b>GEV No.</b>	510815	<b>Ref. No.</b>	180236
<b>description</b>	intake body thread 2" ID ø 51mm		
<b>For models:</b>	AC101, AC105, AC120, AC122, AC135, AC150, AC151, AC152, AC170, AC181, AC182, AC200, AC201, AC202, AC241, AC242, AC2A, AC91, AC95, ACL100, ACL150, ACR, ACR145, ACR205, ACR225, ACR245, ACR260, ACR265, ACR305, ACRS145, ACRS205, ACRS225, ACRS245, ACRS260, ACRS265, ACRS305, ACS101, ACS101-DIGIT, ACS122, ACS122-DIGIT, ACS151, ACS151-DIGIT, ACS152, ACS152-DIGIT, ACS161-DIGIT, ACS162-DIGIT, ACS181, ACS181-DIGIT, ACS182, ACS182-DIGIT...(Other models you can see in the webshop)		

			
1			
<b>GEV No.</b>	519583	<b>Ref. No.</b>	180248
<b>description</b>	intake/drain body thread 1½" ED ø 130mm ID ø 90mm hose ø 50mm		
<b>For models:</b>	C1000E, C1000ERCD, C1001M, C1300E, C1300ERCD, C1301M, GE50RCD, LC1200, LC1200RCD, LC412, LC700, LC700RCD, LC900, LC900RCD, XLC		

			
1			
<b>GEV No.</b>	511319	<b>Ref. No.</b>	180239
<b>description</b>	intake/drain body thread 2" hose ø 26/32mm		
<b>For models:</b>	AC122, AC152, AC182, AC202, AC242, BC25, BC25A, BC25HR, BC30, BC30A, BC30HR, BC30HR380, BC30HRA, BR20, BR20A, BR25, BR25A, FC43, FC43A		

			
1			
<b>GEV No.</b>	511327	<b>Ref. No.</b>	320166
<b>description</b>	lid for inlet valve		
<b>For models:</b>	BHC30HR, BHC30HR-2, BHC30HR380, BHC30HRA, BHC30HRA-2, BHC30HRA380, BHCHR, FC, FC53, FC533, FC533A, FC53A, FC53CBT, FC53LA, FC53LBT, FC54, FC543, FC543A, FC543E, FC543EA, FC544, FC544A, FC54A, FC54CBT, FC54E, FC54EA, FC54LBT, FCHR, FCHRA, FCHRT, FCHRTA, GF70, GF70A		

			
1			
<b>GEV No.</b>	510356	<b>Ref. No.</b>	180102
<b>description</b>	nut thread 1½"		
<b>For models:</b>	AC100, AC101, AC105, AC120, AC122, AC135, AC150, AC151, AC152, AC170, AC181, AC182, AC200, AC201, AC202, AC241, AC242, AC2A, AC90, AC91, AC95, ACL100, ACL150, ACR, ACR145, ACR205, ACR225, ACR245, ACR260, ACR265, ACR305, ACRS145, ACRS205, ACRS225, ACRS245, ACRS260, ACRS265, ACRS305, ACS101, ACS101-DIGIT, ACS122, ACS122-DIGIT, ACS151, ACS151-DIGIT, ACS152, ACS152-DIGIT, ACS161-DIGIT, ACS162-DIGIT, ACS181, ACS181-DIGIT...(Other models you can see in the webshop)		
<b>accessories for</b>	510356		
	<b>GEV No.</b>	510876	<b>Ref. No.</b> 200412
flat gasket rubber ED ø 45mm ID ø 33mm thickness 3mm Qty 1 pcs			
	<b>GEV No.</b>	511298	<b>Ref. No.</b> 160201
hose connector hose ø 35mm			



			
1			
<b>GEV No.</b>	510498	<b>Ref. No.</b>	180109
<b>description</b>	nut thread 1½"		
<b>For models:</b>	AC100, AC101, AC105, AC120, AC122, AC135, AC150, AC151, AC152, AC170, AC181, AC182, AC200, AC201, AC202, AC241, AC242, AC2A, AC90, AC91, AC95, ACL100, ACL150, ACR, ACR145, ACR205, ACR225, ACR245, ACR260, ACR265, ACR305, ACRS145, ACRS205, ACRS225, ACRS245, ACRS260, ACRS265, ACRS305, ACS101, ACS101-DIGIT, ACS122, ACS122-DIGIT, ACS151, ACS151-DIGIT, ACS152, ACS152-DIGIT, ACS161-DIGIT, ACS162-DIGIT, ACS181, ACS181-DIGIT...(Other models you can see in the webshop)		

			
1			
<b>GEV No.</b>	511309	<b>Ref. No.</b>	270104
<b>description</b>	nut thread 1½" ø 66mm H 9mm WS 51 brass Qty 1 pcs		
<b>For models:</b>	AC101, AC105, AC120, AC122, AC135, AC150, AC151, AC152, AC170, AC181, AC182, AC200, AC201, AC202, AC241, AC242, AC91, AC95, ACR, ACR145, ACR205, ACR225, ACR245, ACR260, ACR265, ACR305, ACRS145, ACRS205, ACRS225, ACRS245, ACRS260, ACRS265, ACRS305, ACS101, ACS101-DIGIT, ACS122, ACS122-DIGIT, ACS151, ACS151-DIGIT, ACS152, ACS152-DIGIT, ACS161-DIGIT, ACS162-DIGIT, ACS181, ACS181-DIGIT, ACS182, ACS182-DIGIT, ACS201, ACS201-DIGIT, ACS202...(Other models you can see in the webshop)		





			
1			
<b>GEV No.</b>	511332	<b>Ref. No.</b>	180145
<b>description</b>	nut thread 1 3/4"		
<b>For models:</b>	BHC25, BHC25-2, BHC25A, BHC25A-2, BHC25S, BHC30, BHC30-2, BHC30A, BHC30A-2, BHC30E, BHC30E-2, BHC30EA, BHC30EA-2, BHC30HR, BHC30HR-2, BHC30HR380, BHC30HRA, BHC30HRA-2, BHC30HRA380, BHC433, BHC433-2, BHC433A, BHC433A-2, BHCHR, LB200, LB200-2, LB200A, LB200A-2, LB215, LB215-2, LB215A, LB215A-2, LB260, LB260-2, LB260A, LB260A-2, LB275, LB275-2, LB275A, LB275A-2, LF321, LF321A, LF322, LF322A, LF322MP, LF322MP-A, LF322RCD, LF324, LF324A, LF325E...(Other models you can see in the webshop)		

			
2			
<b>GEV No.</b>	511317	<b>Ref. No.</b>	160771 160783
<b>description</b>	nut thread 2"		
<b>For models:</b>	AC122, AC152, AC182, AC202, AC242, BC25, BC25A, BC25HR, BC30, BC30A, BC30HR, BC30HR380, BC30HRA, BR20, BR20A, BR25, BR25A, FC43, FC43A		

			
1			
<b>GEV No.</b>	510632	<b>Ref. No.</b>	180251
<b>description</b>	opposite support ED 110mm ID 50mm		
<b>For models:</b>	FC3E, FC3EA, FC3M, FC3MA, FC3MR, FC44E, FC44EA, FC4E, FC4EA, FC4EHR, FC4M, FC4MA		
<b>accessories for</b>	510632		
	<b>GEV No.</b>	<b>Ref. No.</b>	<b>200963</b>
	flat gasket rubber ED 110mm ID 88mm thickness 3mm Qty 1 pcs		

			
1			
<b>GEV No.</b>	510469	<b>Ref. No.</b>	191057
<b>description</b>	opposite support ED 130mm H 74mm		
<b>For models:</b>	C140, C85, GF90, GF90-2004, GF90A, GF90A-2004, LC380, LC380BT, LC380RCD, LC400		

			
1			
<b>GEV No.</b>	512111	<b>Ref. No.</b>	200867
<b>description</b>	O-ring EPDM thickness 2.62mm ID 45.69mm Qty 1 pcs		
<b>For models:</b>	BHC25, BHC25-2, BHC25A, BHC25A-2, BHC25S, BHC30, BHC30-2, BHC30A, BHC30A-2, BHC30E, BHC30E-2, BHC30EA, BHC30EA-2, BHC30HR, BHC30HR-2, BHC30HR380, BHC30HRA, BHC30HRA-2, BHC30HRA380, BHC433, BHC433-2, BHC433A, BHC433A-2, BHCHR, LB200, LB200-2, LB200A, LB200A-2, LB215, LB215-2, LB215A, LB215A-2, LB260, LB260-2, LB260A, LB260A-2, LB275, LB275-2, LB275A, LB275A-2, LF315, LF320A, LF320CBT, LF320LA, LF320LBT, LF321, LF321A, LF322, LF322A, LF322MP...(Other models you can see in the webshop)		

			
1			
<b>GEV No.</b>	511339	<b>Ref. No.</b>	200873
<b>description</b>	O-ring EPDM thickness 3.53mm ID 110.7mm Qty 1 pcs		

			
1			
<b>GEV No.</b>	510896	<b>Ref. No.</b>	200828
<b>description</b>	O-ring EPDM thickness 3.53mm ID 183.75mm Qty 1 pcs		
<b>For models:</b>	B13T, B14T, B15, B15T, B15TM, B16, B16T, B16TM, B18, B18T, B18TM, B19, B19T, B19TM, B41, B42, C30, C70, C75, C75BT, C75M, C75RCD, F2, F20, F3, F300, F45, F55, F65, F80, F90M, F90MA, LF280-lav-line, LF315, LF320, LF320A, LF320CBT, LF320L, LF320LA, LF320-lav-line, LF320LBT, LF323, LF323A, LF350, LF350A, LF400A, LF450, LF450A, LP360, LP360BT...(Other models you can see in the webshop)		

			
1			
<b>GEV No.</b>	511331	<b>Ref. No.</b>	200842
<b>description</b>	O-ring EPDM thickness 3.53mm ID 53.57mm Qty 1 pcs		
<b>For models:</b>	BHC25, BHC25-2, BHC25A, BHC25A-2, BHC25S, BHC30, BHC30-2, BHC30A, BHC30A-2, BHC30E, BHC30E-2, BHC30EA, BHC30EA-2, BHC30HR, BHC30HR-2, BHC30HR380, BHC30HRA, BHC30HRA-2, BHC30HRA380, BHC433, BHC433-2, BHC433A, BHC433A-2, BHCHR, LB200, LB200-2, LB200A, LB200A-2, LB215, LB215-2, LB215A, LB215A-2, LB260, LB260-2, LB260A, LB260A-2, LB275, LB275-2, LB275A, LB275A-2, LF321, LF321A, LF322, LF322A, LF322MP, LF322MP-A, LF322RCD, LF324, LF324A, LF325E...(Other models you can see in the webshop)		

			
1			
<b>GEV No.</b>	524483	<b>Ref. No.</b>	200807
<b>description</b>	O-ring EPDM thickness 4mm ID 110mm Qty 1 pcs		
<b>For models:</b>	AC100, AC135, AC90, C1000E, C1000ERCD, C1001M, C1300E, C1300ERCD, C1301M, C33, C34, G115, G131, G65, G66, GE50RCD, LC1200, LC1200RCD, LC412, LC700, LC700RCD, LC900, LC900RCD, NE00, SE, SNL, XLC		

			
1			
<b>GEV No.</b>	524771	<b>Ref. No.</b>	160102
<b>description</b>	overflow stock thread 1 1/2" ED 60mm		
<b>For models:</b>	AC151, AC152, NE3001, NE4001, NE5501, NE7501, NE9001, NG01, NG601E, NG901E		





			
1			
<b>GEV No.</b>	512109	<b>Ref. No.</b>	180147
<b>description</b>	screw connection thread 1 1/4"		
<b>For models:</b>	BHC25, BHC25-2, BHC25A, BHC25A-2, BHC25S, BHC30, BHC30-2, BHC30A, BHC30A-2, BHC30E, BHC30E-2, BHC30EA, BHC30EA-2, BHC30HR, BHC30HR-2, BHC30HR380, BHC30HRA, BHC30HRA-2, BHC30HRA380, BHC433, BHC433-2, BHC433A, BHC433A-2, BHCHR, GF70, GF70A, LB200, LB200-2, LB200A, LB200A-2, LB215, LB215-2, LB215A, LB215A-2, LB260, LB260-2, LB260A, LB260A-2, LB275, LB275-2, LB275A, LB275A-2, LF315, LF320A, LF320CBT, LF320LA, LF320LBT, LF321, LF321A, LF322...(Other models you can see in the webshop)		

			
1			
<b>GEV No.</b>	519623	<b>Ref. No.</b>	160541
<b>description</b>	spacer piece thread 2 ED ø 85mm H 40mm ID ø 45mm		
<b>For models:</b>	AC122, AC152, AC182, AC202, AC242		

			
1			
<b>GEV No.</b>	524580	<b>Ref. No.</b>	190307
<b>description</b>	T-piece thread 1 1/2"		
<b>For models:</b>	AC120, AC170, AC200, ACR, ACR145, ACR205, ACR225, ACR245, ACR260, ACR265, ACR305, ACRS145, ACRS205, ACRS225, ACRS245, ACRS260, ACRS265, ACRS305, GMC, GMC2700, GMC2702, GMC3500, GMC3502, GMC4500, GMC4502, GMC5500, GMC5502, LV1001, LV1501, LV-LVP, LVP1001, LVP1501, NG01, NG02, NG1202, NG1202E, NG601, NG601E, NG602, NG602E, NG901, NG901E, NG902, NG902E, SE		

			
1			
<b>GEV No.</b>	510499	<b>Ref. No.</b>	180128
<b>description</b>	union nut thread 2"		
<b>For models:</b>	AC101, AC105, AC120, AC122, AC135, AC150, AC151, AC152, AC170, AC181, AC182, AC200, AC201, AC202, AC241, AC242, AC2A, AC91, AC95, ACL100, ACL150, ACR, ACR145, ACR205, ACR225, ACR245, ACR260, ACR265, ACR305, ACRS145, ACRS205, ACRS225, ACRS245, ACRS260, ACRS265, ACRS305, ACS101, ACS101-DIGIT, ACS122, ACS122-DIGIT, ACS151, ACS151-DIGIT, ACS152, ACS152-DIGIT, ACS161-DIGIT, ACS162-DIGIT, ACS181, ACS181-DIGIT, ACS182, ACS182-DIGIT...(Other models you can see in the webshop)		

<p>filters</p> 			
1			
<b>GEV No.</b>	511335	<b>Ref. No.</b>	180822
<b>description</b>	drain filter		
<b>For models:</b>	FC, FCHR, FCHRA, FCHRT, FCHRTA		

			
1			
<b>GEV No.</b>	507546	<b>Ref. No.</b>	332058
<b>description</b>	filter for dishwasher H 132mm L 515mm W 260mm SS		
<b>For models:</b>	GE100, GE115		

			
1			
<b>GEV No.</b>	524577	<b>Ref. No.</b>	330583
<b>description</b>	filter for pre-wash zone H 20mm L 572mm W 197mm		
<b>For models:</b>	AC135, AC150, AC170, AC181, AC182, AC200, ACR, ACR205, ACR245, ACR260, ACR265, GMC, GMC3500, GMC4500, GMC5500		

			
1			
<b>GEV No.</b>	524576	<b>Ref. No.</b>	333007
<b>description</b>	filter H 27mm L 632mm W 410mm		
<b>For models:</b>	NL302, NL302E, NL402, NL402E, NL502, NL502E, NL552, NL552E		

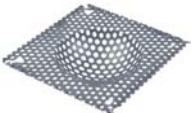
			
1			
<b>GEV No.</b>	518604	<b>Ref. No.</b>	330547
<b>description</b>	filter H 32mm L 150mm W 150mm		
<b>For models:</b>	NE00, NE3001, NE4001, NE5501, NE7501, NE9001, NG00, NG01, NG02, NG1202, NG1202E, NG600, NG600E, NG601, NG601E, NG602, NG602E, NG900, NG900E, NG901, NG901E, NG902, NG902E		

			
1			
<b>GEV No.</b>	519548	<b>Ref. No.</b>	330594
<b>description</b>	filter H 57mm L 300mm W 187mm		



1

<b>GEV No.</b>	519549	<b>Ref. No.</b>	330599
<b>description</b>	filter H 59mm L 463mm W 193mm		



1

<b>GEV No.</b>	518601	<b>Ref. No.</b>	332094
<b>description</b>	filter H 77mm L 460mm W 180mm		
<b>For models:</b>	ACS201, ACS201-DIGIT, ACS202, ACS202-DIGIT, ACS241, ACS241-DIGIT, ACS242, ACS242-DIGIT		



1

<b>GEV No.</b>	519485	<b>Ref. No.</b>	180832
<b>description</b>	filter L 265mm W 250mm		
<b>For models:</b>	LF322, LF322A, LF322MP, LF322MP-A, LF322RCD, LF324, LF324A, LF325E, LF325EA, LF700, LF700A, LFD32E, LFD32EA, LFD32M, LFD32MA		



1

<b>GEV No.</b>	518603	<b>Ref. No.</b>	332091
<b>description</b>	filter L 268mm W 235mm mounting pos. left		
<b>For models:</b>	C1000E, C1000ERCD, C1001M, C1300E, C1300ERCD, C1301M, GE50RCD, LC1200, LC1200RCD, LC412, LC700, LC700RCD, LC900, LC900RCD, XLC		



1

<b>GEV No.</b>	518602	<b>Ref. No.</b>	332090
<b>description</b>	filter L 268mm W 235mm mounting pos. right		
<b>For models:</b>	C1000E, C1000ERCD, C1001M, C1300E, C1300ERCD, C1301M, GE50RCD, LC1200, LC1200RCD, LC412, LC700, LC700RCD, LC900, LC900RCD, XLC		



1

<b>GEV No.</b>	511316	<b>Ref. No.</b>	330597
<b>description</b>	flat filter		
<b>For models:</b>	BC25HR, BC30HR, BC30HR380, BC30HRA		



1

<b>GEV No.</b>	511324	<b>Ref. No.</b>	180824
<b>description</b>	flat filter		



1

<b>GEV No.</b>	519531	<b>Ref. No.</b>	330409
<b>description</b>	flat filter for pre-wash zone H 10mm L 485mm W 225mm		
<b>For models:</b>	SNL		



1

<b>GEV No.</b>	519530	<b>Ref. No.</b>	330508
<b>description</b>	flat filter H 13mm L 545mm W 218mm		
<b>For models:</b>	LV1001, LV1501, LV-LVP, LVP1001, LVP1501, NE00, NE3001, NE4001, NE5501, NE7501, NE9001		

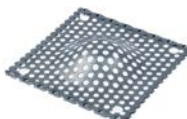

1

<b>GEV No.</b>	524762	<b>Ref. No.</b>	330598
<b>description</b>	flat filter H 18mm L 128mm W 126mm		
<b>For models:</b>	AC151, AC152, ACRS145, ACRS205, ACRS225, ACRS245, ACRS260, ACRS265, ACRS305, NE02, NE3001, NE3002, NE4001, NE4002, NE5002, NE5501, NE5502, NE7002, NE7501, NE7502, NE9001, NE9002, NE9502, NG01, NG02, NG1202E, NG601E, NG602E, NG901E, NG902E, NL302, NL302E, NL402, NL402E, NL502, NL502E, NL552, NL552E		



1

<b>GEV No.</b>	510221	<b>Ref. No.</b>	330584
<b>description</b>	flat filter H 20mm L 570mm W 225mm SS		
<b>For models:</b>	AC120, AC150, AC170, AC200, AC201, AC202, AC241, AC242, ACR, ACR145, ACR205, ACR225, ACR245, ACR260, ACR265, ACR305, ACRS145, ACRS205, ACRS225, ACRS245, ACRS260, ACRS265, ACRS305, GMC, GMC2700, GMC3500, GMC4500, GMC5500		



1

<b>GEV No.</b>	510656	<b>Ref. No.</b>	332003
<b>description</b>	flat filter H 38mm L 428mm W 278mm		
<b>For models:</b>	AC101, AC105, AC122, AC135, AC151, AC152, AC181, AC182, AC201, AC202, AC241, AC242, AC91, AC95		



 <p>1</p>			
<b>GEV No.</b>	510852	<b>Ref. No.</b>	180814 330548
<b>description</b>	flat filter L 160mm W 55mm		
<b>For models:</b>	B13T, B14T, B15, B15T, B15TM, B16, B16T, B16TM, B18, B18T, B18TM, B19, B19T, B19TM, B41, B42, C30, C70, C75, C75BT, C75M, C75RCD, F2, F20, F3, F300, F45, F55, F65, F80, F90M, F90MA, LF280-lav-line, LF315, LF320, LF320A, LF320CBT, LF320L, LF320LA, LF320-lav-line, LF320LBT, LF323, LF323A, LF350, LF350A, LF400A, LF450, LF450A, LP360, LP360BT...(Other models you can see in the webshop)		

 <p>1</p>			
<b>GEV No.</b>	510851	<b>Ref. No.</b>	180811
<b>description</b>	flat filter L 265mm W 200mm		
<b>For models:</b>	C34, GF90, GF90-2004, GF90A, GF90A-2004, LC380, LC380BT, LC380RCD, LC400		

 <p>1</p>			
<b>GEV No.</b>	511326	<b>Ref. No.</b>	180828
<b>description</b>	flat filter L 210mm W 210mm		
<b>For models:</b>	BHC30HR, BHC30HR-2, BHC30HR380, BHC30HRA, BHC30HRA-2, BHC30HRA380, BHCHR		

 <p>1</p>			
<b>GEV No.</b>	512391	<b>Ref. No.</b>	333001
<b>description</b>	flat filter L 535mm W 285mm mounting pos. left/right		
<b>For models:</b>	AC2A, ACL100, ACL150, ACRS145, ACRS205, ACRS225, ACRS245, ACRS260, ACRS265, ACRS305, ACS101, ACS101-DIGIT, ACS122, ACS122-DIGIT, ACS151, ACS151-DIGIT, ACS152, ACS152-DIGIT, ACS161-DIGIT, ACS162-DIGIT, ACS181, ACS181-DIGIT, ACS182, ACS182-DIGIT, ACS201, ACS201-DIGIT, ACS202, ACS202-DIGIT, ACS241, ACS241-DIGIT, ACS242, ACS242-DIGIT, ACS91, ACS91-DIGIT, GMC2702, GMC3502, GMC4502, GMC5502		

 <p>1</p>			
<b>GEV No.</b>	510475	<b>Ref. No.</b>	330591
<b>description</b>	flat filter L 250mm W 150mm		
<b>For models:</b>	BC25, BC25A, BC30, BC30A, BR20, BR20A, BR25, BR25A, FC43, FC43A		

 <p>1</p>			
<b>GEV No.</b>	519529	<b>Ref. No.</b>	332007
<b>description</b>	intake filter for wash pump H 150mm L 158mm W 100mm		
<b>For models:</b>	NE3001, NE4001, NE5501, NE7501, NE9001		

 <p>1</p>			
<b>GEV No.</b>	510224	<b>Ref. No.</b>	180831
<b>description</b>	flat filter L 250mm W 265mm		
<b>For models:</b>	LF321, LF321A		

 <p>1</p>			
<b>GEV No.</b>	519470	<b>Ref. No.</b>	332092
<b>description</b>	intake filter H 110mm L 457mm W 107mm		
<b>For models:</b>	ACRS205, ACRS225, ACRS245, ACRS260, ACRS265, ACRS305, ACS181, ACS181-DIGIT, ACS182, ACS182-DIGIT, ACS201, ACS201-DIGIT, ACS202, ACS202-DIGIT, ACS241, ACS241-DIGIT, ACS242, ACS242-DIGIT, GMC3502, GMC4502, GMC5502, NL302, NL302E, NL402, NL402E, NL502, NL502E, NL552, NL552E		

 <p>1</p>			
<b>GEV No.</b>	510483	<b>Ref. No.</b>	330586
<b>description</b>	flat filter L 255mm W 160mm		
<b>For models:</b>	C155, C155BT, C155E2, C155RCD, C165, C165E2, C165E2BT, C165E2RCD, C166, C166-2, C95, C95BT, C95E2, C95RCD		

 <p>1</p>			
<b>GEV No.</b>	524678	<b>Ref. No.</b>	330566
<b>description</b>	intake filter ø 109mm H 85mm		
<b>For models:</b>	AC120, AC170, AC200, ACR, ACR145, ACR205, ACR225, ACR245, ACR260, ACR265, ACR305, ACRS145, ACRS205, ACRS225, ACRS245, ACRS260, ACRS265, ACRS305, GMC, GMC2700, GMC3500, GMC4500, GMC5500, NE00, NE02, NE3001, NE3002, NE4001, NE4002, NE5002, NE5501, NE5502, NE7002, NE7501, NE7502, NE9001, NE9002, NE9502, NG02, NG1202E, NG602E, NG902E, NL302E, NL402E, NL502E, NL552E, SE		

 <p>1</p>			
<b>GEV No.</b>	510482	<b>Ref. No.</b>	330568
<b>description</b>	flat filter L 260mm W 180mm for model C		
<b>For models:</b>	C140, C85		





			
1			
<b>GEV No.</b>	510814	<b>Ref. No.</b>	330592
<b>description</b>	rectangular filter suction		

			
1			
<b>GEV No.</b>	510914	<b>Ref. No.</b>	330528
<b>description</b>	round filters		
<b>For models:</b>	C140, C30, C33, C34, C85, F2, F3, F300, G115, G131, G65, G66, LC380, LC380BT, LC380RCD, LC400, R40, R70		

			
1			
<b>GEV No.</b>	511325	<b>Ref. No.</b>	332029
<b>description</b>	round filters		

			
1			
<b>GEV No.</b>	511334	<b>Ref. No.</b>	332006
<b>description</b>	round filters		
<b>For models:</b>	FC, FCHR, FCHRA, FCHRT, FCHRTA		

			
1			
<b>GEV No.</b>	512215	<b>Ref. No.</b>	H34430
<b>description</b>	round filters		
<b>For models:</b>	GF90, GF90-2004, GF90A, GF90A-2004		

			
1			
<b>GEV No.</b>	511340	<b>Ref. No.</b>	332002
<b>description</b>	round filters ø 100mm H 78mm		
<b>For models:</b>	C155, C155BT, C155E2, C155RCD, C165, C165E2, C165E2BT, C165E2RCD, C166, C166-2, C95, C95BT, C95E2, C95RCD		

			
1			
<b>GEV No.</b>	510474	<b>Ref. No.</b>	180817
<b>description</b>	round filters ø 100mm H 90mm		
<b>For models:</b>	BC25, BC25A, BC30, BC30A, BR20, BR20A, BR25, BR25A, FC43, FC43A		

			
1			
<b>GEV No.</b>	510841	<b>Ref. No.</b>	180809
<b>description</b>	round filters ø 135mm		
<b>For models:</b>	B10, B10T, B11, B11T, B12, B12T, B20, B20D, B23, B24, B25, B26, B27, LBC210, LBC215, LBC215A, LBC275, LBC275A, LBR, LBR200, LBR215, LBR215A		

			
1			
<b>GEV No.</b>	510967	<b>Ref. No.</b>	330502
<b>description</b>	round filters ø 150mm		

			
1			
<b>GEV No.</b>	511571	<b>Ref. No.</b>	180840
<b>description</b>	round filters ø 155mm H 200mm		
<b>For models:</b>	FC3M, FC3MA, FC3MR, FC4M, FC4MA		





			
1			
<b>GEV No.</b>	518606	<b>Ref. No.</b>	180842
<b>description</b>	round filters ø 155mm H 200mm		
<b>For models:</b>	FC3E, FC3EA, FC44E, FC44EA, FC4E, FC4EA, FC4EHRT		

			
1			
<b>GEV No.</b>	519463	<b>Ref. No.</b>	180816
<b>description</b>	round filters ø 80mm H 72mm		
<b>For models:</b>	AC101, AC105, AC120, AC122, AC135, AC150, AC151, AC152, AC170, AC181, AC182, AC200, AC201, AC202, AC241, AC242, AC2A, AC91, AC95, ACL100, ACL150, ACR, ACR145, ACR205, ACR225, ACR245, ACR260, ACR265, ACR305, ACRS145, ACRS205, ACRS225, ACRS245, ACRS260, ACRS265, ACRS305, ACS101, ACS101-DIGIT, ACS122, ACS122-DIGIT, ACS151, ACS151-DIGIT, ACS152, ACS152-DIGIT, ACS161-DIGIT, ACS162-DIGIT, ACS181, ACS181-DIGIT, ACS182, ACS182-DIGIT...(Other models you can see in the webshop)		

			
1			
<b>GEV No.</b>	510850	<b>Ref. No.</b>	180808
<b>description</b>	round filters ø 180mm H 95mm		
<b>For models:</b>	B13T, B14T, B15, B15T, B15TM, B16, B16T, B16TM, B18, B18T, B18TM, B19, B19T, B19TM, B41, C30, C70, C75, C75BT, C75M, C75RCD, F2, F20, F3, F300, F45, F55, F65, F80, F90M, F90MA, LF280-lav-line, LF315, LF320, LF320A, LF320CBT, LF320L, LF320LA, LF320-lav-line, LF320LBT, LF323, LF323A, LF350, LF350A, LF400A, LF450, LF450A, LP360, LP360BT, LP360RCD...(Other models you can see in the webshop)		

			
1			
<b>GEV No.</b>	510639	<b>Ref. No.</b>	333006
<b>description</b>	round filters ø 90mm H 105mm		
<b>For models:</b>	LF322, LF322A, LF322MP, LF322MP-A, LF322RCD, LF324, LF324A, LF325E, LF325EA, LF700, LF700A, LFD32E, LFD32EA, LFD32M, LFD32MA		

			
1			
<b>GEV No.</b>	510942	<b>Ref. No.</b>	330550
<b>description</b>	round filters ø 185mm H 80mm		
<b>For models:</b>	NE00		

			
1			
<b>GEV No.</b>	507391	<b>Ref. No.</b>	330565
<b>description</b>	round filters suction ø 185mm H 100mm		
<b>For models:</b>	AC100, AC135, AC90, SE, SNL		

			
1			
<b>GEV No.</b>	510932	<b>Ref. No.</b>	330526
<b>description</b>	round filters ø 22mm H 88mm		
<b>For models:</b>	AC100, AC101, AC105, AC120, AC122, AC135, AC150, AC151, AC152, AC170, AC181, AC182, AC200, AC201, AC202, AC241, AC242, AC90, AC91, AC95, ACR, ACR145, ACR205, ACR225, ACR245, ACR260, ACR265, ACR305, ACRS145, ACRS205, ACRS225, ACRS245, ACRS260, ACRS265, ACRS305, ACS101, ACS101-DIGIT, ACS122, ACS122-DIGIT, ACS151, ACS151-DIGIT, ACS152, ACS152-DIGIT, ACS161-DIGIT, ACS162-DIGIT, ACS181, ACS181-DIGIT, ACS182, ACS182-DIGIT, ACS201...(Other models you can see in the webshop)		

			
1			
<b>GEV No.</b>	510376	<b>Ref. No.</b>	450223
<b>description</b>	spring for filter fixing		
<b>For models:</b>	BC25, BC25A, BC30, BC30A, BR20, BR20A, BR25, BR25A, FC43, FC43A		

			
1			
<b>GEV No.</b>	511333	<b>Ref. No.</b>	180818
<b>description</b>	round filters ø 240mm H 95mm		
<b>For models:</b>	FC, FC53, FC533, FC533A, FC53A, FC53CBT, FC53LA, FC53LBT, FC54, FC543, FC543A, FC543E, FC544, FC544A, FC54A, FC54CBT, FC54E, FC54EA, FC54LBT, LC1200, LC1200RCD, LC412, LC700, LC700RCD, LC900, LC900RCD		

<b>overflow pipes</b>			
			
1			
<b>GEV No.</b>	524679	<b>Ref. No.</b>	160777
<b>description</b>	cover L 30mm ø 74mm ID ø 59mm for overflow pipe		
<b>For models:</b>	AC120, AC135, AC150, AC170, AC181, AC182, AC200, AC201, AC202, ACR, ACR145, ACR205, ACR225, ACR245, ACR260, ACR265, ACR305, GMC, GMC2700, GMC3500, GMC4500, GMC5500, NE3001, NE4001, NE5501, NE7501, NE9001		



			
1			
<b>GEV No.</b>	510497	<b>Ref. No.</b>	160738
<b>description</b>	cover plate		
<b>For models:</b>	AC100, AC90, NG00, NG01, NG600, NG600E, NG900, NG900E, NG901, NG901E, SNL		

			
1			
<b>GEV No.</b>	510976	<b>Ref. No.</b>	200917
<b>description</b>	gasket $\varnothing$ 26.5mm ED $\varnothing$ 40.5mm		
<b>For models:</b>	AC122, AC152, AC182, AC202, AC242, BC25, BC25A, BC30, BC30A, BR20, BR20A, BR25, BR25A, FC3M, FC3MA, FC3MR, FC43, FC43A, FC4M, FC4MA		

			
1			
<b>GEV No.</b>	511987	<b>Ref. No.</b>	200912
<b>description</b>	gasket $\varnothing$ 27mm ED $\varnothing$ 40mm		
<b>For models:</b>	NE02, NE3002, NE4002, NE5002, NE5502, NE7002, NE7502, NE9002, NE9502, NG02, NG1202, NG1202E, NG902, NG902E		

			
1			
<b>GEV No.</b>	510887	<b>Ref. No.</b>	200469
<b>description</b>	gasket $\varnothing$ 30.9mm		
<b>For models:</b>	AC101, AC105, AC120, AC122, AC135, AC150, AC151, AC152, AC170, AC181, AC182, AC200, AC201, AC202, AC241, AC242, AC91, AC95, ACL100, ACL150, ACR, ACR145, ACR205, ACR225, ACR245, ACR260, ACR265, ACR305, ACRS145, ACRS205, ACRS225, ACRS245, ACRS260, ACRS265, ACRS305, ACS101, ACS101-DIGIT, ACS122, ACS122-DIGIT, ACS151, ACS151-DIGIT, ACS152, ACS152-DIGIT, ACS161-DIGIT, ACS162-DIGIT, ACS181, ACS181-DIGIT, ACS182, ACS182-DIGIT, ACS201...(Other models you can see in the webshop)		

			
1			
<b>GEV No.</b>	510227	<b>Ref. No.</b>	200950
<b>description</b>	gasket Viton ID $\varnothing$ 27mm ED $\varnothing$ 44mm H 7mm		
<b>For models:</b>	C1000E, C1000ERCD, C1001M, C1300E, C1300ERCD, C1301M, C166-2, GE50RCD, LC1200, LC1200RCD, LC412, LC700, LC700RCD, LC900, LC900RCD, XLC		

			
1			
<b>GEV No.</b>	511321	<b>Ref. No.</b>	180725
<b>description</b>	lid for overflow pipe		
<b>For models:</b>	BHC25, BHC25-2, BHC25A, BHC25A-2, BHC25S, BHC30, BHC30-2, BHC30A, BHC30A-2, BHC30E, BHC30E-2, BHC30EA, BHC30EA-2, BHC30HR, BHC30HR-2, BHC30HR380, BHC30HRA, BHC30HRA-2, BHC30HRA380, BHC433, BHC433-2, BHC433A, BHC433A-2, BHCHR, GF70, GF70A, LB200, LB200-2, LB200A, LB200A-2, LB215, LB215-2, LB215A, LB215A-2, LB260, LB260-2, LB260A, LB260A-2, LB275, LB275-2, LB275A, LB275A-2, LF321, LF321A, LF322, LF322A, LF322MP, LF322MP-A, LF322RCD, LF324...(Other models you can see in the webshop)		
<b>accessories for</b>	511321		
	<b>GEV No.</b>	510028	<b>Ref. No.</b> 180730
	overflow pipe L 120mm $\varnothing$ 26mm		

			
1			
<b>GEV No.</b>	524770	<b>Ref. No.</b>	160778
<b>description</b>	lid $\varnothing$ 74mm ID $\varnothing$ 62mm H 40mm for overflow pipe		
<b>For models:</b>	LV1001, LV1501, LV-LVP, LVP1001, LVP1501, NE3001, NE4001, NE5501, NE7501, NE9001		

			
1			
<b>GEV No.</b>	524766	<b>Ref. No.</b>	451127
<b>description</b>	locking pin L 36.5mm $\varnothing$ 5mm ID $\varnothing$ 3.5mm for overflow pipe		
<b>For models:</b>	AC120, AC135, AC150, AC170, AC181, AC182, AC200, AC201, AC202, AC241, AC242, ACR, ACR145, ACR205, ACR225, ACR245, ACR260, ACR265, ACR305, GMC, GMC2700, GMC3500, GMC4500, GMC5500, NE3001, NE4001, NE5501, NE7501, NE9001, NG01, NG601, NG601E, NG901, NG901E		

			
1			
<b>GEV No.</b>	511322	<b>Ref. No.</b>	200869
<b>description</b>	O-ring EPDM thickness 3.53mm ID $\varnothing$ 20.22mm Qty 1 pcs		
<b>For models:</b>	BHC25, BHC25-2, BHC25A, BHC25A-2, BHC25S, BHC30, BHC30-2, BHC30A, BHC30A-2, BHC30E, BHC30E-2, BHC30EA, BHC30EA-2, BHC30HR, BHC30HR-2, BHC30HR380, BHC30HRA, BHC30HRA-2, BHC30HRA380, BHC433, BHC433-2, BHC433A, BHC433A-2, BHCHR, GF70, GF70A, LB200, LB200-2, LB200A, LB200A-2, LB215, LB215-2, LB215A, LB215A-2, LB260, LB260-2, LB260A, LB260A-2, LB275, LB275-2, LB275A, LB275A-2, LF321, LF321A, LF322, LF322A, LF322MP, LF322MP-A, LF322RCD, LF324...(Other models you can see in the webshop)		







			
1			
<b>GEV No.</b>	511297	<b>Ref. No.</b>	170703
<b>description</b>	overflow pipe		





			
1			
<b>GEV No.</b>	511299	<b>Ref. No.</b>	380825
<b>description</b>	overflow pipe		
<b>For models:</b>	G100L, G101L, G115L, G125L, G50L, G50LM, G51L, G60L, G61L, G65L, G75L, GE125, GE75, GL		



			
1			
<b>GEV No.</b>	511307	<b>Ref. No.</b>	380823
<b>description</b>	overflow pipe		
<b>For models:</b>	G125, G75		



			
1			
<b>GEV No.</b>	512214	<b>Ref. No.</b>	H34431
<b>description</b>	overflow pipe		
<b>For models:</b>	GF90, GF90-2004, GF90A, GF90A-2004		

			
1			
<b>GEV No.</b>	511320	<b>Ref. No.</b>	180724
<b>description</b>	overflow pipe L 103mm ø 26mm		
<b>For models:</b>	BHC25, BHC25-2, BHC25A, BHC25A-2, BHC25S, BHC30, BHC30-2, BHC30A, BHC30A-2, BHC30E, BHC30E-2, BHC30EA, BHC30EA-2, BHC30HR, BHC30HR-2, BHC30HRA, BHC30HRA-2, BHC433, BHC433-2, BHC433A, BHC433A-2, LB200, LB200-2, LB200A, LB200A-2, LB215, LB215-2, LB215A, LB215A-2, LB260, LB260-2, LB260A, LB260A-2, LB275, LB275-2, LB275A, LB275A-2		
<b>accessories for</b>	511320		
	<b>GEV No.</b>	511321	<b>Ref. No.</b> 180725
	lid for overflow pipe		
	<b>GEV No.</b>	511322	<b>Ref. No.</b> 200869
	O-ring EPDM thickness 3.53mm ID ø 20.22mm Qty 1 pcs		
	<b>GEV No.</b>	511323	<b>Ref. No.</b> 450232
	compression spring ø 41.3mm L 57mm wire gauge ø 2mm		
	<b>GEV No.</b>	512109	<b>Ref. No.</b> 180147
	screw connection thread 1¼"		
	<b>GEV No.</b>	560249	<b>Ref. No.</b> —
	sheet metal screws ø 3.9mm L 13mm SS Qty 20 pcs DIN 7982/ISO 7050 intake Phillips head ø 7.5mm		

			
1			
<b>GEV No.</b>	524822	<b>Ref. No.</b>	180727
<b>description</b>	overflow pipe L 104mm		
<b>For models:</b>	BHC30HR, BHC30HR380, BHC30HRA, BHC30HRA380, BHCHR		

			
1			
<b>GEV No.</b>	510943	<b>Ref. No.</b>	160116
<b>description</b>	overflow pipe L 111mm ø 60mm		
<b>For models:</b>	NE00		

			
1			
<b>GEV No.</b>	510028	<b>Ref. No.</b>	180730
<b>description</b>	overflow pipe L 120mm ø 26mm		
<b>For models:</b>	GF70, GF70A, LF321, LF321A, LF322, LF322A, LF322MP, LF322MP-A, LF322RCD, LF324, LF324A, LF325E, LF325EA, LF700, LF700A, LFD32E, LFD32EA, LFD32M, LFD32MA		
<b>accessories for</b>	510028		
	<b>GEV No.</b>	511321	<b>Ref. No.</b> 180725
	lid for overflow pipe		
	<b>GEV No.</b>	511322	<b>Ref. No.</b> 200869
	O-ring EPDM thickness 3.53mm ID ø 20.22mm Qty 1 pcs		

			
1			
<b>GEV No.</b>	510255	<b>Ref. No.</b>	170712
<b>description</b>	overflow pipe L 134mm ø 38mm		
<b>For models:</b>	FC, FC53, FC533, FC533A, FC53A, FC53CBT, FC53LA, FC53LBT, FC54, FC543, FC543A, FC543E, FC543EA, FC544, FC544A, FC54A, FC54CBT, FC54E, FC54EA, FC54LBT		
<b>accessories for</b>	510255		
	<b>GEV No.</b>	510887	<b>Ref. No.</b> 200469
	gasket ø 30.9mm		





			
1			
<b>GEV No.</b>	510835	<b>Ref. No.</b>	170711
<b>description</b>	overflow pipe L 150mm ø 38mm		
<b>For models:</b>	FC, FC53, FC533, FC533A, FC53A, FC53CBT, FC53LA, FC53LBT, FC54, FC543, FC543A, FC543E, FC543EA, FC544, FC544A, FC54A, FC54CBT, FC54E, FC54EA, FC54LBT		
<b>accessories for</b>	510835		
	<b>GEV No.</b>	510887	<b>Ref. No.</b> 200469
gasket ø 30.9mm			

			
1			
<b>GEV No.</b>	511292	<b>Ref. No.</b>	170710
<b>description</b>	overflow pipe L 180mm ø 38mm		
<b>For models:</b>	F90M, F90MA, LF315, LF320, LF320A, LF320CBT, LF320L, LF320LA, LF320LBT, LF323, LF323A, LF350, LF350A, LF450, LF450A		
<b>spare parts for</b>	511292		
	<b>GEV No.</b>	510887	<b>Ref. No.</b> 200469
gasket ø 30.9mm			

			
1			
<b>GEV No.</b>	517594	<b>Ref. No.</b>	380818
<b>description</b>	overflow pipe L 150mm ø 38mm		
<b>For models:</b>	AC120, AC170, AC200, ACR, ACR145, ACR205, ACR225, ACR245, ACR260, ACR265, ACR305, ACRS145, ACRS205, ACRS225, ACRS245, ACRS260, ACRS265, ACRS305, GMC, GMC2700, GMC3500, GMC4500, GMC5500, SE		

			
1			
<b>GEV No.</b>	515046	<b>Ref. No.</b>	180708
<b>description</b>	overflow pipe L 190mm ø 37mm		
<b>For models:</b>	C140, C85, LC380, LC380BT, LC380RCD, LC400, NE00, NE3001, NE4001, NE5501, NE7501, NE9001, NG01, NG601E, NG901E		

			
1			
<b>GEV No.</b>	510444	<b>Ref. No.</b>	180702 180704
<b>description</b>	overflow pipe L 160mm ø 40mm		
<b>For models:</b>	B10, B10T, B11, B11T, B12, B12T, B20, B20D, B23, B24, B25, B26, B27, B31, B32, F2, F300, LBC210, LBC215, LBC215A, LBC275, LBC275A, LBR, LBR200, LBR215, LBR215A, R40, R70		



			
1			
<b>GEV No.</b>	524866	<b>Ref. No.</b>	180709
<b>description</b>	overflow pipe L 200mm ø 37mm plastic ID ø 32mm thickness 2mm		
<b>For models:</b>	SNL		

			
1			
<b>GEV No.</b>	510441	<b>Ref. No.</b>	170707
<b>description</b>	overflow pipe L 165mm ø 38mm		
<b>For models:</b>	B13T, B14T, B15, B15T, B15TM, B16, B16T, B16TM, B18, B18T, B18TM, B19, B19T, B19TM, B41, B42, C30, F2, F20, F3, F300, F45, F55, F65, F80, F90M, F90MA, LF280-lav-line, LF315, LF320, LF320A, LF320CBT, LF320L, LF320LA, LF320-lav-line, LF320LBT, LF323, LF323A, LF350, LF350A, LF400A, LF450, LF450A, LS550, R50		
<b>accessories for</b>	510441		
	<b>GEV No.</b>	510887	<b>Ref. No.</b> 200469
gasket ø 30.9mm			

			
1			
<b>GEV No.</b>	510473	<b>Ref. No.</b>	180716
<b>description</b>	overflow pipe L 210mm ø 30mm		
<b>For models:</b>	BC25, BC25A, BC30, BC30A, BR20, BR20A, BR25, BR25A, FC43, FC43A		





			
1			
<b>GEV No.</b>	510442	<b>Ref. No.</b>	170708
<b>description</b>	overflow pipe L 210mm ø 38mm		
<b>For models:</b>	C70, C75, C75BT, C75M, C75RCD, F45, F55, F65, F80, LP360, LP360BT, LP360RCD		
<b>accessories for</b>	510442		
	<b>GEV No.</b>	510887	<b>Ref. No.</b> 200469
	gasket ø 30.9mm		



			
1			
<b>GEV No.</b>	510630	<b>Ref. No.</b>	170717
<b>description</b>	overflow pipe L 210mm ø 40mm		
<b>For models:</b>	FC3M, FC3MA, FC3MR, FC4M, FC4MA		
<b>accessories for</b>	510630		
	<b>GEV No.</b>	510976	<b>Ref. No.</b> 200917
	gasket ø 26.5mm ED ø 40.5mm		

			
1			
<b>GEV No.</b>	510985	<b>Ref. No.</b>	180703
<b>description</b>	overflow pipe L 215mm ø 36mm		
<b>For models:</b>	C30, C33, C34, F3		

			
1			
<b>GEV No.</b>	510494	<b>Ref. No.</b>	180706
<b>description</b>	overflow pipe L 237mm ø 40mm		
<b>For models:</b>	AC100, AC90, SE, SNL		



			
1			
<b>GEV No.</b>	511306	<b>Ref. No.</b>	380806
<b>description</b>	overflow pipe L 240mm ø 35mm		
<b>For models:</b>	G115, G131, G65, G66		

			
1			
<b>GEV No.</b>	510645	<b>Ref. No.</b>	180729
<b>description</b>	overflow pipe L 283mm ø 42mm		
<b>For models:</b>	LC1200, LC1200RCD, LC412, LC700, LC700RCD, LC900, LC900RCD		
<b>accessories for</b>	510645		
	<b>GEV No.</b>	510227	<b>Ref. No.</b> 200950
	gasket Viton ID ø 27mm ED ø 44mm H 7mm		

			
1			
<b>GEV No.</b>	510476	<b>Ref. No.</b>	180715
<b>description</b>	overflow pipe L 400mm ø 40mm		
<b>For models:</b>	C155, C155BT, C155E2, C155RCD, C165, C165E2, C165E2BT, C165E2RCD, C166, C166-2, C95, C95BT, C95E2, C95RCD		
<b>accessories for</b>	510476		
	<b>GEV No.</b>	510887	<b>Ref. No.</b> 200469
	gasket ø 30.9mm		

			
1			
<b>GEV No.</b>	517591	<b>Ref. No.</b>	380831
<b>description</b>	overflow pipe L 405mm ø 35mm		
<b>For models:</b>	AC120, AC150, AC170, AC181, AC182, AC200, AC201, AC202, ACR, ACR145, ACR205, ACR225, ACR245, ACR260, ACR265, ACR305, GMC, GMC2700, GMC3500, GMC4500, GMC5500		

			
1			
<b>GEV No.</b>	511575	<b>Ref. No.</b>	380836
<b>description</b>	overflow pipe L 420mm ø 35mm		
<b>For models:</b>	AC101, AC105, AC122, AC135, AC151, AC152, AC181, AC182, AC201, AC202, AC241, AC242, AC91, AC95, GE100, GE115, GE60, GE60RCD, GE65, GE65RCD, GE80, LAV1000, LAV1001, LAV1501		

			
1			
<b>GEV No.</b>	517593	<b>Ref. No.</b>	180728
<b>description</b>	overflow pipe L 420mm ø 42mm		
<b>For models:</b>	C1000E, C1000ERCD, C1001M, C1300E, C1300ERCD, C1301M, GE50RCD, XLC		
<b>accessories for</b>	517593		
	<b>GEV No.</b>	510227	<b>Ref. No.</b> 200950
	gasket Viton ID ø 27mm ED ø 44mm H 7mm		

			
1			
<b>GEV No.</b>	517592	<b>Ref. No.</b>	380832
<b>description</b>	overflow pipe L 495mm ø 35mm		
<b>For models:</b>	AC101, AC120, AC122, AC135, AC150, AC151, AC152, AC170, AC181, AC182, AC200, AC201, AC202, AC241, AC242, AC91, ACR, ACR145, ACR205, ACR225, ACR245, ACR260, ACR265, ACR305, GMC, GMC2700, GMC3500, GMC4500, GMC5500		

			
1			
<b>GEV No.</b>	524040	<b>Ref. No.</b>	380856
<b>description</b>	overflow pipe L 530mm ø 35mm		
<b>For models:</b>	ACRS205, ACRS225, ACRS245, ACRS260, ACRS265, ACRS305, ACS181, ACS181-DIGIT, ACS182, ACS182-DIGIT, ACS201, ACS201-DIGIT, ACS202, ACS202-DIGIT, ACS241, ACS241-DIGIT, ACS242, ACS242-DIGIT, GMC3502, GMC4502, GMC5502		
<b>accessories for</b>	524040		
	<b>GEV No.</b>	510887	<b>Ref. No.</b> 200469
	gasket ø 30.9mm		

			
1			
<b>GEV No.</b>	517603	<b>Ref. No.</b>	160114
<b>description</b>	overflow pipe L 70mm ø 60mm		
<b>For models:</b>	AC241, AC242, ACL100, ACL150, ACRS145, ACRS205, ACRS225, ACRS245, ACRS260, ACRS265, ACRS305, ACS181, ACS181-DIGIT, ACS182, ACS182-DIGIT, ACS201, ACS201-DIGIT, ACS202, ACS202-DIGIT, ACS241, ACS241-DIGIT, ACS242, ACS242-DIGIT, GMC2702, GMC3502, GMC4502, GMC5502, NE00, SE, SNL		

			
1			
<b>GEV No.</b>	524763	<b>Ref. No.</b>	342008
<b>description</b>	spindle L 185mm ø 10mm thread M6 for overflow pipe		
<b>For models:</b>	AC120, AC135, AC150, AC170, AC181, AC182, AC200, ACR, ACR145, ACR205, ACR225, ACR245, ACR260, ACR265, ACR305, GMC, GMC2700, GMC3500, GMC4500, GMC5500		

			
1			
<b>GEV No.</b>	510944	<b>Ref. No.</b>	321618
<b>description</b>	spraying protection for overflow pipe		
<b>For models:</b>	NE00		

			
1			
<b>GEV No.</b>	517604	<b>Ref. No.</b>	190345
<b>description</b>	standpipe L 110mm ø 32mm		
<b>For models:</b>	ACS122, ACS122-DIGIT, ACS152, ACS152-DIGIT, ACS162-DIGIT, ACS182, ACS182-DIGIT, ACS202, ACS202-DIGIT, ACS242, ACS242-DIGIT		

			
1			
<b>GEV No.</b>	517595	<b>Ref. No.</b>	180723
<b>description</b>	standpipe L 130mm ø 32mm		
<b>For models:</b>	AC122, AC152, AC182, AC202, AC242		

			
1			
<b>GEV No.</b>	524764	<b>Ref. No.</b>	342072
<b>description</b>	tie bar L 220mm ø 10mm thread M10x1.5 for overflow pipe		
<b>For models:</b>	NE02, NE3002, NE4002, NE5002, NE5502, NE7002, NE7502, NE9002, NE9502, NG02, NG1202, NG1202E, NG602, NG602E, NG902, NG902E, NL402, NL402E, NL552, NL552E		



drive shafts



1			
<b>GEV No.</b>	530878	<b>Ref. No.</b>	342926
<b>description</b>	drive shaft D1 ø 30mm for basket transport steel L 242mm		

containers

container lids



1			
<b>GEV No.</b>	510479	<b>Ref. No.</b>	160715
<b>description</b>	container lid suitable for rinse aid container		
<b>For models:</b>	B10T, B11T, B12T, B13T, B14T, B15T, B15TM, B16T, B16TM, B18T, B18TM, B19T, B19TM, B20, B20D, B23, B24, B25, B26, B27, B31, B41, B42, BC25, BC25A, BC25HR, BC30, BC30A, BC30HR, BC30HR380, BC30HRA, BHC25, BHC25-2, BHC25A, BHC25A-2, BHC25S, BHC30, BHC30-2, BHC30A, BHC30A-2, BHC30E, BHC30EA, BHC30HR, BHC30HR-2, BHC30HR380, BHC30HRA, BHC30HRA-2, BHC30HRA380, BHC433, BHC433-2...(Other models you can see in the webshop)		

dosing containers



1			
<b>GEV No.</b>	510480	<b>Ref. No.</b>	190811
<b>description</b>	rinse aid container		
<b>For models:</b>	BC25, BC25A, BC25HR, BC30, BC30A, BC30HR, BC30HR380, BC30HRA, BR20, BR20A, BR25, BR25A, FC43, FC43A		
<b>spare parts for</b>	510480		
	<b>GEV No.</b>	510479	<b>Ref. No.</b> 160715
	container lid suitable for rinse aid container		



1			
<b>GEV No.</b>	510853	<b>Ref. No.</b>	190802
<b>description</b>	rinse aid container		
<b>For models:</b>	B10T, B11T, B12T, B13T, B14T, B15T, B15TM, B16T, B16TM, B18T, B18TM, B19T, B19TM, B20, B20D, B23, B24, B25, B26, B27, B31, B41, B42, BHC25, BHC25-2, BHC25A, BHC25A-2, BHC25S, BHC30, BHC30-2, BHC30A, BHC30A-2, BHC30E, BHC30EA, BHC30HR, BHC30HR-2, BHC30HR380, BHC30HRA, BHC30HRA-2, BHC30HRA380, BHC433, BHC433-2, BHC433A, BHC433A-2, BHCHR, C30		
<b>accessories for</b>	510853		
	<b>GEV No.</b>	510855	<b>Ref. No.</b> 190106
	bracket for rinse aid container		



1			
<b>GEV No.</b>	510854	<b>Ref. No.</b>	190809
<b>description</b>	rinse aid container		
<b>For models:</b>	B10, B11, B12, B15, B16, B18, B19, F20, F45, F55, F65, F80		



1			
<b>GEV No.</b>	510979	<b>Ref. No.</b>	321156
<b>description</b>	trapdoor suitable for polishing agent tank		
<b>For models:</b>	BC25, BC25A, BC25HR, BC30, BC30A, BC30HR, BC30HR380, BC30HRA, BR20, BR20A, BR25, BR25A, FC43, FC43A		



## salt tanks









1

<b>GEV No.</b>	511574	<b>Ref. No.</b>	170318
<b>description</b>	opposite support L 90mm W 45mm H 55mm for salt tank		
<b>accessories for</b>	511574		
	<b>GEV No.</b>	504351	<b>Ref. No.</b> 160526
	slide bearing $\phi$ 10mm external height 7mm		







1

<b>GEV No.</b>	510929	<b>Ref. No.</b>	631302
<b>description</b>	salt tank $\phi$ 120mm H 117mm hose $\phi$ 10mm mounting $\phi$ 70mm overall height 157mm		
<b>For models:</b>	B12, B12T, B14T, B16, B16T, B16TM, B19, B19T, B19TM, B25, B26, B27, B32, BC25A, BC30A, BHC30HR-2, BHC30HRA-2, BR20A, BR25A, F90MA, FC, FC43A, FC533A, FC53A, FC53LA, FC543A, FC543EA, FC544A, FC54A, FC54EA, FCHRA, FCHRTA, GF70A, GF90A, LBC215, LBC215A, LBC275, LBC275A, LBR, LBR215A, LF320A, LF320L, LF320LA, LF321, LF321A, LF322, LF322A, LF322MP, LF322MP-A, LF323A...(Other models you can see in the webshop)		
<b>spare parts for</b>	510929		
	<b>GEV No.</b>	506015	<b>Ref. No.</b> 200822
	O-ring EPDM thickness 3.53mm ID $\phi$ 39.69mm Qty 1 pcs		
	<b>GEV No.</b>	510018	<b>Ref. No.</b> —
	nut $\phi$ 92mm H 10.5mm for salt tank ID $\phi$ 64mm		
	<b>GEV No.</b>	524177	<b>Ref. No.</b> —
	lid $\phi$ 69mm H 20mm for salt tank ID $\phi$ 50mm		
<b>accessories for</b>	510929		
	<b>GEV No.</b>	510071	<b>Ref. No.</b> —
	flat gasket rubber ED $\phi$ 81mm ID $\phi$ 68mm thickness 3mm for salt tank Qty 1 pcs		
	<b>GEV No.</b>	510654	<b>Ref. No.</b> 200454
	gasket H 6mm D1 $\phi$ 82mm D2 $\phi$ 68mm		
	<b>GEV No.</b>	510883	<b>Ref. No.</b> —
	gasket rubber ED $\phi$ 86mm ID $\phi$ 66mm thickness 2mm for salt tank Qty 1 pcs		



1

<b>GEV No.</b>	504045	<b>Ref. No.</b>	631304
<b>description</b>	salt tank $\phi$ 123mm H 90mm		
<b>For models:</b>	BC30HRA, BHC25A, BHC25A-2, BHC30A, BHC30A-2, BHC30E-2, BHC30EA, BHC30EA-2, BHC30HR, BHC30HR-2, BHC30HRA, BHC30HRA-2, BHC30HRA380, BHC433-2, BHC433A, BHC433A-2, BHCHR, LB200A, LB200A-2, LB215A, LB215A-2, LB260A, LB260A-2, LB275A, LB275A-2		
<b>spare parts for</b>	504045		
	<b>GEV No.</b>	510018	<b>Ref. No.</b> —
	nut $\phi$ 92mm H 10.5mm for salt tank ID $\phi$ 64mm		
	<b>GEV No.</b>	524148	<b>Ref. No.</b> —
	O-ring EPDM thickness 3.53mm ID $\phi$ 40.86mm Qty 1 pcs		
	<b>GEV No.</b>	524177	<b>Ref. No.</b> —
	lid $\phi$ 69mm H 20mm for salt tank ID $\phi$ 50mm		
<b>accessories for</b>	504045		
	<b>GEV No.</b>	510654	<b>Ref. No.</b> 200454
	gasket H 6mm D1 $\phi$ 82mm D2 $\phi$ 68mm		
	<b>GEV No.</b>	510883	<b>Ref. No.</b> —
	gasket rubber ED $\phi$ 86mm ID $\phi$ 66mm thickness 2mm for salt tank Qty 1 pcs		

## accessories



1

<b>GEV No.</b>	510855	<b>Ref. No.</b>	190106
<b>description</b>	bracket for rinse aid container		
<b>For models:</b>	B10T, B11T, B12T, B13T, B14T, B15T, B15TM, B16T, B16TM, B18T, B18TM, B19T, B19TM, B20, B20D, B23, B24, B25, B26, B27, B31, B41, BHC25, BHC25-2, BHC25A, BHC25A-2, BHC25S, BHC30, BHC30-2, BHC30A, BHC30A-2, BHC30E, BHC30EA, BHC30HR, BHC30HR-2, BHC30HR380, BHC30HRA, BHC30HRA-2, BHC30HRA380, BHC433, BHC433-2, BHC433A, BHC433A-2, BHCHR, C30		





1

<b>GEV No.</b>	510857	<b>Ref. No.</b>	190117
<b>description</b>	bracket for rinse aid container		
<b>For models:</b>	B10, B11, B12, B15, B16, B18, B19		



1

<b>GEV No.</b>	510958	<b>Ref. No.</b>	190130
<b>description</b>	bracket for rinse aid container		
<b>For models:</b>	F20, F45, F55, F65, F80		



1

<b>GEV No.</b>	510981	<b>Ref. No.</b>	350745
<b>description</b>	fastening angle for dosing container		
<b>For models:</b>	C30, C33, C34, R70		



1

<b>GEV No.</b>	510874	<b>Ref. No.</b>	191047
<b>description</b>	frame for container		
<b>For models:</b>	F20, F45, F55, F65, F80		



1

<b>GEV No.</b>	510654	<b>Ref. No.</b>	200454
<b>description</b>	gasket H 6mm D1 ø 82mm D2 ø 68mm		
<b>For models:</b>	B12, B12T, B14T, B16, B16T, B16TM, B19, B19T, B19TM, B25, B26, B27, B32, BC25A, BC30A, BC30HRA, BHC25A, BHC25A-2, BHC30A, BHC30A-2, BHC30E-2, BHC30EA, BHC30EA-2, BHC30HR, BHC30HR-2, BHC30HRA, BHC30HRA-2, BHC30HRA380, BHC433-2, BHC433A, BHC433A-2, BHCHR, BR20A, BR25A, F90MA, FC, FC43A, FC533A, FC53A, FC53LA, FC543A, FC543EA, FC544A, FC54A, FC54EA, FCHRA, FCHRTA, GF70A, GF90-2004, GF90A-2004...(Other models you can see in the webshop)		



1

<b>GEV No.</b>	510226	<b>Ref. No.</b>	180149
<b>description</b>	nut ø 65mm for backflow preventer		
<b>For models:</b>	C1000ERCD, C1300ERCD, GE50RCD, GE60RCD, GE65RCD, LC1200RCD, LC700RCD, LC900RCD, LF322RCD, XLC		



1

<b>GEV No.</b>	510977	<b>Ref. No.</b>	340484
<b>description</b>	pin ø 3mm for container suitable for COMENDA Qty 1 pcs L 50mm		
<b>For models:</b>	B10T, B11T, B12T, B13T, B14T, B15T, B15TM, B16T, B16TM, B18T, B18TM, B19T, B19TM, B20, B20D, B23, B24, B25, B26, B27, B31, B41, B42, BC25, BC25A, BC25HR, BC30, BC30A, BC30HR, BC30HR380, BC30HRA, BHC25, BHC25-2, BHC25A, BHC25A-2, BHC25S, BHC30, BHC30-2, BHC30A, BHC30A-2, BHC30E, BHC30EA, BHC30HR, BHC30HR-2, BHC30HR380, BHC30HRA, BHC30HRA-2, BHC30HRA380, BHC433, BHC433-2...(Other models you can see in the webshop)		



1

<b>GEV No.</b>	504351	<b>Ref. No.</b>	160526
<b>description</b>	slide bearing ø 10mm external height 7mm		



1

<b>GEV No.</b>	510978	<b>Ref. No.</b>	450812
<b>description</b>	spring clip for dosing container suitable for COMENDA Qty 1 pcs		
<b>For models:</b>	B10T, B11T, B12T, B13T, B14T, B15T, B15TM, B16T, B16TM, B18T, B18TM, B19T, B19TM, B20, B20D, B23, B24, B25, B26, B27, B31, B41, B42, BC25, BC25A, BC25HR, BC30, BC30A, BC30HR, BC30HR380, BC30HRA, BHC25, BHC25-2, BHC25A, BHC25A-2, BHC25S, BHC30, BHC30-2, BHC30A, BHC30A-2, BHC30E, BHC30EA, BHC30HR, BHC30HR-2, BHC30HR380, BHC30HRA, BHC30HRA-2, BHC30HRA380, BHC433, BHC433-2...(Other models you can see in the webshop)		

## boilers

## boilers for dishwashers



1

<b>GEV No.</b>	511427	<b>Ref. No.</b>	330340
<b>description</b>	boiler		
<b>For models:</b>	BC25, BC25A, BC25HR, BC30, BC30A, BC30HR, BC30HR380, BC30HRA, BR20, BR20A, BR25, BR25A, FC43, FC43A		



1

<b>GEV No.</b>	511428	<b>Ref. No.</b>	330353 330374
<b>description</b>	boiler ø 150mm L 340mm		
<b>For models:</b>	BHC25, BHC25-2, BHC25A, BHC25A-2, BHC25S, BHC30, BHC30-2, BHC30A, BHC30A-2, BHC30E, BHC30E-2, BHC30EA, BHC30EA-2, BHC30HR, BHC30HR-2, BHC30HR380, BHC30HRA, BHC30HRA-2, BHC30HRA380, BHC433, BHC433-2, BHC433A, BHC433A-2, BHCHR, LB200, LB200-2, LB200A, LB200A-2, LB215, LB215-2, LB215A, LB215A-2, LB260, LB260-2, LB260A, LB260A-2, LB275, LB275-2, LB275A, LB275A-2		



1

<b>GEV No.</b>	510646	<b>Ref. No.</b>	330372
<b>description</b>	boiler ø 150mm L 440mm		
<b>For models:</b>	FC3E, FC3EA, FC3M, FC3MA, FC3MR, FC44E, FC44EA, FC4E, FC4EA, FC4EHRT, FC4M, FC4MA		



1

<b>GEV No.</b>	511630	<b>Ref. No.</b>	330368
<b>description</b>	boiler ø 150mm L 445mm flange 3 hole flange inlet ø 57.5		
<b>For models:</b>	GF70, GF70A, LF321, LF321A, LF322, LF322A, LF322MP, LF322MP-A, LF324, LF324A, LF325E, LF325EA, LF700, LF700A, LFD32E, LFD32EA, LFD32M, LFD32MA		



1

<b>GEV No.</b>	511629	<b>Ref. No.</b>	330348
<b>description</b>	boiler ø 155mm L 500mm flange 3 hole flange inlet ø 58		



1

<b>GEV No.</b>	511000	<b>Ref. No.</b>	330307 330331 330342
<b>description</b>	boiler ø 160mm L 500mm capacity 10l flange 3 hole flange inlet ø 12		
<b>For models:</b>	C1000E, C1001M, C1300E, C1301M, C140, C155, C155E2, C165, C165E2, C166, C166-2, C30, C33, C34, C70, C75, C75M, C85, C95, C95E2, F2, F3, F300, F45, F55, F65, F80, F90M, F90MA, FC, FC53, FC533, FC533A, FC53A, FC53LA, FC54, FC543, FC543A, FC543E, FC543EA, FC544, FC544A, FC54A, FC54E, FC54EA, FCHR, FCHRA, FCHRT, FCHRTA, G66...(Other models you can see in the webshop)		



1

<b>GEV No.</b>	524998	<b>Ref. No.</b>	330320
<b>description</b>	boiler ø 160mm L 630mm flange 3 hole flange inlet ø 11		
<b>For models:</b>	AC101, AC122, AC2A, AC91, AC95, ACL100, ACL150, ACRS145, ACRS205, ACRS225, ACRS245, ACRS260, ACRS265, ACRS305, ACS101, ACS101-DIGIT, ACS122, ACS122-DIGIT, ACS151-DIGIT, ACS152-DIGIT, ACS161-DIGIT, ACS162-DIGIT, ACS181-DIGIT, ACS182-DIGIT, ACS201-DIGIT, ACS202-DIGIT, ACS241-DIGIT, ACS242-DIGIT, ACS91, ACS91-DIGIT, G131, GMC2702, GMC3502, GMC4502, GMC5502, LAV1001, LAV1501		



1

<b>GEV No.</b>	524999	<b>Ref. No.</b>	330339
<b>description</b>	boiler with insulation ø 200mm L 630mm flange 3 hole flange inlet ø 1/2" IT		
<b>For models:</b>	AC100, AC105, AC120, AC150, AC151, AC152, AC170, AC181, AC182, AC200, AC2A, AC90, ACL100, ACL150, ACR, ACR145, ACR205, ACR225, ACR245, ACR260, ACR265, ACR305, ACRS145, ACRS205, ACRS225, ACRS245, ACRS260, ACRS265, ACRS305, ACS101-DIGIT, ACS122-DIGIT, ACS151, ACS151-DIGIT, ACS152, ACS152-DIGIT, ACS161-DIGIT, ACS162-DIGIT, ACS181, ACS181-DIGIT, ACS182, ACS182-DIGIT, ACS201-DIGIT, ACS202-DIGIT, ACS241-DIGIT, ACS242-DIGIT, ACS91-DIGIT, GMC, GMC2700, GMC2702, GMC3500...(Other models you can see in the webshop)		



			
1			
<b>GEV No.</b>	524997	<b>Ref. No.</b>	330322
<b>description</b>	boiler with insulation ø 230mm L 640mm flange 3 hole flange inlet ø 1/2" IT		
<b>For models:</b>	AC120, AC135, AC150, AC170, AC200, AC201, AC202, AC241, AC242, AC2A, ACL100, ACL150, ACR, ACR145, ACR205, ACR225, ACR245, ACR260, ACR265, ACR305, ACRS145, ACRS205, ACRS225, ACRS245, ACRS260, ACRS265, ACRS305, ACS101-DIGIT, ACS122-DIGIT, ACS151-DIGIT, ACS152-DIGIT, ACS161-DIGIT, ACS162-DIGIT, ACS181-DIGIT, ACS182-DIGIT, ACS201, ACS201-DIGIT, ACS202, ACS202-DIGIT, ACS241, ACS241-DIGIT, ACS242, ACS242-DIGIT, ACS91-DIGIT, GMC, GMC2700, GMC2702, GMC3500, GMC3502, GMC4500...(Other models you can see in the webshop)		

rotation plates

accessories

			
1			
<b>GEV No.</b>	524767	<b>Ref. No.</b>	410118
<b>description</b>	ball for rotation plate ø 7mm SS		
<b>For models:</b>	B10, B10T, B11, B11T, B12, B12T, B20, B20D, B23, B24, B25, B26, B27, BR20, BR20A, BR25, BR25A, LBR, LBR200, LBR215, LBR215A, R40, R50, R70		

softener cartridges

softening columns

			
1			
<b>GEV No.</b>	530000	<b>Ref. No.</b>	640209
<b>description</b>	softener 4-fold L 380mm W 180mm		
<b>For models:</b>	B12, B12T, B14T, B16, B16T, B19, B19T, B25, B26, B27, B32, BC25A, BC30A, BC30HRA, BHC25A, BHC30A, BHC30EA, BHC30HRA, BH-C30HRA380, BHC433A, BHCHR, BR20A, BR25A, F90MA, FC, FC43A, FC533A, FC53A, FC53LA, FC543A, FC543EA, FC544A, FC54A, FC54EA, FCHRA, FCHRTA, LBC215, LBC215A, LBC275, LBC275A, LBR, LBR215A, LF320A, LF320L, LF320LA, LF323A, LF350A, LF400A, LF450A		

			
1			
<b>GEV No.</b>	530370	<b>Ref. No.</b>	640216
<b>description</b>	softener 4-fold L 380mm W 180mm		
<b>For models:</b>	BHC25A-2, BHC30A-2, BHC30EA-2, BHC30HRA-2, BHC433A-2, LB200A, LB200A-2, LB215A, LB215A-2, LB260A, LB260A-2, LB275A, LB275A-2, LF321A, LF322A, LF322MP-A, LF324A, LF325EA, LF700A		

			
1			
<b>GEV No.</b>	530371	<b>Ref. No.</b>	640223
<b>description</b>	softener 4-fold L 380mm W 180mm		
<b>For models:</b>	BHC25A-2, BHC30EA-2, BHC30HR-2, BHC30HRA-2, BHC433A-2, LB200A, LB215A, LF322MP-A		

			
1			
<b>GEV No.</b>	530019	<b>Ref. No.</b>	640212
<b>description</b>	softener double		
<b>For models:</b>	GF90A, GF90A-2004		

complete

			
1			
<b>GEV No.</b>	530085	<b>Ref. No.</b>	640222
<b>description</b>	softener type M23 container capacity 0.7l		
<b>For models:</b>	FC3EA, FC3MA, FC44EA, FC4EA, FC4MA		

housing and bezels

fastening angles

			
1			
<b>GEV No.</b>	524765	<b>Ref. No.</b>	331106
<b>description</b>	bracket for drying L 75mm W 15mm thickness 2mm H 57mm		
<b>For models:</b>	NL302, NL302E, NL402, NL402E, NL502, NL502E, NL552, NL552E		





1

<b>GEV No.</b>	510980	<b>Ref. No.</b>	331439
<b>description</b>	fastening angle for front panel		
<b>For models:</b>	F20, F45, F55, F65, F80		



1

<b>GEV No.</b>	510937	<b>Ref. No.</b>	330725
<b>description</b>	mounting angle for solenoid valve		
<b>For models:</b>	B23, B24, B25, B26, B27, C1000E, C1000ERCD, C1300E, C1300ERCD, C140, C155, C155BT, C155E2, C155RCD, C165, C165E2, C165E2BT, C165E2RCD, C166, C166-2, C30, C33, C34, C70, C75, C75BT, C75M, C75RCD, C85, C95, C95BT, C95E2, C95RCD, F2, F3, F300, F45, F55, F65, F80, F90M, F90MA, FC, FC3E, FC3EA, FC3M, FC3MA, FC3MR, FC44E, FC44EA...(Other models you can see in the webshop)		



1

<b>GEV No.</b>	510727	<b>Ref. No.</b>	350839
<b>description</b>	mounting plate		
<b>For models:</b>	B10T		



1

<b>GEV No.</b>	510965	<b>Ref. No.</b>	350862
<b>description</b>	mounting plate for front panel		

## miscellaneous



1

<b>GEV No.</b>	524813	<b>Ref. No.</b>	340356 + 340357
<b>description</b>	cover kit for dishwasher		



1

<b>GEV No.</b>	504350	<b>Ref. No.</b>	620222
<b>description</b>	equipment foot for dishwasher L 135-230mm		
<b>For models:</b>	AC100, AC101, AC105, AC120, AC122, AC135, AC150, AC151, AC152, AC170, AC181, AC182, AC200, AC201, AC202, AC241, AC242, AC2A, AC90, AC91, AC95, ACL100, ACL150, ACR, ACR145, ACR205, ACR225, ACR245, ACR260, ACR265, ACR305, ACRS145, ACRS205, ACRS225, ACRS245, ACRS260, ACRS265, ACRS305, ACS101, ACS101-DIGIT, ACS122, ACS122-DIGIT, ACS151, ACS151-DIGIT, ACS152, ACS152-DIGIT, ACS161-DIGIT, ACS162-DIGIT, ACS181, ACS181-DIGIT...(Other models you can see in the webshop)		

## model name plates



1

<b>GEV No.</b>	510998	<b>Ref. No.</b>	460159
<b>description</b>	type plate COMENDA F2		
<b>For models:</b>	B20, B20D, B23, B24, B25, B31, B32, C30, F2, F3, F300, R40, R50, R70		

## hood mechanics for dishwashers

## bolts



1

<b>GEV No.</b>	510988	<b>Ref. No.</b>	340493
<b>description</b>	bolt for hood joint		
<b>For models:</b>	C1000E, C1000ERCD, C1001M, C1300E, C1300ERCD, C1301M, C30, C70, C75, C75BT, C75M, C75RCD, LC1200, LC1200RCD, LC412, LC700, LC700RCD, LC900, LC900RCD, LP360, LP360BT, LP360RCD, XLC		



1

<b>GEV No.</b>	524378	<b>Ref. No.</b>	340443
<b>description</b>	pin ED ø 12mm L 61mm thread M8x1.25 for dishwasher		
<b>For models:</b>	AC100, AC101, AC105, AC120, AC122, AC135, AC150, AC151, AC152, AC170, AC181, AC182, AC200, AC201, AC202, AC241, AC242, AC90, AC91, AC95, ACR, ACR145, ACR205, ACR225, ACR245, ACR260, ACR265, ACR305, ACRS145, ACRS205, ACRS225, ACRS245, ACRS260, ACRS265, ACRS305, ACS101, ACS101-DIGIT, ACS122, ACS122-DIGIT, ACS151, ACS151-DIGIT, ACS152, ACS152-DIGIT, ACS161-DIGIT, ACS162-DIGIT, ACS181, ACS181-DIGIT, ACS182, ACS182-DIGIT, ACS201...(Other models you can see in the webshop)		



bushes



1			
<b>GEV No.</b>	697882	<b>Ref. No.</b>	190679
<b>description</b>	bush ED ø 30mm ID ø 8mm L 14mm for hood mechanics plastic		
<b>For models:</b>	FC3E, FC3EA, FC3M, FC3MA, FC3MR, FC44E, FC44EA, FC4E, FC4EA, FC4EHRT, FC4M, FC4MA		



1			
<b>GEV No.</b>	510922	<b>Ref. No.</b>	330816
<b>description</b>	bush for door hinge hood mechanics		
<b>For models:</b>	B31, B32, C33, C34, F2, F3, F300, G131, G66, R40, R50, R70		



1			
<b>GEV No.</b>	510867	<b>Ref. No.</b>	190632
<b>description</b>	bush hood mechanics		
<b>For models:</b>	C140, C155, C155BT, C155E2, C155RCD, C165, C165E2, C165E2BT, C165E2RCD, C166, C166-2, C85, C95, C95BT, C95E2, C95RCD, LC380, LC380BT, LC380RCD, LC400		



1			
<b>GEV No.</b>	510817	<b>Ref. No.</b>	160530
<b>description</b>	spacer bush for handle hood mechanics		
<b>For models:</b>	C140, C85, LC380		



1			
<b>GEV No.</b>	510848	<b>Ref. No.</b>	290821
<b>description</b>	spacer bush for switch hood mechanics		
<b>For models:</b>	B10T, B11T, B12T, B13T, B14T, B15T, B15TM, B16T, B16TM, B18T, B18TM, B19T, B19TM, C1001M, C1301M, C155, C155BT, C155RCD, C70, C75, C75BT, C75M, C75RCD, C95, C95BT, C95RCD, F90M, F90MA, FC53CBT, FC53LA, FC53LBT, FC54CBT, FC54LBT, GF90, GF90-2004, GF90A, GF90A-2004, LC1200, LC1200RCD, LC380, LC380BT, LC380RCD, LC400, LC412, LC700, LC700RCD, LC900, LC900RCD, LF315, LF320... (Other models you can see in the webshop)		

spring holders



1			
<b>GEV No.</b>	510992	<b>Ref. No.</b>	190616
<b>description</b>	bush for spring holder hood mechanics		
<b>For models:</b>	C33, C34		

guide bars



1			
<b>GEV No.</b>	511005	<b>Ref. No.</b>	180604
<b>description</b>	guide bar L 575mm hood mechanics C33, C34, LC380, LC400		
<b>For models:</b>	C33, C34, LC380, LC380BT, LC380RCD, LC400		



1			
<b>GEV No.</b>	511202	<b>Ref. No.</b>	180613
<b>description</b>	guide bar L 575mm hood mechanics C85, C140		
<b>For models:</b>	C140, C85, LC380		



1			
<b>GEV No.</b>	510948	<b>Ref. No.</b>	180624
<b>description</b>	guide bar L 575mm hood mechanics C95, C155, C165, C166		
<b>For models:</b>	C155, C155BT, C155E2, C155RCD, C165, C165E2, C165E2BT, C165E2RCD, C166, C166-2, C95, C95BT, C95E2, C95RCD		



1			
<b>GEV No.</b>	513126	<b>Ref. No.</b>	180642
<b>description</b>	guide bar L 615mm W 30mm H 29mm		
<b>For models:</b>	C1000E, C1000ERCD, C1001M, C1300E, C1300ERCD, C1301M, LC1200, LC1200RCD, LC412, LC700, LC700RCD, LC900, LC900RCD, XLC		



1			
<b>GEV No.</b>	510827	<b>Ref. No.</b>	180606
<b>description</b>	guide bar mounting pos. left hood mechanics for door		
<b>For models:</b>	C30, C70, C75, C75BT, C75M, C75RCD, LP360, LP360BT, LP360RCD		



1			
<b>GEV No.</b>	510826	<b>Ref. No.</b>	180605
<b>description</b>	guide bar mounting pos. right hood mechanics for door		
<b>For models:</b>	C30, C70, C75, C75BT, C75M, C75RCD, LP360, LP360BT, LP360RCD		

## linkage



1

<b>GEV No.</b>	510845	<b>Ref. No.</b>	330206
<b>description</b>	tie bar		

## hood handle supports



1

<b>GEV No.</b>	510350	<b>Ref. No.</b>	190608
<b>description</b>	guide for hood handle		
<b>For models:</b>	C30, C33, C34		



1

<b>GEV No.</b>	510211	<b>Ref. No.</b>	190637
<b>description</b>	guide for hood handle L 78mm W 50mm H 22mm without roller		
<b>For models:</b>	C1000E, C1000ERCD, C1001M, C1300E, C1300ERCD, C1301M, C140, C155, C155BT, C155E2, C155RCD, C165, C165E2, C165E2BT, C165E2RCD, C70, C75, C75BT, C75M, C75RCD, C85, C95, C95BT, C95E2, C95RCD, LC1200, LC1200RCD, LC380, LC380BT, LC380RCD, LC400, LC412, LC700, LC700RCD, LC900, LC900RCD, LP360, LP360BT, LP360RCD, XLC		
<b>accessories for</b>	510211		
	<b>GEV No.</b>	510336	<b>Ref. No.</b> 340416
	bolt L 12.5mm thread M3 for hinge SS WS 7		



1

<b>GEV No.</b>	510856	<b>Ref. No.</b>	190110
<b>description</b>	handle holder hood mechanics		
<b>For models:</b>	C30, C70, C75, C75BT, C75M, C75RCD, LP360, LP360BT, LP360RCD		



1

<b>GEV No.</b>	510868	<b>Ref. No.</b>	191013
<b>description</b>	handle holder hood mechanics		
<b>For models:</b>	C1000E, C1000ERCD, C1001M, C1300E, C1300ERCD, C1301M, C140, C155, C155BT, C155E2, C155RCD, C165, C165E2, C165E2BT, C165E2RCD, C166, C166-2, C30, C70, C75, C75BT, C75M, C75RCD, C85, C95, C95BT, C95E2, C95RCD, LC1200, LC1200RCD, LC380, LC380BT, LC380RCD, LC400, LC412, LC700, LC700RCD, LC900, LC900RCD, LP360, LP360BT, LP360RCD, XLC		



1

<b>GEV No.</b>	510869	<b>Ref. No.</b>	191014
<b>description</b>	handle holder hood mechanics		
<b>For models:</b>	C1000E, C1000ERCD, C1001M, C1300E, C1300ERCD, C1301M, C140, C155, C155BT, C155E2, C155RCD, C165, C165E2, C165E2BT, C165E2RCD, C166, C166-2, C30, C70, C75, C75BT, C75M, C75RCD, C85, C95, C95BT, C95E2, C95RCD, LC1200, LC1200RCD, LC380, LC380BT, LC380RCD, LC400, LC412, LC700, LC700RCD, LC900, LC900RCD, LP360, LP360BT, LP360RCD, XLC		

## miscellaneous



1

<b>GEV No.</b>	511312	<b>Ref. No.</b>	440703
<b>description</b>	bracket for door contact switch		
<b>For models:</b>	C33, C34, G125, G75		



1

<b>GEV No.</b>	510864	<b>Ref. No.</b>	190607
<b>description</b>	bush for spring holder hood mechanics		
<b>For models:</b>	C1000E, C1000ERCD, C1001M, C1300E, C1300ERCD, C1301M, C140, C155, C155BT, C155E2, C155RCD, C165, C165E2, C165E2BT, C165E2RCD, C166, C166-2, C30, C70, C75, C75BT, C75M, C75RCD, C85, C95, C95BT, C95E2, C95RCD, G125, G125L, G75, G75L, GE125, GE75, GL, LC1200, LC1200RCD, LC380, LC380BT, LC380RCD, LC400, LC412, LC700, LC700RCD, LC900, LC900RCD, LP360, LP360BT, LP360RCD, XLC		



1

<b>GEV No.</b>	510810	<b>Ref. No.</b>	320627
<b>description</b>	fixing plate for guide		
<b>For models:</b>	C30, C70, C75, C75BT, C75M, C75RCD, LP360, LP360BT, LP360RCD		



1

<b>GEV No.</b>	510889	<b>Ref. No.</b>	200497
<b>description</b>	gasket for door guides hood mechanics		
<b>For models:</b>	C140, C155, C155BT, C155E2, C155RCD, C165, C165E2, C165E2BT, C165E2RCD, C166, C166-2, C85, C95, C95BT, C95E2, C95RCD, LC380, LC380BT, LC380RCD, LC400		



			
1			
<b>GEV No.</b>	510882	<b>Ref. No.</b>	200451
<b>description</b>	gasket for opposite support L 100mm hood mechanics rubber H 3mm black W 30mm		
<b>For models:</b>	C30, C70, C75, C75BT, C75M, C75RCD, LF280-lav-line, LF320-lav-line, LP360, LP360BT, LP360RCD		

			
1			
<b>GEV No.</b>	511397	<b>Ref. No.</b>	330917
<b>description</b>	opposite support hood mechanics		
<b>For models:</b>	C30, C75, C75BT, C75M, C75RCD, LP360, LP360BT, LP360RCD		

			
1			
<b>GEV No.</b>	511204	<b>Ref. No.</b>	190638
<b>description</b>	roller		
<b>For models:</b>	C1000E, C1000ERCD, C1001M, C1300E, C1300ERCD, C1301M, C140, C155, C155BT, C155E2, C155RCD, C165, C165E2, C165E2BT, C165E2RCD, C70, C75, C75BT, C75M, C75RCD, C85, C95, C95BT, C95E2, C95RCD, LC1200, LC1200RCD, LC380, LC380BT, LC380RCD, LC400, LC412, LC700, LC700RCD, LC900, LC900RCD, LP360, LP360BT, LP360RCD, XLC		

			
1			
<b>GEV No.</b>	511393	<b>Ref. No.</b>	190149
<b>description</b>	strengthening for handle holder hood mechanics		
<b>For models:</b>	C1000E, C1000ERCD, C1001M, C1300E, C1300ERCD, C1301M, C155, C155BT, C155E2, C155RCD, C165, C165E2, C165E2BT, C165E2RCD, C166, C166-2, C95, C95BT, C95E2, C95RCD, LC1200, LC1200RCD, LC380, LC380BT, LC380RCD, LC400, LC412, LC700, LC700RCD, LC900, LC900RCD, XLC		

<b>basket guides</b>			
<b>guide bars</b>			
			
1			
<b>GEV No.</b>	530459	<b>Ref. No.</b>	620761
<b>description</b>	guide bar L 1320mm W 40mm H 32mm		
<b>For models:</b>	ACS101, ACS101-DIGIT, ACS122, ACS122-DIGIT, ACS151, ACS151-DIGIT, ACS152, ACS152-DIGIT, ACS161-DIGIT, ACS162-DIGIT, ACS181, ACS181-DIGIT, ACS182, ACS182-DIGIT, ACS201, ACS201-DIGIT, ACS202, ACS202-DIGIT, ACS241, ACS241-DIGIT, ACS242, ACS242-DIGIT, ACS91, ACS91-DIGIT		

			
1			
<b>GEV No.</b>	510931	<b>Ref. No.</b>	191051
<b>description</b>	slide guide		
<b>For models:</b>	AC100, AC101, AC105, AC120, AC122, AC135, AC150, AC151, AC152, AC170, AC181, AC182, AC200, AC201, AC202, AC241, AC242, AC90, AC91, AC95, ACR, ACR145, ACR205, ACR225, ACR245, ACR260, ACR265, ACR305, ACRS145, ACRS205, ACRS225, ACRS245, ACRS260, ACRS265, ACRS305, ACS101, ACS101-DIGIT, ACS122, ACS122-DIGIT, ACS151, ACS151-DIGIT, ACS152, ACS152-DIGIT, ACS161-DIGIT, ACS162-DIGIT, ACS181, ACS181-DIGIT, ACS182, ACS182-DIGIT, ACS201...(Other models you can see in the webshop)		

<b>miscellaneous</b>			
			
1			
<b>GEV No.</b>	971144	<b>Ref. No.</b>	190145
<b>description</b>	guide for dishwasher L 100mm W 45mm H 28mm		
<b>For models:</b>	AC101, AC105, AC122, AC135, AC151, AC152, AC181, AC182, AC201, AC202, AC241, AC242, AC91, AC95, ACL100, ACL150, ACRS145, ACRS205, ACRS225, ACRS245, ACRS260, ACRS265, ACRS305, ACS101, ACS101-DIGIT, ACS122, ACS122-DIGIT, ACS151, ACS151-DIGIT, ACS152, ACS152-DIGIT, ACS161-DIGIT, ACS162-DIGIT, ACS181, ACS181-DIGIT, ACS182, ACS182-DIGIT, ACS201, ACS201-DIGIT, ACS202, ACS202-DIGIT, ACS241, ACS241-DIGIT, ACS242, ACS242-DIGIT, ACS91, ACS91-DIGIT		

			
1			
<b>GEV No.</b>	971143	<b>Ref. No.</b>	170324
<b>description</b>	guide for dishwasher L 100mm W 45mm H 30mm		
<b>For models:</b>	AC100, AC120, AC150, AC170, AC200, AC90, ACR, ACR145, ACR205, ACR225, ACR245, ACR260, ACR265, ACR305, SE, SNL		

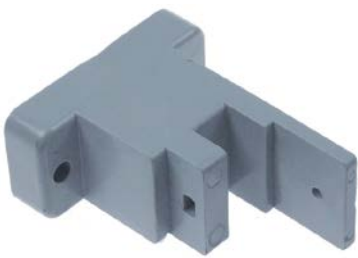

1

<b>GEV No.</b>	512206	<b>Ref. No.</b>	170325
<b>description</b>	guide for guide bar mounting pos. inner L 91mm W 45mm H 113mm		
<b>For models:</b>	AC201, AC202, AC241, AC242, AC2A, ACR, ACR145, ACR205, ACR225, ACR245, ACR260, ACR265, ACR305, ACRS145, ACRS205, ACRS225, ACRS245, ACRS260, ACRS265, ACRS305, SE		



1

<b>GEV No.</b>	512024	<b>Ref. No.</b>	190620
<b>description</b>	guide L 44mm W 34mm H 20mm		
<b>For models:</b>	AC100, AC120, AC150, AC170, AC200, AC90, ACR, ACR145, ACR205, ACR225, ACR245, ACR260, ACR265, ACR305, SE, SNL		

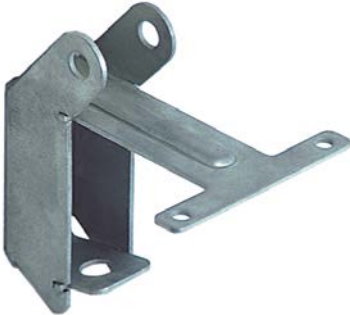

1

<b>GEV No.</b>	511221	<b>Ref. No.</b>	320698
<b>description</b>	lever for basket transport		
<b>For models:</b>	AC100, AC105, AC120, AC135, AC150, AC170, AC200, AC2A, AC90, AC95, ACR, ACR145, ACR205, ACR225, ACR245, ACR260, ACR265, ACR305, ACRS145, ACRS205, ACRS225, ACRS245, ACRS260, ACRS265, ACRS305, ACS101-DIGIT, ACS122-DIGIT, ACS151-DIGIT, ACS152-DIGIT, ACS161-DIGIT, ACS162-DIGIT, ACS181-DIGIT, ACS182-DIGIT, ACS201-DIGIT, ACS202-DIGIT, ACS241-DIGIT, ACS242-DIGIT, ACS91-DIGIT, SE, SNL		



1

<b>GEV No.</b>	970845	<b>Ref. No.</b>	170337
<b>description</b>	roller for transport basket H 8mm ED $\varnothing$ 31mm hole $\varnothing$ 9.9mm PTFE		
<b>For models:</b>	G100L, G101L, G115L, G125, G125L, GE125, GL		



1

<b>GEV No.</b>	511223	<b>Ref. No.</b>	191019
<b>description</b>	sleeve for magnetic switch L 76mm $\varnothing$ 16mm thread M10x1.5 plastic		
<b>For models:</b>	AC100, AC101, AC105, AC120, AC122, AC135, AC150, AC151, AC152, AC170, AC181, AC182, AC200, AC201, AC202, AC241, AC242, AC2A, AC90, AC91, AC95, ACL100, ACL150, ACR, ACR145, ACR205, ACR225, ACR245, ACR260, ACR265, ACR305, ACRS145, ACRS205, ACRS225, ACRS245, ACRS260, ACRS265, ACRS305, ACS101, ACS101-DIGIT, ACS122, ACS122-DIGIT, ACS151, ACS151-DIGIT, ACS152, ACS152-DIGIT, ACS161-DIGIT, ACS162-DIGIT, ACS181, ACS181-DIGIT...(Other models you can see in the webshop)		



1

<b>GEV No.</b>	524584	<b>Ref. No.</b>	160532
<b>description</b>	sliding block for warewashing basket L 110mm W 20mm H 4mm		
<b>For models:</b>	G100L, G101L, G115L, G125L, G50L, G50LM, G51L, G60L, G61L, G65L, G75, G75L, GE75, GL		



1

<b>GEV No.</b>	511224	<b>Ref. No.</b>	341255
<b>description</b>	threaded shaft for basket transport		
<b>For models:</b>	AC100, AC105, AC120, AC135, AC150, AC170, AC200, AC2A, AC90, AC95, ACR, ACR145, ACR205, ACR225, ACR245, ACR260, ACR265, ACR305, ACRS145, ACRS205, ACRS225, ACRS245, ACRS260, ACRS265, ACRS305, SE, SNL		

## air traps

## air traps



1





<b>GEV No.</b>	510347	<b>Ref. No.</b>	161303	
<b>description</b>	air trap			
<b>For models:</b>	AC120, AC170, AC200, ACR, ACR145, ACR205, ACR225, ACR245, ACR260, ACR265, ACR305, B10, B10T, B11, B11T, B12, B12T, B20, B20D, B23, B24, B25, B26, B27, B31, B32, C140, C85, GF90, GF90-2004, GF90A, GF90A-2004, LBC210, LBC215, LBC215A, LBC275, LBC275A, LBR, LBR200, LBR215, LBR215A, LC380, LC380BT, LC380RCD, LC400, NE00, SE			
<b>spare parts for</b>	510347			
	<b>GEV No.</b>	510877	<b>Ref. No.</b>	200415
	flat gasket rubber ED $\varnothing$ 18mm ID $\varnothing$ 10mm thickness 3mm Qty 1 pcs			
	<b>GEV No.</b>	560197	<b>Ref. No.</b>	260407
	nut thread M10 H 8mm WS 17 SS DIN/ISO DIN 934 / ISO 4032/8673 Qty 1 pcs			
<b>accessories for</b>	510347			
	<b>GEV No.</b>	510877	<b>Ref. No.</b>	200415
	flat gasket rubber ED $\varnothing$ 18mm ID $\varnothing$ 10mm thickness 3mm Qty 1 pcs			

Table continues overleaf





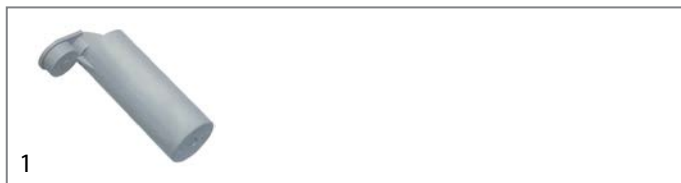

<b>accessories for</b>	510347			
	GEV No.	560197	Ref. No.	260407
	nut thread M10 H 8mm WS 17 SS DIN/ISO DIN 934 / ISO 4032/8673 Qty 1 pcs			



<b>GEV No.</b>	510348	<b>Ref. No.</b>	161305
<b>description</b>	air trap		
<b>For models:</b>	C70, C75, C75BT, C75RCD, F45, F55, F65, F80, F90M, F90MA, FC, FC53, FC533, FC533A, FC53A, FC53CBT, FC53LA, FC53LBT, FC54, FC543, FC543A, FC543E, FC543EA, FC544, FC544A, FC54A, FC54CBT, FC54E, FC54EA, FC54LBT, LF280-lav-line, LF315, LF320, LF320A, LF320CBT, LF320L, LF320LA, LF320-lav-line, LF320LBT, LF323, LF323A, LF350, LF350A, LF400A, LF450, LF450A, LP360, LP360BT, LP360RCD, LS550		

<b>spare parts for</b>	510348		
------------------------	--------	--	--

	GEV No.	510354	Ref. No.	160727
	end cap ø 1/2"mm			

	GEV No.	510486	Ref. No.	161306
	air ducting ø 1/2"mm			

	GEV No.	510877	Ref. No.	200415
	flat gasket rubber ED ø 18mm ID ø 10mm thickness 3mm Qty 1 pcs			

<b>accessories for</b>	510348		
------------------------	--------	--	--

	GEV No.	510354	Ref. No.	160727
	end cap ø 1/2"mm			

	GEV No.	510486	Ref. No.	161306
	air ducting ø 1/2"mm			

	GEV No.	510877	Ref. No.	200415
	flat gasket rubber ED ø 18mm ID ø 10mm thickness 3mm Qty 1 pcs			

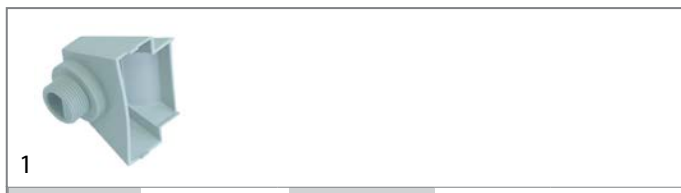

<b>GEV No.</b>	510759	<b>Ref. No.</b>	161316
<b>description</b>	air trap		
<b>For models:</b>	BHC25, BHC25-2, BHC25A, BHC25A-2, BHC25S, BHC30, BHC30-2, BHC30A, BHC30A-2, BHC30E, BHC30E-2, BHC30EA, BHC30EA-2, BHC433, BHC433-2, BHC433A, BHC433A-2, GF70, GF70A, LB200, LB200-2, LB200A, LB200A-2, LB215, LB215-2, LB215A, LB215A-2, LB260, LB260-2, LB260A, LB260A-2, LB275, LB275-2, LB275A, LB275A-2, LF321, LF321A, LF322, LF322A, LF322MP, LF322MP-A, LF322RCD, LF324, LF324A, LF325E, LF325EA, LF700, LF700A, LFD32E, LFD32EA...(Other models you can see in the webshop)		

<b>spare parts for</b>	510759		
------------------------	--------	--	--

	GEV No.	502036	Ref. No.	200805
	O-ring EPDM thickness 2.62mm ID ø 28.25mm Qty 1 pcs			

	GEV No.	510760	Ref. No.	161317
	hose connector			

	GEV No.	510761	Ref. No.	200944 21005
	flat gasket rubber D1 ø 38mm D2 ø 25mm thickness 2mm Qty 1 pcs			

<b>accessories for</b>	510759			
	GEV No.	510760	Ref. No.	161317
	hose connector			

	GEV No.	510761	Ref. No.	200944 21005
	flat gasket rubber D1 ø 38mm D2 ø 25mm thickness 2mm Qty 1 pcs			

	GEV No.	512283	Ref. No.	—
	flat gasket rubber D1 ø 38.5mm D2 ø 24.5mm thickness 2mm Qty 1 pcs			





<b>GEV No.</b>	511199	<b>Ref. No.</b>	161308
<b>description</b>	air trap		

<b>For models:</b>	AC101, AC105, AC122, AC135, AC151, AC152, AC181, AC182, AC201, AC202, AC241, AC242, AC2A, AC91, AC95, ACL100, ACL150, ACRS145, ACRS205, ACRS225, ACRS245, ACRS260, ACRS265, ACRS305, ACS101, ACS101-DIGIT, ACS122, ACS122-DIGIT, ACS151, ACS151-DIGIT, ACS152, ACS152-DIGIT, ACS161-DIGIT, ACS162-DIGIT, ACS181, ACS181-DIGIT, ACS182, ACS182-DIGIT, ACS201, ACS201-DIGIT, ACS202, ACS202-DIGIT, ACS241, ACS241-DIGIT, ACS242, ACS242-DIGIT, ACS91, ACS91-DIGIT, C1000E, C1000ERCD...(Other models you can see in the webshop)		
--------------------	--	--	--

<b>accessories for</b>	511199		
------------------------	--------	--	--

	GEV No.	511283	Ref. No.	200927
	flat gasket rubber ED ø 30mm ID ø 20mm thickness 2mm Qty 1 pcs			

	GEV No.	511284	Ref. No.	270121
	nut			

	GEV No.	511286	Ref. No.	450143
	hose clamp ø 38mm wire gauge ø 3.2mm Qty 1 pcs			

	GEV No.	511289	Ref. No.	161312
	hose ED ø 9.5mm ID ø 5mm L 420mm equiv. no. 161312			



<b>GEV No.</b>	511282	<b>Ref. No.</b>	161310
<b>description</b>	air trap		

<b>For models:</b>	ACL150, ACRS145, ACRS205, ACRS225, ACRS245, ACRS260, ACRS265, ACRS305, ACS161-DIGIT, ACS162-DIGIT, BC25, BC25A, BC25HR, BC30, BC30A, BC30HR, BC30HR380, BC30HRA, BR20, BR20A, BR25, BR25A, FC43, FC43A, GE100, GE115, GE60, GE60RCD, GE65, GE65RCD, GE80, GMC2702, GMC3502, GMC4502, GMC5502, LC1200, LC1200RCD, LC412, LC700, LC700RCD, LC900, LC900RCD		
--------------------	--	--	--





<b>spare parts for</b>	511282		
------------------------	--------	--	--





	GEV No.	511283	Ref. No.	200927
	flat gasket rubber ED ø 30mm ID ø 20mm thickness 2mm Qty 1 pcs			

	GEV No.	511284	Ref. No.	270121
	nut			





	GEV No.	511285	Ref. No.	161311
	hose ED ø 9.5mm ID ø 5mm L 1075mm equiv. no. 161311			

Table continues overleaf

<b>spare parts for</b> 511282			
	GEV No.	511286	Ref. No. 450143
hose clamp ø 38mm wire gauge ø 3.2mm Qty 1 pcs			
<b>accessories for</b> 511282			
	GEV No.	511283	Ref. No. 200927
flat gasket rubber ED ø 30mm ID ø 20mm thickness 2mm Qty 1 pcs			
	GEV No.	511284	Ref. No. 270121
nut			
	GEV No.	511285	Ref. No. 161311
hose ED ø 9.5mm ID ø 5mm L 1075mm equiv. no. 161311			
	GEV No.	511286	Ref. No. 450143
hose clamp ø 38mm wire gauge ø 3.2mm Qty 1 pcs			

			
1			
<b>GEV No.</b>	512407	<b>Ref. No.</b>	161323
<b>description</b>	air trap		
<b>accessories for</b>	512407		
	GEV No.	511283	Ref. No. 200927
flat gasket rubber ED ø 30mm ID ø 20mm thickness 2mm Qty 1 pcs			
	GEV No.	511284	Ref. No. 270121
nut			
	GEV No.	511286	Ref. No. 450143
hose clamp ø 38mm wire gauge ø 3.2mm Qty 1 pcs			
	GEV No.	511289	Ref. No. 161312
hose ED ø 9.5mm ID ø 5mm L 420mm equiv. no. 161312			

			
1			
<b>GEV No.</b>	524759	<b>Ref. No.</b>	380828
<b>description</b>	air trap ø 48mm H 73mm thread M10x1.5 hose ø 6mm metal		
<b>For models:</b>	ACRS145, ACRS205, ACRS225, ACRS245, ACRS260, ACRS265, ACRS305, GMC, GMC2700, GMC3500, GMC4500, GMC5500, NE02, NE3001, NE3002, NE4001, NE4002, NE5002, NE5501, NE5502, NE7002, NE7501, NE7502, NE9001, NE9002, NE9502, NG01, NG02, NG1202E, NG601E, NG602E, NG901E, NG902E, NL302E, NL402E, NL502E, NL552E		

			
1			
<b>GEV No.</b>	510342	<b>Ref. No.</b>	161301
<b>description</b>	air trap ø 49mm H 155mm		
<b>For models:</b>	AC100, AC120, AC150, AC170, AC200, AC90, ACR, ACR145, ACR205, ACR225, ACR245, ACR260, ACR265, ACR305, C30, C33, C34, F2, F3, F300, G100L, G101L, G115, G115L, G125, G125L, G131, G50L, G50LM, G51L, G60L, G61L, G65, G65L, G66, G75, G75L, GE125, GE75, GF90-2004, GF90A-2004, GL, GMC, GMC2700, GMC3500, GMC4500, GMC5500, NE00, NG00, NG600...(Other models you can see in the webshop)		
<b>spare parts for</b>	510342		
	GEV No.	510877	Ref. No. 200415
flat gasket rubber ED ø 18mm ID ø 10mm thickness 3mm Qty 1 pcs			
	GEV No.	560197	Ref. No. 260407
nut thread M10 H 8mm WS 17 SS DIN/ISO DIN 934 / ISO 4032/8673 Qty 1 pcs			
<b>accessories for</b>	510342		
	GEV No.	510877	Ref. No. 200415
flat gasket rubber ED ø 18mm ID ø 10mm thickness 3mm Qty 1 pcs			
	GEV No.	560197	Ref. No. 260407
nut thread M10 H 8mm WS 17 SS DIN/ISO DIN 934 / ISO 4032/8673 Qty 1 pcs			

## air trap accessories

			
1			
<b>GEV No.</b>	510486	<b>Ref. No.</b>	161306
<b>description</b>	air ducting ø 1/2"mm		
<b>For models:</b>	C70, C75, C75BT, C75M, C75RCD, F45, F55, F65, F80, F90M, F90MA, FC, FC53, FC533, FC533A, FC53A, FC53CBT, FC53LA, FC53LBT, FC54, FC543, FC543A, FC543E, FC543EA, FC544, FC544A, FC54A, FC54CBT, FC54E, FC54EA, FC54LBT, FCHR, FCHRA, FCHRT, FCHRTA, LF280-lav-line, LF315, LF320, LF320A, LF320CBT, LF320L, LF320LA, LF320-lav-line, LF320LBT, LF323, LF323A, LF350, LF350A, LF400A, LF450...(Other models you can see in the webshop)		

			
1			
<b>GEV No.</b>	510354	<b>Ref. No.</b>	160727
<b>description</b>	end cap ø 1/2"mm		
<b>For models:</b>	C70, C75, C75BT, C75M, C75RCD, F45, F55, F65, F80, F90M, F90MA, FC, FC53, FC533, FC533A, FC53A, FC53CBT, FC53LA, FC53LBT, FC54, FC543, FC543A, FC543E, FC543EA, FC544, FC544A, FC54A, FC54CBT, FC54E, FC54EA, FC54LBT, FCHR, FCHRA, FCHRT, FCHRTA, LF280-lav-line, LF315, LF320, LF320A, LF320CBT, LF320L, LF320LA, LF320-lav-line, LF320LBT, LF323, LF323A, LF350, LF350A, LF400A, LF450...(Other models you can see in the webshop)		



			
1			
<b>GEV No.</b>	510761	<b>Ref. No.</b>	200944 21005
<b>description</b>	flat gasket rubber D1 ø 38mm D2 ø 25mm thickness 2mm Qty 1 pcs		
<b>For models:</b>	BHC25, BHC25-2, BHC25A, BHC25A-2, BHC25S, BHC30, BHC30-2, BHC30A, BHC30A-2, BHC30E, BHC30E-2, BHC30EA, BHC30EA-2, BHC433, BHC433-2, BHC433A, BHC433A-2, GF70, GF70A, LB200, LB200-2, LB200A, LB200A-2, LB215, LB215-2, LB215A, LB215A-2, LB260, LB260-2, LB260A, LB260A-2, LB275, LB275-2, LB275A, LB275A-2, LF321, LF321A, LF322, LF322A, LF322MP, LF322MP-A, LF322RCD, LF324, LF324A, LF325E, LF325EA, LF700, LF700A, LFD32E, LFD32EA...(Other models you can see in the webshop)		

			
1			
<b>GEV No.</b>	510877	<b>Ref. No.</b>	200415
<b>description</b>	flat gasket rubber ED ø 18mm ID ø 10mm thickness 3mm Qty 1 pcs		
<b>For models:</b>	AC100, AC101, AC120, AC122, AC150, AC151, AC152, AC170, AC181, AC182, AC200, AC201, AC202, AC241, AC242, AC90, AC91, ACR, ACR145, ACR205, ACR225, ACR245, ACR260, ACR265, ACR305, B10, B10T, B11, B11T, B12, B12T, B13T, B14T, B15, B15T, B16, B16T, B18, B18T, B19, B19T, B20, B20D, B23, B24, B25, B26, B27, B31, B32...(Other models you can see in the webshop)		

			
1			
<b>GEV No.</b>	511283	<b>Ref. No.</b>	200927
<b>description</b>	flat gasket rubber ED ø 30mm ID ø 20mm thickness 2mm Qty 1 pcs		
<b>For models:</b>	AC101, AC122, AC151, AC152, AC181, AC182, AC201, AC202, AC241, AC242, AC2A, AC91, ACL100, ACL150, ACRS145, ACRS205, ACRS225, ACRS245, ACRS260, ACRS265, ACRS305, ACS101, ACS101-DIGIT, ACS122, ACS122-DIGIT, ACS151, ACS151-DIGIT, ACS152, ACS152-DIGIT, ACS161-DIGIT, ACS162-DIGIT, ACS181, ACS181-DIGIT, ACS182, ACS182-DIGIT, ACS201, ACS201-DIGIT, ACS202, ACS202-DIGIT, ACS241, ACS241-DIGIT, ACS242, ACS242-DIGIT, ACS91, ACS91-DIGIT, BC25, BC25A, BC30, BC30A, BR20...(Other models you can see in the webshop)		

			
1			
<b>GEV No.</b>	511285	<b>Ref. No.</b>	161311
<b>description</b>	hose ED ø 9.5mm ID ø 5mm L 1075mm equiv. no. 161311		
<b>For models:</b>	AC101, AC105, AC122, AC135, AC151, AC152, AC181, AC182, AC201, AC202, AC241, AC242, AC91, AC95, ACL150, ACRS145, ACRS205, ACRS225, ACRS245, ACRS260, ACRS265, ACRS305, ACS101, ACS101-DIGIT, ACS122, ACS122-DIGIT, ACS151, ACS151-DIGIT, ACS152, ACS152-DIGIT, ACS161-DIGIT, ACS162-DIGIT, ACS181, ACS181-DIGIT, ACS182, ACS182-DIGIT, ACS201, ACS201-DIGIT, ACS202, ACS202-DIGIT, ACS241, ACS241-DIGIT, ACS242, ACS242-DIGIT, ACS91, ACS91-DIGIT, BC25, BC25A, BC25HR, BC30...(Other models you can see in the webshop)		

			
1			
<b>GEV No.</b>	511289	<b>Ref. No.</b>	161312
<b>description</b>	hose ED ø 9.5mm ID ø 5mm L 420mm equiv. no. 161312		
<b>For models:</b>	AC201, AC202, AC241, AC242, AC2A, ACL100, ACL150, ACRS145, ACRS205, ACRS225, ACRS245, ACRS260, ACRS265, ACRS305, ACS101, ACS101-DIGIT, ACS122, ACS122-DIGIT, ACS151, ACS151-DIGIT, ACS152, ACS152-DIGIT, ACS161-DIGIT, ACS162-DIGIT, ACS181, ACS181-DIGIT, ACS182, ACS182-DIGIT, ACS201, ACS201-DIGIT, ACS202, ACS202-DIGIT, ACS241, ACS241-DIGIT, ACS242, ACS242-DIGIT, ACS91, ACS91-DIGIT, C155, C155BT, C155E2, C155RCD, C165, C165E2, C165E2BT, C165E2RCD, C166, C166-2, C95, C95BT...(Other models you can see in the webshop)		

			
1			
<b>GEV No.</b>	511286	<b>Ref. No.</b>	450143
<b>description</b>	hose clamp ø 38mm wire gauge ø 3.2mm Qty 1 pcs		
<b>For models:</b>	AC101, AC105, AC122, AC135, AC151, AC152, AC181, AC182, AC201, AC202, AC241, AC242, AC2A, AC91, AC95, ACL100, ACL150, ACRS145, ACRS205, ACRS225, ACRS245, ACRS260, ACRS265, ACRS305, ACS101, ACS101-DIGIT, ACS122, ACS122-DIGIT, ACS151, ACS151-DIGIT, ACS152, ACS152-DIGIT, ACS161-DIGIT, ACS162-DIGIT, ACS181, ACS181-DIGIT, ACS182, ACS182-DIGIT, ACS201, ACS201-DIGIT, ACS202, ACS202-DIGIT, ACS241, ACS241-DIGIT, ACS242, ACS242-DIGIT, ACS91, ACS91-DIGIT, BC25, BC25A...(Other models you can see in the webshop)		

			
1			
<b>GEV No.</b>	510760	<b>Ref. No.</b>	161317
<b>description</b>	hose connector		
<b>For models:</b>	BHC25, BHC25-2, BHC25A, BHC25A-2, BHC25S, BHC30, BHC30-2, BHC30A, BHC30A-2, BHC30E, BHC30E-2, BHC30EA, BHC30EA-2, BHC433, BHC433-2, BHC433A, BHC433A-2, GF70, GF70A, LB200, LB200-2, LB200A, LB200A-2, LB215, LB215-2, LB215A, LB215A-2, LB260, LB260-2, LB260A, LB260A-2, LB275, LB275-2, LB275A, LB275A-2, LF321, LF321A, LF322, LF322A, LF322MP, LF322MP-A, LF322RCD, LF324, LF324A, LF325E, LF325EA, LF700, LF700A, LFD32E, LFD32EA...(Other models you can see in the webshop)		



1

<b>GEV No.</b>	511284	<b>Ref. No.</b>	270121
<b>description</b>	nut		
<b>For models:</b>	AC101, AC122, AC151, AC152, AC181, AC182, AC201, AC202, AC241, AC242, AC2A, AC91, ACL100, ACL150, ACRS145, ACRS205, ACRS225, ACRS245, ACRS260, ACRS265, ACRS305, ACS101, ACS101-DIGIT, ACS122, ACS122-DIGIT, ACS151, ACS151-DIGIT, ACS152, ACS152-DIGIT, ACS161-DIGIT, ACS162-DIGIT, ACS181, ACS181-DIGIT, ACS182, ACS182-DIGIT, ACS201, ACS201-DIGIT, ACS202, ACS202-DIGIT, ACS241, ACS241-DIGIT, ACS242, ACS242-DIGIT, ACS91, ACS91-DIGIT, BC25, BC25A, BC25HR, BC30, BC30A...(Other models you can see in the webshop)		

## mechanics for flight type dishwashers



1

<b>GEV No.</b>	524589	<b>Ref. No.</b>	342020
<b>description</b>	bolt for tappet L 30mm ø 8mm hole ø 2.5mm suitable for COMENDA		
<b>For models:</b>	AC101, AC105, AC122, AC135, AC151, AC152, AC181, AC182, AC201, AC202, AC241, AC242, AC91, AC95, ACL100, ACL150, ACRS145, ACRS205, ACRS225, ACRS245, ACRS260, ACRS265, ACRS305, ACS101, ACS101-DIGIT, ACS122, ACS122-DIGIT, ACS151, ACS151-DIGIT, ACS152, ACS152-DIGIT, ACS161-DIGIT, ACS162-DIGIT, ACS181, ACS181-DIGIT, ACS182, ACS182-DIGIT, ACS201, ACS201-DIGIT, ACS202, ACS202-DIGIT, ACS241, ACS241-DIGIT, ACS242, ACS242-DIGIT, ACS91, ACS91-DIGIT		



1

<b>GEV No.</b>	511669	<b>Ref. No.</b>	322019
<b>description</b>	bracket for transport system L 132mm W 83mm		
<b>For models:</b>	GMC, GMC2700, GMC2702, GMC3500, GMC3502, GMC4500, GMC4502, GMC5500, GMC5502		



1

<b>GEV No.</b>	504358	<b>Ref. No.</b>	322018
<b>description</b>	bracket for transport system L 190mm W 115mm		
<b>For models:</b>	GMC, GMC2700, GMC2702, GMC3500, GMC3502, GMC4500, GMC4502, GMC5500, GMC5502		



1

<b>GEV No.</b>	504360	<b>Ref. No.</b>	330861
<b>description</b>	bush for transport system L 17mm ID ø 6.3mm ED ø 16mm		
<b>For models:</b>	GMC, GMC2700, GMC2702, GMC3500, GMC3502, GMC4500, GMC4502, GMC5500, GMC5502		



1

<b>GEV No.</b>	524578	<b>Ref. No.</b>	620265
<b>description</b>	cart for basket transport L 505mm W 210mm H 140mm suitable for COMENDA for GMC		
<b>For models:</b>	GMC, GMC2700, GMC2702, GMC3500, GMC3502, GMC4500, GMC4502, GMC5500, GMC5502		



1

<b>GEV No.</b>	504352	<b>Ref. No.</b>	330110
<b>description</b>	connector for transport system L 66mm W 15mm hole ø 6x12mm		
<b>For models:</b>	GMC, GMC2700, GMC2702, GMC3500, GMC3502, GMC4500, GMC4502, GMC5500, GMC5502		



1

<b>GEV No.</b>	504353	<b>Ref. No.</b>	330111
<b>description</b>	connector for transport system L 66mm W 38mm hole ø 6x12mm		
<b>For models:</b>	GMC, GMC2700, GMC2702, GMC3500, GMC3502, GMC4500, GMC4502, GMC5500, GMC5502		



1

<b>GEV No.</b>	504354	<b>Ref. No.</b>	330113
<b>description</b>	connector for transport system L 80mm W 20mm hole ø 8.5mm		
<b>For models:</b>	NE02, NE3001, NE3002, NE4001, NE4002, NE5002, NE5501, NE5502, NE7002, NE7501, NE7502, NE9001, NE9002, NE9502, NG02, NG1202, NG1202E, NG602, NG602E, NG902, NG902E, NL302, NL302E, NL402, NL402E, NL502, NL502E, NL552, NL552E		





1

<b>GEV No.</b>	529234	<b>Ref. No.</b>	510299 620144 620648
<b>description</b>	drive shaft for transport system		
<b>For models:</b>	AC100, AC101, AC105, AC120, AC122, AC135, AC150, AC151, AC152, AC170, AC181, AC182, AC200, AC201, AC202, AC241, AC242, AC90, AC91, AC95, ACR, ACR145, ACR205, ACR225, ACR245, ACR260, ACR265, ACR305, ACRS145, ACRS205, ACRS225, ACRS245, ACRS260, ACRS265, ACRS305, ACS101, ACS101-DIGIT, ACS122, ACS122-DIGIT, ACS151, ACS151-DIGIT, ACS152, ACS152-DIGIT, ACS161-DIGIT, ACS162-DIGIT, ACS181, ACS181-DIGIT, ACS182, ACS182-DIGIT, ACS201...(Other models you can see in the webshop)		





			
1			
<b>GEV No.</b>	541071	<b>Ref. No.</b>	150811
<b>description</b>	duct		
<b>For models:</b>	C33, C34		

			
1			
<b>GEV No.</b>	542126	<b>Ref. No.</b>	330715
<b>description</b>	fastening angle L1 17mm L2 40mm H 39mm ED ø 30mm thickness 2mm		
<b>For models:</b>	AC100, AC101, AC120, AC122, AC150, AC151, AC152, AC170, AC181, AC182, AC200, AC201, AC202, AC241, AC242, AC2A, AC90, AC91, ACL100, ACL150, ACR, ACR145, ACR205, ACR225, ACR245, ACR260, ACR265, ACR305, ACRS145, ACRS205, ACRS225, ACRS245, ACRS260, ACRS265, ACRS305, ACS101, ACS101-DIGIT, ACS122, ACS122-DIGIT, ACS151, ACS151-DIGIT, ACS152, ACS152-DIGIT, ACS161-DIGIT, ACS161-DIGIT, ACS162-DIGIT, ACS181, ACS181-DIGIT, ACS182, ACS182-DIGIT, ACS201... (Other models you can see in the webshop)		

			
1			
<b>GEV No.</b>	524768	<b>Ref. No.</b>	170232
<b>description</b>	finger for stroke arresting device L 80mm W 56mm H 21mm suitable for COMENDA		
<b>For models:</b>	NG02, NG1202, NG1202E, NG602, NG602E, NG902, NG902E		

			
1			
<b>GEV No.</b>	524677	<b>Ref. No.</b>	180201
<b>description</b>	flange for drive shaft ø 85mm hole ø 22mm thickness 14mm suitable for COMENDA		
<b>For models:</b>	NE00, NE02, NE3001, NE3002, NE4001, NE4002, NE5002, NE5501, NE5502, NE7002, NE7501, NE7502, NE9001, NE9002, NE9502, NG00, NG01, NG02, NG1202, NG1202E, NG600, NG600E, NG601, NG601E, NG602, NG602E, NG900, NG900E, NG901, NG901E, NG902, NG902E		

			
1			
<b>GEV No.</b>	524675	<b>Ref. No.</b>	170448
<b>description</b>	gear wheel for transport system ø 175mm hole ø 36mm thickness 13mm suitable for COMENDA		

			
1			
<b>GEV No.</b>	698374	<b>Ref. No.</b>	410292
<b>description</b>	gear wheel ø 114mm hole ø 17mm thickness 30mm suitable for COMENDA		

			
1			
<b>GEV No.</b>	511581	<b>Ref. No.</b>	190146
<b>description</b>	guide for transport system L 45mm W 15mm H 34mm hole ø 8.5mm suitable for COMENDA		
<b>For models:</b>	AC101, AC105, AC122, AC135, AC151, AC152, AC181, AC182, AC201, AC202, AC241, AC242, AC91, AC95, ACL100, ACL150, ACRS145, ACRS205, ACRS225, ACRS245, ACRS260, ACRS265, ACRS305, ACS101, ACS101-DIGIT, ACS122, ACS122-DIGIT, ACS151, ACS151-DIGIT, ACS152, ACS152-DIGIT, ACS161-DIGIT, ACS162-DIGIT, ACS181, ACS181-DIGIT, ACS182, ACS182-DIGIT, ACS201, ACS201-DIGIT, ACS202, ACS202-DIGIT, ACS241, ACS241-DIGIT, ACS242, ACS242-DIGIT, ACS91, ACS91-DIGIT		

			
1			
<b>GEV No.</b>	512491	<b>Ref. No.</b>	190651
<b>description</b>	guide busching for roller spring L 60mm H 8mm W 20mm suitable for COMENDA		
<b>For models:</b>	AC101, AC122, AC151, AC152, AC181, AC182, AC201, AC202, AC241, AC242, AC2A, AC91, ACL100, ACL150, ACRS145, ACRS205, ACRS225, ACRS245, ACRS260, ACRS265, ACRS305, ACS101, ACS101-DIGIT, ACS122, ACS122-DIGIT, ACS151, ACS151-DIGIT, ACS152, ACS152-DIGIT, ACS161-DIGIT, ACS162-DIGIT, ACS181, ACS181-DIGIT, ACS182, ACS182-DIGIT, ACS201, ACS201-DIGIT, ACS202, ACS202-DIGIT, ACS241, ACS241-DIGIT, ACS242, ACS242-DIGIT, ACS91, ACS91-DIGIT, GMC2702, GMC3502, GMC4502, GMC5502, LAV1000... (Other models you can see in the webshop)		

			
1			
<b>GEV No.</b>	701579	<b>Ref. No.</b>	191060
<b>description</b>	holding pin for filter L 25mm ED ø 15.5mm IT M6 suitable for COMENDA		
<b>For models:</b>	AC120, AC170, AC200, ACR, ACR145, ACR205, ACR225, ACR245, ACR260, ACR265, ACR305, GMC, GMC2700, GMC3500, GMC4500, GMC5500, NE3001, NE4001, NE5501, NE7501, NE9001, NG01, NG601E, NG901E		

			
1			
<b>GEV No.</b>	504361	<b>Ref. No.</b>	170238
<b>description</b>	lever L 95mm W 30mm H 35mm		
<b>For models:</b>	NE02, NE3002, NE4002, NE5002, NE5502, NE7002, NE7502, NE9002, NE9502, NL302, NL302E, NL402, NL402E, NL502, NL502E, NL552, NL552E		

			
1			
<b>GEV No.</b>	524761	<b>Ref. No.</b>	170440
<b>description</b>	pulley for impulse ø 114mm hole ø 20mm thickness 26mm suitable for COMENDA		
<b>For models:</b>	LAV1000		





			
1			
<b>GEV No.</b>	510846	<b>Ref. No.</b>	191015
<b>description</b>	ratchet		

			
1			
<b>GEV No.</b>	504345	<b>Ref. No.</b>	170336
<b>description</b>	roller for transport system H 10.5mm $\phi$ 24mm ID $\phi$ 15mm hole $\phi$ 6.2mm		
<b>For models:</b>	GMC, GMC2700, GMC2702, GMC3500, GMC3502, GMC4500, GMC4502, GMC5500, GMC5502		

			
1			
<b>GEV No.</b>	504362	<b>Ref. No.</b>	170303
<b>description</b>	roller for transport system H 10mm $\phi$ 31mm hole $\phi$ 8mm		
<b>For models:</b>	GMC, GMC2700, GMC2702, GMC3500, GMC3502, GMC4500, GMC4502, GMC5500, GMC5502		

			
1			
<b>GEV No.</b>	504346	<b>Ref. No.</b>	170314
<b>description</b>	roller for transport system H 19.5mm $\phi$ 30mm hole $\phi$ 9mm		
<b>For models:</b>	LAV1001, LAV1501, LV1001, LV1501, LV-LVP, LVP1001, LVP1501, NE00, NE02, NE3001, NE3002, NE4001, NE4002, NE5002, NE5501, NE5502, NE7002, NE7501, NE7502, NE9001, NE9002, NE9502, NG00, NG01, NG02, NG1202, NG1202E, NG600, NG600E, NG601, NG601E, NG602, NG602E, NG900, NG900E, NG901, NG901E, NG902, NG902E, NL302, NL302E, NL402, NL402E, NL502, NL502E, NL552, NL552E		

			
1			
<b>GEV No.</b>	524643	<b>Ref. No.</b>	170331
<b>description</b>	roller for transport system W 26mm $\phi$ 120mm hole $\phi$ 20mm suitable for COMENDA		
<b>For models:</b>	LAV1001, LAV1501, LV1001, LV1501, LV-LVP, LVP1001, LVP1501		

			
1			
<b>GEV No.</b>	524583	<b>Ref. No.</b>	290820
<b>description</b>	spacer for impulse ID $\phi$ 40mm ED $\phi$ 52mm thickness 7.5mm suitable for MEIKO		
<b>For models:</b>	GMC, GMC2700, GMC3500, GMC4500, GMC5500		

			
1			
<b>GEV No.</b>	504359	<b>Ref. No.</b>	170215
<b>description</b>	spacer for transport system L 210mm		
<b>For models:</b>	GMC, GMC2700, GMC2702, GMC3500, GMC3502, GMC4500, GMC4502, GMC5500, GMC5502		

			
1			
<b>GEV No.</b>	524548	<b>Ref. No.</b>	340405
<b>description</b>	spindle for conveyor belt L 610mm $\phi$ 8mm suitable for COMENDA		
<b>For models:</b>	LV1001, LV1501, LV-LVP, LVP1001, LVP1501, NE00, NE02, NE3001, NE3002, NE4001, NE4002, NE5002, NE5501, NE5502, NE7002, NE7501, NE7502, NE9001, NE9002, NE9502, NL302, NL302E, NL402, NL402E, NL502, NL502E, NL552, NL552E		

			
1			
<b>GEV No.</b>	510222	<b>Ref. No.</b>	342061
<b>description</b>	spindle for conveyor belt L 698mm $\phi$ 25mm		
<b>For models:</b>	NE02, NE3002, NE4002, NE5002, NE5502, NE7002, NE7502, NE9002, NE9502		

			
1			
<b>GEV No.</b>	511174	<b>Ref. No.</b>	170204
<b>description</b>	tappet		
<b>For models:</b>	NE00, NG01, NG601, NG601E, NG901, NG901E		

			
1			
<b>GEV No.</b>	510651	<b>Ref. No.</b>	170220
<b>description</b>	tappet for dishwasher		
<b>For models:</b>	NE02, NE3001, NE3002, NE4001, NE4002, NE5002, NE5501, NE5502, NE7002, NE7501, NE7502, NE9001, NE9002, NE9502		







			
1			
<b>GEV No.</b>	524590	<b>Ref. No.</b>	510425
<b>description</b>	tappet for dishwasher L 58mm W 42mm H 54mm hole $\phi$ 8.4mm suitable for COMENDA		
<b>For models:</b>	AC101, AC105, AC122, AC135, AC151, AC152, AC181, AC182, AC201, AC202, AC241, AC242, AC91, AC95, ACL100, ACL150, ACRS145, ACRS205, ACRS225, ACRS245, ACRS260, ACRS265, ACRS305, ACS101, ACS101-DIGIT, ACS122, ACS122-DIGIT, ACS151, ACS151-DIGIT, ACS152, ACS152-DIGIT, ACS161-DIGIT, ACS162-DIGIT, ACS181, ACS181-DIGIT, ACS182, ACS182-DIGIT, ACS201, ACS201-DIGIT, ACS202, ACS202-DIGIT, ACS241, ACS241-DIGIT, ACS242, ACS242-DIGIT, ACS91, ACS91-DIGIT		
<b>accessories for</b>	524590		
		<b>GEV No.</b>	524589
		<b>Ref. No.</b>	342020
	bolt for tappet L 30mm $\phi$ 8mm hole $\phi$ 2.5mm suitable for COMENDA		

Table continues overleaf





<b>accessories for</b>	524590		
	<b>GEV No.</b>	560114	<b>Ref. No.</b> 260505
	plain washer ID ø 8.4mm ED ø 16mm thickness 1.6mm SS Qty 20 pcs DIN 125A for thread M8		
	<b>GEV No.</b>	694401	<b>Ref. No.</b> 451002
	roll pin ø 2mm L 12mm stainless steel 1481		

	1		
<b>GEV No.</b>	504355	<b>Ref. No.</b>	170218
<b>description</b>	tappet for dishwasher L 97mm W 74mm		
<b>For models:</b>	NE02, NE3001, NE3002, NE4001, NE4002, NE5002, NE5501, NE5502, NE7002, NE7501, NE7502, NE9001, NE9002, NE9502, NG02, NG1202, NG1202E, NG602, NG602E, NG902, NG902E, NL302, NL302E, NL402, NL402E, NL502, NL502E, NL552, NL552E		

	1		
<b>GEV No.</b>	504356	<b>Ref. No.</b>	170217
<b>description</b>	tappet for dishwasher L 97mm W 74mm		
<b>For models:</b>	NE02, NE3001, NE3002, NE4001, NE4002, NE5002, NE5501, NE5502, NE7002, NE7501, NE7502, NE9001, NE9002, NE9502, NG02, NG1202, NG1202E, NG602, NG602E, NG902, NG902E, NL302, NL302E, NL402, NL402E, NL502, NL502E, NL552, NL552E		



	1		
<b>GEV No.</b>	504357	<b>Ref. No.</b>	170214
<b>description</b>	tappet for dishwasher L 97mm W 84mm		
<b>For models:</b>	GMC, GMC2700, GMC2702, GMC3500, GMC3502, GMC4500, GMC4502, GMC5500, GMC5502		

	1		
<b>GEV No.</b>	504363	<b>Ref. No.</b>	330224
<b>description</b>	tie bar L 497mm W 6mm thread 2xM6		
<b>For models:</b>	GMC, GMC2700, GMC2702, GMC3500, GMC3502, GMC4500, GMC4502, GMC5500, GMC5502		

<b>pipes</b>			
	1		
<b>GEV No.</b>	510808	<b>Ref. No.</b>	160115
<b>description</b>	pipe L 1000mm ø 9.5mm		
<b>For models:</b>	B41, B42, C140, C155, C155BT, C155E2, C155RCD, C165, C165E2, C165E2BT, C165E2RCD, C166, C166-2, C30, C70, C75, C75BT, C75M, C75RCD, C85, C95, C95BT, C95E2, C95RCD, LC380, LC380BT, LC380RCD, LC400, LP360, LP360BT, LP360RCD		

<b>backflow preventers</b>			
<b>backflow preventers</b>			
	1		
<b>GEV No.</b>	504140	<b>Ref. No.</b>	620243
<b>description</b>	backflow preventer		

	1		
<b>GEV No.</b>	504265	<b>Ref. No.</b>	620535
<b>description</b>	backflow preventer		
<b>For models:</b>	AC2A, ACL100, ACL150, ACRS145, ACRS205, ACRS225, ACRS245, ACRS260, ACRS265, ACRS305, ACS101, ACS101-DIGIT, ACS122, ACS122-DIGIT, ACS151, ACS151-DIGIT, ACS152, ACS152-DIGIT, ACS161-DIGIT, ACS162-DIGIT, ACS181, ACS181-DIGIT, ACS182, ACS182-DIGIT, ACS201, ACS201-DIGIT, ACS202, ACS202-DIGIT, ACS241, ACS241-DIGIT, ACS242, ACS242-DIGIT, ACS91-DIGIT, BC25, BC25A, BC25HR, BC30, BC30A, BC30HR, BC30HR380, BC30HRA, BHC25, BHC25-2, BHC25A, BHC25A-2, BHC25S, BHC30, BHC30-2, BHC30A, BHC30A-2...(Other models you can see in the webshop)		

	1		
<b>GEV No.</b>	510220	<b>Ref. No.</b>	191095
<b>description</b>	backflow preventer		
<b>For models:</b>	C1000ERCD, C1300ERCD, GE50RCD, GE60RCD, GE65RCD, LC1200RCD, LC700RCD, LC900RCD, LF322RCD, XLC		
<b>accessories for</b>	510220		
	<b>GEV No.</b>	510226	<b>Ref. No.</b> 180149
	nut ø 65mm for backflow preventer		
	<b>GEV No.</b>	510234	<b>Ref. No.</b> 200498
	flat gasket rubber ED ø 65mm ID ø 47mm thickness 2mm Qty 1 pcs		



1

<b>GEV No.</b>	510993	<b>Ref. No.</b>	620243
<b>description</b>	backflow preventer		
<b>For models:</b>	BC25, BC25A, BC25HR, BC30, BC30A, BC30HR, BC30HR380, BC30HRA, BHC25, BHC25-2, BHC25A, BHC25A-2, BHC25S, BHC30, BHC30-2, BHC30A, BHC30A-2, BHC30E, BHC30E-2, BHC30EA, BHC30EA-2, BHC30HR, BHC30HR-2, BHC30HR380, BHC30HRA, BHC30HRA-2, BHC30HRA380, BHC433, BHC433-2, BHC433A, BHC433A-2, BHCHR, C1000E, C1001M, C1300E, C1301M, C155, C155E2, C165, C165E2, C166, C166-2, C75, C95, C95E2, F90M, F90MA, FC, FC43, FC43A... (Other models you can see in the webshop)		



1

<b>GEV No.</b>	518605	<b>Ref. No.</b>	191108 191111
<b>description</b>	backflow preventer hose ø 11mm		
<b>For models:</b>	FC3E, FC3EA, FC3MA, FC44E, FC44EA, FC4E, FC4EA, FC4EHRT, FC4MA		

## accessories



1

<b>GEV No.</b>	511277	<b>Ref. No.</b>	190330
<b>description</b>	T-piece thread 1/2" ø 18mm		
<b>For models:</b>	BC25, BC25A, BC25HR, BC30, BC30A, BC30HR, BC30HR380, BC30HRA, BHC25, BHC25-2, BHC25A, BHC25A-2, BHC25S, BHC30, BHC30-2, BHC30A, BHC30A-2, BHC30E, BHC30E-2, BHC30EA, BHC30EA-2, BHC30HR, BHC30HR-2, BHC30HR380, BHC30HRA, BHC30HRA-2, BHC30HRA380, BHC433, BHC433-2, BHC433A, BHC433A-2, BHCHR, C1000E, C1001M, C1300E, C1301M, C155, C155E2, C165, C165E2, C166, C166-2, C75, C95, C95E2, F90M, F90MA, FC, FC43, FC43A... (Other models you can see in the webshop)		

## miscellaneous



1

<b>GEV No.</b>	510833	<b>Ref. No.</b>	331814
<b>description</b>	angle piece for filter		
<b>For models:</b>	NE02, NE3001, NE3002, NE4001, NE4002, NE5002, NE5501, NE5502, NE7002, NE7501, NE7502, NE9001, NE9002, NE9502		



1

<b>GEV No.</b>	512490	<b>Ref. No.</b>	190692
<b>description</b>	bush L 30mm D1 ø 34mm ID ø 30mm		



1

<b>GEV No.</b>	511003	<b>Ref. No.</b>	190629
<b>description</b>	bush mounting pos. rear		
<b>For models:</b>	B11, B12, B15, B16, B18, B19		



1

<b>GEV No.</b>	511394	<b>Ref. No.</b>	160784
<b>description</b>	lid for tank with thread D1 ø 88mm D2 ø 65mm		
<b>For models:</b>	BHC25, BHC30, BHC30A, BHC30HR, BHC30HR380, BHC30HRA, BHC30HRA380, BHC433, BHC433A, BHCHR, LB215, LB215A, LB275, LB275A		

<b>accessories for</b>	511394		
<b>GEV No.</b>	511395	<b>Ref. No.</b>	200868

	O-ring EPDM thickness 2.62mm ID ø 71.12mm Qty 1 pcs		
--	---	--	--

<b>GEV No.</b>	511396	<b>Ref. No.</b>	160787
----------------	--------	-----------------	--------

	nut		
--	-----	--	--



			
1			
<b>GEV No.</b>	510349	<b>Ref. No.</b>	160755
<b>description</b>	plug D1 ø 87mm mounting ø 72mm ID ø 60mm		
<b>For models:</b>	B11T, B12T, B13T, B14T, B15T, B15TM, B16T, B16TM, B18T, B18TM, B19T, B19TM, BC25, BC25A, BC25HR, BC30, BC30A, BC30HR, BC30HR380, BC30HRA, BHC25, BHC25-2, BHC30, BHC30-2, BHC30A, BHC30A-2, BHC30E, BHC30E-2, BHC30EA, BHC30EA-2, BHC30HR, BHC30HR-2, BHC30HR380, BHC30HRA, BHC30HRA-2, BHC30HRA380, BHC433, BHC433-2, BHC433A, BHC433A-2, BHCHR, BR20, BR20A, BR25, F90M, F90MA, FC, FC43, FC53, FC533...(Other models you can see in the webshop)		
<b>accessories for</b>	510349		
			
<b>GEV No.</b>	510947	<b>Ref. No.</b>	200489
<b>description</b>	flat gasket rubber ED ø 85mm ID ø 73mm thickness 2mm Qty 1 pcs equiv. no. 200489 suitable for COMENDA		

 <p>Image not available</p>			
1			
<b>GEV No.</b>	970053	<b>Ref. No.</b>	660605
<b>description</b>	ring		

			
1			
<b>GEV No.</b>	524046	<b>Ref. No.</b>	441103 441111 441139
<b>description</b>	vibration damper L 40mm W 25mm H 25mm for pump		
<b>For models:</b>	AC120, AC135, AC150, AC170, AC200, ACS181, ACS181-DIGIT, ACS182, ACS182-DIGIT, ACS201, ACS201-DIGIT, ACS202, ACS202-DIGIT, ACS241, ACS241-DIGIT, ACS242, ACS242-DIGIT, C1000ERCD, C1300ERCD, C140, C155, C155BT, C155E2, C155RCD, C165, C165E2, C165E2BT, C165E2RCD, C166, C166-2, C70, C75, C75BT, C75M, C75RCD, C85, C95, C95BT, C95E2, C95RCD, FC3E, FC3EA, FC3M, FC3MA, FC3MR, FC44E, FC44EA, FC4E, FC4EA, FC4EHRT...(Other models you can see in the webshop)		

door mechanics

bolts

			
1			
<b>GEV No.</b>	511383	<b>Ref. No.</b>	341297
<b>description</b>	bolt		

			
1			
<b>GEV No.</b>	510336	<b>Ref. No.</b>	340416
<b>description</b>	bolt L 12.5mm thread M3 for hinge SS WS 7		
<b>For models:</b>	FC3E, FC3EA, FC3M, FC3MA, FC3MR, FC44E, FC44EA, FC4E, FC4EA, FC4EHRT, FC4M, FC4MA		

springs

torsion springs

			
1			
<b>GEV No.</b>	510652	<b>Ref. No.</b>	391335
<b>description</b>	torsion spring ø 18mm wire gauge ø 3mm Qty 1 pcs		
<b>For models:</b>	FC3E, FC3EA, FC3M, FC3MA, FC3MR, FC44E, FC44EA, FC4E, FC4EA, FC4EHRT, FC4M, FC4MA		

tension springs

			
1			
<b>GEV No.</b>	510228	<b>Ref. No.</b>	450217
<b>description</b>	tension spring ø 12mm total length 165mm wire gauge ø 1mm		
<b>For models:</b>	G100L, G101L, G115, G115L, G50L, G50LM, G51L, G60L, G61L, G65, G65L, GL, LAV1001, LAV1501		

			
1			
<b>GEV No.</b>	511565	<b>Ref. No.</b>	391334
<b>description</b>	tension spring ø 13mm total length 190mm wire gauge ø 1.75mm L1 155mm L2 16mm L3 16mm		
<b>For models:</b>	FC3E, FC3EA, FC3M, FC3MA, FC44E, FC44EA, FC4E, FC4EA, FC4EHRT, FC4M, FC4MA		

			
1			
<b>GEV No.</b>	510064	<b>Ref. No.</b>	450288
<b>description</b>	tension spring ø 13mm total length 78mm wire gauge ø 2.5mm L1 14mm L2 50mm L3 14mm		
<b>For models:</b>	GF70, GF70A, LF321, LF321A, LF322, LF322A, LF322MP, LF322MP-A, LF322RCD, LF324, LF324A, LF325E, LF325EA, LF700, LF700A		

			
1			
<b>GEV No.</b>	519405	<b>Ref. No.</b>	450237
<b>description</b>	tension spring ø 22mm L1 185mm		
<b>For models:</b>	GE100, GE115, GE50RCD, GE60, GE60RCD, GE65, GE65RCD, GE80		

linkage

			
1			
<b>GEV No.</b>	511372	<b>Ref. No.</b>	330227
<b>description</b>	door pin L 168mm thread M5 ø 5mm		
<b>For models:</b>	BC25, BC25A, BC25HR, BC30, BC30A, BC30HR, BC30HR380, BC30HRA, BR20, BR20A, BR25, BR25A, FC43, FC43A, R40, R70		

1 			
<b>GEV No.</b>	511380	<b>Ref. No.</b>	330235
<b>description</b>	door pin L 200mm tie bar ø 5mm		
<b>For models:</b>	BHC25, BHC25-2, BHC25A, BHC25A-2, BHC25S, BHC30, BHC30-2, BHC30A, BHC30A-2, BHC30E, BHC30E-2, BHC30EA, BHC30EA-2, BHC30HR, BHC30HR-2, BHC30HR380, BHC30HRA, BHC30HRA-2, BHC30HRA380, BHC433, BHC433-2, BHC433A, BHC433A-2, BHCHR		

1 			
<b>GEV No.</b>	511386	<b>Ref. No.</b>	330233
<b>description</b>	door pin L 240mm tie bar ø 5mm		
<b>For models:</b>	FC, FC53, FC533, FC533A, FC53A, FC53CBT, FC53LA, FC53LBT, FC54, FC543, FC543A, FC543E, FC543EA, FC544, FC544A, FC54A, FC54CBT, FC54E, FC54EA, FC54LBT, FCHR, FCHRA, FCHRT, FCHRTA		

1 			
<b>GEV No.</b>	510491	<b>Ref. No.</b>	330209
<b>description</b>	door pin L 305mm thread M5 tie bar		
<b>For models:</b>	B18, B18T, B18TM, B19, B19T, B19TM, B41, F2, F20, F3, F300, F45, F55, F65, F80, F90M, F90MA, G115, G65, LF280-lav-line, LF320-lav-line, LF400A, LF450, LF450A, R50		

1 			
<b>GEV No.</b>	511154	<b>Ref. No.</b>	330231
<b>description</b>	door pin tie bar		
<b>For models:</b>	LF315, LF320, LF320A, LF320CBT, LF320L, LF320LA, LF320LBT, LF323, LF323A, LF350, LF350A, LS550		

1 			
<b>GEV No.</b>	519415	<b>Ref. No.</b>	330211
<b>description</b>	tie bar		
<b>For models:</b>	B41, B42, F2, F300, R40, R70		

1 			
<b>GEV No.</b>	519412	<b>Ref. No.</b>	H34440
<b>description</b>	tie bar L 234mm thread M5 ø 4.4mm		
<b>For models:</b>	GF90, GF90A		

threaded shafts

1 			
<b>GEV No.</b>	511373	<b>Ref. No.</b>	341922
<b>description</b>	threaded part ø 10mm L 13mm thread M5 threaded part		
<b>For models:</b>	BC25, BC25A, BC25HR, BC30, BC30A, BC30HR, BC30HR380, BC30HRA, BR20, BR20A, BR25, BR25A, FC43, FC43A		

1 			
<b>GEV No.</b>	510829	<b>Ref. No.</b>	250207
<b>description</b>	threaded part threaded part		
<b>For models:</b>	B18, B18T, B18TM, B19, B19T, B19TM, B41, F2, F20, F3, F300, F45, F55, F65, F80, G115, G65, LF280-lav-line, LF320-lav-line, NG02, NG1202, NG1202E, NG602, NG602E, NG902, NG902E, R50		

1 			
<b>GEV No.</b>	511156	<b>Ref. No.</b>	342010
<b>description</b>	threaded part threaded part		
<b>For models:</b>	F90M, F90MA, FC, FC53, FC533, FC533A, FC53A, FC53CBT, FC53LA, FC53LBT, FC54, FC543, FC543A, FC543E, FC543EA, FC544, FC544A, FC54A, FC54CBT, FC54E, FC54EA, FC54LBT, FCHR, FCHRA, FCHRT, FCHRTA, LF315, LF320, LF320A, LF320CBT, LF320L, LF320LA, LF320LBT, LF323, LF323A, LF350, LF350A, LF400A, LF450, LF450A, LS550		

1 			
<b>GEV No.</b>	511381	<b>Ref. No.</b>	342701
<b>description</b>	threaded part threaded part		
<b>For models:</b>	BHC25, BHC25-2, BHC25A, BHC25A-2, BHC25S, BHC30, BHC30-2, BHC30A, BHC30A-2, BHC30E, BHC30E-2, BHC30EA, BHC30EA-2, BHC30HR, BHC30HR-2, BHC30HR380, BHC30HRA, BHC30HRA-2, BHC30HRA380, BHC433, BHC433-2, BHC433A, BHC433A-2, BHCHR		

sliding plates

1 			
<b>GEV No.</b>	699112	<b>Ref. No.</b>	321948
<b>description</b>	door guides		
<b>For models:</b>	AC120, AC150, AC170, AC200, ACR, ACR145, ACR205, ACR225, ACR245, ACR260, ACR265, ACR305, ACR3145, ACR5205, ACR5225, ACR5245, ACR5260, ACR5265, ACR5305, GMC, GMC2700, GMC3500, GMC4500, GMC5500, SE		

1 			
<b>GEV No.</b>	510492	<b>Ref. No.</b>	160905
<b>description</b>	sliding plate for tie bar		
<b>For models:</b>	B18, B18T, B18TM, B19, B19T, B19TM, B41, BHC25, BHC25-2, BHC25A, BHC25A-2, BHC25S, BHC30, BHC30-2, BHC30A, BHC30A-2, BHC30E, BHC30E-2, BHC30EA, BHC30EA-2, BHC30HR, BHC30HR-2, BHC30HR380, BHC30HRA, BHC30HRA-2, BHC30HRA380, BHC433, BHC433-2, BHC433A, BHC433A-2, BHCHR, F2, F20, F3, F300, F45, F55, F65, F80, F90M, F90MA, FC, FC53, FC533, FC533A, FC53A, FC53CBT, FC53LA, FC53LBT, FC54...(Other models you can see in the webshop)		







			
1			
<b>GEV No.</b>	511371	<b>Ref. No.</b>	160909
<b>description</b>	sliding plate sliding plate		
<b>For models:</b>	BC25, BC25A, BC25HR, BC30, BC30A, BC30HR, BC30HR380, BC30HRA, BR20, BR20A, BR25, BR25A, FC43, FC43A, GF90, GF90A		

hinges

			
1			
<b>GEV No.</b>	511384	<b>Ref. No.</b>	321807
<b>description</b>	door hinge hinge		
<b>For models:</b>	FC, FC53, FC533, FC533A, FC53A, FC53CBT, FC53LA, FC53LBT, FC54, FC543, FC543A, FC543E, FC543EA, FC544, FC544A, FC54A, FC54CBT, FC54E, FC54EA, FC54LBT, FCHR, FCHRA, FCHRT, FCHRTA		

			
1			
<b>GEV No.</b>	511368	<b>Ref. No.</b>	441107
<b>description</b>	door hinge hinge mounting pos. left		
<b>For models:</b>	BC25, BC25A, BC25HR, BC30, BC30A, BC30HR, BC30HR380, BC30HRA, BR20, BR20A, BR25, BR25A, F90M, F90MA, FC43, FC43A, LF315, LF320, LF320A, LF320CBT, LF320L, LF320LA, LF320LBT, LF323, LF323A, LF350, LF350A, LF400A, LF450, LF450A, LS550		

			
1			
<b>GEV No.</b>	511367	<b>Ref. No.</b>	441108
<b>description</b>	door hinge hinge mounting pos. right		
<b>For models:</b>	BC25, BC25A, BC25HR, BC30, BC30A, BC30HR, BC30HR380, BC30HRA, BR20, BR20A, BR25, BR25A, F90M, F90MA, FC43, FC43A, LF315, LF320, LF320A, LF320CBT, LF320L, LF320LA, LF320LBT, LF323, LF323A, LF350, LF350A, LF400A, LF450, LF450A, LS550		

hinge pins

			
1			
<b>GEV No.</b>	510920	<b>Ref. No.</b>	341218
<b>description</b>	hinge pin hinge pin		
<b>For models:</b>	B10, B10T, B11, B11T, B12, B12T, B13T, B14T, B15, B15T, B15TM, B16, B16T, B16TM, B18, B18T, B18TM, B19, B19T, B19TM, B20, B20D, B24, B25, B26, B27, B41, F20, F45, F55, F65, F80, F90M, F90MA, FC, FC3E, FC3EA, FC3M, FC3MA, FC3MR, FC44E, FC44EA, FC4E, FC4EA, FC4EHRT, FC4M, FC4MA, FC53, FC533, FC533A...(Other models you can see in the webshop)		

			
1			
<b>GEV No.</b>	511369	<b>Ref. No.</b>	341921
<b>description</b>	hinge pin hinge pin		
<b>For models:</b>	BC25, BC25A, BC25HR, BC30, BC30A, BC30HR, BC30HR380, BC30HRA, BR20, BR20A, BR25, BR25A, FC43, FC43A		

			
1			
<b>GEV No.</b>	511375	<b>Ref. No.</b>	342087 H15568
<b>description</b>	hinge pin ø 6mm D1 ø 4mm L 55mm thread M4 stainless steel		
<b>For models:</b>	BHC25, BHC25-2, BHC25A, BHC25A-2, BHC25S, BHC30, BHC30-2, BHC30A, BHC30A-2, BHC30E, BHC30E-2, BHC30EA, BHC30EA-2, BHC30HR, BHC30HR-2, BHC30HR380, BHC30HRA, BHC30HRA-2, BHC30HRA380, BHC433, BHC433-2, BHC433A, BHC433A-2, BHCHR, GF70, GF70A, GF90, GF90-2004, GF90A, GF90A-2004		

			
1			
<b>GEV No.</b>	511628	<b>Ref. No.</b>	341927
<b>description</b>	hinge pin ø 6mm L 60mm thread M6x1 stainless steel		
<b>For models:</b>	LB200, LB200-2, LB200A, LB200A-2, LB215, LB215-2, LB215A, LB215A-2, LB260, LB260-2, LB260A, LB260A-2, LB275, LB275-2, LB275A, LB275A-2, LBC210, LBC215, LBC215A, LBC275, LBC275A, LBR, LBR200, LBR215, LBR215A, LF321, LF321A, LF322, LF322A, LF322MP, LF322MP-A, LF322RCD, LF324, LF324A, LF325E, LF325EA, LF700, LF700A		

door seals

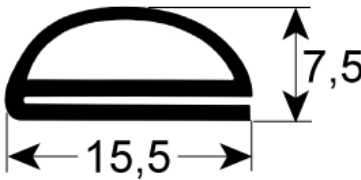
			
1			
<b>GEV No.</b>	511577	<b>Ref. No.</b>	200217
<b>description</b>	door seal L 595mm W 15.5mm H 7mm Qty 1 suitable for COMENDA		
<b>For models:</b>	LF321, LF321A, LF322, LF322A, LF322MP, LF322MP-A, LF322RCD, LF324, LF324A, LF325E, LF325EA, LF700, LF700A		

## doors

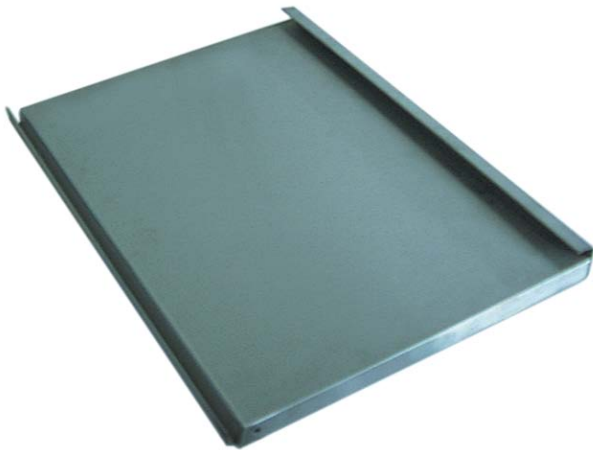

1

<b>GEV No.</b>	510830	<b>Ref. No.</b>	320984
<b>description</b>	door		
<b>For models:</b>	F45, F55, F65, F80		



1

<b>GEV No.</b>	510888	<b>Ref. No.</b>	322941
<b>description</b>	door for dishwasher W 570mm H 465mm		
<b>For models:</b>	FC, FC53, FC533, FC533A, FC53A, FC53CBT, FC53LBT, FC54, FC543, FC543A, FC543E, FC543EA, FC544, FC544A, FC54A, FC54CBT, FC54E, FC54EA, FC54LBT, FCHR, FCHRA, FCHRT, FCHRTA		

## door guides



1

<b>GEV No.</b>	510252	<b>Ref. No.</b>	180630 180651/R
<b>description</b>	door guides L 710mm W 30mm H 16mm with brake		
<b>For models:</b>	AC101, AC105, AC122, AC135, AC151, AC152, AC181, AC182, AC201, AC202, AC241, AC242, AC91, AC95, ACL100, ACL150, ACRS145, ACRS205, ACRS225, ACRS245, ACRS260, ACRS265, ACRS305, ACS101, ACS101-DIGIT, ACS122, ACS122-DIGIT, ACS151, ACS151-DIGIT, ACS152, ACS152-DIGIT, ACS161-DIGIT, ACS162-DIGIT, ACS181, ACS181-DIGIT, ACS182, ACS182-DIGIT, ACS201, ACS201-DIGIT, ACS202, ACS202-DIGIT, ACS241, ACS241-DIGIT, ACS242, ACS242-DIGIT, ACS91, ACS91-DIGIT, GMC2702, GMC3502, GMC4502...(Other models you can see in the webshop)		



1

<b>GEV No.</b>	510223	<b>Ref. No.</b>	180628
<b>description</b>	door guides L 740mm W 30mm H 18mm		
<b>For models:</b>	G100L, G101L, G115L, G50L, G50LM, G51L, G60L, G61L, G65L, GL		

## door bumpers



1

<b>GEV No.</b>	511305	<b>Ref. No.</b>	210402
<b>description</b>	door bumper		
<b>For models:</b>	AC105, AC120, AC135, AC150, AC170, AC200, AC95, ACR, ACR145, ACR205, ACR225, ACR245, ACR260, ACR265, ACR305, ACS101, ACS101-DIGIT, ACS122, ACS122-DIGIT, ACS151, ACS151-DIGIT, ACS152, ACS152-DIGIT, ACS161-DIGIT, ACS162-DIGIT, ACS181, ACS181-DIGIT, ACS182, ACS182-DIGIT, ACS201, ACS201-DIGIT, ACS202, ACS202-DIGIT, ACS241, ACS241-DIGIT, ACS242, ACS242-DIGIT, ACS91, ACS91-DIGIT, B10, B11, B12, B15, B16, B18, B19, B20, B20D, B23, B24...(Other models you can see in the webshop)		





1

<b>GEV No.</b>	510957	<b>Ref. No.</b>	190619
<b>description</b>	door bumper end stop		
<b>For models:</b>	B18, B18T, B18TM, B19, B19T, B19TM, B41, B42, BHC25, BHC25-2, BHC25A, BHC25A-2, BHC25S, BHC30, BHC30-2, BHC30A, BHC30A-2, BHC30E, BHC30E-2, BHC30EA, BHC30EA-2, BHC30HR, BHC30HR-2, BHC30HR380, BHC30HRA, BHC30HRA-2, BHC30HRA380, BHC433, BHC433-2, BHC433A, BHC433A-2, BHCHR, F2, F20, F3, F300, F45, F55, F65, F80, F90M, F90MA, FC, FC53, FC533, FC533A, FC53A, FC53CBT, FC53LA, FC53LBT...(Other models you can see in the webshop)		



			
1			
<b>GEV No.</b>	511176	<b>Ref. No.</b>	190644
<b>description</b>	door bumper end stop		
<b>For models:</b>	BC25, BC25A, BC25HR, BC30, BC30A, BC30HR, BC30HR380, BC30HRA, BR20, BR20A, BR25, BR25A, FC43, FC43A		

			
1			
<b>GEV No.</b>	511699	<b>Ref. No.</b>	H34827
<b>description</b>	door bumper H 27.5mm SS		
<b>For models:</b>	GF90, GF90A		

			
1			
<b>GEV No.</b>	505306	<b>Ref. No.</b>	441138
<b>description</b>	door bumper ø 24.5mm H 44.5mm rubber for dishwasher		
<b>For models:</b>	GE100, GE115, GE50RCD, GE60, GE60RCD, GE65, GE65RCD, GE80		

locks

			
1			
<b>GEV No.</b>	511165	<b>Ref. No.</b>	331112 331116
<b>description</b>	catch hook for door		
<b>For models:</b>	AC100, AC101, AC105, AC120, AC122, AC135, AC150, AC151, AC152, AC170, AC181, AC182, AC200, AC201, AC202, AC241, AC242, AC2A, AC90, AC91, AC95, ACL100, ACL150, ACR, ACR145, ACR205, ACR225, ACR245, ACR260, ACR265, ACR305, ACRS145, ACRS205, ACRS225, ACRS245, ACRS260, ACRS265, ACRS305, ACS101, ACS101-DIGIT, ACS122, ACS122-DIGIT, ACS151, ACS151-DIGIT, ACS152, ACS152-DIGIT, ACS161-DIGIT, ACS162-DIGIT, ACS181, ACS181-DIGIT...(Other models you can see in the webshop)		

			
1			
<b>GEV No.</b>	510008	<b>Ref. No.</b>	180506
<b>description</b>	door catch for dishwasher		
<b>For models:</b>	BC25, BC25A, BC25HR, BC30, BC30A, BC30HR, BC30HR380, BC30HRA, BHC25, BHC25-2, BHC25A, BHC25A-2, BHC25S, BHC30, BHC30-2, BHC30A, BHC30A-2, BHC30E, BHC30E-2, BHC30EA, BHC30EA-2, BHC30HR, BHC30HR-2, BHC30HR380, BHC30HRA, BHC30HRA-2, BHC30HRA380, BHC433, BHC433-2, BHC433A, BHC433A-2, BHCHR, BR20, BR20A, BR25, BR25A, F90M, F90MA, FC, FC43, FC43A, FC53, FC533, FC533A, FC53A, FC53CBT, FC53LA, FC53LBT, FC54, FC543...(Other models you can see in the webshop)		

			
1			
<b>GEV No.</b>	692100	<b>Ref. No.</b>	180508
<b>description</b>	snap lock L 36mm ø 17mm		
<b>For models:</b>	LF321, LF321A, LF322, LF322A, LF322MP, LF322MP-A, LF322RCD, LF324, LF324A, LF325E, LF325EA, LF700, LF700A		

			
1			
<b>GEV No.</b>	510925	<b>Ref. No.</b>	381403
<b>description</b>	snap lock L 70mm W 22mm H 56mm mounting distance 50mm		
<b>For models:</b>	B10, B10T, B11, B11T, B12, B12T, B13T, B14T, B15, B15T, B15TM, B16, B16T, B16TM, B18, B18T, B18TM, B19, B19T, B19TM, B20, B20D, B23, B24, B25, B26, B27, B31, B32, B41, B42, F2, F20, F3, F300, F45, F55, F65, F80, LF280-lav-line, LF320-lav-line, R40, R50, R70		

miscellaneous

			
1			
<b>GEV No.</b>	511377	<b>Ref. No.</b>	261013
<b>description</b>	bearing bearing		
<b>For models:</b>	BHC25, BHC25-2, BHC25A, BHC25A-2, BHC25S, BHC30, BHC30-2, BHC30A, BHC30A-2, BHC30E, BHC30E-2, BHC30EA, BHC30EA-2, BHC30HR, BHC30HR-2, BHC30HR380, BHC30HRA, BHC30HRA-2, BHC30HRA380, BHC433, BHC433-2, BHC433A, BHC433A-2, BHCHR		



1			
<b>GEV No.</b>	510938	<b>Ref. No.</b>	331764
<b>description</b>	fixing plate for door seal fixing plate		
<b>For models:</b>	B15TM, B16TM, B18TM, B19TM, F90M, F90MA, FC, FC53, FC533, FC533A, FC53A, FC53CBT, FC53LA, FC53LBT, FC54, FC543, FC543A, FC543E, FC543EA, FC544, FC544A, FC54A, FC54CBT, FC54E, FC54EA, FC54LBT, FCHR, FCHRA, FCHRT, FCHRTA, GE50RCD, LBR, LBR200, LF280-lav-line, LF315, LF320, LF320A, LF320CBT, LF320L, LF320LA, LF320-lav-line, LF320LBT, LF323, LF323A, LF350, LF350A, LF400A, LF450, LF450A, LS550		



1			
<b>GEV No.</b>	511378	<b>Ref. No.</b>	450829
<b>description</b>	nut		
<b>For models:</b>	BHC25, BHC25-2, BHC25A, BHC25A-2, BHC25S, BHC30, BHC30-2, BHC30A, BHC30A-2, BHC30E, BHC30E-2, BHC30EA, BHC30EA-2, BHC30HR, BHC30HR-2, BHC30HR380, BHC30HRA, BHC30HRA-2, BHC30HRA380, BHC433, BHC433-2, BHC433A, BHC433A-2, BHCHR		



1			
<b>GEV No.</b>	511175	<b>Ref. No.</b>	331461
<b>description</b>	plate for tie bar sliding plate		
<b>For models:</b>	G115, G65		



1			
<b>GEV No.</b>	510596	<b>Ref. No.</b>	160552
<b>description</b>	roller ED ø 8.5mm ID ø 6.3mm W 6.8mm		
<b>For models:</b>	FC3E, FC3EA, FC3M, FC3MA, FC3MR, FC44E, FC44EA, FC4E, FC4EA, FC4EHRT, FC4M, FC4MA		



1			
<b>GEV No.</b>	510324	<b>Ref. No.</b>	160533
<b>description</b>	spacer for handle		



1			
<b>GEV No.</b>	524772	<b>Ref. No.</b>	330894
<b>description</b>	spacer piece for door mechanism ED ø 13mm ID ø 8.5mm H 4mm		
<b>For models:</b>	G100L, G101L, G115L, G50L, G50LM, G51L, G60L, G61L, G65L, GL		



1			
<b>GEV No.</b>	524451	<b>Ref. No.</b>	H35202
<b>description</b>	threaded bush for tie bar L 12mm D1 ø 9.6mm D2 ø 7.75mm		
<b>For models:</b>	GF90, GF90A		

**screw connections**



1			
<b>GEV No.</b>	511296	<b>Ref. No.</b>	180202
<b>description</b>	blind flange		
<b>For models:</b>	NE00, NE02, NE3001, NE3002, NE4001, NE4002, NE5002, NE5501, NE5502, NE7002, NE7501, NE7502, NE9001, NE9002, NE9502, NG00, NG01, NG02, NG1202, NG1202E, NG600, NG600E, NG601, NG601E, NG602, NG602E, NG900, NG900E, NG901, NG901E, NG902, NG902E		



1			
<b>GEV No.</b>	511002	<b>Ref. No.</b>	330841
<b>description</b>	bush mounting pos. front		
<b>For models:</b>	B11, B12, B15, B16, B18, B19		



1			
<b>GEV No.</b>	504349	<b>Ref. No.</b>	160780
<b>description</b>	cap H 30mm Qty 1 pcs		
<b>For models:</b>	NE02, NE3002, NE4002, NE5002, NE5502, NE7002, NE7502, NE9002, NE9502, NG02, NG1202, NG1202E, NG602, NG602E, NG902, NG902E, NL302, NL302E, NL402, NL402E, NL502, NL502E, NL552, NL552E		



1			
<b>GEV No.</b>	510117	<b>Ref. No.</b>	160788
<b>description</b>	end cap thread M10x1.5 WS 23 plastic Qty 1 pcs thread L 15mm		
<b>For models:</b>	BHC25, BHC25-2, BHC25A, BHC25A-2, BHC25S, BHC30, BHC30-2, BHC30A, BHC30A-2, BHC30E, BHC30E-2, BHC30EA, BHC30EA-2, BHC30HR, BHC30HRA, BHC433, BHC433-2, BHC433A, BHC433A-2, C1000E, C1000ERCD, C1001M, C1300E, C1300ERCD, C1301M, FC3E, FC3EA, FC3M, FC3MA, FC3MR, FC44E, FC44EA, FC4E, FC4EA, FC4EHRT, FC4M, FC4MA, GF70, GF70A, GF90-2004, GF90A-2004, LC1200, LC1200RCD, LC412, LC700, LC700RCD, LC900, LC900RCD, LF321, LF321A...(Other models you can see in the webshop)		



1			
<b>GEV No.</b>	519053	<b>Ref. No.</b>	N/A
<b>description</b>	locknut thread 1/2"		

1			
<b>GEV No.</b>	510457	<b>Ref. No.</b>	180127
<b>description</b>	nut for stoff		
<b>For models:</b>	B11T, B12T, B13T, B14T, B15T, B15TM, B16T, B16TM, B18TM, B19TM, LBC215, LBC215A, LBC275, LBC275A		

1			
<b>GEV No.</b>	511276	<b>Ref. No.</b>	260425
<b>description</b>	nut for ventilation		
<b>For models:</b>	BC25HR, BC30HR, BC30HR380, BC30HRA, BHC30HR, BHC30HR-2, BHC30HR380, BHC30HRA, BHC30HRA-2, BHC30HRA380, BHCHR, FC, FCHR, FCHRA, FCHRT, FCHRTA		

1			
<b>GEV No.</b>	511576	<b>Ref. No.</b>	160789
<b>description</b>	nut thread M10x1.5 H 5mm WS 19 plastic Qty 1 pcs		
<b>For models:</b>	BHC25, BHC25-2, BHC25A, BHC25A-2, BHC25S, BHC30, BHC30-2, BHC30A, BHC30A-2, BHC30E, BHC30E-2, BHC30EA, BHC30EA-2, BHC30HR, BHC30HR-2, BHC30HR380, BHC30HRA, BHC30HRA-2, BHC30HRA380, BHC433, BHC433-2, BHC433A, BHC433A-2, BHCHR, C1000E, C1000ERCD, C1001M, C1300E, C1300ERCD, C1301M, FC3E, FC3EA, FC3M, FC3MA, FC3MR, FC44E, FC44EA, FC4E, FC4EA, FC4EHRT, FC4M, FC4MA, GF70, GF70A, GF90-2004, GF90A-2004, LC1200, LC1200RCD, LC412, LC700...(Other models you can see in the webshop)		

1			
<b>GEV No.</b>	510809	<b>Ref. No.</b>	160709
<b>description</b>	screw connection thread 1"		
<b>For models:</b>	AC100, AC101, AC105, AC120, AC122, AC135, AC150, AC151, AC152, AC170, AC181, AC182, AC200, AC201, AC202, AC241, AC242, AC90, AC91, AC95, ACR, ACR145, ACR205, ACR225, ACR245, ACR260, ACR265, ACR305, ACRS145, ACRS205, ACRS225, ACRS245, ACRS260, ACRS265, ACRS305, ACS101, ACS101-DIGIT, ACS122, ACS122-DIGIT, ACS151, ACS151-DIGIT, ACS152, ACS152-DIGIT, ACS161-DIGIT, ACS162-DIGIT, ACS181, ACS181-DIGIT, ACS182, ACS182-DIGIT, ACS201...(Other models you can see in the webshop)		

curtains			
curtains			
1			
<b>GEV No.</b>	533005	<b>Ref. No.</b>	190916
<b>description</b>	curtain W 590mm H 480mm mounting pos. input for dishwasher		
<b>For models:</b>	AC135, AC150, AC170, AC181, AC182, AC200, ACS181, ACS181-DIGIT, ACS182, ACS182-DIGIT, SNL		

1			
<b>GEV No.</b>	533103	<b>Ref. No.</b>	190913 331346
<b>description</b>	curtain W 620mm H 250mm warewashing		
<b>For models:</b>	AC120, AC170, AC200, ACR, ACR145, ACR205, ACR225, ACR245, ACR260, ACR265, ACR305, ACRS145, ACRS205, ACRS225, ACRS245, ACRS260, ACRS265, ACRS305, ACS122, ACS122-DIGIT, ACS152, ACS152-DIGIT, ACS162-DIGIT, ACS181, ACS181-DIGIT, ACS182, ACS182-DIGIT, ACS202, ACS202-DIGIT, ACS242, ACS242-DIGIT, GMC, GMC2700, GMC2702, GMC3500, GMC3502, GMC4500, GMC4502, GMC5500, GMC5502, NE02, NE3001, NE3002, NE4001, NE4002, NE5002, NE5501, NE5502, NE7002, NE7501...(Other models you can see in the webshop)		

1			
<b>GEV No.</b>	510941	<b>Ref. No.</b>	190906 190910
<b>description</b>	curtain W 620mm H 473mm N2S		
<b>For models:</b>	AC100, AC101, AC105, AC120, AC122, AC135, AC150, AC151, AC152, AC170, AC181, AC182, AC200, AC201, AC202, AC241, AC242, AC2A, AC90, AC91, AC95, ACL100, ACL150, ACR, ACR145, ACR205, ACR225, ACR245, ACR260, ACR265, ACR305, ACRS145, ACRS205, ACRS225, ACRS245, ACRS260, ACRS265, ACRS305, ACS101, ACS101-DIGIT, ACS122, ACS122-DIGIT, ACS151, ACS151-DIGIT, ACS152, ACS152-DIGIT, ACS161-DIGIT, ACS162-DIGIT, ACS181, ACS181-DIGIT...(Other models you can see in the webshop)		





<b>GEV No.</b>	511635	<b>Ref. No.</b>	190930
<b>description</b>	curtain W 630mm H 540mm plastic W1 550mm		
<b>For models:</b>	NE02, NE3002, NE4002, NE5002, NE5502, NE7002, NE7502, NE9002, NE9502		

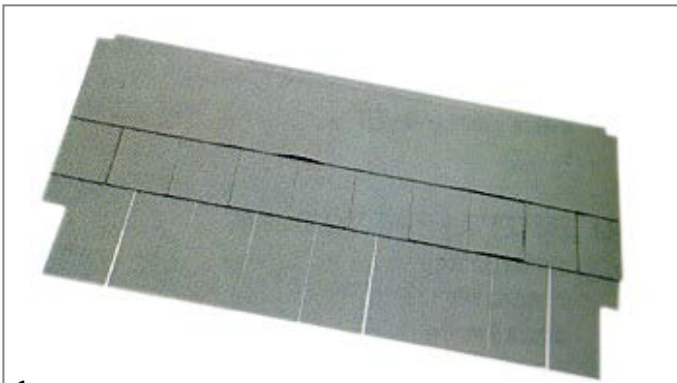

<b>GEV No.</b>	533102	<b>Ref. No.</b>	190909
<b>description</b>	curtain W 690mm H 420mm warewashing		
<b>For models:</b>	LV1001, LV1501, LV-LVP, LVP1001, LVP1501, NE00, NE3001, NE4001, NE5501, NE7501, NE9001		

## curtain rods

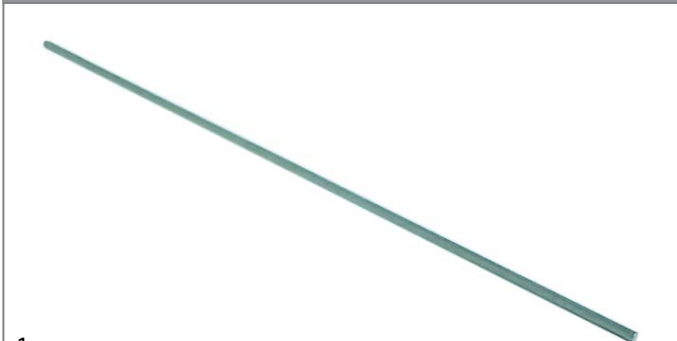

<b>GEV No.</b>	510936	<b>Ref. No.</b>	341210
<b>description</b>	curtain rod		
<b>For models:</b>	LV1001, LV1501, LV-LVP, LVP1001, LVP1501, NE00, NE02, NE3001, NE3002, NE4001, NE4002, NE5002, NE5501, NE5502, NE7002, NE7501, NE7502, NE9001, NE9002, NE9502, NG02, NG1202, NG1202E, NG602, NG602E, NG902, NG902E, NL302, NL302E, NL402, NL402E, NL502, NL502E, NL552, NL552E		



<b>GEV No.</b>	533175	<b>Ref. No.</b>	340422
<b>description</b>	curtain rod L 660mm ø 8mm		
<b>For models:</b>	AC100, AC101, AC105, AC120, AC122, AC135, AC150, AC151, AC152, AC170, AC181, AC182, AC200, AC201, AC202, AC241, AC242, AC2A, AC90, AC91, AC95, ACL100, ACL150, ACR, ACR145, ACR205, ACR225, ACR245, ACR260, ACR265, ACR305, ACRS145, ACRS205, ACRS225, ACRS245, ACRS260, ACRS265, ACRS305, ACS101, ACS101-DIGIT, ACS122, ACS122-DIGIT, ACS151, ACS151-DIGIT, ACS152, ACS152-DIGIT, ACS161-DIGIT, ACS162-DIGIT, ACS181, ACS181-DIGIT...(Other models you can see in the webshop)		

## washing and rinsing systems

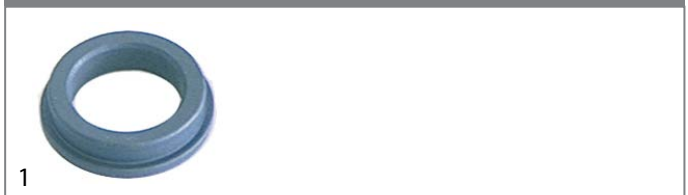

<b>GEV No.</b>	511008	<b>Ref. No.</b>	190647
<b>description</b>	bush		



<b>GEV No.</b>	510231	<b>Ref. No.</b>	190675
<b>description</b>	bush for rinse arm ø 23mm H 20mm		
<b>For models:</b>	C1001M, C1301M, LC1200, LC1200RCD, LC412, LC700, LC700RCD, LC900, LC900RCD		



<b>GEV No.</b>	510865	<b>Ref. No.</b>	190614
<b>description</b>	bush for wash arm		
<b>For models:</b>	C33, C34		

1

<b>GEV No.</b>	511240	<b>Ref. No.</b>	191076
<b>description</b>	bush for wash arm		
<b>For models:</b>	LC380, LC380BT, LC380RCD, LC400		



1

<b>GEV No.</b>	511355	<b>Ref. No.</b>	190645
<b>description</b>	bush for wash arm		
<b>For models:</b>	FC54E, FC54EA, LF315, LF320, LF320A, LF320CBT, LF320L, LF320LA, LF320LBT, LF321, LF321A, LF323, LF323A, LF350, LF350A, LP360, LP360BT, LP360RCD, LS550		



1

<b>GEV No.</b>	511559	<b>Ref. No.</b>	190669
<b>description</b>	bush for wash arm		
<b>For models:</b>	GE100, GE115, GE60, GE60RCD, GE65, GE65RCD, GE80		



1

<b>GEV No.</b>	513318	<b>Ref. No.</b>	190697
<b>description</b>	bush ø 32mm H 28mm thread 3/4" ID ø 15.8mm Qty 1 pcs		



1

<b>GEV No.</b>	512211	<b>Ref. No.</b>	190670 H34383
<b>description</b>	bushing for rinse arm		
<b>For models:</b>	BHC25-2, BHC25A-2, BHC30-2, BHC30A-2, BHC30E, BHC30E-2, BHC30EA, BHC30EA-2, BHC30HR-2, BHC30HRA-2, BHC433-2, BHC433A-2, GF90, GF90-2004, GF90A, GF90A-2004		



1

<b>GEV No.</b>	512492	<b>Ref. No.</b>	191092 191100
<b>description</b>	collector for rinsing L 60mm W 70mm connection ø 13mm suitable for COMENDA		
<b>For models:</b>	C1000E, C1000ERCD, C1001M, C1300E, C1300ERCD, C1301M, GE50RCD, LC1200, LC1200RCD, LC412, LC700, LC700RCD, LC900, LC900RCD, XLC		



1

<b>GEV No.</b>	519571	<b>Ref. No.</b>	180406
<b>description</b>	connecting fitting for wash distributor L 220mm W 120mm H 60mm ED ø 51mm hole ø 42mm thickness 4.75mm		
<b>For models:</b>	AC100, AC101, AC105, AC120, AC122, AC135, AC150, AC151, AC152, AC170, AC181, AC182, AC200, AC201, AC202, AC241, AC242, AC2A, AC90, AC91, AC95, ACL100, ACL150, ACR, ACR145, ACR205, ACR225, ACR245, ACR260, ACR265, ACR305, ACS145, ACS205, ACS225, ACS245, ACS260, ACS265, ACS305, ACS101, ACS101-DIGIT, ACS122, ACS122-DIGIT, ACS151, ACS151-DIGIT, ACS152, ACS152-DIGIT, ACS161-DIGIT, ACS162-DIGIT, ACS181, ACS181-DIGIT...(Other models you can see in the webshop)		
<b>accessories for</b>	519571		
	<b>GEV No.</b>	<b>Ref. No.</b>	200428
	gasket L 100mm W 100mm		
	<b>GEV No.</b>	<b>Ref. No.</b>	450109
	hose clamp ø 50-70mm width 9mm Qty 5 pcs DIN 3017		





1

<b>GEV No.</b>	507571	<b>Ref. No.</b>	180407
<b>description</b>	end piece for wash distributor L 170mm W 120mm H 60mm ED ø 51mm hole ø 41mm thickness 4.75mm suitable for COMENDA for ACxxx		
<b>For models:</b>	AC100, AC101, AC105, AC120, AC122, AC135, AC150, AC151, AC152, AC170, AC181, AC182, AC200, AC201, AC202, AC241, AC242, AC2A, AC90, AC91, AC95, ACL100, ACL150, ACR, ACR145, ACR205, ACR225, ACR245, ACR260, ACR265, ACR305, ACS145, ACS205, ACS225, ACS245, ACS260, ACS265, ACS305, ACS101, ACS101-DIGIT, ACS122, ACS122-DIGIT, ACS151, ACS151-DIGIT, ACS152, ACS152-DIGIT, ACS161-DIGIT, ACS162-DIGIT, ACS181, ACS181-DIGIT...(Other models you can see in the webshop)		
<b>accessories for</b>	507571		
	<b>GEV No.</b>	<b>Ref. No.</b>	200428
	gasket L 100mm W 100mm		
	<b>GEV No.</b>	<b>Ref. No.</b>	450109
	hose clamp ø 50-70mm width 9mm Qty 5 pcs DIN 3017		

			
1			
<b>GEV No.</b>	524644	<b>Ref. No.</b>	330940
<b>description</b>	flange for wash arm support ID $\varnothing$ 31mm ED $\varnothing$ 34mm L 73mm W 73mm mounting distance 53mm hole $\varnothing$ 5mm		
<b>For models:</b>	ACR, ACR145, ACR205, ACR225, ACR245, ACR260, ACR265, ACR305, GMC, GMC2700, GMC3500, GMC4500, GMC5500, LAV1000, LAV1001, LAV1501		

			
1			
<b>GEV No.</b>	524760	<b>Ref. No.</b>	180230
<b>description</b>	flange thread 1 1/4" for wash distributor		
<b>For models:</b>	ACR, ACR145, ACR205, ACR225, ACR245, ACR260, ACR265, ACR305, NE00, NE3001, NE4001, NE5501, NE7501, NE9001, NG01, NG901, NG901E		

			
1			
<b>GEV No.</b>	510884	<b>Ref. No.</b>	200463
<b>description</b>	gasket		
<b>For models:</b>	NE00, NG00, NG600, NG600E, NG900, NG900E, SE		

			
1			
<b>GEV No.</b>	510946	<b>Ref. No.</b>	200434
<b>description</b>	gasket		
<b>For models:</b>	C30, C70, C75, C75BT, C75M, C75RCD, F2, F3, F300, LP360, LP360BT, LP360RCD, R40, R50, R70		

			
1			
<b>GEV No.</b>	511979	<b>Ref. No.</b>	200448
<b>description</b>	gasket for inlet valve ID $\varnothing$ 76mm L 100mm W 100mm thickness 3mm hole distance 78mm		
<b>For models:</b>	G100L, G101L, G115, G115L, G125, G125L, G131, G50L, G50LM, G51L, G60L, G61L, G65, G65L, G66, G75, G75L, GE125, GE75, GL, NE02, NE3002, NE4002, NE5002, NE5502, NE7002, NE7502, NE9002, NE9502, NG02, NG1202, NG1202E, NG602, NG602E, NG902, NG902E, NL302, NL302E, NL402, NL402E, NL502, NL502E, NL552, NL552E		

			
1			
<b>GEV No.</b>	524793	<b>Ref. No.</b>	200936 200959
<b>description</b>	gasket for wash arm mounting pos. upper/lower $\varnothing$ 45mm ID $\varnothing$ 33mm thickness 5mm		
<b>For models:</b>	NE02, NE3002, NE4002, NE5002, NE5502, NE7002, NE7502, NE9002, NE9502, NG02, NG1202, NG1202E, NG602, NG602E, NG902, NG902E		

			
1			
<b>GEV No.</b>	505399	<b>Ref. No.</b>	200977
<b>description</b>	gasket for wash arm $\varnothing$ 21mm ID $\varnothing$ 12mm thickness 5mm		

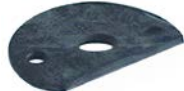
			
1			
<b>GEV No.</b>	510740	<b>Ref. No.</b>	200458
<b>description</b>	gasket for wash arm $\varnothing$ 44mm ID $\varnothing$ 11mm thickness 2mm rubber with flattening		
<b>For models:</b>	B20, B20D, B24, B25, B26, B27		

			
1			
<b>GEV No.</b>	510949	<b>Ref. No.</b>	200483
<b>description</b>	gasket for wash arm support		
<b>For models:</b>	C85		

			
1			
<b>GEV No.</b>	511579	<b>Ref. No.</b>	200955
<b>description</b>	gasket for wash arm support ID $\varnothing$ 36mm thickness 3mm		
<b>For models:</b>	C1000E, C1000ERCD, C1001M, C1300E, C1300ERCD, C1301M, GE50RCD, LC1200, LC1200RCD, LC412, LC700, LC700RCD, LC900, LC900RCD, XLC		





			
1			
<b>GEV No.</b>	504344	<b>Ref. No.</b>	200468
<b>description</b>	gasket for wash arm support ID ø 49mm L 70mm W 70mm thickness 3.5mm		
<b>For models:</b>	ACR, ACR145, ACR205, ACR225, ACR245, ACR260, ACR265, ACR305, GMC, GMC2700, GMC3500, GMC4500, GMC5500, LAV1000, LAV1001, LAV1501, LV1001, LV1501, LV-LVP, LVP1001, LVP1501, NE00, NE3001, NE4001, NE5501, NE7501, NE9001, NG01, NG601, NG601E, NG901, NG901E		

			
2			
<b>GEV No.</b>	511977	<b>Ref. No.</b>	200937
<b>description</b>	gasket for wash arm support ID ø 50mm L 100mm W 78mm thickness 3mm		
<b>For models:</b>	NE02, NE3002, NE4002, NE5002, NE5502, NE7002, NE7502, NE9002, NE9502, NG02, NG1202, NG1202E, NG602, NG602E, NG902, NG902E, NL302, NL302E, NL402, NL402E, NL502, NL502E, NL552, NL552E		

			
1			
<b>GEV No.</b>	510956	<b>Ref. No.</b>	200435
<b>description</b>	gasket for wash pipe ø 40mm		
<b>For models:</b>	C30, C70, C75, C75BT, C75M, C75RCD, F2, F3, F300, LP360, LP360BT, LP360RCD, R40, R70		

			
1			
<b>GEV No.</b>	511978	<b>Ref. No.</b>	200405
<b>description</b>	gasket ID ø 63mm L 100mm W 100mm thickness 3mm		
<b>For models:</b>	AC120, AC150, AC170, AC200, G100L, G101L, G115L, G125, G125L, G50L, G50LM, G51L, G60L, G61L, G65L, G75, G75L, GE125, GE75, GL, LV1001, LV1501, LV-LVP, LVP1001, LVP1501, NE00, NE02, NE3001, NE3002, NE4001, NE4002, NE5002, NE5501, NE5502, NE7002, NE7501, NE7502, NE9001, NE9002, NE9502, NG00, NG01, NG02, NG1202, NG1202E, NG600, NG600E, NG601, NG601E, NG900...(Other models you can see in the webshop)		

			
1			
<b>GEV No.</b>	519462	<b>Ref. No.</b>	200428
<b>description</b>	gasket L 100mm W 100mm		
<b>For models:</b>	AC100, AC101, AC105, AC120, AC122, AC135, AC150, AC151, AC152, AC170, AC181, AC182, AC200, AC201, AC202, AC241, AC242, AC2A, AC90, AC91, AC95, ACL100, ACL150, ACR, ACR145, ACR205, ACR225, ACR245, ACR260, ACR265, ACR305, ACRS145, ACRS205, ACRS225, ACRS245, ACRS260, ACRS265, ACRS305, ACS101, ACS101-DIGIT, ACS122, ACS122-DIGIT, ACS151, ACS151-DIGIT, ACS152, ACS152-DIGIT, ACS161-DIGIT, ACS162-DIGIT, ACS181, ACS181-DIGIT...(Other models you can see in the webshop)		

			
1			
<b>GEV No.</b>	511815	<b>Ref. No.</b>	200928
<b>description</b>	gasket thickness 3.3mm rubber suitable for COMENDA L 55mm W 30mm hole ø 12/7mm hole distance 40mm		
<b>For models:</b>	NE3001, NE4001, NE5501, NE7501, NE9001		



			
1			
<b>GEV No.</b>	511157	<b>Ref. No.</b>	330937
<b>description</b>	holding plate for wash arm		
<b>For models:</b>	ACR, ACR145, ACR205, ACR225, ACR245, ACR260, ACR265, ACR305, GMC, GMC2700, GMC3500, GMC4500, GMC5500, LAV1000, LAV1001, LAV1501, NE3001, NE4001, NE5501, NE7501, NE9001, NG01, NG601, NG601E, NG901, NG901E		

			
1			
<b>GEV No.</b>	530539	<b>Ref. No.</b>	280522
<b>description</b>	hose connector for rinse pipe		
<b>For models:</b>	C155, C155BT, C155E2, C155RCD, C165, C165E2, C165E2BT, C165E2RCD, C166, C166-2, C95, C95BT, C95E2, C95RCD		

			
1			
<b>GEV No.</b>	512387	<b>Ref. No.</b>	190327
<b>description</b>	hose connector for wash pipe		
<b>For models:</b>	C155, C155BT, C155E2, C155RCD, C165, C165E2, C165E2BT, C165E2RCD, C166, C166-2, C95, C95BT, C95E2, C95RCD		

			
1			
<b>GEV No.</b>	512212	<b>Ref. No.</b>	H34998
<b>description</b>	knurled nut thread M10x1.5 ø 30mm H 6.4mm SS		
<b>For models:</b>	GF90, GF90-2004, GF90A, GF90A-2004		



			
1			
<b>GEV No.</b>	510374	<b>Ref. No.</b>	270118
<b>description</b>	nut thread M15x1.25 H 6.5mm WS 27 SS Qty 1 pcs		
<b>For models:</b>	C155, C155BT, C155E2, C155RCD, C165, C165E2, C165E2BT, C165E2RCD, C166, C166-2, C30, C70, C75, C75BT, C75M, C75RCD, C95, C95BT, C95E2, C95RCD, LC380, LC380BT, LC380RCD, LC400, LP360, LP360BT, LP360RCD		

			
1			
<b>GEV No.</b>	518085	<b>Ref. No.</b>	180232 330934
<b>description</b>	opposite support for wash arm mounting pos. upper/lower L 102mm W 102mm		
<b>For models:</b>	AC100, AC101, AC105, AC120, AC122, AC135, AC150, AC151, AC152, AC170, AC181, AC182, AC200, AC201, AC202, AC241, AC242, AC2A, AC90, AC91, AC95, ACL100, ACL150, ACR, ACR145, ACR205, ACR225, ACR245, ACR260, ACR265, ACR305, ACRS145, ACRS205, ACRS225, ACRS245, ACRS260, ACRS265, ACRS305, ACS101, ACS101-DIGIT, ACS122, ACS122-DIGIT, ACS151, ACS151-DIGIT, ACS152, ACS152-DIGIT, ACS161-DIGIT, ACS162-DIGIT, ACS181, ACS181-DIGIT...(Other models you can see in the webshop)		
<b>accessories for</b>	518085		
	<b>GEV No.</b>	510899	<b>Ref. No.</b> 200830
	O-ring EPDM thickness 3.53mm ID ø 37.69mm Qty 1 pcs		
	<b>GEV No.</b>	519462	<b>Ref. No.</b> 200428
	gasket L 100mm W 100mm		

			
1			
<b>GEV No.</b>	505315	<b>Ref. No.</b>	190231
<b>description</b>	opposite support mounting pos. upper		
<b>For models:</b>	FC3E, FC3EA, FC3M, FC3MA, FC3MR, FC44E, FC44EA, FC4E, FC4EA, FC4EHR, FC4M, FC4MA		

			
1			
<b>GEV No.</b>	510801	<b>Ref. No.</b>	160113
<b>description</b>	pipe ID ø 8mm ø 12mm plastic supplied by meter		
<b>For models:</b>	AC101, AC120, AC122, AC150, AC151, AC152, AC170, AC181, AC182, AC200, AC201, AC202, AC241, AC242, AC91, ACR, ACR145, ACR205, ACR225, ACR245, ACR260, ACR265, ACR305, ACRS145, ACRS205, ACRS225, ACRS245, ACRS260, ACRS265, ACRS305, ACS101, ACS101-DIGIT, ACS122, ACS122-DIGIT, ACS151, ACS151-DIGIT, ACS152, ACS152-DIGIT, ACS161-DIGIT, ACS162-DIGIT, ACS181, ACS181-DIGIT, ACS182, ACS182-DIGIT, ACS201, ACS201-DIGIT, ACS202, ACS202-DIGIT, ACS241, ACS241-DIGIT...(Other models you can see in the webshop)		

			
1			
<b>GEV No.</b>	511668	<b>Ref. No.</b>	190674
<b>description</b>	reducer for wash pipe ø 18mm		
<b>For models:</b>	C1001M, C1301M, LC1200, LC1200RCD, LC412, LC700, LC700RCD, LC900, LC900RCD		

			
1			
<b>GEV No.</b>	510481	<b>Ref. No.</b>	190315
<b>description</b>	rinse arm support		
<b>For models:</b>	C140, C155, C155BT, C155E2, C155RCD, C165, C165E2, C165E2BT, C165E2RCD, C166, C166-2, C30, C70, C75, C75BT, C75M, C75RCD, C85, C95, C95BT, C95E2, C95RCD, LC380, LC380BT, LC380RCD, LC400, LP360, LP360BT, LP360RCD		
<b>accessories for</b>	510481		
	<b>GEV No.</b>	511180	<b>Ref. No.</b> 200457
	flat gasket rubber ED ø 24mm ID ø 16mm thickness 3mm Qty 1 pcs		
	<b>GEV No.</b>	511182	<b>Ref. No.</b> 270107
	nut thread 3/8" H 8mm brass WS 24 Qty 1 pcs		

			
1			
<b>GEV No.</b>	511255	<b>Ref. No.</b>	280529
<b>description</b>	rinse arm support mounting pos. upper H 31mm thread 3/8" L 51mm WS 26 hose ø 12mm		
<b>For models:</b>	LBC210, LBC215, LBC215A, LBC275, LBC275A		

			
1			
<b>GEV No.</b>	510333	<b>Ref. No.</b>	380325
<b>description</b>	rinse jet		

			
1			
<b>GEV No.</b>	510256	<b>Ref. No.</b>	332526
<b>description</b>	rinse pipe mounting pos. upper ø 8mm L 300mm SS		
<b>For models:</b>	C1000E, C1000ERCD, C1001M, C1300E, C1300ERCD, C1301M, GE50RCD, LC1200, LC1200RCD, LC412, LC700, LC700RCD, LC900, LC900RCD, XLC		

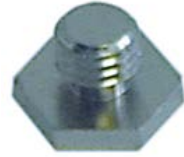
			
1			
<b>GEV No.</b>	511185	<b>Ref. No.</b>	261005
<b>description</b>	screw for wash arm support mounting pos. upper		
<b>For models:</b>	AC101, AC122, AC151, AC152, AC181, AC182, AC201, AC202, AC241, AC242, AC91, ACR, ACR145, ACR205, ACR225, ACR245, ACR260, ACR265, ACR305, ACRS145, ACRS205, ACRS225, ACRS245, ACRS260, ACRS265, ACRS305, B41, C30, C70, C75, C75BT, C75M, C75RCD, C85, F20, F90M, F90MA, FC, FC53, FC533, FC533A, FC53A, FC53CBT, FC53LA, FC53LBT, FC54, FC543, FC543A, FC543E, FC543EA...(Other models you can see in the webshop)		







			
1			
<b>GEV No.</b>	524585	<b>Ref. No.</b>	330218
<b>description</b>	tie bar for wash arm support thread M4 L 69mm		
<b>For models:</b>	NE00, NG00, NG600, NG600E, NG900, NG900E, SE		

			
1			
<b>GEV No.</b>	524672	<b>Ref. No.</b>	330225
<b>description</b>	tie bar for wash arm support thread M4 L 84mm		
<b>For models:</b>	ACR, ACR145, ACR205, ACR225, ACR245, ACR260, ACR265, ACR305, GMC, GMC2700, GMC3500, GMC4500, GMC5500, LAV1000, LAV1001, LAV1501, NE3001, NE4001, NE5501, NE7501, NE9001		

			
1			
<b>GEV No.</b>	510229	<b>Ref. No.</b>	180420
<b>description</b>	T-piece dosing pump ø 28mm L 70mm		
<b>For models:</b>	C1000ERCD, C1300ERCD, FC3M, FC3MR, FC4M, GE50RCD, GE60RCD, GE65RCD, LC1200RCD, LC700RCD, LC900RCD, XLC		

			
1			
<b>GEV No.</b>	510338	<b>Ref. No.</b>	170701
<b>description</b>	union nut dosing pump thread 1/2" ø 32mm H 15mm for dosing pump		
<b>For models:</b>	B10T, B11T, B12T, B13T, B14T, B15T, B15TM, B16T, B16TM, B18T, B18TM, B19T, B19TM, BC25, BC25A, BC25HR, BC30, BC30A, BC30HR, BC30HR380, BC30HRA, BHC25, BHC25-2, BHC25A, BHC25A-2, BHC25S, BHC30, BHC30-2, BHC30A, BHC30A-2, BHC30E, BHC30E-2, BHC30EA, BHC30EA-2, BHC30HR, BHC30HR-2, BHC30HR380, BHC30HRA, BHC30HRA-2, BHC30HRA380, BHC433, BHC433-2, BHC433A, BHC433A-2, BHCHR, BR20, BR20A, BR25, BR25A, C1000E...(Other models you can see in the webshop)		

			
1			
<b>GEV No.</b>	510485	<b>Ref. No.</b>	180123
<b>description</b>	union nut for rinse arm thread 5/8"		
<b>For models:</b>	C140, C155, C155BT, C155E2, C155RCD, C165, C165E2, C165E2BT, C165E2RCD, C166, C166-2, C30, C70, C75, C75BT, C75M, C75RCD, C85, C95, C95BT, C95E2, C95RCD, LC380, LC380BT, LC380RCD, LC400, LP360, LP360BT, LP360RCD		







			
1			
<b>GEV No.</b>	510468	<b>Ref. No.</b>	420307
<b>description</b>	wash pipe		
<b>For models:</b>	F2, F3, F300		



			
1			
<b>GEV No.</b>	511262	<b>Ref. No.</b>	420310/C
<b>description</b>	wash pipe		

washing and rinsing systems (sorted by producer)

COMENDA

			
1			
<b>GEV No.</b>	510746	<b>Ref. No.</b>	430326
<b>description</b>	rinse arm L 405mm mounting pos. upper nozzles 4 mounting ø 12/45mm complete		
<b>For models:</b>	LBC210, LBC215, LBC215A, LBC275, LBC275A		
<b>spare parts for</b>	510746		
	<b>GEV No.</b>	510323	<b>Ref. No.</b> 160734
	end cap for rinse arm		
	<b>GEV No.</b>	510327	<b>Ref. No.</b> 170946
	nozzle for rinse arm		
	<b>GEV No.</b>	510902	<b>Ref. No.</b> 200844
	O-ring EPDM thickness 2mm ID ø 9.5mm Qty 1 pcs		
	<b>GEV No.</b>	528583	<b>Ref. No.</b> 200845 200864
	O-ring EPDM thickness 2.62mm ID ø 9.13mm Qty 1 pcs		

			
<b>1</b>			
<b>GEV No.</b>	510741	<b>Ref. No.</b>	420533
<b>description</b>	wash and rinse arm mounting pos. upper 2 wash arms/ 2 rinse arms		
<b>For models:</b>	B15TM, B16TM, B18TM, B19TM, LBC215, LBC215A, LBC275, LBC275A		
<b>spare parts for</b>	510741		
	<b>GEV No.</b>	510307	<b>Ref. No.</b> 261004 261009
	Thumb screw thread M6 H 3mm thread L 8mm ø 28mm SS		
	<b>GEV No.</b>	510321	<b>Ref. No.</b> 160736
	end cap for wash arm		
	<b>GEV No.</b>	510322	<b>Ref. No.</b> 200812
	O-ring EPDM thickness 1.78mm ID ø 17.17mm Qty 1 pcs		
	<b>GEV No.</b>	510323	<b>Ref. No.</b> 160734
	end cap for rinse arm		
	<b>GEV No.</b>	510325	<b>Ref. No.</b> 170947 170956
	nozzle for wash arm		
	<b>GEV No.</b>	510327	<b>Ref. No.</b> 170946
	nozzle for rinse arm		
	<b>GEV No.</b>	510329	<b>Ref. No.</b> 190624 190649
	bush H 13.5mm D1 ø 20mm D2 ø 16mm D3 ø 12mm for wash arm		
	<b>GEV No.</b>	510901	<b>Ref. No.</b> 200843
	O-ring EPDM thickness 2mm ID ø 13mm Qty 1 pcs		
	<b>GEV No.</b>	510902	<b>Ref. No.</b> 200844
	O-ring EPDM thickness 2mm ID ø 9.5mm Qty 1 pcs		
	<b>GEV No.</b>	528583	<b>Ref. No.</b> 200845 200864
	O-ring EPDM thickness 2.62mm ID ø 9.13mm Qty 1 pcs		

			
<b>1</b>			
<b>GEV No.</b>	512264	<b>Ref. No.</b>	420531
<b>description</b>	wash and rinse arm wash arm L 410mm rinse arm L 410mm mounting pos. lower w. jets 6 r. jets 4 mounting ø 12/45mm 2 wash arms/ 2 rinse arms		
<b>For models:</b>	B13T, B14T, B15T, B15TM, B16T, B16TM, B18T, B18TM, B19T, B19TM, BC25, BC25A, BC30, BC30A, BHC25, BHC25A, BHC30, BHC30A, BHC30HR, BHC30HR380, BHC30HRA, BHC30HRA380, BHC433, BHC433A, BHCHR, F20, FC43, FC43A, LB200, LB200-2, LB200A, LB200A-2, LB215, LB215-2, LB215A, LB215A-2, LB260, LB260-2, LB260A, LB260A-2, LB275, LB275-2, LB275A, LB275A-2, LBC210, LBC215, LBC215A, LBC275, LBC275A		
<b>spare parts for</b>	512264		
	<b>GEV No.</b>	510307	<b>Ref. No.</b> 261004 261009
	Thumb screw thread M6 H 3mm thread L 8mm ø 28mm SS		

<b>spare parts for</b>	512264		
	<b>GEV No.</b>	510321	<b>Ref. No.</b> 160736
	end cap for wash arm		
	<b>GEV No.</b>	510322	<b>Ref. No.</b> 200812
	O-ring EPDM thickness 1.78mm ID ø 17.17mm Qty 1 pcs		
	<b>GEV No.</b>	510323	<b>Ref. No.</b> 160734
	end cap for rinse arm		
	<b>GEV No.</b>	510325	<b>Ref. No.</b> 170947 170956
	nozzle for wash arm		
	<b>GEV No.</b>	510327	<b>Ref. No.</b> 170946
	nozzle for rinse arm		
	<b>GEV No.</b>	510329	<b>Ref. No.</b> 190624 190649
	bush H 13.5mm D1 ø 20mm D2 ø 16mm D3 ø 12mm for wash arm		
	<b>GEV No.</b>	510901	<b>Ref. No.</b> 200843
	O-ring EPDM thickness 2mm ID ø 13mm Qty 1 pcs		
	<b>GEV No.</b>	510902	<b>Ref. No.</b> 200844
	O-ring EPDM thickness 2mm ID ø 9.5mm Qty 1 pcs		
	<b>GEV No.</b>	512265	<b>Ref. No.</b> 140106
	connector holder		
	<b>GEV No.</b>	528583	<b>Ref. No.</b> 200845 200864
	O-ring EPDM thickness 2.62mm ID ø 9.13mm Qty 1 pcs		





			
<b>1</b>			
<b>GEV No.</b>	512385	<b>Ref. No.</b>	420551
<b>description</b>	wash and rinse arm wash arm L 410mm rinse arm L 410mm mounting pos. upper w. jets 6 r. jets 4 mounting ø 12/45mm		
<b>For models:</b>	BC25, BC25A, BC30, BC30A, BHC25, BHC25A, BHC30, BHC30A, BHC30HR, BHC30HR380, BHC30HRA, BHC30HRA380, BHC433, BHC433A, BHCHR, FC43, FC43A, LB200, LB200-2, LB200A, LB200A-2, LB215, LB215-2, LB215A, LB215A-2, LB260, LB260-2, LB260A, LB260A-2, LB275, LB275-2, LB275A, LB275A-2, LBC210, LBC215, LBC215A, LBC275, LBC275A		
<b>spare parts for</b>	512385		
	<b>GEV No.</b>	510307	<b>Ref. No.</b> 261004 261009
	Thumb screw thread M6 H 3mm thread L 8mm ø 28mm SS		
	<b>GEV No.</b>	510322	<b>Ref. No.</b> 200812
	O-ring EPDM thickness 1.78mm ID ø 17.17mm Qty 1 pcs		
	<b>GEV No.</b>	510323	<b>Ref. No.</b> 160734
	end cap for rinse arm		

Table continues overleaf







spare parts for 512385				
	GEV No.	510325	Ref. No.	170947 170956
nozzle for wash arm				
	GEV No.	510327	Ref. No.	170946
nozzle for rinse arm				
	GEV No.	510329	Ref. No.	190624 190649
bush H 13.5mm D1 ø 20mm D2 ø 16mm D3 ø 12mm for wash arm				
	GEV No.	510901	Ref. No.	200843
O-ring EPDM thickness 2mm ID ø 13mm Qty 1 pcs				
	GEV No.	510902	Ref. No.	200844
O-ring EPDM thickness 2mm ID ø 9.5mm Qty 1 pcs				
	GEV No.	512265	Ref. No.	140106
connector holder				
	GEV No.	528583	Ref. No.	200845 200864
O-ring EPDM thickness 2.62mm ID ø 9.13mm Qty 1 pcs				





<b>GEV No.</b>	510275	<b>Ref. No.</b>	420515 420526
<b>description</b>	wash and rinse arm wash arm L 505mm rinse arm L 505mm mounting pos. upper/lower w. jets 8 r. jets 5 mounting ø 12/45mm		
<b>For models:</b>	C30, C33, C34, C70, C75, C75BT, C75RCD, C85, F2, F3, F300, F45, F55, F65, F80, LF280-lav-line, LF315, LF320, LF320A, LF320CBT, LF320L, LF320LA, LF320-lav-line, LF320LBT, LF321, LF321A, LF323, LF323A, LF350, LF350A, LP360, LP360BT, LP360RCD, LS550		

spare parts for 510275				
	GEV No.	510307	Ref. No.	261004 261009
Thumb screw thread M6 H 3mm thread L 8mm ø 28mm SS				
	GEV No.	510321	Ref. No.	160736
end cap for wash arm				
	GEV No.	510322	Ref. No.	200812
O-ring EPDM thickness 1.78mm ID ø 17.17mm Qty 1 pcs				
	GEV No.	510323	Ref. No.	160734
end cap for rinse arm				
	GEV No.	510325	Ref. No.	170947 170956
nozzle for wash arm				
	GEV No.	510327	Ref. No.	170946
nozzle for rinse arm				
	GEV No.	510329	Ref. No.	190624 190649
bush H 13.5mm D1 ø 20mm D2 ø 16mm D3 ø 12mm for wash arm				



spare parts for 510275				
	GEV No.	510902	Ref. No.	200844
O-ring EPDM thickness 2mm ID ø 9.5mm Qty 1 pcs				
	GEV No.	512265	Ref. No.	140106
connector holder				
	GEV No.	528583	Ref. No.	200845 200864
O-ring EPDM thickness 2.62mm ID ø 9.13mm Qty 1 pcs				

	<b>1</b>	<b>GEV No.</b>	510329	<b>Ref. No.</b>	190624 190649
<b>description</b>	bush H 13.5mm D1 ø 20mm D2 ø 16mm D3 ø 12mm for wash arm				
<b>For models:</b>	B13T, B14T, B15T, B15TM, B16T, B16TM, B18T, B18TM, B19T, B19TM, BC25, BC25A, BC30, BC30A, BHC25, BHC25A, BHC30, BHC30A, BHC30HR, BHC30HR380, BHC30HRA, BHC30HRA380, BHC433, BHC433A, BHCHR, F20, F45, F55, F65, F80, FC43, FC43A, FC54E, FC54EA, LB200, LB200-2, LB200A, LB200A-2, LB215, LB215-2, LB215A, LB215A-2, LB260, LB260-2, LB260A, LB260A-2, LB275, LB275-2, LB275A, LB275A-2...(Other models you can see in the webshop)				

	<b>1</b>	<b>GEV No.</b>	512265	<b>Ref. No.</b>	140106
<b>description</b>	connector holder				
<b>For models:</b>	B13T, B14T, B15T, B15TM, B16T, B16TM, B18T, B18TM, B19T, B19TM, C140, C70, C75, C75BT, C75RCD, C85, F20, F45, F55, F65, F80, LBC215, LBC215A, LBC275, LBC275A, LC380, LF280-lav-line, LF320-lav-line, LP360				

	<b>1</b>	<b>GEV No.</b>	510323	<b>Ref. No.</b>	160734
<b>description</b>	end cap for rinse arm				
<b>For models:</b>	B10T, B11T, B12T, B13T, B14T, B15T, B15TM, B16T, B16TM, B18T, B18TM, B19T, B19TM, BC25, BC25A, BC30, BC30A, BHC25, BHC25A, BHC30, BHC30A, BHC30HR, BHC30HR380, BHC30HRA, BHC30HRA380, BHC433, BHC433A, BHCHR, BR20, BR20A, BR25, BR25A, F20, F45, F55, F65, F80, FC43, FC43A, FC54E, FC54EA, LB200, LB200-2, LB200A, LB200A-2, LB215, LB215-2, LB215A, LB215A-2, LB260...(Other models you can see in the webshop)				

	<b>1</b>	<b>GEV No.</b>	510321	<b>Ref. No.</b>	160736
<b>description</b>	end cap for wash arm				
<b>For models:</b>	B13T, B14T, B15T, B15TM, B16T, B16TM, B18T, B18TM, B19T, B19TM, BC25, BC25A, BC30, BC30A, BHC25, BHC25A, BHC30, BHC30A, BHC30HR, BHC30HR380, BHC30HRA, BHC30HRA380, BHC433, BHC433A, BHCHR, F20, F45, F55, F65, F80, FC43, FC43A, FC54E, FC54EA, LB200, LB200-2, LB200A, LB200A-2, LB215, LB215-2, LB215A, LB215A-2, LB260, LB260-2, LB260A, LB260A-2, LB275, LB275-2, LB275A, LB275A-2...(Other models you can see in the webshop)				

			
1			
<b>GEV No.</b>	510327	<b>Ref. No.</b>	170946
<b>description</b>	nozzle for rinse arm		
<b>For models:</b>	B10T, B11T, B12T, B13T, B14T, B15T, B15TM, B16T, B16TM, B18T, B18TM, B19T, B19TM, BC25, BC25A, BC30, BC30A, BHC25, BHC25A, BHC30, BHC30A, BHC30HR, BHC30HR380, BHC30HRA, BHC30HRA380, BHC433, BHC433A, BHCHR, BR20, BR20A, BR25, BR25A, F20, F45, F55, F65, F80, FC43, FC43A, FC54E, FC54EA, LB200, LB200-2, LB200A, LB200A-2, LB215, LB215-2, LB215A, LB215A-2, LB260...(Other models you can see in the webshop)		
<b>accessories for</b>	510327		
			
<b>GEV No.</b>	510902	<b>Ref. No.</b>	200844
<b>description</b>	O-ring EPDM thickness 2mm ID ø 9.5mm Qty 1 pcs		

			
1			
<b>GEV No.</b>	510325	<b>Ref. No.</b>	170947 170956
<b>description</b>	nozzle for wash arm		
<b>For models:</b>	B13T, B14T, B15T, B15TM, B16T, B16TM, B18T, B18TM, B19T, B19TM, BC25, BC25A, BC30, BC30A, BHC25, BHC25A, BHC30, BHC30A, BHC30HR, BHC30HR380, BHC30HRA, BHC30HRA380, BHC433, BHC433A, BHCHR, F20, F45, F55, F65, F80, FC43, FC43A, FC54E, FC54EA, LB200, LB200-2, LB200A, LB200A-2, LB215, LB215-2, LB215A, LB215A-2, LB260, LB260-2, LB260A, LB260A-2, LB275, LB275-2, LB275A, LB275A-2...(Other models you can see in the webshop)		

			
1			
<b>GEV No.</b>	510322	<b>Ref. No.</b>	200812
<b>description</b>	O-ring EPDM thickness 1.78mm ID ø 17.17mm Qty 1 pcs		
<b>For models:</b>	B13T, B14T, B15T, B15TM, B16T, B16TM, B18T, B18TM, B19T, B19TM, BC25, BC25A, BC30, BC30A, BHC25, BHC25A, BHC30, BHC30A, BHC30HR, BHC30HR380, BHC30HRA, BHC30HRA380, BHC433, BHC433A, BHCHR, F20, F45, F55, F65, F80, FC43, FC43A, FC54E, FC54EA, LB200, LB200-2, LB200A, LB200A-2, LB215, LB215-2, LB215A, LB215A-2, LB260, LB260-2, LB260A, LB260A-2, LB275, LB275-2, LB275A, LB275A-2...(Other models you can see in the webshop)		

			
1			
<b>GEV No.</b>	528583	<b>Ref. No.</b>	200845 200864
<b>description</b>	O-ring EPDM thickness 2.62mm ID ø 9.13mm Qty 1 pcs		
<b>For models:</b>	B10T, B11T, B12T, B13T, B14T, B15T, B15TM, B16T, B16TM, B18T, B18TM, B19T, B19TM, BC25, BC25A, BC30, BC30A, BHC25, BHC25A, BHC30, BHC30A, BHC30HR, BHC30HR380, BHC30HRA, BHC30HRA380, BHC433, BHC433A, BHCHR, BR20, BR20A, BR25, BR25A, C75, C75BT, C75RCD, F20, F45, F55, F65, F80, FC, FC43, FC43A, FC53, FC533, FC533A, FC53A, FC53CBT, FC53LA, FC53LBT...(Other models you can see in the webshop)		

			
1			
<b>GEV No.</b>	510901	<b>Ref. No.</b>	200843
<b>description</b>	O-ring EPDM thickness 2mm ID ø 13mm Qty 1 pcs		
<b>For models:</b>	B13T, B14T, B15T, B15TM, B16T, B16TM, B18T, B18TM, B19T, B19TM, BC25, BC25A, BC30, BC30A, BHC25, BHC25A, BHC30, BHC30A, BHC30HR, BHC30HR380, BHC30HRA, BHC30HRA380, BHC433, BHC433A, BHCHR, F20, F45, F55, F65, F80, FC43, FC43A, FC54E, FC54EA, LB200, LB200-2, LB200A, LB200A-2, LB215, LB215-2, LB215A, LB215A-2, LB260, LB260-2, LB260A, LB260A-2, LB275, LB275-2, LB275A, LB275A-2...(Other models you can see in the webshop)		

			
1			
<b>GEV No.</b>	510902	<b>Ref. No.</b>	200844
<b>description</b>	O-ring EPDM thickness 2mm ID ø 9.5mm Qty 1 pcs		
<b>For models:</b>	B10T, B11T, B12T, B13T, B14T, B15T, B15TM, B16T, B16TM, B18T, B18TM, B19T, B19TM, BC25, BC25A, BC30, BC30A, BHC25, BHC25A, BHC30, BHC30A, BHC30HR, BHC30HR380, BHC30HRA, BHC30HRA380, BHC433, BHC433A, BHCHR, BR20, BR20A, BR25, BR25A, F20, F45, F55, F65, F80, FC43, FC43A, FC54E, FC54EA, GF90-2004, GF90A-2004, LB200, LB200-2, LB200A, LB200A-2, LB215, LB215-2, LB215A...(Other models you can see in the webshop)		

			
1			
<b>GEV No.</b>	510307	<b>Ref. No.</b>	261004 261009
<b>description</b>	Thumb screw thread M6 H 3mm thread L 8mm ø 28mm SS		
<b>For models:</b>	B13T, B14T, B15T, B15TM, B16, B16T, B16TM, B18T, B18TM, B19, B19T, B19TM, B41, B42, BC25, BC25A, BC25HR, BC30, BC30A, BC30HR, BC30HR380, BC30HRA, BHC25, BHC25A, BHC25S, BHC30, BHC30A, BHC30HR, BHC30HR380, BHC30HRA, BHC30HRA380, BHC433, BHC433A, BHCHR, C1000E, C1000ERCD, C1001M, C1300E, C1300ERCD, C1301M, C140, C155, C155BT, C155E2, C155RCD, C165, C165E2, C165E2BT, C165E2RCD, C166...(Other models you can see in the webshop)		

			
1			
<b>GEV No.</b>	510279	<b>Ref. No.</b>	170622
<b>description</b>	rinse arm		
<b>For models:</b>	B20, B20D, B24, B25, B26, B27		

			
1			
<b>GEV No.</b>	510743	<b>Ref. No.</b>	331344
<b>description</b>	rinse arm L 270mm mounting pos. lower nozzles 6 complete with nozzle H 390mm		
<b>For models:</b>	B23, B24, B25, B26, B27		



			
1			
<b>GEV No.</b>	510272	<b>Ref. No.</b>	430308
<b>description</b>	rinse arm L 500mm mounting pos. upper/lower nozzles 6 mounting ø 12mm		
<b>For models:</b>	C140, C33, C34, LC380, LC380BT, LC380RCD, LC400		
<b>spare parts for</b>	510272		
	<b>GEV No.</b>	508122	<b>Ref. No.</b> 160718
end cap			
	<b>GEV No.</b>	510303	<b>Ref. No.</b> 200818
O-ring EPDM thickness 1.78mm ID ø 6.75mm Qty 1 pcs			
	<b>GEV No.</b>	510307	<b>Ref. No.</b> 261004 261009
Thumb screw thread M6 H 3mm thread L 8mm ø 28mm SS			
	<b>GEV No.</b>	510309	<b>Ref. No.</b> 170911
nozzle for rinse arm mounting pos. right/left			
	<b>GEV No.</b>	510310	<b>Ref. No.</b> 170704
opposite support for rinse jet			
	<b>GEV No.</b>	510313	<b>Ref. No.</b> 190617
bush H 12mm D1 ø 20mm D2 ø 16mm D3 ø 12mm for wash arm boss			
	<b>GEV No.</b>	510315	<b>Ref. No.</b> 170929
nozzle for rinse arm mounting pos. centre/inside			
	<b>GEV No.</b>	510317	<b>Ref. No.</b> 170930
blank nozzle mounting pos. centre for rinse arm			
	<b>GEV No.</b>	510872	<b>Ref. No.</b> 191030
rinse arm boss			
	<b>GEV No.</b>	560052	<b>Ref. No.</b> 260223
side bolts thread M5 L 10mm SS Qty 20 pcs intake slotted head ø 12.5mm			
	<b>GEV No.</b>	560140	<b>Ref. No.</b> 260402 260418
hexagonal nut thread M4 H 4.8mm SS WS 7 Qty 20 pcs DIN/ISO DIN 985 self-locking			
	<b>GEV No.</b>	560454	<b>Ref. No.</b> 260206
flat-headed bolt thread M4 thread L 22mm SS DIN 84/ISO 1207 Qty 1 pcs intake slotted head ø 7mm head thickness 2.5mm			

			
1			
<b>GEV No.</b>	512209	<b>Ref. No.</b>	H35404
<b>description</b>	rinse arm L 530mm mounting pos. upper/lower nozzles 6 mounting ø 16mm		
<b>For models:</b>	GF90, GF90A		
<b>spare parts for</b>	512209		
	<b>GEV No.</b>	510303	<b>Ref. No.</b> 200818
O-ring EPDM thickness 1.78mm ID ø 6.75mm Qty 1 pcs			
	<b>GEV No.</b>	510309	<b>Ref. No.</b> 170911
nozzle for rinse arm mounting pos. right/left			
	<b>GEV No.</b>	510310	<b>Ref. No.</b> 170704
opposite support for rinse jet			
	<b>GEV No.</b>	511004	<b>Ref. No.</b> 260226
flat-headed bolt thread M4 thread L 12mm SS DIN 84/ISO 1207 Qty 1 pcs intake slotted L 14.5mm			
	<b>GEV No.</b>	512210	<b>Ref. No.</b> H34997
rinse arm shaft			
	<b>GEV No.</b>	512211	<b>Ref. No.</b> 190670 H34383
bushing for rinse arm			
	<b>GEV No.</b>	512212	<b>Ref. No.</b> H34998
knurled nut thread M10x1.5 ø 30mm H 6.4mm SS			
	<b>GEV No.</b>	560140	<b>Ref. No.</b> 260402 260418
hexagonal nut thread M4 H 4.8mm SS WS 7 Qty 20 pcs DIN/ISO DIN 985 self-locking			

			
1			
<b>GEV No.</b>	510739	<b>Ref. No.</b>	170621
<b>description</b>	rinse arm mounting pos. upper		
<b>For models:</b>	B20, B20D, B24, B25, B26, B27		



			
1			
<b>GEV No.</b>	510260	<b>Ref. No.</b>	420515
<b>description</b>	wash and rinse arm 2 wash arms/ 2 rinse arms		
<b>spare parts for</b>	510260		
	<b>GEV No.</b>	508122	<b>Ref. No.</b> 160718
end cap			

Table continues overleaf



spare parts for		510260		
	GEV No.	510300	Ref. No.	160719
end cap for wash arm				
	GEV No.	510302	Ref. No.	200824
O-ring EPDM ID ø 12.42mm thickness 1.78mm Qty 1 pcs				
	GEV No.	510303	Ref. No.	200818
O-ring EPDM thickness 1.78mm ID ø 6.75mm Qty 1 pcs				
	GEV No.	510304	Ref. No.	170915
nozzle for wash arm mounting pos. right				
	GEV No.	510305	Ref. No.	180213
opposite support for wash jet				
	GEV No.	510306	Ref. No.	170916
nozzle for wash arm mounting pos. left				
	GEV No.	510307	Ref. No.	261004 261009
Thumb screw thread M6 H 3mm thread L 8mm ø 28mm SS				
	GEV No.	510309	Ref. No.	170911
nozzle for rinse arm mounting pos. right/left				
	GEV No.	510310	Ref. No.	170704
opposite support for rinse jet				
	GEV No.	510313	Ref. No.	190617
bush H 12mm D1 ø 20mm D2 ø 16mm D3 ø 12mm for wash arm boss				
	GEV No.	510314	Ref. No.	170927
nozzle for wash arm mounting pos. centre/inside				
	GEV No.	510317	Ref. No.	170930
blank nozzle mounting pos. centre for rinse arm				
	GEV No.	510871	Ref. No.	191022
wash arm boss				
	GEV No.	511004	Ref. No.	260226
flat-headed bolt thread M4 thread L 12mm SS DIN 84/ISO 1207 Qty 1 pcs intake slotted L 14.5mm				
	GEV No.	512265	Ref. No.	140106
connector holder				
	GEV No.	560140	Ref. No.	260402 260418
hexagonal nut thread M4 H 4.8mm SS WS 7 Qty 20 pcs DIN/ISO DIN 985 self-locking				

			
1			
<b>GEV No.</b>	510270	<b>Ref. No.</b>	420510
<b>description</b>	wash and rinse arm L 505mm 2 wash arms/ 2 rinse arms		
<b>For models:</b>	C30, F2, F3, F300		



















				
1				
<b>GEV No.</b>	510261	<b>Ref. No.</b>	420516	
<b>description</b>	wash and rinse arm wash arm L 410mm rinse arm L 410mm mounting pos. lower w. jets 6 r. jets 4 mounting ø 12/45mm nozzle type A			
<b>For models:</b>	B13T, B14T, B15T, B15TM, B16, B16T, B16TM, B18T, B18TM, B19, B19T, B19TM, B41, B42, F20			
<b>spare parts for</b>	510261			
	GEV No.	510300	Ref. No.	160719
end cap for wash arm				
	GEV No.	510302	Ref. No.	200824
O-ring EPDM ID ø 12.42mm thickness 1.78mm Qty 1 pcs				
	GEV No.	510303	Ref. No.	200818
O-ring EPDM thickness 1.78mm ID ø 6.75mm Qty 1 pcs				
	GEV No.	510305	Ref. No.	180213
opposite support for wash jet				
	GEV No.	510306	Ref. No.	170916
nozzle for wash arm mounting pos. left				
	GEV No.	510307	Ref. No.	261004 261009
Thumb screw thread M6 H 3mm thread L 8mm ø 28mm SS				
	GEV No.	510309	Ref. No.	170911
nozzle for rinse arm mounting pos. right/left				
	GEV No.	510310	Ref. No.	170704
opposite support for rinse jet				
	GEV No.	510313	Ref. No.	190617
bush H 12mm D1 ø 20mm D2 ø 16mm D3 ø 12mm for wash arm boss				
	GEV No.	510314	Ref. No.	170927
nozzle for wash arm mounting pos. centre/inside				
	GEV No.	510315	Ref. No.	170929
nozzle for rinse arm mounting pos. centre/inside				

Table continues overleaf



spare parts for		510261	
	GEV No.	510316	Ref. No. 170928
blank nozzle mounting pos. centre for wash arm			
	GEV No.	510317	Ref. No. 170930
blank nozzle mounting pos. centre for rinse arm			
	GEV No.	510871	Ref. No. 191022
wash arm boss			
	GEV No.	511004	Ref. No. 260226
flat-headed bolt thread M4 thread L 12mm SS DIN 84/ISO 1207 Qty 1 pcs intake slotted L 14.5mm			
	GEV No.	512265	Ref. No. 140106
connector holder			
	GEV No.	560140	Ref. No. 260402 260418
hexagonal nut thread M4 H 4.8mm SS WS 7 Qty 20 pcs DIN/ISO DIN 985 self-locking			

spare parts for		510747	
	GEV No.	510317	Ref. No. 170930
blank nozzle mounting pos. centre for rinse arm			
	GEV No.	510752	Ref. No. 170923
wash jet mounting pos. right			
	GEV No.	510753	Ref. No. 170922
wash jet mounting pos. left			
	GEV No.	510871	Ref. No. 191022
wash arm boss			
	GEV No.	512265	Ref. No. 140106
connector holder			
	GEV No.	560140	Ref. No. 260402 260418
hexagonal nut thread M4 H 4.8mm SS WS 7 Qty 20 pcs DIN/ISO DIN 985 self-locking			

			
1			
GEV No.	510747	Ref. No.	420545
description	wash and rinse arm wash arm L 410mm rinse arm L 410mm mounting pos. lower w. jets 6 r. jets 4 mounting ø 12/45mm nozzle type C		
For models:	BC25HR, BC30HR, BC30HR380, BC30HRA		
spare parts for		510747	
	GEV No.	510300	Ref. No. 160719
end cap for wash arm			
	GEV No.	510302	Ref. No. 200824
O-ring EPDM ID ø 12.42mm thickness 1.78mm Qty 1 pcs			
	GEV No.	510303	Ref. No. 200818
O-ring EPDM thickness 1.78mm ID ø 6.75mm Qty 1 pcs			
	GEV No.	510305	Ref. No. 180213
opposite support for wash jet			
	GEV No.	510307	Ref. No. 261004 261009
Thumb screw thread M6 H 3mm thread L 8mm ø 28mm SS			
	GEV No.	510309	Ref. No. 170911
nozzle for rinse arm mounting pos. right/left			
	GEV No.	510310	Ref. No. 170704
opposite support for rinse jet			
	GEV No.	510313	Ref. No. 190617
bush H 12mm D1 ø 20mm D2 ø 16mm D3 ø 12mm for wash arm boss			
	GEV No.	510315	Ref. No. 170929
nozzle for rinse arm mounting pos. centre/inside			
	GEV No.	510316	Ref. No. 170928
blank nozzle mounting pos. centre for wash arm			

















			
1			
GEV No.	510268	Ref. No.	420538
description	wash and rinse arm wash arm L 410mm rinse arm L 410mm mounting pos. upper w. jets 6 r. jets 4 mounting ø 12/45mm nozzle type A		
For models:	B15TM, B16TM, B18TM, B19TM		
spare parts for		510268	
	GEV No.	508112	Ref. No. —
union nut SS			
	GEV No.	510300	Ref. No. 160719
end cap for wash arm			
	GEV No.	510302	Ref. No. 200824
O-ring EPDM ID ø 12.42mm thickness 1.78mm Qty 1 pcs			
	GEV No.	510303	Ref. No. 200818
O-ring EPDM thickness 1.78mm ID ø 6.75mm Qty 1 pcs			
	GEV No.	510304	Ref. No. 170915
nozzle for wash arm mounting pos. right			
	GEV No.	510305	Ref. No. 180213
opposite support for wash jet			
	GEV No.	510306	Ref. No. 170916
nozzle for wash arm mounting pos. left			
	GEV No.	510307	Ref. No. 261004 261009
Thumb screw thread M6 H 3mm thread L 8mm ø 28mm SS			
	GEV No.	510309	Ref. No. 170911
nozzle for rinse arm mounting pos. right/left			

Table continues overleaf

spare parts for		510268		
	GEV No.	510310	Ref. No.	170704
	opposite support for rinse jet			
	GEV No.	510313	Ref. No.	190617
	bush H 12mm D1 ø 20mm D2 ø 16mm D3 ø 12mm for wash arm boss			
	GEV No.	510314	Ref. No.	170927
	nozzle for wash arm mounting pos. centre/inside			
	GEV No.	510315	Ref. No.	170929
	nozzle for rinse arm mounting pos. centre/inside			
	GEV No.	510316	Ref. No.	170928
	blank nozzle mounting pos. centre for wash arm			
	GEV No.	510317	Ref. No.	170930
	blank nozzle mounting pos. centre for rinse arm			
	GEV No.	510871	Ref. No.	191022
	wash arm boss			
	GEV No.	511004	Ref. No.	260226
	flat-headed bolt thread M4 thread L 12mm SS DIN 84/ISO 1207 Qty 1 pcs intake slotted L 14.5mm			
	GEV No.	512265	Ref. No.	140106
	connector holder			
	GEV No.	560140	Ref. No.	260402 260418
	hexagonal nut thread M4 H 4.8mm SS WS 7 Qty 20 pcs DIN/ISO DIN 985 self-locking			

				
1				
<b>GEV No.</b>	510749	<b>Ref. No.</b>	420546	
<b>description</b>	wash and rinse arm wash arm L 410mm rinse arm L 410mm mounting pos. upper w. jets 6 r. jets 4 mounting ø 12/45mm nozzle type C			
<b>For models:</b>	BC25HR, BC30HR, BC30HR380, BC30HRA			
spare parts for		510749		
	GEV No.	510300	Ref. No.	160719
	end cap for wash arm			
	GEV No.	510302	Ref. No.	200824
	O-ring EPDM ID ø 12.42mm thickness 1.78mm Qty 1 pcs			
	GEV No.	510303	Ref. No.	200818
	O-ring EPDM thickness 1.78mm ID ø 6.75mm Qty 1 pcs			
	GEV No.	510305	Ref. No.	180213
	opposite support for wash jet			
	GEV No.	510307	Ref. No.	261004 261009
	Thumb screw thread M6 H 3mm thread L 8mm ø 28mm SS			

spare parts for		510749		
	GEV No.	510309	Ref. No.	170911
	nozzle for rinse arm mounting pos. right/left			
	GEV No.	510310	Ref. No.	170704
	opposite support for rinse jet			
	GEV No.	510313	Ref. No.	190617
	bush H 12mm D1 ø 20mm D2 ø 16mm D3 ø 12mm for wash arm boss			
	GEV No.	510315	Ref. No.	170929
	nozzle for rinse arm mounting pos. centre/inside			
	GEV No.	510316	Ref. No.	170928
	blank nozzle mounting pos. centre for wash arm			
	GEV No.	510317	Ref. No.	170930
	blank nozzle mounting pos. centre for rinse arm			
	GEV No.	510467	Ref. No.	191055
	wash arm boss equiv. no. 191055			
	GEV No.	510752	Ref. No.	170923
	wash jet mounting pos. right			
	GEV No.	510753	Ref. No.	170922
	wash jet mounting pos. left			
	GEV No.	511004	Ref. No.	260226
	flat-headed bolt thread M4 thread L 12mm SS DIN 84/ISO 1207 Qty 1 pcs intake slotted L 14.5mm			
	GEV No.	512265	Ref. No.	140106
	connector holder			
	GEV No.	560140	Ref. No.	260402 260418
	hexagonal nut thread M4 H 4.8mm SS WS 7 Qty 20 pcs DIN/ISO DIN 985 self-locking			
	GEV No.	560454	Ref. No.	260206
	flat-headed bolt thread M4 thread L 22mm SS DIN 84/ISO 1207 Qty 1 pcs intake slotted head ø 7mm head thickness 2.5mm			













				
1				
<b>GEV No.</b>	510750	<b>Ref. No.</b>	420522	
<b>description</b>	wash and rinse arm wash arm L 570mm rinse arm L 570mm w. jets 10 r. jets 6 mounting ø 12/45mm			
<b>For models:</b>	C75M, F90M, F90MA, LF400A, LF450, LF450A			
spare parts for		510750		
	GEV No.	508122	Ref. No.	160718
	end cap			
	GEV No.	510300	Ref. No.	160719
	end cap for wash arm			

Table continues overleaf





spare parts for		510750	
	GEV No.	510302	Ref. No. 200824
	O-ring EPDM ID ø 12.42mm thickness 1.78mm Qty 1 pcs		
	GEV No.	510303	Ref. No. 200818
	O-ring EPDM thickness 1.78mm ID ø 6.75mm Qty 1 pcs		
	GEV No.	510304	Ref. No. 170915
	nozzle for wash arm mounting pos. right		
	GEV No.	510305	Ref. No. 180213
	opposite support for wash jet		
	GEV No.	510306	Ref. No. 170916
	nozzle for wash arm mounting pos. left		
	GEV No.	510307	Ref. No. 261004 261009
	Thumb screw thread M6 H 3mm thread L 8mm ø 28mm SS		
	GEV No.	510310	Ref. No. 170704
	opposite support for rinse jet		
	GEV No.	510313	Ref. No. 190617
	bush H 12mm D1 ø 20mm D2 ø 16mm D3 ø 12mm for wash arm boss		
	GEV No.	510314	Ref. No. 170927
	nozzle for wash arm mounting pos. centre/inside		
	GEV No.	510315	Ref. No. 170929
	nozzle for rinse arm mounting pos. centre/inside		
	GEV No.	510316	Ref. No. 170928
	blank nozzle mounting pos. centre for wash arm		
	GEV No.	510317	Ref. No. 170930
	blank nozzle mounting pos. centre for rinse arm		
	GEV No.	510752	Ref. No. 170923
	wash jet mounting pos. right		
	GEV No.	510753	Ref. No. 170922
	wash jet mounting pos. left		
	GEV No.	510871	Ref. No. 191022
	wash arm boss		
	GEV No.	511004	Ref. No. 260226
	flat-headed bolt thread M4 thread L 12mm SS DIN 84/ISO 1207 Qty 1 pcs intake slotted L 14.5mm		
	GEV No.	511230	Ref. No. 170941
	rinse jet ø 11mm H 13mm		
	GEV No.	560140	Ref. No. 260402 260418
	hexagonal nut thread M4 H 4.8mm SS WS 7 Qty 20 pcs DIN/ISO DIN 985 self-locking		
	GEV No.	560454	Ref. No. 260206
	flat-headed bolt thread M4 thread L 22mm SS DIN 84/ISO 1207 Qty 1 pcs intake slotted head ø 7mm head thickness 2.5mm		

			
1	GEV No.	510271	Ref. No. 420511
	description wash arm L 510mm mounting pos. upper/lower nozzles 16 mounting ø 20/57mm		
	For models: C140, C33, C34, LC380, LC380BT, LC380RCD, LC400		
spare parts for		510271	
	GEV No.	510300	Ref. No. 160719
	end cap for wash arm		
	GEV No.	510302	Ref. No. 200824
	O-ring EPDM ID ø 12.42mm thickness 1.78mm Qty 1 pcs		
	GEV No.	510305	Ref. No. 180213
	opposite support for wash jet		
	GEV No.	510346	Ref. No. 280409
	knurled nut thread M17x1 ø 35mm H 6mm SS		
	GEV No.	510352	Ref. No. 170917
	nozzle mounting pos. right type C34		
	GEV No.	510353	Ref. No. 170918
	nozzle mounting pos. left type C34		
	GEV No.	510865	Ref. No. 190614
	bush for wash arm		

			
1	GEV No.	510317	Ref. No. 170930
	description blank nozzle mounting pos. centre for rinse arm		
	For models: B13T, B14T, B15T, B15TM, B16, B16T, B16TM, B18T, B18TM, B19, B19T, B19TM, B41, B42, BC25HR, BC30HR, BC30HR380, BC30HRA, BHC25S, C140, C30, C33, C34, C70, C75, C75BT, C75M, C75RCD, C85, F2, F20, F3, F300, F45, F55, F65, F80, F90M, F90MA, LC380, LC380BT, LC380RCD, LC400, LF400A, LF450, LF450A, LP360		

			
1	GEV No.	510316	Ref. No. 170928
	description blank nozzle mounting pos. centre for wash arm		
	For models: B13T, B14T, B15T, B15TM, B16, B16T, B16TM, B18T, B18TM, B19, B19T, B19TM, B41, B42, BC25HR, BC30HR, BC30HR380, BC30HRA, BHC25S, C140, C30, C33, C34, C70, C75, C75BT, C75M, C75RCD, C85, F2, F20, F3, F300, F45, F55, F65, F80, F90M, F90MA, LC380, LC380BT, LC380RCD, LC400, LF400A, LF450, LF450A, LP360		

1			
<b>GEV No.</b>	510312	<b>Ref. No.</b>	190621
<b>description</b>	bush for wash arm H 20mm ID ø 20mm ED ø 28/25mm		
<b>For models:</b>	C140, C33, C34, LC380, LC380BT, LC380RCD, LC400		

1			
<b>GEV No.</b>	510313	<b>Ref. No.</b>	190617
<b>description</b>	bush H 12mm D1 ø 20mm D2 ø 16mm D3 ø 12mm for wash arm boss		
<b>For models:</b>	B13T, B14T, B15T, B15TM, B16, B16T, B16TM, B18T, B18TM, B19, B19T, B19TM, B41, B42, BC25HR, BC30HR, BC30HR380, BC30HRA, BHC25S, C140, C30, C33, C34, C70, C75, C75BT, C75M, C75RCD, C85, F2, F20, F3, F300, F45, F55, F65, F80, F90M, F90MA, FC, FC53, FC533, FC533A, FC53A, FC53CBT, FC53LA, FC53LBT, FC54, FC543, FC543A...(Other models you can see in the webshop)		

1			
<b>GEV No.</b>	512265	<b>Ref. No.</b>	140106
<b>description</b>	connector holder		
<b>For models:</b>	B13T, B14T, B15T, B15TM, B16T, B16TM, B18T, B18TM, B19T, B19TM, C140, C70, C75, C75BT, C75RCD, C85, F20, F45, F55, F65, F80, LBC215, LBC215A, LBC275, LBC275A, LC380, LF280-lav-line, LF320-lav-line, LP360		

1			
<b>GEV No.</b>	508122	<b>Ref. No.</b>	160718
<b>description</b>	end cap		

1			
<b>GEV No.</b>	510300	<b>Ref. No.</b>	160719
<b>description</b>	end cap for wash arm		
<b>For models:</b>	B13T, B14T, B15T, B15TM, B16, B16T, B16TM, B18T, B18TM, B19, B19T, B19TM, B41, B42, BC25HR, BC30HR, BC30HR380, BC30HRA, BHC25S, C140, C30, C33, C34, C70, C75, C75BT, C75M, C75RCD, C85, F2, F20, F3, F300, F45, F55, F65, F80, F90M, F90MA, LC380, LC380BT, LC380RCD, LC400, LF400A, LF450, LF450A, LP360		

<b>accessories for</b>	510300
	<b>GEV No.</b> 510302 <b>Ref. No.</b> 200824

1			
<b>GEV No.</b>	510346	<b>Ref. No.</b>	280409
<b>description</b>	knurled nut thread M17x1 ø 35mm H 6mm SS		
<b>For models:</b>	C1000E, C1000ERCD, C1001M, C1300E, C1300ERCD, C1301M, C140, C155, C155BT, C155E2, C155RCD, C165, C165E2, C165E2BT, C165E2RCD, C166, C166-2, C33, C34, C95, C95BT, C95E2, C95RCD, G100L, G101L, G50L, G51L, G60L, G61L, GE100, GE115, GE50RCD, GE60, GE60RCD, GE65, GE65RCD, GE80, GF90, GF90-2004, GF90A, GF90A-2004, GL, LC1200, LC1200RCD, LC380, LC412, LC700, LC700RCD, LC900, LC900RCD...(Other models you can see in the webshop)		

1			
<b>GEV No.</b>	510315	<b>Ref. No.</b>	170929
<b>description</b>	nozzle for rinse arm mounting pos. centre/inside		
<b>For models:</b>	B13T, B14T, B15T, B15TM, B16, B16T, B16TM, B18T, B18TM, B19, B19T, B19TM, B41, B42, BC25HR, BC30HR, BC30HR380, BC30HRA, BHC25S, C140, C30, C33, C34, C70, C75, C75BT, C75M, C75RCD, C85, F2, F20, F3, F300, F45, F55, F65, F80, F90M, F90MA, LC380, LC380BT, LC380RCD, LC400, LF400A, LF450, LF450A, LP360		

1			
<b>GEV No.</b>	510309	<b>Ref. No.</b>	170911
<b>description</b>	nozzle for rinse arm mounting pos. right/left		
<b>For models:</b>	B13T, B14T, B15T, B15TM, B16, B16T, B16TM, B18T, B18TM, B19, B19T, B19TM, B20, B20D, B23, B24, B25, B26, B27, B41, B42, BC25HR, BC30HR, BC30HR380, BC30HRA, BHC25S, C140, C30, C33, C34, C70, C75, C75BT, C75RCD, C85, F2, F20, F3, F300, F45, F55, F65, F80, GF90, GF90-2004, GF90A, GF90A-2004, LC380, LC380BT, LC380RCD...(Other models you can see in the webshop)		

1			
<b>GEV No.</b>	510314	<b>Ref. No.</b>	170927
<b>description</b>	nozzle for wash arm mounting pos. centre/inside		
<b>For models:</b>	B13T, B14T, B15T, B15TM, B16, B16T, B16TM, B18T, B18TM, B19, B19T, B19TM, B41, B42, C140, C30, C33, C34, C70, C75, C75BT, C75M, C75RCD, C85, F2, F20, F3, F300, F45, F55, F65, F80, F90M, F90MA, LC380, LC380BT, LC380RCD, LC400, LF400A, LF450, LF450A, LP360		

1			
<b>GEV No.</b>	510306	<b>Ref. No.</b>	170916
<b>description</b>	nozzle for wash arm mounting pos. left		
<b>For models:</b>	B13T, B14T, B15T, B15TM, B16, B16T, B16TM, B18T, B18TM, B19, B19T, B19TM, B41, B42, C30, C70, C75, C75BT, C75M, C75RCD, C85, F2, F20, F3, F300, F45, F55, F65, F80, F90M, F90MA, LF400A, LF450, LF450A, LP360		

1			
<b>GEV No.</b>	510304	<b>Ref. No.</b>	170915
<b>description</b>	nozzle for wash arm mounting pos. right		
<b>For models:</b>	B13T, B14T, B15T, B15TM, B16, B16T, B16TM, B18T, B18TM, B19, B19T, B19TM, B41, B42, C30, C70, C75, C75BT, C75M, C75RCD, C85, F2, F20, F3, F300, F45, F55, F65, F80, F90M, F90MA, LF400A, LF450, LF450A, LP360		

1			
<b>GEV No.</b>	510353	<b>Ref. No.</b>	170918
<b>description</b>	nozzle mounting pos. left type C34		
<b>For models:</b>	C140, C33, C34, LC380, LC380BT, LC380RCD, LC400		







			
1			
<b>GEV No.</b>	510352	<b>Ref. No.</b>	170917
<b>description</b>	nozzle mounting pos. right type C34		
<b>For models:</b>	C140, C33, C34, LC380, LC380BT, LC380RCD, LC400		

			
1			
<b>GEV No.</b>	511230	<b>Ref. No.</b>	170941
<b>description</b>	rinse jet ø 11mm H 13mm		
<b>For models:</b>	C75M, F90M, F90MA, LF400A, LF450, LF450A		

			
1			
<b>GEV No.</b>	510310	<b>Ref. No.</b>	170704
<b>description</b>	opposite support for rinse jet		
<b>For models:</b>	B13T, B14T, B15T, B15TM, B16, B16T, B16TM, B18T, B18TM, B19, B19T, B19TM, B20, B20D, B23, B24, B25, B26, B27, B41, B42, BC25HR, BC30HR, BC30HR380, BC30HRA, BHC25S, C140, C30, C33, C34, C70, C75, C75BT, C75M, C75RCD, C85, F2, F20, F3, F300, F45, F55, F65, F80, F90M, F90MA, GF90, GF90-2004, GF90A, GF90A-2004...(Other models you can see in the webshop)		

			
1			
<b>GEV No.</b>	510307	<b>Ref. No.</b>	261004 261009
<b>description</b>	Thumb screw thread M6 H 3mm thread L 8mm ø 28mm SS		
<b>For models:</b>	B13T, B14T, B15T, B15TM, B16, B16T, B16TM, B18T, B18TM, B19, B19T, B19TM, B41, B42, BC25, BC25A, BC25HR, BC30, BC30A, BC30HR, BC30HR380, BC30HRA, BHC25, BHC25A, BHC25S, BHC30, BHC30A, BHC30HR, BHC30HR380, BHC30HRA, BHC30HRA380, BHC433, BHC433A, BHCHR, C1000E, C1000ERCD, C1001M, C1300E, C1300ERCD, C1301M, C140, C155, C155BT, C155E2, C155RCD, C165, C165E2, C165E2BT, C165E2RCD, C166...(Other models you can see in the webshop)		

			
1			
<b>GEV No.</b>	510305	<b>Ref. No.</b>	180213
<b>description</b>	opposite support for wash jet		
<b>For models:</b>	AC101, AC105, AC120, AC122, AC150, AC151, AC152, AC170, AC200, AC91, AC95, ACR, ACR145, ACR205, ACR225, ACR245, ACR260, ACR265, ACR305, ACRS145, ACRS205, ACRS225, ACRS245, ACRS260, ACRS265, ACRS305, ACS101, ACS101-DIGIT, ACS122, ACS122-DIGIT, ACS151, ACS151-DIGIT, ACS152, ACS152-DIGIT, ACS91, ACS91-DIGIT, B13T, B14T, B15T, B15TM, B16, B16T, B16TM, B18T, B18TM, B19, B19T, B19TM, B41, B42...(Other models you can see in the webshop)		

			
1			
<b>GEV No.</b>	510849	<b>Ref. No.</b>	191027
<b>description</b>	wash arm boss		
<b>For models:</b>	C140, C33, C34, LC380, LC380BT, LC380RCD, LC400		

			
1			
<b>GEV No.</b>	510302	<b>Ref. No.</b>	200824
<b>description</b>	O-ring EPDM ID ø 12.42mm thickness 1.78mm Qty 1 pcs		
<b>For models:</b>	AC101, AC105, AC120, AC122, AC150, AC151, AC152, AC170, AC200, AC91, AC95, ACL150, ACR, ACR145, ACR205, ACR225, ACR245, ACR260, ACR265, ACR305, ACRS145, ACRS205, ACRS225, ACRS245, ACRS260, ACRS265, ACRS305, ACS101, ACS101-DIGIT, ACS122, ACS122-DIGIT, ACS151, ACS151-DIGIT, ACS152, ACS152-DIGIT, ACS161-DIGIT, ACS162-DIGIT, ACS91, ACS91-DIGIT, B13T, B14T, B15T, B15TM, B16, B16T, B16TM, B18T, B18TM, B19, B19T...(Other models you can see in the webshop)		

			
1			
<b>GEV No.</b>	510871	<b>Ref. No.</b>	191022
<b>description</b>	wash arm boss		
<b>For models:</b>	B13T, B14T, B15T, B15TM, B16, B16T, B16TM, B18T, B18TM, B19, B19T, B19TM, B41, B42, BC25HR, BC30HR, BC30HR380, BC30HRA, BHC25S, C30, C70, C75, C75BT, C75M, C75RCD, C85, F2, F20, F3, F300, F45, F55, F65, F80, F90M, F90MA, LF400A, LF450, LF450A, LP360		







			
1			
<b>GEV No.</b>	510303	<b>Ref. No.</b>	200818
<b>description</b>	O-ring EPDM thickness 1.78mm ID ø 6.75mm Qty 1 pcs		
<b>For models:</b>	AC120, AC150, AC170, AC200, ACR, ACR145, ACR205, ACR225, ACR245, ACR260, ACR265, ACR305, B13T, B14T, B15, B15T, B15TM, B16, B16T, B16TM, B18, B18T, B18TM, B19, B19T, B19TM, B41, B42, BC25HR, BC30HR, BC30HR380, BC30HRA, BHC25S, C140, C30, C33, C34, C70, C75, C75BT, C75M, C75RCD, C85, F2, F20, F3, F300, F45, F55, F65...(Other models you can see in the webshop)		

			
1			
<b>GEV No.</b>	510467	<b>Ref. No.</b>	191055
<b>description</b>	wash arm boss equiv. no. 191055		
<b>For models:</b>	B15TM, B16TM, B18TM, B19TM, BC25HR, BC30HR, BC30HR380, BC30HRA, BHC25S		

			
1			
<b>GEV No.</b>	510872	<b>Ref. No.</b>	191030
<b>description</b>	rinse arm boss		
<b>For models:</b>	C140, C33, C34, LC380, LC380BT, LC380RCD, LC400		







			
1			
<b>GEV No.</b>	510753	<b>Ref. No.</b>	170922
<b>description</b>	wash jet mounting pos. left		
<b>For models:</b>	BC25HR, BC30HR, BC30HR380, BC30HRA, BHC25S, C75M, F90M, F90MA, LF400A, LF450, LF450A		

			
1			
<b>GEV No.</b>	510752	<b>Ref. No.</b>	170923
<b>description</b>	wash jet mounting pos. right		
<b>For models:</b>	BC25HR, BC30HR, BC30HR380, BC30HRA, BHC25S, C75M, F90M, F90MA, LF400A, LF450, LF450A		

			
1			
<b>GEV No.</b>	510267	<b>Ref. No.</b>	430306
<b>description</b>	rinse arm		
<b>spare parts for</b>	510267		
	<b>GEV No.</b>	510302	<b>Ref. No.</b> 200824
O-ring EPDM ID ø 12.42mm thickness 1.78mm Qty 1 pcs			
	<b>GEV No.</b>	510305	<b>Ref. No.</b> 180213
opposite support for wash jet			
	<b>GEV No.</b>	510330	<b>Ref. No.</b> 160754
end cap for rinse arm			
	<b>GEV No.</b>	510334	<b>Ref. No.</b> 170926
nozzle holder mounting pos. upper			
	<b>GEV No.</b>	510369	<b>Ref. No.</b> 380314
nozzle for rinse arm			

			
1			
<b>GEV No.</b>	510264	<b>Ref. No.</b>	420535
<b>description</b>	wash and rinse arm L 495mm mounting pos. upper/lower nozzles 16 mounting ø 20/57mm complete		
<b>For models:</b>	C1300E, C1300ERCD, C155, C155BT, C155E2, C155RCD, C165, C165E2, C165E2BT, C165E2RCD, C166, C166-2		
<b>spare parts for</b>	510264		
	<b>GEV No.</b>	510346	<b>Ref. No.</b> 280409
knurled nut thread M17x1 ø 35mm H 6mm SS			
	<b>GEV No.</b>	510823	<b>Ref. No.</b> 190636
bush for wash arm			
	<b>GEV No.</b>	510825	<b>Ref. No.</b> 160768
end cap for wash arm			
	<b>GEV No.</b>	511191	<b>Ref. No.</b> 200813
O-ring EPDM thickness 2.21mm ID ø 16.36mm Qty 1 pcs			

			
1			
<b>GEV No.</b>	510265	<b>Ref. No.</b>	420540
<b>description</b>	wash arm L 500mm mounting pos. upper/lower nozzles 9 mounting ø 20/56.5mm		
<b>For models:</b>	C1000E, C1000ERCD, C95, C95BT, C95E2, C95RCD		
<b>spare parts for</b>	510265		
	<b>GEV No.</b>	510346	<b>Ref. No.</b> 280409
knurled nut thread M17x1 ø 35mm H 6mm SS			
	<b>GEV No.</b>	510823	<b>Ref. No.</b> 190636
bush for wash arm			
	<b>GEV No.</b>	510825	<b>Ref. No.</b> 160768
end cap for wash arm			
	<b>GEV No.</b>	511191	<b>Ref. No.</b> 200813
O-ring EPDM thickness 2.21mm ID ø 16.36mm Qty 1 pcs			

			
1			
<b>GEV No.</b>	511251	<b>Ref. No.</b>	420505
<b>description</b>	wash arm L 540mm mounting pos. lower nozzles 8 mounting ø 30/82mm		
<b>For models:</b>	G115, G131, G65, G66, G75		
<b>spare parts for</b>	511251		
	<b>GEV No.</b>	510351	<b>Ref. No.</b> 170910
nozzle for wash arm			
	<b>GEV No.</b>	511004	<b>Ref. No.</b> 260226
flat-headed bolt thread M4 thread L 12mm SS DIN 84/ISO 1207 Qty 1 pcs intake slotted L 14.5mm			
	<b>GEV No.</b>	511248	<b>Ref. No.</b> 440816
retaining ring bore ø 48mm thickness 1.9mm stainless steel DIN 472			
	<b>GEV No.</b>	511249	<b>Ref. No.</b> 160820
slide ring			
	<b>GEV No.</b>	511252	<b>Ref. No.</b> 510284
knurled nut			
	<b>GEV No.</b>	511253	<b>Ref. No.</b> 180211
opposite support for wash jet			
	<b>GEV No.</b>	560140	<b>Ref. No.</b> 260402 260418
hexagonal nut thread M4 H 4.8mm SS WS 7 Qty 20 pcs DIN/ISO DIN 985 self-locking			





			
1			
<b>GEV No.</b>	517605	<b>Ref. No.</b>	420567 420587R
<b>description</b>	wash arm L 550mm nozzles 16		
<b>For models:</b>	GE100, GE115, GE60, GE60RCD, GE65, GE65RCD, GE80		

			
1			
<b>GEV No.</b>	510823	<b>Ref. No.</b>	190636
<b>description</b>	bush for wash arm		
<b>For models:</b>	C1000E, C1000ERCD, C1300E, C1300ERCD, C155, C155BT, C155E2, C155RCD, C165, C165E2, C165E2BT, C165E2RCD, C166, C166-2, C95, C95BT, C95E2, C95RCD, G100L, G101L, G50L, G51L, G60L, G61L, GE100, GE115, GE50RCD, GE60, GE60RCD, GE65, GE65RCD, GE80, GF90, GF90-2004, GF90A, GF90A-2004, GL, LAV1000		

			
1			
<b>GEV No.</b>	510330	<b>Ref. No.</b>	160754
<b>description</b>	end cap for rinse arm		
<b>For models:</b>	AC101, AC105, AC120, AC122, AC150, AC151, AC152, AC170, AC200, AC91, AC95, ACR, ACR145, ACR205, ACR225, ACR245, ACR260, ACR265, ACR305, ACS101, ACS101-DIGIT, ACS122, ACS122-DIGIT, ACS151, ACS151-DIGIT, ACS152, ACS152-DIGIT, ACS91, ACS91-DIGIT, G115, G125, G65, G75, GMC, GMC2700, GMC3500, GMC4500, GMC5500, NE00, NE02, NE3002, NE4002, NE5002, NE5502, NE7002, NE7502, NE9002, NE9502, NG01, NG02...(Other models you can see in the webshop)		

			
1			
<b>GEV No.</b>	510825	<b>Ref. No.</b>	160768
<b>description</b>	end cap for wash arm		
<b>For models:</b>	C1000E, C1000ERCD, C1300E, C1300ERCD, C155, C155BT, C155E2, C155RCD, C165, C165E2, C165E2BT, C165E2RCD, C166, C166-2, C95, C95BT, C95E2, C95RCD, G100L, G101L, G50L, G51L, G60L, G61L, GE100, GE115, GE50RCD, GE60, GE60RCD, GE65, GE65RCD, GE80, GF70, GF70A, GF90, GF90-2004, GF90A, GF90A-2004, GL, XLC		
<b>accessories for</b>	510825		

			
	<b>GEV No.</b>	511191	<b>Ref. No.</b>
			200813
	O-ring EPDM thickness 2.21mm ID ø 16.36mm Qty 1 pcs		

			
1			
<b>GEV No.</b>	511252	<b>Ref. No.</b>	510284
<b>description</b>	knurled nut		
<b>For models:</b>	G115, G131, G65, G66, G75		

			
1			
<b>GEV No.</b>	510346	<b>Ref. No.</b>	280409
<b>description</b>	knurled nut thread M17x1 ø 35mm H 6mm SS		
<b>For models:</b>	C1000E, C1000ERCD, C1001M, C1300E, C1300ERCD, C1301M, C140, C155, C155BT, C155E2, C155RCD, C165, C165E2, C165E2BT, C165E2RCD, C166, C166-2, C33, C34, C95, C95BT, C95E2, C95RCD, G100L, G101L, G50L, G51L, G60L, G61L, GE100, GE115, GE50RCD, GE60, GE60RCD, GE65, GE65RCD, GE80, GF90, GF90-2004, GF90A, GF90A-2004, GL, LC1200, LC1200RCD, LC380, LC412, LC700, LC700RCD, LC900, LC900RCD...(Other models you can see in the webshop)		

			
1			
<b>GEV No.</b>	510369	<b>Ref. No.</b>	380314
<b>description</b>	nozzle for rinse arm		
<b>For models:</b>	C1000E, C1000ERCD, C1300E, C1300ERCD, C155, C155BT, C155E2, C155RCD, C165, C165E2, C165E2BT, C165E2RCD, C166, C166-2, C75, C75BT, C75RCD, C95, C95BT, C95E2, C95RCD, FC, FC53, FC533, FC533A, FC53A, FC53CBT, FC53LA, FC53LBT, FC54, FC543, FC543A, FC543E, FC543EA, FC544, FC544A, FC54A, FC54CBT, FC54LBT, FCHRA, FCHRT, FCHRTA, G115, G125, G131, G65, G66, G75, GE100...(Other models you can see in the webshop)		

			
1			
<b>GEV No.</b>	510351	<b>Ref. No.</b>	170910
<b>description</b>	nozzle for wash arm		
<b>For models:</b>	G115, G131, G65, G66, G75, NE00, R40, R50, R70, SE		

			
1			
<b>GEV No.</b>	510334	<b>Ref. No.</b>	170926
<b>description</b>	nozzle holder mounting pos. upper		
<b>For models:</b>	AC120, AC150, AC170, AC200, ACR, ACR145, ACR205, ACR225, ACR245, ACR260, ACR265, ACR305, G115, G125, G65, G75, GMC, GMC2700, GMC3500, GMC4500, GMC5500, NE00, NG00, NG01, NG02, NG1202, NG1202E, NG600, NG600E, NG601, NG601E, NG602, NG602E, NG900, NG900E, NG901, NG901E, NG902, NG902E, SE, SNL		

			
1			
<b>GEV No.</b>	510305	<b>Ref. No.</b>	180213
<b>description</b>	opposite support for wash jet		
<b>For models:</b>	AC101, AC105, AC120, AC122, AC150, AC151, AC152, AC170, AC200, AC91, AC95, ACR, ACR145, ACR205, ACR225, ACR245, ACR260, ACR265, ACR305, ACRS145, ACRS205, ACRS225, ACRS245, ACRS260, ACRS265, ACRS305, ACS101, ACS101-DIGIT, ACS122, ACS122-DIGIT, ACS151, ACS151-DIGIT, ACS152, ACS152-DIGIT, ACS91, ACS91-DIGIT, B13T, B14T, B15T, B15TM, B16, B16T, B16TM, B18T, B18TM, B19, B19T, B19TM, B41, B42...(Other models you can see in the webshop)		

			
1			
<b>GEV No.</b>	511253	<b>Ref. No.</b>	180211
<b>description</b>	opposite support for wash jet		
<b>For models:</b>	G115, G131, G65, G66, G75, NE00, NG00, NG600, NG600E, NG900, NG900E, SE		

1			
<b>GEV No.</b>	510302	<b>Ref. No.</b>	200824
<b>description</b>	O-ring EPDM ID ø 12.42mm thickness 1.78mm Qty 1 pcs		
<b>For models:</b>	AC101, AC105, AC120, AC122, AC150, AC151, AC152, AC170, AC200, AC91, AC95, ACL150, ACR, ACR145, ACR205, ACR225, ACR245, ACR260, ACR265, ACR305, ACRS145, ACRS205, ACRS225, ACRS245, ACRS260, ACRS265, ACRS305, ACS101, ACS101-DIGIT, ACS122, ACS122-DIGIT, ACS151, ACS151-DIGIT, ACS152, ACS152-DIGIT, ACS161-DIGIT, ACS162-DIGIT, ACS91, ACS91-DIGIT, B13T, B14T, B15T, B15TM, B16, B16T, B16TM, B18T, B18TM, B19, B19T...(Other models you can see in the webshop)		

1			
<b>GEV No.</b>	530293	<b>Ref. No.</b>	200809
<b>description</b>	O-ring EPDM thickness 1.78mm ID ø 8.73mm Qty 1 pcs		
<b>For models:</b>	AC101, AC105, AC122, AC135, AC151, AC152, AC181, AC182, AC201, AC202, AC241, AC242, AC2A, AC91, AC95, ACL100, ACL150, ACRS145, ACRS205, ACRS225, ACRS245, ACRS260, ACRS265, ACRS305, ACS101, ACS101-DIGIT, ACS122, ACS122-DIGIT, ACS151, ACS151-DIGIT, ACS152, ACS152-DIGIT, ACS161-DIGIT, ACS162-DIGIT, ACS181, ACS181-DIGIT, ACS182, ACS182-DIGIT, ACS201, ACS201-DIGIT, ACS202, ACS202-DIGIT, ACS241, ACS241-DIGIT, ACS242, ACS242-DIGIT, ACS91, ACS91-DIGIT, B15, B16...(Other models you can see in the webshop)		

1			
<b>GEV No.</b>	511191	<b>Ref. No.</b>	200813
<b>description</b>	O-ring EPDM thickness 2.21mm ID ø 16.36mm Qty 1 pcs		
<b>For models:</b>	C1000E, C1000ERCD, C1300E, C1300ERCD, C155, C155BT, C155E2, C155RCD, C165, C165E2, C165E2BT, C165E2RCD, C166, C166-2, C95, C95BT, C95E2, C95RCD, G100L, G101L, G50L, G51L, G60L, G61L, GE100, GE115, GE50RCD, GE60, GE60RCD, GE65, GE65RCD, GE80, GF70, GF70A, GF90, GF90-2004, GF90A, GF90A-2004, GL, XLC		

1			
<b>GEV No.</b>	524863	<b>Ref. No.</b>	420116
<b>description</b>	wash arm mounting pos. bottom right L 410mm nozzles 5 mounting ø 35mm		

1			
<b>GEV No.</b>	524862	<b>Ref. No.</b>	420117
<b>description</b>	wash arm mounting pos. lower L 395mm nozzles 3 mounting ø 34mm		

1			
<b>GEV No.</b>	524865	<b>Ref. No.</b>	420138
<b>description</b>	wash arm mounting pos. lower L 430mm nozzles 2 mounting ø 35mm		

1			
<b>GEV No.</b>	524864	<b>Ref. No.</b>	420137
<b>description</b>	wash arm mounting pos. lower L 430mm nozzles 3 mounting ø 35mm		

1			
<b>GEV No.</b>	524861	<b>Ref. No.</b>	420122
<b>description</b>	wash arm mounting pos. upper left L 400mm nozzles 5 mounting ø 35mm		

1			
<b>GEV No.</b>	510266	<b>Ref. No.</b>	430316
<b>description</b>	rinse arm L 490mm mounting pos. upper/lower nozzles 6 mounting ø 12mm		
<b>For models:</b>	C1000E, C1000ERCD, C1300E, C1300ERCD, C155, C155BT, C155E2, C155RCD, C165, C165E2, C165E2BT, C165E2RCD, C166, C166-2, C95, C95BT, C95E2, C95RCD, XLC		
<b>spare parts for</b>	510266		

<b>GEV No.</b>	510307	<b>Ref. No.</b>	261004 261009
<b>description</b>	Thumb screw thread M6 H 3mm thread L 8mm ø 28mm SS		

<b>GEV No.</b>	510369	<b>Ref. No.</b>	380314
<b>description</b>	nozzle for rinse arm		

<b>GEV No.</b>	510813	<b>Ref. No.</b>	190641
<b>description</b>	bush for rinse arm		

<b>GEV No.</b>	511242	<b>Ref. No.</b>	450218
<b>description</b>	connector holder L 30mm H 16mm W 22mm		

<b>GEV No.</b>	530293	<b>Ref. No.</b>	200809
<b>description</b>	O-ring EPDM thickness 1.78mm ID ø 8.73mm Qty 1 pcs		

1			
<b>GEV No.</b>	510283	<b>Ref. No.</b>	430306 430319
<b>description</b>	rinse arm L 540mm mounting pos. upper nozzles 6 mounting ø 16mm		
<b>For models:</b>	G115, G125, G131, G65, G66, G75		

<b>GEV No.</b>	510283	<b>Ref. No.</b>	430306 430319
<b>description</b>	rinse arm L 540mm mounting pos. upper nozzles 6 mounting ø 16mm		
<b>For models:</b>	G115, G125, G131, G65, G66, G75		







<b>GEV No.</b>	510283	<b>Ref. No.</b>	430306 430319
<b>description</b>	rinse arm L 540mm mounting pos. upper nozzles 6 mounting ø 16mm		
<b>For models:</b>	G115, G125, G131, G65, G66, G75		

<b>GEV No.</b>	510283	<b>Ref. No.</b>	430306 430319
<b>description</b>	rinse arm L 540mm mounting pos. upper nozzles 6 mounting ø 16mm		
<b>For models:</b>	G115, G125, G131, G65, G66, G75		







			
1			
<b>GEV No.</b>	511244	<b>Ref. No.</b>	430321
<b>description</b>	rinse arm L 550mm mounting pos. upper/lower nozzles 6 mounting ø 15mm		
<b>For models:</b>	G100L, G101L, G50L, G51L, G60L, G61L, GL		

			
1			
<b>GEV No.</b>	517458	<b>Ref. No.</b>	430339
<b>description</b>	rinse arm mounting pos. upper/lower L 700mm nozzles 7 mounting ø 12mm		
<b>For models:</b>	GE100, GE115, GE60, GE60RCD, GE65, GE65RCD, GE80		





			
1			
<b>GEV No.</b>	511250	<b>Ref. No.</b>	430323
<b>description</b>	rinse arm L 595mm mounting pos. upper/lower nozzles 6 mounting ø 16mm		
<b>For models:</b>	G115L, G125L, G50LM, G65L, G75L, GE125, GE75, GL		
<b>spare parts for</b>	511250		
	<b>GEV No.</b>	510230	<b>Ref. No.</b> 450219
	connector holder L 31mm W 25mm H 16mm		
	<b>GEV No.</b>	510307	<b>Ref. No.</b> 261004 261009
	Thumb screw thread M6 H 3mm thread L 8mm ø 28mm SS		
	<b>GEV No.</b>	511245	<b>Ref. No.</b> 190642
	bushing		
	<b>GEV No.</b>	511246	<b>Ref. No.</b> 380333
	nozzle for rinse arm		
	<b>GEV No.</b>	530293	<b>Ref. No.</b> 200809
	O-ring EPDM thickness 1.78mm ID ø 8.73mm Qty 1 pcs		

			
1			
<b>GEV No.</b>	511243	<b>Ref. No.</b>	420542
<b>description</b>	wash arm		
<b>For models:</b>	G100L, G101L, G50L, G51L, G60L, G61L, GF90, GF90-2004, GF90A, GF90A-2004, GL		
<b>spare parts for</b>	511243		
	<b>GEV No.</b>	510346	<b>Ref. No.</b> 280409
	knurled nut thread M17x1 ø 35mm H 6mm SS		
	<b>GEV No.</b>	510823	<b>Ref. No.</b> 190636
	bush for wash arm		
	<b>GEV No.</b>	510825	<b>Ref. No.</b> 160768
	end cap for wash arm		
	<b>GEV No.</b>	511191	<b>Ref. No.</b> 200813
	O-ring EPDM thickness 2.21mm ID ø 16.36mm Qty 1 pcs		

			
1			
<b>GEV No.</b>	517459	<b>Ref. No.</b>	430338
<b>description</b>	rinse arm mounting pos. upper/lower L 605mm nozzles 6 mounting ø 12mm		
<b>For models:</b>	GE100, GE115, GE50RCD, GE60, GE60RCD, GE65, GE65RCD, GE80		

			
1			
<b>GEV No.</b>	511247	<b>Ref. No.</b>	420544
<b>description</b>	wash arm L 600mm mounting pos. upper/lower nozzles 10 mounting ø 30/86mm 4-armed		
<b>For models:</b>	G115L, G125L, G50LM, G65L, G75L, GE125, GE75, GL		
<b>spare parts for</b>	511247		
	<b>GEV No.</b>	511248	<b>Ref. No.</b> 440816
	retaining ring bore ø 48mm thickness 1.9mm stainless steel DIN 472		
	<b>GEV No.</b>	511249	<b>Ref. No.</b> 160820
	slide ring		





			
1			
<b>GEV No.</b>	511558	<b>Ref. No.</b>	420562
<b>description</b>	wash arm L 635mm mounting pos. upper/lower nozzles 10 mounting $\varnothing$ 22/66mm for GE 65/115		
<b>For models:</b>	GE100, GE115, GE60, GE60RCD, GE65, GE65RCD, GE80		
<b>spare parts for</b>	511558		
	<b>GEV No.</b>	510346	<b>Ref. No.</b> 280409
	knurled nut thread M17x1 $\varnothing$ 35mm H 6mm SS		
	<b>GEV No.</b>	510825	<b>Ref. No.</b> 160768
	end cap for wash arm		
	<b>GEV No.</b>	511191	<b>Ref. No.</b> 200813
	O-ring EPDM thickness 2.21mm ID $\varnothing$ 16.36mm Qty 1 pcs		
	<b>GEV No.</b>	511559	<b>Ref. No.</b> 190669
	bush for wash arm		

			
1			
<b>GEV No.</b>	510813	<b>Ref. No.</b>	190641
<b>description</b>	bush for rinse arm		
<b>For models:</b>	C1000E, C1000ERCD, C1001M, C1300E, C1300ERCD, C1301M, C155, C155BT, C155E2, C155RCD, C165, C165E2, C165E2BT, C165E2RCD, C166, C166-2, C95, C95BT, C95E2, C95RCD, GE100, GE115, GE50RCD, GE60, GE60RCD, GE65, GE65RCD, GE80, LC1200, LC1200RCD, LC412, LC700, LC700RCD, LC900, LC900RCD, XLC		

			
1			
<b>GEV No.</b>	510940	<b>Ref. No.</b>	190613
<b>description</b>	bush for rinse arm		
<b>For models:</b>	G115, G125, G131, G65, G66, G75		



			
1			
<b>GEV No.</b>	510823	<b>Ref. No.</b>	190636
<b>description</b>	bush for wash arm		
<b>For models:</b>	C1000E, C1000ERCD, C1300E, C1300ERCD, C155, C155BT, C155E2, C155RCD, C165, C165E2, C165E2BT, C165E2RCD, C166, C166-2, C95, C95BT, C95E2, C95RCD, G100L, G101L, G50L, G51L, G60L, G61L, GE100, GE115, GE50RCD, GE60, GE60RCD, GE65, GE65RCD, GE80, GF90, GF90-2004, GF90A, GF90A-2004, GL, LAV1000		

			
1			
<b>GEV No.</b>	511239	<b>Ref. No.</b>	190656
<b>description</b>	bushing		
<b>For models:</b>	C75, C75BT, C75RCD, FC, FC53, FC533, FC533A, FC53A, FC53CBT, FC53LA, FC53LBT, FC54, FC543, FC543A, FC543E, FC543EA, FC544, FC544A, FC54A, FC54CBT, FC54LBT, FCHR, FCHRA, FCHRT, FCHRTA		

			
1			
<b>GEV No.</b>	511245	<b>Ref. No.</b>	190642
<b>description</b>	bushing		
<b>For models:</b>	G100L, G101L, G115L, G125L, G50L, G50LM, G51L, G60L, G61L, G65L, G75L, GE100, GE115, GE125, GE60, GE60RCD, GE65, GE65RCD, GE75, GE80, GL		

			
1			
<b>GEV No.</b>	511242	<b>Ref. No.</b>	450218
<b>description</b>	connector holder L 30mm H 16mm W 22mm		
<b>For models:</b>	C1000E, C1000ERCD, C1001M, C1300E, C1300ERCD, C1301M, C155, C155BT, C155E2, C155RCD, C165, C165E2, C165E2BT, C165E2RCD, C166, C166-2, C95, C95BT, C95E2, C95RCD, G100L, G101L, G50L, G51L, G60L, G61L, GE100, GE115, GE50RCD, GE60, GE60RCD, GE65, GE65RCD, GE80, GL, LC1200, LC1200RCD, LC412, LC700, LC700RCD, LC900, LC900RCD, XLC		

			
1			
<b>GEV No.</b>	510230	<b>Ref. No.</b>	450219
<b>description</b>	connector holder L 31mm W 25mm H 16mm		
<b>For models:</b>	G115L, G125L, G50LM, G65L, G75L, GE125, GE75, GL		

			
1			
<b>GEV No.</b>	510825	<b>Ref. No.</b>	160768
<b>description</b>	end cap for wash arm		
<b>For models:</b>	C1000E, C1000ERCD, C1300E, C1300ERCD, C155, C155BT, C155E2, C155RCD, C165, C165E2, C165E2BT, C165E2RCD, C166, C166-2, C95, C95BT, C95E2, C95RCD, G100L, G101L, G50L, G51L, G60L, G61L, GE100, GE115, GE50RCD, GE60, GE60RCD, GE65, GE65RCD, GE80, GF70, GF70A, GF90, GF90-2004, GF90A, GF90A-2004, GL, XLC		
<b>accessories for</b>	510825		
	<b>GEV No.</b>	511191	<b>Ref. No.</b> 200813
	O-ring EPDM thickness 2.21mm ID $\varnothing$ 16.36mm Qty 1 pcs		





			
1			
<b>GEV No.</b>	510346	<b>Ref. No.</b>	280409
<b>description</b>	knurled nut thread M17x1 ø 35mm H 6mm SS		
<b>For models:</b>	C1000E, C1000ERCD, C1001M, C1300E, C1300ERCD, C1301M, C140, C155, C155BT, C155E2, C155RCD, C165, C165E2, C165E2BT, C165E2RCD, C166, C166-2, C33, C34, C95, C95BT, C95E2, C95RCD, G100L, G101L, G50L, G51L, G60L, G61L, GE100, GE115, GE50RCD, GE60, GE60RCD, GE65, GE65RCD, GE80, GF90, GF90-2004, GF90A, GF90A-2004, GL, LC1200, LC1200RCD, LC380, LC412, LC700, LC700RCD, LC900, LC900RCD...(Other models you can see in the webshop)		

			
2			
<b>GEV No.</b>	510369	<b>Ref. No.</b>	380314
<b>description</b>	nozzle for rinse arm		
<b>For models:</b>	C1000E, C1000ERCD, C1300E, C1300ERCD, C155, C155BT, C155E2, C155RCD, C165, C165E2, C165E2BT, C165E2RCD, C166, C166-2, C75, C75BT, C75RCD, C95, C95BT, C95E2, C95RCD, FC, FC53, FC533, FC533A, FC53A, FC53CBT, FC53LA, FC53LBT, FC54, FC543, FC543A, FC543E, FC543EA, FC544, FC544A, FC54A, FC54CBT, FC54LBT, FCHR, FCHRA, FCHRT, FCHRTA, G115, G125, G131, G65, G66, G75, GE100...(Other models you can see in the webshop)		

			
1			
<b>GEV No.</b>	511246	<b>Ref. No.</b>	380333
<b>description</b>	nozzle for rinse arm		
<b>For models:</b>	G100L, G101L, G115L, G125L, G50L, G50LM, G51L, G60L, G61L, G65L, G75L, GE125, GE75, GL		



			
1			
<b>GEV No.</b>	530293	<b>Ref. No.</b>	200809
<b>description</b>	O-ring EPDM thickness 1.78mm ID ø 8.73mm Qty 1 pcs		
<b>For models:</b>	AC101, AC105, AC122, AC135, AC151, AC152, AC181, AC182, AC201, AC202, AC241, AC242, AC2A, AC91, AC95, ACL100, ACL150, ACRS145, ACRS205, ACRS225, ACRS245, ACRS260, ACRS265, ACRS305, ACS101, ACS101-DIGIT, ACS122, ACS122-DIGIT, ACS151, ACS151-DIGIT, ACS152, ACS152-DIGIT, ACS161-DIGIT, ACS162-DIGIT, ACS181, ACS181-DIGIT, ACS182, ACS182-DIGIT, ACS201, ACS201-DIGIT, ACS202, ACS202-DIGIT, ACS241, ACS241-DIGIT, ACS242, ACS242-DIGIT, ACS91, ACS91-DIGIT, B15, B16...(Other models you can see in the webshop)		

			
1			
<b>GEV No.</b>	511191	<b>Ref. No.</b>	200813
<b>description</b>	O-ring EPDM thickness 2.21mm ID ø 16.36mm Qty 1 pcs		
<b>For models:</b>	C1000E, C1000ERCD, C1300E, C1300ERCD, C155, C155BT, C155E2, C155RCD, C165, C165E2, C165E2BT, C165E2RCD, C166, C166-2, C95, C95BT, C95E2, C95RCD, G100L, G101L, G50L, G51L, G60L, G61L, GE100, GE115, GE50RCD, GE60, GE60RCD, GE65, GE65RCD, GE80, GF70, GF70A, GF90, GF90-2004, GF90A, GF90A-2004, GL, XLC		

			
1			
<b>GEV No.</b>	510955	<b>Ref. No.</b>	200854
<b>description</b>	O-ring EPDM thickness 3mm ID ø 6mm Qty 1 pcs		
<b>For models:</b>	AC100, AC90, G100L, G101L, G50L, G51L, G60L, G61L, GL, NG02, NG1202, NG1202E, NG602, NG602E, NG902, NG902E		

			
1			
<b>GEV No.</b>	517626	<b>Ref. No.</b>	380317
<b>description</b>	rinse jet H 11mm thread 1/8" WS 13 code 317		
<b>For models:</b>	AC122, AC152, AC182, AC202, AC242, ACS122, ACS122-DIGIT, ACS152, ACS152-DIGIT, ACS162-DIGIT, ACS182, ACS182-DIGIT, ACS202, ACS202-DIGIT, ACS242, ACS242-DIGIT		

			
1			
<b>GEV No.</b>	510307	<b>Ref. No.</b>	261004 261009
<b>description</b>	Thumb screw thread M6 H 3mm thread L 8mm ø 28mm SS		
<b>For models:</b>	B13T, B14T, B15T, B15TM, B16, B16T, B16TM, B18T, B18TM, B19, B19T, B19TM, B41, B42, BC25, BC25A, BC25HR, BC30, BC30A, BC30HR, BC30HR380, BC30HRA, BHC25, BHC25A, BHC25S, BHC30, BHC30A, BHC30HR, BHC30HR380, BHC30HRA, BHC30HRA380, BHC433, BHC433A, BHCHR, C1000E, C1000ERCD, C1001M, C1300E, C1300ERCD, C1301M, C140, C155, C155BT, C155E2, C155RCD, C165, C165E2, C165E2BT, C165E2RCD, C166...(Other models you can see in the webshop)		

			
1			
<b>GEV No.</b>	510258	<b>Ref. No.</b>	430325
<b>description</b>	rinse arm		
<b>spare parts for</b>	510258		
	<b>GEV No.</b>	<b>Ref. No.</b>	170958
	rinse jet		

















			
1			
<b>GEV No.</b>	511233	<b>Ref. No.</b>	430332
<b>description</b>	rinse arm L 495mm mounting pos. lower nozzles 6 mounting ø 12mm		
<b>For models:</b>	C75, C75BT, C75RCD, FC, FC53, FC533, FC533A, FC53A, FC53CBT, FC53LA, FC53LBT, FC54, FC543, FC543A, FC543E, FC543EA, FC544, FC544A, FC54A, FC54CBT, FC54E, FC54EA, FC54LBT, FCHR, FCHRA, FCHRT, FCHRTA		
<b>spare parts for</b>	511233		
	<b>GEV No.</b>	<b>Ref. No.</b>	280413
	knurled nut thread M8 ø 30mm H 4.5mm SS		
	<b>GEV No.</b>	<b>Ref. No.</b>	342706
	rinse arm shaft		

Table continues overleaf

<b>spare parts for</b> 511233			
	GEV No.	511235	Ref. No. 190663
	bushing		
	GEV No.	511236	Ref. No. 170963
	nozzle for rinse arm		
	GEV No.	511237	Ref. No. 200850
	O-ring EPDM thickness 1mm ID ø 7mm Qty 1 pcs		

			
1			
<b>GEV No.</b>	519484	<b>Ref. No.</b>	430343
<b>description</b>	rinse arm L 495mm mounting pos. upper/lower nozzles 6 mounting ø 12mm		
<b>For models:</b>	C1001M, C1301M, LC1200, LC1200RCD, LC412, LC700, LC700RCD, LC900, LC900RCD		
<b>spare parts for</b> 519484			
	GEV No.	510307	Ref. No. 261004 261009
	Thumb screw thread M6 H 3mm thread L 8mm ø 28mm SS		
	GEV No.	510813	Ref. No. 190641
	bush for rinse arm		
	GEV No.	511236	Ref. No. 170963
	nozzle for rinse arm		
	GEV No.	511237	Ref. No. 200850
	O-ring EPDM thickness 1mm ID ø 7mm Qty 1 pcs		
	GEV No.	511238	Ref. No. 450236
	opposite support for rinse jet		
	GEV No.	511242	Ref. No. 450218
	connector holder L 30mm H 16mm W 22mm		

			
1			
<b>GEV No.</b>	517457	<b>Ref. No.</b>	430347
<b>description</b>	rinse arm mounting pos. upper/lower L 500mm nozzles 6 thread M10x1.5		
<b>For models:</b>	LF322, LF322A, LF322MP, LF322MP-A, LF322RCD, LF324, LF324A, LF325E, LF325EA, LF700, LF700A, LFD32E, LFD32EA, LFD32M, LFD32MA		



			
1			
<b>GEV No.</b>	518597	<b>Ref. No.</b>	420553
<b>description</b>	wash arm		
<b>spare parts for</b> 518597			
	GEV No.	509999	Ref. No. —
	bush for rinse arm H 53mm ø 48.5mm SS		
	GEV No.	510236	Ref. No. 260568
	plain washer ID ø 21mm ED ø 28mm thickness 1mm SS Qty 1 pcs		
	GEV No.	511241	Ref. No. 191075
	knurled nut thread M26x1 stainless steel ø 48.6mm H 10mm		



			
1			
<b>GEV No.</b>	517597	<b>Ref. No.</b>	420560
<b>description</b>	wash arm L 415mm nozzles 7		
<b>For models:</b>	BHC30E, BHC30EA		



			
1			
<b>GEV No.</b>	510259	<b>Ref. No.</b>	420548
<b>description</b>	wash arm L 505mm mounting pos. upper/lower nozzles 8 mounting ø 12/41mm		
<b>For models:</b>	C75, C75BT, C75RCD, FC, FC53, FC533, FC533A, FC53A, FC53CBT, FC53LA, FC53LBT, FC54, FC543, FC543A, FC543E, FC543EA, FC544, FC544A, FC54A, FC54CBT, FC54E, FC54EA, FC54LBT, FCHR, FCHRA, FCHRT, FCHRTA, LF322, LF322A, LF322MP, LF322MP-A, LF322RCD, LF324, LF324A, LF325E, LF325EA, LF700, LF700A, LFD32E, LFD32EA, LFD32M, LFD32MA		
<b>spare parts for</b> 510259			
	GEV No.	510313	Ref. No. 190617
	bush H 12mm D1 ø 20mm D2 ø 16mm D3 ø 12mm for wash arm boss		
	GEV No.	511007	Ref. No. 191070
	bush for wash arm support		
	GEV No.	511231	Ref. No. 191069
	wash arm bearing		





			
1			
<b>GEV No.</b>	512410	<b>Ref. No.</b>	420550
<b>description</b>	wash arm L 505mm mounting pos. upper/lower nozzles 8 mounting ø 12/41mm edition FCHR-FCHR		
<b>For models:</b>	FC, FC53, FC533, FC533A, FC53A, FC53CBT, FC53LBT, FC54, FC543, FC543A, FC543E, FC543EA, FC544, FC544A, FC54A, FC54CBT, FC54LBT, FCHR, FCHRA, FCHRT, FCHRTA		

			
1			
<b>GEV No.</b>	524037	<b>Ref. No.</b>	420578
<b>description</b>	wash arm L 520mm mounting pos. upper/lower w. jets 8 r. jets 5 mounting ø 12/45mm		
<b>For models:</b>	FC3E, FC3EA, FC3M, FC3MA, FC3MR, FC44E, FC44EA, FC4E, FC4EA, FC4EHRT, FC4M, FC4MA		
<b>spare parts for</b>	524037		
		<b>GEV No.</b>	510051
		<b>Ref. No.</b>	280419
	knurled nut for wash arm thread M10 ø 21mm H 11mm		
		<b>GEV No.</b>	510052
		<b>Ref. No.</b>	342790
	rinse arm shaft		

			
1			
<b>GEV No.</b>	530892	<b>Ref. No.</b>	420592
<b>description</b>	wash arm L 520mm mounting pos. upper/lower w. jets 8 r. jets 5 mounting ø 12/45mm		
<b>accessories for</b>	530892		
		<b>GEV No.</b>	530893
		<b>Ref. No.</b>	342958V02R
	rinse arm shaft mounting pos. upper/lower ED ø 15mm thread M10x1.5 seat ø 12mm		

			
1			
<b>GEV No.</b>	518130	<b>Ref. No.</b>	420554 420572R
<b>description</b>	wash arm L 535mm mounting pos. upper/lower nozzles 10 mounting ø 20/58mm complete with rinse pipe		
<b>For models:</b>	C1001M, C1301M, LC1200, LC1200RCD, LC380, LC380BT, LC380RCD, LC400, LC412, LC700, LC700RCD, LC900, LC900RCD		
<b>spare parts for</b>	518130		
		<b>GEV No.</b>	509999
		<b>Ref. No.</b>	—
	bush for rinse arm H 53mm ø 48.5mm SS		
		<b>GEV No.</b>	511241
		<b>Ref. No.</b>	191075
	knurled nut thread M26x1 stainless steel ø 48.6mm H 10mm		

			
1			
<b>GEV No.</b>	511010	<b>Ref. No.</b>	190652
<b>description</b>	bush		
<b>For models:</b>	C75, C75BT, C75RCD, FC, FC53, FC533, FC533A, FC53A, FC53CBT, FC53LA, FC53LBT, FC54, FC543, FC543A, FC543E, FC543EA, FC544, FC544A, FC54A, FC54CBT, FC54LBT, FCHR, FCHRA, FCHRT, FCHRTA		

			
1			
<b>GEV No.</b>	510813	<b>Ref. No.</b>	190641
<b>description</b>	bush for rinse arm		
<b>For models:</b>	C1000E, C1000ERCD, C1001M, C1300E, C1300ERCD, C1301M, C155, C155BT, C155E2, C155RCD, C165, C165E2, C165E2BT, C165E2RCD, C166, C166-2, C95, C95BT, C95E2, C95RCD, GE100, GE115, GE50RCD, GE60, GE60RCD, GE65, GE65RCD, GE80, LC1200, LC1200RCD, LC412, LC700, LC700RCD, LC900, LC900RCD, XLC		

			
1			
<b>GEV No.</b>	511007	<b>Ref. No.</b>	191070
<b>description</b>	bush for wash arm support		
<b>For models:</b>	C75, C75BT, C75RCD, FC, FC53, FC533, FC533A, FC53A, FC53CBT, FC53LA, FC53LBT, FC54, FC543, FC543A, FC543E, FC543EA, FC544, FC544A, FC54A, FC54CBT, FC54E, FC54EA, FC54LBT, FCHR, FCHRA, FCHRT, FCHRTA, LF322, LF322A, LF322MP, LF322MP-A, LF322RCD, LF324, LF324A, LF325E, LF325EA, LF700, LF700A, LFD32E, LFD32EA, LFD32M, LFD32MA		

	<b>1</b>		
<b>GEV No.</b>	510313	<b>Ref. No.</b>	190617
<b>description</b>	bush H 12mm D1 ø 20mm D2 ø 16mm D3 ø 12mm for wash arm boss		
<b>For models:</b>	B13T, B14T, B15T, B15TM, B16, B16T, B16TM, B18T, B18TM, B19, B19T, B19TM, B41, B42, BC25HR, BC30HR, BC30HR380, BC30HRA, BHC25S, C140, C30, C33, C34, C70, C75, C75BT, C75M, C75RCD, C85, F2, F20, F3, F300, F45, F55, F65, F80, F90M, F90MA, FC, FC53, FC533, FC533A, FC53A, FC53CBT, FC53LA, FC53LBT, FC54, FC543, FC543A...(Other models you can see in the webshop)		



	<b>2</b>		
<b>GEV No.</b>	510232	<b>Ref. No.</b>	190673
<b>description</b>	bush ø 23mm H 21mm for rinse arm		
<b>For models:</b>	C1001M, C1301M, LC1200, LC1200RCD, LC380, LC380RCD, LC400, LC412, LC700, LC700RCD, LC900, LC900RCD		

	<b>1</b>		
<b>GEV No.</b>	511235	<b>Ref. No.</b>	190663
<b>description</b>	bushing		
<b>For models:</b>	C75, C75BT, C75RCD, FC, FC53, FC533, FC533A, FC53A, FC53CBT, FC53LA, FC53LBT, FC54, FC543, FC543A, FC543E, FC543EA, FC544, FC544A, FC54A, FC54CBT, FC54E, FC54EA, FC54LBT, FCHR, FCHRA, FCHRT, FCHRTA, GF70, GF70A, LC1200, LC700, LC900, LF322, LF322A, LF322MP, LF322MP-A, LF322RCD, LF324, LF324A, LF325E, LF325EA, LF700, LF700A, LFD32E, LFD32EA, LFD32M, LFD32MA		

	<b>1</b>		
<b>GEV No.</b>	511242	<b>Ref. No.</b>	450218
<b>description</b>	connector holder L 30mm H 16mm W 22mm		
<b>For models:</b>	C1000E, C1000ERCD, C1001M, C1300E, C1300ERCD, C1301M, C155, C155BT, C155E2, C155RCD, C165, C165E2, C165E2BT, C165E2RCD, C166, C166-2, C95, C95BT, C95E2, C95RCD, G100L, G101L, G50L, G51L, G60L, G61L, GE100, GE115, GE50RCD, GE60, GE60RCD, GE65, GE65RCD, GE80, GL, LC1200, LC1200RCD, LC412, LC700, LC700RCD, LC900, LC900RCD, XLC		



	<b>1</b>		
<b>GEV No.</b>	510051	<b>Ref. No.</b>	280419
<b>description</b>	knurled nut for wash arm thread M10 ø 21mm H 11mm		
<b>For models:</b>	FC3E, FC3EA, FC3M, FC3MA, FC3MR, FC44E, FC44EA, FC4E, FC4EA, FC4EHRT, FC4M, FC4MA		

	<b>1</b>		
<b>GEV No.</b>	511009	<b>Ref. No.</b>	280413
<b>description</b>	knurled nut thread M8 ø 30mm H 4.5mm SS		
<b>For models:</b>	C75, C75BT, C75RCD, FC, FC53, FC533, FC533A, FC53A, FC53CBT, FC53LA, FC53LBT, FC54, FC543, FC543A, FC543E, FC543EA, FC544, FC544A, FC54A, FC54CBT, FC54E, FC54EA, FC54LBT, FCHR, FCHRA, FCHRT, FCHRTA		

	<b>1</b>			
<b>GEV No.</b>	511236	<b>Ref. No.</b>	170963	
<b>description</b>	nozzle for rinse arm			
<b>For models:</b>	BHC25-2, BHC25A-2, BHC30-2, BHC30A-2, BHC30E, BHC30E-2, BHC30EA, BHC30EA-2, BHC30HR-2, BHC30HRA-2, BHC433-2, BHC433A-2, C1001M, C1301M, C75, C75BT, C75RCD, FC, FC53, FC533, FC533A, FC53A, FC53CBT, FC53LA, FC53LBT, FC54, FC543, FC543A, FC543E, FC543EA, FC544, FC544A, FC54A, FC54CBT, FC54E, FC54EA, FC54LBT, FCHR, FCHRA, FCHRT, FCHRTA, GF70, GF70A, LC1200, LC1200RCD, LC412, LC700, LC700RCD, LC900, LC900RCD...(Other models you can see in the webshop)			
<b>accessories for</b>	511236			
	<b>GEV No.</b>	511237	<b>Ref. No.</b>	200850
	O-ring EPDM thickness 1mm ID ø 7mm Qty 1 pcs			
	<b>GEV No.</b>	511238	<b>Ref. No.</b>	450236
	opposite support for rinse jet			

	<b>1</b>		
<b>GEV No.</b>	511238	<b>Ref. No.</b>	450236
<b>description</b>	opposite support for rinse jet		
<b>For models:</b>	BHC25-2, BHC25A-2, BHC30-2, BHC30A-2, BHC30E, BHC30E-2, BHC30EA, BHC30EA-2, BHC30HR-2, BHC30HRA-2, BHC433-2, BHC433A-2, C1001M, C1301M, C75, C75BT, C75RCD, FC, FC53, FC533, FC533A, FC53A, FC53CBT, FC53LA, FC53LBT, FC54, FC543, FC543A, FC543E, FC543EA, FC544, FC544A, FC54A, FC54CBT, FC54E, FC54EA, FC54LBT, FCHR, FCHRA, FCHRT, FCHRTA, GF70, GF70A, LC1200, LC1200RCD, LC412, LC700, LC700RCD, LC900, LC900RCD...(Other models you can see in the webshop)		







	<b>1</b>		
<b>GEV No.</b>	511237	<b>Ref. No.</b>	200850
<b>description</b>	O-ring EPDM thickness 1mm ID ø 7mm Qty 1 pcs		
<b>For models:</b>	BHC25-2, BHC25A-2, BHC30-2, BHC30A-2, BHC30E, BHC30E-2, BHC30EA, BHC30EA-2, BHC30HR-2, BHC30HRA-2, BHC433-2, BHC433A-2, C1001M, C1301M, C75, C75BT, C75RCD, FC, FC53, FC533, FC533A, FC53A, FC53CBT, FC53LA, FC53LBT, FC54, FC543, FC543A, FC543E, FC543EA, FC544, FC544A, FC54A, FC54CBT, FC54E, FC54EA, FC54LBT, FCHR, FCHRA, FCHRT, FCHRTA, GF70, GF70A, LC1200, LC1200RCD, LC412, LC700, LC700RCD, LC900, LC900RCD...(Other models you can see in the webshop)		

	<b>1</b>			
<b>GEV No.</b>	511012	<b>Ref. No.</b>	170958	
<b>description</b>	rinse jet			
<b>For models:</b>	C75, C75BT, C75RCD, FC, FC53, FC533, FC533A, FC53A, FC53CBT, FC53LA, FC53LBT, FC54, FC543, FC543A, FC543E, FC543EA, FC544, FC544A, FC54A, FC54CBT, FC54LBT, FCHR, FCHRA, FCHRT, FCHRTA			
<b>accessories for</b>	511012			
	<b>GEV No.</b>	528583	<b>Ref. No.</b>	200845 200864
	O-ring EPDM thickness 2.62mm ID ø 9.13mm Qty 1 pcs			







			
1			
<b>GEV No.</b>	510307	<b>Ref. No.</b>	261004 261009
<b>description</b>	Thumb screw thread M6 H 3mm thread L 8mm ø 28mm SS		
<b>For models:</b>	B13T, B14T, B15T, B15TM, B16, B16T, B16TM, B18T, B18TM, B19, B19T, B19TM, B41, B42, BC25, BC25A, BC25HR, BC30, BC30A, BC30HR, BC30HR380, BC30HRA, BHC25, BHC25A, BHC25S, BHC30, BHC30A, BHC30HR, BHC30HR380, BHC30HRA, BHC30HRA380, BHC433, BHC433A, BHCHR, C1000E, C1000ERCD, C1001M, C1300E, C1300ERCD, C1301M, C140, C155, C155BT, C155E2, C155RCD, C165, C165E2, C165E2BT, C165E2RCD, C166...(Other models you can see in the webshop)		

			
1			
<b>GEV No.</b>	510276	<b>Ref. No.</b>	430130
<b>description</b>	rinse arm L 450mm mounting pos. upper/lower nozzles 4 mounting ø 34mm complete		
<b>For models:</b>	SE		
<b>spare parts for</b>	510276		
	<b>GEV No.</b>	510305	<b>Ref. No.</b>
			180213
	opposite support for wash jet		
	<b>GEV No.</b>	510334	<b>Ref. No.</b>
			170926
	nozzle holder mounting pos. upper		
	<b>GEV No.</b>	511220	<b>Ref. No.</b>
			380323
	nozzle for rinse arm		
<b>accessories for</b>	510276		
	<b>GEV No.</b>	504347	<b>Ref. No.</b>
			380324
	nozzle for rinse arm thread 1/8" L 11mm		
	<b>GEV No.</b>	524588	<b>Ref. No.</b>
			380321
	rinse jet H 11mm thread 1/8" WS 13 code 321		

			
1			
<b>GEV No.</b>	510277	<b>Ref. No.</b>	430136
<b>description</b>	rinse arm L 485mm mounting pos. upper/lower nozzles 6 mounting ø 25mm complete with nozzle		
<b>For models:</b>	AC100, AC120, AC135, AC150, AC170, AC200, AC90, ACR, ACR145, ACR205, ACR225, ACR245, ACR260, ACR265, ACR305, ACRS145, ACRS205, ACRS225, ACRS245, ACRS260, ACRS265, ACRS305, GMC, GMC2700, GMC3500, GMC4500, GMC5500, SE, SNL		

			
1			
<b>GEV No.</b>	510672	<b>Ref. No.</b>	430184 430185
<b>description</b>	rinse arm mounting pos. upper/lower L 525mm nozzles 6 with bayonet coupling		
<b>For models:</b>	AC101, AC122, AC151, AC152, AC181, AC182, AC201, AC202, AC241, AC242, AC91, ACRS145, ACRS205, ACRS225, ACRS245, ACRS260, ACRS265, ACRS305, ACS151, ACS151-DIGIT, ACS152, ACS152-DIGIT, ACS161-DIGIT, ACS162-DIGIT, ACS181, ACS181-DIGIT, ACS182, ACS182-DIGIT, ACS201, ACS201-DIGIT, ACS202, ACS202-DIGIT, ACS241, ACS241-DIGIT, ACS242, ACS242-DIGIT, GMC2702, GMC3502, GMC4502, GMC5502		

			
1			
<b>GEV No.</b>	517598	<b>Ref. No.</b>	430214
<b>description</b>	rinse arm mounting pos. upper/lower right L 615mm nozzles 6		
<b>For models:</b>	NE02, NE3002, NE4002, NE5002, NE5502, NE7002, NE7502, NE9002, NE9502, NL302, NL302E, NL402, NL402E, NL502, NL502E, NL552, NL552E		

			
1			
<b>GEV No.</b>	524642	<b>Ref. No.</b>	170628 170648
<b>description</b>	wash arm L 284mm mounting pos. upper/lower left nozzles 4 complete with nozzle H 83mm W 63mm		
<b>For models:</b>	AC100, AC101, AC105, AC135, AC90, AC91, AC95, SNL		
<b>spare parts for</b>	524642		
	<b>GEV No.</b>	524586	<b>Ref. No.</b>
			170960
	wash jet H 38mm ø 4.5mm		



1

<b>GEV No.</b>	524673	<b>Ref. No.</b>	420227
<b>description</b>	wash arm L 550mm mounting pos. upper/lower nozzles 6 mounting ø 52mm		
<b>For models:</b>	NE3001, NE4001, NE5501, NE7501, NE9001		



1

<b>GEV No.</b>	524579	<b>Ref. No.</b>	170612
<b>description</b>	wash arm L 98mm mounting pos. upper right nozzles 1 short H 84mm W 63mm		
<b>For models:</b>	AC100, AC101, AC105, AC120, AC135, AC150, AC170, AC200, AC90, AC91, AC95, SNL		



1

<b>GEV No.</b>	517599	<b>Ref. No.</b>	170629
<b>description</b>	wash arm mounting pos. upper right L 102mm W 63mm H 83mm nozzles 1		
<b>For models:</b>	AC100, AC105, AC135, AC90, AC95, SNL		

**spare parts for** 517599



<b>GEV No.</b>	517600	<b>Ref. No.</b>	170921
----------------	--------	-----------------	--------

wash jet H 39mm ø 34mm



1

<b>GEV No.</b>	524827	<b>Ref. No.</b>	430186
<b>description</b>	wash arm stationary mounting pos. upper/lower L 525mm nozzles 6		
<b>For models:</b>	AC101, AC122, AC91, ACS101, ACS101-DIGIT, ACS122, ACS122-DIGIT, ACS91, ACS91-DIGIT		



1

<b>GEV No.</b>	517596	<b>Ref. No.</b>	170611
<b>description</b>	wash arm without nozzles mounting pos. upper/lower L 280mm W 64mm H 83.5mm nozzles 4		
<b>For models:</b>	AC100, AC101, AC105, AC135, AC90, AC91, AC95, SNL		



1

<b>GEV No.</b>	517428	<b>Ref. No.</b>	160724
<b>description</b>	end cap for wash arm mounting pos. upper/lower ø 50mm H 16mm		
<b>For models:</b>	AC100, AC101, AC105, AC120, AC135, AC150, AC170, AC200, AC90, AC91, AC95, ACR, ACR145, ACR205, ACR225, ACR245, ACR260, ACR265, ACR305, GMC, GMC2700, GMC3500, GMC4500, GMC5500, NE00, NE3001, NE4001, NE5501, NE7501, NE9001, NG00, NG01, NG600, NG600E, NG900, NG900E, NG901, NG901E, R40, R50, R70, SE, SNL		



1

<b>GEV No.</b>	511631	<b>Ref. No.</b>	200480
<b>description</b>	gasket ID ø 13.5mm ED ø 26mm H 10mm		
<b>For models:</b>	AC100, AC101, AC105, AC120, AC122, AC135, AC150, AC151, AC152, AC170, AC181, AC182, AC200, AC201, AC202, AC241, AC242, AC2A, AC90, AC91, AC95, ACL150, ACR, ACR145, ACR205, ACR225, ACR245, ACR260, ACR265, ACR305, ACS145, ACS205, ACS225, ACS245, ACS260, ACS265, ACS305, ACS101, ACS101-DIGIT, ACS122, ACS122-DIGIT, ACS151, ACS151-DIGIT, ACS152, ACS152-DIGIT, ACS161-DIGIT, ACS162-DIGIT, ACS181, ACS181-DIGIT, ACS182...(Other models you can see in the webshop)		



1

<b>GEV No.</b>	511220	<b>Ref. No.</b>	380323
<b>description</b>	nozzle for rinse arm		
<b>For models:</b>	AC101, AC122, AC91, AC95, ACS101, ACS101-DIGIT, ACS122, ACS122-DIGIT, ACS91, ACS91-DIGIT, SE		





1

<b>GEV No.</b>	504347	<b>Ref. No.</b>	380324
<b>description</b>	nozzle for rinse arm thread 1/8" L 11mm		
<b>For models:</b>	AC100, AC101, AC120, AC122, AC135, AC150, AC151, AC152, AC170, AC181, AC182, AC200, AC201, AC202, AC241, AC242, AC2A, AC90, AC91, ACR, ACR145, ACR205, ACR225, ACR245, ACR260, ACR265, ACR305, ACS145, ACS205, ACS225, ACS245, ACS260, ACS265, ACS305, ACS151, ACS151-DIGIT, ACS152, ACS152-DIGIT, ACS161-DIGIT, ACS162-DIGIT, ACS181, ACS181-DIGIT, ACS182, ACS182-DIGIT, ACS201, ACS201-DIGIT, ACS202, ACS202-DIGIT, ACS241, ACS241-DIGIT...(Other models you can see in the webshop)		





			
1			
<b>GEV No.</b>	510334	<b>Ref. No.</b>	170926
<b>description</b>	nozzle holder mounting pos. upper		
<b>For models:</b>	AC120, AC150, AC170, AC200, ACR, ACR145, ACR205, ACR225, ACR245, ACR260, ACR265, ACR305, G115, G125, G65, G75, GMC, GMC2700, GMC3500, GMC4500, GMC5500, NE00, NG00, NG01, NG02, NG1202, NG1202E, NG600, NG600E, NG601, NG601E, NG602, NG602E, NG900, NG900E, NG901, NG901E, NG902, NG902E, SE, SNL		

			
1			
<b>GEV No.</b>	510305	<b>Ref. No.</b>	180213
<b>description</b>	opposite support for wash jet		
<b>For models:</b>	AC101, AC105, AC120, AC122, AC150, AC151, AC152, AC170, AC200, AC91, AC95, ACR, ACR145, ACR205, ACR225, ACR245, ACR260, ACR265, ACR305, ACRS145, ACRS205, ACRS225, ACRS245, ACRS260, ACRS265, ACRS305, ACS101, ACS101-DIGIT, ACS122, ACS122-DIGIT, ACS151, ACS151-DIGIT, ACS152, ACS152-DIGIT, ACS91, ACS91-DIGIT, B13T, B14T, B15T, B15TM, B16, B16T, B16TM, B18T, B18TM, B19, B19T, B19TM, B41, B42...(Other models you can see in the webshop)		

			
1			
<b>GEV No.</b>	530293	<b>Ref. No.</b>	200809
<b>description</b>	O-ring EPDM thickness 1.78mm ID ø 8.73mm Qty 1 pcs		
<b>For models:</b>	AC101, AC105, AC122, AC135, AC151, AC152, AC181, AC182, AC201, AC202, AC241, AC242, AC2A, AC91, AC95, ACL100, ACL150, ACRS145, ACRS205, ACRS225, ACRS245, ACRS260, ACRS265, ACRS305, ACS101, ACS101-DIGIT, ACS122, ACS122-DIGIT, ACS151, ACS151-DIGIT, ACS152, ACS152-DIGIT, ACS161-DIGIT, ACS162-DIGIT, ACS181, ACS181-DIGIT, ACS182, ACS182-DIGIT, ACS201, ACS201-DIGIT, ACS202, ACS202-DIGIT, ACS241, ACS241-DIGIT, ACS242, ACS242-DIGIT, ACS91, ACS91-DIGIT, B15, B16...(Other models you can see in the webshop)		

			
1			
<b>GEV No.</b>	510955	<b>Ref. No.</b>	200854
<b>description</b>	O-ring EPDM thickness 3mm ID ø 6mm Qty 1 pcs		
<b>For models:</b>	AC100, AC90, G100L, G101L, G50L, G51L, G60L, G61L, GL, NG02, NG1202, NG1202E, NG602, NG602E, NG902, NG902E		

			
1			
<b>GEV No.</b>	524588	<b>Ref. No.</b>	380321
<b>description</b>	rinse jet H 11mm thread 1/8" WS 13 code 321		
<b>For models:</b>	AC120, AC150, AC170, AC200, ACR, ACR145, ACR205, ACR225, ACR245, ACR260, ACR265, ACR305, GMC, GMC2700, GMC3500, GMC4500, GMC5500, NG00, NG01, NG02, NG1202, NG1202E, NG600, NG600E, NG601, NG601E, NG602, NG602E, NG900, NG900E, NG901, NG901E, NG902, NG902E, SE		

			
1			
<b>GEV No.</b>	524587	<b>Ref. No.</b>	170962
<b>description</b>	wash jet H 38mm		
<b>For models:</b>	AC101, AC91		

			
1			
<b>GEV No.</b>	524586	<b>Ref. No.</b>	170960
<b>description</b>	wash jet H 38mm ø 4.5mm		
<b>For models:</b>	AC100, AC101, AC105, AC135, AC90, AC91, AC95		

			
1			
<b>GEV No.</b>	517600	<b>Ref. No.</b>	170921
<b>description</b>	wash jet H 39mm ø 34mm		
<b>For models:</b>	AC100, AC101, AC105, AC135, AC90, AC91, AC95, SNL		

			
1			
<b>GEV No.</b>	517601	<b>Ref. No.</b>	170909
<b>description</b>	wash jet H 39mm ø 34mm		
<b>For models:</b>	AC120, AC135, AC150, AC170, AC200, NE00, NG00, NG600, NG600E, NG900, NG900E, SNL		

			
1			
<b>GEV No.</b>	510737	<b>Ref. No.</b>	170636 430313
<b>description</b>	rinse arm L 205mm mounting pos. upper nozzles 3 mounting ø 12mm complete with nozzle		
<b>For models:</b>	B10T, B11T, B12T, BR20, BR20A, BR25, BR25A, LBR, LBR200, LBR215, LBR215A		

			
1			
<b>GEV No.</b>	510728	<b>Ref. No.</b>	170603
<b>description</b>	wash arm L 250mm mounting pos. lower nozzles 4 mounting ø 25mm suitable for B23-27-10-11		
<b>For models:</b>	B10, B10T, B11, B11T, B12, B12T, B20, B20D, B23, B24, B25, B26, B27, BR20, BR20A, BR25, BR25A, LBR, LBR200, LBR215, LBR215A		
<b>spare parts for</b>	510728		
	<b>GEV No.</b>	510731	<b>Ref. No.</b> 160710
	<b>GEV No.</b>	560140	<b>Ref. No.</b> 260402 260418
	hexagonal nut thread M4 H 4.8mm SS WS 7 Qty 20 pcs DIN/ISO DIN 985 self-locking		

Table continues overleaf

spare parts for 510728			
	GEV No.	560376	Ref. No.
			260510
lock washer ID ø 4.3mm ED ø 7.3mm SS UNI 1751 A Qty 1 pcs for thread M4			





1	GEV No.	510280	Ref. No.	170604
description wash arm L 282mm mounting pos. upper nozzles 2 lateral Hmm suitable for B23-12t				
For models: B10T, B11, B11T, B12, B12T, B23, B24, B25, B26, B27, BR25, BR25A, LBR, LBR200, LBR215, LBR215A				





1	GEV No.	524674	Ref. No.	170605
description wash arm L 500mm nozzles 5 mounting ø 30mm without nozzles				
For models: B31, B32				

	1	GEV No.	510323	Ref. No.	160734
description end cap for rinse arm					
For models: B10T, B11T, B12T, B13T, B14T, B15T, B15TM, B16T, B16TM, B18T, B18TM, B19T, B19TM, BC25, BC25A, BC30, BC30A, BHC25, BHC25A, BHC30, BHC30A, BHC30HR, BHC30HR380, BHC30HRA, BHC30HRA380, BHC433, BHC433A, BHCHR, BR20, BR20A, BR25, BR25A, F20, F45, F55, F65, F80, FC43, FC43A, FC54E, FC54EA, LB200, LB200-2, LB200A, LB200A-2, LB215, LB215-2, LB215A, LB215A-2, LB260...(Other models you can see in the webshop)					

	1	GEV No.	510731	Ref. No.	160710
description end cap for wash arm					
For models: B10, B10T, B11, B11T, B12, B12T, B20, B20D, B23, B24, B25, B26, B27, BR20, BR20A, BR25, BR25A, LBR, LBR200, LBR215, LBR215A					

	1	GEV No.	510761	Ref. No.	200944 21005
description flat gasket rubber D1 ø 38mm D2 ø 25mm thickness 2mm Qty 1 pcs					
For models: BHC25, BHC25-2, BHC25A, BHC25A-2, BHC25S, BHC30, BHC30-2, BHC30A, BHC30A-2, BHC30E, BHC30E-2, BHC30EA, BHC30EA-2, BHC433, BHC433-2, BHC433A, BHC433A-2, GF70, GF70A, LB200, LB200-2, LB200A, LB200A-2, LB215, LB215-2, LB215A, LB215A-2, LB260, LB260-2, LB260A, LB260A-2, LB275, LB275-2, LB275A, LB275A-2, LF321, LF321A, LF322, LF322A, LF322MP, LF322MP-A, LF322RCD, LF324, LF324A, LF325E, LF325EA, LF700, LF700A, LFD32E, LFD32EA...(Other models you can see in the webshop)					

	1	GEV No.	510885	Ref. No.	200464
description gasket suitable for COMENDA equiv. no. 200464 L 60mm W 30mm					
For models: B10T, B11T, B12T, BR20, BR20A, BR25, BR25A, LBR, LBR200, LBR215, LBR215A					

	1	GEV No.	510327	Ref. No.	170946
description nozzle for rinse arm					
For models: B10T, B11T, B12T, B13T, B14T, B15T, B15TM, B16T, B16TM, B18T, B18TM, B19T, B19TM, BC25, BC25A, BC30, BC30A, BHC25, BHC25A, BHC30, BHC30A, BHC30HR, BHC30HR380, BHC30HRA, BHC30HRA380, BHC433, BHC433A, BHCHR, BR20, BR20A, BR25, BR25A, F20, F45, F55, F65, F80, FC43, FC43A, FC54E, FC54EA, LB200, LB200-2, LB200A, LB200A-2, LB215, LB215-2, LB215A, LB215A-2, LB260...(Other models you can see in the webshop)					
accessories for 510327					
		GEV No.	510902	Ref. No.	200844
O-ring EPDM thickness 2mm ID ø 9.5mm Qty 1 pcs					

	1	GEV No.	510734	Ref. No.	170924
description nozzle for wash arm suitable for B23-10-11-12					
For models: B10, B10T, B11, B11T, B12, B12T, B20, B20D, B23, B24, B25, B26, B27, BR20, BR20A, BR25, BR25A, LBR, LBR200, LBR215, LBR215A					

	1	GEV No.	510736	Ref. No.	170908
description nozzle for wash arm suitable for B23-10-12					
For models: B10, B10T, B11, B11T, B12, B12T, B20, B20D, B23, B24, B25, B26, B27, B31, B32, BR20, BR20A, BR25, BR25A, LBR, LBR200, LBR215, LBR215A					







			
1			
<b>GEV No.</b>	510735	<b>Ref. No.</b>	190618
<b>description</b>	nozzle holder for wash arm		
<b>For models:</b>	B10, B10T, B11, B11T, B12, B12T, B20, B20D, B23, B24, B25, B26, B27, BR20, BR20A, BR25, BR25A, LBR, LBR200, LBR215, LBR215A		

			
1			
<b>GEV No.</b>	510335	<b>Ref. No.</b>	380309
<b>description</b>	rinse jet for glass rinsing		
<b>For models:</b>	B13T, B14T, B15, B15T, B16, B16T, B18, B18T, B19, B19T, B31, B32		

			
1			
<b>GEV No.</b>	511200	<b>Ref. No.</b>	270106
<b>description</b>	nut thread 1" H 6mm brass WS 45 Qty 1 pcs		
<b>For models:</b>	B10, B10T, B11, B11T, B12, B12T, B20, B20D, B23, B24, B25, B26, B27, BR20, BR20A, BR25, BR25A, LBR, LBR200, LBR215, LBR215A		

			
1			
<b>GEV No.</b>	519471	<b>Ref. No.</b>	332552
<b>description</b>	wash arm L 550mm H 440mm mounting pos. upper nozzles 24		
<b>For models:</b>	ACRS145, ACRS205, ACRS225, ACRS245, ACRS260, ACRS265, ACRS305, GMC2702, GMC3502, GMC4502, GMC5502		



			
1			
<b>GEV No.</b>	507309	<b>Ref. No.</b>	200819
<b>description</b>	O-ring EPDM thickness 2.62mm ID ø 17.13mm Qty 1 pcs		
<b>For models:</b>	B10, B10T, B11, B11T, B12, B12T, B20, B20D, B23, B24, B25, B26, B27, B31, B32, BR20, BR20A, BR25, BR25A, C33, C34, LBR, LBR200, LBR215, LBR215A		

<b>spare parts for</b> 519471			
	<b>GEV No.</b>	502073	<b>Ref. No.</b> 200933
	<b>GEV No.</b>	510899	<b>Ref. No.</b> 200830
	<b>GEV No.</b>	519464	<b>Ref. No.</b> 160721 160781

			
1			
<b>GEV No.</b>	528583	<b>Ref. No.</b>	200845 200864
<b>description</b>	O-ring EPDM thickness 2.62mm ID ø 9.13mm Qty 1 pcs		
<b>For models:</b>	B10T, B11T, B12T, B13T, B14T, B15T, B15TM, B16T, B16TM, B18T, B18TM, B19T, B19TM, BC25, BC25A, BC30, BC30A, BHC25, BHC25A, BHC30, BHC30A, BHC30HR, BHC30HR380, BHC30HRA, BHC30HRA380, BHC433, BHC433A, BHCHR, BR20, BR20A, BR25, BR25A, C75, C75BT, C75RCD, F20, F45, F55, F65, F80, FC, FC43, FC43A, FC53, FC533, FC533A, FC53A, FC53CBT, FC53LA, FC53LBT...(Other models you can see in the webshop)		

			
1			
<b>GEV No.</b>	524777	<b>Ref. No.</b>	332557
<b>description</b>	wash arm L 560mm nozzles 12 mounting pos. upper W 255mm H 65mm		
<b>For models:</b>	ACS181, ACS181-DIGIT, ACS182, ACS182-DIGIT		

			
1			
<b>GEV No.</b>	510742	<b>Ref. No.</b>	380604 380605
<b>description</b>	rinse arm L 292mm H 270mm mounting pos. upper nozzles 4 complete with nozzle		
<b>For models:</b>	B13T, B14T, B15, B15T, B16, B16T, B18, B18T, B19, B19T		

			
1			
<b>GEV No.</b>	519464	<b>Ref. No.</b>	160721 160781
<b>description</b>	plug		
<b>For models:</b>	AC122, AC151, AC152, AC181, AC182, AC201, AC202, AC241, AC242, ACL100, ACL150, ACR, ACR145, ACR205, ACR225, ACR245, ACR260, ACR265, ACR305, ACRS145, ACRS205, ACRS225, ACRS245, ACRS260, ACRS265, ACRS305, ACS101, ACS101-DIGIT, ACS122, ACS122-DIGIT, ACS151, ACS151-DIGIT, ACS152, ACS152-DIGIT, ACS161-DIGIT, ACS162-DIGIT, ACS181, ACS181-DIGIT, ACS182, ACS182-DIGIT, ACS201, ACS201-DIGIT, ACS202, ACS202-DIGIT, ACS241, ACS241-DIGIT, ACS242, ACS242-DIGIT, ACS91, ACS91-DIGIT...(Other models you can see in the webshop)		
<b>accessories for</b>	519464		
	<b>GEV No.</b>	502073	<b>Ref. No.</b> 200933
	O-ring EPDM thickness 4mm ID ø 24mm Qty 1 pcs		

			
1			
<b>GEV No.</b>	510331	<b>Ref. No.</b>	270101
<b>description</b>	nut thread 1/2" H 7mm SS WS 30 Qty 1 pcs		
<b>For models:</b>	AC100, AC101, AC105, AC120, AC122, AC135, AC150, AC151, AC152, AC170, AC181, AC182, AC200, AC201, AC202, AC241, AC242, AC2A, AC90, AC91, AC95, ACL100, ACL150, ACR, ACR145, ACR205, ACR225, ACR245, ACR260, ACR265, ACR305, ACRS145, ACRS205, ACRS225, ACRS245, ACRS260, ACRS265, ACRS305, ACS101, ACS101-DIGIT, ACS122, ACS122-DIGIT, ACS151, ACS151-DIGIT, ACS152, ACS152-DIGIT, ACS161-DIGIT, ACS162-DIGIT, ACS181, ACS181-DIGIT...(Other models you can see in the webshop)		



## miscellaneous



<b>GEV No.</b>	510339	<b>Ref. No.</b>	380402
----------------	--------	-----------------	--------

**description** nozzle rinsing



<b>GEV No.</b>	510455	<b>Ref. No.</b>	380313
----------------	--------	-----------------	--------

**description** rinse jet



<b>GEV No.</b>	512196	<b>Ref. No.</b>	170954
----------------	--------	-----------------	--------

**description** rinse jet H 18.5mm

**For models:** AC101, AC105, AC120, AC122, AC151, AC152, AC170, AC200, AC91, AC95, ACL150, ACR, ACR145, ACR205, ACR225, ACR245, ACR260, ACR265, ACR305, ACRS145, ACRS205, ACRS225, ACRS245, ACRS260, ACRS265, ACRS305, ACS101, ACS101-DIGIT, ACS122, ACS122-DIGIT, ACS151, ACS151-DIGIT, ACS152, ACS152-DIGIT, ACS161-DIGIT, ACS162-DIGIT, ACS91, ACS91-DIGIT, GMC, GMC2700, GMC2702, GMC3500, GMC3502, GMC4500, GMC4502, GMC5500, GMC5502, NE00, NE02, NE3001...(Other models you can see in the webshop)



<b>GEV No.</b>	510866	<b>Ref. No.</b>	190623
----------------	--------	-----------------	--------

**description** union nut for rinse jet  $\phi$  14mm

**For models:** ACR, ACR145, ACR205, ACR225, ACR245, ACR260, ACR265, ACR305, GMC, GMC2700, GMC3500, GMC4500, GMC5500, LAV1000, NE00, SE



<b>GEV No.</b>	510828	<b>Ref. No.</b>	170907
----------------	--------	-----------------	--------

**description** wash jet

## wash arm supports

## wash arm supports



<b>GEV No.</b>	510466	<b>Ref. No.</b>	191024
----------------	--------	-----------------	--------

**description** opposite support

**For models:** F300



<b>GEV No.</b>	510035	<b>Ref. No.</b>	190232
----------------	--------	-----------------	--------

**description** opposite support mounting pos. lower for wash arm support

**For models:** FC3E, FC3EA, FC3M, FC3MA, FC3MR, FC44E, FC44EA, FC4E, FC4EA, FC4EHRT, FC4M, FC4MA



<b>GEV No.</b>	510461	<b>Ref. No.</b>	190210
----------------	--------	-----------------	--------

**description** opposite support mounting pos. lower for wash arm support suitable for LBC 215-215A/275-275A

**For models:** BC25, BC25A, BC25HR, BC30, BC30A, BC30HR, BC30HR380, BC30HRA, FC43, FC43A, LBC210, LBC215, LBC215A, LBC275, LBC275A



<b>GEV No.</b>	510471	<b>Ref. No.</b>	510265
----------------	--------	-----------------	--------

**description** wash arm support

**For models:** C30, F2, F3, F300



<b>GEV No.</b>	512411	<b>Ref. No.</b>	190126
----------------	--------	-----------------	--------

**description** wash arm support ED  $\phi$  65mm thickness 10mm L 75mm mounting  $\phi$  23mm ID  $\phi$  45mm

**For models:** NE00, NG00, NG600, NG600E, NG900, NG900E, SE



<b>GEV No.</b>	511256	<b>Ref. No.</b>	191083
----------------	--------	-----------------	--------

**description** wash arm support mounting pos. lower

**For models:** BHC25, BHC25-2, BHC25A, BHC25A-2, BHC25S, BHC30, BHC30-2, BHC30A, BHC30A-2, BHC30E, BHC30E-2, BHC30EA, BHC30EA-2, BHC30HR, BHC30HR-2, BHC30HR380, BHC30HRA, BHC30HRA-2, BHC30HRA380, BHC433, BHC433-2, BHC433A, BHC433A-2, BHCHR, LB200, LB200-2, LB200A, LB200A-2, LB215, LB215-2, LB215A, LB215A-2, LB260, LB260-2, LB260A, LB260A-2, LB275, LB275-2, LB275A, LB275A-2





<b>GEV No.</b>	511265	<b>Ref. No.</b>	191071
----------------	--------	-----------------	--------

**description** wash arm support mounting pos. lower

**For models:** C75, C75BT, C75RCD





			
1			
<b>GEV No.</b>	511269	<b>Ref. No.</b>	341736
<b>description</b>	wash arm support mounting pos. lower		
<b>For models:</b>	G115L, G125L, G50LM, G65L, G75L, GE125, GE75, GL		



			
1			
<b>GEV No.</b>	512027	<b>Ref. No.</b>	190941
<b>description</b>	wash arm support mounting pos. lower		
<b>For models:</b>	LF322, LF322A, LF322MP, LF322MP-A, LF322RCD, LF324, LF324A, LF325E, LF325EA, LF700, LF700A, LFD32E, LFD32EA, LFD32M, LFD32MA		

			
1			
<b>GEV No.</b>	512269	<b>Ref. No.</b>	190223
<b>description</b>	wash arm support mounting pos. lower		
<b>For models:</b>	BHC25, BHC25A, BHC25S, BHC30, BHC30A, BHC30HR, BHC30HR380, BHC30HRA, BHC30HRA380, BHC433, BHC433A, BHC30HR, LB200, LB200-2, LB200A, LB200A-2, LB215, LB215-2, LB215A, LB215A-2, LB260, LB260-2, LB260A, LB260A-2, LB275, LB275-2, LB275A, LB275A-2		

			
1			
<b>GEV No.</b>	510460	<b>Ref. No.</b>	191064
<b>description</b>	wash arm support mounting pos. lower D1 ø 12mm D2 ø 43mm D3 ø 50mm H 133mm		
<b>For models:</b>	BC25, BC25A, BC25HR, BC30, BC30A, BC30HR, BC30HR380, BC30HRA, F90M, F90MA, FC43, FC43A, LF315, LF320, LF320A, LF320CBT, LF320L, LF320LA, LF320LBT, LF323, LF323A, LF350, LF350A, LF400A, LF450, LF450A, LS550		

			
1			
<b>GEV No.</b>	511073	<b>Ref. No.</b>	191068
<b>description</b>	wash arm support mounting pos. lower ED ø 100mm thread M8 ID ø 34mm seat ø 40mm shaft ø 12mm		
<b>For models:</b>	FC, FC53, FC533, FC533A, FC53A, FC53CBT, FC53LA, FC53LBT, FC54, FC543, FC543A, FC543E, FC543EA, FC544, FC544A, FC54A, FC54CBT, FC54E, FC54EA, FC54LBT, FCHR, FCHRA, FCHRT, FCHRTA		

			
1			
<b>GEV No.</b>	524464	<b>Ref. No.</b>	191102
<b>description</b>	wash arm support mounting pos. lower ø 59mm H 88mm ID ø 33mm		
<b>For models:</b>	LF322, LF322A, LF322MP, LF322MP-A, LF322RCD, LF324, LF324A, LF325E, LF325EA, LF700, LF700A, LFD32E, LFD32EA, LFD32M, LFD32MA		

			
1			
<b>GEV No.</b>	510873	<b>Ref. No.</b>	191031
<b>description</b>	wash arm support mounting pos. lower with rinse arm shaft		
<b>For models:</b>	C30, C70, C75, C75M, F2, F3, F45, F55, F65, F80, LP360, LP360BT, LP360RCD		
<b>accessories for</b>	510873		
		<b>GEV No.</b>	510447
		<b>Ref. No.</b>	200829
	O-ring EPDM thickness 5.34mm ID ø 81.92mm Qty 1 pcs		

			
1			
<b>GEV No.</b>	510470	<b>Ref. No.</b>	510201
<b>description</b>	wash arm support mounting pos. upper		
<b>For models:</b>	F2, F3, F300		

			
1			
<b>GEV No.</b>	511259	<b>Ref. No.</b>	190218
<b>description</b>	wash arm support mounting pos. upper		
<b>For models:</b>	FC54E, FC54EA		

			
1			
<b>GEV No.</b>	511266	<b>Ref. No.</b>	190216
<b>description</b>	wash arm support mounting pos. upper		
<b>For models:</b>	C75, C75BT, C75RCD		

			
1			
<b>GEV No.</b>	511268	<b>Ref. No.</b>	510503
<b>description</b>	wash arm support mounting pos. upper		
<b>For models:</b>	LC380, LC380BT, LC380RCD, LC400		

			
1			
<b>GEV No.</b>	511271	<b>Ref. No.</b>	510280
<b>description</b>	wash arm support mounting pos. upper		
<b>For models:</b>	G115, G125, G131, G65, G66, G75		

			
1			
<b>GEV No.</b>	512488	<b>Ref. No.</b>	190215 190944
<b>description</b>	wash arm support mounting pos. upper thread M6		
<b>For models:</b>	FC, FC53, FC533, FC533A, FC53A, FC53CBT, FC53LA, FC53LBT, FC54, FC543, FC543A, FC543E, FC543EA, FC544, FC544A, FC54A, FC54CBT, FC54E, FC54EA, FC54LBT, FCHR, FCHRA, FCHRT, FCHRTA, LF321, LF321A		

			
1			
<b>GEV No.</b>	510319	<b>Ref. No.</b>	510238
<b>description</b>	wash arm support mounting pos. upper/lower		
<b>For models:</b>	C140, C33, C34, G100L, G101L, G50L, G51L, G60L, G61L, GF90, GF90-2004, GF90A, GF90A-2004, GL, LC380, LC380BT, LC380RCD, LC400		

			
1			
<b>GEV No.</b>	524581	<b>Ref. No.</b>	190127
<b>description</b>	wash arm support $\varnothing$ 65mm L 75mm W 65mm H 65mm		
<b>For models:</b>	NE00, NG00, NG600, NG600E, NG900, NG900E, SE		

			
1			
<b>GEV No.</b>	510320	<b>Ref. No.</b>	191025
<b>description</b>	wash arm support with rinse arm shaft mounting pos. lower		
<b>For models:</b>	B13T, B14T, B15, B15T, B15TM, B16, B16T, B16TM, B18, B18T, B18TM, B19, B19T, B19TM, B41, B42, F2, F20, F3, F300, F45, F55, F65, F80, F90M, F90MA, LBC210, LBC215, LBC215A, LBC275, LBC275A, LF280-lav-line, LF315, LF320, LF320A, LF320CBT, LF320L, LF320LA, LF320-lav-line, LF320LBT, LF323, LF323A, LF350, LF350A, LF400A, LF450, LF450A, LS550		

			
1			
<b>GEV No.</b>	510448	<b>Ref. No.</b>	190209
<b>description</b>	wash arm support with rinse arm shaft mounting pos. upper		
<b>For models:</b>	B15TM, B16TM, B18TM, B19TM, BC25, BC25A, BC25HR, BC30, BC30A, BC30HR, BC30HR380, BC30HRA, BHC25, BHC25A, BHC25S, BHC30, BHC30A, BHC30HR, BHC30HR380, BHC30HRA, BHC30HRA380, BHC433, BHC433A, BHCHR, FC43, FC43A, LB200, LB200-2, LB200A, LB200A-2, LB215, LB215-2, LB215A, LB215A-2, LB260, LB260-2, LB260A, LB260A-2, LB275, LB275-2, LB275A, LB275A-2, LBC210, LBC215, LBC215A, LBC275, LBC275A		

			
1			
<b>GEV No.</b>	510114	<b>Ref. No.</b>	190227
<b>description</b>	wash arm support with rinse arm shaft mounting pos. upper/lower $\varnothing$ 74mm H 142mm		
<b>For models:</b>	C1000E, C1000ERCD, C1001M, C1300E, C1300ERCD, C1301M, GE50RCD, LC1200, LC1200RCD, LC412, LC700, LC700RCD, LC900, LC900RCD, XLC		

## gaskets

			
1			
<b>GEV No.</b>	510975	<b>Ref. No.</b>	200421
<b>description</b>	gasket D1 $\varnothing$ 40mm D2 $\varnothing$ 70mm thickness 2mm rubber with 4 screw holes wash arm support equiv. no. 200421 suitable for COMENDA		
<b>For models:</b>	F2, F3, F300		

			
1			
<b>GEV No.</b>	510972	<b>Ref. No.</b>	200909
<b>description</b>	gasket with 4 screw holes D1 $\varnothing$ 58mm D2 $\varnothing$ 100mm thickness 2mm wash arm support		
<b>For models:</b>	C155, C155BT, C155E2, C155RCD, C165, C165E2, C165E2BT, C165E2RCD, C166, C166-2, C95, C95BT, C95E2, C95RCD		

			
1			
<b>GEV No.</b>	510302	<b>Ref. No.</b>	200824
<b>description</b>	O-ring EPDM ID $\varnothing$ 12.42mm thickness 1.78mm Qty 1 pcs		
<b>For models:</b>	AC101, AC105, AC120, AC122, AC150, AC151, AC152, AC170, AC200, AC91, AC95, ACL150, ACR, ACR145, ACR205, ACR225, ACR245, ACR260, ACR265, ACR305, ACRS145, ACRS205, ACRS225, ACRS245, ACRS260, ACRS265, ACRS305, ACS101, ACS101-DIGIT, ACS122, ACS122-DIGIT, ACS151, ACS151-DIGIT, ACS152, ACS152-DIGIT, ACS161-DIGIT, ACS162-DIGIT, ACS91, ACS91-DIGIT, B13T, B14T, B15T, B15TM, B16, B16T, B16TM, B18T, B18TM, B19, B19T...(Other models you can see in the webshop)		



			
1			
<b>GEV No.</b>	528333	<b>Ref. No.</b>	200806
<b>description</b>	O-ring EPDM thickness 2.62mm ID ø 13.1mm Qty 1 pcs		
<b>For models:</b>	AC181, AC182, AC201, AC202, AC241, AC242, ACS122, ACS122-DIGIT, ACS152, ACS152-DIGIT, ACS162-DIGIT, ACS182, ACS182-DIGIT, ACS202, ACS202-DIGIT, ACS242, ACS242-DIGIT, B13T, B14T, B15, B15T, B15TM, B16, B16T, B16TM, B18, B18T, B18TM, B19, B19T, B19TM, B41, B42, BC25, BC25A, BC25HR, BC30, BC30A, BC30HR, BC30HR380, BC30HRA, C30, C70, C75, C75BT, C75M, C75RCD, F2, F20, F3...(Other models you can see in the webshop)		

			
1			
<b>GEV No.</b>	510408	<b>Ref. No.</b>	200820
<b>description</b>	O-ring EPDM thickness 5.34mm ID ø 47mm Qty 1 pcs		
<b>For models:</b>	B10T, B11T, B12T, B13T, B14T, B15, B15T, B15TM, B16, B16T, B16TM, B18, B18T, B18TM, B19, B19T, B19TM, B20, B20D, B23, B24, B25, B26, B27, B31, B32, B41, B42, BC25, BC25A, BC25HR, BC30, BC30A, BC30HR, BC30HR380, BC30HRA, BHC25, BHC25-2, BHC25A, BHC25A-2, BHC255, BHC30, BHC30-2, BHC30A, BHC30A-2, BHC30E, BHC30E-2, BHC30EA, BHC30EA-2, BHC30HR...(Other models you can see in the webshop)		

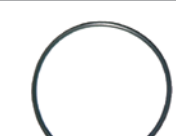
			
1			
<b>GEV No.</b>	510974	<b>Ref. No.</b>	200852
<b>description</b>	O-ring EPDM thickness 2.62mm ID ø 58.42mm Qty 1 pcs		
<b>For models:</b>	C155, C155BT, C155E2, C155RCD, C165, C165E2, C165E2BT, C165E2RCD, C166, C166-2, C95, C95BT, C95E2, C95RCD		

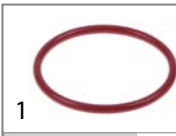

			
1			
<b>GEV No.</b>	510447	<b>Ref. No.</b>	200829
<b>description</b>	O-ring EPDM thickness 5.34mm ID ø 81.92mm Qty 1 pcs		
<b>For models:</b>	B13T, B14T, B15, B15T, B15TM, B16, B16T, B16TM, B18, B18T, B18TM, B19, B19T, B19TM, B41, B42, C30, C70, C75, C75BT, C75M, C75RCD, F2, F20, F3, F300, F45, F55, F65, F80, F90M, F90MA, FC, FC53, FC533, FC533A, FC53A, FC53CBT, FC53LA, FC53LBT, FC54, FC543, FC543A, FC543E, FC543EA, FC544, FC544A, FC54A, FC54CBT, FC54E...(Other models you can see in the webshop)		

			
1			
<b>GEV No.</b>	510973	<b>Ref. No.</b>	200853
<b>description</b>	O-ring EPDM thickness 3.53mm ID ø 63.09mm Qty 1 pcs		
<b>For models:</b>	C155, C155BT, C155E2, C155RCD, C165, C165E2, C165E2BT, C165E2RCD, C166, C166-2, C95, C95BT, C95E2, C95RCD		

			
1			
<b>GEV No.</b>	532594	<b>Ref. No.</b>	200808
<b>description</b>	O-ring silicone thickness 3.53mm ID ø 50.8mm Qty 1 pcs		
<b>For models:</b>	FC3E, FC3EA, FC3M, FC3MA, FC3MR, FC44E, FC44EA, FC4E, FC4EA, FC4EHRT, FC4M, FC4MA		

			
1			
<b>GEV No.</b>	510971	<b>Ref. No.</b>	200855
<b>description</b>	O-ring EPDM thickness 3mm ID ø 43mm Qty 1 pcs		
<b>For models:</b>	BC25, BC25A, BC25HR, BC30, BC30A, BC30HR, BC30HR380, BC30HRA, F90M, F90MA, FC43, FC43A, LF315, LF320, LF320A, LF320CBT, LF320L, LF320LA, LF320LBT, LF323, LF323A, LF350, LF350A, LF400A, LF450, LF450A, LS550		

wash arm bearings

			
1			
<b>GEV No.</b>	511231	<b>Ref. No.</b>	191069
<b>description</b>	wash arm bearing		
<b>For models:</b>	C75, C75BT, C75RCD, FC, FC53, FC533, FC533A, FC53A, FC53CBT, FC53LA, FC53LBT, FC54, FC543, FC543A, FC543E, FC543EA, FC544, FC544A, FC54A, FC54CBT, FC54E, FC54EA, FC54LBT, FCHR, FCHRA, FCHRT, FCHRTA, LF322, LF322A, LF322MP, LF322MP-A, LF322RCD, LF324, LF324A, LF325E, LF325EA, LF700, LF700A, LFD32E, LFD32EA, LFD32M, LFD32MA		
<b>accessories for</b>	511231		
	<b>GEV No.</b>	510313	<b>Ref. No.</b> 190617
	bush H 12mm D1 ø 20mm D2 ø 16mm D3 ø 12mm for wash arm boss		

			
1			
<b>GEV No.</b>	510970	<b>Ref. No.</b>	200856
<b>description</b>	O-ring EPDM thickness 3mm ID ø 81mm Qty 1 pcs		
<b>For models:</b>	BC25, BC25A, BC25HR, BC30, BC30A, BC30HR, BC30HR380, BC30HRA, F90M, F90MA, FC43, FC43A, LF315, LF320, LF320A, LF320CBT, LF320L, LF320LA, LF320LBT, LF323, LF323A, LF350, LF350A, LF400A, LF450, LF450A, LS550		



1

<b>GEV No.</b>	510050	<b>Ref. No.</b>	190233
<b>description</b>	wash arm bearing mounting pos. upper/lower suitable for wash arm FC2006		
<b>For models:</b>	FC3E, FC3EA, FC3M, FC3MA, FC3MR, FC44E, FC44EA, FC4E, FC4EA, FC4EHRT, FC4M, FC4MA		



1

<b>GEV No.</b>	510644	<b>Ref. No.</b>	330824
<b>description</b>	wash arm bearing ø 25mm H 52mm		
<b>For models:</b>	C1001M, C1301M, LC1200, LC1200RCD, LC412, LC700, LC700RCD, LC900, LC900RCD		

## miscellaneous



1

<b>GEV No.</b>	510449	<b>Ref. No.</b>	260539
<b>description</b>	disc		
<b>For models:</b>	B13T, B14T, B15T, B15TM, B16T, B16TM, B18T, B18TM, B19T, B19TM		



1

<b>GEV No.</b>	511241	<b>Ref. No.</b>	191075
<b>description</b>	knurled nut thread M26x1 stainless steel ø 48.6mm H 10mm		
<b>For models:</b>	C1001M, C1301M, LC1200, LC1200RCD, LC380, LC380BT, LC380RCD, LC400, LC412, LC700, LC700RCD, LC900, LC900RCD		



1

<b>GEV No.</b>	510236	<b>Ref. No.</b>	260568
<b>description</b>	plain washer ID ø 21mm ED ø 28mm thickness 1mm SS Qty 1 pcs		
<b>For models:</b>	C1001M, C1301M, LC1200, LC1200RCD, LC412, LC700, LC700RCD, LC900, LC900RCD		



1

<b>GEV No.</b>	511248	<b>Ref. No.</b>	440816
<b>description</b>	retaining ring bore ø 48mm thickness 1.9mm stainless steel DIN 472		
<b>For models:</b>	G115, G115L, G125L, G131, G50LM, G65, G65L, G66, G75, G75L, GE125, GE75, GL		



1

<b>GEV No.</b>	511249	<b>Ref. No.</b>	160820
<b>description</b>	slide ring		
<b>For models:</b>	G115, G115L, G125L, G131, G50LM, G65, G65L, G66, G75, G75L, GE125, GE75, GL		

## rinse arm shafts



1

<b>GEV No.</b>	510052	<b>Ref. No.</b>	342790
<b>description</b>	rinse arm shaft		
<b>For models:</b>	FC3E, FC3EA, FC3M, FC3MA, FC3MR, FC44E, FC44EA, FC4E, FC4EA, FC4EHRT, FC4M, FC4MA		



1

<b>GEV No.</b>	510311	<b>Ref. No.</b>	340448
<b>description</b>	rinse arm shaft		



1

<b>GEV No.</b>	510318	<b>Ref. No.</b>	340499
<b>description</b>	rinse arm shaft		
<b>For models:</b>	C140, C155, C155BT, C155E2, C155RCD, C165, C165E2, C165E2BT, C165E2RCD, C166, C166-2, C33, C34, C95, C95BT, C95E2, C95RCD, G100L, G101L, G50L, G51L, G60L, G61L, GE100, GE115, GE60, GE60RCD, GE65, GE65RCD, GE80, GL, LC380, LC380BT, LC380RCD, LC400		



1

<b>GEV No.</b>	510919	<b>Ref. No.</b>	341215
<b>description</b>	rinse arm shaft		



1

<b>GEV No.</b>	511011	<b>Ref. No.</b>	342051
<b>description</b>	rinse arm shaft		
<b>For models:</b>	C75, C75BT, C75RCD, FC, FC53, FC533, FC533A, FC53A, FC53CBT, FC53LA, FC53LBT, FC54, FC543, FC543A, FC543E, FC543EA, FC544, FC544A, FC54A, FC54CBT, FC54LBT, FCHR, FCHRA, FCHRT, FCHRTA		

<b>accessories for</b>	511011		
	<b>GEV No.</b>	511198	<b>Ref. No.</b>
			—
	bush for wash arm		







			
1			
<b>GEV No.</b>	511234	<b>Ref. No.</b>	342706
<b>description</b>	rinse arm shaft		
<b>For models:</b>	C75, C75BT, C75RCD, FC, FC53, FC533, FC533A, FC53A, FC53CBT, FC53LA, FC53LBT, FC54, FC543, FC543A, FC543E, FC543EA, FC544, FC544A, FC54A, FC54CBT, FC54E, FC54EA, FC54LBT, FCHR, FCHRA, FCHRT, FCHRTA		

			
1			
<b>GEV No.</b>	511270	<b>Ref. No.</b>	341912
<b>description</b>	rinse arm shaft		
<b>For models:</b>	G115L, G125L, G50LM, G65L, G75L, GE125, GE75, GL		

			
1			
<b>GEV No.</b>	511272	<b>Ref. No.</b>	340489
<b>description</b>	rinse arm shaft		
<b>For models:</b>	G115, G125, G131, G65, G66, G75		

			
1			
<b>GEV No.</b>	512210	<b>Ref. No.</b>	H34997
<b>description</b>	rinse arm shaft		
<b>For models:</b>	GF90, GF90-2004, GF90A, GF90A-2004		

			
1			
<b>GEV No.</b>	510489	<b>Ref. No.</b>	340468
<b>description</b>	rinse arm shaft F2 ø 12mm H 82mm		
<b>For models:</b>	C30, F2, F3, F300		

			
1			
<b>GEV No.</b>	511232	<b>Ref. No.</b>	342056
<b>description</b>	rinse arm shaft mounting pos. upper ø 12mm H 50mm thread 3/8" thread L 10mm		
<b>For models:</b>	LBC210, LBC215, LBC215A, LBC275, LBC275A		

			
1			
<b>GEV No.</b>	530893	<b>Ref. No.</b>	342958V02R
<b>description</b>	rinse arm shaft mounting pos. upper/lower ED ø 15mm thread M10x1.5 seat ø 12mm		

gear wheels

			
1			
<b>GEV No.</b>	698347	<b>Ref. No.</b>	410258
<b>description</b>	gear wheel splitting 1/2" teeth 13 shaft intake ø 19mm H 28mm		
<b>For models:</b>	LV1001, LV1501, LV-LVP, LVP1001, LVP1501, NL302, NL302E, NL402, NL402E, NL502, NL502E, NL552, NL552E		

			
1			
<b>GEV No.</b>	698346	<b>Ref. No.</b>	410235
<b>description</b>	gear wheel splitting 1/2" teeth 18 shaft intake ø 17mm H 28mm		

			
1			
<b>GEV No.</b>	698348	<b>Ref. No.</b>	410346
<b>description</b>	gear wheel splitting 1/2" teeth 20 shaft intake ø 49mm H 7mm		

			
1			
<b>GEV No.</b>	698349	<b>Ref. No.</b>	410348
<b>description</b>	gear wheel splitting 1/2" teeth 23 shaft intake ø 49mm H 7mm		

		
1		
<b>GEV No.</b>	698345	<b>Ref. No.</b> 410245
<b>description</b>	gear wheel splitting 1/2" teeth 24 shaft intake ø 17mm H 28mm	

		
1		
<b>GEV No.</b>	699284	<b>Ref. No.</b> 170342
<b>description</b>	gear wheel pair for impulse teeth 7 shaft intake ø 25mm H 37.5mm suitable for COMENDA plastic	
<b>For models:</b>	NE02, NE3002, NE4002, NE5002, NE5502, NE7002, NE7502, NE9002, NE9502, NG02, NG1202, NG1202E, NG602, NG602E, NG902, NG902E, NL302, NL302E, NL402, NL402E, NL502, NL502E, NL552, NL552E	

## knobs

### producer-specific knobs

#### COMENDA

		
1		
<b>GEV No.</b>	111418	<b>Ref. No.</b> 450330
<b>description</b>	adjusting knob	
<b>For models:</b>	AC122, AC151, AC152, AC181, AC182, AC201, AC202, AC241, AC242, ACR, ACR145, ACR205, ACR225, ACR245, ACR260, ACR265, ACR305, ACRS145, ACRS205, ACRS225, ACRS245, ACRS260, ACRS265, ACRS305, ACS101, ACS101-DIGIT, ACS122, ACS122-DIGIT, ACS151, ACS151-DIGIT, ACS152, ACS152-DIGIT, ACS161-DIGIT, ACS162-DIGIT, ACS181, ACS181-DIGIT, ACS182, ACS182-DIGIT, ACS201, ACS201-DIGIT, ACS202, ACS202-DIGIT, ACS241, ACS241-DIGIT, ACS242, ACS242-DIGIT, ACS91, ACS91-DIGIT, GMC, GMC2700...(Other models you can see in the webshop)	

		
1		
<b>GEV No.</b>	110061	<b>Ref. No.</b> 450316
<b>description</b>	knob switch zero mark ø 42mm shaft ø 5x5mm black	
<b>For models:</b>	B10, B10T, B11, B11T, B12, B12T, B13T, B15, B16, B18, B19, C140, C70, C85, F20, F45, F55, F65, F80	

		
1		
<b>GEV No.</b>	511193	<b>Ref. No.</b> 180131
<b>description</b>	knob switch zero mark ø 45mm shaft ø 5x5mm green	

						
1						
<b>GEV No.</b>	110918	<b>Ref. No.</b> 180120				
<b>description</b>	knob switch zero mark ø 45mm shaft ø 6x6mm black					
<b>For models:</b>	NE00, SE, SNL					
<b>accessories for</b>	110918					
		<table border="1"> <tr> <td><b>GEV No.</b></td> <td>510923</td> <td><b>Ref. No.</b></td> <td>440817</td> </tr> </table>	<b>GEV No.</b>	510923	<b>Ref. No.</b>	440817
<b>GEV No.</b>	510923	<b>Ref. No.</b>	440817			
	clamping ring for shaft ø 10mm ID ø 9.4mm H 6mm					

		
1		
<b>GEV No.</b>	110093	<b>Ref. No.</b> 450323
<b>description</b>	knob switch zero mark t.max. °C ø 42mm shaft ø 5x5mm shaft flat black	
<b>For models:</b>	AC122, AC151, AC152, AC181, AC182, AC201, AC202, AC241, AC242, ACR, ACR145, ACR205, ACR225, ACR245, ACR260, ACR265, ACR305, ACRS145, ACRS205, ACRS225, ACRS245, ACRS260, ACRS265, ACRS305, BC25, BC25A, BC25HR, BC30, BC30A, BC30HR, BC30HR380, BC30HRA, BHC25, BHC25A, BHC25S, BHC30, BHC30A, BHC30HR, BHC30HR380, BHC30HRA, BHC30HRA380, BHC433, BHC433A, BHCHR, BR20, BR20A, BR25, BR25A, C1001M, C1301M...(Other models you can see in the webshop)	

		
1		
<b>GEV No.</b>	110062	<b>Ref. No.</b> 180111
<b>description</b>	knob switch zero mark t.max. °C ø 45mm shaft ø 5x5mm shaft flat black	
<b>For models:</b>	AC100, AC101, AC105, AC120, AC122, AC135, AC150, AC151, AC152, AC170, AC181, AC182, AC200, AC201, AC202, AC241, AC242, AC90, AC91, AC95, ACR, ACR145, ACR205, ACR225, ACR245, ACR260, ACR265, ACR305, ACS101, ACS122, ACS151, ACS152, ACS181, ACS182, ACS201, ACS202, ACS241, ACS242, ACS91, B20, B20D, B23, B24, B25, B26, B27, B31, B41, B42, C30...(Other models you can see in the webshop)	





 <p>1</p>			
<b>GEV No.</b>	511304	<b>Ref. No.</b>	450315
<b>description</b>	knob thermostat t.max. 90°C 30-90°C ø 43mm shaft ø 6x4.6mm shaft flat -135°		
<b>For models:</b>	AC100, AC101, AC105, AC120, AC122, AC135, AC150, AC151, AC152, AC170, AC181, AC182, AC200, AC201, AC202, AC241, AC242, AC2A, AC90, AC91, AC95, ACL100, ACL150, ACR, ACR145, ACR205, ACR225, ACR245, ACR260, ACR265, ACR305, ACS101, ACS101-DIGIT, ACS122, ACS122-DIGIT, ACS151, ACS151-DIGIT, ACS152, ACS152-DIGIT, ACS161-DIGIT, ACS162-DIGIT, ACS181, ACS181-DIGIT, ACS182, ACS182-DIGIT, ACS201, ACS201-DIGIT, ACS202, ACS202-DIGIT, ACS241...(Other models you can see in the webshop)		

 <p>1</p>			
<b>GEV No.</b>	110310	<b>Ref. No.</b>	191040
<b>description</b>	rosette knob up to ø 45mm		
<b>For models:</b>	AC100, AC101, AC105, AC120, AC122, AC135, AC150, AC151, AC152, AC170, AC181, AC182, AC200, AC201, AC202, AC241, AC242, AC2A, AC90, AC91, AC95, ACL100, ACL150, ACR, ACR145, ACR205, ACR225, ACR245, ACR260, ACR265, ACR305, ACS101, ACS101-DIGIT, ACS122, ACS122-DIGIT, ACS151, ACS151-DIGIT, ACS152, ACS152-DIGIT, ACS161-DIGIT, ACS162-DIGIT, ACS181, ACS181-DIGIT, ACS182, ACS182-DIGIT, ACS201, ACS201-DIGIT, ACS202, ACS202-DIGIT, ACS241...(Other models you can see in the webshop)		

accessories

<p>fascias</p>			
 <p>1</p>			
<b>GEV No.</b>	510375	<b>Ref. No.</b>	460776
<b>description</b>	bezel for knob		
<b>For models:</b>	B10, B11, B12, B15, B16, B18, B19, F45		

 <p>1</p>			
<b>GEV No.</b>	511215	<b>Ref. No.</b>	460777
<b>description</b>	bezel for knob		
<b>For models:</b>	F20		

<p>gaskets</p>			
 <p>1</p>			
<b>GEV No.</b>	112706	<b>Ref. No.</b>	200921
<b>description</b>	bottom gasket for knob shaft ø 9mm ED ø 34mm Qty 1 pcs rubber		
<b>For models:</b>	AC101, AC105, AC122, AC151, AC152, AC181, AC182, AC201, AC202, AC241, AC242, AC2A, AC91, AC95, ACL100, ACL150, ACS101, ACS101-DIGIT, ACS122, ACS122-DIGIT, ACS151, ACS151-DIGIT, ACS152, ACS152-DIGIT, ACS161-DIGIT, ACS162-DIGIT, ACS181, ACS181-DIGIT, ACS182, ACS182-DIGIT, ACS201, ACS201-DIGIT, ACS202, ACS202-DIGIT, ACS241, ACS241-DIGIT, ACS242, ACS242-DIGIT, ACS91, ACS91-DIGIT, LAV1000, LAV1001, LAV1501, NL302, NL302E, NL402, NL402E, NL502, NL502E, NL552...(Other models you can see in the webshop)		

<p>rosettes</p>			
 <p>1</p>			
<b>GEV No.</b>	110105	<b>Ref. No.</b>	191040
<b>description</b>	rosette knob ø 42mm ø 56mm zero mark		

handles and hand wheels

ball handles

 <p>1</p>			
<b>GEV No.</b>	510496	<b>Ref. No.</b>	180126
<b>description</b>	ball handle thread M6 ø 29mm with metal bush black		
<b>For models:</b>	AC100, AC120, AC135, AC150, AC170, AC181, AC182, AC200, AC201, AC202, AC241, AC242, AC90, ACR, ACR145, ACR205, ACR225, ACR245, ACR260, ACR265, ACR305, GMC, GMC2700, GMC3500, GMC4500, GMC5500, LV1001, LV1501, LV-LVP, LVP1001, LVP1501, NE3001, NE4001, NE5501, NE7501, NE9001, NG00, NG01, NG02, NG1202, NG1202E, NG600, NG600E, NG601, NG601E, NG602, NG602E, NG900, NG900E, NG901...(Other models you can see in the webshop)		

handle bars

<p>handle bars</p>			
 <p>1</p>			
<b>GEV No.</b>	394000	<b>Ref. No.</b>	331012
<b>description</b>	handle rod tube ø 25mm L 412mm SS		
<b>For models:</b>	AC100, AC120, AC150, AC170, AC200, AC90, ACR, ACR145, ACR205, ACR225, ACR245, ACR260, ACR265, ACR305, G115, G125, GMC, GMC2700, GMC3500, GMC4500, GMC5500, NE00, NG00, NG600, NG600E, NG900, NG900E, SE, SNL		

consoles

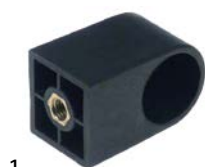

1	<b>GEV No.</b>	510284	<b>Ref. No.</b>	190129
<b>description</b> console for door handle tube ø 25mm H 52mm mounting pos. left/right thread M8				
<b>For models:</b> AC100, AC120, AC150, AC170, AC200, AC90, ACR, ACR145, ACR205, ACR225, ACR245, ACR260, ACR265, ACR305, G115, G125, G65, GMC, GMC2700, GMC3500, GMC4500, GMC5500, LV1001, LV1501, LV-LVP, LVP1001, LVP1501, NE00, NG00, NG600, NG600E, NG900, NG900E, SE, SNL				

handle rails

COMENDA



1	<b>GEV No.</b>	510445	<b>Ref. No.</b>	170805
<b>description</b> handle rail				



1	<b>GEV No.</b>	510493	<b>Ref. No.</b>	170808 170809
<b>description</b> handle rail				
<b>For models:</b> B11, B12				



1	<b>GEV No.</b>	511388	<b>Ref. No.</b>	170809
<b>description</b> handle rail				
<b>For models:</b> B10				
<b>accessories for</b> 511388				
	<b>GEV No.</b>	510818	<b>Ref. No.</b>	210405
end cap				



1	<b>GEV No.</b>	510453	<b>Ref. No.</b>	170810
<b>description</b> handle rail hole distance 460mm				
<b>For models:</b> B15, B16				



1	<b>GEV No.</b>	510454	<b>Ref. No.</b>	170806
<b>description</b> handle rail L 480mm W 52mm H 20mm Qty 1 pcs				
<b>For models:</b> B18, B19				

handle rails



1	<b>GEV No.</b>	510445	<b>Ref. No.</b>	170805
<b>description</b> handle rail				



1	<b>GEV No.</b>	510493	<b>Ref. No.</b>	170808 170809
<b>description</b> handle rail				
<b>For models:</b> B11, B12				



1	<b>GEV No.</b>	511388	<b>Ref. No.</b>	170809
<b>description</b> handle rail				
<b>For models:</b> B10				
<b>accessories for</b> 511388				
	<b>GEV No.</b>	510818	<b>Ref. No.</b>	210405
end cap				



1	<b>GEV No.</b>	510453	<b>Ref. No.</b>	170810
<b>description</b> handle rail hole distance 460mm				
<b>For models:</b> B15, B16				



1	<b>GEV No.</b>	510454	<b>Ref. No.</b>	170806
<b>description</b> handle rail L 480mm W 52mm H 20mm Qty 1 pcs				
<b>For models:</b> B18, B19				



end caps

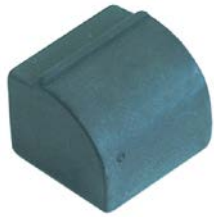

1			
<b>GEV No.</b>	510818	<b>Ref. No.</b>	210405
<b>description</b>	end cap		
<b>For models:</b>	B10T, B11T, B12T, B13T, B14T, B15T, B15TM, B16T, B16TM, B18T, B18TM, B19T, B19TM, BHC25S, F20, F45, F55, F65, F80		

bracket handles



1			
<b>GEV No.</b>	510478	<b>Ref. No.</b>	170801 170812
<b>description</b>	pull handle L 170mm H 37mm mounting distance 150mm thread M5 W 30mm		
<b>For models:</b>	B20, B20D, B23, B24, B25, B26, B27, B31, B32, B41, B42, F90M, F90MA, GF90, GF90A, LBC210, LBC215, LBC215A, LBC275, LBC275A, LBR, LBR200, LBR215, LBR215A, LF280-lav-line, LF315, LF320, LF320A, LF320CBT, LF320L, LF320LA, LF320-lav-line, LF320LBT, LF323, LF323A, LF350, LF350A, LF400A, LF450, LF450A, LS550		

locks

snap locks

producer-specific

COMENDA



1			
<b>GEV No.</b>	692100	<b>Ref. No.</b>	180508
<b>description</b>	snap lock L 36mm ø 17mm		
<b>For models:</b>	LF321, LF321A, LF322, LF322A, LF322MP, LF322MP-A, LF322RCD, LF324, LF324A, LF325E, LF325EA, LF700, LF700A		



1			
<b>GEV No.</b>	510925	<b>Ref. No.</b>	381403
<b>description</b>	snap lock L 70mm W 22mm H 56mm mounting distance 50mm		
<b>For models:</b>	B10, B10T, B11, B11T, B12, B12T, B13T, B14T, B15, B15T, B15TM, B16, B16T, B16TM, B18, B18T, B18TM, B19, B19T, B19TM, B20, B20D, B23, B24, B25, B26, B27, B31, B32, B41, B42, F2, F20, F3, F300, F45, F55, F65, F80, LF280-lav-line, LF320-lav-line, R40, R50, R70		

miscellaneous



1			
<b>GEV No.</b>	701044	<b>Ref. No.</b>	341016
<b>description</b>	angle piece for catch hook L 54mm W 27mm H 8.5mm		
<b>For models:</b>	AC100, AC101, AC105, AC120, AC122, AC135, AC150, AC151, AC152, AC170, AC181, AC182, AC200, AC201, AC202, AC241, AC242, AC2A, AC90, AC91, AC95, ACL100, ACL150, ACR, ACR145, ACR205, ACR225, ACR245, ACR260, ACR265, ACR305, ACS145, ACS205, ACS225, ACS245, ACS260, ACS265, ACS305, ACS101, ACS101-DIGIT, ACS122, ACS122-DIGIT, ACS151, ACS151-DIGIT, ACS152, ACS152-DIGIT, ACS161-DIGIT, ACS162-DIGIT, ACS181, ACS181-DIGIT...(Other models you can see in the webshop)		

pullouts

rollers

rollers

accessories



1			
<b>GEV No.</b>	560133	<b>Ref. No.</b>	260404
<b>description</b>	hexagonal nut thread M6 H 5mm WS 10 SS DIN/ISO DIN 934 / ISO 4032/8673 Qty 20 pcs		
<b>For models:</b>	AC101, AC122, AC151, AC152, AC181, AC182, AC201, AC202, AC241, AC242, AC91, ACR, ACR145, ACR205, ACR225, ACR245, ACR260, ACR265, ACR305, ACS101, ACS101-DIGIT, ACS122, ACS122-DIGIT, ACS151, ACS151-DIGIT, ACS152, ACS152-DIGIT, ACS161-DIGIT, ACS162-DIGIT, ACS181, ACS181-DIGIT, ACS182, ACS182-DIGIT, ACS201, ACS201-DIGIT, ACS202, ACS202-DIGIT, ACS241, ACS241-DIGIT, ACS242, ACS242-DIGIT, ACS91, ACS91-DIGIT, B10T, B11T, B12T, B13T, B14T, B15T, B15TM...(Other models you can see in the webshop)		

fittings for catering equipment

drain taps

stainless steel

gaskets



1			
<b>GEV No.</b>	510974	<b>Ref. No.</b>	200852
<b>description</b>	O-ring EPDM thickness 2.62mm ID ø 58.42mm Qty 1 pcs		
<b>For models:</b>	C155, C155BT, C155E2, C155RCD, C165, C165E2, C165E2BT, C165E2RCD, C166, C166-2, C95, C95BT, C95E2, C95RCD		



## equipment feet and end caps

### equipment feet

#### with fixing plate



<b>GEV No.</b>	504350	<b>Ref. No.</b>	620222
<b>description</b>	equipment foot for dishwasher L 135-230mm		
<b>For models:</b>	AC100, AC101, AC105, AC120, AC122, AC135, AC150, AC151, AC152, AC170, AC181, AC182, AC200, AC201, AC202, AC241, AC242, AC2A, AC90, AC91, AC95, ACL100, ACL150, ACR, ACR145, ACR205, ACR225, ACR245, ACR260, ACR265, ACR305, ACRS145, ACRS205, ACRS225, ACRS245, ACRS260, ACRS265, ACRS305, ACS101, ACS101-DIGIT, ACS122, ACS122-DIGIT, ACS151, ACS151-DIGIT, ACS152, ACS152-DIGIT, ACS161-DIGIT, ACS162-DIGIT, ACS181, ACS181-DIGIT...(Other models you can see in the webshop)		

### screw-in feet



<b>GEV No.</b>	510939	<b>Ref. No.</b>	440201
<b>description</b>	equipment foot thread M10 thread L 40mm H 14mm ø 60mm		
<b>For models:</b>	AC100, AC101, AC105, AC120, AC122, AC135, AC150, AC151, AC152, AC170, AC181, AC182, AC200, AC201, AC202, AC241, AC242, AC90, AC91, AC95, ACR, ACR145, ACR205, ACR225, ACR245, ACR260, ACR265, ACR305, C30, F2, F3, F300, F45, F55, F65, F80, FC, FC53, FC533, FC533A, FC53A, FC53CBT, FC53LA, FC53LBT, FC54, FC543, FC543A, FC543E, FC543EA, FC54A...(Other models you can see in the webshop)		

<b>accessories for</b>	510939
	GEV No. 524547 Ref. No. 160753
	plug pipe type 40x40 thickness 1.5mm thread M10 plastic Qty 1 pcs for equipment foot



<b>GEV No.</b>	510904	<b>Ref. No.</b>	210203
<b>description</b>	equipment foot thread M10 thread L 40mm ø 60mm H 30mm Qty 1 pcs		
<b>For models:</b>	C140, C155, C155BT, C155E2, C155RCD, C33, C34, C70, C75, C75BT, C75M, C75RCD, C85, C95, C95BT, C95E2, C95RCD, F45, F55, F65, F80, F90M, F90MA, FC, FC544, FC544A, GF90, GF90-2004, GF90A, GF90A-2004, LC380, LC380BT, LC380RCD, LC400, LF450, LF450A, LP360, LP360BT, LP360RCD, LV1001, LV1501, LV-LVP, LVP1001, LVP1501		



<b>GEV No.</b>	513321	<b>Ref. No.</b>	210207
<b>description</b>	equipment foot thread M10x1.5 thread L 22mm H 29mm WS 25 Qty 1 pcs		
<b>For models:</b>	BHC25, BHC25-2, BHC25A, BHC25A-2, BHC25S, BHC30, BHC30-2, BHC30A, BHC30A-2, BHC30E, BHC30E-2, BHC30EA, BHC30EA-2, BHC30HR, BHC30HR-2, BHC30HR380, BHC30HRA, BHC30HRA-2, BHC30HRA380, BHC433, BHC433-2, BHC433A, BHC433A-2, BHCHR, FC3E, FC3EA, FC3M, FC3MA, FC3MR, FC44E, FC44EA, FC4E, FC4EA, FC4EHRT, FC4M, FC4MA, GF70, GF70A, LF321, LF321A, LF322, LF322A, LF322MP, LF322MP-A, LF322RCD, LF324, LF324A, LF325E, LF325EA, LF700...(Other models you can see in the webshop)		



<b>GEV No.</b>	701098	<b>Ref. No.</b>	441111
<b>description</b>	equipment foot thread M6 thread L 19mm ø 25mm H 25mm Qty 1 pcs		
<b>For models:</b>	C1000E, C1001M, C1300E, C1301M, C155, C155BT, C155E2, C155RCD, C165, C165E2, C165E2BT, C165E2RCD, C166, C166-2, C95, C95BT, C95E2, C95RCD		

### bolting feet



<b>GEV No.</b>	692308	<b>Ref. No.</b>	210204
<b>description</b>	equipment foot ø 29mm H 12mm rubber Qty 1 pcs		
<b>For models:</b>	B10, B10T, B11, B11T, B12, B12T, B13T, B14T, B15, B15T, B15TM, B16, B16T, B16TM, B18, B18T, B18TM, B19, B19T, B19TM, B20, B20D, B41, BC25, BC25A, BC25HR, BC30, BC30A, BC30HR, BC30HR380, BC30HRA, BR20, BR20A, BR25, BR25A, F20, FC43, FC43A, LB200, LB200-2, LB200A, LB200A-2, LB215, LB215-2, LB215A, LB215A-2, LB260, LB260-2, LB260A, LB260A-2...(Other models you can see in the webshop)		

### equipment feet with stem



<b>GEV No.</b>	701046	<b>Ref. No.</b>	210404
<b>description</b>	equipment foot push-in ø 35mm H 5mm mounting ø 9.5mm overall height 19mm rubber Qty 1 pcs		
<b>For models:</b>	AC100, AC101, AC105, AC120, AC122, AC135, AC150, AC151, AC152, AC170, AC181, AC182, AC200, AC201, AC202, AC241, AC242, AC2A, AC90, AC91, AC95, ACL100, ACL150, ACR, ACR145, ACR205, ACR225, ACR245, ACR260, ACR265, ACR305, ACRS145, ACRS205, ACRS225, ACRS245, ACRS260, ACRS265, ACRS305, ACS101, ACS101-DIGIT, ACS122, ACS122-DIGIT, ACS151, ACS151-DIGIT, ACS152, ACS152-DIGIT, ACS161-DIGIT, ACS162-DIGIT, ACS181, ACS181-DIGIT...(Other models you can see in the webshop)		



end caps and plugs

for square pipes



1

<b>GEV No.</b>	524547	<b>Ref. No.</b>	160753
<b>description</b>	plug pipe type 40x40 thickness 1.5mm thread M10 plastic Qty 1 pcs for equipment foot		
<b>For models:</b>	AC100, AC101, AC105, AC120, AC122, AC135, AC150, AC151, AC152, AC170, AC181, AC182, AC200, AC201, AC202, AC241, AC242, AC90, AC91, AC95, ACR, ACR145, ACR205, ACR225, ACR245, ACR260, ACR265, ACR305		
<b>accessories for</b>	524547		
	<b>GEV No.</b>	510939	<b>Ref. No.</b> 440201
	equipment foot thread M10 thread L 40mm H 14mm ø 60mm		

miscellaneous



1

<b>GEV No.</b>	511153	<b>Ref. No.</b>	160509
<b>description</b>	bracket for equipment foot		
<b>For models:</b>	C140, C155, C155BT, C155E2, C155RCD, C30, C33, C34, C70, C75, C75BT, C75M, C75RCD, C85, C95, C95BT, C95E2, C95RCD, F45, F55, F65, F80, F90M, F90MA, FC, FC544, FC544A, GF90, GF90-2004, GF90A, GF90A-2004, LC380, LC380BT, LC380RCD, LC400, LF450, LF450A, LP360, LP360BT, LP360RCD, R70		

DERBY RUOTE

spare parts and accessories

miscellaneous



1

<b>GEV No.</b>	700134	<b>Ref. No.</b>	260415
<b>description</b>	nut SS thread M8 self-locking		

baskets

warewashing baskets

plastic baskets round



1

<b>GEV No.</b>	970319	<b>Ref. No.</b>	660703
<b>description</b>	mix basket ED ø 380mm H 160mm seat ø 365mm mesh type close-meshed/plastic		
<b>For models:</b>	B10, B10T, B11, B11T, B12, B12T, B20, B20D, B23, B24, B25, B26, B27, BR20, BR20A, BR25, BR25A, LBR, LBR200, LBR215, LBR215A		

steel wire baskets square

glass basket



1

<b>GEV No.</b>	970066	<b>Ref. No.</b>	520131
<b>description</b>	glass basket L 400mm W 400mm H 200mm number of rows 4 rows spacing 85mm		
<b>For models:</b>	B13T, B14T, B15T, B15TM, B16T, B16TM, B18T, B18TM, B19T, B19TM, BC25, BC25A, BC25HR, BC30, BC30A, BC30HRA, BHC25, BHC25-2, BHC25A, BHC25A-2, BHC30, BHC30-2, BHC30A, BHC30A-2, BHC30E, BHC30E-2, BHC30EA, BHC30EA-2, BHC30HR, BHC30HR-2, BHC30HR380, BHC30HRA, BHC30HRA-2, BHC30HRA380, BHC433, BHC433-2, BHC433A, BHC433A-2, BHCHR, F20, FC43, FC43A, LBC215, LBC215A, LBC275, LBC275A		

plastic baskets square

glass basket



1

<b>GEV No.</b>	970041	<b>Ref. No.</b>	660714
<b>description</b>	glass basket L 400mm W 400mm		
<b>For models:</b>	B13T, B14T, B15, B15T, B15TM, B16, B16T, B16TM, B18, B18T, B18TM, B19, B19T, B19TM, BC25, BC25A, BC25HR, BC30, BC30A, BC30HRA, BHC25, BHC25A, BHC30, BHC30A, BHC30E, BHC30EA, BHC30HR, BHC30HR380, BHC30HRA, BHC30HRA380, BHC433, BHC433A, BHCHR, F20		

mix baskets

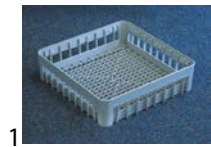



<b>GEV No.</b>	970040	<b>Ref. No.</b>	660712
<b>description</b>	mix basket L 400mm W 400mm H 110mm		
<b>For models:</b>	B13T, B14T, B15, B15T, B15TM, B16, B16T, B16TM, B18, B18T, B18TM, B19, B19T, B19TM, BC25, BC25A, BC25HR, BC30, BC30A, BC30HRA, BHC25, BHC25-2, BHC25A, BHC25A-2, BHC30, BHC30-2, BHC30A, BHC30A-2, BHC30E, BHC30E-2, BHC30EA, BHC30EA-2, BHC30HR, BHC30HR-2, BHC30HR380, BHC30HRA, BHC30HRA-2, BHC30HRA380, BHC433, BHC433-2, BHC433A, BHC433A-2, BHCHR, F20, FC43, FC43A, LBC215, LBC215A, LBC275, LBC275A		
<b>accessories for</b>	970040		
	<b>GEV No.</b>	970043	<b>Ref. No.</b> 520126
	section insert for glasses L 400mm W 400mm number of rows 4		
	<b>GEV No.</b>	970048	<b>Ref. No.</b> 660234 + 660235
	section insert for glasses number of glasses 16		

plate baskets



<b>GEV No.</b>	970045	<b>Ref. No.</b>	660713
<b>description</b>	plate basket L 400mm W 400mm H 110mm		
<b>For models:</b>	BHC25-2, BHC25A-2, BHC30-2, BHC30A-2, BHC30E-2, BHC30EA-2, BHC30HR-2, BHC30HRA-2, BHC433-2, BHC433A-2, F20, FC43, FC43A		

system basket GASTROTOP 500x500mm

universal baskets



<b>GEV No.</b>	973082	<b>Ref. No.</b>	660217 CBR/1
<b>description</b>	mix basket L 500mm W 500mm H 100mm mesh type wide-meshed usable height 75mm		



<b>GEV No.</b>	973119	<b>Ref. No.</b>	660218 CBR/2
<b>description</b>	mix basket L 500mm W 500mm H 150mm usable height 115mm		

glass basket



<b>GEV No.</b>	973080 <sup>1</sup>	<b>Ref. No.</b>	660511 B316
<b>description</b>	glass basket L 500mm W 500mm number of glasses 16 H 186-250mm usable height 151-215mm size of compartment 113x113mm		
<b>spare parts for</b>	973080		
	<b>GEV No.</b>	973000	<b>Ref. No.</b> —
	bolt for glass basket Qty 20 pcs		

<sup>1</sup>adjustable height



<b>GEV No.</b>	973091	<b>Ref. No.</b>	660214 B236
<b>description</b>	glass basket L 500mm W 500mm number of glasses 36 H 150mm usable height 115mm size of compartment 73x73mm		

accessories

cutlery inserts



<b>GEV No.</b>	970349	<b>Ref. No.</b>	660519
<b>description</b>	cutlery insert L 130mm W 57mm ømm H 110mm		
<b>For models:</b>	B15TM, B16TM, B18TM, B19TM, BC25, BC25A, BC25HR, BC30, BC30A, BC30HRA, BHC25, BHC25-2, BHC25A, BHC25A-2, BHC25S, BHC30, BHC30-2, BHC30A, BHC30A-2, BHC30E, BHC30E-2, BHC30EA, BHC30EA-2, BHC30HR, BHC30HR-2, BHC30HR380, BHC30HRA, BHC30HRA-2, BHC30HRA380, BHC433, BHC433-2, BHC433A, BHC433A-2, BHCHR, BR20, BR20A, BR25, BR25A, FC43, FC43A, LBC215, LBC215A, LBC275, LBC275A, LBR, LBR200, LBR215, LBR215A		

section inserts for glasses



<b>GEV No.</b>	970043	<b>Ref. No.</b>	520126
<b>description</b>	section insert for glasses L 400mm W 400mm number of rows 4		
<b>For models:</b>	B13T, B14T, B15, B15T, B16, B16T, B18, B18T, B19, B19T, BHC25-2, BHC25A-2, BHC30-2, BHC30A-2, BHC30E-2, BHC30EA-2, BHC30HR-2, BHC30HRA-2, BHC433-2, BHC433A-2, F20		

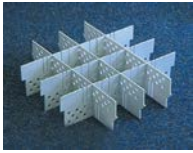

1

<b>GEV No.</b>	970048	<b>Ref. No.</b>	660234 + 660235
<b>description</b>	section insert for glasses number of glasses 16		

basket holders



1

<b>GEV No.</b>	971156	<b>Ref. No.</b>	530238
<b>description</b>	basket support L 585mm W 585mm H 200mm SS		
<b>For models:</b>	C1000E, C1000ERCD, C1001M, C1300E, C1300ERCD, C1301M, LC1200, LC1200RCD, LC412, LC700, LC700RCD, LC900, LC900RCD		

miscellaneous



1

<b>GEV No.</b>	970055	<b>Ref. No.</b>	660803
<b>description</b>	pin for dishwasher rack		



1

<b>GEV No.</b>	970056	<b>Ref. No.</b>	660804, k804\$000
<b>description</b>	pin for dishwasher rack		

plate inserts



1

<b>GEV No.</b>	970044	<b>Ref. No.</b>	520621
<b>description</b>	plate insert L 345mm W 100mm plates 17		

gaskets

O-rings

EPDM



1

<b>GEV No.</b>	510302	<b>Ref. No.</b>	200824
<b>description</b>	O-ring EPDM ID ø 12.42mm thickness 1.78mm Qty 1 pcs		
<b>For models:</b>	AC101, AC105, AC120, AC122, AC150, AC151, AC152, AC170, AC200, AC91, AC95, ACL150, ACR, ACR145, ACR205, ACR225, ACR245, ACR260, ACR265, ACR305, ACRS145, ACRS205, ACRS225, ACRS245, ACRS260, ACRS265, ACRS305, ACS101, ACS101-DIGIT, ACS122, ACS122-DIGIT, ACS151, ACS151-DIGIT, ACS152, ACS152-DIGIT, ACS161-DIGIT, ACS162-DIGIT, ACS91, ACS91-DIGIT, B13T, B14T, B15T, B15TM, B16, B16T, B16TM, B18T, B18TM, B19, B19T...(Other models you can see in the webshop)		



1

<b>GEV No.</b>	504512	<b>Ref. No.</b>	200826
<b>description</b>	O-ring EPDM thickness 1.78mm ID ø 14mm Qty 1 pcs		
<b>For models:</b>	C75M, LBC215, LBC215A, LBC275, LBC275A		



1

<b>GEV No.</b>	528243	<b>Ref. No.</b>	200939
<b>description</b>	O-ring EPDM thickness 1.78mm ID ø 15.6mm Qty 1 pcs		
<b>For models:</b>	C1000ERCD, C1300ERCD, C155BT, C155RCD, C165E2BT, C165E2RCD, C75BT, C75RCD, C95BT, C95RCD, FC3E, FC3EA, FC3MA, FC44E, FC44EA, FC4E, FC4EA, FC4EHRT, FC4MA, FC53CBT, FC53LBT, FC54CBT, FC54LBT, GE50RCD, GF70, GF70A, GF90, GF90-2004, GF90A, GF90A-2004, LC1200RCD, LC380BT, LC380RCD, LC700RCD, LC900RCD, LF320CBT, LF320LBT, LF322RCD, LP360BT, LP360RCD, XLC		

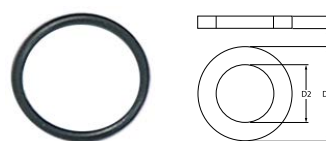

1

<b>GEV No.</b>	510322	<b>Ref. No.</b>	200812
<b>description</b>	O-ring EPDM thickness 1.78mm ID ø 17.17mm Qty 1 pcs		
<b>For models:</b>	B13T, B14T, B15T, B15TM, B16T, B16TM, B18T, B18TM, B19T, B19TM, BC25, BC25A, BC30, BC30A, BHC25, BHC25A, BHC30, BHC30A, BHC30HR, BHC30HR380, BHC30HRA, BHC30HRA380, BHC433, BHC433A, BHCHR, F20, F45, F55, F65, F80, FC43, FC43A, FC54E, FC54EA, LB200, LB200-2, LB200A, LB200A-2, LB215, LB215-2, LB215A, LB215A-2, LB260, LB260-2, LB260A, LB260A-2, LB275, LB275-2, LB275A, LB275A-2...(Other models you can see in the webshop)		

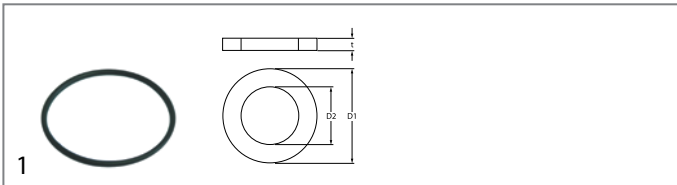

<b>GEV No.</b>	510824	<b>Ref. No.</b>	200849
<b>description</b>	O-ring EPDM thickness 1.78mm ID ø 20.35mm Qty 1 pcs		

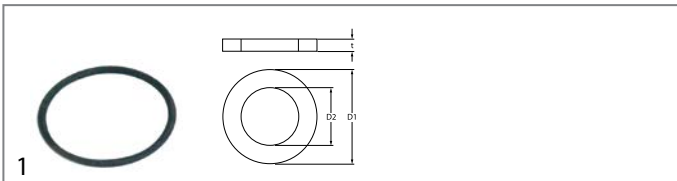

<b>GEV No.</b>	508084	<b>Ref. No.</b>	200817
<b>description</b>	O-ring EPDM thickness 1.78mm ID ø 25.12mm Qty 1 pcs		
<b>For models:</b>	AC101, AC122, AC151, AC152, AC181, AC182, AC201, AC202, AC241, AC242, AC91, ACL100, ACL150, ACS101, ACS101-DIGIT, ACS122, ACS122-DIGIT, ACS151, ACS151-DIGIT, ACS152, ACS152-DIGIT, ACS161-DIGIT, ACS162-DIGIT, ACS181, ACS181-DIGIT, ACS182, ACS182-DIGIT, ACS201, ACS201-DIGIT, ACS202, ACS202-DIGIT, ACS241, ACS241-DIGIT, ACS242, ACS242-DIGIT, ACS91, ACS91-DIGIT		

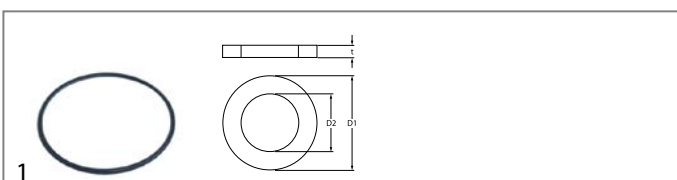

<b>GEV No.</b>	510900	<b>Ref. No.</b>	200833
<b>description</b>	O-ring EPDM thickness 1.78mm ID ø 41mm Qty 1 pcs		
<b>For models:</b>	B13T, B14T, B15, B15T, B15TM, B16, B16T, B16TM, B18, B18T, B18TM, B19, B19T, B19TM, B41, B42, C30, F2, F20, F3, F300, R50		

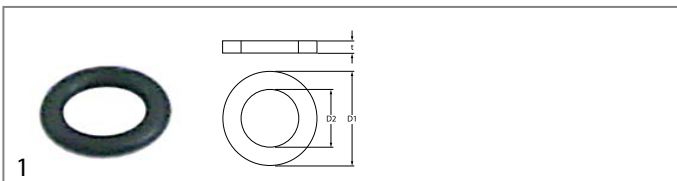

<b>GEV No.</b>	505045	<b>Ref. No.</b>	200973
<b>description</b>	O-ring EPDM thickness 1.78mm ID ø 5.28mm Qty 1 pcs		

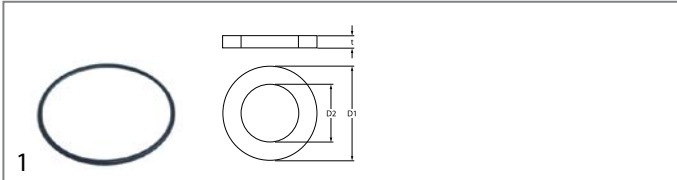

<b>GEV No.</b>	532628	<b>Ref. No.</b>	630417
<b>description</b>	O-ring EPDM thickness 1.78mm ID ø 56.87mm Qty 1 pcs		
<b>For models:</b>	SE		

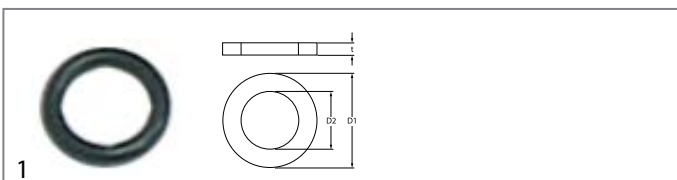

<b>GEV No.</b>	510303	<b>Ref. No.</b>	200818
<b>description</b>	O-ring EPDM thickness 1.78mm ID ø 6.75mm Qty 1 pcs		
<b>For models:</b>	AC120, AC150, AC170, AC200, ACR, ACR145, ACR205, ACR225, ACR245, ACR260, ACR265, ACR305, B13T, B14T, B15, B15T, B15TM, B16, B16T, B16TM, B18, B18T, B18TM, B19, B19T, B19TM, B41, B42, BC25HR, BC30HR, BC30HR380, BC30HRA, BHC25S, C140, C30, C33, C34, C70, C75, C75BT, C75M, C75RCD, C85, F2, F20, F3, F300, F45, F55, F65...(Other models you can see in the webshop)		

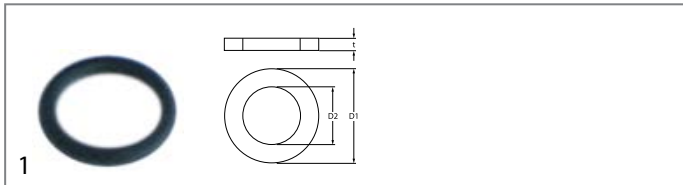

<b>GEV No.</b>	510177	<b>Ref. No.</b>	200809
<b>description</b>	O-ring EPDM thickness 1.78mm ID ø 7.66mm Qty 1 pcs		

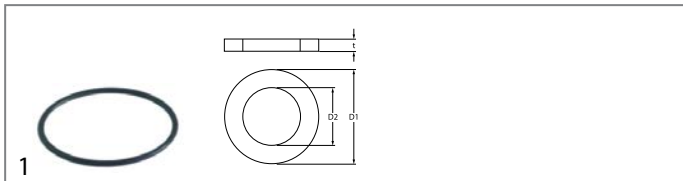

<b>GEV No.</b>	530293	<b>Ref. No.</b>	200809
<b>description</b>	O-ring EPDM thickness 1.78mm ID ø 8.73mm Qty 1 pcs		
<b>For models:</b>	AC101, AC105, AC122, AC135, AC151, AC152, AC181, AC182, AC201, AC202, AC241, AC242, AC2A, AC91, AC95, ACL100, ACL150, ACRS145, ACRS205, ACRS225, ACRS245, ACRS260, ACRS265, ACRS305, ACS101, ACS101-DIGIT, ACS122, ACS122-DIGIT, ACS151, ACS151-DIGIT, ACS152, ACS152-DIGIT, ACS161-DIGIT, ACS162-DIGIT, ACS181, ACS181-DIGIT, ACS182, ACS182-DIGIT, ACS201, ACS201-DIGIT, ACS202, ACS202-DIGIT, ACS241, ACS241-DIGIT, ACS242, ACS242-DIGIT, ACS91, ACS91-DIGIT, B15, B16...(Other models you can see in the webshop)		

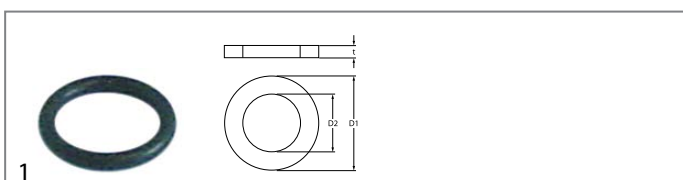

<b>GEV No.</b>	504574	<b>Ref. No.</b>	200844
<b>description</b>	O-ring EPDM thickness 1.78mm ID ø 9.25mm Qty 1 pcs		

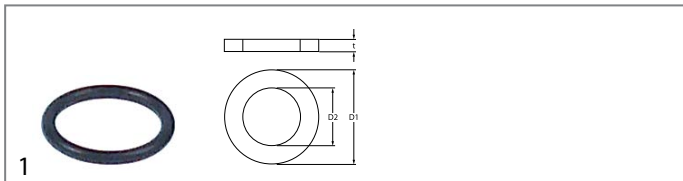

<b>GEV No.</b>	511237	<b>Ref. No.</b>	200850
<b>description</b>	O-ring EPDM thickness 1mm ID ø 7mm Qty 1 pcs		
<b>For models:</b>	BHC25-2, BHC25A-2, BHC30-2, BHC30A-2, BHC30E, BHC30E-2, BHC30EA, BHC30EA-2, BHC30HR-2, BHC30HRA-2, BHC433-2, BHC433A-2, C1001M, C1301M, C75, C75BT, C75RCD, FC, FC53, FC533, FC533A, FC53A, FC53CBT, FC53LA, FC53LBT, FC54, FC543, FC543A, FC543E, FC543EA, FC544, FC544A, FC54A, FC54CBT, FC54E, FC54EA, FC54LBT, FCHR, FCHRA, FCHRT, FCHRTA, GF70, GF70A, LC1200, LC1200RCD, LC412, LC700, LC700RCD, LC900, LC900RCD...(Other models you can see in the webshop)		

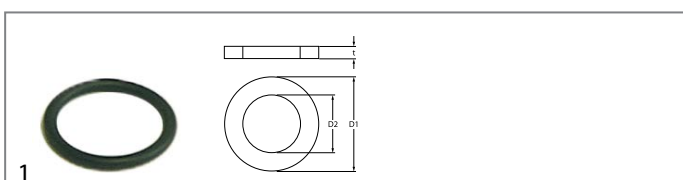

<b>GEV No.</b>	511191	<b>Ref. No.</b>	200813
<b>description</b>	O-ring EPDM thickness 2.21mm ID ø 16.36mm Qty 1 pcs		
<b>For models:</b>	C1000E, C1000ERCD, C1300E, C1300ERCD, C155, C155BT, C155E2, C155RCD, C165, C165E2, C165E2BT, C165E2RCD, C166, C166-2, C95, C95BT, C95E2, C95RCD, G100L, G101L, G50L, G51L, G60L, G61L, GE100, GE115, GE50RCD, GE60, GE60RCD, GE65, GE65RCD, GE80, GF70, GF70A, GF90, GF90-2004, GF90A, GF90A-2004, GL, XLC		





<b>GEV No.</b>	528333	<b>Ref. No.</b>	200806
<b>description</b>	O-ring EPDM thickness 2.62mm ID ø 13.1mm Qty 1 pcs		
<b>For models:</b>	AC181, AC182, AC201, AC202, AC241, AC242, ACS122, ACS122-DIGIT, ACS152, ACS152-DIGIT, ACS162-DIGIT, ACS182, ACS182-DIGIT, ACS202, ACS202-DIGIT, ACS242, ACS242-DIGIT, B13T, B14T, B15, B15T, B15TM, B16, B16T, B16TM, B18, B18T, B18TM, B19, B19T, B19TM, B41, B42, BC25, BC25A, BC25HR, BC30, BC30A, BC30HR, BC30HR380, BC30HRA, C30, C70, C75, C75BT, C75M, C75RCD, F2, F20, F3...(Other models you can see in the webshop)		

<b>GEV No.</b>	512111	<b>Ref. No.</b>	200867
<b>description</b>	O-ring EPDM thickness 2.62mm ID ø 45.69mm Qty 1 pcs		
<b>For models:</b>	BHC25, BHC25-2, BHC25A, BHC25A-2, BHC25S, BHC30, BHC30-2, BHC30A, BHC30A-2, BHC30E, BHC30E-2, BHC30EA, BHC30EA-2, BHC30HR, BHC30HR-2, BHC30HR380, BHC30HRA, BHC30HRA-2, BHC30HRA380, BHC433, BHC433-2, BHC433A, BHC433A-2, BHCHR, LB200, LB200-2, LB200A, LB200A-2, LB215, LB215-2, LB215A, LB215A-2, LB260, LB260-2, LB260A, LB260A-2, LB275, LB275-2, LB275A, LB275A-2, LF315, LF320A, LF320CBT, LF320LA, LF320LBT, LF321, LF321A, LF322, LF322A, LF322MP...(Other models you can see in the webshop)		

<b>GEV No.</b>	507309	<b>Ref. No.</b>	200819
<b>description</b>	O-ring EPDM thickness 2.62mm ID ø 17.13mm Qty 1 pcs		
<b>For models:</b>	B10, B10T, B11, B11T, B12, B12T, B20, B20D, B23, B24, B25, B26, B27, B31, B32, BR20, BR20A, BR25, BR25A, C33, C34, LBR, LBR200, LBR215, LBR215A		

<b>GEV No.</b>	510974	<b>Ref. No.</b>	200852
<b>description</b>	O-ring EPDM thickness 2.62mm ID ø 58.42mm Qty 1 pcs		
<b>For models:</b>	C155, C155BT, C155E2, C155RCD, C165, C165E2, C165E2BT, C165E2RCD, C166, C166-2, C95, C95BT, C95E2, C95RCD		

<b>GEV No.</b>	505073	<b>Ref. No.</b>	200821
<b>description</b>	O-ring EPDM thickness 2.62mm ID ø 20.63mm Qty 1 pcs		
<b>For models:</b>	B15TM, B16TM, B18TM, B19TM, BC25, BC25A, BC25HR, BC30, BC30A, BC30HR, BC30HR380, BC30HRA, BHC25, BHC25-2, BHC25A, BHC25A-2, BHC25S, BHC30, BHC30-2, BHC30A, BHC30A-2, BHC30E, BHC30E-2, BHC30EA, BHC30EA-2, BHC30HR, BHC30HR-2, BHC30HR380, BHC30HRA, BHC30HRA-2, BHC30HRA380, BHC433, BHC433-2, BHC433A, BHC433A-2, BHCHR, FC43, FC43A, GE100, GE115, GE60, GE60RCD, GE65, GE65RCD, GE80, LB200, LB200-2, LB200A, LB200A-2, LB215...(Other models you can see in the webshop)		

<b>GEV No.</b>	511395	<b>Ref. No.</b>	200868
<b>description</b>	O-ring EPDM thickness 2.62mm ID ø 71.12mm Qty 1 pcs		
<b>For models:</b>	BHC25, BHC25A, BHC30, BHC30A, BHC30HR, BHC30HR380, BHC30HRA, BHC30HRA380, BHC433, BHC433A, BHCHR, LB215, LB215A, LB275, LB275A		

<b>GEV No.</b>	502036	<b>Ref. No.</b>	200805
<b>description</b>	O-ring EPDM thickness 2.62mm ID ø 28.25mm Qty 1 pcs		
<b>For models:</b>	ACR, ACR145, ACR205, ACR225, ACR245, ACR260, ACR265, ACR305, BHC25, BHC25-2, BHC25A, BHC25A-2, BHC25S, BHC30, BHC30-2, BHC30A, BHC30A-2, BHC30E, BHC30E-2, BHC30EA, BHC30EA-2, BHC30HR, BHC30HR-2, BHC30HR380, BHC30HRA, BHC30HRA-2, BHC30HRA380, BHC433, BHC433-2, BHC433A, BHC433A-2, BHCHR, GF70, GF70A, GMC, GMC2700, GMC3500, GMC4500, GMC5500, LB200, LB200-2, LB200A, LB200A-2, LB215, LB215-2, LB215A, LB215A-2, LB260, LB260-2, LB260A...(Other models you can see in the webshop)		

<b>GEV No.</b>	532490	<b>Ref. No.</b>	630421
<b>description</b>	O-ring EPDM thickness 2.62mm ID ø 72.69mm Qty 1 pcs		
<b>For models:</b>	BHC25, BHC25A, BHC25S, BHC30, BHC30A, BHC30HR, BHC30HR380, BHC30HRA, BHC30HRA380, BHC433, BHC433A, BHCHR		

<b>GEV No.</b>	528800	<b>Ref. No.</b>	630427
<b>description</b>	O-ring EPDM thickness 2.62mm ID ø 75.87mm Qty 1 pcs		
<b>For models:</b>	C1000ERCD, C1300ERCD, FC3E, FC3EA, FC3M, FC3MA, FC3MR, FC44E, FC44EA, FC4E, FC4EA, FC4EHRT, FC4M, FC4MA, GE50RCD, LC1200RCD, LC700RCD, LC900RCD, LF322RCD, XLC		

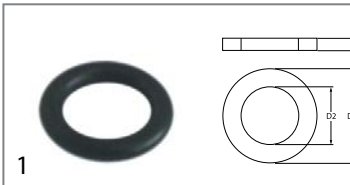

<b>GEV No.</b>	528583	<b>Ref. No.</b>	200845 200864
<b>description</b>	O-ring EPDM thickness 2.62mm ID ø 9.13mm Qty 1 pcs		
<b>For models:</b>	B10T, B11T, B12T, B13T, B14T, B15T, B15TM, B16T, B16TM, B18T, B18TM, B19T, B19TM, BC25, BC25A, BC30, BC30A, BHC25, BHC25A, BHC30, BHC30A, BHC30HR, BHC30HR380, BHC30HRA, BHC30HRA380, BHC433, BHC433A, BHCHR, BR20, BR20A, BR25, BR25A, C75, C75BT, C75RCD, F20, F45, F55, F65, F80, FC, FC43, FC43A, FC53, FC533, FC533A, FC53A, FC53CBT, FC53LA, FC53LBT...(Other models you can see in the webshop)		

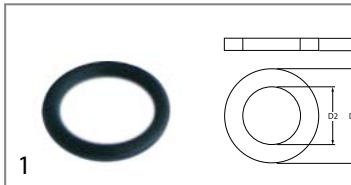

<b>GEV No.</b>	510902	<b>Ref. No.</b>	200844
<b>description</b>	O-ring EPDM thickness 2mm ID ø 9.5mm Qty 1 pcs		
<b>For models:</b>	B10T, B11T, B12T, B13T, B14T, B15T, B15TM, B16T, B16TM, B18T, B18TM, B19T, B19TM, BC25, BC25A, BC30, BC30A, BHC25, BHC25A, BHC30, BHC30A, BHC30HR, BHC30HR380, BHC30HRA, BHC30HRA380, BHC433, BHC433A, BHCHR, BR20, BR20A, BR25, BR25A, F20, F45, F55, F65, F80, FC43, FC43A, FC54E, FC54EA, GF90-2004, GF90A-2004, LB200, LB200-2, LB200A, LB200A-2, LB215, LB215-2, LB215A...(Other models you can see in the webshop)		

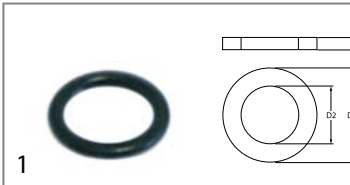

<b>GEV No.</b>	510893	<b>Ref. No.</b>	200810 200845
<b>description</b>	O-ring EPDM thickness 2.62mm ID ø 9.92mm Qty 1 pcs		
<b>For models:</b>	B10, B10T, B11, B11T, B12, B12T, B13T, B14T, B15, B15T, B15TM, B16, B16T, B16TM, B18, B18T, B18TM, B19, B19T, B19TM, B20, B20D, B23, B24, B25, B26, B27, B31, B32, BC25, BC25A, BC25HR, BC30, BC30A, BC30HR, BC30HR380, BC30HRA, BR20, BR20A, BR25, BR25A, F20, F90M, F90MA, FC, FC43, FC43A, FC53, FC533, FC533A...(Other models you can see in the webshop)		

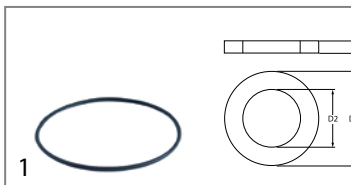

<b>GEV No.</b>	511339	<b>Ref. No.</b>	200873
<b>description</b>	O-ring EPDM thickness 3.53mm ID ø 110.7mm Qty 1 pcs		

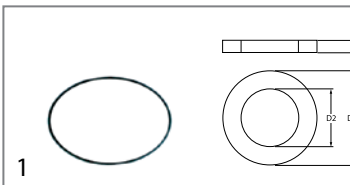

<b>GEV No.</b>	510554	<b>Ref. No.</b>	200142
<b>description</b>	O-ring EPDM thickness 2mm ID ø 120mm Qty 1 pcs		

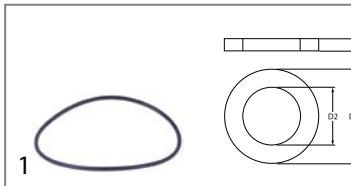

<b>GEV No.</b>	532537	<b>Ref. No.</b>	630433
<b>description</b>	O-ring EPDM thickness 3.53mm ID ø 113.9mm Qty 1 pcs		
<b>For models:</b>	FC3E, FC3EA, FC3M, FC3MA, FC3MR, FC44E, FC44EA, FC4E, FC4EA, FC4EHR, FC4M, FC4MA		

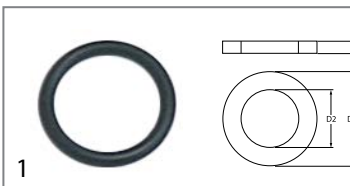

<b>GEV No.</b>	510901	<b>Ref. No.</b>	200843
<b>description</b>	O-ring EPDM thickness 2mm ID ø 13mm Qty 1 pcs		
<b>For models:</b>	B13T, B14T, B15T, B15TM, B16T, B16TM, B18T, B18TM, B19T, B19TM, BC25, BC25A, BC30, BC30A, BHC25, BHC25A, BHC30, BHC30A, BHC30HR, BHC30HR380, BHC30HRA, BHC30HRA380, BHC433, BHC433A, BHCHR, F20, F45, F55, F65, F80, FC43, FC43A, FC54E, FC54EA, LB200, LB200-2, LB200A, LB200A-2, LB215, LB215-2, LB215A, LB215A-2, LB260, LB260-2, LB260A, LB260A-2, LB275, LB275-2, LB275A, LB275A-2...(Other models you can see in the webshop)		

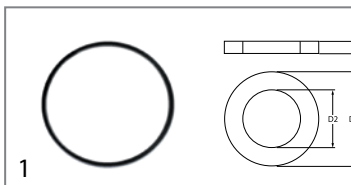

<b>GEV No.</b>	510896	<b>Ref. No.</b>	200828
<b>description</b>	O-ring EPDM thickness 3.53mm ID ø 183.75mm Qty 1 pcs		
<b>For models:</b>	B13T, B14T, B15, B15T, B15TM, B16, B16T, B16TM, B18, B18T, B18TM, B19, B19T, B19TM, B41, B42, C30, C70, C75, C75BT, C75M, C75RCD, F2, F20, F3, F300, F45, F55, F65, F80, F90M, F90MA, LF280-lav-line, LF315, LF320, LF320A, LF320CBT, LF320L, LF320LA, LF320-lav-line, LF320LBT, LF323, LF323A, LF350, LF350A, LF400A, LF450, LF450A, LP360, LP360BT...(Other models you can see in the webshop)		

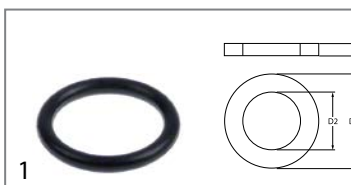

<b>GEV No.</b>	511322	<b>Ref. No.</b>	200869
<b>description</b>	O-ring EPDM thickness 3.53mm ID ø 20.22mm Qty 1 pcs		
<b>For models:</b>	BHC25, BHC25-2, BHC25A, BHC25A-2, BHC255, BHC30, BHC30-2, BHC30A, BHC30A-2, BHC30E, BHC30E-2, BHC30EA, BHC30EA-2, BHC30HR, BHC30HR-2, BHC30HR380, BHC30HRA, BHC30HRA-2, BHC30HRA380, BHC433, BHC433-2, BHC433A, BHC433A-2, BHCHR, GF70, GF70A, LB200, LB200-2, LB200A, LB200A-2, LB215, LB215-2, LB215A, LB215A-2, LB260, LB260-2, LB260A, LB260A-2, LB275, LB275-2, LB275A, LB275A-2, LF321, LF321A, LF322, LF322A, LF322MP, LF322MP-A, LF322RCD, LF324...(Other models you can see in the webshop)		

<b>GEV No.</b>	510895	<b>Ref. No.</b>	200814
<b>description</b>	O-ring EPDM thickness 3.53mm ID ø 34.52mm Qty 1 pcs		
<b>For models:</b>	AC100, AC101, AC105, AC120, AC122, AC135, AC150, AC151, AC152, AC170, AC181, AC182, AC200, AC201, AC202, AC241, AC242, AC90, AC91, AC95, ACR, ACR145, ACR205, ACR225, ACR245, ACR260, ACR265, ACR305, ACRS145, ACRS205, ACRS225, ACRS245, ACRS260, ACRS265, ACRS305, ACS101, ACS101-DIGIT, ACS122, ACS122-DIGIT, ACS151, ACS151-DIGIT, ACS152, ACS152-DIGIT, ACS161-DIGIT, ACS162-DIGIT, ACS181, ACS181-DIGIT, ACS182, ACS182-DIGIT, ACS201...(Other models you can see in the webshop)		



<b>GEV No.</b>	512498	<b>Ref. No.</b>	200877
<b>description</b>	O-ring EPDM thickness 3.53mm ID ø 52.39mm Qty 1 pcs		

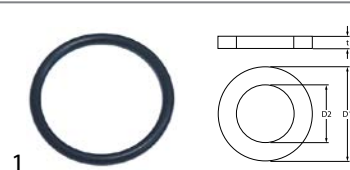

<b>GEV No.</b>	510899	<b>Ref. No.</b>	200830
<b>description</b>	O-ring EPDM thickness 3.53mm ID ø 37.69mm Qty 1 pcs		
<b>For models:</b>	AC100, AC101, AC105, AC120, AC122, AC135, AC150, AC151, AC152, AC170, AC181, AC182, AC200, AC201, AC202, AC241, AC242, AC2A, AC90, AC91, AC95, ACL100, ACL150, ACR, ACR145, ACR205, ACR225, ACR245, ACR260, ACR265, ACR305, ACRS145, ACRS205, ACRS225, ACRS245, ACRS260, ACRS265, ACRS305, ACS101, ACS101-DIGIT, ACS122, ACS122-DIGIT, ACS151, ACS151-DIGIT, ACS152, ACS152-DIGIT, ACS161-DIGIT, ACS162-DIGIT, ACS181, ACS181-DIGIT...(Other models you can see in the webshop)		

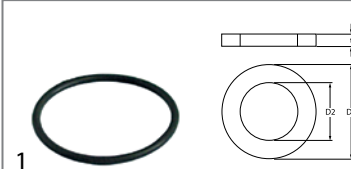

<b>GEV No.</b>	511331	<b>Ref. No.</b>	200842
<b>description</b>	O-ring EPDM thickness 3.53mm ID ø 53.57mm Qty 1 pcs		
<b>For models:</b>	BHC25, BHC25-2, BHC25A, BHC25A-2, BHC25S, BHC30, BHC30-2, BHC30A, BHC30A-2, BHC30E, BHC30E-2, BHC30EA, BHC30EA-2, BHC30HR, BHC30HR-2, BHC30HR380, BHC30HRA, BHC30HRA-2, BHC30HRA380, BHC433, BHC433-2, BHC433A, BHC433A-2, BHCHR, LB200, LB200-2, LB200A, LB200A-2, LB215, LB215-2, LB215A, LB215A-2, LB260, LB260-2, LB260A, LB260A-2, LB275, LB275-2, LB275A, LB275A-2, LF321, LF321A, LF322, LF322A, LF322MP, LF322MP-A, LF322RCD, LF324, LF324A, LF325E...(Other models you can see in the webshop)		



<b>GEV No.</b>	506015	<b>Ref. No.</b>	200822
<b>description</b>	O-ring EPDM thickness 3.53mm ID ø 39.69mm Qty 1 pcs		
<b>For models:</b>	B12T, B14T, B16, B16T, B16TM, B19, B19T, B19TM, BC25A, BC30A, BC30HRA, BHC25-2, BHC25A, BHC25A-2, BHC30-2, BHC30A, BHC30A-2, BHC30E-2, BHC30EA, BHC30EA-2, BHC30HR, BHC30HR-2, BHC30HRA, BHC30HRA-2, BHC30HRA380, BHC433-2, BHC433A, BHC433A-2, BHCHR, BR20A, BR25A, F90MA, FC, FC43A, FC533A, FC53A, FC53LA, FC543A, FC543EA, FC544A, FC54A, FC54EA, FCHRA, FCHRTA, GF70A, GF90-2004, GF90A, GF90A-2004, LB215A, LB215A-2...(Other models you can see in the webshop)		

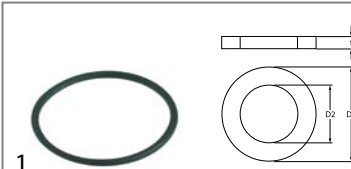

<b>GEV No.</b>	511828	<b>Ref. No.</b>	200801
<b>description</b>	O-ring EPDM thickness 3.53mm ID ø 56.74mm Qty 1 pcs		
<b>For models:</b>	C30, F2, F3, F300, R40, R70		

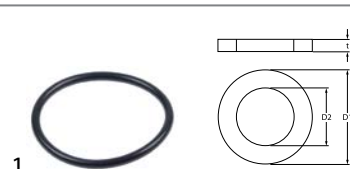

<b>GEV No.</b>	528632	<b>Ref. No.</b>	200802
<b>description</b>	O-ring EPDM thickness 3.53mm ID ø 44.04mm Qty 1 pcs		
<b>For models:</b>	NE00, NE02, NE3001, NE3002, NE4001, NE4002, NE5002, NE5501, NE5502, NE7002, NE7501, NE7502, NE9001, NE9002, NE9502, NG00, NG01, NG02, NG1202, NG1202E, NG600, NG600E, NG601, NG601E, NG602, NG602E, NG900, NG900E, NG901, NG901E, NG902, NG902E		



<b>GEV No.</b>	510973	<b>Ref. No.</b>	200853
<b>description</b>	O-ring EPDM thickness 3.53mm ID ø 63.09mm Qty 1 pcs		
<b>For models:</b>	C155, C155BT, C155E2, C155RCD, C165, C165E2, C165E2BT, C165E2RCD, C166, C166-2, C95, C95BT, C95E2, C95RCD		

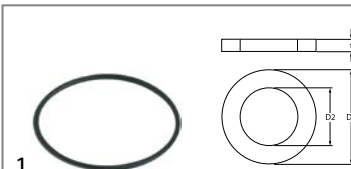

<b>GEV No.</b>	511711	<b>Ref. No.</b>	200834
<b>description</b>	O-ring EPDM thickness 3.53mm ID ø 78.97mm Qty 1 pcs		
<b>For models:</b>	B11, B12, B19, B20, B20D, B24, B25, B26, B27, LB200A, LB200A-2, LB260A, LB260A-2		

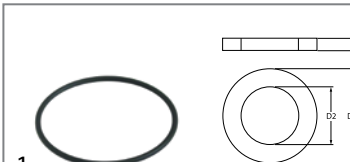

<b>GEV No.</b>	532144	<b>Ref. No.</b>	200803
<b>description</b>	O-ring EPDM thickness 3.53mm ID ø 98.02mm Qty 10 pcs		
<b>For models:</b>	AC100, AC101, AC105, AC120, AC122, AC135, AC150, AC151, AC152, AC170, AC181, AC182, AC200, AC201, AC202, AC241, AC242, AC2A, AC90, AC91, AC95, ACR, ACR145, ACR205, ACR225, ACR245, ACR260, ACR265, ACR305, ACRS145, ACRS205, ACRS225, ACRS245, ACRS260, ACRS265, ACRS305, ACS101, ACS101-DIGIT, ACS122, ACS122-DIGIT, ACS151, ACS151-DIGIT, ACS152, ACS152-DIGIT, ACS161-DIGIT, ACS162-DIGIT, ACS181, ACS181-DIGIT, ACS182, ACS182-DIGIT...(Other models you can see in the webshop)		



<b>GEV No.</b>	510970	<b>Ref. No.</b>	200856
<b>description</b>	O-ring EPDM thickness 3mm ID ø 81mm Qty 1 pcs		
<b>For models:</b>	BC25, BC25A, BC25HR, BC30, BC30A, BC30HR, BC30HR380, BC30HRA, F90M, F90MA, FC43, FC43A, LF315, LF320, LF320A, LF320CBT, LF320L, LF320LA, LF320LBT, LF323, LF323A, LF350, LF350A, LF400A, LF450, LF450A, LS550		



<b>GEV No.</b>	503187	<b>Ref. No.</b>	200872
<b>description</b>	O-ring EPDM thickness 3.6mm ID ø 23mm Qty 1 pcs		
<b>For models:</b>	AC2A		



<b>GEV No.</b>	524483	<b>Ref. No.</b>	200807
<b>description</b>	O-ring EPDM thickness 4mm ID ø 110mm Qty 1 pcs		
<b>For models:</b>	AC100, AC135, AC90, C1000E, C1000ERCD, C1001M, C1300E, C1300ERCD, C1301M, C33, C34, G115, G131, G65, G66, GE50RCD, LC1200, LC1200RCD, LC412, LC700, LC700RCD, LC900, LC900RCD, NE00, SE, SNL, XLC		



<b>GEV No.</b>	510971	<b>Ref. No.</b>	200855
<b>description</b>	O-ring EPDM thickness 3mm ID ø 43mm Qty 1 pcs		
<b>For models:</b>	BC25, BC25A, BC25HR, BC30, BC30A, BC30HR, BC30HR380, BC30HRA, F90M, F90MA, FC43, FC43A, LF315, LF320, LF320A, LF320CBT, LF320L, LF320LA, LF320LBT, LF323, LF323A, LF350, LF350A, LF400A, LF450, LF450A, LS550		



<b>GEV No.</b>	502073	<b>Ref. No.</b>	200933
<b>description</b>	O-ring EPDM thickness 4mm ID ø 24mm Qty 1 pcs		
<b>For models:</b>	AC122, AC151, AC152, AC181, AC182, AC201, AC202, AC241, AC242, ACR, ACR145, ACR205, ACR225, ACR245, ACR260, ACR265, ACR305, ACRS145, ACRS205, ACRS225, ACRS245, ACRS260, ACRS265, ACRS305, ACS101, ACS101-DIGIT, ACS122, ACS122-DIGIT, ACS151, ACS151-DIGIT, ACS152, ACS152-DIGIT, ACS161-DIGIT, ACS162-DIGIT, ACS181, ACS181-DIGIT, ACS182, ACS182-DIGIT, ACS201, ACS201-DIGIT, ACS202, ACS202-DIGIT, ACS241, ACS241-DIGIT, ACS242, ACS242-DIGIT, ACS91, ACS91-DIGIT, GMC2702, GMC3502...(Other models you can see in the webshop)		



<b>GEV No.</b>	510811	<b>Ref. No.</b>	200816
<b>description</b>	O-ring EPDM thickness 3mm ID ø 59.2mm Qty 1 pcs		
<b>For models:</b>	B10T, B11T, B12T, B13T, B14T, B15T, B15TM, B16T, B16TM, B18T, B18TM, B19T, B19TM, BC25, BC25A, BC25HR, BC30, BC30A, BC30HR, BC30HR380, BC30HRA, BHC25, BHC25-2, BHC25A, BHC25A-2, BHC25S, BHC30, BHC30-2, BHC30A, BHC30A-2, BHC30E, BHC30E-2, BHC30EA, BHC30EA-2, BHC30HR, BHC30HR-2, BHC30HR380, BHC30HRA, BHC30HRA-2, BHC30HRA380, BHC433, BHC433-2, BHC433A, BHC433A-2, BHCHR, BR20, BR20A, BR25, BR25A, C1000E...(Other models you can see in the webshop)		

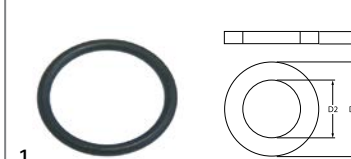

<b>GEV No.</b>	510408	<b>Ref. No.</b>	200820
<b>description</b>	O-ring EPDM thickness 5.34mm ID ø 47mm Qty 1 pcs		
<b>For models:</b>	B10T, B11T, B12T, B13T, B14T, B15, B15T, B15TM, B16, B16T, B16TM, B18, B18T, B18TM, B19, B19T, B19TM, B20, B20D, B23, B24, B25, B26, B27, B31, B32, B41, B42, BC25, BC25A, BC25HR, BC30, BC30A, BC30HR, BC30HR380, BC30HRA, BHC25, BHC25-2, BHC25A, BHC25A-2, BHC25S, BHC30, BHC30-2, BHC30A, BHC30A-2, BHC30E, BHC30E-2, BHC30EA, BHC30EA-2, BHC30HR...(Other models you can see in the webshop)		



<b>GEV No.</b>	510955	<b>Ref. No.</b>	200854
<b>description</b>	O-ring EPDM thickness 3mm ID ø 6mm Qty 1 pcs		
<b>For models:</b>	AC100, AC90, G100L, G101L, G50L, G51L, G60L, G61L, GL, NG02, NG1202, NG1202E, NG602, NG602E, NG902, NG902E		

1

<b>GEV No.</b>	510409	<b>Ref. No.</b>	200815
<b>description</b>	O-ring EPDM thickness 5.34mm ID ø 56.52mm Qty 1 pcs		
<b>For models:</b>	AC100, AC101, AC105, AC120, AC122, AC135, AC150, AC151, AC152, AC170, AC181, AC182, AC200, AC201, AC202, AC241, AC242, AC2A, AC90, AC91, AC95, ACR, ACR145, ACR205, ACR225, ACR245, ACR260, ACR265, ACR305, ACS101, ACS101-DIGIT, ACS122, ACS122-DIGIT, ACS151, ACS151-DIGIT, ACS152, ACS152-DIGIT, ACS161-DIGIT, ACS162-DIGIT, ACS181, ACS181-DIGIT, ACS182, ACS182-DIGIT, ACS201, ACS201-DIGIT, ACS202, ACS202-DIGIT, ACS241, ACS241-DIGIT, ACS242...(Other models you can see in the webshop)		

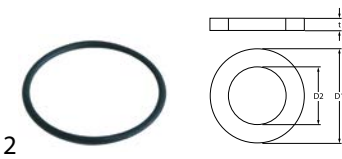

2

<b>GEV No.</b>	510447	<b>Ref. No.</b>	200829
<b>description</b>	O-ring EPDM thickness 5.34mm ID ø 81.92mm Qty 1 pcs		
<b>For models:</b>	B13T, B14T, B15, B15T, B15TM, B16, B16T, B16TM, B18, B18T, B18TM, B19, B19T, B19TM, B41, B42, C30, C70, C75, C75BT, C75M, C75RCD, F2, F20, F3, F300, F45, F55, F65, F80, F90M, F90MA, FC, FC53, FC533, FC533A, FC53A, FC53CBT, FC53LA, FC53LBT, FC54, FC543, FC543A, FC543E, FC543EA, FC544, FC544A, FC54A, FC54CBT, FC54E...(Other models you can see in the webshop)		

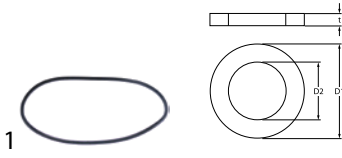

1

<b>GEV No.</b>	510551	<b>Ref. No.</b>	630426 H33855
<b>description</b>	pump cover gasket ID ø 158.3mm pump type 1214/1293/1225/2243/1226/1204/3473/1241 thickness 3.53mm EPDM Qty 1 pcs		
<b>For models:</b>	C1000E, C1000ERCD, C1001M, C1300E, C1300ERCD, C1301M, GE50RCD, GF90, GF90-2004, GF90A, GF90A-2004, NL302, NL302E, NL402, NL402E, NL502, NL502E, NL552, NL552E, XLC		

**silicone**

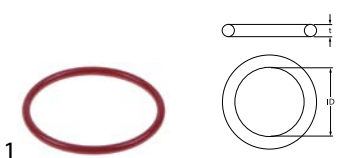

1

<b>GEV No.</b>	532594	<b>Ref. No.</b>	200808
<b>description</b>	O-ring silicone thickness 3.53mm ID ø 50.8mm Qty 1 pcs		
<b>For models:</b>	FC3E, FC3EA, FC3M, FC3MA, FC3MR, FC44E, FC44EA, FC4E, FC4EA, FC4EHRT, FC4M, FC4MA		

**Viton**



1

<b>GEV No.</b>	528525	<b>Ref. No.</b>	200823
<b>description</b>	O-ring Viton thickness 3.53mm ID ø 18.64mm Qty 1 pcs		

**NBR**



1

<b>GEV No.</b>	532720	<b>Ref. No.</b>	200878
<b>description</b>	O-ring NBR ID ø 17.86mm thickness 2.62mm Qty 1 pcs		

**sealing washers**

**fibre gaskets**



1

<b>GEV No.</b>	510535	<b>Ref. No.</b>	460528
<b>description</b>	flat gasket FIBER ED ø 15mm ID ø 10mm thickness 2mm Qty 1 pcs		
<b>For models:</b>	AC101, AC122, AC151, AC152, AC181, AC182, AC201, AC202, AC241, AC242, AC2A, AC91, ACL100, ACL150, ACR, ACR145, ACR205, ACR225, ACR245, ACR260, ACR265, ACR305, ACRS145, ACRS205, ACRS225, ACRS245, ACRS260, ACRS265, ACRS305, ACS151, ACS151-DIGIT, ACS152, ACS152-DIGIT, ACS161-DIGIT, ACS162-DIGIT, ACS181, ACS181-DIGIT, ACS182, ACS182-DIGIT, ACS201, ACS201-DIGIT, ACS202, ACS202-DIGIT, ACS241, ACS241-DIGIT, ACS242, ACS242-DIGIT, C155, C155BT, C155E2...(Other models you can see in the webshop)		





1

<b>GEV No.</b>	510996	<b>Ref. No.</b>	460502
<b>description</b>	flat gasket FIBER ED ø 31mm ID ø 21.5mm thickness 2mm for thread 1/2" Qty 1 pcs		
<b>For models:</b>	AC100, AC101, AC105, AC120, AC122, AC135, AC151, AC152, AC170, AC181, AC182, AC200, AC201, AC202, AC241, AC242, AC2A, AC90, AC91, AC95, ACL100, ACL150, ACR, ACR145, ACR205, ACR225, ACR245, ACR260, ACR265, ACR305, ACRS145, ACRS205, ACRS225, ACRS245, ACRS260, ACRS265, ACRS305, ACS101, ACS101-DIGIT, ACS122, ACS122-DIGIT, ACS151, ACS151-DIGIT, ACS152, ACS152-DIGIT, ACS161-DIGIT, ACS162-DIGIT, ACS181, ACS181-DIGIT, ACS182...(Other models you can see in the webshop)		



			
1			
<b>GEV No.</b>	506232	<b>Ref. No.</b>	460535
<b>description</b>	flat gasket fibre ED ø 12.7mm ID ø 6.3mm thickness 2.3mm Qty 1 pcs		
<b>For models:</b>	BHC25, BHC25-2, BHC25A, BHC25A-2, BHC25S, BHC30, BHC30-2, BHC30A, BHC30A-2, BHC30E, BHC30E-2, BHC30EA, BHC30EA-2, BHC30HR, BHC30HR-2, BHC30HR380, BHC30HRA, BHC30HRA-2, BHC30HRA380, BHC433, BHC433-2, BHC433A, BHC433A-2, BHCHR, LB200, LB200-2, LB200A, LB200A-2, LB215, LB215-2, LB215A, LB215A-2, LB260, LB260-2, LB260A, LB260A-2, LB275, LB275-2, LB275A, LB275A-2, LC1200, LC700, LC900, LF322MP, LF322MP-A, LFD32E, LFD32EA, LFD32M, LFD32MA		

			
1			
<b>GEV No.</b>	521110	<b>Ref. No.</b>	460527
<b>description</b>	flat gasket fibre ED ø 20mm ID ø 13mm thickness 2mm Qty 1 pcs		

			
1			
<b>GEV No.</b>	506072	<b>Ref. No.</b>	460503
<b>description</b>	flat gasket fibre ED ø 38mm ID ø 27mm thickness 2mm outflow for thread 1 1/4" Qty 1 pcs		
<b>For models:</b>	AC100, AC101, AC105, AC120, AC122, AC135, AC150, AC151, AC152, AC170, AC181, AC182, AC200, AC201, AC202, AC241, AC242, AC2A, AC90, AC91, AC95, ACL150, ACR, ACR145, ACR205, ACR225, ACR245, ACR260, ACR265, ACR305, ACRS145, ACRS205, ACRS225, ACRS245, ACRS260, ACRS265, ACRS305, ACS101, ACS101-DIGIT, ACS122, ACS122-DIGIT, ACS151, ACS151-DIGIT, ACS152, ACS152-DIGIT, ACS161-DIGIT, ACS162-DIGIT, ACS181, ACS181-DIGIT, ACS182...(Other models you can see in the webshop)		

			
1			
<b>GEV No.</b>	510355	<b>Ref. No.</b>	460501
<b>description</b>	gasket fibre ED ø 24mm ID ø 17mm thickness 2mm Qty 1 pcs		
<b>For models:</b>	AC101, AC105, AC120, AC122, AC135, AC150, AC151, AC152, AC170, AC181, AC182, AC200, AC201, AC202, AC241, AC242, AC91, AC95, ACR, ACR145, ACR205, ACR225, ACR245, ACR260, ACR265, ACR305, ACRS145, ACRS205, ACRS225, ACRS245, ACRS260, ACRS265, ACRS305, ACS101, ACS101-DIGIT, ACS122, ACS122-DIGIT, ACS151, ACS151-DIGIT, ACS152, ACS152-DIGIT, ACS161-DIGIT, ACS162-DIGIT, ACS181, ACS181-DIGIT, ACS182, ACS182-DIGIT, ACS201, ACS201-DIGIT, ACS202...(Other models you can see in the webshop)		

rubber gaskets

			
1			
<b>GEV No.</b>	510844	<b>Ref. No.</b>	160814
<b>description</b>	flat gasket Qty 1 pcs		

			
1			
<b>GEV No.</b>	510761	<b>Ref. No.</b>	200944 21005
<b>description</b>	flat gasket rubber D1 ø 38mm D2 ø 25mm thickness 2mm Qty 1 pcs		
<b>For models:</b>	BHC25, BHC25-2, BHC25A, BHC25A-2, BHC25S, BHC30, BHC30-2, BHC30A, BHC30A-2, BHC30E, BHC30E-2, BHC30EA, BHC30EA-2, BHC433, BHC433-2, BHC433A, BHC433A-2, GF70, GF70A, LB200, LB200-2, LB200A, LB200A-2, LB215, LB215-2, LB215A, LB215A-2, LB260, LB260-2, LB260A, LB260A-2, LB275, LB275-2, LB275A, LB275A-2, LF321, LF321A, LF322, LF322A, LF322MP, LF322MP-A, LF322RCD, LF324, LF324A, LF325E, LF325EA, LF700, LF700A, LFD32E, LFD32EA...(Other models you can see in the webshop)		

			
1			
<b>GEV No.</b>	510631	<b>Ref. No.</b>	200963
<b>description</b>	flat gasket rubber ED ø 110mm ID ø 88mm thickness 3mm Qty 1 pcs		
<b>For models:</b>	FC3E, FC3EA, FC3M, FC3MA, FC3MR, FC44E, FC44EA, FC4E, FC4EA, FC4EHR, FC4M, FC4MA		

			
1			
<b>GEV No.</b>	518206	<b>Ref. No.</b>	200462
<b>description</b>	flat gasket rubber ED ø 14mm ID ø 9mm thickness 1mm Qty 1 pcs		
<b>For models:</b>	LB200, LB200-2, LB215, LB215-2, LB215A, LB215A-2, LB260, LB260-2, LB275, LB275-2, LB275A, LB275A-2		

			
1			
<b>GEV No.</b>	512376	<b>Ref. No.</b>	200870
<b>description</b>	flat gasket rubber ED ø 18mm ID ø 10mm thickness 2mm Qty 1 pcs		
<b>For models:</b>	C1000E, C1000ERCD, C1001M, C1300E, C1300ERCD, C1301M, FC3E, FC3EA, FC3M, FC3MA, FC3MR, FC44E, FC44EA, FC4E, FC4EA, FC4EHR, FC4M, FC4MA, GF70, GF70A, GF90-2004, GF90A-2004, LC1200, LC1200RCD, LC412, LC700, LC700RCD, LC900, LC900RCD, LF321, LF321A, LF322, LF322A, LF322MP, LF322MP-A, LF322RCD, LF324, LF324A, LF325E, LF325EA, LF700, LF700A, LFD32E, LFD32EA, LFD32M, LFD32MA, XLC		

			
1			
<b>GEV No.</b>	510877	<b>Ref. No.</b>	200415
<b>description</b>	flat gasket rubber ED ø 18mm ID ø 10mm thickness 3mm Qty 1 pcs		
<b>For models:</b>	AC100, AC101, AC120, AC122, AC150, AC151, AC152, AC170, AC181, AC182, AC200, AC201, AC202, AC241, AC242, AC90, AC91, ACR, ACR145, ACR205, ACR225, ACR245, ACR260, ACR265, ACR305, B10, B10T, B11, B11T, B12, B12T, B13T, B14T, B15, B15T, B16, B16T, B18, B18T, B19, B19T, B20, B20D, B23, B24, B25, B26, B27, B31, B32...(Other models you can see in the webshop)		





			
1			
<b>GEV No.</b>	510989	<b>Ref. No.</b>	160811
<b>description</b>	flat gasket rubber ED ø 18mm ID ø 8.5mm thickness 1mm Qty 1 pcs		
<b>For models:</b>	C1000E, C1000ERCD, C1001M, C1300E, C1300ERCD, C1301M, C155, C155BT, C155E2, C155RCD, C165, C165E2, C165E2BT, C165E2RCD, C30, C70, C75, C75BT, C75RCD, C95, C95BT, C95E2, C95RCD, LC1200, LC1200RCD, LC380, LC380BT, LC380RCD, LC400, LC412, LC700, LC700RCD, LC900, LC900RCD, LP360, LP360BT, LP360RCD, XLC		

			
1			
<b>GEV No.</b>	510886	<b>Ref. No.</b>	200467
<b>description</b>	flat gasket rubber ED ø 21mm ID ø 11.5mm thickness 2mm Qty 1 pcs		
<b>For models:</b>	BC25, BC25A, BC25HR, BC30, BC30A, BC30HR, BC30HR380, BC30HRA, BHC25, BHC25-2, BHC25A, BHC25A-2, BHC25S, BHC30, BHC30-2, BHC30A, BHC30A-2, BHC30E, BHC30E-2, BHC30EA, BHC30EA-2, BHC30HR, BHC30HR-2, BHC30HR380, BHC30HRA, BHC30HRA-2, BHC30HRA380, BHC433, BHC433-2, BHC433A, BHC433A-2, BHCHR, BR20, BR20A, BR25, BR25A, C166-2, C70, C75, C75BT, C75M, C75RCD, F45, F55, F65, F80, F90M, F90MA, FC, FC3E...(Other models you can see in the webshop)		

			
1			
<b>GEV No.</b>	520054 <sup>1</sup>	<b>Ref. No.</b>	200416
<b>description</b>	flat gasket rubber ED ø 23.5mm ID ø 14mm thickness 2.3mm Qty 10 pcs		
<b>For models:</b>	B11, B12, B15, B16, B18, B19, B23, B24, B25, B26, B27, B32, B41, B42, BC25, BC25A, BC25HR, BC30, BC30A, BC30HR, BC30HR380, BC30HRA, BHC25, BHC25-2, BHC25A, BHC25A-2, BHC25S, BHC30, BHC30-2, BHC30A, BHC30A-2, BHC30E, BHC30E-2, BHC30EA, BHC30EA-2, BHC30HR, BHC30HR-2, BHC30HR380, BHC30HRA, BHC30HRA-2, BHC30HRA380, BHC433, BHC433-2, BHC433A, BHC433A-2, BHCHR, BR20, BR20A, BR25, BR25A...(Other models you can see in the webshop)		

<sup>1</sup>Qty 10 pieces

			
1			
<b>GEV No.</b>	511180	<b>Ref. No.</b>	200457
<b>description</b>	flat gasket rubber ED ø 24mm ID ø 16mm thickness 3mm Qty 1 pcs		
<b>For models:</b>	AC2A, B16, B16TM, B19, B19TM, C140, C155, C155BT, C155E2, C155RCD, C165, C165E2, C165E2BT, C165E2RCD, C166, C166-2, C30, C70, C75, C75BT, C75M, C75RCD, C85, C95, C95BT, C95E2, C95RCD, LC380, LC380BT, LC380RCD, LC400, LP360, LP360BT, LP360RCD		

			
1			
<b>GEV No.</b>	511283	<b>Ref. No.</b>	200927
<b>description</b>	flat gasket rubber ED ø 30mm ID ø 20mm thickness 2mm Qty 1 pcs		
<b>For models:</b>	AC101, AC122, AC151, AC152, AC181, AC182, AC201, AC202, AC241, AC242, AC2A, AC91, ACL100, ACL150, ACRS145, ACRS205, ACRS225, ACRS245, ACRS260, ACRS265, ACRS305, ACS101, ACS101-DIGIT, ACS122, ACS122-DIGIT, ACS151, ACS151-DIGIT, ACS152, ACS152-DIGIT, ACS161-DIGIT, ACS162-DIGIT, ACS181, ACS181-DIGIT, ACS182, ACS182-DIGIT, ACS201, ACS201-DIGIT, ACS202, ACS202-DIGIT, ACS241, ACS241-DIGIT, ACS242, ACS242-DIGIT, ACS91, ACS91-DIGIT, BC25, BC25A, BC30, BC30A, BR20...(Other models you can see in the webshop)		

			
1			
<b>GEV No.</b>	510876	<b>Ref. No.</b>	200412
<b>description</b>	flat gasket rubber ED ø 45mm ID ø 33mm thickness 3mm Qty 1 pcs		
<b>For models:</b>	AC100, AC101, AC105, AC120, AC122, AC135, AC150, AC151, AC152, AC170, AC181, AC182, AC200, AC201, AC202, AC241, AC242, AC2A, AC90, AC91, AC95, ACL100, ACL150, ACR, ACR145, ACR205, ACR225, ACR245, ACR260, ACR265, ACR305, ACRS145, ACRS205, ACRS225, ACRS245, ACRS260, ACRS265, ACRS305, ACS101, ACS101-DIGIT, ACS122, ACS122-DIGIT, ACS151, ACS151-DIGIT, ACS152, ACS152-DIGIT, ACS161-DIGIT, ACS162-DIGIT, ACS181, ACS181-DIGIT...(Other models you can see in the webshop)		

			
1			
<b>GEV No.</b>	511196	<b>Ref. No.</b>	200919
<b>description</b>	flat gasket rubber ED ø 59mm ID ø 48mm thickness 2mm Qty 1 pcs		
<b>For models:</b>	FC, FC53, FC533, FC533A, FC53A, FC53CBT, FC53LA, FC53LBT, FC54, FC543, FC543A, FC543E, FC544, FC544A, FC54A, FC54CBT, FC54E, FC54EA, FC54LBT, FCHR, FCHRA, FCHRT, FCHRTA, GE50RCD		

			
1			
<b>GEV No.</b>	510234	<b>Ref. No.</b>	200498
<b>description</b>	flat gasket rubber ED ø 65mm ID ø 47mm thickness 2mm Qty 1 pcs		
<b>For models:</b>	C1000ERCD, C1300ERCD, GE60RCD, GE65RCD, LC1200RCD, LC700RCD, LC900RCD, LF322RCD, XLC		

			
1			
<b>GEV No.</b>	516254	<b>Ref. No.</b>	200410
<b>description</b>	flat gasket rubber ED ø 66mm ID ø 46mm thickness 2.1mm Qty 1 pcs		

			
<b>GEV No.</b>	511318	<b>Ref. No.</b>	200913
<b>description</b>	flat gasket rubber ED ø 75mm ID ø 59mm thickness 2mm Qty 1 pcs		
<b>For models:</b>	AC122, AC152, AC182, AC202, AC242, BC25, BC25A, BC25HR, BC30, BC30A, BC30HR, BC30HR380, BC30HRA, BR20, BR20A, BR25, BR25A, FC43, FC43A		

			
<b>GEV No.</b>	510947	<b>Ref. No.</b>	200489
<b>description</b>	flat gasket rubber ED ø 85mm ID ø 73mm thickness 2mm Qty 1 pcs equiv. no. 200489 suitable for COMENDA		
<b>For models:</b>	AC122, AC152, AC182, AC202, AC242, B11T, B12T, B13T, B14T, B15T, B15TM, B16T, B16TM, B18T, B18TM, B19T, B19TM, BC25, BC25A, BC25HR, BC30, BC30A, BC30HR, BC30HR380, BC30HRA, BHC25, BHC25-2, BHC25A, BHC30, BHC30-2, BHC30A, BHC30A-2, BHC30E, BHC30E-2, BHC30EA, BHC30EA-2, BHC30HR, BHC30HR-2, BHC30HR380, BHC30HRA, BHC30HRA-2, BHC30HRA380, BHC433, BHC433-2, BHC433A, BHC433A-2, BHC30HRA, BR20, BR20A, BR25...(Other models you can see in the webshop)		

			
<b>GEV No.</b>	510832	<b>Ref. No.</b>	200906
<b>description</b>	flat gasket rubber ED ø 92mm ID ø 66mm thickness 2mm Qty 1 pcs equiv. no. 200906/33456		
<b>For models:</b>	AC101, AC105, AC120, AC122, AC135, AC150, AC151, AC152, AC170, AC181, AC182, AC200, AC201, AC202, AC241, AC242, AC2A, AC91, AC95, ACL100, ACL150, ACR, ACR145, ACR205, ACR225, ACR245, ACR260, ACR265, ACR305, ACRS145, ACRS205, ACRS225, ACRS245, ACRS260, ACRS265, ACRS305, ACS101, ACS101-DIGIT, ACS122, ACS122-DIGIT, ACS151, ACS151-DIGIT, ACS152, ACS152-DIGIT, ACS161-DIGIT, ACS162-DIGIT, ACS181, ACS181-DIGIT, ACS182, ACS182-DIGIT...(Other models you can see in the webshop)		

			
<b>GEV No.</b>	511158	<b>Ref. No.</b>	200482
<b>description</b>	gasket rubber ED ø 50mm ID ø 35mm thickness 4mm Qty 1 pcs		
<b>For models:</b>	C1000E, C1000ERCD, C1001M, C1300E, C1300ERCD, C1301M, C140, GE50RCD, GF90, GF90-2004, GF90A, GF90A-2004, LC1200, LC1200RCD, LC380, LC380BT, LC380RCD, LC400, LC412, LC700, LC700RCD, LC900, LC900RCD, XLC		

<b>plastic gaskets</b>			
			
<b>GEV No.</b>	510838	<b>Ref. No.</b>	160803
<b>description</b>	gasket plastic ED ø 10.5mm ID ø 5mm thickness 3mm Qty 1 pcs		
<b>For models:</b>	AC101, AC122, AC151, AC152, AC181, AC182, AC201, AC202, AC241, AC242, AC91, B23, B24, B25, B26, B27, B31, B32, F90M, F90MA, LAV1000, LBC210, LBC215, LBC215A, LBC275, LBC275A, LF315, LF320, LF320A, LF320CBT, LF320L, LF320LA, LF320LBT, LF323, LF323A, LF350, LF350A, LF400A, LF450, LF450A, LS550		

			
<b>GEV No.</b>	510839	<b>Ref. No.</b>	160804
<b>description</b>	gasket plastic ED ø 13mm ID ø 6.5mm thickness 4mm Qty 1 pcs		
<b>For models:</b>	B10, B10T, B11, B11T, B12, B12T, B13T, B14T, B15, B15T, B15TM, B16, B16T, B16TM, B18, B18T, B18TM, B19, B19T, B19TM, B20, B20D, B24, B25, B26, B27, BHC25-2, BHC25A-2, BHC30-2, BHC30A-2, BHC30E, BHC30E-2, BHC30EA, BHC30EA-2, BHC30HR-2, BHC30HRA-2, BHC433-2, BHC433A-2, C155, C155BT, C155E2, C155RCD, C165, C165E2, C165E2BT, C165E2RCD, C166, C166-2, C95, C95BT...(Other models you can see in the webshop)		

			
<b>GEV No.</b>	510840	<b>Ref. No.</b>	160805
<b>description</b>	gasket plastic ED ø 16mm ID ø 8.5mm thickness 4mm Qty 1 pcs		
<b>For models:</b>	AC100, AC101, AC120, AC122, AC150, AC151, AC152, AC170, AC181, AC182, AC200, AC201, AC202, AC241, AC242, AC90, AC91, ACR, ACR145, ACR205, ACR225, ACR245, ACR260, ACR265, ACR305, ACRS145, ACRS205, ACRS225, ACRS245, ACRS260, ACRS265, ACRS305, ACS101, ACS101-DIGIT, ACS122, ACS122-DIGIT, ACS151, ACS151-DIGIT, ACS152, ACS152-DIGIT, ACS161-DIGIT, ACS162-DIGIT, ACS181, ACS181-DIGIT, ACS182, ACS182-DIGIT, ACS201, ACS201-DIGIT, ACS202, ACS202-DIGIT...(Other models you can see in the webshop)		

			
<b>GEV No.</b>	511146	<b>Ref. No.</b>	200495
<b>description</b>	gasket plastic ED ø 43mm ID ø 36mm Qty 1 pcs		
<b>For models:</b>	ACR, ACR145, ACR205, ACR225, ACR245, ACR260, ACR265, ACR305, GMC, GMC2700, GMC3500, GMC4500, GMC5500, LAV1000, LV1001, LV1501, LV-LVP, LVP1001, LVP1501, NE3001, NE4001, NE5501, NE7501, NE9001, NG01, NG601, NG601E, NG901, NG901E		

<b>PTFE gaskets</b>			
			
<b>GEV No.</b>	511861	<b>Ref. No.</b>	160832
<b>description</b>	flat gasket with PTFE ED ø 11mm ID ø 4.5mm thickness 0.8mm Qty 1 pcs		
<b>For models:</b>	B10, B11, B12, B15, B16, B18, B19		



foam rubber gaskets



1

<b>GEV No.</b>	505302	<b>Ref. No.</b>	200925
<b>description</b>	foam rubber gasket W 20mm thickness 1.5mm self-adhesive Qty 1m		
<b>For models:</b>	C1000E, C1000ERCD, C1001M, C1300E, C1300ERCD, C1301M, LC1200, LC1200RCD, LC412, LC700, LC700RCD, LC900, LC900RCD, XLC		



1

<b>GEV No.</b>	505304	<b>Ref. No.</b>	200924
<b>description</b>	foam rubber gasket W 20mm thickness 4mm Qty 600mm punched		
<b>For models:</b>	F90M, F90MA, LF315, LF320, LF320A, LF320CBT, LF320L, LF320LA, LF320LBT, LF323, LF323A, LF350, LF350A, LF400A, LF450, LF450A, LS550		



1

<b>GEV No.</b>	511391	<b>Ref. No.</b>	200402
<b>description</b>	foam rubber gasket W 24mm thickness 4mm self-adhesive Qty 1m suitable for COMENDA		
<b>For models:</b>	AC101, AC122, AC151, AC152, AC181, AC182, AC201, AC202, AC241, AC242, AC91, ACR, ACR145, ACR205, ACR225, ACR245, ACR260, ACR265, ACR305, ACS101, ACS101-DIGIT, ACS122, ACS122-DIGIT, ACS151, ACS151-DIGIT, ACS152, ACS152-DIGIT, ACS161-DIGIT, ACS162-DIGIT, ACS181, ACS181-DIGIT, ACS182, ACS182-DIGIT, ACS201, ACS201-DIGIT, ACS202, ACS202-DIGIT, ACS241, ACS241-DIGIT, ACS242, ACS242-DIGIT, ACS91, ACS91-DIGIT, BHC25-2, BHC25A-2, BHC30-2, BHC30A-2, BHC30E-2, BHC30EA-2, BHC30HR-2...(Other models you can see in the webshop)		



1

<b>GEV No.</b>	505303	<b>Ref. No.</b>	200957
<b>description</b>	foam rubber gasket W 28mm thickness 2.7mm self-adhesive Qty 640mm punched		
<b>For models:</b>	C1000E, C1000ERCD, C1001M, C1300E, C1300ERCD, C1301M, LC1200, LC1200RCD, LC412, LC700, LC700RCD, LC900, LC900RCD		



1

<b>GEV No.</b>	510881	<b>Ref. No.</b>	200433
<b>description</b>	foam rubber gasket W 6mm thickness 2.5mm self-adhesive Qty 1m		
<b>For models:</b>	ACS181, ACS181-DIGIT, ACS182, ACS182-DIGIT, BHC25, BHC25A, BHC25S, BHC30, BHC30A, BHC30E, BHC30EA, BHC30HR, BHC30HR380, BHC30HRA, BHC30HRA380, BHC433, BHC433A, BHCHR, C30, C70, C75, C75BT, C75M, C75RCD, LB200, LB200-2, LB200A, LB200A-2, LB215, LB215-2, LB215A, LB215A-2, LB260, LB260-2, LB260A, LB260A-2, LB275, LB275-2, LB275A, LB275A-2, LBC210, LBC215, LBC215A, LBC275, LBC275A, LBR, LBR200, LBR215, LBR215A, LP360...(Other models you can see in the webshop)		



1

<b>GEV No.</b>	510880	<b>Ref. No.</b>	200432 H33408
<b>description</b>	foam rubber gasket W 8mm thickness 4mm self-adhesive Qty supplied by meter		
<b>For models:</b>	ACS101, ACS101-DIGIT, ACS91, ACS91-DIGIT, C140, C33, C34, C85, GE100, GE115, GE125, GE50RCD, GE60, GE60RCD, GE65, GE65RCD, GE75, GE80, GF70, GF70A, LAV1000, LC380, LC380BT, LC380RCD, LC400, NE3001, NE4001, NE5501, NE7501, NE9001, NG01, NG601, NG601E, NG901, NG901E, R40, R70		

shaft gaskets

v-rings



1

<b>GEV No.</b>	511631	<b>Ref. No.</b>	200480
<b>description</b>	gasket ID ø 13.5mm ED ø 26mm H 10mm		
<b>For models:</b>	AC100, AC101, AC105, AC120, AC122, AC135, AC150, AC151, AC152, AC170, AC181, AC182, AC200, AC201, AC202, AC241, AC242, AC2A, AC90, AC91, AC95, ACL150, ACR, ACR145, ACR205, ACR225, ACR245, ACR260, ACR265, ACR305, ACRS145, ACRS205, ACRS225, ACRS245, ACRS260, ACRS265, ACRS305, ACS101, ACS101-DIGIT, ACS122, ACS122-DIGIT, ACS151, ACS151-DIGIT, ACS152, ACS152-DIGIT, ACS161-DIGIT, ACS162-DIGIT, ACS181, ACS181-DIGIT, ACS182...(Other models you can see in the webshop)		

shaft gaskets



1

<b>GEV No.</b>	697121	<b>Ref. No.</b>	440411
<b>description</b>	shaft seal ID ø 17mm ED ø 40mm thickness 7mm		
<b>For models:</b>	AC100, AC101, AC105, AC120, AC122, AC135, AC150, AC151, AC152, AC170, AC181, AC182, AC200, AC201, AC202, AC241, AC242, AC90, AC91, AC95, ACR, ACR145, ACR205, ACR225, ACR245, ACR260, ACR265, ACR305, ACRS145, ACRS205, ACRS225, ACRS245, ACRS260, ACRS265, ACRS305, ACS101, ACS101-DIGIT, ACS122, ACS122-DIGIT, ACS151, ACS151-DIGIT, ACS152, ACS152-DIGIT, ACS161-DIGIT, ACS162-DIGIT, ACS181, ACS181-DIGIT, ACS182, ACS182-DIGIT, ACS201...(Other models you can see in the webshop)		



1

<b>GEV No.</b>	697475	<b>Ref. No.</b>	440402
<b>description</b>	shaft seal ID ø 20mm ED ø 30mm thickness 5mm		
<b>For models:</b>	NE00, NE3001, NE4001, NE5501, NE7501, NE9001, NG00, NG01, NG600, NG600E, NG601, NG601E, NG900, NG900E, NG901, NG901E		



1

<b>GEV No.</b>	698002	<b>Ref. No.</b>	440409
<b>description</b>	shaft seal ID $\varnothing$ 25mm ED $\varnothing$ 40mm thickness 7mm		
<b>For models:</b>	GMC, GMC2700, GMC2702, GMC3500, GMC3502, GMC4500, GMC4502, GMC5500, GMC5502		



1

<b>GEV No.</b>	511988	<b>Ref. No.</b>	440401
<b>description</b>	shaft sealing ID $\varnothing$ 19mm ED $\varnothing$ 31.5mm H 7mm		
<b>For models:</b>	NE00, NG00, NG600, NG600E, NG900, NG900E		



1

<b>GEV No.</b>	698410	<b>Ref. No.</b>	440413
<b>description</b>	shaft sealing ID $\varnothing$ 20mm ED $\varnothing$ 32mm H 7mm		



1

<b>GEV No.</b>	512487	<b>Ref. No.</b>	200979
<b>description</b>	shaft sealing ID $\varnothing$ 29mm ED $\varnothing$ 40mm H 7mm COMENDA		

special gaskets

door seals for dishwashers

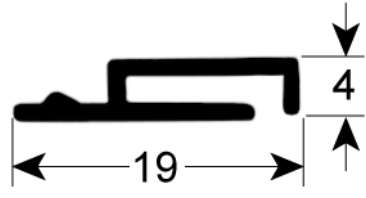

1

<b>GEV No.</b>	510911	<b>Ref. No.</b>	200901
<b>description</b>	door seal		

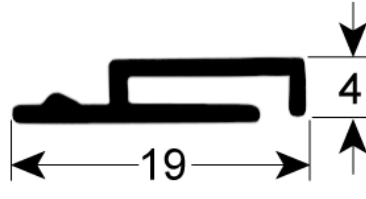

1

<b>GEV No.</b>	511311	<b>Ref. No.</b>	200901 200923
<b>description</b>	door seal L 1000mm dishwasher suitable for COMENDA equiv. no. 200923		
<b>For models:</b>	B10T, B11T, B12T, B13T, B14T, B15T, B15TM, B16T, B16TM, B18T, B18TM, B19T, B19TM, F20, F45, F55, F65, F80, F90M, F90MA, FC, FC53, FC533, FC533A, FC53A, FC53CBT, FC53LA, FC53LBT, FC54, FC543, FC543A, FC543E, FC543EA, FC544, FC544A, FC54A, FC54CBT, FC54E, FC54EA, FC54LBT, FCHR, FCHRA, FCHRT, FCHRTA, GE60, GE65, GE80, LF280-lav-line, LF315, LF320...(Other models you can see in the webshop)		

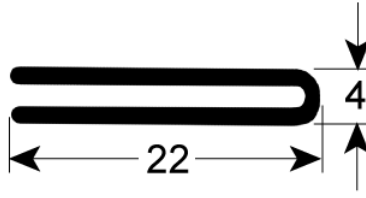

1

<b>GEV No.</b>	511389	<b>Ref. No.</b>	200945
<b>description</b>	door seal L 1370mm dishwasher suitable for COMENDA equiv. no. 200945		
<b>For models:</b>	BHC25, BHC25-2, BHC25A, BHC25A-2, BHC25S, BHC30, BHC30-2, BHC30A, BHC30A-2, BHC30E, BHC30E-2, BHC30EA, BHC30EA-2, BHC30HR, BHC30HR-2, BHC30HR380, BHC30HRA, BHC30HRA-2, BHC30HRA380, BHC433, BHC433-2, BHC433A, BHC433A-2, BHCHR		



1

<b>GEV No.</b>	511310	<b>Ref. No.</b>	200918
<b>description</b>	door seal L 1830mm W 16mm dishwasher suitable for COMENDA equiv. no. 200918		
<b>For models:</b>	BC25, BC25A, BC25HR, BC30, BC30A, BC30HR, BC30HR380, BC30HRA, BHC25, BHC25A, BHC30, BHC30A, BHC30HR, BHC30HRA, BHC433, BHC433A, BR20, BR20A, BR25, BR25A, FC43, FC43A		

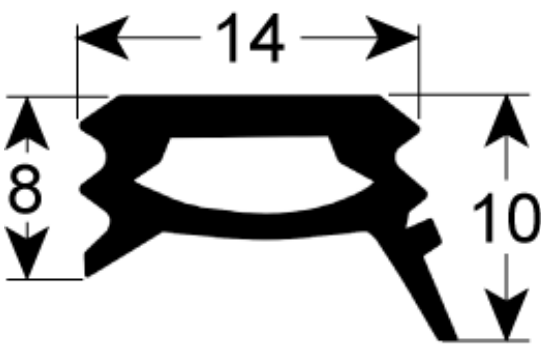

1

<b>GEV No.</b>	901767	<b>Ref. No.</b>	200974
<b>description</b>	door seal L 445mm W 560mm rubber 3-sided		





<b>GEV No.</b>	511990	<b>Ref. No.</b>	H36926
<b>description</b>	door seal L 590mm		
<b>For models:</b>	GF70, GF70A		

<b>GEV No.</b>	511577	<b>Ref. No.</b>	200217
<b>description</b>	door seal L 595mm W 15.5mm H 7mm Qty 1 suitable for COMENDA		
<b>For models:</b>	LF321, LF321A, LF322, LF322A, LF322MP, LF322MP-A, LF322RCD, LF324, LF324A, LF325E, LF325EA, LF700, LF700A		

<b>GEV No.</b>	504279	<b>Ref. No.</b>	200216R
<b>description</b>	door seal L 595mm W 18mm mounting pos. upper H 13mm Qty 1 suitable for COMENDA		
<b>For models:</b>	LF321, LF321A, LF322, LF322A, LF322MP, LF322MP-A, LF322RCD, LF324, LF324A, LF325E, LF325EA, LF700, LF700A		

<b>GEV No.</b>	511390	<b>Ref. No.</b>	200215
<b>description</b>	door seal L 930mm dishwasher suitable for COMENDA equip. no. 200215		
<b>For models:</b>	LB200, LB200-2, LB200A, LB200A-2, LB215, LB215-2, LB215A, LB215A-2, LB260, LB260-2, LB260A, LB260A-2, LB275, LB275-2, LB275A, LB275A-2, LBC210, LBC215, LBC215A, LBC275, LBC275A, LBR, LBR200, LBR215, LBR215A		

<b>GEV No.</b>	511989	<b>Ref. No.</b>	H36883
<b>description</b>	door seal Qty supplied by meter		
<b>For models:</b>	GE100, GE115, GE50RCD, GE60, GE60RCD, GE65, GE65RCD, GE80		

<b>GEV No.</b>	511391	<b>Ref. No.</b>	200402
<b>description</b>	foam rubber gasket W 24mm thickness 4mm self-adhesive Qty 1m suitable for COMENDA		
<b>For models:</b>	AC101, AC122, AC151, AC152, AC181, AC182, AC201, AC202, AC241, AC242, AC91, ACR, ACR145, ACR205, ACR225, ACR245, ACR260, ACR265, ACR305, ACS101, ACS101-DIGIT, ACS122, ACS122-DIGIT, ACS151, ACS151-DIGIT, ACS152, ACS152-DIGIT, ACS161-DIGIT, ACS162-DIGIT, ACS181, ACS181-DIGIT, ACS182, ACS182-DIGIT, ACS201, ACS201-DIGIT, ACS202, ACS202-DIGIT, ACS241, ACS241-DIGIT, ACS242, ACS242-DIGIT, ACS91, ACS91-DIGIT, BHC25-2, BHC25A-2, BHC30-2, BHC30A-2, BHC30E-2, BHC30EA-2, BHC30HR-2...(Other models you can see in the webshop)		

<b>GEV No.</b>	510881	<b>Ref. No.</b>	200433
<b>description</b>	foam rubber gasket W 6mm thickness 2.5mm self-adhesive Qty 1m		
<b>For models:</b>	ACS181, ACS181-DIGIT, ACS182, ACS182-DIGIT, BHC25, BHC25A, BHC255, BHC30, BHC30A, BHC30E, BHC30EA, BHC30HR, BHC30HR380, BHC30HRA, BHC30HRA380, BHC433, BHC433A, BHCHR, C30, C70, C75, C75BT, C75M, C75RCD, LB200, LB200-2, LB200A, LB200A-2, LB215, LB215-2, LB215A, LB215A-2, LB260, LB260-2, LB260A, LB260A-2, LB275, LB275-2, LB275A, LB275A-2, LBC210, LBC215, LBC215A, LBC275, LBC275A, LBR, LBR200, LBR215, LBR215A, LP360...(Other models you can see in the webshop)		

<b>GEV No.</b>	510880	<b>Ref. No.</b>	200432 H33408
<b>description</b>	foam rubber gasket W 8mm thickness 4mm self-adhesive Qty supplied by meter		
<b>For models:</b>	ACS101, ACS101-DIGIT, ACS91, ACS91-DIGIT, C140, C33, C34, C85, GE100, GE115, GE125, GE50RCD, GE60, GE60RCD, GE65, GE65RCD, GE75, GE80, GF70, GF70A, LAV1000, LC380, LC380BT, LC380RCD, LC400, NE3001, NE4001, NE5501, NE7501, NE9001, NG01, NG601, NG601E, NG901, NG901E, R40, R70		

miscellaneous



1

<b>GEV No.</b>	511664	<b>Ref. No.</b>	200419
<b>description</b>	bottom gasket suitable for COMENDA for dishwasher ED ø 35.5mm ID ø 24mm rubber thickness 11mm		
<b>For models:</b>	AC181, AC182, SE		



1

<b>GEV No.</b>	510884	<b>Ref. No.</b>	200463
<b>description</b>	gasket		
<b>For models:</b>	NE00, NG00, NG600, NG600E, NG900, NG900E, SE		



1

<b>GEV No.</b>	510879	<b>Ref. No.</b>	200431
<b>description</b>	gasket external height 4mm microswitch ED ø 9mm ID ø 2.5mm		
<b>For models:</b>	B11, B12, B15, B16, B18, B19, B41, B42, G131, G66, R50		



1

<b>GEV No.</b>	510882	<b>Ref. No.</b>	200451
<b>description</b>	gasket for opposite support L 100mm hood mechanics rubber H 3mm black W 30mm		
<b>For models:</b>	C30, C70, C75, C75BT, C75M, C75RCD, LF280-lav-line, LF320-lav-line, LP360, LP360BT, LP360RCD		

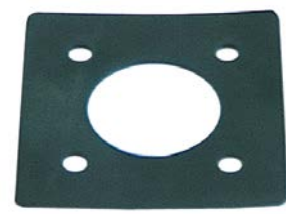

1

<b>GEV No.</b>	510822	<b>Ref. No.</b>	200423
<b>description</b>	gasket L 100mm W 100mm pipe ID ø 48.5mm thickness 3mm		
<b>For models:</b>	C33, C34, SE		



1

<b>GEV No.</b>	511370	<b>Ref. No.</b>	160837
<b>description</b>	gasket L 34mm W 14mm for door guides ID ø 7mm thickness 3mm		
<b>For models:</b>	BC25, BC25A, BC25HR, BC30, BC30A, BC30HR, BC30HR380, BC30HRA, BR20, BR20A, BR25, BR25A, F90M, F90MA, FC43, FC43A, GF90, GF90A, LF315, LF320, LF320A, LF320CBT, LF320L, LF320LA, LF320LBT, LF323, LF323A, LF350, LF350A, LF400A, LF450, LF450A, LS550		



1

<b>GEV No.</b>	510847	<b>Ref. No.</b>	440405
<b>description</b>	gasket polishing agent dosing ID ø 22mm ED ø 32mm external height 5mm		
<b>For models:</b>	B10T, B11T, B12T, B13T, B14T, B15T, B15TM, B16T, B16TM, B18T, B18TM, B19T, B19TM, BC25, BC25A, BC25HR, BC30, BC30A, BC30HR, BC30HR380, BC30HRA, BHC25, BHC25-2, BHC25A, BHC25A-2, BHC25S, BHC30, BHC30-2, BHC30A, BHC30A-2, BHC30E, BHC30E-2, BHC30EA, BHC30EA-2, BHC30HR, BHC30HR-2, BHC30HR380, BHC30HRA, BHC30HRA-2, BHC30HRA380, BHC433, BHC433-2, BHC433A, BHC433A-2, BHCHR, BR20, BR20A, BR25, BR25A, C1000E...(Other models you can see in the webshop)		



1

<b>GEV No.</b>	511981	<b>Ref. No.</b>	460525
<b>description</b>	gasket pump inlet ID ø 75mm L 175mm ED ø 127mm H 2mm		
<b>For models:</b>	G100L, G101L, G115L, G125, G125L, G50L, G50LM, G51L, G60L, G61L, G65L, G75, G75L, GE100, GE115, GE125, GE60, GE60RCD, GE65, GE65RCD, GE75, GE80, GL, NG00, NG01, NG600, NG600E, NG601, NG601E, NG900, NG900E, NG901, NG901E		



1

<b>GEV No.</b>	511980	<b>Ref. No.</b>	460526
<b>description</b>	gasket pump outlet ID ø 57mm L 155mm ED ø 107mm H 2mm		
<b>For models:</b>	G100L, G101L, G115L, G125, G125L, G50L, G50LM, G51L, G60L, G61L, G65L, G75, G75L, GE100, GE115, GE125, GE60, GE60RCD, GE65, GE65RCD, GE75, GE80, GL, NG00, NG01, NG600, NG600E, NG601, NG601E, NG900, NG900E, NG901, NG901E		



1

<b>GEV No.</b>	510885	<b>Ref. No.</b>	200464
<b>description</b>	gasket suitable for COMENDA equip. no. 200464 L 60mm W 30mm		
<b>For models:</b>	B10T, B11T, B12T, BR20, BR20A, BR25, BR25A, LBR, LBR200, LBR215, LBR215A		



thermostat gaskets



<b>GEV No.</b>	501353	<b>Ref. No.</b>	200491
<b>description</b>	gasket for thermostat hole ø 6.6mm L 98mm W 68mm thickness 2mm		
<b>For models:</b>	AC100, AC101, AC105, AC120, AC122, AC135, AC150, AC151, AC152, AC170, AC181, AC182, AC200, AC201, AC202, AC241, AC242, AC90, AC91, AC95, ACL100, ACL150, ACR, ACR145, ACR205, ACR225, ACR245, ACR260, ACR265, ACR305, ACRS145, ACRS205, ACRS225, ACRS245, ACRS260, ACRS265, ACRS305, ACS101, ACS101-DIGIT, ACS122, ACS122-DIGIT, ACS151, ACS151-DIGIT, ACS152, ACS152-DIGIT, ACS161-DIGIT, ACS162-DIGIT, ACS181, ACS181-DIGIT, ACS182... (Other models you can see in the webshop)		



<b>GEV No.</b>	512154	<b>Ref. No.</b>	200494
<b>description</b>	gasket for thermostat ID ø 20mm equiv. no. 200494/H200494 hole distance 41mm suitable for COMENDA, HOONVED		
<b>For models:</b>	B10T, B11T, B12T, B13T, B14T, B15T, B15TM, B16T, B16TM, B18T, B18TM, B19T, B19TM, BC25, BC25A, BC25HR, BC30, BC30A, BC30HR, BC30HR380, BC30HRA, BHC25, BHC25-2, BHC25A, BHC25A-2, BHC25S, BHC30, BHC30-2, BHC30A, BHC30A-2, BHC30E, BHC30E-2, BHC30EA, BHC30EA-2, BHC433, BHC433-2, BHC433A, BHC433A-2, BR20, BR20A, BR25, BR25A, FC43, FC43A, LB200, LB200-2, LB200A, LB200A-2, LB215, LB215-2...(Other models you can see in the webshop)		

gaskets for wash arm support



<b>GEV No.</b>	510934	<b>Ref. No.</b>	200406
<b>description</b>	gasket D1 ø 70mm D2 ø 130mm thickness 2mm with 6 holes wash arm support		
<b>For models:</b>	NE00		

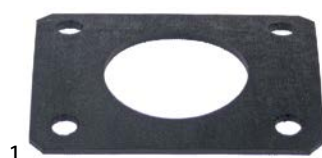

<b>GEV No.</b>	511977	<b>Ref. No.</b>	200937
<b>description</b>	gasket for wash arm support ID ø 50mm L 100mm W 78mm thickness 3mm		
<b>For models:</b>	NE02, NE3002, NE4002, NE5002, NE5502, NE7002, NE7502, NE9002, NE9502, NG02, NG1202, NG1202E, NG602, NG602E, NG902, NG902E, NL302, NL302E, NL402, NL402E, NL502, NL502E, NL552, NL552E		



<b>GEV No.</b>	511815	<b>Ref. No.</b>	200928
<b>description</b>	gasket thickness 3.3mm rubber suitable for COMENDA L 55mm W 30mm hole ø 12/7mm hole distance 40mm		
<b>For models:</b>	NE3001, NE4001, NE5501, NE7501, NE9001		

miscellaneous



<b>GEV No.</b>	698470	<b>Ref. No.</b>	160806
<b>description</b>	gasket ID ø 10mm ED ø 20mm H 5mm PTFE		
<b>For models:</b>	F2, F3, F300		

transmission technology and ball bearings

chains

roller chains 08B-1 single



<b>GEV No.</b>	697897	<b>Ref. No.</b>	410801
<b>description</b>	roller chain DIN/ISO 08 B-1 splitting 1/2" / 12.7mm links 39 internal width 7.75mm rollerø 8.51mm single		
<b>For models:</b>	AC100, AC101, AC105, AC120, AC122, AC135, AC150, AC151, AC152, AC170, AC181, AC182, AC200, AC201, AC202, AC241, AC242, AC90, AC91, AC95, ACR, ACR145, ACR205, ACR225, ACR245, ACR260, ACR265, ACR305, ACRS145, ACRS205, ACRS225, ACRS245, ACRS260, ACRS265, ACRS305, ACS101, ACS101-DIGIT, ACS122, ACS122-DIGIT, ACS151, ACS151-DIGIT, ACS152, ACS152-DIGIT, ACS161-DIGIT, ACS162-DIGIT, ACS181, ACS181-DIGIT, ACS182, ACS182-DIGIT, ACS201...(Other models you can see in the webshop)		

<b>accessories for</b>	697897			
	<b>GEV No.</b>	693276	<b>Ref. No.</b>	410903
	connector single DIN/ISO 08 B-1 splitting 1/2" links 1 L 23mm internal width 11.8mm rollerø 4.3mm metal			
	<b>GEV No.</b>	697841	<b>Ref. No.</b>	410902
	half link single DIN/ISO 08 B-1 splitting 1/2"			

connectors



<b>GEV No.</b>	693276	<b>Ref. No.</b>	410903
<b>description</b>	connector single DIN/ISO 08 B-1 splitting 1/2" links 1 L 23mm internal width 11.8mm rollerø 4.3mm metal		
<b>For models:</b>	AC100, AC101, AC105, AC120, AC122, AC135, AC150, AC151, AC152, AC170, AC181, AC182, AC200, AC201, AC202, AC241, AC242, AC90, AC91, AC95, ACR, ACR145, ACR205, ACR225, ACR245, ACR260, ACR265, ACR305, ACRS145, ACRS205, ACRS225, ACRS245, ACRS260, ACRS265, ACRS305, ACS101, ACS101-DIGIT, ACS122, ACS122-DIGIT, ACS151, ACS151-DIGIT, ACS152, ACS152-DIGIT, ACS161-DIGIT, ACS162-DIGIT, ACS181, ACS181-DIGIT, ACS182, ACS182-DIGIT, ACS201...(Other models you can see in the webshop)		

half links



<b>GEV No.</b>	697841	<b>Ref. No.</b>	410902
<b>description</b>	half link single DIN/ISO 08 B-1 splitting 1/2"		
<b>For models:</b>	AC100, AC101, AC105, AC120, AC122, AC135, AC150, AC151, AC152, AC170, AC181, AC182, AC200, AC201, AC202, AC241, AC242, AC90, AC91, AC95, ACR, ACR145, ACR205, ACR225, ACR245, ACR260, ACR265, ACR305, ACRS145, ACRS205, ACRS225, ACRS245, ACRS260, ACRS265, ACRS305, ACS101, ACS101-DIGIT, ACS122, ACS122-DIGIT, ACS151, ACS151-DIGIT, ACS152, ACS152-DIGIT, ACS161-DIGIT, ACS162-DIGIT, ACS181, ACS181-DIGIT, ACS182, ACS182-DIGIT, ACS201...(Other models you can see in the webshop)		

springs

torsion springs



<b>GEV No.</b>	510652	<b>Ref. No.</b>	391335
<b>description</b>	torsion spring ø 18mm wire gauge ø 3mm Qty 1 pcs		
<b>For models:</b>	FC3E, FC3EA, FC3M, FC3MA, FC3MR, FC44E, FC44EA, FC4E, FC4EA, FC4EHRT, FC4M, FC4MA		

compression springs



<b>GEV No.</b>	511983	<b>Ref. No.</b>	450226
<b>description</b>	compression spring ø 10.55mm L 26mm wire gauge ø 1mm		
<b>For models:</b>	NE02, NE3002, NE4002, NE5002, NE5502, NE7002, NE7502, NE9002, NE9502		



<b>GEV No.</b>	511984	<b>Ref. No.</b>	450220
<b>description</b>	compression spring ø 10mm L 16mm wire gauge ø 1.2mm		
<b>For models:</b>	GMC2702, GMC3502, GMC4502, GMC5502, LAV1001, LAV1501, NG02, NG1202, NG1202E, NG602, NG602E, NG902, NG902E, NL302, NL302E, NL402, NL402E, NL502, NL502E, NL552, NL552E		



<b>GEV No.</b>	511982	<b>Ref. No.</b>	450214
<b>description</b>	compression spring ø 25mm L 83mm wire gauge ø 1.7mm for dosing pump warewashing		
<b>For models:</b>	B10T, B11T, B12T, B13T, B14T, B15T, B15TM, B16T, B16TM, B18T, B18TM, B19T, B19TM, BC25, BC25A, BC25HR, BC30, BC30A, BC30HR, BC30HR380, BC30HRA, BHC25, BHC25-2, BHC25A, BHC25A-2, BHC25S, BHC30, BHC30-2, BHC30A, BHC30A-2, BHC30E, BHC30E-2, BHC30EA, BHC30EA-2, BHC30HR, BHC30HR-2, BHC30HR380, BHC30HRA, BHC30HRA-2, BHC30HRA380, BHC433, BHC433-2, BHC433A, BHC433A-2, BHCHR, BR20, BR20A, BR25, BR25A, C1000E...(Other models you can see in the webshop)		



<b>GEV No.</b>	511323	<b>Ref. No.</b>	450232
<b>description</b>	compression spring ø 41.3mm L 57mm wire gauge ø 2mm		
<b>For models:</b>	BHC25, BHC25-2, BHC25A, BHC25A-2, BHC25S, BHC30, BHC30-2, BHC30A, BHC30A-2, BHC30E, BHC30E-2, BHC30EA, BHC30EA-2, BHC30HR, BHC30HR-2, BHC30HR380, BHC30HRA, BHC30HRA-2, BHC30HRA380, BHC433, BHC433-2, BHC433A, BHC433A-2, BHCHR, GF70, GF70A, LB200, LB200-2, LB200A, LB200A-2, LB215, LB215-2, LB215A, LB215A-2, LB260, LB260-2, LB260A, LB260A-2, LB275, LB275-2, LB275A, LB275A-2, LF321, LF321A, LF322, LF322A, LF322MP, LF322MP-A, LF322RCD, LF324...(Other models you can see in the webshop)		



<b>GEV No.</b>	511376	<b>Ref. No.</b>	450234 H30438
<b>description</b>	compression spring ø 6mm L 25mm wire gauge ø 0.65mm		
<b>For models:</b>	BHC25, BHC25-2, BHC25A, BHC25A-2, BHC25S, BHC30, BHC30-2, BHC30A, BHC30A-2, BHC30E, BHC30E-2, BHC30EA, BHC30EA-2, BHC30HR, BHC30HR-2, BHC30HR380, BHC30HRA, BHC30HRA-2, BHC30HRA380, BHC433, BHC433-2, BHC433A, BHC433A-2, BHCHR, GF70, GF70A, GF90, GF90-2004, GF90A, GF90A-2004		



roller springs

roller springs



1			
<b>GEV No.</b>	511166	<b>Ref. No.</b>	391315
<b>description</b>	roller spring 2kg complete incl. holder		
<b>For models:</b>	AC120, AC150, AC170, AC200, AC2A, ACR, ACR145, ACR205, ACR225, ACR245, ACR260, ACR265, ACR305, ACRS145, ACRS205, ACRS225, ACRS245, ACRS260, ACRS265, ACRS305, GMC, GMC2700, GMC2702, GMC3500, GMC3502, GMC4500, GMC4502, GMC5500, GMC5502, LAV1001, LAV1501, LV1001, LV1501, LV-LVP, LVP1001, LVP1501, NE00, NE3001, NE4001, NE5501, NE7501, NE9001		



1			
<b>GEV No.</b>	511155	<b>Ref. No.</b>	391314
<b>description</b>	roller spring 3kg complete incl. holder		
<b>For models:</b>	AC120, AC150, AC170, AC200, ACR, ACR145, ACR205, ACR225, ACR245, ACR260, ACR265, ACR305, GMC, GMC2700, GMC3500, GMC4500, GMC5500, NE00, NE3001, NE4001, NE5501, NE7501, NE9001		



1			
<b>GEV No.</b>	511663	<b>Ref. No.</b>	391318
<b>description</b>	roller spring 4.5kg complete incl. holder L 125mm W 40mm lug length 125mm		
<b>For models:</b>	AC101, AC122, AC151, AC152, AC181, AC182, AC201, AC202, AC241, AC242, AC91, LAV1001, LAV1501, NE02, NE3001, NE3002, NE4001, NE4002, NE5002, NE5501, NE5502, NE7002, NE7501, NE7502, NE9001, NE9002, NE9502, NG01, NG601, NG601E, NG901, NG901E		

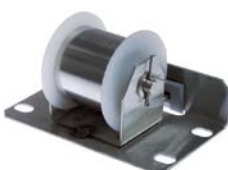

1			
<b>GEV No.</b>	511922	<b>Ref. No.</b>	391309
<b>description</b>	roller spring 4kg complete incl. holder L 125mm W 40mm ID ømm lug length 125mm		
<b>For models:</b>	AC101, AC120, AC122, AC150, AC151, AC152, AC170, AC181, AC182, AC200, AC201, AC202, AC241, AC242, AC91, ACR, ACR145, ACR205, ACR225, ACR245, ACR260, ACR265, ACR305, ACRS145, ACRS205, ACRS225, ACRS245, ACRS260, ACRS265, ACRS305, ACS201, ACS201-DIGIT, ACS202, ACS202-DIGIT, ACS241, ACS241-DIGIT, ACS242, ACS242-DIGIT, G125, G125L, G131, G66, GE125, GL, GMC, GMC2700, GMC2702, GMC3500, GMC3502, GMC4500...(Other models you can see in the webshop)		



1			
<b>GEV No.</b>	511578	<b>Ref. No.</b>	391332
<b>description</b>	roller spring 5.5kg complete incl. holder W 40mm		
<b>For models:</b>	AC101, AC122, AC151, AC152, AC181, AC182, AC201, AC202, AC241, AC242, AC91, ACRS145, ACRS205, ACRS225, ACRS245, ACRS260, ACRS265, ACRS305, GMC2702, GMC3502, GMC4502, GMC5502, LAV1001, LAV1501, NE02, NE3002, NE4002, NE5002, NE5502, NE7002, NE7502, NE9002, NE9502, NG02, NG1202, NG1202E, NG602, NG602E, NG902, NG902E		



1			
<b>GEV No.</b>	511552	<b>Ref. No.</b>	391331
<b>description</b>	roller spring complete incl. holder W 40mm ID ømm lug length 70mm		
<b>For models:</b>	AC101, AC122, AC151, AC152, AC181, AC182, AC201, AC202, AC241, AC242, AC91, ACL100, ACL150, ACS101, ACS101-DIGIT, ACS122, ACS122-DIGIT, ACS151, ACS151-DIGIT, ACS152, ACS152-DIGIT, ACS161-DIGIT, ACS162-DIGIT, ACS181, ACS181-DIGIT, ACS182, ACS182-DIGIT, ACS201, ACS201-DIGIT, ACS202, ACS202-DIGIT, ACS241, ACS241-DIGIT, ACS242, ACS242-DIGIT, ACS91, ACS91-DIGIT, LAV1000, NG02, NG1202, NG1202E, NG602, NG602E, NG902, NG902E, NL302, NL302E, NL402, NL402E, NL502...(Other models you can see in the webshop)		

accessories



1			
<b>GEV No.</b>	512491	<b>Ref. No.</b>	190651
<b>description</b>	guide busching for roller spring L 60mm H 8mm W 20mm suitable for COMENDA		
<b>For models:</b>	AC101, AC122, AC151, AC152, AC181, AC182, AC201, AC202, AC241, AC242, AC2A, AC91, ACL100, ACL150, ACRS145, ACRS205, ACRS225, ACRS245, ACRS260, ACRS265, ACRS305, ACS101, ACS101-DIGIT, ACS122, ACS122-DIGIT, ACS151, ACS151-DIGIT, ACS152, ACS152-DIGIT, ACS161-DIGIT, ACS162-DIGIT, ACS181, ACS181-DIGIT, ACS182, ACS182-DIGIT, ACS201, ACS201-DIGIT, ACS202, ACS202-DIGIT, ACS241, ACS241-DIGIT, ACS242, ACS242-DIGIT, ACS91, ACS91-DIGIT, GMC2702, GMC3502, GMC4502, GMC5502, LAV1000...(Other models you can see in the webshop)		

tension springs



1			
<b>GEV No.</b>	510926	<b>Ref. No.</b>	391312
<b>description</b>	tension spring for hood		
<b>For models:</b>	C30, C70, C75, C75BT, C75M, C75RCD, LP360, LP360BT, LP360RCD		





			
<b>GEV No.</b>	510927	<b>Ref. No.</b>	391313
<b>description</b>	tension spring for hood C34		
<b>For models:</b>	C33, C34		

			
<b>GEV No.</b>	511985	<b>Ref. No.</b>	450203
<b>description</b>	tension spring ø 11mm total length 47mm wire gauge ø 1mm Qty 1 pcs		
<b>For models:</b>	GMC2702, GMC3502, GMC4502, GMC5502, LV1001, LV1501, LV-LVP, LVP1001, LVP1501, NE00, NE3001, NE4001, NE5501, NE7501, NE9001, NG00, NG600, NG600E, NG900, NG900E		

			
<b>GEV No.</b>	511986	<b>Ref. No.</b>	450213
<b>description</b>	tension spring ø 11mm total length 54mm wire gauge ø 1mm Qty 1 pcs		
<b>For models:</b>	NE00, NE3001, NE4001, NE5501, NE7501, NE9001, NG00, NG01, NG600, NG600E, NG601, NG601E, NG900, NG900E, NG901, NG901E		

			
<b>GEV No.</b>	701047	<b>Ref. No.</b>	450229
<b>description</b>	tension spring ø 12mm total length 110mm wire gauge ø 1.2mm		
<b>For models:</b>	NE02, NE3002, NE4002, NE5002, NE5502, NE7002, NE7502, NE9002, NE9502, NG02, NG1202, NG1202E, NG602, NG602E, NG902, NG902E, NL302, NL302E, NL402, NL402E, NL502, NL502E, NL552, NL552E		

			
<b>GEV No.</b>	510228	<b>Ref. No.</b>	450217
<b>description</b>	tension spring ø 12mm total length 165mm wire gauge ø 1mm		
<b>For models:</b>	G100L, G101L, G115, G115L, G50L, G50LM, G51L, G60L, G61L, G65, G65L, GL, LAV1001, LAV1501		

			
<b>GEV No.</b>	510225	<b>Ref. No.</b>	391336
<b>description</b>	tension spring ø 12mm total length 185mm wire gauge ø 1.5mm		
<b>For models:</b>	FC3E, FC3EA, FC3M, FC3MA, FC3MR, FC44E, FC44EA, FC4E, FC4EA, FC4EHRT, FC4M, FC4MA		

			
<b>GEV No.</b>	511565	<b>Ref. No.</b>	391334
<b>description</b>	tension spring ø 13mm total length 190mm wire gauge ø 1.75mm L1 155mm L2 16mm L3 16mm		
<b>For models:</b>	FC3E, FC3EA, FC3M, FC3MA, FC44E, FC44EA, FC4E, FC4EA, FC4EHRT, FC4M, FC4MA		

			
<b>GEV No.</b>	701045	<b>Ref. No.</b>	450222
<b>description</b>	tension spring ø 13mm total length 195mm wire gauge ø 1.2mm		
<b>For models:</b>	G100L, G101L, G115L, GL		

			
<b>GEV No.</b>	510064	<b>Ref. No.</b>	450288
<b>description</b>	tension spring ø 13mm total length 78mm wire gauge ø 2.5mm L1 14mm L2 50mm L3 14mm		
<b>For models:</b>	GF70, GF70A, LF321, LF321A, LF322, LF322A, LF322MP, LF322MP-A, LF322RCD, LF324, LF324A, LF325E, LF325EA, LF700, LF700A		

			
<b>GEV No.</b>	511580	<b>Ref. No.</b>	H34773
<b>description</b>	tension spring ø 16.5mm total length 98mm wire gauge ø 2.5mm for dishwasher		
<b>For models:</b>	GF90, GF90-2004, GF90A, GF90A-2004		

			
<b>GEV No.</b>	510928	<b>Ref. No.</b>	391316
<b>description</b>	tension spring ø 37mm total length 910mm wire gauge ø 5.3mm for hood C85/140-G75		
<b>For models:</b>	C1000E, C1000ERCD, C1001M, C1300E, C1300ERCD, C1301M, C140, C155, C155BT, C155E2, C155RCD, C165, C165E2, C165E2BT, C165E2RCD, C166, C166-2, C85, C95, C95BT, C95E2, C95RCD, G125, G125L, G75, G75L, GE125, GE75, GL, LC1200, LC1200RCD, LC380, LC380BT, LC380RCD, LC400, LC412, LC700, LC700RCD, LC900, LC900RCD, XLC		

## dosing pumps

### peristaltic dosing pumps

GERMAC  
built-in version  
with frequency control













<b>GEV No.</b>	361268	<b>Ref. No.</b>	440632
<b>description</b>	dosing pump GERMAC frequency control 3l/h 230VAC detergent hose ø 4x6mm hose thermoplastic type G300 built-in version dimensions 67x72x101mm		
<b>For models:</b>	BHC25, BHC25-2, BHC25A, BHC25A-2, BHC25S, BHC30, BHC30-2, BHC30A, BHC30A-2, BHC30E, BHC30E-2, BHC30EA, BHC30EA-2, BHC30HR, BHC30HR-2, BHC30HR380, BHC30HRA, BHC30HRA-2, BHC30HRA380, BHC433, BHC433-2, BHC433A, BHC433A-2, BHCHR, FC3E, FC3EA, FC3M, FC3MA, FC3MR, FC44E, FC44EA, FC4E, FC4EA, FC4EHRT, FC4M, FC4MA, FC53LA, GF70, GF70A, LF320L, LF320LA, LF321, LF321A, LF322, LF322A, LF322MP, LF322MP-A, LF322RCD, LF324, LF324A...(Other models you can see in the webshop)		
<b>spare parts for</b>	361268		
	<b>GEV No.</b>	361467	<b>Ref. No.</b> —
	pump hose GERMAC detergent hose type thermoplastic hose ø 6x10mm for model G43/G45/G53/G54/G55/G300/G305		

Table continues overleaf



<b>spare parts for</b> 361268				
	GEV No.	361557	Ref. No.	—
control PCB type G300/G302/G305 GERMAC				
	GEV No.	361589	Ref. No.	—
roller assembly GERMAC suitable for G42/43/45/53/54/55/300/302/305/705				
<b>accessories for</b> 361268				
	GEV No.	361106	Ref. No.	—
container filter with weight and non-return valve SS hose ø 4x6mm ø 21mm L 51mm non return valve lip valve				
	GEV No.	520090	Ref. No.	—
PVC hose ID ø 4mm ED ø 6mm L 2m thickness 1mm t.max. 60°C transparent				
	GEV No.	520091	Ref. No.	—
nylon hose ID ø 4mm ED ø 6mm L 2m thickness 1mm operating p. 10bar burst p. 50bar t.max. 100°C transparent				

<b>spare parts for</b> 361152				
	GEV No.	361815	Ref. No.	—
pump hose detergent hose ø 6x10mm hose ø 4x6mm hose type K hose Santoprene type SEKO				
<b>accessories for</b> 361152				
	GEV No.	361142	Ref. No.	—
mounting set detergent hose type 4x6mm hose length 2m PVC 2x hose/container filter/tank intake transparent				
	GEV No.	520090	Ref. No.	—
PVC hose ID ø 4mm ED ø 6mm L 2m thickness 1mm t.max. 60°C transparent				
	GEV No.	520091	Ref. No.	—
nylon hose ID ø 4mm ED ø 6mm L 2m thickness 1mm operating p. 10bar burst p. 50bar t.max. 100°C transparent				

<b>spare parts</b>				
				
1				
GEV No.	361554	Ref. No.	200608	
description	pump hose GERMAC detergent hose type thermoplastic hose ø 5x8mm for model G200/G250/G252			
For models:	BHC25, BHC25-2, BHC25A, BHC25A-2, BHC25S, BHC30, BHC30-2, BHC30A, BHC30A-2, BHC30E, BHC30E-2, BHC30EA, BHC30EA-2, BHC30HR, BHC30HR-2, BHC30HR380, BHC30HRA, BHC30HRA-2, BHC30HRA380, BHC433, BHC433-2, BHC433A, BHC433A-2, BHCHR, FC53LA, GF70, GF70A, LF320L, LF320LA, LF321, LF321A, LF322, LF322A, LF322MP, LF322MP-A, LF322RCD, LF324, LF324A, LF325E, LF325EA, LF400A, LF700, LF700A, LFD32E, LFD32EA, LFD32M, LFD32MA			

<b>piston pumps</b>				
<b>spare parts</b>				
				
1				
GEV No.	510298	Ref. No.	200444	
description	lip valve dosing pump suitable for DB2/DS5			

<b>SEKO</b>				
built-in version				
without control				
				
1				
GEV No.	361152 <sup>1</sup>	Ref. No.	440627	
description	dosing pump SEKO without control 3l/h 230VAC detergent hose ø 4x6mm hose type K hose Santoprene suction level 1.5m horizontal/vertical type PG built-in version dimensions 67x95x52mm			
For models:	FC, FCHR, FCHRA, FCHRT, FCHRTA			
<b>spare parts for</b> 361152				
	GEV No.	361136	Ref. No.	—
roller assembly for dosing pump hole ø 4.8x4mm				
	GEV No.	361562	Ref. No.	—
pump cover for dosing pump yellow				

<sup>1</sup>with accessories

<b>membrane dosing pumps</b>				
<b>self-priming</b>				
<b>various</b>				
				
1				
GEV No.	361015	Ref. No.	N/A	
description	dosing pump membrane dosing pump rinse aid inlet 6x8mm outlet 4x6mm pressure connection ø 4x6mm suction connection ø 6x8mm			
<b>spare parts for</b> 361015				
	GEV No.	361132	Ref. No.	—
membrane dosing pump				
	GEV No.	510298	Ref. No.	200444
lip valve dosing pump suitable for DB2/DS5				

			
1			
<b>GEV No.</b>	361002	<b>Ref. No.</b>	620120
<b>description</b>	dosing pump rinse aid inlet 6x8mm outlet 4x6mm pressure connection ø 4x6mm suction connection ø 6x8mm		
<b>For models:</b>	B10T, B11T, B12T, B13T, B14T, B15, B15T, B15TM, B16, B16T, B16TM, B18, B18T, B18TM, B19, B19T, B19TM, B20, B20D, B23, B24, B25, B26, B27, B31, B32, B41, B42, BC25, BC25A, BC25HR, BC30, BC30A, BC30HR, BC30HR380, BC30HRA, BHC25, BHC25-2, BHC25A, BHC25A-2, BHC25S, BHC30, BHC30-2, BHC30A, BHC30A-2, BHC30E, BHC30E-2, BHC30EA, BHC30EA-2, BHC30HR...(Other models you can see in the webshop)		
<b>spare parts for</b>	361002		
	<b>GEV No.</b>	510297	<b>Ref. No.</b> 630614
	membrane for dosing pump ED ø 83mm thickness 1mm dosing pump equiv. no. 630614 suitable for COMENDA		
	<b>GEV No.</b>	510298	<b>Ref. No.</b> 200444
	lip valve dosing pump suitable for DB2/DS5		
	<b>GEV No.</b>	510299	<b>Ref. No.</b> 180306
	hose connector for dosing pump		
	<b>GEV No.</b>	510338	<b>Ref. No.</b> 170701
	union nut dosing pump thread 1/2" ø 32mm H 15mm for dosing pump		
	<b>GEV No.</b>	510847	<b>Ref. No.</b> 440405
	gasket polishing agent dosing ID ø 22mm ED ø 32mm external height 5mm		
	<b>GEV No.</b>	510870	<b>Ref. No.</b> 191018
	filter support for dosing pump		
	<b>GEV No.</b>	510916	<b>Ref. No.</b> 330543
	filter for dosing pump		

spare parts

			
1			
<b>GEV No.</b>	510916	<b>Ref. No.</b>	330543
<b>description</b>	filter for dosing pump		
<b>For models:</b>	B10T, B11T, B12T, B13T, B14T, B15T, B15TM, B16T, B16TM, B18T, B18TM, B19T, B19TM, BC25, BC25A, BC25HR, BC30, BC30A, BC30HR, BC30HR380, BC30HRA, BHC25, BHC25-2, BHC25A, BHC25A-2, BHC25S, BHC30, BHC30-2, BHC30A, BHC30A-2, BHC30E, BHC30E-2, BHC30EA, BHC30EA-2, BHC30HR, BHC30HR-2, BHC30HR380, BHC30HRA, BHC30HRA-2, BHC30HRA380, BHC433, BHC433-2, BHC433A, BHC433A-2, BHCHR, BR20, BR20A, BR25, BR25A, C1000E...(Other models you can see in the webshop)		

			
1			
<b>GEV No.</b>	510870	<b>Ref. No.</b>	191018
<b>description</b>	filter support for dosing pump		
<b>For models:</b>	B10T, B11T, B12T, B13T, B14T, B15T, B15TM, B16T, B16TM, B18T, B18TM, B19T, B19TM, BC25, BC25A, BC25HR, BC30, BC30A, BC30HR, BC30HR380, BC30HRA, BHC25, BHC25-2, BHC25A, BHC25A-2, BHC25S, BHC30, BHC30-2, BHC30A, BHC30A-2, BHC30E, BHC30E-2, BHC30EA, BHC30EA-2, BHC30HR, BHC30HR-2, BHC30HR380, BHC30HRA, BHC30HRA-2, BHC30HRA380, BHC433, BHC433-2, BHC433A, BHC433A-2, BHCHR, BR20, BR20A, BR25, BR25A, C1000E...(Other models you can see in the webshop)		

			
1			
<b>GEV No.</b>	510847	<b>Ref. No.</b>	440405
<b>description</b>	gasket polishing agent dosing ID ø 22mm ED ø 32mm external height 5mm		
<b>For models:</b>	B10T, B11T, B12T, B13T, B14T, B15T, B15TM, B16T, B16TM, B18T, B18TM, B19T, B19TM, BC25, BC25A, BC25HR, BC30, BC30A, BC30HR, BC30HR380, BC30HRA, BHC25, BHC25-2, BHC25A, BHC25A-2, BHC25S, BHC30, BHC30-2, BHC30A, BHC30A-2, BHC30E, BHC30E-2, BHC30EA, BHC30EA-2, BHC30HR, BHC30HR-2, BHC30HR380, BHC30HRA, BHC30HRA-2, BHC30HRA380, BHC433, BHC433-2, BHC433A, BHC433A-2, BHCHR, BR20, BR20A, BR25, BR25A, C1000E...(Other models you can see in the webshop)		



			
1			
<b>GEV No.</b>	510298	<b>Ref. No.</b>	200444
<b>description</b>	lip valve dosing pump suitable for DB2/DS5		

			
1			
<b>GEV No.</b>	510297	<b>Ref. No.</b>	630614
<b>description</b>	membrane for dosing pump ED ø 83mm thickness 1mm dosing pump equiv. no. 630614 suitable for COMENDA		
<b>For models:</b>	B10T, B11T, B12T, B13T, B14T, B15T, B15TM, B16T, B16TM, B18T, B18TM, B19T, B19TM, BC25, BC25A, BC25HR, BC30, BC30A, BC30HR, BC30HR380, BC30HRA, BHC25, BHC25-2, BHC25A, BHC25A-2, BHC25S, BHC30, BHC30-2, BHC30A, BHC30A-2, BHC30E, BHC30E-2, BHC30EA, BHC30EA-2, BHC30HR, BHC30HR-2, BHC30HR380, BHC30HRA, BHC30HRA-2, BHC30HRA380, BHC433, BHC433-2, BHC433A, BHC433A-2, BHCHR, BR20, BR20A, BR25, BR25A, C1000E...(Other models you can see in the webshop)		

			
1			
<b>GEV No.</b>	510229	<b>Ref. No.</b>	180420
<b>description</b>	T-piece dosing pump ø 28mm L 70mm		
<b>For models:</b>	C1000ERCD, C1300ERCD, FC3M, FC3MR, FC4M, GE50RCD, GE60RCD, GE65RCD, LC1200RCD, LC700RCD, LC900RCD, XLC		



 <p>1</p>			
<b>GEV No.</b>	510338	<b>Ref. No.</b>	170701
<b>description</b>	union nut dosing pump thread 1/2" ø 32mm H 15mm for dosing pump		
<b>For models:</b>	B10T, B11T, B12T, B13T, B14T, B15T, B15TM, B16T, B16TM, B18T, B18TM, B19T, B19TM, BC25, BC25A, BC25HR, BC30, BC30A, BC30HR, BC30HR380, BC30HRA, BHC25, BHC25-2, BHC25A, BHC25A-2, BHC25S, BHC30, BHC30-2, BHC30A, BHC30A-2, BHC30E, BHC30E-2, BHC30EA, BHC30EA-2, BHC30HR, BHC30HR-2, BHC30HR380, BHC30HRA, BHC30HRA-2, BHC30HRA380, BHC433, BHC433-2, BHC433A, BHC433A-2, BHCHR, BR20, BR20A, BR25, BR25A, C1000E...(Other models you can see in the webshop)		

<b>accessories for</b>	361010		
	<b>GEV No.</b>	520090	<b>Ref. No.</b> —
	PVC hose ID ø 4mm ED ø 6mm L 2m thickness 1mm t.max. 60°C transparent		
	<b>GEV No.</b>	520091	<b>Ref. No.</b> —
	nylon hose ID ø 4mm ED ø 6mm L 2m thickness 1mm operating p. 10bar burst p. 50bar t.max. 100°C transparent		

self-priming with supporting pressure



<b>ELETTROBAR</b>			
 <p>1</p>			
<b>GEV No.</b>	510298	<b>Ref. No.</b>	200444
<b>description</b>	lip valve dosing pump suitable for DB2/DS5		



<b>GEV No.</b>	361387	<b>Ref. No.</b>	620736 H35388
<b>description</b>	dosing pump rinse aid pressure connection ø 8mm suction connection ø 4mm auxiliary pressure connection 10mm		
<b>For models:</b>	FC3E, FC3EA, FC3MA, FC44E, FC44EA, FC4E, FC4EA, FC4EHRT, FC4MA, GF70, GF70A, GF90-2004, GF90A-2004		



GERMAC

<b>spare parts</b>			
 <p>1</p>			
<b>GEV No.</b>	510298	<b>Ref. No.</b>	200444
<b>description</b>	lip valve dosing pump suitable for DB2/DS5		

<b>spare parts for</b>	361387		
	<b>GEV No.</b>	361383	<b>Ref. No.</b> 200444 200942
	lip valve rinse aid pressure connection ømm suction connection ømm auxiliary pressure connectionmm		
	<b>GEV No.</b>	361384	<b>Ref. No.</b> 630632
	membrane rinse aid pressure connection ømm suction connection ømm auxiliary pressure connectionmm		
	<b>GEV No.</b>	508008	<b>Ref. No.</b> —
	O-ring EPDM thickness 2.62mm ID ø 15.88mm Qty 1 pcs		

HOONVED

 <p>1</p>			
<b>GEV No.</b>	361010	<b>Ref. No.</b>	620788
<b>description</b>	dosing pump rinse aid pressure connection ø 4x6mm suction connection ø 4mm auxiliary pressure connection 10mm HOONVED		
<b>For models:</b>	C1000ERCD, C1300ERCD, C155BT, C155RCD, C165E2BT, C165E2RCD, C75BT, C75RCD, C95BT, C95RCD, FC53CBT, FC53LBT, FC54CBT, FC54LBT, GE50RCD, GF90, GF90A, LC1200RCD, LC380BT, LC380RCD, LC700RCD, LC900RCD, LF320CBT, LF320LBT, LF322RCD, LP360BT, LP360RCD, XLC		
<b>spare parts for</b>	361010		
	<b>GEV No.</b>	361383	<b>Ref. No.</b> 200444 200942
	lip valve rinse aid pressure connection ømm suction connection ømm auxiliary pressure connectionmm		
	<b>GEV No.</b>	361384	<b>Ref. No.</b> 630632
	membrane rinse aid pressure connection ømm suction connection ømm auxiliary pressure connectionmm		

<b>accessories for</b>	361387		
	<b>GEV No.</b>	520022	<b>Ref. No.</b> —
	PVC hose ID ø 8mm ED ø 12mm L 10m thickness 2mm t.max. 60°C transparent		
	<b>GEV No.</b>	520090	<b>Ref. No.</b> —
	PVC hose ID ø 4mm ED ø 6mm L 2m thickness 1mm t.max. 60°C transparent		

 <p>1</p>			
<b>GEV No.</b>	361383	<b>Ref. No.</b>	200444 200942
<b>description</b>	lip valve rinse aid pressure connection ømm suction connection ømm auxiliary pressure connectionmm		
<b>For models:</b>	C1000ERCD, C1300ERCD, C155BT, C155RCD, C165E2BT, C165E2RCD, C75BT, C75RCD, C95BT, C95RCD, FC3E, FC3EA, FC3MA, FC44E, FC44EA, FC4E, FC4EA, FC4EHRT, FC4MA, FC53CBT, FC53LBT, FC54CBT, FC54LBT, GE50RCD, GF70, GF70A, GF90, GF90-2004, GF90A, GF90A-2004, LC1200RCD, LC380BT, LC380RCD, LC700RCD, LC900RCD, LF320CBT, LF320LBT, LF322RCD, LP360BT, LP360RCD, XLC		



<b>GEV No.</b>	361384	<b>Ref. No.</b>	630632
<b>description</b>	membrane rinse aid pressure connection ømm suction connection ømm auxiliary pressure connectionmm		
<b>For models:</b>	C1000ERCD, C1300ERCD, C155BT, C155RCD, C165E2BT, C165E2RCD, C75BT, C75RCD, C95BT, C95RCD, FC3E, FC3EA, FC3MA, FC44E, FC44EA, FC4E, FC4EA, FC4EHR, FC4MA, FC53CBT, FC53LBT, FC54CBT, FC54LBT, GE50RCD, GF70, GF70A, GF90, GF90-2004, GF90A, GF90A-2004, LC1200RCD, LC380BT, LC380RCD, LC700RCD, LC900RCD, LF320CBT, LF320LBT, LF322RCD, LP360BT, LP360RCD, XLC		

## accessories

### container filters



<b>GEV No.</b>	361062	<b>Ref. No.</b>	N/A
<b>description</b>	container filter hose ø 4mm		

### container filters with non-return valve



<b>GEV No.</b>	361058	<b>Ref. No.</b>	180726 18719
<b>description</b>	container filter with non-return valve SS hose ø 4x6mm ø 20mm L 56mm		
<b>For models:</b>	BHC25, BHC25-2, BHC25A, BHC25A-2, BHC25S, BHC30, BHC30-2, BHC30A, BHC30A-2, BHC30E, BHC30E-2, BHC30EA, BHC30EA-2, BHC30HR, BHC30HR-2, BHC30HR380, BHC30HRA, BHC30HRA-2, BHC30HRA380, BHC433, BHC433-2, BHC433A, BHC433A-2, BHCHR, FC3E, FC3EA, FC3M, FC3MA, FC3MR, FC44E, FC44EA, FC4E, FC4EA, FC4EHR, FC4M, FC4MA, FC53LA, LF320L, LF320LA, LF321, LF321A, LF322, LF322A, LF322MP, LF322MP-A, LF322RCD, LF324, LF324A, LF325E, LF325EA...(Other models you can see in the webshop)		

### intake lances



<b>GEV No.</b>	361118	<b>Ref. No.</b>	180719
<b>description</b>	intake lance with filter L 415mm ø 17mm tube ø 10mm hose ø 4x6mm cable lengthmm PVC		
<b>For models:</b>	BC25, BC25A, BC25HR, BC30, BC30A, BC30HR, BC30HR380, BC30HRA, BR20, BR20A, BR25, BR25A, F90M, F90MA, FC, FC43, FC43A, FC53, FC533, FC533A, FC53A, FC53CBT, FC53LBT, FC54, FC543, FC543A, FC543E, FC543EA, FC544, FC544A, FC54A, FC54CBT, FC54E, FC54EA, FC54LBT, FCHR, FCHRA, FCHRT, FCHRTA, LF315, LF320, LF320A, LF320CBT, LF320LA, LF320LBT, LF323, LF323A, LF350, LF350A, LF450...(Other models you can see in the webshop)		

## hoses

### silicone hoses



<b>GEV No.</b>	361609	<b>Ref. No.</b>	200130
<b>description</b>	silicone hose ID ø 5mm ED ø 8mm L 5m thickness 1.5mm operating pressure without pressure burst pressure non defined t.max. 200°C transparent dosing Qty 5m for peristaltic pump Shore A 55°		
<b>For models:</b>	BC25, BC25A, BC25HR, BC30, BC30A, BC30HR, BC30HR380, BC30HRA, BHC30E, BHC30EA, BR20, BR20A, BR25, BR25A, FC43, FC43A, LB200, LB200-2, LB215, LB215-2, LB215A, LB260, LB260-2, LB275, LB275-2, LB275A, LF315, LF320, LF320A, LF320LA, LF323, LF323A, LF350, LF350A, LF450, LF450A, LS550		

### tank inlets



<b>GEV No.</b>	361270	<b>Ref. No.</b>	180308 251213
<b>description</b>	tank inlet SS M12 hose ø 4mm		
<b>For models:</b>	BC25, BC25A, BC25HR, BC30, BC30A, BC30HR, BC30HR380, BC30HRA, BHC25, BHC25-2, BHC25A, BHC25A-2, BHC25S, BHC30, BHC30-2, BHC30A, BHC30A-2, BHC30E, BHC30E-2, BHC30EA, BHC30EA-2, BHC30HR, BHC30HR-2, BHC30HR380, BHC30HRA, BHC30HRA-2, BHC30HRA380, BHC433, BHC433-2, BHC433A, BHC433A-2, BHCHR, BR20, BR20A, BR25, BR25A, C166-2, F90M, F90MA, FC, FC3E, FC3EA, FC3M, FC3MA, FC3MR, FC43, FC43A, FC44E, FC44EA, FC4E...(Other models you can see in the webshop)		



<b>GEV No.</b>	510816	<b>Ref. No.</b>	180308
<b>description</b>	tank inlet stainless steel M10 hose ø 4mm		
<b>For models:</b>	BC25HR, BC30HR, BC30HR380, BC30HRA, FC, FCHR, FCHRA, FCHRT, FCHRTA		





hoses

supply hoses

stainless steel flexi hoses

universal hoses

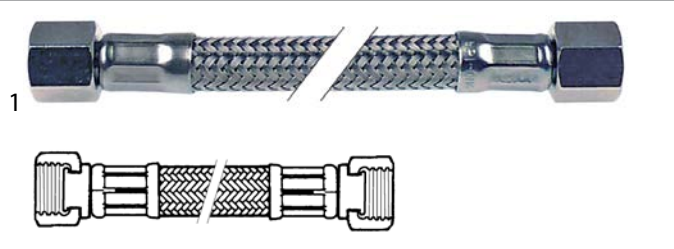

<b>GEV No.</b>	520627	<b>Ref. No.</b>	200715
<b>description</b>	flex hose SS braid straight-straight DN12 connections 3/4" L 2000mm approval DVGW operating p. 10bar test pressure 32bar burst p. 95bar		
<b>For models:</b>	B31, B32, C1000E, C1000ERCD, C1001M, C1300E, C1300ERCD, C1301M, C140, C155, C155BT, C155E2, C155RCD, C165, C165E2, C165E2BT, C165E2RCD, C166, C166-2, C30, C33, C34, C70, C75, C75BT, C75M, C75RCD, C85, C95, C95BT, C95E2, C95RCD, F2, F3, F300, F45, F55, F65, F80, F90M, F90MA, FC, FC3E, FC3EA, FC3M, FC3MA, FC3MR, FC44E, FC44EA, FC4E...(Other models you can see in the webshop)		

drain hoses

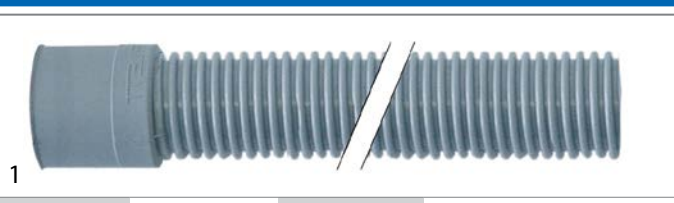

<b>GEV No.</b>	530587	<b>Ref. No.</b>	200721
<b>description</b>	drain hose DN28 L 2000mm straight $\phi$ inside 32mm straight ext. $\phi$ 40mm outer hose $\phi$ 35mm		
<b>For models:</b>	AC151, AC152, ACS151, ACS151-DIGIT, ACS152, ACS152-DIGIT, B13T, B14T, B15, B15T, B15TM, B16, B16T, B16TM, B18, B18T, B18TM, B19, B19T, B19TM, B41, B42, C1000E, C1000ERCD, C1001M, C1300E, C1300ERCD, C1301M, C140, C155, C155BT, C155E2, C155RCD, C165, C165E2, C165E2BT, C165E2RCD, C166, C166-2, C75, C75BT, C75RCD, C85, C95, C95BT, C95E2, C95RCD, F2, F20, F3...(Other models you can see in the webshop)		

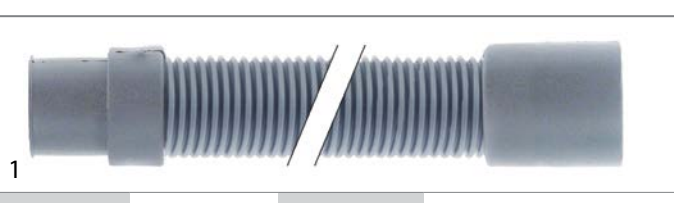

<b>GEV No.</b>	530607	<b>Ref. No.</b>	200779
<b>description</b>	drain hose DN24 L 2000mm A int. $\phi$ 24mm A ext. $\phi$ 28mm B int. $\phi$ 28mm B ext. $\phi$ 35mm outer hose $\phi$ 29mm temp.-resist. 90°C		
<b>For models:</b>	BC25, BC25A, BC30, BC30A, BHC25, BHC25-2, BHC25A, BHC25A-2, BHC25S, BHC30, BHC30-2, BHC30A, BHC30A-2, BHC30E, BHC30E-2, BHC30EA, BHC30EA-2, BHC30HR-2, BHC30HRA-2, BHC433, BHC433-2, BHC433A, BHC433A-2, BR20, BR20A, BR25, BR25A, FC3M, FC3MR, FC43, FC43A, FC4M, GF70, GF70A, LB200, LB200-2, LB200A, LB200A-2, LB215, LB215-2, LB215A, LB215A-2, LB260, LB260-2, LB260A, LB260A-2, LB275, LB275-2, LB275A, LB275A-2...(Other models you can see in the webshop)		

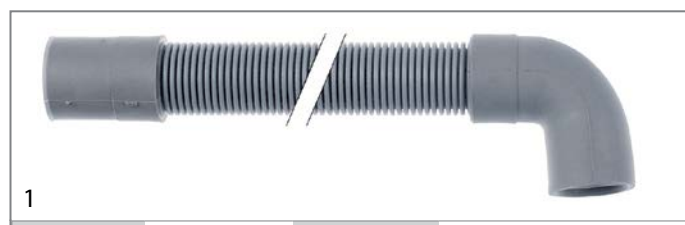

<b>GEV No.</b>	530613	<b>Ref. No.</b>	200346
<b>description</b>	drain hose DN19 L 3000mm straight $\phi$ inside 21mm straight ext. $\phi$ 27mm elbow $\phi$ inside 21mm elbow ext. $\phi$ 27mm outer hose $\phi$ 20mm		
<b>For models:</b>	B10T, B11T, B12T, B24, B25, B26, B27, BC25HR, BC30HR, BC30HR380, BC30HRA, BHC25, BHC25-2, BHC25A, BHC25A-2, BHC25S, BHC30, BHC30-2, BHC30A, BHC30A-2, BHC30E, BHC30E-2, BHC30EA, BHC30EA-2, BHC30HR, BHC30HR-2, BHC30HR380, BHC30HRA, BHC30HRA-2, BHC30HRA380, BHC433, BHC433-2, BHC433A, BHC433A-2, BHCHR, C1000E, C1300E, F90M, F90MA, FC, FC3E, FC3EA, FC3M, FC3MA, FC3MR, FC43, FC44E, FC44EA, FC4E, FC4EA...(Other models you can see in the webshop)		

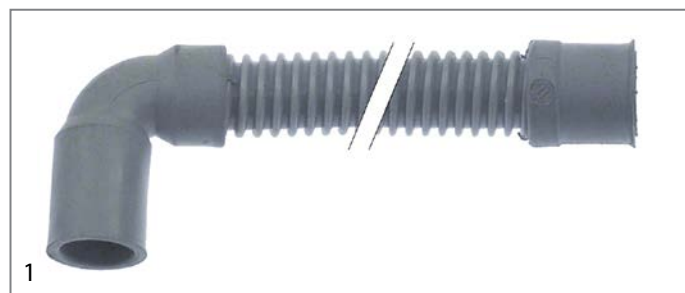

<b>GEV No.</b>	524819	<b>Ref. No.</b>	200303
<b>description</b>	drain hose DN20 L 720mm straight $\phi$ inside 21mm straight ext. $\phi$ 28mm elbow $\phi$ inside 21mm elbow ext. $\phi$ 28mm outer hose $\phi$ 25mm		
<b>For models:</b>	FC3E, FC3EA, FC44E, FC44EA, FC4E, FC4EA, FC4EHR		

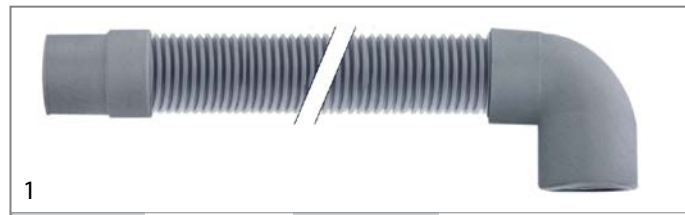

<b>GEV No.</b>	530572	<b>Ref. No.</b>	N/A
<b>description</b>	drain hose DN24 L 2000mm straight $\phi$ inside 24mm straight ext. $\phi$ 29mm elbow $\phi$ inside 29mm elbow ext. $\phi$ 35mm outer hose $\phi$ 29mm		

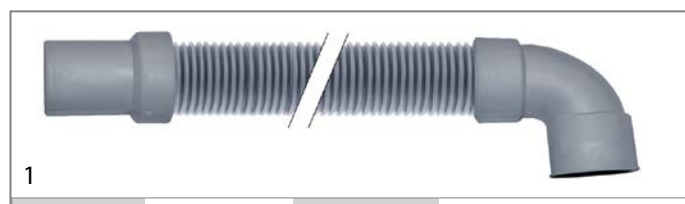

<b>GEV No.</b>	530069	<b>Ref. No.</b>	200794
<b>description</b>	drain hose DN24 L 2000mm straight $\phi$ inside 32mm straight ext. $\phi$ 35mm elbow $\phi$ inside 40mm elbow ext. $\phi$ 46mm outer hose $\phi$ 38mm		



industrial hoses

Niplaflex hoses



<b>GEV No.</b>	530561	<b>Ref. No.</b>	200122
<b>description</b>	pressure hose ID ø 10mm ED ø 17mm L 5m thickness 3.5mm operating p. 10bar burst p. 30bar t.max. 110°C		



<b>GEV No.</b>	530562	<b>Ref. No.</b>	200122
<b>description</b>	pressure hose ID ø 13mm ED ø 21mm L 5m operating p. 10bar burst p. 30bar t.max. 110°C		

pressure control hoses



<b>GEV No.</b>	530583	<b>Ref. No.</b>	200353
<b>description</b>	pressure control hose ID ø 4.5mm ED ø 10mm L 245mm		
<b>For models:</b>	AC100, AC90, B10, B10T, B11, B11T, B12, B12T, B20, B20D, B23, B24, B25, B26, B27, B31, B32, C30, C33, C34, G100L, G101L, G115, G115L, G125, G125L, G131, G50L, G50LM, G51L, G60L, G61L, G65, G65L, G66, G75, G75L, GE125, GE75, GL, LBC210, LBC215, LBC215A, LBC275, LBC275A, LBR, LBR200, LBR215, LBR215A, LC380...(Other models you can see in the webshop)		



<b>GEV No.</b>	530560	<b>Ref. No.</b>	160121
<b>description</b>	pressure control hose ID ø 5mm ED ø 9mm L 5m operating p. 30bar burst p. 90bar temp.-resist. 60°C		
<b>For models:</b>	B13T, B14T, B15T, B15TM, B16T, B16TM, B18T, B18TM, B19T, B19TM, BHC25, BHC25-2, BHC25A, BHC25A-2, BHC25S, BHC30, BHC30-2, BHC30A, BHC30A-2, BHC30E, BHC30E-2, BHC30EA, BHC30EA-2, BHC433, BHC433-2, BHC433A, BHC433A-2, C1000ERCD, C1300ERCD, C140, C155BT, C155RCD, C165E2BT, C165E2RCD, C166-2, C70, C75, C75BT, C75M, C75RCD, C85, C95BT, C95RCD, F20, F45, F55, F65, F80, F90M, F90MA...(Other models you can see in the webshop)		

PVC hoses



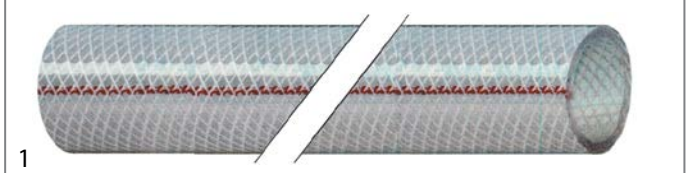



PVC braided hoses



<b>GEV No.</b>	520018	<b>Ref. No.</b>	200129
<b>description</b>	PVC braided hose ID ø 4mm ED ø 10mm L 5m thickness 3mm operating p. 10bar burst p. 30bar t.max. 60°C transparent Qty 5m		
<b>For models:</b>	AC120, AC122, AC150, AC151, AC152, AC170, AC181, AC182, AC200, AC201, AC202, AC241, AC242, ACR, ACR145, ACR205, ACR225, ACR245, ACR260, ACR265, ACR305, GMC, GMC2700, GMC3500, GMC4500, GMC5500, LAV1000, LV1001, LV1501, LV-LVP, LVP1001, LVP1501, NE02, NE3001, NE3002, NE4001, NE4002, NE5002, NE5501, NE5502, NE7002, NE7501, NE7502, NE9001, NE9002, NE9502, NG01, NG02, NG1202, NG1202E...(Other models you can see in the webshop)		

PVC hoses without fabric



<b>GEV No.</b>	520026	<b>Ref. No.</b>	160105	
<b>description</b>	PVC hose ID ø 4mm ED ø 6mm L 10m thickness 1mm t.max. 60°C transparent			
<b>For models:</b>	B10T, B11T, B12T, B13T, B14T, B15T, B15TM, B16T, B16TM, B18T, B18TM, B19T, B19TM, B20, B20D, B23, B24, B25, B26, B27, B31, B32, B41, B42, BC25, BC25A, BC25HR, BC30, BC30A, BC30HR, BC30HR380, BC30HRA, BHC25, BHC25-2, BHC25A, BHC25A-2, BHC25S, BHC30, BHC30-2, BHC30A, BHC30A-2, BHC30E-2, BHC30EA-2, BHC30HR, BHC30HR-2, BHC30HR380, BHC30HRA, BHC30HRA-2, BHC30HRA380, BHC433...(Other models you can see in the webshop)			
<b>accessories for</b>	520026			
	<b>GEV No.</b>	361058	<b>Ref. No.</b>	180726 18719
	container filter with non-return valve SS hose ø 4x6mm ø 20mm L 56mm			
	<b>GEV No.</b>	361066	<b>Ref. No.</b>	—
	container filter straight SS hose ø 4x6mm L 37mm non return valve ball valve			
	<b>GEV No.</b>	361106	<b>Ref. No.</b>	—
	container filter with weight and non-return valve SS hose ø 4x6mm ø 21mm L 51mm non return valve lip valve			
	<b>GEV No.</b>	361141	<b>Ref. No.</b>	—
	container filter with weight ceramic hose ø 4mm			
	<b>GEV No.</b>	361230	<b>Ref. No.</b>	—
	container filter with weight stainless steel hose ø 4x6mm			
	<b>GEV No.</b>	361462	<b>Ref. No.</b>	—
	container filter with weight SS hose ø 4x6mm			
	<b>GEV No.</b>	361728	<b>Ref. No.</b>	—
	container filter with 4m 4x6 hose SS hose ø 4x6mm hose length 4000mm			



hoses wire reinforced



<b>GEV No.</b>	530218	<b>Ref. No.</b>	200121
<b>description</b>	drain hose ID ø 45mm ED ø 55mm wire reinforced		
<b>For models:</b>	ACL100, ACL150, ACRS145, ACRS205, ACRS225, ACRS245, ACRS260, ACRS265, ACRS305, ACS181, ACS181-DIGIT, ACS182, ACS182-DIGIT, ACS201, ACS201-DIGIT, ACS202, ACS202-DIGIT, ACS241, ACS241-DIGIT, ACS242, ACS242-DIGIT, GMC2702, GMC3502, GMC4502, GMC5502, LAV1001, LAV1501		

silicone hoses  
without fabric



<b>GEV No.</b>	361609	<b>Ref. No.</b>	200130
<b>description</b>	silicone hose ID ø 5mm ED ø 8mm L 5m thickness 1.5mm operating pressure without pressure burst pressure non defined t.max. 200°C transparent dosing Qty 5m for peristaltic pump Shore A 55°		
<b>For models:</b>	BC25, BC25A, BC25HR, BC30, BC30A, BC30HR, BC30HR380, BC30HRA, BHC30E, BHC30EA, BR20, BR20A, BR25, BR25A, FC43, FC43A, LB200, LB200-2, LB215, LB215-2, LB215A, LB260, LB260-2, LB275, LB275-2, LB275A, LF315, LF320, LF320A, LF320LA, LF323, LF323A, LF350, LF350A, LF450, LF450A, LS550		

for peristaltic pumps



<b>GEV No.</b>	361609	<b>Ref. No.</b>	200130
<b>description</b>	silicone hose ID ø 5mm ED ø 8mm L 5m thickness 1.5mm operating pressure without pressure burst pressure non defined t.max. 200°C transparent dosing Qty 5m for peristaltic pump Shore A 55°		
<b>For models:</b>	BC25, BC25A, BC25HR, BC30, BC30A, BC30HR, BC30HR380, BC30HRA, BHC30E, BHC30EA, BR20, BR20A, BR25, BR25A, FC43, FC43A, LB200, LB200-2, LB215, LB215-2, LB215A, LB260, LB260-2, LB275, LB275-2, LB275A, LF315, LF320, LF320A, LF320LA, LF323, LF323A, LF350, LF350A, LF450, LF450A, LS550		

formed hoses

straight



<b>GEV No.</b>	530598	<b>Ref. No.</b>	200318
<b>description</b>	formed hose		
<b>For models:</b>	G100L, G101L, G50L, G51L, G60L, G61L, GL, LV1001, LV1501, LV-LVP, LVP1001, LVP1501, NE00, NE02, NE3001, NE4001, NE4002, NE5501, NE5502, NE7501, NE7502, NE9001, NE9502, NG01, NG601, NG601E, NG901, NG901E, NL402, NL402E, NL552, NL552E		



<b>GEV No.</b>	511347	<b>Ref. No.</b>	200369
<b>description</b>	formed hose D1 ø 36mm D2 ø 28mm L 45mm dishwasher straight equiv. no. 200369		
<b>For models:</b>	B10, B10T, B11, B11T, B12, B12T, B24, B25, B26, B27, LBR, LBR200, LBR215, LBR215A		

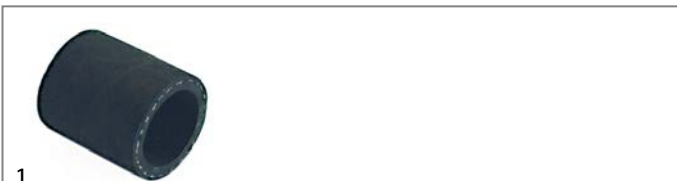

<b>GEV No.</b>	511343	<b>Ref. No.</b>	200319
<b>description</b>	formed hose dishwasher straight		
<b>For models:</b>	B20, B20D, B23, B24, B25, B26, B27		





<b>GEV No.</b>	511584	<b>Ref. No.</b>	200757
<b>description</b>	formed hose dishwasher straight equiv. no. 200757		
<b>For models:</b>	C85		





<b>GEV No.</b>	511362	<b>Ref. No.</b>	200758
<b>description</b>	formed hose dishwasher straight equiv. no. 200758		
<b>For models:</b>	AC135, C140, LC380, LC380BT, LC380RCD, LC400		

			
<b>GEV No.</b>	511366	<b>Ref. No.</b>	200759
<b>description</b>	formed hose dishwasher straight equiv. no. 200759		
<b>For models:</b>	AC120, AC122, AC152, AC170, AC182, AC200, AC202, AC242, ACR, ACR145, ACR205, ACR225, ACR245, ACR260, ACR265, ACR305, ACR5145, ACR5205, ACR5225, ACR5245, ACR5260, ACR5265, ACR5305, ACS122, ACS122-DIGIT, ACS152, ACS152-DIGIT, ACS162-DIGIT, ACS182, ACS182-DIGIT, ACS202, ACS202-DIGIT, ACS242, ACS242-DIGIT, C1000ERCD, C1300ERCD, C155BT, C155RCD, C165E2BT, C165E2RCD, C75BT, C75RCD, C95BT, C95RCD, FC53CBT, FC53LBT, FC54CBT, FC54LBT, GMC, GMC2700...(Other models you can see in the webshop)		

			
<b>GEV No.</b>	511350	<b>Ref. No.</b>	200776
<b>description</b>	formed hose dishwasher straight equiv. no. 200776		
<b>For models:</b>	BC25, BC25A, BC25HR, BC30, BC30A, BC30HR, BC30HR380, BC30HRA, FC43, FC43A		

			
<b>GEV No.</b>	506412	<b>Ref. No.</b>	200105
<b>description</b>	formed hose dishwasher straight hose ext. ø 60mm hose int. ø 50mm		
<b>For models:</b>	AC100, AC101, AC105, AC120, AC122, AC135, AC150, AC151, AC152, AC170, AC181, AC182, AC200, AC201, AC202, AC241, AC242, AC2A, AC90, AC91, AC95, ACL100, ACL150, ACR, ACR145, ACR205, ACR225, ACR245, ACR260, ACR265, ACR305, ACR5145, ACR5205, ACR5225, ACR5245, ACR5260, ACR5265, ACR5305, ACS101, ACS101-DIGIT, ACS122, ACS122-DIGIT, ACS151, ACS151-DIGIT, ACS152, ACS152-DIGIT, ACS161-DIGIT, ACS162-DIGIT, ACS181, ACS181-DIGIT...(Other models you can see in the webshop)		

			
<b>GEV No.</b>	511598	<b>Ref. No.</b>	201072
<b>description</b>	formed hose hose ext. ø 35mm hose int. ø 28mm L 68mm black Qty 1		
<b>For models:</b>	C1000ERCD, C1300ERCD, FC3MA, FC4MA, LC1200RCD, LC700RCD, LC900RCD		

<p>form L</p> 			
<b>GEV No.</b>	530054	<b>Ref. No.</b>	200767 201061
<b>description</b>	formed hose		
<b>For models:</b>	AC105, AC120, AC122, AC135, AC150, AC151, AC152, AC170, AC181, AC182, AC200, AC201, AC202, AC241, AC242, AC95, ACR, ACR145, ACR205, ACR225, ACR245, ACR260, ACR265, ACR305, ACS101, ACS101-DIGIT, ACS122, ACS122-DIGIT, ACS151, ACS151-DIGIT, ACS152, ACS152-DIGIT, ACS161-DIGIT, ACS162-DIGIT, ACS181, ACS181-DIGIT, ACS182, ACS182-DIGIT, ACS201, ACS201-DIGIT, ACS202, ACS202-DIGIT, ACS241, ACS241-DIGIT, ACS242, ACS242-DIGIT, ACS91, ACS91-DIGIT, GE100, GE115...(Other models you can see in the webshop)		

			
<b>GEV No.</b>	510799	<b>Ref. No.</b>	200393
<b>description</b>	formed hose end piece A ext. ø 30mm end piece A int. ø 22mm AD2 ø 35mm ø end piece B 27mm L 630mm Qty 1 L-shape		
<b>For models:</b>	F45, F55, F65, F80		

			
<b>GEV No.</b>	524821	<b>Ref. No.</b>	201070
<b>description</b>	formed hose end piece A ext. ø 35mm end piece A int. ø 27mm AD2 ø 35mm ø end piece B 27mm L 145mm Qty 1 warewashing L-shape		
<b>For models:</b>	C1000ERCD, C1300ERCD, GE50RCD, GE60RCD, GE65RCD, LC1200RCD, LC700RCD, LC900RCD, LF322RCD, XLC		

			
<b>GEV No.</b>	511599	<b>Ref. No.</b>	201066
<b>description</b>	formed hose end piece A ext. ø 39mm end piece A int. ø 29mm AD2 ø 39mm ø end piece B 29mm L 98mm rubber Qty 1 L-shape		
<b>For models:</b>	BHC25-2, BHC25A-2, BHC30-2, BHC30A-2, BHC30E, BHC30E-2, BHC30EA, BHC30EA-2, BHC30HR, BHC30HR-2, BHC30HR380, BHC30HRA, BHC30HRA-2, BHC30HRA380, BHC433-2, BHC433A-2, BHCHR, LB200, LB200-2, LB200A, LB200A-2, LB215, LB215-2, LB215A, LB215A-2, LB260, LB260-2, LB260A, LB260A-2, LB275, LB275-2, LB275A, LB275A-2, LF321, LF321A, LF322, LF322A, LF324, LF324A, LF325E, LF325EA, LF700, LF700A		





1

<b>GEV No.</b>	530580	<b>Ref. No.</b>	200726
<b>description</b>	formed hose end piece A ext. ø 47mm end piece A int. ø 36mm AD2 ø 39mm end piece B 28mm L 630mm warewashing L-shape Qty 1 black		
<b>For models:</b>	C30		



1

<b>GEV No.</b>	524697	<b>Ref. No.</b>	H26556
<b>description</b>	formed hose end piece A ext. ø 50mm end piece A int. ø 45mm AD2 ø 78mm end piece B 54mm L 192mm warewashing Qty 1 black		
<b>For models:</b>	C1000E, C1000ERCD, C1001M, C1300E, C1300ERCD, C1301M, GF90, GF90-2004, GF90A, GF90A-2004, LC1200, LC1200RCD, LC700, LC700RCD, LC900, LC900RCD, XLC		



1

<b>GEV No.</b>	504390	<b>Ref. No.</b>	200612
<b>description</b>	formed hose end piece A ext. ø 56mm end piece A int. ø 45mm AD2 ø 59mm end piece B 48mm L 180mm warewashing		
<b>For models:</b>	LF321, LF321A, LF322, LF322A, LF322MP, LF322MP-A, LF322RCD, LF324, LF324A, LF325E, LF325EA, LF700, LF700A, LFD32E, LFD32EA, LFD32M, LFD32MA		



1

<b>GEV No.</b>	524779	<b>Ref. No.</b>	200753
<b>description</b>	formed hose end piece A ext. ø 60mm end piece A int. ø 45mm AD2 ø 54mm end piece B 39mm L 410mm L-shape		
<b>For models:</b>	SNL		



1

<b>GEV No.</b>	511352	<b>Ref. No.</b>	201029
<b>description</b>	formed hose end piece A ext. ø 60mm end piece A int. ø 46mm AD2 ø 45mm end piece B 29mm warewashing L-shape equiv. no. 201029		
<b>For models:</b>	BHC25, BHC25A, BHC25S, BHC30, BHC30A, BHC30HR, BHC30HR380, BHC30HRA, BHC30HRA380, BHC433, BHC433A, BHCHR		



1

<b>GEV No.</b>	524698	<b>Ref. No.</b>	200728
<b>description</b>	formed hose end piece A ext. ø 66mm end piece A int. ø 52mm AD2 ø 62mm end piece B 48mm L 142mm warewashing L-shape Qty 1 black		
<b>For models:</b>	SE		



1

<b>GEV No.</b>	530578	<b>Ref. No.</b>	200749
<b>description</b>	formed hose end piece A ext. ø 69mm end piece A int. ø 60mm AD2 ø 56mm end piece B 45mm L 250mm warewashing L-shape Qty 1 black		
<b>For models:</b>	C85		



1

<b>GEV No.</b>	512129	<b>Ref. No.</b>	H29532
<b>description</b>	formed hose end piece A ext. ø 75mm end piece A int. ø 59mm AD2 ø 75mm end piece B 59mm warewashing L-shape equiv. no. 29532		
<b>For models:</b>	GF90, GF90-2004, GF90A, GF90A-2004		





1

<b>GEV No.</b>	530577	<b>Ref. No.</b>	200750
<b>description</b>	formed hose L 350mm warewashing L-shape equiv. no. 200750 ID ø 60mm		
<b>For models:</b>	C140, LC380, LC400		



1

<b>GEV No.</b>	530592	<b>Ref. No.</b>	200355
<b>description</b>	formed hose warewashing L-shape equiv. no. 200355		
<b>For models:</b>	C30		



1

<b>GEV No.</b>	530585	<b>Ref. No.</b>	200359
<b>description</b>	formed hose warewashing L-shape		
<b>For models:</b>	C33, C34, XLC		



1

<b>GEV No.</b>	511337	<b>Ref. No.</b>	200372
<b>description</b>	formed hose warewashing L-shape equiv. no. 200372		
<b>For models:</b>	B41, B42, F20		



1

<b>GEV No.</b>	530559	<b>Ref. No.</b>	200312
<b>description</b>	formed hose warewashing L-shape equiv. no. 200312		
<b>For models:</b>	F2, F300, F45, F55, F65, F80		



1

<b>GEV No.</b>	511356	<b>Ref. No.</b>	200389
<b>description</b>	formed hose warewashing L-shape equiv. no. 200389		
<b>For models:</b>	F2, F3, F300, F45, F55, F65, F80, LF280-lav-line, LF320-lav-line		



1

<b>GEV No.</b>	530579	<b>Ref. No.</b>	200724
<b>description</b>	formed hose warewashing L-shape equiv. no. 200724		
<b>For models:</b>	C30, C70, C75, C75M, LP360		



1

<b>GEV No.</b>	530582	<b>Ref. No.</b>	200334
<b>description</b>	formed hose warewashing L-shape equiv. no. 200334		
<b>For models:</b>	F2, F3, F300, F45, F55, F65, F80, LF280-lav-line, LF320-lav-line, R40, R50		



1

<b>GEV No.</b>	511344	<b>Ref. No.</b>	200732
<b>description</b>	formed hose warewashing L-shape equiv. no. 200732		
<b>For models:</b>	B13T, B14T, B15, B15T, B15TM, B16, B16T, B16TM, B18, B18T, B18TM, B19, B19T, B19TM		



			
1			
<b>GEV No.</b>	511345	<b>Ref. No.</b>	200733
<b>description</b>	formed hose warewashing L-shape equiv. no. 200733		
<b>For models:</b>	B13T, B14T, B15, B15T, B16, B16T, B18, B18T, B19, B19T		

			
1			
<b>GEV No.</b>	511186	<b>Ref. No.</b>	200787
<b>description</b>	formed hose warewashing L-shape equiv. no. 200787		
<b>For models:</b>	FC, FC53, FC533, FC533A, FC53A, FC53CBT, FC53LA, FC53LBT, FC54, FC543, FC543A, FC543E, FC543EA, FC544, FC544A, FC54A, FC54CBT, FC54E, FC54EA, FC54LBT, FCHR, FCHRA, FCHRT, FCHRTA		

			
1			
<b>GEV No.</b>	530599	<b>Ref. No.</b>	200311 200735
<b>description</b>	formed hose warewashing L-shape equiv. no. 200735, 200311		
<b>For models:</b>	F2, F300, F45, F55, F65, F80, LF280-lav-line, LF320-lav-line, R40		

			
1			
<b>GEV No.</b>	511364	<b>Ref. No.</b>	201014
<b>description</b>	formed hose warewashing L-shape equiv. no. 201014		
<b>For models:</b>	F90M, F90MA, LF350, LF350A, LF450, LF450A		

			
1			
<b>GEV No.</b>	530544	<b>Ref. No.</b>	200769
<b>description</b>	formed hose warewashing L-shape equiv. no. 200769		
<b>For models:</b>	C155, C155BT, C155E2, C155RCD, C165, C165E2, C165E2BT, C165E2RCD, C166, C166-2, C95, C95BT, C95E2, C95RCD		

			
1			
<b>GEV No.</b>	511365	<b>Ref. No.</b>	201017
<b>description</b>	formed hose warewashing L-shape equiv. no. 201017		
<b>For models:</b>	C155BT, C155RCD, C165E2BT, C165E2RCD, C75BT, C75RCD, C95BT, C95RCD, FC53CBT, FC53LBT, FC54CBT, FC54LBT, LF320CBT, LF320LBT, LF322RCD		

			
1			
<b>GEV No.</b>	511351	<b>Ref. No.</b>	200777
<b>description</b>	formed hose warewashing L-shape equiv. no. 200777		
<b>For models:</b>	BR20, BR20A, BR25, BR25A		

			
1			
<b>GEV No.</b>	511359	<b>Ref. No.</b>	201019
<b>description</b>	formed hose warewashing L-shape equiv. no. 201019		
<b>For models:</b>	C75BT, C75RCD, LP360BT, LP360RCD		

			
1			
<b>GEV No.</b>	511348	<b>Ref. No.</b>	200781
<b>description</b>	formed hose warewashing L-shape equiv. no. 200781		
<b>For models:</b>	LBC210, LBC215, LBC215A, LBC275, LBC275A		

			
1			
<b>GEV No.</b>	511360	<b>Ref. No.</b>	201020
<b>description</b>	formed hose warewashing L-shape equiv. no. 201020		
<b>For models:</b>	C75BT, C75RCD, LP360BT, LP360RCD		





1

<b>GEV No.</b>	511353	<b>Ref. No.</b>	201030
<b>description</b>	formed hose warewashing L-shape equiv. no. 201030		
<b>For models:</b>	BHC25, BHC25A, BHC25S, BHC30, BHC30A, BHC30HR, BHC30HR380, BHC30HRA, BHC30HRA380, BHC433, BHC433A, BHCHR		



1

<b>GEV No.</b>	511346	<b>Ref. No.</b>	200765
<b>description</b>	pressure hose		
<b>For models:</b>	B15TM, B16TM, B18TM, B19TM		



1

<b>GEV No.</b>	512380	<b>Ref. No.</b>	201059
<b>description</b>	pressure hose L-shape		
<b>For models:</b>	BHC25, BHC25-2, BHC25A, BHC25A-2, BHC30, BHC30-2, BHC30A, BHC30A-2, BHC30E, BHC30E-2, BHC30EA, BHC30EA-2, BHC30HR, BHC30HR-2, BHC30HR380, BHC30HRA, BHC30HRA-2, BHC30HRA380, BHC433, BHC433-2, BHC433A, BHC433A-2, BHCHR, LB200, LB200-2, LB200A, LB200A-2, LB215, LB215-2, LB215A, LB215A-2, LB260, LB260-2, LB260A, LB260A-2, LB275, LB275-2, LB275A, LB275A-2		

with branch



1

<b>GEV No.</b>	511208	<b>Ref. No.</b>	200768
<b>description</b>	formed hose warewashing equiv. no. 200768 with piggyback		
<b>For models:</b>	C155, C155BT, C155E2, C155RCD, C165, C165E2, C165E2BT, C165E2RCD, C166, C166-2, C95, C95BT, C95E2, C95RCD		

form S



1

<b>GEV No.</b>	511226	<b>Ref. No.</b>	200755
<b>description</b>	formed hose		
<b>For models:</b>	C70, C75, C75M, LP360		



1

<b>GEV No.</b>	511479	<b>Ref. No.</b>	201004
<b>description</b>	formed hose hose ext. ø 65mm hose int. ø 50mm S-shape		
<b>For models:</b>	AC105, AC122, AC135, AC151, AC152, AC181, AC182, AC201, AC202, AC241, AC242, AC95, GE100, GE115, GE60, GE65, GE80		



1

<b>GEV No.</b>	511342	<b>Ref. No.</b>	200719
<b>description</b>	formed hose S-shape warewashing equiv. no. 200719		
<b>For models:</b>	B10, B10T, B11, B11T, B12, B12T, B20, B20D, B23, B24, B25, B26, B27, BC25HR, BC30HR, BC30HR380, BHC25S, FC43, LBC210, LBC215, LBC215A, LBC275, LBC275A, LBR, LBR200, LBR215, LBR215A		

form U



1

<b>GEV No.</b>	512032	<b>Ref. No.</b>	200611
<b>description</b>	formed hose D1 ø 30mm D2 ø 37mm L 645mm Qty 1		
<b>For models:</b>	LF321, LF321A, LF322, LF322A, LF322MP, LF322MP-A, LF322RCD, LF324, LF324A, LF325E, LF325EA, LF700, LF700A, LFD32E, LFD32EA, LFD32M, LFD32MA		



1

<b>GEV No.</b>	511349	<b>Ref. No.</b>	200778
<b>description</b>	formed hose D1 ø 44mm D2 ø 42mm L 260mm warewashing black Qty 1 U-shape equiv. no. 200778		
<b>For models:</b>	BC25, BC25A, BC25HR, BC30, BC30A, BC30HR, BC30HR380, BC30HRA, BR20, BR20A, BR25, BR25A, FC43, FC43A		



			
1			
<b>GEV No.</b>	511357	<b>Ref. No.</b>	200355 200725
<b>description</b>	formed hose D1 ø 54mm D2 ø 50mm L 330mm warewashing black Qty 1 U-shape equiv. no. 200725		
<b>For models:</b>	C30		

			
1			
<b>GEV No.</b>	524820	<b>Ref. No.</b>	201056
<b>description</b>	formed hose D1 ø 75mm D2 ø 83mm L 340mm warewashing black Qty 1		
<b>For models:</b>	LC1200, LC1200RCD, LC412, LC700, LC700RCD, LC900, LC900RCD		

			
1			
<b>GEV No.</b>	512390	<b>Ref. No.</b>	200391
<b>description</b>	formed hose ext. ø 30 D1 ø 35/28mm D2 ø 36/29mm L 580mm warewashing black		
<b>For models:</b>	F2, F3, F300, F45, F55, F65, F80, LF280-lav-line, LF320-lav-line		

miscellaneous

			
1			
<b>GEV No.</b>	511363	<b>Ref. No.</b>	200788
<b>description</b>	formed hose warewashing equiv. no. 200788		
<b>For models:</b>	LF400A		

for dishwashers

miscellaneous

			
1			
<b>GEV No.</b>	510806	<b>Ref. No.</b>	160108
<b>description</b>	extraction hose ED ø 8mm ID ø 5mm Qty supplied by meter		
<b>For models:</b>	B10T, B11T, B12T, B13T, B14T, B15, B15T, B15TM, B16, B16T, B16TM, B18, B18T, B18TM, B19, B19T, B19TM, B31, B41, B42, BHC25, BHC25-2, BHC25A, BHC25A-2, BHC25S, BHC30, BHC30-2, BHC30A, BHC30A-2, BHC30E-2, BHC30EA-2, BHC30HR, BHC30HR-2, BHC30HR380, BHC30HRA, BHC30HRA-2, BHC433, BHC433-2, BHC433A, BHC433A-2, BHCHR, C1000E, C1000ERCD, C1001M, C1300E, C1300ERCD, C1301M, C155, C155BT, C155E2...(Other models you can see in the webshop)		

			
1			
<b>GEV No.</b>	530590	<b>Ref. No.</b>	200117
<b>description</b>	hose ED ø 15mm ID ø 8mm equiv. no. 200117 Qty supplied by meter		
<b>For models:</b>	B10T, B11T, B12T, B13T, B14T, B15, B15T, B15TM, B16, B16T, B16TM, B18, B18T, B18TM, B19, B19T, B19TM, B41, B42, BC25, BC25A, BC25HR, BC30, BC30A, BC30HR, BC30HR380, BC30HRA, BHC25-2, BHC25A-2, BHC30-2, BHC30A-2, BHC30E-2, BHC30EA-2, BHC30HR-2, BHC30HRA-2, BHC433-2, BHC433A-2, BR20, BR20A, BR25, BR25A, C1000E, C1000ERCD, C1001M, C1300E, C1300ERCD, C1301M, C140, C155, C155BT...(Other models you can see in the webshop)		

			
1			
<b>GEV No.</b>	530589	<b>Ref. No.</b>	200113
<b>description</b>	hose ED ø 22mm ID ø 12mm L 1000mm		
<b>For models:</b>	AC100, AC101, AC105, AC120, AC122, AC135, AC150, AC151, AC152, AC170, AC181, AC182, AC200, AC201, AC202, AC241, AC242, AC2A, AC90, AC91, AC95, ACL100, ACL150, ACR, ACR145, ACR205, ACR225, ACR245, ACR260, ACR265, ACR305, ACRS145, ACRS205, ACRS225, ACRS245, ACRS260, ACRS265, ACRS305, ACS101, ACS101-DIGIT, ACS122, ACS122-DIGIT, ACS151, ACS151-DIGIT, ACS152, ACS152-DIGIT, ACS161-DIGIT, ACS162-DIGIT, ACS181, ACS181-DIGIT...(Other models you can see in the webshop)		

			
1			
<b>GEV No.</b>	511562	<b>Ref. No.</b>	160117
<b>description</b>	hose ED ø 6.3mm ID ø 4.1mm for by-pass L 2150mm polypropylene		
<b>For models:</b>	B16TM, B19TM, BC25A, BC30A, BC30HRA, BHC25A, BHC25A-2, BHC30A, BHC30A-2, BHC30EA, BHC30EA-2, BHC30HR, BHC30HR-2, BHC30HRA, BHC30HRA-2, BHC30HRA380, BHC433A, BHC433A-2, BHCHR, F90MA, FC, FC3E, FC3EA, FC3MA, FC43A, FC44E, FC44EA, FC4E, FC4EA, FC4EHRT, FC4MA, FC533A, FC53A, FC53LA, FC543A, FC543EA, FC544A, FC54A, FC54EA, FCHRA, FCHRTA, GF70A, LB200A, LB200A-2, LB215A, LB215A-2, LB260A, LB260A-2, LB275A, LB275A-2...(Other models you can see in the webshop)		

			
1			
<b>GEV No.</b>	511285	<b>Ref. No.</b>	161311
<b>description</b>	hose ED ø 9.5mm ID ø 5mm L 1075mm equiv. no. 161311		
<b>For models:</b>	AC101, AC105, AC122, AC135, AC151, AC152, AC181, AC182, AC201, AC202, AC241, AC242, AC91, AC95, ACL150, ACRS145, ACRS205, ACRS225, ACRS245, ACRS260, ACRS265, ACRS305, ACS101, ACS101-DIGIT, ACS122, ACS122-DIGIT, ACS151, ACS151-DIGIT, ACS152, ACS152-DIGIT, ACS161-DIGIT, ACS162-DIGIT, ACS181, ACS181-DIGIT, ACS182, ACS182-DIGIT, ACS201, ACS201-DIGIT, ACS202, ACS202-DIGIT, ACS241, ACS241-DIGIT, ACS242, ACS242-DIGIT, ACS91, ACS91-DIGIT, BC25, BC25A, BC25HR, BC30...(Other models you can see in the webshop)		





1

<b>GEV No.</b>	511289	<b>Ref. No.</b>	161312
<b>description</b>	hose ED ø 9.5mm ID ø 5mm L 420mm equiv. no. 161312		
<b>For models:</b>	AC201, AC202, AC241, AC242, AC2A, ACL100, ACL150, ACRS145, ACRS205, ACRS225, ACRS245, ACRS260, ACRS265, ACRS305, ACS101, ACS101-DIGIT, ACS122, ACS122-DIGIT, ACS151, ACS151-DIGIT, ACS152, ACS152-DIGIT, ACS161-DIGIT, ACS162-DIGIT, ACS181, ACS181-DIGIT, ACS182, ACS182-DIGIT, ACS201, ACS201-DIGIT, ACS202, ACS202-DIGIT, ACS241, ACS241-DIGIT, ACS242, ACS242-DIGIT, ACS91, ACS91-DIGIT, C155, C155BT, C155E2, C155RCD, C165, C165E2, C165E2BT, C165E2RCD, C166, C166-2, C95, C95BT...(Other models you can see in the webshop)		



1

<b>GEV No.</b>	511573	<b>Ref. No.</b>	161320
<b>description</b>	hose ED ø 9mm ID ø 5mm L 2400mm Qty 1 ext. ø 9.5		
<b>For models:</b>	C1000E, C1000ERCD, C1001M, C1300E, C1300ERCD, C1301M, GE50RCD, LC1200, LC1200RCD, LC412, LC700, LC700RCD, LC900, LC900RCD, XLC		



1

<b>GEV No.</b>	510843	<b>Ref. No.</b>	180408 h33817
<b>description</b>	T-piece plastic hose ø 10-6-10mm		
<b>For models:</b>	C1000E, C1001M, C1300E, C1301M, C140, C155, C155E2, C165, C165E2, C166, C166-2, C30, C33, C34, C70, C75, C75M, C85, C95, C95E2, F2, F3, F300, F45, F55, F65, F80, F90M, F90MA, FC, FC43, FC43A, FC53, FC533, FC533A, FC53A, FC53LA, FC54, FC543, FC543A, FC543E, FC543EA, FC544, FC544A, FC54A, FC54E, FC54EA, FCHR, FCHRA, FCHRT...(Other models you can see in the webshop)		



1

<b>GEV No.</b>	510842	<b>Ref. No.</b>	180403
<b>description</b>	T-piece plastic hose ø 13-13-13mm 3-way		
<b>For models:</b>	AC101, AC122, AC151, AC152, AC181, AC182, AC201, AC202, AC241, AC242, AC91, ACR, ACR145, ACR205, ACR225, ACR245, ACR260, ACR265, ACR305, B10T, B11T, B12T, B13T, B14T, B15, B15T, B15TM, B16, B16T, B16TM, B18, B18T, B18TM, B19, B19T, B19TM, B20, B20D, B24, B25, B26, B27, B31, B32, BR20A, BR25A, C140, C165, C30, C70...(Other models you can see in the webshop)		



1

<b>GEV No.</b>	511273	<b>Ref. No.</b>	191026
<b>description</b>	cross fitting		
<b>For models:</b>	B20, B20D, B41, B42		

## fittings, hose and pipe connectors

### hose connectors

#### without screw connection



1

<b>GEV No.</b>	541109	<b>Ref. No.</b>	190314
<b>description</b>	Y-piece plastic hose ø 8-6-8mm for pressure switch		
<b>For models:</b>	ACR, ACR145, ACR205, ACR225, ACR245, ACR260, ACR265, ACR305, C166-2, FC3E, FC3EA, FC44E, FC44EA, FC4E, FC4EA, GMC, GMC2700, GMC3500, GMC4500, GMC5500, NE00, NG00, NG600, NG600E, NG900, NG900E		





fittings

double nipples



1			
<b>GEV No.</b>	520169	<b>Ref. No.</b>	270308
<b>description</b>	double nipple brass thread 3/4" - 3/4" Qty 1 pcs		
<b>For models:</b>	AC101, AC105, AC122, AC135, AC151, AC152, AC181, AC182, AC201, AC202, AC241, AC242, AC91, AC95, ACS101, ACS101-DIGIT, ACS122, ACS122-DIGIT, ACS151, ACS151-DIGIT, ACS152, ACS152-DIGIT, ACS161-DIGIT, ACS162-DIGIT, ACS181, ACS181-DIGIT, ACS182, ACS182-DIGIT, ACS201, ACS201-DIGIT, ACS202, ACS202-DIGIT, ACS241, ACS241-DIGIT, ACS242, ACS242-DIGIT, ACS91, ACS91-DIGIT, NE02, NE3002, NE4002, NE5002, NE5502, NE7002, NE7502, NE9002, NE9502, NG00, NG600, NG600E...(Other models you can see in the webshop)		



1			
<b>GEV No.</b>	506277	<b>Ref. No.</b>	332162
<b>description</b>	double nipple SS thread 3/8" - 3/4" Qty 1 pcs		



1			
<b>GEV No.</b>	506272	<b>Ref. No.</b>	190696
<b>description</b>	double nipple plastic thread 3/8" - 3/4" Qty 1 pcs		

angle pieces



1			
<b>GEV No.</b>	541924	<b>Ref. No.</b>	280101
<b>description</b>	angle piece thread 1/2" IT - 1/2" IT brass		
<b>For models:</b>	AC101, AC105, AC122, AC151, AC152, AC181, AC182, AC201, AC202, AC241, AC242, AC91, AC95, ACRS145, ACRS205, ACRS225, ACRS245, ACRS260, ACRS265, ACRS305, ACS101, ACS101-DIGIT, ACS122, ACS122-DIGIT, ACS151, ACS151-DIGIT, ACS152, ACS152-DIGIT, ACS161-DIGIT, ACS162-DIGIT, ACS181, ACS181-DIGIT, ACS182, ACS182-DIGIT, ACS201, ACS201-DIGIT, ACS202, ACS202-DIGIT, ACS241, ACS241-DIGIT, ACS242, ACS242-DIGIT, ACS91, ACS91-DIGIT, C75, FC, FC53, FC533, FC54, FC543...(Other models you can see in the webshop)		



1			
<b>GEV No.</b>	510464	<b>Ref. No.</b>	280118
<b>description</b>	angle piece thread 1/4" IT - 3/8" IT brass		
<b>For models:</b>	C155, C155BT, C155E2, C155RCD, C165, C165E2, C165E2BT, C165E2RCD, C166, C166-2, C95, C95BT, C95E2, C95RCD, GF90-2004, GF90A-2004, LC380, LC380BT, LC380RCD, LC400		

hose connectors

brass



1			
<b>GEV No.</b>	511280	<b>Ref. No.</b>	290410
<b>description</b>	hose connector brass straight thread 1/2" hose ø 14mm Qty 1 pcs		
<b>For models:</b>	AC100, AC101, AC105, AC120, AC122, AC135, AC150, AC151, AC152, AC170, AC181, AC182, AC200, AC201, AC202, AC241, AC242, AC90, AC91, AC95, ACR, ACR145, ACR205, ACR225, ACR245, ACR260, ACR265, ACR305, ACRS145, ACRS205, ACRS225, ACRS245, ACRS260, ACRS265, ACRS305, ACS101, ACS101-DIGIT, ACS122, ACS122-DIGIT, ACS151, ACS151-DIGIT, ACS152, ACS152-DIGIT, ACS161-DIGIT, ACS162-DIGIT, ACS181, ACS181-DIGIT, ACS182, ACS182-DIGIT, ACS201...(Other models you can see in the webshop)		



1			
<b>GEV No.</b>	511279	<b>Ref. No.</b>	290407
<b>description</b>	hose connector brass straight thread 3/8" hose ø 12mm Qty 1 pcs		
<b>For models:</b>	AC105, AC135, AC95, B31, B32, B41, B42, C33, C34		





1			
<b>GEV No.</b>	511278	<b>Ref. No.</b>	280509
<b>description</b>	hose connector brass straight thread M8 hose ø 6mm Qty 1 pcs		
<b>For models:</b>	B13T, B14T, B15, B15T, B15TM, B16, B16T, B16TM, B18, B18T, B18TM, B19, B19T, B19TM, B41, B42, F2, F20, F3, F300, R50		





1			
<b>GEV No.</b>	510059	<b>Ref. No.</b>	H34426
<b>description</b>	screw-in nipple brass straight thread 1/4" hose ø 11.5mm Qty 1 pcs		
<b>For models:</b>	GF90, GF90-2004, GF90A, GF90A-2004		

producer-specific

			
1			
<b>GEV No.</b>	510912	<b>Ref. No.</b>	290217
<b>description</b>	angle piece connection 3/8"-1/2" for pipe ø 12-14mm		
<b>For models:</b>	AC101, AC120, AC122, AC150, AC151, AC152, AC170, AC181, AC182, AC200, AC201, AC202, AC241, AC242, AC91, ACR, ACR145, ACR205, ACR225, ACR245, ACR260, ACR265, ACR305, ACRS145, ACRS205, ACRS225, ACRS245, ACRS260, ACRS265, ACRS305, ACS101, ACS101-DIGIT, ACS122, ACS122-DIGIT, ACS151, ACS151-DIGIT, ACS152, ACS152-DIGIT, ACS161-DIGIT, ACS162-DIGIT, ACS181, ACS181-DIGIT, ACS182, ACS182-DIGIT, ACS201, ACS201-DIGIT, ACS202, ACS202-DIGIT, ACS241, ACS241-DIGIT...(Other models you can see in the webshop)		

			
1			
<b>GEV No.</b>	510859	<b>Ref. No.</b>	190202
<b>description</b>	hose connector		
<b>For models:</b>	B12, B16, B16TM, B19, B19TM		

			
1			
<b>GEV No.</b>	510952	<b>Ref. No.</b>	290216
<b>description</b>	hose connector connection 1/2" / 8mm		
<b>For models:</b>	C33, C34, NE3001, NE4001, NE5501, NE7501, NE9001, NG01, NG601, NG601E, NG901, NG901E		

			
1			
<b>GEV No.</b>	510359	<b>Ref. No.</b>	510290
<b>description</b>	hose connector for rinse arm		
<b>For models:</b>	B23, B24, B25, B26, B27, SE		



			
1			
<b>GEV No.</b>	361854	<b>Ref. No.</b>	510403
<b>description</b>	hose connector thread 1/2" angled 90° grommet ø 12mm grommet length 22mm WS 26 total length 52mm thread L 12mm brass		
<b>For models:</b>	AC100, AC120, AC150, AC170, AC200, ACR, ACR145, ACR205, ACR225, ACR245, ACR260, ACR265, ACR305, ACRS145, ACRS205, ACRS225, ACRS245, ACRS260, ACRS265, ACRS305, ACS101, ACS101-DIGIT, ACS122, ACS122-DIGIT, ACS151, ACS151-DIGIT, ACS152, ACS152-DIGIT, ACS161-DIGIT, ACS162-DIGIT, ACS181, ACS181-DIGIT, ACS182, ACS182-DIGIT, ACS201, ACS201-DIGIT, ACS202, ACS202-DIGIT, ACS241, ACS241-DIGIT, ACS242, ACS242-DIGIT, ACS91, ACS91-DIGIT, C166-2, GMC, GMC2700, GMC2702, GMC3500, GMC3502...(Other models you can see in the webshop)		

			
1			
<b>GEV No.</b>	361853	<b>Ref. No.</b>	510407
<b>description</b>	hose connector thread 1/2" T-piece grommet ø 12mm grommet length 22/25mm WS 26 total length 55mm thread L 12mm brass		
<b>For models:</b>	AC100, AC101, AC105, AC120, AC122, AC135, AC150, AC151, AC152, AC170, AC181, AC182, AC200, AC201, AC202, AC241, AC242, AC90, AC91, AC95, ACR, ACR145, ACR205, ACR225, ACR245, ACR260, ACR265, ACR305, ACS101, ACS101-DIGIT, ACS122, ACS122-DIGIT, ACS151, ACS151-DIGIT, ACS152, ACS152-DIGIT, ACS161-DIGIT, ACS162-DIGIT, ACS181, ACS181-DIGIT, ACS182, ACS182-DIGIT, ACS201, ACS201-DIGIT, ACS202, ACS202-DIGIT, ACS241, ACS241-DIGIT, ACS242, ACS242-DIGIT...(Other models you can see in the webshop)		

			
1			
<b>GEV No.</b>	510954	<b>Ref. No.</b>	190309
<b>description</b>	hose connector thread 3/8" straight		
<b>For models:</b>	B41, B42, C140, C155, C155BT, C155E2, C155RCD, C165, C165E2, C165E2BT, C165E2RCD, C166, C166-2, C30, C70, C75, C75BT, C75M, C75RCD, C85, C95, C95BT, C95E2, C95RCD, LC380, LC380BT, LC380RCD, LC400, LP360, LP360BT, LP360RCD		

			
1			
<b>GEV No.</b>	511274	<b>Ref. No.</b>	180415
<b>description</b>	manifold 4-way hose ø 12-12-12-12mm plastic		
<b>For models:</b>	BC25, BC25A, BC25HR, BC30, BC30A, BC30HR, BC30HR380, BC30HRA, BHC25, BHC25-2, BHC25A, BHC25A-2, BHC25S, BHC30, BHC30-2, BHC30A, BHC30A-2, BHC30HR, BHC30HR380, BHC30HRA, BH-C30HRA380, BHC433, BHC433-2, BHC433A, BHC433A-2, BHCHR, C166-2, FC, FC3M, FC3MR, FC43, FC43A, FC4M, FC533A, FC53A, FC-53CBT, FC53LA, FC53LBT, FC543A, FC543E, FC543EA, FC544A, FC54A, FC54CBT, FC54EA, FC54LBT, FCHR, FCHRA, FCHRT, FCHRTA...(Other models you can see in the webshop)		

			
1			
<b>GEV No.</b>	511275	<b>Ref. No.</b>	180416
<b>description</b>	T-piece		
<b>For models:</b>	BC25HR, BC30HR, BC30HR380, BC30HRA, BHC30HR, BHC30HR-2, BHC30HR380, BHC30HRA, BHC30HRA-2, BHC30HRA380, BHCHR, FC, FCHR, FCHRA, FCHRT, FCHRTA		

			
1			
<b>GEV No.</b>	510933	<b>Ref. No.</b>	180411
<b>description</b>	T-piece connection 1/4" plastic hose ø 11-4-11mm		
<b>For models:</b>	B16TM, B19TM, BC25A, BC30A, BC30HRA, BHC25A, BHC25A-2, BHC30A, BHC30A-2, BHC30EA, BHC30EA-2, BHC30HR, BHC30HR-2, BHC30HRA, BHC30HRA-2, BHC30HRA380, BHC433A, BHC433A-2, BHC30HR, F90MA, FC, FC3E, FC3EA, FC3MA, FC43A, FC44E, FC44EA, FC4E, FC4EA, FC4EHRT, FC4MA, FC533A, FC53A, FC53LA, FC543A, FC543EA, FC544A, FC54A, FC54EA, FCHRA, FCHRTA, GF70A, LB200A, LB200A-2, LB215A, LB215A-2, LB260A, LB260A-2, LB275A, LB275A-2...(Other models you can see in the webshop)		
<b>accessories for</b>	510933		
	<b>GEV No.</b>	511563	<b>Ref. No.</b> 180130
	union nut thread 1/4" connection 1/4" plastic H 17.5mm for by-pass hose ø 4mm		

			
1			
<b>GEV No.</b>	510984	<b>Ref. No.</b>	190311
<b>description</b>	T-piece plastic		
<b>For models:</b>	C33, C34		

			
1			
<b>GEV No.</b>	511277	<b>Ref. No.</b>	190330
<b>description</b>	T-piece thread 1/2" ø 18mm		
<b>For models:</b>	BC25, BC25A, BC25HR, BC30, BC30A, BC30HR, BC30HR380, BC30HRA, BHC25, BHC25-2, BHC25A, BHC25A-2, BHC25S, BHC30, BHC30-2, BHC30A, BHC30A-2, BHC30E, BHC30E-2, BHC30EA, BHC30EA-2, BHC30HR, BHC30HR-2, BHC30HR380, BHC30HRA, BHC30HRA-2, BHC30HRA380, BHC433, BHC433-2, BHC433A, BHC433A-2, BHC30HR, C1000E, C1001M, C1300E, C1301M, C155, C155E2, C165, C165E2, C166, C166-2, C75, C95, C95E2, F90M, F90MA, FC, FC43, FC43A...(Other models you can see in the webshop)		

			
1			
<b>GEV No.</b>	511563	<b>Ref. No.</b>	180130
<b>description</b>	union nut thread 1/4" connection 1/4" plastic H 17.5mm for by-pass hose ø 4mm		
<b>For models:</b>	B16TM, B19TM, BC25A, BC30A, BC30HRA, BHC25A, BHC25A-2, BHC30A, BHC30A-2, BHC30EA, BHC30EA-2, BHC30HR, BHC30HR-2, BHC30HRA, BHC30HRA-2, BHC30HRA380, BHC433A, BHC433A-2, BHC30HR, F90MA, FC, FC3E, FC3EA, FC3MA, FC43A, FC44E, FC44EA, FC4E, FC4EA, FC4EHRT, FC4MA, FC533A, FC53A, FC53LA, FC543A, FC543EA, FC544A, FC54A, FC54EA, FCHRA, FCHRTA, GF70A, LB200A, LB200A-2, LB215A, LB215A-2, LB260A, LB260A-2, LB275A, LB275A-2...(Other models you can see in the webshop)		

## water cycle components

### pressure reduction valves

#### pressure reduction valves

##### universal

			
1			
<b>GEV No.</b>	520556	<b>Ref. No.</b>	281102
<b>description</b>	pressure reduction valve Caleffi series 5360 connection 1/2" default setting 3bar setting range 0.5-6bar EN1567 p max 25bar t.max. 80°C with manometer brass DVGW/SVGW/WRAS/ACS		
<b>For models:</b>	AC100, AC101, AC120, AC122, AC135, AC150, AC151, AC152, AC170, AC181, AC182, AC200, AC201, AC202, AC241, AC242, AC90, AC91, ACR, ACR145, ACR205, ACR225, ACR245, ACR260, ACR265, ACR305, ACRS145, ACRS205, ACRS225, ACRS245, ACRS260, ACRS265, ACRS305, ACS101, ACS101-DIGIT, ACS122, ACS122-DIGIT, ACS151, ACS151-DIGIT, ACS152, ACS152-DIGIT, ACS161-DIGIT, ACS162-DIGIT, ACS181, ACS181-DIGIT, ACS182, ACS182-DIGIT, ACS201, ACS201-DIGIT, ACS202...(Other models you can see in the webshop)		

			
1			
<b>GEV No.</b>	520870	<b>Ref. No.</b>	281101
<b>description</b>	pressure reduction valve Caleffi series 5360 connection 3/4" default setting 3bar setting range 0.5-6bar p max 25bar t.max. 80°C with manometer brass DVGW/SVGW/WRAS/ACS		
<b>For models:</b>	ACR, ACR145, ACR205, ACR225, ACR245, ACR260, ACR265, ACR305, GMC, GMC2700, GMC3500, GMC4500, GMC5500, NE00, NE02, NE3001, NE3002, NE4001, NE4002, NE5002, NE5501, NE5502, NE7002, NE7501, NE7502, NE9001, NE9002, NE9502, NG00, NG01, NG600, NG600E, NG601, NG601E, NG900, NG900E, NG901, NG901E, NL302, NL302E, NL402, NL402E, NL502, NL502E, NL552, NL552E, SE		



supply filters



<b>GEV No.</b>	520557	<b>Ref. No.</b>	620121
<b>description</b>	supply filter thread 1/2" IT - 1/2" IT total length 140mm brass ø 40mm H 112mm W 54mm		
<b>For models:</b>	AC100, AC101, AC105, AC120, AC122, AC135, AC150, AC151, AC152, AC170, AC181, AC182, AC200, AC201, AC202, AC241, AC242, AC90, AC91, AC95, ACR, ACR145, ACR205, ACR225, ACR245, ACR260, ACR265, ACR305, ACS101, ACS101-DIGIT, ACS122, ACS122-DIGIT, ACS151, ACS151-DIGIT, ACS152, ACS152-DIGIT, ACS161-DIGIT, ACS162-DIGIT, ACS181, ACS181-DIGIT, ACS182, ACS182-DIGIT, ACS201, ACS201-DIGIT, ACS202, ACS202-DIGIT, ACS241, ACS241-DIGIT, ACS242, ACS242-DIGIT...(Other models you can see in the webshop)		

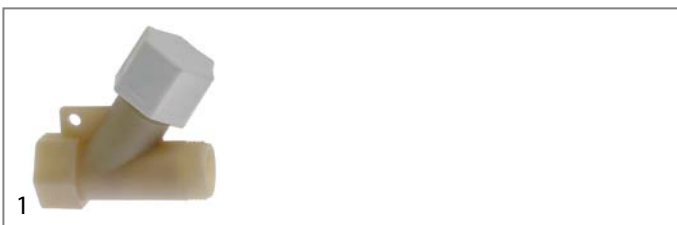

<b>GEV No.</b>	510836	<b>Ref. No.</b>	620209
<b>description</b>	supply filter thread 3/4" ET - 3/4" IT total length 76mm plastic		
<b>For models:</b>	B10T, B11T, B12T, B13T, B14T, B15T, B15TM, B16T, B16TM, B18T, B18TM, B19T, B19TM, B31, B32, B41, BC25, BC25A, BC25HR, BC30, BC30A, BC30HR, BC30HR380, BC30HRA, BHC25, BHC25-2, BHC25A, BHC25A-2, BHC25S, BHC30, BHC30-2, BHC30A, BHC30A-2, BHC30E, BHC30E-2, BHC30EA, BHC30EA-2, BHC30HR, BHC30HR-2, BHC30HR380, BHC30HRA, BHC30HRA-2, BHC30HRA380, BHC433, BHC433-2, BHC433A, BHC433A-2, BHCHR, BR20, BR20A...(Other models you can see in the webshop)		

non-return valves



<b>GEV No.</b>	520274	<b>Ref. No.</b>	290603
<b>description</b>	non-return valve brass connection 3/4" IT - 3/4" IT total length 65mm		
<b>For models:</b>	C166-2		

ancillary products

clamps

hose clamps

DIN 3017 - W2



<b>GEV No.</b>	520111	<b>Ref. No.</b>	450102
<b>description</b>	hose clamp ø 10-16mm width 9mm Qty 10 pcs DIN 3017		
<b>For models:</b>	B10T, B11T, B12, B12T, B13T, B14T, B15, B15T, B15TM, B16, B16T, B16TM, B18, B18T, B18TM, B19, B19T, B19TM, B41, BC25, BC25A, BC25HR, BC30, BC30A, BC30HR, BC30HR380, BC30HRA, BHC25, BHC25-2, BHC25A, BHC25A-2, BHC25S, BHC30, BHC30-2, BHC30A, BHC30A-2, BHC30E, BHC30E-2, BHC30EA, BHC30EA-2, BHC30HR, BHC30HR-2, BHC30HR380, BHC30HRA, BHC30HRA-2, BHC30HRA380, BHC433, BHC433-2, BHC433A, BHC433A-2...(Other models you can see in the webshop)		



<b>GEV No.</b>	520112	<b>Ref. No.</b>	450103
<b>description</b>	hose clamp ø 12-20mm width 9mm Qty 10 pcs DIN 3017		
<b>For models:</b>	AC2A, B10T, B11T, B12, B12T, B13T, B14T, B15, B15T, B15TM, B16, B16T, B16TM, B18, B18T, B18TM, B19, B19T, B19TM, B20, B20D, B24, B25, B26, B27, B41, B42, BC25, BC25A, BC25HR, BC30, BC30A, BC30HR, BC30HR380, BC30HRA, BHC25, BHC25-2, BHC25A, BHC25A-2, BHC25S, BHC30, BHC30-2, BHC30A, BHC30A-2, BHC30E, BHC30E-2, BHC30EA, BHC30EA-2, BHC30HR, BHC30HR-2...(Other models you can see in the webshop)		



<b>GEV No.</b>	520113	<b>Ref. No.</b>	450104
<b>description</b>	hose clamp ø 16-27mm width 9mm Qty 10 pcs DIN 3017		
<b>For models:</b>	AC100, AC101, AC105, AC120, AC122, AC135, AC150, AC151, AC152, AC170, AC181, AC182, AC200, AC201, AC202, AC241, AC242, AC2A, AC90, AC91, AC95, ACL100, ACL150, ACR, ACR145, ACR205, ACR225, ACR245, ACR260, ACR265, ACR305, ACRS145, ACRS205, ACRS225, ACRS245, ACRS260, ACRS265, ACRS305, ACS101, ACS101-DIGIT, ACS122, ACS122-DIGIT, ACS151, ACS151-DIGIT, ACS152, ACS152-DIGIT, ACS161-DIGIT, ACS162-DIGIT, ACS181, ACS181-DIGIT...(Other models you can see in the webshop)		



1

<b>GEV No.</b>	520114	<b>Ref. No.</b>	450114
<b>description</b>	hose clamp ø 20-32mm width 9mm Qty 10 pcs DIN 3017		
<b>For models:</b>	AC122, AC151, AC152, AC182, AC202, AC242, ACL150, ACRS145, ACRS205, ACRS225, ACRS245, ACRS260, ACRS265, ACRS305, ACS122, ACS122-DIGIT, ACS151, ACS151-DIGIT, ACS152, ACS152-DIGIT, ACS161-DIGIT, ACS162-DIGIT, ACS182, ACS182-DIGIT, ACS202, ACS202-DIGIT, ACS242, ACS242-DIGIT, B10, B11, B12, B20, B20D, B23, B24, B25, B26, B27, B31, B32, B41, B42, BHC25, BHC25-2, BHC25A, BHC25A-2, BHC25S, BHC30, BHC30-2, BHC30A...(Other models you can see in the webshop)		



1

<b>GEV No.</b>	520119	<b>Ref. No.</b>	450119
<b>description</b>	hose clamp ø 60-80mm width 9mm Qty 5 pcs DIN 3017		
<b>For models:</b>	AC100, AC122, AC135, AC151, AC152, AC181, AC182, AC201, AC202, AC241, AC242, AC2A, AC90, ACR, ACR145, ACR205, ACR225, ACR245, ACR260, ACR265, ACR305, C1000E, C1000ERCD, C1001M, C1300E, C1300ERCD, C1301M, C155, C155BT, C155E2, C155RCD, C165, C165E2, C165E2BT, C165E2RCD, C166, C166-2, C33, C34, C95, C95BT, C95E2, C95RCD, G100L, G101L, G50L, G51L, G60L, G61L, GE100...(Other models you can see in the webshop)		



2

<b>GEV No.</b>	520115	<b>Ref. No.</b>	450105
<b>description</b>	hose clamp ø 25-40mm width 9mm Qty 10 pcs DIN 3017		
<b>For models:</b>	AC122, AC152, AC182, AC202, AC242, B20, B20D, B23, B24, B25, B26, B27, BC25, BC25A, BC30, BC30A, BHC25-2, BHC25A-2, BHC30-2, BHC30A-2, BHC30E-2, BHC30EA-2, BHC30HR, BHC30HR-2, BHC30HR380, BHC30HRA, BHC30HRA-2, BHC30HRA380, BHC433-2, BHC433A-2, BHCHR, BR20, BR20A, BR25, BR25A, C1000E, C1000ERCD, C1300E, C1300ERCD, F45, F55, F65, F80, F90M, F90MA, FC, FC3E, FC3EA, FC3M, FC3MA...(Other models you can see in the webshop)		



1

<b>GEV No.</b>	520117	<b>Ref. No.</b>	450135
<b>description</b>	hose clamp stainless steel ø 40-60mm width 9mm Qty 5 pcs DIN 3017		
<b>For models:</b>	AC100, AC101, AC120, AC122, AC150, AC151, AC152, AC170, AC181, AC182, AC200, AC201, AC202, AC241, AC242, AC90, AC91, ACR, ACR145, ACR205, ACR225, ACR245, ACR260, ACR265, ACR305, ACRS205, ACRS245, ACRS260, ACRS265, ACS101, ACS101-DIGIT, ACS122, ACS122-DIGIT, ACS181, ACS181-DIGIT, ACS182, ACS182-DIGIT, ACS91, ACS91-DIGIT, B13T, B14T, B15, B15T, B15TM, B16, B16T, B16TM, B18, B18T, B18TM...(Other models you can see in the webshop)		



1

<b>GEV No.</b>	520116	<b>Ref. No.</b>	450106 450107
<b>description</b>	hose clamp ø 32-50mm width 9mm Qty 5 pcs DIN 3017		
<b>For models:</b>	AC101, AC105, AC122, AC135, AC151, AC152, AC91, AC95, ACL100, ACL150, ACRS145, ACRS205, ACRS225, ACRS245, ACRS260, ACRS265, ACRS305, ACS101, ACS101-DIGIT, ACS122, ACS122-DIGIT, ACS151, ACS151-DIGIT, ACS152, ACS152-DIGIT, ACS181, ACS181-DIGIT, ACS182, ACS182-DIGIT, ACS201, ACS201-DIGIT, ACS202, ACS202-DIGIT, ACS241, ACS241-DIGIT, ACS242, ACS242-DIGIT, ACS91, ACS91-DIGIT, B13T, B14T, B15, B15T, B15TM, B16, B16T, B16TM, B18, B18T, B18TM...(Other models you can see in the webshop)		

double wire clamps



1

<b>GEV No.</b>	511286	<b>Ref. No.</b>	450143
<b>description</b>	hose clamp ø 38mm wire gauge ø 3.2mm Qty 1 pcs		
<b>For models:</b>	AC101, AC105, AC122, AC135, AC151, AC152, AC181, AC182, AC201, AC202, AC241, AC242, AC2A, AC91, AC95, ACL100, ACL150, ACRS145, ACRS205, ACRS225, ACRS245, ACRS260, ACRS265, ACRS305, ACS101, ACS101-DIGIT, ACS122, ACS122-DIGIT, ACS151, ACS151-DIGIT, ACS152, ACS152-DIGIT, ACS161-DIGIT, ACS162-DIGIT, ACS181, ACS181-DIGIT, ACS182, ACS182-DIGIT, ACS201, ACS201-DIGIT, ACS202, ACS202-DIGIT, ACS241, ACS241-DIGIT, ACS242, ACS242-DIGIT, ACS91, ACS91-DIGIT, BC25, BC25A...(Other models you can see in the webshop)		



1

<b>GEV No.</b>	520118	<b>Ref. No.</b>	450109
<b>description</b>	hose clamp ø 50-70mm width 9mm Qty 5 pcs DIN 3017		
<b>For models:</b>	AC100, AC101, AC105, AC120, AC135, AC150, AC170, AC181, AC182, AC200, AC201, AC202, AC241, AC242, AC2A, AC90, AC91, AC95, ACL100, ACL150, ACR, ACR145, ACR205, ACR225, ACR245, ACR260, ACR265, ACR305, ACRS145, ACRS205, ACRS225, ACRS245, ACRS260, ACRS265, ACRS305, ACS101, ACS101-DIGIT, ACS122, ACS122-DIGIT, ACS151, ACS151-DIGIT, ACS152, ACS152-DIGIT, ACS161-DIGIT, ACS162-DIGIT, ACS181, ACS181-DIGIT, ACS182, ACS182-DIGIT, ACS201...(Other models you can see in the webshop)		



1

<b>GEV No.</b>	513268	<b>Ref. No.</b>	450134
<b>description</b>	hose clamp ø 8-10mm wire gauge ø 1mm Qty 1 pcs		
<b>For models:</b>	AC101, AC105, AC122, AC135, AC151, AC152, AC181, AC182, AC201, AC202, AC241, AC242, AC91, AC95, BHC25-2, BHC25A-2, BHC30-2, BHC30A-2, BHC30E, BHC30E-2, BHC30EA, BHC30EA-2, BHC433-2, BHC433A-2, C1000E, C1000ERCD, C1001M, C1300E, C1300ERCD, C1301M, C155BT, C155RCD, C165E2BT, C165E2RCD, C75BT, C75RCD, C95BT, C95RCD, FC3E, FC3EA, FC3MA, FC44E, FC44EA, FC4E, FC4EA, FC4EHRT, FC4MA, FC53CBT, FC53LBT, FC54CBT...(Other models you can see in the webshop)		





1

<b>GEV No.</b>	510959	<b>Ref. No.</b>	450115
<b>description</b>	hose clamp ø 8mm wire gauge ø 1mm Qty 1 pcs		
<b>For models:</b>	B10T, B11T, B12T, B13T, B14T, B15, B15T, B15TM, B16, B16T, B16TM, B18, B18T, B18TM, B19, B19T, B19TM, B31, B41, B42, BC25, BC25A, BC25HR, BC30, BC30A, BC30HR, BC30HR380, BC30HRA, BHC25, BHC25-2, BHC25A, BHC25A-2, BHC25S, BHC30, BHC30-2, BHC30A, BHC30A-2, BHC30E, BHC30E-2, BHC30EA, BHC30EA-2, BHC30HR, BHC30HR-2, BHC30HR380, BHC30HRA, BHC30HRA-2, BHC30HRA380, BHC433, BHC433-2, BHC433A...(Other models you can see in the webshop)		



1

<b>GEV No.</b>	511147	<b>Ref. No.</b>	450125
<b>description</b>	wire clamp ø 12-14mm wire gauge ø 1.5mm zinc-coated steel Qty 1 pcs		
<b>For models:</b>	AC100, AC120, AC150, AC170, AC200, AC90, ACR, ACR145, ACR205, ACR225, ACR245, ACR260, ACR265, ACR305, ACRS145, ACRS205, ACRS225, ACRS245, ACRS260, ACRS265, ACRS305, ACS101, ACS101-DIGIT, ACS122, ACS122-DIGIT, ACS151, ACS151-DIGIT, ACS152, ACS152-DIGIT, ACS161-DIGIT, ACS162-DIGIT, ACS181, ACS181-DIGIT, ACS182, ACS182-DIGIT, ACS201, ACS201-DIGIT, ACS202, ACS202-DIGIT, ACS241, ACS241-DIGIT, ACS242, ACS242-DIGIT, ACS91, ACS91-DIGIT, B10, B10T, B11, B11T, B12...(Other models you can see in the webshop)		

ø52mm



1

<b>GEV No.</b>	541065	<b>Ref. No.</b>	450905
<b>description</b>	thermometer mounting ø 52mm t.max. 120°C 0 up to +120°C probe ø 6.5mm probe L 28mm capillary pipe 1500mm		
<b>For models:</b>	AC100, AC101, AC105, AC120, AC122, AC135, AC150, AC151, AC152, AC170, AC181, AC182, AC200, AC201, AC202, AC241, AC242, AC90, AC91, AC95, ACS101, ACS101-DIGIT, ACS122, ACS122-DIGIT, ACS151, ACS151-DIGIT, ACS152, ACS152-DIGIT, ACS161-DIGIT, ACS162-DIGIT, ACS181, ACS181-DIGIT, ACS182, ACS182-DIGIT, ACS201, ACS201-DIGIT, ACS202, ACS202-DIGIT, ACS241, ACS241-DIGIT, ACS242, ACS242-DIGIT, ACS91, ACS91-DIGIT, C1001M, C1301M, C140, C155, C155BT, C155RCD...(Other models you can see in the webshop)		

## fastening material

### spacers



1

<b>GEV No.</b>	694471	<b>Ref. No.</b>	290801
<b>description</b>	spacer thread M3 L 16.5mm		
<b>For models:</b>	GE100, GE115, GE125, GE60, GE60RCD, GE65, GE65RCD, GE75, GE80		

### screws

#### sheet metal screws



1

<b>GEV No.</b>	560095	<b>Ref. No.</b>	260712
<b>description</b>	sheet metal screws ø 2.9mm L 9.5mm SS Qty 20 pcs DIN 7981/ISO 7049 head ø 5.6mm oval head		
<b>For models:</b>	ACS101, ACS101-DIGIT, ACS122, ACS122-DIGIT, ACS151, ACS151-DIGIT, ACS152, ACS152-DIGIT, ACS161-DIGIT, ACS162-DIGIT, ACS181, ACS181-DIGIT, ACS182, ACS182-DIGIT, ACS201, ACS201-DIGIT, ACS202, ACS202-DIGIT, ACS241, ACS241-DIGIT, ACS242, ACS242-DIGIT, ACS91, ACS91-DIGIT, BHC25, BHC25-2, BHC25A, BHC25A-2, BHC25S, BHC30, BHC30-2, BHC30A, BHC30A-2, BHC30E, BHC30E-2, BHC30EA, BHC30EA-2, BHC30HR, BHC30HR-2, BHC30HR380, BHC30HRA, BHC30HRA-2, BHC30HRA380, BHC433, BHC433-2, BHC433A, BHC433A-2, BHCHR		

## measuring equipment

### thermometers

#### built-in thermometers



1

<b>GEV No.</b>	541063	<b>Ref. No.</b>	450902
<b>description</b>	thermometer mounting measurements 58x25.5mm 0 up to +120°C capillary pipe 1500mm probe ø 6.5mm probe L 23mm		





1

<b>GEV No.</b>	541086	<b>Ref. No.</b>	450902
<b>description</b>	thermometer mounting measurements 58x25.5mm 0 up to +120°C capillary pipe 2000mm probe ø 6mm probe L 23mm		





			
1			
<b>GEV No.</b>	560103	<b>Ref. No.</b>	260706
<b>description</b>	sheet metal screws ø 3.9mm L 13mm SS Qty 20 pcs DIN 7981/ISO 7049 head ø 7.5mm oval head		
<b>For models:</b>	BHC25, BHC25-2, BHC25A, BHC25A-2, BHC25S, BHC30, BHC30-2, BHC30A, BHC30A-2, BHC30E, BHC30E-2, BHC30EA, BHC30EA-2, BHC30HR, BHC30HR-2, BHC30HR380, BHC30HRA, BHC30HRA-2, BHC30HRA380, BHC433, BHC433-2, BHC433A, BHC433A-2, BHCHR, C1000ERCD, C1300ERCD, C155RCD, C165E2RCD, C75M, C75RCD, C95RCD, FC53CBT, FC53LBT, FC54CBT, FC54LBT, GF90, GF90A, LB200, LB200-2, LB200A, LB200A-2, LB215, LB215-2, LB215A, LB215A-2, LB260, LB260-2, LB260A, LB260A-2, LB275...(Other models you can see in the webshop)		

 <p>Image not available</p>			
1			
<b>GEV No.</b>	511183	<b>Ref. No.</b>	261015
<b>description</b>	sheet-metal screw ø 3.9mm L 13mm		
<b>For models:</b>	BHC25, BHC25-2, BHC25A, BHC25A-2, BHC25S, BHC30, BHC30-2, BHC30A, BHC30A-2, BHC30E, BHC30E-2, BHC30EA, BHC30EA-2, BHC30HR, BHC30HR-2, BHC30HR380, BHC30HRA, BHC30HRA-2, BHC30HRA380, BHC433, BHC433-2, BHC433A, BHC433A-2, BHCHR, LB200, LB200-2, LB200A, LB200A-2, LB215, LB215-2, LB215A, LB215A-2, LB260, LB260-2, LB260A, LB260A-2, LB275, LB275A-2, LB275A, LB275A-2		

			
1			
<b>GEV No.</b>	560231	<b>Ref. No.</b>	H33277
<b>description</b>	sheet metal screws ø 2.9mm L 9.5mm SS Qty 20 pcs DIN 7982/ISO 7050 head ø 5.5mm sunk head		
<b>For models:</b>	GF70, GF70A, GF90, GF90-2004, GF90A, GF90A-2004		

 <p>Image not available</p>			
1			
<b>GEV No.</b>	560532	<b>Ref. No.</b>	260701
<b>description</b>	sheet-metal screw ø 3.5mm L 12mm SS Qty 1 pcs intake slotted head ø 7mm		
<b>For models:</b>	ACS101, ACS101-DIGIT, ACS122, ACS122-DIGIT, ACS151, ACS151-DIGIT, ACS152, ACS152-DIGIT, ACS161-DIGIT, ACS162-DIGIT, ACS181, ACS181-DIGIT, ACS182, ACS182-DIGIT, ACS201, ACS201-DIGIT, ACS202, ACS202-DIGIT, ACS241, ACS241-DIGIT, ACS242, ACS242-DIGIT, ACS91, ACS91-DIGIT, B41, BHC25, BHC25A, BHC25S, BHC30, BHC30A, BHC30E, BHC30E-2, BHC30EA, BHC30EA-2, BHC433, BHC433A, C1000E, C1000ERCD, C1001M, C1300E, C1300ERCD, C1301M, C155, C155BT, C155E2, C155RCD, C165, C165E2, C165E2BT, C165E2RCD...(Other models you can see in the webshop)		

flat-headed bolts			
			
1			
<b>GEV No.</b>	560528	<b>Ref. No.</b>	260203
<b>description</b>	flat-headed bolt thread M3.5 thread L 12mm SS DIN 84/ISO 1207 Qty 1 pcs intake slotted head ø 6mm head thickness 2.5mm		
<b>For models:</b>	ACS101, ACS101-DIGIT, ACS122, ACS122-DIGIT, ACS151, ACS151-DIGIT, ACS152, ACS152-DIGIT, ACS161-DIGIT, ACS162-DIGIT, ACS181, ACS181-DIGIT, ACS182, ACS182-DIGIT, ACS201, ACS201-DIGIT, ACS202, ACS202-DIGIT, ACS241, ACS241-DIGIT, ACS242, ACS242-DIGIT, ACS91, ACS91-DIGIT		

			
1			
<b>GEV No.</b>	511004	<b>Ref. No.</b>	260226
<b>description</b>	flat-headed bolt thread M4 thread L 12mm SS DIN 84/ISO 1207 Qty 1 pcs intake slotted L 14.5mm		
<b>For models:</b>	AC101, AC122, AC151, AC152, AC91, ACR, ACR145, ACR205, ACR225, ACR245, ACR260, ACR265, ACR305, ACS101, ACS101-DIGIT, ACS122, ACS122-DIGIT, ACS151, ACS151-DIGIT, ACS152, ACS152-DIGIT, ACS91, ACS91-DIGIT, B13T, B14T, B15T, B15TM, B16T, B16TM, B18T, B18TM, B19T, B19TM, BC25HR, BC30HR, BC30HR380, BC30HRA, C140, C33, C34, C70, C75, C75BT, C75RCD, C85, F20, F90M, F90MA, G115, G125...(Other models you can see in the webshop)		

			
1			
<b>GEV No.</b>	560454	<b>Ref. No.</b>	260206
<b>description</b>	flat-headed bolt thread M4 thread L 22mm SS DIN 84/ISO 1207 Qty 1 pcs intake slotted head ø 7mm head thickness 2.5mm		
<b>For models:</b>	BC25HR, BC30HR, BC30HR380, BC30HRA, F90M, F90MA, FC3E, FC3EA, FC3M, FC3MA, FC3MR, FC44E, FC44EA, FC4E, FC4EA, FC4EHR, FC4M, FC4MA, LC380, LC380BT, LC380RCD, LC400, LF400A, LF450, LF450A		

			
1			
<b>GEV No.</b>	560529	<b>Ref. No.</b>	260207
<b>description</b>	flat-headed bolt thread M4 thread L 25mm SS DIN 84/ISO 1207 Qty 1 pcs intake slotted head ø 7mm head thickness 2.5mm		
<b>For models:</b>	C140, C33, C34, LC380, LC380BT, LC380RCD, LC400		

oval head screws			
			
1			
<b>GEV No.</b>	560455	<b>Ref. No.</b>	260238
<b>description</b>	oval head screw thread M4 thread L 10mm L 12.5mm head ø 10mm stainless steel intake slotted Qty 1 pcs		
<b>For models:</b>	ACS101, ACS101-DIGIT, ACS122, ACS122-DIGIT, ACS151, ACS151-DIGIT, ACS152, ACS152-DIGIT, ACS161-DIGIT, ACS162-DIGIT, ACS181, ACS181-DIGIT, ACS182, ACS182-DIGIT, ACS201, ACS201-DIGIT, ACS202, ACS202-DIGIT, ACS241, ACS241-DIGIT, ACS242, ACS242-DIGIT, ACS91, ACS91-DIGIT, B10, B11, B12, B15, B16, B18, B19, BC25, BC25A, BC25HR, BC30, BC30A, BC30HR, BC30HR380, BC30HRA, BHC25, BHC25-2, BHC25A, BHC25A-2, BHC25S, BHC30, BHC30-2, BHC30A, BHC30A-2, BHC30E, BHC30E-2...(Other models you can see in the webshop)		

hexagonal screws



<b>GEV No.</b>	560499	<b>Ref. No.</b>	260133
<b>description</b>	hexagonal screw thread M10 thread L 55mm SS WS 17 Qty 1 pcs head thickness 6.5mm DIN 933 / ISO 4017		
<b>For models:</b>	AC101, AC122, AC151, AC152, AC181, AC182, AC201, AC202, AC241, AC242, AC91, ACS101, ACS101-DIGIT, ACS122, ACS122-DIGIT, ACS151, ACS151-DIGIT, ACS152, ACS152-DIGIT, ACS161-DIGIT, ACS162-DIGIT, ACS181, ACS181-DIGIT, ACS182, ACS182-DIGIT, ACS201, ACS201-DIGIT, ACS202, ACS202-DIGIT, ACS241, ACS241-DIGIT, ACS242, ACS242-DIGIT, ACS91, ACS91-DIGIT		



<b>GEV No.</b>	560081	<b>Ref. No.</b>	260138
<b>description</b>	hexagonal screw thread M4 thread L 10mm SS WS 7 Qty 20 pcs DIN 933 / ISO 4017		
<b>For models:</b>	BHC25, BHC25-2, BHC25A, BHC25A-2, BHC25S, BHC30, BHC30-2, BHC30A, BHC30A-2, BHC30E, BHC30E-2, BHC30EA, BHC30EA-2, BHC30HR, BHC30HR-2, BHC30HR380, BHC30HRA, BHC30HRA-2, BHC30HRA380, BHC433, BHC433-2, BHC433A, BHC433A-2, BHCHR, GF70, GF70A, LF322MP, LF322MP-A, LFD32E, LFD32EA, LFD32M, LFD32MA		



<b>GEV No.</b>	560527	<b>Ref. No.</b>	260151
<b>description</b>	hexagonal screw thread M4 thread L 12mm SS WS 7 Qty 1 pcs head thickness 3mm DIN 933 / ISO 4017		
<b>For models:</b>	BC25HR, BC30HR, BC30HR380, BC30HRA, BHC25S, C1000E, C1000ERCD, C1001M, C1300E, C1300ERCD, C1301M, F90M, F90MA, GE50RCD, LB200, LB200-2, LB215, LB215-2, LB215A, LB260, LB260-2, LB275, LB275-2, LB275A, LC1200, LC1200RCD, LC700, LC700RCD, LC900, LC900RCD, LF400A, LF450, LF450A		



<b>GEV No.</b>	560385	<b>Ref. No.</b>	260126
<b>description</b>	hexagonal screw thread M5 thread L 12mm SS WS 8 Qty 1 pcs DIN 933 / ISO 4017		
<b>For models:</b>	AC101, AC122, AC151, AC152, AC181, AC182, AC201, AC202, AC241, AC242, AC91, ACR, ACR145, ACR205, ACR225, ACR245, ACR260, ACR265, ACR305, ACS101, ACS101-DIGIT, ACS122, ACS122-DIGIT, ACS151, ACS151-DIGIT, ACS152, ACS152-DIGIT, ACS161-DIGIT, ACS162-DIGIT, ACS181, ACS181-DIGIT, ACS182, ACS182-DIGIT, ACS201, ACS201-DIGIT, ACS202, ACS202-DIGIT, ACS241, ACS241-DIGIT, ACS242, ACS242-DIGIT, ACS91, ACS91-DIGIT, BHC25, BHC25-2, BHC25A, BHC25A-2, BHC25S, BHC30, BHC30-2...(Other models you can see in the webshop)		



<b>GEV No.</b>	560084	<b>Ref. No.</b>	260126
<b>description</b>	hexagonal screw thread M5 thread L 16mm SS WS 8 Qty 20 pcs DIN 933 / ISO 4017		



<b>GEV No.</b>	524118	<b>Ref. No.</b>	260104
<b>description</b>	hexagonal screw thread M6 thread L 16mm SS WS 10 Qty 1 pcs DIN 933 / ISO 4017		



<b>GEV No.</b>	560087	<b>Ref. No.</b>	260104
<b>description</b>	hexagonal screw thread M6 thread L 16mm SS WS 10 Qty 20 pcs DIN 933 / ISO 4017		
<b>For models:</b>	ACS151, ACS151-DIGIT, ACS152, ACS152-DIGIT, ACS181, ACS181-DIGIT, ACS182, ACS182-DIGIT, ACS201, ACS201-DIGIT, ACS202, ACS202-DIGIT, ACS241, ACS241-DIGIT, ACS242, ACS242-DIGIT, BHC25, BHC25-2, BHC25A, BHC25A-2, BHC25S, BHC30, BHC30-2, BHC30A, BHC30A-2, BHC30E, BHC30E-2, BHC30EA, BHC30EA-2, BHC30HR, BHC30HR-2, BHC30HR380, BHC30HRA, BHC30HRA-2, BHC30HRA380, BHC433, BHC433-2, BHC433A, BHC433A-2, BHCHR, C140, C166, C75, C75BT, C75RCD, C85, GE50RCD, GF70, GF70A, LAV1000...(Other models you can see in the webshop)		





<b>GEV No.</b>	560089	<b>Ref. No.</b>	260106
<b>description</b>	hexagonal screw thread M6 thread L 25mm SS WS 10 Qty 20 pcs DIN 933 / ISO 4017		
<b>For models:</b>	BHC25-2, BHC25A-2, BHC30-2, BHC30A-2, BHC30E, BHC30E-2, BHC30EA, BHC30EA-2, BHC30HR-2, BHC30HRA-2, BHC433-2, BHC433A-2, C75, C75BT, C75RCD, F90M, F90MA, FC, FC53, FC533, FC533A, FC53A, FC53CBT, FC53LA, FC53LBT, FC54, FC543, FC543A, FC543E, FC543EA, FC544, FC544A, FC54A, FC54CBT, FC54E, FC54EA, FC54LBT, FCHR, FCHRA, FCHRT, FCHRTA, LF315, LF320, LF320A, LF320CBT, LF320L, LF320LA, LF320LBT, LF322, LF322A...(Other models you can see in the webshop)		



<b>GEV No.</b>	502214	<b>Ref. No.</b>	260112
<b>description</b>	hexagonal screw thread M8 thread L 16mm SS WS 13 Qty 1 pcs head thickness 5.5mm DIN 933 / ISO 4017		
<b>For models:</b>	AC101, AC120, AC122, AC150, AC170, AC200, AC91, ACR, ACR145, ACR205, ACR225, ACR245, ACR260, ACR265, ACR305, ACS101, ACS101-DIGIT, ACS122, ACS122-DIGIT, ACS151, ACS151-DIGIT, ACS152, ACS152-DIGIT, ACS161-DIGIT, ACS162-DIGIT, ACS181, ACS181-DIGIT, ACS182, ACS182-DIGIT, ACS201, ACS201-DIGIT, ACS202, ACS202-DIGIT, ACS241, ACS241-DIGIT, ACS242, ACS242-DIGIT, ACS91, ACS91-DIGIT, C1000E, C1000ERCD, C1001M, C1300E, C1300ERCD, C1301M, C155, C155E2, C165, C165E2, C166...(Other models you can see in the webshop)		



 <p>1</p>			
<b>GEV No.</b>	510990	<b>Ref. No.</b>	260113
<b>description</b>	hexagonal screw thread M8 thread L 20mm SS WS 13 Qty 1 pcs DIN 933 / ISO 4017		
<b>For models:</b>	ACS101, ACS101-DIGIT, ACS122, ACS122-DIGIT, ACS151, ACS151-DIGIT, ACS152, ACS152-DIGIT, ACS161-DIGIT, ACS162-DIGIT, ACS181, ACS181-DIGIT, ACS182, ACS182-DIGIT, ACS201, ACS201-DIGIT, ACS202, ACS202-DIGIT, ACS241, ACS241-DIGIT, ACS242, ACS242-DIGIT, ACS91, ACS91-DIGIT, C1000E, C1000ERCD, C1001M, C1300E, C1300ERCD, C1301M, C140, C155, C155BT, C155E2, C155RCD, C165, C165E2, C165E2BT, C165E2RCD, C75M, C85, C95, C95BT, C95E2, C95RCD, GE50RCD, LC1200, LC1200RCD, LC380, LC380BT...(Other models you can see in the webshop)		

 <p>1</p>			
<b>GEV No.</b>	560530	<b>Ref. No.</b>	260232
<b>description</b>	side bolts thread M6 L 28mm SS Qty 1 pcs intake slotted head ø 13.5mm		
<b>For models:</b>	B13T, B14T, C75, C75BT, C75RCD, F45, F55, F65, F80, F90M, F90MA, GE100, GE115, GE60, GE60RCD, GE65, GE65RCD, GE80, LF280-lav-line, LF315, LF320, LF320A, LF320CBT, LF320L, LF320LA, LF320-lav-line, LF320LBT, LF323, LF323A, LF350, LF350A, LF400A, LF450, LF450A, LP360, LP360BT, LP360RCD, LS550		

**cylinder head bolts**

**miscellaneous**

 <p>1</p>			
<b>GEV No.</b>	510953	<b>Ref. No.</b>	260213 260237
<b>description</b>	cylinder head bolt thread M5 thread L 25mm SS Qty 1 pcs intake slotted		
<b>For models:</b>	B10, B10T, B11, B11T, B12, B12T, B13T, B14T, B15, B15T, B15TM, B16, B16T, B16TM, B18, B18T, B18TM, B19, B19T, B19TM, BC25, BC25A, BC25HR, BC30, BC30A, BC30HR, BC30HR380, BC30HRA, BHC25, BHC25-2, BHC25A, BHC25A-2, BHC25S, BHC30, BHC30-2, BHC30A, BHC30A-2, BHC30E, BHC30E-2, BHC30EA, BHC30EA-2, BHC30HR, BHC30HR-2, BHC30HR380, BHC30HRA, BHC30HRA-2, BHC30HRA380, BHC433, BHC433-2, BHC433A...(Other models you can see in the webshop)		

**grub screws**

**DIN 914/ISO 4027**

 <p>1</p>			
<b>GEV No.</b>	504230	<b>Ref. No.</b>	250202
<b>description</b>	grub screw thread M5 L 8mm A2-A2L DIN 914/ISO 4027 WS 2.5 Qty 1 pcs		
<b>For models:</b>	ACRS145, ACRS205, ACRS225, ACRS245, ACRS260, ACRS265, ACRS305, ACS101, ACS101-DIGIT, ACS122, ACS122-DIGIT, ACS151, ACS151-DIGIT, ACS152, ACS152-DIGIT, ACS161-DIGIT, ACS162-DIGIT, ACS181, ACS181-DIGIT, ACS182, ACS182-DIGIT, ACS201, ACS201-DIGIT, ACS202, ACS202-DIGIT, ACS241, ACS241-DIGIT, ACS242, ACS242-DIGIT, ACS91, ACS91-DIGIT, C166-2		

**side bolts**

 <p>1</p>			
<b>GEV No.</b>	560052	<b>Ref. No.</b>	260223
<b>description</b>	side bolts thread M5 L 10mm SS Qty 20 pcs intake slotted head ø 12.5mm		
<b>For models:</b>	AC101, AC122, AC151, AC152, AC181, AC182, AC201, AC202, AC241, AC242, AC91, ACR, ACR145, ACR205, ACR225, ACR245, ACR260, ACR265, ACR305, ACS101, ACS101-DIGIT, ACS122, ACS122-DIGIT, ACS151, ACS151-DIGIT, ACS152, ACS152-DIGIT, ACS161-DIGIT, ACS162-DIGIT, ACS181, ACS181-DIGIT, ACS182, ACS182-DIGIT, ACS201, ACS201-DIGIT, ACS202, ACS202-DIGIT, ACS241, ACS241-DIGIT, ACS242, ACS242-DIGIT, ACS91, ACS91-DIGIT, BHC25, BHC25-2, BHC25A, BHC25A-2, BHC25S, BHC30, BHC30-2...(Other models you can see in the webshop)		

**DIN 916/ISO 4029**

 <p>1</p>			
<b>GEV No.</b>	510906	<b>Ref. No.</b>	250206
<b>description</b>	grub screw thread M6 L 8mm stainless steel DIN 914/ISO 4027 WS 3 Qty 1 pcs		
<b>For models:</b>	C1000E, C1000ERCD, C1001M, C1300E, C1300ERCD, C1301M, C140, C155, C155BT, C155E2, C155RCD, C165, C165E2, C165E2BT, C165E2RCD, C166, C166-2, C70, C75, C75BT, C75M, C75RCD, C85, C95, C95BT, C95E2, C95RCD, LC1200, LC1200RCD, LC380, LC380BT, LC380RCD, LC400, LC412, LC700, LC700RCD, LC900, LC900RCD, LP360, LP360BT, LP360RCD		

 <p>1</p>			
<b>GEV No.</b>	560531	<b>Ref. No.</b>	H31910
<b>description</b>	side bolts thread M5 L 11mm SS Qty 1 pcs intake slotted head ø 11mm		
<b>For models:</b>	GE50RCD, GF90, GF90A		

 <p>1</p>			
<b>GEV No.</b>	560207	<b>Ref. No.</b>	250209
<b>description</b>	grub screw thread M8 L 10mm steel DIN 916/ISO 4029 intake internal hexagon WS 4 Qty 1 pcs		

knurled screws



1

<b>GEV No.</b>	510307	<b>Ref. No.</b>	261004 261009
<b>description</b>	Thumb screw thread M6 H 3mm thread L 8mm ø 28mm SS		
<b>For models:</b>	B13T, B14T, B15T, B15TM, B16, B16T, B16TM, B18T, B18TM, B19, B19T, B19TM, B41, B42, BC25, BC25A, BC25HR, BC30, BC30A, BC30HR, BC30HR380, BC30HRA, BHC25, BHC25A, BHC25S, BHC30, BHC30A, BHC30HR, BHC30HR380, BHC30HRA, BHC30HRA380, BHC433, BH-C433A, BHCHR, C1000E, C1000ERCD, C1001M, C1300E, C1300ERCD, C1301M, C140, C155, C155BT, C155E2, C155RCD, C165, C165E2, C165E2BT, C165E2RCD, C166...(Other models you can see in the webshop)		

miscellaneous



1

<b>GEV No.</b>	511006	<b>Ref. No.</b>	260228
<b>description</b>	screw		
<b>For models:</b>	C1000E, C1000ERCD, C1001M, C1300E, C1300ERCD, C1301M, C140, C155, C155BT, C155E2, C155RCD, C165, C165E2, C165E2BT, C165E2RCD, C166, C166-2, C30, C70, C75, C75BT, C75M, C75RCD, C85, C95, C95BT, C95E2, C95RCD, LC1200, LC1200RCD, LC380, LC380BT, LC380RCD, LC400, LC412, LC700, LC700RCD, LC900, LC900RCD, LP360, LP360BT, LP360RCD		

nuts

cap nuts



1

<b>GEV No.</b>	560138	<b>Ref. No.</b>	290702
<b>description</b>	cap nuts thread M8 WS 13 SS Qty 20 pcs DIN/ISO DIN 1587		

knurled nuts



1

<b>GEV No.</b>	511252	<b>Ref. No.</b>	510284
<b>description</b>	knurled nut		
<b>For models:</b>	G115, G131, G65, G66, G75		



1

<b>GEV No.</b>	512212	<b>Ref. No.</b>	H34998
<b>description</b>	knurled nut thread M10x1.5 ø 30mm H 6.4mm SS		
<b>For models:</b>	GF90, GF90-2004, GF90A, GF90A-2004		



1

<b>GEV No.</b>	510346	<b>Ref. No.</b>	280409
<b>description</b>	knurled nut thread M17x1 ø 35mm H 6mm SS		
<b>For models:</b>	C1000E, C1000ERCD, C1001M, C1300E, C1300ERCD, C1301M, C140, C155, C155BT, C155E2, C155RCD, C165, C165E2, C165E2BT, C165E2RCD, C166, C166-2, C33, C34, C95, C95BT, C95E2, C95RCD, G100L, G101L, G50L, G51L, G60L, G61L, GE100, GE115, GE50RCD, GE60, GE60RCD, GE65, GE65RCD, GE80, GF90, GF90-2004, GF90A, GF90A-2004, GL, LC1200, LC1200RCD, LC380, LC412, LC700, LC700RCD, LC900, LC900RCD...(Other models you can see in the webshop)		



1

<b>GEV No.</b>	511009	<b>Ref. No.</b>	280413
<b>description</b>	knurled nut thread M8 ø 30mm H 4.5mm SS		
<b>For models:</b>	C75, C75BT, C75RCD, FC, FC53, FC533, FC533A, FC53A, FC53CBT, FC53LA, FC53LBT, FC54, FC543, FC543A, FC543E, FC543EA, FC544, FC544A, FC54A, FC54CBT, FC54E, FC54EA, FC54LBT, FCHR, FCHRA, FCHRT, FCHRTA		

hexagonal nuts

DIN 934 / ISO 4032/8673



1

<b>GEV No.</b>	560129	<b>Ref. No.</b>	260403
<b>description</b>	hexagonal nut thread M5 H 4mm WS 8 SS DIN/ISO DIN 934 / ISO 4032/8673 Qty 1 pcs		





1

<b>GEV No.</b>	560133	<b>Ref. No.</b>	260404
<b>description</b>	hexagonal nut thread M6 H 5mm WS 10 SS DIN/ISO DIN 934 / ISO 4032/8673 Qty 20 pcs		
<b>For models:</b>	AC101, AC122, AC151, AC152, AC181, AC182, AC201, AC202, AC241, AC242, AC91, ACR, ACR145, ACR205, ACR225, ACR245, ACR260, ACR265, ACR305, ACS101, ACS101-DIGIT, ACS122, ACS122-DIGIT, ACS151, ACS151-DIGIT, ACS152, ACS152-DIGIT, ACS161-DIGIT, ACS162-DIGIT, ACS181, ACS181-DIGIT, ACS182, ACS182-DIGIT, ACS201, ACS201-DIGIT, ACS202, ACS202-DIGIT, ACS241, ACS241-DIGIT, ACS242, ACS242-DIGIT, ACS91, ACS91-DIGIT, B10T, B11T, B12T, B13T, B14T, B15T, B15TM...(Other models you can see in the webshop)		







			
1			
<b>GEV No.</b>	560134	<b>Ref. No.</b>	260405
<b>description</b>	hexagonal nut thread M8 H 6.5mm WS 13 SS DIN/ISO DIN 934 / ISO 4032/8673 Qty 20 pcs		

			
1			
<b>GEV No.</b>	560197	<b>Ref. No.</b>	260407
<b>description</b>	nut thread M10 H 8mm WS 17 SS DIN/ISO DIN 934 / ISO 4032/8673 Qty 1 pcs		
<b>For models:</b>	AC100, AC101, AC120, AC122, AC150, AC151, AC152, AC170, AC181, AC182, AC200, AC201, AC202, AC241, AC242, AC2A, AC90, AC91, ACR, ACR145, ACR205, ACR225, ACR245, ACR260, ACR265, ACR305, ACRS145, ACRS205, ACRS225, ACRS245, ACRS260, ACRS265, ACRS305, ACS101, ACS101-DIGIT, ACS122, ACS122-DIGIT, ACS151, ACS151-DIGIT, ACS152, ACS152-DIGIT, ACS161-DIGIT, ACS162-DIGIT, ACS181, ACS181-DIGIT, ACS182, ACS182-DIGIT, ACS201, ACS201-DIGIT, ACS202, ACS202-DIGIT, ACS241, ACS241-DIGIT, ACS242, ACS242-DIGIT, ACS91, ACS91-DIGIT...(Other models you can see in the webshop)		

			
1			
<b>GEV No.</b>	506166	<b>Ref. No.</b>	260408
<b>description</b>	nut thread M12 H 10mm WS 19 SS DIN/ISO DIN 934 / ISO 4032/8673 Qty 1 pcs		
<b>For models:</b>	BC25, BC25A, BC25HR, BC30, BC30A, BC30HR, BC30HR380, BC30HRA, BHC25, BHC25-2, BHC25A, BHC25A-2, BHC25S, BHC30, BHC30-2, BHC30A, BHC30A-2, BHC30E, BHC30E-2, BHC30EA, BHC30EA-2, BHC30HR, BHC30HR-2, BHC30HR380, BHC30HRA, BHC30HRA-2, BHC30HRA380, BHC433, BHC433-2, BHC433A, BHC433A-2, BHCHR, BR20, BR20A, BR25, BR25A, C1000E, C1300E, C166-2, C70, C75, C75BT, C75M, C75RCD, F90M, F90MA, FC, FC3E, FC3EA, FC3M...(Other models you can see in the webshop)		

 <p>Image not available</p>			
1			
<b>GEV No.</b>	520246	<b>Ref. No.</b>	260410
<b>description</b>	nut thread M12 SS		
<b>For models:</b>	F45, F55, F65, F80, LF280-lav-line, LF320-lav-line, NG01, NG601, NG601E, NG901, NG901E		

<b>ISO 4033 / UNI5587</b>			
			
1			
<b>GEV No.</b>	560470	<b>Ref. No.</b>	260406
<b>description</b>	nut thread M8x1.25 H 8mm WS 13 SS Qty 1 pcs DIN/ISO ISO 4033 / UNI5587		
<b>For models:</b>	AC101, AC122, AC151, AC152, AC181, AC182, AC201, AC202, AC241, AC242, AC91, ACR, ACR145, ACR205, ACR225, ACR245, ACR260, ACR265, ACR305, ACRS145, ACRS205, ACRS225, ACRS245, ACRS260, ACRS265, ACRS305, ACS101, ACS101-DIGIT, ACS122, ACS122-DIGIT, ACS151, ACS151-DIGIT, ACS152, ACS152-DIGIT, ACS161-DIGIT, ACS162-DIGIT, ACS181, ACS181-DIGIT, ACS182, ACS182-DIGIT, ACS201, ACS201-DIGIT, ACS202, ACS202-DIGIT, ACS241, ACS241-DIGIT, ACS242, ACS242-DIGIT, ACS91, ACS91-DIGIT...(Other models you can see in the webshop)		

<b>DIN 985</b>			
			
1			
<b>GEV No.</b>	560140	<b>Ref. No.</b>	260402 260418
<b>description</b>	hexagonal nut thread M4 H 4.8mm SS WS 7 Qty 20 pcs DIN/ISO DIN 985 self-locking		
<b>For models:</b>	AC101, AC120, AC122, AC150, AC151, AC152, AC170, AC200, AC91, ACR, ACR145, ACR205, ACR225, ACR245, ACR260, ACR265, ACR305, ACS101, ACS101-DIGIT, ACS122, ACS122-DIGIT, ACS151, ACS151-DIGIT, ACS152, ACS152-DIGIT, ACS161-DIGIT, ACS162-DIGIT, ACS181, ACS181-DIGIT, ACS182, ACS182-DIGIT, ACS201, ACS201-DIGIT, ACS202, ACS202-DIGIT, ACS241, ACS241-DIGIT, ACS242, ACS242-DIGIT, ACS91, ACS91-DIGIT, B10T, B11T, B12T, B13T, B14T, B15T, B15TM, B16T, B16TM...(Other models you can see in the webshop)		

			
1			
<b>GEV No.</b>	560141	<b>Ref. No.</b>	260414
<b>description</b>	hexagonal nut thread M5 H 5.4mm SS WS 8 Qty 20 pcs DIN/ISO DIN 985 self-locking		
<b>For models:</b>	AC101, AC122, AC151, AC152, AC181, AC182, AC201, AC202, AC241, AC242, AC91, ACR, ACR145, ACR205, ACR225, ACR245, ACR260, ACR265, ACR305, ACS101, ACS101-DIGIT, ACS122, ACS122-DIGIT, ACS151, ACS151-DIGIT, ACS152, ACS152-DIGIT, ACS161-DIGIT, ACS162-DIGIT, ACS181, ACS181-DIGIT, ACS182, ACS182-DIGIT, ACS201, ACS201-DIGIT, ACS202, ACS202-DIGIT, ACS241, ACS241-DIGIT, ACS242, ACS242-DIGIT, ACS91, ACS91-DIGIT, BHC25, BHC25-2, BHC25A, BHC25A-2, BHC25S, BHC30, BHC30-2...(Other models you can see in the webshop)		

			
1			
<b>GEV No.</b>	560142	<b>Ref. No.</b>	260412
<b>description</b>	hexagonal nut thread M6 H 6mm SS WS 10 Qty 20 pcs DIN/ISO DIN 985 self-locking		
<b>For models:</b>	AC101, AC122, AC151, AC152, AC181, AC182, AC201, AC202, AC241, AC242, AC91, ACR, ACR145, ACR205, ACR225, ACR245, ACR260, ACR265, ACR305, ACS101, ACS101-DIGIT, ACS122, ACS122-DIGIT, ACS151, ACS151-DIGIT, ACS152, ACS152-DIGIT, ACS161-DIGIT, ACS162-DIGIT, ACS181, ACS181-DIGIT, ACS182, ACS182-DIGIT, ACS201, ACS201-DIGIT, ACS202, ACS202-DIGIT, ACS241, ACS241-DIGIT, ACS242, ACS242-DIGIT, ACS91, ACS91-DIGIT, C155, C155BT, C155E2, C155RCD, C165, C165E2, C165E2BT...(Other models you can see in the webshop)		

hexagonal nuts metric (without norm)



1

<b>GEV No.</b>	510374	<b>Ref. No.</b>	270118
<b>description</b>	nut thread M15x1.25 H 6.5mm WS 27 SS Qty 1 pcs		
<b>For models:</b>	C155, C155BT, C155E2, C155RCD, C165, C165E2, C165E2BT, C165E2RCD, C166, C166-2, C30, C70, C75, C75BT, C75M, C75RCD, C95, C95BT, C95E2, C95RCD, LC380, LC380BT, LC380RCD, LC400, LP360, LP360BT, LP360RCD		

hexagonal nuts inch thread



1

<b>GEV No.</b>	511200	<b>Ref. No.</b>	270106
<b>description</b>	nut thread 1" H 6mm brass WS 45 Qty 1 pcs		
<b>For models:</b>	B10, B10T, B11, B11T, B12, B12T, B20, B20D, B23, B24, B25, B26, B27, BR20, BR20A, BR25, BR25A, LBR, LBR200, LBR215, LBR215A		



1

<b>GEV No.</b>	510331	<b>Ref. No.</b>	270101
<b>description</b>	nut thread 1/2" H 7mm SS WS 30 Qty 1 pcs		
<b>For models:</b>	AC100, AC101, AC105, AC120, AC122, AC135, AC150, AC151, AC152, AC170, AC181, AC182, AC200, AC201, AC202, AC241, AC242, AC2A, AC90, AC91, AC95, ACL100, ACL150, ACR, ACR145, ACR205, ACR225, ACR245, ACR260, ACR265, ACR305, ACRS145, ACRS205, ACRS225, ACRS245, ACRS260, ACRS265, ACRS305, ACS101, ACS101-DIGIT, ACS122, ACS122-DIGIT, ACS151, ACS151-DIGIT, ACS152, ACS152-DIGIT, ACS161-DIGIT, ACS162-DIGIT, ACS181, ACS181-DIGIT...(Other models you can see in the webshop)		



1

<b>GEV No.</b>	511182	<b>Ref. No.</b>	270107
<b>description</b>	nut thread 3/8" H 8mm brass WS 24 Qty 1 pcs		
<b>For models:</b>	AC101, AC105, AC120, AC122, AC135, AC150, AC151, AC152, AC170, AC181, AC182, AC200, AC201, AC202, AC241, AC242, AC91, AC95, ACR, ACR145, ACR205, ACR225, ACR245, ACR260, ACR265, ACR305, ACRS145, ACRS205, ACRS225, ACRS245, ACRS260, ACRS265, ACRS305, ACS101, ACS101-DIGIT, ACS122, ACS122-DIGIT, ACS151, ACS151-DIGIT, ACS152, ACS152-DIGIT, ACS161-DIGIT, ACS162-DIGIT, ACS181, ACS181-DIGIT, ACS182, ACS182-DIGIT, ACS201, ACS201-DIGIT, ACS202...(Other models you can see in the webshop)		



1

<b>GEV No.</b>	511309	<b>Ref. No.</b>	270104
<b>description</b>	nut thread 1 1/2" ø 66mm H 9mm WS 51 brass Qty 1 pcs		
<b>For models:</b>	AC101, AC105, AC120, AC122, AC135, AC150, AC151, AC152, AC170, AC181, AC182, AC200, AC201, AC202, AC241, AC242, AC91, AC95, ACR, ACR145, ACR205, ACR225, ACR245, ACR260, ACR265, ACR305, ACRS145, ACRS205, ACRS225, ACRS245, ACRS260, ACRS265, ACRS305, ACS101, ACS101-DIGIT, ACS122, ACS122-DIGIT, ACS151, ACS151-DIGIT, ACS152, ACS152-DIGIT, ACS161-DIGIT, ACS162-DIGIT, ACS181, ACS181-DIGIT, ACS182, ACS182-DIGIT, ACS201, ACS201-DIGIT, ACS202...(Other models you can see in the webshop)		

washers

spring rings



1

<b>GEV No.</b>	560209	<b>Ref. No.</b>	260514
<b>description</b>	lock washer ID ø 10.3mm ED ø 17.2mm SS Qty 1 pcs for thread M10		
<b>For models:</b>	AC101, AC122, AC151, AC152, AC181, AC182, AC201, AC202, AC241, AC242, AC91, ACRS145, ACRS205, ACRS225, ACRS245, ACRS260, ACRS265, ACRS305, ACS101, ACS101-DIGIT, ACS122, ACS122-DIGIT, ACS151, ACS151-DIGIT, ACS152, ACS152-DIGIT, ACS161-DIGIT, ACS162-DIGIT, ACS181, ACS181-DIGIT, ACS182, ACS182-DIGIT, ACS201, ACS201-DIGIT, ACS202, ACS202-DIGIT, ACS241, ACS241-DIGIT, ACS242, ACS242-DIGIT, ACS91, ACS91-DIGIT, FC44E, FC44EA, LAV1000		



1

<b>GEV No.</b>	560376	<b>Ref. No.</b>	260510
<b>description</b>	lock washer ID ø 4.3mm ED ø 7.3mm SS UNI 1751 A Qty 1 pcs for thread M4		
<b>For models:</b>	AC122, AC151, AC152, AC181, AC182, AC201, AC202, AC241, AC242, ACR, ACR145, ACR205, ACR225, ACR245, ACR260, ACR265, ACR305, ACS101, ACS101-DIGIT, ACS122, ACS122-DIGIT, ACS151, ACS151-DIGIT, ACS152, ACS152-DIGIT, ACS161-DIGIT, ACS162-DIGIT, ACS181, ACS181-DIGIT, ACS182, ACS182-DIGIT, ACS201, ACS201-DIGIT, ACS202, ACS202-DIGIT, ACS241, ACS241-DIGIT, ACS242, ACS242-DIGIT, ACS91, ACS91-DIGIT, B10T, B11T, B12T, BHC25, BHC25-2, BHC25A, BHC25A-2, BHC25S, BHC30...(Other models you can see in the webshop)		



1

<b>GEV No.</b>	560122	<b>Ref. No.</b>	260511
<b>description</b>	lock washer ID ø 5.2mm ED ø 9mm SS DIN127 Qty 20 pcs for thread M5		
<b>For models:</b>	AC101, AC122, AC151, AC152, AC181, AC182, AC201, AC202, AC241, AC242, AC91, ACS101, ACS101-DIGIT, ACS122, ACS122-DIGIT, ACS151, ACS151-DIGIT, ACS152, ACS152-DIGIT, ACS161-DIGIT, ACS162-DIGIT, ACS181, ACS181-DIGIT, ACS182, ACS182-DIGIT, ACS201, ACS201-DIGIT, ACS202, ACS202-DIGIT, ACS241, ACS241-DIGIT, ACS242, ACS242-DIGIT, ACS91, ACS91-DIGIT, BHC25, BHC25-2, BHC25A, BHC25A-2, BHC25S, BHC30, BHC30-2, BHC30A, BHC30A-2, BHC30E, BHC30E-2, BHC30EA, BHC30EA-2, BHC30HR, BHC30HR-2...(Other models you can see in the webshop)		



1

<b>GEV No.</b>	560123	<b>Ref. No.</b>	260512
<b>description</b>	lock washer ID ø 6.3mm ED ø 11mm SS DIN127 Qty 20 pcs for thread M6		
<b>For models:</b>	AC101, AC122, AC151, AC152, AC181, AC182, AC201, AC202, AC241, AC242, AC91, ACR, ACR145, ACR205, ACR225, ACR245, ACR260, ACR265, ACR305, ACS101, ACS101-DIGIT, ACS122, ACS122-DIGIT, ACS151, ACS151-DIGIT, ACS152, ACS152-DIGIT, ACS161-DIGIT, ACS162-DIGIT, ACS181, ACS181-DIGIT, ACS182, ACS182-DIGIT, ACS201, ACS201-DIGIT, ACS202, ACS202-DIGIT, ACS241, ACS241-DIGIT, ACS242, ACS242-DIGIT, ACS91, ACS91-DIGIT, B10T, B11T, B12T, B13T, B14T, B15T, B15TM...(Other models you can see in the webshop)		



			
1			
<b>GEV No.</b>	510236	<b>Ref. No.</b>	260568
<b>description</b>	plain washer ID ø 21mm ED ø 28mm thickness 1mm SS Qty 1 pcs		
<b>For models:</b>	C1001M, C1301M, LC1200, LC1200RCD, LC412, LC700, LC700RCD, LC900, LC900RCD		

			
1			
<b>GEV No.</b>	560301	<b>Ref. No.</b>	260530
<b>description</b>	plain washer ID ø 7mm ED ø 22mm thickness 2mm SS Qty 1 pcs		
<b>For models:</b>	AC100, AC90, ACS101, ACS101-DIGIT, ACS122, ACS122-DIGIT, ACS151, ACS151-DIGIT, ACS152, ACS152-DIGIT, ACS161-DIGIT, ACS162-DIGIT, ACS181, ACS181-DIGIT, ACS182, ACS182-DIGIT, ACS201, ACS201-DIGIT, ACS202, ACS202-DIGIT, ACS241, ACS241-DIGIT, ACS242, ACS242-DIGIT, ACS91, ACS91-DIGIT, B24, B25, C1001M, C1301M, C140, C155, C155BT, C155E2, C155RCD, C165, C165E2, C165E2BT, C165E2RCD, C166, C166-2, C75, C75BT, C75RCD, C85, C95, C95BT, C95E2, C95RCD, GE50RCD...(Other models you can see in the webshop)		

## fasteners

## slot nuts

			
1			
<b>GEV No.</b>	560286	<b>Ref. No.</b>	441122
<b>description</b>	slot nut W 6mm H 6mm L 25mm		
<b>For models:</b>	AC100, AC101, AC105, AC120, AC122, AC135, AC150, AC151, AC152, AC170, AC181, AC182, AC200, AC201, AC202, AC241, AC242, AC90, AC91, AC95, ACR, ACR145, ACR205, ACR225, ACR245, ACR260, ACR265, ACR305, ACRS145, ACRS205, ACRS225, ACRS245, ACRS260, ACRS265, ACRS305, ACS101, ACS101-DIGIT, ACS122, ACS122-DIGIT, ACS151, ACS151-DIGIT, ACS152, ACS152-DIGIT, ACS161-DIGIT, ACS162-DIGIT, ACS181, ACS181-DIGIT, ACS182, ACS182-DIGIT, ACS201...(Other models you can see in the webshop)		

## clamps

## hose clamps

## DIN 3017 - W2

			
1			
<b>GEV No.</b>	520111	<b>Ref. No.</b>	450102
<b>description</b>	hose clamp ø 10-16mm width 9mm Qty 10 pcs DIN 3017		
<b>For models:</b>	B10T, B11T, B12, B12T, B13T, B14T, B15, B15T, B15TM, B16, B16T, B16TM, B18, B18T, B18TM, B19, B19T, B19TM, B41, BC25, BC25A, BC25HR, BC30, BC30A, BC30HR, BC30HR380, BC30HRA, BHC25, BHC25-2, BHC25A, BHC25A-2, BHC25S, BHC30, BHC30-2, BHC30A, BHC30A-2, BHC30E, BHC30E-2, BHC30EA, BHC30EA-2, BHC30HR, BHC30HR-2, BHC30HR380, BHC30HRA, BHC30HRA-2, BHC30HRA380, BHC433, BHC433-2, BHC433A, BHC433A-2...(Other models you can see in the webshop)		

			
1			
<b>GEV No.</b>	520112	<b>Ref. No.</b>	450103
<b>description</b>	hose clamp ø 12-20mm width 9mm Qty 10 pcs DIN 3017		
<b>For models:</b>	AC2A, B10T, B11T, B12, B12T, B13T, B14T, B15, B15T, B15TM, B16, B16T, B16TM, B18, B18T, B18TM, B19, B19T, B19TM, B20, B20D, B24, B25, B26, B27, B41, B42, BC25, BC25A, BC25HR, BC30, BC30A, BC30HR, BC30HR380, BC30HRA, BHC25, BHC25-2, BHC25A, BHC25A-2, BHC25S, BHC30, BHC30-2, BHC30A, BHC30A-2, BHC30E, BHC30E-2, BHC30EA, BHC30EA-2, BHC30HR, BHC30HR-2...(Other models you can see in the webshop)		

			
1			
<b>GEV No.</b>	520113	<b>Ref. No.</b>	450104
<b>description</b>	hose clamp ø 16-27mm width 9mm Qty 10 pcs DIN 3017		
<b>For models:</b>	AC100, AC101, AC105, AC120, AC122, AC135, AC150, AC151, AC152, AC170, AC181, AC182, AC200, AC201, AC202, AC241, AC242, AC2A, AC90, AC91, AC95, ACL100, ACL150, ACR, ACR145, ACR205, ACR225, ACR245, ACR260, ACR265, ACR305, ACRS145, ACRS205, ACRS225, ACRS245, ACRS260, ACRS265, ACRS305, ACS101, ACS101-DIGIT, ACS122, ACS122-DIGIT, ACS151, ACS151-DIGIT, ACS152, ACS152-DIGIT, ACS161-DIGIT, ACS162-DIGIT, ACS181, ACS181-DIGIT...(Other models you can see in the webshop)		

			
1			
<b>GEV No.</b>	520114	<b>Ref. No.</b>	450114
<b>description</b>	hose clamp ø 20-32mm width 9mm Qty 10 pcs DIN 3017		
<b>For models:</b>	AC122, AC151, AC152, AC182, AC202, AC242, ACL150, ACRS145, ACRS205, ACRS225, ACRS245, ACRS260, ACRS265, ACRS305, ACS122, ACS122-DIGIT, ACS151, ACS151-DIGIT, ACS152, ACS152-DIGIT, ACS161-DIGIT, ACS162-DIGIT, ACS182, ACS182-DIGIT, ACS202, ACS202-DIGIT, ACS242, ACS242-DIGIT, B10, B11, B12, B20, B20D, B23, B24, B25, B26, B27, B31, B32, B41, B42, BHC25, BHC25-2, BHC25A, BHC25A-2, BHC25S, BHC30, BHC30-2, BHC30A...(Other models you can see in the webshop)		

			
1			
<b>GEV No.</b>	520115	<b>Ref. No.</b>	450105
<b>description</b>	hose clamp ø 25-40mm width 9mm Qty 10 pcs DIN 3017		
<b>For models:</b>	AC122, AC152, AC182, AC202, AC242, B20, B20D, B23, B24, B25, B26, B27, BC25, BC25A, BC30, BC30A, BHC25-2, BHC25A-2, BHC30-2, BHC30A-2, BHC30E-2, BHC30EA-2, BHC30HR, BHC30HR-2, BHC30HR380, BHC30HRA, BHC30HRA-2, BHC30HRA380, BHC433-2, BHC433A-2, BHCHR, BR20, BR20A, BR25A, C1000E, C1000ERCD, C1300E, C1300ERCD, F45, F55, F65, F80, F90MA, F90MA, FC, FC3E, FC3EA, FC3M, FC3MA...(Other models you can see in the webshop)		





			
1			
<b>GEV No.</b>	520116	<b>Ref. No.</b>	450106 450107
<b>description</b>	hose clamp ø 32-50mm width 9mm Qty 5 pcs DIN 3017		
<b>For models:</b>	AC101, AC105, AC122, AC135, AC151, AC152, AC91, AC95, ACL100, ACL150, ACRS145, ACRS205, ACRS225, ACRS245, ACRS260, ACRS265, ACRS305, ACS101, ACS101-DIGIT, ACS122, ACS122-DIGIT, ACS151, ACS151-DIGIT, ACS152, ACS152-DIGIT, ACS181, ACS181-DIGIT, ACS182, ACS182-DIGIT, ACS201, ACS201-DIGIT, ACS202, ACS202-DIGIT, ACS241, ACS241-DIGIT, ACS242, ACS242-DIGIT, ACS91, ACS91-DIGIT, B13T, B14T, B15, B15T, B15TM, B16, B16T, B16TM, B18, B18T, B18TM...(Other models you can see in the webshop)		

			
1			
<b>GEV No.</b>	520118	<b>Ref. No.</b>	450109
<b>description</b>	hose clamp ø 50-70mm width 9mm Qty 5 pcs DIN 3017		
<b>For models:</b>	AC100, AC101, AC105, AC120, AC135, AC150, AC170, AC181, AC182, AC200, AC201, AC202, AC241, AC242, AC2A, AC90, AC91, AC95, ACL100, ACL150, ACR, ACR145, ACR205, ACR225, ACR245, ACR260, ACR265, ACR305, ACRS145, ACRS205, ACRS225, ACRS245, ACRS260, ACRS265, ACRS305, ACS101, ACS101-DIGIT, ACS122, ACS122-DIGIT, ACS151, ACS151-DIGIT, ACS152, ACS152-DIGIT, ACS161-DIGIT, ACS162-DIGIT, ACS181, ACS181-DIGIT, ACS182, ACS182-DIGIT, ACS201...(Other models you can see in the webshop)		

			
1			
<b>GEV No.</b>	520119	<b>Ref. No.</b>	450119
<b>description</b>	hose clamp ø 60-80mm width 9mm Qty 5 pcs DIN 3017		
<b>For models:</b>	AC100, AC122, AC135, AC151, AC152, AC181, AC182, AC201, AC202, AC241, AC242, AC2A, AC90, ACR, ACR145, ACR205, ACR225, ACR245, ACR260, ACR265, ACR305, C1000E, C1000ERCD, C1001M, C1300E, C1300ERCD, C1301M, C155, C155BT, C155E2, C155RCD, C165, C165E2, C165E2BT, C165E2RCD, C166, C166-2, C33, C34, C95, C95BT, C95E2, C95RCD, G100L, G101L, G50L, G51L, G60L, G61L, GE100...(Other models you can see in the webshop)		

			
1			
<b>GEV No.</b>	520117	<b>Ref. No.</b>	450135
<b>description</b>	hose clamp stainless steel ø 40-60mm width 9mm Qty 5 pcs DIN 3017		
<b>For models:</b>	AC100, AC101, AC120, AC122, AC150, AC151, AC152, AC170, AC181, AC182, AC200, AC201, AC202, AC241, AC242, AC90, AC91, ACR, ACR145, ACR205, ACR225, ACR245, ACR260, ACR265, ACR305, ACRS205, ACRS245, ACRS260, ACRS265, ACS101, ACS101-DIGIT, ACS122, ACS122-DIGIT, ACS181, ACS181-DIGIT, ACS182, ACS182-DIGIT, ACS91, ACS91-DIGIT, B13T, B14T, B15, B15T, B15TM, B16, B16T, B16TM, B18, B18T, B18TM...(Other models you can see in the webshop)		

<p>double wire clamps</p> 			
1			
<b>GEV No.</b>	511286	<b>Ref. No.</b>	450143
<b>description</b>	hose clamp ø 38mm wire gauge ø 3.2mm Qty 1 pcs		
<b>For models:</b>	AC101, AC105, AC122, AC135, AC151, AC152, AC181, AC182, AC201, AC202, AC241, AC242, AC2A, AC91, AC95, ACL100, ACL150, ACRS145, ACRS205, ACRS225, ACRS245, ACRS260, ACRS265, ACRS305, ACS101, ACS101-DIGIT, ACS122, ACS122-DIGIT, ACS151, ACS151-DIGIT, ACS152, ACS152-DIGIT, ACS161-DIGIT, ACS162-DIGIT, ACS181, ACS181-DIGIT, ACS182, ACS182-DIGIT, ACS201, ACS201-DIGIT, ACS202, ACS202-DIGIT, ACS241, ACS241-DIGIT, ACS242, ACS242-DIGIT, ACS91, ACS91-DIGIT, BC25, BC25A...(Other models you can see in the webshop)		

			
1			
<b>GEV No.</b>	513268	<b>Ref. No.</b>	450134
<b>description</b>	hose clamp ø 8-10mm wire gauge ø 1mm Qty 1 pcs		
<b>For models:</b>	AC101, AC105, AC122, AC135, AC151, AC152, AC181, AC182, AC201, AC202, AC241, AC242, AC91, AC95, BHC25-2, BHC25A-2, BHC30-2, BHC30A-2, BHC30E, BHC30E-2, BHC30EA, BHC30EA-2, BHC433-2, BHC433A-2, C1000E, C1000ERCD, C1001M, C1300E, C1300ERCD, C1301M, C155BT, C155RCD, C165E2BT, C165E2RCD, C75BT, C75RCD, C95BT, C95RCD, FC3E, FC3EA, FC3MA, FC44E, FC44EA, FC4E, FC4EA, FC4EHR, FC4MA, FC53CBT, FC53LBT, FC54CBT...(Other models you can see in the webshop)		

			
1			
<b>GEV No.</b>	510959	<b>Ref. No.</b>	450115
<b>description</b>	hose clamp ø 8mm wire gauge ø 1mm Qty 1 pcs		
<b>For models:</b>	B10T, B11T, B12T, B13T, B14T, B15, B15T, B15TM, B16, B16T, B16TM, B18, B18T, B18TM, B19, B19T, B19TM, B31, B41, B42, BC25, BC25A, BC25HR, BC30, BC30A, BC30HR, BC30HR380, BC30HRA, BHC25, BHC25-2, BHC25A, BHC25A-2, BHC25S, BHC30, BHC30-2, BHC30A, BHC30A-2, BHC30E, BHC30E-2, BHC30EA, BHC30EA-2, BHC30HR, BHC30HR-2, BHC30HR380, BHC30HRA, BHC30HRA-2, BHC30HRA380, BHC433, BHC433-2, BHC433A...(Other models you can see in the webshop)		





1

<b>GEV No.</b>	511147	<b>Ref. No.</b>	450125
<b>description</b>	wire clamp ø 12-14mm wire gauge ø 1.5mm zinc-coated steel Qty 1 pcs		
<b>For models:</b>	AC100, AC120, AC150, AC170, AC200, AC90, ACR, ACR145, ACR205, ACR225, ACR245, ACR260, ACR265, ACR305, ACRS145, ACRS205, ACRS225, ACRS245, ACRS260, ACRS265, ACRS305, ACS101, ACS101-DIGIT, ACS122, ACS122-DIGIT, ACS151, ACS151-DIGIT, ACS152, ACS152-DIGIT, ACS161-DIGIT, ACS162-DIGIT, ACS181, ACS181-DIGIT, ACS182, ACS182-DIGIT, ACS201, ACS201-DIGIT, ACS202, ACS202-DIGIT, ACS241, ACS241-DIGIT, ACS242, ACS242-DIGIT, ACS91, ACS91-DIGIT, B10, B10T, B11, B11T, B12...(Other models you can see in the webshop)		

**miscellaneous**



1

<b>GEV No.</b>	510923	<b>Ref. No.</b>	440817
<b>description</b>	clamping ring for shaft ø 10mm ID ø 9.4mm H 6mm		
<b>For models:</b>	AC100, AC122, AC151, AC152, AC181, AC182, AC201, AC202, AC241, AC242, ACR, ACR145, ACR205, ACR225, ACR245, ACR260, ACR265, ACR305, ACRS145, ACRS205, ACRS225, ACRS245, ACRS260, ACRS265, ACRS305, B10, B10T, B11, B11T, B12, B12T, B13T, B14T, B15, B15T, B15TM, B16, B16T, B16TM, B18, B18T, B18TM, B19, B19T, B19TM, B20, B20D, B24, B25, B26...(Other models you can see in the webshop)		

**retaining rings**

**DIN 471**



1

<b>GEV No.</b>	528689	<b>Ref. No.</b>	440811
<b>description</b>	retaining ring shaft ø 15mm thickness 1mm steel DIN 471		
<b>For models:</b>	NE00, NE02, NE3001, NE3002, NE4001, NE4002, NE5002, NE5501, NE5502, NE7002, NE7501, NE7502, NE9001, NE9002, NE9502, NG02, NG1202, NG1202E, NG602, NG602E, NG902, NG902E		



1

<b>GEV No.</b>	504519	<b>Ref. No.</b>	440802
<b>description</b>	retaining ring shaft ø 17mm thickness 1mm SS DIN 471		
<b>For models:</b>	NE00, NE3001, NE4001, NE5501, NE7501, NE9001, NG00, NG01, NG600, NG600E, NG601, NG601E, NG900, NG900E, NG901, NG901E		



1

<b>GEV No.</b>	693061	<b>Ref. No.</b>	440820
<b>description</b>	retaining ring shaft ø 25mm thickness 1.2mm steel DIN 471		
<b>For models:</b>	GMC, GMC2700, GMC3500, GMC4500, GMC5500		

**DIN 472**



1

<b>GEV No.</b>	525153	<b>Ref. No.</b>	440815
<b>description</b>	retaining ring bore ø 32mm thickness 1.1mm DIN 472		
<b>For models:</b>	NE00, NE02, NE3001, NE3002, NE4001, NE4002, NE5002, NE5501, NE5502, NE7002, NE7501, NE7502, NE9001, NE9002, NE9502, NL302, NL302E, NL402, NL402E, NL502, NL502E, NL552, NL552E		



1

<b>GEV No.</b>	511248	<b>Ref. No.</b>	440816
<b>description</b>	retaining ring bore ø 48mm thickness 1.9mm stainless steel DIN 472		
<b>For models:</b>	G115, G115L, G125L, G131, G50LM, G65, G65L, G66, G75, G75L, GE125, GE75, GL		

**roll pins**



1

<b>GEV No.</b>	694401	<b>Ref. No.</b>	451002
<b>description</b>	roll pin ø 2mm L 12mm stainless steel 1481		
<b>For models:</b>	AC100, AC101, AC105, AC120, AC122, AC135, AC150, AC151, AC152, AC170, AC181, AC182, AC200, AC201, AC202, AC241, AC242, AC90, AC91, AC95, ACL100, ACL150, ACR, ACR145, ACR205, ACR225, ACR245, ACR260, ACR265, ACR305, ACRS145, ACRS205, ACRS225, ACRS245, ACRS260, ACRS265, ACRS305, ACS101, ACS101-DIGIT, ACS122, ACS122-DIGIT, ACS151, ACS151-DIGIT, ACS152, ACS152-DIGIT, ACS161-DIGIT, ACS162-DIGIT, ACS181, ACS181-DIGIT, ACS182...(Other models you can see in the webshop)		



1

<b>GEV No.</b>	560533	<b>Ref. No.</b>	451123
<b>description</b>	roll pin ø 4mm L 16mm SS		
<b>For models:</b>	AC101, AC105, AC122, AC135, AC151, AC152, AC181, AC182, AC201, AC202, AC241, AC242, AC2A, AC91, AC95, ACL150, ACR, ACR145, ACR205, ACR225, ACR245, ACR260, ACR265, ACR305, ACRS145, ACRS205, ACRS225, ACRS245, ACRS260, ACRS265, ACRS305, ACS101, ACS101-DIGIT, ACS122, ACS122-DIGIT, ACS151, ACS151-DIGIT, ACS152, ACS152-DIGIT, ACS161-DIGIT, ACS162-DIGIT, ACS181, ACS181-DIGIT, ACS182, ACS182-DIGIT, ACS201, ACS201-DIGIT, ACS202, ACS202-DIGIT, ACS241...(Other models you can see in the webshop)		



			
1			
<b>GEV No.</b>	692236	<b>Ref. No.</b>	451118
<b>description</b>	roll pin ø 4mm L 40mm		
<b>For models:</b>	LAV1000, LV1001, LV1501, LV-LVP, LVP1001, LVP1501, NE00, NG00, NG600, NG600E, NG900, NG900E		

screw caps

			
1			
<b>GEV No.</b>	510233	<b>Ref. No.</b>	290105
<b>description</b>	screw cap thread 1/2" thread L 12mm brass WS 27 head thickness 7mm		
<b>For models:</b>	AC101, AC105, AC120, AC122, AC135, AC150, AC151, AC152, AC170, AC181, AC182, AC200, AC201, AC202, AC241, AC242, AC2A, AC90, AC91, AC95, ACL100, ACL150, ACR, ACR145, ACR205, ACR225, ACR245, ACR260, ACR265, ACR305, ACR5145, ACR5205, ACR5225, ACR5245, ACR5260, ACR5265, ACR5305, ACS101, ACS101-DIGIT, ACS122, ACS122-DIGIT, ACS151, ACS151-DIGIT, ACS152, ACS152-DIGIT, ACS161-DIGIT, ACS162-DIGIT, ACS181, ACS181-DIGIT, ACS182... (Other models you can see in the webshop)		

consumables

fuses

fine fuses

			
1			
<b>GEV No.</b>	358667	<b>Ref. No.</b>	130263
<b>description</b>	fine fuse size ø5x20mm 0.4A fast-acting rated 250V Qty 10 pcs		

			
1			
<b>GEV No.</b>	358596	<b>Ref. No.</b>	130273
<b>description</b>	fine fuse size ø5x20mm 0.25A slow-acting rated 250V Qty 10 pcs		
<b>For models:</b>	AC122, AC151, AC152, AC181, AC182, AC201, AC202, AC241, AC242, ACR, ACR145, ACR205, ACR225, ACR245, ACR260, ACR265, ACR305, C155BT, C155RCD, C75BT, C75RCD, C95BT, C95RCD, FC53CBT, FC53LA, FC53LBT, FC54CBT, FC54LBT, GF90, GF90A, GMC, GMC2700, GMC3500, GMC4500, GMC5500, LC1200RCD, LC380BT, LC380RCD, LC700RCD, LC900RCD, LF320CBT, LF320L, LF320LA, LF320LBT, LF400A, LP360BT, LP360RCD		

			
1			
<b>GEV No.</b>	358702	<b>Ref. No.</b>	130262
<b>description</b>	fine fuse size ø5x20mm 0.315A slow-acting rated 250V Qty 10 pcs		

			
1			
<b>GEV No.</b>	358602	<b>Ref. No.</b>	130265
<b>description</b>	fine fuse size ø5x20mm 1.6A slow-acting rated 250V Qty 10 pcs		
<b>For models:</b>	AC122, AC151, AC152, AC181, AC182, AC201, AC202, AC241, AC242, ACR, ACR145, ACR205, ACR225, ACR245, ACR260, ACR265, ACR305, GMC, GMC2700, GMC3500, GMC4500, GMC5500, NE3001, NE4001, NE5501, NE7501, NE9001, NG01, NG601, NG601E, NG901, NG901E		

			
1			
<b>GEV No.</b>	358600	<b>Ref. No.</b>	130264
<b>description</b>	fine fuse size ø5x20mm 1A slow-acting rated 250V Qty 10 pcs		
<b>For models:</b>	AC122, AC151, AC152, AC181, AC182, AC201, AC202, AC241, AC242, ACR, ACR145, ACR205, ACR225, ACR245, ACR260, ACR265, ACR305, BHC30E, BHC30EA, C155BT, C155RCD, C75BT, C75RCD, C95BT, C95RCD, FC53CBT, FC53LA, FC53LBT, FC54CBT, FC54E, FC54EA, FC54LBT, GF90, GF90A, GMC, GMC2700, GMC3500, GMC4500, GMC5500, LC1200RCD, LC380BT, LC380RCD, LC700RCD, LC900RCD, LF320CBT, LF320L, LF320LA, LF320LBT, LF400A, LP360BT... (Other models you can see in the webshop)		

			
1			
<b>GEV No.</b>	358603	<b>Ref. No.</b>	130270
<b>description</b>	fine fuse size ø5x20mm 2A slow-acting rated 250V Qty 10 pcs		
<b>For models:</b>	C155BT, C155RCD, C75BT, C75RCD, C95BT, C95RCD, FC53CBT, FC53LA, FC53LBT, FC54CBT, FC54LBT, GF90, GF90A, LC1200RCD, LC380BT, LC380RCD, LC700RCD, LC900RCD, LF320CBT, LF320L, LF320LA, LF320LBT, LF400A, LP360BT, LP360RCD		

			
1			
<b>GEV No.</b>	358606	<b>Ref. No.</b>	130266
<b>description</b>	fine fuse size ø5x20mm 4A slow-acting rated 250V Qty 10 pcs		

			
1			
<b>GEV No.</b>	358609	<b>Ref. No.</b>	130274
<b>description</b>	fine fuse size ø5x20mm 5A slow-acting rated 250V Qty 10 pcs		
<b>For models:</b>	C155BT, C155RCD, C75BT, C75RCD, C95BT, C95RCD, FC53CBT, FC53LA, FC53LBT, FC54CBT, FC54LBT, GF90, GF90A, LC1200RCD, LC380BT, LC380RCD, LC700RCD, LC900RCD, LF320CBT, LF320L, LF320LA, LF320LBT, LF400A, LP360BT, LP360RCD		

			
1			
<b>GEV No.</b>	358607	<b>Ref. No.</b>	130275
<b>description</b>	fine fuse size ø5x20mm 6.3A slow-acting rated 250V Qty 10 pcs		
<b>For models:</b>	AC122, AC151, AC152, AC181, AC182, AC201, AC202, AC241, AC242, ACR, ACR145, ACR205, ACR225, ACR245, ACR260, ACR265, ACR305, C155BT, C155RCD, C75BT, C75RCD, C95BT, C95RCD, FC53CBT, FC53LA, FC53LBT, FC54CBT, FC54LBT, GF90, GF90A, GMC, GMC2700, GMC3500, GMC4500, GMC5500, LC1200RCD, LC380BT, LC380RCD, LC700RCD, LC900RCD, LF320CBT, LF320L, LF320LA, LF320LBT, LF400A, LP360BT, LP360RCD		

<b>ø10x38mm 400V</b>			
			
1			
<b>GEV No.</b>	358041	<b>Ref. No.</b>	130236
<b>description</b>	fine fuse size ø10x38mm 20A slow-acting rated 400V type aM Qty 1 pcs		
<b>For models:</b>	AC100, AC101, AC120, AC122, AC150, AC151, AC152, AC170, AC181, AC182, AC200, AC201, AC202, AC241, AC242, AC91, ACR, ACR145, ACR205, ACR225, ACR245, ACR260, ACR265, ACR305, ACR5145, ACR5205, ACR5225, ACR5245, ACR5260, ACR5265, ACR5305, ACS101, ACS101-DIGIT, ACS122, ACS122-DIGIT, ACS151, ACS151-DIGIT, ACS152, ACS152-DIGIT, ACS161-DIGIT, ACS162-DIGIT, ACS181, ACS181-DIGIT, ACS182, ACS182-DIGIT, ACS201, ACS201-DIGIT, ACS202, ACS202-DIGIT, ACS241...(Other models you can see in the webshop)		

<b>ø10x38mm 500V</b>			
			
Image not available			
1			
<b>GEV No.</b>	358196	<b>Ref. No.</b>	130246
<b>description</b>	fine fuse size ø10x38mm 12A rated 500V type Gg fast-acting Qty 1 pcs		

			
1			
<b>GEV No.</b>	358027	<b>Ref. No.</b>	130247
<b>description</b>	fine fuse size ø10x38mm 16A rated 500V type Gg fast-acting Qty 1 pcs		
<b>For models:</b>	AC100, AC105, AC120, AC150, AC170, AC200, AC90, AC95, ACR, ACR145, ACR205, ACR225, ACR245, ACR260, ACR265, ACR305, ACR5145, ACR5205, ACR5225, ACR5245, ACR5260, ACR5265, ACR5305, G66, GMC, GMC2700, GMC2702, GMC3500, GMC3502, GMC4500, GMC4502, GMC5500, GMC5502, NE00, NE3001, NE4001, NE5501, NE7501, NE9001, SE, SNL		

			
1			
<b>GEV No.</b>	358028	<b>Ref. No.</b>	130248
<b>description</b>	fine fuse size ø10x38mm 20A rated 500V type Gg fast-acting Qty 1 pcs		
<b>For models:</b>	AC101, AC120, AC122, AC150, AC151, AC152, AC170, AC181, AC182, AC200, AC201, AC202, AC241, AC242, AC91, ACR, ACR145, ACR205, ACR225, ACR245, ACR260, ACR265, ACR305, ACR5145, ACR5205, ACR5225, ACR5245, ACR5260, ACR5265, ACR5305, ACS101, ACS101-DIGIT, ACS122, ACS122-DIGIT, ACS151, ACS151-DIGIT, ACS152, ACS152-DIGIT, ACS161-DIGIT, ACS162-DIGIT, ACS181, ACS181-DIGIT, ACS182, ACS182-DIGIT, ACS201, ACS201-DIGIT, ACS202, ACS202-DIGIT, ACS241, ACS241-DIGIT...(Other models you can see in the webshop)		

			
1			
<b>GEV No.</b>	358032	<b>Ref. No.</b>	130253
<b>description</b>	fine fuse size ø10x38mm 25A rated 500V type Gg fast-acting Qty 1 pcs		
<b>For models:</b>	G115		

			
1			
<b>GEV No.</b>	358021	<b>Ref. No.</b>	130260
<b>description</b>	fine fuse size ø10x38mm 2A rated 500V type gl fast-acting Qty 1 pcs		

			
1			
<b>GEV No.</b>	358024	<b>Ref. No.</b>	130245
<b>description</b>	fine fuse size ø10x38mm 8A rated 500V type gl fast-acting Qty 1 pcs		
<b>For models:</b>	AC120, AC150, AC170, AC200, ACR, ACR145, ACR205, ACR225, ACR245, ACR260, ACR265, ACR305, ACR5145, ACR5205, ACR5225, ACR5245, ACR5260, ACR5265, ACR5305, G100L, G101L, G115L, G125L, G50L, G50LM, G51L, G60L, G61L, G65, G65L, G75, G75L, GL, GMC, GMC2700, GMC2702, GMC3500, GMC3502, GMC4500, GMC4502, GMC5500, GMC5502		

			
1			
<b>GEV No.</b>	358039	<b>Ref. No.</b>	130234
<b>description</b>	fine fuse size ø10x38mm 12A slow-acting rated 500V type aM Qty 1 pcs		
<b>For models:</b>	AC101, AC120, AC122, AC150, AC151, AC152, AC170, AC181, AC182, AC200, AC201, AC202, AC241, AC242, AC90, AC91, ACR, ACR145, ACR205, ACR225, ACR245, ACR260, ACR265, ACR305, ACS101, ACS101-DIGIT, ACS122, ACS122-DIGIT, ACS151, ACS151-DIGIT, ACS152, ACS152-DIGIT, ACS161-DIGIT, ACS162-DIGIT, ACS181, ACS181-DIGIT, ACS182, ACS182-DIGIT, ACS201, ACS201-DIGIT, ACS202, ACS202-DIGIT, ACS241, ACS241-DIGIT, ACS242, ACS242-DIGIT, ACS91, ACS91-DIGIT, G131, G66...(Other models you can see in the webshop)		





			
1			
<b>GEV No.</b>	358040	<b>Ref. No.</b>	130235
<b>description</b>	fine fuse size $\varnothing$ 10x38mm 16A slow-acting rated 500V type aM Qty 1 pcs		
<b>For models:</b>	AC120, AC150, AC170, AC200, ACR, ACR145, ACR205, ACR225, ACR245, ACR260, ACR265, ACR305, G66, GMC, GMC2700, GMC3500, GMC4500, GMC5500, LAV1000, NE3001, NE4001, NE5501, NE7501, NE9001		

			
1			
<b>GEV No.</b>	358036	<b>Ref. No.</b>	130231
<b>description</b>	fine fuse size $\varnothing$ 10x38mm 6A slow-acting rated 500V type aM Qty 1 pcs		
<b>For models:</b>	AC100, AC101, AC120, AC122, AC150, AC151, AC152, AC170, AC181, AC182, AC200, AC201, AC202, AC241, AC242, AC90, AC91, ACR, ACR145, ACR205, ACR225, ACR245, ACR260, ACR265, ACR305, ACS101, ACS101-DIGIT, ACS122, ACS122-DIGIT, ACS151, ACS151-DIGIT, ACS152, ACS152-DIGIT, ACS161-DIGIT, ACS162-DIGIT, ACS181, ACS181-DIGIT, ACS182, ACS182-DIGIT, ACS201, ACS201-DIGIT, ACS202, ACS202-DIGIT, ACS241, ACS241-DIGIT, ACS242, ACS242-DIGIT, ACS91, ACS91-DIGIT, GMC...(Other models you can see in the webshop)		

			
1			
<b>GEV No.</b>	358033	<b>Ref. No.</b>	130259
<b>description</b>	fine fuse size $\varnothing$ 10x38mm 1A slow-acting rated 500V type aM Qty 1 pcs		
<b>For models:</b>	AC101, AC105, AC122, AC151, AC152, AC181, AC182, AC201, AC202, AC241, AC242, AC91, AC95, ACS101, ACS101-DIGIT, ACS122, ACS122-DIGIT, ACS151, ACS151-DIGIT, ACS152, ACS152-DIGIT, ACS161-DIGIT, ACS162-DIGIT, ACS181, ACS181-DIGIT, ACS182, ACS182-DIGIT, ACS201, ACS201-DIGIT, ACS202, ACS202-DIGIT, ACS241, ACS241-DIGIT, ACS242, ACS242-DIGIT, ACS91, ACS91-DIGIT, G100L, G101L, G115, G115L, G125L, G50L, G50LM, G51L, G60L, G61L, G65, G65L, G75...(Other models you can see in the webshop)		

			
1			
<b>GEV No.</b>	358037	<b>Ref. No.</b>	130232
<b>description</b>	fine fuse size $\varnothing$ 10x38mm 8A slow-acting rated 500V type aM Qty 1 pcs		
<b>For models:</b>	AC100, AC101, AC120, AC122, AC150, AC151, AC152, AC170, AC181, AC182, AC200, AC201, AC202, AC241, AC242, AC90, AC91, ACR, ACR145, ACR205, ACR225, ACR245, ACR260, ACR265, ACR305, ACS101, ACS101-DIGIT, ACS122, ACS122-DIGIT, ACS151, ACS151-DIGIT, ACS152, ACS152-DIGIT, ACS161-DIGIT, ACS162-DIGIT, ACS181, ACS181-DIGIT, ACS182, ACS182-DIGIT, ACS201, ACS201-DIGIT, ACS202, ACS202-DIGIT, ACS241, ACS241-DIGIT, ACS242, ACS242-DIGIT, ACS91, ACS91-DIGIT, GMC...(Other models you can see in the webshop)		

			
1			
<b>GEV No.</b>	358034	<b>Ref. No.</b>	130260
<b>description</b>	fine fuse size $\varnothing$ 10x38mm 2A slow-acting rated 500V type aM Qty 1 pcs		
<b>For models:</b>	AC101, AC122, AC151, AC152, AC181, AC182, AC201, AC202, AC241, AC242, AC91, ACS101, ACS101-DIGIT, ACS122, ACS122-DIGIT, ACS151, ACS151-DIGIT, ACS152, ACS152-DIGIT, ACS161-DIGIT, ACS162-DIGIT, ACS181, ACS181-DIGIT, ACS182, ACS182-DIGIT, ACS201, ACS201-DIGIT, ACS202, ACS202-DIGIT, ACS241, ACS241-DIGIT, ACS242, ACS242-DIGIT, ACS91, ACS91-DIGIT, G100L, G101L, G115, G115L, G125L, G50L, G50LM, G51L, G60L, G61L, G65, G65L, G75, G75L, GE100...(Other models you can see in the webshop)		

			
1			
<b>GEV No.</b>	358035	<b>Ref. No.</b>	130230
<b>description</b>	fine fuse size $\varnothing$ 10x38mm 4A slow-acting rated 500V type aM Qty 1 pcs		
<b>For models:</b>	AC100, AC101, AC105, AC120, AC122, AC150, AC151, AC152, AC170, AC181, AC182, AC200, AC201, AC202, AC241, AC242, AC90, AC91, AC95, ACR, ACR145, ACR205, ACR225, ACR245, ACR260, ACR265, ACR305, ACS101, ACS101-DIGIT, ACS122, ACS122-DIGIT, ACS151, ACS151-DIGIT, ACS152, ACS152-DIGIT, ACS161-DIGIT, ACS162-DIGIT, ACS181, ACS181-DIGIT, ACS182, ACS182-DIGIT, ACS201, ACS201-DIGIT, ACS202, ACS202-DIGIT, ACS241, ACS241-DIGIT, ACS242, ACS242-DIGIT, ACS91...(Other models you can see in the webshop)		





<b>A</b>		
alarm devices	36	
<b>B</b>		
bi-metal thermostats	10, 10	
booster pumps I	78	
booster pumps II	79	
<b>C</b>		
cables	84	
cap nuts	210	
castors and bumper angles	167	
clamps	204, 214	
coil heating elements	3	
condensators & interference suppression filters	80	
consumables	217	
contactors	36	
container filters	190	
control equipment	25	
control thermostats	11	
cylinder head bolts	209	
<b>D</b>		
digital timers	36	
door seals for dishwashers	180	
dosing pumps	186	
double nipples	201	
double wire clamps	205, 215	
drain hoses	191	
drain pumps	78	
<b>E</b>		
electric accessories	84	
electrodes	60	
electronic controllers	42	
end caps and plugs	167	
<b>F</b>		
fasteners	214	
fastening material	206	
filters	81	
fine fuses	217	
fittings	201	
flat-headed bolts	207	
float switches	21	
foam rubber gaskets	179	
foil heating elements	10	
formed hoses	193	
fuses	81, 217	
<b>G</b>		
gaskets for wash arm support	183	
grub screws		209
<b>H</b>		
heating elements		3
heating elements for pasta cookers		3
hexagonal nuts		210
hexagonal screws		208
hose clamps		204, 214
hose connectors		200, 201
hoses		191
hoses wire reinforced		193
<b>I</b>		
immersion heating elements		3
indicator lights		26
indicator lights (complete)		28
industrial hoses		192
intake lances		190
<b>K</b>		
knurled nuts		210
knurled screws		210
<b>L</b>		
lamps		26
<b>M</b>		
magnetic switches		23
measuring equipment		206
microswitches		17
motors		61
<b>N</b>		
neon light bulbs		27, 30
Niplaflex hoses		192
non-return valves		204
nuts		210
<b>O</b>		
operating capacitors		80
O-rings		169
oval head screws		207
<b>P</b>		
plunger sockets		13
position switches		18
pressure control hoses		192
pressure reduction valves		203, 203
pressure switches		58
probes		43
programme timers		30
pump hoses		190
pumps		61

push/momentary push switches	16
PVC hoses	192
<b>R</b>	
relays	39
retaining rings	216
ribbon cables	84
rocker/momentary rocker switches	14
roll pins	216
rotary switches	21
<b>S</b>	
safety thermostats	11, 12
screw caps	217
screws	206
sealing washers	175
shaft gaskets	179
sheet metal screws	206
side bolts	209
silicone hoses	190, 193
slot nuts	214
snap locks	165
solenoid valves	48
spring rings	212
stainless steel flexi hoses	191
supply filters	204, 204
supply hoses	191
switches and momentary switches	14
system switches (ROLD)	19
<b>T</b>	
tank inlets	190
terminals	84
thermostat gaskets	183
thermostats	10
time relays	41
timers	30
toggle switches	17
touch sensitive light switches	23
transformers	41
<b>U</b>	
universal hoses	191
<b>W</b>	
wash and rinse pumps	61
washers	213
water cycle components	203