



GAS COMPONENTS



ELECTRIC COMPONENTS



WATER TECHNOLOGY



MECHANICAL COMPONENTS



TOOLS

Spare parts suitable for

COFFEEQUEEN

Find the complete and up-to-date range of products in our GEV Webshop



Manufacturer catalogue

The most important spare parts and accessories arranged clearly for every manufacturer

- ✓ Complete product range and all appliance data always up to date in the GEV Webshop
- ✓ Alphabetical Index at the end of the catalogue

GEV Webshop

www.gev-online.co.uk

www.gev-online.com



- 🔍 Add to Favourites
- 🔍 Sign In with email address and usual password
- 🔍 Easy-order – place several items in your basket at the same time
- 🔍 Quick Item search – no login needed



heating elements

heating elements for coffee machine



1

GEV No.	417491	Ref. No.	160102
description	heating element 180W 230V heating circuits 2 ED ø 100mm connection plug-in connection tube ø 6.5mm cable length 150mm		



1

GEV No.	417493	Ref. No.	160104
description	heating element 2000W 230V heating circuits 1 L 215mm W 50mm H 30mm mounting distance 50mm tube ø 8.5mm thread M14x1.5 windings 3 stainless steel connection M4 2 hole fixing immersion heater		



1

GEV No.	417492	Ref. No.	160106
description	heating element 2000W 230V L 160mm W 120mm L1 40mm L2 120mm W1 50mm W2 34mm thread M10x1 mounting distance 24mm tube ø 6.5mm connection male faston 6.3mm heating circuits 1 immersion heater 2 hole fixing		





1

GEV No.	417503	Ref. No.	1601311
description	heating element 2200W 230V heating circuits 1 ø 56mm H 240mm W1 34mm H1 175mm H2 65mm mounting distance 28mm thread M10x1.5 windings 7 tube ø 6.5mm connection male faston 6.3mm suitable for COFFEE QUEEN		









1

GEV No.	417514	Ref. No.	160092 160092-01
description	heating element 2500W 230V ø 160mm L 170mm L1 10mm H 20mm thread M10x1 mounting distance 30mm		
spare parts for	417514		
	GEV No.	519125	Ref. No. —
	flat gasket FIBER ED ø 18mm ID ø 10mm thickness 1.5mm Qty 1 pcs equiv. no. 903400		
	GEV No.	520231	Ref. No. —
	nut thread M10x1 H 6mm WS 14 zinc-coated steel Qty 1 pcs		



1

GEV No.	417443	Ref. No.	160110
description	heating element 3000W 230V heating circuits 1 L 280mm W 50mm H 30mm mounting distance 50mm tube ø 8.5mm thread M14x1.5 windings 3 stainless steel connection M4 2 hole fixing immersion heater		
accessories for	417443		
	GEV No.	510417	Ref. No. —
	flat gasket fibre ED ø 20mm ID ø 14mm thickness 2mm Qty 1 pcs		
	GEV No.	520228	Ref. No. —
	tooth lock washer ID ø 15.3mm ED ø 24mm steel Qty 1 pcs for thread M14		
	GEV No.	520230	Ref. No. —
	nut thread M14x1.5 H 5mm WS 19 zinc-coated steel Qty 1 pcs		
	GEV No.	521101	Ref. No. —
	nut thread M14x1.5 H 5mm WS 19 SS Qty 1 pcs		
	GEV No.	550262	Ref. No. —
	flat gasket copper ED ø 20mm ID ø 14mm thickness 2mm		



1

GEV No.	417502	Ref. No.	1601312
description	heating element 3000W 230V heating circuits 1 L 600mm W 50mm H 35mm mounting distance 50mm tube ø 8mm thread M14x1.5 windings 3 connection M4 2 hole fixing suitable for COFFEE QUEEN		



1

GEV No.	417444	Ref. No.	160101
description	heating element 95W 230V heating circuits 1 ED ø 100mm connection plug-in connection tube ø 6.4mm cable length 200mm dry heating element		



1

GEV No.	417483	Ref. No.	120811
description	hot plate 95W 230V heating circuits 1 L 160mm W 150mm H 15mm connection plug connection cable length 200mm suitable for COFFEE QUEEN		



1

GEV No.	525458	Ref. No.	130300 130300-02
description	hot plate ø 168mm H 13mm black metal		

flow heaters



1

GEV No.	417480	Ref. No.	120501 120501-02 1205101
description	flow heater 2200W 230V ø 68mm L 104mm Wmm connection male faston 6.3mm suitable for COFFEE QUEEN		

thermostats

bi-metal thermostats

sets



1

GEV No.	390725	Ref. No.	160212-03
description	bi-metal safety thermostat NC 1+1-pole connection male faston 6.3mm vertical mounting ø 16mm set		

control and safety thermostats



EGO

control thermostats

55.13_ series



1

GEV No.	375007	Ref. No.	160214	
description	thermostat t.max. 110°C temperature range 30-110°C 1-pole 1NO 16A probe ø 6mm probe L 113mm capillary pipe 870mm capillary pipe isolatedmm gland nut M9x1 shaft L 25mm shaft position upper rotation 270°			
accessories for	375007			
	GEV No.	110119	Ref. No.	—
	knob thermostat t.max. 110°C ø 50mm shaft ø 6x4.6mm shaft flat upper black temperature range 30-110°C rotation 270°			
	GEV No.	110241	Ref. No.	—
	knob thermostat t.max. 110°C ø 50mm shaft ø 6x4.6mm shaft flat upper black temperature range 30-110°C			

55.34_ series



1

GEV No.	375143	Ref. No.	160215
description	thermostat t.max. 110°C temperature range 32-110°C 3-pole 3NO 16A probe ø 6mm probe L 138mm capillary pipe 1480mm capillary pipe isolated 1100mm gland nut M9x1 shaft ø 6x4.6mm shaft L 23mm shaft position upper rotation 270°		



safety thermostats

55.13_series



GEV No.	375910	Ref. No.	220220
description	safety thermostat switch-off temp. 115°C 1-pole 1NC 16A probe ø 6mm probe L 78mm capillary pipe 350mm capillary pipe isolatedmm gland nut M9x1 probe probe material SS		

switches and momentary switches

rocker/momentary rocker switches

30x11mm



GEV No.	301014	Ref. No.	160819-02 160819-03
description	momentary rocker switch mounting measurements 30x11mm black 1NO 250V 16A connection male faston 6.3mm ambient temperature max. 85/125°C protection IP40 mounting ømm male faston 6.3mm		

30x22mm



GEV No.	345512	Ref. No.	160801-03 160801-04
description	rocker switch mounting measurements 30x22mm orange 2NO 400V 16A illuminated 0-I connection male faston 6.3mm ambient temperature max. 85/125°C protection IP40		



GEV No.	346840	Ref. No.	160809-03
description	rocker switch mounting measurements 30x22mm red/black 2NO 230V 16A connection male faston 6.3mm ambient temperature max. 85°C protection IP40		



GEV No.	347412	Ref. No.	160802-04
description	rocker switch mounting measurements 30x22mm orange/orange 1NO/NO 250V 16A illuminated 0-I/0-II connection male faston 6.3mm ambient temperature max. 125/55°C protection IP40		
accessories for	347412		
	GEV No.	301036	Ref. No.
	protective cover internal size 30x22mm for rocker switch mounting measurementsmm		



GEV No.	347413	Ref. No.	160805-04
description	momentary rocker switch mounting measurements 30x22mm orange/black 1NO/indicator light 230V 16A coffee/water connection male faston 6.3mm ambient temperature max. 85°C protection IP40		

microswitches

lever actuated



GEV No.	347456	Ref. No.	160823
description	microswitch with lever 250V 16A 1CO connection male faston 6.3mm ambient temperature max. 85°C lever length 58mm		

pin-plunger actuated



GEV No.	347411	Ref. No.	160821
description	microswitch with plunger 250V 16A 1CO connection male faston 6.3mm L1 29.6mm ambient temperature max. 125°C mounting distance 22mm type V15T16-CZ100 actuating force: 46g grey		

miscellaneous



GEV No.	347432	Ref. No.	160817
description	microswitch front fixing 250V 16A 1CO connection male faston 6.3mm ambient temperature max. 85°C thread M12x0.8		



float switches

			
1			
GEV No.	347415	Ref. No.	120613
description	float switch thread 1/8" 1NC ø 28mm L 43mm mounting ø 1/8"mm 100V 0.5A cable cable length 350mm		

magnetic switches

miscellaneous



			
1			
GEV No.	347419	Ref. No.	160217
description	magnetic switch 100V 0.1A NO connection screw 10W mounting measurements 12x48mm mounting distance 40mm set voltage DC nominal 0.1A		

lamps

indicator lights

indicator lights (complete)

30x22mm

			
1			
GEV No.	359157	Ref. No.	160818-02
description	indicator light mounting measurements 30x22mm 230V green connection male faston 6.3mm temp.-resist. 125/55°C type RL2		
accessories for	359157		
	GEV No.	301036	Ref. No. —
	protective cover internal size 30x22mm for rocker switch mounting measurementsmm		

			
1			
GEV No.	357022	Ref. No.	160804-03 160804-04
description	indicator light mounting measurements 30x22mm 250V yellow connection male faston 6.3mm coffee		

			
1			
GEV No.	301138	Ref. No.	160839
description	indicator light mounting measurements 30x22mm 230V red/green connection male faston 6.3mm temp.-resist. 125/55°C type RL2		

contactors

ALLEN BRADLEY

power contactors

			
1			
GEV No.	380930	Ref. No.	160225
description	power contactor resistive load 20A 230VAC (AC3/400V) 5.3A/2.2kW main contacts 3NO auxiliary contacts 1NO connection screw connection type 100-K05*10		

			
1			
GEV No.	380931	Ref. No.	160222-01 1602221
description	power contactor resistive load 32A 230VAC (AC3/400V) 23A/11kW main contacts 3NO auxiliary contacts 1NO connection screw connection type 100-C23KF10		

			
1			
GEV No.	380523	Ref. No.	160223-02 1602231
description	power contactor resistive load 32A 230VAC (AC3/400V) 9A/4kW main contacts 3NO auxiliary contacts 1NO connection screw connection type 100-C09KF10		



relays

power relays

with male contacts

bullet connectors, 11 contacts



1

GEV No.	380132	Ref. No.	160207
description	power relays Italiana Relè 230VAC 10A 3CO connection plug-in connection round 11-pole manif. no. C43-230AC ZVE11 250V 11-pole		
accessories for	380132		
	GEV No.	380136	Ref. No.
			—
	relay socket 11-pole connection plug-in connection round 11-pole dimensions 65x28x40mm 250V voltage AC 10A Italiana Relè manif. no. ZVE11		

female contact 4.8mm



1

GEV No.	380475	Ref. No.	160245 160245-01
description	power relays FINDER 220-240VAC 12A 2CO connection F4.8 raster size 10mm plug-in connection manif. no. 56.32.8.230.0040 250V 2-pole connection 4.8mm		
accessories for	380475		
	GEV No.	380476	Ref. No.
			160246 160246-01
	relay socket dimensions 78x27x33.5mm 250V voltage AC 10A FINDER manif. no. 96.72		

relay sockets



1

GEV No.	380476	Ref. No.	160246 160246-01
description	relay socket dimensions 78x27x33.5mm 250V voltage AC 10A FINDER manif. no. 96.72		
accessories for	380476		
	GEV No.	380804	Ref. No.
			—
	support bracket		

accessories



1

GEV No.	358833	Ref. No.	160434-01
description	end plate		

time relays

time relays



1

GEV No.	381163	Ref. No.	1602491
description	time relay CROUZET EMER8-88829198 time range 0.1s-20h 12-240V AC/DC 5A mounting measurements DIN railmm 1CO		



1

GEV No.	380692	Ref. No.	1602491
description	time relay CROUZET MER1-88826195 time range 0.1s-10h 24-240VAC/24VDC 5A		



1

GEV No.	380928	Ref. No.	160205
description	time relay Y047-2-230-150S 5A 2CO connection plug-in connection 230V 11-pole voltage AC 70/150s		





			
1	GEV No.	380934	Ref. No.
	description	time relay Y047B-2-230 5A 2CO connection plug-in connection 230V 11-pole voltage AC 400-580s	

			
1	GEV No.	402834	Ref. No.
	description	PCB coffee machine COFFEE QUEEN L 135mm W 48mm 230V with display	

probes

producer-specific probes

probes

			
1	GEV No.	379519	Ref. No.
	description	temperature probe NTC cable silicone probe -40 up to +110°C cable -50 up to +180°C connection male faston thread probe ø10x30mm cable length 0.05m	
accessories for	379519		
	GEV No.	531063	Ref. No.
	description	gasket ø 24mm ID ø 9mm H 19mm mounting ø 20mm silicone	

			
1	GEV No.	402831	Ref. No.
	description	PCB L 135mm W 48mm 230V with display for COFFEE QUEEN	

			
1	GEV No.	402835	Ref. No.
	description	PCB L 135mm W 48mm 230V with display for COFFEE QUEEN	

accessories

miscellaneous

			
1	GEV No.	531063	Ref. No.
	description	gasket ø 24mm ID ø 9mm H 19mm mounting ø 20mm silicone	

electronics

PCBs

			
1	GEV No.	402771	Ref. No.
	description	PCB coffee machine COFFEE QUEEN L 134mm W 48mm 230V with display	

keypads

front foils

			
1	GEV No.	402774	Ref. No.
	description	keypad foil suitable for COFFEE QUEEN L 160mm W 95mm buttons 5	



membrane keypads



1

GEV No.	402839	Ref. No.	1603853
description	membrane keypad buttons 2 suitable for COFFEE QUEEN L 67mm W 40mm		



1

GEV No.	402838	Ref. No.	1603856
description	membrane keypad buttons 6 suitable for COFFEE QUEEN L 330mm W 50mm		



1

GEV No.	402773	Ref. No.	1603854
description	membrane keypad buttons 3 suitable for COFFEE QUEEN L 125mm W 41mm		



1

GEV No.	402862	Ref. No.	1603859
description	membrane keypad buttons 3 suitable for COFFEE QUEEN L 333mm W 52mm		

solenoid valves

solenoid valves (water)

ROBERTSHAW/INVENSYS

medium temperature: 90°C 90°C 60°C
 ambient temperature: 60°C 25°C 60°C
 duty cycle: 40% 100% 100%

solenoid valves with reducers

single



1

GEV No.	370613	Ref. No.	120624-01
description	solenoid valve single straight 230VAC inlet 3/4" outlet 11.5mm input 10l/min output 2.5l/min EATON (INVENSYS) plastic flow regulating valve outlet brown flow regulating valve inlet white		



1

GEV No.	370608	Ref. No.	120620-01
description	solenoid valve single straight 230VAC inlet 3/4" outlet 11.5mm input 9l/min output 0.95l/min EATON (INVENSYS) flow regulating valve outlet stainless steel flow regulating valve inlet blue		



1

GEV No.	370624	Ref. No.	120634
description	solenoid valve single straight 230VAC inlet 3/4" outlet 11.5mm input 9l/min output 5l/min EATON (INVENSYS) plastic flow regulating valve outlet black flow regulating valve inlet blue 6VA		



2-fold



GEV No.	370614	Ref. No.	120625 120625-01
description	solenoid valve double straight 230VAC inlet 3/4" outlet 11.5mm input 9l/min EATON (INVENSYS) plastic flow regulating valve inlet blue output A 0.95l/min output B 2.5l/min flow regulating valve outlet A stainless steel flow regulating valve outlet B brown		



GEV No.	370609	Ref. No.	120621-01
description	solenoid valve double straight 230VAC inlet 3/4" outlet 11.5mm input 9l/min flow regulating valve inlet blue output A 0.95l/min output B 0.95l/min flow regulating valve outlet A stainless steel flow regulating valve outlet B stainless steel		



GEV No.	372214	Ref. No.	120629-01 1206291
description	solenoid valve double straight 230VAC inlet 3/4" outlet 14mm input 9l/min t.max. 90°C EATON (INVENSYS) plastic flow regulating valve inlet light blue output B 2.5l/min flow regulating valve outlet B brown output A with adapter		

3-fold



GEV No.	370612	Ref. No.	120622-01
description	solenoid valve triple straight 230VAC inlet 3/4" outlet 11.5mm input 9l/min EATON (INVENSYS) plastic flow regulating valve inlet blue output A 0.95l/min output B 2.5l/min output C 0.95l/min flow regulating valve outlet A stainless steel flow regulating valve outlet B brown flow regulating valve outlet C stainless steel		

various



GEV No.	371141	Ref. No.	160230 160230-05
description	solenoid valve single angled 240VAC outlet 11.5mm inlet 15mm		

metal

ODE

solenoid valves steam (water)

21A series



GEV No.	370615	Ref. No.	160202-02
description	solenoid valve brass 2-ways 230VAC inlet 1/8" outlet 1/8" connection 1/8" L 40mm DN 3mm slide-on receptacle large -10 up to 140°C ODE coil type BDA membranes FKM (water/steam) p max 10bar 50/60Hz		

31A series



GEV No.	370616	Ref. No.	160201-02
description	solenoid valve brass 3-ways 230VAC connection 1/4" L 40mm DN 2mm slide-on receptacle large -10 up to 140°C ODE coil type BDA membranes FKM (water/steam) p max 10bar straight		

electrodes



GEV No.	402769	Ref. No.	120549-01 120549-02
description	level electrode 4 hole flange total length 90mm probe L 26/60mm insulated probe length 10mm connection M3 ø 3mm suitable for COFFEE QUEEN		



GEV No.	402832	Ref. No.	1205305
description	level electrode thread probe L 30mm ø 3mm thread M3 suitable for COFFEE QUEEN		



1 

GEV No.	402863	Ref. No.	1205301
description	level electrode thread probe L 82mm ø 3mm thread M3 suitable for COFFEE QUEEN		

1 

GEV No.	402837	Ref. No.	1205302
description	level electrode thread total length 55mm probe L 38mm insulated probe lengthmm connection ø 3mm thread M3 suitable for COFFEE QUEEN		

fans

axial fans

ebm-papst

1 

GEV No.	601082 ¹	Ref. No.	160415
description	axial fan L 92mm W 92mm H 25mm 230VAC 50/60Hz 9/11W bearing ball bearing manuf. no. 3956 metal connection male faston 2.8mm ebm-papst fan wheel ø 85mm temp.-resist. 80°C		
accessories for	601082		
	GEV No.	691103	Ref. No. —
	guard ø 90mm mounting distance 83mm for axial fan 92mm		

¹with ball bearings

fuses

fine fuses

1 

GEV No.	358603	Ref. No.	160431 160431-01
description	fine fuse size ø5x20mm 2A slow-acting rated 250V Qty 10 pcs		

fine fuse holders

1 

GEV No.	358832	Ref. No.	160432-01 160432-02
description	fuse holder suitable fuse ø5x20mm 6.3A rated 250V		

line circuit breakers

miscellaneous

1 

GEV No.	380927	Ref. No.	160429-02
description	power contactor nominal 6A 1-pole characteristic B		

electric accessories

plugs - couplings - power sockets

protective contact power sockets

producer-specific power sockets

BONAMAT

1 

GEV No.	551035	Ref. No.	160700
description	power socket with lid max. 16A countries DE 240V H 60mm mounting ø 45mm W 60mm 1 phase L/N/PE		

appliance sockets/plugs

low temperature appliances 70°C

1 

GEV No.	550704	Ref. No.	160570
description	low temperature appliance plug C14 male faston 6.3mm max 10A/250V T70 mounting distance 40mm hole ø 3.5mm thermoplastic		

cables

power supply cables

1 

GEV No.	551116	Ref. No.	160565
description	low temperature appliance supply cable CEE7/7 - C13 3-pole contacts P+N+E 1.5mm ² max. 10A max 250V 1.4m H05VVH T70 2-pole + earthing insulation PVC		

			
1			
GEV No.	550929	Ref. No.	160522 160531
description	low temperature appliance supply cable CEE7/7 3x1.0mm ² 1.8m T70 2-pole + earthing insulation PVC		

terminals

connection terminals with screw/faston connections

			
1			
GEV No.	550411	Ref. No.	160549-01
description	power terminal block 6-pole max. 40A max 450V connection ø6mm ² / F6.3 temp.-resist. 150°C cross section 6mm ²		

			
1			
GEV No.	550977 ¹	Ref. No.	160549
description	power terminal block 6-pole max. 40A max 450V connection ø6mm ² / F6.3 temp.-resist. 150°C cross section 6mm ² with ground lug		

¹with ground lug

connection terminals with faston connections

			
1			
GEV No.	519304	Ref. No.	160351
description	distribution terminal block 3-pole max. 15A max 450V connection male faston 6.3mm temp.-resist. 110°C Qty 1 pcs		

ignition parts

ignition switches

			
1			
GEV No.	301014	Ref. No.	160819-02 160819-03
description	momentary rocker switch mounting measurements 30x11mm black 1NO 250V 16A connection male faston 6.3mm ambient temperature max. 85/125°C protection IP40 mounting ømm male faston 6.3mm		

equipment-specific units for espresso machines

- filter holders
- filter holders standard
- filter holder without spout

			
1			
GEV No.	525977	Ref. No.	N/A
description	filter holder suitable for CREM-EXPOBAR/WEGA/GRIMAC/SANRAMO without outlet mounting ø 83mm outlet 3/8" ID ø 61.5mm wedge height 10mm wedge position horizontal number of wedges 2 lever inclined		

for pour machines

coffee pots

			
1			
GEV No.	960014	Ref. No.	110001 110303
description	coffee pot 1.8l glas suitable for COFFEE QUEEN		

coffee filters

paper filters

basket filters

			
1			
GEV No.	960017	Ref. No.	110102-02
description	paper filter D1 ø 110mm D2 ø 400mm Qty 500 pcs suitable for COFFEE QUEEN		



			
1			
GEV No.	960015	Ref. No.	110110
description	paper filter for coffee makers D1 ø 110mm D2 ø 250mm Qty 1000 pcs		

			
1			
GEV No.	960100	Ref. No.	110100
description	paper filter for coffee makers D1 ø 90mm D2 ø 250mm Qty 1000 pcs		

filter pans

filter pans

COFFEE QUEEN

			
1			
GEV No.	531086	Ref. No.	1102131
description	filter pan int. ø 1 255mm int. ø 2 145mm W 280mm D 340mm H 165mm filter no. 960017		

			
1			
GEV No.	525464	Ref. No.	1102001
description	filter pan plastic ED ø 172mm int. ø 1 152mm int. ø 2 90mm H 100mm filter no. 960105 suitable for COFFEE QUEEN		

			
1			
GEV No.	525465	Ref. No.	110200
description	filter pan plastic ED ø 190mm int. ø 1 173mm int. ø 2 110mm H 90mm filter no. 960105 suitable for COFFEE QUEEN		

			
1			
GEV No.	525463	Ref. No.	1102002
description	filter pan plastic ED ø 194mm int. ø 1 153mm int. ø 2 90mm H 100mm filter no. 960100 suitable for COFFEE QUEEN		

			
1			
GEV No.	525462	Ref. No.	1102016
description	filter pan stainless steel ED ø 193mm int. ø 1 153mm int. ø 2 90mm H 100mm filter no. 960100 suitable for COFFEE QUEEN		

			
1			
GEV No.	531065	Ref. No.	1102011
description	filter pan stainless steel ED ø 193mm int. ø 1 175mm int. ø 2 125mm H 100mm filter no. 960015		

drain taps

drain taps

			
1			
GEV No.	525466	Ref. No.	120203 120203-04
description	outlet tap complete pipe length 50mm thread 1/4" red suitable for COFFEE QUEEN		

			
1			
GEV No.	527557	Ref. No.	120200 120200-02
description	outlet tap complete pipe lengthmm thread 3/4" ET black/chrome suitable for COFFEE QUEEN		

			
1			
GEV No.	531061	Ref. No.	1103363
description	outlet tap tube 6mm pipe lengthmm thread 3/4" black/chrome suitable for COFFEE QUEEN		

			
1			
GEV No.	531088	Ref. No.	120199
description	outlet tap with nut tube ø 10.2mm pipe length 60mm thread M13x1.25 red suitable for COFFEE QUEEN		

			
1			
GEV No.	531062	Ref. No.	1201924
description	outlet tap with nut tube ø 26mm pipe length 33mm thread M15x1 red suitable for COFFEE QUEEN		

components

			
1			
GEV No.	525469	Ref. No.	150111
description	gasket for tap H 21mm ø 20mm suitable for COFFEE QUEEN		

			
1			
GEV No.	525433	Ref. No.	150110
description	gasket for tap H 29mm ø 31mm		

EQUIPMENT-SPECIFIC UNITS COFFEEQUEEN

accessories			
			
1			
GEV No.	531091	Ref. No.	180210-01
description	connecting fitting for outlet tap T1: 1/2" L 50mm suitable for COFFEE QUEEN		

			
1			
GEV No.	531087	Ref. No.	180211 1802120
description	extension for drain tap T1: 3/4" T2: 1/2" L 57mm suitable for COFFEE QUEEN		

drain pipes

			
1			
GEV No.	527558	Ref. No.	180242
description	spout IT 1/4" ET 3/8"		

brew units

brewing units

				
1				
GEV No.	527559	Ref. No.	1801803-04	
description	rotating joint for brewarm suitable for COFFEE QUEEN EVENT			
accessories for	527559			
	GEV No.	527560	Ref. No.	1801805
	slide bearing ID ø 25mm ED ø 30.5mm			
	GEV No.	527561	Ref. No.	1206502
	O-ring EPDM thickness 3mm ID ø 22mm Qty 1 pcs			
	GEV No.	527562	Ref. No.	1801806
	slide bearing ID ø 25mm ED ø 27.2mm			
	GEV No.	527563	Ref. No.	120647-01
	O-ring EPDM thickness 2.4mm ID ø 16.3mm Qty 1 pcs			

			
1			
GEV No.	527562	Ref. No.	1801806
description	slide bearing ID ø 25mm ED ø 27.2mm		



 <p>1</p>			
GEV No.	527560	Ref. No.	1801805
description	slide bearing ID ø 25mm ED ø 30.5mm		

manifolds			
 <p>1</p>			
GEV No.	525485	Ref. No.	1204016
description	manifold ø 35mm plastic suitable for COFFEE QUEEN		



 <p>1</p>			
GEV No.	525459	Ref. No.	120412 120412-01
description	water distributor ø 16mm IT 1/4" suitable for COFFEE QUEEN		

 <p>1</p>			
GEV No.	531067	Ref. No.	1031801
description	water distributor ø 30mm thread M18x1.5 stainless steel suitable for COFFEE QUEEN		

 <p>1</p>			
GEV No.	531089	Ref. No.	120419
description	water distributor thread 3/8" IT 1/4" stainless steel suitable for COFFEE QUEEN		

flow controllers			
 <p>1</p>			
GEV No.	525467	Ref. No.	160192 160192-01
description	flow controller inlet 7/16" outlet 9.6mm suitable for COFFEE QUEEN		

 <p>1</p>			
GEV No.	525468	Ref. No.	160193
description	flow controller inlet 7/16" outlet M10mm suitable for COFFEE QUEEN		

liquid level pipes			
liquid level pipes			
 <p>1</p>			
GEV No.	525487	Ref. No.	120213
description	water level tube ED ø 15.5mm ID ø 11.5mm H 240mm for COFFEE QUEEN		
 <p>1</p>			
GEV No.	525474	Ref. No.	120227
description	water level tube ED ø 15.5mm ID ø 11.5mm H 280mm for COFFEE QUEEN		
 <p>1</p>			
GEV No.	525488	Ref. No.	120215
description	water level tube ED ø 15.5mm ID ø 11.5mm H 316mm for COFFEE QUEEN		

1



GEV No.	531066	Ref. No.	1103459
description	water level tube ED ø 8mm ID ø 6mm H 210mm for container		

1



GEV No.	531092	Ref. No.	1103359
description	water level tube ED ø 8mm ID ø 6mm H 240mm with ball for COFFEE QUEEN		

complete

1



GEV No.	525470	Ref. No.	120218
description	water level tube complete H 220mm thread 1/2" suitable for COFFEE QUEEN		

1



GEV No.	525471	Ref. No.	120210
description	water level tube complete H 270mm thread 1/2" suitable for COFFEE QUEEN		
spare parts for	525471		
	GEV No.	Ref. No.	120213
	water level tube ED ø 15.5mm ID ø 11.5mm H 240mm for COFFEE QUEEN		

1



GEV No.	525472	Ref. No.	120211
description	water level tube complete H 320mm thread 1/2" suitable for COFFEE QUEEN		

1



GEV No.	525473	Ref. No.	120212
description	water level tube complete H 350mm thread 1/2" suitable for COFFEE QUEEN		

accessories

gaskets

1



GEV No.	531090	Ref. No.	150116
description	flat gasket D1 ø 16.8mm D2 ø 10.5mm thickness 3.2mm Qty 1 pcs suitable for COFFEE QUEEN		



 <p>1</p>			
GEV No.	525440	Ref. No.	150101
description	flat gasket EPDM ED ø 15mm ID ø 8mm thickness 4.8mm for water level tube Qty 1 pcs		

miscellaneous

 <p>1</p>			
GEV No.	531060	Ref. No.	1103461
description	cover for water level tube W 45mm H 205mm		

 <p>1</p>			
GEV No.	531093	Ref. No.	1103361
description	cover for water level tube W 45mm H 235mm		

housing and bezels

handles

 <p>1</p>			
GEV No.	528962	Ref. No.	120230
description	handle hinged handle 1 pair		

non-return valves

 <p>1</p>			
GEV No.	525461	Ref. No.	120612-02 1206123
description	non-return valve for hose ø 10.5mm H 14mm plastic		

hoses

 <p>1</p>			
GEV No.	520609	Ref. No.	1505041
description	formed hose ED ø 14mm ID ø 10mm silicone coffee machine parts transparent Qty 1 U-shape		

floats

floats

 <p>1</p>			
GEV No.	525460	Ref. No.	120402
description	float complete L 62mm W 33mm H 54mm plastic		

fittings for catering equipment

dispenser tap

complete

 <p>1</p>			
GEV No.	527557	Ref. No.	120200 120200-02
description	outlet tap complete pipe lengthmm thread 3/4" ET black/chrome suitable for COFFEE QUEEN		

equipment feet and end caps

screw-in feet



1

GEV No.	526001	Ref. No.	120323
description	equipment foot thread M10 thread L 20mm ø 50mm H 42mm Qty 1 pcs		

gaskets

O-rings

EPDM

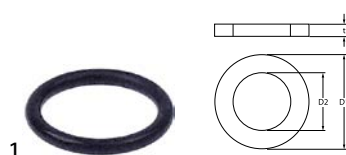

1

GEV No.	527563	Ref. No.	120647-01
description	O-ring EPDM thickness 2.4mm ID ø 16.3mm Qty 1 pcs		



1

GEV No.	527561	Ref. No.	1206502
description	O-ring EPDM thickness 3mm ID ø 22mm Qty 1 pcs		

sealing washers

rubber gaskets



1

GEV No.	525440	Ref. No.	150101
description	flat gasket EPDM ED ø 15mm ID ø 8mm thickness 4.8mm for water level tube Qty 1 pcs		

hoses

formed hoses

form U



1

GEV No.	520609	Ref. No.	1505041
description	formed hose ED ø 14mm ID ø 10mm silicone coffee machine parts transparent Qty 1 U-shape		

tools

cleaning tools

brushes

pipe brushes

nylon



1

GEV No.	801464	Ref. No.	1103360
description	pipe brush nylon ø 10mm total length 300mm brush length 100mm		

consumables

coffee filters

basket filters

paper filters



1

GEV No.	960015	Ref. No.	110110
description	paper filter for coffee makers D1 ø 110mm D2 ø 250mm Qty 1000 pcs		



1

GEV No.	960100	Ref. No.	110100
description	paper filter for coffee makers D1 ø 90mm D2 ø 250mm Qty 1000 pcs		



fuses

fine fuses



1

GEV No.	358603	Ref. No.	160431 160431-01
description	fine fuse size ø5x20mm 2A slow-acting rated 250V Qty 10 pcs		

A			
appliance sockets/plugs	11	probes	8
axial fans	11	protective contact power sockets	11
B		R	
bi-metal thermostats	4	relays	7
brushes	18	rocker/momentary rocker switches	5
C		S	
cables	11	safety thermostats	5
cleaning tools	18	sealing washers	18
coffee filters	18	solenoid valves	9
consumables	18	switches and momentary switches	5
contactors	6	T	
control thermostats	4	terminals	12
E		thermostats	4
electric accessories	11	time relays	7
electrodes	10	tools	18
F			
fans	11		
fine fuses	19		
float switches	6		
flow heaters	4		
formed hoses	18		
fuses	11, 19		
H			
heating elements	3		
heating elements for coffee machine	3		
hoses	18		
I			
ignition switches	12		
indicator lights	6		
indicator lights (complete)	6		
L			
lamps	6		
M			
magnetic switches	6		
microswitches	5		
O			
O-rings	18		
P			
pipe brushes	18		
plugs - couplings - power sockets	11		
power supply cables	11		